

PLUS
25 PAGES OF
HANDS ON ADVICE

Personal Computer World

TECHNOLOGY, TESTED!

www.pcw.co.uk

WILL YOUR
PC RUN
WINDOWS
VISTA? 

HASSLE-FREE SAT NAV

- 10 EASY-TO-USE IN-CAR MODELS
- SAVE TIME: AVOID THE JAMS
- AFFORDABLE: FROM ONLY £179.99



FUTURE BIOS TECHNOLOGY

EFI: THE NEW INTERFACE THAT
WILL REVOLUTIONISE PC DESIGN

LABS MEGA-TESTS

£699 
NOTEBOOKS

The best budget
bargains with Wifi, big
screens and lots more

**COLOUR
LASERS**

Fast printing
for under £300



Profit from Extreme Deals!

SALE
UP TO £200 OFF

MASSIVE SAVINGS

Dell™ recommends Windows® XP Professional.

Technology to take your business forward

Now's a great time to profit from the great Dell March Sale. We've gone to extremes to offer your business fantastic value with massive savings on many systems. Because we only deal direct, we don't have expensive store overheads or inventory. That's why you get high-quality, reliable computers at an amazingly good price. Remember, the UK's number one PC company¹ deals direct so call or go online. But hurry, these extreme deals won't last long!

HDC 2005 Q3 Vendor Ranking



Dell™ Dimension 3100

- Intel® Pentium® 4 Processor 521 with HT Technology (2.80GHz, 1MB L2 Cache, 800MHz FSB)
- Genuine Windows® XP Professional
- 512MB DDR2 RAM
- 160GB Serial ATA Hard Drive (7200 RPM)
- 17" Flat Panel Monitor
- Integrated Intel® Graphic Media Accelerator 900
- 16x DVD+/-RW Drive²
- 1 Year Collect and Return Service
- Exploring the Internet e-Learning Lite Pack Europe

~~£399~~
£349

Save £50

~~£529~~
£470
Incl. VAT, Shipping & handling

E-VALUE Code: PPUK4-D03312

Further enhancements³

- | | | |
|---|-----------|------|
| • 3 Year Basic Services Package | incl. VAT | £98 |
| • Microsoft® Office Small Business Edition 2003 | | £212 |
| • 250GB Serial ATA Hard drive | | £47 |

Dell™ Inspiron 630

- Intel® Centrino® Mobile Technology with Intel® Pentium® M Processor 740 (1.73GHz, 2MB L2 Cache, 533MHz FSB)
- Genuine Windows® XP Home
- 512MB 533MHz DDR2 SDRAM
- 40GB Hard Drive
- 14.1" Wide XGA screen
- Intel® GMA 900 shared graphics memory up to 128MB
- Integrated 24xCD-RW/8xDVD Combo Drive
- 56K Data Fax Modem with up to 1 Meg Wanadoo Broadband from £14.99 a month¹
- Intel® PRO/Wireless 2200 802.11b/g MiniPCI wireless LAN

~~£499~~
£399

Save £100

~~£649~~
£529
Incl. VAT, Shipping & handling

E-VALUE Code: PPUK4-N03631

Further enhancements³

- | | | |
|--|-----------|------|
| • 3 Year Basic Services Package | incl. VAT | £153 |
| • Microsoft® Office Basic Edition 2003 | | £106 |
| • Belkin 6 Socket Surge Protector | | £17 |

ACCESSORIES³

Dell 1907FP Monitor

The Dell UltraSharp™ 1907FP 19" LCD Monitor incorporates many advanced features for great performance and ease of use. Sleek, new design and its improved panel specifications enhance any viewing experience.

£279
Excl. VAT

£328
Incl. VAT



Dell Photo All-in-One Printer 924

Enjoy colour printing, scanning, and photocopying. Produce professional looking documents and print fantastic borderless photos – with or without a PC

£59
Excl. VAT

£70
Incl. VAT



0% Finance Available* Call for Details!



For crazy prices on great systems click www.dell.co.uk/business

Home PCs **0870 353 3017** Business PCs **0870 353 3020**

Re-inventing Value.





Maximise your margins with March savings!



Dell™ Dimension™ 5150

- Intel® Pentium® 4 Processor 630 with HT Technology (3GHz, 2MB L2 Cache, 800MHz FSB)
- Genuine Windows® XP Home Edition
- 1024MB DDR2 RAM
- 160GB Serial ATA Hard Drive (7200 RPM)
- 19" Flat Panel Monitor
- 128MB PCI-Express™ ATI® Radeon™ X300 HyperMemory™
- 16x DVD+/-RW Drive*
- 1 Year Collect and Return Service

~~£569~~
£499
Excl. VAT, Shipping & handling

Save
£70

~~£729~~
£646
Incl. VAT, Shipping & handling

E-VALUE Code: PPUK4-D03512

Further enhancements³ incl. VAT

- 3 Year Basic Services Package £141
- Microsoft® Office Basic Edition 2003 £106
- Logitech® LX700 Cordless Keyboard & Mouse £59

Dell Dimension 9150

- Intel® Pentium® D Processor 930 (3GHz, 2x 2MB L2 Cache, 800MHz FSB)
- Genuine Windows® XP Home Edition
- 1024MB DDR2 RAM
- 320GB (SATA) Stripe Raid 0 Hard Drive
- 19" Flat Panel Monitor
- 256MB nVidia® GeForce™ 7300LE TurboCache™ graphics card
- 16x DVD+/-RW Drive*
- Media Card Reader Flash 13-in-1

~~£799~~
£699
Excl. VAT, Shipping & handling

Save
£100

~~£999~~
£881
Incl. VAT, Shipping & handling

E-VALUE Code: PPUK4-D03912

Further enhancements³ incl. VAT

- 3 Year Standard Service Package £188
- Microsoft® Office Basic Edition 2003 £106
- Kensington® Slim Microsaver Lock £25

Dell Dimension 5150C

- Intel® Pentium® D Processor 820 (2.80GHz, 2x1MB Cache, 800MHz FSB)
- Genuine Windows® XP Professional
- 1024MB DDR2 RAM
- 160GB Serial ATA Hard Drive (7200 RPM)
- 17" Flat Panel Monitor
- Integrated Intel® Extreme Graphics
- 24x DVD-ROM/CD-RW Combo Drive
- 1 Year Collect and Return Service
- Microsoft® Works 7.0

~~£699~~
£599
Excl. VAT, Shipping & handling

Save
£100

~~£881~~
£764
Incl. VAT, Shipping & handling

E-VALUE Code: PPUK4-D0352C

Further enhancements³ incl. VAT

- 3 Year Standard Service Package £188
- Microsoft® Office Basic Edition 2003 £106
- Dell Photo All-in-One Printer 924 £70

HOT DEALS ON THESE AND MORE³

Dell UltraSharp™ 2005FPW 20.1-inch Flat Panel LCD Monitor is a wide aspect desktop display that redefines the performance of LCD display. 300cd/m2 brightness, 600:1 contrast, 16ms response time.

~~£429~~
£344
Excl. VAT.

~~£504~~
£404
Incl. VAT.



20% Off

Dell UltraSharp 30" Widescreen FP -

Display 30" Response time 14ms Brightness 400cd/m2 contrast 700:1 viewing angle 178/178 Native resolution WXGA (2560 x 1600) PC connectivity DVI-D (dual link) x 1 with HDCP others 4-port USB hub, 9-in-1 multimedia card reader slots, height adjustable stand, swivel & tilt

£1249
Excl. VAT

£1468
Incl. VAT



NEW

Dell 5100MP Projector

Dell's new 5100MP projector delivers high-performance features and connectivity, at a great price. Ideal for data and multimedia presentations, the 5100MP projector features an incredible SXGA+ (1400x1050) resolution, 3300* ANSI lumens brightness.

~~£1999~~
£1499
Excl. VAT.

~~£2349~~
£1762
Incl. VAT.



25% Off

Dell Laser Printer 1710

Ideal for home and small offices requiring a fast, durable and cost-effective personal (USB connect) monochrome laser printer. Fast printing (up to 26 A4 pages per minute) is combined with crisp text and enhanced graphics.

From

£115
Excl. VAT.

£135
Incl. VAT



Dell Axim™ X51-416MHz

Intel® XScale® Processor at 416MHz, Microsoft® Windows® Mobile™ 5.0, 128MB Intel® StrataFlash™ ROM, Integrated Bluetooth®, CF and SD expansion slots, USB sync cable.

£189
Excl. VAT.

£223
Incl. VAT.



Dell Colour Laser Printer 3100cn This network colour laser printer is ideal for medium sized workgroups that require affordable, high quality printing or presentations, business documents or spreadsheets.

~~£289~~
£231
Excl. VAT.

~~£339~~
£271
Incl. VAT.



20% Off

0% Finance Available, Call for Details!*



**Dell recommends
Windows® XP Professional.**



Dell™ Inspiron™ 1300

- Intel® Pentium® M Processor 735A (1.70GHz 2MB, L2 Cache 400MHz FSB)
- Genuine Windows® XP Home
- 1024MB 533MHz DDR2 SDRAM
- 80GB Hard Drive
- 15.4" Widescreen WXGA (1280x800)
- Integrated Direct AGP Graphics
- Integrated 8xDVD+/- RW Drive²
- 56K Data Fax Modem with up to 1 Meg Wanadoo Broadband from £14.99 a month¹
- 90 Day Collect and Return Service⁵
- Dell Wireless 1370 802.11b/g MiniPCI Wireless Card

~~£599~~
£499
Excl. VAT, Shipping & handling

Save
£100

~~£764~~
£646
Incl. VAT, Shipping & handling

E-VALUE Code: PPUK4-N03133

Further enhancements³ incl. VAT

- 3 Year Basic Services Package £94
- Microsoft® Office Basic Edition 2003 £106
- Additional 6 Cell High Capacity Lithium-Ion Battery £59

Dell Inspiron 9400

- Intel® Centrino® Mobile Technology with Intel® Core™ Solo Processor T 1300 (1.66GHz, 2MB L2 Cache, 667MHz FSB)
- Genuine Windows® XP Home
- 512MB 677MHz DDR2 SDRAM
- 60GB Serial ATA Hard Drive (5400 RPM)
- 17" Wide Screen XGA (1440x900)
- Intel® GMA 950 shared graphics memory up to 128MB
- 56K Data Fax Modem with up to 1 Meg Wanadoo Broadband from £14.99 a month¹
- 1 Year Euro Collect and Return Service⁴
- Internal 8X DVD+/-RW Drive²
- Intel® PRO/Wireless 2200 802.11b/g MiniPCI wireless LAN card

~~£729~~
£679
Excl. VAT, Shipping & handling

Save
£50

~~£917~~
£858
Incl. VAT, Shipping & handling

E-VALUE Code: PPUK4-N03941

Further enhancements³ incl. VAT

- 3 Year Basic Services Package £199
- Microsoft® Office Small Business Edition 2003 £212
- Dell Leather Carry Case £47

Dell Inspiron 9400

- Intel® Centrino® Mobile Technology with Intel® Core™ Duo Processor T 2400 (1.83GHz, 2MB L2 Cache, 667MHz FSB)
- Genuine Windows® XP Home
- 1024MB 667MHz DDR2 SDRAM
- 80GB Serial ATA Hard Drive (5400 RPM)
- 17" UltraSharp™ WUXGA display with TrueLife™
- 256MB nVidia® GeForce™ Go 7800 Ultra Graphics Card
- 56K Data Fax Modem with up to 1 Meg Wanadoo Broadband from £14.99 a month¹
- 1 Year Euro Collect and Return Service⁴
- Internal 8X DVD+/-RW Drive²
- Intel® PRO/Wireless 2200 802.11b/g MiniPCI wireless LAN card

~~£1149~~
£999
Excl. VAT, Shipping & handling

Save
£150

~~£1410~~
£1234
Incl. VAT, Shipping & handling

E-VALUE Code: PPUK4-N03943

Further enhancements³ incl. VAT

- 3 Year Basic Services Package £199
- Microsoft® Office Small Business Edition 2003 £212
- Kensington® Twin Microsaver Lock £42

**Dell 1100MP Projector + Screen + Speakers³
A complete presentation solution**

The Dell 1100MP projector offers great features with incredible value and allows you to perfectly see data or video on a large screen. This month we offer 20% discount on the projector, a 1500mm Nobo Screen and a speaker set. Get a complete presentation solution for a fantastic price!

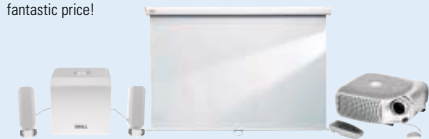

~~£603~~
£482
Excl. VAT.

~~£709~~
£567
Incl. VAT.

20% Off

Dell PC Services

Dimension / Inspiron Recommended Upgrades

3 Year Next Business Day On-Site Service.

Protect against the cost of repairs and get your system up and running faster.

Includes:

- Access to our award winning technical support hotline
- 3 years of parts cover

- If necessary after phone based trouble shooting a next business day visit from an engineer.

System Set Up and Installation

Busy? We can un-box, check and set up your system making sure it is optimally configured. We can even connect it to your network and transfer the data (up to 1GB) from the old machine.

Please ask our Sales Team to advise you.

Dell Products. c/o PO Box 69, Milbanke House, Western Road, Bracknell, Berkshire, RG12 1RD. Terms and Conditions of Sales, Service and Finance apply and are available at www.dell.co.uk or on request. UK Business customers only. Subject to availability, prices and specifications are correct at date of publication and may change without notice. Systems promoted above were advertised at the "was" price/specification (excluding promoted items) listed above on dell.co.uk for a minimum of 28 days ending on 1/03/2006. Since then they may have been subjected to other price and/or specification altering promotions. One GB = 1 billion bytes; actual capacity varies with preloaded material and operating environment and will be less. Dell™ Dimension desktops and Inspiron notebooks include Microsoft Works 7.0 as standard unless otherwise specified. Promotional Offers apply to a maximum order size of 5 systems. Shipping & Handling charge is £49.50 Ex VAT (£60 incl. VAT) per system. Additional charges may apply for credit/debit card holders. ¹BT line needed. Existing line rental required. Fastest download speeds up to 1 Meg, subject to availability, compatibility and survey. 12 month contract. See www.wanadoo.co.uk/terms. ²Discs burned with DVD+/-RW and DVD-RW drives, where featured, may not be compatible with certain existing drives. ³Delivery charge ranges from £3 Excl. VAT (£3.53 Incl. VAT) to £13 Excl. VAT (£15.28 Incl. VAT) per item depending on order size when purchased without a system. ⁴Euro Collect and Return Service is available in limited countries and places. ⁵Dell service offerings do not affect customers' statutory rights. ⁶Processor upgrade offers apply to servers bought before the 15th March. ⁷Based on ANSI/NAPM 117. 228-1997 tests (using new bulbs) of between 34-305 units in 2002-5 (dependent on model). Average Lumens at least 90% of max Lumens. Bulb brightness degrades with use – periodic changes recommended. ©2006 Dell Inc. Dell, the Dell logo, Dimension, Inspiron, PowerEdge, PowerConnect, UltraSharp and Axim, are registered trademarks or trademarks of Dell Inc. Dell disclaims proprietary interest in the trademarks or trade names of other entities used to refer to them or their products. Microsoft, MS and Windows are registered trademarks of Microsoft Corporation. Celeron, Celeron Inside, Centrino, Centrino Logo, Core Inside, Intel, Intel Logo, Intel Core, Intel Inside, Intel Inside Logo, Intel SpeedStep, Intel Viiv, Itanium, Itanium Inside, Pentium, Pentium Inside, Xeon and Xeon Inside are trademarks or registered trademarks of Intel Corporation or its subsidiaries in the United States and other countries. *0% Finance is available from Dell Financial Services (CIT Group (UK) Limited). Credit is available only to UK body corporate and subject to status. All amounts exclude delivery and VAT. Prices shown may vary without notice. Terms and conditions and written quotations are available on request. Credit scoring used. Those not qualifying for 0% may qualify for other finance offers. Documentation fee applies.

Servers

Order before 15th March for free Processor Upgrade.⁶



Dell™ PowerEdge™ SC1420 SATA

- Intel® Xeon® Processor at 3GHz, 2MB L2 Cache, 800MHz FSB (was 2.80GHz, 2MB)
- Dual Processor Support with 800MHz FSB⁶
- 256MB DDR2 SDRAM (Upgradeable to 8GB)
- 80GB 7200rpm SATA hard drive
- Optional CERC SATA RAID Controller
- Embedded Gigabit NIC
- 1 Year Next Business Day Service

WAS ~~£359~~ **SAVE** **£100** **NOW** **£259**
Excl. VAT, Shipping and Handling

E-VALUE Code: PPUK4-SC031421



Dell PowerEdge 2850

- Two Intel® Xeon® Processors at 3GHz, 2MB L2 Cache, 800MHz FSB for the price of single one⁶
- Dual Processor Support with 800MHz FSB (Upgradeable to 12GB)
- 1GB ECC DDR2 (400MHz) SDRAM Memory
- 73GB 10,000rpm 1" U320 SCSI hard drive
- Dual embedded U320 SCSI controller
- Dual Embedded Gigabit NIC
- 3 Year Next Business Day Service

WAS ~~£1119~~ **SAVE** **£200** **NOW** **£919**
Excl. VAT, Shipping and Handling

E-VALUE Code: PPUK4-PE032851

Everything you need to print³



Dell All-in-One Printer 944

Enjoy colour printing, scanning, photocopying and PC-based faxing plus advanced photo features with the new Dell Photo All-in-One Printer 944. Produce professional looking documents and print fantastic borderless photos - with or without a PC.

£93 **£109**
Excl. VAT Incl. VAT



Dell All-in-One Printer 964

Enjoy printing, scanning, standalone faxing and copying plus photo features with the Dell Photo All-in-One Printer 964.

£110 **£129**
£88 **£103**
Excl. VAT Incl. VAT



Dell Workgroup Laser Printer M5200n

Networked Laser Printer for high-quality, high-volume and low-cost black and white printing for workgroups. Print speeds up to 35 ppm and one year of Dell's Next Business Day onsite service included.

£499 **£586**
£349 **£410**
Excl. VAT Incl. VAT

30% Off

20% Off

Dell All-in-One Ink

3 Pack Ink Cartridges. Get 2 high capacity black cartridges and one high capacity colour for your Dell 924/944/964.

From £47 Excl. VAT
From £56 Incl. VAT



Dell Premium Photo Paper



With the Dell™ Premium Photo Paper, you can print high quality photos at home or in the office. Available in A4 (75 sheets) or 4"x6" (100 sheets)

From £9 Excl. VAT
From £11 Incl. VAT

Dell™ Multi-function Laser Printer 1600n

Print, scan, copy, and stand alone fax with the Dell Laser Printer 1600n. Multifunction performance at a single-function laser printer price. Network as standard.

£229 **£269**
£183 **£215**
Excl. VAT Incl. VAT

20% Off



For crazy prices on great systems click www.dell.co.uk/business

Home PCs **0870 353 3017** Business PCs **0870 353 3020**

Re-inventing Value.



Contents



69
HASSLE-FREE SAT NAV
Affordable, easy-to-use in-car devices

REGULARS

- 9 Editorial
- 188 Reader offers
- 191 Competition
- 192 Contact us & PCW on the web
- 193 In the next issue
- 194 Flashback

INTERACTIVE

- 26 Letters
- 30 The Adviser
- 33 Gordon Laing – Inside information
- 34 Barry Fox – Straight talking
- 36 Guy Kewney – Kewney @ large

NEWS

- 14 TV war as access hits 100Mbps/sec
- 15 Phoccam snaps before you shoot
Mac Mini goes Intel
- 16 3GSM reports: first '11n' Wifi gear
- 17 DAB TV starts up
- 20 Web calls increase spitting
- 21 1.6TB net store for homes and offices
- 22 E-paper 'powered by wireless'
- 24 Providers defend email charges

WIN
£250
AMAZON
VOUCHERS

Complete our reader survey for a chance to win. See page 25

REVIEWS

43 Contents

Hardware

- 44 Apple IMac desktop computer
- 45 Elonex Presentia 800 BTX PC
Dell Dimension 5150c Media Center PC
- 46 Asus W3V AMD notebook
Rock Xtreme 64 AMD 64 notebook
- 47 Mesh Titan X1800 Fire Crossfire PC
Acoustic Energy Wifi Radio

Peripherals

- 50 Samsung Pro 815 digital camera
- 51 Eizo Flexscan S2110W 21in TFT
Viewsonic VX922 19in TFT
- 52 Sony VPL-HS50 HD projector
- 53 ATI All-in-Wonder
X1900 graphics card
Logitech Z-5450 5.1 speakers
- 54 Magellan Roadmate 800
sat nav device
Vonage Utstarcom Wifi Phone

GROUP TESTS

- 69 All-in-one sat nav devices**
In-car navigation systems are becoming must-have devices for drivers. We road test some sub-£300 models

- 83 Colour laser printers**
Laser printers are now more affordable than ever. We put eight through their paces and explain the running costs

- 55 Draytel Vigortalk VoIP adapter
- 56 Ipod AV Connection Kit
Logitech Wireless Music System
Hela Perifc mouse; VoIPvoice Uconnect

Components

- 58 EVGA 7800GS CO Superclocked
NEC ND-4551A DVD drive
Enlight EN-7473 Home Media case
Nexus Anti-Vibration Mounting Kit

Software

- 61 Coreldraw X3 graphics suite
- 62 CA Etrust Internet Security Suite
- 63 Netobjects Fusion 9 website tool
- 64 Remote Desktop for Mobiles 2
Apple iLife '06 multimedia suite

Games

- 66 Psychonauts
- 67 Stubbs the Zombie
And then there were none

- 93 £699 notebooks**

As the cost of notebooks has dropped, now you can spend less and get more. We put nine £699 portables to the test



- 104 How we test**



83
COLOUR LASERS
 Fast printing for under £300

➔ For daily news updates, reviews and downloads
www.pcw.co.uk

106
CAN YOU RUN VISTA?
 Find out what hardware you need



COMPETITION

WIN

191 Your chance to win a copy of Symantec Norton Internet Security 2006

FEATURES

106 Will your PC run Vista?

Rumours and scare stories are rife that older PCs won't be able to run Microsoft's new operating system. We put the record straight, with some practical advice on what you'll need

114 Goodbye Bios, Hello EFI

The Bios has finally bitten the dust, to be replaced by the Extensible Firmware Interface. We explore this new technology and find out what it has to offer users and developers

HANDS ON - Practical how-to advice

119 Contents

120 Question time

Our experts can help find real-world solutions to your everyday problems

124 Hardware

Throw away your marker pens and add a touch of style to your discs using Labelflash technology

126 Performance

Find out just how much juice the tiny PicoPSU ATX produced when we put it to the test

128 Windows

Prevent duplicate icons appearing on your desktop, and solve a couple of network niggles

130 Linux/Unix

How to add and remove user privileges with Ubuntu; and set up a connection to a remote server

132 Digital imaging & video

If you want to be the first to try HD video editing, here's some inside info

134 Word processing

Turn off the most recently used font list; and create chord diagrams

136 Spreadsheets

Send email from Excel; and sort things using macros

138 Web development

Use Perl or PHP scripts to automate tasks and improve ease of use

141 Networks

Run a mail server on your network

143 Databases

Size matters when indexing tables with millions of rows

146 Visual programming

Using Visual Studio 2005's WebBrowser

BUYER'S GUIDE

A listing of the best products PCW has tested, helping you to make the right decision when planning a purchase

- 149 PCs
- 150 Graphics cards; notebooks
- 151 Motherboards; soundcards
- 152 Hard drives; DVD drives
- 153 Digital cameras
Camcorders
- 154 Printers; scanners
- 155 Routers; speakers
- 156 Monitors; TV tuners
- 157 Digital music players
Smartphones
PDAs
- 158 Portable media players
Personal video recorders
- 159 Backup software
Digital image-editing software
Media creation software
PC maintenance software
- 160 PC security software
Office software
Video-editing software
- 162 Product index

COVER DISC

11 & 181 Six full versions

Motion Artist 2, Jaws PDF Editor 2.5, Registry Mechanic 5, Ashampoo WinOptimizer and Serif 3DPlus 3, plus loads more tools, freeware and utilities.

ASUS recommends Windows® XP Professional



Be there, wherever you are



ASUS
Rock Solid • Heart Touching

ASUS Notebooks are Intel® Centrino® Duo Mobile Technology Ready!!

As the leading provider of high-performance notebook computers, ASUS presents you with 5 notebook series incorporated with the latest mobile computing platform. Offering the latest dual-core processor technology, the A6J, A7J, V6J, W5F and W2J provide increased computing performance for multitasking with longer battery supply by better power management.

Wireless TV Broadcasting Anytime, Anywhere



A7J-R004M

- Intel® Centrino® Mobile Technology Duo
- Intel® Core™ Duo Processor T2400 (1.83GHz, 667MHz, 2MB L2 Cache)
- Intel® 945GM Express Chipset
- Intel® Wireless/PRO 3945 a/b/g
- Microsoft® Windows® XP Media Center Edition
- LCD TFT 17" WXGA, Color Shine
- HDD 100GB / 1024MB(1024x1) DDR II SDRAM
- DVD Super Multi / ATI Mobility Radeon X1600 256MB
- Video Camera Built-in (1.3 million pixels)
- Hybrid (Digital & Analogue) TV Tuner built-in
- Gigabit LAN 802.11g WLAN
- Bluetooth built-in

£ 1,399 inc VAT

Built-in Webcam for Wire-Free Video Communication



W5F-G001P

- Intel® Centrino® Mobile Technology Duo
- Intel® Core™ Duo Processor T2400 (1.83GHz, 667MHz, 2MB L2 Cache)
- Intel® 945GM Express Chipset
- Intel® Wireless/PRO 3945 a/b/g
- Microsoft® Windows® XP Professional
- Black Chassis
- LCD TFT 12" WXGA, Color-Shine
- HDD 80GB / 512MB(512x1) DDR II SDRAM
- Ultra Slim DVD±/RW Dual
- Video Camera built-in (1.3 million pixels)
- Bluetooth built-in
- 802.11g WLAN

£ 1,399 inc VAT



A6Ja-Q002H

- Intel® Centrino® Mobile Technology Duo
- Intel® Core™ Duo Processor T2300 (1.66GHz, 667MHz, 2MB L2 Cache)
- Intel® 945PM Express Chipset
- Intel® Wireless/PRO 3945 a/b/g
- Microsoft® Windows® XP Home
- LCD TFT 15.4" WXGA, Colour-Shine
- HDD 100GB / 1024MB(512x2) DDR II SDRAM
- DVD Super Multi Double Layer
- ATI Mobility Radeon X1600 256MB
- Video Camera built-in (1.3 million pixels)
- Bluetooth built-in
- 802.11g WLAN

£ 1,199 inc VAT

Slim and Lightweight Design for Superior Computing Mobility



V6J-X001P

- Intel® Centrino® Mobile Technology Duo
- Intel® Core™ Duo Processor T2400 (1.83GHz, 667MHz, 2MB L2 Cache)
- Intel® 945PM Express Chipset
- Intel® Wireless/PRO 3945 a/b/g
- Microsoft® Windows® XP Professional
- LCD TFT 15" SXGA+, Colour Shine, Zero Bright Dot
- HDD 100GB
- 1024MB(512x2) DDR II SDRAM
- Slim DVD Super Multi
- NVidia GeForceGo 7400 256MB Turbo Cache
- 802.11g WLAN
- Bluetooth built-in

£ 1,599 inc VAT



dylan_armbrust@vnu.co.uk

Editorial

Hats off to progress: hassle-free technology really does exist

Rather than making our lives more difficult, some technology can reduce the stress, says Dylan Armbrust

Now that we're in the 21st century there's an ever-increasing expectation that technology will make our lives easier and that technology should be easier to use. Of course, anyone who's had a crack at trying to program a basic VCR, reset a digital watch or get to grips with understanding how their digital microwave works beyond pressing the 'start' button, will know this isn't the truth. And PC users will understand this situation better than most.

I could go on about the overwhelming amounts of information that is thrown at us via email, voicemail, SMS text messaging and so on, but that would be too easy. Instead, I'm going to tip my hat to some welcome progress.

The first tip goes to the much anticipated arrival of Microsoft's latest operating system, now known as Windows Vista. It's been five years since Windows XP launched and I have to say it was a relief when it arrived. Yes, you had to activate it, which was a pain. Naturally, it took up more hard drive space. And of course, it wasn't cheap. But it was stable, especially compared to its Windows predecessors (and for those Unix/Linux advocates out there – yes, I know what you're going to say, but don't worry as I've already conceded the point. I'm just talking about Windows here).

I'm absolutely positive most of you who made the switch will agree that XP made Windows ME look as stable as an Italian government in the 1970s. ME was tetchy, unreliable, barely coped with plug-and-play and it crashed a lot, thus throwing up the inevitable, dreaded Blue Screen of Death. Today, and for the past five years, I have to say that in the grand scheme of things my XP PC has served me well and I've lost little data when my PC did decide to lock up, which hasn't been very often.

This brings me back to Windows Vista and ease of use. It will come with a lot of user interface changes, 64bit support and more. For a more in-depth look at how Windows Vista works and what it offers, have a look at our feature (*Will your PC run Vista?*) on page 106. But one key point to highlight from our investigations, is that it should be even more stable than XP, which is no bad thing.

My second tip of the hat goes to sat nav devices. They have taken a while to mature, but as technology devices go, they deliver. It's not often that a computer-powered product is easy to use and makes our lives easier, but I think sat nav does.

Anyone who has made the transition from the super-size road atlas to a pocket-sized or dashboard-mounted sat nav device will agree. Gone are the days of having to take half an hour to pre-plan your route and, when you're halfway to your destination and lost, having to pull over to re-orientate yourself, especially at night. And I won't even mention the domestic strife they can help avoid on a long trip in the car. Today, all you have to do is punch a postcode or street name into the device and off you go. They aren't perfect yet – no technology is – but they can save time, hassle and peace of mind. If this sounds like something to you'd be interested in, have a look at our sat nav feature and group test on page 69 to see how you can make this technology work for you, and which all-in-one device you should go for.

Finally, I'd like to thank all those readers who wrote in last month to provide me with their views and feedback about what they feel *PCW* is and should be, and where they want it to go. It was greatly appreciated. **PCW**

'XP made Windows ME look as stable as an Italian government in the 1970s'

We are always happy to hear from you, email us at letters@pcw.co.uk

➔ For daily news updates,
reviews and downloads
www.pcw.co.uk

Editorial Tel 020 7316 9000 • Fax 020 7316 9313

Subscription enquiries Online via our secure website: www.subscription.co.uk/help/vnu

Email vnu@subscription.co.uk • Tel 01858 438 881

Back issue and cover disc orders Tel: 01858 438 883 For full contact details see page 192



WORRY LESS. INNOVATE MORE.

Trend Micro™ Worry-Free Security Solutions.

Introducing the next generation of all-in-one security for Small and Medium Business – a breakthrough approach that provides Automatic Protection 24/7, with zero administration. Spend time building your business. Don't spend time worrying about security. Trend Micro. Far more protection, far less worries.

Free yourself from worries at www.trendmicro.co.uk/worryfree

MAY

COVER DISC

Let our workshops show you how to use some of the software on the CD and DVD



5 FULL PROGRAMS WORTH £167

WORTH £167

see page 182

see page 185

see page 183

see page 184



DVD EDITION - 8 FULL PROGRAMS WORTH £187

WORTH £187

see page 186

see page 185

ON THE CD & DVD

Motion Artist 2

Replace boring, static HTML pages with stylish Flash animations - no scripting required
For workshop see page 182

Jaws PDF Editor 2.5

Get more from your pdf files by adding bookmarks and annotations with this useful editing toolkit
For workshop see page 183

Registry Mechanic 5

Boost your PC's performance with a quick spring clean for your Registry
For workshop see page 184

Ashampoo WinOptimizer

Optimise your PC with Platinum Suite 2's integrated range of utilities, all wrapped up in a simple and stylish interface
See page 185

Serif 3DPlus 3

3D modelling doesn't have to be complicated thanks to 3DPlus - and it won't take you long to get up and running with its uncluttered interface
See page 185



EXCLUSIVE TO THE DVD

Ashampoo Photo Illuminator 2

Ideal for locating and viewing your digital photos, with plenty of wizards to help you create slideshows and screensavers, so you can email and share your pics with friends
See page 186

Magix Music Manager 2006

Music Manager comes packed with audio playback, management and conversion features to help manage your music files
See page 186



PLUS MUCH MORE!

FOR A FULL LISTING OF SOFTWARE TURN TO PAGE 181

MESH recommends Windows® XP Media Center Edition

**FREE
UPGRADE TO
19" TFT**

E-Direct e1010-05

Matrix Inspire

The ultimate best buy TFT flat panel PC offer

- AMD Athlon™ 64 CPU 3200+ with HyperTransport™ Tech
- Genuine Windows® XP Home Edition
- ASUS A8N-VM NVIDIA Nforce 410 PCI-X Mainboard
- 512MB DDR 400 Memory (2x256MB)
- 160GB Serial ATA hard drive with 8MB buffer
- 128MB NVIDIA 6100 Graphics Accelerator (SMA*)
- 19" Flat Panel TFT Display
- Sony Multi-Format Dual Layer 16x DVD Writer**
- 5.1 channel surround sound audio (on-board)
- Logitech Desktop Keyboard and Optical Mouse
- Classic Warranty¹ - 3 Years Free Parts & Labour

£499 INC. VAT **£424.68** EX. VAT

For full details go on-line www.meshcomputers.com



Start something entertaining



E-Direct e1020-05

Matrix Premier

Great value home/office multi-media system

**£70 OFF
SALE**

- AMD Athlon™ 64 CPU 3500+ with HyperTransport™ Tech
- Genuine Windows® XP Media Center Edition 2005
- ASUS A8N-VM NVIDIA Nforce 410 PCI-X Mainboard
- 1GB DDR 400 Memory (2x512MB)
- 200GB Serial ATA hard drive with 8MB buffer
- 512MB NVIDIA GeForce 7300GS PCI-X, DVI & TV Out (256MB SMA*)
- 19" Viewsonic VA912 Flat Panel TFT Multi Media Display
- Sony Multi-Format Dual Layer 16x DVD Writer**
- 5.1 channel surround sound audio (on-board)
- Built-in Stereo Speakers
- Logitech Desktop Keyboard and Optical Mouse
- Classic Warranty¹ - 3 Years Free Parts & Labour

£649 INC. VAT **£552.34** EX. VAT

Popular Upgrades

	EX. VAT	INC. VAT
■ Upgrade from 3500+ to X2 3800+ CPU	£75	£88.13
■ Upgrade from 1GB to 2GB Memory	£75	£88.13
■ Upgrade from 200GB to 300GB Hard Drive	£30	£35.25
■ Logitech Cordless Keyboard & Mouse	£10	£11.75



E-Direct e1030-05

Matrix² Prestige

Power PC with Dual Core CPU & 512MB graphics

**£100 OFF
SALE**

- AMD Athlon™ 64 X2 Dual-Core CPU 3800+ HyperTransport™
- Genuine Windows® XP Media Center Edition 2005
- ASUS A8N-E NVIDIA Nforce 4 PCI-X Mainboard
- 1GB DDR 400 Memory (2x512MB)
- 250GB Serial ATA hard drive with 8MB buffer
- 512MB ATI X1300 Pro PCI Express with DVI & TV Out
- 19" Viewsonic VA912 Flat Panel TFT Multi Media Display
- Sony Multi-Format Dual Layer 16x DVD Writer**
- 7.1 channel surround sound audio (on-board)
- Built-in Stereo Speakers
- Logitech Desktop Keyboard & Optical Mouse
- 6x USB 2.0, 10/100/1000 Network connection
- Classic Warranty¹ - 3 Years Free Parts & Labour

£799 INC. VAT **£680** EX. VAT

Popular Upgrades

	EX. VAT	INC. VAT
■ Upgrade from 3800+ to X2 4200+ CPU	£45	£52.88
■ Upgrade from 1GB to 2GB Memory	£75	£88.13
■ Upgrade from 250GB to 400GB Hard Drive	£80	£94.00
■ Upgrade to 19" Viewsonic VA1912W Widescreen	£35	£41.13



E-Direct e1040-05

Matrix² Vector

Cutting edge powerhouse PC with an array of features

**£50 OFF
SALE**

- AMD Athlon™ 64 X2 Dual-Core CPU 4200+ HyperTransport™
- Genuine Windows® XP Media Center Edition 2005
- ASUS A8N-E NVIDIA Nforce 4 PCI-X Mainboard
- 1GB DDR 400 Memory (2x512MB)
- 250GB Serial ATA hard drive with 8MB buffer
- 512MB ATI X1600 Pro PCI Express with DVI & TV Out
- 19" Viewsonic VA1912 Widescreen TFT Flat Panel Display (8ms)
- Sony Multi-Format Dual Layer 16x DVD Writer**
- 7.1 channel surround sound audio (on-board)
- Logitech S200 2.1 Speakers & Subwoofer
- Logitech Desktop Cordless Keyboard & Optical Mouse
- Advantage Warranty² - 2 Yrs On-site + 1Yr B-to-B

£999 INC. VAT **£850.21** EX. VAT

Popular Upgrades

	EX. VAT	INC. VAT
■ Upgrade from 4200+ to X2 4400+ CPU	£65	£76.38
■ Upgrade from 1GB to 2GB Memory	£75	£88.13
■ Upgrade from 250GB to 400GB Hard Drive	£80	£94.00
■ Logitech Cordless Keyboard & Rechargeable Mouse	£20	£23.50

Matrix Features (unless otherwise stated) • **Inspire** - Black case with 250W PSU, **Premier** - Black & Silver Mini Tower case with 550W PSU • 4x USB 2.0 • 10/100 Network Connection • **Prestige & Vector** - Black & Silver Midi Tower case with 550W PSU, 6x USB 2.0 & 10/100/1000 Network Connection • Floppy Drive & modem are optional • **FREE Software: Microsoft Works 8.5 +60 Day Microsoft Office Trial, eTrust Antivirus v.9 - 70 day Trial, CyberLink PowerDVD, Power2Go, PowerProducer3, PowerDirector3, PowerBackup, MediaShowSE, PowerCinema4 (OEM product)**

Please Read: Sales subject to terms & conditions (copy available on request). Pictures shown for illustration purposes only - colours may vary. Operating System supplied is an OEM product - Full version. VM/Micro Case's purchased with internal Card Reader benefit from only 4 free USB 2.0 ports. *SMA (Shared Memory Architecture) allows for memory to be taken from RAM to supplement the graphics card requirements. **Sony Multi-burner R/W all standard formats Except DVD-RAM. All PCs carry a 3 Year Parts & Labour Warranty & includes 24/7 on-line support, system restore facility, national rate hardware support and premium rate software support - see terms. All monitors come with 3 years manufacturers swap-out warranty. All peripherals are supplied with manufacturers full warranty. Matrix Inspire, Premier & Prestige carry a back-to-base component only. Base unit Pick up & collection is available from MESH at £41 inc. VAT. All other PCs carry an On-site element - UK Mainland only. For full terms please call or go on-line. Warranty upgrades & extensions are available and full terms are provided separately. Notebook warranties - Our Asus series carry an international 24 months warranty to the Asus repair centre network. Carriage - On the UK Mainland this includes full Carriage and Return service. Outside the UK Mainland this is a back to base service to a local Asus repair centre to be paid for by the customer. All other Notebooks carry a 3 year Collect & Return, Parts and Labour warranty. Non-BT customers please check that the modem will work on your line before ordering. Prices quoted for calls to MESH are based on a BT landline - other carriers may charge you more. Our minimum standard PC delivery charge is £45.83 inc (UK Mainland Only). Please call for a written quotation. ©2004 Advanced Micro Devices, Inc. All rights reserved. AMD, the AMD Arrow logo, AMD Athlon, and combinations thereof, are trademarks of Advanced Micro Devices, Inc. Microsoft and Windows are registered trademarks of Microsoft Corporation in the United States and other countries. All trademarks are acknowledged. E&OE. ¹Finance £699 Payment Example - 9 MONTHS BNPL - Available to UK Residents aged 18 or over subject to status. No deposit. Either pay £699 within 9 months of the date of purchase, total amount repayable £699, pay no interest. Or 39 monthly payments of £31.97 commencing 9 months after purchase date. Total amount payable £1246.83. Interest calculated from date of agreement. Credit subject to status to UK residents aged 18 years or over. Credit arranged by Creditenabler Limited, 400 Metropex, Salford, Manchester, M50 2UE. Credit provided by Clydesdale Financial Services. Registered in England No. 02901725. Prices correct at time of going to press (22/2/06). Business hours Mon-Fri 9am-6pm, Sat 10am-5pm, Sun 11am-4pm. Goods provided by MESH Computers, Unit 1 Ogate Centre, Ogate Lane, London, NW2 7JA. Typical **29.8%** APR

Call or go on-line now to check-out our latest offers and deals on notebooks and accessories



All notebooks include pin-hole camera



4 HRS

2.6 KG

includes USB Mouse

E-Direct e3080-05

ASUS A6U

ASUS business notebook exclusive to MESH

- AMD Sempron™ 3000+ Mobile Processor
- Genuine Windows® XP Home Edition
- 15.4" TFT WXGA Active Colour Screen (1280x800)
- 512MB DDR Memory
- 60GB ATA-100 Hard Drive
- 128MB SIS Mirage TM Graphics (SMA*)
- Multi-Format 8x Dual Layer DVD Writer
- Wireless LAN 802.11b/g
- Pin-hole Video Camera
- 3D stereo sound, SPDIF, sir-115 supported
- 2x Speakers and built-in Microphone
- 4 in 1 Card Reader & USB Mouse
- Dimensions: 354(W)x284(D)x35.2(H) - 2.6Kg
- 2 Years Full International Warranty (Collect & Return - UK Mainland)

£599 INC. VAT **£509.78** EX. VAT

For full details go on-line www.meshcomputers.com



Everything you need and more



3.5 HRS

4 KG

includes USB Mouse

E-Direct e3015-05

ASUS A7D

Desktop replacement 17.1" ASUS notebook

- AMD Turion™ 64 Mobile Processor MT-30 (1MB cache)
- Genuine Windows® XP Home Edition
- 17.1" TFT WXGA+ Active 'Crystal Bright' screen (1440x900)
- 1024MB DDR2 533MHz Memory
- 100GB ATA-100 Hard Drive
- 128MB ATI Mobility Radeon X700 Graphics
- Multi-Format 8x Dual Layer DVD Writer
- Wireless LAN 802.11b/g
- Pin-hole Camera 1.3M pixel
- Intel Azalia High Definition sound with virtual 8 channel output
- 2x Speakers and built-in microphone
- 4-in-1 Card Reader supports MMC/SD/MS/MS Pro
- 56kbps Fax/Modem, 10/100/1000 Giga LAN
- 5x USB, 1x S/PDIF, parallel, 1x line-in, VGA out, TV out
- Dimensions: 405(W)x314(D)x38.2(H) - 4Kg inc Battery
- Battery Life - up to 3.5 hours continuous use
- 2 Years Full International Warranty (Collect & Return - UK Mainland)

£999 INC. VAT **£850.21** EX. VAT



3 HRS

3.8 KG

E-Direct e3065-05

Discovery 7800 WUXGA

Powerful notebook with 17" WUXGA display

- Intel® Pentium® M Processor 750 (1.86GHz, 2MB Cache, 533MHz)
- Genuine Windows® XP Home Edition
- 17.1" TFT WUXGA Crystal bright screen Technology (1900x1200)
- 1024MB DDR2 533MHz Memory
- 80GB 5400rpm Hard Drive
- 256MB NVIDIA GeForce Go 7800GTX Graphics
- Multi-Format 8x Dual Layer DVD Writer
- Wireless LAN 802.11b/g & Bluetooth module
- Pin-hole Camera 1.3M pixel
- Virtual 8 Channel 7.1 Surround Sound output
- 2x Speakers and SRS WOW Surround Sound
- 4-in-1 Card Reader supports MMC/SD/MS/MS Pro
- 56kbps Fax/Modem, 10/100/1000 Giga LAN
- 4x USB, FireWire, 1xDVI VGA out, S/P DIF, S-Video out, TV out
- Dimensions: 397(W)x294(D)x44(H) - 3.8Kg inc Battery
- Battery Life - up to 3 hours continuous use
- 3 Years Free Collection & Return, Parts & Labour (UK mainland)

£1599 INC. VAT **£1360.85** EX. VAT



2 HRS

5.2 KG

E-Direct e3095-05

Pegasus 7800 WUXGA

Leading edge notebook ready for any task!

- AMD Athlon™ 64 X2 Dual-Core CPU 4200+ HyperTransport™
- Genuine Windows® XP Home Edition
- 17.1" TFT WUXGA+Crystal bright screen (1900x1200)
- 2042MB DDR 400 Memory
- 80GB 5400rpm Hard Drive
- 256MB NVIDIA GeForce Go 7800GTX
- Multi-Format 8x Dual Layer DVD Writer
- Wireless LAN 802.11b/g & Bluetooth module
- Internal Video Camera
- Intel Azalia High Definition Sound with virtual 8 Channel output
- 4x Speakers and Subwoofer
- 7-in-1 Media card reader
- 56kbps Fax/Modem, 10/100/1000 Giga LAN
- 4x USB, FireWire, 1xDVI VGA out, S/P DIF, TV out, P, S, PS/2, IrDA
- Dimensions: 397(W)x294(D)x44(H) - 5.2Kg inc Battery
- Battery Life - up to 2 hours continuous use
- 3 Year Free Collection & Return, Parts & Labour (UK mainland)

£1999 INC. VAT **£1701.28** EX. VAT

Common Features (unless otherwise stated) • Full size keyboard
 • 1x Type II PCMCIA module • Kensington Lock Facility • FREE Software:
 (Discovery & Pegasus only) Microsoft Works 8.5 +60 Day Microsoft Office
 Trial • Free Carry Case on all Notebooks



Visit our new MESH notebook portal for a wide range of unbeatable mobile solutions - click on meshcomputers.com

call or go on-line for more

08700 46 47 47 meshcomputers.com

showroom & sales • Mon-Fri 9-6pm • Sat 10-5pm • Sun 11am - 4pm

MESH
computers

NEWS

IN THIS SECTION

NEWS

- 20 Web calls increase spitting Slow advent of VoIP More councils plan free access
- 21 1.6TB net drive for homes and offices New Canon SLR
- 22 E-paper 'powered by wireless' Phones read paper data
- 24 ISPs defend email charges

SPECIAL REPORT

- 16 News from the 3GSM: First '11n' Wifi Monitor Ebay from a mobile Virgin debuts DAB TV Nokia Wifi phone

Keep up to date with the news, reviews and competitions in our weekly newsletter. To subscribe go to www.vnuservices.co.uk/pcw



TV war as access hits 100Mbps

Cable giant NTL is field testing a 100Mbps/sec home link in the opening shot of a new battle for dominance of next-generation networks. But BT countered with news that exchanges covering 99.6 per cent of the country will be upgraded to provide links of up to 8Mbps/sec from 31 March.

BT is also testing ADSL2+ offering speeds up to 20Mbps/sec, something rivals are already providing at some exchanges. But the real battle is less over who can offer the fastest speeds (see below) and more about who is going to make what money from the system.

Telcos face a vicious circle. Faster broadband speeds mean more use of video and a huge increase in bandwidth demand. This will require massive new investment – BT alone is spending £10b on its 21st Century Network. Yet revenues from traditional voice calls fell 15 per cent last year as people switched to VoIP (Voice over IP). So how are telcos going to make their money? One way is to charge more for bandwidth, either as per MB charges or by subsuming them into the price of a video download.



A BT exchange gets an upgrade

Another way is for the telcos to sell content themselves. Both BT and NTL plan to offer IPTV services (TV delivered using the Internet Protocol) and they are far from alone. Some see this as wishful thinking: how can BT compete with the likes of Sky and the BBC?

Mac Taylor, chief executive of The Moriana consultancy, told a Netevents forum last month (see page 20) that telcos can make money from IPTV if they offer content not available on existing TV or episodes of popular series not yet shown in Europe.

Other speakers pointed out that IPTV can generate money from advertising targeted at individual users or groups and from the fact that viewers can interact speedily with adverts.

There were also signs of an industry reacting against the likes of Google and Yahoo, which are getting ready to offer video-on-demand and stand accused of creaming off revenues from other people's services.

Rob Keil, VP of infrastructure provider Hammerhead, said: 'Google and Yahoo don't want to pay anything more than they do now [for content delivery], which is nothing.' He predicted that telcos would demand a premium for delivering video of the same quality they themselves provided.

But, as Taylor pointed out, telcos face competition from a host of smaller providers. IPTV could go the way of radio, which has at least 10,000 stations streaming over the web.

The BBC is even encouraging 'people's TV' by making content available for non-commercial use: you can edit footage to create your own programs. *Clive Akass*
→ Go to www.pcw.co.uk/2151273 for more

NTL's cable links are faster but BT has wider reach

NTL's 100Mbps/sec trial (see above) began in March at Ashford in Kent and is a bandwidth-on-demand system – you get the bandwidth you need when you need it.

NTL staged a demonstration at a show flat in Pimlico, London, in which the system delivered three high-definition TV streams simultaneously, leaving bandwidth to spare for other Internet uses.

Kevin Baughan, NTL's director of network strategy, said cable has far more capacity than ADSL+, which can deliver 20Mbps/sec to users close to

the exchange and is already on offer by BT rivals.

Rival DSL vendors dispute this, claiming that cable bandwidth has to be shared within an area whereas phone links have copper connections dedicated to each house. But DSL is contended further up the line and cable undoubtedly has more headroom in the short term at least.

DSL is available over far more of the country, however. BT is upgrading 5,300 exchanges to make links of up to 8Mbps/sec available for 99.6 per cent of Britain from 31 March. The

services should be available more or less immediately to new customers, either from BT or one of the many providers reselling its bandwidth, but upgrading existing users could take months.

Speeds drop off with distance, so only people living very close to an exchange will get 8Mbps/sec, but BT reckons 78 per cent should get at least 4Mbps/second and 42 per cent at least 6Mbps/sec.

BT Wholesale said other newly deployed technology should make the upgraded service, branded ADSL Max and ADSL Max Premium, more reliable.

Phonecam won't miss a shot

Sony Ericsson has unveiled a cameraphone that takes pictures *before* you push the button. The K800 Cybershot phone takes four snaps as soon as the autofocus kicks in, another when you click the shutter and another four immediately afterwards.

The idea is to ensure you don't miss the best shot: after you have pressed the button you are invited to make a choice from the best of the nine pictures.

The feature is similar to the burst mode found in cameras, but that takes multiple pictures only *after* you press the shutter.

Sony Ericsson says the K800 is the first cameraphone to offer the quality of a dedicated digital camera, which is why it is the first to carry Sony's Cybershot brand. It has a 3.2megapixel sensor, 68MB of internal memory, a Memory Stick micro slot, autofocus, auto red-eye reduction and a built-in Xenon flash. The price is expected to be around £300.



With Sony Ericsson's K800 you will never miss the action again

It supports Pictbridge for direct connection to a printer and lets you post a picture to a blog at the press of a button. You don't need to set up a blog site; the first time you use the camera it sets one up for you, under a deal with Google.

The company also launched a another phone in its Walkman

range – the W300. This is expected to cost less than £200 and is targeted at the mass market.

Also launched were two sub-£100 camera phones (the K510 and K310), the Z530i, which will cost less than £150, three Bluetooth headsets and the HCB-100 Bluetooth car speakerphone.

In brief

Jeeves sacked

The world's most famous butler has been sacked. Jeeves and his picture have been dropped from the site originally called Ask Jeeves. Asked why he had been sacked, the site now called ask.com simply listed Jeeves references. Perhaps they'll have to get him another job.



Blu-ray burner

Pioneer will ship one of the first Blu-ray burners in March. The BDR-101A will store up to 25GB on a media disc the size of a CD. The drive supports the Blu-ray BD-R, BD-RE, and BD-Rom formats and is compatible with all DVD formats except for DVD-Ram.

The BDR-101A can read, but not write, 50GB dual-layer Blu-ray. It is expected to cost between £340 and £400, with discs at about £10 each.

Office 2007 home users pay school price

The next version of the world's most-used office suite, due for release late this year, is to be called Microsoft Office 2007.

Microsoft has merged the home and education editions into one called Home and Student 2007 selling in the US for just \$149 (£85). In the past you had to have

a student living in your home to buy the schools edition, but that requirement is to be dropped.

There are also Professional, Standard and Small Business editions priced at \$499 (£283), \$449 (£254) and \$399 (£226) respectively. The upgrade prices \$329 (£186), \$279 (£158) and

\$239 (£135.13) may be more significant, as Microsoft must persuade people that the new features are worth paying for.

Microsoft has also confirmed that Windows Vista will come in six core versions, two for business, three for home users and a starter edition for developing countries.

Mac mini gets speed boost with Intel Core Duo

Apple has launched its compact Mac mini desktop using the dual-core Intel Core Duo processor and claiming performance up to four times that of previous models.

The new Intel-based models will use the slower 1.5GHz and 1.6GHz Core Duo processors, with system prices (without monitor) at £449 and £599 respectively.

It is not clear whether this is because Apple wanted to keep prices down, or because faster processors would overheat and

require noisy cooling. Both models include Gigabit Ethernet, 11g Wifi, Bluetooth 2.0 and four USB2 ports, and come with the iLife '06 suite 'digital lifestyle' applications (see review page 64).

Apple also launched a £249 hifi speaker system for the Ipod, which can be operated by remote control.



Join the PCW team!

If a career in technology journalism excites you, PCW is looking for a staff writer. The right candidate will join our busy team of online journalists who are writing and publishing reviews and news every day. You will write for our fast-growing blog, The Test Bed, take part in our online broadcasts, and learn how to test equipment in our industry-leading lab.

You must have decent technical knowledge, as well as a flair for writing – and be prepared for foreign travel as well. If this sounds like the job for you, then email your CV and a covering letter to rob_jones@vnu.co.uk.

Stereo headset

Jabra is offering a Bluetooth headset supporting A2DP, the Advanced Audio Digital Profile, allowing it to be used for hands-free calls and listening to stereo music.

The company says the BT620s lasts 14 hours between charges. Jabra also launched the A320s adapter, allowing Bluetooth devices such as the BT620s to play music streamed directly from a PC.

Shozu award

Shozu, a free service that can cut a third or more off the cost of sending pictures from a mobile, won a Best Mobile Messaging award at 3GSM. As PCW reported last month (see www.pcw.co.uk/2148639), Shozu's software client sends the file more efficiently than standard methods; it also lets you send to multiple recipients for the price of one call.

→ www.shozu.com

Skype on 3

Hutchison, which runs the 3G network, is to offer phones with a Skype client so they can make Voice over IP (VoIP) calls; it also gives them an instant messaging client.

Big picture

The divide between phonedcams and dedicated point-and-shoot devices narrowed with the launch of an 8megapixel camera phone from Xcute Mobile. The phone uses mpeg4 and a DivX codec from Intervideo.

Global IM

Cellular operators have agreed to attempt something that has yet to be achieved on fixed Internet links: fully interoperable instant messaging services. Eight of the world's biggest operators, plus all of India's GSM networks, signed up to the Personal IM initiative at 3GSM.

But mobile operators will have to negotiate ways to connect with fixed-link services such as Aim and MSN Messenger. It is unclear what operators will charge for instant messaging, but they will not want to undermine their SMS revenues.

Broadcom boasts first 11n kit

Rivalry between Wifi chip providers reached new levels of confusion at 3GSM when Broadcom announced unofficially that it had the first chips to truly implement the next-generation IEEE 802.11n standard, which is still only in draft form.

The announcement by chief technology officer Henry Samueli came during an impressive round of Broadcom product releases, including a new modular mobile platform called Cellarity.

PCW reported last month that analysts had warned companies to be cautious of buying products claiming to be 11n before the standard is ratified. But Samueli denied Broadcom was jumping the gun.

He claimed: 'The spec is all but nailed down, and we can be 99 per cent certain our implementation is the one that the IEEE will go with, and will be what the Wifi standard



Samueli claimed that the 11n spec is 'all but nailed down'

for multiple-input multiple-output (Mimo) will become.'

His statement follows a year of obscure political wrangling among industry groups anxious to get their own pet design approved as the 11n standard. The argument became more heated after Airgo predicted

that its technology would be adopted.

The conflict continued when tests by a US website claimed an Airgo-based 'pre-11n' Netgear RM240 router could quash legacy 11g signals when using channel 6.

Samueli said Airgo's explanation that the problem was due to channel restrictions inherent in 11n was a 'weak excuse', and that it would not happen with a properly designed Mimo wireless.

He also dismissed fears that the 11n's enhanced range will make airwave congestion worse. 'With dual-frequency Mimo, you can choose between 2.4GHz and 5GHz bands and just search for a free channel,' Samueli claimed.

'There will be plenty of free channels, even with the added range; and, more importantly, if the 11n design can't find a free channel it will power back to avoid congestion.' *Guy Kewney*

Rabbit net survives crash

When Rabbit Point set up a Voice over IP (VoIP) mesh network at the 3GSM exhibition, the company was quickly told by the official Wifi provider to turn it off.

That turned out to be a big mistake, as the official provider trod on a cable and cut off access. As a result, Rabbit Point had queues of people asking to use its web connection, according to chief technology officer Russell Hutson. 'If they'd left us with our hall-wide mesh, the exhibition would have had a working wireless Lan.'

Rabbit Point offers a Wifi hotspot service based on Locustworld mesh

technology that relies on access points which talk to each other wirelessly and self-organise into a network that can be extended by simply plugging in another node.

The system is designed to offer a low-cost way to provide access throughout large company sites and branch offices. The company supplies a VoIP software client to allow voice calls over the network or any public Wifi hotspot.

Hutson claimed the system can reduce staff cellphone bills. 'We're seeing people who have corporate contracts with hotels... insisting the hotel sign up for our service'. *GK*

Monitor Ebay from a mobile

Jamster has launched a mobile application that will let you monitor your online Ebay auctions. According to the company, two-thirds of all Ebay bidders are away from their desks during the crucial, closing stages of auctions.

It will let you search, view and bid on items, and tracks your bids. A scrolling ticker bar shows your transaction status for live auctions and SMS alerts will be sent when you are outbid. The service costs £5 per month and runs on GPRS and 3G-enabled Internet phones. *Martin Lynch*

HP splits off Ipaq division

HP is to separate its handheld and notebook operations into different divisions in a bid to bring devices to market faster. Neil Dagger, manager of HP's UK and Ireland handheld business, said wireless devices are becoming more important to businesses and required more resources and development.

The move followed the announcement at 3GSM of HP's hw6900 Mobile Messenger, an Ipaq handheld supporting push email, Tom Tom sat nav, Bluetooth and Wifi.

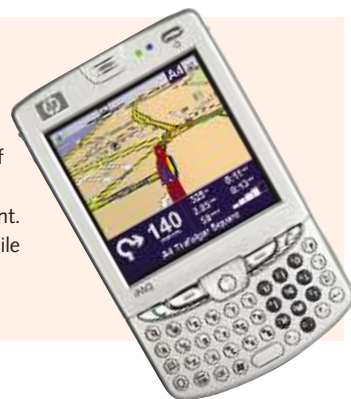

Virgin debuts TV on a mobile



Virgin Mobile will become the first operator in Europe to offer a broadcast TV service to mobile phones, as opposed to a point-to-point video stream over a 3G link as provided by Orange.

The service, launched in conjunction with BT Movio, will use Digital Audio Broadcasting (DAB) signals from Britain's existing digital radio network. Oddly, O₂, another BT spin-off, has been testing a TV service via rival DVB-H technology. This employs a mobile version of the signal used for terrestrial digital TV broadcasts (see box, right).

Mobile handset maker Nokia is enthusiastic about DVB-H, partly because it has invested in the technology, but also because it says DAB is little known outside Europe, with the notable exception of Korea.

Dab hander... the Trilogy TV-enabled handset

But full DVB-H services in the UK would require a new broadcasting infrastructure and an allocation of scarce spectrum, possibly some of that freed up by the move from analogue to digital TV services.

DAB broadcasters are currently heavily constrained by regulators in the bandwidth they are allowed to use for non-audio data, but Virgin will nevertheless be able to offer five digital TV channels and 350 radio channels. And, of course, the UK infrastructure is already in place.

BT and HTC have developed a mobile, called Trilogy, that is capable of receiving the broadcasts. It has a 2.2in screen and a range of other media-driven features, including removable storage and an integrated 1.3megapixel camera.

It remains to be seen what effect DAB reception has on battery life: the signals require a lot of power-hungry processing.

Emma Lloyd, managing director of BT Movio, said at the launch of the service at 3GSM: 'Virgin Mobile will be able to offer customers a real live TV experience. We are delighted they have chosen our platform.'

Virgin has exclusive rights to the service at the moment, but other carriers may be able to use the signal once the service is established.

Nvidia boosts mobile television

Graphics giant Nvidia has teamed up with chip designer Dibcom to boost the quality of DVB-H mobile TV (see above) on handhelds. They will produce a new low-drain chip, with both Nvidia's Geforce 5500 graphics processing unit and Dibcom's DIB7000H DVB-H demodulator.

The 5500 offers 30fps (frames per second) of H.264 or Windows Media Video with high resolution, as well as support for surround sound. Handsets using the chip should be available later this year.

Fast texting

A predictive text utility from Zi Corporation, Ezitype for smart phones and handhelds, is said to increase writing speed and improve spelling.

It includes an auto-correct feature that spots misspelled words and offers suggested corrections.

→ www.zicorp.com



Path cleared for mobile Wifi

Cambridge Silicon Radio (CSR) demonstrated Voice over IP (VoIP) calls over a Wifi connection coexisting with a Bluetooth headset link on a PDA. The 11b and 11g flavours of Wifi use the same 2.4GHz band as Bluetooth, so getting them to work in the same device can be tricky.

The PDA used a combo card with CSR's Unifi-1 single-chip Wifi implementation for mobile devices and its Bluecore4-Rom Bluetooth chip, together with special twin antennas from Fractus.

UK-based CSR hopes the Unifi-1 chip will allow it to match in the Wifi market the success it has had in Bluetooth design, in which it is a world leader.

CSR's strategic marketing chief Simon Finch claimed Unifi was the smallest single-chip Wifi implementation for mobiles. 'Its tiny physical size and extremely low power consumption have effectively removed the barriers to mass-market deployment of Wifi in mobile devices,' he said.

Nokia handset hits the Wifi hotspot

Nokia showed off its first handset designed to allow a handover between a cellular and Wifi network. The Nokia 6136 phone, due to ship this summer, uses Unlicensed Mobile Access (UMA), a specification developed by operators and handset vendors to extend phone voice and data services over different wireless services.

It means a phone using GSM cellular network can switch to

Wifi when the user moves into a hotspot. Orange will be one of the first carriers to offer the handset, according to Nokia.

The quad-band 6136 supports an email client, as well as support for attachments and push-to-talk capability.

'The Nokia 6136 clearly demonstrates the complementary nature of cellular and IP-based networks,' said Nokia's Kai

Oistamo. 'By implementing UMA into this device, worldwide GSM coverage is combined with Wlan coverage for a seamless communications experience.'

Meanwhile Sony Ericsson announced a range of applications for its Wifi-enabled P990 UMTS smartphone, including a business-card scanner, new entertainment features and Blackberry-style push email.

Smart email

Windows Mobile handset manufacturer HTC announced an Orange-branded smartphone, the SPV M600, that supports Blackberry-style email delivery directly to the handset. It also comes with 802.11b/g Wifi, Bluetooth and a 2megapixel camera.



Budget

- AMD® Semperon® 64bit 2600 + 1600MHz HTT/128K (754 pin)
- Memory 512 MB DDR400 PC3200 Lifetime Warranty!
- Hard Drive SATA 80Gb (7200rpm 8mb cache)
- Graphics Card Integrated SIS Real 256E Graphics
- FOXCONN 760GX Motherboard, SIS760GX Chipset, 8X AGP, SATA, 3 PCI
- Six USB 2.0 Ports (4 Rear + 2 Front)
- 4x +R Dual Layer DVD-Writer (16x +/-R) (& RW) + 40x CD-RW
- High-End Onboard 6 channel sound
- Network Facilities 10/100 Network Card
- Floppy Drive 1.44Mb Floppy Disk Drive
- Black Stylish Case + 2 Front USB
- Power Supply & Cooling 350W PSU + 80mm Fan
- Microsoft® Windows® XP Home Edition

1 Year Return-to-Base Warranty + 1 Month Free Collect & Return

£340 inc. vat and delivery

Add: Logitech® Cordless Internet Pro Desktop Keyboard + Mouse, Logitech® S200 2.1 speaker system, Monitor 17" TFT Silver/Black 1280x1024

£495 inc. vat and delivery



Family

- INTEL® Pentium® 4 640 (64 BIT) 3.2GHZ 800mhz FSB/HTT/2MB
- Memory 1024 MB DDR2-533 PC4200 Lifetime Warranty!
- Hard Drive SATA 160Gb (7200rpm 8mb cache)
- Graphics Card 256MB RADEON X550 PCI Express + DVI + TV-OUT
- High-End ASUS® Motherboard Dual DDR, S-ATA, x16 slot, 3 PCI, 2 PCI-EX
- Six USB 2.0 Ports (4 Rear + 2 Front)
- 16x DVD-ROM With 48X CD-ROM
- 4x +R Dual Layer DVD-Writer(16x +/-R) (& RW) + 40x CD-RW
- Sound Card High-End Onboard 8 channel sound
- Network Facilities 10/100/1000 Network Card
- Internal 7 In 1 card reader with 1.44Mb Floppy Disk Drive
- Silver X-Plode Case + 2 Front USB
- Power Supply & Cooling Silent 400W PSU + 80mm internal Fan
- Logitech® Cordless Internet Pro Desktop Keyboard + Mouse
- Logitech® S200 2.1 speaker system
- Monitor 17" TFT Silver/Black 1280x1024 Res: 12ms
- Microsoft® Windows® XP Home Edition

1 Year Return-to-Base Warranty + 1 Month Free Collect & Return

£768 inc. vat and delivery



Images are for illustrative purposes only, and prices are subject to change without notice.

You Dream it...

Why choose pcspecialist.co.uk?

- Our computers are probably the cheapest in the UK despite the fact that we only use quality components.
- You can choose your desired specification online, customise it and order online. When your order is processed we will build your system and deliver it to you. Simple!
- Our after-sales service includes local call rate (0845) hardware technical support, an online account for order tracking, technical support, downloads and returns. If you prefer we also provide standard email support.
- We only use quality manufacturers for our components. We do not try to make our systems appear cheaper by using cheaper components.
- Don't be fooled into thinking that you are getting a three year warranty with our competitors - some companies offer a three year warranty which consists of 1 year parts and a further two years labour only - they don't even collect for free, making their service lesser than ours.
- We are an established company with the ability to provide excellent customer service. We aim to respond to emails and messages as quickly as possible and have dedicated call center staff for technical support and dedicated technical staff for fast processing of returns.
- Don't just take our word for it. View the customer testimonials posted on our website.

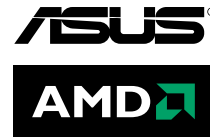

Gaming

- AMD Athlon® (64BIT) X2 4400 1MB L2 Cache
- Memory 2048 MB DDR400 PC3200 Lifetime Warranty!
- Hard Drive SATA 320 Gb (7200rpm 8mb cache)
- Graphics Card 256MB GEFORCE 7800GT PCI Express
- Motherboard ASUS® A8N-E: DUAL DDR, S-ATA, x16 slot, 3 PCI etc
- Six USB 2.0 Ports (4 Rear + 2 Front)
- DVD-ROM 16x DVD-ROM With 48X CD-ROM
- DVD Writer 4x +R Dual Layer DVD-Writer(16x +/-R) (& RW) + 40x CD-RW
- Sound Card High-End Onboard 8 channel sound
- Network Facilities 10/100/1000 Network Card
- Floppy Drive 1.44Mb Floppy Disk Drive

- Silver X-Plode Case + 2 Front USB
- Silent 600W PSU + 120mm Fan + 19.2 dBA CPU Cooler + Super Quiet
- Logitech® Cordless Internet Pro Desktop Keyboard + Mouse
- Creative Inspire 7.1 T7900 Speaker System
- Monitor 19" TFT Silver/Black 1280x1024 Res
- Microsoft® Windows® XP Home Edition

1 Year Return-to-Base Warranty + 1 Month Free Collect & Return

£1395 inc. vat and delivery



- Black X-Plode Case + 2 Front USB
- Silent 600W PSU + 120mm Fan + 19.2 dBA CPU Cooler! Super Quiet!
- Logitech® Cordless Internet Pro Desktop Keyboard + Mouse
- Logitech® S200 2.1 speaker system
- Monitor 19" TFT Silver/Black 1280x1024 Res
- Microsoft® Windows® XP Home Edition

1 Year Return-to-Base Warranty + 1 Month Free Collect & Return

£977 inc. vat and delivery



- INTEL® Pentium® 4 650 (64 BIT) 3.4GHZ 800mhz FSB/HTT/2M
- Memory 1024 MB DDR2-533 PC4200 Lifetime Warranty!
- Hard Drive SATA 200Gb (7200rpm 8mb cache)
- Second Hard Drive Hard Drive SATA 200Gb (7200rpm 8mb cache)
- Graphics Card 512MB RADEON X1300 PRO PCI Express + DVI + TV-OUT
- High-End ASUS® Motherboard Dual DDR, S-ATA, x16 slot, 3 PCI, 3 PCI-EX
- Six USB 2.0 Ports (4 Rear + 2 Front)
- DVD Writer 4x +R Dual Layer DVD-Writer(16x +/-R) (& RW) + 40x CD-RW
- High-End Onboard 8 channel sound
- Network Facilities 10/100/1000 Network Card
- Internal 23 In 1 XD Memory Card Reader

Video Editing

Base Unit

- INTEL® Pentium® 4 630 (64 BIT) 3.0GHZ 800mhz FSB/HTT/2MB
- Memory 512 MB DDR400 PC3200 Lifetime Warranty!
- Hard Drive SATA 160Gb (7200rpm 8mb cache)
- Graphics Card Integrated SIS Real 256E Graphics
- High-End ASUS® Motherboard Dual DDR, S-ATA, x16 slot, 3 PCI, 3 PCI-EX
- Six USB 2.0 Ports (4 Rear + 2 Front)
- DVD Writer 4x +R Dual Layer DVD-Writer(16x +/-R) (& RW) + 40x CD-RW
- Sound Card High-End Onboard 6 channel sound
- Network Facilities 10/100 Network Card
- Floppy Drive 1.44Mb Floppy Disk Drive

- Black Stylish Case + 2 Front USB
- Power Supply & Cooling 350W PSU + 80mm Fan
- Microsoft® Windows® XP Home Edition

1 Year Return-to-Base Warranty + 1 Month Free Collect & Return

£439 inc. vat and delivery



... We'll Build it

Each system we build is as individual as the customer who ordered it. The samples shown here are just 5 of the hundreds of solutions you can build. Our web based system builder will allow you to create that ideal system you've always dreamed of. Don't know what you want? Then call us and we'll help you.

0845 226 4036
www.pcspecialist.co.uk



LCoS projectors

Projectors built round Texas Instruments' Digital Light Processing (DLP) chips have received so much attention that you could be forgiven for forgetting that there are other types available.

But Canon is still pushing its Liquid Crystal on Silicon (LCoS) models, and has just launched three in its Xeed range. The SX6 (pictured above), SX60 and X600 all use Canon's advanced AISYS optical system, which the company says allows them to be small for their class.

Canon claims the Xeed score over DLP models in having superior lenses and that it avoids certain image aberrations.

→ www.canon-europe.com

Win \$100,000

VMWare is offering a free version of software allowing a server to be compartmentalised into several virtual machines. VM Server is available as a beta download at www.vmware.com/products/server. The move follows the release of VM Player, a similar product for desktop machines, which the company says has had more than a million downloads in less than two months. It is offering a \$100,000 (£56,000) prize for the best 'virtual appliance' – that is, a preconfigured application using a virtual machine.

High contrast

LG has launched a range of LCD panels using a new technology called DFC (digital fine contrast), which provides a contrast ratio of 1,600:1 – more than double that of previous products. The effect is to make colours brighter and text sharper, the company said. The DFC-enabled L1780Q plus, L1980Q plus, L1770H, L1970H, L1932P and L1732P will be available in April.

Web calls increase spitting

Networks face a new threat with the growth of web telephony: spit (spam over Internet telephony), security experts warn.

Hackers who manage to get into Voice over IP (VoIP) call-management servers could use them to automate rogue calls in the same way PCs that are hijacked by Trojans, and linked to form botnets, are used to launch spam.

Instead of those emails inviting you to call sexy Sadie in Solihull, you might get Sadie herself calling you, or someone trying to sell you a timeshare in Baghdad.

'It's not happening yet, but it is something we talk about in our labs. It is going to happen and we should begin to prepare for it now,' said Johan Beckers, technical-solutions director at Internet Security Systems (ISS).

He points out that hacking has become more criminalised, with gangs threatening to knock out sites by swamping them with messages in denial of service attacks.

Beckers was speaking at a Netevents industry forum in Garmisch, Germany, where he was introducing ISS' suite of enterprise security products, which includes intrusion detection and prevention features.

VoIP transition 'will take 20 years'

Voice over IP (VoIP) could take 20 years to see off the old steam telephone, according to HP networking chief John McHugh.

The 'slow retirement' of the PBX phone shows how long network infrastructure takes to change, he told a Netevents forum in Garmisch, Germany. 'Every year, for at least five years, we have

been told VoIP is about to happen. It isn't.

'It is going to be a slow erosion [of legacy telephony] over 15 to 20 years,' said HP's Pro-Curve Networking's VP McHugh.

He predicted that by 2010 10Gbits/sec links to the desktop over copper lines would be available to a privileged few, but

1Gbit/sec would be sufficient for most links between company premises and metropolitan trunk lines.

Mobile roaming will be 'transparent and robust' and video calling from handhelds will be widely available and largely unused. 'That's because people simply don't want it,' McHugh said.

Councils plan to expand free Wifi access to all

Free wireless access services provided by local authorities are likely to proliferate over the next couple of years, according to a leading Gartner analyst.

Ian Keene, vice-president of research, said he could see a number of reasons councils could justify the cost of providing access. The networks could be used for surveillance systems, as well as for distributing public information, regeneration of run-down areas and messaging for emergency services.

Social services applications were likely to be the biggest winners because they attract central government funding. 'But the biggest push of all will come from politicians because they see votes in it,' said Keene.

He told a Netevents forum in Garmisch, Germany, that he knew of several local authorities that are currently considering the move. But he was unable to say if municipal networks would



Keene: Politicians see votes in public Wifi

predominantly use Wifi or Wimax. He also said that the frequencies used by both technologies are poor at penetrating walls, so the free networks would do little to close the digital divide by offering access to poorer homes.

In some cities networks would result from public-private

partnerships. In one case, a council got a free network by allowing its 'street furniture' such as lampposts to be used for cellular base stations, Keene said.

Others at the forum reported that the shortage of base-station sites have turned lampposts into money spinners.

1.6TB net drive for homes and offices

Intel has launched a network-attached storage unit with a capacity of up to 1.6TB, with a price and features that could find a market in homes and businesses.

The SS4000E takes four hot-swappable hard disks of any capacity between 80GB and 400GB, and will cost around €1 (68p) per gigabyte – so a 1TB drive will cost around £680. But the device will only be sold through resellers, probably rebranded.

It supports Raid levels 10, 5 and 1, though Dennis Stutterheim, product manager for Europe, said a simple GUI allows users to set it up for speed, maximum capacity, or failsafe data security even if they know nothing about Raid.

'You can put it off site, so you have a backup even if your place burns down,' Stutterheim said.

The box can act as a file server or media streamer, making it suitable as a repository for home video, TV recordings and family photographs. It will also mirror a

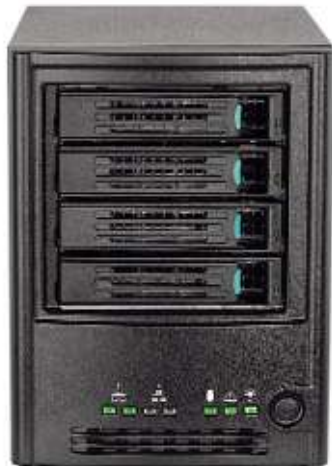

Intel SS4000E: up to 400GB of storage

disk on a laptop or desktop, or perform scheduled backups, and two USB2 ports allow USB drives to be shared across the network.

Clive Longbottom, service director of analysts Quocirca, liked the SS4000E so much that he bought one when Intel showed it off at the Netevents forum in Darmisch.

Canon shoots new SLR

Canon has launched a successor to its popular EOS 20D single-lens reflex (SLR) camera. It will be superseded by the EOS 30D, which retains the 8.2megapixel resolution of its predecessor, but has a wider 2.5in viewing screen.

The shooting rate can now be adjusted between three and five

frames per second, and sensitivity can be adjusted in one-third increments up to ISO 3200.

The EOS 30D is available from March at £1,099.99 for the body only, or £1,179.99 with an EF-S 18-55mm zoom lens. It can be used with all Canon EF and EF-S lenses and EX-series Speedlites.

Low-light camera shines bright

Fujifilm has fitted its latest Finepix F30 camera with its most sensitive sensor yet, going up to ISO 3200, allowing it to take pictures in very low light. Alternatively, faster shutter speeds can be used either to capture a fast-moving subject or to eliminate camera shake.

The maximum sensitivity of previous models was ISO 1600. The F30 has a 6.3megapixel sensor, a 3x optical zoom, a long-life battery lasting up to a claimed 500 shots, and a VGA movie-capture mode.

It will be available in May, but the price is yet to be announced.

NO LIMITS - NO HANGOVER



Simple, easy, effective.
Nuance software packages are ready to be appreciated...

Dragon NaturallySpeaking

The Voice Interpreter that recognises your voice as well as your accent. You dictate; it writes and instructs your computer...

PDF Converter

The PDF Editor you can trust. You think; it creates, converts, annotates...

OmniPage

The Document Converter that simplifies your life. You import; it converts and archives in PDF format...

PaperPort

The Document Administrator that provides reliable back up. You produce; it organises, classifies and searches for your (e-) documents...

Systran Translator

The Translator that stays faithful to you. You compose; it translates your words as well as your ideas...

PC WORLD dabs Insight MISCO
The Computer Authority .com The Best Deals on the Appointer
ebuyer.com amazon.co.uk
and you're done.

NUANCE.CO.UK

NUANCE

© Copyright 2006 Nuance Communications, Inc. All rights reserved.

Nuance, the Nuance logo, the PDF Converter Professional logo, the Dragon logo, OmniPage, PaperPort and Dragon NaturallySpeaking are trademarks and/or registered trademarks of Nuance Communications Inc. and/or its affiliates in the United States and/or other countries. Systran and the Systran logo are trademarks or registered trademarks of Systran. All other trademarks are the properties of their respective owners.

Laptops to use anything going

Laptops equipped with wireless links will be able to sense and use any public resource on any network within range under a system being developed by Fujitsu.

It is attempting to implement fully the ideas behind the UPnP standard, developed by the Universal Plug and Play Forum, which could mean laptop users no longer need to carry around peripherals such as printers, projectors and optical drives.

The most familiar example of the idea is the Wifi utility in Windows XP, which registers all networks within range and invites users to choose one.

The Fujitsu prototype system, called Task Computing, would also register other devices available in offices, hotels and airports. It can be used either to play or download music or videos and could also allow mobile devices to register and buy products in shows and automats.

In its current form, the interface – demonstrated at the Fujitsu Technology Forum in Windsor – is more suitable for engineers than end users. But in a commercial version it should allow you to, say, print a document simply by dragging its icon to that of the nearest printer.

The UPnP Forum is backed by 750 companies including IBM, Intel and Microsoft.

Robot escort

Fujitsu has start limited sales in the Japan of a robot called Enon that can escort visitors, run errands and act as a security guard, patrolling premises and relaying pictures.

The company showed at the Technology Forum a rather more engaging robot called HOAP-3 that could sit down and stand up without help, and (just about) kick a ball.

It was less successful at hitting a ball with a stick, so we look to be a long way from the golfing equivalent of the supercomputer that beats a chess grandmaster.

Check out some pictures of HOAP-3 at http://labs.pcw.co.uk/2006/02/robot_does_his_.html.

Signs are good for e-paper

Electronic paper (e-paper) developed by Fujitsu requires so little power that the colour image can be changed by the energy from a wireless signal.

Wireless power is not in itself new: smart cards using active RFID chips, like those in Oyster travel cards issued by Transport for London, are powered in this way. But screens are the most power-hungry component of most portable devices and a frugal, usable display would constitute a major advance.

PCW previewed the screen last year but Fujitsu showed a prototype for the first time in the UK at its Technology Forum in Windsor. Fujitsu puts it under the heading of e-paper because it is flexible and bistable, which means it retains its image between rewrites without drawing power.

The prototype was in a rigid frame but judging from pictures it can be bent round an arc of about 3in radius, which is not tight enough for use as a scroll-out screen in a pocket device. The brightness and colours fell far short of what you'd

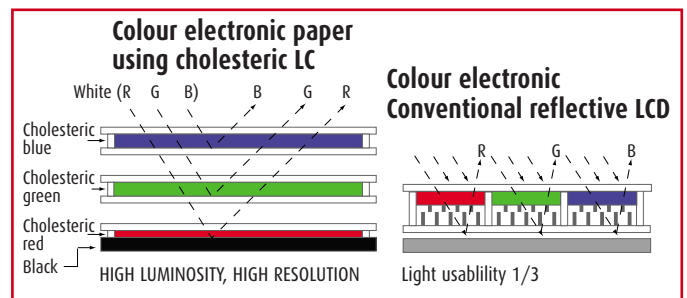

Above: Standard reflective LCD screens (right) use adjacent red, green and blue filters, each of which rejects the other two colours, wasting two thirds of the light falling on them

The Fujitsu screen (left) uses three layers of cholesteric liquid crystal (above left), which forms spiral structures that reflect different colours according to their pitch.

expect from paper, but presumably the quality will improve. The reflective screen does not require the power-hungry backlighting of transmissive LCD screens; it is also more efficient in its use of the light that falls on it (see caption).

Initial uses are expected to be in updatable information displays from price tags to timetables, but

Fujitsu says the screens will eventually be used in laptops and handheld devices.

The fact that they can be updated wirelessly does not mean they will be. Smart cards have to be close to their wireless power source and the available energy drops off rapidly with the square of the distance.

Phonecams capture hidden picture data

Camera phones can be used to capture web addresses and other information directly from printed pictures using a process developed by Fujitsu.

It used a technology called steganography to embed a 12-digit decimal number in a picture that is as small as a postage stamp.

Software on the phone reads the number and relays it to a server, which returns information relating to it; the data could be

anything from a web address to details of a product or location.

The data is invisible unless the image is enlarged, at which point it appears as coloured streaks. A camera phone at Fujitsu's Technology Forum read information from what looked like photocopies, showing the system is easily robust enough for the printed page.

Camera phones have been used to read bar codes. The BBC, in conjunction with HP Labs and

Gavitec, set up plaques last year carrying bar codes at 100 locations on the UK's coastline last year to coincide with the screening of the BBC 2 series *Coast*. Viewers could download software for Series 60 camera phones that could read the codes and retrieve information on the area.

However, Fujitsu says its system can be integrated more easily into the design of pages, adverts and business cards.

Mobile fuel cells 'within two years'

Methanol fuel cells could be used to power handheld devices within two years, according to researchers at the Technology Forum, where they showed off a prototype backup cell for mobile phones (pictured right).

Fuel cells offer clean energy and can be refilled with a methanol capsule, but re-usable cartridges that can be swapped for refilled ones may be used when products hit the shelves. Fujitsu says it has triple the energy



density of its cells and therefore the life between charges, since it started to develop them.

Get industry-leading software from Adobe and Macromedia® in **ONE BOX**

Introducing three new product bundles that will help you create rich interactive experiences and compelling content in print, on the web, in video and across mobile devices. Together, these bundles offer a powerful combination of tools and resources that will expand your creative options and help you start realising your ideas faster than ever before.



The Adobe Design Bundle offers the unified design environment of Adobe Creative Suite 2 Premium software with Macromedia® Flash® Professional 8 software, the industry's choice for creating advanced interactive content. Now with one package, you can design, develop, manage and deliver a consistent experience – using industry standards such as Adobe PDF and Macromedia Flash format – to millions of people around the world in print, on the web and on mobile devices.



The Adobe Web Bundle offers Macromedia Studio 8, the essential solution for web design and development, with the unified design environment of Adobe Creative Suite 2 Premium software. Now with one package, you can design, develop, manage and maintain rich interactive experiences for easy delivery to millions of viewers on the web, on mobile devices and in print using industry standards such as Macromedia Flash format and Adobe PDF.



The Adobe Video Bundle offers the powerful, Windows® based production toolset of Adobe Video Collection Professional with Macromedia Flash Professional 8 software, the industry's choice for authoring rich interactive content for the web. Now with one value-priced package, you can design, develop and produce professional results for film, video and DVD, plus easily incorporate video into interactive content for the web using the Macromedia Flash format.



© 2006 Adobe Systems Incorporated. All rights reserved. Adobe, the Adobe logo, Acrobat, Adobe Audition, Adobe Encore, the Adobe PDF logo, Adobe Premiere, After Effects, Contribute, Dreamweaver, Fireworks, Flash, FlashPaper, GoLive, Illustrator, InDesign, Macromedia, Photoshop, PostScript, PostScript 3 and Version Cue are either registered trademarks or trademarks of Adobe Systems Incorporated in the United States and/or other countries. All other trademarks are the property of their respective owners.

For more information please contact your local reseller

www.jigsaw24.com www.microanvika.com www.pcwb.com www.misco.co.uk
www.insight.com/uk/adobe www.macwarehouse.co.uk www.inmac.co.uk



In brief

**12GB 1in drive**

Seagate has announced a 1in portable drive offering 12GB of storage space, 50 per cent more than its previous minidrive, despite physically being 23 per cent smaller.

The ST1.3 drive uses perpendicular recording, in which the magnetic dipoles that represent each bit of data are stood on end rather than lying flat, allowing a greater data density.

These drives are designed as an alternative to flash in mobile phones, digital music and video players.

ID theft insurance

BT is offering its broadband customers insurance against ID theft. The initial cost is £44.99 for up to £50,000 cover. The price rises to £59.99 after the first 12 months.

The service monitors online activity and warns customers of suspicious activity.

But the consumer association Which? said ID fraud insurance is inspired marketing cashing in on public concern and is 'almost worthless' as banks are liable for the financial losses. *Dinah Greek*

Budget facelift

Serif has released Drawplus 8, the first new version of its budget drawing package in three years. It includes support for pressure-sensitive graphics tablets and pdf import. Drawplus 8 costs £79.99.

WW1 records

Details of soldiers who died in the First World War are available in a searchable index at the 1837 online family history site. Users can pinpoint exactly where a relative was killed or injured.

→ www.1837online.com

Email charges 'only for firms'

Service providers AOL and Yahoo are charging companies for allowing 'legitimate' promotional emails through spam filters. But they deny that the move is a prelude to charging for all email.

Charges have been suggested in the past as a sure way to stop spam, by making it financially unviable. Most spam relies on responses from a tiny fraction of thousands or even millions of recipients, and the costs (beyond those of buying mailing lists) are negligible.

AOL and Yahoo are charging between 0.25 and one US cent (about 0.15p to 0.5p), depending on the volume of mail, which would make spam costs prohibitive. But in any case spammers would not be allowed to sign up for the system.

The two operators have signed up to a system run by a company called Goodmail, which authenticates the source of an email to prevent spoofer and phishers posing as well-known companies to hoodwink customers. Charges will be paid by the sender and not the user.

An AOL spokesman said he believed the operator would take a proportion of the revenue but he did not know how much.

AOL also has a free White List system by which smaller firms can get trusted status by conforming to a set of rules, such as allowing their domain-name server to confirm the source of an email.

AOL says the Goodmail system will be available only to US and Canadian companies at first, though the authentication will benefit customers in Europe and

elsewhere. It will go live in the second quarter of this year.

But the move is not popular among some online vendors. Ling Valentine, owner of Lingscars.com, an Internet-based car leasing firm, said: 'This will not protect UK businesses and individuals from yet more spam; it just means that Yahoo and AOL make money from allowing this rubbish through.'

Jason Zimmel, owner of online health and beauty retailer, halfpriceperfumes.co.uk, said the system could anger both vendors and users. 'Responsible web retailers who send legitimate messages only to people who have asked to receive them are likely to suffer... especially if order confirmation and tracking emails are also affected.'

TDK snubs HD-DVD sales

A disc manufacturer involved in the battle between next-generation optical storage technologies is so confident of the outcome that it plans to produce only Blu-ray discs, ignoring the market for rival HD-DVD.

Vendors such as Imation are happy to sell both Blu-ray and HD-DVD discs while makers of the players and burners that use them fight it out in the market.

But TDK, one of the leading sellers of DVD discs, believes HD-DVD will lose because Blu-ray offers more capacity – 25GB per disc compared with 15GB.

Corporate strategy director Jean-Paul Eekhout said Blu-ray will also get a big boost with the release of Sony's Playstation 3 games console, and from the fact that it will have burners on the market before HD-DVD vendors. But he admitted that TDK could miss out on HD-DVD media sales.

TDK, a member of the Blu-ray Association, will offer both read-only and rewritable discs, known respectively as BD and BD-RE media – the RW suffix of

previous disc generations has been dropped, apparently for the benefit of non-English speakers, to whom it makes more sense than an acronym based on the silent 'w' in 'writable'.

Blu-ray capacities and read-write speeds are expected to increase quickly after the first drives are launched.

Eekhout said TDK had already produced four-layer discs capable of storing 200GB.

He demonstrated a hard coating TDK is giving its discs to protect BD data. It sits far closer to the surface than on CDs and DVDs.

He rubbed both a standard disc and coated one with wire wool, showing how one was scratched and the other was not.

Eekhout admitted that BD media manufacturers required more investment than HD-DVD discs, which supporters say can be made in DVD plants.

But he said HD-DVD would also need some investment and that the difference would not be reflected in the prices of the media.



Media PCs

Sony has launched an all-in-one Media Center PC, the Vaio VA1 (pictured), that lacks any of the cutting-edge style associated with the Vaio range. The 2.8GHz £1,500 machine has a 250GB hard disk drive, a dual-layer DVD rewriter, and a 20in screen.

Meanwhile, Elonex has taken the wraps of its Lumina Media Center PC, one of the first to use Intel's new Viiv platform.

The all-in-one Lumina 3 resembles a large flat-screen TV and can be table-mounted or hung on the wall. It comes with a choice of 40in or 32in LCD panels and uses an Intel dual-core processor, 1GB of DDR2 memory and a 500GB hard drive, with an option to add another drive up to 120GB. Prices will start at about £2,500 for the 32in version.

Your chance to win Amazon vouchers

Although *PCW* is the UK's oldest and most authoritative monthly computing magazine, we haven't achieved this remarkable feat by magic. We listen to all your comments and criticisms and regularly update the magazine to reflect your changing technology needs.

One way we accomplish this is by getting direct feedback from you in our regular reader surveys, and it's time for us to once again ask for your help.

We want to know about your technology buying plans for the coming year and the factors that influence your choices for a range of products and services. We've compiled a



amazon.co.uk

simple online survey that should only take you about 10 minutes to complete.

In return for your valued help, every reader who completes the

survey will be entered into a draw to win a first prize of a £250 Amazon voucher. There'll also be a £50 Amazon voucher for three lucky runners-up.

So if you want to help influence the future content of *PCW*, now's your chance. Just log on to www.pcw.co.uk/buying for your chance to win.

TELL US YOUR PLANS: www.pcw.co.uk/buying

DrayTek Broadband Firewall/Routers



Vigor3300V

Make free Internet Voice Calls!

VigorTalk for DrayTEL
www.draytel.org



Vigor2900

DrayTek routers and firewalls provide a vast array of essential and advanced features, designed around users needs. The new Vigor2800 series provides compatibility with the latest ADSL2+ lines, as well as enhanced security, content filtering, VPN, 108Mb/s wireless and Voice-over-IP. Also available is the Vigor2900 series for cable modem users and the new Vigor3100 router/firewall for SDSL.

The new Vigor3300V is a high performance firewall, VPN concentrator and VoIP (Voice-over-IP) device. Stateful Firewall, load balancing, content filtering, up to 200 VPN tunnels and up to 8 VoIP ports. (Due March).



Vigor3100 SDSL



Vigor2800 Series

DrayTek VoIP-equipped routers let you use your broadband line to make and receive voice calls. Calls to any other VoIP-equipped users are completely free and you can make calls to regular phones via DrayTEL with national & international calls from just 1p/min.



Available from
SEG
020 8381 5500
VoIP : 800800@draytel.org

For full details of all models visit
www.draytek.co.uk

Specification subject to change. Facilities vary with model.

IN THIS SECTION

- 26 LETTERS
- 30 THE ADVISER
- OPINION
- 33 Gordon Laing
- 34 Barry Fox
- 36 Guy Kewney

LETTERS

➔ Send your letters to The Editor, PCW, VNU Business Publications, 32-34 Broadwick Street, London. W1A 2HG.

Send your email to letters@pcw.co.uk

★ LETTER OF THE MONTH

Broadband underclass

Spare a thought for those poor souls without broadband. We rural folk, deep in Norfolk, 12 miles from Norwich, have to rely on dial-up Internet. This makes updating Windows and so on a real chore.

BT claims more than 98 per cent of the UK can get ADSL, a figure our group, Lyng Area Broadband Group, disputes. Although the local exchange is enabled, the village is served by a very poor copper connection. If one lives next to the BT cabinet, broadband is available, but 20m away there's no chance. Trying to talk to anyone at BT is difficult with no local numbers to phone, only distant indifferent call centres. We have opened discussions

with officials at BT's Newgate HQ but to no avail. They have told us rural trials to extend coverage are taking place and we have invited them to try our area. BT won't because it knows the infrastructure is so poor.

In the near future the local primary school will have a fibre-optic VPN link installed. What about those children, as well as the others in secondary and further education in the area, who need a decent Internet service? If BT is installing one cable, it wouldn't cost much to upgrade and put another in alongside.

We pay the same line rental as others, so why do we get an inferior service? Pete Clough

PCW TOOLBOX

A few years ago I used the open-source My HTPC as an entertainment system front end; I then moved onto Meedio. Latterly I decided to have a shake-up and build my own Media Center PC. I built a system but Windows MCE didn't like the hard disk on several occasions.

The TV card needed extra drivers and Registry hacks to make it work and all this took a long time to get working.

Then after a period of operation, it would turn itself off. After lengthy investigation I found it was a memory fault.

Computers are tricky things. In the car industry, manufacturers state that users can maintain certain parts – in the case of one car I owned the manual stated that I should only touch the yellow bits. The same principles could be applied to IT products. If you want a user to try a few things, a level of competence must be ascertained and a set of standardised tools is vital.

As a well-respected magazine, would you consider putting

together a set of tools for hardware problem isolation? Encouraging people to build their own machines is commendable, but can you help us further by publishing the diagnostic tools that will help to isolate issues, should they occur? A standardised test procedure from a creditable source that could isolate a specific faulty component will help consumers and suppliers alike.

The majority of consumers and retailers don't want the hassle involved with fault finding as this can lead to friction and unsolved problems. The PCW hardware test could solve all of this. Have I sold it to you yet? Alex Hill

Kelvyn Taylor replies: It's certainly an idea we'll look into.

MEGAPIXELS BUT MINIBUCKS

Gordon Laing's column in the March issue posed what seems a sensible question, but in my opinion we consumers are now 'hoist by our own petard'.

A recent trip to Jessops to purchase a Canon EOS 350D following your recommendation brought home to me that we are all victims of the march of technology marketing and the law of diminishing returns.

In past years I have upgraded film SLRs by trading in my existing but ageing model. Not so this time!

About two years ago and again following your recommendation, I bought an Olympus C-4040ZOOM. From memory the price was over £650. The camera is excellent but has a relatively small eyepiece and as I

Mr Johnston found it impossible to do a part exchange when buying the Canon



Unless otherwise stated, letters sent to the Editor, PCW team or contributors will be considered for publication. Letters may be edited for clarity or length.

now wear spectacles this causes me some difficulty. I did not expect to be offered a massive amount for the camera, but as soon as the assistant saw that it was a 4.1 megapixel model he smiled and said they could offer nothing for the camera despite its mint condition. 'We could never sell it' was the blunt reason.

In line with Gordon's article, I would defy anyone but a professional to tell the difference between the results achieved by the Olympus and cameras with many, many more megapixels.

It is to your credit that the issue is highlighted and a campaign by yourselves and other magazines is needed to overturn the public perception of the megapixel myth.

John G Johnston

BETTER NEVER LATE

My McAfee virus scanner has taken to updating its definition files every day. The company is presumably in the US and publishes its new file late on in my business day; I log on to collect my email on my laptop when on the train the following morning and don't wish to run up a huge mobile phone bill downloading large files.

That should be OK in theory because I can choose to download later but the only offerings are two or four hours later and not at a time of my choice.

If I log on to check emails after lunch I am bothered by the notification all over again. There is a choice to manually check and not be reminded, which sort of overcomes the problem.

I tried to inform McAfee of the problem but this proved to be impossible. I set up a chat session with an 'agent' but it turned out that I was really just talking to a computer. It seems that these software companies have no real means of finding out what is wrong with their products – their FAQs are presumably developed from questions they think people would wish to ask and if you ask or suggest anything different there is no way for them to know.

Peter W Bradshaw

SKY+ USB PORTS

I have just enjoyed reading Nigel Whitfield's article on PVRs (*PCW*, April 2006).

I own the Sky+160 PVR which – like some of the non-Sky machines you describe – also has a USB port on the back. Neither the instruction manual nor the installing Sky engineer can tell me what it is for.

Currently, in order to transfer recorded material to my PC, I connect the Sky+160 S-video output to the S-video input of a Leadtek Winfast VC100 video capture card which I have to say does a pretty good job.

However, it would presumably be even better if I could transfer recorded programmes in digital quality either direct to the PC or to my external USB2 hard drive. Is accessing recorded material on the Sky+160 possible using this USB port?

R G Willis

Kelvyn Taylor replies: As far as we can tell, the USB ports on the Sky+160 box are currently disabled. They are presumably intended for hook-up to future portable devices or external storage.

PET HATE NUMBER 2

I have worked in software development for 16 years. The companies I have worked for have had development processes that range from rigorous to plain cavalier; however, in all of them someone has at least thought about whether the application would work under restricted logins. So why is it that a number of software packages I have recently bought for my PC refuse to work under anything less than the administrator login?

This just seems sloppy to me and doesn't bode well for the quality of the software; Windows has supported multiple users for well over a decade now and we are constantly bombarded by viruses and spyware only too happy to take advantage of a powerful login, so you would think that some effort would be made to test under a restricted



The Topfield AH4 PVR GT is a recommended hard disk PVR

user. I have vowed to return the next piece of software that does this, much to my children's dismay as it's mostly their games that are the offenders.

By the way, pet hate number one? Progress bars that don't indicate accurate progress!

Kevin Roche

COME THE REVOLUTION

Communications and entertainment are on the brink of revolution with the launch of digital TV and radio, and I want to be part of it. We now have the ability to receive information, entertainment and news via the Internet, then view it at a time and place that we choose.

However, like a lot of people in the UK, I live in an area which is a communications 'black hole'. I cannot get digital broadcasts; I cannot get cable; I will not be able to see HDTV and I cannot even receive Channel 5! The only way I can see some of them is via satellite. But this content is all on the Internet (or soon will be).

To do all this, I believe I will need a wireless router attached to my PC and wireless receivers fitted to the TVs and radios. But what else? What limitations are there? What will all this cost? Is there a package solution already out there or are we still in the pioneering DIY days?

This is something that I think *PCW* can take the lead on. Over to you!

Tony Rix

FILLING THE FREEVIEW HOLE

Like Nick Hawryliw (*Letters*, March 2006), I am one of the many who live in a location (central Bath) with poor

terrestrial analogue TV reception and no Freeview. This area is also without any cable TV service. You would have thought the cable companies would have had the sense to cable areas with poor terrestrial reception, but no.

The best answer I have found to this problem is the Freesat service provided by Sky. Install a dish and a digibox, pay a one-off sum of £20 and you get virtually the same range of channels as Freeview, but with excellent reception.

The only problem is finding a PVR you can buy rather than rent – any chance of some tips on building one?

Geoff Hoults

Kelvyn Taylor replies: As you will have seen from our 'PVR tips and tricks' feature in the April issue, there are a now several good hard disk PVRs on the market, from manufacturers such as Panasonic, Humax and Topfield.

WIN The letter of the month will win a copy of Corel Paint Shop Pro X



This powerful image-editing package has an intuitive interface making it suitable for beginners but, thanks to the huge range of tools available, it will also keep advanced users happy. You can fix flaws such as red-eye as well as perspective and other settings. The package also includes Corel Photo Album to import and sort photos direct from your digital camera. For more information on Paint Shop Pro X, go to www.corel.co.uk.



Best PC Firm 2004



Best PC Manufacturer 2001-2003
Company of the Year 2004



Best Computer
Manufacturer 2001-2003



Best Laptop Performance
Award 2003 & 2004
Best Service and Support 2005



Best PC Service &
Reliability 2001-2003



Brand of the Year
2003 & 2004

"Packed with features, great price" Computer Buyer, Recommended

Home theatre-quality mobile entertainment

AMD Turion 64 mobile processor

1.3M pixel camera with rotation

Fingerprint reader



GOLD 3YR WARRANTY

COMPUTER BUYER RECOMMENDED



- 9 cell Li-Ion battery (life up to 3 hrs approx)
- 4xUSB2.0, Firewire, VGA, TV-out, DVI, PCMCIA, Express Card, IR, 10/100/1000 LAN
- Weight - 2.9kg, Dimensions - 358x259x33mm
- **Gold 3 year warranty** - 1st & 2nd year in-home service (parts & labour), 3rd year return-to-base (parts&labour). National rate telephone support & BigFix pre-emptive support.

Quest A420 PLUS

e-CODE:QU1106



- AMD Turion 64 Mobile Technology MT-37
- Genuine Windows® XP Media Center Edition 2005
- 256MB ATI Mobility Radeon X1600 graphics
- 15.4" WXGA X-Bright widescreen display (1280x800)
- 1GB DDR RAM 333MHz
- 80GB 5400rpm hard drive
- DVD/CD-RW/Dual Layer DVD-RW drive
- Wireless Mini PCI 802.11bg (54Mbps) LAN & Bluetooth
- Fingerprint reader
- Built-in audio and speakers
- 6 in 1 card reader (SD, MMC, MS/Pro, XD, SM)

£999 inc VAT (£850.21 ex VAT)



BRONZE WARRANTY

Latest Intel Technology



Radeon X1600
Graphics

GOLD 3YR WARRANTY



GOLD 3YR WARRANTY

Quest A215

e-CODE: QU1091

- Mobile AMD Sempron processor 3000+
- Genuine Windows® XP Home Edition
- Integrated graphics
- 15" XGA display (1024x768)
- 512MB DDR RAM 333MHz
- 60GB 5400rpm hard drive
- DVD/CD-RW drive
- Wireless Mini PCI 802.11bg (54Mbps) LAN
- Built-in audio and speakers

£599 inc VAT
(£509.79 ex VAT)

Upgrade to Silver
3 year warranty
£29.99

- 6 cell Li-Ion battery (life up to 3hrs) • 4xUSB2.0, VGA, PCMCIA, & 10/100 LAN
- Weight - 2.9kg, Dimensions - 326x277x36.7mm
- **Bronze 1 year warranty** - 1 year return-to-base service (parts & labour). National rate telephone support.

Voyager C550

e-CODE: VY1538



- Intel Centrino Duo Mobile Technology:
Intel Core Duo processor T2400
(1.83GHz, 2MB L2cache, 667MHz)
- Genuine Windows® XP Media Center Edition 2005
- 256MB ATI Mobility Radeon X1600 graphics
- 15.4" WXGA X-Bright wide screen display (1280x800)
- 1GB DDR II RAM, 667MHz (2x512MB)
- 80GB hard drive
- DVD/CD-RW/Dual Layer DVD-RW drive
- Wireless Mini PCIe 802.11abg (54Mbps) LAN
- Built-in audio and speakers
- 4 in 1 card reader (SD, MMC, MS/Pro)

£1149 inc VAT
(£977.87 ex VAT)

- 8 cell Li-Ion battery (life up to 3hrs approx) • 4xUSB2.0, Firewire, VGA, DVI, TV-out, PCMCIA, 10/100/1000 LAN
- Weight - 2.9kg Dimensions - 354x284x35.2mm
- **Gold 3 year warranty** - 1st & 2nd year in-home service (parts & labour), 3rd year return-to-base (parts&labour). National rate telephone support & BigFix pre-emptive support.

Voyager C720

e-CODE: VY1504



- Intel Centrino Mobile Technology:
Intel Pentium M processor 760
(2GHz, 2MB L2 cache, 533MHz)
- Genuine Windows® XP Media Center Edition 2005
- 256MB NVIDIA GeForce Go 7800 GTX graphics
- 17" WXGA X-Bright wide screen display (1440x900)
- 1GB DDR2 RAM 533MHz (2x512MB)
- 80GB S-ATA 5400rpm hard drive
- DVD/CD-RW/Dual Layer DVD-RW drive
- Wireless Mini PCI 802.11abg (54Mbps) LAN
- Virtual 8 channel audio and speakers
- Built-in media card reader (MS/Pro, SD, MMC)

£1399 inc VAT
(£1190.64 ex VAT)

- 8 cell Li-Ion battery (life up to 2hrs approx) • 4xUSB2.0, Firewire, Serial, VGA, DVI, S/PDIF out, parallel, TV-out, PCMCIA & 10/100/1000 LAN
- Weight - 3.8kg Dimensions - 397x293x44.9mm
- **Gold 3 year warranty** - 1st & 2nd year in-home service (parts & labour), 3rd year return-to-base (parts&labour). National rate telephone support & BigFix pre-emptive support.

FREE Vodafone 3G/GPRS Mobile Connect data card FREE on all Evesham Intel & AMD notebooks!**

- Send email, access the internet from almost anywhere*
- A simple user interface to get & keep you connected

* Subject to network coverage and availability

**The 3G service may be affected by: The number of users accessing the 3G network in your cell. The strength of signal & your distance from the nearest antenna. Factors outside our control, such as atmospheric conditions. Vodafone, the Vodafone logo and Vodafone Mobile Connect are trademarks of the Vodafone Group.



SOFTWARE INCLUDED



•Roxio Easy Media Creator 7 CD/DVD creation, video editing and DVD playback software



•BullGuard Internet Security Anti-virus with FREE 90 day updates - plus firewall & online backup.

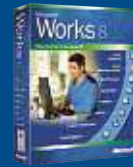

•Microsoft Works 8 Word processor, spreadsheet and database applications

"A beautifully balanced PC" PC Pro, A-List



"Quality components throughout"

The experts at PC PRO placed the Evesham Axis RD PLUS top of The Labs A-List £799 PCs.

The Axis was the clear winner combining outstanding performance, features and comprehensive warranty.

ATI CrossFire Multi-GPU Ready

Keep ahead of fast-moving gaming effects and technology changes with CrossFire's advanced features



Upgrade to 2nd ATI X800GTO CrossFire graphics £99.99

- Midi tower case (453x222x495mm) 6xUSB2.0 & 10/100 LAN
- Logitech internet Pro cordless keyboard & mouse
- Gold 3 year warranty - 1st & 2nd year in-home service (parts & labour), 3rd year return-to-base (parts&labour). National rate telephone support & BigFix pre-emptive support.

Axis RD A-List

e-CODE:AX1251

- AMD Athlon 64 X2 processor 3800+
- Genuine Windows® XP Media Center Edition 2005
- 1x 256MB ATI Radeon X800GTO CrossFire graphics
- 17" Viewsonic VX715 flat panel TFT display (8ms response)
- ATI Radeon Xpress 200 Crossfire motherboard
- 512MB dual channel DDR RAM (PC3200) 400MHz (2x256MB)
- 200GB Serial ATA hard drive with 8MB buffer
- 16x DVD-ROM
- Multi Format Dual Layer DVD Writer (16x)/CD-RW (40x) drive
- On-board audio
- Creative I-Trigue 3220 2.1 speakers
- Optional floppy drive & modem

Dual Core Processor



£938.83 inc VAT
(£799.00 ex VAT)



Creative I-Trigue 3220 2.1



17" TFT

Axis XTR

e-CODE: AX1528

- AMD Sempron processor 3000+ 64 bit
- Genuine Windows® XP Home Edition
- Direct 2D/3D graphics (on-board)
- 17" flat panel TFT display
- 512MB DDR RAM (PC3200) 400MHz (2x256MB)
- 160GB 7200rpm hard drive with 8MB buffer
- Multi Format Dual Layer DVD Writer (16x)/CD-RW (40x) drive
- On-board audio
- Optional floppy drive & modem

£499 inc VAT
(£424.68 ex VAT)

- Mini tower case (411x175x398mm) 4xUSB2.0 & 10/100 LAN
- Internet keyboard & optical wheel mouse
- Bronze 1 year warranty - 1 year return-to-base service (parts & labour) National rate telephone support.



Family, Home/Office

Axis SB

e-CODE: AX1254

- AMD Athlon 64 3000+ processor with HyperTransport technology
- Genuine Windows® XP Media Center Edition 2005
- ATI Radeon Xpress 200 series graphics (on-board)
- 17" flat panel TFT display
- ATI Radeon XPRESS 200 chipset motherboard
- 512MB dual channel DDR RAM (PC3200) 400MHz (2x256MB)
- 160GB 7200rpm hard drive with 8MB buffer
- Multi Format Dual Layer DVD Writer (16x)/CD-RW (40x) drive
- On-board audio
- Optional floppy drive & modem

£629 inc VAT
(£535.32 ex VAT)

- Mini tower case (352x180x365mm) 4xUSB2.0 & 10/100 LAN
- Logitech keyboard & optical wheel mouse
- Silver 3 year warranty - 1 year in-home service (parts & labour), 2nd & 3rd year return-to-base (labour). National rate telephone support & BigFix pre-emptive support.



Shown with widescreen VA1912w not included



X1900 XT Graphics

Axis Vulcan

e-CODE: AX1252

- AMD Athlon 64 FX-57 processor
- Genuine Windows® XP Media Center Edition 2005
- 512MB ATI Radeon X1900 XT graphics
- Monitor not included
- ATI Radeon Xpress 200 CrossFire motherboard
- 1GB dual channel DDR RAM (PC3200) 400MHz (2x512MB)
- 320GB Ultra Fast 7200rpm hard drive with 8MB buffer
- DVD-ROM (16x) drive
- Multi Format Dual Layer DVD Writer (16x) / CD-RW (40x) drive
- Sound Blaster X-Fi XtremeMusic sound card
- FREE Creative headphones**
- 1.44MB Floppy drive with 7-in-1 card reader

£1799 inc VAT
(£1531.06 ex VAT)



FREE Creative Headphones with every X-Fi Evesham PC

**Limited availability while stocks last

- Brushed aluminium case (510x205x457mm) 6xUSB2.0 & 10/100/1000 LAN
- Logitech Internet Pro cordless keyboard & mouse
- Optional modem
- Gold 3 year warranty - 1st & 2nd year in-home service (parts & labour), 3rd year return-to-base (parts&labour). National rate telephone support & BigFix pre-emptive support.

Call 0870 160 9530

Click www.evesham.com

To contact your nearest store call 0870 160 9800

Altrincham | Birmingham | Bournemouth | Bristol | Cambridge | Evesham | Glasgow | Ipswich | Leeds | London | Norwich
Milton Keynes | Nottingham | Peterborough | Reading | Southampton | Swansea | Tunbridge Wells

THE ADVISER

COVER YOURSELF

- Keep good records; store all receipts in one safe place as proof of purchase is vital.
- Create a folder in your email client to store emailed receipts – and print a copy. Print spec sheets from websites as proof of an order.
- Get written quotes specifying components used.
- Use a credit card for purchases of £100 or more – credit card companies are liable if the vendor goes out of business.
- Do not try to repair faults – this invalidates your rights in the majority of cases.
- Think before buying expensive hardware outside the EU, because if something goes wrong, enforcing your rights is difficult. Shipping faulty kit back will be costly.

- Never cancel a direct debit or standing order as a means to resolve a dispute over payments or service. You may get a poor credit rating and face court action.

HOW TO COMPLAIN

- Keep records of who you speak to, along with any paperwork and emails.
- Stay calm – companies will respond defensively to abuse and shouting, regardless of whether you are in the right.
- If the dispute reaches an impasse, insist on escalating the complaint. Get a director's name and send correspondence by recorded delivery.

TWO-YEAR WARRANTY

I heard on a BBC Radio 4 programme from a Member of the European Parliament (MEP), who said that he was part of the body that created the law that all electrical goods should come with a minimum two-year guarantee. He said that most goods in the UK were not sold with such a guarantee and so UK retailers were breaking EU law. Is this true?
Kevin Boyd

In a word, no. Mr Boyd was unable to provide us with the name of the MEP in question, so it has not been possible for us to check the specific comment. However, we believe that we have got to the bottom of what may have been meant by such a comment, and can certainly give some guidance on manufacturers' guarantees.

We spoke to David Sanders, lead officer for civil law at the Trading Standards Institute, who said he believed the issue of two-year guarantees had arisen during talks on the EU Directive that was implemented in the UK as the Sale and Supply of Goods to Consumers Regulations 2002. 'There was talk of the two-year limit in consultation, but it never made it into the legislation because it wasn't practical. Establishing that guarantees were enforceable was more important, as some EU states had nothing like the Sale of Goods Act,' said Sanders.

The Regulations tidied up many aspects of consumer law across Europe and provided a minimum standard of protection for countries that had little or few statutory measures. One important feature of the Directive was

PCW GIVES ADVICE ON YOUR RIGHTS

➔ Send details of your dispute to theadviser@pcw.co.uk. Please provide a daytime telephone number so we can contact you if necessary.



The EU Directive does not impose a minimum lifespan on electrical goods

the standardisation of manufacturers' guarantees. In the UK, it had long been accepted that a manufacturer's guarantee, if offered (and it is not obligatory for product makers to offer formal guarantees) was enforceable as part of the contract of sale under the Sale of Goods Act. This was not the case in other member states.

What the Directive did not state was a minimum duration of guarantee for specific types of goods. The reason for this is that it is simply not possible to set a standard for such a broad family of products. We may think that it's reasonable for a PC to last a guaranteed minimum of two years, but could you apply the same standard to an electric razor? As with all products, durability is reliant on use.

There is a misconception that everything we buy comes with a one-year warranty. This is not so – the legal measures that protect us when we buy are enforceable against sellers, not manufacturers. The rise of Internet selling, with companies trading fast at low margins, has blurred this line.

Manufacturers' warranties are an added protection, but can be enforced if offered.

Visit www.dti.gov.uk/ccp/topics1/guide/saleshort.pdf for a user's guide to the regulations.

RETURN TO SENDER

I purchased a Buffalo wireless router from Dabs in November, but did not open the package as it was intended as a Christmas present. When I eventually tried to set it up, the wireless bit wouldn't work. I contacted Buffalo technical support, which advised me to return it to the retailer. I went through the returns procedure and returned the router at a postage cost of nearly £10 through the Dabs website. Dabs agreed that the router was faulty and has credited me with the cost of the router, but not the money I had to pay to return it. According to your article in the March issue courier fees should also be refunded as consumers should not lose out financially.
Elwyn Watkins

Dabs is still looking into this case for us, so we'll report back next issue. But if the company agreed that the goods were faulty and asked Mr Watkins to send them back, then it should refund the postage cost. You should open all goods and test them directly after delivery.

The Sale of Goods Act states that consumers should not be financially penalised for repairing faulty goods. We've found that some online retailers, which work on very low margins, seem to believe that this doesn't apply to them on the grounds that they can't afford it. This is not the case, but we fear that a significant number of *PCW* readers may have lost out on postage to companies that simply refuse to honour their legal responsibilities. We're planning a survey to find out – more details when we have them.

CASE UPDATE – DELL

In the January issue, the Adviser reported on John Matchett's problems with Dell after he ordered an XPS PC and didn't receive the installation and network setup he had paid for.

Dell promised to fix things, but when we last updated the case a couple of months ago the problem had still not been resolved. The days have got longer since then, and still the hours of sunlight fail to stretch as far as Mr Matchett's patience. He emailed us to say that Dell has finally installed all the equipment. Well, almost. He's still waiting for the memory card reader, but you can't have everything.

CONTACT THE ADVISER

If you're involved in a serious dispute with a seller, send us a brief description of your complaint, name the company involved and provide an order number or other information that we can use to identify your order with the company. We cannot guarantee to resolve your dispute but we will try. We obviously cannot take on every case, but the answers we give should help readers to resolve their own disputes.

You can also get advice from Consumer Direct, a DTI-backed agency, at www.consumerdirect.gov.uk.

No way out of domain maze

I have lost the domain for my six-year-old website because Easyspace, the company I paid to renew it, failed to secure the name. The domain has now been bought by a domain speculator, who has since offered to sell the name back to me for £5,000. I have asked the company to pay the fee to get my website back, but it has offered only the return of my renewal fee and a new domain name. David Partridge

Easyspace has accepted the blame for failing to renew the website name, but said Mr Partridge did not inform the company that the domain had been lost until it was almost too late to retrieve it.

The renewal of a .info top-level domain (TLD) goes through three stages: post-expiry, a 30-day period when the domain is fully functional and can be renewed; redemption, a 40-day period when the domain is unavailable, but returns valid responses regarding the owner in Whois searches, and can be recovered for a fee; and pending delete, when the owner has only five days left to pay for the renewal.

Domain name speculators buy lapsed website names and resell them.

Mr Partridge's .info TLD falls under the administrative remit of ICANN (Internet Corporation for Assigned

Names and Numbers). The body offers mediation in the form of the Uniform Dispute Resolution Service for domains where ownership is in dispute under TLDs it manages. See www.icann.org/udrp for details.

Edward Phillips, company solicitor for Nominet, which administrates the .uk TLD, said Mr Partridge would be unlikely to succeed because ICANN has only taken back domain names when they have featured a trademarked word or brand name belonging to a company. 'The market in deleted domain names is big business and generic names are a particular target as they have no protection under the UDRP,' said Mr Phillips.

The case is complicated by the fact that www.maze.info was run as a small-business website. That means there is no recourse to consumer protection law. Mr Partridge could sue Easyspace for breach of contract, where he has a strong case. However, he has decided not to pursue it and has now registered www.greatmaze.info instead.



KNOW YOUR RIGHTS

- In England and Wales, the retailer must prove that faults found within six months of purchase are not inherent.
- Consumers should not suffer financial loss in order to repair a faulty item, so postage and courier fees should be claimed back if the fault is inherent.
- Companies are not obliged to repair goods damaged by accident or misuse.
- The contract of sale is between the buyer and the company that accepted your money. It can be quicker to deal direct with manufacturers, but do not let resellers bully you into this.
- Goods ordered online, by post or phone can be returned within a reasonable time under the Distance Selling Regulations. This is widely accepted as being seven days.
- Companies cannot charge for services they fail to deliver, regardless of any contract you have signed – the contract goes both ways.
- Benefits provided under extended warranties are an addition to your statutory rights, so buying one does not invalidate your consumer rights under legislation.
- Online auction sellers are only obliged to ensure goods are described accurately. However, individuals selling more than one of an item, and those listed as power sellers, may be classed as businesses rather than individuals.
- For more detailed information on consumer law in England and Wales, visit www.ofc.gov.uk/ consumer. In Scotland, visit www.scotscourt.gov.uk.

POWERFUL • INTEGRATED • RELIABLE • SILENT
Don't just run windows, fly it with Panrix AMD Dual Core...

Ultimate Silent Performance Systems

Panrix IQ Cube 3800X2

Specifications:

AMD Athlon 64 X2 Dual-Core 3800 + S939
Gigabyte GA K8N51GMF-9 NF4 S939 PCI-E
uATX DDR400 SATA USB2/1394 7.1Ch Audio
256Mb Sapphire PCI-E ATI X800GT GDDR3
VGA TV DVI Graphics Card
1GB Corsair PC3200 DDR400
300GB SATA Maxtor Diamondmax 6L300S0
Hard Disk
Pioneer DVR-110D DVD Writer
ViewSonic VX924 19in TFT 1,280 x 1,024
Antec Aria MicroATX Cube Case

£815.00 ex. VAT
£957.63 inc. VAT

Panrix Magnum 3700

Specifications:

AMD Athlon 64 3700 32/64Bit CPU S939
Asus A8N-SLI , ATX, DDR400, PCI-E, Gbit
Lan, USB 2.0, 1394, 8ch Audio, 4 x SATA, Raid
nVidia GeForce 6600GT/128MB XFX PCI-E
Graphics Card
1GB PC3200 DDR400
250GB Samsung SP2504C Hard Disk
16X DVD+/-R Samsung SH-W162C DVD Writer
LG L1950SQ 8ms 19" 1280x1024
Jou Jye NU4292 Silver/Black ATX / 300W Power
Supply

£594.89 ex. VAT
£699.00 inc. VAT



Tel: 0870 027 1981
Fax: 0870 027 1984
sales@panrix.co.uk

Full range of systems
available at our website



Panrix Ltd Unit 19 Sheepscar Street South Leeds LS7 1AD

www.panrix.co.uk

Gordon Laing



gordonl@pcw.co.uk

Mobile Macs could cut consumption

The use of mobile processors in Apple's new Intel Imacs could usher in a new era of energy-saving PCs, thinks Gordon Laing

When Apple announced it was going to use Intel processors in its latest range of Macs, I was curious to see which models it would go for. Sure, the laptops would use mobile processors, but what about the desktops? The assumption was that the Mac engineers would pop a Pentium inside.

But they didn't. When Apple launched the first Intel-based IMac earlier this year, it housed the new Core Duo which is a mobile processor. Did Apple know something PC manufacturers didn't? Annoyingly this is the kind of question which Apple rarely comments on. During the Intel announcement last year, Apple boss Steve Jobs spoke about wanting the best performance per watt, but beyond that, Apple's technical decision-making processes aren't discussed.

'If your PC is switched on all day, cutting your power by half can really save money'

Of course by talking about performance per watt, most people assumed Jobs was referring to mobile platforms. So everyone looked forward to new Mac portables, but assumed the desktop line would adopt traditional processors.

In terms of marketing, anyone unfamiliar with Intel's branding would assume the new Imacs do in fact use a traditional desktop processor. After all, the name Core Duo certainly doesn't imply a mobile architecture, but it's the same processor in the latest PC and Mac laptops, and a visit to Intel's website will tell you about its battery-saving advantages. So why use a mobile processor in a mains-powered desktop?

The answer is because Intel's mobile architecture makes a fantastic desktop platform. Anyone who's been reading my Hands on Hardware column (see page 124) will know I'm a big fan of using the Pentium M in desktop systems. It's fast, runs cool and the battery-saving technologies allow it to run on less than half the power of a typical desktop. Sure, the chip itself and a desktop motherboard to house it may cost more than a Pentium 4 or Athlon64 system, but the benefits are clear – I've been using one in my Media PC for a year and it's worked like a dream

One of the most impressive aspects of using a mobile processor in a desktop is its modest power consumption. In my Hardware column I've measured the power consumption of my Pentium M system at around 60w when idle and rarely over 80w when under load. In contrast, a typical Pentium 4 system can consume 110w when idle and jump to 200w under load. If your PC is switched on for the best part of every day, reducing your power by a half or up to two-thirds can really save money.

I was curious to see how the new Intel-based Imacs measured up, so I got hold of the latest Intel and Power PC G5 models, running at 2GHz and 2.1GHz respectively.

Both featured built-in 20in LCD monitors, the same hard disks, although the Ram configurations Apple supplied were different: 512MB for the Intel model and 1GB for the G5.

When idle, the G5 consumed 104w compared to 80w for the Core Duo – impressive, especially considering both also included powering their 20in screens. I then measured the consumption under load by encoding a five-minute DVD clip into the H.264 avc format using Handbrake (<http://handbrake.m0k.org>). Here the G5 increased to 121w, while the Intel model barely made triple figures at 101w.

Clearly the Power PC G5 was a more modest consumer of power than the traditional PC desktop processors to start with, but even then, the new Intel Core Duo consumed less. In terms of performance, the G5 scored 77.42 compared to 62.73 for the Intel in the Mac benchmark Xbench 1.2 (www.xbench.com), although the Core Duo completed video encode in just six minutes, 30 seconds compared to over 36 minutes for the G5.

Ultimately the Mac engineers may have selected the Core Duo as there was no way to squeeze a Pentium into the slim IMac and keep it cool quietly, but I'd like to think they also appreciated the power consumption benefits.

Either way, the new Intel Imacs provide a fascinating preview of what PC builders could enjoy when the first Core Duo-compatible desktop motherboards are launched during Cebit; they also hint at what Intel's forthcoming desktop architecture may be capable of. **PCW**

Barry Fox



barryf@pcw.co.uk

That synching feeling

Unusually, the broadcast industry is driving innovation in digital audio-visual processing for consumers, says Barry Fox

When we look at a film or TV screen, we immediately notice if the sound and picture are not perfectly synchronised. Just one frame of lip-sync slippage, an error of 40 milliseconds, offends the ear-eye-brain mechanism.

The first cinema sound systems used a gear train to mechanically link the projector to a disc player. Because projectionists sometimes played the wrong discs and reels, the system was replaced with an optical soundtrack down the side of the film. The cinema went back to sound-on-disc with DTS (Digital Theatre System), which uses a time code to lock a CD-Rom or hard disk containing the digital soundtrack to the film.

Every time a digital sound or visual signal is processed it gets delayed. Compression, special effects and editing all lose a few milliseconds.

'Consumers need an affordable box to delay sound or pictures by an adjustable amount'

Decompression and error correction lose more. Each step change is not in itself noticeable, but add them all together and the delays become apparent.

Delays at the transmission end can be corrected by the broadcaster. But in the home, plasma and LCD panels and projectors add extra delay because they convert interlaced TV signals for progressive scan display. More delay is added if the pictures are then enhanced or upscaled to add more lines and pixels, by storing several pictures for long enough to analyse them and guess what might be missing. The sound needs less processing, so words end up ahead of lip movement. This never happens in nature, where sound is behind vision.

When the delay hits around 30 milliseconds, we start to notice it. Modern TV delays can be 80 milliseconds or more. German company Micronas sells a \$5 chipset with onboard memory that delays audio by 40 or 80 milliseconds. The chip is inside a TV, and factory-adjusted to compensate for the delay introduced by onboard picture processing.

But when a panel or projector is working with a separate surround-sound processor and amplifier, all are adding different delays that may cancel each other out.

Last year Motorola launched a new digital wireless audio system that uses the latest version of Bluetooth. Bluetooth Class 1 extends the range from 10m to 100m and A2DP (Advanced Audio Distribution Profile) adds stereo. Motorola's 'Home Entertainment Solution' is a digital wireless streamer (DC800) and wireless stereo headphones (HT8200) costing only around £100.

'We never did a formal press release or launch' said Motorola, 'but they have recently gone into stores in the UK'. I borrowed a system and for a while was chuffed. Here was a way to listen to TV and home-cinema sound without disturbing others, using an interference-free digital wireless link.

I quickly got a dose of reality. The Bluetooth circuitry has to do so much processing that the sound heard through the headphones lags horribly behind the pictures on screen. I asked Motorola whether this is fixable, but was ignored. This may be why the launch was low key; Moto's engineers know they have a problem and no solution.

The same problem is troubling professional sound engineers. TV studios and stage shows use analogue FM radio microphones. They would go digital to avoid interference, but processing delays, or 'latency', make it impossible, especially if the sound is being picked up by a combination of wired, analogue FM and digital radio microphones. When direct and delayed sounds are mixed, the ear identifies a 10-millisecond difference. Just five or six milliseconds is enough to cause 'comb filter' effects, similar to those used to create pseudo-stereo sound from a mono signal.

Beyer sells a secure digital wireless system for conferences. It uses 128bit encryption on a 2.4GHz frequency, and the Bank of England and Ministry of Defence consider it safe against eavesdropping. But processing adds a 15-millisecond latency. Beyer's next chips will reduce this to eight milliseconds, and the target is two. This needs very high-speed processing, but research is under way.

Usually the broadcast industry feeds off consumer developments – think Betacam, DAT, Minidisc and laptop editing – but this time it's the other way round. The industry's work on latency may help the consumer audio-visual world get what it needs: an affordable box to delay sound or pictures by an infinitely adjustable amount. **PCW**



Awesome gaming power

KN1 SLI LITE

NVIDIA nForce4 SLI

● SLI-ready for AMD platform



- Supports AMD Athlon™64 CPU
- System Bus 2000MT/s
- Dual DDR400 up to 4GB
- Gigabit LAN
- 8-channel audio
- 2 PCI-E x16 + 1 PCI-E x1 + 3 PCI
- 4 SATAII with RAID 0, 1, 0+1, eSATA



C51G-M754

NVIDIA GeForce6100 + nForce4 410

● NVIDIA GeForce6100 GPU



- Supports AMD Athlon™64 CPU
- System Bus 1066 MT/s
- DDR400 up to 2GB
- 10/100 LAN
- 6-channel audio
- 1 PCI-E x16 + 1 PCI-E x1 + 2 .PCI
- 2 SATAII with RAID 0, 1



directfrom.com

www.directfrom.com
0870 870 4407

ebuyer.com

www.ebuyer.com
0545 140 1722

MAPLIN
UK ELECTRONICS

www.maplin.co.uk
0870 430 0020

MID
MICRODIRECT

www.microdirect.co.uk
0870 444 4806

pcnextday

www.pcnextday.co.uk

savastore.com

www.savastore.com
0971 882 5500

diggit

www.udggt.com
0870 993 0470

Guy Kewney



guykewney@gmail.com

When unlimited really means limited

If an ISP states a broadband service is unlimited, then that's exactly what it should provide, says Guy Kewney

Technically, if I showed up in a restaurant that advertised 'all you can eat' it would be right to say that if they only sold hash browns and only had one pan to fry them in, I might not eat very much. The chef could also argue that if he made one hash brown every half an hour, I couldn't eat any more than that.

So I was extremely vexed to find that the world's ISPs are sneakily rationing what we get from broadband. 'Unlimited' doesn't mean what it should. In particular, if you use Bit Torrent or Edonkey for downloading big files, your ISP is quite likely to strangle the bit pipe.

I learned this from Sandvine, a company that makes the equipment the ISP uses to do this. The technology is quite simple: a device sits in the network and looks at the data coming in. If it's peer-to-peer traffic – like Skype or Bit Torrent –

'What's immoral is pretending a broadband service is unlimited when it really isn't'

it puts a lower priority on those packets and in some cases can prevent connections. They spot an attempt to connect to a Bit Torrent node – either to download or to upload and they limit the number of connections that are successful.

The sneaky thing about this is that you, the user, will just see a failure to connect or, even worse, you won't. Someone else will. They'll ask their Bit Torrent client to find a host (you) and the client will try and fail. So you won't be able to upload the file and the ISP will have more capacity, without buying more equipment.

Even nastier: if they have their own Internet voice service, they can give that priority. So if you use their VoIP phone service, you can find that it works really well, but if a Skype call comes in, it will buzz, blip and hiccup.

Is that unlimited broadband? In one sense, yes. If you accept that they aren't setting a cap on the number of bytes you can download, it's unlimited. And, if you think that limited broadband means 200 minutes a month and they let you surf the web 24 hours a day, then anything else really is unlimited. But in a very real sense they are limiting what you can do.

Apparently this is very common. Exactly how many ISPs are using this equipment is hard to find out, because the ISPs aren't boasting about it and Sandvine isn't saying who its customers are. But Sandvine did boast that peer-to-peer traffic was accounting for 70 per cent of all bits carried on networks before their equipment was installed and afterwards it was down to 20 per cent. The missing 50 per cent were 'failed' invisibly.

Of course in the real world it isn't possible to offer everybody a service that runs at full speed for all subscribers all the time. The economics of being an ISP mean it assumes that most of the time most customers are offline or only sending a few web page requests every few minutes.

Uploading pictures to Flickr isn't too bad. You're looking at about 1MB per photo and Flickr limits you to so many pictures per month. But with Bit Torrent, things get hairy, as we're in the age of digital video. A new episode of *Desperate Housewives* airs in the US and fans in Europe want it now – so they start downloading files around 600MB or more. And when they've got it, they forward it to other fans, which is a serious problem.

Speed isn't the issue here. The system will only improve if the ISPs create a bigger data pipe, which costs serious money. So you can have the pipe, if you're prepared to pay, but a standard £15 per month subscription won't buy it. When you're the first customer, you'll get it; when 50 other customers are sharing your connection in the local exchange, you certainly won't.

What will happen is that technology will find a way around Sandvine. It can spot the digital signature of a VoIP call today; so if you encrypt it first, it will look like raw data. But the big switch makers still reckon they have ways of detecting traffic patterns and will spot 'unwelcome' traffic, offering customers the option of switching it off. Some corporations prohibit Skype and there's nothing illegal or immoral about their doing so.

What is immoral though, is pretending that a service is unlimited, when it isn't. I intend to approach the Advertising Standards Authority, and complain that ISPs who offer an unlimited service should either stop limiting what you can do or stop making unwarranted claims. I suggest you do so, as well. **PCW**



WHAT'S NEW THIS MONTH

Ever since Apple mentioned it might consider joining forces with Intel, Mac sales started to fall as people waited for the new breed. But now the Intel IMac has landed (read the review overleaf), you can expect the sales of Macs to soar once again.

Recent price drops mean satellite navigation is more affordable than ever. In our group test we test drive sub-£300 standalone devices. It's not just sat nav devices that have plummeted in price, colour laser printers are also far cheaper these days. Incredibly, you can now pick one up for just £210. Turn to page 83 to find out more. Don't forget you can catch the latest reviews by keeping your browser pointed at www.pcw.co.uk.



REVIEWS

CONTENTS

HARDWARE

- 44 Apple IMac
- 45 Elonex Prosentia 800
Dell Dimension 5150c
- 46 Asus W3V
Rock Xtreme 64
- 47 Mesh Titan X1800 Fire
Acoustic Energy Wifi Radio

PERIPHERALS

- 50 Samsung Pro 815
- 51 Eizo Flexscan S2110W
Viewsonic VX922
- 52 Sony VPL-HS50
- 53 ATI All-in-Wonder X1900
Logitech Z-5450
- 54 Magellan Roadmate 800
Vonage Utstarcom
Wifi Phone

- 55 Draytel Vigortalk
- 56 Ipod AV Connection Kit
Logitech Wireless
Music System
Hela Perifric mouse
VolPvoice Uconnect

COMPONENTS

- 58 EVGA Geforce 7800GS
CO Superclocked
NEC ND-4551A
Enlight EN-7473 Home
Media Case
Nexus Anti Vibration
Mounting Kit

SOFTWARE

- 61 Coreldraw X3
- 62 CA Etrust Internet
Security Suite
- 63 Netobjects Fusion 9
- 64 Remote Desktop for
Mobiles 2
Apple iLife '06

GAMES

- 66 Psychonauts
- 67 Stubbs the Zombie
And then there were none

GROUP TESTS

- 69 All-in-one sat nav devices
- 83 Budget colour laser printers
- 93 £699 notebooks
- 104 How we test

Prices include VAT unless otherwise stated

OUR SCORING

Excellent ★★★★★ Very good ★★★★☆ Good ★★★☆☆ Below average ★★☆☆☆ Poor ★☆☆☆☆

OUR AWARDS

Editor's Choice: The best product in a comparative group test. Anything that wins this award is of better quality than its competitors.

Recommended: A product that combines great features, usability and value for money.

Great Value: Not the best in class, but a product that has superior features and performance for the price.

The business awards are used for products that are more suited to home offices or small businesses.



Editor's Choice



Recommended



Great Value



Editor's Choice
Business



Recommended
Business



Great Value
Business



'With all-in-one, in-car navigation you need never get lost again. We steer you through 10 of the best devices for less than £300'

See our group test on page 69

DESKTOP COMPUTER

Apple IMac

Fast performance and elegant design for the first Imacs with 'Intel Inside'



The Shuffle-style remote control lets you control the iMac from the comfort of your sofa – great for multimedia

When Steve Jobs introduced the new iMac he said it was 'a little bit ahead of schedule'. Back in June 2005, Apple's head honcho announced his company would be abandoning IBM's PowerPC and instead use Intel processors in its Macintosh computers. He said it would take a year to get the first Intel-Macs ready, but the new iMac is in the shops right now.

Out goes the PowerPC G5 processor that was used in the previous iMac, and in comes the brand new Intel Core Duo processor. Apple claims the Core Duo, with its dual-core design, is twice as fast as the old G5, and the new iMac certainly feels nippy enough.

There are two models available. Our review system was the £1,229 model, which has a 20in flat-panel display, 2GHz Core Duo processor, 512MB of Ram and 250GB hard disk. The 512MB of Ram is a bit stingy in a machine at this price, but the iMac does compensate in other areas.

It's got a built-in webcam, wireless networking and Bluetooth as standard. There are two Firewire and three USB2 ports, a DVD burner, Ethernet and digital audio output. Thankfully, Apple has also finally decided to provide the iMac with a decent graphics card – the Radeon X1600 with 128MB of video memory.

If you're on a bit of a budget there's also a £929 model that has a 17in monitor, 1.8GHz processor and 160GB hard disk.

Of course, now the iMac has an Intel processor, it's tempting to suggest that it is just another PC-clone. However, the real difference between Macs and PCs has always been Apple's easy-to-use software. The elegant and colourful OS X operating system has been fully rewritten to run on the Intel processor, as has

Apple's iLife software suite, which comes free with every Mac and includes software for playing music, video editing, creating DVDs and mucking about with digital photographs.

All this software makes the iMac very good value for money. It performs well with the speedy new processor and, in terms of ease of use, it runs rings around most comparable Windows software.

There is, however, one little fly in the ointment. Apple may have updated its own software for the new Intel processor, but no other software developers have done this yet. Existing software written for the old PowerPC processor will still run on the new iMac (thanks to an emulation system called Rosetta), but it won't run as fast as native software specifically written for the Intel processor. This isn't too much of a problem for programs such as the Mac version of Microsoft Office. Neither Word nor Excel need vast amounts of processor power to run smoothly, and these two programs ran perfectly well on the new iMac during our tests.

However, load up some heavy-duty software such as Photoshop, or a few 3D games, and the iMac's performance suffers quite noticeably. Fortunately, there aren't many people who buy the Mac to play games and their iLife software will run better than ever on the new Intel processor. However, the likes of Photoshop and Quark Xpress are another matter altogether, and we suspect Apple is going to have a few sticky months with its professional users while it waits for developers to update these programs for the new generation of Intel Macs. Thanks to its elegant design and relatively low price tag, we suspect this latest iMac will sell well.

Cliff Joseph

Details

Price £1,299
Best price www.pcw.co.uk/bestprices
Contact Apple 0800 039 1010
www.apple.com/uk
Specifications 2GHz Intel Core Duo processor • 512MB of Ram • 250GB hard disk • Radeon X1600 128MB graphics • 8x DVD writer • Webcam • Bluetooth • 802.11g • iTunes, iMovie, iPhoto, iDVD, iWeb, Garageband

Verdict

Pros Elegant design; improved performance; good software
Cons Most software needs an Intel update
Features ★★★★★
Performance ★★★★★
Value for money ★★★★★

Overall A great machine for home users, but it will take some time for software manufacturers to develop Intel updates

★★★★★

BTX PC

Elonex Prosentia 800

A tiny, quiet system that could appeal to business and home users alike



The promised avalanche of small, quiet PCs hasn't happened in quite the way Intel had envisaged. The latest model in Elonex's Prosentia range, the 800, is an even rarer beast as it uses the smallest BTX motherboard, the pico-BTX. This allows it to sit in an extremely small case, measuring just 75 x 310 x 325mm (w x d x h). The PC will sit as a desktop chassis or, using the stand provided, a thin tower. Either way, it's not going to take up much room.

Despite its size, this is one heavy PC, due mostly to the colossal BTX heatsink on the CPU. This is cooled by two 8cm fans drawing air through a honeycombed grill on the front panel. The air flows across the CPU and is vented out of the rear of the case. When first powered up these fans make quite a racket, but almost immediately they settle down to being barely audible.

At the heart of the Prosentia 800 sits a 3.06GHz Pentium 4 backed up by an Intel 915GV chipset and 1GB of DDR400 memory, which means it can handle most tasks, as proved by the Sysmark 2004 SE score of 197. Unfortunately, thanks to the Intel GMA900 integrated graphics, games performance is very poor. 3Dmark05 wouldn't even run, and 6.7fps (frames per second) in the Far Cry test is as bad as we expected. That said, this isn't designed as a gaming PC.

The monitor is an Elonex-branded 19in model with a native resolution of 1,280 x 1,024. Adding a TV card into the single PCI slot can give you the basis of a compact home-theatre PC. The 400GB hard drive and integrated 7.1 audio also suit an entertainment PC.

Elonex is aiming the Prosentia 800 at business, health, educational and financial environments, but its diminutive design may also appeal to those building a home-entertainment PC. *Simon Crisp*

Performance

PCmark 2005 **2,883**

Details

Price £999**Best price** www.pcw.co.uk/bestprices**Contact** Elonex www.elonex.co.uk

Specifications Intel Pentium 4 3.06GHz • 1GB PC3200 Ram • 19in Elonex TFT • Intel GMA900 graphics • 400GB hard drive • Dual-layer DVD writer • Gigabit Lan • 4 USB2 ports

Verdict

Pros Compact; quiet**Cons** Poor graphics**Features** ★★★★★**Performance** ★★★★★**Value for money** ★★★★★

Overall Worth considering if you're after a quiet office PC, but would also fit as part of a home entertainment setup

★★★★★

MEDIA CENTER PC

Dell Dimension 5150c

An entertainment PC with an Intel Viiv badge, but not a TV tuner in sight



The Dell Dimension 5150c Media Center is going to make Intel very happy. Not only does it use the new Intel Viiv platform (read about the Viiv launch at http://labs.pcw.co.uk/2006/01/intels_viiv_lea.html), but inside the tiny case is a pico-BTX form factor motherboard.

The miniature tower case measures 91 x 310 x 363mm (w x d x h) and there's a single fan at the front of the case to keep the temperature under control while making very little noise.

Although the 5150c qualifies for the Viiv sticker, the hardware is fairly conventional, with a combination of an Intel 945G chipset and a dual-core Pentium D processor that runs at 2.8GHz. There's 1GB of dual-channel DDR2 memory with two slots free for an upgrade.

Even though the motherboard has integrated Intel graphics, Dell installed a Radeon X600 128MB SE graphics card. However, this card is inadequate for playing 3D games at any sort of detail level and throttles the PC's performance. A lack of space inside the case and marginal airflow means an upgrade is impractical.

On the back of the case ports include digital audio, four USB2 and one Firewire. On the front, a spring-loaded flap reveals a multi-format card reader, DVD writer, two more USB, Firewire, plus standard audio jacks.

Dell's 24in 2405FPW monitor has a clear, bright picture and 1,920 x 1,200 resolution. A review of the 20in version is at www.pcw.co.uk/2149433.

Despite being a Viiv system and running Media Center, a TV tuner doesn't come as standard. Dell will supply an Avermedia USB TV tuner as an option that costs a further £69.

Although the Dimension 5150c isn't a bad system, especially since you get a large monitor, Dell could have made so much more of it. *Leo Waldoock*

Performance

Sysmark 2004 SE: **205**3Dmark05* **1,266**

*Tested at 1,024 x 768 in 32bit colour

Details

Price £1,399**Best price** www.pcw.co.uk/bestprices**Contact** Dell 0870 152 4649www.dell.co.uk

Specifications 2.8GHz Pentium D 820 • 1GB 533MHz DDR2 memory • ATI Radeon X600 128MB SE • Dell 2405FPW monitor • 250GB hard disk • 8x DVD writer • Dell A525 2.1 speakers • Wireless keyboard, mouse • Windows XP MCE 2005 • Works 7

Verdict

Pros Tiny case; huge display; stylish**Cons** 3D performance; no TV tuner**Features** ★★★★★**Performance** ★★★★★**Value for money** ★★★★★

Overall The price is low, but graphics performance is poor and there's no TV tuner

★★★★★

CENTRINO NOTEBOOK

Asus W3V

Great-looking, lightweight and reasonably powerful



A growing number of Asus notebooks look stylish enough to compete well with Sony Vaio or Apple Ibooks. Subtle application and multimedia buttons on the W3V meld seamlessly into the chassis edge, while a cylindrical hinge steadies the bright 14.1in widescreen LCD monitor and hosts a glowing blue power button. The keyboard letters have a futuristic look and even the trackpad looks stylish.

However, while this Centrino notebook looks sharp, its performance isn't quite as cutting edge. Instead of the Intel Core Duo processor, Asus has

stuck with a single-core Pentium M 750 (1.86GHz) processor. The 512MB of DDR2 Ram and 64MB ATI Mobility Radeon X600 graphics are aimed at mobile users wanting steady performance in Windows and multimedia tasks.

It's now the norm to have an 80GB hard disk and a double-layer, dual-format DVD writer in notebooks of this size and price, and the W3V includes both.

Asus has kept the rear portion of the chassis clear, with all ports and sockets woven into the edges. Here we find the usual suspects, plus three USB2, one mini-Firewire, a TV-out port and a memory card reader.

One low point is the flexibility of the LCD screen. Even the slightest knock sends the liquid crystals into spasm, a downside we thought we'd seen the back of. The instant-on feature gives access to multimedia files within about 10 seconds of pressing the media button.

The Asus W3V would suit business users who don't need a super-fast notebook, or students who want to use a laptop in lectures. At 2.6kg it is portable, but by no means the lightest around. If you want more power you'll have to sacrifice the lightweight design, but the Gateway 8550GB (see www.pcw.co.uk/2149487) is a good alternative.

Luke Peters

Performance

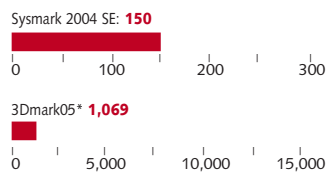

*Tested at 1,024 x 768 in 32bit colour

Details

Price £1,249
Best price www.pcw.co.uk/bestprices
Contact Asus <http://uk.asus.com>
Specifications Intel Pentium M 750 (1.86GHz) • 512MB of Ram • 14.1in screen • ATI Mobility Radeon X600 64MB • 80GB hard disk • 802.11a/b/g • 3 USB2, 1 Firewire • Card reader • 330 x 247 x 30mm (w x d x h) • 2.6kg

Verdict

Pros Good design; portable
Cons 3D graphics performance not great; flimsy LCD
Features ★★★★★
Performance ★★★★★
Value for money ★★★★★
Overall A good portable notebook with a stylish design, but nothing outstanding
 ★★★★★

AMD 64 DESKTOP REPLACEMENT

Rock Xtreme 64

Big, heavy and not particularly attractive, but this is a powerful notebook



The Acer Travelmate 8204WLMi has shown that Intel's Centrino Duo is allowing notebooks to stay relatively small and light while boosting system speeds without a detrimental effect on battery life (see www.pcw.co.uk/2148122).

However, while this Rock Xtreme 64 is a powerful dual-core notebook, it shuns aesthetics and battery life in favour of size; it's big enough to house a 17in display, full-size keyboard with number pad and stereo speakers either side. At 5cm, the Clevo-designed chassis is even thick enough to house a double-layer DVD writer and a spare drive bay underneath. Its 6kg weight is also rather hefty.

Inside is an AMD Athlon 64 Dual Core Processor 4800+, which is usually reserved for desktops. There's also 1GB of Ram, and two 100GB hard disks.

The Xtreme is fast; its Sysmark 2004 SE score of 221 means it's one of the quickest performing notebooks we've seen. Go to www.reportlabs.com/testbed/version1/nbv1/nbtop50.php for the full results. This speed obviously results in a lot of heat, which requires five fans to cool it down, and these can cause quite a racket at times.

The 256MB Nvidia Geforce Go 7800 GTX graphics chipset churned out a fantastic 3Dmark05 result of 6,720, and the screen's native 1,680 x 1,050 resolution enables the Xtreme 64 to make full use of this power.

A huge collection of ports and sockets around the edge of the chassis include four USB2, two mini-Firewire, DVI, video inputs and surround-sound outputs. There's also a small webcam in the lid, 802.11g Wifi, and a sub-woofer underneath, which complements the four speakers around the case.

The Xtreme 64 is built like a heavyweight boxer and will take a few knocks. However, the fashion conscious will be instantly put off by its bruising looks. It's not cheap, but if you're happy to forsake looks and portability, it's a true powerhouse.

Luke Peters

Performance

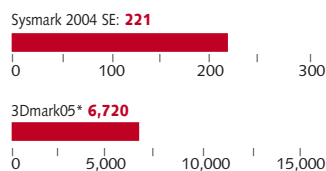

*Tested at 1,024 x 768 in 32bit colour

Details

Price £2,231.33
Best price www.pcw.co.uk/bestprices
Contact Rock 08709 909 090
www.rockdirect.com
Specifications AMD Athlon 64 4800+ • 2GB Corsair DDR 400 Ram • 2 100GB hard drives • 17in display • 256MB Geforce Go 7800 GTX • Dual-layer DVD writer • Card reader • 4 USB2, 1 Firewire • Roxio Creator 7 • Microsoft Works 8 • Windows XP Home • Three-year C&R warranty • 6kg

Verdict

Pros Powerful; fantastic graphics
Cons Enormous chassis; heavy
Features ★★★★★
Performance ★★★★★
Value for money ★★★★★
Overall A quality desktop replacement
 ★★★★★

CROSSFIRE PC

Mesh Titan X1800 Fire

Powerful graphics but faster Crossfire PCs are just round the corner



The key component in the Mesh Titan X1800 Fire is the pair of ATI Radeon X1800XT graphics cards (to read a review, go to www.pcw.co.uk/2143241) connected in a Crossfire configuration. This gives it a huge amount of graphics power to drive the 20in Viewsonic VA2012WB and its 1,680 x 1,050 widescreen resolution.

To back up the graphics, Mesh has selected an AMD Athlon 64 dual-core X2 4600+ processor; this can be upgraded to a 4800+ for an extra £70. An FX-60 upgrade would take the price close to £2,400. This combination of fast graphics and processor are

supported by ATI's Xpress 200 chipset and the Asus A8R-MVP motherboard. Both parts of the chipset have passive heatsinks.

Mesh has worked hard to balance the PC's cooling requirements while also taking noise reduction into account. A fan mounted in the side panel of the Chieftec case sits directly over the processor heatsink, while on the back of the case there's a huge, yet quiet, 120mm fan. AMD's Cool 'n' Quiet power-saving feature is enabled and the Bios is set to build up the CPU fan speed once the temperature passes 35°C.

While the Titan X1800 Fire is fast and impressive (see the full performance results at www.reportlabs.com/testbed/version1/pcv1/detailpc.php?pcid=86), its biggest problem is that it's already out of date, as the new Radeon X1900 Crossfire Edition is now available (for a review go to www.pcw.co.uk/2149098) – although we're yet to see a Crossfire PC with two X1900 cards.

To add to these woes, in March ATI will launch its RD580/Radeon Xpress 3200 chipset, which will be used in the Asus A8R32-MVP Deluxe motherboard.

The Titan X1800 Fire PC from Mesh offers excellent performance at a good price but if you're after top-notch graphics performance, you should wait until a dual-X1900 PC is released.

Leo Waldoock

Performance

Sysmark 2004 SE: **223**



3Dmark05* **11,155**

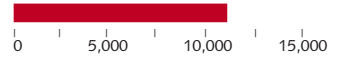

*Tested at 1,024 x 768 in 32bit colour

Details

Price £1,999

Best price www.pcw.co.uk/bestprices

Contact Mesh 08700 464 747

www.meshcomputers.com

Specifications AMD Athlon 64 X2 4600+ processor • 1GB PC3200 DDR Ram • 300GB hard drive • 16x dual-layer DVD writer • 2 ATI Radeon X1800XT graphics cards in Crossfire • 2yr on-site, 1yr RTB warranty

Verdict

Pros Superb performance; fair price; 20in widescreen TFT

Cons X1900 Crossfire PCs are imminent; glitches in Bios

Features ★★★★★

Performance ★★★★★

Value for money ★★★★★

Overall A powerhouse PC, but X1900 Crossfire PCs will be substantially faster

★★★★★

INTERNET RADIO

Acoustic Energy Wifi Radio

Listen to broadcasts from all over the world



Acoustic Energy's Internet radio, which draws its programmes from the web via a Wifi link, does not at first sight seem like a winner when you can buy an FM receiver for a fiver and a digital (DAB) model for less than £50.

Acoustic Energy points out that the estimated 10,000 stations you can access on the web are far more than you can get on DAB, but there is nothing to stop you reaching them through your PC.

However, until the ergonomics of home networks improve, your average granny is not about to access

her media server from any room in the house and instruct it to contact the station of her choice. But she could access her favourites on this web radio, which has presets just like a standard model.

There will certainly be a market for this device among exiles who want single-click access to their home stations. But it will appeal to anyone who has ever been touched by the romance of short-wave radio, which allows you to eavesdrop on exotic places all over the world in real time. And the web, unlike short wave, is not prone to static and fading.

The device is linked to a dedicated radio portal and makes station browsing as easy as possible given the limitations of its 60 x 20mm monochrome display. You can choose a station by country or genre and clicking your way through the menus is no more difficult than using a tuning dial. The device will also play mp3, wma or Real Audio files residing on a linked PC.

The radio does have its drawbacks. It is mains driven, so you have to use it near a power socket and stations take longer to access than on a standard radio. Furthermore, the sound occasionally drops out for a couple of seconds but these are minor gripes when weighed up against the delight of have an easy-to-use ear on the world.

Clive Akass

Details

Price £199

Best price www.pcw.co.uk/bestprices

Contact Acoustic Energy

www.acoustic-energy.co.uk

Specifications Real Media, mp3 and wma compatible • Alarm clock • Search facility • 3.5mm headphone jack • 60 x 20mm display • 802.11b/g • 128bit Wep security

Verdict

Pros A simple way to listen in on the world

Cons More expensive than a standard radio

Features ★★★★★

Ease of use ★★★★★

Value for money ★★★★★

Overall A little expensive but a great way to receive a massive number of radio stations from around the world

★★★★★

NOTEBOOK PCs

quicklink	IBM	£ inc VAT	£ ex VAT
3Y1SPW	ThinkPad R51e CM370 512 40 DVDRW XPH	515.74	438.93
3X49PW	ThinkPad Z60M PM1.5 512 80 COMBO XPH	719.99	612.76
3WP7PW	ThinkPad Z60M 1.86 512 80GB DVDRW XPH	923.98	786.37
3T52PW	ThinkPad T43 PM1.73 512 40 dvdrw XPH	1081.99	920.84
357NPP	ThinkPad T43 M750 512Mb 40Gb XPP	1092.26	929.58
FUJITSU-SIEMENS			
3XYFPW	AmitoPro V2030 256 40 COMBO XPH	468.99	399.14
3X22PW	AmitoPro V2030 256 40 COMBO XPH	493.99	420.42
3Y9WPW	AmitoL1310G CM 512 60 DVDRW XPH	549.98	468.07
3Y07PW	AmitoM6450G 512 80 DVDRW XPH	679.98	578.71
HP PAVILION			
3VHCPW	dv4200EA Cel-M 360 512/40 XPH	598.99	509.78
3VHDPW	ze2355EA AMD 64 1024/60 XPH	699.00	594.89
3VH4PW	dv4232EA P-M 725A 512/80 XPH	799.00	680.00
3WX0PW	zd8303EA P4 630 512/80 XPH	968.40	824.17
3VH6PW	dv4277EA P-M 740 1024/100 XPH	999.00	850.21
3VGRPW	zd8369EA P4 640 1024/100 XPH	1299.00	1105.53
SONY VAIO			
3XV3PW	NEW FS415E Celeron 390 400 MHz FSB	666.98	567.65
3XV2PW	NEW FS-415B Centrino 740 533 MHz FSB	790.98	673.18
3XV0PW	NEW FS415S Centrino 740 533 MHz FS	984.99	838.29
3TG8PW	Vaio TX1HP/W Centrino 733	1394.99	1187.23
3TG7PW	Vaio TX1XP/B Centrino 753	1579.98	1344.67
3TGBPW	A517B Centrino 740 512MB 80GB	1064.46	905.92
3TG9PW	A517S Centrino 760 1GB 120GB	1585.08	1349.00
3TG5PW	S5M/S Centrino 740 512MB 80GB	1115.08	949.00
TOSHIBA			
3W02PW	Sat Pro L20 CM 1.4 256 40 XPH	441.79	375.99
3VP8PW	SatProL20 CM 256 40 COMBO XPH	453.55	386.00
3XFTPW	SatM40 C-M370 512 60 DVDRW XPH	549.98	468.07
3XP3PW	Tecra A3 C-M370 512 60 COMBO XPP	620.99	528.50
3R91PW	Portege S100 P-M740 1.73 XP	869.99	740.42
3TJ9PW	Tecra M3 PM740 512 40 COMBO XPP	970.01	825.54

FS-415B VAIO WIDESCREEN XP HOME NOTEBOOK

Enough power to handle any task...

SONY



Function and value, The FS415B is designed for basic home computing needs including e-mail, web surfing and multimedia.

- Intel Celeron M 380
- 512MB RAM 80GB HDD
- 15.4" X-Black screen technology
- DVD+/-RW Dual layer
- Microsoft Windows XP Home Edition

Complimentary Vodafone 3G card



NEW STOCK NOW IN!



BUY NOW PAY DEC 06

quicklink 3XV2PW

DESKTOP PCs

quicklink	ACER	£ inc VAT	£ ex VAT
3TYNPP	CelD335 2.8ghz 512mb 80gb XPP	375.92	319.93
3Y51PW	ASPIRE P4-2.93G 80 512 DVD XPH	391.99	333.61
APPLE			
3XW0PW	Emac G41.42 160 512	712.99	606.80
3YKWPW	iMac 17-inch 1.83GHz Intel	975.99	830.63
3YKVPW	iMac 20-inch 2.0GHz Intel	1254.99	1068.08
FUJITSU-SIEMENS			
3WG5PW	Sempron3000 256 40 DVD XPH	258.38	219.90
3S23PW	SCENIC X102 CelD 256 40 XPH	276.99	235.74
3XH6PW	X103 CEL 2.8 256 80 DVD XPH	314.00	267.23
3Y70PW	ScaleoE Media Centre XPMCE	918.99	782.12
HP PAVILION DESKTOPS			
3VDPPW	a1209 Cel-D 336 256/80 XPH	350.00	297.87
3VDDPW	i3255 P-D 820 1GB 320GB XPH	811.00	690.21
3VDTPW	w5261 P-D 830 1.5GB 200GB XPH	920.00	782.98
3VDQPW	m7281 P4 640 1GB 250GB XPH	1066.31	907.50
SONY VAIO			
3VXXPW	RC102 PD820 512/320GB DVD	1238.99	1054.46

- Intel Celeron M 380 • 512MB memory • 80GB HDD
- 15.4" X-Black screen technology • Windows XP Home

from £797.82 (£679.00 ex VAT)

IPAQ RX1950 NAVIGATOR



PLUG & DRIVE SOLUTION



quicklink 3YB1PW

Get this Simple-to-use and efficient in-car GPS navigation system featuring wireless Pocket PC capability at an affordable price. Compact, portable and stylish design (including CarCradle with loudspeaker) which is not restricted to your own vehicle and is easily transportable between cars.

With a Simple 3-step installation - just plug in the power supply, insert the navigation SD card and go. A user-friendly interface design which allows quick access to all key functions via the main menu touch-screen also comes with Integrated Wi-Fi (802.11b) for high-speed wireless access.

HANDHELDS

quicklink	HP	£ inc VAT	£ ex VAT
3VB8PW	iPAQ rx1950	202.11	172.01
3VB9PW	iPAQ hx2190	231.75	197.24
3VD5PW	iPAQ hx2790	346.98	295.31
3PFHPW	iPAQ hw6510	421.82	359.00
3NWDPW	iPAQ hw6515	422.98	359.99
PALM			
3FXWPW	Tungsten T5	210.32	170.21
3NH2PW	Tungsten E2	219.99	116.00

- Samsung SC32442 Processor 300Mhz • 96MB Total Memory
- 3.5" Transflective TFT • MS Windows Mobile 5.0 Pocket PC

only £283.98 (£241.69 ex VAT)

AMILO-M6450G

SATELLITE PRO L20



Complimentary Vodafone 3G card

quicklink 3Y07PW

- Intel Centrino P-M
- 512MB Memory
- 80GB Hard Drive
- 14" WXGA Widescreen
- DVD±RW Dual Layer
- 802.11b/g Wireless LAN
- Windows XP Home



quicklink 3YT2PW

- Intel Celeron M 1.5GHz
- 256MB Memory
- 40GB Hard Drive
- DVD±RW
- Wireless 802.11g
- Windows XP Home Edition



BUY NOW PAY DEC 06

TOSHIBA



BUY NOW PAY DEC 06

COMPONENTS

quicklink	MEDIA	£ inc VAT	£ ex VAT
3M5YPW	Verbatim DVD-R 16x 25 pack Spindle	9.46	8.05
DVD - RECORDERS			
3XSJPW	Philips DVD+-R/RW DL 16x IDE BEIGE OEM	26.09	22.20
3L31PW	Samsung DVD+-R/RW 16x16x Beige OEM	27.33	23.26
3XQDPW	Liteon DVD+-R/RW Double Layer 16x Black	28.04	23.86
3TQGPW	NEC DVD+-R/RW/RAM 16x DL BLACK OEM	30.17	25.68
3TPSPW	LG DVD + - R/RW 16x DL Black Retail	30.00	25.53
INTERNAL IDE HARD DRIVES			
3XRGPW	DiamondMax10 160GB S300	53.80	45.79
3XRYPW	Raptor 150GB S150 8mb 10000rpm	199.99	169.99
32YKPW	Barracuda 7200.7+ 200GB U100	58.75	50.00
3XRCPW	DiamondMax 11 500GB U133 16MB	214.63	182.66
3W4MPW	Barracuda 7200.9 500GB S300	230.21	195.92
SYSTEM MEMORY			
2LGMPW	Crucial 512MB 184DIMM PC3200 CL3	27.61	23.50
37JGPW	dabsvalue 512MB 184DIMM PC3200 CL2.5	25.66	21.84
FLASH MEMORY			
37R5PW	Kingston 256MB SD Secure Digital Card	11.34	9.65
36FRPW	Sony 256MB Memory Stick Pro Duo Hi	53.93	45.90
36FFPW	Sony 512MB Memory Stick Pro	41.24	35.10
36FFPW	Sony 1GB Memory Stick Pro Duo	59.99	51.06
USB FLASH DRIVES			
319LPW	dabsvalue 128MB USB 2.0 Flash Drive	11.97	7.23
319MPW	dabsvalue 256MB USB 2.0 Flash Drive	18.55	8.93
35QRPW	Kingston 512MB USB 2.0 Flash Drive	19.34	16.46
35QSPW	Kingston 1GB USB 2.0 Flash Drive	42.03	35.77

from £669.98 (£570.20 ex VAT)

only £500.25 (£438.29 ex VAT)

IPAQ RX1950 POCKET PC

LIFEDRIVE



quicklink 3VB8PW

The sleek and stylish HP iPAQ rx1950 Pocket PC offers a range of simple to use features, popular applications and multimedia options meaning you can stay organised, entertained and in-touch.



quicklink 3PPFPW

With a 4GB HDD and built-in Wi-Fi® and Bluetooth® wireless support, the LifeDrive™ mobile manager from palmOne lets you easily carry all the essentials of your busy life. Files and folders from your desktop computer, 300 songs, 2.5 hours of video, 1000 photos, and more are right there with you.

NEW



LOW PRICE

only £185.96 (£158.27 ex VAT)

only £276.13 (£235.00 ex VAT)

PAGEPRO 1400W MONO LASER



quicklink 3X17PW

In the modern office environment, space may be limited but the demands for printing performance will always be high. Enter the PagePro 1400W, small enough to fit on a bookshelf yet with outstanding print speed and high-quality output, it blends good looks and user-friendliness in a professional, affordable package.

One of the smallest monochrome laser printers in the world, the PagePro 1400W is a pleasure to own and use. Output speed is 16 pages per minute, with razor-sharp 1200 x 600 dpi resolution. It can print on a variety of media including postcards, memos and letters.

LOW PRICE

•1200 dpi •16ppm •Microsoft Windows 98SE/2000/ME/XP

only **£59.99** (**£51.06** ex VAT)

FINEPIX F11 ZOOM



quicklink 3YGXPW

The F11's predecessor the FinePix F10 Zoom had a winning combination of impressive battery life and class-leading low light ability. These were just two of the reasons why it was voted European Pocket Camera of the Year 2005/6. Without tampering with the excellent sensor performance, the FinePix F11 Zoom adds aperture and shutter priority modes, a higher resolution LCD screen and improved macro performance.



NEW

•6.3 Megapixels •2.5" LCD display •VGA movie mode
•ISO 80-1600 ISO range •3x optical zoom lens

only **£215.29** (**£183.23** ex VAT)

IPOD NANO - 1GB BLACK/WHITE



Other models available - see listing for the full range of Apple iPods

quicklink 3Z2ZPW

quicklink 3Z30PW

- Only 9.0 x 4.0 x 0.69 cm and weighing just 42g
- Bright 3.81 cm colour LCD display
- Up to 14 hours of battery life
- Apple Click Wheel
- Charges and syncs via USB 2.0
- Accessory-compatible Dock connector
- Completely skip-free playback
- Plays music, podcasts and audiobooks
- Holds up to 25,000 photos
- Syncs contacts, calendars and to-do lists

•Holds up to 1,000 songs and full-colour album art
•Works with Mac OS X or Windows 2000/XP

only **£105.59** (**£89.87** ex VAT)

32" HD READY LCD TV

DVD+-RW/RAM 16X IDE DUAL LAYER



quicklink 3PFZPW

offering an incredible amount of value, the 32" LCD TV itself easily competes head on with similar products costing considerably more.

- 170 degrees viewing angle
- 16:9 image aspect ratio

BUY NOW PAY DEC 06



quicklink 3XYYPW

NEC introduces DVD burner with Labelflash technology. Labelflash burns custom motifs, lettering or images onto the top side of blank DVD media, giving users the chance to get creative when labeling their DVD and CD collections. The ND-4551 burner offers NEC's highest specification performance to date, plus Labelflash functionality.

LABELFLASH TECHNOLOGY

only **£786.42** (**£669.29** ex VAT)

only **£33.49** (**£28.50** ex VAT)

15-IN-1 MEDIA READER/WRI

NORTON INTERNET SECURITY 2006



quicklink 3BBBPW

Drag and drop files, images, and music to your computer from your PDA or handheld, MP3 player, digital camera, or other device. This Media Reader & Writer lets you transfer files from one media card to another, or transfer files from all four media cards simultaneously. Accommodates all popular types of media.

BELKIN.

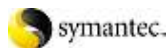

quicklink 3VD1PW

Symantec's Norton Internet Security 2006 provides essential protection from viruses, hackers, and privacy threats. Norton AntiVirus is the world's most trusted antivirus solution. Norton Personal Firewall keeps personal data in and hackers out.

only **£20.06** (**£17.08** ex VAT)

only **£34.99** (**£29.78** ex VAT)

DIGITAL CAMERAS

quicklink	CANON	£ inc VAT	£ ex VAT
3T0JPW	Powershot A410	99.99	85.10
3T09PW	Ixus I Zoom - Black	194.99	165.95
3T02PW	Ixus 750	287.99	245.10
3S2KPW	Ixus 55	238.84	203.27
3T0GPW	PowerShot A620	228.81	194.73
3T0KFW	PowerShot S80	351.33	299.00
3MHYPW	EOS 350D Digital SLR Lens Kit	599.99	510.63
FUJII			
3Y06PW	FinePix F11	223.21	189.97
3T09PW	FinePix 5600	220.00	187.23
3XNZPW	FinePix Z2 in Silver	202.50	172.34
3TC8PW	FinePix 9500	375.00	319.15
HP			
3S0YPW	Photosmart R717	150.00	127.66
SONY			
3MF0PW	DSC-W55 Cyber-shot 5.1 MP	186.83	159.00
3MF3PW	DSC-W17 Cyber-shot 7.2 MP	236.18	201.00
3L5JPW	DSC-P200S Cyber-shot 7.2MP	229.13	195.00

PRINTERS & SCANNERS

quicklink	PRINTERS	£ inc VAT	£ ex VAT
3SLGPW	Canon Pixma iP1600	46.82	39.85
3SLJPW	Canon Pixma iP4200	78.84	67.10
3SLLPW	Canon Pixma iP5200R	150.29	127.91
3T33PW	Epson Stylus D68 Photo	52.21	44.43
3SN6PW	Epson Stylus D88 Photo	69.00	58.73
3SHWPW	Epson Stylus Photo R220	69.80	59.40
3TFQPW	Epson Picturemate 100	96.01	81.71
3R27PW	HP Deskjet 3940	51.82	44.10
3XN5PW	HP Photosmart 335 with free paper	79.99	68.08
3RFDPW	HP Photosmart 8250	141.20	120.17
ALL-IN-ONE PRINTER/SCANNER			
3HBQPW	Canon Pixma MP780	204.58	174.11
3WC8PW	Canon MF5730 with Axis Bundle	233.83	199.00
3SHVPW	Epson Stylus DX3800	60.35	51.36
3SN7PW	Epson Stylus DX4800	86.55	73.66
3P2XPW	HP PSC 1410	60.35	49.00
3SD9PW	HP PSC 1510	79.54	67.69
3SBCPW	HP Photosmart 2575	141.32	120.27
SCANNERS			
3RKLPW	Canoscan Lide 25	38.74	32.97
3RKMPW	Canoscan Lide 60	46.87	39.89
3S3XPW	Epson Perfection 3490 Photo	61.45	52.30
3S3YPW	Epson Perfection 3590 Photo	89.09	75.82
2HY3PW	HP Scanjet 2400	40.43	34.41
3RSFPW	HP Scanjet 4370	63.38	53.94

LCD DISPLAYS

quicklink	LCD DISPLAYS	£ inc VAT	£ ex VAT
3KB2PW	Acer AL19135 19" Silver	172.73	147.00
3TX7PW	Acer 17" AL17165 8ms LCD	148.05	126.99
3TJCPW	Samsung 17" SM740N Height Adjust	211.49	179.99
3PRXPW	Samsung 19" SM913N Angle Piv Height ADJ	225.60	192.00
3TWYPW	Viewsonic 17"LCD Display with Stylish	152.74	129.99
3R1MPW	Viewsonic VX724 17" BLK/SIL DVI 4MS	247.47	210.61
3QYLPW	Sony SDM-S75AB 17" TFT SXGA Black	165.68	141.00
3QYMPW	Sony SDM-S95AB 19" TFT SXGA Black	210.33	179.00

ESSENTIALS

quicklink	WIRELESS NETWORKING	£ inc VAT	£ ex VAT
36P3PW	NetGear 802.11g Wireless USB 2.0 Adapter	28.07	23.89
3MWWPW	NetGear RangeMax Wireless PC Card	51.57	43.89
3V25PW	Netgear DG834PN Wireless Modem & Router	94.58	80.50
2CS4PW	Belkin 802.11G Notebook Card	17.46	14.86
2CS7PW	Belkin 54g Wireless Access Point	39.29	33.44
2CS8PW	Belkin 802.11g Wireless Cable/DSL Router	44.14	37.57
KEYBOARDS			
3H7VPW	Logitech LX700 Cordless Desktop	52.63	44.79
3JQDPW	Logitech DiNovo Media Desktop 2.0	116.56	99.20
3FKHPW	Microsoft Optical Desktop with Fingerprint	44.14	37.57
3NFYPW	Microsoft Wireless Optical Desktop 1000	26.11	22.22
MICE			
3FPQPW	Logitech MX1000 Laser Cordless Mouse	43.48	37.00
22XSPW	Microsoft Notebook Optical Mouse	13.12	11.17
POWER PROTECTION			
2D4CPW	1-Way SurgeCube	6.30	5.36
3FHZPW	4-Surge Protected Sockets BUY 1 GET 1	17.87	15.21
2V43PW	1000VA Universal UPS w/AVR	111.11	94.56

SOFTWARE (FOR WINDOWS)

quicklink	SOFTWARE	£ inc VAT	£ ex VAT
3P9WPW	Adobe Creative Suite Pre CS2 VU Win	433.56	368.99
3V6XPW	Microsoft MS Autoroute 2006	39.97	34.02
3TSHPW	Ahead Nero 7 Premium	47.53	40.45
3TF2PW	Mcafee Personal Firewall Plus 2006	24.68	21.00
3SK0PW	Studio 8.0 Win / Mac	684.98	582.96
2RYWPW	Microsoft Office 2003 Professional	376.00	320.00
31LTPW	ACDSee v6 PowerPack	10.00	8.51
3XFFPW	Microsoft Premium Pack 2005	29.99	25.52
3TZTPW	Symantec Norton AntiVirus 2006	34.04	28.97
3VD1PW	Symantec Norton Internet Security 2006	44.97	38.27

Prices and product details correct at time of going to press and subject to change without notice. Errors and omissions excepted.

PROSUMER DIGITAL CAMERA

Samsung Pro 815



A groundbreaking device with three colour screens and a massive 15x zoom lens



Samsung's Pro 815 is not an SLR (single-lens reflex) camera, but to dismiss it as a cheaper alternative would be to do it a vast disservice.

Similar in size and shape to an SLR, it sits at the larger, and heavier, end of the ever-growing category of fixed-lens prosumer digital cameras. Its size is due in no small part to the whopping 15x zoom optical lens. With minimum f numbers ranging from f2.2 to f4.6 and a 35mm equivalent zoom of 28-420mm, it certainly looks good on paper.

Although rather compact when the lens is retracted, twisting the manual zoom ring causes it to lurch forth to almost double its original length – something that will no doubt provoke gasps from onlookers. Control of the large zoom is both smooth and accurate.

Further surprises await at the rear. Where some more recent digital SLRs have increased the size of the LCD panels up to 2.5in, the Pro 815 stomps all over them with a massive 3.5in screen. This panel takes up pretty much the whole of the back of the camera. Unfortunately, the 235,000 pixel resolution doesn't seem quite enough for a panel of this size and pixels are clearly visible.

Unlike digital SLR cameras, which house a direct through-the-lens viewfinder, the Samsung Pro 815 has to make do with an electronic version. This works in the same way as the LCD preview screen on the back of a standard digital camera, but gives the feel of an SLR. The electronic viewfinder on the Pro 815 sits just to the left of the main panel. It has a similar resolution to the 3.5in screen and delivers a clear display with plenty of on-screen information including a live histogram. This histogram allows you to ensure your photos are correctly exposed.

Amazingly, the Pro 815 houses three colour LCD screens – the third is mounted on the top of the camera and is used chiefly to display current shooting parameters. This offers two main advantages over the multi-segment LCD status displays more usually found on SLR cameras. First, it's brightly illuminated and flexible in what it can display. Second, it doubles up as a live waist-level viewfinder.

Unlike many big zoom cameras, the Pro 815 uses a 2/3in 8megapixel sensor that delivers sharp, detailed images. However, when compared to a good budget digital SLR, the photos can appear a little noisy.

Despite its huge zoom, the Pro 815 has no image stabiliser. Instead, at the touch of a button a high-speed mode sets up the camera for the fastest shutter speed and highest ISO setting available. As expected, this also increases the amount of noise in the resulting image. Furthermore, it's not available in all shooting modes, making handheld shooting at the extreme end of the zoom range rather difficult.

The camera's movie capture mode can record at 25fps (frames per second), with stereo sound and at a resolution of 640 x 480. The limit of just 30 seconds of continuous recording seriously limits the 815's appeal.

In operation, the 815 can also seem rather sluggish, with noticeable waiting times between shots. The on-screen menus could do with a usability overhaul as settings are often denoted only by cryptic icons with no plain-text help. To compound the issue, the printed manual has no index.

A unique and groundbreaking camera, the Samsung Pro 815 is a little less impressive in use than it is on paper. That said, it's still a hugely capable prosumer model that's packed with features. *Paul Monckton*

Details

Price £550

Best price www.pcw.co.uk/bestprices

Contact Samsung

www.samsung.co.uk

Specifications 8megapixel • 2/3in CCD • 15x optical zoom • 28-420mm focal length (35mm equivalent) • f2.2-4.6 • Raw support • 640 x 480 30-second movies (25fps) • Compact Flash • 3.5in rear LCD panel • 87 x 78.6 x 35.5mm (w x d x h) • 870g

Verdict

Pros Massive zoom with barrel-mounted control; three colour screens

Cons No image stabilisation; unhelpful menus; slightly slow operation; poor movie mode

Features ★★★★★

Performance ★★★★★

Value for money ★★★★★

Overall The Pro 815 redefines our expectations from this segment of the digital camera market

★★★★★

21IN TFT

Eizo Flexscan S2110W

An expensive but top-performing monitor for graphics professionals



There are few good reasons for a flat-screen monitor to be expensive, but Eizo's Flexscan S2110W has most of them covered. Its functional form combines with enough style and panache to keep designers satisfied.

As you switch it on, it smacks you in the face with a full 450cd/m² of brightness at a contrast ratio of 1,000:1 – a level of output more akin to that of LCD televisions. Its widescreen format has a high, 1,680 x 1,050 pixel resolution and 8ms response time across the whole colour range, enabling it to keep up with the fastest-moving video.

We calibrate monitors as part of our review process and the results show just how far from perfect LCD panels can be when it comes to reproducing accurate colour. However, the S2110W was spot on. We selected a gamma of 2.2 from the menu and measured a practically perfect curve with all colours tracking accurately. Calibration was essentially unnecessary.

Six channel colour adjustments and a huge selection of colour temperatures and gammas combine with 14bit colour processing to produce a level of precision that reliably reproduces anything you choose to display in exactly the way you want.

Eizo's robust Arcswing holds the display firmly enough to require some effort to shift it. Raising the height involves pushing the monitor backwards and away from you.

But the S2110W is not perfect. The control switches are a subtly embossed black-on-black affair, which renders them almost invisible. Because they're touch-sensitive, attempting to navigate them by feel alone can result in multiple unwanted menu selections.

Gamers and business users would find better value for money elsewhere, but those with exacting colour quality requirements will find the Flexscan S2110W is capable of impressive performance. *Paul Monckton*

Details

Price £712.05
Best price www.pcw.co.uk/bestprices
Contact Eizo www.eizo.co.uk
Specifications 21.1in screen (1,680 x 1,050) • S-PVA panel • 8ms response time • 1,000:1 contrast ratio • 450cd/m² • Dual DVI-I inputs • 178° horizontal and vertical viewing angles • Integral power supply • Dead pixel policy: ISO 13406-2 Class II • 501 x 341 x 230mm (w x d x h) • 8.2kg • Five-year warranty

Verdict

Pros Accurate colour; brightness and contrast; viewing angles

Cons Price; invisible control buttons

Features ★★★★★

Performance ★★★★★

Value for money ★★★☆☆

Overall Excellent performance and a formidable spec, but at a price that will only appeal to those who really need it

★★★★★

19IN TFT

Viewsonic VX922

A staggering 2ms response time that will impress gamers



Viewsonic's 19in VX922 TFT monitor bears more than a passing resemblance to the VX912. It shares the smart silver and black case design and control buttons, but is fitted with a new, higher-specification panel that brings many improvements.

The VX912's 8ms response time was considered fast. But time and panel technology have advanced since then and the latest incarnation of Viewsonic's Clearmotiv overdrive technology has brought the

VX922's response times down further to a lightning-fast 2ms, which will appeal to hard-core gamers.

Internally, the VX922's panel has a response time of 6ms. Viewsonic improves on this by using a proprietary overdrive technology to boost the initial voltages applied to the liquid crystals, achieving a 2ms response time for both grey-to-grey and off-on-off transitions.

The maximum brightness remains at a highly respectable 270cd/m² while the enhanced contrast ratio of 650:1 improves readability with sharper, deeper black reproduction. Based on TN panel technology (see www.pcw.co.uk/2149165 for more information), the VX922 suffers from slightly narrower viewing angles than more expensive MVA and IPS monitors. That said, the angles have been expanded by around 10° in each direction compared to the older model.

A lightweight, tilt-only monitor stand offers built-in cable management. The buttons are large and responsive and, although there's no dedicated Auto switch, entering the on-screen menu takes you straight to the auto image adjust option. It's entirely text-based but very easy to navigate.

With a few significant performance enhancements, the VX922 is a definite improvement over the VX912. However, it lacks multimedia speakers. *Paul Monckton*

Details

Price £319
Best price www.pcw.co.uk/bestprices
Contact Viewsonic www.viewsonic.co.uk
Specifications 19in screen • 2ms response time (grey-to-grey) • 160° horizontal/150° vertical viewing angles • 270 cd/m² • 650:1 contrast ratio • DVI and analogue inputs • Tilting stand • Cable management • Dead pixel policy: ISO 13406-2 Class II • 421 x 201 x 468mm (w x d x h) • 6.7kg • Two-year warranty

Verdict

Pros Build quality; response time

Cons No Auto button; lacks speakers and USB; TN panel restrictions

Features ★★★★★

Performance ★★★★★

Value for money ★★★☆☆

Overall A premium product with class-beating response times aimed at serious gamers

★★★★★

HD PROJECTOR

Sony VPL-HS50

Enjoy high-definition video on the big screen



Most projectors on sale at the moment don't offer a high enough resolution to be able to support forthcoming high-definition TV (HDTV) broadcasts. Nor can they support the new generation of DVD players that scale images up to HDTV levels. More worryingly for computer users is the fact that they can't support decent PC screen resolutions either.

Sony has come to the aid of those who want to watch the big picture in high definition with the VPL-HS50 projector. Although it doesn't carry the HD-Ready badge that indicates full compatibility with all the HDTV standards, it still ticks all the right boxes.

The resolution is 1,280 x 720, which equates to the widescreen 720p resolution and, although it will accept the higher 1080i resolution signals, it has to scale these down to fit the screen.

The picture is smooth and clear, with good levels of detail and contrast – the projector boasts a very impressive 6,000:1 contrast ratio, which is much higher than what's found in most of its competitors.

The VPL-HS50 uses Sony's Real Color Processing (RCP) technology which allows you to individually adjust red, green and blue settings. This works well, but it does mean a fair amount of work is involved to get the picture looking its best. It also suffers from a lack of brightness, which means that, while the picture is fine in the dark, it's not so impressive in daylight conditions to the point of being almost invisible.

However, it is exceptionally quiet for a projector. The remote control is easy to use and the buttons can be lit for use in the dark. It also comes with HDMI (with HD content protection – HDCP), component and VGA sockets, but there's no DVI.

Although the bulb should last a long time (a life of 3,000 hours is quoted), replacements cost around £250. Other than that, the VPL-HS50 is good value for money for an HDTV projector. *Anthony Dhanendran*

Details

Price £1,400

Best price www.pcw.co.uk/bestprices

Contact Sony 01932 816 000
www.sony.co.uk

Specifications LCD projector • 1,280 x 720 pixels • 40-200in screen • 135w lamp • Ceiling mountable • 195w (3w standby) power consumption • Inputs: VGA, component, composite, HDMI • 348 x 360 x 135mm (w x d x h) • 5.6kg

Verdict

Pros Sharp image; easy to use; good colour

Cons Laborious to set up perfectly; poor brightness

Features ★★★★★

Performance ★★★★★

Value for money ★★★★★

Overall An excellent projector that makes HD content look as good as it's supposed to

★★★★★

BECOME THE NEXT SPONSOR OF ONE OF OUR REPORTS

Increase awareness of your company with this amazing package including:

- Your logo on the front cover
- A page of sponsor's comment
- A generous number of adverts
- A PDF e-book of the report on the PCW cover disc
- Up to 1000 run-ons of the report
- 1-month solus sponsorship of a dedicated section of www.pcw.co.uk

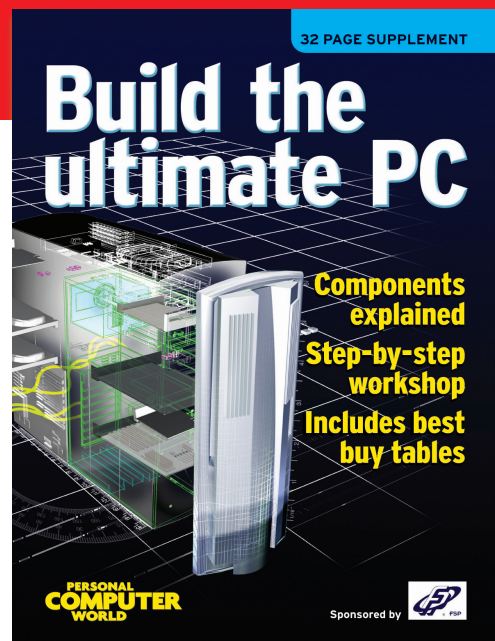

For more details call Paul Harvey on 020 7316 9465 or email him at paul_harvey@vnu.co.uk

MULTIMEDIA GRAPHICS CARD

ATI All-in-Wonder X1900

Media Center-compatible 3D gaming card with impressive performance



As expected, core and memory clock speeds aren't as fast in this R580-based chip as the top-of-the-range X1900 XTX (see www.pcw.co.uk/2149098). The core drops 150MHz down to 500MHz, while the effective memory speed sits at 960MHz compared to the X1900 XTX's 1,550MHz. ATI has also halved the onboard memory to 256MB.

Despite this, the number of vertex and pixel pipelines remains at eight and 48 respectively, which means the X1900 XTX is still a fast card. In 3Dmark05

it scored 8,347 while Far Cry ran at 62.2fps (frames per second). These results place it above the X1800 XT (see www.pcw.co.uk/2143241) in terms of performance.

Although dropping the memory and core clock speeds means it's not as quick as the X1900 XTX, it runs far cooler. As a consequence, the bulky two-PCI slot design is replaced with a standard-sized card.

The Theatre 200-based TV tuner will receive either standard analogue or digital Freeview broadcasts (check www.freeview.co.uk for details of coverage). The tuner will also work fine in conjunction with Windows Media Center Edition. However, it's only a single tuner, so if you want to record two channels at once you will need to purchase a second tuner.

Bundled accessories include a remote control, the Remote Wonder Plus, and an external box for hooking up component, S-video and composite connections. You also get a single DVI output.

For those after a multimedia graphics card that is also able to handle intensive 3D gaming, the All-in-Wonder X1900 certainly fits the bill. With slower clock speeds and half the memory of the X1900 XTX, performance obviously takes a hit, but for most gamers it will be perfectly adequate. What's more, at under £300 it's very reasonably priced.

Will Stapley

Performance

3Dmark05* 8,347



*Tested at 1,024 x 768 in 32bit colour

Details

Price £279

Best price www.pcw.co.uk/bestprices
Contact ATI www.ati.com

Specifications R580 core • 256MB of GDDR3 Ram • 500MHz core • 480MHz memory (960MHz effective) • 8 vertex shaders • 48 pixel pipelines • Shader Model 3 support • 6x Adaptive Anti Aliasing • Parallax Occlusion Mapping • Remote Control

Verdict

Pros Runs cooler than X1900 XTX; can be used with XP Media Center
Cons Single tuner; can't match other X1900 cards for performance

Features ★★★★★
Performance ★★★★★
Value for money ★★★★★

Overall The X1900 All-in-Wonder combines excellent multimedia features with equally impressive performance

★★★★★

5.1 SPEAKERS

Logitech Z-5450

Dolby Digital surround-sound speakers with wireless rear satellites



Setting up a home cinema can get expensive, but it also brings with it endless wires to clutter up your lounge. The Z-5450 5.1 surround-sound speakers from Logitech reduce the number of wires by operating its two rear speakers wirelessly.

It's worth pointing out that, although these rear speakers don't need to be hooked up directly to the Z-5450's Control Center, they do both require power and will therefore need to be near power sockets.

Depending on the layout of your lounge, this might not be a problem. However, if there aren't any power sockets near where you want to place the speakers (the power cable on each speaker is just under 2.2m long), you'll need to use some form of extension lead.

The rear speakers use a Wifi connection to talk to the Z-5450's Control Center. To avoid conflicts with nearby 802.11g networks, the Control Center will hop channels on the 2.4GHz band if it detects interference.

We tested the speakers in a fairly cluttered wireless environment and suffered no signal problems.

As for sound quality, the Z-5450s perform extremely well. Each speaker outputs around 40w, with the large sub-woofer thumping out 116w of bass. The Control Center will decode Dolby Digital and DTS signals and will upmix a standard stereo input.

The remote is a little disappointing. Logitech has tried to keep it simple, but it's easy to accidentally jam the rubbery buttons under the casing. We also found it struggled to operate when used at a distance of more than 3.5m.

The £349 price is high, especially when Logitech's standard wired Z-5500 system is more powerful yet £70 cheaper. However, at the time of writing we found the Z-5450s on Amazon.co.uk for an incredible £145.

Rear wireless speakers won't suit all environments and many will be better off sticking with a standard wired surround-sound system. But for those who have plugs in the right place, the Z-5450 is a quality set of 5.1 speakers that won't disappoint.

Will Stapley

Details

Price £349

Best price www.pcw.co.uk/bestprices
Contact Logitech 020 7309 0127
www.logitech.co.uk

Specifications 5 satellites (38-42w) • 1 sub-woofer (116w) • 2.4GHz wireless rear speakers • Dolby Digital and DTS hardware decoder • 2 digital optical inputs • Digital coax input • 6-channel 3.5mm input • Stereo 3.5mm input • Headphone socket • Wireless remote

Verdict

Pros Lack of wires; Wifi; performance
Cons Powered rear speakers won't suit all environments; remote; price

Features ★★★★★
Performance ★★★★★
Value for money ★★★★★

Overall The rear speakers still require power cables, but this is a quality speaker system complete with a digital decoder

★★★★★

SATELLITE NAVIGATION

Magellan Roadmate 800

A good route planner with multimedia features



Satellite navigation is finding its way into all kinds of devices these days, from PDAs to mobile phones.

Magellan's Roadmate 800 comes at it from the other way round. It's a dedicated sat nav device that just happens to have a bunch of multimedia functions built into it.

The Roadmate 800 looks very similar to Magellan's previous systems – a chunky grey slab with a large (3.5in) colour touchscreen on the left and a series of buttons arranged in a circle on the right.

The difference with this Roadmate is that it has its own hard drive. We've seen hard disk-based GPS devices before, but this piece of kit has 20GB

of space – 5GB of which is available to store pictures or music.

Media can be transferred via USB and a rechargeable battery allows you to remove the unit from its in-car mount and use it as a portable jukebox and digital photo album. As such it works pretty well, although audio performance is not spectacular.

The navigation software is quick and easy to use, the display is clear and the speaker provides good audio for voice commands. Magellan has made a few tweaks to its software, including a useful 3D bird's-eye map view.

Other neat touches include automatic night mode when low levels of natural light are detected, and an automatic volume increase to compensate for engine noise at speeds over 45mph. Detailed maps of 27 European countries are pre-loaded on the disk. North America is on there too, but needs to be unlocked for an additional fee.

The multimedia feature is interesting, but not necessarily a deal breaker. Besides, the sort of gadget fan who would fork out £599 for this type of satellite navigation device will almost certainly already have something like a photo Ipod at their disposal.

Jonathan Parkyn

Details

Price £599.95
Best price www.pcw.co.uk/bestprices
Contact Magellan 00800 6243 5526 www.magellangps.com
Specifications 20GB hard disk drive (5GB free for storing media) • 3.5in touch-sensitive screen • SD/MMC memory card slot • USB connection • Integrated lithium-ion battery • Car windscreen mount • 12v car adapter • Stereo headphones • 156 x 40 x 80mm (w x d x h) • 300g

Verdict

Pros Touchscreen; rechargeable battery; car mount and power adapter
Cons Expensive; extras may be surplus to requirements

Features ★★★★★
Performance ★★★★★
Value for money ★★★★★

Overall With great route-planning software, this is an excellent, if costly, device

★★★★★

WIFI VOIP PHONE

Vonage Utstarcom Wifi Phone

A simple way to make wireless Internet calls, but this is a very dated handset



Vonage is keen to promote its VoIP service as a viable alternative to traditional landline calling and is about to launch the Wifi Phone in conjunction with handset manufacturer Utstarcom – it has been available in the US for some time now.

The Wifi Phone is about the same size as most mobiles and features a Nokia-style button layout. But since many people buy mobiles based on looks, this handset is badly in need of an updated design.

You'll need a wireless router or access point and a broadband Internet connection to use this phone. Setting it up is relatively easy, although it does its best to confuse matters with the unintuitive menu system. Once it has performed a search for nearby wireless networks, you select the appropriate one and, if necessary, enter the WEP or WPA security key. You can then save the network settings in one of four preset slots.

We managed to set the Wifi Phone up in around five minutes without going anywhere near a PC, and during our tests call clarity was good.

We did come across one problem though. When we strayed out of the range of our wireless network while on a call, the phone lost the connection. However, the call continued to stay active and only terminated when we hung up on the other line. Even when the Wifi Phone reconnected to our wireless network, there was no way to hang up the previous call. Vonage tells us this problem will be ironed out when the final version is released.

Although the phone is in dire need of an update, we have no doubt that wireless VoIP phones such as this will become very popular. As expected, it will only work with Vonage's VoIP service, so you'll need to sign up for an account if you don't already have one.

Will Stapley

Details

Price £89.99
Best price www.pcw.co.uk/bestprices
Contact Vonage 0800 008 6000 www.vonage.co.uk
Specifications Utstarcom F1000 phone • 802.11b • Call waiting • Call transfer • Three-way calling • Calendar • Alarm • USB charger

Verdict

Pros Relatively easy to set up
Cons Dated handset; some call issues

Features ★★★★★
Performance ★★★★★
Value for money ★★★★★

Overall A few problems need to be ironed out, but we see a bright future for wireless VoIP calls

★★★★★

VOIP ADAPTER

Draytel Vigortalk

Make calls over the Internet easily using a standard phone



Voice over IP (VoIP) services can be tricky to set up, and to help overcome this Draytel has launched Vigortalk. This is a hardware VoIP adapter that sits between a standard phone and Ethernet router. You won't need a PC during setup, but you will need to log on to the Draytel website to create a new account.

There are three sockets on the back of the small Vigortalk box for power, Ethernet and phone

connections. Once you've hooked it up to your router, connected a phone and powered up the Vigortalk, you can enter your username and password directly through the handset – this only needs to be done once.

This process is painless enough, although the voice instructions could be made a little more human. We had our test unit set up within five minutes and were able to make and receive calls straight away.

Annoyingly, if you fail to dial a number six seconds after picking up the phone, an engaged tone is played. You then have to hang up and start again.

As expected, the Vigortalk will only work with Draytel's VoIP service, so it's money down the drain if you decide to switch provider.

Draytel's calling charges start from 1p per minute and calls to other Sip (Session Initiation Protocol) VoIP users are free. You get £2 of initial calling credit and once you've purchased £10 of credit (within a 60-day period), you're eligible for free voicemail and a number with a UK geographic dialling code (such as 01273) instead of the 0870/0845 numbers.

The Vigortalk is cheap, easy to set up and portable. Having to carry the AC adapter around is a pain, and we'd like to see a wireless version, but it's a hassle-free way to join the VoIP revolution.

Will Stapley

Details

Price £29.99

Best price www.pcw.co.uk/bestprices

Contact Draytel www.draytel.org

Specifications Analogue VoIP adapter • G.711 and G.729A/B codecs • Ethernet port (1.6m RJ45 cable included) • Compatible with standard phones (including Dect) • Requires Draytel account • £2 free calling credit included • AC adapter • one-year warranty

Verdict

Pros Simple to set up; cheap; works well

Cons Ethernet only; some minor irritations

Features ★★★★★

Performance ★★★★★

Value for money ★★★★★

Overall A decent VoIP adapter that's painless to set up and use

★★★★★

NETWORK OFFER • NETWORK OFFER

A complete 5 user network with E-mail /internet from each PC, fully installed and cabled for less than £34 per week



Package includes

- Compaq P4 Windows 2003 server
- Router with Firewall for Internet and E-mail to desk
- Cat5 cabling for 12 points + 16 port switch
- 5 workstations with Windows XP
- Automated backup system
- 2 days on-site installation and configuration



Call us now on
01279 718693
more offers on our website
www.hardsoft.co.uk

HARD SOFT

Hatfield Grange Farm, Hatfield Broad Oak
Bishop's Stortford, Herts. CM22 7JZ



iPod AV Connection Kit

Price £69 **Contact** www.apple.com/uk **Overall** ★★★★★

Designed to output direct to a TV or home stereo, this is aimed primarily at those with iPods that can store and play back images and video.

The dock connects to a TV via the supplied composite cables (or S-video, not supplied). The remote can then be used to cycle through photo slideshows, music and videos. Annoyingly, the menu screen isn't displayed on the TV, making it hard to navigate. Furthermore, the remote's menu button is rendered inactive when using the iPod.

On the surface, this appears to be a good-value bundle. A far better alternative, however, is to buy the Apple iPod AV cable separately for £15 and sacrifice limited wireless control in favour of a £51 saving. *Luke Peters*

Overall Looks good on paper but is extremely restrictive

Logitech Wireless Music System

Price £99.99 **Contact** www.logitech.co.uk **Overall** ★★★★★

This audio streamer is aimed at iPod owners but it will also work with any other type of mp3 player that has a standard 3.5mm audio connector.

When you turn on the iPod, the transmitter beams the music via Bluetooth from the iPod to the receiver unit, which then feeds it straight to your speakers.

It works well and we didn't detect any degradation in sound quality. However, the size of the transmitter unit means it is best suited for use with larger iPod models. It looks odd bolted onto the slimline iPod Nano, especially as the headphone socket is on the base of the unit. *Cliff Joseph*

Overall A little expensive but a quick and convenient way of streaming music



Hela Perific Mouse

Price £81.08 **Contact** www.hela.co.uk **Overall** ★★★★★

The Perific Mouse comes with two sets of left and right buttons, a trackball, a small rubber scroll wheel and an optical light and is designed to be used holding it in mid air or in your lap.

This can be done either one-handed or, slightly more bizarrely, by placing it over your left hand just behind your knuckles and using your right hand to control the trackball. Button clicks are controlled by the left hand. The compact design of the entire unit makes it difficult to reach the mouse buttons if you've got large hands.

Whatever it uses, this mouse is expensive and therefore won't be to everyone's tastes. *Will Stapley*

Overall Interesting, but not something we see taking off

VoIPvoice Uconnect

Price £39.99 **Contact** www.voipvoice.com **Overall** ★★★★★

Uconnect lets you operate the free Skype software with your home phone. Plug the device into a USB port on your PC, then connect it to the phone and finally to the wall socket. You need to install software to enable communication between the phone and Skype.

The device uses its own soundcard so you have to unplug it to listen to audio on your PC, which isn't ideal. Uconnect will also only work when your PC is switched on.

Despite its convenience, Uconnect is let down by the requirement for a physical connection between PC and phone as well as the way in which it overrides your PC's soundcard. *Paul Rowlingson*

Overall Good-value VoIP adapter but it has its fair share of issues



BUFFALO™

Seamless Sharing.

New! Designed to DLNA (Digital Living Network Alliance™) guidelines, LinkStation Multimedia Home Server and TeraStation Home Server series offer affordable network attached storage (NAS) solutions for sharing digital media over your network. With built-in media server software, Buffalo Home Servers automatically find and access all DLNA-based devices on your network for instant streaming of stored videos, images or music. Enjoy the freedom of seamless multimedia sharing with Buffalo Home Server Solutions!

Store Photos, Music and Videos

Access Files from Multiple Computers

Share Digital Files Easily Over your Network

Stream Media to Any DLNA Compatible Player



**Store.
Access.
Share.
Stream.**

- 272,000 Photos* 
- 75,000 Songs* 
- 333 Hours of Video* 
- Thousands of Files 



HS-D300GL/HS-D400GL



HS-D1.0TGLR5

Buffalo offers unique solutions for the digital home. Choose from our range of wireless networking, multimedia and storage products.

Learn more: www.buffalo-technology.com

amazon.co.uk
and you're done™

broadbandstuff.co.uk

dabs.com

• amazon - www.amazon.co.uk • broadbandstuff.co.uk • 0870 7662329 • dabs - www.dabs.com

© 2006 Buffalo Technology (UK), Limited. Buffalo Technology and Buffalo Technology logo are registered trademarks of Buffalo Technology (UK) Limited. The names and logos of other companies mentioned herein belong to their respective owners.

*Based on LinkStation Multimedia Home Server 300 GB, model HS-D300GL. Values used for videos, photos, files and mp3s are approximates based on typical length, compression and resolutions.



EVGA 7800GS CO Superclocked

Price £TBC **Contact** www.evga.com **Overall** ★★★★★

If you're running a PC with AGP graphics, EVGA's latest card will be of interest. As its name suggests, this model is overclocked and runs with a core speed of 460MHz (85MHz faster than the reference design) while the memory has been tweaked to a blistering 675MHz (1.35GHz effective). Impressively, all this is done with the reference single-slot cooling solution.

In our 3Dmark05 tests, the card notched up a score of 6,299, the fastest 3Dmark05 AGP result we've seen.

Although this card isn't currently available in the UK, we're expecting stores to be stocking it soon. Amazingly, it's going to be priced at around £160, which is tremendous value for money.

Simon Crisp

Overall An excellent choice for AGP owners who want fast graphics

NEC ND-4551A

Price £35 **Contact** www.nec.co.uk **Overall** ★★★★★

The NEC ND-4551A is the first drive to show off the new Labelflash technology. Much like its Lightscribe rival from HP, Labelflash burns images directly onto the surface of a compatible disc. These are currently only manufactured by Fujifilm – a pack of five DVD-R discs on Dabs.com costs just over £5. The main advantage over Lightscribe is that Labelflash can also burn a label to an unused area of the data side of any standard disc.

The drive was very quick, producing a finished single-layer DVD in just six minutes, 15 seconds and a dual-layer DVD in just over 27 minutes

Another advantage of Labelflash over Lightscribe is that the image can be written in just seven minutes at the lowest resolution. We didn't see much difference between the best and lowest quality, so this is a real saving. However, when comparing the quality of Lightscribe images to those of Labelflash, the former has the edge. Labelflash simply isn't as vibrant.

Although Labelflash can't match Lightscribe in terms of the vibrancy, it's faster and has the benefit of burning both sides of a disc.

Tim Smith

Overall An excellent value DVD drive that supports Labelflash



Enlight EN-7473 Home Media case

Price £52.88 **Contact** www.xcase.co.uk **Overall** ★★★★★

In terms of design, Enlight's Home Media case takes a different route compared to other entertainment system cases around at the moment. It ends up looking like two stacked hi-fi units.

Constructed from steel, the EN-7473 is designed to accept standard micro-ATX boards and, thanks to its height, full-size expansion cards. This is a definite benefit when it comes to sourcing TV cards etc to build into your entertainment system. Among other bays, you get one 5.25in that sits behind a dropdown panel and two vertical 3.5in bays. Enlight provides a 250w power supply that is barely audible. Two 6cm fans sit on the rear panel providing quiet but effective cooling.

Simon Crisp

Overall Perfect for a home entertainment system

Nexus Anti-Vibration Mounting Kit

Price £11.59 **Contact** www.specialtech.co.uk **Overall** ★★★★★

The Anti Vibration Mounting Kit from Nexus is a small, but very useful box full of goodies. The pack consists of 60 components to quieten and tidy up the internals of your PC. You'll find rubber fan mounts, cable ties, rubber grommets and four rubber feet.

For cutting down the noise in case fans, there are 12 rubber mounts for open chassis case fans and the same number again for closed chassis fans. You also get rubber mounting grommets with screws for mounting hard drives and 20 tie wraps to tidy up any loose cabling.

Finally there are four rubber feet to replace the hard plastic feet to minimise noisy vibrations.

Simon Crisp

Overall Really useful box of bits and extremely cheap



Bring Dead Spots Back to Life!

HIGH POWER

TURBO G Wireless

5^x Further & **50%** faster than Standard 802.11g. **3.5^x** Further than MIMO Solutions.*¹

Tired of hitting "dead spots" in your wireless network? Buffalo Technology's *Turbo G High Power* Wireless Solutions bring those dead spots back to life! Now you can go places you never could with standard 802.11g devices. With an effective *outdoor range of up to 600m*, connecting in the bedroom or office down the hall should be no problem.*² Whether you're upgrading your wireless LAN or just getting started, the Turbo G High Power Wireless Solutions provide the perfect answer for those who need *Speed, Performance and Value*. Bring dead spots to life while enjoying faster connections and extended range.



WHR-HP-G54
Wireless Smart Router



WLI-CB-G54HP
Wireless CardBus Adapter



24th Nov 05
(Issue 203)



WLI-TX4-G54HP
Wireless Ethernet Converter

Great for Wireless Online Gaming!

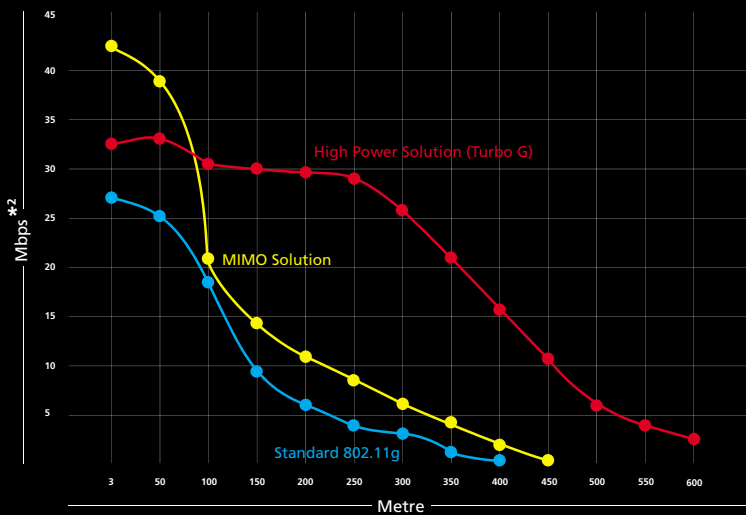

• broadbandbuyer.co.uk - 0870 7665175 • eBuyer.com - 0845 146 1720 • Transparent - 0870 7522690

BUFFALO™

Learn more: www.buffalo-technology.com

© 2006 Buffalo Technology (UK), Limited. Buffalo Technology, Buffalo Technology logo and AOSS logo are registered trademarks of Buffalo Technology (UK) Limited. The names and logos of other companies mentioned herein belong to their respective owners. *1 Based on Buffalo Technology internal testing results. Products tested: High Power solution (WHR-HP-G54, WLI-CB-G54HP), MIMO Solution (WZR-G108, WLI-CB-G108), Standard 802.11g (WBR2-G54, WLI-CB-G54S). *2 Wireless networking performance will vary depending on environment.

PROBLEMS WITH SPACE?

GO WIDE WITH VIEWSONIC!

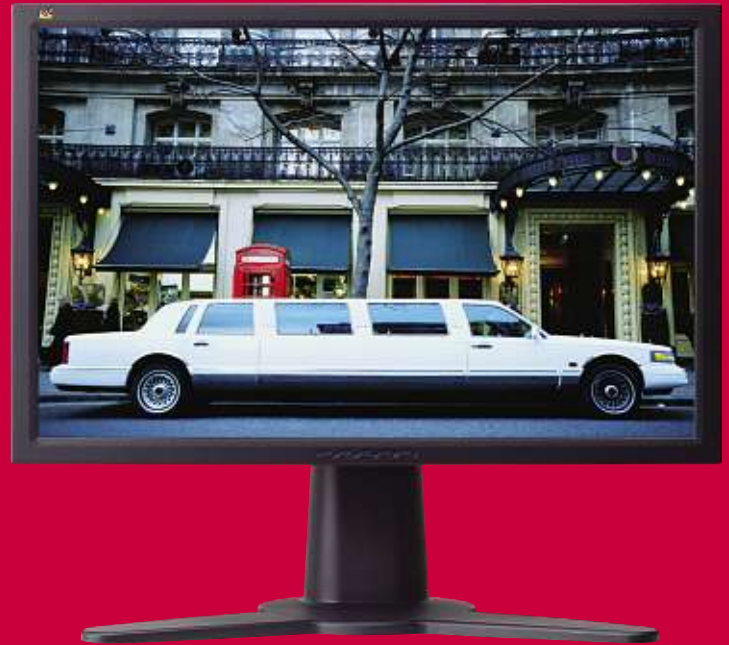

March 06



April 06



VA1912w (19"):

Resolution 1440 x 900, contrast ratio 500:1, response time 8ms, brightness 300 cd/m², viewing angles 150°/130° h/v



VA2012w (20"):

1680 x 1050, 600:1, 8ms, 300 cd/m², 140°/125° h/v



VX2025wm (20"):

1680 x 1050, 800:1, 8ms (gtg), 300 cd/m², 140°/125° h/v



VP231wb (23"):

1920 x 1200, 500:1, 12ms (gtg), 250 cd/m², 176°/176° h/v

Expand your view with ViewSonic's widescreen displays. The 16:10 aspect ratio provides more productive space for multiple windows, high definition images and immersive gaming action. These feature-rich displays ensure crystal-clear images and crisp text. Upgrade your workspace while staying within your budget – choose a widescreen display from ViewSonic.

For further information or to purchase from a ViewSonic authorised reseller go to www.ViewSonic.co.uk

ViewSonic 
the choice of professionals

GRAPHICS SUITE

Coreldraw X3

A competent package aimed at business and professional users on a budget

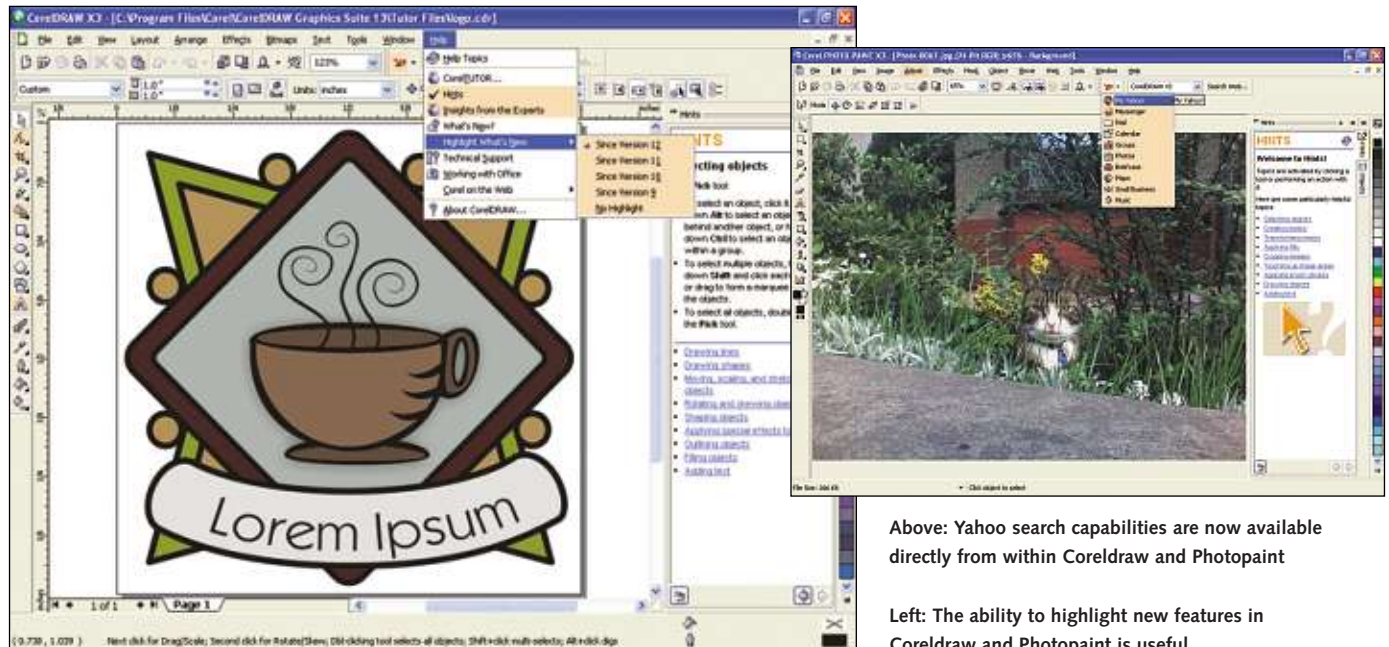

Above: Yahoo search capabilities are now available directly from within Coreldraw and Photopaint

Left: The ability to highlight new features in Coreldraw and Photopaint is useful

Along with Wordperfect Office X3 (see our review at www.pcw.co.uk/2149856), Corel has released the latest version of its Coreldraw Graphics Suite – the 'X3' is PR-speak for 13.

The suite is aimed at professional designers as well as business users. Along with Coreldraw X3, you get the image editor Photopaint X3, screenshot utility Capture X3, Bitstream Font Navigator, and Pixmaptec Rawshooter essentials (for a review of Rawshooter Premium, go to www.pcw.co.uk/2147920). As always, you also get thousands of clipart and fonts and a wealth of training videos and tutorials.

Coreldraw first appeared in 1989 and has always had a good reputation for innovation. Unfortunately, it has also suffered from a difficulty in handling multi-page text documents and problems with print output.

The first thing you notice about Coreldraw's interface is the Hints docker (palette) on the right; this gives you tips about the current tool. Another great improvement is the way new features are highlighted in orange. You can even specify how far back this process goes, so if you haven't upgraded since version 9, for instance, you can highlight all enhancements since this point.

Corel has clearly spent time improving the way Coreldraw handles text. You now get various new text formatting dockers, a Wysiwyg font menu and automatic hyphenation. Even better is the interactive Fit Text to Path tool that makes it easier to attach a line of text to a specific path, such as a curve.

However, page layout features are still comparatively limited or cumbersome – for instance, the only way to add headers/footers is by creating a new master layer (and you can't import them – or columns – at all).

Image editing comes in for its share of improvements, too. The interactive Crop tool lets you remove all parts of bitmap or vector objects that fall outside the boundary you define, while the Bevel docker makes applying bevels to graphics or text a lot quicker.

Furthermore, the innovative Smartfill tool lets you apply fills to enclosed areas with just a click and the old standalone Coreltrace has been replaced by Powertrace. This is now accessible from within Coreldraw and makes a far better fist of converting bitmaps into resolution-free vectors (though we found large bitmaps tended to make it crash). Additionally, Coreldraw supplies enhanced spot colour and pdf support.

Photopaint shares Coreldraw's Hints docker (which makes using its tools easier) and it houses the new Image Adjustment Lab – a one-stop shop for correcting digital photos.

One great feature here is the ability to create snapshots as you work. These are then collected at the base of the window. Clicking a snapshot restores the image to the state when the snapshot was created.

Photopaint's enhanced Cutout Lab provides improved brushes, simplifying the process of extracting subjects from the background of photos.

Professional users with big budgets will probably go for Adobe Illustrator and Photoshop and it's true that Coreldraw X3 doesn't quite match Adobe in some areas. However, leaving aside the occasional gap, this package is an excellent choice for professionals and business users who need powerful graphics capabilities at a reasonable price. Just don't expect it to compete with dedicated page-layout software such as Indesign. *Stephen Copstake*

Details

Price Boxed £386.80

Download £347.80

Upgrade £157.45

Best price www.pcw.co.uk/bestprices

Contact Corel 01628 589 800

www.corel.co.uk

System requirements 600MHz

Pentium III • 256MB of Ram •

200MB minimum hard disk •

Windows 2000, XP Tablet PC,

XP or Windows Server 2003 with

latest Service Pack

Verdict

Pros Competitively priced; huge clipart collection

Cons Relatively poor text handling; no animation tools

Features ★★★★★

Ease of use ★★★★★

Value for money ★★★★★

Overall Great drawing and photo-editing capabilities with lots of innovative features

★★★★★

ONLINE SECURITY

CA Etrust Internet Security Suite

Not the most polished of suites, but it protects against all manner of online threats



Left: The Security Center screen displays your PC's security status

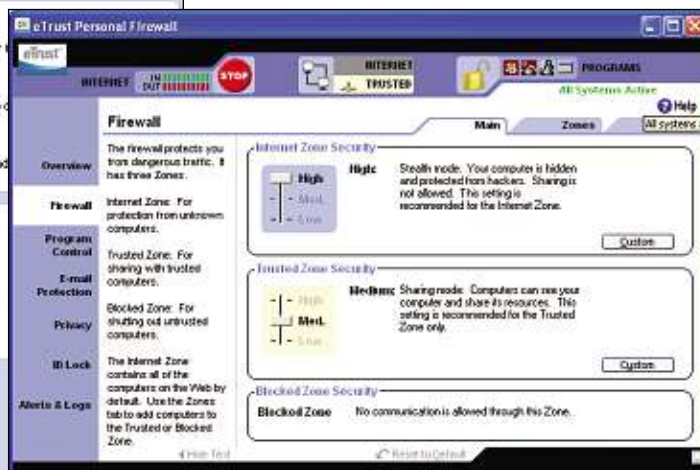

Below: The firewall is a version of the popular Zonealarm

While it's estimated that only 300,000 PCs were hit with the recent Nyxem-E virus, also known as My Wife, the very fact that some people woke up to discover documents missing from their PCs shows once again how important it is to install decent security software on Windows systems.

CA's Etrust Internet Security Suite is yet another package that aims to provide users with complete online protection.

As with its established rivals, Etrust includes both anti-virus software and a firewall to keep electronic bugs and hackers at bay. A big benefit here is that this firewall is a version of the incredibly popular Zonealarm (see www.pcw.co.uk/2043756), which is proven technology that's easy to configure. The suite also includes Pest Patrol to counter spyware, as well as an anti-spam module.

Installation and initial setup are refreshingly easy, with the option to automatically set access rules in the firewall for popular applications and DLLs (Dynamic Link Libraries). More good news is that CA has gone for a unified interface across the modules to give each area a consistent appearance.

Unfortunately, the company hasn't gone all the way and integrated everything in the same way that Symantec and McAfee do. You can check the status of each module and perform basic functions, such as system scans, from the main Security Center, but you'll need to launch each part separately to get to the advanced features. Here the look and feel can vary quite a bit.

Key features on the anti-virus side include scheduled, on-demand and realtime heuristic scanning,

quarantine facilities for dealing with suspect files at a later date, email scanning for Pop3 clients and automatic signature updates (a 12-month subscription is provided). In tests it worked well, but scanning was remarkably slow on our 3GHz Pentium 4 test PC.

The anti-spam module integrates with both Pop3 and Imap accounts under Outlook and Outlook Express. Essentially, this works by grabbing any email from an address not on your currently approved 'senders' list and sticking it in a potential spam folder. It works fine with an existing list but can be a pain if you're setting up a new account. Spam is 'scored' on the basis of content (this can be adjusted) and the package can be trained by pointing it at examples of good and bad messages.

There's a tad less flexibility in Pest Patrol but you do get the chance to exclude files from detection scans and call up statistics on the latest spyware. You can also join in the fun by opting to provide data logs from your PC to help CA keep track of threats.

Other key features include an easy-to-use ID lock in the firewall to prevent sensitive information from being sent over the web or in an email, such as credit card and address details, and blocking for pop-up and pop-under ads.

The Etrust Internet Security Suite is a well thought-out set of utilities that provide a good level of online protection. We'd like to see tighter integration between the modules and there are sections of the help file referring to items that aren't actually included in this program, such as parental control, which is a bit sloppy. However, the package is easy to use and, at £39.95, should give the likes of Norton a run for their money.

Chris Cain

Details

Price £39.95
Best price www.pcw.co.uk/bestprices
Contact Computer Associates
 01753 577 733
System requirements 300MHz processor or higher • 128MB of Ram • 55MB hard disk • 55MB free disk space

Verdict

Pros Easy to set up and use; includes proven firewall

Cons UK version lacks parental control; could be more integrated

Features ★★★★★

Ease of use ★★★★★

Value for money ★★★★★

Overall While not quite as polished as some of its more established rivals, Etrust Internet Security Suite offers a good level of protection

★★★★★

WEBSITE CREATION

Netobjects Fusion 9

A fully featured website editor with CSS support



Left: You can quickly get a site off the ground using the templates

Below: Support helps you make the most of your site



Creating an enticing website, whether personal or for business, is no mean feat. Netobjects Fusion 9 bridges the gap between the cheap yet limited web page editing programs and the far more expensive Dreamweaver-style alternatives.

Fusion 9 comes with a couple of templates to get you going, but more importantly supports cascading style sheets (CSS) and has useful extras such as photo galleries.

The opening page has links to online services from Netobjects and lists recently edited sites. New sites can be created using one of the templates or with the site wizard. Only two templates are provided, although they are complete sites and a good way to see what Fusion is capable of doing. It's more likely that you'll use the site wizard to create your own. This provides you with a list of suggestions for pages to include a variety of colour schemes. Once you've completed the groundwork, you can apply all sorts of styles; hundreds are available online through Fusion at no extra cost. Each can be applied with a click of a button thanks to the support for CSS.

The Site Design page shows the overall structure of the website and the view can be collapsed or expanded to prevent it becoming confusing. One useful function is the ability to mark pages as finished and add comments to help keep track of progress in large sites.

One of the biggest advantages of designing a site in this way is that Fusion can take care of all navigation links. Fusion can display the navigation bar on your site as text, graphics, or a Flash animation. We were pleased to see that the alt text (used if a

visitor has images turned off in their browser) for the graphical option was added automatically.

If you like dabbling with HTML, you'll be disappointed, as Fusion doesn't offer the option to edit the code behind a page. However, it is possible to add snippets of code for linking to a favourite browser or advertiser. A Google search bar and RSS feed can also be added to pages.

During editing, pages are displayed with a background grid and a ruler in pixels, allowing content to be placed with a high degree of accuracy. A master border around the page is used for navigation buttons and top images. During testing, we occasionally found that moving an image in the master border led to some annoying margin changes.

Although there is a competent photo gallery creation tool, Fusion has a strong business feel, with the ability to create rotating images for advertisements and strong product catalogue and shopping tools.

Thankfully, the days of having to use a separate FTP program to upload your site files are long gone. Indeed, Fusion 9 is quite capable of uploading everything itself. You can, of course, preview your site locally at any time without uploading content.

A new element to the Fusion stable is the addition of Npower. Working with Fusion 9 in the same way that Contribute does with Dreamweaver, the cheaper Npower allows other users to edit the content on a website with the full site design tools.

This software has its limitations, such as the lack of HTML editing and only two templates, but Fusion 9 is a well-featured website editor that would suit small businesses on a tight budget.

Tim Smith

Details

Price £139.99

Best price www.pcw.co.uk/bestprices

Contact Avanquest 01752 895 100
www.avanquest.co.uk/

System requirements 660MHz
Intel Pentium III • 256MB of Ram •
250MB hard disk • Macromedia Flash
Player 7 or later • Microsoft Windows
98SE/2000/XP

Verdict

Pros Uses CSS; good for ecommerce newcomers

Cons No HTML editing; only two templates

Features ★★★★★

Ease of use ★★★★★

Value for money ★★★★★

Overall A quality web design suite with plenty of features for newcomers to ecommerce

★★★★★

REMOTE ACCESS

Remote Desktop for Mobiles 2

Access and control a PC from your mobile phone



Services such as Mywebex and GotomyPC are great for accessing remote computers, but you need to use a PC with an Internet connection. Remote Desktop for Mobiles 2 lets you perform similar functions from a mobile phone. It works with any Java-enabled mobile and, while a 3G connection is preferable, you can use the service on a GPRS connection.

Like similar services, Remote Desktop for Mobiles requires a server application to be running on the PC to which you want to connect. Using this application, you

can set up user accounts, passwords and access rights. You then download the 90KB client application to your mobile. A special version is available for most Blackberry devices and there's also a web-based option.

Once the connection is made, you can click the Desktop option to see what's displayed on your remote PC. Mobiles with larger screens cope better at displaying the desktop, but you can alter the magnification level to make it usable with small displays.

You use your mobile to control the mouse pointer and, in magnification mode, the pointer can be used to scroll around the desktop. It's also possible to send individual keystrokes or blocks of text using your keypad.

While the desktop view is impressive, there are plenty of other options to play with. You can browse through the contents of your hard disk, cut and paste files and run preset commands. Of course, you'll be charged by your mobile operator for data usage every time the desktop refreshes or you perform a function.

Compared to using a web browser on a second PC, Remote Desktop for Mobiles 2 is more fiddly. However, for those times when you're not able to use a PC, it's an excellent alternative to standard remote access software. A free 10-day trial is available. *Will Stapley*

Details

Price \$29.99 (approx £17)
Best price www.pcw.co.uk/bestprices
Contact RDM
www.desktopmobiles.com
System requirements Java phone with 2MB of Ram and 64KB+ application size • 3G, GPRS or Edge
 • 2MB of Ram • Windows 98/NT4/2000/XP

Verdict

Pros Works well; plenty of functions
Cons Can be fiddly; usability depends on mobile screen size

Features ★★★★★
Ease of use ★★★★★
Value for money ★★★★★

Overall A good alternative to traditional remote access applications

★★★★★

MULTIMEDIA SUITE

Apple iLife '06

A web design application joins these well-designed creativity tools

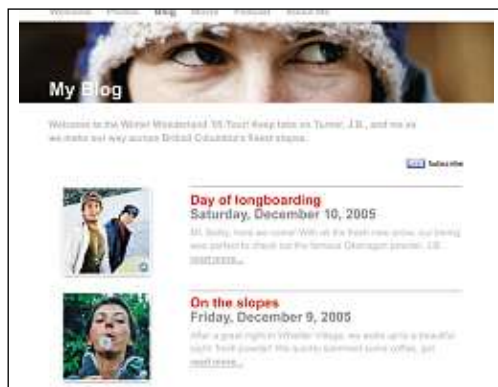

Bundled with new Macs and sold separately for £55, iLife is a one-stop shop for home multimedia projects. Aimed specifically at non-experts, it lets you edit your camcorder movies, create DVDs, retouch photos, print professional-quality picture books and even compose music.

iLife '06 features updated versions of its five key applications; iPhoto, iMovie HD, iDVD, iTunes and iGarageband. It also introduces iWeb, a brand new web-design program optimised for use with Apple's .Mac online service.

The secret of iLife's success is that each application is built around a simple interface and a set of well-designed, yet customisable templates. Most operations are drag and drop, and you can get good results fast.

A case in point is iWeb, which features templates for blogs, online photo slideshows, audio and video podcasts and more. There are a few annoying restrictions when it comes to presentation but on the whole we're very impressed.

New features in iPhoto kick off with a huge improvement in speed. Scrolling through your library is now faster and the program can cope with up to 250,000 images. We also like the option to quickly produce Photocasts – folders of images other iPhoto users can subscribe to over the Internet like a podcast.

Key improvements in iGarageband 3 include a Podcast recording studio and the package can also record interviews over Apple's iChat. Meanwhile, iMovie HD now includes realtime effects and titling, movie themes and the option to open multiple projects at once. Finally, iDVD has a spruced-up map view, can produce widescreen DVDs and supports third-party DVD writers.

With tighter integration between the packages and the excellent new iWeb, iLife '06 really is a must-have for any Mac user. *Chris Cain*

Details

Price £55
Best price www.pcw.co.uk/bestprices
Contact Apple 0800 039 1010
www.apple.com/uk
System requirements Mac with a PowerPC G4/G5 or Intel Core Duo processor • 256MB of Ram • Mac OS X v10.3.9 or later • DVD drive • 10GB hard disk

Verdict

Pros Easy to use; good value; excellent integration with .Mac
Cons Need .Mac account to get full benefits from iWeb; blog template limited

Features ★★★★★
Ease of use ★★★★★
Value for money ★★★★★

Overall Packed with features, supremely easy to use and excellent value for money, iLife '06 is the best version yet of Apple's home creative suite

★★★★★



2 Years relaxing plus lots more!



Sit back and relax with AVG! AVG is successfully protecting millions of computers, allowing their owners to relax with no worries of virus attack. You too can get AVG's advanced antivirus protection plus lots more:

- + **savings** – generous **2-year** licence comparable to typical 1-year licence
- + **support** – friendly, professional, UK- based support
- + **reliability** – several detection methods for multiple levels of protection
- + **simplicity** – easy to install and easy to use with automatic settings
- + **peace of mind** – silently working in the background

AVG is available as AVG Anti-Virus and AVG plus Firewall. As well as protecting your home PC, discover how AVG Network Edition with powerful centralised management can protect business networks.



AVG Anti-Virus

SECURITY + SUPPORT

New features in AVG Anti-Virus

- Faster, Improved File Scanning
- Smaller Update Files
- Detection of Unwanted Applications
- Support for Windows 64-bit Editions

Discover more and download 30 day trial version from

www.avguk.com/doc/pcw

or contact your local computer reseller



AVG UK
27B Cartergate, Newark, Notts, NG24 1UA

Telephone: 01636 700496
E-mail: sales@avguk.com

3D PLATFORM

Psychonauts



Run and jump your way through this thoroughly twisted journey of the imagination



When it comes to quality platform games, the PC is often sorely neglected. The Playstation has its Ratchets and Clanks, Nintendo has its Marios and Luigis, but there are few colourful coin-collecting characters outside the console format. This is one of the reasons Psychonauts is such a breath of fresh air.

The other reason is that the development of Psychonauts was overseen by one of PC gaming's legends, Tim Schaffer. And since Schaffer was one of the creative forces behind some of the most original adventure titles ever to grace the desktop – namely The Day of the Tentacle and Grim Fandango – it's no wonder that Psychonauts is a little, well, different.

The action kicks off when our diminutive hero, Razputin, gatecrashes a summer camp for psychic kids and joins the rag-tag bunch of 'gifted' children in a bid to hone his own extra-sensory abilities.

The early stages offer a lot of freedom, leaving you to wander about, talk to people and explore. A fairly extended set of introductory tasks is intended to acclimatise you to the gameplay. But soon a fiendish plot is revealed, at which point it becomes Raz's responsibility to save the day. This he does by entering a series of characters' minds and traversing their perilous subconscious planes in order to find out exactly who is behind the mystery and defeat them.

The task of journeying through different characters' mental landscapes is really only a device for creating a series of platforming levels. But it's imaginative and makes for some weird and wonderful environments. A military-obsessed character's psyche is decked out with guns and ammo, for example, while a hippy chick's mind is like a rainbow-coloured psychedelic trip.

Not only is every world you visit very different visually from the last, but each environment also provides a unique experience with its own tasks and challenges.

Naturally, there's a lot of the sort of jumping around and bashing things that you'd normally associate with a platform game, but Psychonauts even manages to inject these humdrum elements with new life.

Being a platform game, Psychonauts provides a series of boss levels that need to be beaten before you can proceed. Ultimately, it's these sections that are the game's only real weakness, as they feel mechanical and perfunctory in comparison with the rest of the action.

Graphically, Psychonauts looks amazing. Its bold cartoon style doesn't mean that the developers have cut any corners in terms of textures and shading and, with a powerful graphics card, it's hard to tell the pre-rendered video-cut scenes from the in-game animation. Sound effects and music are strong too.

This is all backed up by some excellent voice acting and – something you don't often come across in a video game – a cracking script. Psychonauts can be played using a keyboard and mouse, but we thoroughly recommend getting hold of a gamepad if you haven't already got one and button-mashing your way through as the game's creators intended.

Psychonauts isn't very long or particularly challenging and won't appeal to anybody who has already decided that platform gaming isn't for them. It also comes from a genre that wouldn't normally appeal to many adult gamers. Nevertheless, this is a game full of the kind of wit, originality and detail that's regrettably lacking in many of today's titles. And, as such, we heartily recommend it to your inner (psychic) child.

Jonathan Parkyn

Details

Price £29.99

Best price www.pcw.co.uk/bestprices

Contact THQ www.thq.co.uk

System requirements 1GHz processor • 256MB of Ram • 3.75GB hard disk • 64MB Geforce 3 or Radeon 8500 • Windows 98SE/2000/XP

Verdict

Overall At last – a decent platform game for the desktop. Psychonauts is colourful, imaginative and, above all, fun



3D SHOOTER

Stubbs the Zombie

Defeat your human victims by eating their brains or slinging your innards at them



Thanks to the success of titles such as Resident Evil and Hollywood's general zombie fixation, many games let players take on the role of a human who cuts through swathes of undead creatures. Well, it's time to tell the other side of the story.

Stubbs the Zombie has an unashamedly silly premise. You play a semi-decomposed, re-animated corpse let loose in a city with one single-minded aim; to eat as many human brains as possible and thus propagate yourself into a swelling zombie horde. Plotwise, that's all

you need to know. Stubbs pops out of the ground at the beginning of the game – why, we're never told – and the rest of the game sees him gallivanting round Punchbowl, the game's space-age, 1950s-style American setting, wreaking havoc as he goes.

As a Zombie, there are several ways to dispatch your victims. You can grab them and tuck into their brains there and then. Alternatively, you can use a number of repellent 'weapons' such as a deadly form of flatulence or a kind of grenade that involves dipping into your own innards and hurling a putrid organ at your foes.

When the joke starts to wear thin you can always tear off an arm and send it creeping over to a human, whereupon you can possess your victim and control him, making him shoot all his human counterparts with a range of more traditional firearms.

If this all sounds puerile in the extreme, that's because it is. But the schoolboy humour and relentlessly daft gameplay are not without charm. Played in small doses, Stubbs is a fairly satisfying third-person action game. It's based on the Halo engine, although graphically speaking it's solid rather than spectacular. On the other hand, the game's dialogue and music are both very sharp. *Jonathan Parkyn*

Details

Price £29.99

Best price www.pcw.co.uk/bestprices

Contact THQ www.thq.co.uk

System requirements 1.2GHz processor • 256MB of Ram • 4GB of free hard disk space • 64MB video card • Windows 2000/XP

Verdict

Overall This clever twist turns out to be a brainless, but very enjoyable romp

★★★★★

ROLEPLAY ADVENTURE

And Then There Were None

Magnifying glasses at the ready – the queen of the whodunit comes to the desktop



It's amazing no-one has thought of basing a point-and-click adventure game on an Agatha Christie book before. Christie's slightly old-fashioned murder-mystery style suits the slightly old-fashioned gameplay of the adventure genre perfectly.

This game takes its plot from one of the novelist's most popular books, which was recently adapted for the West End stage. Fans of the original book, which has seen a few title changes over the years, will no doubt take enormous pleasure from being able to

solve the mystery themselves, but may be slightly less pleased with the amount of artistic licence that has been taken.

The mechanics of converting the story into a game means that several of the alterations are unavoidable. In the novel, for example, only 10 characters were stuck on Shipwreck Island, getting bumped off one by one. In the game an eleventh character, Patrick, has been added so the player can take on the role of someone unconnected with the story.

Similarly, the ending has been left open so that even those who know the story by heart can enjoy the mystery as it unravels. As Patrick you are part observer, part amateur sleuth as you nose your way around the mansion, explore the island and interact with the rapidly diminishing number of guests.

And then there were none's point and click gameplay might seem quaint to those who are used to the pyrotechnics of modern shooters and action games. Graphically, too, it looks a little dated, particularly the character models. Nevertheless, it's one of the better adventure games to have been released in recent years and has enough intrigue and atmosphere to keep you playing through its lengthy (20 or so hours) running time. *Jonathan Parkyn*

Details

Price £19.99

Best price www.pcw.co.uk/bestprices

Contact Agatha Christie www.agathachristiegame.com

System requirements 850MHz processor • 256MB of Ram • 1.5GB hard disk • Windows 98/ME/2000/XP

Verdict

Overall An old-school murder mystery given an old-school adventure game treatment, but it will probably feel a bit old hat to some

★★★★★

£5
369AUK
Coupon Code
*Valid until
April 15, 2006

■ System Performance



O&O Defrag V8

Maximum Performance through Optimal Defragmentation

Repacks fragmented files together and optimizes your hard drives. Get the maximum performance possible out of your expensive hardware simply, quickly, and securely with only minimal effort.

FREE Bonus:

Now with unique 3D screen saver. First ever screen saver displaying real-time 3D graphics that charts O&O Defrag's progress, cluster by cluster.

Defragment with the Editor's Choice!



O&O Defrag V8.0
"Very Good"
Issue 08/2005



O&O Defrag V4
"they can't live without"



O&O Defrag V6.5
"Editor's Choice"
Issue 213

Special Price! instead of £29.99 **£24.99***

■ System Performance



**Activate Hidden
System Resources!**

O&O CleverCache V6

Through intelligent management of the Windows file cache, more memory is made available to the system, increasing overall computer performance.

Special Price! instead of £19.99 **£14.99***

■ Data Security



**Erase your data -
once and for all!**

O&O SafeErase V2

Securely delete sensitive data from your hard disk, offering you the ultimate protection of your private sphere.

Special Price! instead of £19.99 **£14.99***

■ Data Recovery



**Professional data
recovery made easy!**

O&O DiskRecovery V4

This software combs every sector of a hard disk, memory card, or digital camera to find lost files. Over 350 file types can be recognized and restored.

Special Price! instead of £49.99 **£44.99***

*Prices include £5 coupon for the O&O Online Shop: www.oo-software.com
Please note: The £5 coupon is valid for the O&O Online Shop only until April 15, 2006 and is limited to one order per household.

Hassle-free sat nav

Falling prices, congested roads and a love of shiny gizmos make in-car navigation attractive for everyone, says Nigel Whitfield. Find out how these sub-£300 products fared in our test drive



ON TEST

- 73** Blue Media BM6380GPS
Evesham Nav-Cam 7000
- 74** Garmin Street Pilot i3
Magellan Roadmate 300
- 75** Medion Go Pal PNA350
Mio 268+
- 76** Navman ICN520
Novogo A30
- 77** Tom Tom One
Viamichelin X930

- 78** Table of features
- 80** Top-of-the-range options
The choice between all-in-ones
or PDA add-ons
- 81** Europe's GPS constellation
Editor's Choice

'One of the most popular options for satellite navigation is the all-in-one solution you can plug in and stick on your dashboard'

In the January 2006 issue of *PCW*, we investigated GPS (Global Positioning System) navigation software that you can add to your mobile phone or PDA, but one of the most popular options for satellite navigation is the all-in-one solution that you can just plug in and stick on your car's dashboard, without worrying about linking to the computer or performing a tricky installation.

Devices like these have been around for a while, but were quite expensive; the development of pocket computers has helped commoditise the hardware, while companies like Tom Tom, with its Go range, provided attractive and simple solutions that outshone some of the old-fashioned offerings from traditional GPS manufacturers.

But just how good are these newer devices – does a sleek case and some bought-in navigation

software make for a real alternative to an integrated system from a single manufacturer?

We've looked at 10 models, ranging in price from around £180 to £300 – our brief was that they cost less than £300, include at least UK street-level navigation and come ready to use, complete with car mounting kits. There are remarkable similarities between some of them, while others stand out in various ways.

As well as test driving all the units, we'll explain what you should look for from a GPS device and provide lots of practical hints and tips to help you make the most of the system.

We'll also help you decide which of the products really is the best one for the kind of driving that you do.

In-car GPS navigation may be one of the top gadgets of the moment, but why would you need it and what exactly can it do for you,

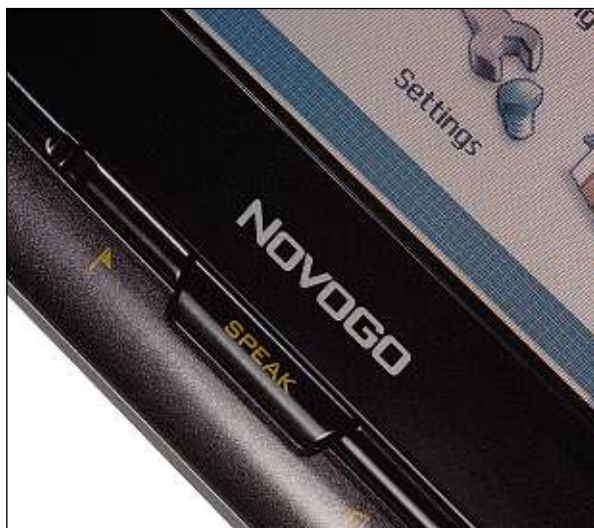

Good controls can make a lot of difference, such as this Speak button that repeats the details of the next turn

postcode entry; some allow you to enter just the first part, providing a list of streets to choose from, while others don't even do that, requiring you to narrow down the area by region or town, then picking a street.

With a well-designed interface, that can be fairly straightforward; with a poor one, it can be nothing short of a nightmare – and in some cases an interface that looks straightforward may turn out

besides the obvious benefit of helping you get from A to B without getting lost en route?

GPS relies on a constellation of satellites operated by the US, constantly transmitting data. A GPS receiver picks up the signals from these and, with the aid of some clever mathematics, is able to work out its own position on the planet.

Add a little intelligence, and it can work out which direction it's moving in and how fast as, contrary to popular myth, GPS doesn't track you. It simply allows a receiver to know where it is and the receiver can do what it wants with the information – send it to Smersh, UNCLE or just helping you find your way around the North Circular Road.

If you want to know where someone is, you need a GPS system that combines a receiver either with software that records a log of all the locations, or hardware – such as a mobile phone – that can send information about the position to someone else.

So, while most navigation systems will keep a 'track' in their memory, recording where you've been, simply using GPS doesn't mean the satellites are spying on you; unless you give someone access to that track, you're just as anonymous as you were.

Having dispensed with that concern, just what can you expect from a GPS unit, and what should you consider when you're choosing one?

Navigation

The basic task for all GPS receivers is helping you get from A to B, and the first hurdle is how you tell it where those two places are. Much of the time, your journey will start from your current location, and the system can work that out for itself.

When it comes to the destination, you need some way of saying exactly where that is. In the UK, we're fortunate to have a detailed postcode system that can, with the addition of a house number, accurately locate any address in the country, and doesn't need much effort to enter. Unfortunately, most GPS units don't support full

to be a nuisance if the unit's buttons are unresponsive, or the on-screen icons too fiddly to press with anything other than a tiny finger.

It's also worth considering whether or not a system supports waypoints – intermediate destinations that you can add to a list. You may want these if you have to visit several clients in turn, or you want to take a specific route – for example, Paris via the Channel Tunnel and Oban via the ferry at Fishnish instead of Tobermory.

You can, of course, achieve much the same by driving to one destination and planning another route from there or by marking some roads as blocked and hoping the GPS routes you round them the way you want to – but it's a lot more hit and miss than specifying waypoints.

Test out waypoints before relying on them though – it can be annoying if you pass one only to find that the GPS tells you to double back, because you didn't get quite close enough for it to realise you're ready to go on

to the next destination. You should also be aware that some units might call waypoints by different names, such as 'Favourites' or 'Stopovers'.

For an occasional user, some awkwardness may be OK; if you need the GPS to take you to a different client a few times a day, it'll soon become extremely annoying.

To avoid frustration, you really need a system with a range of methods to enter destinations, good support for waypoints and an interface flexible enough to let you update the route easily if you need to.

Points of interest

Much driving, of course, isn't necessarily about a straightforward journey to somewhere with an identifiable address. Do you really know the postcode of your local sports centre, for example? Or the street name of the nearest cinema multiplex?

It's for just this sort of situation that navigation systems provide Points of Interest or POIs; you can select types of POI and see the nearest ones, making it easy to navigate to the place you want – and a potential life-saver when you're running low on fuel and need to find somewhere to fill up.

One fairly recent addition to the canon of useful POIs, found on many of the units we tested, is information about safety cameras. We have mixed feelings about this, but undoubtedly some people will find it useful to be alerted to the cameras and, unlike radar detectors, there are no doubts about the legality of using the information.

While many of the traditional types of POI are fairly static – churches, for example, don't tend to come and go very frequently – information about such things as safety cameras



With downloads from the Internet, you can keep information about safety cameras up to date



'Satellite navigation can make a big difference to your journeys'

Avoiding traffic jams

Maps aren't the only hidden extras that you might find when you start investigating the world of GPS. Several of the systems that we looked at can provide dynamic routing; that means they will be able to update your planned route based on traffic conditions, helping you to avoid traffic jams. It's a neat idea, and very useful. But is it worth paying for?

Some manufacturers obviously think so; in the UK the Trafficmaster system has been available for many years and broadcasts information that can help you identify delays – basic information is available free, while an annual subscription provides more detailed information.

But you don't necessarily need to pay. An add-on to RDS (Radio Data System), called TMC (Traffic Message Channel), allows a small receiver the size of a pencil eraser to pick up travel information and feed it into the GPS unit via USB, where it can be used to provide dynamic routing, without the need to pay a subscription – and TMC works both in the UK and on the continent.

An alternative solution appears in some products, including the Navicore smartphone navigation system we looked at in our GPS software group test (PCW January 2006). Most people will have a mobile with them, even if they're not using it to run navigation software. Using a mobile phone link, traffic information can be downloaded from the web. It's another neat solution, but you're reliant on the server

PC software for some navigation systems allows you to choose which maps are stored on the system's memory card, and transfer additional ones from the PC

often need to be kept up to date; you'd also be pretty annoyed if the nearest petrol station on the map turned out to be closed. So it's useful if you're able to add extra information manually, or update existing information.

Not all systems allow that; most will let you mark roads as blocked, in case there's been a change to a one-way system, for example, and some will let you create POIs on your PC, to transfer to the device.

One thing you won't get, however, is a complete set of new maps, and you need to resign yourself to replacing them every few years, just as you'd replace a printed road atlas from time to time, albeit it at rather more cost.

If you don't use the system much, in fact, you may want to consider a GPS system purchased now as your last one and hold off on spending more for updates until the European Galileo network is up and running (see box on page 81).

Beyond borders

While many people simply need to get from one place to another in the UK, for others it's essential to be able find their way on the continent and additional map information, either for one country at a time, or for entire regions is available for most systems.

It's also quite common for GPS systems to come with 'major roads of Europe' which sounds attractive, and may be useful to get you to a

If the maps you want aren't all on the same card, you may need to swap over at borders

few places, but almost certainly won't be up to finding your holiday chalet in the Swiss Alps or tracking down that amazing restaurant just outside Le Touquet.

If you're serious about finding places, you do need to pay for street-level mapping in the countries you're going to.

There's another potential gotcha, though – if you have individual maps on memory cards, you can't usually plan a route that starts on one card and ends on the other; you'll have to stop at the border and switch maps, so an all-in-one map really is essential for seamless motoring, and that can push up the cost of some of the units quite dramatically.





A compact TMC receiver can allow dynamic routing round heavy traffic, without the need to pay a subscription

morning, it can save time to switch the receiver on the night before, especially if you didn't use it to reach your present location.

Some of the latest windscreens have special reflective coatings to avoid the car heating up too much in hot weather, so watch out as they can disrupt the GPS signals, making them impossible to receive.

The only alternative in that situation is an external antenna, which you can clip on the outside

of the car – with more trailing wires across the interior. Add a TMC receiver that plugs into the GPS rather than one that's built-in, plus its aerial, and you're in danger of creating a dangerous bird's nest effect in the front of your car. It's vital to sort this out properly, tucking cables away wherever you can; you don't want to be distracted by anything when you're on the road. And for that reason, take care positioning the display. You need to be able to see it when you want to, but without it obstructing your view of anything important – like a small child in front of your car.

Equally you should be able to see it without having to take your eye off the road. Realistically, while the display is useful, when you're driving the spoken directions should be telling you all you need to know; a glance at the screen when you've stopped at a junction should be enough.

Remember, too, that you'll need to use the controls on the GPS from time to time – entering destinations, zooming in or changing the volume, for example. Once again, you need to be able to access things easily, so check that you can reach everything you need to from your driving position.

In fact, with most of these units, entering addresses at arm's length is tedious; you may be able to zoom in and out of a map, but selecting something via an on-screen keyboard like that is not easy.

So either position the GPS where you can use it comfortably, or resign yourself to removing it from the cradle each time you want to set up a new journey or alter your existing one.

And don't forget – as apparently one in 10 GPS owners claimed to do in a recent survey by Privilege Insurance – that you should set up the route before you drive off; it's much harder, not to

mention extremely reckless and potentially illegal, to program the navigation system when you're driving.

Making the right choice

So, buying a navigation system isn't just a case of getting the one that looks the best in the shop; there's inevitably some compromise – certainly at the price level we looked at here – and there's not necessarily one right answer for every driver.

To test the systems, we fitted them in turn in a Citroën saloon and conducted test drives around the London area. As well as ease of use of the controls, we made some assessment of the routing capabilities. All the systems will get you from one place to another, of course – they all rely on one of two sources of map data, Navteq or Teleatlas, so you'd expect there to be little real difference between them.

But it's what the software does with the information that makes the difference – whether it gives you adequate notice of lane changes, for example, or unambiguous directions at complicated junctions or prefers back roads to major routes.

We used test routes that included multiple-lane roads, with different destinations for different lanes, and made plenty of deliberate mistakes to see how well we were re-routed.

We've picked out the systems that we think did the best in our tests, but remember, the right choice for you may not even be one of the products on test here; for some people, a more expensive option will provide the extra features or ease of use they need; or you may want to revisit our round-up of navigation software for PDAs and mobile phones.

Whichever you choose, what you'll quickly realise is that, especially for those who don't have someone to sit next to them and read a map, satellite navigation really can make a tremendous difference to your journeys.

that provides the information, rather than a network of many FM radio stations. And while Navicore's option is free, not all are; Tom Tom's traffic update service requires a subscription, for instance. Even free isn't without cost, though, if you're motoring abroad, where you could pay heavy roaming charges for the mobile connection necessary to retrieve the data.

If routing around delays is important – rather than merely a way to avoid frustration – we'd recommend a system that can be used with a TMC receiver; it's a one-off cost and you won't get a nasty shock on your mobile bill later.

On the road

All the GPS units that we've looked at in this test are designed to be used in a car; they're supplied with a windscreen suction mount, allowing you to position them so you can glance quickly at the display when you approach a junction and press the buttons necessary to set up routes and start or stop navigation.

You'll also need to provide them with power; though most have internal rechargeable batteries, for longer journeys you don't want to risk running out of juice at a crucial moment. That means a trailing cable to the cigarette lighter – plus an adapter if you want to charge up your mobile phone at the same time.

You can mount the GPS on the dashboard too – but you'll generally need to ensure that the antenna can 'see' the sky in order to pick up the satellite signals.

Normally, that happens within a few minutes, unless you've not used the system for a while or have travelled a long distance from the last location where you turned it off; when that happens, a GPS receiver has to do a 'cold start' and can take 10 minutes or so to work out where it is – so if you'll be in a hurry in the

'Check that you can reach everything you need from your driving position'



Portable units can be easily moved between cars, thanks to a suction mount and charging cable

Blue Media BM6380GPS

Price £299.98 **Contact** www.lowestonweb.com



The Blue Media BM6380 is distributed by Evesham; it's based on a cut-down Pocket PC, and has an array of buttons on the front panel – there's a four-way navigation grouping with 'OK' in the middle, plus zoom buttons, back, navigation, power and a button to take you to the device's main menu, from where you can also access a music player and photo viewer. There's a small volume control at the right.

When we started setting up the unit, we had trouble – until we realised that it wanted the date in US format. Even then, the interface was nasty; select the time zone, press the OK button and you're taken back to the previous screen before you can set date or time. And the buttons may feel positive, but they're way too small.

The navigation software provided is Destinator, which we reviewed in the January issue of *PCW* and it wasn't our favourite then. It's even less so with this cock-eyed interface. For example, tap the screen and a menu appears with options. But you can't select from those options using the navigation buttons – you have to tap the screen some more. The same is true when entering info using the on-screen keyboard or menus – the hardware buttons don't do anything. This gets worse when you realise that the speaker's too quiet to hear and the screen's cluttered with tiny icons. And when you finally grab it from the cradle to try and enter an address with the stylus, you have to unplug the power cord first.

The receiver itself worked fine, and the routes were reasonable, but the awful buttons, the poor support for them in the software, and the fiddliest way we've seen of finding an address suggest the BM6380 was put together by a team of non-drivers with extremely sensitive hearing.

Verdict

Pros Remote control supplied

Cons Horrid buttons; horrid interface; too quiet

Features ★★★★★

Ease of use ★★★★★

Value for money ★★★★★

Overall The inclusion of a remote control does nothing to redeem the other features of this unit. Take a detour

★★★★★

Evesham Nav-Cam 7000

Price £279.98 **Contact** www.nav-cam.com



Evesham's own Nav-Cam 7000 is another Windows-based system, in a smart, compact case with a flip-up GPS receiver on the back. The front panel has a four-way navigation button with centre OK, zoom buttons, plus home screen and destination buttons.

All have a good, positive feel and are large enough to press easily, even with your driving gloves on. One omission, though, is a volume control wheel – you

have to use the on-screen menus. Thankfully, though, once you do set the volume, it's loud enough to hear when you're on the road. One other annoying niggle is that the slot for the stylus – which can be useful for setting up destinations – can't be accessed when it's in the cradle.

The system includes mp3 and photo programs, though they're of dubious utility we feel. The routing software is Smart2go, which we'd not come across before. It includes information on safety cameras, which you can update from the Evesham website free of charge for six months.

The on-screen buttons for setting up routes are pretty large and easy to use, and the four-way hardware navigation buttons work in the on-screen keyboards, so you don't have to touch the screen if you don't want to. But postcode support doesn't go down to street level – just five digits, so you need to enter at least a partial street name too. An additional niggle is that some options on screen are represented by small tabs right at the bottom – a little too fiddly for arm's-length use.

Routing performance was adequate, but a little eccentric – at one stage we were directed off the North Circular onto a roundabout, then back on at the same roundabout, even though the map clearly showed we could have just driven over the flyover.

Verdict

Pros Easy-to-use buttons

Cons Fiddly-to-use software

Features ★★★★★

Ease of use ★★★★★

Value for money ★★★★★

Overall A reasonable performance, but loses out because the included software isn't as simple to use as some of the competition

★★★★★

Garmin Street Pilot i3

Price £179.99 Contact www.garmin.co.uk



Not much larger than a tennis ball, the Garmin Street Pilot i3 is the cheapest of the units in our group test and has a screen that measures just 5.6cm diagonally. That is a little bit of a limitation, but not, it turned out, as much of one as we imagined.

The mapping data – stored on a tiny Transflash card, rather than the SD cards used by other units – has support for full seven-digit UK postcodes, which is

the quickest way of finding somewhere; the scroll wheel moves you through the alphabet and a click on it selects a letter. There's a select/back key and the power switch, and that's it.

Even so, we found it quite straightforward to use and get to grips with, even without resorting to the manual. The use of standard AA batteries means you can take it just about anywhere, but, most importantly, the spoken directions are loud and clear. Additional Points of Interest (POI) can be downloaded, including speed camera information.

We did have some niggles; trying to find an address by scrolling through street names was pretty slow at times, so you just have to sit and wait while the Street Pilot catches up; and when you try to find an intersection, it doesn't restrict the choice of the second street, which slows you down again. There were also some annoying Americanisms, such as referring to the GMT timezone as 'Western Europe (WET)' and hiding things like railway stations in a 'transit' category in the POI database.

But, if you're on a limited budget, and you don't mind the small screen or the other niggles, this is definitely worth looking at. If you're a regular business driver, there are better options, but for the casual driver and occasional user, price alone makes this unit highly attractive.



Verdict

Pros Compact; good spoken instructions

Cons Small screen; interface sometimes slow

Features ★★★★★

Ease of use ★★★★★

Value for money ★★★★★

Overall Despite the small screen and limited interface, this budget unit is well worth a look for casual users

★★★★★

Magellan Roadmate 300

Price £274 Contact www.magellangps.com



Magellan is one of the oldest and best-known names in GPS navigation systems, and the Roadmate 300 looks much more like a traditional GPS system than the current crop of 'Pocket PCs in disguise'. To the right of the screen there are zoom buttons and a circular navigation pad surrounded by Option, Enter, Cancel, View and Locate buttons – no obscure icons to decipher here. There's no internal battery, so you're dependent on the car

power or mains adapter. When connected up, the buttons are all backlit in a range of colours, which helps ease of use. Another useful feature is support for multiple users, so that each person can have their own favourites or address book, which can be invaluable for families sharing a car.

The screen is touch sensitive, so you can find a location by browsing the map; the Locate button tells you exactly where you are and allows you to save the location. Most importantly, the voice is clear and loud so you won't have any problems hearing the directions. Each action is confirmed by voice and when you enter information using the on-screen keyboard, letters are spoken and those that won't follow the one you entered are dimmed and non-selectable.

It's not all perfect, however. We were disappointed that there's no postcode support, and the buttons have a bit of a spongy, plastic feel, especially the multi-way navigation key. There's a good range of POIs to help navigate by, but we felt that a little more information would be helpful when you've searched by name – there was no icon indicating, for example, whether the Alexandra Palace on the list was the railway station or the Palace itself, leaving you to read the address details.

If our few minor complaints about this unit were rectified, then it would be a winner, standing head and shoulders above many of the others on test.

Verdict

Pros Clear directions; good interface; multiple user support

Cons Needs power cable; no postcode support

Features ★★★★★

Ease of use ★★★★★

Value for money ★★★★★

Overall The performance you'd expect from Magellan, but sadly let down by lack of postcode support and internal power

★★★★★

Medion Go Pal PNA350

Price £299.99 **Contact** www.medion.co.uk



Trying hard to look as little like a Pocket PC as possible, the design of Medion's Go Pal PNA350 is influenced by the original Tom Tom Go; it's like a miniature version of the first-generation iMac computer, with an SD slot, power and up/down buttons on the front. Everything else is done using the touchscreen.

The unit was supplied with a TMC (Traffic Message Channel) receiver that connects to the USB port and

via a splitter to the power cable. TMC also requires an FM aerial wire so you can end up with quite a messy installation – and removing the Go Pal from the cradle tends to disconnect power and USB.

The supplied software is from Navigon and works well; thanks to the TMC receiver, it can automatically route you around traffic trouble spots and we found that aspect of the system was pretty much plug and play. It was fairly simple to enter addresses, even with just partial postcode support, but the lack of a space on the on-screen numeric keypad makes that slightly fiddlier than it really needs to be.

With only the two buttons on the front, you need to use the touch-sensitive screen much of the time, and we felt the screen keyboard was a little too small without a stylus, which isn't included.

In use Navigon software works well, but despite the boasts of its two speakers, the Medion just wasn't loud enough for us to hear on a fast road with the radio on. Without enough hardware buttons, it was also too easy to end up with the display showing the wrong thing until you tapped the right place on screen.

The inclusion of TMC means this is potentially better value than some of the alternatives, but a few more buttons would make Navigon easier to use – something you'll find on the two other units that use this software.

Verdict

Pros TMC included

Cons Lots of cables; too quiet; very few buttons

Features ★★★★★

Ease of use ★★★★★

Value for money ★★★★★

Overall The inclusion of TMC

is good, but reliance on the touchscreen and the quiet sound are major problems

★★★★★

Mio 268+

Price £275 **Contact** www.mio-tech.be



The Mobile Navigation System from Mio is another Navigon-based unit, with mp3 playback functionality and an address book which you can sync with Outlook, allowing easy navigation to your contacts. The front panel provides a navigation pad, with a mute button – of dubious utility, we think – and a back button on the left of the screen. To the right is a Home button, which will quickly set up a route to your home address, a

location button to take you to the main Navigon screen to enter a new location or change settings, and zoom controls. A volume control is tucked away on the side. A useful fold-out chart gives basic instructions to help you get up and running when planning your first route. The memory card includes major roads of Europe, while the DVD in the box contains more detailed ones – a welcome inclusion at this price; spend the extra for a TMC receiver and you'll have a full-featured solution, albeit with a bit of a bird's nest of wires.

As you'd expect from the Navigon software, the route planning is good, with clear displays in a range of views, and being able to route to contacts is useful; we think you'll be better off syncing contacts than managing them on the Mio – the built-in contact application lacks finesse.

There's a good range of POIs, complete with logos – it was a little surprising to see a Burger King icon appear on screen, but we found the navigation control a bit fiddly at times, and it can't be used with the on-screen keyboard – you'll probably whip out the stylus from its slot on the rear fairly often. The addition of the extra buttons makes quite a difference to usability, compared to the Medion, but the lack of precision on the navigation control, coupled with a quiet speaker, means we can't wholeheartedly recommend this unit.

Verdict

Pros Good software; European maps supplied

Cons Too quiet; fiddly buttons

Features ★★★★★

Ease of use ★★★★★

Value for money ★★★★★

Overall The supplied European maps are welcome, but this unit is let down by a poor control pad and low volume

★★★★★

Navman ICN520

Price £249 Contact www.navman-europe.com



Navman is another well-established name in GPS and the ICN520 is a compact unit that runs Navman's own SmartST software; the system is supplied with maps on an SD card, and a companion PC application allows you to add or remove maps from the card – if you have a larger card, you can pick and choose which maps you want.

There's a volume control on the right-hand side of the case, and the front panel includes six buttons and

a navigation pad. There's a power button, a Home key that takes you to the main screen, and a key to cycle through the different map display options.

Esc takes you back to your last screen, and then there are + and – buttons, which control zoom and brightness. These, presumably, were added by someone who reads from right to left, since the plus button is on the left which just feels odd. Even more so when you hold down the buttons to change brightness, and you have to hold down the left-hand button to move the brightness bar to the right.

The navigation pad was horribly imprecise, leading us to keep selecting the wrong thing on screen. If you want to enter addresses, you'll be best off using the stylus.

Another couple of niggles – and we'd expected better from Navman – is that the speech isn't really loud enough, and you have to unplug the power cord to remove the unit from the cradle.

On the whole, navigation was pretty reliable, as we expected, however we did have one odd moment where the instruction was to go straight ahead, but the map display clearly showed a left turn onto a different road. Admittedly, this is one of the cheaper units on test, but not by much, and we expected a lot more from a company with Navman's pedigree.

Verdict

Pros Flexible map management via PC

Cons Awkward buttons

Features ★★★★★

Ease of use ★★★★★

Value for money ★★★★★

Overall Annoying buttons and low volume contribute to a surprisingly lacklustre result from such a well-known name
★★★★★

Novogo A30

Price £279 Contact www.novogo.com



A new name in the navigation market, Novogo, like two of the other suppliers here, has produced a system based on Navigon's software. In the A30's case, the company has contrived to make it look bigger, with a large bezel around the screen. There are zoom controls to the left, while below the screen there's a menu button that takes you to the Navigon main screen – the software's been given a brighter skin which improves it no end –

a location button to show or save the current position, volume controls and a central button labelled Speak. Pressing this repeats the voice instruction for your next turn. Pressing the volume controls makes the unit say 'Louder' or 'Quieter,' which is a useful feature. This attention to detail makes the unit the simplest to use of the Navigon-based systems in the test.

There seemed to be a wider range of POI categories than on the Medion, though it wasn't as extensive as we'd have liked – despite a category appearing in the list for courts, we couldn't find Snaresbrook Crown Court, for example, which is one of the largest in the country.

In use, the button arrangement makes a surprising difference to the software, as does the much brighter colour scheme. Navigation was reliable, though some recently changed roads didn't appear to have been included and – importantly – the sound was more audible than on the other Pocket PC-based units we tested, though not as good as on the Garmin, Magellan and Tom Tom systems. Where you need to use the touchscreen, icons are large enough, though there is a stylus tucked away at the back.

With the addition of a TMC receiver, this would be a very good option; the A70 version includes full European mapping, but the additional cost of £120 makes it less good value.



Verdict

Pros Simple design; easy to use

Cons A little quiet; pricey with European maps

Features ★★★★★

Ease of use ★★★★★

Value for money ★★★★★

Overall A well thought-out system, easy to use, but it could do with being a little louder
★★★★★

Tom Tom One

Price £279.99 Contact www.tomtom.com



Tom Tom arguably kicked off the recent trend for all-in-one GPS units with the Tom Tom Go, based on its PDA software; it wasn't the first, but it was a lot more attractive than some of the other options. The One is the latest version and has just one button – a power switch on the top.

Everything else is done via a touchscreen; and where others fail to grasp the ergonomics, Tom Tom's experience pays off. The reasonable size on-screen

buttons are straightforward and easy to use, though the on-screen keyboard is best suited to those with small fingers, and there's no stylus supplied.

Routing is quick and re-routing is fast too, without too many annoying requests for U-turns. While driving, the display is clear, with the top left and right corners being used for zoom controls, while tapping elsewhere brings up a screen of big icons – no fiddly things to tap on here. The speech is clear and loud, and you can even link the volume to the car speed, which is a unique and very sensible idea.

The One also has Bluetooth built in, so the unit can use your mobile phone to fetch traffic information and weather data from the Internet; there are even different voices you can download. But you have to pay a subscription for these, so factor in another £40 per year, plus any mobile data charges.

There's a good built-in demo tour which will help you get to grips with the system quickly; our only tiny niggles are one blocked road that wasn't on the map, plus the way you're returned straight to the map after changing any preferences rather than being allowed to choose when to return. When it comes to ease of use, and a well thought-out design, the Tom Tom One knocks out most of the competition and shows that there is more to satellite navigation than just repackaging a Pocket PC with some different buttons.

Verdict

Pros Easy to use; good on-screen buttons

Cons Traffic service requires subscription

Features ★★★★★

Ease of use ★★★★★

Value for money ★★★★★

Overall With good sound and a straightforward interface, the Tom Tom One is almost everything a navigation system should be

★★★★★

Viamichelin X930

Price £269 Contact www.viamichelin.com



Viamichelin's X930 runs the same software we tested as a standalone solution in the January issue of *PCW*, and the installed map data includes tourist information from Michelin's *Green Guide*, which is likely to be more useful to families than to professional drivers.

The front panel provides volume controls to the left of the screen, with buttons at the right to access the main menu, call up the history of

destinations, view GPS status and navigate to a POI. Navigation was reasonable, with good lane directions most of the time, though a lack of clarity at one junction resulted in us being sent into a tunnel instead of around it. Re-routing is something the Viamichelin software seems pretty good at, and it manages very quickly, without nagging exhortations to turn round.

While most of the interface is simple enough to use with your fingers, we did find some annoyances. Chiefly, if you go into any of the menus while navigating, it's fiddly to get back to where you were, unless you use the History button and then reselect your destination from the list. And pressing Exit from the main menu – which you might think would take you to the map – results in the screen being switched off, so you need to press the power button again.

There's also support for partial postcodes, but if a long road appears in two different postcodes, you'll only be able to find it in one of them. And, though it's better than some of the other systems and adequate at lower speeds, the volume still isn't good enough in a fast-moving car.

Overall, this is a reasonable package, with extensive POI information that may appeal to leisure travellers, but it lacks panache and it's outclassed by some of the other products.

Verdict

Pros Quick re-routing; comprehensive POIs

Cons A little quiet; interface a bit fiddly

Features ★★★★★

Ease of use ★★★★★





Value for money ★★★★★

Overall A great range of POIs ultimately doesn't make up for some interface quirks and the lack of volume on spoken instructions







★★★★★



All-in-one sat nav devices

				
MANUFACTURER	BLUE MEDIA	EVESHAM	GARMIN	MAGELLAN
Model	BM6380 GPS	Nav-Cam 7000	Street Pilot i3	Roadmate 300
Price inc VAT	£299.98	£279.98	£179.99	£274
URL	www.lowestonweb.com	www.nav-cam.com	www.garmin.co.uk	www.magellangps.com
Telephone number	0870 160 9500	0870 160 9500	0808 238 0000	00800 6243 5526
Screen size (diagonal, cm)	9	9	5.6	9
MAP INFORMATION				
Maps included	UK, Ireland	UK, major European	UK, Ireland	UK, north west France
Map source	Navteq	Teletlas	Navteq	Navteq
Cost for European maps	£70	Not available	£90.08 per country	£100 per region
Support for UK postcodes	Partial	Partial	Full	✗
Safety camera data	✓	✓	Downloadable	✗
Other Points of Interest (POI)	✓	✓	✓	✓
User-defined POI	✓	✗	✓	✓
Downloadable POI available?	Camera updates; £30pa after six months	Camera updates; £30pa after six months	✓	✗
Map updates available?	Paid for	Paid for	Paid for	Free
Software/firmware updates available?	✗	✗	✓	✓
TRAFFIC INFORMATION				
Dynamic routing	✗	✗	✗	✗
Cost	N/A	N/A	N/A	N/A
ADDITIONAL INFORMATION				
Type of battery	Li-ion	Li-ion	2 x AA	None
Typical run time	3-4 hours	2 hours	Depends on battery type	N/A
ACCESSORY PRICES				
Mains adapter	✓	✓	Not available	✓
Car adapter	✓	✓	Not available	✓
Car mount	✓	✓	✓	✓
External GPS antenna	£25	£25	£21.68	£75
Additional accessories	USB cable, remote control	USB cable	USB cable	USB cable
Telephone support	✓	✓	✓	✓
Other features	Mp3 player, photo viewer, voice notes, alarms	Mp3 player and photo viewer	None	Supports multiple users
SCORES				
Features	★★★★☆	★★★★☆	★★★★☆	★★★★☆
Ease of use	★★★★☆	★★★★☆	★★★★☆	★★★★☆
Value for money	★★★★☆	★★★★☆	★★★★★	★★★★☆
OVERALL	★★★★☆	★★★★☆	★★★★★	★★★★☆



						
	MEDION	MIO	NAVMAN	NOVOGO	TOM TOM	VIAMICHELIN
	Go Pal PNA350	268+	ICN520	A30	One	X930
	£299.99	£275	£249	£279	£279.99	£269
	www.medion.co.uk	www.mio-tech.be	www.navman-europe.com	www.novogo.com	www.tomtom.com	www.viamichelin.com
	01793 715 715	020 7294 0074	01293 780 500	N/A	+31 20 850 0800	020 7365 1878
	9	9	9	9	9	9
	UK, Ireland	UK, Ireland, major European	UK, major European	UK and Ireland	UK	UK, Ireland
	Navteq	Teleatlas	Teleatlas	Navteq	Teleatlas	Teleatlas
	£69.99 per country	DVD included	£100	A70 model; £399	£170	Complete European pack £349
	Partial	Partial	Partial	Partial	Partial	Partial
	✗	✗; speed limit warning	Downloadable	✗; speed limit warning	Via Internet subscription to Tom Tom Plus	✗
	✓	✓	✓	✓	✓	✓
	✓	✓	✓	✗	✓	✗
	✓	✓; safety cameras by subscription £20pa	✓	✗	✓	✗
	Paid for	Paid for	Paid for	Free	Both	Paid for
	✗	✓	✓	✓	✗	✗
	✓ via TMC	✓ via TMC	✗	✓ via TMC	✓ via Internet	✗
	Receiver included	TMC receiver £50	N/A	TMC receiver £80	£40 per year Tom Tom Plus subscription	N/A
	Li-ion Poly	Li-ion	Li-ion	Li-ion	Li-ion	Li-ion
	4 hours	4.5 hours	1.5 hours	6 hours	2 hours	5 hours
	Not available	✓	✓	Not available	£20	✓
	✓	✓	✓	✓	✓	✓
	✓	✓	✓	✓	✓	✓
	3rd party	✓	£39.99	Third party	£33	N/A
	TMC receiver	USB cable	Carry case; USB cable	USB cable; carry case	USB cable	USB cable
	✓	✓	✓	✓	✓	✓
	Full postcode mapping due summer 06	Mp3 player, address book	None	None	Can connect to Internet via Bluetooth mobile	None
	★★★★☆	★★★★☆	★★★★☆	★★★★☆	★★★★☆	★★★★☆
	★★★★☆	★★★★☆	★★★★☆	★★★★☆	★★★★☆	★★★★☆
	★★★★☆	★★★★☆	★★★★☆	★★★★☆	★★★★☆	★★★★☆
	★★★★☆	★★★★☆	★★★★☆	★★★★☆	★★★★☆	★★★★☆

Top-of-the-range options

While the maximum £300 price point that we set for the products in this round-up may seem like a lot of money to some, it's still a fraction of what you can spend on a navigation system for your car. So, what can you get for extra money, and is it worth it?

One of the most useful options is wider coverage. That means you can buy map data for other countries or the whole of Europe. The price depends on the system you bought originally; we've shown in the features table (see page 78) how much European mapping will cost for the different products, where available. If you drive a lot on the continent, it's often worth buying a package that includes maps at the outset.

Larger screens of five or more inches are available on some of the more expensive units; with a widescreen display like the ones on some high-end products, you can see both the details of your next turn and an overview of the route, without things seeming cramped. The makers of those products give a clue about another key element of high-end navigation systems – integration. Blaupunkt and Pioneer are both known more for their in-car audio than navigation products and at

In-car entertainment vendors such as Pioneer include DVD-based navigation in their high-end units



the top of the range, you can expect both to be part of the same system. That immediately gives an advantage – instructions can be fed through the car speaker system. And it can also provide a more professional-looking product, with everything integrated into the dashboard.

Another big advantage is better storage, with many systems now relying on a DVD



Navman's ICN 550 has a 4GB hard drive for maps

or hard drive to store map data. Some more expensive models such as Navman's ICN 550 (about £500) also feature miniature hard drives for increased map storage (see picture, left). And just how much can you spend? A standard car radio with built-in GPS starts at around £350; Avmap's Geosat 2.5 portable GPS with a 5.6in screen will come in around £600, while Blaupunkt's top-of-the-line CD-based Travel Pilot DX-V with a 6.5in monitor weighs in at £1,200, without maps, and Pioneer's European AVIC-800DVD (pictured above) will come in at about £1,000 for the controller – allow £600-£800 for a display on top of that.

Such prices mean you may need to think long and hard. But remember that, as long as you have the right map coverage, all the systems will get you there in the end.

The choice between all-in-ones or PDA add-ons

Compared to a few years ago, there are lot more GPS solutions on the market; one of the reasons for that is the number of packages that are available for Windows Mobile/Pocket PC. We tested software solutions in the January 2006 issue and some of those packages make an appearance on the dedicated units we looked at here.

Some of the units tested in this group test are, essentially, just a Pocket PC in a box with different buttons and navigation software. And in some cases it shows. There is more to creating a workable GPS unit than adding dedicated buttons to a portable computer, and one of the biggest failings we found was that many of the systems simply weren't loud enough to hear in a moving car. When you're buying software to run on an existing PDA, you don't mind buying an amplified cradle. But these are supposed to be all-in-one devices, complete with in-car mounts and you shouldn't have to spend more money to make them audible. It was, broadly speaking, the established GPS manufacturers such as Garmin and Magellan that got this right.

Unless you have a whisper-quiet top-of-the-range executive saloon – which may well

have built-in GPS anyway – and never listen to the car audio system, this is a silly shortcoming that will make using many of these units frustrating, and shows a lack of real navigation experience and a box-shifting mentality on the part of the makers.

Sound may seem a trivial issue, but it's vitally important if you're going to rely on a GPS to get you somewhere safely. The screen is useful, but really only something to glance at when you're not sure about a junction; without audible sound, you'll look at the screen more often and pay less attention to the road; hardly a recipe for safer motoring.

So, are these all-in-one units reasonable solutions? Or should you choose the software you like and run it on a PDA with an amplified cradle, or pick a smartphone package?

Ultimately, we can't give you a definitive answer; the performance of systems from established navigation firms such as Magellan is good, and they provide a decent all-in-one solution.

Beyond some dedicated buttons, which are not always well implemented, many of the solutions that are based on Windows Mobile

don't offer anything you won't get from running the same software on a full-blown PDA. Token inclusion of things like mp3 players and photo viewers might add a tick box to the feature list, but it doesn't do anything to alter our conclusion that, with a couple of exceptions, these are built down to a price by people who've never driven a car cheaper or noisier than a Mercedes.

A well-designed dedicated GPS system will provide a simple and reliable solution, especially for the less techno-literate, and the established navigation firms still know what they're doing when it comes to that sort of equipment. You really can just plug and go, without the fiddling with cradles that a PDA solution naturally involves.

However, unless that ease of use is paramount, or you don't have any suitable hardware, many readers will be better off considering adding the software to their PDA or, as we suggested in our last group test, opting for smartphone software such as Navicore. This will work through your car's hands-free phone system, and effectively let your mobile network subsidise the cost of the hardware for you.

Europe gets its own GPS constellation

The US GPS system is getting quite long in the tooth, and has some well-known shortcomings. It can be tricky, for example, to get a signal in urban 'canyons' between tall buildings and even in some densely wooded areas. Originally designed for military use, there's no guarantee of service availability; if the US decides it's necessary, civilian use of the signals could be stopped at the flick of a switch.

Some of those problems can be overcome with receivers able to pick up additional signals from ground or satellite-based overlays, providing greater accuracy. But with roads and skies becoming more and more congested, navigation systems are seen as one of the key tools to solve the problems, helping track aircraft, charge for road use and perhaps one day even to allow accurate computer driving.

None of that, though, could be possible in a situation where the civilian GPS signal might suddenly disappear. And so Galileo has been born, with one satellite recently launched, to claim the frequencies necessary for the system to operate.

Galileo is a European project, with other countries around the world joining in as

partners. It will provide a civilian navigation system with greater accuracy than GPS, and has been designed to provide multiple levels of service – so there will be enhanced facilities available at a price, for groups of users that need them. The system is expected to be in operation between 2008 and 2010.

It's designed to be interoperable with GPS; in future, you'll be likely to hear talk of GNSS or Global Navigation Satellite Service, a term that encompasses both Galileo and GPS.

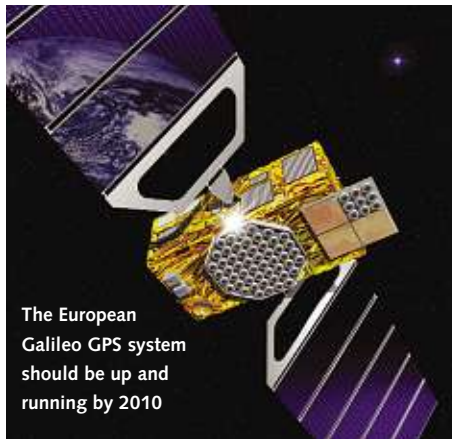

The European Galileo GPS system should be up and running by 2010

Existing receivers aren't likely to notice any difference – though a software update may make them Galileo-aware – but within a couple of years, equipment should appear that will receive both signals, providing faster and more accurate positioning. In fact, it's this equipment that's one of the other driving factors behind Galileo, with the European Commission expecting that Galileo will spawn a market for new receivers and services around the world. Some estimates suggest revenues of over €250b per year and many new jobs in Europe.

What does Galileo mean right now? Really, the answer to that is 'not much'. If you're thinking of buying GPS equipment, go ahead. With just one test satellite so far, whatever you buy now is going to be adequate for a few years. You may even have time to buy a fresh set of maps for your system in a couple of years' time, too. By then, the hardware you're using will be ripe for replacement, and that's the time you should start thinking about a system that will work with the Galileo satellites. For more information, go to www.esa.int/esaNA/galileo.html.

PICTURE: ESA-J. Huart

Editor's Choice

Editor's Choice Tom Tom One
Recommended Garmin Street Pilot i3 • Novogo A30



Tom Tom One

Choosing a sat nav device is very much a personal decision; not everyone needs one for the same reason or drives in the same sort of circumstances. We've explained the things that you should consider when you're looking for a navigation system, so which of the ones on test meets our criteria?

First, as you can see by looking at the results of our testing with the three Navigon-equipped systems, it's not just a matter of the software.

The map data makes a difference and the interface can make or break these, especially when it comes to the really important thing – being able to use them in a car safely.

Too many of the systems on test here had quirks or annoyances that might leave you frustrated, glancing at the screen or fiddling with things when you should be paying attention to the road, with lack of audio volume a common thread running through this group test.

We'd also like to see more units include full support for UK postcodes – and the manufacturers should be more honest in that regard. UK postcodes are much more detailed than in other countries and, while a few units claimed to support them, only one of those on test actually lets you enter a complete postcode – the Garmin Street Pilot i3. It may have a small screen, but it has a good voice and, though its interface isn't perfect, it comes with an attractive price tag and with the full postcode support. That's sufficient for it to garner the first of our PCW Recommended awards, and anyone on a tight budget should give it a serious look.

The second Recommended award goes to a relative newcomer, the Novogo A30, which

takes the Navigon software and builds on it with a sensible selection of buttons, a brighter interface and a reasonable – though not perfect – speaker. With the addition of a TMC receiver, it would provide an extremely capable solution for most users and, after the first two years, would even work out cheaper than our Editor's Choice – the Tom Tom One.

With no price premium over the other units in the test, this Tom Tom One system shows off the experience that the company has gained over the years, both with its software and the earlier all-in-ones. It is simple to use, despite only having a touchscreen, and provides spoken instructions that are more than loud enough. We'd prefer to see the European maps costing a little less, and the same is true for the subscription service that provides traffic information. But even without those, this outclasses the competition and really does provide a solution that you can plug in and use. **PCW**

'The Tom Tom One is simple to use and has loud spoken instructions'



NEW!! LaCie Safe Mobile Hard Drives

- Biometric encryption - Fingerprint recognition
- Safely store and transport your private data
- Ultra-portable - only 8 x13.8 x2.5cm & 200g
- USB 2.0 interface - all cables included
- AC adapter-free, powered by USB
- Sleek, robust enclosure - designed by F.A. Porsche
- 2 years manufacturer's warranty as standard

Available Models :
40GB, 80GB, 120GB



NEW! LaCie Triple Interface FireWire 800/400 & USB2.0 d2 Hard Drives

- Sleek, aluminium heat dissipating robust case
- 7200rpm ideal for DV Video - silent operation
- Fast FireWire 800 'Extreme' up to 88MB/s sustained
- FW 400, USB2.0 & FW800 (all cables included)
- Compatible with Windows® backup utility
- 2 years manufacturer's warranty as standard

Available Models :
160GB, 250GB, 300GB, 500GB, 600GB, 1000GB, 1200GB, 1600GB, 2000GB



LaCie USB/FireWire 2.5" Mobile Drives

- Ultra-portable - only 7.6 x12.9 x1.7cm & 200g
- USB 2.0 and/or FireWire interface - cables included
- AC adapter-free, powered by USB or FireWire
- Ideal for notebook/laptop users as mobile storage
- Sleek, robust enclosure - design by F.A. Porsche
- Compatible with Windows® backup utility
- 2 years manufacturer's warranty as standard

Available Models :
USB2.0 - 40GB, 60GB, 80GB, 100GB
FireWire & USB2.0 - 40GB, 60GB, 80GB, 100GB



LaCie 'Biggest Disk' FireWire 800 & USB2.0 RAID

- Up to 2000GB, RAID 0, 0+1, 5, 5+ hot spare
- Exceptionally high transfer rates of 80MB/s FW800
- Sturdy aluminium enclosure & ultra quiet operation
- Compact size - only 15.3 x29.8 x17.6cm
- Hot swappable hard disks; superior RAID security
- Automatic online rebuilding with RAID 5
- 2 years manufacturer's warranty as standard

Available Models :
1000GB, 1600GB, 2000GB



LaCie d2 'Lightscribe' Firewire or USB2.0 16x DVD+/-RW's & CD-RW

- Lightscribe direct disk labelling technology
- For professional looking created media
- Double Layer DVD up to 8.5GB capacity
- Dual format DVD+/-RW (and CD-RW)
- Super fast write and re-write speeds
- Bundles Include DVD authoring software
- 2 years manufacturer's warranty as standard

Available Models :
DVD+/-RW 16x4x16x Double layer & CD-RW
CD-RW 52x32x52x



LaCie d2 'Ethernet Disk Mini' Network Hard Drives and USB2.0

- Share data across a network by unlimited users
- Easily administered via any web browser
- Quick and simple installation - no drives needed
- No server required, NAS hard drive
- Fast ethernet connection or USB direct attach
- For Windows®, Mac OS® and Linux
- 2 years manufacturer's warranty as standard

Available Models :
'd2' mini NAS & USB2.0 - 250GB, 400GB, 500GB
Ethernet Disk XP embedded - 800GB, 1000GB



LaCie 100 Series Monitors

- Extremely high contrast ratio of up to 1000:1 (119 model)
- Wide viewing angles of 170° horizontally/vertically
- Premium MVA LCD panel
- Height-adjustable stand, tilt, swivel
- 3 years advance replacement warranty

Available Models :
119 TFT/LCD Monitor - 19"
120 TFT/LCD Monitor - 20"



LaCie 300 Series Monitors

- DVI and VGA connectors
- Highest specification Superfine TFT Panel
- 321 - maximum resolution 1600x1200
- 321 - response time 20ms
- 321 - dot pitch 0.27
- 321 - 176 degree viewing angle (S-IPS)
- 3 years advance replacement warranty

Available Models :
321 - 21"
319 - 19"



LaCie Blue Eye Pro Colour Calibrator

- Automatic hardware calibration
- Creates and activates advanced ICC profiling
- Time saver colour test module
- Switchable colourimetric environments
- Designed to complement the LaCie 300 series
- USB interface - all cables and software included
- 2 years manufacturer's warranty as standard

Available Models :
Blue Eye Pro
Blue Eye 2

**ON TEST**

- 84** Canon Laser Shot LBP 5200
Dell 3100cn
- 85** Epson Aculaser C1100N
HP Color Laserjet 2600n
- 86** Konica Minolta Magicolor
2430DL
Lexmark C510n
- 87** OKI C3200
Xerox Phaser 6120
- 88** Table of features
- 90** Performance results
How we tested the printers
- 91** The real cost of printing
Editor's Choice

'The cost of running printers can be important if you're planning on printing large volumes or charging a customer per print'

Add colour with a laser printer

Colour printing is part of everyday life for lots of us and, since laser printers have become more affordable, Paul Monckton checks out eight models and explains the real running costs

The price of colour laser printers continues to plummet. Two years ago we tested what were then budget models, ranging in price from £450 to £850. Now for just over £200 you can buy a network-capable model that prints full A4 pages at up to eight pages per minute, without any of the hassle of constantly replacing tiny and expensive inkjet cartridges.

If your main requirement is for monochrome printing but you want to add the occasional colour job, there are printers that will churn out black and white pages at up to 30 pages per minute and deliver respectable colour performance for a shade over £300. Today, we're so used to working with colour web pages, colour photographs and colour presentations that the benefits of colour printing are obvious. Many of us supplement

our monochrome laser printer with an inkjet device for colour output. However, with budget colour lasers approaching the price of high-end inkjets, why not combine your day-to-day colour and mono tasks into a single low-cost device?

As is always the case with printers, the cost of running them can be of vital importance, especially if you're planning on printing large volumes of output or charging a customer per print. It's no coincidence that the printer which is cheapest to buy is also the most expensive to run. It also requires far more user intervention as its lower-capacity cartridges will need replacing more frequently. Make sure you look at the price and capacities of all consumable items, not just toner, when deciding what to buy. We also cover this aspect on page 91.

Canon Laser Shot LBP 5200

Price £239 Contact www.canon.co.uk



One of the least expensive printers here, Canon's Laser Shot LBP 5200 is designed specifically for Windows users who want a no-nonsense printing solution at a low price.

Its relatively compact body displays a distinct lack of fiddly control buttons and confusing status panels. It's a basic design that conveys an air of easy-to-use simplicity rather than a lack of features. Four LED indicators keep status information to the bare

essentials, and the single 'Toner' button is used only when consumables need replacing. The toner cartridges themselves slot into a drum that rotates automatically to provide convenient access to the correct cartridge from the front of the printer.

The small input paper tray has no cover and offers a rather paltry 125-sheet capacity. In operation it's rather like using a large inkjet printer that happens to use laser technology and print at a far higher speed.

While the device itself may be simple, the supplied driver software is rather sophisticated with a large selection of print options. The more complex options are kept safely behind an advanced settings button, keeping day-to-day operation simple and decision-free.

Rated at 19ppm (pages per minute) in monochrome and 4ppm in colour, the Laser Shot LBP 5200 is the slowest colour printer in this round-up. You also have a relatively long wait before the first page is printed. However, if you print a lot of mono documents and use colour less frequently, you'll find it a better performer than HP's Color Laserjet 2600n which, despite being around twice as fast in colour, at 8ppm, is also limited to this speed in mono.

The Canon Laser Shot LBP 5200 is a great choice for low-volume users who print only from Windows and want to retain high-speed mono printing with the minimum financial outlay.

Verdict

Pros Low price; easy to use; good driver support

Cons Performance; Windows-only; exposed paper tray; no printer control buttons

Features ★★★★★

Performance ★★★★★

Value for money ★★★★★

Overall Superb value for mono printing with occasional colour, but lacks expansion options, flexibility and performance

★★★★★

Dell 3100cn

Price £339.58 Contact www.dell.co.uk



Dell's 3100cn stands out from the crowd, in terms of both physical stature and its combination of performance, quality and features. Finished in a striking black and grey, it stands tall upon a detachable 250-sheet paper tray which, in combination with the multipurpose feeder, brings the total paper capacity to 400 sheets – expandable to a maximum of 900.

It features full PCL 5e, PCL6 and Postscript 3 support, making it compatible with a large number of

operating systems. It also boasts 25ppm printing in mono (5ppm in colour), a fast time to first page and by far the lowest running costs in this group test. Also included as standard are USB and parallel ports, plus a network interface with browser-based management and configuration. Unlike budget models such as Canon's Laser Shot LBP 5200, a 16 x 2 character dot matrix LCD status display is provided, which allows full configuration via built-in menus. It also provides a constant display of toner levels. A printed manual is provided, which is a welcome change from the disc-only documentation so often delivered with low-cost printers.

In our tests, the 3100cn was a good performer across the board. It printed close to its rated speed on all but the full-page photographic test, which it completed in a fast time with a very high-quality result.

Initial setup does require a little patience, but Dell includes a huge wall-chart-sized reference card to guide you through. Driver installation is simple, with the option to select a personal or shared network installation immediately. Features such as a toner status monitor with email alerts, network management and optional duplex printing, give the 3100cn the flexibility to work in larger networked environments while remaining cost effective and easy to use in smaller ones. If the initial price is too high, check out this printer's baby brother, the 3000cn, which comes without the lower paper tray.

Verdict

Pros Paper handling; fast mono printing; lowest running costs

Cons High price; colour performance unexceptional; driver settings confusing

Features ★★★★★

Performance ★★★★★

Value for money ★★★★★

Overall A very good choice for those with a mixture of mono and colour printing requirements. Very low running costs and excellent features with good potential to expand

★★★★★

Epson Aculaser C1100N

Price £296.10 Contact www.epson.co.uk



At £296.10, the Aculaser C1100N is more expensive than Canon's Laser Shot LBP 5200, but this is due to the inclusion of the network interface denoted by the 'N' suffix. The non-networked version undercuts Canon's printer by a few pounds, offers faster performance and comes with additional features such as an LCD status panel, Macintosh support and optional duplex printing – all of which were lacking from our review model.

The paper tray, like that of the LBP 5200, is more of a slot, although it is protected from office dust behind a small door. Capacity is rather low, at 180 pages, but this can be expanded to 680 with an additional tray.

With a speed of 25ppm in mono, you're unlikely to notice a drop in performance when compared to a typical mono laser. It's also incredibly quick to deliver the first page of your print job, beating the 30ppm Lexmark C510n to a 10-page mono sprint. At 5ppm, colour printing speed is adequate. Achieving a faster rate would involve sacrificing mono performance, image quality or you would pay a much higher price. The C1100N is particularly fast at printing full-page colour photos, thanks to configurable compression settings, placing it at the top of our graph in this test.

Compared to more expensive printers, the status display and control panel are rather basic, but more useful than no panel at all – simply having a 'cancel' button is enough to avoid many paper-wasting headaches. Included as standard is a software pack containing 150 design templates for Microsoft Office and Web2Page software to ensure printed web pages fit neatly onto your chosen paper.

In its networkable incarnation the C1100N supports a large number of printing and network management protocols, making it suitable for workgroups of various sizes at a much lower price than Dell's 3100cn.

Verdict

Pros Excellent mono performance, especially with small jobs; print quality

Cons Modest front-panel control/display; no duplex option

Features ★★★★★

Performance ★★★★★

Value for money ★★★★★

Overall A very good budget printer with a solid set of features, excellent performance and print quality and good expansion options

★★★★★

HP Color Laserjet 2600n

Price £210.33 Contact www.hp.com



With the lowest price of any of the printers reviewed here, HP's Color Laserjet 2600n is an excellent way of achieving high-speed colour printing for a minimal price.

The 2600n turns out full-colour pages at a rate of up to 8ppm, leaving many more expensive printers lagging at just over half its speed. It has a network interface as standard, an LCD status panel with control buttons and works with Windows and Macintosh systems.

Single-pass colour technology places the toner cartridges in a line, making refilling extremely easy and there's no need to interact with menus or wait for toner carousels to rotate. It's this technology that allows the printer to achieve its high colour-printing speeds – the page goes straight through the printer in one pass at the full engine speed, rather than having to complete a separate pass for each colour of toner, which effectively slows the process down by a factor of four. Unfortunately, the engine in the 2600n is rather slow, and switching to mono gains you no performance increase whatsoever. It's less than half the speed of its nearest rival when printing in black and white, which is a serious disadvantage if you're hoping to introduce modest colour requirements to print jobs that contain many mono-only pages.

As is often the case with printers that are inexpensive, the true cost of the Laserjet 2600n is hidden in the high price of its consumables, which make it the most expensive printer of the group to run. It's also restricted to rather low-capacity cartridges, which could mean you have to replace them frequently.

Software installation is very easy with a good set of features in the Windows driver, although the print quality settings are curiously placed in the 'Finishing' section rather than in the section labelled 'Paper/Quality'.



Verdict

Pros Low price; fast colour printing; quiet with good-quality output

Cons High running costs; slow mono printing; low-capacity toner cartridges

Features ★★★★★

Performance ★★★★★

Value for money ★★★★★

Overall An excellent low-cost introduction to colour laser printing for those who output mainly colour pages in relatively modest amounts. Watch out for the slow mono printing speed, though

★★★★★

Konica Minolta Magicolor 2430DL

Price £405.38 Contact <http://printer.konicaminolta.com>



At the pricier end of the market, Konica Minolta's Magicolor 2430DL is externally identical to the Xerox Phaser 6120 but with a grey upper casing and different software inside and out.

Rated at 20ppm in mono and 5ppm in colour, performance is acceptable. Our testers rated the text quality among the best, but colour photos were average. The text results are probably due to the true 2,400 x 600dpi print engine, which delivers crisp detail.

Unique among these laser printers is the inclusion of a front-facing USB port and Pictbridge compatibility for printing photos directly from digital cameras. This feature, commonly found on inkjet printers, can require large amounts of memory to be installed in a laser printer, due to the need to render the whole image in one go before the page is printed. You'll need to install an additional 256MB to enable the highest quality mode on the Magicolor 2430DL for Pictbridge printing.

The standard 200-sheet multipurpose input tray is covered by a removeable plastic cover that rests loosely on the tray – it's good protection from dust but could easily become lost.

Where the Magicolor differs most significantly from the Phaser 6120 is in its lack of support for high-level printer languages such as PCL6 and Postscript, although support is provided for Mac OSX and Linux via supplied utility software, making it suitable for heterogeneous workgroups of networked computers.

A network interface is included as standard and web-based management makes remote configuration simple. The desktop status display minimises trips to the printer to check up on job progress. The Magicolor is also expandable, with an additional 500-sheet paper tray and automatic duplexing unit options.

The Magicolor is a solid, flexible printer that's manageable and easy to use.

Verdict

Pros Easy setup; good remote management; Pictbridge support
Cons No Postscript or PCL support; high price

Features ★★★★★

Performance ★★★★★

Value for money ★★★★★

Overall A competent printer that's very easy to set up and use but considerably more expensive than products such as Epson's Aculaser C1100N

★★★★★

Lexmark C510n

Price £339.58 Contact www.lexmark.co.uk



Lexmark's C510n ought to be a speed demon. Rated at 30ppm in mono and 8ppm in colour it has a considerable edge in engine speed. It's also fitted with a large 16 x 2 character dot matrix status display and control buttons, which provide access to full built-in help guides that can be printed directly from the front panel.

Printing costs can be kept down by using built-in account tracking features, and a 'black-only' driver

allows system administrators to lock away colour capability from selected users by removing software support from their PCs. Consumables are competitively priced and, were it not for Dell's incredibly low prices, they would be the least expensive of the group.

In our tests, the printer delighted and disappointed in equal measure. When printing simple mono text, the 30ppm mark was exceeded, coming in at a little over 32ppm. Simple colour pages were also reproduced at very close to the 8ppm speed. In one colour test, speeds of over 12ppm were achieved. This is because the C510n was clever enough to spot that only magenta toner was required and skip the passes for the remaining colours. Only Lexmark's printer was able to do this; the remaining printers all ran at their rated colour speeds regardless.

Unfortunately, full-page colour photos took longer to print, with the C510n coming in slowest of all.

Unexpected pauses during our mono mixed text and graphics test saw performance slashed to around 13ppm.

Fitted with USB and network ports, the C510n is already well connected, but serial, parallel and even wireless 802.11g cards can be added for maximum flexibility, as can auto duplexing and a 530-sheet additional paper tray.

You can use the C510n with just about anything including Mac OS 8.x and up, Linux, Novell and Unix.

Verdict

Pros Wide range of OS support; very fast print engine; low running costs
Cons A little pricey; slow photo printing

Features ★★★★★

Performance ★★★★★

Value for money ★★★★★

Overall Fast in colour, fastest in mono, which makes the printer ideal for longer print runs and slightly larger workgroups with multiple operating systems

★★★★★

OKI C3200

Price £327.83 **Contact** www.oki.co.uk



The second single-pass printer here, OKI's C3200 is not a laser printer at all. Instead it uses less expensive LED technology to achieve much the same effect. It also has the distinction of being the fastest colour printer of the group, rated at 12ppm in full colour.

Despite using single-pass technology, print speeds in colour and mono are not the same on the C3200. There are no extra passes required to print in colour

but OKI, realising that it could safely run its print engine faster when using a single colour, has designed the printer to move the colour printing components out of the way while printing in mono and at the same time ramp up the speed. This allows the C3200 to achieve speeds of up to 20ppm in mono.

In our colour pdf test, the C3200 was far and away the fastest device in this group test – it won't take many colour pages in your mix of print jobs to prove itself a very fast printer indeed. Only if you print the vast majority of your pages in mono could you consider its black and white performance to be an issue.

Unfortunately, all this speed comes at the expense of image quality, which was judged to be joint lowest for mono text quality and achieved lowest when printing colour photos. These were quite noticeably inferior to those of the laser-based competitors. Colours were drab and skin tones simply didn't look realistic. While many of the output samples required quite close scrutiny to discern differences, the output of the C3200 was easily picked out from a distance. Even the 'photo-enhance' option was unable to rescue it.

The standard version of this printer is fitted with a high-speed USB2 port, to which the C3200n adds Ethernet connectivity, an LCD control panel and optional auto duplex printing.

Verdict

Pros Very high-speed colour output; included template software; banner printing

Cons Poor print quality; no LCD on non-network version; no PCL or Postscript

Features ★★★★★

Performance ★★★★★

Value for money ★★★★★

Overall For high-speed colour printing, this is way ahead of the field, although photo image quality is disappointing

★★★★★

Xerox Phaser 6120

Price £421.83 **Contact** www.office.xerox.com



The most expensive printer here, the Phaser 6120 looks like a trendier brother to Konica Minolta's Magicolor 2430DL, finished in blue and white but otherwise identical on the exterior.

Like the 2430DL it offers an engine with 20ppm mono and 5ppm colour print speeds, although consumables are priced differently and, in the case of the photoconductor unit, rated for very different page yields. The photoconductor in the 2430DL is rated to

last twice as long as the similarly priced unit in the Phaser 6120, making the latter more expensive to run.

The Phaser 6120 supports an optional hard disk, which you can use to store fonts and forms, as well as perform electronic collation. It also allows you to proof the first print from a multiple copy run and then enable printing of the remaining copies from the front panel. Secure printing lets you to send your print job to the printer but delays output until you are physically in front of it and have entered your password.

The Windows printer driver includes features such as booklet printing, driver macros which let you set up favourite configurations, N-up printing and two-way communication so you can get alerts at your desktop.

The printer comes with Postscript 3, PCL6, 5c and 5e emulations for maximum multiplatform capability and performance. Like the Magicolor 2430DL, the Phaser 6120 supports optional automatic duplex printing and a lower 500-sheet paper tray.

Although it missed out on top honours, we were pleased with the print quality from the Phaser 6120 and its Pantone-approved colours will be useful to graphic artists and those involved in pre-press proofing.

Excellent features and software support combined with touches such as progress indicators on the front panel, make this a 'deluxe' option for personal use or a good lower-cost addition to any existing Xerox printers.

Verdict

Pros More options to expand and upgrade than the competition; excellent network support and management; Pantone-approved colours

Cons Expensive; small workgroups may not need its advanced features

Features ★★★★★

Performance ★★★★★

Value for money ★★★★★

Overall A high level of features and support but at a high price. Many could make do with a Magicolor 2430DL without missing the Phaser's extras

★★★★★



Budget colour laser printers

MANUFACTURER	CANON	DELL	EPSON
Model	Laser Shot LBP 5200	3100cn	Aculaser C1100N
Price inc VAT	£239	£339.58	£296.10
URL	www.canon.co.uk	www.dell.co.uk	www.epson.co.uk
Calculated cost per page mono (five per cent coverage black)	1.9p	1.0p	1.7p
Calculated cost per page colour (five per cent coverage CMYK)	9.9p	6.3p	10.0p
Printing technology	Laser	Laser	Laser
Single-pass or multi-pass	Multi	Multi	Multi
Supplied memory (MB)	8	64	32
Maximum memory (MB)	8	576	256
Ports (standard)	USB	USB/parallel/Ethernet	USB/Ethernet
Ports (optional)	10/100 Ethernet	None	None
Hard disk	✗	✗	✗
Maximum print resolution (dpi)	600 x 600, 9,600 x 600 enhanced	600 x 600 x 2,400 enhanced mode	2,400 enhanced
Dimensions (w x d x h)	482 x 451 x 325	425 x 420 x 536	445 x 445 x 439
Weight (kg)	17	31	28
Warranty	1 year	1 year	1 year
CONSUMABLES			
Starter toner mono/colour	2,000/2,000	4,000/4,000	1,500/1,500
Toner cartridge mono price inc VAT	£61.10	£29.38	£52.39
Toner life mono (pages at five per cent coverage)	5,000	4,000	4,000
Toner cartridge colour price inc VAT	£72.85	£45.83/£55.23	£54.78/£91.30
Toner life colour (pages at five per cent coverage)	4,000	2,000 or 4,000	1,500 or 4,000
Photoconductor unit life (mono/colour)	20,000/5,000	42,000/10,500	42,000/10,500
Photoconductor unit price	£129.25	£116.33	£157.99
Imaging drum price inc VAT	Not specified	Not specified	Not specified
Imaging drum life mono/colour (pages)	Not specified	Not specified	Not specified
Fuser life	Not specified	100,000	Not specified
Fuser price inc VAT	Not specified	Covered by warranty	Not specified
Maximum pages per month	Not specified	45,000	45,000
OPERATION			
Printer languages supported	Host-based	PCL 5e, PCL6, Postscript 3	ESC/Page-Color S
Pantone-approved	✗	✗	✗
Noise levels - standby/running (dba)	Not specified/<54	<40/<63	Silent/53
Resident fonts	✗	136 PS/81 PCL	None
Max/min paper weights (gsm)	Not specified	60-216	64-210
SPEED			
Claimed warm-up time (seconds)	0 seconds (<120 seconds from power on)	Not specified	Not specified
Claimed pages per minute mono	19	25	25
Claimed pages per minute colour	4	5	5
Claimed time to first page mono (seconds)	17.6	9	9
Claimed time to first page colour (seconds)	26.8	17	17
PAPER			
Input tray capacity (pages)	125	400	180
Input tray capacity with optional paper tray (pages)	250	900	680
Output tray capacity (pages)	126	250	250
Auto duplex	✗	Optional	Optional
SOFTWARE SUPPORT (SUPPLIED IN BOX)			
Windows 98	✓	✓	✓
Windows ME	✓	✓	✓
Windows NT	✗	✓	✓
Windows 2000	✓	✓	✓
Windows Server 2003	✓	✓	✓
Windows XP	✓	✓	✓
Mac OS 9	✗	Optional	✓
Mac OSX	✗	Optional	✓
Linux	✗	✓	✗
SCORES			
Features	★★★★☆	★★★★★	★★★★☆
Performance	★★★★☆	★★★★★	★★★★★
Value for money	★★★★☆	★★★★☆	★★★★☆
OVERALL	★★★★☆	★★★★★	★★★★☆



HP	KONICA MINOLTA	LEXMARK	OKI	XEROX
Color LaserJet 2600n	Magicolor 2430DL	C510n	C3200	Phaser 6120
£210.33	£405.38	£339.58	£327.83	£421.83
www.hp.com	http://printer.konicaminolta.com	www.lexmark.co.uk	www.oki.co.uk	www.office.xerox.com
2.4p	1.7p	1.4p	1.9p	1.9p
11.9p	10.3p	9.6p	9.8p	10.6p
Laser	Laser	Laser	LED	Laser
Single	Multi	Multi	Single	Multi
16	32	128	32	128
16	544	300	288	640
USB/Ethernet	USB/Ethernet	USB/Ethernet	USB	USB/Ethernet/parallel
None	None	802.11g/serial/parallel	10/100 Ethernet	None
✗	✗	✗	✗	Optional 20GB
600 x 600, ImageREt 2400	2,400 x 600	2,400 Enhanced	1,200 x 600	600, 2,400 Enhanced
407 x 453 x 370	430 x 502 x 341	680 x 645 x 670	342 x 400 x 528	442 x 395 x 341
18.4	20	30.3	20	20.2
1 year	3 years	1 year	1 year	1 year
£1.25	1,500/1,500	1,500/1,500	1,500/1,500	4,500/1,500
£58.75	£63.45	£65.63/£110.29	£28.79/£32.61	£60.10
2,500	4,500	5,000 or 10,000	1,500 or 3,000	4,500
£63.45	£63.45/£111.63	£74.96/£149.47	£53.17/£77.84	£52.97/£112.06
2,000	1,500 or 4,500	3,000 or 6,000	1,500 or 3,000	1,500 or 4,500
Built into toner cartridge	45,000/11,250	40,000/10,000	N/A	20,000/10,000
N/A	£128.08	£133.36	N/A	£118.17
Not specified	Not specified	Not specified	14,000 (1 per colour)	Not specified
Not specified	Not specified	Not specified	K - £70.50 CMY - £81.96	Not specified
Not specified	Not specified	51,000	45,000	Not specified
Not specified	Not specified	Not specified	£85.78	Not specified
35,000	35,000	35,000	35,000	35,000
Host-based	Host-based	Postscript 3/PCL6/PDF 1.2, 1.3	Windows host-based	Postscript 3, PCL6/5c/5e
✗	✗	✗	✗	✓
0/47	<39/<53	41/53	37/52	<35/<54
None	1	158 PS/84 PCL	None	139 PS/81 PCL
60-220	60-163	60-210	75-203	60-163
Not specified	45	Not specified	90	Not specified
8	20	30	20	20
8	5	8	12	5
<20	12	13	9	13
<20	21	19	14	22
251	200	250	300	200
501	700	780	N/A	700
125	200	250	250+100	200
✗	Optional	Optional	✗	Optional
✓	✓	✓	✓	✓
✓	✓	✓	✓	✓
✗	✓	✓	✗	✓
✓	✓	✓	✓	✓
✗	✓	✓	✗	✓
✓	✓	✓	✓	✓
✗	✗	✓	✗	✓
✓	✓	✓	✗	✓
✗	✓	✓	✗	✓
★★★★★	★★★★★	★★★★★	★★★★★	★★★★★
★★★★★	★★★★★	★★★★★	★★★★★	★★★★★
★★★★★	★★★★★	★★★★★	★★★★★	★★★★★
★★★★★	★★★★★	★★★★★	★★★★★	★★★★★

Lab results

There's a wide range of performance and quality represented in this group of printers, but there should be something to suit most users' needs

Text speed (pages per minute)

Bigger is better

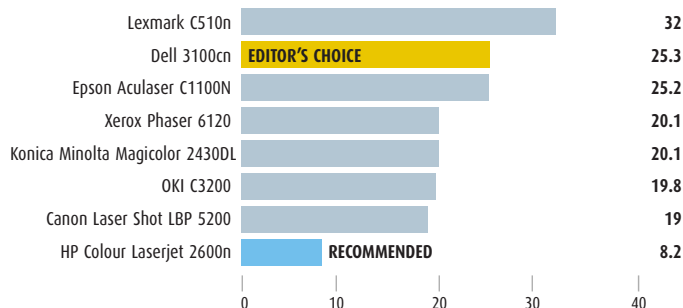

Colour pdf speed (pages per minute)

Bigger is better

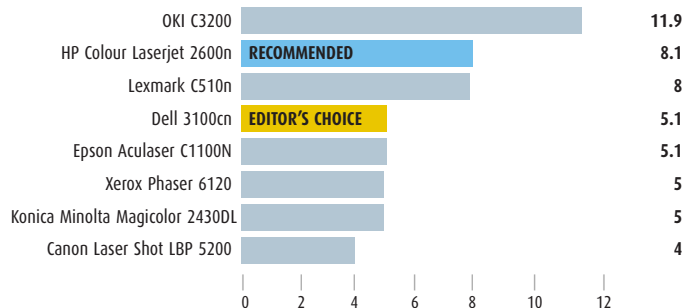

Mixed mono speed (pages per minute)

Bigger is better

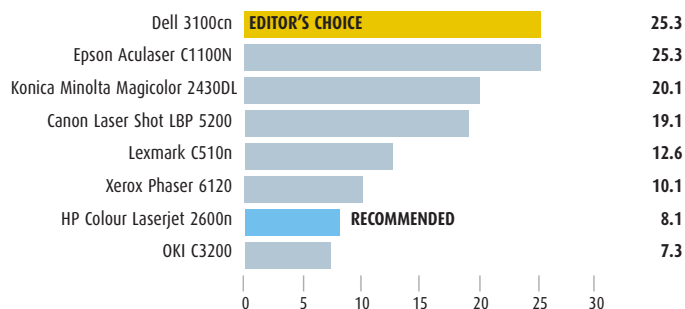

A4 photo speed (pages per minute)

Bigger is better

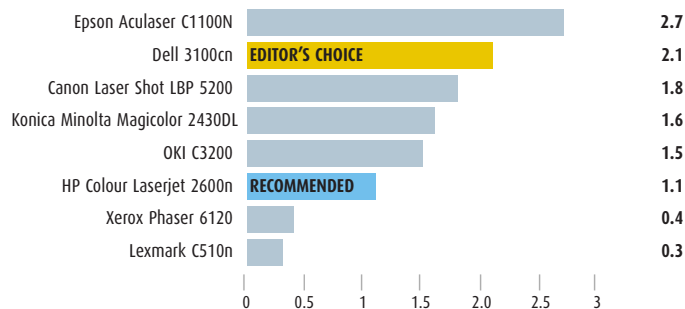

Text print quality score

Bigger is better

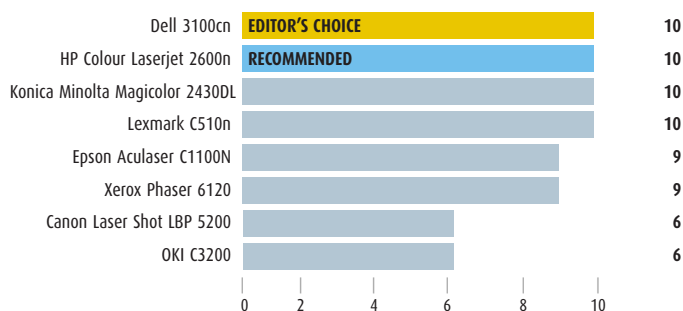

Colour photo quality score

Bigger is better

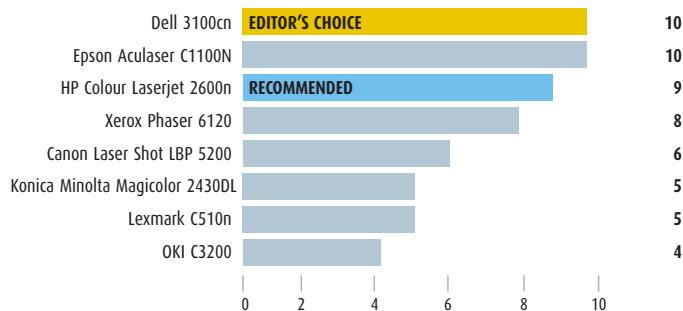

How we tested the printers

In order to judge the various strengths and weaknesses of each printer, we put them through a series of different tests.

To assess print speed, we timed their output performance when printing plain text, pdfs, mixed content pages and finally an A4 colour photograph. Behind the scenes, we

also ran tests using virtually blank pages, to measure the absolute maximum performance in both mono and colour modes and verify the manufacturers' rated speeds, which are usually based on simply passing blank pages through the printer as fast as possible.

To evaluate output quality we assembled a panel of judges consisting of PCW staff to compare the output of our text and colour photo tests. The best print in each test was awarded maximum points with the remaining scores allocated according to how well they compared relative to these benchmark prints.

The real cost of printing

The low purchase cost of modern budget printers can make them appear to be a much more sensible investment than their more expensive counterparts. However, when you hand over your cash, you're not only buying a printer but tying yourself into a programme of replacement toner cartridges and other consumable items that you're stuck with for as long as you continue to use the printer. Make sure you investigate the prices of these items before you make your purchasing decision.

If your printer is for personal use, it's possible that it will last you a very long time before you have to replace the consumables, but if your cartridges should all run out at around the same time you could be in for a sudden, nasty shock. For example, HP's Color Laserjet 2600n can be purchased for £210.33. It comes pre-installed with toner, so discounting the cost of your electricity, your first five reams of paper can essentially be printed for nothing if you're printing in mono. If you're printing in full colour all the time you'll get through about four reams of paper for light coverage.

Once you've printed your 'free' pages, you'll need to replace your toner cartridges: Remember, for a colour laser printer that's a total of four cartridges, one for each of the cyan, yellow, magenta and black shades. For this printer that'll set you back a total of £249 – well over the cost of a new printer complete with toner.

IT departments keep reserve stocks of toner bought in advance and would be likely to notice what's going on here, but home users

are unlikely to exhaust all their toner cartridges at exactly the same time, which masks the fact that you're paying over the odds for your consumables.

By contrast, Dell's 3100cn comes fitted with large 4,000-page toner cartridges meaning you'll get through around eight packs of paper before it's time to replace them. When you do, it'll cost you £195.07 to swap out the lot. This is a massive saving when compared to the HP printer.

However it's not just toner that needs to be replaced. There are imaging drums, fusers and sometimes belts that need replacing at longer intervals, often costing considerably more than a toner cartridge and sometimes a significant sum when compared to the price of the printer. The HP has imaging drums built into the toner cartridges and the fuser is designed to survive for the life of the printer, but the remaining printers require additional components that need replacing at intervals of around 20,000-50,000 pages and they cost approximately £115-£150. It may be that you never print this many pages, but when you do, be prepared for an extra expense.

We've factored in the prices of these extra items (where available) to our running cost calculations and worked out that the Dell 3100cn is still around twice as cost-effective to run as the HP Color Laserjet 2600n. Let's say you know you want to print 4,000 pages, would you rather buy a Dell 3100cn for £339.58 or two HPs for £420.66?

Editor's Choice

Editor's Choice **Dell 3100cn**
Recommended **HP Color Laserjet 2600n**



Dell 3100cn

When it comes to making a budget laser printer there are a few ways to cut costs: you can get rid of extras such as LCD panels, control switches and covered paper trays. Powerful features such as network adapters, duplex printing can be expensive add-ons and you can ramp up the cost of the consumables and ship just the bare minimum of toner with the printer.

The printers here cover all these approaches and have a somewhat confusing array of strengths and weaknesses. Three printers, from Canon, HP and Epson, stand out due to their



HP Color Laserjet 2600n

exceptionally low prices. They are commended for achieving this while delivering products that, while inexpensive, are never 'cheap'.

Spending a little, or in some cases quite a lot, more will buy you greater speed, expansion options or both. You can also have the flexibility to print from a variety of operating systems and support larger numbers of users on a network by using print languages such as PCL and Postscript.

OKI's C3200 leads the field in delivering colour print speeds of up to 12ppm, but suffers noticeably in terms of print quality, especially with photographic content.

Lexmark's C510n is capable of blistering mono print speeds and is also very fast in colour with good print quality.

If you're a low-volume home user who wants colour printing but your mono requirements are quite modest, HP's Color Laserjet 2600n is an excellent low-cost option. For just over £200 it will give all but the very fastest of its rivals a run for their money when printing in colour and comes ready to plug into your network as standard. Print quality is excellent and it's very easy to use.

However, an important caveat is the high running costs – in common with some inkjets, at current prices it would be cheaper to buy a new printer than replace all the consumables. This fact and its slow mono printing preclude it from being an Editor's Choice, but we still consider that its quality, performance, features and ease of use merit our Recommended award.

Our Editor's Choice printer delivers very low running costs, a large paper capacity, superb print quality and Postscript capability. These are all features you'd expect from premium workgroup printers, but Dell's 3100cn delivers them and more in a product costing just shy of £340. Its high-capacity toner cartridges undercut the competition by a huge margin and, fortunately, it's these that you'll find shipped with the printer.**PCW**

Your potential. Our passion.™
Microsoft®



A Service Managing 7 Million Transactions a Day.
Running on Microsoft SQL Server 2005.

How does Xerox Global Services manage millions of office devices for its customers? Their largest application requires 99.999+% availability and it runs on new SQL Server™ 2005 64-bit running on Windows Server™ 2003. See how at microsoft.com/uk/bigdata

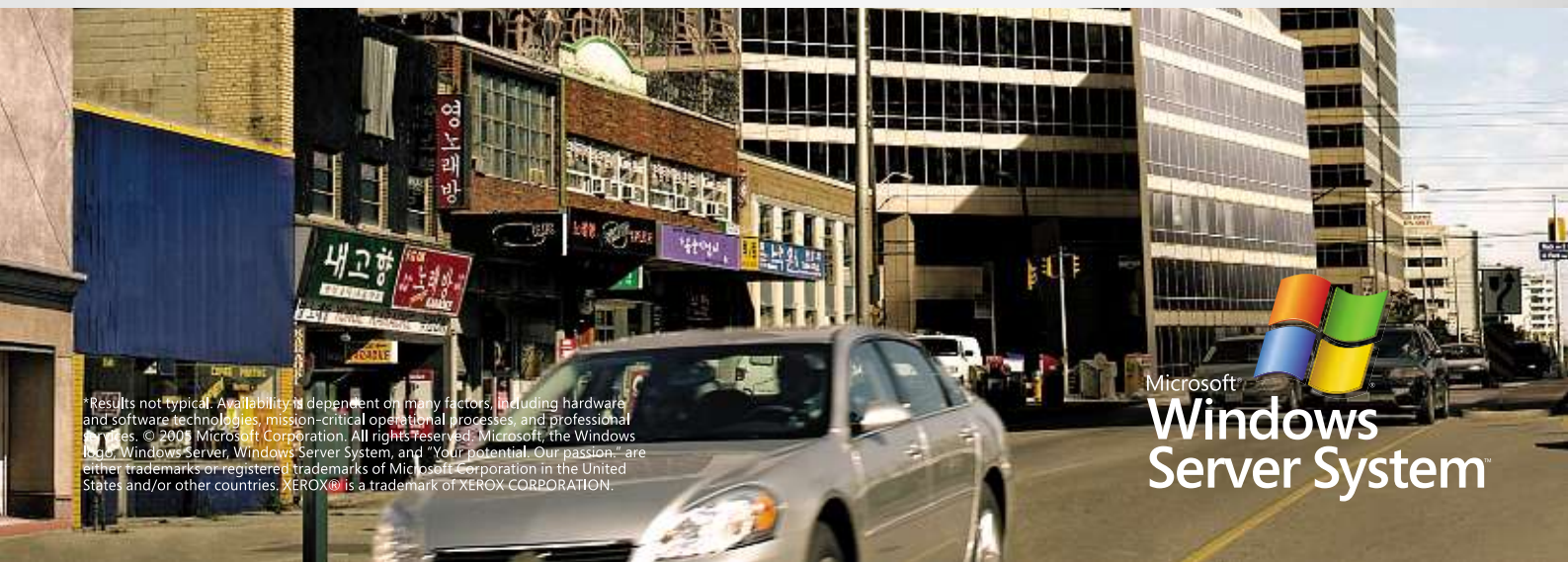

*Results not typical. Availability is dependent on many factors, including hardware and software technologies, mission-critical operational processes, and professional services. © 2007 Microsoft Corporation. All rights reserved. Microsoft, the Windows logo, Windows Server, Windows Server System, and "Your potential. Our passion." are either trademarks or registered trademarks of Microsoft Corporation in the United States and/or other countries. XEROX® is a trademark of XEROX CORPORATION.

Microsoft
**Windows
Server System™**

Portable and affordable

Until recently, even notebooks with low specs have cost a fair whack. Now, though, £699 will buy a laptop that will suit most people's needs. Luke Peters puts nine of them to the test

Laptops continue to fly off the shelves and are still outselling their desktop counterparts, even with the advent of powerful dual-core desktop processors from Intel and AMD. For this group test, we wanted to find out exactly what type of laptops people are buying and what price is proving most popular.

Phoning the top manufacturers established that the most popular price is £699. This could suggest a few things. Perhaps most buyers aren't looking for the fastest, most feature-packed laptop with the best graphics chips and processors. Or it could be that many consumers want a value-for-money model to complement a desktop PC. Of course, we could be way off, and £699 is simply the price people are willing to pay for a portable computer.

So, what does £699 get you these days? It's clear graphics aren't given priority, as most of the notebooks in this test arrived with integrated graphics chips. Construction quality focuses heavily on plastic, and you should be prepared to sacrifice processing power for budget CPU options from Intel and AMD. Also, count yourself lucky if you find more than 512MB of Ram installed.

Nevertheless, not long ago similar specs would easily cost four figures. On the plus side, you can get a massive 17in widescreen display, up to 80GB of storage, Wifi and Bluetooth and even flash card readers. One of the models reviewed here is bound to fit your needs, so read on and find out which one it's going to be.

ON TEST

- 94 Acer Aspire 9503EWSMi
AJP M551G-E
- 95 Elonex Prowire 153
Evesham Voyager A215
- 96 Fujitsu Siemens Amilo
M 6450G
Hi-Grade Notino C5515-1700
- 98 HP Compaq nx6125 (EK157ET)
Mesh Pegasus 3070
- 99 MV Sirius+
- 99 Living with a laptop: pitfalls
to avoid
- 100 Table of features
- 102 Lab results
- 103 The next level
Editor's Choice

'It's clear that graphics aren't given priority... nevertheless, not long ago similar specs would easily cost four figures'



Acer Aspire 9503EWSMi

Price £699 Contact www.acer.co.uk



When asking manufacturers for their best notebook at £699, we hardly expected a 17in widescreen model to turn up. So hats off to Acer for putting together the Aspire 9503EWSMi. It towers over everything else here, weighing 3.6kg, offering a maximum screen resolution of 1,440 x 900 (WXGA) and containing a full-size keyboard with separate number pad.

However, while the chassis is of gargantuan proportions, its innards are dwarf-like. An Intel Celeron M 370 (1.5GHz) is aided by just 512MB of DDR2 Ram, which combine to achieve a low Sysmark score of 124. The PCmark result was an unexceptional 1,607, although to be fair this is as good as some of the £999 small form factor desktop PCs we tested in our March 2006 issue.

Like many others here, the integrated Intel i915GM graphics will dynamically steal up to 128MB of system memory to help with 3D-intensive tasks and games, but it's not powerful enough to play the latest first-person shooters at any respectable detail level. A 3Dmark score of 200 may be high compared to some others here, but it's still poor.

The display is this notebook's best feature. It is designed with Acer's Crystalbrite technology, so things look clear and sharp. The whole notebook feels rugged but sleek, thanks to its curved finish.

There's a slot-loading DVD writer on one side of the chassis and a 5-in-1 memory card reader on the other. Its size has enabled Acer to include five USB ports, a PCI Express Card slot and an S/PDIF audio socket. 80GB of hard disk space is provided and Microsoft Works is bundled. Both Bluetooth and 802.11b/g Wifi are built in, as is Acer's Arcade software that allows multimedia files to be played via a supplied remote control.



Verdict

Pros 17in WXGA screen; great battery life; lots of bundled Acer software
Cons Budget Intel processor; poor 3D graphics

Features ★★★★★
Performance ★★★★★
Value for money ★★★★★

Overall Amazingly good value for a 17in widescreen notebook, with enough features to keep most users happy

★★★★★

AJP M551G-E

Price £699 Contact www.ajp.co.uk



Flip up the lid of the Centrino-branded M551G-E and you immediately get the feeling you're getting your money's worth. The palm rest may be made of plastic, but the silver rim around the keyboard, brushed metallic trackpad (with scroll slider) and glowing blue power light all add an air of luxury.

However, the 1.4GHz Intel Celeron M 360 processor and 512MB of memory reminds us why this notebook is so inexpensive. Couple this with Intel's integrated

i915GM chipset which shares 128MB of system memory, and you have a notebook that will perform standard Windows tasks easily but lacks graphics horsepower.

The score of 117 in Sysmark was one of the lowest here but things improved with its PCmark rating of 1,390. However, a score of 190 in 3Dmark and 4.4fps (frames per second) in Far Cry underline that at this price level, state-of-the-art gaming is not on the menu. The 80GB hard disk is a reasonable size, though.

The 15.1in SXGA+ screen can display a maximum resolution of 1,400 x 1,050. It's crisp and among the best here.

As this notebook uses a low-power processor, we expected battery life to be better: topping two hours, 13 minutes at its best will mean you'll have to find bag space for the AC adapter if you're out and about a lot.

Overall build quality is pretty good. A slim eight-speed DVD writer is moulded into the right-hand edge and four USB ports are included. An integrated webcam peers down from within the lid, a 4-in-1 memory card reader will please digital camera fans and the S/PDIF port will be well received by those looking to work with digital audio. 802.11g Wifi is included, but Bluetooth is an added-cost option.

The 2.7kg weight is consistent with most notebooks here and, at the time of writing, AJP was including a free Vodafone 3G/GPRS Mobile Connect Card.

Verdict

Pros 15.1in SXGA+ screen; integrated webcam; design
Cons No Bluetooth; poor graphics
Features ★★★★★
Performance ★★★★★
Value for money ★★★★★

Overall Great screen and well built, but not the fastest notebook around

★★★★★

Elonex Prowire 153

Price £699 Contact www.elonex.co.uk



At 2.8kg, the Prowire 153 is up there with the heaviest notebooks on test. However, Elonex's entrant is the only one with 1GB of DDR Ram. Double the amount of memory and your computer will operate faster – it's as simple as that.

The Intel Pentium M 740 (1.73GHz) is also one of the fastest processors used in this group test and helped the Prowire 153 achieve 135 in Sysmark and 1,792 in PCmark tests.

Like most of the notebooks here, Intel's i915GM chipset is used for graphics, and it can borrow up to 128MB of the system memory. As expected with integrated graphics, the 3Dmark score was 184 and Far Cry didn't run.

A technical glitch with Mobilemark 2005 stopped us getting a battery life score before we went to press, but by the time you read this we will have posted full results for all the notebooks at www.reportlabs.com.

Having a maximum resolution of 1,024 x 768 means things can get a bit crowded on the 15in display and it only takes a slight knock to get that shimmering effect that occurs on some budget LCD screens.

The 80GB hard disk matches what's provided in the other notebooks here, as does the dual-layer DVD writer, which is unusually positioned on the front edge of the chassis rather than the side. There are four USB ports and a switch for turning on the 802.11a/b/g Wifi radio.

The palm rest is bigger than others here and the keyboard feels good to type on. There's a 3-in-1 card reader that supports MMC (Multimedia Card), SD (Secure Digital) and Memory Stick formats, and there's also an S/PDIF socket.

Windows XP Home is installed and you get WinDVD 4 plus a collection of Nero applications for multimedia work and disc burning. Elonex includes a carry case, and you can order online with the E-web code 05-PCW-153.

Verdict

Pros Pentium Mobile processor; 80GB hard disk; 1GB of Ram

Cons Heavy; unimpressive screen

Features ★★★★★

Performance ★★★★★

Value for money ★★★★★

Overall Only notebook here with 1GB of Ram; it's not the prettiest of machines but is a solid performer

★★★★★

Evesham Voyager A215

Price £699 Contact www.evesham.com



This is one of four notebooks here that uses a version of AMD's budget Turion 64 mobile processor. The MT-34 CPU runs at a frequency of 1.8GHz and is supported by 512MB of DDR Ram. Its Sysmark result of 130 and PCmark score of 1,497 are nothing to crow about, but the Voyager outperformed the AJP, which uses Intel's low-spec 1.4GHz Celeron M.

The Via chipset with S3G integrated graphics, which uses 64MB of shared system memory, is also pretty

unimpressive – it achieved 6.04fps in Far Cry and wouldn't even run 3Dmark05 (which requires at least 128MB of graphics memory) – but we weren't expecting any notebook here to dazzle us with 3D capability. It should have no problem dealing with Adobe Photoshop and similar programs, but exert heavy video-editing burdens and it will slow right down.

An 80GB hard disk is what you should expect for a notebook of this price, as is the 15in XGA screen that displays a maximum resolution of 1,024 x 768. Anything over and above this is good value for money.

Its design is typical of a low-cost notebook; nothing flashy, plastic everywhere and components incorporated into the case wherever they'll fit. Four USB ports and a VGA socket sit awkwardly either side of a vent on the left-hand side and a dual-layer DVD writer overhangs the otherwise neat finish on the right. Headphone and microphone sockets are positioned on the front and sit below a standard row of status LEDs.

This is a solid notebook with a robust keyboard and trackpad. Its 2.8kg weight makes it just about portable, but there's no memory card reader for transferring data quickly while on the move.

It comes with Microsoft Works 8, Roxio Easy Media Creator 7, Bullguard Internet and PC Angel, as well as a three-year warranty (two years on-site, one year return-to-base).

Verdict

Pros Solidly built; 80GB hard disk; good software collection

Cons 15in XGA screen; patchy design quality

Features ★★★★★

Performance ★★★★★

Value for money ★★★★★

Overall A middle-of-the-road entrant that fares poorly when compared to others

★★★★★

Fujitsu Siemens Amilo M 6450G

Price £699 Contact www.fujitsu-siemens.co.uk



Bucking the trend of most notebooks here, the stout Fujitsu Siemens Amilo M6450G has a 14.1in widescreen display that offers a surprisingly high maximum resolution of 1,280 x 768. In this mode, text and Windows icons are razor sharp.

Having a smaller screen has an impact on its overall weight; at 2.4kg it's the lightest here. Nevertheless, it still manages to use an Intel Pentium M 735 (1.6GHz).

which is twinned with 512MB of Ram. It would have been good to see 1GB, as with the Elonex, but it still managed to score 136 in Sysmark and 1,887 in PCmark.

Graphics didn't hit the right note, either, and although the Intel i915GM chipset can share up to 192MB of system memory, it wasn't enough to generate a decent frame rate. Scores of 237 in 3Dmark and 5.06fps in Far Cry illustrate this point.

The 80GB hard disk provides some comfort, as does the dual-layer DVD writer that can burn up to 8.5GB on the right discs.

The notebook is quite well designed. Each corner is rounded, while the lid and keyboard are sturdy. A set of green LEDs under the display keep you informed of the status and a PCI Express Card slot gives you a degree of future-proofing in terms of I/O capability. There are also three USB ports, a mini Firewire port, a 4-in-1 memory card reader, S-video and VGA outputs.

Other than Windows XP Home, additional software supplied is Microsoft Works, WinDVD 5, Nero Smartsuite 6 and a three-month trial of Norton Internet Security. Fujitsu Siemens also provides a one-year collect-and-return warranty with parts and labour.



Verdict

Pros Lightweight design; clear screen; Pentium M processor

Cons Small screen

Features ★★★★★

Performance ★★★★★

Value for money ★★★★★

Overall A well-designed notebook with a good but small screen

★★★★★

Hi-Grade Notino C5515-1700

Price £699 Contact www.higrade.com



Hi-Grade's Notino C5515 stood out because it has Windows XP Media Center Edition (MCE) installed. However, there's no integrated TV tuner so you'll have buy one separately and it will use up one of the two USB ports.

The Notino's silver skin helps it stand out, yet closer inspection reveals a plasticky construction and hardware components that almost look as if they've been forced into the chassis.

Inside the 2.9kg case lie an Intel Pentium M 735 processor (1.7GHz) and 512MB of DDR Ram, which scored just 119 in Sysmark and 1,850 in PCmark. As some of the notebooks with Celeron M processors scored higher in some areas, we wondered just what difference the hallowed Pentium label was making.

The 15.1in XGA screen has a maximum resolution of 1,024 x 768 and didn't produce the sharpness that other notebooks, such as the AJP, displayed. The screen seemed to vary in contrast depending on where it was viewed from and the black level was fairly bright, which is annoying when watching DVDs in letterbox mode.

Intel's integrated 915GM chipset can steal up to 128MB of system memory, but the 3Dmark score of 191 and 4.36fps Far Cry rating won't appeal to gamers. To be fair, not many of its competitors fare much better.

Only a brace of USB ports are on offer, plus there's no memory card reader, but you do get integrated 802.11b/g Wifi. The basic DVD writer will be needed to archive data to disc if the small 60GB hard disk fills up quickly, which is very likely if you're using MCE's multimedia features to their full potential.

The keyboard feels less robust compared to others here, but there's a four-way directional pad for navigating around documents and web pages. Hi-Grade also bundles a carry-case, Open Office (which is free anyway) and a one-year collect-and-return warranty.

Verdict

Pros Windows Media Center Edition; Pentium M processor

Cons Small hard disk; two USB ports; no TV tuner

Features ★★★★★

Performance ★★★★★

Value for money ★★★★★

Overall A TV tuner and bigger hard disk would have made this a great little Media Center laptop, but in this guise it's sadly lacking

★★★★★



ASUS A8R-MVP

Made for Overclockers

Innovative Overclocking Features Raises the Performance of the Already Powerful Athlon 64 X2/Radeon Xpress 200 CrossFire Platform

It takes a lot out of the system to run 3D games, movies or any applications that require high-speed graphics cards, superb audio quality and powerful memory performance. Sometimes the standard specification is simply not enough, and that's why more people are looking into overclocking to milk every last drop of performance out of their computers.

The ASUS A8R-MVP motherboard supports the powerful Athlon 64 X2 dual-core CPU and CrossFire multiple-VPU graphics interface and incorporated the Radeon Xpress 200 CrossFire chipset. The all-new board, though already awesome in performance, also packed in innovative overclocking features that bring out the system's true potential.

Flexible and precise tweaking

The A8R-MVP offers several ways to increase system performance inch-by-inch to get the most out of the processor, memory and system bus.

- ① An 8-step DIMM voltage control permits the most suitable amount of power to enter the memory modules.
- ② The board lets you fine tune CPU voltage at 0.025 increments to find out exactly how much power is needed.
- ③ And last but not least is Stepless Frequency Selection (SFS), which allows FSB tweaking from 200MHz to 400MHz at 1MHz intervals.

PEG Link Mode - Boost VPU performance

This latest technology lets you to increase VPU and graphics card memory performances via the BIOS the same way system bus and memory bus are tweaked. It provides excellent video quality on DX8 and DX9 applications.

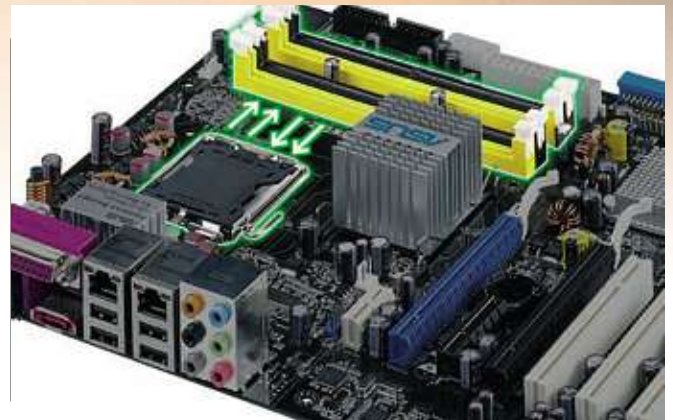

PEG Link - Exclusive technology to boot up graphics card memory performance

Serial ATA 3Gbps - Prepare for future upgrades

The A8R-MVP is not bad when comes to future expansion either. It supports the next-generation hard drives based on the Serial ATA 3Gbps storage specification, delivering enhanced scalability and doubling the bus bandwidth for high-speed data saves and retrievals.

If you care about getting your money's worth and enjoying the real performance of the system, then you should definitely give the ASUS A8R-MVP a try With industry-leading specifications and the overclocking features to take its performance to the stratosphere, the A8R-MVP is made for overclockers.

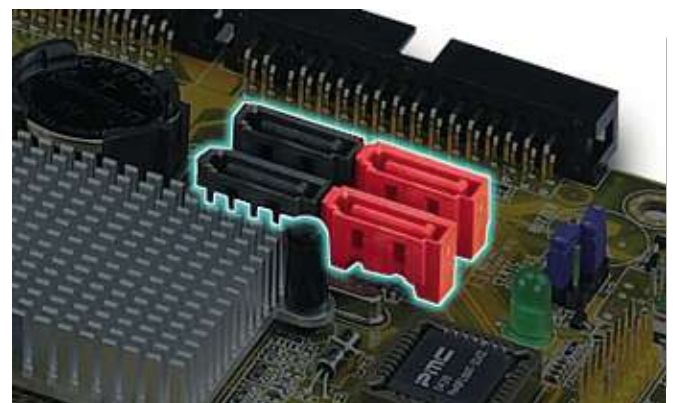

Super-Fast 3Gbps SATA ports for future upgrades

HP Compaq nx6125 (EK157ET)

Price £699 Contact www.hp.com/uk



The HP Compaq nx6125 is a business-oriented notebook using AMD's Turion 64 processor. It's the only machine to use an ML-32 version, which runs at 1.8GHz. There's not much difference between ML and MT processors, apart from the wattage; MLs are rated at 35w, while the MT uses 25w.

Like the other notebooks in this group test, the nx6125 has no dedicated graphics chip. Instead it uses ATI's Radeon Xpress 200M chipset, which scored 512

in 3Dmark and 11.21fps in Far Cry, better than most, and impressive considering the target market.

There is 512MB of Ram to play with, which may sound stingy when compared to the Elonex, but what the HP lacks in Ram it makes up for in other areas.

Scores in Sysmark and PCmark were 119 and 1,871 respectively. An extra 512MB of Ram could have provided more headroom for demanding applications.

Like the Hi-Grade, the HP Compaq only stretches to a 60GB hard disk, which shouldn't be too much of an issue for business types, but start adding media files and it will soon fill up. If space is looking a little short, the dual-layer DVD writer can archive multiple gigabytes worth of files.

This notebook has some great security features. There's a biometric fingerprint reader on the front and HP's Protect Tools software built into the Bios. It's the only notebook here with Windows XP Professional, and has a wealth of pre-installed software, including HP One-Touch Button Software, the HP Wireless Assistant, Sonic Recordnow, Intervideo WinDVD player and Norton Antivirus. There's also a software CD with Intervideo WinDVD Creator for basic DVD authoring.

The 15in XGA screen is acceptable for basic Windows tasks, and Bluetooth and 802.11g Wifi networking is built in. Other sockets include a PCI Express Card slot and a 6-in-1 card reader.

Verdict

Pros Lots of security features; good for small-business users; software bundle

Cons Small hard disk; dull styling

Features ★★★★★

Performance ★★★★★

Value for money ★★★★★

Overall A great notebook for those who need security, plus it's a decent all-round performer

★★★★★

Mesh Pegasus 3070

Price £699 Contact www.meshcomputers.com



When it comes to building good-value PCs, Mesh can usually be counted on. We fully expected the Pegasus 3070 to have the production hallmarks of a cheap notebook, but it has some components we thought could have been better.

For example, money saved using AMD's 2.2GHz Turion 64 MT-40 processor could have been spent on increasing the 512MB of DDR Ram to 1GB. However, the Sysmark score of 158 was one of the fastest here.

PCmark was less forgiving, with this notebook garnering a paltry 890. This is predominantly due to the notebook's graphics ability and the integrated Via/S3G chipset, which shares only 64MB of the system memory, and just isn't powerful enough to do anything fancy in more than two dimensions. It didn't even have sufficient memory to run 3Dmark and notched up a sloth-like 3.67fps when running Far Cry at its native resolution of 1,024 x 768. In its defence, though, nothing else in this group test is suitably equipped to play modern 3D games at any decent detail setting or screen resolution.

The 15.1in screen is bright, sturdy and balances colours well across the whole display. Using the eight-speed dual-layer DVD writer to play a movie provided a good visual experience; however, the cinematics were a little jumpy at times, which is proof of the notebook's low graphics clout. Battery life wasn't too hot, either, achieving just over two hours before dropping dead.

Four USB ports are included and all ports and sockets, bar those for the headphone and microphone, are on the left-hand side. There's no memory card reader but TV-out and VGA sockets will allow connection to a larger display.

At 2.8kg, the notebook falls below the magic 3kg weight for easy portability and there's a heap of productivity software included too.

Verdict

Pros Good productivity performance; four USB ports

Cons No memory card reader; low battery life; 15in XGA screen

Features ★★★★★

Performance ★★★★★

Value for money ★★★★★

Overall A respectable effort from Mesh, with well-balanced features, although it's let down by its graphics

★★★★★

MV Sirius+

Price £699 Contact www.go-mv.com



The MV Sirius uses exactly the same chassis as the Evesham reviewed in this group test. Almost everything, from the number of USB ports to the positioning of the modem and network sockets, is the same. The one difference is the optical drive; MV has plumped for an old-school CD-RW/DVD-Rom combo drive, whereas the Evesham boasts a more impressive dual-layer DVD writer.

The MV wins back some points with its choice of processor; a Turion 64 MT-40, which runs at a clock speed of 2.2GHz. Coupled with 512MB of Ram, the MV racked up 142 in Sysmark and 1,667 in PCmark.

However, the Sirius+ is the only entrant to contain a 40GB hard disk, which is half the amount of five other notebooks here. It's hardly the stuff of 21st Century computing, and even the lightest computer user will fill that up quickly once programs are installed and My Documents starts to bloat.

The Via/S3G graphics aren't much to write home about, either. Just 64MB of shared memory is allocated to power 3D graphics, which resulted in 3Dmark not running and 6.86 fps in Far Cry.

Like the Voyager A215, the 15in XGA screen will display a maximum resolution of 1,024 x 768. However, compared to those that can produce resolutions in excess of this, the MV looks dated.

You do get 802.11g wireless networking, though, and a software package that contains Roxio Creator, Microsoft Works, Bullguard Firewall AV software and a 60-day trial of Office 2003. The warranty runs to a one-year collect-and-return-policy with two further years' return-to-base with labour.

Verdict

Pros Healthy software bundle; fast Turion processor

Cons No DVD writer; small hard disk; poor graphics

Features ★★★★★

Performance ★★★★★

Value for money ★★★★★

Overall With a hard disk half the size of most others here and no DVD writer, it's hard to recommend the MV

★★★★★

Living with a laptop: pitfalls to avoid

There's no denying that, for most everyday computing tasks, notebooks win hands down over desktop PCs in terms of their portability and ease of use. Yet despite notebooks having arguably been around for as long as the desktop PC (the Osborne 1 portable was launched in 1981, the same year as the IBM PC), it's only in the past 12 months that they've really caught up with desktops in terms of numbers sold in the UK.

The main driver for increased laptop sales has, perhaps unsurprisingly, been lower prices. With models available from around £300, they're not now limited to deep-pocketed executives and business users. Many people will now have had some experience of using a notebook, but if you're one of those who've never owned a laptop before, there are a couple of things to be aware of before you start out in the world of mobile computing.

Easy to set up

First of all, one of the great attractions of a notebook is the ease of setup – take it out of the box, plug it in and it will (usually) be up and running straight away. No spaghetti of wires to connect up, no clearing out your office or study to find a place to install it. But if you're replacing a desktop PC, you might find it's not quite as straightforward connecting up your printers, scanners, joysticks and other assorted peripherals, especially if your old PC lived under your desk. Dragging out all the old cables and connectors can be a chore, particularly if you want to take advantage of your notebook's portability and use it around the house – it's no fun reconnecting everything every time you want to print or scan a document.

One way around this is to use a universal USB docking station or port replicator, such as those from Targus (see www.targus.com/uk/accessories_mobile_docking.asp for more information on this product). Costing around £50-£100, you can connect your USB, parallel, Ethernet or serial devices to these permanently, and just plug the dock into your notebook's USB port when you need the peripherals. Some models also have PS/2 and VGA ports so you can connect a keyboard, mouse and a monitor.

Power problems

Another potential gotcha lurks in the notebook's power system. AC power adapters and batteries don't last forever; and to be safe, don't bank on them lasting the lifetime of the notebook. It's worth considering buying spares with your new notebook, as a couple of years down the line you might have great trouble finding replacements. Some brands are better than others in this respect; for many years, any IBM notebook power adapter would work with any IBM notebook, but this is the exception rather than the rule, and it's best to assume the worst.

Finally, the major downside of notebooks is the cost of repair: they're not designed for user maintenance, and they can be expensive to fix when core components break, so it's worth investigating the cost of insurance cover once the standard warranty expires – for example, we found a two-year extended warranty for a one-year-old £699 laptop from Warranty Ex (www.warrantyex.co.uk) for about £126.

Kelvyn Taylor







£699 notebooks



MANUFACTURER	ACER	AJP	ELONEX	EVESHAM
Model name	Aspire 9503EWSMi	M551G-E	Prowire 153	Voyager A215
Price inc VAT	£699	£699	£699	£699
Sales telephone	0800 161 3060	0870 720 7907	0870 780 1010	0870 160 9500
URL	www.acer.co.uk	www.ajp.co.uk	www.elonex.co.uk	www.evesham.com
HARDWARE				
Processor	Intel Celeron M 370 (1.5GHz)	Intel Celeron M 360 (1.4GHz)	Intel Pentium M 740 (1.73GHz)	AMD Turion 64 MT-34 (1.8GHz)
Chipset	Intel i915GM	Intel i915GM	Intel i915GM	Via K8N800
Available memory/type	512MB PC2-4200 DDR2	512MB PC2-4200 DDR2	1GB PC-2700 DDR333	512MB PC-2700 DDR333
Occupied/spare memory slots	1/1	1/1	2/0	1/1
Hard disk manufacturer and model	Hitachi HTS42180H9AT00	Fujitsu MHT2080AH	Hitachi HTS42180H9AT00	Toshiba MK8032GAX
Hard disk size	80GB	80GB	80GB	80GB
Network/speed	Realtek RTL8169/10/100/1,000	Realtek RTL8169/10/100/1,000	Realtek RTL8139/10/100	Via Rhine II/10/100
No of PCI Express card slots	1	0	0	0
No of PC Card slots	1	1	1	1
No of Firewire/serial/parallel/PS/2 ports	1/0/1/0	1/0/0/0	1/0/1/0	0/0/0/0
No of USB ports	5	4	4	4
D-Sub/DVI/S-video ports	D-Sub/S-video	D-Sub/S-video	D-Sub/S-video	D-Sub/S-video
MULTIMEDIA				
Optical drive	Matshita UJ-845D	NEC ND-6650A	Samsung TS-L532A	Sony DW-Q58A
Optical drive formats and speed (max)	8x DVD, 8x DVD-R/+R, 4x DVD-RW/+RW, 2.4x +R DVD DL	8x DVD, 8x DVD -R/+R, 8x DVD+RW, 6x DVD-RW, 4x -/+ R DVD DL	8x DVD, 8x DVD+R /-R, 4x DVD+RW /-RW	8x DVD, 8x DVD+/-R, 8x DVD+RW, 4x DVD-RW, 4x DVD-/+ DVD DL
Sound chip	Realtek	Realtek	Realtek	Realtek
Graphics type/memory	Intel GMA900/128MB shared system memory	Intel GMA900/128MB shared system memory	Intel GMA900/128MB shared system memory	Via/S3G Unichrome Pro IGP/64MB shared system memory
Screen size (maximum resolution)	17.1in (1,440 x 900)	15.1in (1,400 x 1,050)	15in (1,024 x 768)	15in (1,024 x 768)
OTHER INFORMATION				
Misc hardware/modem	Soft Data V.92 56K modem, 5-in-1 card reader	Motorola SM56 modem, 4-in-1 card reader, built-in video camera	56K V.92 modem, 3-in-1 card reader	Agere 56K V.92 modem
Wireless technology	802.11b/g, Bluetooth	802.11.a/b/g	802.11 a/b/g	802.11b/g
Weight excluding AC adapter (kg)	3.6	2.7	2.8	2.8
Dimensions (w x d x h) mm	402 x 286 x 38.2	333 x 276 x 33	334 x 276 x 36	326 x 277 x 36.7
Operating system	Windows XP Home SP2	Windows XP Home SP2	Windows XP Home SP2	Windows XP Home SP2
Bundled software	Acer Empowering Technology, Grid Vista, Launch Manager, Arcade 2.2, Norton Antivirus, Adobe Reader, Cyberlink Power DVD, NTI CD Maker, Microsoft Works	Virgin.net - Internet access with no 12-month contract	WinDVD 4, Nero Burning Rom OEM	Microsoft Works 8, Roxio Easy Media Creator 7, Bullguard Internet, PC Angel
Standard warranty	1yr International Traveller's warranty	3 yrs (1yr parts & labour, 2yrs labour only)	1yr RTB (parts & labour)	3yr parts & labour (2yrs on-site, 1yr RTB)
SCORES				
Features	★★★★★	★★★★☆	★★★★☆	★★★★☆
Performance	★★★★☆	★★★★☆	★★★★☆	★★★★☆
Value for money	★★★★☆	★★★★☆	★★★★☆	★★★★☆
OVERALL	★★★★☆	★★★★☆	★★★★☆	★★★★☆

RTB = return to base; C&R = collect and return



				
FUJITSU SIEMENS	HI-GRADE	HP	MESH	MV
Amilo M 6450G	Notino C5515-1700	Compaq nx6125 (EK157ET)	Pegasus 3070	Sirius+
£699	£699	£699	£699	£699
09068 633 416	020 8532 6100	0870 010 4320	0870 046 4747	0871 855 4668
www.fujitsu-siemens.co.uk	www.higrade.com	www.hp.com/uk	www.meshcomputers.com	www.go-mv.com
Intel Pentium M 735 (1.6GHz)	Intel Pentium M 735 (1.7GHz)	AMD Turion 64 ML-32 (1.8GHz)	AMD Turion 64 MT-40 (2.2GHz)	AMD Turion 64 MT-40 (2.2GHz)
Intel i915GM	Intel i915GM	ATI Radeon Xpress 200M	Via K8N800	Via K8N800
512MB PC-2 3200 DDR2	512MB PC2700 DDR333	512MB PC2700 DDR333	512MB PC3200 DDR400	512MB PC2700 DDR400
1/1	1/0	2/0	1/1	2/0
Samsung HM040HI	Hitachi HTS726060M9AT00	Toshiba MK6025GAS	Fujitsu MHV2060AH	Hitachi HTS424040M9AT00
80GB	60GB	60GB	60GB	40GB
Realtek RTL8139/10/100	Realtek RTL8139/10/100	Netextreme/10/100/1,000	Via Rhine II/10/100	Via Rhine II /10/100
1	0	1	0	0
0	1	1	1	1
1/0/0/0	1/0/1/0	1/0/0/0	0/0/0/0	0/0/0/0
3	2	3	4	4
D-Sub	D-Sub/S-video	D-Sub/S-video	D-Sub/S-video	D-Sub/S-video
Philips SDVD8431	Sony DW-Q58A	Matshita UJ-840D	Sony DW-Q58A	Sony CRX-835E
8x DVD, 8x DVD+R, 4x DVD-R, 2x DVD+RW/-RW	8x DVD, 8x DVD+/-R, 8x DVD+RW, 4x DVD-RW, 4x DVD-/+ DVD DL	8x DVD, 8x DVD+R, 4x DVD-R, 4x DVD+RW, 2x DVD-RW, 2.4x DVD+R DL	8x DVD, 8x DVD+/-R, 8x DVD+RW, 4x DVD-RW, 4x DVD-/+ DVD DL	8x DVD, 24x CD-RW, 24x CD-R
Realtek	Realtek	Realtek	Realtek	Realtek
Intel GMA900/192MB shared system memory	Intel GMA900/128MB shared system memory	ATI Radeon Xpress 200 (X300)/128MB	Via/S3G Unichrome Pro IGP/64MB shared system memory	Via/S3G Unichrome Pro IGP/64MB shared system memory
14.1in (1,280 x 768)	15.1in (1,024 x 768)	15in (1,024 x 768)	15in (1,024 x 768)	15in (1,024 x 768)
Motorola SM56 modem, 4-in-1 card reader	Agere 56K V.92 modem	Soft 56K V.90 soft modem, 6-in-1 card reader	Agere 56K V.92 modem	Agere 56K V.92 modem
802.11a/b/g	802.11a/b/g	802.11b/g, Bluetooth	802.11g	802.11a/g
2.4	2.9	2.8	2.8	2.8
332 x 233 x 35	326 x 258 x 32	310 x 328 x 267	325 x 280 x 30	326 x 277 x 36.7
Windows XP Home SP2	Windows XP Media Center Edition	Windows XP Professional SP2	Windows XP Home SP2	Windows XP Home SP2
Microsoft Works, WinDVD 5, Nero SmartSuite 6, Norton Internet Security (three-month trial)	Open Office	HP One-Touch Button Software, HP Wireless Assistant, Sonic Recordnow, Intervideo WinDVD, Norton Antivirus, Intervideo WinDVD Creator	Microsoft Works 8.5, Cyberlink Power DVD 5, Power2Go 4, Power Producer 3, Power Director 3, Mediashow SE, Power Cinema 4	Microsoft Works 8, Bullguard Firewall AV, Roxio Creator, 60-day trial of Office 2003
1yr C&R	1yr C&R	1yr RTB (parts & labour)	1yr C&R (parts & labour)	3yrs C&R (1yr parts & labour, 2yrs RTB labour only)
★★★★★	★★★★★	★★★★★	★★★★★	★★★★★
★★★★★	★★★★★	★★★★★	★★★★★	★★★★★
★★★★★	★★★★★	★★★★★	★★★★★	★★★★★
★★★★★	★★★★★	★★★★★	★★★★★	★★★★★

Vendors of group test products are only obliged to sell them at the prices quoted here (which include delivery and credit card surcharges) for the life of this PCW issue. They may also change components under certain circumstances.

Lab results

Our benchmark took their toll on some of these notebooks, particularly the 3D graphics tests, some of which need at least 128MB of video memory to run

Sysmark 2004 SE (overall)

Bigger is better

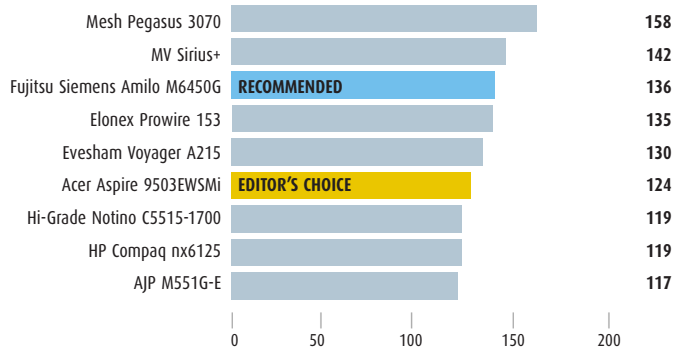

Sysmark 2004 SE Internet content creation

Bigger is better

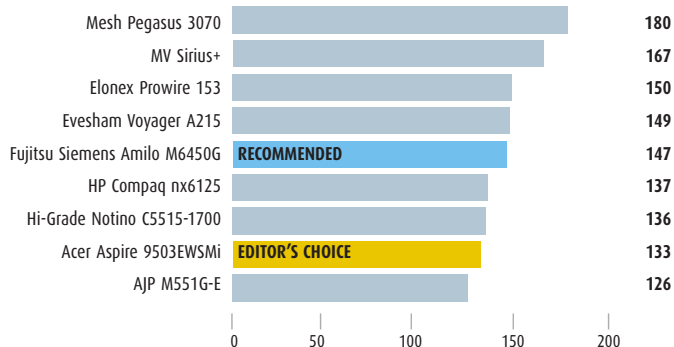

Sysmark 2004 SE office productivity

Bigger is better

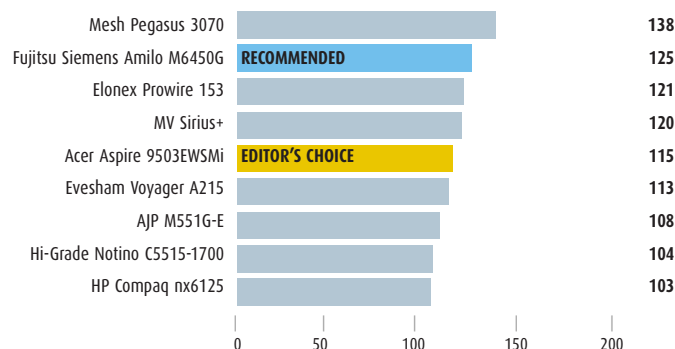

PCmark05 (overall)

Bigger is better

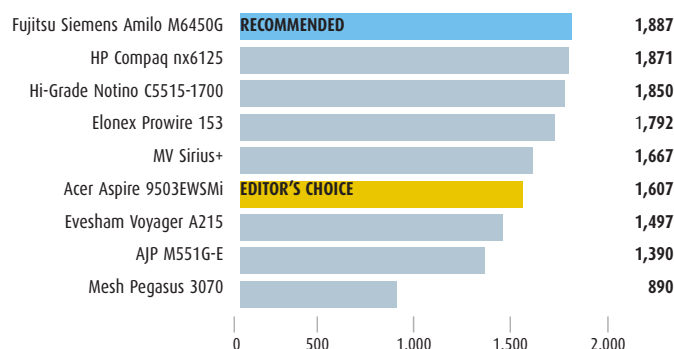

3Dmark05 (1,024 x 768 in 32bit colour)

Bigger is better

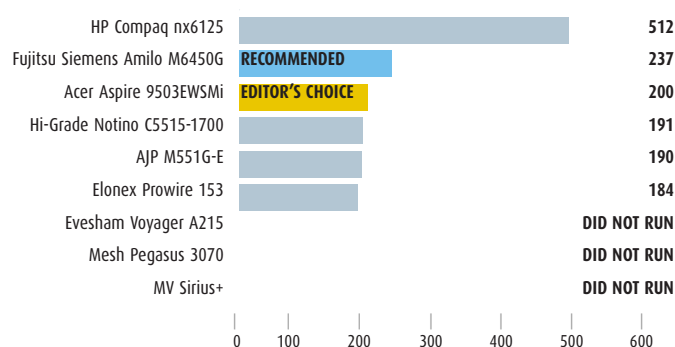

Far Cry (1,024 x 768 in 32bit colour)

Bigger is better

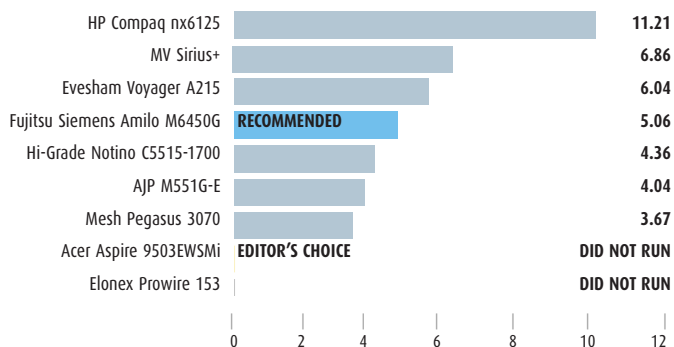

Mobilemark 2005 (DVD playback) (hours:minutes)

Bigger is better

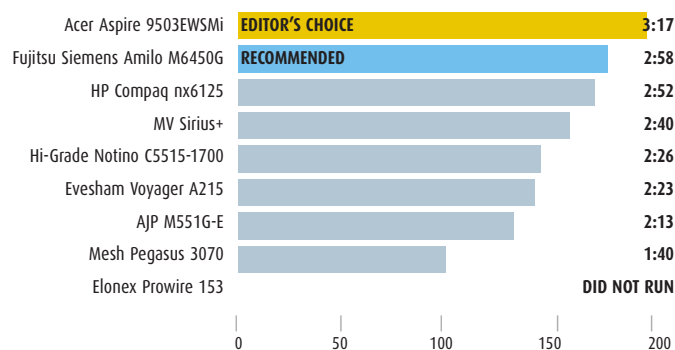

Cinebench (1 CPU)

Bigger is better

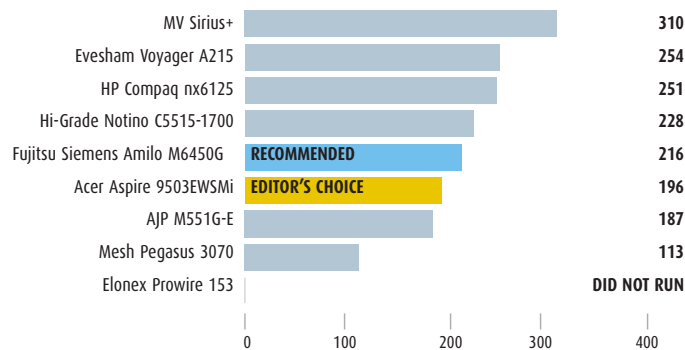

Go to www.reportlabs.com for full results. Please see page 104 for an explanation of how we tested the notebooks

The next level

The old adage 'you get what you pay for' is true for computer components. We've seen three types of processor in this mid-range laptop group test, which unsurprisingly includes budget options from Intel and AMD; the Celeron M and Turion 64 Mobile respectively.

AMD may boast quicker clock speeds with its mobile Turion 64, but don't forget that even the fastest model – the MT-40 – has just 1MB of Level 2 (L2) cache. And the ML-32, as featured in the HP Compaq, has just 512KB of L2 cache.

What raised our eyebrows, though, was the number of Pentium M processors on show; 40 per cent of the notebooks here featured a Pentium M. Even the lowest-rated Pentium M has at least 2MB of L2 cache and, as prices fall and power increases, the end may soon be nigh for Celeron M. In AMD's case, this may have already happened with the Mobile Sempron, which didn't appear at all in our review models.

Graphics have also taken a back seat. Judging by what we've seen inside these notebooks, 3D gaming has been compromised in favour of components that will offer versatility in Windows, such as a faster processor, Ram and DVD writer.

So how much more should we expect to pay for a notebook that can play games to an acceptable standard and include dedicated graphics from ATI or Nvidia, instead of Intel's integrated and underpowered 915GM Express chipset?

Our Labs gurus recommend that a notebook with a 3Dmark05 score of more than 3,000 will be good enough to play the latest games at a

decent frame rate, resolution and detail setting. A quick look on PCW's Test Bed (www.reportlabs.com/testbed) identified the Evesham Voyager C720 (pictured) as the fastest current gaming notebook. This uses a 256MB Nvidia Geforce Go 7800GTX and costs a whopping £1,348.99.

That may be £650 more than the cost of the notebooks in this group test, but for that you'll get a Pentium M 770 (2.13GHz) processor, 1GB of Ram and a 17in widescreen, capable of displaying resolutions up to 1,440 x 900. But is it really worth paying the price of nearly two of the notebooks featured here? Quite frankly, for most people, we don't think it is.



Getting decent gaming performance from a notebook will cost you much more than the laptops reviewed here

Editor's Choice

Editor's Choice Acer Aspire 9503EWSMi

Recommended Fujitsu Siemens Amilo M 6450G



Acer Aspire 9503EWSMi



Fujitsu Siemens Amilo M 6450G

So, with all the laptops tested and picked apart with a fine-tooth comb, it was obvious that a £699 notebook wasn't going to set the world alight. Manufacturers simply can't pack their laptops with the latest processors, graphics chipsets and construction materials at this price. Instead, compromises have to be made; but with the right balance, it seems companies can still offer some decent machines.

Those looking for a business solution will find a great product in the HP Compaq nx6125. It may

have achieved one of the lowest scores in Sysmark, but the amount of extra security features and bundled software make this a real value-for-money option. We would have liked the hard disk to be a little bigger, but the well-heeled road warrior should find it adequate. The Elonex Prowire 153 also deserves a mention. It's quite big and heavy, but has some good components, including one of the fastest processors in the group, 1GB of Ram and an 80GB hard disk.

We were quite surprised to find one of the participants – the Hi-Grade Notino C5515-1700

– using Windows Media Center Edition as its operating system. If Hi-Grade had offered a bigger hard disk and bundled a USB TV tuner, we would have scored it a lot higher.

Our Recommended award, however, goes to the Fujitsu Siemens Amilo M 6450G. It may have the smallest screen here, but the display is crisp and will operate at a maximum resolution of 1,280 x 768. It's one of the few notebooks to use Intel's Pentium M processor and is, by far, the lightest laptop here. With an 80GB hard disk, Express Card slot, dual-layer DVD-writer and a great design, it strikes a good balance between power and portability and style.

Although the Acer Aspire 9503EWSMi wasn't the fastest, we were pleasantly surprised to find a laptop of this size in the group test. The budget Celeron processor may put off speed freaks but the canny buyer with no unusually demanding hardware demands will spot a great bargain here. The WXGA screen has a 1,440 x 990 native resolution and the large chassis means you get the benefit of a full-size keyboard. And, as with most Acer notebooks, there's Acer's 'Empowering Technology' software to give you simple access via a dedicated hardware button to many of the system's more advanced features. In short, it's a well thought-out product with a great screen and good battery life, and thoroughly deserves our Editor's Choice award. **PCW**

How we test

Performance testing is an important part of PCW's reviewing process and to obtain our authoritative results we use the UK's best PC testing resource – VNU Labs. Here we explain why you can trust our results and give you a tour of our most frequently used benchmark programs.

One of the main reasons people upgrade their PCs is because their old model seems 'too slow'. But how do you tell whether the one you're going to replace it with is any faster? At PCW we take PC testing very seriously and we have the UK's best PC testing labs – VNU Labs – on tap to help us give you reliable, authoritative performance figures, to help you with your purchasing decisions.

It's true that speed isn't everything, but it's an important part of the buying equation, especially when there are so many components out there. As many of our PC group tests are based on price bands, checking the performance is even more important – if the core system is underperforming, you need to know before you part with your hard-earned cash.

In VNU's UK Labs, which is part of the European VNU Labs network, our staff have over 20 years of combined testing experience. We know all the perils and pitfalls of practical benchmarking and we contribute to the development of industry-standard benchmarks through our full membership of Bapco (www.bapco.com), the non-profit benchmark consortium. We are also a media member of the Futuremark Benchmark Development Program (www.futuremark.com). Listed below are the main benchmarks we use for testing PC systems and components.

- Bapco Sysmark 2004 SE – an application-based benchmark that tests real-world system performance.
- Futuremark 3Dmark03 – a 3D graphics benchmark designed to test the performance of DirectX 8 graphics cards.
- Futuremark 3Dmark05 – the latest version of 3Dmark that tests DirectX 9 3D graphics performance.
- Ubisoft Far Cry – we use the Fort level timedemo to see how graphics cards perform in a real DirectX 9 game.
- Futuremark PCmark05 – a synthetic benchmark used to test the performance of a PC's major subsystems.
- Bapco Mobilemark 2005 – used to assess the battery life of notebooks using real-world applications and usage scenarios.
- Test beds – we use standardised AMD and Intel-based test rigs to test components and peripherals.

There's more information about our testing procedures and benchmarks on our Labs site at www.reportlabs.com/testbed/bguides/benchmarks.php.

Performance

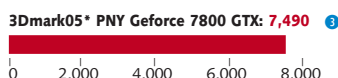
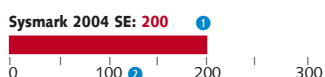

* tested at 1,024x768 in 32bit colour

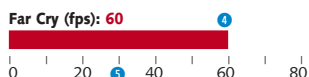

- 1 A score of 200 indicates that the system is twice as fast as the reference PC
- 2 The reference PC (2GHz P4 512MB of Ram) scores 100
- 3 A Geforce 7800 GTX would score in the region of 7,490
- 4 A score of 60fps (frames per second) or higher is most desirable
- 5 A result of 30fps or above means the machine can produce playable frame rates at the tested resolution



3Dmark03 is used to test DirectX 7/8 graphics cards

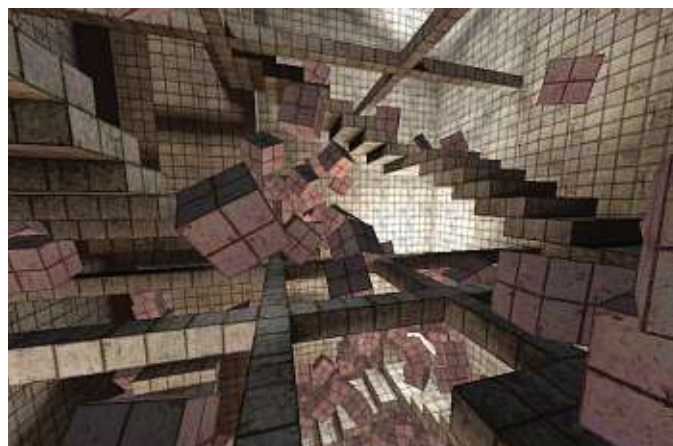

PCmark05 measures memory, processor, graphics and hard drive performance



3Dmark05 pushes modern graphics cards to their limits

CD-ROM 6 OUT NOW!

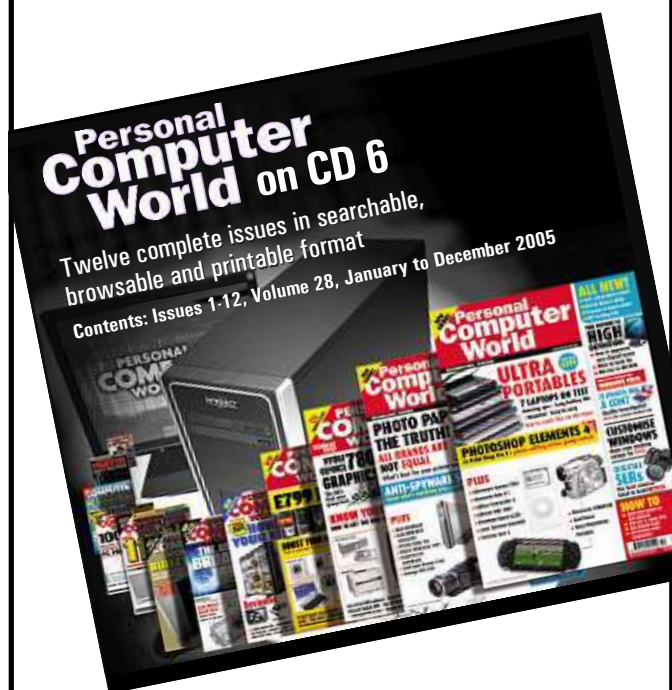

Enjoy all 2005's issues of PCW in a format that is

- ✓ Searchable
- ✓ Browsable
- ✓ Printable

To order call
0870 830 4973

Or visit
www.direct-pcw.co.uk

Technology for Winners



What do Porsche and BitDefender have in common?

- Highest possible degree of **security**.
- Easy **handling**.
- Extremely good **reaction time**.
- Clear and functional **structure**.
- Award winning **engine**.
- Excellent **performance**.
- Value for **money**.

Reaction time of antivirus solution manufacturer after the outbreak of the internet worm Blackworm

QuickHeal	16. 01. 2006	09:00	I-Worm.Generic.0875
BitDefender	16. 01. 2006	11:13	Win32.Worm.P2P.ABM
Kaspersky	16. 01. 2006	11:44	Email-Worm.Win32.VB.bi
AntiVir	16. 01. 2006	13:52	TRIKI/AV.GR
F-Secure	16. 01. 2006	15:03	Email-Worm.Win32.VB.bi
AVG	16. 01. 2006	16:05	Worm/Generic.FX
Sophos	16. 01. 2006	16:25	W32/Nyxem-D
Trend Micro	17. 01. 2006	03:16	WORM GREW.A
Norman	17. 01. 2006	07:49	W32/Small.KI
Avast!	17. 01. 2006	15:31	Win32.VB-CD (Wrm)
eTrust-INO	17. 01. 2006	16:52	Win32/Cabinet.Worm
Symantec	17. 01. 2006	17:03	W32.Blackmal.E@mm

Source: www.pcmag.com

For product requests or orders please contact our partners in the online partner-locator:
www.bitdefender.co.uk



infosecurity
EUROPE

25-27 April 2006
London, United Kingdom
www.infosec.co.uk

Booth 624

bitdefender
secure your every bit

Will your PC run Vista?



The first question PC users ask when a new version of Windows is launched is 'Do I need to get new hardware?' To help you prepare for Vista's arrival, Klaus Langer explains the demands the new operating system will make on your hardware

Rumours that hardware requirements will be excessive for Microsoft's new Vista operating system have swept through websites and blogs, causing alarm among PC users. Figures such as a minimum spec being a 4GHz dual-core processor, 2GB of Ram and a 1TB hard disk abounded.

But there's really no need to panic. The new operating system will run even if you don't have a dual-core CPU and high-end graphics card. Practically all new computers are quite capable of running Vista. However, unlike earlier versions of Windows, the new operating system can scale with the hardware's capabilities. For example, if you have a high-performance 3D graphics card

you will be offered more advanced graphical interface features than if you're running Vista on a laptop with an older integrated graphics adapter.

Direct3D for the desktop

Many Windows users look enviously at the transparency and transition effects in Apple's Mac OS X. You can get effects like these under Windows XP, but only by using special add-on programs such as Windows Blinds or WindowFX from Stardock (www.stardock.com). However, these effects have nowhere near the same fluid and elegant visual impact as those on the Mac.

Windows Vista is supposed to change this with its vector-based graphics engine,

Specs to optimise performance

The majority of PCs made in the past two or three years are powerful enough to run Windows Vista, but just being able to run it doesn't guarantee that it will be an enjoyable experience. For the best performance, particularly in the graphics area, your computer should meet the following requirements.

PROCESSOR: Any current mid-range AMD or Intel CPU will do for Vista. Dual-core processors are better because, when running under Vista, Superfetch and Indexing services run in the background all the



time. Vista will have many more 64bit drivers than the current 64bit edition of Windows XP Professional.

CHIPSET: If your motherboard has graphics integrated into its chipset, only boards based on the Intel 945G, ATI Radeon Xpress 200 or Nforce 410/430 chipsets will support the Aero Glass graphics



interface. The main requirements are 64MB of dedicated graphics memory and the use of dual-channel memory.

MEMORY: 512MB of Ram is enough for Vista, but 1GB or even 2GB is better as this will allow the operating system to use more memory for the Superfetch feature.

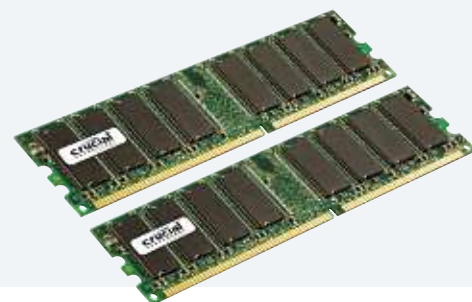



codenamed Aero. It takes care of translucent frames and shadow effects around windows, and animated transitions when minimising or maximising windows (see screen 1); it even has a 3D-effect clock speed adjuster. There

'Practically all new computers are quite capable of running Vista'

are two flavours of Aero: Aero Glass is the fully featured interface with all transparency effects, while Aero Express has a similar theme but doesn't use the demanding 3D effects and is designed for use on older

systems. To make use of Aero Glass, your graphics card must support DirectX 9 and the Windows Display Driver Model (WDDM), and it should have at least 64MB of memory. If these requirements are not met, Vista will use Aero Express. You'll also be able to use the 'Classic' Windows 2000 theme if you really want to. You can find more information about the Vista graphics system on page 110.

Benchmarking built in

To enable Windows Vista to adjust itself to the hardware in the computer, the developers have integrated a sort of benchmarking tool, the Windows System Assessment Tool (Winsat). This program is

run automatically during Vista installation and every time hardware is added or changed. Vista uses the information to work out whether the PC's graphics card is up to running the Aero Glass interface, what the PC's 3D capabilities are and whether HD (high-definition) videos will play smoothly. The resulting data, which includes information about the processor, Ram and hard-disk performance, is stored in an XML file and is available to other applications. So a game could read the data obtained by Winsat and set the numbers of AI (artificial intelligence) opponents or the level of graphics detail accordingly.

Further diagnostic functions are supposed, above all, to increase stability. For example,



GRAPHICS CARD: Aero Glass needs DirectX 9 compatible cards with at least 64MB of memory. For higher resolutions the card should have 256MB of memory or more. HD (high-definition) videos can only be played back on systems with a graphics card that has HDCP-capable DVI or HDMI connectors.

HARD DISK: In principle, Vista can be installed on any hard disk larger than 10GB (Vista itself occupies 6GB). Microsoft recommends, for best performance with several applications in a multitasking environment, Serial ATA (Sata) disks



with at least an 8MB buffer and support for Native Command Queuing.

OPTICAL DRIVES: As Vista is only supplied on DVD, a DVD-Rom drive is a requirement for all PCs where installation won't be carried out via a network. The burning function in Vista now supports most common DVD formats.



The Aero interface sparkles with transparency, animated transition effects when maximising and minimising windows and a preview in the taskbar

defective regions on memory modules can be recognised and excluded from use, to avoid system crashes. Vista is also reputed to be able to detect imminent failures on hard drives, a feature that obviously uses the industry-standard Smart (Self-Monitoring, Analysis and Reporting Technology) information built in to most hard drives. Under Windows XP, you need third-party software to do this.

Changes to the Windows core

There are few changes in Vista's processor support. The main new feature is that all variants of Vista except the Starter Edition (see page box, right) will be available in 64bit versions. There are improvements in power management: a new standby mode combines Suspend to Disk and Suspend to Ram, to make resumes much quicker. Superfetch technology uses improved memory management to start frequently used applications more quickly. Windows XP device drivers will only be of very limited use under Vista. The reason for this is that the new driver model moves substantial parts of the drivers from the kernel to User Mode, which is supposed to deliver more stability. You can read more about the improvements in the Windows Vista kernel on the next page.

Mini-computer in a notebook lid

For notebooks, Vista will support a completely new class of device, known as Auxiliary Displays. These are effectively mini-computers with their own small display integrated into a notebook lid. They can also be used to interactively display information when the notebook is turned off. There's more about this on page 111. Current notebooks will also benefit from

The six Vistas

As we went to press, Microsoft announced that there will be no fewer than six versions of Vista released at the same time. Targeting low-end home users will be the very limited Home Basic version for basic home computing needs, the Home Premium version, which adds the Aero interface and tablet PC capabilities and the Ultimate version. This version will incorporate all the capabilities of the Home Premium and Business versions. For 'emerging markets' there will be a stripped-down Starter version.

For business customers, there will be a Business and an Enterprise version of Vista. All versions of Vista will be available in 32 and 64bit flavours.

There won't be a separate Media Center Edition (MCE) of Vista, according to Microsoft. Instead, the functions of the Media Center software will be incorporated in the Home Premium and Ultimate versions.

Vista, as Microsoft has refined the power-management features and made them easier to use than those in Windows XP.

Support for HD DVDs

New features for multimedia PCs include making a reworked version of the Media Center software an integral part of most Vista versions for home use. Microsoft is also working on a module to allow reception of subscription TV services; and Vista will support the new high-resolution HD-DVD format. A wide-reaching system for Digital Rights Management (DRM) when playing videos or audio files is under development too, but this technology is not likely to be popular with many users.

Is the change to Vista worth it?

Spectacular graphics are only one aspect of Microsoft's new operating system. Even if your computer's graphics card isn't powerful enough to support the new visual effects, the change is worth considering. The new driver architecture makes Vista more stable than XP and provides more functions for notebooks and Media Center PCs. In addition, it's more secure than any previous version of Windows, as large parts of the program code have been written from scratch, taking into account potential exploits such as buffer over-runs.

It's easier to use Vista without running as an Administrator than it was under Windows 2000 and XP. If you start Internet Explorer 7 under Vista, it defaults to using drastically reduced access rights for more secure surfing.



The advanced search functions and virtual folders make working with files much easier.

THE HEART OF VISTA

Not as obvious as Vista's chic graphics, but nonetheless important, are the changes in the way Vista interacts with the computer's system components.

Vista is based on the NT kernel, now at version 6. This means there's not much change to the interface between the operating system and the processor. However, in comparison with XP, support for 64bit processors is much better; apart from the cut-down Starter Edition, all versions will be available with 64bit CPU support. This practically forces hardware manufacturers to make 64bit drivers available for all current peripheral devices.

To make use of the virtualisation hardware in the new Intel and AMD processors, Microsoft has come up with the Hypervisor. However, this won't arrive until Vista Server is released in 2007.

Vista and EFI

Vista is the first consumer desktop operating system from Microsoft that fully supports the replacement for the Bios: the Extensible Firmware Interface (EFI). As EFI no longer switches the processor to Real Mode, motherboards using the Bios replacement can boot faster. In addition, hard disk partitions can, in theory, be up to 18 Exabytes in size, with up to 128 primary partitions per hard disk. Pre-boot applications replace the customary Dos system tools. These could include diagnostic tools, partitioning programs or software for auto-installing a hard disk image.

The first motherboards with EFI support will be on the market soon. You can find



SCREEN 2

Above: Audio drivers allow you to set separate volume levels for every application that uses sound

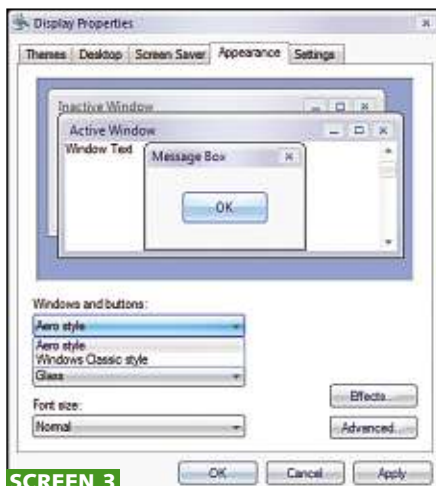

SCREEN 3

Left: Without DX9 graphics, the desktop looks very similar to that in Windows XP

more detailed information on EFI in the feature on page 114.

A clever cache

Windows XP makes use of Prefetch to keep frequently required program code ready for use in memory, so the corresponding programs can start more quickly. For Vista, Microsoft's programmers have extended and refined this mechanism. Unlike Prefetch, Vista's Superfetch does not just load the 'usual suspects' when it comes to frequently required programming code; it also makes a step-by-step analysis of program use, thus learning the applications you use most often and what to store in its cache.

More stable drivers

Windows XP moved parts of the drivers for USB devices and printers from the kernel into the user space. This prevents system crashes if the drivers are faulty. Microsoft Vista extends this technique to graphics card and audio hardware drivers. In Windows NT4, Microsoft integrated the graphics drivers into the kernel in order to get better performance, but at the expense of lower stability. Vista's Windows Display Driver Model (WDDM) represents a partial reversal of this step, as it drastically reduces the proportion of the code that is running in the kernel. This not only makes the whole system more stable, ↘

Vista and the TPM

TPM stands for Trusted Platform Module, and describes a small chip that is currently a source of heated discussion. Many users fear they will only be allowed to use certified applications. The chip is one of the central elements in Vista's planned Next Generation Secure Computing Base (NGSCB). It creates protected areas in the system for working with sensitive data, makes encrypted storage possible, and allows content to be digitally signed. Currently, TPM is only used to encrypt the system partition and check the system status (Secure Startup). A TPM is not a requirement for using Vista, nor is it used in DRM for audio or video files.



Hot topic: the TPM chip makes it possible to digitally sign content



The task switcher Flip3D shows window previews with a 3D effect

but also allows a new graphics driver to be installed without a reboot.

Individual volume controls

The audio subsystem also runs largely in user mode and can no longer impact negatively on kernel performance. One new feature is that you can now set the volume level individually for each application (see screen 2). The majority of USB or Firewire audio devices no longer need drivers from the manufacturer, but can use Vista's own drivers.

With Vista, unlike Windows XP, users without administrator rights can install device drivers, as long as the administrator has given them the necessary rights and the drivers are digitally signed.

GRAPHICS EFFECTS

Until now, even with powerful graphics cards and 2D applications, Windows has

seemed a bit dull in terms of its graphics. With Vista, that's about to change: DirectX 9 cards will deliver cool graphical effects.

Many users are expecting a futuristic 3D desktop from Microsoft's new Aero graphics system, because the full implementation of Aero (Aero Glass) requires a DirectX 9 graphics chip.

In reality, Vista just uses the graphics system's 3D functions to generate 2D graphics (see figure 1). The advantage of this is that the strain is taken off the CPU, and the graphics chip's power is used rather than being idle as it is at present. For example, under Windows XP, a dual-display setup with a resolution of 1,600 x 1,200 requires just 7.4MB of memory on the graphics card. As modern graphics cards have a large amount of memory for storing textures – at least 128MB is normal these days – this remains mostly unused with 2D applications under XP.

Work for the graphics card

Microsoft has finally moved away from the ancient Graphical Device Interface (GDI and GDI+) used in its existing operating systems, to a desktop compositing engine, the Desktop Window Manager, that is based on DirectX. A GDI compatibility layer is built into the new engine, though, to allow older applications to run. It's worth noting that Vista uses the graphics memory as an off-screen buffer, so elements of the user interface are built up in the background and only put on the screen as they are required. Using this technique, the operating system can move complex windows over the screen without any jerkiness.

A further advantage is that the graphics card looks after the scaling and transformation of windows or other user interface elements. Therefore the processor does not have to be concerned about optical effects such as the transition when



Vista graphics architecture

FIG 1

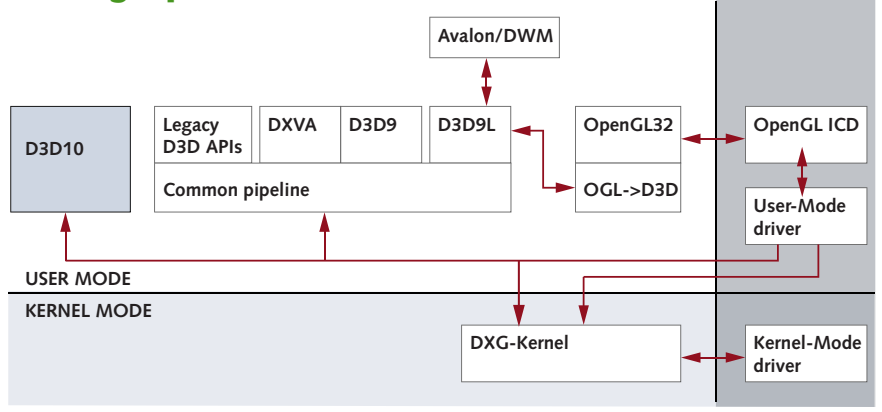

KEY: D3D10 = Direct 3D 10; D3D = Direct 3D; DXVA = DirectX Video Acceleration; OGL = OpenGL; DWM = Desktop Window Manager; DXG = DirectX Graphics

maximising or minimising windows, moving previews in the Windows Taskbar or 3D previews in the task switcher replacement known as Flip3D (see screen 4). Applications such as 3D games can no longer take over control of the graphics chip under Vista. They only get control over the display from the Desktop Window Manager, which is responsible for drawing the windows. The advantage of this is that the screen redraw is more fluid when switching between a game and the desktop than under Windows XP.

At least 256MB of memory

The technical foundation for the Aero Glass graphics are the WDDM and the overlying Desktop Window Manager. The WDDM

'Many users are expecting a futuristic 3D desktop from the graphics system'

uses the graphics chip in a similar way to the processor by generating a virtual address space for the graphics hardware and allocating processing time on the graphics chip to each application. Vista uses virtual graphics memory consisting of the memory on the card and areas of main system memory. For optimal performance the memory on the graphics card should be at least 256MB. Vista is able to take full advantage of PCI Express graphics cards as data transfer can take place in full duplex mode at 3.73Gbytes/sec. AGP, on the other hand, is limited to 1.99Gbytes/sec and cannot transport data in both directions simultaneously.

A completely new 3D API

Until now, Windows game developers have had the choice of two 3D application programming interfaces (APIs): DirectX and OpenGL.

OpenGL will remain in Vista. As previously, full support for OpenGL requires installable client drivers supplied by the graphics chip manufacturer. If required, you can use XP drivers, but for best performance you will need WDDM drivers. Vista will have two DirectX versions installed simultaneously. Existing games make use of DirectX 9, which is also used by games written for older versions of DirectX.

In addition to this, Vista will have a completely new version of DirectX, which is not backwards compatible: DirectX 10 (now officially known as Windows Graphics Foundation 2) will only run on Vista. New in DirectX 10 is Shader version 4, which adds the geometry shader to the existing vertex

and pixel shaders. These are programs written in special high-level languages that can be used to directly program the geometry and rendering parts of the graphics chip. For DirectX 10, you will need a new type of graphics chip, because of the new shader model. At the time of writing, graphics manufacturers had not officially announced when these new chips will be available.

VISTA ON NOTEBOOKS

2006 will probably be the first year when more notebooks are sold than desktop PCs, which is a good reason for Microsoft to make sure Vista is fully prepared for life on the road.

Windows XP already works pretty well when used with notebooks. It supports power-saving modes and ACPI (Advanced Configuration and Power Interface) functions such as Suspend to Ram. Vista builds on this, and introduces a power-saving mode, Hybrid Sleep, which combines the speed of Suspend to Ram with the security and power saving of Suspend to Disk (hibernate). If you

Top: The Asus notebook's auxiliary display is controlled using cursor keys

Bottom: Asus displayed a prototype notebook with an auxiliary display in the lid, at the Microsoft Winhec 2005 hardware developers' conference



ACPI support only

Vista means the end of the line for old notebooks without ACPI (Advanced Configuration and Power Interface) support. Windows Vista no longer supports the old, outdated APM (Advanced Power Management).

Microsoft has also disposed of the burden of supporting older notebook processors: the energy-saving function drivers for the AMD K6-2 and the mobile Pentium III are no longer included. Notebooks using these processors would not really be suitable for Vista anyway.

send your notebook to sleep, the contents of Ram are saved to the hard disk before the drive and processor turn off. The Ram is, however, still supplied with power, and when the notebook is woken it is ready for instant use – with all the programs that were loaded when it went to sleep. And if you want to remove the battery while the computer is asleep, a backup copy of the Ram contents is loaded from the hard disk.

Microsoft has made some changes to the power-management system. A new power manager in the kernel now controls the energy-saving functions. For example, if the battery level is low, the notebook can switch automatically from the power-hungry Aero graphics mode to a simpler display mode that uses less power.

Mobility Center

Under Windows XP, the various notebook-related settings are strewn between different control panel applets or left to the manufacturers' own utility programs.

Obviously this is inconvenient for users and, in Vista, the frequently used items have been brought together in the Mobility Center: power-saving settings, battery charge level indicator, settings for the TFT display and external monitors, wireless networks and synchronisation with other devices.

Extra displays in the lid

Auxiliary displays are a particularly interesting innovation. At the Winhec 2005 developers' conference, Microsoft showed an Asus Notebook with an auxiliary display in the lid (see picture, left). This was not just an additional mini-display but also a small standalone computer, communicating with Vista via an internal USB connection. If the notebook is running you can, for example, control the Media Player via the auxiliary display or read incoming emails in Outlook. If the notebook is

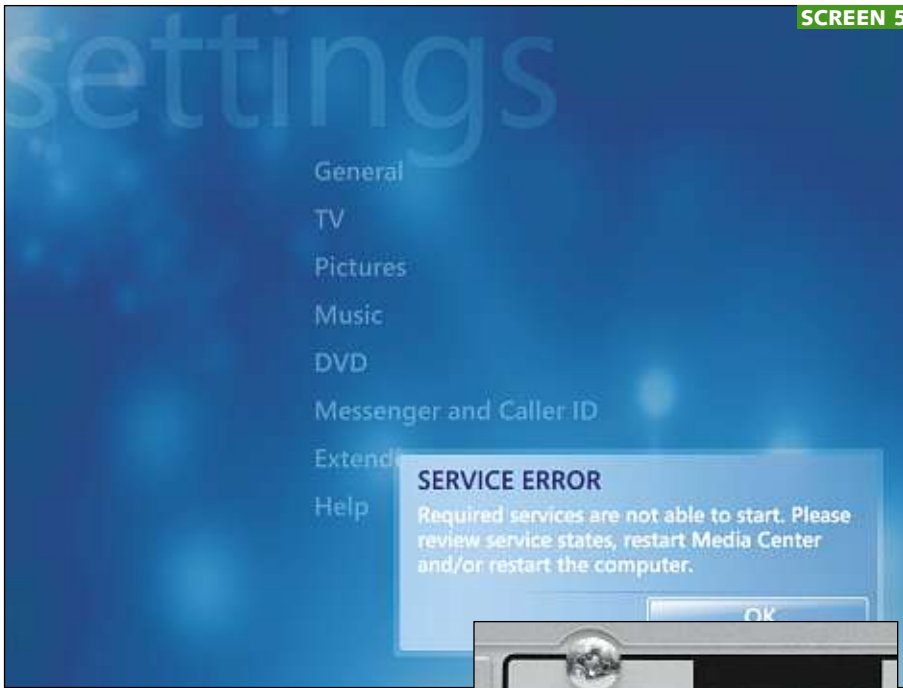

SCREEN 5

Top and right: Vista supports HD videos, but you need to have DVI and HDMI interfaces with HDCP enabled, otherwise Vista will not play the content



The display is controlled by cursor keys, and you can install extra mini-applications called Gadgets.

Auxiliary displays everywhere

Notebooks are not the only devices that could use auxiliary displays; they could be installed in Media Center PCs or even keyboards. As well as small LCD screens, small LCD panels could be used to display just a line or two of text on the front panel of a notebook.

In principle, as an alternative to a fixed, embedded device, a smartphone or PDA with the matching software could act as an auxiliary display, using Bluetooth rather than USB to communicate with the notebook.

Support for Tablet PCs

Microsoft is not planning a special edition of Vista for the business-oriented Tablet PCs. Instead of this, Tablet PC support with handwriting recognition and Tablet applications is built into all business-oriented Pro Editions. Vista Home Premium will probably also feature Tablet PC support. Vista's handwriting recognition no longer just relies on the samples in its database, but will also learn the user's writing. This means that you can specifically train it to recognise letters or words which are persistently misrecognised. It's also possible to teach it whole sentences. As input devices, Vista supports not only pen-controlled digitisers, but also classic touchscreens.

switched off, the extra display can show information such as the battery charge level. In addition, when the notebook is running, some data, such as calendar entries, emails, navigation or weather information can be copied over and remain available when the computer is turned off.

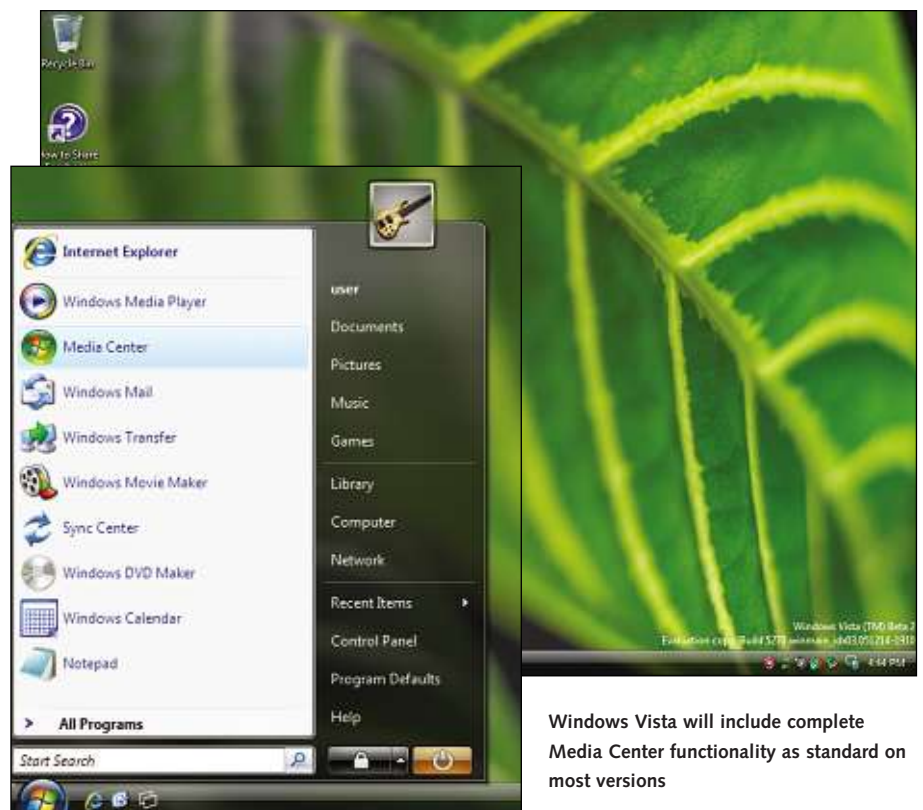

Windows Vista will include complete Media Center functionality as standard on most versions

MULTIMEDIA IN CHAINS?

According to some, copy protection and DRM infringe civil liberties, whereas others believe they're a nuisance but a necessary way of protecting intellectual property. So what's the score with Vista?

If you talk to people about Vista, the theme of copy protection will come up sooner or later. Speculation includes the claim that Vista won't allow unlicensed music or video files to be played back.

These fears are not entirely unfounded. Vista has a whole set of functions for DRM. It will play mp3 files or backup copies of video DVDs without complaining, just like previous versions of Windows, as there is no DRM information present in files of that sort. Consequently, Vista's copy protection can't kick in. It's a different matter with the new generation of digital videos and music files. The major movie studios and recording companies have simply said that without copy protection there will be no high-resolution movies or CD-quality music. As a result, Microsoft has extended and improved upon the existing DRM in Windows XP. The software giant has used this to open up the possibility of co-operation with the entertainment industry. There are two very important copy-protection mechanisms: PVP-OPM (Protected Video Path – Output Protection Management) for movies (see figure 2 and <http://tinyurl.com/9ksv4> for more information), and Puma (Protected User Mode Audio) for music.

'If you talk to people about Vista, copy protection will come up sooner or later'

Copy protection for HD movies

In order to prevent the copying of movies, PVP-OPM intervenes at two points. First, it creates a secure processing environment and authenticates the hardware. This prevents, for example, users copying a movie to the hard disk or reading it directly from Ram. Second, the mechanism controls any TV interfaces as well as the computer's DVI (Digital Video Interface) and VGA outputs, putting a barrier in the way of making high-quality 1:1 copies.

Hardware authentication is carried out in several stages: the graphics driver checks whether the card has been modified, and that it is allowed to output the content. Then the operating system checks whether the original graphics driver is being used. The Input Trust Authority (ITA) module on the video DVD checks whether the operating system has a copy-protection mechanism.

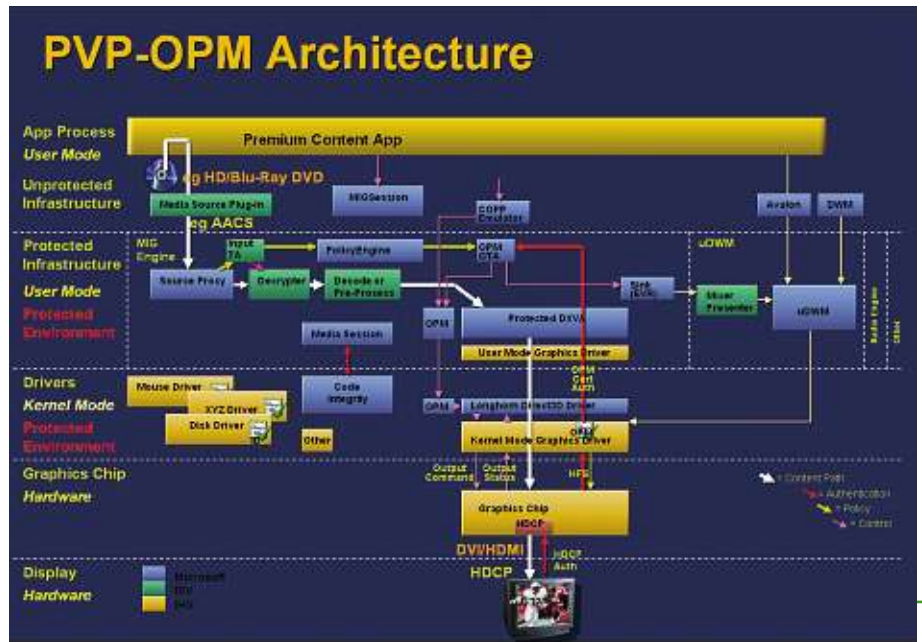

Only when all the links in the chain are complete will the computer play the movie. If a modification is detected, PVP-OPM will stop playback.

New graphics cards required

To play back DRM-protected high-definition (HD) movies, you will need to have suitable graphics cards and displays. Without them, PVP-OPM will make sure that you see, at best, a degraded resolution version. To get the best quality, the graphics card and monitor need to have DVI or HDMI (High-Definition Multimedia Interface) connectors, as they are the only types capable of handling data encrypted using HDCP (High Bandwidth Digital Content Protection) (see screen 5). Tough luck if you try to get round the copy protection by switching to analogue outputs – Vista's copy protection also covers outputs such as Scart, TV-out and S-video.

While monitors and TVs with the HD-Ready logo already support HDCP, the choice of graphic cards is currently zero; even though some graphics chips claim to 'support' HDCP, none of the cards on sale with these chips have the necessary HDCP licence keys built in, and it's not possible to retroactively add these keys. HDCP-enabled cards are slated for launch during the course of the year.

Puma shows its claws

The audio DRM system works in a similar way to PVP-OPM: Puma stops any alteration or modification of those program components that are responsible for playback. In some circumstances, digital audio outputs without copy protection might even be turned off. Directives embedded in the music files lay down what you may or may not do with the content. **PCW**

KEY:

- MIG = Media Interoperability Gateway
- HDCP = High Bandwidth Digital Content Protection
- EVR = Enhanced Video Renderer
- AACS = Advanced Access Content System
- DVI = Digital Video Interface
- DWM = Desktop Window Manager
- TA = Trust Authority
- PVP = Protected Video Path



Goodbye Bios, hello EFI

One of the last relics of the early PC era has finally bitten the dust, to be replaced by the faster, more versatile Extensible Firmware Interface. Klaus Langer investigates the technology and explains its advantages for users and developers alike

The traditional Bios is no longer capable of keeping up with the requirements of today's computers, so Intel has developed a faster, more versatile successor that is easier for developers to program. For users, the advantages of this new technology, the EFI (Extensible Firmware Interface), are that their PC will boot faster, and system tools, which previously had to be run from a Dos boot disk, are already built in. In addition, EFI settings can be changed via a user-friendly graphical interface.

It's certainly time for something new, as the Bios is a legacy relic in the PC ecosystem, a remnant from its creation. Since 1982 it has served as the PC boot loader and functioned as the interface

between the hardware and software. The problem with the Bios is that it is still, in principle, geared to the requirements of MS-Dos. Even the latest 64bit dual-core processors run in 16bit 'real mode' when the computer starts, emulating the 1978 Intel 8086 processor. Memory above 1MB is still not addressable at boot time. Expansion cards or onboard devices that need to be accessible during booting still have to have an option Rom (read-only memory), which can be no bigger than 128KB.

Bios programming still uses the assembly language. This enables faster and more compact code to be generated, but the programming is time consuming and complicated. New functions have been added to the Bios in recent years, but the

downside is that the Bios construction has been made more and more complicated and error-prone – as evidenced by the regular Bios updates that appear on motherboard manufacturers' websites.

Modular and compatible

As long ago as 1999, Intel produced the first version of the EFI specification, intended at that time for computers using the Intel Itanium 64bit (but non-x86-compatible) server processor, originally codenamed Merced. Later it was also implemented for x86 and Xscale-based computers, so the same firmware interface could be used on all Intel platforms.

Its far-reaching platform independence means EFI is constructed in a more modular fashion than a conventional Bios. The lowest

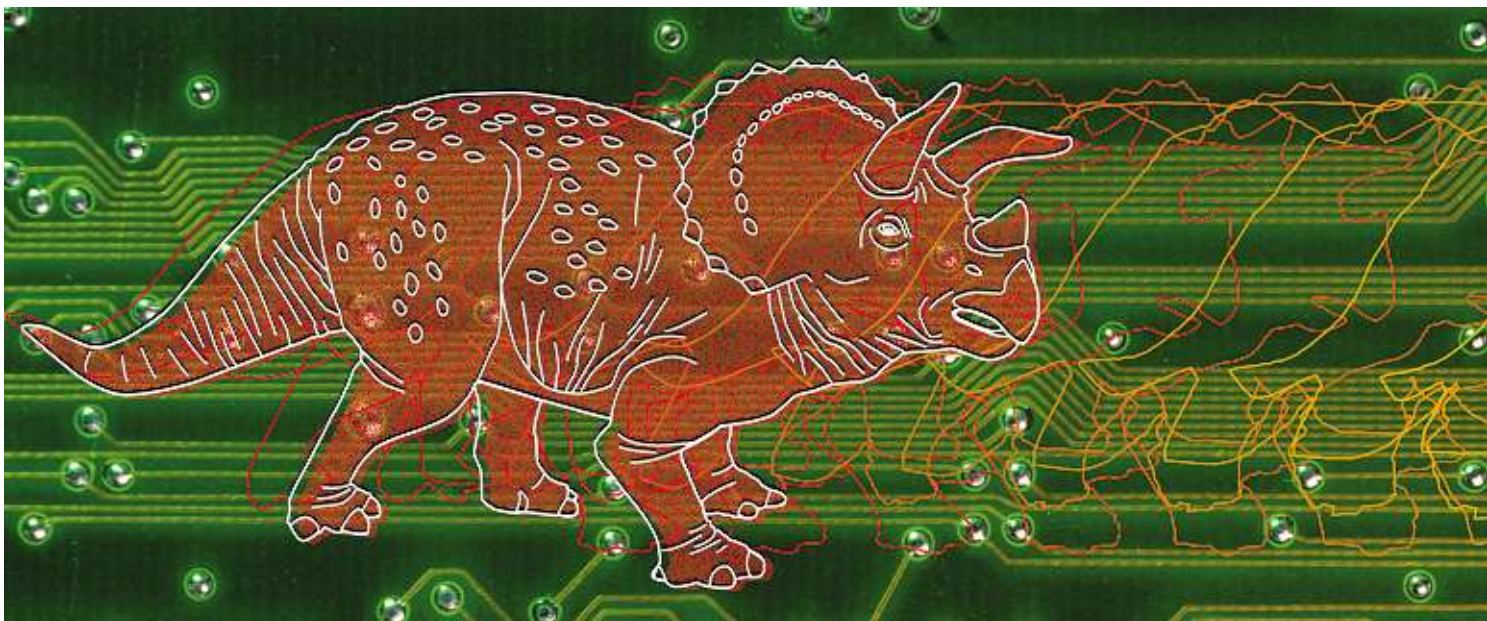

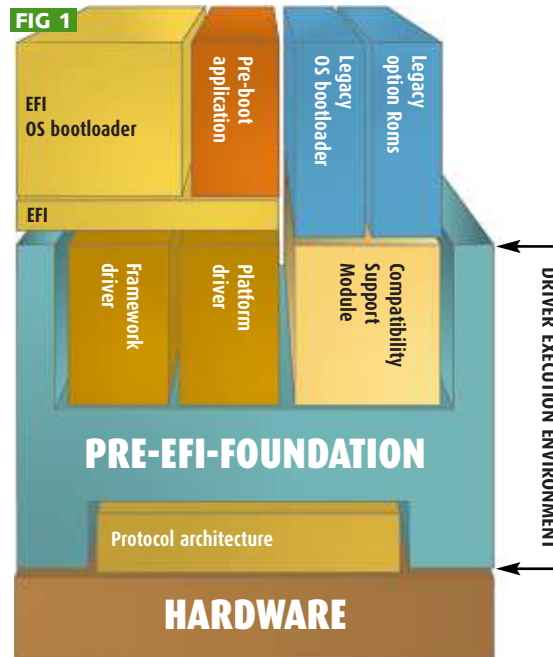

FIG 1

The structure of the Intel EFI Framework resembles that of an operating system. At the bottom is the hardware and above that is the Driver Execution Layer, which consists of the architecture protocols, the drivers and the compatibility module for non-EFI-compliant operating systems. The EFI layer incorporates the boot loader for operating systems and special pre-boot programs such as system tools

layer forms a rudimentary platform firmware that loads the EFI image (see figure 1). You can also use hard disks, CD-Roms or network drives as storage media. Above this is the Driver Execution Environment, which consists of the hardware-independent Pre-EFI-Foundation with framework and platform drivers as well as the x86-specific Compatibility Support Module (CSM). It will continue to support operations in 16bit real mode and be able to access expansion devices' option Roms. You'll still be able to use operating systems and hardware components that are not specifically designed for EFI.

The EFI OS loader can either load the operating system or open a setup screen. EFI supports screen output in text mode and via a graphical user interface (GUI). Screen output

is not limited, unlike Bios output, to a VGA resolution of 640 x 480, but can also use higher screen resolutions. The GUI replaces the Bios setup screen and lets you choose which operating system to start (in a multi-boot system) or can launch so-called Pre-boot Applications, such as diagnostic or security software. Previous EFI implementations from Insyde, Phoenix and AMI, are more like a Windows application in appearance and use than a classical Bios setup screen (see screen 1). In principle, you can work with an EFI interface from a remote computer, as well as control it from a web interface.

When the operating system is up and running, the Advanced Configuration and Power Interface (ACPI) remains the mechanism for the EFI to communicate with

the operating system in order to recognise hardware, configure devices and control power management.

Drivers and applications for EFI

In principle, EFI works like a miniature operating system. However, it is in no way a replacement for a complete OS such as Windows or Linux, as EFI does not support multitasking or multithreading. To address devices such as the graphics card, the chipset or hard disk controller, the EFI loads its own drivers in the form of compressed binary files. The file system for the EFI Firmware Volumes is specified in the Fat32 standard. The platform drivers communicate with the hardware via a set of architecture protocols and therefore work without being specifically tied to certain processors, chips or motherboards.

Preboot Execution Environment technology (PXE), which is already in use for remote maintenance, is an integral part of the EFI architecture. This allows you, for example, to install an operating system across a network or even to boot from a network drive. PXE works independently of particular manufacturers' network drivers. Unlike the current PXE 2.0 standard, where PXE has been developed as an option Rom limited to 16bit real mode, PXE will run in Protected Mode on EFI, with the result that it will be much faster.

As the EFI drivers allow direct access to the hardware, it's possible to run pre-boot applications such as diagnostic tools, partitioning programs or software to install a hard disk image automatically. For additional security, the drivers and applications are digitally signed.

Goodbye to Assembler

One of the big advantages of EFI when compared with the conventional Bios is in

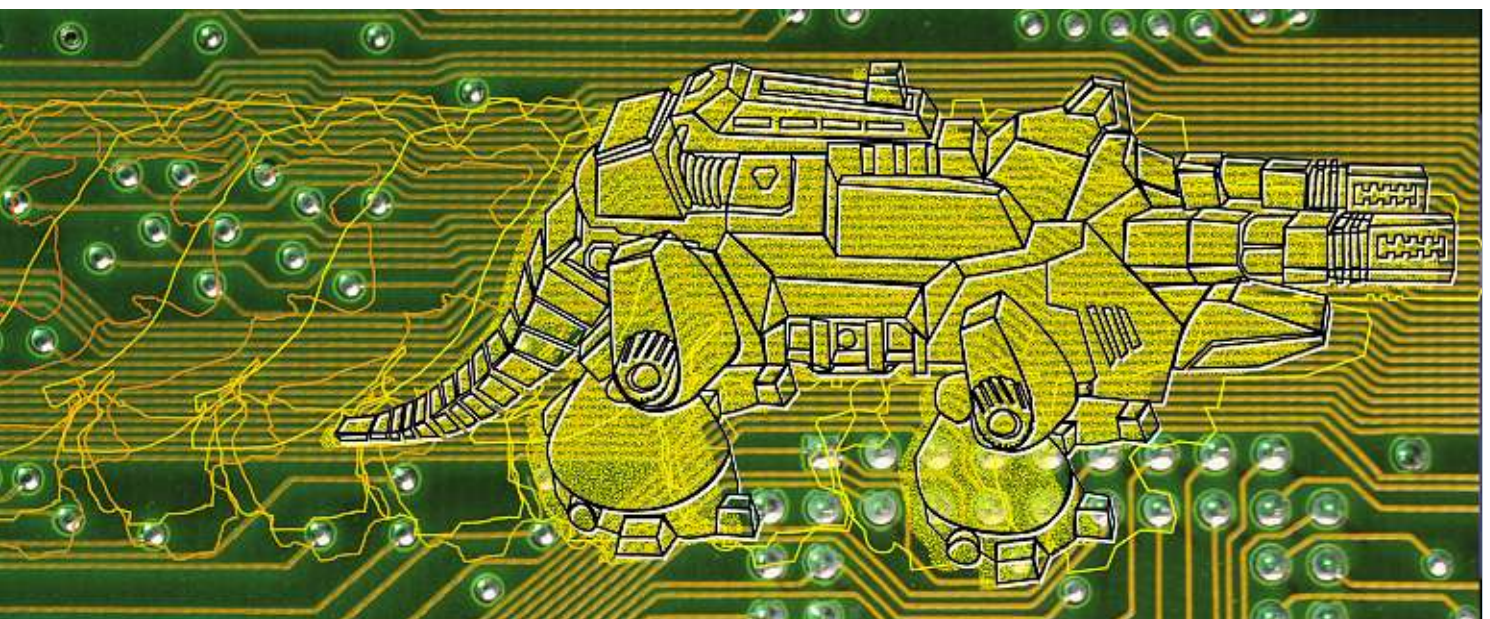



SCREEN 1

The old text-based Bios display will be replaced in EFI implementations, such as this one from Phoenix, and will look more like Windows applications that most users are now familiar with



SCREEN 2

Vista, the successor to Windows XP, will be the first operating system to offer native support for the EFI Bios replacement, but Vista will still run on PCs with a conventional Bios

the programming. While a Bios is written in assembly language, the programming language for EFI is C, which is also used for the overwhelming majority of current software. This will not only make it easier for the manufacturers to write, but also simpler to debug their EFI implementations. There ought to be fewer bugs than in many current Bios software versions, for which updates appear almost weekly.

EFI and Windows Vista

Windows Vista will be the first x86 desktop operating system with native EFI support (see screen 2). One big advantage of this is that Microsoft will finally be able to retire the obsolete Master Boot Record format (MBR) for bootable hard disks and will change over to the Globally Unique Identifier (GUID) Partition Table Format (GPT) instead. A hard disk partitioned using MBR can have a maximum of four primary partitions, or three primary and one extended partition; the maximum size of a partition is 2TB. The number of logical drives in the extended partition is limited by the need to identify each drive with a letter.

Until now, to get around the 2TB limit several logical drives have had to be amalgamated into one. With the GPT, on the other hand, you can in theory have partitions up to a mind-boggling 18exabytes in size (an exabyte, or EB, is a million terabytes). Each disk can have up to 128 primary partitions, each identified by a unique ID. Data integrity is increased by having two redundant partition tables, and backwards compatibility is ensured by using a pseudo-MBR. Microsoft already supports GPT-formatted hard disks in Windows versions for the Intel Itanium and in Windows 2003 Server; however, in these

cases, the boot partition still has to have the MBR format.

Microsoft has announced that it will be developing its own pre-boot applications, for example for hard disk partitioning. Whether these new EFI applications will replace the existing Windows Recovery Console entirely, or simply complement it, remains to be seen. In addition, EFI is supposed to make waking up from S4 standby mode (hibernation) a lot quicker, as the memory snapshot saved on the hard disk is in theory able to load faster using the CPU's Protected Mode.

When will EFI arrive?

On large servers or workstations using Intel's Itanium processor, EFI is already reality. Exactly when the first EFI motherboards for PCs will be on the market is still uncertain; at present, both of the big Bios manufacturers, Phoenix and American Megatrends (AMI), are working on their own implementations. AMI's version of EFI is known as Aptio (www.ami.com/aptio) and can be ordered as a development kit by the motherboard manufacturers. Phoenix will be integrating EFI into the Trusted Core Bios it is developing with Microsoft (www.phoenix.com). **PCW**

EFI in the open-source world

In order to increase acceptance of EFI as the successor to Bios technology, Intel has joined with some partners and released the EFI standards as open source. In addition, Intel has handed control of the EFI specification to the United EFI Forum (www.uefi.org). Along with Intel, this organisation's members include AMI, Phoenix, Insyde, AMD, Dell, HP and Microsoft. EFI has, in the course of this move, been officially renamed UEFI (Unified Extensible Firmware Interface), although as yet hardly anyone is using the new name.

Intel has built on the specification to develop an EFI Framework and has made parts of it available as open source. To co-ordinate further developments, Intel has set up the Tiano Core Project (www.tianocore.org).



Best Buys

- **Established UK Brand**
Over 19 years experience of the European IT market place
- **Award Winning**
Time products have consistently won industry awards for value and quality
- **Money Back Guarantee**
TimeUK.COM are one of the only PC company to offer a 14 day no quibble money back guarantee
- **Buy Direct - No Shops - No Middlemen**
Time can deliver the latest technology for less money
- **Pay-As-You-Go Support Packages**
A range of support and extended warranty packages with no up front fee
- **Quality Assured**
Every product goes through extensive testing and quality checks

Order by phone and
PAY NOTHING for 12 months.
Order on-line and get
FREE DELIVERY!

TimeUK.COM are the direct sales division of TIME UK Factory Ltd., which produces computer and TV products for trade customers.

Largest PC manufacturing plant in the UK

Time UK Factory Ltd. runs the largest PC and plasma TV manufacturing facility in the UK. In the past this facility has manufactured and configured PCs for IBM, Olivetti, Compaq, Tiny and others in addition to Time.

Leading Brands

Time is one of the UK's leading consumer brands with an installed base of almost 2 million PC systems. TimeUK.COM will also sell other leading brands of PC and digital products

Quality Service & Support

TimeUK.COM offer a no quibble money back guarantee on all its products and free set-up support. 3 Year extended warranty is available from, Total Care and Support Ltd. from just £2.99 per month.

Choice of Operating System

Choose Linspire Linux as standard or Microsoft Windows XP Home for just £40 extra.



Linspire is the best Linux operating system and comes with a full office suite compatible with Microsoft Office

Please Note: Although this factory also produced PCs for Granville Technology Group Ltd., which went into administration in July last year, Time UK Factory Ltd. is a completely separate company to Granville Technology Group Ltd. Granville was one of the largest trade customers of this factory and if you bought a Time PC via Granville, we have arranged FREE 12 month standard warranty support via www.totalcaresupport.com



£499 | Time Home

Top Spec Time Home PC with 19" TFT for just £499!

- AMD Athlon 64 3200+ processor
- 1024Mb DDR RAM memory
- 200GB Serial ATA 7200rpm hard disk
- ATI Radeon 128MB PCI express graphics
- 16x Dual layer DVDRw drive
- 16x DVD-ROM Drive
- Multiformat card reader/writer panel
- Firewire port
- 19" Flat panel TFT screen

All standard features including: USB 2.0 ports x5, 5.1 sound system, 10/100 ethernet networking, multimedia keyboard and mouse.

Choice of operating systems: Linux as standard or Windows XP home for £40 extra

Pay Nothing For 12 Months £499 Inc. VAT Plus Delivery*
E-code:C00015



£499 | Time Traveller

Time Traveller Widescreen Notebook with 512MB memory for just £499!

- AMD Sempron 2800+ mobile processor
 - 512MB DDR RAM memory
 - 80GB Hard disk drive
 - ATI Radeon 128MB graphics
 - DVD-Rw Multiformat dual layer – Copy any DVD or CD
 - 15.4" Widescreen high definition display
 - Wi-Fi Wireless built in
- Advanced features: USB 2.0 ports x4, TV-out, 56K modem, ethernet network card, 6 cell Li-ion battery.

Choice of operating systems: Linux as standard or Windows XP home for £40 extra

Pay Nothing For 12 Months £499 Inc. VAT Plus Delivery*
E-code:L00004



£999 | Time Plasma

42" Complete Plasma TV Package for just £999!

- Superb hi-res plasma panel
 - 3,000: 1 Contrast ratio
 - Built-in advanced tuner system
 - Full connectivity with SCART, component video and more
 - Desktop stand and detachable stereo speaker system
- PLUS** Plasma table
PLUS 5.1 Speaker system
PLUS Internet box
PLUS DVD player 5.1

Pay Nothing For 12 Months £999 Inc. VAT Plus Delivery*
E-code:P00003

Visit timeuk.com for our latest products:

- HD-TV Ready
- 10,000:1 Contrast
- Digital Freeview

Offers End 30th April

Delivery charge of £39.99 for PCs/Notebooks and £99.99 for Plasma TVs. Free delivery only when you order on-line. Finance Example: Cash price £1000; Pay just the delivery charge by credit card, then pay nothing for 12 months. Decide to pay in full and no interest is then payable or choose 36 monthly payments of £51.42. Total price £1851.12. APR 29.8%. Finance is subject to status. Money back guarantee excludes carriage costs. Linux may not support all hardware. Product appearance may vary. Written details on request. Prices, specifications and offers are subject to change, availability and our conditions of sale – copies available from Time UK Factory Ltd., Time Technology Park, Burnley. BB12 7TW.

Click **www.timeuk.com**

Call **0870 122 4300**

Lines open Mon-Fri 9am-6pm; Sat 9am -1pm

HOT DEALS

FREE DOMAIN NAME

with every new web hosting account from £4.99 pcm*

EUROPEAN DOMAIN NAME SPECIALISTS



CHOOSE FROM OVER 260 DOMAINS **£4.99** from per annum

- ✓ Protect brands and trademarks
- ✓ Powerful online control panel
- ✓ **FREE** email and web forwarding
- ✓ **FREE** web page creator

including .com .net .org .biz and .info

QUALITY EMAIL PLANS

Turn your domain into feature packed POP3 email addresses for the family or office.



- ✓ Choose from 4 plans
- ✓ 2 - 50 POP3 boxes
- ✓ 50 - 750MB storage
- ✓ Unlimited forwarding
- ✓ Advanced webmail

£1.49 from per month



AWARD WINNING WEB HOSTING

FREE SET UP - NO CONTRACT
FREE DOMAIN NAME*
FREE ADVANCED WEB TOOLS

£4.99 from per month



All-inclusive pricing includes:

- ✓ Comprehensive control panel
- ✓ **FREE** expert advice and support
- ✓ Powerful web based email
- ✓ Instant activation
- ✓ Virus and spam protection
- ✓ Powered by Namesco's Network

+ Packages include E-commerce, PHP, ASP, SSL, MySQL and Frontpage extensions

FEATURE RICH HOSTING

PACKAGE	SPACE	POP3	B/W	PCM
Starter	250MB	5	2GB	£4.99
Starter+	500MB	10	5GB	£7.99
Business	2000MB	100	20GB	£15.99
Business+	3000MB	200	30GB	£18.99



WINDOWS



or LINUX

NEW BROADBANDMAX - UP TO 8Mb** FROM

£15.95 inc VAT

FREE CONNECTION
FREE DOMAIN NAME*
FREE ANNUAL HOSTING*
FREE VIRUS & SPAM FILTERING



£15.95 from per month

Package	Speed	Contention	10GB/month Usage	Unlimited Usage*
Home 500	upto 512Kbps	50 : 1	£15.95 inc VAT	£24.95 inc VAT
Home 1000	upto 1Mbps	50 : 1	£17.95 inc VAT	£29.95 inc VAT
Home 2000	upto 2Mbps	50 : 1	£19.95 inc VAT	£34.95 inc VAT
Home Max	upto 8Mbps	50 : 1	£24.95 inc VAT	£39.95 inc VAT
Office 500	upto 512Kbps	20 : 1	£22.95 ex VAT	£31.99 ex VAT
Office 1000	upto 1Mbps	20 : 1	£26.95 ex VAT	£49.99 ex VAT
Office 2000	upto 2Mbps	20 : 1	£29.95 ex VAT	£69.99 ex VAT
Office Max	upto 8Mbps	20 : 1	£39.95 ex VAT	£74.99 ex VAT

GREAT VALUE!



Total Peace of Mind - Not only will your services benefit from 24/7 network monitoring and daily backups, they will be hosted on our super fast and secure clustered servers located in multiple UK based data centres, ensuring accelerated communications, total efficiency and security.

www.names.co.uk | sales@names.co.uk

Call us on **0845 363 8888**



*Offer applies to .co.uk, .me.uk & .org.uk domains only. **Subject to availability and compatibility of BT telephone line. *Fair usage policy applies on all unlimited broadband packages. Prices quoted exclude VAT at 17.5% unless otherwise stated. Cheques and major credit/debit cards accepted. Namesco Limited. Est. 1996. Acton House, Perdiswell Park, Worcester. WR3 7GD
*Included Web Hosting free for 12 months only

“ When we require webspace, or need to purchase domain names, we can guarantee to get a speedy response from Namesco. They are always helpful to a fault and have never let us down. ”
www.haigh-cs.co.uk



GET STARTED WITH HDV

High-definition video (HDV) is very much in people's minds at the moment, spurred on by the advent of high-definition TV (HDTV) and widespread adoption of large flat-screen TVs in the home. But until now there's been a paucity of both HDV-capable camcorders and editing applications that support this format.

If this is an area that really interests you, Ken McMahon's Digital imaging and video column should be your starting point this month, as he gets to grips with the practicalities of using HDV formats in a variety of popular video-editing software packages.

Barry Shilliday's introduction to Ubuntu Linux has proved remarkably popular with you, with lots of requests for help and clarification, so this month he's continuing the series, this time with a look under the hood at user privileges and network connections. And if you've missed any of the previous installments, don't panic – you can download them in pdf format from www.pcw.co.uk/2150862.

CONTENTS

120 QUESTION TIME

Your problems solved and queries answered by our team of experts

124 HARDWARE

Forget marker pens, find out how you can add style to your disc labels using Labelflash technology

126 PERFORMANCE

Discover how much juice the tiny PicoPSU ATX power supply unit produced when put to the test

128 WINDOWS

How to prevent duplicate icons appearing on your desktop; and solve some annoying network niggles

130 LINUX/UNIX

Get connected with Ubuntu and learn how to add and remove privileges

132 DIGITAL IMAGING & VIDEO

Explore the software and hardware you need for high-definition video editing

134 WORD PROCESSING

Disable the most recently used font list and learn how to create chord diagrams

136 SPREADSHEETS

Send personalised messages to customers from Excel; and readers come up with some useful macros to sort data

138 WEB DEVELOPMENT

How Perl or PHP scripts can automate tasks and improve ease of use

141 NETWORKS

If you've your own network you don't need to rely on an ISP. Find out how to run your own mail server

144 DATABASES

How much does size matter when indexing tables with millions of rows?

146 VISUAL PROGRAMMING

An in-depth look at how to use Visual Studio 2005's WebBrowser control



Far left:
Learn the basics of HD video editing on page 132

Left: How powerful is the tiny PicoPSU ATX? See page 126

HANDS ON

25 PAGES OF...

- ADVICE
- TOP TIPS
- TECHNIQUES
- WORKSHOPS
- HARDWARE SOLUTIONS
- SOFTWARE SOLUTIONS
- Q&A

Advice from our experts

Our team of experts offers advice and suggests solutions to your technical queries

HARDWARE

Missing TV listings in XP Media Center

Q I've built my own media PC running Windows XP Media Center Edition 2005. It's more or less working fine, but my TV Guide shows 'No data available' for most of the digital channels. I am connected to the Internet and the system reports a successful Guide download, so where are the listings?

Vince Rutter

A This is a common problem with new Media Center Edition (MCE) installations and is partly down to the fact that, unlike digital TVs and set-top boxes that take their scheduling information from the Freeview service itself, MCE uses a separate Electronic Programming Guide. Consequently setting up the TV channels and Guide listings on an MCE system is essentially a three-stage process.

First you need to enter your postcode and choose your local transmitter. This identifies which channels should be available to you, then downloads the schedules for them. The second step is to tune your TV cards. The third stage involves associating the appropriate Guide listings with each channel. So for the actual BBC2 channel, you'll need to associate the BBC2 Guide listings.



Strangely this last stage doesn't always work automatically, leaving you with the channels tuned in, but the Guide listings for them mysteriously absent. The solution is to manually associate the Guide listings for each channel.

Go to the Guide section under TV Settings and select 'Add Listings to Channel'. Here you'll see a list of the numbered channels, such as 1 for BBC1 and 7 for BBC3 (for DVB users) and, to their right, the Guide listings which are associated with them. Simply go to the desired channel, click OK then choose the desired listing for that channel from the guide that appears.

Restore digital TV channels to Windows Media Center

HARDWARE

Sata plug and pray

Q I sometimes try out new motherboards for friends who are putting together their own systems. I normally use the same Serial ATA (Sata) hard disk for my tests, but I've read that there's a limit to the number of times the connector can be plugged in and out. Is this a real problem?

Gary Leach

A According to The Serial ATA International Organisation (www.sata-io.org), the internal Sata connector is only specified to withstand 50 insertions and removals. In practice, this figure could vary.

That said, we've found some internal Sata connectors can be fragile. The sockets which don't have a ring of plastic to encompass the plug can easily be bent in some circumstances. One such plug on a test motherboard recently fell apart, rendering the port useless. We hadn't counted the insertions, but it was fewer than 50. To be fair, the plug had occasionally been pressed by other cables in some PC cases, but it shows the socket is not as robust as the old parallel ATA models.

The recent e-Sata specification for external devices uses a connector designed to withstand over 5,000 insertions and removals.

HARDWARE

Trouble with removing DVD drive fascia

Q I recently got hold of a media case which comes with a matching cover for the DVD drive tray.

You need to remove the fascia to get to the drive, and I've tried pressing on the four clips which appear to hold it in place, but it won't come off.

Is there a trick involved with removing this?

Steve Andrews

A You're correct, the plastic fascia for DVD and CD drives is held in place by four clips – two under the drive and one on either side – but the cover for the tray itself also holds the surrounding fascia in place. While it is possible to remove the fascia with the tray closed, you'll need brute force and almost certainly bend it out of shape.

Rather than do that, simply eject the tray, either under electrical power

or by straightening a paper clip and pushing it into the tiny hole in the front of the drive. Once the tray is extended even by just a few millimetres, you'll find pressing in on the four clips easily releases the main fascia from the drive. Of course the tray cover will still prevent you from removing the fascia completely, so you'll need to remove this too. Luckily the cover is easy to unclip and re-attach if necessary.

DATABASES

Using Access queries in Oracle

Q I have been using Access for a while and am getting used to the query builder. I also use Oracle at my place of work and wanted to try some of my queries there. How do I transfer them?

Damian Stephens

A Access has a GUI query builder but, even when you use that, Access is building the query in SQL (the standard language for querying databases). You can see on the screen (right) the SQL in Access and you just cut and paste it into Oracle. Bear in mind there are often minor (sometimes major) syntactical differences in the SQL used by different database engines, so some editing may be required.

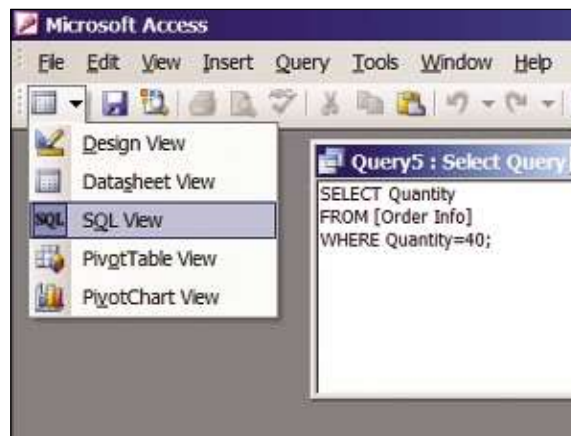

Access reveals the SQL behind the query

SPREADSHEETS

Shortcut for column headings

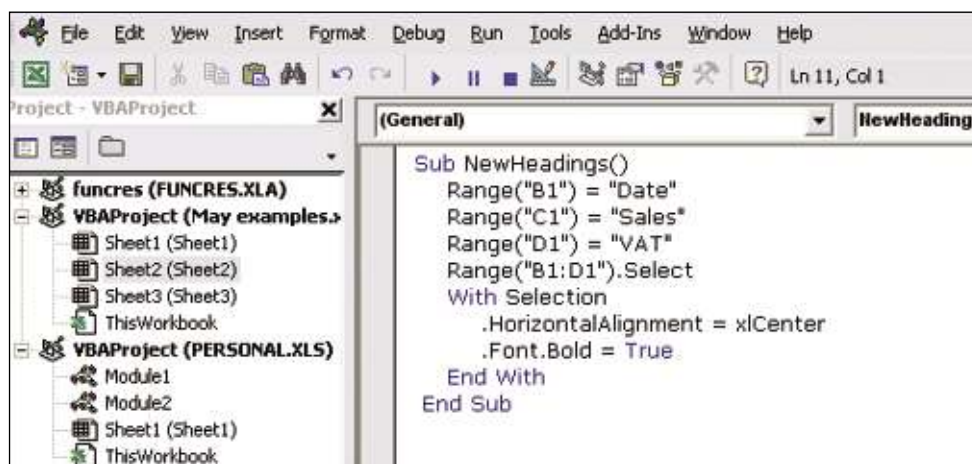

Q Is it possible to have Excel automatically fill in column headings using a shortcut?

Louisa Hayden

A Yes, open Excel and press Alt & F11 to open the VBA editor. In the left-hand panel choose VBA Project (Personal.xls) and Module on the Insert menu. Right-click on the new module and choose View Code. In the right-hand panel enter the following:

```
Sub NewHeadings()  
Range("B1") = "Date"  
Range("C1") = "Sales"  
Range("D1") = "VAT"  
Range("B1:D1").Select  
With Selection
```

```
.HorizontalAlignment = xlCenter  
.Font.Bold = True  
End With  
End Sub
```

Click the Save tool and close the VBA editor. When you return to the worksheet press Alt & F8, choose Personal.xls!NewHeadings and click the Options button. Here you can create a keyboard shortcut such as Ctrl & Shift & H. Click OK. Close the Macro dialogue box. The file will be called Book 1 but don't save that. Just close Excel. If you are then asked if you wish to save the changes in Personal.xls, acknowledge that you do. Open Excel afresh, press your new shortcut and Date, Sales, and VAT will appear in the range B1:D1, centred and bold.

A macro can be created to instantly enter column headings

LINUX

Ubuntu resolution

Q I've installed Ubuntu following the recent Hands on series, but on installation I entered the wrong screen details and now my screen resolutions are limited. I can't figure out how to change this after the event. Can you help?

Jake Dovey

A Ubuntu unfortunately doesn't currently provide a graphical utility to fix this problem. One option is to edit the /etc/X11/xorg.conf file, placing the required resolution in the list. This is a bit of a hack job though. Another option is to rerun the configuration utility. You can do this by running 'sudo dpkg-reconfigure xserver-xorg'. Most of the questions are already completed, based on your current configuration. When you get to the monitor section, select the highest resolution you want to use, as this is the default. You can change to other resolutions once logged in.

LINUX

More Ubuntu

Q I have installed Ubuntu Linux mainly for fun and experimentation. For now I still want to use Windows as my main operating system. How can I get Windows to be at the top of the list in the bootloader?

Jon Hughes

A Ubuntu places itself first on the list, which means unless you choose otherwise, Ubuntu will boot automatically when the PC is switched on. The configuration file is found in /boot/grub/menu.lst. You can edit this file with 'sudo gedit /boot/grub/menu.lst', but be extremely careful if doing so – a mistake could mean that your PC will no longer boot and you'll have to run a rescue session.

If you change the line which reads 'default 0' to 'default saved', the bootloader will boot the operating system you booted last time. This might be the easiest and safest solution.

SPREADSHEETES

Shrinking Excel

Q A file I have been using for a number of years has grown into a multi-megabyte size. Is there any way to reduce it?
Jo Eden

A If you have added a lot of links or graphics, that will happen. But it's also likely that Excel is storing empty rows or columns. For each worksheet, press Ctrl & End to see if the focus jumps to a cell way beyond the last one you are using. If that's the problem, click on the row number below your last used row to select it. Press Ctrl & Shift & Down Arrow. On the Edit menu choose Clear, All. Take the equivalent steps to clear the columns to the right of your used ones using Ctrl & Shift & Right Arrow. Press Ctrl & Home to go to the first cell you are using – probably A1. Now press Ctrl & End and the focus should shift to the last cell you are using.

Repeat this whole exercise for each used worksheet in your workbook and delete any unused worksheets.

SPREADSHEETS

Follow the leader

Q I want to make a contents page in Excel and automatically fill in any remaining space in some cells with leader dots. How can I do that?
RM Roberts

A You can do it with custom formatting. Increase the width of the relevant

How to add leaders from chapter heads to page numbers

column to suit. Highlight the chapter heading cells.

On the Format menu, choose Cells, Number tab, Custom category. Type @*. (full-stop). Instead of the full-stop you could also use any other symbol you like. For example, the illustration (see screen below) uses tildes. When this is done, click OK.

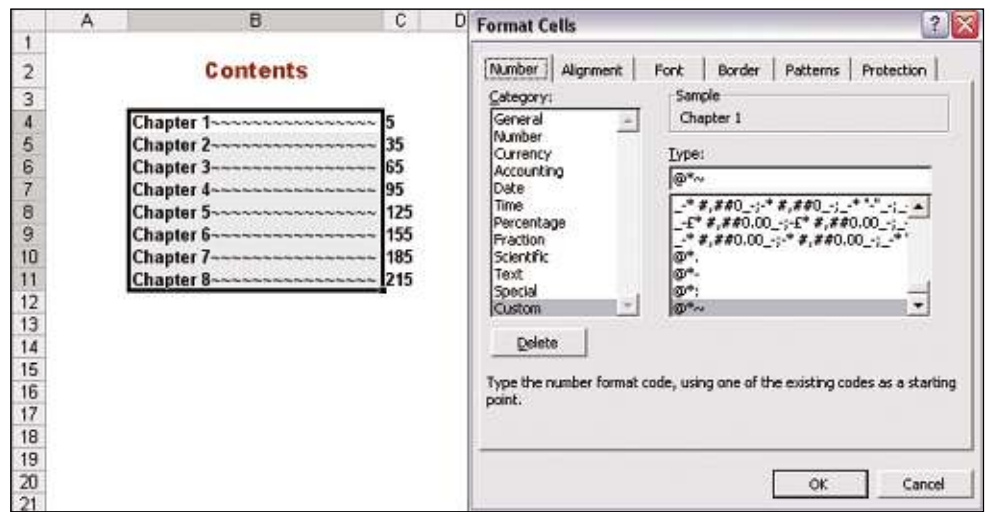

SPREADSHEETS

Protection racket

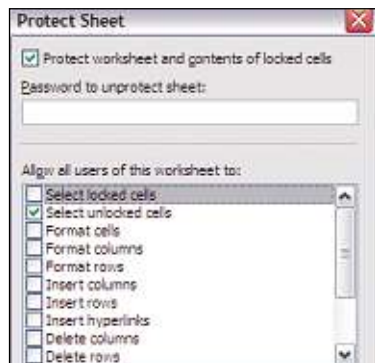

Q Can you stop users changing selected cells in Excel?
Syeda Irtizall

A Click the Select All button. On the Format menu select Cells, Protection. Remove the checkmark against Locked. Highlight the cells you wish to lock. Go back to Format, Cells, Protection. Check, Locked. On the Tools menu choose Protection, Protect Sheet. Remove the checkmark against Allow users to select locked cells. That's it.

SPREADSHEETS

Find and replace formats

Q Is it possible in an Excel workbook to change the formatting of all entries of a particular word?
Eleanor Boyle

A To find all entries of the word Total, for example, change the colour of the font, make it bold and align to the right. Hold down Shift

and click the first and last tab in the workbook to group the worksheets. Press Ctrl & H. Enter the word Total in both Find and Replace boxes. Choose Options, then Format by the second box and you are offered all the usual opportunities for formatting a cell and its contents. Click OK, then Replace All. OK. Right-click on any tab and choose Ungroup Sheets.

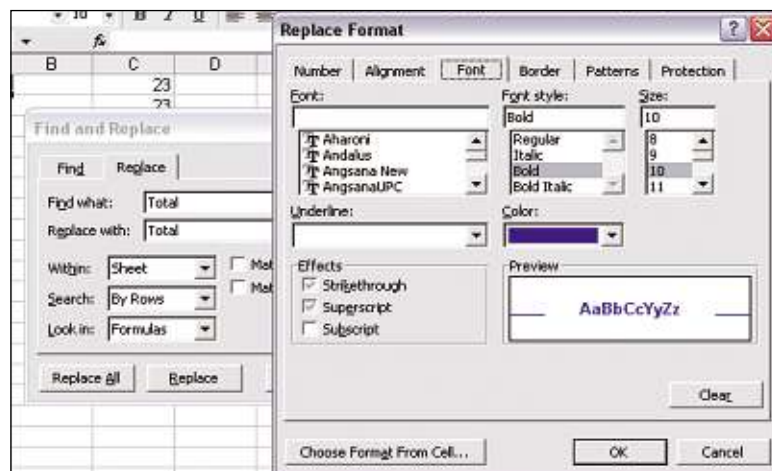

Excel will let you format multiple cells automatically

WINDOWS

XP search solution

Q I was asked by a telephone help person to look for a file called reboot.bat on my hard disk. I know what this file is and I know it should be in a sub-folder of Program Files called Intuit. Search could not find it but I was able to navigate to where I expected it to be and there it was. Experimentation and watching the status bar shows that, on my machine, Search does not look in Program Files at all, which I find rather unhelpful. A solution to this mystery would be gratefully received. I am running Windows XP SP2.

William Barneby

A This is a well-known XP gotcha. Search won't look in sub-folders of the target folder, nor in system or hidden folders unless it is explicitly told to do. And Program Files is classified as a system folder.

If you expand the 'More advanced options' item in the search dialogue, you'll get the options to look in hidden, system and sub-folders.

Alternatively you might consider getting the free Windows Desktop Search tool from Microsoft that we discussed in February 2006's Hands on Windows.



You can get Search to look everywhere

WORD PROCESSING

Spinning the landscape

Q I have created a document with Word that contains several pages with tables and charts in landscape mode. I'd like the landscape pages to have the header (chapter title) and footer (page number) in the same position as the other pages, but Word insists on rotating them to match the landscape format. Is there a way to cure this?

Jeff Christie

A There are several ways around this, from fairly to extremely complicated, and we'll be covering these in detail in a future Word processing column. Our favourite solution is to create the tables or charts as separate documents, and leave blank but headered and numbered pages in the appropriate places in the main document. Print the main document, then print the tables and charts onto the appropriate blank pages.

WORD PROCESSING

Getting around Word file bloat

Q I write a lot of technical documents in Word – usually about 20/30KB in size. I always edit them a lot, without adding many (or any) bytes, but the editing can double or even treble the file size. I assume that's because Word stores some sort of document history, but I've checked that no additional versions are being stored. I can get the file down to size by cutting and pasting the whole text into a new blank file, but there must be a simpler way to do it – I would be grateful to know what it is.

Albert Green

A This sounds as if you have 'Fast Saves' enabled. When this is the case Word appends altered paragraphs to the file rather than

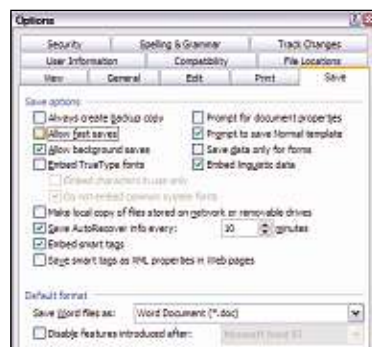

Enabling Fast Saves can make your documents bloated

substituting them, which will increase the file size. This means deleted content may still exist in the file – it won't appear in Word, but it can be seen with a text editor, and this might well be undesirable. The solution is to turn off Fast Saves from Tools, Options, Save.

WORD PROCESSING

Quote unquote

Q I like the way Word automatically replaces typewriter-style straight single and double quote marks with the respective opening and closing versions, but there are times when I want straight quotes – for example, as ditto marks, feet and inches or minutes and seconds of arc. I know I can do these from 'Insert symbol' without the Autoformat kicking in, but whenever I set up a keyboard shortcut for straight quotes in the Insert Symbol dialogue, this reverts to being Autoformatted. Is there a simple way to get straight quotes without going through the dialogue?

Monica Smith

A There are two easy ways to do this – one is to press Ctrl & Z (or Alt & Backspace) immediately after typing the quote mark, which undoes the Autoformat-as-you-type. The disadvantage of this method is that it works immediately – if you type anything else after the quote, then that will be undone, but the Autoformatting will stay put.

A more intuitive way is to set up Autocorrect entries, for example to replace /" and /' with " and '. Autocorrect pulls rank over Autoformat-as-you-type, so your straight quotes will stay put unless you subsequently do a manual Autoformat on the selection or document.

LET US HELP YOU

All our experts welcome your queries. Please respond to the appropriate address below

Databases database@pcw.co.uk

Digital imaging & video

digitalimaging@pcw.co.uk

Hardware hardware@pcw.co.uk

Linux linux@pcw.co.uk

Networks networks@pcw.co.uk

Performance performance@pcw.co.uk

Sound sound@pcw.co.uk

Spreadsheets spreadsheets@pcw.co.uk

Visual programming visual@pcw.co.uk

Web development webdev@pcw.co.uk

Windows win@pcw.co.uk

Word processing wp@pcw.co.uk



Gordon Laing has been a hardware enthusiast since his first Sinclair ZX80 and as a former editor of PCW and contributor for over 10 years, what he doesn't know about technology isn't worth knowing.

→ Comments welcome on the Hardware column.

Email hardware@pcw.co.uk

Please do not send unsolicited file attachments.

Add style with flash labels

Forget marker pens – there are far more sophisticated ways to name your discs



There can be few people who've never picked up a recorded CD or DVD and wondered what on earth is stored on it. While I always try and keep discs I've recorded in sleeves or jewel cases, there always seem to be loose ones lying around whose contents are only revealed by inserting them into a PC.

The answer, of course, is labelling, but I've never been fond of current printed solutions for optical media. I much prefer the idea of directly writing on, or into, the disc itself – and I'm not talking about using a marker pen.

Back in 2004, HP, together with Verbatim's parent company Mitsubishi Kagaku Media, announced a technology to do just that: Lightscribe could burn silkscreen-quality monochrome labelling directly onto the non-data side of special optical media using a modified drive. The idea was to simply flip the disc over once you'd recorded your data on it, then burn the label on the other side using the same drive. For more information visit www.lightscribe.com.

Today there's an increasing number of optical drives that support Lightscribe, and the latest development supports coloured backgrounds on new types of blank media. So far so good, but the downside to Lightscribe is the speed at which the labels are burned: you're

looking at around half an hour per disc, and of course you'll need special media – and while prices are falling, they're still nowhere near as cheap as a mass spindle of standard blanks.

Interestingly, Yamaha previously addressed the need for special media with an earlier technology that could write on unused portions of the data side of discs. While this could in theory allow you to label any kind of blank media, it did so at the cost of reduced storage capacity.

It was an interesting concept nonetheless, and now makes a reappearance as part of the new Labelflash technology, jointly developed by Yamaha and Fujifilm and announced last November. Like Lightscribe, special media allows the non-data side of Labelflash discs to be labelled with a monochrome image,

NEC's ND-4551A and ND-3551A drives are the first to feature Labelflash technology. This allows you to burn text or graphics in 256 shades on the top side of special blank media

although Yamaha's input also supports labelling on spare areas of the data side. The key advantage over Lightscribe is the claim of much faster label burning: in as little as seven minutes, although higher quality settings will take closer to half an hour.

To put Labelflash technology to the test, we got hold of NEC's ND-4551A, the first optical drive to support the technology. While dedicated Labelflash media is currently only available in the DVD-R format, the NEC drive can also write data to a variety of conventional discs, including DVD+/-RW, DVD+R9, DVD-R DL and DVD-Ram. The drive is available in beige, silver or black and costs around £35, while Fujifilm's blank 16-speed DVD-R Labelflash media costs around £5.99 for five.

Using Labelflash

Labelflash exploits the optical characteristics of the standard data burn process, where burned areas appear darker than those that remain untouched. By adapting the process, different shades can be achieved and a graphical image generated.

The layer containing the image is at the same 0.6mm depth as a standard data layer, allowing the drive to use the same lens and focusing distance. Since the resulting label is below the surface of the disc, it's better-protected than a surface-based label.

The newly developed organic dye used in the label layer influences the colour of the image generated, which for the Fujifilm media results in a monochrome image with a blue tint. Fujifilm claims that up to 256 shades can be achieved and that the labels have a high level of durability and resistance to fading. Discs may be available in other colours in the future, but this has yet to be decided.

Labelflash blank media is currently only available in the DVD-R format from Fujifilm





At the time of writing, Fujifilm was the only manufacturer of Labelflash media and they were only available in the DVD-R format, albeit supporting 16-speed writing. In theory the system should also allow you to create labels on the data side of standard types of blank media, but this has to be supported by both the drive firmware and the writing software.

It should also be noted that some non-Labelflash aware applications may attempt to write over a label previously burnt onto the data side of a disc. This should be avoided as the resulting disc is unlikely to be readable. As such, it's recommended to only burn labels onto the data layer after the data writing is complete, and only using Labelflash-aware software. Of course, if you only burn labels on the dedicated label side of Labelflash media, this won't be an issue.

The software

At the time of writing, the only software that natively supported Labelflash was Nero Express version 6.6.1.3, which should be supplied with the NEC 4551A drive. This looks like the standard version of Nero Express, but by clicking the More button at the bottom of the main window you'll see a new option to Burn Label.

This opens a new window (see screen 1), which shows the available disc area and allows you to insert images, text or graphics. Text can run straight across the disc or be automatically curved around the edge.

Once your label is designed you can choose one of four printing quality options: Fast, Medium, Highest and

The top side of a Labelflash disc created using the NEC ND-4551A drive. Labelflash media uses a special 0.6mm thick top coating that won't fade, but the burned image is currently only possible in shades of blue

To exploit the Labelflash capabilities of a drive you'll need the right software. OEM versions of the NEC drive are supplied with a special version of Nero Express (6.6.1.13), which offers the Burn Label option

Testing Labelflash

To test Labelflash we created a simple label consisting of a high-resolution colour photograph with some curved text. We first burnt this onto the dedicated label side of Fujifilm Labelflash media using the best quality option, which took just under 27 minutes. Next we repeated the process on a new blank, except using the high-speed option, which took six minutes and 42 seconds. Finally we turned the disc over and used the high-speed option to burn the same label onto the normal data side of the disc – this again took just under seven minutes.

The first thing that stands out when you see the labelled discs is their blue tint. While they don't look as natural as a greyscale image, they still have a pleasing quality. The dye and burning processes result in a tonal density that is much lower than a conventional photographic image, so the result can appear slightly faint but is acceptable.

The three tests delivered measurably different quality. Taking the dedicated label side first, the longer

Custom, the latter allowing you to manually adjust the contrast level along with the rotation/encoding speed. The Fast option takes just under seven minutes, while the slowest high-quality option comes in close to 27 minutes.

The same options are available whether the disc's inserted with the data or dedicated label side up. As with standard optical drives, the layer facing down is the one that will be written to.

burn time of the high-quality setting delivered a noticeably wider tonal dynamic range with our test image. The white text on the disc burnt with the high-speed option, although the darker areas and overall resolution appeared the same on both discs. The quality on the data side was very disappointing, though, with our test image barely visible from some angles using the high-speed writing option.

Weighing it up

The major selling point of Labelflash over its rival Lightscribe is the faster burn time and, while Labelflash can indeed produce a result in under seven minutes, we ultimately felt the improved tonal range on the longer burn was worth the wait with our test image. This places the two technologies roughly neck-and-neck in terms of label burning speed.

When it comes to image quality, the dedicated Labelflash results looked good in isolation, although their blue tint and tonal density doesn't look very natural next to the denser and more neutral images of Lightscribe media. As for burning labels to the data side of the disc, it's an undeniably neat technology, but the results in our tests were too faint.

In Labelflash's favour, the dedicated DVD-R media is rated at 16-speed, compared to eight-speed for the current Lightscribe alternative. That said, DVD-R is the only format available with Labelflash, whereas Lightscribe supports others, including CD-R, which can be more appropriate for burning audio compilations. Labelflash media is also currently only made by one company.

Consequently, Lightscribe has the overall edge, although to be fair it's a more mature technology. We'll watch how Labelflash evolves and report back with any new developments.

In the meantime, unless you demand support for Lightscribe, the NEC-4551A is a great drive. It supports a wide range of recordable media, and since the support for Labelflash costs only a few pounds more than the version without, it's really a no-brainer to go for it. At around £35, it's remarkable value.

If you've had any positive or negative experiences with disc labelling, whether by print or laser, I'd love to hear from you. **PCW**





Gordon Laing has been a hardware enthusiast since his first Sinclair ZX80 and as a former editor of PCW and contributor for over 10 years, what he doesn't know about technology isn't worth knowing.

→ Comments welcome on the Performance column.

Email performance@pcw.co.uk

Please do not send unsolicited file attachments.

More power to you

Find out how much juice the tiny PicoPSU ATX produced when tested

The words PC and power supply conjure up images of a hefty box screwed into the back of a case, but as the rise of small form factor systems has proved, PC power supplies don't have to occupy a large volume.

Indeed, as you reduce the power requirements of a PC it's amazing what you can get away with. In this month's column we're testing the PicoPSU, which at just 31 x 45 x 20mm is officially the world's smallest snap-in DC-DC ATX power supply – to put that in perspective, it's about the size of two AA batteries next to each other.

The power supply components are built into the ATX connector itself, allowing the entire unit to be plugged directly into a motherboard. A cable harness offers two full-size drive power plugs and one floppy drive plug, while a second lead is used to connect to an external 12v laptop-style AC power adapter.

Since there are no fans, the power supply runs silently, and it's clearly ideal for systems where space is at a premium. That said, it could, in theory, snap into any system, replacing a standard power supply unit. So the big question then is what kind of specification is it capable of powering?

The designers of the PicoPSU claim the unit is theoretically capable of delivering up to 120w of power, although this depends on the kind of external adapter it is connected to; we tested our PicoPSU with a 110w model. The next step is figuring out what 110w can power in practice.

Counting the watts

The PicoPSU is best suited to low power consumption boards such as Via's Epia range, and I had it powering one plus a 3.5in hard disk and laptop-style slimline optical drive without a problem. Where it starts to get

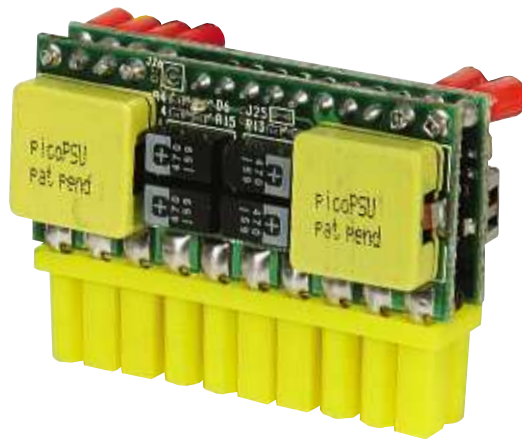

interesting, though, is with more traditional desktop components.

It's not wise to blindly connect a PicoPSU to an existing system and keep your fingers crossed that it'll boot up. To be safe you should spend some time measuring the power consumed by your PC during a variety of tasks with its existing power supply, and only swap it for the PicoPSU if it consistently and comfortably comes in below the maximum draw.

To do this you'll need a power meter such as a Maplin model which costs £24.99 from www.maplin.co.uk (product code L61AQ).

By connecting an appliance to the meter, then connecting the whole thing to a mains socket you can measure exactly how much power it's consuming.

In previous Hands on Hardware and Performance columns, I've measured the consumption of typical Pentium 4 and Athlon64 systems while idle and under load.

Consuming 115w while idle and close to 200w under load, my P4 model 660 configuration was clearly too hungry for the PicoPSU. Similarly, while my Athlon 64 4000+ system consumed just 80w when idle, this figure increased up to 150w when under load, again making it unsuitable.

Measuring the same size as two AA batteries, the PicoPSU is the world's smallest snap-in DC-DC ATX PC power supply

The Pentium M processor looked more promising, with my Aopen i915GMm-HFS test rig consuming around 50w when idle. While comfortably within the specification of the PicoPSU, it's important to consider power consumption during other tasks.

For example, full-size optical drives can be very hungry, and while burning a DVD, my Pentium M system's consumption increased to 70w. Most systems also spike when first powering up, with the Pentium M rig briefly consuming 78w. You should also measure the impact of graphics cards while gaming, not to mention peripherals.

My basic Pentium M configuration appeared to consume less than 100w under all circumstances, so I disconnected the original full size power supply and replaced it with the PicoPSU. Unfortunately, I tripped at the next hurdle: the PicoPSU doesn't have a four-pin supplemental power plug and the Aopen board refuses to boot without one connected. I'm getting hold of an adapter for one of the four-pin Molex plugs to convert it and will report back in a future edition.

In the meantime, the PicoPSU is an interesting option for low-power systems, such as those based on Via Epia boards or older platforms. The key is to measure the power consumption of your system performing various tasks before switching to the PicoPSU.

The PicoPSU costs £45.82 from the Mini-ITX store at www.mini-itx.com/store, where you'll also find a choice of three external power adapters, delivering 110, 80 or 60w for £41.13, £29.38 and £22.32 respectively. The 100w model is the most flexible and, while it employs a tiny internal cooling fan, it is essentially inaudible. **PCW**

Morgan

WAREHOUSE SURPLUS OUTLET

MAIL ORDER SALES LINE 0870 120 4940

www.morgancomputers.co.uk

Stores in London, Birmingham and Manchester.
See below for store locations/opening hours.

KONICA MINOLTA 5 MEGAPIXEL

Dimage e500 compact camera with 2" LCD screen and 3x optical zoom lens.

- 5 megapixel (2584 x 1936 dpi)
- Optical viewfinder, LCD screen
- Movie clip recording with sound
- 12MB memory, accepts SD cards

Stock status: Manufacturer refurb
Warranty: 6 month Minolta warranty

£69⁹⁹ ex VAT £82²⁴ inc VAT



EMACHINES 2.6GHZ PC

Home office/family PC with DVD re-writer, Win XP and Works 8.0

- Intel Celeron 2.6GHz chip
- 256MB RAM, 80GB hard drive
- 16x DL DVD±RW, card reader
- Keyboard, mouse & speakers

Stock status: Factory refurb stock
Warranty: 6 month warranty

£199⁹⁹ ex VAT £234⁹⁹ inc VAT



512MB MP3/FM RADIO

- Lavod LFA-409 with 2 colour LCD
- Voice rec mode, USB data storage
- Hi-speed USB 2.0, inc headphones

Brand new stock, 1 year warranty
£34⁹⁹ ex VAT £41¹¹ inc VAT



TRUST VOIP HANDSET

- VOIP phone for free Internet calls
- LCD display for caller ID, date/time
- Ideal for use with Skype software

Brand new stock, 2 year warranty
£19⁹⁹ ex VAT £23⁴⁹ inc VAT



TOSHIBA PORTEGE S100

Ultra slim sub 2Kg notebook with DVD Supermulti drive and integrated WiFi.

- Intel Pentium M 760 (2.0GHz) chip
- 512MB RAM, 80GB hd, DVD±R/RW
- 14.1" TFT, 64MB nVidia graphics
- 56K/LAN/WiFi, Win XP Pro Edition

Stock status: Brand new stock
Warranty: 3 year international wty

£899⁹⁹ ex VAT £1057²⁴ inc VAT



ARTEC USB FREEVIEW TUNER

- Watch free-to-air TV on your PC
- USB interface - no PSU required
- Includes infrared remote control

Brand new stock, 1 year warranty
£29⁹⁹ ex VAT £35²⁴ inc VAT



DYNAMODE WIFI MODEM/ROUTER

- ADSL modem & 11b/g WiFi router
- Up to 108Mbps wireless transfer
- 4 port switch, built-in firewall

Brand new stock, 1 year warranty
£46⁹⁹ ex VAT £55²¹ inc VAT



WIDESCREEN NOTEBOOK

Asus A6R with WiFi technology, DVD re-writer & widescreen TFT.

- Intel Celeron M 380 1.6GHz
- 256MB RAM, 40GB hard drive
- 15.4" wide-TFT, PCIe graphics
- Windows XP Home & Works

Stock status: Brand new stock
Warranty: 2 year collect & return

£469⁹⁹ ex VAT £552²⁴ inc VAT



HP M1180 MEDIA CENTRE

Powerful media centre PC with 160GB removable hard drive & front AV ports.

- Intel Pentium 4 540 3.2GHz chip
- 512MB RAM, 2 x 160GB hard disks
- DVD±R/RW, ATI 128MB graphics
- TV card, WiFi, XP Media Centre Ed.

Stock status: Brand new stock
Warranty: 1 year collect and return

£569⁹⁹ ex VAT £669⁷⁴ inc VAT



ACER HANDHELD SAT NAV

Handheld or in-car GPS system with full UK and Ireland maps.

- Pocket PC with integral GPS
- Bright 3.5" TFT colour display
- Includes in-car cradle/charger
- Maps supplied on 256MB SD

Stock status: Factory re-work
Warranty: 6 month warranty

£139⁹⁹ ex VAT £164⁴⁹ inc VAT



PURE EVOKE-2 DAB RADIO

- Portable stereo DAB digital radio
- More stations, hiss free listening
- Powered via mains or batteries

Re-work stock, 1 year Pure warranty
£79⁹⁹ ex VAT £93⁹⁹ inc VAT



17" ZERO DEAD PIXEL TFT

- Optronix OP-7005 17" TFT display
- Class 1 panel - zero dead pixel
- 8ms response, 1280 x 1024 dpi

Brand new, 1yr pixel/3 yr warranty
£149⁹⁹ ex VAT £176²⁴ inc VAT



TOSHIBA SATELLITE PRO L20

Slimline notebook with double layer DVD burner and integrated WiFi (11g).

- Intel Pentium-M 740 (1.73GHz) chip
- 512MB DDR RAM, 40GB hard drive
- 15" XGA TFT, up to 64MB graphics
- 56K/LAN/WiFi, Win XP Home Ed.

Stock status: Brand new stock
Warranty: 1 year International warranty

£549⁹⁹ ex VAT £646²⁴ inc VAT



MSI PERSONAL CINEMA

- nVidia FX5600 128MB AGP graphics
- Built in TV tuner, 128MB RAM
- Inc AV in/out box & infrared remote

New, plain boxed stock, 1 yr warranty
£29⁹⁹ ex VAT £35²⁴ inc VAT



LABTEC EDGE WIRELESS DESKSET

- Slimline multimedia keyboard
- Rechargeable optical mouse
- PS2 receiver (2 free ports req)

Brand new stock, 2 year warranty
£9⁹⁹ ex VAT £11⁷⁴ inc VAT



APPLE IMAC G5 17" SYSTEM

Ultra stylish designer PC with integrated 17" widescreen TFT.

- 1.8GHz powerful G5 processor
- 256MB RAM, 80GB SATA hdd
- DVD re-writer, modem/LAN
- Inc keyboard/mouse & OS X

Stock status: Re-work, like new
Warranty: 1 year warranty

£599⁹⁹ ex VAT £704⁹⁹ inc VAT



FAMOUS BRAND 3GHZ DESKTOP

Household brand desktop PC with 1GB DDR RAM and 256MB nVidia graphics.

- Intel Pentium 4 3.06GHz processor
- 1GB RAM, 160GB SATA hard drive
- DVD±R/RW, 256MB 6200 graphics
- Microsoft Windows XP Home

Stock status: Factory refurb stock
Warranty: 1 year on-site warranty

£349⁹⁹ ex VAT £411²⁴ inc VAT



Buy now. Pay later.

6 MONTHS INTEREST FREE CREDIT ON ANY SALE OVER £400

SUBJECT TO STATUS, OVER 18'S, WRITTEN QUOTE UPON REQUEST

MEDION 5.1 SPEAKER SET

- 5 x NXT flat panel satellites
- Subwoofer with integrated amp
- Powerful 50W RMS total output

2nd's stock with 1 year warranty
£19⁹⁹ ex VAT £23⁴⁹ inc VAT



TO HAVE A FREE COPY OF OUR FLYER DELIVERED TO YOUR DOOR EVERY MONTH PLEASE CALL 0870 120 4940



CENTRAL LONDON
64-72 New Oxford Street
London WC1A 1AX
Tel 020 7255 2115
Fax 020 7436 6285

GREENFORD
Unit 25 Derby Road
Metropolitan Ctr UB6 8UJ
Tel 020 8575 0055
Fax 020 8575 7985

BIRMINGHAM
34 Edgbaston Centre, Hagley
Road, Birmingham B16 8SH
Tel 0121 452 1141
Fax 0121 455 6855

MANCHESTER
Unit 11-12 Station Approach
Manchester M1 2GH
Tel 0161 237 1111
Fax 0161 237 3146

BUSINESS HOURS

Monday-Friday 9.00am-5.30pm
New Oxford St late night Thurs 'til 7.30
Saturday 9.00am-5.00pm
Sunday 10.00am-4.00pm
Greenford branch closed at weekends



Stock & prices subject to change, E&OE



Tim Nott is a full-time freelance journalist. When he's not writing about Windows and word processing, he tackles many other diverse subjects. He currently lives in France with his wife and family.

→ Comments welcome on the Windows column.

Email windows@pcw.co.uk

Please do not send unsolicited file attachments.

Stop seeing double

Prevent duplicate icons appearing on your desktop and solve some network niggles

Now here's a strange thing. Whenever reader George Webster created a shortcut on his XP desktop, or whenever a program installation put one there, he got two icons. Clicking on either of the twin icons started up the selected software, but if he deleted one the remaining icon wouldn't work.

The key to this is that the desktop consists of three entities. First there's the user's desktop folder, which is kept in Documents and Settings\\Desktop. This will contain all the shortcuts and other content that the named user has placed there, as well as shortcuts installed by programs for that user only. Then there's the common desktop folder, stored at Documents and Settings\All Users\Desktop. Typically this will contain shortcuts to programs installed for all users. Finally there's the platonic desktop – the ultimate destination of any trip up the folder tree. This isn't an actual folder but through smoke and mirrors 'contains' system icons such as My Computer and the Recycle bin.

The duplicate problem can occur when the common desktop and the user desktop are set to the same folder. Without dwelling too much on how this can happen, it can cause the problem outlined above (see screen 1).

Sometimes you'll find that if you try to delete one icon, it stays put but its twin disappears, and you'll often find double-clicking on a survivor produces a variety of error messages (see screen 2). The cure isn't too difficult, but does involve some Registry editing, so if you are trying to solve this problem, do create a System Restore point first.

Run regedit, and go first to HKEY_CURRENT_USER\Software\Microsoft\Windows\CurrentVersion



\Explorer\User Shell Folders. Look in the right-hand pane for a string value named 'Desktop'.

This should be set to %USERPROFILE%\Desktop – in other words, Windows should be looking to load the current user's desktop from that user's profile. Correct the entry if this isn't the case by double-clicking on the Desktop value to get the editing box (see screen 3).

Next, go to HKEY_LOCAL_MACHINE\SOFTWARE\Microsoft\Windows\CurrentVersion\Explorer\User Shell Folders. There should be a value in the right-hand pane named Common Desktop.

Verify that this is set to %ALLUSERSPROFILE%\Desktop, amending if necessary. This should cure the problem.

Duplicated desktop icons...

...and strange error messages can be eliminated with some Registry tweaks

Unplugged

If you are running a home or small-business network, you may well have seen the message that 'A network cable is unplugged'. The first thing to try is the obvious – check that any devices such as hubs are powered up, all connectors are seated and check cables for damage. However, there are other possible causes: we've seen this message on a Virtual PC running XP Home hosted on a XP Pro machine – and a Virtual PC doesn't have any cables or plugs.

By far the most common cause of this problem is that the network device has turned itself off. To check this, go to Control Panel, Network Connections, right-click on Local Area Connection and choose Properties.

On the General tab, click the 'Configure...' button. In the Adapter Properties dialogue that appears you'll see a tab for Power Management – turn to this and make sure 'Allow the computer to turn off this device...' is unchecked.

If that doesn't cure the problem, check the settings on the 'Advanced' tab of Adapter Properties. Click on the 'Connection Type' item and look at the value. Normally this is set to Autosense or Auto-negotiation (see screen 4).

Try changing this to '10Mbps/Full Duplex' – if this cures the problem you could then try upgrading this to '100Mbps/Full Duplex', then if the problem reappears drop back down to '10Mbps/Full Duplex'.



SCREEN 2

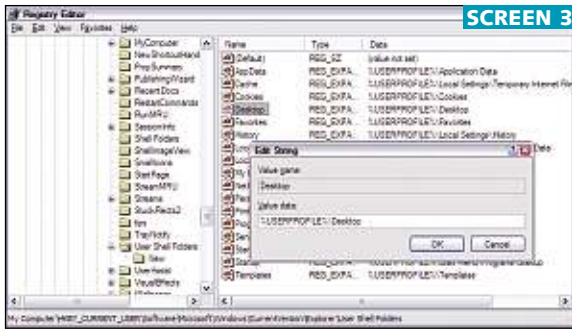

SCREEN 3

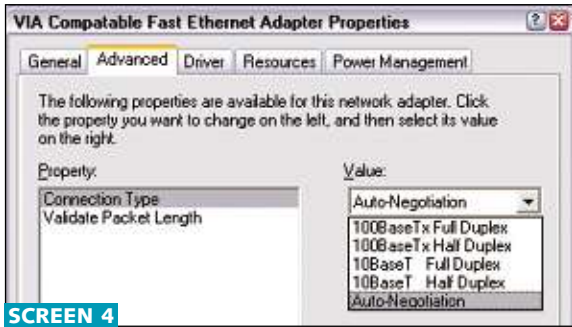

SCREEN 4

Turning to another networking annoyance, you might find folders in 'My Network Places' that are long-gone – perhaps referencing a PC that is no longer on the network – and if you click on one of these to open it you'll get an error message. You can delete these folders, and if the folder is still present the deletion will not affect the target folder as these entries are shortcuts. If you want to stop folders from being added automatically to 'My Network Places' there is a setting in TweakUI for XP, at Explorer, 'Maintain Network History', which you can untick. You can also turn off 'Automatically search for network folders and printers' from Explorer's Tools, Folder Options, View.

Where are they now?

In the early days of Windows 95 there was a feature whereby if Windows was closed down with folders open, these folders would be re-opened when Windows was restarted. I can't have got excited about this, as I'd totally forgotten about it until reader John Norris complained that this had stopped working in Windows 2000 SP4 after applying an update. After a little digging I found this feature is still supported in Windows XP, and it even has an interface control, tucked away in Folder Options, View (see screen 5).

This appears to correspond to a Registry setting at HKEY_CURRENT_USER\Software\Microsoft\Windows\CurrentVersion\Explorer\Advanced. There should be a DWORD value entitled PersistBrowsers: a value of 1

Top: Where the user's desktop should be

Bottom: Changing the connection type may cure an 'unplugged' error

You can set Windows to re-open folders at startup

Buttoned up, toy story and a shortcut

Further to March's 'D'oh' item, Clive Belbin took me to task for referring to the 'right-hand mouse button'. He points out that the buttons can be swapped in Control Panel and as such, the left-hand button on a two-button mouse could have this effect. He points out that we refer to keys by function rather than position and should thus refer to the 'secondary' rather than 'right' mouse button.

The logic of this is irrefutable, and means I've been getting it wrong throughout my Windows-writing career. This therefore leaves three courses of action. I could use 'secondary-click', 'right-click' (or for those of you with the buttons reversed, 'left-click') or I could plod on as before and hope those of you with their buttons reversed will filter the instruction accordingly and forgive my inaccuracy.

In February's column we mentioned that the Microsoft Synctoy was for Windows XP only. Well, that's what it says under 'supported operating systems' on the download page at <http://snipurl.com/gtd2>. Not so, says Andy Graham-Cumming, who is running it on a Windows 2000 SP4 PC. The same PC also passed the 'genuine Windows' hurdle.

Keith Eves mailed concerning February's Question time on the shutdown shortcut.

Although the Windows key & L will lock the PC, not every keyboard has this key. Keith points out that a shortcut with the command line: `%windir%\System32\rundll32.exe user32.dll,LockWorkStation` will achieve the same end. This also applies to Windows 2000, which returns to the log-in dialogue.

reopens Explorer windows after a restart, and a value of 0 doesn't. So if you don't have the option in Folder Options, View – which Windows 2000 users don't – then this is worth a try, as it worked for John. The usual Registry backup warning applies.

Another old Windows 95 friend was the Tip of the day. Some readers may remember the thrill of being told that 'You can find many interesting programs by clicking the Start button, pointing to Programs, and then

pointing to Accessories' for the umpteenth time. If you want a Tip of the day in Windows XP, then in any Explorer window, go to View, Explorer Bar, Tip of the day.

This will give you a tip in its own panel at the bottom of the Explorer window. These tips all seem to be Internet-related, but curiously enough, the original Windows 95 tips are still in the Registry at HKLM\Software\Microsoft\Windows\CurrentVersion\Explorer\Tips, though we've never seen them displayed in XP.

Please tell...

You've doubtless seen the message when a program has unexpectedly gone 'belly up'. The main text may vary – you may even get an apology, which is a great improvement on the Blue screen of death – but the punchline is the same: 'Please tell Microsoft about this problem.'

You can choose not to send the error report, but as I've yet to hear of anybody benefiting from sending a report you may want to stop Windows asking you in the first place. If you go to System Properties, click on the Advanced Tab, and then click the Error reporting button, you'll have various options available, ranging from turning the whole thing off to choosing which programs you want to name and shame to Microsoft. **PCW**

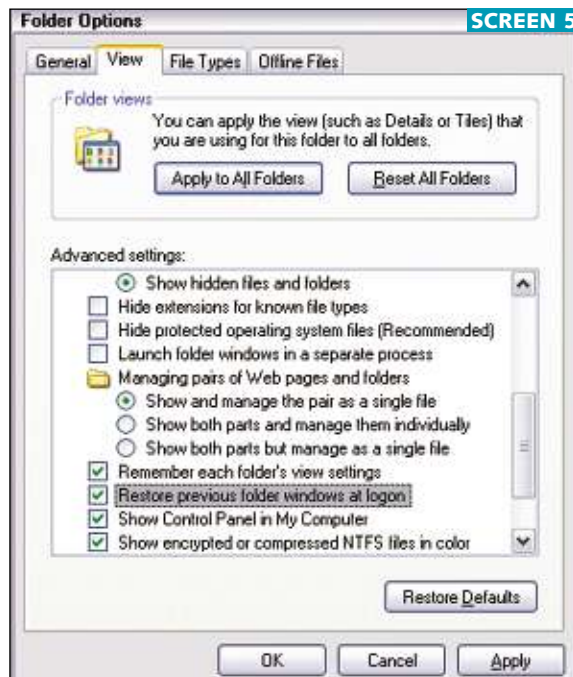

SCREEN 5



Barry Shilliday has worked with computers for almost two decades. By day, he is a Linux and Unix consultant, but in his free time he prefers to travel the world – and snap it with his camera.

→ Comments welcome on the Linux/Unix column.

Email linux@pcw.co.uk

Please do not send unsolicited file attachments.

Get connected with Ubuntu

Add and remove user privileges and set up a network connection to a remote server

For the past few months we've been doing a series on Ubuntu Linux (www.ubuntulinux.com). Last month I explained how to get DVDs and other video formats playing, and set up Evolution, the email and groupware program. This month we'll look at user privileges and network connections. If you have missed past articles and would like to install and configure the distribution, pdfs of the previous installments will be on the PCW website in the near future (www.pcw.co.uk/2150862), and if you've bought the DVD edition of PCW you'll find them on the cover disc.

Ubuntu super-user

When you install and set up Ubuntu, you may notice there's no need to enter a root (super-user) password. When we've performed administration tasks through the graphical tools the desktop has asked for our user password, and when we've performed similar tasks at the command line we've run the 'sudo' command and had to provide the same.

Ubuntu does not permit access to the root account by default. There are many reasons for this, primarily security. Using the root account can be dangerous; a wrong command can wipe your hard drive. Running as root also removes all the system's file security; you can overwrite and change any file. Trojan virus developers would be happy if people used root blindly more often, but luckily it's rarely necessary.

Ubuntu implements sudo for super-user access, a program that temporarily provides full access to a restricted set of users. To gain that access, the user must enter their own password as if they were logging into the desktop. This is what's happening when you click to update the system, for example – in the background sudo is authenticating you for super-user access, and a window pops up to do that.

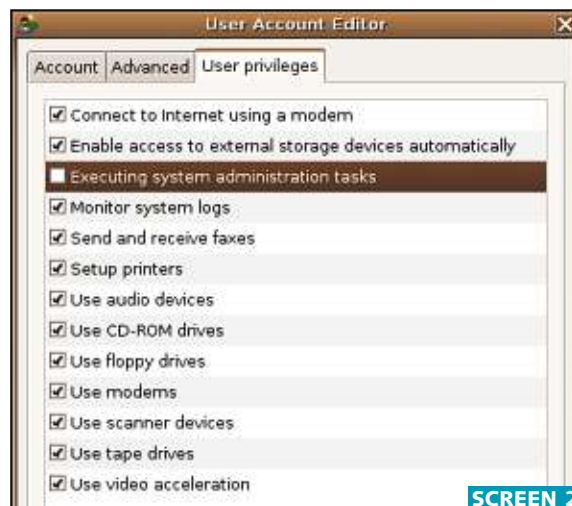

At the command line, if you prefix any command with 'sudo' you will run that command as root. For example, 'rm file.txt' will attempt to delete a file as your user, while 'sudo rm file.txt' will attempt to remove the file as if you had first logged in as root. Super-user access is required for any modifications to the system; be it configuring the network or installing the latest security updates. To prevent you having to enter your password too often, the access is

Top: Creating or modifying a user is easy

Bottom: Grant and restrict users' privileges with the User Account editor

made available for a certain period of time. Once you enter your password at the prompt, you can run another command with sudo without entering your password, so long as it's in the same terminal window.

Not every user has access to sudo. When you install the system, the user you initially add is given sudo privileges; this is necessary since there's no access to root directly, so there would be no way otherwise to perform administration tasks. You can add and remove sudo access for others by using the user manager.

User management

Ubuntu provides a graphical tool for manipulating users. Select 'Users and Groups' from the administration menu and click 'add', or 'properties' with a user selected. A window pops up (see screen 1) where you can fill in or change the user's details. At the top you will see three tabs. The Advanced tab lets you select a user profile. These are fairly basic, but future versions of Ubuntu should allow precise desktop setups for different kinds of users.

In the third tab you can control a user's privileges (see screen 2). By using Unix groups, Ubuntu lets you control who can access what. For example, the 'audio' group provides access to the computer's sound hardware, so access is granted by being a member of that group. That's what happens behind the scenes, but the graphical user tool simplifies this by presenting a list of privileges you can tick. A standard user has access to everything except sudo; tick or untick the 'Executing system administration tasks' option to grant or remove access to sudo. As the administrator of your computer you will want access, but other users shouldn't. Create these users without this privilege and apart from this they'll be able to use the computer fully. For the ultra-



SCREEN 3



SCREEN 4

Far left: A straightforward configuration window for setting up a remote server connection

Left: You can treat remote servers just like directories on your hard drive

cautious, you may want to create a day-to-day user for yourself without sudo access, though this will mean having to log in as another user to perform tasks such as updating the system.

It is possible to provide normal root access in Ubuntu, but I'd recommend against it. By using sudo you only use super-user privileges when necessary, which is a good habit to get into. No standard tasks require the use of a root login; however, if you're executing a long series of commands as root, you may wish to gain temporary access to a root shell. This can be done using sudo – just run the following:

\$ sudo -s

Enter your password and the shell will now be logged in as root. This is identical to using 'su -' on a traditional Linux system, but this method doesn't require a super-user password. If you still wish to enable the root account for direct login you must set a password – run 'sudo passwd root' to do this.

Network connections

Ubuntu's Gnome desktop doesn't have the sophistication that KDE's has when it comes to network and virtual filesystem transparency. However, a useful option exists when connecting to a Windows network share or an FTP server. You can set up a permanent or temporary link to a server, then access that as a standard folder.

Let's say we have a website and need to transfer files to it by FTP. The made-up server in this example is ftp.wherever.com and the user ID is myftpid. All the files for the website need to be within the htdocs directory structure. To set up a link select File -> Connect to Server from a file browser window's menu, or select the same option from the top-level menu. A window asks which sort of connection you want, so choose FTP. Next comes a configuration window to set up the

connection (see screen 3). Here we can see the details have been filled in; we're using the standard FTP port, so that's left blank, and we've given the connection a user-friendly name. Click the Connect button and enter your password. You can choose to save the password for the session or in the keyring; the latter means you can access this connection at any time. Once done, an icon appears on the desktop for this connection giving one-click access.

A clever feature allows you to use this connection like a regular local folder (see screen 5). Here we're saving a screenshot of the desktop, and when we click the 'Save in folder' option, some shortcuts appear in the dropdown menu. Included is the FTP connection. If we select this, it automatically saves it to the remote server. Or you can browse the remote FTP server in the Save dialogue, to choose a different directory.

Dapper Drake

You may have heard of the next Ubuntu release codenamed Dapper Drake. Each Ubuntu release is given a numeric version and a codename (involving an animal); Breezy Badger being 5.10 and Dapper Drake 6.04. In the release numbers, the first digit represents the year and the number after the point the month of release. Ubuntu has a new

release every six months, so the next version will be 6.10.

Dapper Drake should be available as a release candidate by the time you read this. It carries on from Breezy Badger and upgrades a few packages, such as Firefox 1.5 and Open Office 2.0.1, but its overall aim is to polish the desktop rather than introduce new features. This may disappoint some, but overall it's a good thing: popular applications receive updates to new versions for extra features and stability, but the release concentrates on ensuring everything works smoothly, leaving time to add exciting features for version 6.10.

The official main release of Ubuntu is based on the Gnome desktop. An alternative version is Kubuntu (www.kubuntu.org), which is Ubuntu with a KDE desktop. There's nothing to stop you installing Ubuntu then the KDE packages; the result should be the same. There's also Edubuntu (www.edubuntu.org), which has educational software for children and a child-friendly desktop. These alternatives haven't received the same attention as the primary Ubuntu release; Dapper Drake should help raise their profile.

Keep an eye out here for details on how to upgrade Breezy to Dapper. Thanks to the package-management system Ubuntu uses, the process isn't too difficult at all. **PCW**

Save directly to a remote server



SCREEN 5



Ken McMahon is a freelance journalist and graphic designer. His involvement with digital cameras began with a Commodore 64. He graduated to Macs and now works mostly with PCs.

→ Comments welcome on the Digital imaging & video column. Email digitalimaging@pcw.co.uk Please do not send unsolicited file attachments.

Lowdown on high definition

If you want to be the first to try HD video editing, here are the basics

The past couple of years have seen a lot of talk about high definition video (HDV), but not much action. Early adopters, a group among whose members I unhappily count myself, may already have bought HD-ready TVs, but have little to watch on them, and the stand-off between HD-DVD and Blu-ray looks no nearer to a resolution.

At the beginning of last year Steve Jobs proclaimed 2005 to be 'the year of high-definition video'. Jobs delivered, introducing support for HDV into all three of Apple's video-editing applications, but the hardware required to make use of it, namely an HDV-capable camcorder, remained beyond the pockets of all but the professionals.

Hurry up and wait

This year all that could change. The release late last year of Sony's HDV camcorder, the HDR-HC1, currently selling for around £1,000, marks the first step of a consumer migration from standard to high-definition video that is as inevitable as the move from analogue to digital a few years ago.

Like Apple, PC video-editing software developers haven't been slow to pick up on the early potential of HDV. Of the five applications reviewed in February's video-editing software group test, three provided support for HDV capture and editing (go to www.pcw.co.uk/personal-computer-world/compare/2149821/shift-focus).

For anyone wanting to record and edit HDV other than for professional use, the only sensible advice is to wait, probably at least until later in the year when a number of advantages will begin to appear. First, we are likely to see the release of HDV camcorder models from Sony's competitors which will have the effect of driving prices



Sony's HR-HC1 HDV camera marks the start of the consumer HD revolution

down. If you wait until Christmas, it's a fair bet that you'll be able to pick up an HDV camcorder for under £700.

By the year end, options for storage and distribution of high-definition home movies will also have improved. Though it's too early to say how much they are likely to cost, external HD-DVD and Blu-ray rewriters as well as recordable media are on the horizon. Currently the only way to view your high-definition movies is on your PC or by plugging the camcorder into an HD-ready television.

I want my HDV

If you're still dead set on being among the first to enjoy the advantages of HDV making you'll need to get yourself an HDR-HC1 and, if you don't already have it, an HDV-compliant editor. These include Pinnacle Studio Plus 10, Ulead Videostudio 9, Cyberlink Power Director 5, Adobe Premiere Pro 2 and Sony Vegas 6. If you're a Mac user you can capture and edit HDV using iMovie, Final Cut Express, or Final Cut Pro.

Working with HDV is not all that different from standard-resolution DV editing, though processing the additional data required to produce high-definition images requires a fast processor, lots of Ram and a high-spec graphics card. If you're still reading at this stage, that must mean you really are up for this, so I'll devote the

remainder of this month's column to dealing with the practicalities of HDV capture and editing using three alternative programs – Pinnacle Studio Plus 10, Ulead Videostudio 9 and Final Cut Express on the Mac.

Whatever software you use, you'll need to set up the camcorder for HDV output. With the HDR-HC1 you can mix 1080i HDV and standard-resolution 720 x 576 Pal DV on the same tape and, in the default setup the camcorder automatically selects the correct output format.

If you run into problems, manually setting HDV output may be the solution. In Play/Edit mode select p-menu>menu>standard set>VCR HDV/DV and select HDV. The camcorder should appear in the Device Manager under Sound, Video and game controllers as an AV/C Tape Device. If it appears under Imaging Devices as 'Sony DV camcorder', the output format is incorrectly set to DV (or it's on auto and the footage is DV). The current output format for example, HDVout is displayed on the LCD panel.

Mixing DV and HDV on the same tape isn't recommended as it can cause capture problems. I didn't experience any difficulty capturing from a tape with DV on the first half and HDV on the





second half, but mixing up DV and HDV shots (I can't think of a good reason you would want to) is asking for trouble. Connect the camcorder using the I-Link (Firewire) cable and power it using the mains adapter.

Pinnacle Studio Plus 10

Pinnacle Studio Plus 10 will allow you to capture and edit HDV from an HCR-HD1 straight out of the box. Make sure you get the Plus and not the standard version which has no HDV support.

Select Capture Source from the setup menu and choose the HDR-HC1 from the video source pulldown menu, this automatically selects the native HDV 2 mpeg capture format which can't be changed, so you can't transcode the footage on capture.

If your hardware doesn't meet the minimum system requirements for HDV, Studio won't allow you to place clips on the storyboard or timeline for editing. But, interestingly, it doesn't stop you from capturing (though, without the means to edit, this is clearly going to be of limited use).

Unlike Ulead Videostudio, Pinnacle Studio will allow you to record finished projects back to the camcorder in HDV format (see screen 1). Doing this, then connecting the camcorder to an HDTV is currently the best available viewing option. You can also export to HDV resolution mpeg2 and wmv formats.

Ulead Videostudio 9

Before you can capture and edit HDV in Ulead Videostudio 9 you need to download the HDV plug-in from the Ulead website at www.ulead.co.uk/events/vs9_hdv/runme.htm.

The plug-in is only available to registered users, so if you haven't registered your copy of Videostudio 9 previously you'll have to do so now.

With the plug-in installed, launch Videostudio and select Change

Ulead Videostudio can capture and export HD files, but it can't write HDV back to the camcorder

On the Mac, HDV is transcoded into an intermediate format which takes time during capture, but makes editing easier

Hardware requirements for HDV

The additional workload involved in processing the native HD Video (HDV) stream, means system requirements for software that supports HDV capture and editing are much more stringent than for standard-definition Pal DV. Generally, this equates to a fast CPU, more Ram and a capable graphics card with plenty of video Ram.

The minimum system requirements for Ulead Videostudio 9 HD editing are a 3GHz P4 or equivalent, 512MB of Ram and a

PCI Express Nvidia 6600 graphics card or equivalent. Pinnacle Studio 10 doesn't mention specific processor requirements for HDV, but the general requirements recommend a 2.4GHz CPU. For HDV editing you need a minimum 1GB of Ram and a graphics card with 256MB of Ram for 1080i HDV.

Apple's Final Cut Express HD requires a 1GHz G4, 1GB of Ram and a graphics card that supports Quartz Extreme – ie Nvidia's Geforce 2 or later, or any AGP ATI Radeon card.

Capture Plug-in from the Tools menu. Choose Ulead HDV Capture Plug-in from the pulldown menu and click OK. With the camcorder connected, powered up and in Play/Edit mode you should see 'Sony - - HDV in the source filed of the Options Panel – if you have more than one device connected you may need to select it from a pulldown menu with all the available options.

You can use device control to capture footage from the camcorder, but you won't be able to use the new DV Quick Scan feature with HDV, nor can you automatically split captured footage on a scene-by-scene basis.

Cue up the tape using the device controls and press Capture Video to start capturing. When you press Stop Capture, or the Escape key, the captured footage is added to the library as a single clip. If your CPU and graphics hardware aren't up to the task, you'll experience dropped frames and other artifacts.

Videostudio doesn't currently support HDV output back to the camcorder, so you're limited to viewing files on your PC (see screen 2). You

can, however, use the Create Video File option to produce mpeg2 HD and wmv-HD files at full HD resolution.

Final Cut Express HD

As I mentioned earlier, all Apple's video-editing applications support capture and editing of HDV. Unlike the PC applications, on the Mac captured HDV footage is transcoded on the fly to an intermediate editing format using the proprietary Apple Intermediate Codec (aic).

The practical implications of this are twofold. First, depending on the hardware specification there's a capture 'lag' while the Mac tries to keep up with transcoding. All this means is that you need to watch the camcorder's LCD panel, not the canvas, to decide when to stop the capture, and that you'll be in for a wait while the remaining footage is transcoded.

And, of course, when it comes to writing finished movies back to the tape in the camcorder, there's another wait while the aic files are re-encoded into HDV. Round tripping your footage from HDV to aic and back again inevitably also results in a small loss in quality (see screen 3). Lastly, aic files are much larger than HDV ones, so you'll need plenty of available hard disk space.

With all these drawbacks you might wonder why Apple opted for using an intermediate editing codec, rather than simply working with the native HDV 2 mpeg files as Ulead and Pinnacle have done.

The answer is that aic-encoded video is much easier to deal with, so editing and playback is much quicker and smoother, and doesn't require such high hardware specifications as with applications that handle native HDV. **PCW**





Tim Nott is a full-time freelance journalist. When he's not writing about Windows and word processing, he tackles many other diverse subjects. He currently lives in France with his wife and family.

→ Comments welcome on the Word processing column.

Email wp@pcw.co.uk

Please do not send unsolicited file attachments.

No more fretting over fonts

How to turn off the most recently used list; and create chord diagrams

If you use Word's dropdown font list on the Format toolbar, you may have noticed two things. Word 97 brought us the font MRU ('most recently used') list, whereby the most recently used fonts are shown 'above the line' at the top of the list. The next version, Word 2000, added the luxury of seeing each font name set in its corresponding typeface, which is a great help to those of us who confuse our Goudys with our Garamonds.

This brings us two little mysteries – how to turn both these features off. I find them useful, but not everyone agrees. You can spend a long time poring through 'Tools, Options', but you'll find this fruitless. The 'List font names in their font' feature is controlled from a checkbox in 'Tools, Customise, Options', along with various other options including that other great source of frustration, 'Always show full menus'. Disabling the font MRU is somewhat trickier, as Microsoft has not included a way of doing this from the user interface. This doesn't mean it can't be done, as this behaviour is controlled by a value in the Windows Registry.

Although there is no built-in user interface control, Microsoft has provided a macro to deal with this and other 'unreachable' settings. You need to look for a file called Support.dot (or Supportn.dot where n is the Word version number), which should be in a folder named Macros under the Office program files folder. If it isn't there, you'll need to dig out your Office installation CD, then go to Windows Control Panel, Add/Remove Programs, select Microsoft Office and choose the option to add or remove features. The file you want is under 'Word, Wizards and Templates, More templates and macros'. Having done this, and opened support.dot, you should find a macro to edit the Word Registry settings – in most versions you can run this straight

Fretqwik combines ordinary letters and numbers with guitar fret diagram builders

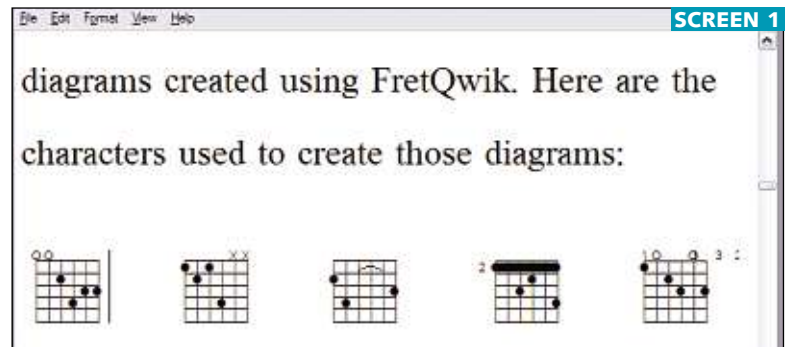

from a button in the template text or from a toolbar that will appear. The setting you want is 'NoFontMRUList' – setting this to 1 disables the list, but you'll need to restart Word for the changes to take effect. You might also like to look at the other options, which range from changing the .doc extension to changing the colour of the spelling and grammar wavy underlines.

We found that the Word 2003 version of Support.dot didn't seem to be hitting the right spot in the Registry. If the macro doesn't work, or you prefer to hit the Registry directly, here's how. Having taken backup precautions, or made a System Restore Point, run Regedit and go to HKEY_CURRENT_USER\Software\Microsoft\Office\N\Word\Options, where n is the version number of Word. If there is a string value named 'NoFontMRUList' in the right-hand pane, double-click it and change its value to 1. If not, right-click in the right-hand pane, choose 'New, String value' and create a value with that name first.

There may be more than one branch for different values of n – our Office 2003 installation had 8.0, 10.0 and 11.0, presumably to cover backward-compatibility issues. The macro was putting the 'NoFontMRUList' value under 10.0, which is presumably why it wasn't working. When we moved this to the 11.0 branch, it worked correctly.

Strike a chord

Matthew Finch's request is a first for this column. He was looking for a guitar chord font that could be used in a word processor. Although there are several musical note fonts and sheet music composition programs, we had never come across a font showing the chord windows; that is, a diagram of the guitar fretboard showing where to put your fingers. After searching, we've found two – both free. The Frets font by Chris Poehler and Ken Drake is, in fact, three font files with a huge range of chords. The problem is finding them; although the A-G major and minor chords are attached to the corresponding upper- and lower-case keys, you'd need to print out a crib sheet and know the names for the rest. You'll find it at www.dingbatpages.com/arts/arts.shtml.

Robert Allgeyer's Fretqwik is more of a DIY font. The lower Ansi range consists of the usual letters and numbers, but the upper range contains blank fret windows with dots, bars and other symbols. Some clever tweaking with the character spacing means you can combine several symbols to form a chord. This worked well in Notepad (see screen 1), but we found word processors such as Word, Wordperfect and Wordpad tended to mess up the spacing. Fretqwik is at www.icogitate.com/~ergosum/fonts/music-fonts2.htm. **PCW**

Pine scent not included



In today's environmentally-conscious world, the P150 Quiet PC Case establishes a new benchmark in computer cases. Designed around the highly-efficient Neo HE 430-Watt power supply, the P150 draws less power and reduces the impact your computer has on the power grid. A gleaming snow white finish and innovative Quiet Computing technologies round out the package, making your computer whisper-quiet and unobtrusive. Throw in some pine-scented air freshener and you might even forget you're at the office — it will give a whole new meaning to "computing environment".

Learn more about the P150 at www.antec.com.

Antec
The Power of You

dabs
com

MAPLIN
ELECTRONICS

Insight

MAD
MICRO DIRECT

savastore.com
a division of WATFORD electronics

Specialist PC
GEEK
www.geek.com.au
0079 660 0000

ebuyer.com

OVERCLOCK
make the right choice



Stephen Wells is a freelance journalist and a regular contributor to computer magazines. He's been writing PCW's Spreadsheets column for over 10 years.

→ Comments welcome on the Spreadsheets column.

Email spreadsheets@pcw.co.uk

Please do not send unsolicited file attachments.

Easy email from Excel

Send personalised messages to customers; and sort things with macros

Simon Olney has an Excel spreadsheet with each row containing details for one of his customers. Using Outlook Express, he would like to be able to send out personalised emails that pick up data from this list. As with any Excel task there are several ways of doing it but here is one using the emailing tool Excel provides.

Let's assume Simon's list looks like screen 1 with a customer reference number, the surname, first name, town and a hobby in columns A through E. In this example we have five fields and currently there are 12 records. Highlight the range A2:E13. In the Name box, at the left of the Formula bar, enter the range name 'List'.

Click a new tab to choose a clean worksheet for creating the message to be emailed. Choose Options on the Tools menu and under the View tab remove the tick in the Gridlines box. This simply stops your message looking like a spreadsheet.

This example shows a sale notice to be emailed (see screen 2). Some of the cells only contain text, as in cell C1. The formatting sets alignment left (see box, below).

Before each message is sent, Simon can enter that client's customer number in cell B25. The number could

	A	B	C	D	E	F
1	Customer No	Surname	First name	Town	Hobby	
2	1	Black	Sam	Northfield	woodworker	
3	2	Brown	Sid	Bristol	potter	
4	3	Carpenter	Val	Coventry	woodworker	
5	4	Cooper	Art	Darlington	painter	
6	5	Driver	Bob	Hereford	gardener	
7	6	Farmer	Dot	Leeds	potter	
8	7	Green	Gus	Newcastle	woodworker	
9	8	Jones	Iris	Norwich	painter	
10	9	Painter	Meg	Nottingham	gardener	
11	10	Smith	Pam	Plymouth	potter	
12	11	Wainwright	Peg	Portsmouth	woodworker	
13	12	White	Ron	York	gardener	
14						
15						
16						

SCREEN 1

be formatted white on white so it won't show in the colour version and will be well away from the message if it is received as regular text. For this example, customer number 1 has been chosen by entering 1.

Cell C3 has the formula:
`=CONCATENATE("Supersaver Sale, ",VLOOKUP(B25,List,3,FALSE))`

(Key: ↵ code string continues)

The CONCATENATE function is designed to join several text strings together. But you can use it to join text with the result of a formula, as shown here. Although the data picked up is from another worksheet, the named range 'List' is available throughout the workbook. The customer number 1 is picked up from cell B25 on the message worksheet and the VLOOKUP function finds the first name, Sam, from column 3 of the List table. The fourth argument

Data from this kind of list can be picked out to send selective messages

of the function is entered as False, simply to avoid having to have the table in numerical or alphabetical order.

Cell C5 contains the formula:
`=CONCATENATE("and only in ",VLOOKUP(B25,List,4,FALSE))`

After the text, the VLOOKUP function adds the customer's town from column 4 of the table.

In C7 we use:
`=CONCATENATE("including many bargains for ",VLOOKUP(B25,List,5,FALSE),"s")`

which picks up the customer's hobby and adds an 's' to make it plural.

Cells C9, C11 and C15 carry only text. The rows in between are spaces. Cell C13 has:

`=CONCATENATE("In addition this coupon entitles, ",VLOOKUP(B25,List,3,FALSE)," ",VLOOKUP(B25,List,2,FALSE))`

It picks up information from two columns, first name and surname, with a space in between.

Each customer's email address is best kept elsewhere. Enter these in your Outlook Express or Windows Address Book. To send the message to customer number 1, click the Email button on the Standard Excel toolbar. The From: box will automatically show your email address. The Subject: box will give the name of your workbook, so when you save the file it would be better to give it a name such as Upcoming Sale rather than Emailform, for example. You can click the To: button to pick the customer's name from the Address Book. Click the Send this Sheet button and that's the first message sent.

Back on the sale notice worksheet, change the customer reference number in cell B25 to 2 and you are ready to send the next email. The customer's first name, surname, home town and hobby will all change automatically.

Vexed by text?

For any one of a host of reasons the prescribed fonts, type sizes and colours may not survive the journey across the Internet. But if you retain the normal left alignment in each cell and use only one cell on each line, as in the example above, then the text version will look like this and be quite acceptable. Without the fancy formatting, the methods and formulas given here work just as well.

	A	B	C	D	E
1			It's a		
2					
3			Supersaver Sale, Sam		
4					
5			and only in Northfield		
6					
7			including many bargains for woodworkers		
8					
9			next weekend only, June 2nd, 3rd & 4th		
10					
11			at 23 High Street		
12					
13			In addition this coupon entitles, Sam Black		
14					
15			to a further £5.00 discount on any purchase over £50.00		
16					
17					
18					

	A	B	C	D	E	F	G	H	I	J
1			It's a							
2			Supersaver Sale, Sam							
3			and only in Northfield							
4			including many bargains for woodworkers							
5			next weekend only, June 2nd, 3rd & 4th							
6			at 23 High Street							
7										
8										
9										
10										
11										
12										

SCREEN 2

Emailing selective data means you can personalise messages to customers

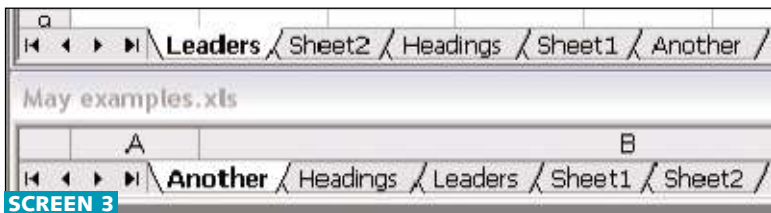

SCREEN 3

A simple macro can sort your worksheet tabs into alphabetical and numerical order

Of course, if you have hundreds of customers it would get a bit boring to keep adding a digit to cell B25 and clicking the Email button so a macro could do the job. As some readers of this column are fond of writing those, I welcome suggestions. I believe VBA for Excel has a Sendmail Method which would open Outlook Express.

Sorting it out

This month two readers have sent me macros for sorting things in Excel. The first puts the sheets in a workbook into alphabetical or numerical order.

Suppose your displayed tabs, reading left to right, are Leaders, Sheet2, Headings, Sheet1, Another. Judah Mazer's macro (see figure 1) will sort them into this order: Another, Headings, Leaders, Sheet1 and Sheet2 (see screen 3). This would be particularly useful if the workbook had a large number of worksheets added in no particular order.

The other contribution is from Ian Selhorn. It's a User Defined function that reverses text in a cell, even whole sentences as in screen 4. It's not exactly mirror writing as it doesn't reverse the design of characters, but it would be great for instantly changing passwords. Create the reversing text function (see figure 2) then enter your sentence in, say, cell B2. In another cell enter: **=ReverseText(B2)**

If you want to make these or any other macros always available there are two ways to do it. One is to keep open a workbook that contains the macros while you are working on another workbook. The second is to put the macros in a file called

Personal.xls in your XLStart folder. Excel offers an easy way to create this file and put it in the right folder.

Open a new workbook and choose Macro, Record New Macro and choose Tools menu. Type any name in the Macro Name: box. With the dropdown arrow choose Personal Macro Workbook in the Store macro in: box. Click OK. Click on the worksheet. Click the square Stop button to stop recording. Close Excel and click Yes if offered the option to save changes in your Personal Macro Workbook.

Now when you open a new or existing workbook, then the VBA editor, in the left-hand panel you'll see a folder called VBAProject (Personal.xls). Macros listed in modules in that folder will be globally available.

	A	B
1		
2		let's look at that another way
3		
4		yaw rehtona taht ta kool s'tel
5		

SCREEN 4

Reversing text

The code below is a User Defined function for reversing text:

```
Function ReverseText(text) As String
    Dim TextLen As Integer
    Dim i As Integer
    TextLen = Len(text)
    For i = TextLen To 1 Step -1
        ReverseText = ReverseText &
Mid(text, i, 1)
    Next i
End Function
```

(Key: & code string continues)

Sorting worksheets

FIG 1

This macro will sort the worksheets, by tab name, both alphabetically and numerically:

```
Sub SortSheets()
    Dim a As Integer, b As Integer, x As Integer
    x = Sheets.Count
    On Error GoTo Trap:
    For a = 1 To x - 1
        For b = a + 1 To x
            If Sheets(b).Name < Sheets(a).Name Then
                Sheets(b).Move Before:=Sheets(a)
            End If
        Next
    Next
    Sheets(1).Select
Trap:
End Sub
```

(Key: & code string continues)

Other views

Last month we looked at the Scenario Manager, the first of a trio of related features that store several versions of a worksheet within Excel. The others are Views and the Report Manager.

Views are useful if you are passing a file on to others and want to show how you wish it to be viewed or printed. A Custom View can specify which worksheet is active and which cells are selected. You can control column widths, row heights and whether rows and columns are displayed or hidden. You can also make a Zoom setting, but bear in mind the resolution of the screens on which it will be viewed.

You can stipulate whether zero values, sheet tabs or column indicators are shown and anything else offered under the Options, View tab on the Tools menu. It's also possible to set up the Window details, including size, position and whether split tiled, horizontally, vertically, or cascaded. A View will retain Outline or Grouping settings and filter settings, including Autofilter and Advanced Filter options. Print settings, including defined print areas, are also saved.

Once all that is set up you simply choose Custom Views on the View menu, click the Add button, and give the View a name so you can display it later. Alternatively, save this short macro in your VBA ThisWorkbook folder and the customised View will be displayed whenever the file is opened: **Private Sub Workbook_Open() ActiveWorkbook.CustomViews ("View name").Show End Sub PCW**



Nigel Whitfield edited computer magazines before going freelance in 1995. A specialist in Internet and consumer issues, he has a degree in Computing Science from Imperial College.

→ Comments welcome on the Web development column. It returns in the July issue. Email webdev@pcw.co.uk Please do not send unsolicited file attachments.

Processing data on the web

How to use Perl or PHP scripts to automate tasks and improve ease of use

If you read our feature on tweaking and upgrading personal video recorders (PVRs) (*PCW*, April 2006), you'll have seen mention of how some PVRs, particularly the Topfield, can be extended with software that allows you to enhance or modify the way they work. There are lots of different ways to tweak PVRs, but you're probably wondering what they have to do with web development. On the face of it, not a huge amount, but the web can be the most logical place to do some things, and not just for PVRs, so it's worth looking at why and when it can be useful.

On the PVR – and, of course, on a lot of other devices and for numerous pieces of software – the behaviour of many features is controlled by parameters stored in a text file, often an ini file. Windows doesn't tend to use them much, preferring the ghastly abomination of the Registry, but you'll still find text configuration files in many, many places such as mail servers, and just about everywhere in Linux systems.

Often, these files may stay unchanged for ages, and then suddenly, perhaps because there's a new release of a mail server with new options, or a virus that makes some change to a file necessary, they need updating. You can tweak the files manually, but that's not always helpful if people don't have the expertise to do it themselves. It can be far easier to use a tool, and programming languages such as PHP and Perl, with their pattern matching and processing functions, are ideal to enable people to change files programmatically.

The question then is how to get people to use a tool to update the files that need updating; if they can't do the tweaks themselves, will they be able to install and run a Perl or PHP script?

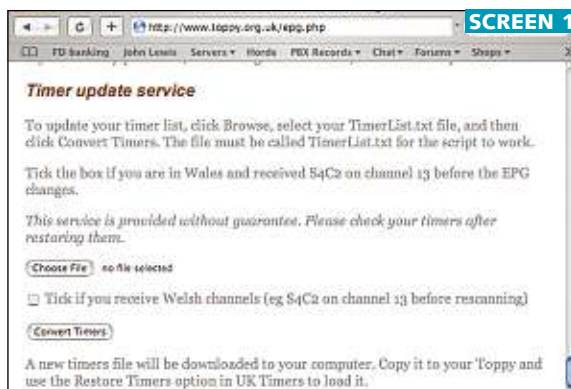

Possibly not. And that's where the web comes in; for tasks like this, hosting a script on a web server that accepts a file in one format then spits it out in another is a simple-to-use and easy way of doing things.

We've looked in the past at how you can use uploaded files in PHP

Web applications using languages such as PHP or Perl are ideal for systematically updating text files

scripts (*PCW*, July 2003 – available to buy at <http://tinyurl.com/bx2k6>), so I won't cover all the details here. Instead, I'll be looking at the other end of things – getting the results out in the right format.

It's a minor issue from a programming point of view, but from a usability angle it makes a big difference. You can create a file in the right format and send it as text to the browser, but if it just appears, and then people have to save it and rename it, there's more potential for error. Far easier, then, to make sure that when people run the script, they get a file with the right name saved on their computer, for example 'myconfig.ini'. Then all they have to do is copy that file to the appropriate location; no renames, no 'Save As...'.
SCREEN 1

Pitfalls and benefits of a website spring clean

I've been overhauling one of my websites recently, and one of the most useful things has been to look for newcomers in the forums, asking questions that you thought were answered elsewhere, and finding out where they had looked on the site, and why. Aside from the occasional response along the lines of 'I'd like someone to describe a process in detail especially for me because I don't want to download a manual', it's been quite illuminating, and pointed up a few areas where information I thought was logically placed – such as a button labelled FAQs – wasn't catching people's attention. It's been a worthwhile exercise, and I'd recommend it, especially if you have a forum where you can ask visitors to your site how to make things easier for them.

I'm not the only person updating my website; one of the suppliers I use fairly often has updated its website with a new shopping cart and layout. When the time came to check

out, I entered my email address and password, certain it was the right one. Told no, I checked the email receipts from previous orders, and knew I had the right address.

In fact, the new site required logins, while the old one didn't; using lots of sites, I'd simply assumed that a cookie was remembering things, and I'd probably set it up years ago. I can't have been the only visitor to think that – we don't all remember the process on every online shop we visit, and a simple note explaining the change would have done the trick. Better yet, since the company had email addresses from previous orders and wanted people to use addresses to log in, wouldn't a one-off mailshot, and perhaps the creation of an account with a temporary password for existing customers, have been a reasonable solution?

So, if you're planning a spring clean of your website, think beforehand; talk to users, if you can, and consider whether changes may confuse existing customers, too.

Currently indisposed

It's quite straightforward to do this via a couple of headers in your script; I'll look at how to do it with PHP, since that's the language of choice round here, but you can also do it in others, including Perl with CGI.pm.

The trick is to define the content type in the usual way – for example, text/plain, and then to add an extra Content-Disposition header, which tells the receiving browser that it's an attachment and what name to use to save it. In the first code example, we're going through a list of timers saved from a PVR as a backup; the intention is to use the script to update all the channel numbers to take into account a reshuffle and then reimport the list of timers, so all our recordings carry on fine (see screen 1).

The following code specifies a filename:

```
$timerdata =
file($_FILES['timerfile']
[ 'tmp_name' ] );
header('Content-Type:
text/plain');
header('Content-Disposition:
attachment;
filename=TimerList.txt');
foreach( $timerdata as
$timer ) {
// process a line of data
}
exit ;
```

(Key: ↵ code string continues)

As you can see, it's very straightforward; just one header to output, with the filename specified, and it works fine when you're running everything through a web browser (see screen 2). But that's not always the case.

That may sound like a strange thing to say of a web application, but web browsers aren't necessarily the only thing that will look at your site. In the example we just gave, it will most likely be a browser, since the user will be using it to select a file to upload to the script initially; but in another case, it might not be. If information is designed to be retrieved unattended – for example, a script that's fetching data from a central database – you may need to code things a little more carefully.

A custom script that queries a database on your site can save the results however it likes; that's not really a problem, it's up to the script's author. But what if your database is intended to produce a file for people to use?

Let's say you have a script called fetchdata.php, which lets people



If you send the right headers, files that would normally open in the browser will be saved on the hard drive instead

request a file, called categoryinfo.txt, via a URL that ends with something like fetchdata.php?catid=21.

That's going to work fine with the PHP code we have above as long as people use a web browser. But suppose someone wants to automate it, and have the file ready first thing each morning. One of the simplest tools to fetch parts of a website is wget; we talked about it in the November 2004 issue. Usually, you give it a web address and it downloads the file to

'If information is designed to be retrieved unattended you may need to code things more carefully'

disk; it's great for copying a website, fetching downloads, and is often used in scripts to fetch data.

Unfortunately, what happens when you feed wget a URL like the one in our example is that, while it fetches your data, it saves it in a file with the name fetchdata.php?catid=21, which is not very informative or useful. Names that include non-alphabetical characters such as question marks are just a plain nuisance on a Linux system.

One solution, which I've used in several of my scripts, is to provide people with an alternative, based on the PATH_INFO of a request to the web server. What this means is that you give people two alternative URLs for fetching the same data. The first is the one we've already seen; the second looks like this: www.myserver.somewhere.com/fetchdata.php/21/categoryinfo.txt.

When wget processes a URL like this, it saves the data in the file you expect; so all you have to do is handle it in your script, using code like that shown in our second example (see figure 1).

As you can see, we've used a Perl-style regular expression match to pull out just the numeric part of the URL; for those who aren't familiar with these, the / at each end delimits the pattern; so, to look out for a / within it, we have to prefix those with a backslash. Parts of the pattern in brackets will be extracted and stored in the \$matches array, so \$matches[1] ends up with the part of the pattern that matches \d+, which stands for 'one or more digits.' You can find more about regular expressions in the October 2002 column (which you can buy online at <http://tinyurl.com/arrjk>). PCW

FIG 1

```
header('Content-Disposition: attachment;
filename=categoryinfo.txt');
if ( ! isset($PATH_INFO) ) {
// a standard HTTP GET, with a parameter
// eg something like fetchdata.php?catid=21
$catid = $HTTP_GET_VARS['catid'];
} else {
// since some methods don't pay attention to the
filename we output
// eg, a command like wget fetchdata.php/21/
categoryinfo.txt
$pat = '/\\/(\\d+)\\/' ;
preg_match($pat, $PATH_INFO, $matches);
$catid = $matches[1];
}
```

(Key: ↵ code string continues)



putting spring in your step

domains

Prices inclusive of all fees

.co.uk **£1.99**

.com/.net/.org **£8.99**

Some domains payable 2-yearly

Free Parking

hosting

£4.49 per month

500mb web space

100 POP3 accounts

PHP Support

Virus scan included

Automated account activation

order online: www.switchmedia.co.uk

sales hotline: uk 0151 236 9111

ireland +353 1 636 0317



Alan Stevens has implemented and supported networks for over 25 years, working for IT vendors, system integrators and customers. He now mostly researches and writes about networking matters.

→ Comments welcome on the Networks column.
 Email networks@pcw.co.uk
 Please do not send unsolicited file attachments.

Run your own mail server

With your own network, there's no need to rely on the hosted facilities of your ISP

Because it's easy, and usually free, most home and small-business users rely on the hosted email server facilities offered by their Internet service provider (ISP) to send and receive messages. However, if you have your own network there's no reason you shouldn't run a mail server of your own, with numerous benefits.

A server of your own lets you send messages over the local network without having to connect to the Internet. It also provides total control over user mailboxes with no artificial limits when it comes to message size or attachments, and a free rein in terms of anti-virus and spam protection, content filtering, message archiving and so on. Plus you can implement your own calendar and address book sharing and other collaboration features, over and above basic messaging services.

A locally hosted mail server makes it easier to switch service provider, which can be a real boon for the growing company and needn't be costly or difficult to run. But careful planning is still required, with decisions to make in terms of what to buy and how it's put together, which is what this month's column is all about.

Server requirements

One of the first things you'll need is a proper email server package and suitable hardware on which to run it.

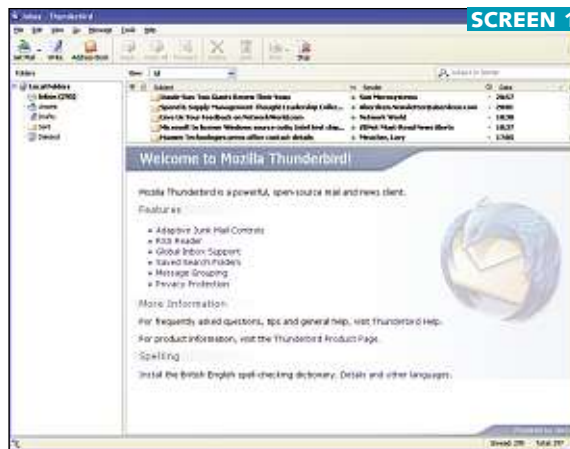

Which client?

You'll need a client for users to connect to the server, but that too is pretty easy to sort out. Chances are you're already using Outlook or Outlook Express to connect to your ISP's mail server and there's no reason you shouldn't do the same when deploying a server of your own. Alternatively, there are plenty of other email clients, including Eudora and Thunderbird, the free email client from Mozilla (www.pcw.co.uk/2129012), the company behind the open-source Firefox browser. Some mail packages come with their own client software, and browser-based webmail clients are increasingly supported (see screen 1).

You will need to decide what protocols to use when connecting clients to the server. Not so much for sending mail, where the Simple Message Transfer Protocol (SMTP) is more or less universally employed, but in terms of how messages are retrieved, with a choice between Pop3 (Pop is short for Post Office Protocol) and Imap (Internet Mail Access Protocol).

As with SMTP, these protocols are almost universally supported by both servers and clients, but they work in quite different ways. With Pop3, users download their email messages to their local PC before opening them, whereas with Imap the messages stay on the mail server and only brief summary (header) information is ever downloaded.

Contrary to what some vendors might tell you, there's not a huge amount of processing involved and you don't need a powerful or dedicated system. On a small network, an existing file or web server will usually be more than adequate or, failing that, a spare PC that can be left switched on all the time. Just make sure the system has plenty of memory and enough disk space for all the messages you expect to handle.

Neither do you need an expensive server operating system. A lot of the small-business mail server packages can be run on ordinary desktop versions of Windows (see the table below for the requirements of the top five small-business products), while most Linux users will find suitable open-source mail server software bundled as standard.

Support for standard protocols such as Pop3 and Imap means that you can use a variety of email client software with your mail server, including the open-source Mozilla Thunderbird product

Top five SMTP Windows email servers

PRODUCT	URL	MINIMUM OPERATING SYSTEM REQUIREMENTS	POP3 CLIENTS	IMAP CLIENTS	WEB CLIENT	COLLABORATION FEATURES
FTGate 4	www.ftgate.com	Windows NT4 or above	✓	✓	✓	✓
Gordano Messaging Suite	www.gordano.com	Windows NT4 or above (Linux, AIX and Solaris also supported)	✓	✓	✓	Optional add-ons required
Imail Server 2006	www.ipswitch.com	Windows 2000 or above	✓	✓	✓	✓
Kerio Mail Server 6	www.kerio.co.uk	Windows 2000 or above (Linux also supported)	✓	✓	✓	✓
Mdaemon 8	www.zensoftware.co.uk	Windows 2000 or above	✓	✓ (Pro version)	✓	✓

One of the benefits of Imap is that it allows users to access messages from any PC, not just their own. They can also be given easy access to their mail remotely, using a secure VPN tunnel to the server, for example. Imap is also widely used to provide collaboration features such as shared address books and calendars (see screen 2).

However, server-side support for Imap can vary, and it's not quite as robust or well defined a standard as Pop3. Plus, if you want to keep messages on the server and provide easy remote access, web-based clients are arguably better and more flexible. Developers are increasingly ditching Imap in favour of other ways of implementing collaboration features so take care before choosing an Imap solution.

Talking to the world

Another consideration is how the mail server will send and receive messages over the Internet. Again, sending mail isn't a big issue, as all mail servers use SMTP and for that all you need is broadband or some other kind of Internet connection, plus access to a DNS (Domain Name Server) to resolve target addresses.

Incoming mail is more problematic. Again, it's possible to use SMTP, with the server listening for incoming connections on port 25 – the port a sending mail server will use. But that requires a fixed public IP address, so the server can't be located behind a Nat (Network Address Translation) firewall unless this lets you expose a protected server using port forwarding – as outlined in last month's column. Plus you'll need to get your ISP to configure its DNSs to point your email domain name to the public IP address you want to use.

These prerequisites are easy enough to arrange, but there is an alternative, and that's to use the client Pop3 protocol to 'pull' messages down to the mail server rather than wait for them to be sent by SMTP. Not all mail servers provide this facility, so check before you buy if you want to do this. And most implementations require a multi-drop mail account on the host ISP server where messages for everyone in the domain are stored in just one mailbox. Typically that will be an account where you're allowed as many email addresses as you want, with no need to supply the details of each user individually.

One big advantage of Pop3 retrieval is that you don't need a public IP

The Exchange question

Microsoft Exchange is one of the most popular email servers available, especially in larger companies. There are a number of good reasons for this, most notable of which is because it's designed to work with Microsoft Outlook – the world's most popular email client. It also provides additional groupware-like features over and above the basic messaging facilities. These include global and shared address books, and shared calendars to let you schedule meetings, check on availability and send out invitations, all through the familiar Outlook interface.

The latest implementation also features a web-based client (Outlook Web Access) with a look and feel almost identical to that of Outlook, plus support for a range of mobile devices and instant messaging. Exchange is a very scalable, standards-compliant mail server, with extensive support from third-party developers and plenty of 'experts' on tap to help with deployment, day-to-day management and problem solving as and when required.

On the downside, Microsoft's mail server can be costly to license, putting it beyond the reach of many small companies. Plus, because it offers so much functionality beyond basic messaging, the amount of setup and management required can be an issue for those with limited resources.



A low-cost way of deploying Exchange is through the Windows Server 2003 for Small Business package, which includes the mail server and management tools as standard

If you're still tempted, there are ways of buying into the Microsoft solution without breaking the bank or spending hours figuring out how it all works. For instance, some service providers will host and manage the Exchange server for you. All you have to do is tell them the names of your users then connect to the server over the Internet. Alternatively, if you buy the Windows Server 2003 for Small Business package, a full implementation of Exchange will be included as standard along with extra tools to help simplify the setup and management of Exchange and other bundled services.

address or DNS records, but there are downsides, not least of which is that most mail servers strip off the addressing information used to deliver messages when they are stored in user mailboxes. As such, a mail server retrieving messages with Pop3 has to read through the headers looking for user names in order to work out who the mail is intended for. And that can lead to mistakes, as when messages have been addressed to a mailing list, for example. Pop3 retrieval also leaves you reliant on the host email server at the ISP and, because you have to schedule retrieval sessions, can be a lot slower than using SMTP alone.

Most SMTP email servers will support a mix of Pop3, Imap and web-based client access to user mailbox contents, although some of these may be optional as here with Mdaemon Pro

Other concerns

Even when you've sorted all that out, the job's not over. For example, you also have to look at how users will be configured and managed. On a small network, direct user management and a custom database should be fine, but larger companies may want to import existing user details or link their email server into Active Directory or an LDAP server.

You'll also need to manage security yourself. Virtually all mail server packages now allow for anti-virus scanning of incoming and outgoing messages using either built-in or third-party anti-virus tools, with spam protection and content filtering options also commonplace. Plus you'll want to arrange backup protection of both your mail server and its mailbox stores, to enable you to get up and running again in the event of a hardware or software failure.

So, a fair amount of work to do, but although it sounds complex it needn't be that daunting. In next month's column I'll be walking you through an implementation of a Windows mail server and at how some of these issues can be tackled in practice. **PCW**





Mark Whitehorn is one of those lost souls who actually likes databases. He splits his time between consultancy, writing, working for two universities and tinkering with old cars.

→ Comments welcome on the Databases column.
 Email database@pcw.co.uk
 Please do not send unsolicited file attachments.

How big is big?

Find out how much size matters when indexing tables with millions of rows

In last month's column I explained how indexes can dramatically improve the speed with which queries run against a database. Indexes exist to speed up the retrieval of data stored on hard disks. Relative to other operations performed by a computer, disks are very slow because they are mechanical devices and the head has to move around to collect the information it needs in order to build an answer table. If tables were held in memory they would have to become truly, awesomely, mind-bogglingly huge before we needed indexes.

Most database engines automatically index primary key columns in a table and you can apply other indexes. Foreign key columns are likely candidates, as well as any field likely to be queried frequently. My parting comment last month was that indexes only help with large tables, and I promised an investigation into the meaning of 'large' in the context of indexing. So here it is.

Size certainly matters and is always open to exaggeration. For example, my experience is that if you ask any database person 'What's the largest table with which you typically work?' the answer is likely to be exaggerated by around 100 per cent. I am, of course, never guilty of this.

Another factor that has a huge effect is the type of company for which you work and the kind of data it collects: a telecoms company, for instance, may have seven million customers, each making an average of five communications a day. That's 35 million rows of data accruing per day, without taking into account the communications that take place between phones and the network at regular intervals. The number can easily exceed 100 million rows a day. I think that would constitute a large table in most people's books and

Order No	Item No	Quantity
81685	16	1
81685	21	1
81685	82	1
81686	60	1
81686	77	1
81686	88	1
81686	116	1
81686	123	1
81686	132	1
81687	36	1
81687	37	1
81687	84	1
81687	93	1
81687	111	1
81687	112	1
81687	124	1
81688	65	1
81689	56	1
81690	46	1

would undoubtedly benefit from indexing. It will also be running on an enterprise-level engine (DB2, SQL Server etc). What constitutes a table large enough to need indexing if we were to use Access and a desktop PC?

I started experimenting with an Access order-entry database of six tables. One is an Orders table with one million rows and another OrderInfo with 3.09 million rows. (No really, this is not an exaggeration, you don't have to divide by two!) Is this large enough to benefit from indexing? In the OrderInfo table in screen 1 Access has automatically applied an index to the two columns that make up its primary key and I've added no others. In the Quantity column, only four values are ever found: 1, 2, 3 and 40, and there are only three instances of 40.

I wrote a simple query to find all the rows where the quantity was 40:

Adding an index to the Quantity field:
 the indexes to the primary key fields were added automatically by Access

```
SELECT Quantity
FROM [Order Info]
WHERE Quantity=40;
```

and it took five seconds to return the three-row answer table. Then I applied an index to the Quantity column (see screen 2) and ran the query again. The answer came back instantaneously.

However, as usual in the database world, all is not what it seems. I reduced the size of the OrderInfo table to about half a million rows which should, all things being equal, mean the query would run in about a second with no index on the Quantity column. I tried running the query both with and without that index and under both conditions the response was effectively instantaneous – way under a second. In other words, with a table of half a million rows the index had no effect on the response time of the query. What's going on here?

Part of the trick to understanding this lies in memory usage. The test machine has 1GB of memory and the smaller Access .mdb file is about 35MB. I used Windows' Task Manager to monitor memory usage during the tests. It was 455MB before Access was launched. With the database open in Access the usage jumps to 465MB and, as soon as the query is run, it jumps again to 480MB. About 25MB of Ram is busy being used for something...



SCREEN 3

Contact ID	First Name	Last Name	Address	City	Postal Code
1	Fred	James	23 Acatia Gdns.	Dublin	AA 123
2	Betty	James	23 Acatia Gdns.	Dublin	AA 123
3	Simon	Smith	18 Alice Rd.	London	BB124
4	Sarah	James	14 Wombat Terrace	Edinburgh	QA121
5	Sarah	Smith	18 Alice Rd.	London	BB124
6	Jenny	Smith	18 Alice Rd.	London	BB124
7	Michael	James	14 Wombat Terrace	Edinburgh	QA121
8	Sally	James	13 Wombat Terrace	Edinburgh	QA123

The second element is that, when a query is run, Access uses some internal software called a Query Optimizer: its job is to find the optimal (fastest) way of answering a query.

In the smaller database and using the non-indexed table, the Optimizer knows that, without an index, it is going to have to look at every single row in the table. It can probably read several rows per disk read but that is likely to mean hundreds or thousands of separate head movements. This will be very slow. An alternative strategy is to perform a single massive disk read and lift a copy of the entire table into system memory. Then it can run the query against that version of the table in Ram. Of course, it can only do this if there is enough spare Ram.

My guess is that, even when I gave it an index, it was using the same trick of copying the table into memory and was ignoring the index I had carefully provided. (Remember that indexes came into being to speed up the slow performance of reading data from a disk drive). Accessing data in memory is approximately 100,000 times faster than accessing data on a physical disk drive, and the Optimizer 'knows' about this difference and uses the knowledge to determine the optimal path for answering a query. It balances the speed of various options against the availability of memory.

When running queries against the larger .mdb file, the Optimizer presumably decided there was not enough free memory to enable it to read the table into Ram in one go. The query was therefore run against the table on disk and used the index to improve performance.

To some extent I am guessing about what the Optimizer is 'thinking' since Access doesn't have the ability to tell you how it solves a particular problem. Other database engines, such as SQL Server, can and will tell you.

As a teaser (which will be answered next month). The query below is logically exactly the same as the one above. It finds the three rows with the value 40 in the Quantity field. So why,

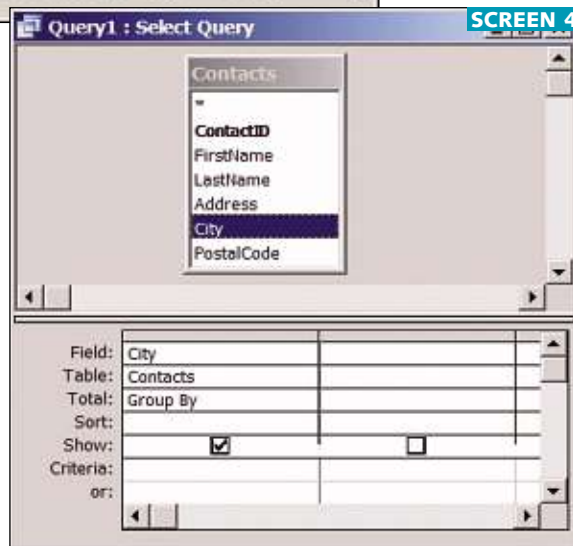

The Contacts table shows that several members share addresses

Greek E on it). This puts a new row into the grid, called Totals, with Group By as the default operation, which is just what we want here. The query is shown in screen 4 and the SQL to generate it is:

```
SELECT City
FROM Contacts
GROUP BY City;
```

The answer table contains three rows, one instance of each city that is represented in the City column (see screen 5).

I can group by more than one column, so I can add the Address and Postal Code fields to the query and group by all three columns. This produces a larger number of unique results (see screen 6). The SQL reads:

```
SELECT Address, City,
PostalCode
FROM Contacts
GROUP BY Address, City,
PostalCode;
```

One address appears twice in the answer table: 23 Acatia Gardens. Closer inspection reveals that in one, Gardens is abbreviated to Gdns and in the other to Gdns. (with a full stop). Access sees these as separate entities, so each appears in the answer table. The best way to reduce such confusion is to control data entry and keep data clean. I'll cover some techniques for doing this in a later column.

To answer Craig's question in a nutshell, his group by query needs to comprise the specific address fields that hold the data he wishes to see once only. If you've bought the DVD edition of PCW, you'll find the database DBCMAY06.MDB on the cover disc. It's also at www.penguinsoft.co.uk. PCW

even if I give it an index, does it take five seconds to run against the large table; exactly the same time as if the index wasn't there?

```
SELECT Quantity
FROM [Order Info]
WHERE Quantity Not In
(0,1,2,3);
```

(Key: < code string continues)

Famous group bys

Craig Brown's Access database holds around 800 membership records, including names and addresses. Sometimes both husband and wife are members and each must have a separate record, even though they share a postal address. Craig has to prepare mailshots to members and does not want to send two items to one address (would that all mailshots were managed so conscientiously). He wants a query to sort the records so he can identify records with common data in separate fields.

What Craig needs is a 'group by' query. Given a table like the one shown in screen 3 I can build a query that includes a 'group by' instruction in the City column. Open a query grid, add the Contacts table and the City column and then click the Totals button on the menu bar (it has a

The answer table grouping on all three columns (Address, City, Postal Code) shows each unique address from the Contacts table

Set the group by option for the City column

The result of the group by query shows the three cities that are represented in the Contacts table

SCREEN 5

City
Dublin
Edinburgh
London

SCREEN 6

Address	City	Postal Code
23 Acatia Gdns.	Dublin	AA 123
23 Acatia Gdns	Dublin	AA 123
14 Wombat Terrace	Edinburgh	QA121
13 Wombat Terrace	Edinburgh	QA123
18 Alice Rd.	London	BB124



Hosting solutions as individual as you

From £3 per month

As one of Europe's leading and longest established Web Hosting Service Providers, Netcetera offers a complete hosting solution for your business. For over 10 years every aspect of our company has been focused on providing a secure and reliable service for customers with business critical applications. Passionate about hosting.

STARTER Package

- 500 Mb UK Web Space
- POP3/SMTP email
- Spam & Virus protection
- Webmail
- Frontpage Server Extensions
- Graphical Web Stats
- FREE dial-up access

£30/PA or £3/PM

DEVELOPER Package

- As per STARTER Package PLUS
- 4 Gb UK Web Space
- ASP & ASP.NET V 2.0 support
- MS-SQL Server & MySQL
- 100 POP3/SMTP email accounts
- 10 Gb/pm Bandwidth
- Hosting for up to 10 domains

£10/PM OR £100/PA

The ultimate self-managed Dedicated Server

- .NETpliance 2800
- CPU: Intel P4 2.8 Ghz
- HDD: 80 Gb
- RAM: 256 Mb
- Bandwidth: 100 Gb/pm
- OS: Windows 2003 Web Edition
- Full SLA as standard

£65/PM

Full range of managed Dedicated Servers

- .NETpliance 2800+
- CPU: Intel P4 2.8 Ghz
- RAM: 1Gb RAM
- HDD: 2x40Gb RAID 1
- Bandwidth: 200 Gb/pm
- OS: Windows 2003 Standard Edition
- Full SLA as standard
- Hardware Firewall

£200/PM

powered by Txt-U.com
 text INFO.YourEmail to
0796 242 6000
 for instant info
Your normal text rate applies

CONNECTIVITY

DOMAIN NAMES

E-COMMERCE

DEDICATED SERVERS

FREEPHONE 0800 2987214

www.netcetera.co.uk/pcw
sales@netcetera.co.uk

All trademarks acknowledged. All Prices subject to VAT at 17.5%
 Details correct at time of going to press. Set up fee, T&C apply.





Tim Anderson is an IT journalist and software developer, and began writing for PCW in 1993. Since his first Commodore Pet, he has acquired expertise in Rad programming, Windows and the Internet.

→ Comments welcome on the Visual programming column.

Email visual@pcw.co.uk

Please do not send unsolicited file attachments.

Working with the WebBrowser

How to use Visual Studio 2005's new control and why it's not always the best option

It's the most common Rapid Application Development (Rad) demo in the book. Drag a WebBrowser control, then a textbox for the URL and then a button for Go onto a form, and you have a custom browser with one line of code:

```
WebBrowser1.Navigate
(me.txtUr1.Text)
```

(Key: `<` code string continues)

The problem is that few people want to build alternative web browsers, especially when they turn out to be wrappers of Internet Explorer. It is more likely that you want to display HTML generated by your application, embed content from a website, or display the output from an RSS feed, which means customising the WebBrowser. Another problem is that embedded IE can be hard to tame, running unwanted scripts and opening unnecessary new windows.

Microsoft created a new WebBrowser control for .Net 2. In the earlier 1 and 1.1 versions of .Net, you had to import the COM WebBrowser control, whereas the .Net 2.0 version is wrapped in a .Net Framework class. The new control has several advantages. Some users found the old version unreliable, especially when nested on panels and tabs and the update is better behaved. It also has a set of convenient properties and methods. The DocumentText property lets you read or set the HTML contents from a string, rather than always having to navigate to a file or URL. There is also a simplified wrapper class for the HTML DOM (Document Object Model), called HtmlDocument. This is read-write and makes it easy either to parse or build HTML in code.

Each HtmlDocument is composed of a hierarchy of HtmlElement objects. IE does a good job of parsing HTML into a tidy structure (see screen 1).



The WebBrowser control navigates asynchronously. This means that the Navigate method returns immediately, even if the document is large. The control then retrieves the content in the background, firing a DocumentCompleted event when it is done. This has the huge advantage that your application does not lock up while fetching HTML, but it makes it a little more awkward to code.

The following example shows how you can retrieve a web page and show its structure in a TreeView control. To do this, you need to use recursion. Here is the code to display an HtmlElement:

```
Private Sub DisplayElements
(ByVal e1 As HtmlElement,
ByVal ParentNode As TreeNode)
Dim nd As TreeNode
If ParentNode Is Nothing Then
nd = Me.TreeView1.
Nodes.Add(e1.TagName + " ID="
+ e1.Id)
Else
nd = ParentNode.Nodes.
Add(e1.TagName + " ID=" + e1.Id)
End If
Dim ChildE1 As HtmlElement
For Each ChildE1 In e1.Children
DisplayElements(ChildE1, nd)
Next
End Sub
```

Now you can call this from the DocumentCompleted event handler:

```
Private Sub WebBrowser1_
```

Use the WebBrowser control to display a web page and work with it programmatically through the Document Object Model

```
DocumentCompleted
(ByVal sender As System.
Object, ByVal e As
System.Windows.Forms.
WebBrowserDocumentCompleted
EventArgs) Handles
WebBrowser1.DocumentCompleted
Me.TreeView1.Nodes.Clear()
'parse the document
Dim e1 As HtmlElement =
WebBrowser1.Document.Body
DisplayElements(e1, Nothing)
End Sub
```

Creating a new document is just as easy. First, navigate to the unlikely URL 'About:Blank'. Then put code such as this in the DocumentCompleted event handler:

```
Dim doc As HtmlDocument =
WebBrowser1.Document
Dim e1 As HtmlElement =
doc.CreateElement("h1")
e1.InnerText = "PCW Hands On"
doc.Body.AppendChild(e1)
e1 = doc.CreateElement("p")
e1.InnerText = "Some text"
doc.Body.AppendChild(e1)
```

In practice, there is little advantage in building up a document through the DOM rather than simply generating an HTML string and zapping it in through DocumentText. The DOM method comes into its own when you want to amend an existing document.

It is not necessary to have all your code in DocumentCompleted. You can program against the HtmlDocument anywhere in your application, but check the WebBrowser's ReadyState property, looking for a value of Complete, before making use of the Document property.

Customising the WebBrowser

The new WebBrowser control is not all good news. The underlying ActiveX control is highly customisable, but only a small portion of the options have been exposed in the

Opening Office documents in the WebBrowser

Visual Basic 6 has an OLE control that lets you include Office documents on Windows forms, but there is no direct equivalent in Visual Basic .Net. Microsoft's suggestion is that you use the WebBrowser control instead. It is not such a strange idea as it first sounds. Internally, Internet Explorer is split into several parts. There is a shell, which provides the window management, menu and toolbars, and a separate HTML-rendering component called Mshtml. The shell hosts Mshtml as an ActiveX document, so Internet Explorer is itself an OLE container. When you navigate to an Office document, Internet Explorer hosts the appropriate Office application in place of Mshtml.

This can be useful, but what if you need to interact with the document? The new WebBrowser control is two steps forward and one step back. It has a Document property, but this is the .Net wrapper for an HTMLDocument and cannot be cast to an Office document type. An HTMLDocument has a DomDocument property, which exposes the underlying COM reference, but this will not help you here, since when an Office document is displayed the HTMLDocument is null.

The solution is to use the WebBrowser's ActiveXInstance property. This too has a Document property, which can be cast to whatever type of COM object is being hosted. For example, here is how you could display and control a Powerpoint document. You could use similar code for Word and Excel. Note that this only works if Powerpoint is installed on the machine.

1 Start a new Windows Form application and add a WebBrowser control and a couple of buttons.

2 Add a reference to the Powerpoint object model. You can find this by right-clicking the project in the Solution Explorer and choosing Add Reference. From the COM tab, choose Microsoft Powerpoint xx Object Library, where xx is the version of Powerpoint that you have installed.

3 Add an imports clause for Office at the top of your code:
Imports Microsoft.Office.Interop

4 Add a class field that will hold a reference to a Powerpoint document:
Dim pptdoc As PowerPoint.Presentation

5 Add this code to the DocumentCompleted event handler:
If TypeOf (WebBrowser1.ActiveXInstance. Document) Is Microsoft.Office.Interop.PowerPoint.Presentation Then Me.pptdoc = WebBrowser1.ActiveXInstance.Document Else Me.pptdoc = Nothing End If

(Key: ↵ code string continues)

6 Now you can use the Powerpoint object model to control a hosted presentation. To test this out, call the WebBrowser's navigate method, with the target being a Powerpoint presentation. Then write this code in a button's click event handler to navigate to the next slide:

If Me.pptdoc Is Nothing Then Exit Sub pptdoc.SlideShowWindow.View.Next()

.Net wrapper. In some ways it is less flexible than the old version. Advanced customisation of the WebBrowser involves heavy use of COM interfaces, and these are inconvenient to use from .Net. Microsoft does not supply the code for the WebBrowser control, making some of the possible customisations beyond reach. For this reason, some developers have created their own wrappers for the Internet Explorer ActiveX.

Certain properties are easy to set. IsWebBrowserContextMenuEnabled determines whether a pop-up menu appears if the user right-clicks the control. You will often want to disable the built-in menu in an application. You can also provide your own menu with the ContextMenu or ContextMenuStrip properties. Printing is straightforward, using several methods including ShowPrintPreviewDialog, although it does not allow you to specify a print template for greater control over the appearance of the page.

The next stage is to code directly against the underlying ActiveX control. The WebBrowser makes

this possible by exposing an ActiveXInstance property, although the documentation states, unhelpfully, that this is not intended to be used directly from your code; sometimes you have no choice. In preparation, it helps to add a reference to two COM libraries, Microsoft Internet Controls and Microsoft HTML object library. You can then cast the ActiveXInstance to SHDocVw.WebBrowser as follows:

Dim ax As SHDocVw.WebBrowser ax = Me.WebBrowser1.ActiveXInstance

This gives you access to a powerful method called ExecWB, as well as an alternative Document property which has a more complete DOM than what is wrapped by HtmlDocument. Making sense of all the options means going back to the SDK documentation for the WebBrowser control and Mshtml.

The biggest roadblock comes when you need to implement certain COM interfaces in the WebBrowser's OLE container. One of these is IDocHostUIHandler, which controls options such as disabling scripts. To

use IDocHostUIHandler, you need to use an alternative .Net wrapper.

Alternative methods

The WebBrowser is a powerful control, but it is also heavyweight and complex, and its dependency on Internet Explorer can cause problems. It is possible to work with HTML without it, provided you do not need to display it. For example, grabbing an RSS feed into a string is easily done with the WebClient class. Declare a field of type WebClient:

Dim WithEvents wc As WebClient

Next, call one of its download methods, such as DownloadStringAsync:
wc = New WebClient wc.DownloadStringAsync(New Uri("http://www.vnunet.com/feeds/rss/pcw"))

Finally, in the DownloadStringCompleted event handler, grab the string:
txtHTML.Text = e.Result

There are many ways to add live web content to an application without embedding a web browser. **PCW**



Break Free from Your PC!

The whole world
can talk for free.



CIT200
Cordless Internet Telephony Kit

With the new Linksys Cordless Internet Telephony Kit, you can make or receive free Skype calls without being forced to sit in front of your PC. Simply plug the USB Base Station into your computer, and your Skype contact list appears on the handset's illuminated color screen. Just choose from the list and talk! It even supports optional SkypeOut dialing for calls to conventional telephones. Enjoy the freedom and convenience of a cordless handset anywhere in the home!

Linksys. Nobody makes networking easier!

Visit www.linksys.com/uk today
for product details. Freephone
Technical Support 0800 026 1418.

How to buy the best products tested by our Labs

This Buyer's Guide is a comprehensive listing of the best products PCW has tested across a range of areas, helping you to make the best decision when you're planning a purchase. Over the following pages you'll find products, their verdicts and ratings, plus information on where you can read the full review.

CONTENTS

149 PCs	154 Printers	158 Portable media players
150 Graphics cards	Scanners	Personal video recorders
Notebooks	155 Routers	159 Backup software
151 Motherboards	Speakers	Digital image-editing software
Soundcards	156 Monitors	Media creation software
152 Hard drives	TV tuners	PC maintenance software
DVD drives	156 Digital music players	160 PC security, office and
153 Digital cameras	Smartphones	video-editing software
Digital camcorders	PDA's	162 Product index

Prices are for guide purposes only and may be subject to change

HOW TO BUY: PCs



Many of the choices you are faced with when buying a PC are covered in the following pages. You need to think about the graphics card, memory, onboard sound or separate soundcard, size and type of hard disk, CD burner or DVD burner and so on.

Once your budget is set, the starting point is the CPU (central processing unit), because it is the brains of your PC.

Intel and AMD offer a bewildering number of processors. The differences between the CPUs are in technical details that don't necessarily mean much to end users. Pricing is also competitive, with AMD PCs generally cheaper than comparable Intel models.

Budget PCs come with Intel's Celeron or AMD's Sempron CPUs. These are aimed at undemanding users. If your needs are for word processing tasks and surfing the Internet with some low-end gaming or image editing, a PC running either of these processors is fine. You won't need a huge hard disk - 80GB will be plenty - coupled with between 256MB and 512MB of Ram and a low-end graphics card, or even onboard graphics for the truly undemanding. You'll be fine with onboard sound, and can expect to pay up to about £500, depending on your monitor.

In the mainstream desktop market it's Pentium 4 and Pentium D versus AMD's Athlon XP and Athlon 64. The chief

1		Panrix Magnum IQ 3700 £699 ★★★★★ Reviewed April 06 www.panrix.co.uk	Strong performance and impressive features makes this an excellent value for money PC
2		Mesh Titan X1800 Fire £1,999 ★★★★★ Reviewed May 06 www.meshcomputers.com	A fast dual-graphics PC making use of two Radeon X1800s and an Athlon 64 4600+ processor
3		Fujitsu-Siemens Scaleo E £870 ★★★★★ Reviewed April 06 www.microanvika.com	Big and bulky, but powerful enough to make use of its Windows Media Center Edition operating system

difference is that older Pentium 4 and Athlon XP models are 32bit CPUs, while some newer Pentium 4s, the Pentium D and Athlon 64 are 64bit models. To take full advantage of this, you need a 64bit operating system and applications.

More memory can be supported by 64bit systems - 32bit Windows or Linux systems are limited to 4GB of Ram, whereas a 64bit Windows or Linux system can support 128GB. Data is also moved in larger chunks, allowing a theoretical speed advantage.

AMD and Intel offer high-end processors with the Pentium Extreme Edition and Athlon FX ranges, both aimed at the hardcore gaming market. They also have dual-core CPUs. These processors effectively act as two CPUs in one and offer superior performance.

If you're choosing a PC running the above CPUs, other considerations come

down to your needs. If you store lots of music, video or photos, go for a big hard disk - 200GB or above. Memory will help speed up applications, so aim for 1GB or above and don't drop below 512MB. The latest games demand the latest graphics cards, but for most people, cards that were new six to 12 months ago will be powerful enough. And look at the CPU's cache memory, which helps eliminate data bottlenecks.

Most PCs are Windows XP, and the Home Edition is fine. If it's for a small business or you need features such as remote access, buy XP Professional. Few PCs are sold running Linux, and we'd recommend only the technically confident buy a Linux-only system. Linux can always be installed later. Finally, don't overlook the monitor, especially if you're using the PC for gaming or imaging; buy the best you can afford.

BUYER'S GUIDE

145 PRODUCTS
REVIEWED TO MAKE
YOUR BUYING
DECISION EASIER

GRAPHICS CARDS

SUB £200		EVGA GeForce 7800GS CO Superlocked £160 ★★★★★ Reviewed May 06 www.evga.com	An excellent choice for AGP owners who demand fast graphics but don't want to spend a fortune.
		Sapphire Radeon X800 £114.99 ★★★★★★ Reviewed February 06 www.sapphiretech.com	A decent PCI Express card based on ATI's X800 series with 256MB of Ram.
		Sapphire Radeon X1300 £37.99 ★★★★★★ Reviewed February 06 www.sapphiretech.com	Great budget card with a core clock of 450MHz and 128MB of Ram.
£200-£349		Gecube Radeon X850XT Uniwise £269.97 ★★★★★★ Reviewed May 05 www.gecube.com	A single-slot design using Gecube's own cooling system, and it offers good performance.
		Powercolor Radeon X850XT Platinum Edition £320 ★★★★★★ Reviewed July 05 www.powercolor.com	Based on ATI's fastest Radeon processor, this card will run the latest games with ease.
		Gecube X850XT Platinum Edition Uniwise £307 ★★★★★★ Reviewed January 06 www.gecube.com	High-end performance and quiet cooling for AGP motherboards.
£350+		Galaxy GeForce 6800 Glacier £208 ★★★★★★ Reviewed February 06 www.galaxy-hk.com	Nvidia GeForce 6800 card using older AGP technology instead of PCI Express.
		ATI Radeon X1900 XTX £363 ★★★★★★ Reviewed April 06 www.ati.com	Using the new R580 core, this is the fastest single-core graphics card currently available.
		HIS Radeon X850XT Platinum Edition IceQII £370 ★★★★★★ Reviewed June 05 www.hisdigital.com	Making use of the IceQII efficient cooling system, this is a quiet and super-fast card.
		Nvidia GeForce 7800 GTX 512 £516 ★★★★★★ Reviewed February 2006 www.nvidia.com	This card has an updated 7800 GTX chipset with a massive 512MB of Ram.

HOW TO BUY

Most graphics cards are based on either the Nvidia GeForce or ATI Radeon family of chips. Each has their strengths and both offer state-of-the-art image acceleration and comparable features.

Performance improves as you move up a range. Top chips offer more features and draw more pixels or textures in a single pass than cut-down, lower-cost options. All current graphics processors are fine for office work, but hardcore gamers favour Nvidia's GeForce 6800 or new 7800 series and ATI's latest X1900 XTX card.

Ensure the card you buy can display favoured resolutions with at least a 75Hz monitor refresh rate to avoid eye strain from flicker (if using a CRT monitor).

There are usually three clock speeds quoted (in megahertz). Core clock is the internal speed of the graphics processor. Memory speed (or memory clock) is the speed of data transfer between the graphics card's onboard memory and the graphics processor. Ramdac speed is the capability of the digital-to-analogue converter that provides the graphics output from the card.

Graphics cards use their own dedicated video memory to store data, images and textures. The more you have, the better the performance. A card with 64MB is fine for office tasks, but we

recommend at least 128MB or 256MB for the latest games and video applications.

Around £40 will buy you a GeForce FX 5200 or Radeon 9200 card with 128MB of Ram, which is good for 2D action/strategy games, image editing and less demanding 3D games.

To play 3D action games smoothly, look at £100-£150 cards. Serious gamers should consider the GeForce FX 6800 GT at £280-plus, Radeon 850 XT at £320-plus, or 7800 GTX at £350-plus.

Depending on the motherboard, you'll need an AGP or PCI Express graphics card. PCI Express is the newest interface standard, offering up to double the bandwidth of an AGP 8x slot for even faster and more complex graphics. Both ATI and Nvidia offer PCI Express versions of most of their cards. Nvidia also has its SLI (Scalable Link Interface) technology that lets you use two PCI Express graphics cards in SLI-enabled motherboards for ultimate performance. ATI's rival technology Crossfire is due soon.

Look for support for both analogue (VGA) and digital (DVI) displays, and S-video and composite video outputs for use with TVs. Some 'all-in-one' cards have a built-in TV tuner and video-capture options, so you can save money rather than buying separate cards.

NOTEBOOKS

1		Acer Travelmate 8204WLMi £1,761.33 ★★★★★★ Reviewed April 06 www.acer.co.uk	Powered by Intel's new Core Duo processor, this notebook beats most desktop PCs on performance.
2		Sony Vaio VGN-TX1HP £1,499 ★★★★★★ Reviewed December 05 www.sony.co.uk	A stylish, well-designed notebook with exceptional battery life and a wealth of features.
3		Evesham Voyager C720 £1,499 ★★★★★★ Reviewed February 2006 www.evesham.com	Great gaming notebook with a 17in display and Geforce Go 7800 graphics.
4		Rock Xtreme 64 £2,231.33 ★★★★★★ Reviewed May 06 www.rockdirect.com	A quality notebook with plenty of features and the processing power to match a desktop.
5		Gateway 8550GB £950 ★★★★★★ Reviewed February 2006 www.uk.gateway.com	This is a quality desktop replacement notebook at an even better price.

HOW TO BUY

Notebooks have caught on like wildfire with consumers thanks to plummeting prices and massive marketing campaigns. However, there are so many options that it's easy to get confused.

Decide what you want your notebook for. If it's for occasional use, running some office applications, accessing the Internet and email, then almost any low-cost notebook will do the job. If it's for gaming or running video-editing software, you will be looking for a notebook with a large 15in/17in screen - possibly widescreen - a high-end Nvidia or ATI graphics chip, 1GB of memory and an 80GB (or bigger) hard disk.

In the low-cost arena, Intel has its Mobile Celeron chip and AMD has Sempron. In the midrange/high-end space, there are Intel's Mobile Pentium 4 or Pentium 4 chips, while AMD offers Mobile Athlon 64 and Athlon 64. Expect to find these in desktop replacement systems and those used by gamers.

For the best in performance with power-saving technology, go for Intel's Pentium M or AMD's Turion 64 processors.

Any notebook you get should have in-built Bluetooth and Wifi connectivity, a 30-40GB hard disk drive, 512MB of Ram, 14-15in screen, USB2 or Firewire ports, DVD/CD-RW combo drive and three to four hours' battery life.

MOTHERBOARDS

1		ECS PF88 £64.63 ★★★★★ Reviewed August 05 www.ecs.com.tw	The PF88 is feature-packed and compatible with both Intel and AMD processors.
2		Aopen i915GMm-HFS £79 ★★★★★ Reviewed June 05 www.aopen.com	The HFS makes the ideal platform for building a quiet, power-efficient Intel PC.
3		Asus A8N-SLI Deluxe £98 ★★★★★ Reviewed April 05 www.asus.com	A good, all-round AMD SLI board that is packed with plenty of features.
4		ECS 915-A £61.81 ★★★★★ Reviewed June 05 www.ecs.com.tw	All the features you'd expect from a modern Intel-based motherboard and outstanding value for money.
5		Asus K8N-E Deluxe £59 ★★★★★ Reviewed November 04 www.asus.com	A tidy AMD board with lots of room around the major components and a wide range of features.
6		EpoX 8HDA3+ £79.92 ★★★★★ Reviewed July 04 www.epox.com	An AMD board that stands out from the crowd thanks to its dual Lan and external Sata support.
7		MSI 945P Platinum £99 ★★★★★ Reviewed November 05 www.msi.com.tw	An Intel board that features DTS Connect, so you can output true DTS surround-sound audio.
1		Gigabyte GA-8N-SLI Royal £149 ★★★★★ Reviewed October 05 www.giga-byte.com	Featuring an Nforce4 chipset, this model from Gigabyte supports all Intel 775 processors.
2		Abit Fatal1ty AN8 £119.80 ★★★★★ Reviewed August 05 www.abit.com.tw	This AMD board has enough flexibility and Bios features to keep overclockers happy.
3		ECS PF22 Extreme £123 ★★★★★ Reviewed February 06 www.ecs.com.tw	A good range of features including dual graphics support courtesy of ATI's Crossfire technology.

HOW TO BUY

The motherboard dictates the type of processor you can use, how well the other components

communicate, the features on offer and future upgrade potential.

Cheap boards limit processor support, graphics and expansion options. Around £70-£100 gets you the latest technologies.

Most desktop and tower cases use a standard ATX-size motherboard but, if you're building a small system, look at compact MiniATX or MicroATX designs. If using an existing case, make sure you buy the right form factor.

Your choice is also dictated by the processor. You'll need Socket 775 for current Intel processors, Socket A for AMD Athlon XP or Duron, and Socket 939 for an Athlon 64. The Athlon 64 FX series requires Socket 940. If using an older CPU, check the socket type.

We would recommend an Intel P4 or Athlon 64 for a good all-round system. The Athlon 64 can address one terabyte of Ram (1,000GB) and handle difficult calculations with relative ease.

The new generation of processors also change the way data is transferred. Whereas P4s rely on the motherboard chipset to shuttle data between processor and memory, Athlon 64s avoid this by integrating the memory controller into the CPU die.

Divided into northbridge and southbridge, the chipset handles the communication between all the components and dictates the features on offer. Today's leading chipset manufacturers include Via, Silicon Integrated Systems (Sis), ATI, Nvidia and Intel. Chipsets can include integrated graphics.

Today's motherboards mainly use DDR or DDR2 Ram, available in 200, 266, 333 and 400, 667 and 800MHz modules.

Also consider the number of slots available. Fit dual in-line memory modules (Dimms) in pairs if the chipset supports dual-channel operation.

The latest boards support both older IDE and new, faster Serial ATA (Sata) hard disks. Check the number of connectors available for both.

Some chipsets provide Raid support, so data can be spread across two drives for extra performance or backups. SCSI controllers can be found on more expensive boards, or be added with expansion cards.

Also important is the number of USB2 and Firewire sockets for external add-ons. You may need serial, parallel and PS/2 interfaces if using older legacy peripherals. Look out, too, for onboard Ethernet networking, a built-in 56K modem and onboard sound. The latter is fine for all but audio buffs or avid gamers.

SOUND CARDS

1		Creative Audigy 4 Pro £179.99 ★★★★★ Reviewed July 05 http://europe.creative.com	This updated version of Audigy 2 has fantastic performance and a good software bundle.
2		Creative Soundblaster X-Fi Elite Pro £249 ★★★★★ Reviewed November 05 http://europe.creative.com	This latest Creative offering has a variety of features, but will take time to be fully supported.
3		M-Audio Revolution 7.1 £99 ★★★★★ Reviewed July 05 www.m-audio.com	An excellent mid-priced soundcard offering great audio quality, but gamers might be disappointed.
4		Hercules Fortissimo IV £44.99 ★★★★★ Reviewed July 05 www.guillemot.co.uk	If you're looking to upgrade your system, but have a limited budget, this is an excellent option.
5		Terratec Aureon 7.1 Universe £114 ★★★★★ Reviewed July 05 www.terratec.com	We wouldn't recommend this over the Audigy 4 for gamers, but musicians may be tempted.

HOW TO BUY

Many PCs have built-in surround sound on the motherboard. Some support six-channel (5.1), others eight-channel (7.1) and the sound quality is fine for most people.

If you want a dedicated soundcard for playing and making CDs and mp3s, DVDs and games, most will fit the bill.

Entry-level soundcards support 16bit-quality sound recorded or played back at 44.1KHz, which is CD-quality. The next step is 24bit sound at higher sampling rates of 48KHz or 96KHz, recommended for those creating music or playing DVD movies with THX surround or Dolby Digital EX 6.1 or 7.1 sound formats. More cards now also support 24bit 192KHz

playback, required for the DVD-Audio music format.

The signal-to-noise (SNR) ratio, measured in decibels (dB), is the amount of sound you expect (signal) versus that which you don't (noise). Decibel ratings range from 60dB to over 100dB and the higher the dB rating, the better.

Most cards share many similar options, such as microphone-in, line-in/line-out, line-out, Midi/joystick port, CD-in and headphones connectors. Newer cards also have high-speed Firewire ports. Audio enthusiasts should look for S/PDIF (Sony/Philips Digital Interface) -in and -out, to connect speakers via a single optical or coaxial cable and get higher quality digital sound.

HARD DRIVES

INTERNAL		Seagate Barracuda 7200.9 £293.32 ★★★★★ Reviewed December 04 www.seagate.com	Massive 500GB capacity and 16MB buffer – smaller models available
		Seagate Barracuda 7200.8 (ST3400832A) 400GB £186.96 ★★★★★ Reviewed July 05 www.seagate.com	This massive 400GB drive offers impressive capacity and an 8ms seek time.
		Hitachi Deskstar 7K250 (250GB SATA150) £88 ★★★★★ Reviewed May 04 www.hitachi.co.uk	Those needing a large SATA150 drive will find this a great bargain.
		Samsung Spinpoint P120S £80.11 ★★★★★ Reviewed February 06 www.samsung.co.uk	This isn't the fastest drive on the market, but it is extremely cool and quiet
		Western Digital Caviar WD1600JD (160GB SATA150) £72.61 ★★★★★ Reviewed May 04 www.wdc.com	With dual power connectors this drive will suit users transitioning to SATA technology.
EXTERNAL		Maxtor Onetouch II Firewire 800 300GB £179 ★★★★★ Reviewed November 05 www.maxtor.com	A good-quality 300GB USB and Firewire hard drive that comes with backup software.
		Lacie Safe Mobile Hard Drive 80GB £149 ★★★★★ Reviewed December 05 www.lacie.co.uk	Featuring a fingerprint reader for security, this 80GB external hard drive would suit business users.
		Buffalo Linkstation 120GB £240 ★★★★★ Reviewed October 04 www.buffalotech.com	If you want easy-to-use external network storage, this is a great choice.
		Buffalo Ministation HD-PHS40U2/UC £70 ★★★★★ Reviewed April 06 www.buffalo-technology.com	This 40GB portable hard drive includes shock protection to minimise the risk of data loss.
		Smartdisk Firelite 80GB £189.98 ★★★★★ Reviewed October 04 www.smartdisk.co.uk	Available with either USB or Firewire interfaces, it's a great performer at an attractive price.

HOW TO BUY

If you're building a high-performance system, buy the fastest drive you can afford; if you just want lots of capacity then slower drives offer better value.

OEM or 'brown box' drives are cheaper – this is the bare drive without the extras, such as cables, included in retail boxed versions.

The transfer rates in today's Ultra ATA drives are 100Mbytes/sec (133Mbytes/sec for Maxtor drives), while Serial ATA (Sata) drives are rated at 150Mbytes/sec. Check the seek times, spindle speed, buffer size and the areal density of the platters (disks).

Usually in milliseconds, seek time is how long a drive's heads take to find data on the disk. The speed at which the spindle holding the disks spins ranges from 4,200rpm for a notebook drive to 15,000rpm for some SCSI drives. Generally, faster speeds give better performance.

The larger the buffer (cache), the more recently written or stored data is held in the drive's memory, resulting in less time seeking the data on the disk.

Areal density is the amount of data stored on a given area of a drive's platter. The more data per square centimetre (gigabytes per platter), the less disk movement is required to bring it under the heads.

Originally Integrated Drive Electronics (IDE), then Enhanced IDE (E-IDE), this common parallel interface is usually written as ATA (AT Attachment), modified with speed improvements in recent years to Ultra ATA/xxx, where xxx is the peak bandwidth in Mbytes/sec. To differentiate Ultra ATA from Sata, the term Parallel ATA is used.

Faster Sata drives are more expensive than Parallel ATA. Sata uses two pairs of high-frequency cables, working at low voltage.

SCSI (Small Computer System Interface) drives are technically no different to ATA drives, but support up to 16 devices on a single channel and you can have multiple channels in a PC. The disadvantage, though, is price.

Most motherboards support Raid (Redundant Array of Independent Disks), which connects multiple drives, to improve performance or provide fault tolerance.

One problem you may hit is the inability to access the new drive's full capacity. Some older Bioses only support drives up to 137GB. This may be solved by updating the PC's Bios. Retail boxed disks often come with software to fool the Bios into recognising the disk, or you can buy a separate disk controller card, which fits into a PCI slot.

DVD DRIVES

1		NEC ND-4551A £35 ★★★★★ Reviewed May 06 www.nec.co.uk	An excellent DVD drive supporting every format and Labelflash technology.
2		Pioneer DVR-110 Supermulti £40 ★★★★★ Reviewed March 06 www.pioneer.co.uk	Supports all major formats, including DVD-Ram. Good value for money.
3		Toshiba SD-R6472 £83.42 ★★★★★ Reviewed September 05 www.span.com	A slimline dual-layer DVD writer that performs well and is perfect for small form factor PCs.
4		Philips DVDR16LSK £59.99 ★★★★★ Reviewed October 05 www.philips.co.uk	An excellent Lightscribe-capable dual-layer DVD burner that's very keenly priced.
5		LG 12X Super Multi DVD £116.99 ★★★★★ Reviewed January 05 www.lge.co.uk	Good-value external USB2/Firewire rewriter with all-format media support.

HOW TO BUY

DVD drives have largely replaced CD-Rom, CD-R and CD-RW drives in all but a few entry-level PCs and notebooks. Many systems still offer DVD-Rom drives as secondary drives – used for playback of discs only – while a growing number have a DVD writer or rewriter for burning your own DVDs as the main system drive.

DVD burners can be divided into internal and external drives. Internal drives are cheaper than their external counterparts, but require a level of knowledge so you can install them yourself. You can opt for one of the external offerings which can be hooked up simply via USB2 or Firewire.

Most drives are multi-format, meaning they can write to all key media types, so make sure yours supports DVD+R, DVD+RW, DVD-R and DVD-RW discs. Newer double and dual-layer drives can write to new discs which can store 8.5GB versus the 4.7GB capacity of existing discs. This is useful for backing up your DVD movie collection or chunks of your hard drive on a single disc.

The dual-layer drives cost little more than single-layer drives, so are a good investment. The same cannot be said for the cost of dual-layer discs. A branded, dual-layer 8.5GB disc will cost around £3.75. Rewritable dual-layer discs will not arrive until the end of 2006.

DIGITAL CAMERAS

1 COMPACT		Canon Powershot A520 £239 ★★★★★ Reviewed July 05 www.canon.co.uk	Perfect for those who want a versatile and easy-to-use digicam without spending a fortune.
		Nikon Coolpix S1 £229 ★★★★★ Reviewed August 05 www.nikon.co.uk	Small enough to fit in the tightest of pockets – and quality images to boot.
		Casio Exilim Zoom EX-Z57 £229 ★★★★★ Reviewed August 05 www.casio.co.uk	Another quality compact, with the added bonus of a manual focus and a 2.6in monitor.
		Konica Minolta Dimage X1 £299 ★★★★★★ Reviewed December 05 www.konicaminolta.co.uk	8megapixels, image stabilisation and a stylish and compact design, but indoor shots can be noisy.
2 PROSUMER		Fujifilm Finepix S9500 Zoom £469.99 ★★★★★★ Reviewed February 06 www.fujifilm.co.uk	A serious contender to entry-level digital SLRs with a 10x zoom and 9megapixel CCD.
		Olympus E-500 £600 ★★★★★★ Reviewed April 06 www.olympus.co.uk	The long awaited successor to the popular E-300 doesn't fail to impress.
		Canon Powershot PRO1 £400 ★★★★★★ Reviewed July 04 www.canon.co.uk	A well-designed camera for the serious user who wants stunning photos.
		Nikon Coolpix 8700 £402 ★★★★★★ Reviewed July 04 www.canon.co.uk	Features an impressive 280mm telephoto lens and 30fps (frames per second) movies.
1 DIGITAL SLR		Canon EOS 350D £799 ★★★★★★ Reviewed December 05 www.canon.co.uk	This is a hugely capable digital SLR camera that won't disappoint.
		Konica Minolta Dynax 5D £649.99 ★★★★★★ Reviewed December 05 www.konicaminolta.co.uk	A very usable camera, although it's a little weighty. Anti-shake mechanism is excellent.

HOW TO BUY

Decent 4-5megapixels point-and-shoot digital cameras start from about £150, while enthusiasts looking for flexibility can buy a new fully featured digital SLR for under £600.

In general, the higher the megapixel count of a digital camera's sensor – and the bigger the sensor's physical size – the more detailed the images. A small sensor and high megapixel count won't always produce better image quality.

Four to 5megapixels is good for 8 x 10in or larger prints. The quoted 'effective' pixels number is the camera's true megapixel resolution.

Forget digital zoom and concentrate on the optical zoom, which zooms in on the subject and produces a better-quality image. Digital zooms simply crop into the centre of the picture.

Many cameras offer higher ISO speeds – some compacts and all DSLRs hit 1,600. But while good for low light photos, it may result in noisy pictures.

The minimum optical zoom is typically 3x; about 35-105mm. If buying an SLR, multiply a lens size by 1.6 to get its true focal length, so a 100mm lens is 160mm when put on a digital body.

Look at the selection of automatic or preset picture modes

for standard shots, portraits, night shots and landscapes, plus macro modes for close-up photography.

Movie modes aren't as good as even a basic camcorder, but are fine for short movie clips to play on your PC. Most offer 15fps, but some are 30fps, which means the video will be smoother.

Experienced photographers will want manual controls for aperture and shutter priority, white balance and focusing. Good cameras should also provide quick and easy access to image quality, resolution and format settings.

Built-in flashes are fine for everyday shots, and many include a red-eye reduction mode, but cameras with a hot-shoe for external flashes will allow much greater illumination and control over lighting.

Check start-up time because cheaper models are likely to take longer to be ready from switch-on. And check shutter lag, as there may be a delay between pressing the button and taking the photo.

Many models use NiMH (nickel-metal hydride) rechargeable batteries, but lithium batteries typically last longer. Also, smaller cameras often mean smaller capacity batteries.

Finally, remember digicams must write the image onto flash media before taking the next shot, and the better quality the card, the faster this will happen.

CAMCORDERS

1		Sony DCR-HC19E £297.87 ★★★★★★ Reviewed September 05 www.sony.co.uk	An excellent low-cost camcorder with a touchscreen LCD and good video software.
2		Canon MV850i £349 ★★★★★★ Reviewed September 05 www.canon.co.uk	Simple to use and good quality, although it doesn't come with video-editing software.
3		Panasonic VDR-M55B £499.99 ★★★★★★ Reviewed December 05 www.panasonic.co.uk	Expensive, but being able to burn footage direct to DVD makes it easy to use.
4		Samsung VP-D453 £280.84 ★★★★★★ Reviewed September 05 www.samsung.co.uk	An attractive, compact camcorder with a good range of features and decent-quality images.
5		Panasonic NV-G521 £322.54 ★★★★★★ Reviewed September 05 www.panasonic.co.uk	A robust model with good image quality and a wide range of connectivity options as standard.

HOW TO BUY

Smaller camcorder designs are easy to carry, but can be awkward for larger hands.

The MiniDV format is usually in mid-range to high-end models. Digital-8 is entry-level and plays analogue Hi8 and 8mm tapes.

Some digicams record directly to DVD-R/RW and Ram, or solid-state memory cards. The amount of data needed for quality video makes the latter impractical. Sony's tiny MicroMV is a better alternative. Cassettes are smaller than MiniDV and it stores video in mpeg-2. Files are smaller for editing, but you'll need software that accepts this type of data.

Look at optical zoom and forget digital zoom. Around 10x is



normal, with up to 20x for more expensive models.

To transfer edited images back to tape you'll need a DV-in and out Firewire (Ilink/IEEE 1394) port. Otherwise DV-in is fine to transfer footage to your PC.

Built-in microphones are susceptible to noise, so look for a 3.5mm jack or an accessory shoe and use a separate mic.

Most digicams take still photos, but limited resolutions mean you're better off with a dedicated stills camera. In addition, look for image stabilisers (optical is better than digital) and a good range of AV connectors. Some camcorders have a USB port, so they can be used as a webcam.

PRINTERS

PHOTO PRINTERS		Epson Picturemate 100 £100 ★★★★★ Reviewed January 06 www.epson.co.uk	This is a high-quality photo printer that is both cheap and easy to use.
		Canon Pixma IP5000 £129 ★★★★★ Reviewed June 05 www.canon.co.uk	If it's pixel-perfect printing you're after, look no further than the IP5000 - a real bargain.
		HP Photosmart 8450 £170 ★★★★★ Reviewed April 05 www.hp.com/uk	HP's Photosmart 8450 is a bulky printer, but it's capable of producing stunning photo prints.
		Epson Stylus Photo R340 £149 ★★★★★ Reviewed February 06 www.epson.co.uk	Excellent-quality prints and the ability to function without a PC.
MULTIFUNCTION DEVICES		Canon Pixma MP150 £69 ★★★★★ Reviewed December 05 www.canon.co.uk	Photo quality might not be the best, but as a budget MFP the MP150 is a great buy.
		Dell Photo All In One 944 £121 ★★★★★ Reviewed April 06 www.dell.co.uk	A bulky, but good quality MFD that would suit both home and small office use.
LASER PRINTERS		Dell 1600n £236 ★★★★★ Reviewed September 05 www.dell.co.uk	A good multifunction mono laser, perfectly suited to small or home offices.
		Canon LBP-5200 £224 ★★★★★ Reviewed October 05 www.canon.co.uk	A great-value colour laser printer that's both small and capable of delivering quality prints.
		Dell Laser Printer 1100 £93 ★★★★★ Reviewed November 05 www.dell.co.uk	A cheap mono laser printer, but it comes with a relatively small starter toner cartridge.
		HP Laserjet 1020 £89 ★★★★★ Reviewed August 05 www.hp.com/uk	A great home laser printer that's fast, good quality and is one of the cheapest lasers available.

HOW TO BUY

If you don't need colour, consider a monochrome laser or LED printer. The latter tend to be cheaper and may last longer than a laser, but LED printers have a fixed resolution and can't take advantage of software-based resolution enhancements.

If you print hundreds of pages a week, a laser is the best option as they're cheaper and more reliable for high-volume printing. If you print a few pages a month, buy a cheap colour inkjet. If printing high-quality colour photos, buy a good photo printer.

Look for the manufacturer's quoted 'duty cycle' - this is how many pages a month the machine can handle. Choose a duty cycle three or four times larger than your expected average usage. Also check the printer's 'engine life' or 'total print volume' - after this expires, the printer's on borrowed time and uneconomical to repair.

Quoted printer speeds often refer to the speed the printer pushes a blank sheet of paper through the mechanism; for documents they tend to refer to lower quality settings. PCW's tests use real documents and photos, giving a better idea of print speed.

For serious inkjet photo printing, consider higher-end models that use six, seven or eight colour cartridges. Normal

inkjets use three colours (cyan, yellow and magenta) plus black, while specialised photo printers add extra shades to improve colour fidelity. Cheaper models often combine three colours in a single cartridge, which is not as economical as using separate cartridges for each colour.

Some 'convertible printers' use four separate black cartridges for longer-life mono printing and you can replace three of them with cyan, magenta and yellow cartridges for colour printing.

Laser models for business use often have a large number of paper-handling options. They're usually modular so you can add features as required. They also have a wider range of interface options and consumables.

You'll often find bundled software with a printer. Their quality varies, but there can be some useful programs.

The quality and usability of the driver software is vital, but it's difficult to assess before buying. Check PCW's reviews and online forums (www.pcw.co.uk/forums) and read the manufacturer's technical support site for any known problems.

Third-party or refurbished consumables generally work fine, but can cause problems with quality and reliability. Your warranty may not cover the use of non-approved consumables.

FLATBED SCANNERS

1		Epson 2480 Photo £79 ★★★★★ Reviewed February 05 www.epson.co.uk	It's rather large, but is easy to use and includes a transparency adapter.
2		HP Scanjet 3770 £69 ★★★★★ Reviewed February 05 www.hp.com/uk	You get plenty of scanning options, plus it's fast and produces good image quality.
3		Mustek Bearpaw 4800TA Pro II £69 ★★★★★ Reviewed February 05 www.mustek.com	Simple to install and it includes a built-in transparency adapter with automatic cropping.
4		Vivioneer Onetouch 9220 USB £99.99 ★★★★★ Reviewed February 05 www.vivioneer.com	You get plenty of features for your money, and it produces good-quality scans.
5		Canon Lide 35 £59 ★★★★★ Reviewed February 05 www.canon.co.uk	Compact, stylish with some useful software, but it doesn't include a transparency adapter.

HOW TO BUY

Flatbed scanners are the simplest way of digitising your old photos. Whether you just want to back them up on your PC, email them, stick them on a website or edit them, just hook up a scanner to your PC or notebook and off you go.

That said, not all scanners are created equal and there is a huge choice out there. Here are some key features to look out for to make it easier.

A good scanner will connect via USB2 or Firewire. Try and avoid older models offering USB1.1 since large scans can take a while to transfer to your PC. It should also offer at least 48bit colour depth and a resolution of

2,400 x 2,400dpi. This is more than enough for scanning photos or documents.

Also look out for a 35mm slide adapter for scanning slides or, even better, an automatic film loader that allows you to insert your film negatives or slides for simple scanning and enlargement.

On the software front, see if your model comes with tools that allow you to fix and edit the photos. This can include anything from removing red-eye, to colour restoration and eliminating dust and cracks. Some entry-level models even come with a cut-down version of the leading professional editing software, Adobe Photoshop.

ROUTERS

1		Netgear 108 ADSL router	£159 ★★★★★ Reviewed April 05 www.netgear.co.uk	If you need a Super-G router with built-in ADSL modem, this offering from Netgear is great value.		
		2		Ozenda 11g ADSL Router	£70 ★★★★★ Reviewed November 04 www.ozenda.com	Ozenda has come up trumps – wireless ADSL doesn't get any easier than this.
				3Com Office Connect ADSL Wireless 11G	£59 ★★★★★ Reviewed August 05 www.3com.co.uk	A wireless ADSL router that's good for Soho environments and simple to set up and configure.
1		Linksys WAG54G (wireless)	£76 ★★★★★ Reviewed August 05 www.linksys.com	This 802.11g wireless model offers advanced features for home and professional users.		
		2		D-Link DSL-G624M	£110 ★★★★★ Reviewed March 06 www.d-link.co.uk	Combines Mimo technology with Super G to give faster speeds and extended coverage.
				Netgear WGT634U	£106 ★★★★★ Reviewed August 05 www.netgear.co.uk	Good design, high quality and easy configuration make this a great wireless choice.
4		Belkin Wireless Pre-N router	£119.99 ★★★★★ Reviewed April 05 www.belkin.com	Excellent coverage and easy installation and configuration make this a great product.		
		1		Intertex IX66+ ADSL Airsip GW (wireless VoIP)	£269.08 ★★★★★ Reviewed March 05 www.intertex.se	For a small business needing multi-user VoIP telephony, the Intertex IX66+ is hard to beat.
				Zoom Zoomtel X5V	£100 ★★★★★ Reviewed March 05 www.zoom.com	For a no-fuss VoIP solution at home, the Zoomtel X5V is worth considering.
3		Draytek Vigor 2500V	£139.83 ★★★★★ Reviewed March 05 www.draytek.co.uk	A great wired router for those wanting to reap the benefits of VoIP telephony.		

HOW TO BUY

The router is at the heart of any home network. Costing less than £100, they are an inexpensive way to exploit the advantages of being able to share information between the computing devices in your home.

A router is a simple networking device to which you connect your PCs and notebooks using a network cable. They often include built-in firewalls and other security measures, making them ideal for protecting your PCs from intruders.

The router connects to your broadband modem, as long as your modem uses an RJ45 Ethernet connection – most routers don't support USB modems. Special broadband routers, also called ADSL gateways, come with built-in ADSL modems. If your broadband is provided via a cable company's set-top box, you should buy a standard router without a built-in modem.

Once hooked up, your devices can share the broadband connection as well as swap data and let you play networked games. Wireless (Wifi) routers are increasingly popular in the home market, allowing devices to remotely connect to the Internet and each other without the need for cables – but wireless routers also usually have ordinary network (Ethernet) ports to let you connect non-wireless devices.





Wireless standards

802.11b This was the first and, until recently, the most common wireless variant used. With transmission speeds of just 11Mbps/sec it is also the slowest. It also used the 40bit Wireless Equivalency Privacy (Wep) security protocol, which was found to have a number of holes. An updated version of this, 802.11b+ boosted speeds to 22Mbps/sec.

802.11g This is now the mainstream standard in use, offering more respectable data transfer speeds of up to 54Mbps/sec – although in reality speeds are much lower. It also uses the more robust Wifi Protected Access (WPA) security protocol. Both 'b' and 'g' products can work together, which is handy if you have older 802.11b kit you still wish to use on your home network.

802.11n This is still in the process of being officially ratified and will not arrive in its final form until next year. It promises real data transfer speeds of 100Mbps/sec and, theoretically, up to 300Mbps/sec as well as increased range. At the moment there are two competing groups battling for supremacy. There are already numerous 'Pre-N' or 'Mimo' routers available that offer significant data transfer speeds over 'g' routers.

SPEAKERS

1		Creative Gigaworks S750	£237 ★★★★★ Reviewed April 04 http://europe.creative.com	Although no Dolby Digital encoder is included, the sound quality and construction are superb.
		2		Logitech X-530
3				Hercules XPS5-101-Black
		4		Creative Inspire T7900
5				Logitech Z-5500 Digital

HOW TO BUY

PC speakers have come a long way, with most manufacturers now offering 2.1, 5.1, 6.1, 7.1, and even 8.1 packages.

Here are three things to watch for when you're looking to buy. First is the output, often expressed in watts. Try to look beyond the manufacturer's statements, as they can be misleading. For instance, a 125w output might comprise a 100w sub-woofer and five 5w speakers. You may see speaker output quoted as PMPO (Peak Music Power), which relates to the maximum output that can be achieved under perfect conditions and is misleading. Lastly, there is RMS (Root Mean Square), which is expressed in watts, for example

total 200w RMS. This is a better reference for overall power, but not perfect.

Impedance is measured in ohms and tells you how much of an electrical load a speaker presents to the amplifier.

The higher the impedance, the less power the amplifier needs to drive it. The average on most speakers is 8ohms. If lower than 8ohms the amplifier has to work harder to drive the speakers, which can result in distortion.

Frequency response refers to a speaker's tonal qualities and its ability to reproduce sounds at different frequencies. Speakers listed as having a response of 20Hz-20KHz are the most common for PC speakers.

MONITORS

17IN		LG Flatron L1732P £239 ★★★★★ Reviewed February 06 www.lge.co.uk	Fast response times make this 17in panel a good choice for gamers.
		Samsung Syncmaster 173P £237 ★★★★★ Reviewed November 04 www.samsung.co.uk	Ergonomic, with a good picture quality, if slightly under-saturated, and the screen is very adjustable.
		Viewsonic VP171B £229 ★★★★★ Reviewed November 04 www.viewsonic.com	The VP171B has great picture quality, but the viewing angles are slightly restrictive.
19IN		Acer AL1922HS £279 ★★★★★ Reviewed September 05 www.acer.co.uk	The AL1922HS offers a great balance of features, performance and price.
		CTX S966A £219 ★★★★★ Reviewed September 05 www.ctxeurope.com	Excellent value for money and looks a lot more expensive than it really is.
		Viewsonic VX922 £319 ★★★★★ Reviewed May 06 www.viewsonic.co.uk	A quality monitor with a staggering 2ms response time – perfect for gamers.
20IN+		AGM CW-19 £199 ★★★★★ Reviewed April 06 www.agm-display.com	A basic, no-frills monitor with a smart and compact design along with decent performance.
		HP f2105 £549 ★★★★★ Reviewed March 06 www.hp.com/uk	Expensive, but hugely impressive monitor with excellent image quality.
		Eizo Flexscan S2110W £712.05 ★★★★★ Reviewed May 06 www.eizo.co.uk	Excellent performance and a formidable specification, but very expensive.
		Fujitsu-Siemens S20-1W £399 ★★★★★ Reviewed April 06 www.fujitsu-siemens.co.uk	Superb build and image quality combine to make one of the most attractive monitors in its class.

HOW TO BUY

CRT (cathode-ray tube) monitors are less fashionable, mainly due to the rapidly dropping prices of TFT (thin-film transistor) flat-panel models. But CRT technology is more than 100 years old and has a lot of strengths. CRTs are bulky, heavy and power-hungry, but are now excellent value for money.

Resolution is the number of graphics elements displayed on a screen. Known as pixels, they are generated by your graphics card. In any TFT or LCD, each pixel is composed of three sub-pixels coloured red, green and blue. In a CRT the pixels are spread in a grid across the screen separated by a distance called the dot pitch. The smaller the dot pitch, the sharper the image.

With TFTs, each pixel is composed of three rectangular thin-film transistors. The number of pixels equals the 'native' resolution; a 1,024 x 768 TFT will have exactly that number of pixels horizontally and vertically.

CRTs usually have a higher resolution than a TFT of the same size and work perfectly at any standard resolution up to the quoted maximum. Running a TFT below its native resolution can result in a poor picture.

Check your TFT's native resolution meets your needs – gamers wanting 1,600 x 1,200 will probably need an expensive

20in model – most 19in panels are currently limited to 1,280 x 1,024 and budget 14/15in models might only support 800 x 600.

Modern TFTs can be viewed from a wide range of angles vertically and horizontally, but anything over +/- 45° makes no difference in normal use.

Response time is the time taken for a pixel to reach maximum brightness – 12-25ms is typical – faster is better. Some newer monitors now have response times of 4ms or 8ms.

TFTs have high quoted contrast ratios, but this is often a maximum figure. Evenness of lighting is more important than the overall brightness specification.

The ISO 13406-2 standard specifies minimum requirements for display contrast, viewing angle, brightness, reflections, flicker, contrast and defective pixels. You may see the standard incorporated in a TUV label with the words 'Ergonomics Approved' or 'ISO 13406-certified'. The TCO'95 and '03 standards cover electromagnetic emissions, noise and ergonomics – ensure the monitor has at least one of these. ISO 13406-2 has stringent standards for defective pixels. Only Class I TFTs are guaranteed no defective pixels – most consumer models are Class II. Some manufacturers offer some dead pixel guarantees with Class II TFTs.

TV TUNERS

1		Nebula Digitv £99.95 ★★★★★ Reviewed August 05 www.nebula-electronics.com	This external USB2 tuner has a built-in web server to let you share TV over your network.
2		Twinhan Magic Box £69.99 ★★★★★ Reviewed August 05 www.twinhan.com	A stylish external USB2 tuner with good software and an attractive price.
3		Terratec Cinergy 400 TV £89.99 ★★★★★ Reviewed March 05 http://en.terratec.net	A PC Card-based analogue tuner with good software, it's a great buy for laptop users.
4		Visionplus VisionDTV £69.99 ★★★★★ Reviewed November 04 www.twinhan.com	A bargain price and top-notch features make this a must-buy USB2 digital TV tuner.
5		Avermedia Avertv DVB-T USB2 £84.99 ★★★★★ Reviewed August 05 www.aver.com	The Avertv impressed us with its sheer simplicity, and its small size makes it ideal for notebook users.

HOW TO BUY

Internal TV tuners require a PCI slot. External options connect via USB and are easier to set up. Hi-speed USB2 is often needed and devices typically require Windows ME, 2000 or XP. Check if you run Windows 98 or NT.

A Freeview digital tuner offers the best channel choice, picture and sound, but may need an outdoor aerial or a wideband aerial (you can check at www.freeview.co.uk). Analogue terrestrial TV tuners may give better results if using an indoor receiver. If a digital tuner receives digital audio broadcasting (DAB) support. Look for Teletext and subtitle support.

Digital tuners record to disk for maximum quality; analogue signals need to be digitally encoded – look for mpeg-2 hardware for realtime video and audio encoding; cheaper tuners need your CPU to do this in software.

Most analogue systems let you capture video from a VCR or camcorder. Look for composite or S-video connectors and stereo phono inputs. Typically, an hour of mpeg-2 video uses up to 2GB of disk space. VHS-quality mpeg-1 gives just over an hour on a CD.

Better TV cards have personal video recorder functionality, letting you pause, fast forward and rewind live TV, and have an electronic programme guide to record shows to your PC.

DIGITAL MUSIC PLAYERS

1		Apple iPod £219 ★★★★★ Reviewed January 06 www.apple.com/uk	All the usual iPod features but now with the ability to play video.
2		Creative Zen Nano Plus £99 ★★★★★ Reviewed December 05 http://europe.creative.com	1GB flash player that houses a radio, voice recorder and mp3 encoding from a line-in source.
3		Philips HDD6320 £229 ★★★★★★ Reviewed March 06 www.philips.co.uk	Sleek and stylish, this 30GB player from Philips is incredibly easy to use.
4		Apple iPod Shuffle £89 (1GB); £69 (512MB) ★★★★★★ Reviewed May 05 www.apple.com/uk/ipod	Small yet perfectly formed, it's easy to use, has good sound and is set to be a big hit.
5		Iriver H340 SE £339 ★★★★★★ Reviewed January 05 www.epinx.com	A good all-round player with a colour screen and built-in FM tuner.

SMARTPHONES

1		O2 XDA Mini £99.99 ★★★★★★ Reviewed March 06 www.o2.co.uk	A compact and well-featured PDA, complete with a slide out keyboard
2		T-Mobile MDA Pro £139 ★★★★★★ Reviewed January 06 www.t-mobile.com	A well-designed smartphone that's absolutely loaded with features.
3		Sony Ericsson P910i Econtract dependent ★★★★★★ Reviewed December 04 www.sonyericsson.co.uk	The Symbian-powered P910i has heaps of features and impressed us a great deal.
4		Motorola A780 From free ★★★★★★ Reviewed April 06 www.dialaphone.co.uk	Combines a mobile phone, PDA and satellite navigation in one easy to use smartphone.
5		Sony Ericsson D750i Econtract dependent ★★★★★★ Reviewed December 05 www.t-mobile.com	It's no substitute for a digicam, but this 2megapixel camera phone is packed with features.

PDAS

1		Dell Axim X50v £304 ★★★★★★ Reviewed May 05 www.dell.co.uk	A good PDA, with a great VGA-resolution screen, which is perfect for multimedia use.
2		Asus My Pal A730W £356 ★★★★★★ Reviewed July 05 www.uk.asus.com	A fully-loaded Pocket PC, with a large set of utilities at a reasonable price.
3		Palm Tungsten T5 £279 ★★★★★★ Reviewed March 05 www.palm.com	Another sterling Tungsten upgrade with great new features, let down only by having no Wifi.
4		HP IpaqRX3715 MMC £224 ★★★★★★ Reviewed November 04 www.hp.com/uk	A fantastic Pocket PC with some great features, but the camera's viewfinder could be better.
5		Palmone Zire 72 £169 ★★★★★★ Reviewed August 04 www.palm.com	Provided you don't mind the styling, the Zire 72 is a cheap, yet powerful PDA.

HOW TO BUY

The mp3 music format recently celebrated its tenth birthday and in that short space of time it has revolutionised the music industry. On the way, it has spawned a global market for digital music players, none more famous than Apple's iPod and related offerings.

There are two main categories that players can be divided into: Flash memory-based players, which range in size from 256MB to 1GB and mini hard drive-based models, which run from 4GB to 60GB. Prices for a 256MB player start as low as £20 rising to around £300 for a 60GB player. In terms of songs, the difference is the ability to hold 40 on one and 15,000 on the other. If you just

want something for using on-the-move, then Flash-based players are the way to go, since they are very small and light.

The software used in many players determines how easy it is to use in terms of tracklisting and organising songs.

If you need a portable record store, then start by looking at the wide range of 4GB-6GB players and, if that's not enough, head for the 20GB, 40GB and 60GB models. Ensure whatever you buy supports playback in different formats. The ability to listen to FM radio and record voice is also a bonus. Most importantly, check out the battery life, since this can vary wildly between similar devices.

HOW TO BUY

Smartphones are essentially mobile phones that can do a lot more than send texts and make calls. They are increasingly popular because you get both phone and PDA functions in a single device.

There are two key types of smartphones - those that look roughly like slightly bigger mobile phones and those that are essentially PDAs with voice functionality (Blackberry, Palm, Nokia, etc). We will look primarily at the mobile phone smartphones. They usually boast small colour screens and allow you to send email, access the Internet, run third-party applications, use instant messaging software and sort out your calendar and contacts. Even

better, all of this information can be synchronised with your PC or laptop and some even allow you to store and play mp3s, take photos and shoot video.

There are two main operating systems in use: Symbian and Microsoft's Windows Mobile 2003, the latter with a new version due. Symbian controls the lion's share of the market at the moment and its key partner, Nokia, ships over 50 per cent of all smartphones. These smartphones are general-purpose devices and suitable for all the above tasks in moderation.

If you are a heavy email user or plan to work on documents on the move, then consider a PDA-style smartphone with a keypad.

HOW TO BUY

A PDA, or personal digital assistant, is essentially a handheld computer. The PDA market is not as clear cut as it once was, as newer devices with voice capabilities have now arrived. For our purposes, handhelds do not include smartphones.

There are two main types of devices: those that run the Palm operating system and those that run Pocket PC from Microsoft. Both have their advantages, but if you want familiarity, go with a Pocket PC-based device, since it will run versions of common Microsoft applications.

If you plan to write a lot, consider a model with a keyboard. Otherwise, go for a

pen-based device which is typically half the price and offers an on-screen keyboard or has handwriting recognition features.

Most PDAs use memory for storage, so look for a device with 64MB or more, if possible. Storage can be boosted using flash memory cards in the SD card slot. Newer devices now have tiny hard disk drives with capacities of up to 4GB.

Most PDAs come with colour screens for viewing photos and media files. If watching video is a priority, go for one with the highest screen resolution. For the best in connectivity, opt for a model with in-built Bluetooth and wireless networking or Wifi technology.

PORTABLE MEDIA PLAYERS

1		Archos AV400 20GB £314.99 ★★★★★ Reviewed June 05 www.datamind.co.uk	A great alternative to Microsoft-based models, offering more features than the competition.
2		Archos Gmini 400 20GB £239.99 ★★★★★ Reviewed June 05 www.datamind.co.uk	A scaled-down version of the AV400, it's portable, with great battery life and an array of features.
3		Digital Cube I-Station 20GB £329.99 ★★★★★★ Reviewed July 05 www.datamind.co.uk	A 20GB model with an FM tuner and mp3 recorder, it also supports a wide range of video formats.
4		Hauppauge PVMP 20GB £399 ★★★★★★ Reviewed June 05 www.hauppauge.co.uk	The PVMP offers a large 7in widescreen display, perfect for watching movies.
5		MSI Megaview 566 20GB £250 ★★★★★★ Reviewed June 05 http://msicomputer.co.uk	A lightweight media player that will happily record from a video source.

HOW TO BUY

Portable media players (PMPs), also called personal video players (PVPs), are the big brothers of mp3 players with video capabilities thrown in. You may also come across the term Personal Media Center (PMC), which are players built around Microsoft's Windows Mobile operating system.

PMPs, like many larger mp3 players, are based on mini hard disk drive technology and usually start at around 20GB. They allow you to watch movies, view photos and play music files. A good model will support mpeg-2 and 4, wmv and DivX movie formats, as well as mp3, wav asf and wma audio files. Some

can also receive and record FM radio and voice.

They come in a variety of sizes, with screens ranging from just over 2in to around 4in. The most common screen size is around 2.5-3in. Thanks largely to the screen and the mini hard drives, PMPs weigh a bit more than, say, an iPod, but at 150-300g they're not going to be too heavy to carry around. Many of the features on these devices are similar, from screen size to hard disks and supported formats. What sets them apart is weight, screen resolution, movie playback quality and battery life.

Test them out, if possible, or check out the PCW reviews before splashing out.

PERSONAL VIDEO RECORDERS

1		Plextor ConverTX PVR £151.56 ★★★★★★ Reviewed June 05 www.plextor.be	The ConverTX is an external analogue tuner that can also record from most video sources.
2		Twinhan Magic Box £69.99 ★★★★★★ Reviewed August 05 www.twinhan.com	Another PC-based stylish external USB2 tuner with good software and an attractive price.
3		Kiss DP-558 £293.75 ★★★★★★ Reviewed October 05 www.kiss-technology.com	A networkable PVR that lets you play Internet radio, although it has only got an analogue tuner.
4		Mustek DVD R580 £244.87 ★★★★★★ Reviewed September 05 www.mustek.com	Lots of features and connectivity options in this combo DVD recorder/hard disk standalone PVR.
5		Humax PVR-9200T £229 ★★★★★★ Reviewed February 06 www.humaxdigital.com/uk	Twin digital tuners and a 160GB hard drive make this a great choice.

HOW TO BUY

The personal video recorder (PVR), also known as a digital video recorder (DVR), is a device that records TV onto a hard drive in digital format. Unlike video and DVD recorders, there is no need for tapes or disks.

Tivo launched the world's first PVR in 1999 and most PVRs use the mpeg format for encoding video. Unlike VHS recorders, PVRs give you the ability to pause live TV, instantly replay scenes just watched while continuing to record and, most importantly, skip through adverts.

In the UK, Sky+ PVRs dominate the market, with other players, including Tivo and Telewest, trailing a long way behind.

The first thing to consider when buying a PVR is the size of the hard drive. Try going for one with a minimum of 40GB, but 80GB would be better. Most will come with a single Freeview tuner for getting free digital TV signals, but an increasing number are arriving with two. This means you can watch one channel and record another or even record two different channels while watching a previous recording.

At the heart of any PVR is the electronic programme guide (EPG). It's needed for selecting all the things you want your PVR to record. The better the EPG, the more intuitive your PVR becomes, recording programmes by itself based on your previous choices.

Got a product or service you want to sell? **Place it here.**

97% of readers refer to our product reviews.

95% use our best buy listings for purchasing advice.

Source: PCW readership survey 2005

To advertise here call Paul Harvey on 020 7316 9465
or email on paul_harvey@vnu.co.uk

BACKUP SOFTWARE

1	Roxio Backup My PC Deluxe 6 £34.99 ★★★★★ Reviewed June 05 www.roxio.co.uk	Takes the mystery out of backups and is ideal as a simple solution to protect PC files.
2	Acronis True Image 8 £29.99 ★★★★★ Reviewed February 05 www.phoenixglobalsoftware.co.uk	This easy-to-use disk imaging package should be part of every PC owner's toolkit.
3	X Drive \$99.50 per year for 5GB ★★★★★★ Reviewed October 05 www.xdrive.com	A flexible, simple-to-use and attractively priced online backup service.

HOW TO BUY

Backing up important data is something a lot of home users, and homeworkers, fail to take seriously. Until, of course, they lose everything and have no way of getting it back. In order to avoid such a calamitous event, consider some form of backup solution now.

Most of the leading backup packages cost between £30 and £50. A good solution will allow

you to do full hard disk backups, as well as single files and folders, plus let you schedule backups of data that's changed since the last full backup was executed. They should be easy to install and set up.

Backups should be easy to restore and retain the original file organisation. Any solution should be able to write backups to your hard drive, external hard drives and blank CD/DVD discs.

DIGITAL IMAGE-EDITING SOFTWARE

1	Adobe Photoshop Elements 4 £69 ★★★★★ Reviewed December 05 www.adobe.co.uk	A great choice for home users looking for an image-editing package that's easy to use.
2	Adobe Photoshop CS2 £538 ★★★★★★ Reviewed June 05 www.adobe.co.uk	Still the undisputed leader for professional photo editing, but its high price will put most off.
3	Corel Paintshop Pro X £99.95 ★★★★★★ Reviewed December 05 www.corel.co.uk	Power, sophistication plus ease of use make this great for beginners and experienced users.

HOW TO BUY

Many digital cameras come bundled with some form of basic photo-editing software, but to move on to the next level you really need to start using a dedicated editing package.

For good mid-range programs, prices range from free for open-source programs such as Gimp, up to about £90.

Look out for features including advanced colour correction,

lighting controls, automatic photo-fix wizards, scratch and blemish remover, multiple undo options, special effects, layers and templates. The software should also let you create slideshows, publish to the web, save in many different formats and archive images to CD/DVD discs.

Most importantly, there should be extensive help files, FAQs, tutorials, web forums, email and phone support.

MEDIA CREATION SOFTWARE

1	Roxio Easy Media Creator 8 £59 ★★★★★ Reviewed January 06 www.roxio.co.uk	Intuitive media editing suite to sort, enhance and share all your digital media.
2	Apple iLife '06 £55 ★★★★★★ Reviewed May 05 www.apple.com/uk	Packed with features, supremely easy to use and excellent value for money.
3	ROXIO Easy DVD Copy 2 £19.99 ★★★★★★ Reviewed April 06 www.roxio.co.uk	Useful if you've got a variety of unprotected material to copy or convert to DivX.

HOW TO BUY

This is the software you need for burning CDs and DVDs. Most new PCs and DVD burners come bundled with some kind of media creation software. A good product will allow you to burn audio and video content onto CDs and DVDs, back up data, create electronic photo albums, and make your own DVD menus and labels.

Bundled versions are usually limited, or 'lite', versions of

leading brands such as Nero, Roxio Easy Media Creator, Intervideo WinDVD or Pinnacle CD/DVD Creator, among others. You can usually upgrade to the full version online and save about 20 per cent or more on what you would pay for a standalone version.

Prices for standalone media creation software start at £20 for basic CD/DVD authoring software and rise to around £60 for the most advanced suites.

PC MAINTENANCE/UTILITY SOFTWARE

1	Winzip 10 Professional \$49.95 (£28 approx) ★★★★★ Reviewed March 06 www.winzip.co.uk	A Standard version is available, but this Pro version offers advanced compression
2	Allume BoostXP £19.99 ★★★★★★ Reviewed May 05 www.allume.com	BoostXP makes tweaking your system much easier than doing it manually.
3	Orlogix Replacemypc Suite £59.99 ★★★★★★ Reviewed March 06 www.orlogix.com	Useful package to securely migrate data from one PC to another.

HOW TO BUY

Just like your car, PCs need regular maintenance to keep them in good working order. There are tools within Windows that can help, but a dedicated suite of maintenance or utility software should do a better job.

Utility software often comes with a virus scanner, but you may already have one, so concentrate on one with the following features. It should offer a simple

overview of system and application performance, the ability to clean out the Registry and restore it easily if any mistakes occur, defragment the hard disk drive and memory, and optimise application performance. It should have some form of reporting and let you simplify the control of key Windows settings.

Other common tools will back up data, recover deleted files and speed up your Internet surfing.

PC SECURITY SOFTWARE

1	Bitdefender 8 Professional Plus £39.99 ★★★★★ Reviewed August 05 www.bitdefender.com	An easy-to-use suite that includes two years of free updates and 24/7 live online support.
2	Norton Internet Security 2006 £49.99 ★★★★★ Reviewed March 06 www.symantec.com	This latest version from Norton provides complete online security for your PC
3	Zone Labs Zone Alarm Security Suite 6 £49.95 ★★★★★ Reviewed November 05 www.zonelabs.com	A comprehensive product that offers excellent Internet security, including spam filtering.

HOW TO BUY

You cannot own a PC or laptop today without taking adequate security measures. The Internet may have opened up many opportunities, but it is also a dangerous place for an unprotected PC. In order to cover yourself, both online and offline, you will need a decent security software suite which combines numerous utilities to tackle different threats.

Popular brands include those from Zone Labs, Trend Micro, Norton and McAfee.

A good security suite should include a firewall, email scanner, spyware checker, anti-virus and anti-spam tools.

Prices for some of the best tools start at around £35 and usually include a year's online updates. After a year you will need to pay a yearly subscription to keep your software up to date.

OFFICE SOFTWARE

1	Microsoft Office Professional 2003 £459 ★★★★★ Reviewed May 04 www.microsoft.com/uk/office	Sets the standard for office suites for those prepared to pay the price.
2	Openoffice.org 2 Free ★★★★★ Reviewed July 05 www.openoffice.org	New features and improved compatibility make this a genuine alternative to Microsoft Office.
3	Microsoft Works 2006 £90 ★★★★★ Reviewed February 06 www.microsoft.com/uk	Comprehensive office package suitable for most home users. Great value for money.

HOW TO BUY

Office software generally refers to word processors, spreadsheets, presentation software and email utilities. Microsoft Office dominates this arena. But most new PCs come bundled with Microsoft Works Suite 2005, which has Word, Works Database, Spreadsheet and a range of home packages.

To upgrade to a full version of Microsoft Office will cost around

£150. Many will not need the functionality of Office though, and the Outlook Express email software shipped with all Windows PCs is enough for most users. If you can wait, then do so, since Microsoft plans to launch Office 12 in July 2006. But don't forget the competition either: products such as Ability Office, Star Office and the free open-source version, Open Office, are available.

VIDEO-EDITING SOFTWARE

1	Adobe Premiere Elements 2 £69.32 ★★★★★ Reviewed February 06 www.adobe.com	The best video-editing package available for beginners and intermediate users.
2	Pinnacle Studio 10 £69.99 ★★★★★ Reviewed February 06 www.pinnaclesys.com	Suitable for novices or intermediate users, Studio 10 is a good budget option.
3	Ulead Videostudio 9 £49.99 ★★★★★ Reviewed February 06 www.ulead.co.uk	Simple yet thorough, Videostudio offers plenty, whatever your level of expertise.

HOW TO BUY

This is a must for anyone hoping to turn hours of camcorder footage into tightly edited, watchable movies. There are a lot of packages to choose from, but new tools geared towards the novice are popping up in all of them. Not only are they making it easy to get your movies onto DVD, but a wider range of tools allow you to personalise what you've shot.

Basic packages cover capture, storyboarding, timeline video editing and template-based DVD authoring. More advanced software will let you create a wide range of special effects and are aimed at the home movie enthusiast. Prices start at around £40, but it's important to find a package with good help files - video-editing software often assumes a lot of prior knowledge.

Over 250,000 technology consumers will look **HERE** in the next 30 days.

Call Paul Harvey on 020 7316 9465 to advertise here.

Award-winning peace of mind...

InfraStruXure™

Finally, you can quickly deploy a standard- or high-density site of any size with scalable, top-tier availability.

Now is the time to reap the very real benefits of InfraStruXure's open, building-block approach to data centre design. Optimize system availability, increase agility, and lower the total cost of ownership with its built-in N+1 power and cooling, scalable, hot-swappable modules, and integrated management software.

For more information on how InfraStruXure can meet the demanding requirements of IT environments from wiring closets to data centres, visit us online at www.apc.com.

InfraStruXure™
DATA CENTRES ON DEMAND



InfraStruXure™ can be purchased as a modular or mobile system



APC is committed to innovative and cost-effective solutions to your power, cooling and management needs. With the industry's newest patent-pending approach to these problems, you can count on APC and our partners to ensure integrity in your blade application.

Optimize Availability • Increase Agility • Lower Costs

"After a thorough review of our defined requirements, we determined that APC's on-demand InfraStruXure™ solution was by far the best fit... InfraStruXure™ accommodates our new high-density blade servers and significantly reduces our total cost of ownership."



Henry Mota, Network Analyst (left)
Howard Rubin, Director, IS Technical Services (right)
Care New England

...from desktop to data centre



Mobile

Power up on-the-go with availability solutions for mobile users, including power, surge protection, and security.



UPS

From reliable power protection for the home to scalable, redundant UPSs for business or industrial installations, APC has a solution to suit your needs.



Rack Systems

Organize and secure IT equipment in high-quality racks and enclosures with a variety of accessories to create the optimal rack environment.



Cooling

Effectively address the cooling challenges posed by emerging IT trends with a range of innovative solutions, from precision cooling to air distribution and removal.



Management

Remotely monitor and control your network-critical physical infrastructure easily with APC's wide range of management hardware and software tools.



Services

From project management and needs assessment to installation services and extended warranties, APC provides end-to-end service and support.



Register to receive a **FREE** InfraStruXure™ brochure and get a chance to **WIN** a Sony PlayStation Portable

Visit <http://promo.apc.com> Enter Key Code 46362t • Call 0118 903 7800 • Fax 0118 903 7840

APC®
Legendary Reliability®

PRODUCT INDEX

Below is a list of every product reviewed by PCW over the past three months, to help you find the full reviews quickly and easily in your back issues.

Key: ★ Editor's Choice ★ Recommended ★ Great Value All scores are out of five

COMPANY	PRODUCT	ISSUE	SCORE	COMPANY	PRODUCT	ISSUE	SCORE	COMPANY	PRODUCT	ISSUE	SCORE
01 Communique	I'm In Touch 5.10	April 06	4	Evesham	E-kube (SFF PC)	March 06	3	Philips	170X6 (monitor)	March 06	3
★ 3am Labs	Log Me In Pro 2.30.523	April 06	5	Evesham	Mini PC Plus (SFF PC)	March 06	3	Philips	Brilliance 200W6 (TFT monitor)	March 06	3
3Com	Office Connect VPN Firewall	March 06	2	Evesham	Axis SB (desktop computer)	April 06	4	★ Philips	HDD6320	March 06	4
Abit	RX600 Pro Guru (graphics card)	Feb 06	1	★ Fortinet	Fortigate FG-60 (VPN device)	March 06	4	Philips	SPC 610NC (webcam)	April 06	3
Acer	Aspire 9504 (notebook)	Feb 06	4	★ Freedom2surf	Connect Home (broadband)	Feb 06	5	Pinnacle	Studio Plus 10	Feb 06	3
Acer	AT2001 LCD TV	Feb 06	4	★ Fujifilm	Finepix S9500 Zoom	Feb 06	4	★ Pioneer	DVR-110 Supermulti	March 06	5
★ Acer	Travelmate 8204WLMi	April 06	5	★ Fujitsu Siemens	Lifebook P1510 (tablet PC)	April 06	4	Pipex	1000 (broadband package)	Feb 06	3
Acer	Travelmate C202Tmi (tablet PC)	April 06	3	Fujitsu Siemens	S20-1W (monitor)	April 06	4	★ Pixmantec	Rawshooter Premium 2006	Feb 06	4
★ Actinic	Express (e-commerce software)	April 06	4	Fujitsu Siemens	Scaleo E (Media Center PC)	April 06	4	PNY Technologies	Geforce 6200 (graphics card)	Feb 06	2
Active@ Undelete	Active Data Recovery	March 06	4	Gainward	Ultra 3500PCX Golden Sample)	Feb 06	3	Powercolor	X800 GameFX 256	Feb 06	3
★ Activision	Call of Duty 2	Feb 06	5	Galaxy	Geforce 6800 Glacier	Feb 06	4	★ Restoration Man.	Restoration Manager	March 06	5
★ Activision	The Movies	April 06	4	Gametrak	Real World Golf	April 06	3	★ Roxio	Easy DVD Copy 2	April 06	4
★ Adobe	Premiere Elements 2	Feb 06	5	★ Gateway	8550GB (notebook computer)	Feb 06	4	★ R-Tools Technology	Technology R-Studio	March 06	4
★ AGM	CW-19 (monitor)	April 06	4	Gecube	Gecube Radeon X800 XL	Feb 06	3	Samsung	M50 (notebook)	Feb 06	3
AIST	Movie DV 7	Feb 06	4	Gizmondo	Gizmondo (portable gaming)	Feb 06	3	Samsung	Spinpoint P120S SP2504C	Feb 06	4
★ AJP	M575A (notebook)	March 06	4	Hawking Tech.	HBB1 (broadband booster)	Feb 06	3	Samsung	SE-W084 Slim	March 06	4
Akasa	All-in-one (component)	Feb 06	3	★ HP	f2105 (TFT monitor)	March 06	5	Samsung	SH-W162L	March 06	3
★ Alienware	Area-51 m5700 (notebook)	Feb 06	4	HP	Compaq tc4200 PV984ET	April 06	4	Samsung	SH-W163 (removable storage)	April 06	4
Ambros	Shuttle SB83G5 (SFF PC)	March 06	3	Hi-Grade	Ultinote A9700-3400 (notebook)	Feb 06	3	Sandisk	1GB Cruiser Titanium	April 06	4
Ambros	Shuttle SK21G Sempron 754	April 06	3	HIS	Radeon X700 Pro IceQ II	Feb 06	4	Sanyo	Xacti E6 (digital camera)	Feb 06	3
★ Antec	P150 (PC case)	March 06	5	Turbo Enabled (graphics card)	Feb 06	4	★ Sapphire	ATI Radeon X1300	Feb 06	4	
Anyplace Control	2.12 (remote access software)	April 06	3	Homechoice	Max Pack (broadband package)	Feb 06	4	Sapphire	Radeon X550 Silent Cooling	Feb 06	2
AOL	Platinum (broadband package)	Feb 06	4	★ Humax	PVR-9200T (PVR)	Feb 06	4	Sapphire	Radeon X800 (graphics card)	Feb 06	4
Aopen	Aeolus PCX DV128 Xtreme	Feb 06	3	Inno3D	Geforce 6800 LE (graphics card)	Feb 06	3	★ Sapphire	Radeon X800GT02	Feb 06	5
Aopen	PCX 6600-DV128LP	Feb 06	3	Inno3D	Geforce 7800 GTX (graphics card)	Feb 06	4	Sapphire	Radeon X850XT	Feb 06	3
Apple	20in Cinema Display	March 06	4	Intellect	Prodesk A64/3500s (desktop)	April 06	3	Platinum Edition 256MB	Feb 06	3	
Asus	A7VC (notebook)	Feb 06	3	Jabra	JX10 (Bluetooth headset)	April 06	3	Sapphire	Radeon X1800XT (graphics card)	March 06	4
Asus	A8N-VM CSM (motherboard)	Feb 06	4	Kingston	U3 Data Traveler	March 06	3	Sapphire	Radeon X800GTO (AGP)	March 06	4
Asus	DRW-1608P25 (optical drive)	Feb 06	4	Konica Minolta	Pagepro 1380MF (laser printer)	March 06	4	★ Scan	EVGA Geforce	Feb 06	5
Asus	Extreme N6800 GT	Feb 06	3	Lacie	Brick Desktop Hard Drive	March 06	4	7800GTX Black Pearl	April 06	5	
Asus	VR Guard CPU cooler	March 06	4	★ Laplink	Everywhere 4 (remote access)	April 06	4	Seagate	Barracuda 7200.9 (hard disk)	March 06	4
Asus	EN7800GT Top Silent	April 06	4	★ LG	Flatron L1732P (monitor)	Feb 06	4	Seasonic	S12 (component)	Feb 06	3
Atari	The Matrix: Path of Neo	March 06	3	LG	M203WX (TFT monitor)	March 06	3	Silentmaxx	ST11-Pro (computer case)	April 06	3
ATI	Radeon X1600 XT	Feb 06	3	Lixxus	Lixx Startbasic (broadband)	Feb 06	3	★ Skype	2 (VoIP service)	April 06	5
ATI	Radeon X1800 XT	Feb 06	4	★ Mesh	Xtreme Fire (desktop PC)	Feb 06	4	★ Sonic Wall	TZ 170 (VPN device)	March 06	5
★ ATI	Radeon X1900 (graphics card)	April 06	5	★ Mesh	Cubex X-Cite (SFF PC)	March 06	4	★ Sony	Playstation Portable	Feb 06	5
★ Auralog	Tell Me More (language tuition)	Feb 06	5	★ Mesh	Xtreme FX60 (desktop PC)	March 06	4	Stellar	Phoenix Fat + NTFS	March 06	2
Averatec	1050 (notebook)	April 06	3	Mesh	Matrix Vector PCW (desktop)	April 06	3	★ Supportplus	Q-Be (portable media player)	Feb 06	4
★ Belinea	10 20 35W (TFT monitor)	March 06	4	★ Microsoft	Works Suite 2006	Feb 06	5	★ Symantec	Norton Internet Security 2006	March 06	4
BenQ	FP202W (monitor)	March 06	3	★ Microsoft	Xbox 360	March 06	4	★ Symantec	PC Anywhere 11.5	April 06	3
Binary Biz	Virtual Lab (data recovery)	March 06	2	Microsoft	Zoo Tycoon 2	March 06	3	Telewest	Broadband Complete	Feb 06	4
BT Yahoo	Power Surfing (broadband)	Feb 06	3	★ Mindjet	Mindmanager Pro 6	March 06	4	Tesco	Broadband 512K	Feb 06	3
★ Buffalo	Ministation HD-PHS40U2/UC	April 06	4	Mobotix	M10M-Basic (IP camera)	Feb 06	3	Think Outside	Stowaway Bluetooth Keyboard	Feb 06	2
★ Bulldog	Interactive (broadband)	Feb 06	5	Motion Computing	LS800 (tablet PC)	April 06	4	Tiscali	Broadband 2MB (broadband)	Feb 06	4
Canon	DC20 (digital camcorder)	Feb 06	3	★ Motorola	A780 (smartphone)	April 06	4	T-Mobile	Sidekick II (PDA)	March 06	3
Check Point	Safe@Office 425W (VPN device)	March 06	4	MSI	NX6800GT-TD256E	Feb 06	3	Toshiba	Satellite Pro M70 (notebook)	April 06	2
Citrix	GotomyPC 5.0 (remote access)	April 06	4	★ NEC	ND-4550 (DVD writer)	Feb 06	5	Toshiba	SD-R6572M	April 06	3
Colour Confidence	Datacolor Spyder TV (TV plugin)	April 06	4	Netgear	Prosafe VPN Firewall FV5328	March 06	3	Toshiba	TDP-TW90 (projector)	April 06	3
Conceptronic	Grab'n'Go TV Media Player	Feb 06	3	Nildram	Broadband 2Go	Feb 06	4	Toshiba	Tecra M4 (tablet PC)	April 06	3
Coolermaster	Stacker 830 (computer case)	April 06	4	★ Nintendo	Nintendo DS	Feb 06	4	Translution	Pro (translation software)	Feb 06	4
Creative	Zen Vision: M	April 06	4	Nintendo	Game Boy Micro	Feb 06	3	Trust	Mobile Laptop Alarm	April 06	2
Crucial	Radeon X800 Pro	Feb 06	3	Nokia	N-Gage	Feb 06	2	Ubisoft	Peter Jackson's King Kong	Feb 06	3
Cube	247 Atlas S13 (desktop)	April 06	4	★ Nvidia	Geforce 6800 GS (graphics card)	Feb 06	4	★ Ubisoft	Prince of Persia:	Feb 06	3
Cyberlink	Power Director 5	Feb 06	3	Nvidia	Geforce 6800 Ultra	Feb 06	3	The Two Thrones	April 06	5	
Dell	Ultrasharp 2005FPW (TFT)	March 06	3	★ Nvidia	Geforce 7800 GTX 512	Feb 06	5	★ UK Online	Broadband 8000	Feb 06	5
D-Link	Photo All in One Printer 944	April 06	3	★ Nvidia	Geforce 7800 GTX 512MB	Feb 06	5	★ Ulead	Videostudio 9	Feb 06	4
D-Link	DSL-G624M (wireless router)	March 06	4	O2	XDA Mini (PDA)	March 06	4	Vadim	Fusion CS (desktop PC)	Feb 06	4
D-Link	Network Security	March 06	4	★ Olympus	E-500 (digital SLR)	April 06	4	Viewsonic	VA2012W (monitor)	April 06	3
Firewall DFL-700	March 06	3	★ Orantrac	Easy Recovery Lite	March 06	4	irgin	Plan One (broadband package)	Feb 06	3	
EA Games	Need For Speed - Most Wanted	March 06	4	Orange	SPV M5000 (mobile phone)	Feb 06	4	★ Vivendy Games	First Encounter Assault Recon	Feb 06	5
Eclipse	Flex Home 500 (broadband)	Feb 06	4	Orlogix	Replace MyPC Suite	March 06	3	Vodafone	Mobile TV	Feb 06	4
★ ECS	PF22 Xtreme (motherboard)	Feb 06	4	Packard Bell	Audiostar	Feb 06	2	Wanadoo	Heavy User	Feb 06	3
ECS	KA1 MVP Xtreme	April 06	3	Panasonic	SDR-S100 (digital camcorder)	March 06	3	Watford	Media Centre Cube (SFF PC)	March 06	4
Elonex	Mediastar 1541 (notebook)	Feb 06	2	★ Panrix	IQ Cube 3800X2 (SFF PC)	March 06	5	★ Winzip	10 Pro (utility software)	March 06	4
★ Epson	Epson EMP-TW520	Feb 06	4	★ Panrix	Magnum IQ 3700 (desktop)	April 06	5	XFX	Geforce 7800GTX (graphics card)	Feb 06	3
★ Epson	Stylus Photo R340 (photo printer)	Feb 06	4	★ Pantone	Huey (image editing software)	April 06	4	Zalman	CNPS9500-LED (cooler)	April 06	4
Evesham	Blaze X850 (desktop PC)	Feb 06	3	PC Nextday	Zoostorm 9-6201 (SFF PC)	March 06	3	Zalman	FS-C77 Fatal1ty (CPU cooler)	Feb 06	3
★ Evesham	Bluemedia BM6380 (sat nav)	Feb 06	4	★ PC Nextday	Zoostorm 9-5401 (desktop)	April 06	4	Zalman	FS-V7 Fatal1ty VGA cooler	March 06	3
★ Evesham	Voyager C720 (notebook)	Feb 06	5	PC Tools	File Recover 5 (data recovery)	March 06	3	Zen	ADSL Home 2000 (broadband)	Feb 06	3
Evesham	Axis FX 60 (desktop PC)	March 06	4	Philips	Digital Photo Display	Feb 06	3	ZicPlay	Minikey 256MB FM	March 06	3

SAVE TIME AND SPACE BANNISH YOUR CLUTTER TODAY!

Here at Personal Computer World we value our readers and are always striving for ways to make your lives easier and to save you money. That's why we are offering you a chance to **own all of 2005's issues** of Personal Computer World on one CD-Rom and receive a **FREE gift**.

With the editorial from every issue of Personal Computer World 2005 now on CD-Rom, this is the perfect opportunity to clear that clutter!

Own all of
PCW 2005 on one
CD-Rom. Order today at the
reduced rate of just **£13.45** for
subscribers or the regular
price of **£14.99**

Personal Computer World on CD 6

Twelve complete issues in searchable,
browsable and printable format

Contents: Issues 1-12, Volume 28, January to December 2005

**Personal
Computer
World Direct**

Own
every feature,
review and
more on one
CD-Rom

The CD-ROM boasts:-

- ✓ Enhanced search tool that allows you to search by key words, phrases, products or authors
- ✓ No more flicking through hundreds of pages
- ✓ Printable format
- ✓ Create your own files of useful articles

**PLUS, order today and get
a FREE GIFT***

Your free Databank
lets you store names,
phone numbers,
addresses and more.



**Worth
£9.99**

*while stocks last

**SAVE time and space
PLUS GET A FREE GIFT!
ORDER a copy TODAY!**

Order online:
www.direct-pcw.co.uk

By telephone:
0870 830 4973

Post this form to:
PCW DIRECT, Tower House, Sovereign Park,
Market Harborough, Leicester, LE16 9EF

Yes please, I would like to receive my copy of PCW CD-ROM 6 for £14.99 + £1.99 P&P.

Your Details

Title	Initials	Surname
Email		
Address		
Postcode	Subscriber number (if known)	
Telephone		

Payment Options (Please indicate your preferred method of payment)

1. Cheque enclosed for £ _____ (made payable to VNU Business Publications Ltd)
2. Please charge £ _____ to my
 Visa MasterCard Amex Delta Switch/Maestro (Issue No. ___)
 Card No.
 Valid from / / Expiry Date / /

Signature _____ Today's Date _____

We will use one or more of the various contact details supplied to contact you about your order, reader research and related products or events. Please indicate below your privacy wishes for other contact from VNU and 3rd party organisations: Email Tick box to receive information about other products or services from the VNU group of companies by email Tick box to receive information about products or services from selected companies by email Mobile/SMS Tick box to receive information about other products and services from the VNU group of companies by SMS Tick box to receive information about products and services from selected companies by SMS Postal/telephone Tick box if you do NOT want to receive information about other products and services from the VNU group of companies by post/telephone Tick box if you do NOT want to receive information about products and services from selected companies by post/telephone.



EST. 1984



power computing ltd

opening hours
mon - fri 9 - 6pm
sat 10 - 4pm sun closed

Custom build your Pc on-line

All prices include VAT. **t 01234 851500**

Sale Sale Sale!

2 YEARS RTB PARTS & LABOUR WARRANTY FREE COLLECT & RETURN ON ALL SYSTEMS

Power Cracker 2800+ 64bit DDR PC

Customise Me!

- ATX Midi Tower Case
- ASUS K8V-MX Socket 754 M/Board
- 1xAGPx8 3xPCI 1x Parallel
- 2x Front USB 2.0 4x Rear USB 2.0 2x SATA
- AMD Sempron 2800+ 64bit
- 256MB DDR 3200
- 6 Channel On-Board Sound Card
- 40GB 7200RPM Hard Drive
- 1.44MB Floppy Disk Drive
- 52x CD Rom Drive
- Integrated 3D Graphics Card
- Integrated 10/100 Ethernet Card
- 2 Years Parts & Labour Warranty

Free Collect & Return
Change CDROM to CDRW for only £10.00 Extra!
Or CDROM to DVDRW16x +/- for only £30.00 Extra!

~~WAS £219.95~~
NOW £189.95

Save £30!

Power Evo 3000+ 64bit DDR PC

Customise Me!

- ATX Midi Tower Case
- ASUS K8N-VM Socket 754 M/Board
- 1x PCI Express x16 2xPCI 1xPCI Express x1 1x Parallel
- 2x Front USB 2.0 4x Rear USB 2.0 2x SATA
- AMD Sempron 3000+ 64bit
- 512MB DDR 3200
- 6 Channel On-Board Sound Card
- 80GB 7200RPM Hard Drive
- 1.44MB Floppy Disk Drive
- ASUS 52x32x52 CDRW 16x DVD
- Nero 6 & Power DVD
- Integrated Nvidia 6100 3D Graphics Card
- Integrated 10/100 Ethernet Card
- 2 Years Parts & Labour Warranty

Free Collect & Return
Change CDRW/DVD Combo Drive to DVDRW16x +/- for only £10.00 Extra!

~~WAS £279.95~~
NOW £249.95

Save £30!

Power Predator 64bit 3200+ DDR PC

Customise Me!

- ATX Midi Tower Case
- ASUS Socket 939 M/Board
- 1xPCI Express x16 2xPCI 1xPCI Express x1 1x Parallel
- 2x Front USB 2.0 4x Rear USB 2.0 4x SATA RAID 0, 1 1x Firewire
- AMD Athlon 64Bit 3200+ Skt. 939
- 512MB DDR 3200
- 8 Channel On-Board Sound Card
- 80GB 7200RPM Hard Drive
- 1.44MB Floppy Disk Drive
- LG 16x DUAL LAYER DVD RW & CDRW
- Nero 6 & Power DVD
- Integrated Nvidia 6150 3D Graphics Card
- Integrated 10/100/1000 Ethernet Card
- 2 Years Parts & Labour Warranty

~~WAS £359.95~~
NOW £329.95

Save £30!

Power AMD64 3200+ DDR PC

Customise Me!

- ATX Midi Tower Case
- FOXCONN NFORCE 4 M/Board
- 1xPCI Express x16, 4xPCI, 2x PCI Express x1
- 2x Front USB 2.0 4x Rear USB 2.0
- 1x Parallel 4x SATA RAID 0,1
- AMD Athlon 64Bit 3200+ Skt. 939
- 512MB DDR 3200
- 6 Channel On-Board Sound Card
- 160GB 7200RPM Hard Drive
- 1.44MB Floppy Disk Drive
- LG 16x DUAL LAYER DVD RW & CDRW
- Nero 6 & Power DVD
- ASUS 6200 256MB Nvidia Turbo Cache Graphics Card
- Integrated 10/100 Ethernet Card
- 2 Years Parts & Labour Warranty

~~WAS £449.95~~
NOW £399.95

Save £50!

Power Stopper 2800+ 64bit DDR PC

Customise Me!

- ATX Midi Tower Case
- ASUS K8V-MX Socket 754 M/Board
- 1xAGPx8 3xPCI 1x Parallel
- 2x Front USB 2.0 4x Rear USB 2.0 2x SATA
- AMD Sempron 2800+ 64bit
- 512MB DDR 3200
- 6 Channel On-Board Sound Card
- 80GB 7200RPM Hard Drive
- Microsoft Keyboard
- Microsoft Optical Wheel Mouse
- 1.44MB Floppy Disk Drive
- ASUS 52x32x52 CDRW 16x DVD
- Nero 6 & Power DVD
- Integrated 3D Graphics Card
- Integrated 10/100 Ethernet Card
- Windows XP Home Inc. CD & Licence
- Anti Virus Software
- 2 Years Parts & Labour Warranty

Free Collect & Return
Change CDRW/DVD Combo Drive to DVDRW16x +/- for only £10.00 Extra!

~~WAS £349.95~~
NOW £299.95

Save £50!

Power Xtra Black 3000+ 64bit DDR PC

Customise Me!

- ATX Midi Tower Case Black
- ASUS K8V-MX Socket 754 M/Board
- 1xAGPx8 3xPCI 1x Parallel
- 2x Front USB 2.0 4x Rear USB 2.0 2x SATA
- AMD Sempron 3000+ 64bit
- 512MB DDR 3200
- 6 Channel On-Board Sound Card
- 160GB 7200RPM Hard Drive
- 17" TFT 16m/s Silver & Black Flat Panel Monitor Inc. Speakers
- Microsoft Keyboard
- Microsoft Optical Wheel Mouse
- 1.44MB Floppy Disk Drive
- LG 16x DUAL LAYER DVD RW & CDRW
- Nero 6 & Power DVD
- GE Cube ATI 9550 128MB 3D Graphics
- Integrated 10/100 Ethernet Card
- 56.6k Internal Dial Up Modem
- Windows XP Home Inc. CD & Licence
- Microsoft Works
- Anti Virus Software
- 2 Years Parts & Labour Warranty

Free Collect & Return
Warranty Free Collect & Return
~~WAS £609.95~~
NOW £559.95

Save £50!

Millennium Black 64bit 3200+ DDR PC

Customise Me!

- ATX Midi Tower Case Black
- FOXCONN NFORCE 4 M/Board
- 1xPCI Express x16, 2x PCI Express x1, 4xPCI
- 2x Front USB 2.0 4x Rear USB 2.0
- 3x FireWire Port 1x Parallel 4x SATA RAID 0,1
- AMD Athlon 64Bit 3200+ Skt 939
- 1GB DDR 3200
- 6 Channel On-Board Sound Card
- 160GB 7200RPM Hard Drive
- 19" TFT 16m/s Silver & Black Flat Panel Monitor Inc. Subwoofer & Speakers
- Logitech Internet Pro Wireless Keyboard & Mouse
- 1.44MB Floppy Disk Drive
- LG 16x DUAL LAYER DVD RW & CDRW
- Nero 6 & Power DVD
- ASUS 6200 256MB Nvidia Turbo Cache Graphics Card
- Integrated 10/100 Ethernet Card
- 56.6k Internal Dial Up Modem
- Windows XP Home Inc. CD & Licence
- Anti Virus Software
- 2 Years Parts & Labour Warranty

Free Collect & Return
~~WAS £849.95~~
NOW £749.95

Save £100!

Power Extreme 3800+ Dual Core DDR PC

Customise Me!

- CoolerMaster Cavalier T03 Black Tower Case
- Tagan 480Watt PSU
- ASUS A8N-SLI Deluxe M/Board M/Board
- 2xPCI Express x16, 3xPCI, 2x PCI Express x1
- 2x Front USB 2.0 6x Rear USB 2.0
- 1x FireWire Port 1x Parallel 4x SATA RAID 0,1,5
- AMD 64Bit 3800+ Dual Core Skt 939
- 1GB DDR 3200
- 8 Channel On-Board Sound Card
- 250GB SATA 7200RPM Hard Drive 16MB Cache
- LG 16x DUAL LAYER DVD RW & CDRW
- Nero 6 & Power DVD
- ASUS Extreme 7800GT Graphics Card
- 2x Integrated GB Ethernet Card
- Windows XP Home Inc. CD & Licence
- Anti Virus Software
- 2 Years Parts & Labour Warranty

Free Collect & Return
~~WAS £1050.95~~
NOW £999.95

Save £50!

We Custom Build PC's to your specification - please call



FREE UK MAINLAND DELIVERY on all ORDERS
when you spend £50.00 or more
No Surcharge on Credit Cards!

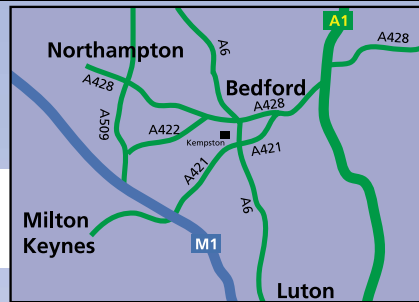

www.powerc.com

Memory Madness!

WHILE STOCKS LAST!

DDR2 now available, please call

256MB PC2700 DDR 184PIN 333 mhz
WOW PRICE! £19.95

512MB PC3200 DDR 184PIN 400 mhz
WOW PRICE! £34.95

512MB PC2700 DDR 184PIN 333 mhz
WOW PRICE! £34.95

Memory Pens
128MB USB2.0
Memory Pen.....£11.95
256MB USB2.0
Memory Pen.....£19.95
512MB USB2.0
Memory Pen.....£29.95

256MB PC3200 DDR 184PIN 400 mhz
WOW PRICE! £19.95

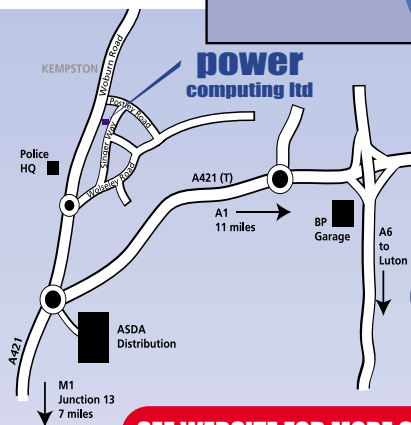

SHOWROOM
unit 82a, singer way
woburn rd ind. est.,
kempston
bedford mk42 7pu

We custom build Pc's on-line

SEE WEBSITE FOR MORE GREAT OFFERS!
www.powerc.com

Laptops from £499.95

LG DVD/RW16x+/- only £39.95!
Nero 6 inc.

17" TFT Monitor Silver Inc. Speakers 8MS Response Time only £169.95!

Maxtor 80GB 7200 HD only £39.95!

Wow! Upgrade your PC for Less!

All prices include VAT.

Hard Drive Upgrades

Maxtor 40GB 7200RPM IDE.....	£33.95
Maxtor 80GB 7200RPM IDE.....	£39.95
Maxtor 160GB 7200RPM IDE (8MB Cache).....	£59.95
Maxtor 200GB 7200RPM IDE (8MB Cache).....	£64.95
Maxtor 250GB 7200RPM IDE (16MB Cache).....	£74.95
Maxtor 300GB 7200RPM IDE (16mb Cache).....	£89.95
Maxtor 200GB 7200RPM SATA (8MB Cache).....	£69.95
Samsung 250GB 7200RPM SATA II (8MB Cache).....	£79.95
Maxtor 300GB 7200RPM SATA (16mb Cache).....	£99.95
Removable HardDrive Caddy/Bay IDE.....	£19.95
External Hard Drive Case USB2.0/Firewire.....	£39.95
IDE Rounded Hard Drive /CD Cable.....	£5.95

Monitors All Have 3 Years On-Site Warranty

17" CRT Monitor.....	£79.95
15" TFT SILVER/BLACK 16m/s.....	£129.95
17" TFT BLACK 12m/s.....	£169.95
19" TFT LG 12m/s.....	£209.95

Modems & Network

56.6k V92 Internal PCI Modem (Rockwell Chipset).....	£9.95
56.6k V90 External USB Modem.....	£29.95
10/100 RJ45 PCI Network Card.....	£9.95
5 Port Switch Hub.....	£24.95
8 Port Switch Hub.....	£29.95
Netgear WG602 Wireless Access Point.....	£59.95
Netgear WGE111 54G Wireless Game Adapter.....	£49.95
Netgear DG632 ADSL Modem USB Router 1x Lan 10/100.....	£49.95
Netgear DG834 ADSL Modem Router 4x Lan 10/100.....	£59.95
Netgear DG834G Wireless ADSL 54G Router 4x Lan 10/100.....	£69.95
Netgear DG834GT Wireless ADSL 108G Router 4x Lan 10/100.....	£79.95
Netgear DG834PN Rangemax Wireless ADSL Router 4x Lan 10/100.....	£99.95
Netgear RP614 DSL Router 4x Lan 10/100.....	£39.95
Netgear WGR614 Wireless DSL 54G Router 4x Lan 10/100.....	£59.95
Netgear WGT624 Wireless DSL 108G Router 4x Lan 10/100.....	£79.95
Netgear WPN824 Rangemax Wireless DSL Router 4x Lan 10/100.....	£99.95
Netgear WG111TGE USB 2.0 Wireless 108G.....	£49.95
Netgear WG311T PCI Wireless 108G.....	£49.95
ASUS PCI Wireless 54G.....	£24.95
ASUS USB 2.0 Wireless 54G.....	£24.95

Ports

USB 2.0 4 Port Internal PCI.....	£14.95
PCI I/O Ports 2x Serial 1x Parallel.....	£19.95
Firewire & USB 2 Combo Card Inc.....	£29.95
Firewire Cable & Software.....	£29.95
USB Bluetooth Dongle Upto 100Metre.....	£19.95
USB Serial/Parallel Converter.....	£29.95
USB Smart Card Reader 17 in 1 External.....	£14.95

CDROM/CDRW/DVD Drives (Retail Boxed)

ASUS DVD-E616 16x DVD (Beige or Black).....	£19.95
ASUS 52x32x52 CDRW,Nero Quiet.....	£19.95
ASUS CDRW/DVD Combo 52x32x52 16xDVD.....	£29.95
ASUS 52x24x52 External.....	£49.95
LG Dual Layer 16x/+ DVD RW + RAM (Beige or Black).....	£39.95

Cases

ATX Midi Tower Case with Front USB 350 Watt.....	£29.95
350 watt PSU.....	£19.95
550 watt PSU.....	£39.95
Tagan 480 watt TG480-U22.....	£64.95
Seasonic 600 watt true power.....	£99.95

Graphics Cards AGP

MSI NVIDIA FX 5200 128MB AGPx8.....	£34.95
MSI NVIDIA FX 5500 128MB AGPx8.....	£39.95
ASUS NVIDIA N6200 128MB AGPx8.....	£44.95
ASUS NVIDIA N6200 256MB AGPx8.....	£59.95
ASUS NVIDIA 6600 256MB AGPx8.....	£99.95
ASUS NVIDIA 6600GT 128MB AGPx8.....	£134.95
GE Cube ATI 9550 128MB AGPx8.....	£44.95
GE Cube ATI X800 GT0 128MB AGPx8.....	£139.95

Graphics Cards PCI Express 16

ASUS NVIDIA EN6200 Turbo Cache 128MB.....	£44.95
ASUS NVIDIA EN6600 256MB.....	£99.95
ASUS NVIDIA EN6600 GT 256MB.....	£159.95
ASUS NVIDIA EN7800GT 256MB.....	£259.95
ASUS NVIDIA EN7800GTX 256MB.....	£369.95

CPU'S

AMD SEMPRON SOCKET 754 2800+ 64bit (Retail Boxed Inc. Heatsink & Fan).....	£59.95
AMD SEMPRON SOCKET 754 3000+ 64bit (Retail Boxed Inc. Heatsink & Fan).....	£69.95
AMD ATHLON 64Bit 3200+ Socket 939 (Retail Boxed Inc. Heatsink & Fan).....	£119.95
AMD ATHLON 64Bit 3500+ Socket 939 (Retail Boxed Inc. Heatsink & Fan).....	£149.95
AMD ATHLON 64Bit 3700+ Socket 939 (Retail Boxed Inc. Heatsink & Fan).....	£169.95
AMD ATHLON 64Bit 3800+ Dual Core Socket 939 512k Cache (Retail Boxed Inc. Heatsink & Fan).....	£229.95
AMD ATHLON 64Bit 4200+ Dual Core Socket 939 512k Cache (Retail Boxed Inc. Heatsink & Fan).....	£279.95
AMD ATHLON 64Bit 4400+ Dual Core Socket 939 1MB Cache (Retail Boxed Inc. Heatsink & Fan).....	£359.95
AMD ATHLON 64Bit 4800+ Dual Core Socket 939 1MB Cache (Retail Boxed Inc. Heatsink & Fan).....	£489.95

Sound Cards

SoundBlaster 4.1 PCI.....	£14.95
SoundBlaster 7.1 Audigy Value.....	£19.95
Creative X-Fi XtremeMusic.....	£99.95
Creative X-Fi Fatal1ty.....	£159.95
Creative X-Fi Elite Pro.....	£249.95

MOTHERBOARDS AMD SOCKET A (Retail Boxed)

FOXCONN K7541MG S15748, uATX, DDR333, VGA10/100 Lan, USB 2.0, 5.1 Audio, IDE, AGPx8.....	£39.95
Asus A7V880 VIA KT880, ATX, DDR400, Gbit Lan, USB 2.0, 6Ch Audio, SATA, Raid, WiFi Port AGPx8.....	£49.95

MOTHERBOARD AMD SOCKET 754 (Retail Boxed)

ASUS K8V-MX, MicroATX, DDR400, VGA 10/100 Lan, USB 2.0, 6Ch Audio, 2 x SATA, AGPx8.....	£39.95
ASUS K8N-VM, MicroATX, DDR400, VGA 10/100 Lan, USB 2.0, 6Ch Audio, 2 x SATA, 1xPCI Express x16.....	£44.95

MOTHERBOARD AMD SOCKET 939 (Retail Boxed)

FOXCONN NF4K8AC, NForce 4, PCI Express 10/100 Lan, USB 2.0, 6Ch Audio, 2 x SATA Raid 0, 1.....	£59.95
ASUS A8N-SLI (Standard), ATX, PCI-Express, Gbit Lan, USB 2.0, 1394, 8ch Audio, 4 x SATA, Raid.....	£99.95
ASUS A8N-SLI Deluxe, ATX, PCI-Express, 2 x Gbit Lan, USB 2.0, 1394, 8ch Audio, 4 x SATA, Raid 5.....	£109.95
ASUS A8N-32, ATX, PCI-Express, 2 x Gbit Lan, USB 2.0, 1394, 8ch Audio, 4 x SATA, Raid 5.....	£149.95
Abit Fatal1ty AN8-SLI, ATX, PCI-Express, 2 x Gbit Lan, USB 2.0, 1394, 5.1ch Audio, 4 x SATA, Raid 5.....	£134.95

Motherboard Bundles (Assembled)

ATX Midi Tower Case PSU ASUS K8V-ZX Socket 754 M/Board 1xAGPx8 3xPCI 4x Rear USB 2.0 1x Parallel 2x Front USB 2.0 2x SATA AMD Sempron 2800+ 64 bit 256MB DDR 3200 6 Channel On-Board Sound Card Integrated 3D Graphics Card Integrated 10/100 Ethernet Card.....	£149.95
--	---------

customise your motherboard bundle on-line

ATX Midi Tower Case PSU ASUS K8N-VM Socket 754 M/Board 1x PCI Express x16 2xPCI 1xPCI Express x1 1x Parallel 2x Front USB 2.0 2x SATA AMD Sempron 3000+ 64 bit 512MB DDR 3200 6 Channel On-Board Sound Card Integrated 3D Graphics Card Integrated 10/100 Ethernet Card.....	£179.95
--	---------

ATX Midi Tower Case PSU ASUS Socket 939 M/Board 1xPCI Express x16 2xPCI 1xPCI Express x1 4x Rear USB 2.0 1x Parallel 1x Firewire 2x Front USB 2.0 4x SATA Raid 0, 1 AMD Athlon 3200+ 64bit 512MB DDR 3200 8 Channel On-Board Sound Card Integrated Nvidia 6150 3D Graphics Card Integrated 10/100/1000 Ethernet Card.....	£239.95
--	---------

all power computing pcs are subject to availability and come with 2 year return to base, parts & labour warranty (free collection & return) on hardware faults only unless otherwise specified by manufacturer. industry standard practice is to quote a monitor crt size, the actual size is one inch less. details correct at time of going to press. prices, specifications subject to change without notice. all sales are subject to power computing ltd terms and conditions, a copy of which may be obtained on request. all trademarks are acknowledged. all prices include vat.

Most Major Credit Cards Accepted



MICROMART

CLASSIFIED ADVERTISING

Index

Business & Services

Digital Data 179

Consumables & Disc Media

Cartridge Express 170

Manx 170

Offtek 170

Ink Factory 179

Data Recovery

Dataquest 166

Digital Data 179

Hardware

Sterling XS 174

Digital All 168

Internet Services

Abel 179

123 Reg 171

Web Fusion 172

Fast Host 172

Abel Internet 179

Memory

Offtek 170

Peripherals & Accesories

Sterling XS 174

Software

Saver Software 176

PCW Marketplace

Marketplace 179

USB Products

Direct USB 171

Digital All 168

Laptops

Laptop Genius 167

Laptop Spares 166

Digital Cameras

Digital All 168

Collectibles

Blades 179

WWW.LAPTOPSPARES.COM

SALES@LAPTOPSPARES.COM

- ALL LAPTOP AC ADAPTORS
- ALL LAPTOP BATTERIES
- ALL KEYBOARDS, FDD DRIVES
- LAPTOP RAM, HARDDRIVES
- CD ROMS, SCREENS, PLASTIC INCLUDING TINY, DELL, AJP, HP, PICO, CLEVO, TOSHIBA, DELTA, SONY, FUJITSU, ACER, MESH AND OTHERS

WWW.DESKTOPSPARES.COM

SALES@PHONESPARES.CO.UK

- ALL MOBILE PHONE BATTERIES
 - ALL IN CAR PHONE CHARGERS
 - WIRELESS HEADSETS, HANDSETS
 - ALL HANDS FREE KITS, CORDS
- Please Call 0870 7773015



DATA RECOVERY SPECIALISTS

- FREE DIAGNOSIS
- No Fix No FEE POLICY
- 24hr COMPREHENSIVE SERVICE
- IN-LAB RECOVERY OPTIONS
- CLEAN ROOM FACILITIES

Tel: 0845 2009241
Fax: 023 9263 9664
E-mail: sales@dq-int.co.uk
Website: www.dq-int.co.uk

Building an online shop isn't as difficult as you think

ekmpowershop : no assembly required

everything you need for just

£19.99 per month



call our sales hotline
0870 013 0626

try our free online demo at
ekmpowershop.co.uk

LAPTOP GENIUS

LCD & TFT • BACKLIGHT • M/PASSWORD • DATA RECOVERY
UPGRADE • VIRUS REMOVAL • ACCESSORIES • SPARE PARTS

◆ **NO FIX - NO FEE**

- ◆ ALL MAKES OF LAPTOP & DESKTOP. WE CAN REPAIR ALL MAKES OF CAMCORDER, TFT AND PLASMA
- ◆ OUR TECHNICIANS ARE TRAINED BY AIWA, GRUNDIG, JVC, LG, PANASONIC, PIONEER, SONY, SAMSUNG AND THOMSON
- ◆ DELL, COMPAQ, HP, TOSHIBA, SONY



020 7316 9144

- ◆ ALL REPAIRS CARRIED OUT IN STATIC FREE WORKSHOP.
- ◆ 98% REPAIRS COMPLETED WITHIN 48HRS.
- ◆ WE GUARANTEE SATISFACTION OR MONEY BACK.
- ◆ FIXED REPAIR CHARGE ON LAPTOPS

- £85.00**
- ◆ BACK LIGHTS, INVERTORS
VIRUS REMOVAL,
PASSWORD
REMOVAL, M/B
REPAIR, DVD/CD
COMBO REPAIR,
HDD REPAIR, DATA
RECOVERY, BROKEN POWER
CONNECTION & BROKEN
USB SOCKETS



- £169.00**
- ◆ LCD REPLACEMENT,
M/B REPLACEMENT,
PROCESSOR
REPLACEMENT,
DVD/CD COMBO
REPLACEMENT,
KEYBOARD
REPLACEMENT

WE OPERATE UNDER CODES OF THE OFFICE OF FAIR TRADING AND WE ARE A MEMBER OF GUILD OF MASTER CRAFTSMEN.

FREE COLLECTION & FREE DELIVERY NATIONWIDE

08000 435005

WWW.LAPTOP-GENIUS.COM

ONLINE BOOKING..MAIL@LAPTOP-GENIUS.COM

4 PORCHESTER PLACE, LONDON W2 2BS

Digital
all

Digital life with
www.digitalall.co.uk



3.5" HDD Based Multi A/V Player
RAPSODY RSH-100

MPEG MOVIE PLAYER
JPG PHOTO VIEWER
PORTABLE STORAGE
MP3 MUSIC PLAYER
OTG USB HOST

Support
Divx, Xvid, Mpeg, AVI,
VOB, ISO, DAT
MP3, OGG, WMA, JPG



£135.00 (inc VAT)

3.5" HDD Based Multi A/V Player
TVIX HD-5000U

HD Playback,
Multimedia Player,
DVD Juke Box
Network Connective,
USB HOST, DVI
Additional EXT HDD

Support
Divx, Xvid, Mpeg, AVI,
VOB, ISO, DAT, WMV9,
Asf, TP, TRP, MP3,
OGG, WMA, JPG



£225.00 (inc VAT)

2.5 Mobile OTG Storage
RAPSODY S-25



Bidirectional optional
Copy
File navigation
Display the data
Battery rechargeable
USB HOST
Firmware Upgradeable
Backup PSP

£79.99 (inc VAT)

Bluetooth MP3 Player
STORMBLUE A9 (1GB)



Bluetooth MP4 Player A9
2.0" TFT LCD Colour Screen
SD/MMC Extension Card Slot
USB 2.0 High Speed
FM Tuner

£145.00 (inc VAT)

802.11g Ethernet Adapter
AEROPAD Mini

The AeroPad Mini lets
you breathe new
life in your older
Mac models such as
iBooks, G3's, iMacs,
and any computer
that do not have a
802.11g wireless solution available to them (e.g.
no AirPort Card slot, no AirPort Extreme slot, no
PCMCIA card slot, or no PCI slot. Now these
computers can be placed anywhere without the
hassle of running long cables.



£57.00 (inc VAT)

2.5" HDD Based Multi A/V Player
RAPSODY RSH-250



MPEG MOVIE PLAYER
JPG PHOTO VIEWER
PORTABLE STORAGE
MP3 MUSIC PLAYER
OTG USB HOST

Support
Divx, Xvid, Mpeg, AVI,
VOB, ISO, DAT
MP3, OGG, WMA, JPG

£95.00 (inc VAT)

Digital Voice Recorder
PENDOZER IRS800L/1600L



Recording Up to 396 Messages
Telephone Conversation Recording
Auto Power-Off
Search & Play (INTRO SCAN)
Various Repetitions
Record Mode Index Separation
Earphone Monitoring During Line-in
Recording
VOR (Voice Operation Recording)
Backlight
Low Speed Play
Fast Saving PC Via USB

£25.00 (inc VAT)

Bluetooth Mirror Handsfree Car Kit
ModooFree IMHF-R220BT

Bluetooth Rearview Mirror
Handsfree Car Kit



£74.99 (inc VAT)

Travel Mini Wireless Mouse
Digitalall for Laptop



Wireless Mini Mouse
One Body
Receiver Mouse

£12.00 (inc VAT)

Digitalall Limited. 580 Kingston Road Raynes Park London SW20 8DR
T. 020 8545 2120 F. 020 8545 2129 E. sales@digitalall.co.uk www.digitalall.co.uk

RSH-250

RAPSODY
www.digitalall.co.uk

2.5" HDD Based Multimedia Player with OTG Backup



RSH-100

3.5" HDD Based Multimedia Player with OTG Backup



EXCELLENT FUNCTIONS OF PRODUCT



MULTICODEC MPEG PLAYER

RSH-100 supports various MPEG formats such as MPEG-1, 2, 4, DivX and XviD by embedding hardware codec. You can enjoy greatest image quality using DTV by utilizing progressive scan feature.



DIGITAL MUSIC JUKEBOX

Using high capacity HDD, RSH-100 can be used as your favorite music jukebox. By using front LCD, TV is not required to play MP3, Ogg vorbis, and WMA file formats.



DIGITAL PHOTO ALBUM

Whole family can enjoy digital photos on big screen TV.



EXTERNAL USB STORAGE

USB 2.0 interface enables RSH-100 as external storage which supports up to 480Mbps.



LCD DISPLAY

128 X 128 dots 4 gray full graphics LCD is provided for you to view various information about the file you are playing.



USB HOST (ON THE GO)

RSH-100 enables USB Host feature using USB OTG socket. Use supplementary USB OTG cable to backup data directly from USB memory stick or memory card reader.



FM TRANSMITTER (OPTIONAL)

FM Transmitter is embedded to send music signals wirelessly. Wireless connection to any FM radio is possible.



DTS DECODING (OPTIONAL)

Existing DivX players cannot play DTS encoded files without external DTS decoder. However, RSH-100 supports optional DTS hardware decoder to mix down DTS sounds into stereo channels.

Order online at www.offtek.co.uk
and take Advantage of FREE UK Delivery!



Notebook Memory

Prices from	64MB	128MB	256MB	512MB
	£19	£19	£21	£38

Desktop Memory

Prices from	32MB	64MB	128MB	256MB	512MB
72 Pin Simms	£20	£63			
168 Pin Dimms	£38	£15	£23	£40	£59
184 Pin DDR Dimms			£20	£35	£76
Rambus Rimms			£31	£59	£166

Workstation/Server Memory

Dell PowerEdge, Sun Enterprise, Compaq Proliant, IBM Netfinity, HP Netserver & many more!
For prices and available upgrades please visit our website at: www.offtek.co.uk or call our Freephone Salesline

Flash Memory

Prices from	32MB	64MB	128MB	256MB
Compact Flash			£12	£14
XD Cards		£13	£14	£19
Multimedia	£11	£12	£12	£16
Secure Digital Card			£12	£15
Memory Sticks		£15	£17	£41

Also, USB based card readers for all types of cards from £15.00

Free UK delivery for online orders!
Over 30,000 memory products for Desktops, Notebooks, Printers, Servers, Workstations, MP3 Players, Network Routers, Handheld PC's Digital Cameras, and much more...



Memory for virtually all makes and models!
Installation guides and memory faq's available online at www.offtek.co.uk

Need extra income? Earn commission selling OFFTEK products. See our website for details.

- ✓ All OFFTEK memory carries a lifetime warranty and is guaranteed 100% compatible.
- ✓ All OFFTEK memory is manufactured using Premium brand chips which ensures the highest level of reliability and compatibility.
- ✓ Our large stock holding ensures that the majority of our products are held in stock.
- ✓ Free telephone support with identifying and installing your memory.
- ✓ Official orders are welcome from plc's, government and educational establishments.

Freephone
0800 698 4100

Tel: 0121 722 3993 Fax: 0121 743 9845
Brymar House, Walford Drive, Solihull, West Midlands, B92 9DW.
All Trademarks & Registered Trademarks acknowledged.
Prices subject to change without notice.
E & OE. Prices ex VAT. P&P £5.00



No surcharge on Credit or Debit Cards.

WOW
Save up to 80% on
Printer Cartridges

All Brands & Models **Printer Cartridges** No Minimum Order

- CD/DVD Media
- Inkjet Papers
- Computer Accessories & Batteries
- Cleaning Cartridges
- Inkjet Refills
- Memory Cards

To start saving visit our website
cartex.co.uk
Free Delivery Online
or call: **0870 2435610**

fax: 0870 2435611

UK's Lowest Prices Guaranteed!

Find the same product cheaper and we will beat the price by 10%.
Delivery charges included in price comparison. Verification required.

www.printconsumables.com



Order on line - secure server or call us FREE.
We WILL cut your printing costs.

80% OF OUR INK ORDERS ARE REPEATS OR FROM PERSONAL RECOMMENDATIONS - 14 years as specialists to home user, business, PLCs and public sector. Immediate despatch.

Widest range of printer cartridges, inks, toners, papers etc. for all makes of inkjets, lasers, faxes, copiers etc. on premium or economy compatibles and branded originals.

A few current offers - carriage and VAT included, No hidden extras:

- EPSON C62 compat (T40) etc Blk chipped cartsfrom £1.25 INCL
- EPSON C62 compat (T41) etc Col chipped cartsfrom £2.38 INCL
- HP51645A Blk High Capacity branded cartsfrom £17.95 INCL
- HPC6578A Double Capacity branded cartsfrom £35.89 INCL
- LEXMARK 16 Blk High Capacity branded carts .from £17.99 INCL
- LEXMARK 26 Col High Capacity branded carts .from £18.99 INCL
- HP LJ4000 Compat tonerfrom £32.90 INCL

1000's more available.

One off, or one thousand, talk to us for the best deal.

JettManx Inkjet refill inks and kits. Bulk inks. Continuous ink feed systems. Over 80 specifically formulated inks. Refill toners too.

THERE IS NO SUCH THING AS UNIVERSAL INK
as you will know if you have tried it!

Visit us online for more info. Our reputation is your guarantee.

FREEPHONE 0800 0 19 06 07

We pay for your call. No 0845 or 0870 rip off here

info@printconsumables.com

Manx Print Care Ltd. Clocktower Industrial Park,
Foxdale. IM4 3HF.



The UK's best value DOMAIN NAMES

.co.uk
.org.uk/.me.uk
£2.59

.com
.net/.org/.info/.biz/.name
£8.99

.tv/.cc
£30.95

Bulk Discounts available for multiple domains

.eu
domains
PRE-REGISTER
NOW!

Transfer your .uk domain name for FREE

Or transfer your .com, .net, .org domain for **half price**, now only £9.99

It's as simple as...

123-reg.co.uk

Price per year inclusive of all fees.
Some domains are payable 2-yearly, visit 123-reg.co.uk for more info.
We welcome all major credit cards. Prices exclude VAT @ 17.5%.
123-reg.co.uk is part of the PIPEX Group

For all your domain & web hosting solutions: www.123-reg.co.uk

DirectUSB
Store

Order line: 01327 300566
www.directusbstore.com

Spend over £10 and buy a
4 port hub for only £1.99

Kingston Data
Traveler



- Superb design
- 5 Year Warranty

from
£10.99
inc VAT

Freecom DVB-T
Stick



- Digital TV on your PC
- Free Remote Control

£44.99
inc VAT

HotDrive -
Mobile 2.5"
Hard Disk
Enclosure



£16.95
inc VAT

21-in-1
POWERED
Card Reader
& USB Hub
Combo



£22.95
inc VAT

LG Retractable USB Drive



- Fully retractable head
- Password Protection

from
£13.99
inc VAT



- World's smallest external hard drive
- Award winning - in 20Gb, 40Gb, 60Gb

Trade Customers Welcome

Direct USB Store is a leader in the supply of a
customised USB memory disks and optical mice

FREE Delivery
on all orders



WE ACCEPT THE FOLLOWING CARDS :



ALL PRICES CORRECT AT TIME OF GOING TO PRINT.

Free Hosting!

Flexible Hosting

- ASP, ASP.NET, PHP4, Perl 5 scripting
- Up to 500 POP3/IMAP boxes
- Up to 10GB webspace
- Up to 40GB monthly traffic
- MyServerWorld Control Panel
- Free Google Adwords
- Free .uk domain included

Special offer:
1 Year's Free Hosting*

from just **£5.99** per month

Reseller Package

- White label customer control panels **NEW**
- Host unlimited no. of websites
- Unlimited email addresses
- Unmetered data transfer
- Custom Nameservers
- Resell PIPEX ADSL at trade prices

only **£26.99** per month

VPS: Virtual Private Servers

- Configurable step-up from shared hosting
- Customisable environment & root access
- Enterprise grade Dell 1855 Blade servers
- Plesk control panel for easy admin
- Host up to 100 domains per VPS
- 1 month free trial
- 2 months free when paid annually

from just **£25.99** per month

Dedicated Servers

- Create a secure custom environment
- Unmetered data transfer
- No bandwidth bills!
- Industry-leading Intel® technology
- Secure, resilient Tier 1 Data Centres
- 24/7 technical support service

from just **£79.99** per month



Rapid set-up



24/7/365 Support



99.99% Connectivity



Money-back guarantee



Secure data centres



Tier 1 Infrastructure



Hosted in the UK

The UK's No.1 Host!

* Free Hosting applies to Fusion Starter package, excludes set-up. Limited period offer. Terms apply, see website.

0800 0317 800

WebFusion

www.webfusion.co.uk

Professional eCommerce

Dedicated servers

Website hosting

Personalised email

Unlimited broadband

Find it at Fasthosts

Get online from **£2.95** pa

Get one month's **free** hosting at
fasthosts.co.uk/free

0870 888 3802

OFFER CODE:PCW0306 Prices exclude VAT



Domain names • Web hosting • Dedicated servers • Exchange 2003 email • eCommerce • Broadband • Reseller solution

www.computerbattery.co.uk



Acer, Apple, Compaq, Dell, IBM, Sony, Toshiba and many others

Use the Quick Selector on our web site to find the power products available for your Laptop. We have a massive range of Batteries and AC Aapters always held in stock.

or call us on 0870 872 6730

★ Laptop Batteries

★ Power Adapters

★ Car & Airplane Adapters

★ PDA Batteries

★ Digital Camera Batteries



FAST, FREE Delivery to Europe

Usually next day delivery to mainland UK

2-power distributor



all trademarks acknowledged

INK2LASER.CO.UK

Original Printer Ink Cartridges & Toners Specialists

Photo Printing Media & Data Storage Media

HEWLETT PACKARD PRINTING PAPERS HP Photo Printing Papers Premium+ Photo Glossy (C6832A) 20 £13 Premium+ Photo Matte (C6851A) 20 £14 Premium Glossy Paper (C6837A) 10 £9 Premium HeavyWeight 2-Side(C1853A) 100 £12 Professional Brochure/Flyer (C6818/21A) 50 £9 £18 Premium Inkjet (A4-200/A3-100) (51634/1856A) £14 £22 Premium Photo (A4-15/A3-20) (C6040/35A) £7 £23 Bright White (A4-500/A3-200) (C1825/1858A) £7 £10	HEWLETT PACKARD INK CARTRIDGES HP Colour Inkjet Printer Cartridges DJ 920/940/PSC750/950 (15/78) £16 £19 DJ 930/950/970/G55/85/95/K6/80 (45/78) £18 £19 Deskjet 3830/3940/PSC1410 (21/27) £9 £10 Deskjet 3320/3420 (27/28) £10 £14 Deskjet 5550/PS7000 (56/57) £12 £19 PSC1510/DJ5440 (336/342) £10 £11 PSC226/2710/81/8450/2355 (Low-338/344) £13 £16 PSC226/2710/91/9450 (High-338/344) £17 £19 Photosmart 8250 (363BK/C/M/Y/LC/LM) £9 £6	HEWLETT PACKARD MONO TONER HP Laserjet Toners Laserjet 1010 / 1012/1015 (Q2612A) £44 Laserjet 1150 (Q2624A) £44 Laserjet 1160/1320 (Q5949A/X) £42 £79 Laserjet 1200 / 1220 (C7115A/X) £35 £45 Laserjet 1300 (Q2613A) £42 Laserjet 2100 / 2200 (C4096A) £55 Laserjet 2300 (Q2610A) £69 Laserjet 4200 (Q1338A) £59 Laserjet 4300 (Q1339A) £119	HEWLETT PACKARD COLOUR TONERS HP Colour Laserjet Toners Laserjet 2550/2850 (H-Q3960A/61A/62A/63A) £45 £55 Laserjet 2600N (H-Q6000A/01A/02A/03A) £46 £49 Laserjet 3000 (Q7560A/61A/62A/63A) £82 £79 Laserjet 3500/3550 (Q2670A/71A/72A/73A) £75 £79 Laserjet 3600 (Q6470A/71A/72A/73A) £75 £79 Laserjet 3700 (Q2670A/81A/82A/83A) £79 £99 Laserjet 3800 (Q6470A/Q7561A/82A/83A) £75 £99 Laserjet 4600/4650 (C9720A/21A/22A/23A) £92 £125 Laserjet 4700 (Q5950A/51A/52A/53A) £112 £185
EPSON PRINTING PAPERS EPSON Photo Printing Papers Premium Glossy 20 £11 £24 £31 Premium Semi-Gloss 20 £11 £25 £32 Glossy Photo Weight 20 £10 £23 £29 Photo Glossy 20 £8 £18 £22 Photo Paper 20 £10 £21 £25 Archival Matte Paper 50 £11 £23 £30 Matte Heavy Weight 50 £10 £22 £28 Matte H/W Double Sided 50 £14 720/1440 Dpi Photo Quality 100 £10 £26 £30	EPSON INK CARTRIDGES EPSON Colour Inkjet Printer Cartridges BK COL Stylus Photo 950 (T331/2/3/4/5/6) £10 cmv £11 Stylus Photo 2100 (T341/3/4/5/6/7/8) £11 cmv £11 Stylus R2/300/RX5/600 (T481/2/3/4/5/6) £9 cmv £10 Stylus Photo R800 (T0541/2/3/4/7/8/9) £10 cmv £10 Stylus C42/C44/C46 (T036/T037) £10 £14 Stylus C82/CX5400 (T321/422/423/424) £22 cmv £7 Stylus C66/CX6400 (T431/C452/M53/Y54) £20 cmv £9 Stylus C84/86 (T431/C442/M443/Y444) £20 cmv £7	EPSON PRINTER INK CART KITS C70/80 C/M/Y Triple Pack (T0255) £29 C64/66/84/86/CX36/64/6600 Quad Pk(T041408BA) £26 RX420/RX425 C/M/Y/BK Picture Pack (T055640) £23 R200/300/RX500/600/620 All 6 Col. (T0481408BA) £35 Photo R800 (All 7 Col. + Optimizer) (T054740) £74	EPSON / SAMSUNG TONERS EPSON Colour Laser Toners BK COL AcuLaser C300/1300 (60100/90C/98M/97T) £34 cmv £30 AcuLaser C1000/2000 (60033/34Y/35M/36C) £45 cmv £32 AcuLaser C4000 (60091/83Y/89M/90C) £26 cmv £19 SAMSUNG Laser Toners BK COL Samsung CLP500 (D7K/05Y/05M/05C) £62 cmv £75 Samsung ML1210 (ML1610) £38 Samsung ML2250 (ML2250) £59 Samsung ML4500/ML4600 (ML4500) £45
LEXMARK INK CARTRIDGES Lexmark Colour Inkjet Printer Cartridges BK COL Z43/45/51/52/54/X63/73/83/85/125 (70/20) £18 £22 Z12/22/23/29 (50/60) £18 £21 Z13/25/33/51/57/61/57/X75/X2250 (12/28) £19 £20 Z25/Z35/X75/Z601/Z605/X1150 (17/27) £11 £13 Z55/SE/Z65/Z65N/X5150/P6170 (62/83) £17 £20 Z615/X3350/X5250/P4350/P6250 (32/33) £12 £14 P900/P6200/X710/XP3000/A10 - As Above (33/35) £15 £18 Z810 Series-F315 (33/35) £14 £18 Z735/X2350 (No.1) £11	CANON INK CARTRIDGES Canon Colour Inkjet Printer Cartridges BK COL BJC2/4/5000series/MP/C20/50 (BC21BK/21C) £5 £12 S2/300/2/3/4/50/IP12000 (BC24BK/24C) £5 £10 S500/600/600/520/550/750 (BC33BK/C/M/Y) £6 £6 BJC3/600/S400/S450/4500 (BC33BK/PC/M/Y) £7 £7 SB/900/1950/965/IP6000/8500 (BC63BK/C/M/Y) £6 £6 SB/900/1950/965/IP6000/8500 (BC63PC/M/Y) £6 £6 IP1600/2200/MP150/170/450 (PC40/C/M/Y) £13 £17 IP4200/5200/R/MP500/800 (CL83BK/PC/M/Y) £9 £9 IP6600 - As Above (CL83PC/M/Y) £9 £9	BROTHER INKS & TONERS BROTHER Inkjet Printer Cartridges BK COL MFC 580/590/890 (LC600BK/C/M/Y) £13 £7 MFC 3420C/3820C/4100 (LC600BK/C/M/Y) £11 £6 DCP110/3100/MFC21410 (LC900BK/C/M/Y) £11 £6 MFC3240/3340/5440/5840 (LC900BK/C/M/Y) £11 £6 BROTHER Laser Printer Toners HL2030/2040 (TN2000/DR2000) £34 £52 HL1510/5140/5150/5170 (TN3000/DR3000) £49 £89 1230/40/50/70/1430/40/50 (TN8600/DR8600) £46 £86 1650/70/1870/5030/40/50 (TN7600/DR7600) £38 £88	KONICA MINOLTA TONERS Konica Laser Toners BK COL MagicColor 2300/W/2350 (High Cap.) £55 cmv £85 MagicColor 2400W/2430D (High Cap.) £55 cmv £92 MagicColor 5400DL £72 cmv £119 MagicColor 5440DL/5450 (Std. Cap.) £72 cmv £109 MagicColor 5440DL/5450 (High Cap.) £112 cmv £189 MagicColor 6100 £109 cmv £136 MagicColor 2300/2350 3-Toner Value Pack cmv £242 MagicColor 2400/2430 3-Toner Value Pack cmv £249 MagicColor 5430DL 3-Toner Value Pack cmv £339
COURIER USB FLASH DRIVE 128Mb £8.50 256Mb £12.95 512Mb £23.50 1.0Gb £38.50	INTEGRAL DIGITAL CAMERA MEMORY Compact Flash (CF) 128Mb £20 Compact Flash (CF) 256Mb £28 Multimedia Card (MMC) 512Mb £20 Multimedia Card (MMC) 1Gb £38 Secure Digital Card (SD) 256Mb £12 Secure Digital Card (SD) 512Mb £18 Secure Digital Card (SD) 1Gb £30 Secure Digital Card (SD) 2Gb £55 Sony Memory Stick Pro 512Mb £38 Sony Memory Stick Pro 1Gb £39	CD-RECORDABLE 80Min/700Mb BRAND Pack 50, 100- £19 IMATION Jewel Case £19 £34 SONY Jewel Case £20 £36 TDK Jewel Case £19 £34 TDK Slim Case £18 £32 VERBATIM Jewel Case £22 £40 IMATION (Inkjet Printable) Bulk 50's £12 IMATION Bulk 100's £20 TDK Bulk 50's £15 VERBATIM (Inkjet Printable) Bulk 100's £28	DVD-/+ RECORDABLE 4.7Gb BRAND Pack 50, 100- £20 SONY TDK DVD-R Jewel Case £22 £40 SONY TDK DVD+R Jewel Case £22 £40 VERBATIM DVD-R (Inkjet Printable) Jewel Case £25 £46 RITEK DVD-R (Inkjet Printable) Bulk 50's £15 VERBATIM DVD-R (Inkjet Printable) Bulk 50's £19 DVD-/+ REWRITABLE 4.7Gb SONY TDK DVD-RW Jewel Case £38 £72 SONY TDK DVD+RW Jewel Case £38 £72

Order online at www.ink2laser.co.uk • Freephone: 0800 100 8 200

440 HIGH ROAD, WEMBLEY, MIDDX. HA9 6AH • Tel: 020 8902 2392 • Fax: 020 8902 1780 • Email: sales@ink2laser.co.uk
 CARRIAGE: UK MAINLAND MAX 25KGS £6.00 (STANDARD), £8.00 (NEXT DAY), OVER 25 KGS £10.00 (STANDARD), £14.00 (NEXT DAY) • OUTSIDE U.K. MAINLAND: P.O.A.
 Terms & Conditions: TRADING HOURS: 9:00 AM - 5:30 PM (MON - SAT) PAYMENT MUST ACCOMPANY ALL ORDERS. CREDIT CARD ORDERS ARE NORMALLY DISPATCHED THE SAME DAY. PLEASE ALLOW 5 WORKING DAYS FOR CHECKS TO CLEAR. GOODS ARE NOT SUPPLIED ON A TRIAL BASIS. WE ACCEPT AM-EX. VISA, MASTERCARD, ACCESS, DELTA & SWITCH. NO CREDIT CARD SURCHARGE. SPECIALS & SPECIFICATIONS MAY CHANGE WITHOUT NOTICE (ALL TRADEMARKS ACKNOWLEDGED). GOODS OFFERED SUBJECT TO AVAILABILITY. ALL PRICES EXCLUDE DELIVERY & V.A.T. (E.O.E.)

DELL www.laptopPARTS.co.uk

LAPTOP PARTS

MEMORY - NEW WEBSITE NOW ONLINE

512/256mb Dell Inspiron/Latitude	£49/29
256/128mb Sony/VAIO PCG-FX series	£49/32
256/128mb Compaq Presario/Armada	£54/35
256/128mb IBM ThinkPad series	£53/35
512/256MB DDR400 PC3200 200pin	£47/29
1GB PC3200 400 DDR 200pin laptop	£89
512/256MB - PC 133 laptop SODIMM	£79/49
256/128MB - PC 100 laptop SODIMM	£53/29
Secure Digital (SD) 1GB Memory card	£36.95
1GB COMPACT FLASH CARD RETAIL	£34.95
Portable USB 2 Pen Drive 512MB Retail	£19.95
Portable USB 2 Pen Drive 1 GB Retail	£28.95
6-in-One Card Reader Alu Ext USB2	£12.00
4GB USB2 Pen Drive LIMITED STOCK OFFER	£49.95

Matched Memory for Compaq/IBM/Toshiba/DELL

LAPTOPS - NEW WEBSITE NOW ONLINE

ASUS A66 Intel Celeron M 380 1.6GHz 256MB DDR2 40GB DVD+/-RW DL WLAN 15.4 WXGA WinXP 2yr Warr	£449
Toshiba Satellite Pro L20 Intel Celeron M 360 1.4GHz 256MB 40GB CD-RW/DVD 15.1" LAN XP Home	£399.00
ASUS A6T AMD Sempron 3000 64Mb graphics 512MB 15.4" WXGA 60GB HDD DVD+/-RW WLAN WinXP £499.95	
HP NX6110 Intel Celeron M 360 1.4GHz 256MB DDR2 40GB CD-RW/DVD COMBO 15.1" TFT WLAN Win XP	£399.95
HP NX6125 Turion ML32 1.8GHz 512MB 60GB DVD+/-RW 15" WLAN Bluetooth XP Pro inc fingerprint sensor	£599
Samsung R65 Centurio Duo run multiple programs 1.66GHz 512MB 60GB DVD+/-RW 15" WLAN Bluetooth XP Pro	£845
Sony Vaio BX195VP Centurio 740 1.73GHz 512MB 80GB SATA DVD+/-RW 12.8MB graphics 15" WLAN XP Pro	£699
Dell Latitude C610 Intel P3 1GHz 256MB RAM, 20GB Hard drive, FDD, CD ROM Modem & Lan 14.1" TFT	£250.00
Toshiba Sat-pro 4600 P3-700 256mb 10gb CD FDD 14" TFT 56k-10/100/Wireless with Win 2K CDA	£285.00
Dell Latitude D810 Intel Pentium M 1.73GHz 1024MB Ram 80GB HDD & X DVD+/-RW 15.4" Widescreen	£539.00
IBM Thinkpad A20M Intel P3 750MHz, 256MB 20GB HDD CD-RW FDD Battery & AC Modem & Lan 14.1" TFT	£275

For the full range of Notebooks CALL US

HARD DRIVES - NEW WEBSITE NOW ONLINE

Fujitsu 20/30gb 2.5" 4200rpm ATA100	£49.00/£55.00
Fujitsu 40/80gb 2.5" 4200rpm ATA100	£69.00/£79.00
Acer Aspire/Tmate HDD 20/20/30gb	£55/75/89
HP OmniBook XE/2/3 20/30/40gb	£59/79/95
IBM Thinkpad Series 20/30/40gb	£59/79/95
Compaq Presario+Armada 20/30/40gb HDD	£59/79/94
Dell Latitude/Inspiron 20/30/40gb HDD	£58/65/85
Toshiba Satellite+Pro 20/30/40gb HDD	£56/65/89
SONY VAIO PCG harddisk 20/30/40gb	£79/75/99

Online HDD Configurator SEE WEB SITE

PARTS - NEW WEBSITE NOW ONLINE

Laptop Internal CD RW+DVD drive FROM	£75.00
Laptop Internal DVD ROM drive FROM	£45.00
PCMCIA EXTRA 4 port USB2.0 controller	£19.99
PCMCIA EXTRA2 port USB2.0 + firewall A+B	£24.99
USB Bluetooth Dongle communicate wirelessly	£18.00
ASUS Ultra Slim CD/RW/DVD Ext USB 2.0/Firewire	£89
Targus USB2 Port Replicator W/10/100 Enet Audio	£85
DVD Rewriter Liten D/Layer Ext USB2 DVD+/-RW	£79
Portable 2.5" HDD External Case USB2.0/1.1	£29.00
3KS External Note Book Cooler with 2 fan USB	£14.95
Internal 56.6K PCMCIA modem for Laptops	£29.00

DELL LAPTOP PARTS SEE NEW WEBSITE

Dell Latitude D series DVD REWRITWR	£99
Dell Latitude & Inspiron CDRW + DVD Combo	£85
Dell Latitude & Inspiron CD/DVD/CDRW	£49/69/79
Dell Latitude & Inspiron Floppy Drive	£29.00
Dell Latitude BATTERY / AC ADAPTER	£57/39
Dell Inspiron BATTERY / AC ADAPTER	£55/35
Dell Latitude & Inspiron UK Keyboard	£85.00
Dell D Series D-Bay USB 2 Caddy	£45.00
DELL Hard drive Caddy Main/2nd	£35.00/£5.00
DELL SCREENS / DELL MAINBOARDS CALL	

SELECT MEMORY FOR ALL MAKES & MODELS
FREE TECHNICAL SUPPORT
WE ALSO OFFER: Laptop Batteries • Laptop Mains / AC adapters • Laptop Car Cords

LIFETIME WARRANTY ON ALL MODULES
FREE DELIVERY on all memory orders - quote What Laptop

SUPPLIERS OF LAPTOP PARTS FOR ALL MAJOR BRANDS
SALES: 0870 027 6115
sales@laptopparts.co.uk
 Prices Ex VAT @17.5% / Subject to change

SECURE 24HR ONLINE ORDERING

PRINTABLES AFFORDABLE PRINTER CARTRIDGES

WE AIM TO DELIVER HIGH QUALITY INKJET CARTRIDGES AT AFFORDABLE PRICES
 THE PRICE YOU SEE IS THE PRICE YOU PAY.

Product Examples:

EPSON		
T0481-6 Multi Pack.....	£15.99	No 45£8.99
T0551-4 Multi Pack.....	£12.99	No 78£10.99
T0441-4 Multi Pack.....	£11.99	No 56£13.49
T0611-4 Multi Pack.....	£14.99	No 57£15.49
T036/T037 Twin Pack ...	£4.99	
T040/T041 Twin Pack ...	£4.99	
T026/T027 Twin Pack ...	£4.99	
Canon		
BCI-24BK/C Twin Pack ..	£3.49	LC-900 Multi Pack £11.99
BCI-6 Multi Pack From...	£7.49	LC-800 Multi Pack £11.99
Other Makes include:		
Samsung, Olivetti, Xerox and more.....		

LEXMARK

10N0016	£14.99
10N0026	£15.99

brother

www.printablesuk.com

Email: info@printablesuk.com Sales: 0845 094 0514

Highest Quality **Free Delivery** **Fast Efficient Service** **Competitive Pricing**

THE BEST DEALS ON NEW, EXCESS AND REFURBISHED LAPTOPS & PCs. ESTABLISHED 1991

ORDER
ON-LINE

www.sterlingxs.co.uk

See website
for full list
of products

DELL 24" WIDESCREEN BARGAIN

DELL Ultrasharp 2405PW 24" WIDESCREEN HIGH RESOLUTION TFT FLAT PANEL MONITOR

- 24" active matrix TFT ratio (WXGA+)
- 1920 x 1200 resolution - widescreen 16:10
- Tilt & Height adjustable
- Digital (DVI) & VGA inputs
- Integrated powered USB 2.0 hub - 4 downstream, 1 upstream ports
- 9 in one card reader - cf/II, SD/mini SD, MS/MS Pro, MMC/Smart Media & microdrive
- Pivots to portrait mode (- no software included)
- S-Video out & Composite Video
- Dimensions: H,W,D: 451 x 559 x 229mm
- Vesa wallmounting compatible & security slot
- As New & boxed, with three year warranty, until January 2009
- Includes driver CD, USB, DVI & VGA cables & setup guide



£549.99 ex-vat ~~£646.24~~ inc-vat

PERSONAL ENTERTAINMENT CENTRE

- The PES 2052, includes a 20GB portable Hard Drive, with card reader & LCD display
- Transfer photos & videos & view them on the inbuilt 2" LCD colour Display, or on a TV
- Input files using the integral 9 in 1 card reader, or from USB connection to a PC/Mac
- Includes - Earphones, AV/USB cables, Remote, Battery & PSU Card reader supports CF, SM, MS, SD, MMC etc
- View JPEG photos, play MP3 and WMA music
- Play MPEG-1 or Motion JPEG in AVI or MOD videos
- Weights just 332g. Dimensions: LWH: 135x86x35mm
- New & boxed with one year RTB warranty



£127.65 ex-vat ~~£149.99~~ inc-vat

MINI TOWER BARGAIN

Patriot 2940 mini tower with recordable DVD

- Intel P4 2.93GHZ (540) processor
- 256MB DDR RAM & 40GB Hard Drive
- DVD Rewriter drive
- SIS 661fx shared graphics (max 64MB)
- 56k modem & 10/100 network
- Onboard Sound
- 6x USB 2.0 ports & 1x Firewire port
- 2x PS2 ports, serial & parallel ports
- UK keyboard, wheel mouse & speakers
- Windows XP Home, Works V8.0, Nero & power DVD
- Restore Partition on hard drive
- As new and boxed (factory refurb) with One year RTB warranty



£199.99 ex-vat ~~£234.99~~ inc-vat

DELL DIMENSION 5150

DELL Dimension 5150 Minitower computer

- Intel Pentium 4 Processor 630 3.0GHz HT processor
- 2MB L2 cache
- 1024MB DDR2 RAM & 160GB SATA hard disk
- 1x DVD-RW drive
- Separate DVD rom drive
- Multicard reader
- 10/100 network & 56k modem
- Soundblaster live 24 bit soundcard
- ATI Radeon X600 256MB Hypermemory Graphics with VGA, DVI & Svideo
- 7x USB 2.0 ports (2 on front)
- UK keyboard, mouse & microphone
- Windows XP Home SP2 & MS works V7, supplied with backup & driver Cds
- As new & boxed (Dell cancelled order factory outlet sealed stock) with one year Dell collect & return warranty until January 2007



£399.99 ex-vat ~~£469.99~~ inc-vat

DELL DIMENSION SPECIAL

DELL Dimension 3100 Minitower computer

- Intel Celeron D 2.66GHz processor
- 512MB DDR SDRAM & 80GB hard drive
- CDRW/DVD combo drive
- 10/100 network & 56k modem
- On board sound & graphics
- 6x USB 2.0 ports
- UK keyboard, mouse & microphone
- Windows XP Home SP2, with COA & Works 7 supplied with backup CDs
- Dimensions (mm): H:411, W:187, D:438
- As new & boxed (Dell cancelled order factory outlet sealed stock) with one year Dell collect & return warranty until Jan 2007



£219.99 ex-vat ~~£258.49~~ inc-vat

COMPAQ ARMADA BARGAIN

HP Compaq Armada 110 - Corporate quality notebook

- Intel Pentium mobile III 850 MHz processor
- 128MB memory & 10GB hard drive
- 14.1" TFT screen (1024x768)
- Integral CD drive & integral 3.5" floppy drive
- Sound system, with built in speakers
- UK keyboard with trackpoint pointing device
- Integral 10/100 network & 56k modem
- 2x USB port, 1x PS2 ports
- Parallel, infrared, VGA & serial ports
- Built in 10/100 network & 56k modem
- 2x Type II PCMCIA slot
- Li-ion battery & AC adaptor/charger
- Preloaded with Win 2000 professional, with COA & restore CD.
- Refurbished product with 90 days RTB warranty



£199.99 ex-vat ~~£234.99~~ inc-vat

PANASONIC TOUGHBOOK CF-27

- Ideal for Industrial/Outdoor applications
- Magnesium Alloy Case - 20 times stronger than plastic
- Shock resistant & water resistant
- Intel Pentium 266MHz MMX processor
- 64MB RAM, 4GB hard drive
- 12.1" TFT Colour display
- Internal DVD ROM
- UK Keyboard & Touchpad
- USB, Serial, Parallel, PS2 & VGA ports
- Refurbished with 90 day RTB warranty
- Also available preloaded with Windows 98, with COA & backup CD at £199.99 inc vat



£149.99 ex-vat ~~£176.24~~ inc-vat

ADVENT SUB NOTE SPECIAL

Advent 7066 Slimline subnote - only 25mm (1") thin, with Intel Mobile processor, DVD-RW drive & wireless network

- Intel Celeron Mobile 1.5ghz processor
- 512MB DDR RAM & 80GB Hard Drive
- 12.1" Widescreen TFT screen WXGA (1280 x 768)
- SIS graphics - upto 128MB shared
- DVD-RW drive - record your own DVDs & CDs
- AC97 audio, with built in speakers
- UK keyboard & touchpad pointing device
- Wireless network & 3 in 1 memory card reader
- 56k modem, 10/100 network interface
- 3 x USB 2.0 port, VGA & Firewire ports
- 1x pcmcia type II slot
- Windows XP Home & Nero Burning & Power DVD
- Dimensions 303mm x 246mm x 25mm
- As new and boxed (factory refurb) with one year RTB warranty



£425.52 ex-vat ~~£499.99~~ inc-vat

NEW LAPTOP SPECIAL

IFriend NC733E Notebook features a powerful Intel Celeron 2.8ghz processor & recordable DVD

- Intel Celeron D335 processor - 2.8GHZ
- 256MB RAM & 40GB Hard Drive
- UK keyboard layout with Touch Pad pointing device
- DVD-RW drive - play & record CDs & DVDs
- 15.1" TFT colour display (1024x768)
- SIS M661fx shared Graphics (up to 64MB)
- 56k modem & 10/100 network interface
- 1 x Type II PCMCIA slot
- 2 x USB ports & parallel port
- Firewire (IEEE 1394), Infrared, TV-out & VGA ports
- Built in speakers & microphone • Li-ion battery & ac adaptor
- Supplied with driver CD & DVD/Burning software & manual
- No operating system included. • New and boxed with one year RTB warranty



£340.42 ex-vat ~~£399.99~~ inc-vat

ALL-IN-ONE PC CLEARANCE

DIGITAL LIFESTYLES 17" WIDESCREEN LCD TFT PANEL, WITH BUILT IN PC

- Intel Centrino 1.6GHZ processor
- 512MB RAM & 120GB hard drive
- DVD/CDRW Combo drive
- Detachable speakers - 'Beat Box'
- Wireless keyboard (US layout) & wireless optical mouse
- 17" panel (incorporating pc) Widescreen WXGA+ (1440x900 res)
- ATI mobility Radeon 9600 64MB graphics
- Unit has 3x USB 2.0 & 10/100 network, PCMCIA & 802.11b/g wireless network
- Docking unit (105 x 16.5 x 58mm) has 3x USB, firewire & 7 in 1 card reader
- System can be wall mounted (VESA standard - mount not included)
- Preloaded with Windows XP home SP2 & Works New with one year RTB warranty



£340.42 ex-vat ~~£399.99~~ inc-vat

ADVENT 7040 NOTEBOOK

Slimline notebook, with Intel Centrino processor, CDRW/DVD Combo drive & wireless network

- Intel Centrino Mobile 1.4GHZ processor
- 256MB DDR RAM & 40GB Hard Drive
- 14.1" TFT screen
- Intel 855GM shared graphics
- CDRW/DVD Combo drive
- AC97 audio, with built in speakers
- UK keyboard & touchpad pointing device
- Wireless network interface
- 56k modem, 10/100 network interface
- 3 x USB 2.0 ports
- VGA, parallel & serial & PS2 ports
- 2x pcmcia type II slot
- Windows XP Home & Nero Burning & Power DVD
- As new and boxed (factory refurb) with manuals & recovery cds
- Dimensions 328mm x 273mm x 33mm
- One year RTB warranty



£349.99 ex-vat ~~£411.24~~ inc-vat

P4 3.8GHZ MINI TOWER

Patriot 3825 - Ultra powerful system

- Intel P4 3.8GHZ (570) processor
- 512MB RAM
- 250GB SATA Hard Drive
- DVD Rewriter multiride & separate DVD drive
- SIS on board Graphics
- 56k modem & 10/100 network
- 6x USB & 1x Firewire port
- 2x PS2 ports, Serial & parallel ports
- UK keyboard & wheel mouse
- Windows XP Home & Works V8.0
- Restore Partition on Hard Drive
- As new & boxed (factory refurb), with one year RTB warranty



£425.52 ex-vat ~~£499.99~~ inc-vat

Updated daily, don't forget to check out our website for full list of currently available products

SAME DAY DISPATCH



Sterling Management
Systems Ltd
13-15 Barrack Road,
Guildford, Surrey, GU2 9ZU

Tel: 01483 301331
Fax: 01483 533079
e-mail: sales@sterlingxs.co.uk

PLACE YOUR ORDER
ON-LINE OR BY
PHONE, FAX OR POST

Prices exclude delivery at Initial City Link standard rates by weight. Goods have a 1-year RTB warranty unless otherwise stated. Credit card payments are subject to a 2.5% surcharge, no surcharge for Switch, Delta or Solo. All trademarks acknowledged. Stocks are finite - please telephone before travelling to confirm availability. Photos for illustration only. E&OE.

Finest Quality
CANON & EPSON
Compatible Ink Cartridges

We only stock **brand new** cartridges - not recycled or refilled cartridges.
Our ink cartridges are manufactured to **ISO9001** standards, will not invalidate your printer warranty, and come with a **100% money back** guarantee!

Epson Stylus:

C20, C40, 400, 460, 480
580, 600, 640, 660, 670
700, 740, 750, 760, 880

Black Ink Cartridges

£1.99 each

3 pack: **£4.99**

Colour Ink Cartridges

£2.99 each

3 pack: **£7.99**

Epson Stylus:

C42, C44, C46, C60, C62
CX3200, 680, 790, 830
890, 900, 915, 925, 1290

Black Ink Cartridges

£2.99 each

3 pack: **£7.99**

Colour Ink Cartridges

£3.99 each

3 pack: **£9.99**

Epson Stylus:

C64, C66, C70, C80, C82
C84, C86, RX420, RX425
CX3600, CX6600, CX6600

Full sets of 4 cartridges:

(Black/Cyan/Magenta/Yellow)

£11.99 per full set

3 full sets: **£32.99**

Black Ink Cartridges

£3.99 each

3 pack: **£9.99**

Colour Ink Cartridges

£2.99 each

any 3 colours: **£7.99**

"Premier Ink Supplies stock the compatible cartridges that achieved top ratings under independent testing, and provide all the guarantees of quality, reliability and service that should assure any customer"
- **Independent on Sunday, September 04.**



We stock the **ONLY** Epson compatible ink cartridges tested and recommended by the *British Journal of Photography*: "The inks do a sound job - producing prints preferable to OEM inks on some occasions, as good as on the majority of occasions"
- **British Journal of Photography, April 05**

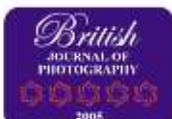

Canon Compatible Cartridges

BCI24 / BCI21 Black Ink Cartridges: **£1.99** each or 3 pack **£4.99**
BCI24 / BCI21 Colour Ink Cartridges: **£2.99** each or 3 pack **£7.99**
BCI3e Ink Cartridges: **£2.99** each or 3 pack **£7.99**
BCI6 Ink Cartridges: **£2.99** each or 3 pack **£7.99**

IP1600, IP2200, IP4200, IP5200, IP6600 cartridges in stock: see website!

Brother Compatible Cartridges

LC600 or LC700 Black/Cyan/Mag/Yellow Compatible Cartridges - Set of 4 **£11.99**
LC800 or LC900 Black/Cyan/Mag/Yellow Compatible Cartridges - Set of 4 **£11.99**

HP Genuine Original Cartridges

No.27 (c8727a) Original HP Black Ink Cartridge (10ml): **£11.99**
No.28 (c8728a) Original HP Colour Ink Cartridge (8ml): **£14.99**
No.56 (c6556a) Original HP Black Ink Cartridge (19ml): **£11.99**
No.57 (c6557a) Original HP Colour Ink Cartridge (17ml): **£19.99**
No.339 (c8767e) Original HP Black Ink Cartridge (21ml): **£17.99**
No.344 (c9363e) Original HP Colour Ink Cartridge (14ml): **£19.99**

Lexmark Genuine Original Cartridges

No.17 (10N0217) Original Lexmark Black Ink Cartridge: **£12.99**
No.27 (10N0227) Original Lexmark Colour Ink Cartridge: **£14.99**
No.32 (18C0032) Original Lexmark Black Ink Cartridge: **£12.99**
No.33 (18C0033) Original Lexmark Colour Ink Cartridge: **£15.99**
No.48 (17G0648) Original Lexmark Black Ink Cartridge: **£12.99**
No.19 (15M2619) Original Lexmark Colour Ink Cartridge: **£15.99**

Orink Professional Photographic Papers

255gsm Gloss Photo Paper, High Quality, Instant Dry, 10x15cm, 50 sheets **£5.99**
255gsm Gloss Photo Paper, High Quality, Instant Dry, A4, 20 sheets **£7.99**
251gsm Satin Photo Paper, High Quality, Instant Dry, 10x15cm, 50 sheets **£5.99**
251gsm Satin Photo Paper, High Quality, Instant Dry, A4, 20 sheets **£7.99**

EPSON®
ORIGINAL INK
CARTRIDGES

C48 *NEW - DUE IN SOON*

T066 Black cartridge: **£4.99**
T067 Colour cartridge: **£8.99**

D68/D88/DX3800/DX4800

T0611 Black: **£5.99**
T0612 Cyan: **£4.99**
T0613 Magenta: **£4.99**
T0614 Yellow: **£4.99**
T0611/2/3/4 Set: **£19.99**

RX420/RX425

T0551 Black: **£5.99**
T0552 Cyan: **£4.99**
T0553 Magenta: **£4.99**
T0554 Yellow: **£4.99**
T0551/2/3/4 Set: **£19.99**

R200/R300/RX500/RX600

T0481 Black: **£8.99**
T0482 Cyan: **£7.99**
T0483 Magenta: **£7.99**
T0484 Yellow: **£7.99**
T0485 Light Cyan: **£7.99**
T0486 Light Magenta: **£7.99**
T0481/2/3/4/5/6 Set: **£39.99**

C64/C66/C84/C88/CX3600

T0441 Black: **£9.99**
T0452 Cyan: **£6.99**
T0453 Magenta: **£6.99**
T0454 Yellow: **£6.99**
T0441/52/53/54 Set: **£29.99**

RX700 Set of 6 cartridges: **£39.99**
R800 Set of 8 cartridges: **£79.99**
R1800 Set of 8 cartridges: **£79.99**
R2400 Set of 9 cartridges: **£79.99**

T007 Black cartridge: **£12.99**
T008 Colour cartridge: **£10.99**
T009 Colour cartridge: **£14.99**
T026 Black cartridge: **£15.99**
T027 Colour cartridge: **£12.99**
T036 Black cartridge: **£9.99**
T037 Colour cartridge: **£9.99**
T040 Black cartridge: **£19.99**
T041 Colour cartridge: **£19.99**

- Royal Mail 1st Class Delivery • P&P 99p Per Order •
- Freephone Number • Secure Online Ordering •
- All Prices Include VAT • No Minimum Order •

Premier
INK SUPPLIES

www.PremierInk.co.uk
0800 1075 270

Premier Ink Supplies
12 Longfield Road
Sydenham Industrial Estate
Leamington Spa CV31 1XB

Secure Online Shopping with:

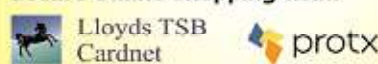

SaverSoftware.co.uk

BRANDED SOFTWARE - UNBEATABLE PRICES



Pinnacle Studio 10
£39.99 (£5 Off)

Licences & Educational Prices on request.

Pinnacle Studio 10 Plus	£59.99 (£10 Off)
Pinnacle Studio 10 MediaSuite	£79.99 (£10 Off)
Pinnacle Studio 10 Plus Upgrade	£34.99 (£5 Off)

We are Specialists in Retail & Licenced Software
For further offers available, please email us today.
email: pinnacle@saversoftware.co.uk
Order online or our through our dedicated order line

Freephone: 0800 458 8071

Prices are correct at the time of going to press



AL-JAZEERA



BORIS



HEAVY Drinker

HOW'S MY NURSING
01276488000 *
www.howsmynursing.com

* choose your phone number
T-shirts £18 (inc P&P) - see our full range at
WWW.TEEMARTO.COM
Call: 01276 488 000

BECOME THE NEXT SPONSOR OF ONE OF OUR REPORTS

Increase awareness of your company with this amazing package including:

- Your logo on the front cover
- A page of sponsor's comment
- A generous number of adverts
- A PDF e-book of the report on the PCW cover disc
- Up to 1000 run-ons of the report
- 1-month solus sponsorship of a dedicated section of www.pcw.co.uk



For more details call Paul Harvey on 020 7316 9465 or email him at paul_harvey@vnu.co.uk

www.computerbargains.co.uk

WARRANTY. TRADE PRICES

Order On-Line at www.computerbargains.co.uk

SAME DAY SHIPPING. FREE TECHNICAL SUPPORT. NO CREDIT CARD SURCHARGE. ALL GOODS BRAND NEW WITH

SHIPPING. TRADE PRICES DIRECT TO THE PUBLIC. NO CREDIT CARD SURCHARGE. FREE TECHNICAL SUPPORT



DELL INSPIRON 1300
15.4" WIFI NOTEBOOK
£399 ~~£468.83~~
+VAT inc VAT

- Dell Inspiron 1300, Intel Celeron Mobile 1.4GHz CPU
- 256MB Ram (512MB add £25+VAT £29.38inc)
- 60GB Hard Drive, DVD Rewriter Drive, Modem & Lan
- 15.4" Widescreen Display, Built in Wireless Network
- Microsoft Windows XP Home & MS Works
- Brand New with 1 Year Dell European Warranty



HP PAVILION
ATHLON 64 3200+
1GB/200GB DVD-RW
£379 ~~£445.33~~
+VAT inc VAT

- HP Pavilion T680UK PC, AMD Athlon 64 3200+ CPU
- 1GB DDR SD RAM and 200GB Hard Drive
- DVD-Rewriter Drive, 9 in 1 Card Reader, Modem & Lan
- MS Windows XP Home, Works & Norton software
- Factory clearance refurb stock with 1 year warranty
- CRT Monitor add £75+VAT, 15" TFT add £115+VAT
- TFT Monitor add 139+VAT (£163.33inc VAT)



IBM THINKPAD A21M
PIII 700MHz NOTEBOOK
£175 ~~£205.63~~
+VAT inc VAT

- IBM A21M, Intel Pentium III-700MHz CPU
- 256MB Ram, 20GB Hard Drive, 14.1" TFT Screen
- CD ROM Drive, 3.5" Floppy Drive, Battery & Charger
- Built in 56K Modem and 10/100 Network card
- 2x PCMCIA, Serial, Parallel, IrDA, VGA & USB Ports
- Dell factory refurbished stock with 3 month warranty
- Notebook carry case add £20+VAT (£23.50inc VAT)
- Operating System available at extra cost

IN STOCK FOR COLLECTION OR NEXT DAY DELIVERY



EMACHINE
CELERON 2.53GHz
256MB/40GB CDRW+DVD
£189 ~~£222.03~~
+VAT inc VAT

- eMachine Model 2230 with Intel Celeron 2.53GHz
- 256MB Ram (512MB add £20), 40GB Hard Drive
- CDRW+DVD Combo, Modem, Networks & USB Ports
- Microsoft Windows XP Home and Works software
- Factory clearance refurb stock with 1 year warranty
- 17" CRT Monitor add £69+VAT, 15" TFT add £115+VAT
- 17" TFT Monitor add 139+VAT (£163.33inc VAT)



DELL LATITUDE C610
PIII 1GHz NOTEBOOK
£199 ~~£233.83~~
+VAT inc VAT

- Dell Latitude C610 Notebook, Intel Pentium III 1GHz
- 256MB Ram, 20GB Hard Drive, CD ROM Drive
- 14.1" TFT Colour Screen with 1024 x 768
- 3.5" Floppy Drive, Modem and Network
- Serial, Parallel, VGA, PS2, PCMCIA slots
- Refurb stock with 6 months warranty
- Notebook carry case add £20+VAT (£23.50inc VAT)



DELL LATITUDE C840
P4 1.6GHz NOTEBOOK
£269 ~~£316.08~~
+VAT inc VAT

- Dell Latitude C840 Notebook, Intel Pentium 4 1.6GHz
- 512MB Ram, 30GB Hard Drive, 15" TFT Display
- CD Rewriter Drive plus 3.5" Floppy Drive
- Modem, Lan, Serial, Parallel & USB Ports
- Operating System excluded, available at extra cost
- All factory refurbished stock with 6 months warranty
- Notebook carry case add £20+VAT (£23.50inc VAT)

DELL FACTORY REFURBISHED



TOSHIBA TECRA 2100
P4 1.8GHz NOTEBOOK
£285 ~~£334.88~~
+VAT inc VAT

- Toshiba Tecra 2100, Intel Pentium 4 1.8GHz CPU
- 256MB Ram, 30GB Hard Drive, CDRW+DVD Drive
- Built in 56K Modem and 10/100 Network Card
- 14.1" 1024 x 768 Resolution TFT Colour Display
- Serial, Parallel, VGA, USB and PCMCIA Slots
- Factory refurbished & supplied with 6 months warranty
- Notebook carry case add £20+VAT (£23.50inc)



DELL CENTRINO XP PRO
15.4" WIFI NOTEBOOK
£569 ~~£668.58~~
+VAT inc VAT

- Dell Inspiron 6000, Intel Pentium M Centrino 1.7GHz
- 512MB Ram, 60GB HDD, DVD Rewriter, Card Reader
- 15.4" Widescreen Display, Built in Wireless Network
- Supplied with Microsoft Windows XP Professional SW
- Brand New with 1 Year Dell European Warranty
- Notebook carry case add £20+VAT (£23.50inc)



TOSHIBA TECRA 8100
PIII-800MHz NOTEBOOK
£225 ~~£264.38~~
+VAT inc VAT

- Toshiba Tecra 8100, Intel Pentium III-800MHz CPU
- 256MB Ram, 20GB Hard Drive, CDRW+DVD Drive
- Built in 56K Modem and 10/100 Network Card
- 14.1" 1024 x 768 Resolution TFT Colour Display
- Serial, Parallel, VGA, USB and PCMCIA Slots
- Ex-Corporate & refurbished with 3 months warranty
- Notebook carry case add £20+VAT (£23.50inc)

ORDER NOW FOR NEXT DAY DELIVERY



IBM THINKPAD R50e
DVD REWRITER 15" TFT WIRELESS NOTEBOOK
£399 ~~£468.83~~
+VAT inc VAT

- IBM Thinkpad R50e, Intel Celeron M360 1.4GHz CPU
- 256MB Ram, 40GB HDD, Modem and 10/100 Network Card
- DVD Rewriter Drive, 15" TFT Colour Display
- Built in Intel Pro 2200B Wireless Network
- Microsoft Windows XP Home Software
- Brand New with 1 year IBM warranty
- Upgrade to 512MB Ram add £25+VAT



HP COMPAQ
ATHLON 64 3000+
512MB 160GB DVDRW
£299 ~~£351.33~~
+VAT inc VAT

- Compaq Presario SR1229 PC.
- AMD Athlon 64 3000+ CPU 512MB Ram, 160GB HDD
- Dual Layer DVD Rewriter Drive, Built in Modem & Lan
- MS Windows XP Home, Works & Anti Virus software
- Factory clearance refurb stock with 1 year warranty
- CRT Monitor add £75+VAT, 15" TFT add £109+VAT
- TFT Monitor add 139+VAT (£163.33inc VAT)



FAMOUS BRAND
P4 3GHz 512MB
200GB DVDRW PC
£329 ~~£386.58~~
+VAT inc VAT

- Famous high street brand, Intel Pentium 4 3.06GHz
- 512MB Ram memory, 200GB Hard Drive
- DVD Rewriter Drive, 56K Modem & 10/100 Lan
- 8 in 1 Card Reader, USB ports, Keyboard & Mouse
- MS Windows XP Home, Works & Anti Virus Software
- Upgrade to 1GB Ram add £40+VAT (£47inc VAT)
- 17" TFT Monitor add 139+VAT (£163.33inc VAT)

LIMITED STOCK



ACER N35
POCKET PDA WITH BUILT IN SAT NAV
£169 ~~£198.58~~
+VAT inc VAT

- Acer N35 PDA with satellite navigation solution
- Includes PDA with built in GPS and local country maps bundled onto a 256MB Card. Easy to use & navigate
- Package includes Acer N35 PDA with 266MHz CPU
- Windows Pocket PC 2003 Software, plus Destinator Voice guidance Sat Nav Software, cables & car kit etc.
- Acer factory refurbished with 1 year warranty.



GATEWAY
PENTIUM 4 MOBILE
1.6GHz NOTEBOOK
£235 ~~£276.13~~
+VAT inc VAT

- Gateway 600YGR, Intel P4 Mobile 1.6GHz CPU
- 256MB Ram, 20GB HDD, CD Rewriter Drive
- 15" TFT Display, Serial, Parallel, VGA and USB Ports
- Factory refurbished with 3 months warranty extended
- Operating excluded, available at extra cost
- Notebook Carry Case add £20+VAT (£23.50inc)



IBM THINKPAD PIII 1GHz
CD-RW NOTEBOOK
£219 ~~£257.33~~
+VAT inc VAT

- IBM A22M, Intel Pentium III-1GHz CPU
- 256MB Ram, 30GB Hard Drive, 14.1" TFT Screen
- CD-RW Drive, 3.5" Floppy Drive, Battery & Charger
- Built in 56K Modem and 10/100 Network card
- 2x PCMCIA, Serial, Parallel, IrDA, VGA & USB
- Factory refurbished stock with 3 month warranty
- Notebook carry case add £20+VAT (£23.50inc)
- Operating System available at extra cost

ORDER NOW FOR NEXT DAY DELIVERY

REDUCED TO CLEAR



SAMSUNG MP3 PLAYERS
VARIOUS MODELS
£32 from ~~£37.60~~
+VAT inc VAT

- Samsung Yepp MP3 players with 512MB, 1GB, 5GB and 20GB capacity. Special features including voice recording and direct MP3 record through line input. These units are factory refurbished with 1 year warranty
- 512MB MP3 £37.60 inc Vat. 1GB MP3 £54 inc Vat
- 5GB MP3 £89inc Vat. 20GB MP3 £109 inc Vat



ARTEC USB DIGITAL TV TUNER BOX
£30 ~~£35.25~~
+VAT inc VAT

- Artec USB Digital TV Box is a portable, advanced, and fine designed Digital TV solution that enhances the digital functionality on either your laptop computer or Multi Media PC. Watch all the main TV channels like BBC, ITV etc, plus Sky News, Music channels and more. Complete with remote control, aerial & software



EMACHINE
PENTIUM 4 2.93GHz
DVD REWRITER PC
£269 ~~£316.08~~
+VAT inc VAT

- eMachine Model 3240 with Intel Pentium 4 2.93GHz
- 256MB DDR Ram, (512MB add £25+VAT £29.38inc)
- 80GB SATA Hard Drive, DVD+/-RW Drive
- Built in 56K Modem, 10/100 Lan, USB Ports
- Microsoft Windows XP Home and Works software
- Factory clearance refurb stock with 1 year warranty
- 15" TFT Monitor £109+VAT 17" TFT add 139+VAT

COMPUTER BARGAINS

1 STAND LANE, RADCLIFFE, MANCHESTER, M26 1NW.

Mail Order Sales Call: **0161 723 2222** Other Enquires Call: **0870 757 2210**
Fax No: **0870 757 2219**

Email: sales@computerbargains.co.uk ALL MAJOR CREDIT CARDS, GOVERNMENT & EDUCATIONAL ORDERS ACCEPTED

CALLERS WELCOME TO OUR SHOWROOM
PLEASE PHONE TO CONFIRM AVAILABILITY
OPENING TIMES
MON-FRI 9am-6pm SAT 9am-12pm
or visit our website at

www.computerbargains.co.uk



All Trademarks Acknowledged. E & OE



WITH CD!
£4.99

Available at **WHSmith**

and all good newsagents.

Or order by calling: 0870 830 4973 (please quote code Z253).

Consumables

Win  **the new Canon EOS 350D**
free entry online, no purchase necessary

INK FACTORY inkfactory.com

www.inkfactory.com

Collectables

WWW.BLADES-UK.COM
Mon - Fri 10am - 4pm 0845 226 5514



Also Accept Paypal, Notes, Moneyorders & cheques.

IT Directories



itnerd.com
The London IT Directory

To advertise here call
Shila Shah
on 020 7316
9144

Consumables

Ink Cartridges www.eezytrade.co.uk

For Service, Quality, Value and FREE Delivery it's Black & White!
Same Day Despatch order online or call 0845 6449 428 before 3pm Mon-Fri

Business Services

CD & DVD SERVICES

Contact Digital Data for full details on all aspects of: Short run duplication, Thermal Printing, Screen printing, Credit Card CDs, Design, Pressing, Packaging, Printers and Duplicators.

CD/DVD PRINTING & DUPLICATION:
Rapid turnaround on high quality CD-R & DVD-R colour thermal printing & duplication. No minimum quantities. Screen printing, pressing & fulfillment also available. Everest thermal printer ribbons at competitive prices.

DUPLICATORS:
CD & DVD tower duplicators available from a 3 burner 52 speed CD unit at £349 to a 16 speed 7 burner DVD unit at £625. See our website for specifications & full pricing information.

ADOBE ACROBAT & DOCUMENT SCANNING:
We are expert at converting your existing paper and electronic material to Acrobat format, ask for a free sample conversion of your electronic or paper based information.

Digital Data Ltd
T: 01732-460421 F: 01732-740992
E: sales@d-data.co.uk sooner or later you need digital data W: www.d-data.co.uk

Internet Services

Abel Internet **0871 717 8252**
Broadband Packages from £9.99
www.abelalways.co.uk

★ **Subscription Free & Unmetered Dial Packages**

- Reseller Packages
- Create Client Loyalty
- Generate Extra Income
- Domain Registration & Hosting
- Business Packages
- Server Co-location

www.abelvisp.co.uk www.abelbiz.info

Sign up for Dialup or Broadband
More Details & FREE software on Cover CD

VIDEO, DVD & CD DUPLICATION
Duplicate from any master in any quantity
PAL, NTSC & SECAM standards conversion
Wide variety of packaging available

DVD AUTHORIZING & ENCODING
Encoding to MPEG2 from any video format
Personalised menus and chapter points
Archive your home movies onto DVD

NON-LINEAR EDITING
Realtime digital NLE suites for hire
Very competitive hourly rates
3D graphics and effects

CVS INTERNATIONAL
0800 018 9289
www.cvsinternational.co.uk
BRANCHES IN LONDON, ESSEX, KENT & SUFFOLK
Head Office: 20 Tallon Road, Hutton Industrial Estate, Brentwood, Essex, CM13 1TJ

To advertise here call
Shila Shah on 020
7316 9144

active Home

PLAIN ENGLISH AND JARGON FREE!

Only
£3.99

£3.25 Direct from
our website*

**ON SALE
FEBRUARY
16TH!**

- Jargon-free Buyers Guide to the latest digital home technology
- Hot new products for 2006
- 24 pages of in-depth group tests
- Plus, 15 pages of step-by-step workshops



Available at **WHSmith** and all good retailers
or **www.direct-pcw.co.uk**

* Only available at this price directly from Personal Computer World Direct



ON THE CD

Motion Artist 2 ● Jaws PDF Editor 2.5 ● Registry Mechanic 5 ● Ashampoo WinOptimizer Platinum Suite 2 ● Serif 3DPlus 3



ON THE DVD

Ashampoo Photo Illuminator 2 ● Magix Music Manager 2006 ● Motion Artist 2 ● Jaws PDF Editor 2.5 ● Registry Mechanic 5 ● Ashampoo WinOptimizer Platinum Suite 2 ● AUSTRUMI 1.1.0 ● GoblinX Mini 1.2.2 ● Ubuntu 5.10 Breezy Badger

SOFTWARE LISTING

ON THE CD

FULL VERSIONS

Motion Artist 2
Jaws PDF Editor 2.5
Registry Mechanic 5
Ashampoo WinOptimizer Platinum Suite 2
Serif 3DPlus 3

TRIAL VERSIONS INCLUDING

ACDsee Pro Photo Manager
Concept Draw Net
Diagrammer
Jawspdf Creator 4
Burrn 1.14
Reaper 0.79
Songbird 0.1

FROM THE MAGAZINE

FTGate 4
MDaemon Mail Server v8.1.4

FREWARE INCLUDING

Fontpage 3.0
Gigaget 1.0.0.21
PSP Video 9 1.74
Quotes 2006.2.1.1
Truecrypt 4.1
WPanorama 6.4.1

RESOURCES INCLUDING

Adobe Reader 7
Cobian Backup 7.4.5.343
Paint.Net 2.5
Partition Logic 0.61

PDFCreator 0.8.1
Skype 2.0.0.81

ON THE DVD EVERYTHING ON THE CD PLUS...

FULL VERSIONS

Ashampoo Photo Illuminator 2
Magix Music Manager 2006

TRIAL VERSIONS

Corel Wordperfect Office
X3 Standard
Manga Studio 3

LINUX & OPEN SOURCE

AUSTRUMI 1.1.0

Damn Small Linux 2.2
GoblinX Mini 1.2.2
Ubuntu 5.10 Breezy Badger

FREWARE

StudioLine Photo Basic 3.2

FROM THE MAGAZINE

Imlail Secure Server 2006
Kerio Mailserver 6

RESOURCES

Open Office 2.01
Ultimate Boot CD Basic 3.4

GAME DEMOS INCLUDING

Battle of Europe; Timeshift

USING THE COVER DISC

The PCW cover disc uses a web-browser-style interface. To get full functionality, you'll need to use Microsoft Internet Explorer (version 5.5 or later). Unfortunately, Netscape doesn't properly support this software. However, we have also provided links to the featured programs so that you can still copy them to your hard disk or install them manually (the standard download dialogue box will appear). Programs can be found in the \software\ folder on the disc.

STARTING THE DISC

The CD-Rom (or DVD) should auto-start. If it doesn't, double-click the CD-Rom/DVD icon in My Computer or open the terms.htm file on the root of the disc.

PROBLEMS?

Please note that we cannot give support on individual programs contained on this disc. If you have problems running the disc or any of its content, please note these guidelines:

FAULTY DISC

If the disc is physically damaged and will not load, return it to this address for a replacement:

PCW May 2006, cover disc ABT, 306 St Mary's Lane, Upminster, Essex RM14 3HL quoting reference: 'PCW Vol 29 No 5'.

PROBLEMS INSTALLING/ RUNNING THE SOFTWARE

Check the support page on the disc or check the manufacturer's site.

GENERAL DIFFICULTIES

Call 08700 885 995 (9.30am to 5pm Mon, Tues, Thurs & Fri; open until 8pm on Wed and 10am to 2pm Sat). Or go to www.vnusupport.co.uk or email us at pcw@vnusupport.co.uk.

COVER DISC

SIX PAGES OF DISC INFO INCLUDING

- PRODUCT DESCRIPTIONS
- WORKSHOPS
- UPGRADE OFFERS
- KEY FEATURES
- CONTACT DETAILS
- NEED TO KNOW

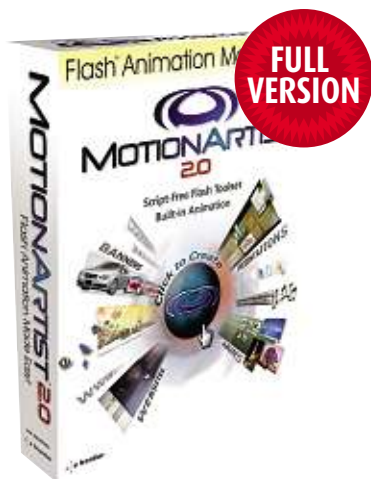

Motion Artist 2

Replace boring static HTML pages with stylish Flash animations

Creating a stylish Flash-driven website doesn't have to involve buying expensive development tools, or bulky scripting manuals. Motion Artist 2 replaces all the complexity with point-and-click animation settings and simple mouse movements, letting you create effective Flash animations in minutes.

It comes with animation templates, which make it easy to get started. Pick the 'Digital Camera Album' template, choose a visual style, add your photos, and Motion Artist will build the animation for you. Browse the other templates and you'll find it's just as easy to create an animated site splash screen, or a complete menu system, with no Flash experience required.

If you prefer to go your own way, there's always the option of creating a new animation

from scratch. Start by choosing backgrounds, buttons and objects from the built-in Motion Artist libraries, or draw and import new images of your own.

Adding basic animation is just a matter of picking options from a dialogue box, maybe setting up a title to fade in when the animation begins and shoot off to the right when it's done.

There's support for interactivity, by creating clickable regions that will jump to another page in the animation (or an external website). You can dress up the project by adding audio files, or Flash applets, then fine-control their use via a timeline. And when you've finished, click File > Create SWF to export the finished results and a matching HTML file, ready for immediate use.

INFORMATION

System requirements Windows 98 or later, 150MB of disk space

Contact www.e-frontier.com

Registration Obtain your serial code from www.e-frontier.com/go/ma2_pcw

Bring new life to your website with a stylish Flash interface



1 Click New Flash Wizard on the Motion Artist Startup Panel, then select the Homepage Menu template, choose a preferred colour scheme and enter a site welcome message. Then, at the Menu Item page, enter a title for the four default sections of your site (CV, holiday photos, whatever you like) and click Finish.



2 The bottom of the page shows your site: page 1 is the opening animation, and there are more pages for the sections you've just defined. Click on one to select it, then use the Object menu to add content like text, buttons (which can be just images) or sound. Explore dialogues like Object > Properties to set up links.



3 It's not always obvious to tell what the site will look like in real life, so click File > Preview Movie occasionally to see for yourself. Use File > Document properties to tweak settings like the animation resolution, or just click File > Create SWF to build the final animation and HTML file, ready to use.

UPGRADE OFFER

NEW FEATURES

Cell mode simplifies animation
Image List reduces file size
Variables support adds versatility
New and improved clipart gallery

MOTION ARTIST 3

The latest version of Motion Artist includes a Cell Mode animation mode, where the program automatically produces a series of image frames for you. The Image List holds your graphics in one central collection, letting you re-use them as required without increasing file size. New support for Variables lets you perform complex operations without scripting, while a reworked clipart gallery provides more objects to populate your animations. All this normally costs \$49.99, but you can upgrade for just \$9.99 (approx £6): click Help > Upgrade to order.





Jaws PDF Editor 2.5

Add bookmarks and annotations to pdf files with this editing toolkit

Jaws PDF Editor takes over where Adobe Reader leaves off, giving you the power to manipulate pdf files without having to go back to the original document. And although it doesn't let you edit the text directly, or create pdf files from scratch, the program does offer features that you'll find immediately useful.

Take bookmarks, for instance. If you find something interesting in a pdf file, there's no need to copy and paste the text elsewhere; just click Action > Bookmarks > Add Bookmark to make a note of it for quick reference later.

You can annotate pages, too – useful if you're reviewing documents within a company. These notes can be viewed later on a separate Comments page, or within the document by

double-clicking on yellow markers they leave on the page. Each note has a title bar containing the date it was made, and the person who made it, and all your notes may be exported in fdf (Forms Data Format) or XML formats.

A range of pdf manipulation options starts with the ability to delete or rotate one or more pages. The Extract command lets you take a random selection of pages and export them as a new pdf file. The Insert option lets you merge pages from one pdf file into another.

The program also allows you to change the security of a pdf file, perhaps encrypting it, or limiting features like printing, or the copying of text or graphics. Add handy Save options to cut pdf file size or optimise files for the web, and this could be just the pdf toolkit you need.

INFORMATION

System requirements Windows 98SE/ME/2000 Professional SP4/2000 Server SP4/XP Professional SP1a/SP2/Server 2003, 25MB of disk space

Contact www.jawspdf.com

Registration Visit www.jawspdf.com/en/promo and enter the magazine code PFEditor25

Three ways to get more from your pdf files



1 You're reading a pdf file and a line catches your attention. Normally you'd have to make a note of this elsewhere, but pdf Editor lets you click Action > Comments, then Highlight to draw a yellow 'marker pen' over your text. You can highlight complete areas, underline text or try a couple of strikethrough options, too.



2 Click Action > Bookmarks > Add Bookmark for a different approach, which lets you mark particular points of interest in the file. Try Action > Bookmarks > Add Comment if you'd prefer to add a detailed note about something in the file, then use Window > Action Pane to organise and navigate through these entries later.



3 Splitting your annotations across several pdf files may be inconvenient. So why not merge them into one? Click Action > Pages > Insert, browse to another pdf file, and click OK. PDF Editor then automatically adds the pages from that file to the one you currently have open, bookmarks and annotations included.

UPGRADE OFFER

NEW FEATURES

Create pdfs from any application
Complete pdf resolution control
Microsoft Office integration
CIE-based colour support
Complies with PDF 1.5 specs

SAVE 25% ON JAWS PDF CREATOR 4

Creator 4 extends PDF Editor's functionality by incorporating a virtual printer driver that lets you 'Print to pdf' from just about any application. Use the Microsoft Word, Excel or Powerpoint macros included and the pdf file will even incorporate structure from the original document, such as bookmarks, hyperlinks and even transitions in Powerpoint slides. And your control over file resolution means they can all be quickly optimised for regular, web or high-quality pre-press work. What's more, if you order now you'll only pay £34, which will save you more than 25 per cent on the £47 list price. Visit www.jawspdf.com/en/promo and enter the magazine code PFEditor25 to find out more.





Registry Mechanic 5

Boost your PC's performance with a quick Registry overhaul

The Registry on a new PC is compact and efficient, containing only the entries required to run your installed applications. But as you add and remove other programs, orphaned entries are left behind, with the result that the Registry keeps getting larger. Over time, it will consume more Ram and take longer to locate Registry values, slowing down your PC.

So if you want to restore your system to full working order then you'll need to reach for Registry Mechanic. Click the Scan button and it will go to work checking just about every Registry entry, looking for anything that might have been left behind by long-forgotten applications.

Registry Mechanic checks for a range of problems, too, from non-existent Startup

programs, to Add/Remove Programs entries that no longer point to an uninstall program, missing fonts, invalid file registrations and more.

Deleting that many Registry entries may well make you nervous, of course, but you do get three layers of protection. First, it's possible to evaluate particular entries to decide whether they should be deleted or not. Second, Registry Mechanic makes backups of everything it deletes, so if you do wipe something important then it's easy to bring it back. And just in case that's not enough, Registry Mechanic also creates a System Restore point before carrying out any repair. The end result is you can use the program with confidence, secure in the knowledge that any accidental errors can be quickly undone.

INFORMATION

System requirements Windows 98/ME/NT Workstation 4/2000 Professional/XP, 7MB of disk space, Internet Explorer 5.5

Contact www.pctools.com

Registration Go to www.pctools.com/registry-mechanic/free/promo/VNU0306

Get your Registry and PC back into peak condition

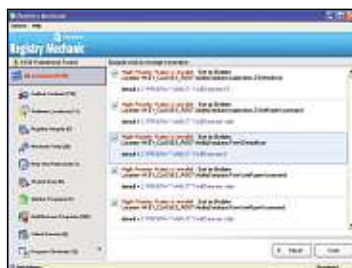

1 Click 'Start Scan', and let the program analyse your Registry. When it's done, browse through the Registry sections and check the identified problems, clearing the box next to any entries you'd like to keep. Then select Repair to delete the remaining checked Registry entries, or Close to leave them all intact.



2 Deleting hundreds of unnecessary entries doesn't immediately cut the Registry size. To do that you need to defragment the Registry, by clicking the Compact Registry button. Wait while the program calculates how much space you'll save, then click 'Compact now' when it's done to cut your Registry down to size.



3 Complete the job by clicking 'Optimise your System', which applies several Registry tweaks aimed at improving PC performance. These cover everything from helping applications load more quickly, to reducing the time it takes Windows to close down. See the application Help file for more detailed information.

UPGRADE OFFER

NEW FEATURES

- Detect and remove spyware
- Protect against viruses
- Recover deleted files
- Clear your Internet tracks
- Ditch spam forever
- Keep your network malware-free

SAVE 20% ACROSS THE PC TOOLS RANGE

PC Tools is offering 20 per cent discount on any product, including further updates to Registry Mechanic. Other options include Spyware Doctor, PC Tools Antivirus, Spam Monitor, File Recover (an Undelete tool) and Privacy Guardian (wipe online and application tracks), so you've got plenty of quality software to choose from. Visit www.pctools.com to read about each package and enter the promotional code VNU0306 on the purchase form to qualify for your special discount price.

Ashampoo WinOptimizer 2

FULL
VERSION



Ashampoo WinOptimizer Platinum Suite 2 provides many of the most common PC cleanup and management functions in single, straightforward interface, making it easier to keep your system running at peak performance.

The Cleaning Tools section starts with a Drive Cleaner, which searches your PC for redundant files that you can safely delete. A matching DLL Cleaner locates duplicate DLLs (Dynamic Link Libraries), the Registry Cleaner removes orphaned Registry entries left over from uninstalled applications, and the Internet Cleaner wipes away your surfing tracks. Each Cleaner is fully configurable, and the Registry Cleaner

INFORMATION

System requirements Windows 98/ME/2000/XP, Internet Explorer 5.0 or later, 20MB of disk space

Contact www.ashampoo.com

Registration Click 'Get Free Key' during installation

WinOptimizer Platinum Suite 2 integrates a range of useful PC utilities into one stylish interface

creates backups just in case you delete something important.

The Tuning Tools section features an Internet Tuner that tweaks your TCP/IP settings to improve online performance. A StartUp Tuner controls which programs are launched when Windows boots, an 'IP Spam Blocker' and more.

The third File Tools section lets you delete confidential files permanently, and a module to encrypt or decrypt files. For a really easy life, schedule the '1-Click-Optimisation' feature to run every couple of weeks. It will clean up your hard drive, Registry and Internet traces automatically, with no further input required.

UPGRADE OFFER

SAVE 40% ON WINOPTIMIZER PLATINUM 3

The latest WinOptimizer Platinum includes new modules such as Tweaking (change many Windows settings from one screen), a speedy Defrag tool, System Information program and a Disk Space Explorer to show how your hard drive is being used. There's also a skinnable interface, Explorer integration, faster and more thorough Registry cleaning and more. This would normally cost £29.99, but you can upgrade for only £17.99 — visit www.ashampoo.com/shop/1306/upgrade_edition to place your order.

Serif 3DPlus 3

FULL
VERSION

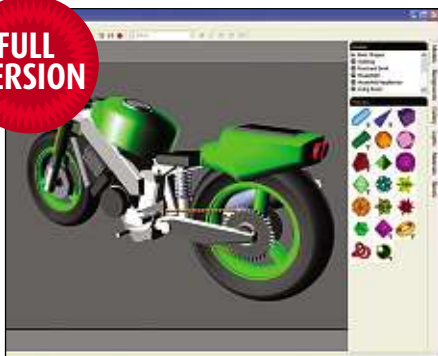

3D modelling software has a well-deserved reputation for complexity, but it doesn't have to be that way. Serif 3DPlus is so straightforward that you can produce genuinely useful work in less than 60 seconds: here's one example.

Click 'Start from scratch' on the opening screen and browse the Models palette. 3DPlus comes with lots of pre-built models, so you're not forced to build everything from scratch. Scroll to 'Planets', click the Earth-like one at the top left and it will appear in the work area.

Now click the left-hand Gallery, and click Animations. This provides colour changes, fades, fly-throughs and other effects you can apply to

INFORMATION

System requirements 16bit SVGA display, Windows 98 or later (XP in single-user mode only), 40MB of free disk space

Contact www.serif.com

Registration Install the software and follow the on-screen prompts for freephone registration

Need to know Under Windows XP, ATI graphics card users should upgrade to the latest ATI Catalyst drivers (www.ati.com)

A series of docked palettes ensure the 3DPlus workspace stays largely uncluttered

any object. Click Spins, and select one you think would make for a realistic planetary orbit.

Click Play on the Animation toolbar, to preview the effect, then select File > Export Animation. Choose the animated gif or avi option to see the animation, and you're finished.

3DPlus is just as good with more advanced 3D work. You can build your own 3D shapes from 2D figures, for instance, then group them together into complex models. Apply colours or textures to add realism, then finish the job with the lighting and shadow effects. Multiple scene planes and 3D print preview help manage the production and the results can be impressive.

UPGRADE OFFER

SAVE £20 ON IMPACTPLUS 5

The latest 3D package from Serif includes powerful 3D modelling and animation features and can also generate 3D headers, text and logos, web graphics, animated e-greetings cards for emailing to friends and more. Use presets such as the particle systems to enhance your image with realistic rain, snow or fire, or use the Particle Workshop to create your own effects.

Normally priced at £59.99, you can upgrade for only £39.95 if you order before 20 May 2006. Call 0800 376 7070 (freephone); (+44 115 914 5454 from outside the UK), quoting code RO/PCW/3D3/0305 to qualify for your reader discount.

Ashampoo Photo Illuminator 2

FULL
VERSION



At first glance Photo Illuminator looks like yet another image browser, but the real power comes in the program's wizards. Take the file conversion wizard, for instance. You could use it to convert a bunch of jpeg files into png files, if you like, but it also lets you resize, rotate and rename images as part of the same operation.

You can also create slideshows of your own in three mouse clicks, and save them locally for speedy recall later. Another wizard lets you record a commentary for each image, then package everything into a standalone executable file for emailing to friends. And there's a third

INFORMATION

System requirements 128MB of Ram, Windows 98 or later, 10MB of disk space

Contact www.ashampoo.com

Registration Follow the instructions during installation

Ideal for locating and viewing your digital photos, but that's just the start of its abilities

option to create screensavers, again for your use, or to be shared with others via email.

You might just want to send a bunch of images, of course, but then it's all too easy to exceed the maximum email attachment size for your account. That's where the Pack'n' Go wizard comes in, letting you dynamically adjust resolution and quality to squeeze in a few more images.

And there's more, with further wizards to grab screenshots, print single or index prints of selected images, or quickly save them to CD. It's a powerful collection of features and makes Photo Illuminator a must for anyone who ever needs to share or manipulate digital images.

UPGRADE OFFER

SAVE 40%
ON PHOTO
COMMANDER 4

Photo Commander takes the features of Photo Illuminator and adds extras such as image-editing (fix red-eye, change colour balance, rotate, flip and more). Videos are displayed as thumbnail images then displayed along with your photos and you get audio support, too (play and organise your tracks and create playlists).

The list price for all this multimedia power is £29.99, but as a PCW reader you need only pay £17.99. Visit www.ashampoo.com/shop/0618/upgrade_edition to find out more.

Magix Music Manager 2006

FULL
VERSION



INFORMATION

System requirements 600MHz CPU, 128MB of Ram, Windows 2000/XP, 110MB of disk space

Contact www.magix.net

Registration Not required

Need to know Some functions displayed on the interface, such as the Music Search feature, are only available via the upgrade deal

Music Manager 2006 comes packed with audio playback, management and conversion features

In a world full of software audio players, it takes something special for one program to stand out from the crowd. The Magix approach is to try and win you over by sheer breadth of features.

The program opens up as an audio player, playing either audio files or CDs. There's a 12-level equaliser (and 12 presets) to customise the sound and you can control playback order through Loop and Shuffle options.

Music Manager includes a Visualiser, if you'd like to add some special effects to the music. Or if you're short on system resources then turn on Minimode instead. Music Manager collapses into a single, small control bar that takes up the minimum of screen space.

It can help organise your audio files, too, by allowing you to edit the properties of mp3 files, for instance, or creating and saving playlists.

A powerful Export function takes care of your audio conversion and CD ripping needs, with support for mp3, wma and Ogg Vorbis. And it's just as easy to create audio CDs, with no other CD mastering software required.

Keep exploring and you'll find Internet radio support, a Podcasts link to Magix's own (free) podcast subscription site, and a 'Portable' mode for transferring playlisted files to your mp3 player. It's an impressive list, and if your current audio player isn't up to scratch then Music Manager 2006 will make a useful replacement.

UPGRADE OFFER

MAGIX MP3
MAKER 11

MP3 Maker 11 takes the features of Music Manager and adds extras such as 25 new audio effects, a headphone surround-sound option and a music file search tool. An AutoDJ helps

create a party mix by beat-matching, or you can record directly from any device, and there's Universal Plug and Play

and a whole lot more. The purchase price is £26.99, and you can click Help > Upgrade > Activate Now > Order Online to grab a copy.





WITH DVD!
£4.99

WITH DVD

WITH DVD

ORDER ONLINE NOW!

<http://www.computeractive-direct.co.uk>

or order by calling: 01858 438883

(please quote code Z180)

Amazing offers choose

Personal Computer World Direct brings you the **Saitek A-250 Wireless Speakers**, allowing you to access your entire PC music library and listen to Internet radio from anywhere in and around your home, at the amazing price of **only £79.99** – **Saving you £20 on the RRP.**

- ✓ Stream music from your PC wirelessly all around your home
- ✓ Enjoy quality digital 2.1 stereo with active bass
- ✓ Portable and durable for everyday use

Transfer music easily from room to room, whether you're studying upstairs, cooking in the kitchen, working in the garage or entertaining friends – you can listen to music anywhere, even outside. Stream music wirelessly from your PC... to anywhere around your home!

Quality wireless speakers – the perfect gift



RRP ~~£99.99~~
Your Price
only £79.99 +p&
SAVING YOU £20!

Features of the Saitek A-250 Wireless Speakers

- ✓ True digital-delivery 2.1 stereo sound
- ✓ Active sub-woofer
- ✓ No Wi-Fi network needed - plug in & play
- ✓ Three separate amplifiers for high fidelity and natural sound
- ✓ LCD display to keep you in control
- ✓ Audio range within 30m
- ✓ Wireless connection to PC (requires Windows 2000/XP)
- ✓ Connect to MP3, CD and portable media players via 3.5mm jack audio cable (provided)
- ✓ Listen to internet radio anywhere
- ✓ AC adapter included
- ✓ Plays for up to 24hrs with 4 x AA batteries (not included)
- ✓ Dimensions 335mm x 115mm x 78mm

For even more great value offers, visit
www.direct-pcw.co.uk

Personal Computer World Direct

Over **300 products available** on our website visit www.direct-pcw.co.uk today!



Redshift 5.1
only £29.99



Epson Stylus D68
only £49.99

Labtec Wireless keyboard
only £24.99

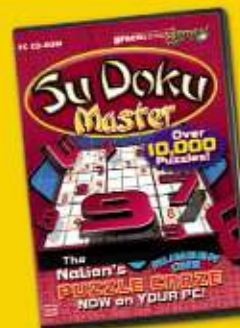

Su Doku Master
only £9.99

en especially for you!

The most complete train simulator ever!

3 fantastic packages for just £17.99



BUY IT!
Computer active

Trains Railway Simulator
"A hugely addictive title that will have even the most disheartened commuter loving trains again." Computeractive Issue 157

Personal Computer World Direct brings you the most realistic railway experience ever!

Trains Deluxe is a 3 in 1 package offering you all the realism of locomotive trains, model railways and live action films.

A must have for all train lovers! *Trains Deluxe* contains two fantastic simulators and a DVD, so once you have designed your own train route you can relax in front of your TV or PC with the *Trains from the Lineside* DVD.

Your complete train package containing 2 CD-ROMs & 1 DVD

Trains Railway Simulator

Design, build and operate your own train with this amazingly realistic piece of software. Act as the Driver or Surveyor and create your own train service.

- ✓ Over 130 locomotives and rolling stock
- ✓ Create your own terrains and routes or try existing services
- ✓ Work the turntables and crossings, couple rolling stock
- ✓ Design and create your own trains using the Paint Shed

This is the most realistic train simulator you will ever experience!

SAVE 40%

Create your own Model Railway

If a real train simulator is not enough we also include this - Create your own Model Railway. You can also:

- ✓ Watch your creation come to life in colourful, high resolution 3D
- ✓ Create your own stunning layouts by placing track, junctions and signals with ease
- ✓ View superb 3D graphics detailing highly realistic objects
- ✓ Follow detailed tutorial with 11 examples
- ✓ View your track from any angle, rotate up to 360 degrees and zoom in and out

RRP £29.99 Your Price £17.99
+ P&P SAVING YOU £12

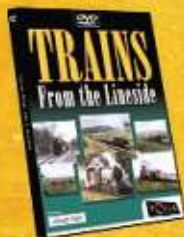

Trains from the Lineside

Once you have created your own simulator watch the real thing with the *Trains from the Lineside* DVD.

- ✓ Follow majestic steam trains on their journeys
- ✓ See steam engines in action in real-life settings
- ✓ Visit the private light railways at East Lancashire, Worth Valley and Great Central

Enjoy this fascinating DVD compilation of British railway scenes.

Plays on PC DVD-ROM drive or DVD player

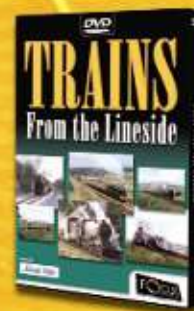

Fantastic offers, available for a limited time only
ORDER them TODAY!

Order online:
www.direct-pcw.co.uk

By telephone:
0870 830 4973

Post this form to:
PCW DIRECT, Tower House, Sovereign Park, Market Harborough, Leicester, LE16 9EF

I would like to order the following products:-

- Saitek A250 Wireless Speakers @ £79.99 (Z470)
- Trains Deluxe Package @ £17.99 (Z477)
- Redshift 5.1 £29.99 (Z472)

(Please add £1.99 Postage & Packing for each product)

- Labtec Wireless keyboard £24.99 (Z473)
- Epson Stylus D68 £49.99 (Z474)
- Su Doku Master £9.99 (Z475)

Your Details

Title	Initials	Surname
Email		
Address		
Postcode	Subscriber number (if known)	
Telephone		

Payment Options (Please indicate your preferred method of payment)

- 1. Cheque enclosed for £ _____ (made payable to VNU Business Publications Ltd)
- 2. Please charge £ _____ to my
 Visa MasterCard Amex Delta Switch/Maestro (Issue No. ___)
 Card No.
 Valid from / / Expiry Date / /

Signature _____ Today's Date _____

We will use one or more of the various contact details supplied to contact you about your order, reader research and related products or events. Please indicate below your privacy wishes for other contact from VNU and 3rd party organisations: Email Tick box to receive information about other products or services from the VNU group of companies by email Tick box to receive information about products or services from selected companies by email Mobile/SMS Tick box to receive information about other products and services from the VNU group of companies by SMS Tick box to receive information about products and services from selected companies by SMS Postal/telephone Tick box if you do NOT want to receive information about other products and services from the VNU group of companies by post/telephone Tick box if you do NOT want to receive information about products and services from selected companies by post/telephone.

SUBSCRIPTIONS OFFER - DVD Edition

3 ISSUES FOR £1

when you subscribe to the **new**
Personal Computer World DVD Edition

- ◆ Get your first 3 issues for just £1
- ◆ Save 37% on the shop price after that – only £3.17 an issue (shop price £4.99)
- ◆ Never miss an issue
- ◆ 4GB DVD with every issue

**Personal
Computer
World** DVD
ROM



**SAVE
37%**

Order online:

www.subscription.co.uk/pcwdvd/v142

or call: **0870 830 4968** quoting V142

Please return this form to: Personal Computer World subscriptions,
FREEPOST LON 14776, Market Harborough, LE87 4NZ (No stamp required)

I want to get my first 3 issues for only £1, then pay £9.50 every three months by Direct Debit for 3 issues of Personal Computer World DVD Edition. (Code V142)

Your details

Title	Initials	Surname
Email		
Address		
		Postcode
Telephone		

Direct Debit details

Instruction to your Bank or Building Society to pay Direct Debits Please fill in and send it to: Personal Computer World, FREEPOST LON14776, Market Harborough, Leics, LE87 4NZ		Originator's Identification number 9 4 2 5 7 9
1. Name and full postal address of your Bank or Building Society branch		
To: The Manager	Bank or Building Society	
Address		Postcode
2. Name(s) of account holder(s)		5. Reference number (for office use only)
3. Branch Sort code		6. Instruction to your Bank or Building Society
(from top right hand corner of your cheque)		Please pay VNU Business Publications Ltd Direct Debits from the account detailed on this instruction subject to the safeguards assured by the Direct Debit Guarantee. I understand that this instruction may remain with VNU Business Publications Ltd and, if so, details will be passed electronically to my Bank or Building Society
4. Bank or Building Society account number		SIGNATURE
		DATE

We will use the details provided by you to contact you about your subscription

- Tick box to receive information about products and services from the VNU Group by email.
 - Tick box to receive information about products and services from selected companies by email.
 - Tick box if you do not want to receive information about products and services from the VNU Group by post/telephone.
 - Tick box if you do not want to receive information about products and services from selected companies by post/telephone.
- Offer available in the UK only - for overseas subscriptions please call +44 (0) 1858 438870 Offer ends 31st May 2006

COMPETITION

WIN! Symantec Norton Internet Security 2006

In these days of phishing attacks, Trojans and viruses, it is essential to keep your computer safe and ready to cope with any eventuality.

Security specialist Symantec has these suggestions to keep your PC safe: use anti-virus software, keep it up to date with the latest virus definitions, and run regular virus scans on all internal and external hard disks. Ensure your computer is set to automatically install key security updates and that it is protected by a firewall.

Finally, to avoid falling victim to identity theft through phishing and spyware, don't provide your personal details without checking who they are going to and don't accept software agreements without reading them first.

We have teamed up with Symantec to give 20 readers the chance to win a copy of Norton Internet Security 2006. This is a full Internet security suite, including Symantec's Norton Antivirus and Norton Personal Firewall, as well

as other key security components, and it comes with 12 months of updates.

Norton Antivirus automatically removes viruses, worms and Trojan programs and can block viruses that are transmitted through instant messaging software. The updates will help ensure the virus killer is kept up to date. The program will also protect your PC against spyware and adware. It includes Norton Personal Firewall, which can help protect against hackers, viruses and spyware. Norton Privacy Control helps ensure your personal data is only sent out to sites you trust. Norton Parental Control blocks access to websites that are unsuitable for children, while Norton Antispam helps detect and filter spam and junk email.

For more information on Symantec and its products visit www.symantec.com, or for your chance to win a copy of the software, just answer the question and return the coupon or enter online at www.pcw.co.uk/competitions.

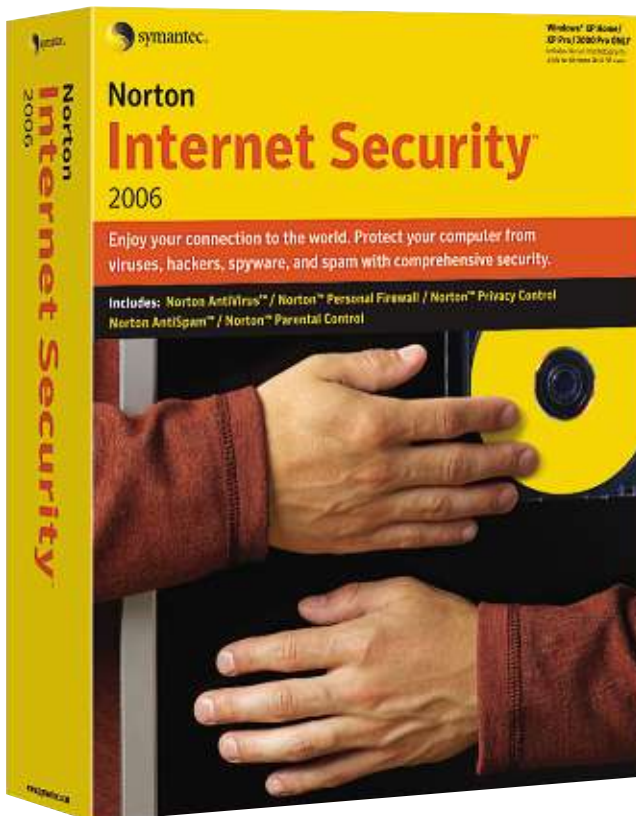

Norton Internet Security 2006 contains a range of useful software to help keep your PC safe

PCW Symantec competition

How to enter

For your chance to win the prize from Symantec, tick the box next to the correct answer to the question below, fill in the coupon and send it to: Symantec competition, PCW, PO Box 10218 Sutton Coldfield, B76 1ZB by the closing date. Or go to

www.pcw.co.uk/competitions and follow the instructions. The competition opens on 16 March and closes on 21 April 2006.

What does Norton Antivirus help protect against?

- a) Hardware failure
b) Overheating
c) Hackers



Name: _____

Address: _____

Post code: _____

Daytime phone no: _____

Email: _____

This competition is open to readers of *PCW*, except for employees (and their families) of VNU Business Publications and Symantec. *PCW* is the sole judge of the competition and the Editor's choice is final. Offer applies to residents of the UK and the Irish Republic only. Entrants must be over the age of 18 and only one entry per household will be accepted. Winners will be selected at random from all correct entries received. No cash alternative is available in lieu of prizes. VNU will use all reasonable endeavours to notify the winner(s) within 14 days of the close of the competition. VNU reserves the right to substitute the prize for one of greater or equal value if circumstances make this unavoidable. Prizes will be dispatched by the competition sponsor(s) and the winner(s) name(s) and address(es) will be provided to the competition sponsor(s) for this purpose. No purchase of the magazine is necessary to enter the competition. VNU will use all reasonable efforts to ensure that the prizes are as described on this page. However, VNU cannot accept any liability in respect of any prize, and any queries regarding a prize should be taken up directly with the sponsor of that prize.

We will use the details provided to contact you regarding this competition. Tick box to receive information about products and services from the VNU Group by email. Tick box to receive information about products and services from selected companies by email. Tick box if you do not want to receive information about products and services from the VNU Group by post/telephone. Tick box if you do not want to receive information about products and services from selected companies by post/telephone.

The winners of the March competition are Sam Knott, who wins a Packard Bell Easynote W3 notebook computer and a copy of King Kong: The Official Game of the Movie. William Barclay, Kate Grellier, Neil Grindley, Indra Bahadur Pun and David Reed win a copy of the King Kong game. Richard Stuart-Grenville wins the Gigabyte upgrade bundle.

On the web

www.pcw.co.uk

PCW is not just a great monthly magazine, we also have a website carrying news, reviews, features, analysis, downloads, competitions and blogs written by us and our sister VNU titles. The website is updated daily, to help keep you abreast of the latest, most important events and new products hitting the market.



The Test Bed

Rapidly developing a cult following, the Test Bed is our labs blog, written by the team who test and review products. It gives you regular updates on the latest gossip, technology trends and products. We also have a performance area, where product test results can be compared so you can see how well rival products fare against each other – no other PC magazine in the UK offers such an interactive service. Our database of products is growing daily, making it the most comprehensive tool you will find and the perfect complement to our new Buyer's Guides and reviews.

→ <http://labs.pcw.co.uk> → <http://www.reportlabs.com/testbed>

PCW Interactive

You may recognise some entries in this blog from our Letters pages, but they're published here first, letting you add your views. The Customer Services section is also very popular. Here you can comment on how manufacturers have performed and if you would recommend them.

→ <http://interactive.pcw.co.uk>

PCW Newsletter

If you want to keep up with the latest news, reviews and software downloads, plus see what's happening in our blogs, then sign up for our free newsletter, sent out every Friday. It's a quick, easy and convenient way of reading the latest from the industry without scouring the Internet.

→ <https://www.vnuservices.co.uk/pcw>

PCW tests and reviews

Our tests and reviews are independent, with no outside influence from manufacturers. Vendors are not allowed to see the results of our tests before publication, ensuring you can completely trust the independence of what you read.

Prices: All prices include VAT unless otherwise stated.

EDITORIAL

Tel 020 7316 9000 Fax 020 7316 9313 www.pcw.co.uk

Group Editor in Chief Dylan Armbrust
Deputy Editor Kelynn Taylor
Associate Editor (News) Clive Akass
Reviews Editor Will Stapley
Group Editorial Assistant Anna Lagerkvist
Editorial contributors Tim Anderson, Chris Cain, Stephen Copstake, Anthony Dhanendran, Barry Fox, Cliff Joseph, Guy Kewney, Gordon Laing, Klaus Langer, Ken McMahon, Paul Monckton, Tim Nott, Jonathan Parkyn, Luke Peters, Paul Rowlingson, Barry Shilliday, Tim Smith, Alan Stevens, Stephen Wells, Leo Waldoock, Mark Whitehorn, Nigel Whitfield

ONLINE EDITORIAL

Online Editor in Chief Rob Jones
Reviews Will Stapley
News Clive Akass
Labs Project Manager Simon Crisp
Production Editor Kathryn Twyford

ART & PRODUCTION

Art Editor Jonathan Ross
Production Editor Debbie Oliver
Deputy Production Editor Kathryn Twyford
Senior Sub Editor Madeleine Kent

Art & Production Contributors Bruce Mackie, Susie Norris, Salvatore Spagnuolo

PUBLISHING

Publishing Director Duncan Tickell
Managing Director & Chief Executive Ruud Bakker
Founder Angelo Zgorelec

To email any PCW staff member use the following:
forename_surname@vnu.co.uk, substituting the person's name as it appears on this page

vnu labs VNU's European Labs fulfil the testing needs of VNU's portfolio of magazines. The labs in London, Amsterdam, Milan, Brussels, Paris, Munich and Madrid provide testing for all VNU's European titles.

MARKETING & CIRCULATION

Group Marketing Manager Timothy Webb
Marketing Executive Kieran Proverbs
Subscriptions Manager Harriet Cumming
Newsstand Manager Emma Smyth
New Media Manager (CD/DVD) Chris Wiles

ADVERTISING

Advertisement Sales Hotline 020 7316 9465
Sales Manager Jonathan Busse 020 7316 9773
Major Client Manager Paul Harvey 020 7316 9465
Client Manager Mark Rankine 020 7316 9305
Sales Executive Shila Shah 020 7316 9144

US Sales Representation Global Media USA LLC, 565 Commercial Street, 4th Floor, San Francisco, CA 94111-3031, USA Tel: 001 415 249 1620 www.vnuglobalmedia.com

European/Asian/Middle East Representation Global Media Europe Ltd, 32-34 Broadwick Street, London, W1A 2HG. Tel 020 7316 9638 www.globalreps.com

Taiwan Sales Representatives TransactionMedia Ltd, 7th floor, Suite 7, 2 Fu Hsing North Road, Taipei, Taiwan 00 886 2 8772 5145. Contacts: Nitin Joshi, Lilly Mao

CENTRAL PRODUCTION

Production Director Joanne Hurst
Production Manager Cathy Mahoney
Production Controller Luke Humphreys

Printed and bound by St Ives (Roche) Ltd
Distributed by Marketforce (UK) Ltd, 5th Floor, Low Rise Building, King's Reach Tower, Stamford Street, London SE1 9LS

93,086
Jan-June 2005

vnu business publications

CUSTOMER SERVICES

Enquiries or complaints regarding any advertiser in this magazine should be emailed to anna_lagerkvist@vnu.co.uk, or sent to: Anna Lagerkvist at 32 Broadwick Street, London, W1A 2HG. Tel: 020 7316 9404

The opinions expressed and results published in connection with reviews and laboratory test reports carried out on computing systems and/or other related items are confined to, and are representative of, only those goods as supplied and should not be construed as a recommendation to purchase.

PCW cannot give technical help/support services, either written or verbal.

REPRINTS & EXTRACTS

We offer a full reprint service for reproduction of all or part of previous articles. For orders, call Natalie Lue on 020 7316 9208. We are happy for people to use quotations and segments for internal or promotional purposes. No material may be reproduced in whole or in part without written consent from the copyright holder. © VNU Business Publications 2006

MAIL ORDER PROTECTION SCHEME (MOPS)

When you order goods as a private individual reader from a UK supplier's advertisement in PCW and pay by post in advance of delivery to that Mail Order Advertiser, which subsequently ceases to trade and goes into liquidation or Bankruptcy prior to delivery of such goods, you may, under the MOPS scheme, qualify for compensation, providing:

1. You have not received the goods or had your money returned.
2. The goods ordered were as depicted/described in a display advertisement.
3. You have taken all reasonable steps to effect delivery or refund.
4. You have retained irrefutable proof of purchase, for verification purposes:

- a) The original advertisement from which the goods were ordered.
- b) Comprehensive proof of payment.

GUIDELINES Claims must be submitted so as to arrive 'NOT EARLIER THAN TWENTY-EIGHT DAYS AND NOT LATER THAN THREE MONTHS' from the official on-sale date of the magazine. Claims must be submitted to Lisa Cook IN WRITING, summarising the situation and lodged strictly within the time schedule stated. Claims received outside this period will not qualify for consideration for compensation under the Mops scheme. Once a supplier who has advertised in this magazine has become subject to either Liquidation or Bankruptcy proceedings and upon completion of all winding-up procedures, PCW guarantees to expeditiously

process those private individual readers' claims made and submitted, in accordance with those procedures outlined, up to the following limits:

- a) £2,000 in respect of any claim submitted by one Private Individual Reader.
- b) £100,000 in respect of all advertisers so affected in any one year.
- c) £30,000 in respect of any one advertiser. These sums define the Publisher's maximum liability under the scheme, and any additional payments above and beyond these thresholds will be entirely at the Publisher's discretion. As soon as legal confirmation that a state of liquidation or bankruptcy exists, the processing of claims will immediately commence. If, however, assets are available and the receiver/liquidator appointed confirms that an eventual payment will be made by way of a dividend, all claims under the Mops scheme will be subject to reprocessing and will take into account any shortfall which may then exist. Payments under the scheme will also take into consideration the obligations and liabilities of other interested parties, such as credit card and/or insurance organisations, etc.

EXCEPTIONS This guarantee only applies to advance postal payments made by private individuals in direct response for goods itemised/illustrated in display advertisements. It does not cover goods ordered from advertising Inserts or Cards, classified advertisements or Micromart, or Catalogues obtained from, or supplied by, any advertiser regardless. Similarly, protection does not exist in relation to purchases made as a result of reviews and/or editorial comment. The Mops

scheme is designed to safeguard the PRIVATE individual reader. It does not provide protection to any companies, societies, organisations, unincorporated bodies or any other commercially orientated outlet of any description. Neither is cover provided for orders placed from, or to, any overseas suppliers or for goods purchased for resale.

CAVEAT EMPTOR Readers are reminded that the Mail Order Protection Scheme was solely implemented to provide protection to the private individual when goods are ordered "Off the Page" and paid for by post. It was not designed for, nor will it offer any protection, in the event whereby goods are purchased via the Internet.

CREDIT CARD PROTECTION Always pay by credit card when ordering goods valued in excess of £100, thereby ensuring maximum protection in the event that an advertiser ceases to trade prior to such goods actually being received.

DISCLAIMERS Readers are reminded that the opinions expressed, and the results published in connection with reviews and/or laboratory test reports carried out on computing systems and/or related items, are confined to, and are representative of, only those goods as supplied and should not be construed as a recommendation to purchase. Whilst every precaution is taken to ensure that reliability and good business practices prevail, the Publisher cannot be held responsible for the overall trading activities of any supplier referred to, or advertising within, this publication.



SUBSCRIPTION ENQUIRIES

Benefits of subscribing

- Save money on the cover price
- Special subscriber discounts on all PCW Reader Offer products
www.direct-pcw.co.uk
- Receive your issue before the on-sale date
- Money-back guarantee – if you're not 100% satisfied with your subscription, we will refund the cost of any unmailed issues – no questions asked

Contact us for information about existing or new subscriptions

Online via our secure website:
www.subscription.co.uk/help/vnu

Email vnu@subscription.co.uk

Tel 01858 438 881

(Weekdays 8am – 9.30pm;
Saturdays 8am – 4pm)

Fax 01858 468 969

Post Personal Computer World, Tower House,
Sovereign Park, Market Harborough,
Leicestershire LE16 9EF

Manage your subscription online

Just visit www.subscription.co.uk/help/vnu for instant access to your subscription account. Use the above email address to check your current subscription – see how many issues you have left, or find out our publication dates.

Personal Computer World, VNU House,
32-34 Broadwick Street, London W1A 2HG

Main switchboard 020 7316 9000

Anna Lagerkvist 020 7316 9852

READERS AND SUBSCRIBERS

Register your email address with us to receive information about PCW special offers. Just visit:
www.vnuserVICES.co.uk/pcw

Personal Computer World

NEXT MONTH

ON SALE 20 APRIL 2006

Office 2007 preview

Microsoft's Office 2007 promises to be the most significant release of its world-dominating office suite for years. Our guided tour will show you exactly why this is the case, and what the implications are for both home and business users.



Go for VoIP

Voice over IP (VoIP) is now firmly entrenched as a great cost-saving technology for phone calls. But how does it all work, what innovations are on the horizon and which are the best services to sign up for? Our in-depth guide to VoIP will explain everything you need to know.

Robotics

Mankind's fascination with robots never seems to wane, and the good news is that these days it's possible to buy or even build your own robot. Our introduction to the world of affordable robotics will show you how technological advances have made it a hobby suitable for almost anyone.



Media Center PCs

Whether or not Intel's Viiv makes waves in the world of Media Center entertainment PCs, it's certain that this type of PC is becoming more and more in demand. To help you find your way through the maze we've rounded up 10 of the best-specified Media Center PC base units you can buy.



**There's lots more in June's PCW
DON'T MISS IT...**

MAY 1991

'The Incredible Shrinking Amstrad' took centre stage on the cover of our 1991 issue as Guy Kewney compared the Amstrad PC4386 and the Ergo Brick, two PCs that were small enough to fit into his briefcase. Although the Brick was the superior computer, our writer felt that at £1,400 it was too pricey to recommend. His preference was the simple Arche Messenger notebook. It was also small but had everything he needed already attached to it, namely a battery, keyboard and screen, keeping things neat and tidy.



From the archives: Take a look at the important events in technology five, 15 and 25 years ago.

Perhaps even more exciting was Geof Wheelwright's interview with Microsoft co-founder, Bill Gates. Flying high at the time as the youngest ever self-made billionaire in the US, he chatted about topics such as Dos, OS/2, Unix, Excel and the future of Microsoft. Full of ideas and ambitions for his ever-expanding company, Gates remained cool, approachable and confident about the future of what was already the most successful software company in the world.

Cyberzone was a virtual reality game show aimed at fans of video game technology. Hosted by Craig Charles of Red Dwarf fame, contestants on mobility stations, wired with pressure pads and armed with gun holsters, competed with each other to control and move their electronic 'borgs' through virtual layouts.

MAY 1981

The cover line 'Picking a Programmer' referring to part nine of the ongoing series 'Secrets of systems analysis'. In this article, Lyn Antill examined the various methods of finding, choosing and managing programmers. Always a difficult task, the options came down to hiring a programmer you could train, calling in a pricier software house with a few more guarantees, or freelancing the work out. But how competent a programmer were you getting? Here, Lyn made it clear

that you must ask the candidate if they fully understand the task and get them to relay it back to you. Logic and technical assessment as well as timescale awareness must also be considered.

This issue's benchtest looked at the Pasca 640, a surprisingly large Japanese micro with integral twin 8in disks. Although it was an all-in-one unit that used a 12in screen, a 2MHz Z80 CPU, 64KB of dynamic Ram and 2KB of EPROM, the steep £3,500 price tag meant that the Pasca wasn't really cost-effective when compared to other Z80-CP/M systems.



MAY 2001

One of the group tests in this issue was notebooks, including desktop replacements and ultraportables. The market was growing stronger, and we tried and tested 24 of the best models. The final winner in the fully featured category was the Elonex Piranha Pro, which had a high level of functionality for its £3,049 price tag. The two bundled docking bays impressed us, as did the 17in monitor and features such as a webcam and CD-RW drive. The ultimate ultraportable was HP's Omnibook 500 as it offered 'the most versatile solutions we [had] seen'.

The exciting world of spreadsheets was also explored in this issue, as our resident Excel guru Stephen Wells trawled through the wonders of cells, macros and formulas. He foresaw that the next generation of spreadsheets would have the ability to converse. Users would talk through the data to be entered and the software would reply with the solutions. We haven't the nerve to ask him why it hasn't happened yet!



Dedicated Servers

Powered by **DELL** hardware and your choice of Linux, Unix or Windows

from
£79
per month
plus VAT



**Dell servers with Xeon processors,
a choice of Linux, Unix or Windows
plus free data transfer**

All dedicated servers include:

- ▶ A choice of Fedora, CentOS, RedHat, Debian, Mandriva, FreeBSD, Solaris or Windows Server 2003
- ▶ Unmetered Data Transfer
- ▶ Secure Private Gigabit LAN
- ▶ Your own IP range
- ▶ Shared Hardware Firewall Protection
- ▶ Unrestricted Administrator Access
- ▶ Install any applications
- ▶ Remote Power Reboot Control
- ▶ 24/7/365 Telephone Support
- ▶ 100% Network Uptime Guarantee
- ▶ The best support in the industry!



Additional options:

- ▶ Full System Tape Backup (Daily, Weekly or Monthly)
- ▶ External USB Storage Device
- ▶ Dedicated Hardware Firewall

*Your server, your way:
Build your custom Dell server at
redstation.com and get an
instant online quote!*

Call 01329 828224
or visit www.redstation.com

redstation[®]
Dedicated Servers for Professionals