

Personal Computer

FIRST BITE OF THE APPLE III

US \$2.00/FF8:80/LIRE 1700/DM 3.80/FL4.00/BF 59
DKr 10.75/SKr 7.65/NKr 10.50/A Sch 28/S Fr 3.50/Pts 135

World JULY 1980 60p

EUROPE'S LEADING MICRO MAGAZINE



GATEWAYS TO LOGIC

Britain's first step-by-step guide to teaching microcomputing

The best computers PLUS the best service

At MicroCentre, we're concentrating our resources on what we genuinely believe are the very best computers available today. . . . Cromemco computers, naturally. This way we can offer you the best deal possible.

What we don't do

What we don't do is spread our expertise thinly amongst umpteen different systems, or try to stock every S100 product on the market. We don't claim to offer "impartial" advice on the best buy. And we don't sell from price lists or catalogues.

The MicroCentre approach

Some micro-computer suppliers work like that, but we don't. Because we realise that when you're buying a computer you want more than the "brochures and boxes" approach. You want to see computers running; to try them out with different software products; to study the documentation; above all, you want expert answers to your most searching questions.

Cromemco specialists

That's why we've specialised in Cromemco systems. Not simply because we think Cromemco systems are the best serious computers available at the price.



MicroCentre's Cromemco demonstration room, with the full range of Cromemco computers, peripherals, operating systems and software products on permanent exhibition. Why not pay us a visit? We're only an hour's Shuttle flight from Heathrow!



Cromemco Model Z-2H hard disc computer. 10 megabyte hard disc, 2 floppy discs, Z-80 computer and 64K memory. MicroCentre price £5,326.

But because by doing so we can dedicate our time, energy and resources to giving you the highest standard of Cromemco support possible.

demonstration; expect the full range of Cromemco peripherals; single-user and multi-user systems; and interactive graphics.

Demonstrations

So when you visit MicroCentre expect to find Cromemco systems on permanent

Software

Expect a choice of operating systems and compilers to evaluate; expect complete documentation; and expect the largest collection of Cromemco systems software in the UK.

Expertise

Expect to find in-depth professional expertise at MicroCentre, the kind that is only acquired by installing Cromemco systems all over Britain. Expect a thorough appreciation of how Cromemco systems can be applied . . . in business, scientific research, industrial engineering, medicine and education.

Support

Expect to get frank, accurate answers to your questions at MicroCentre. Above all, once you've bought a Cromemco system from us, expect to get a very high standard of technical support with your hardware enhancements and continuing software needs.

At MicroCentre, simply expect the best.

For  **Cromemco... call the experts**

**NOW IN SPACIOUS
NEW SHOWROOMS**

Tel. 031-556 7354

MicroCentre

**STILL IN
CENTRAL EDINBURGH**

Complete Micro Systems Ltd., 30 Dundas Street, Edinburgh EH3 6JN

CONTENTS

Volume 3 No 7 July 1980

38 NEWSPRINT: Guy Kewney with this month's news and views.

45 YANKEE DOODLES: Dramatic word on the Apple III — from Tom Williams in California.

46 COMMUNICATION: Readers, in their own write.

48 BENCHTEST: Mike Dennis reviews the Acorn Atom

53 BENCHTEST: Sue Eisenbach reviews the DDE SPC/1.

57 ANIMISTICS: Neil Frude takes us into a future world where computers are cuddly; a special PCW Interrupt.

61 COMPUTER ANSWERS: More questions and answers from Sheridan Williams and his team of consultants.

64 GATEWAYS TO LOGIC: For the first time, a series on the art of teaching others about micros — by Derrick Daines.

70 FACE TO FACE: First of a new series by David Hebditch on life at the man/machine interface.

72 INSTALLATION: Apple and Cream. . . David Tebbutt relates the story.

77 CHECKOUT: High resolution graphics on the Research Machines 380Z.

80 PLOTTING IN THREE DIMENSIONS: Malcolm Banthorpe offers a simple program for evolving 3D representations.

82 SYSTEMS: Mike Knight. . . this month with a second look at Stock Control packages.

85 BEST OF BOTH WORLDS: R M Yorston explains the practicalities of adding a different family of chip to your micro.

91 NETWORK NOTES: David Hebditch again, with a report on the state of his brainchild, the Personal Computer Network.

93 COMPUTER GAMES: Bluffing and psychology — David Levy's instalment for this month.

96 M68000 — MOTOROLA'S SWEET 16: Nicholas Jarmany reports on a forthcoming addition to the new range of 16-bit super micros.

105 BOOKFARE: The politics of IT researched and written by Malcolm Peltu. Malcolm has just been named Technology Writer of the Year (Specialist Section)

109 YOUNG COMPUTER WORLD: Derrick Daines introduces with a cautionary tale.

110 CALCULATOR CORNER: At last, the pocket computer! Dick Pountain Benchtests Sharp's 'little marvel'.

112 MICRO CHESS: Kevin J O'Connell reports events and news from the world of micro chess.

114 DIRECT ACCESS: Featuring IN STORE, TRANSACTION FILE, DIARY DATA.

123 PROGRAMS: Another interesting selection of programs sent in by our readers.

130 LEISURE LINES: J J Clessa does it again — fun for all the family.

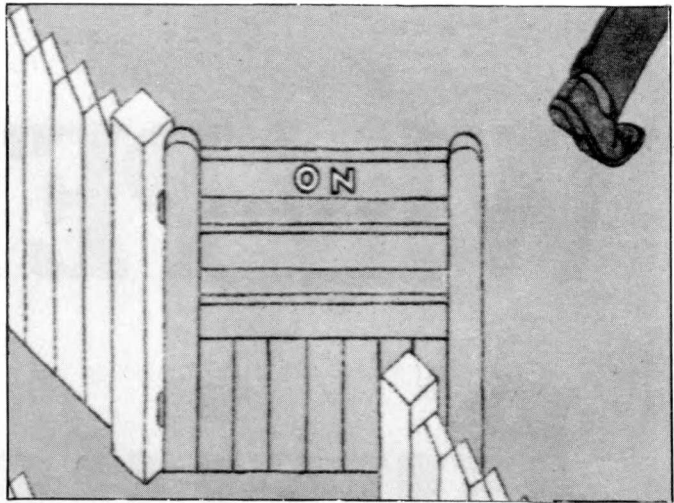

130 BLUNDERS: More of what we don't like to talk about!

167 CHIP CHAT: This month's dirt from the underworld.

Founder
Angelo Zgorelec

Editor
David Tebbutt

Deputy Editor
Peter Rodwell

Executive Editor
Bruce Sawford

Editorial Office:
01-637 7991/2/3

Consultants
John Coll, Mike Dennis,
Michael James, David Hebditch,
Sheridan Williams,
Dr. Adrian Stokes, Dr.
Stephen Castell.

Advertisement Manager
Stephen England
(01-631 1786)

Micomart
Jacquie Hancock
(01-631 1682)

Group Advertising Director
Richard Howell (01-631
3187)

Production Manager
Dick Pountain

Art Director
Paul Carpenter

Art Assistants
Julia Davies,
Jimmy Egerton

Typesetter
Jane Hammell

Cover Illustration
George Hardie

Published by SportsScene Publishers (PCW) Ltd., 14 Rathbone Place, London W1P 1DE, England. Tel: 01-637 7991/2/3. Telex: 8954139 A/B 'Bunch' G. London.

Copyright notice
Personal Computer World is published by SportsScene Publishers (PCW) Ltd. © 1980 Felten Productions. No material may be reproduced in whole or part without written consent from the copyright holders.

Printed by Riverside Press, Whitstable.

PCW welcomes all unsolicited material (written, photographic and illustrative) and although no guarantee can be given as to its safe return, reasonable care and attention will be exercised.

Guidelines for contributors

PCW welcomes articles of interest. Don't be put off if your style of writing is 'under developed'. . . true worth lies in the content, and shaping features comes naturally to us! Manuscripts should not exceed 3,000 words and authors are asked to use triple-spaced lines with a wide left-hand margin; diagrams, listings and/or photographs should be included wherever possible. Please enclose a stamped, self-addressed envelope if you would like your article returned.

Because of the foregoing, it is necessary to add that the views expressed in articles we publish are not necessarily those of Personal Computer World. Overall, however, the magazine will try to represent a balanced viewpoint.

Finally, before submitting an article, please check it through thoroughly for legibility and accuracy.

Why PETSOF Business Softw



WORDCRAFT

WORDCRAFT A true Word Processor for the 32K PET. Wordcraft is a genuine word processing system, easy to understand and use, but containing all the facilities normally found only on more expensive dedicated Word Processors. Features include scrolling in both vertical and horizontal directions (to overcome small screen size), up to 117 characters wide and 98 lines deep for a full page of text. Written entirely in machine code for speed and compactness. Truly the Rolls-Royce of PET Word Processors. Send for brochure. **£325** on CompuThink Disk system.

ACT PURCHASE LEDGER

ACT PURCHASE LEDGER £120
Developed by ACT's own software teams this comprehensive package includes full facilities for the maintenance of the Purchase Ledger, the preparation of a list of outstanding balances and printing of remittance advices. The system produces the following printed results: Audit List, Aged Creditors List, Control Accounts, Purchase Ledger Record, Remittance Advice Cheques and Payments List. For 32K PETs. Full manual supplied. Brochure available on request. **£120** on Commodore Disk. **£95** on Cassette.

ACT SALES LEDGER

ACT SALES LEDGER A powerful system developed to ACT's own high standards. Provides full facilities for maintenance of the Sales Ledger, preparation of a list of outstanding balances and printing of statements. All data including new customer details, invoices, credits, cash and transfers are entered under step by step guidance on the display screen. Printed results include Audit List, Aged Debtors List, Control Accounts and Statements. For 32K PETs. Full manual supplied. Brochure available on request. **£120** on Commodore Disk. **£95** on Cassette.

PAYROLL 200

PAYROLL 200 Comprehensive, easy-to-use package for small businesses with up to 200 employees. Facilities provided include Holiday Pay, Sick Pay, Bonus Payments and two rates of overtime, as well as allowing a 'Standard week' to be specified for each employee. Weekly and monthly summaries are provided and amendments necessary because of a Budget are made very easy. Prints wage slip and coin/note analysis. Tax & NI are computed automatically from knowledge of employees codes. Update service available. Full manual provided. **£50** on Commodore or CompuThink Disk. Cassette system also available at **£25**

STOCK CONTROL

STOCK CONTROL Powerful and flexible stock system with full facilities for recording and control of stock information. An audit listing is automatically printed which itemises all transactions including the entry amendment and deletion of master stock information, issues receipts, allocations purchase orders. Printed reports include Full Stock Control, Stock Valuation, Reordering Report, Audit Listing, The system is highly flexible. **£50** on CompuThink or Commodore Disk.

PETPLAN BUSINESS SIMULATION

PETPLAN BUSINESS SIMULATION
Petplan is a general management business simulation game which is exciting to play. Already it is widely used by colleges and Industrial Trainers to teach the skills needed to run a business. The program creates the model of a manufacturing company; you take the decisions. You will need to hire workers, invest in plant and premises, set advertising budgets and prices. At each stage screen reports (which may be printed out) show the results of decisions as they take effect. 50 page manual and voice guide on cassette. For 32K PETs. **£60** on Cassette.



are No.1 in...

are for the PET



VISICALC PROBLEM SOLVING SOFTWARE Acclaimed by the press as the most outstanding piece of PET software yet written, VisiCalc is a new breed of problem solving software that takes the hard work out of planning, projections and costings. Once your first projection is complete, you are ready to use the powerful recalculation feature. It lets you ask 'What if', examining new options and planning for contingencies. What if sales drop 20% in October? Just type in the sales figures and VisiCalc instantly updates all other figures affected by October sales. Invaluable to businessmen and students alike. Full manual supplied. Available late June. £125 on Commodore Disk.

Petsoft sell more programs in Britain than anyone else, for two simple reasons: **Quality and Value!**

You will find Petsoft programs on sale in more than 200 computer shops throughout the country, and in many more all over the world. We invite you to try them.

If you can't find the program you need, contact us directly. We offer over 200 titles and can supply you directly. We will even take credit card orders over the telephone. Since we normally carry all programs in stock, you won't have long to wait.

Petsoft is backed by the resources of Applied Computer Techniques Ltd., Britain's leading computing group. With over fifteen years experience of developing business software, ACT has a reputation second to none in the industry. That is your guarantee.

If you would like more information on any of the programs mentioned on these pages, clip out the coupon. We will see that a free copy of our complete PET software catalogue reaches you without delay.

PET is the trademark of Commodore.

Plus

Some other PETSFT products described in our catalogue:

Programmers Toolkit £55

Plug-in ROM Chip adds nine useful commands to PET BASIC including RENUMBER, TRACE, DUMP, FIND and APPEND.

Talking Calculator £10

Calculator program with synthetic speech via user port sound generator.

Micro Pools Package £20

A scientific approach to winning the Football Pools, on cassette.

6502 Assembler Tutorial £25

How to program in 6502 Assembly language. On CompuThink or Commodore Disk.

Presto Digitizer £42

Electronic tablet accepts handwritten input for the PET.

User Port Sound Generator £27

for Talking Calculator program, electronic music etc. With volume control.

76 Common Basic Programs £15

Adam Osborne & Associates classic collection of financial and mathematical programs on cassette.



Radclyffe House, 66-68 Hagley Road
Edgbaston, Birmingham B16 8PF
Tel: 021-455 8585 Telex: 339396 ACTNET

ACT Petsoft

Please rush a FREE copy of the latest Petsoft catalogue to:

Name:
Address:
Postcode:
I have an 8K PET
 16K PET
 32K PET
 No PET yet

TANDY

ANOTHER BREAKTHROUGH



5 FIGURE COMPUTING POWER AT A 4 FIGURE PRICE!

COMPLETE SYSTEMS FROM

£1999

(Plus V.A.T.) Delivery 30-60 Days

- * Built-in 1/2 Megabyte 8" Floppy Disk
- * 32 or 64k Random Access Memory
- * 12" High Resolution Video Monitor
- * 24 Lines of 80 or 40 (wide) characters
- * Upper/Lower Case
- * Two RS-232C Serial Interface Ports
- * "Power-Up" Self Testing
- * One Centronics Parallel Interface Port
- * Two Programmable Special Function Keys
- * Direct Memory Access
- * Vector Driven Interrupts
- * Full 4 Megahertz operating speed
- * Provisions for plug-in Expansion Boards

We've added a bigger, more powerful "brother" to the TRS-80 family. It's TRS-80 Model II - a completely new microcomputer whose capabilities begin where TRS-80 Model I approaches upper limits. Model II operates at twice Model I's speed, but it's not intended to replace - or compete with - the original TRS-80. It is designed specifically for the user who needs more data storage and versatility. Model II uses the enhanced Level III version of TRS-80's Level II BASIC and 27k Disk Operating System - automatically loaded into memory. System software is on diskette so future languages will permit maximum use of available memory. Operation is easy and requires no special training when our applications software is used. And like its little brother, Model II is completely modular, allowing easy-plug-in expansion. Listed above are some of Model II's sensational capabilities. See your nearest Tandy store or Computer Center for details. Discover how 5-figure computing - at a 4-figure price - can benefit you!

32k, 1-Disk TRS-80 Model II. 26-4001

£2298.85*

64k, 1-Disk TRS-80 Model II. 26-4002

£2586.35*

32k Memory Board. 26-4102

£343.85*

THE EXPANDABLE TRS-80 MODEL II SYSTEM



Like TRS-80

Model I, Model II systems are expandable to meet changing - or growing - needs. Three expansion connectors (one parallel and two serial) allow you to connect printers, plotters, digitizers, telephone communications and many other external devices. Internal plug-in card slots allow for more expansion and enhancement options in the future... several are in the planning stages now.

Model II comes with a disk containing our expanded Level III BASIC programming language and our all-new command-compatible 'TRSDOS' operating system. This "system software" will be upgraded periodically with new features, and we plan to offer additional programming languages for Model II in the future.

Complete Model II packages can include up to 2 Megabyte Disk storage, advanced line printer for hard copy, system disk and more... 1/2 Megabyte System illustrated includes 26-4002, 26-4161, 26-4301, 26-1156

£5,433.60*

*These prices are inclusive of V.A.T.

TRS-80 CENTRE

NEW COMPUTER CENTERS OPEN!



THE BIG NAME CENTRES FOR LITTLE COMPUTERS

Tandy are opening specialist TRS-80 micro-computer centers the length and breadth of Britain - many are already open and new ones will be appearing all the time. So you'll be able to drop in and experiment with the TRS-80 range, discuss your needs with a TRS-80 expert and buy one over-the-counter. Each store will be backed by a service engineer to iron out any problems you may encounter when commissioning your system.

SHORT TEACHING COURSES

Every TRS-80 Computer Center has its own classroom where inexpensive practical short courses in TRS-80 use and programming take place regularly. Anybody can use a TRS-80 the courses are designed to prove it - fast.

- Level 1 Basic Course - 1 day
- Level 2 Basic Course - 2 days
- Level 3 (TRS-Disc operating system) - 2 days

TRS-80 COMPUTER CENTRES NOW OPEN AT:-

BIRMINGHAM, Edgbaston Shopping Precinct, Hagley Road, **BRADFORD**, 2/4 Forster Square, **BRISTOL**, Colston Centre, Colston Avenue, **MANCHESTER**, 30 Market Place, Deansgate, **SOUTHAMPTON**, East Street Centre.

NEW COMPUTER CENTRE/ AUDIO SUPERSTORES NOW OPEN AT:

DOWNEND, 5 Badminton Road, Downend, Bristol, **HENDON**, 21 Sentinel Square, Brent St., London NW4, **LEEDS**, 72 Merrion Centre, **LIVERPOOL**, 168 Market Way, St. John's Centre, **LONDON**, 1-2 Seacoal Lane, Ludgate Hill, London EC4, **WEDNESBURY**, Bilston Road, **WIMBLEDON**, 124-126 The Broadway, London SW19.

OVER 180 STORES AND DEALERSHIPS NATIONWIDE.

KNOWN AS RADIO SHACK IN U.S.A. MAKERS OF THE WORLD'S BIGGEST SELLING MICROCOMPUTER TRS-80.

THE WORLD'S BIGGEST SELLING MICROCOMPUTER

TRS-80 MODEL 1 FOR BUSINESS, LEARNING & ENTERTAINMENT

4K LEVEL I
£385.25
26-1001

16K LEVEL II
£559.95
26-1006 (with green screen monitor)

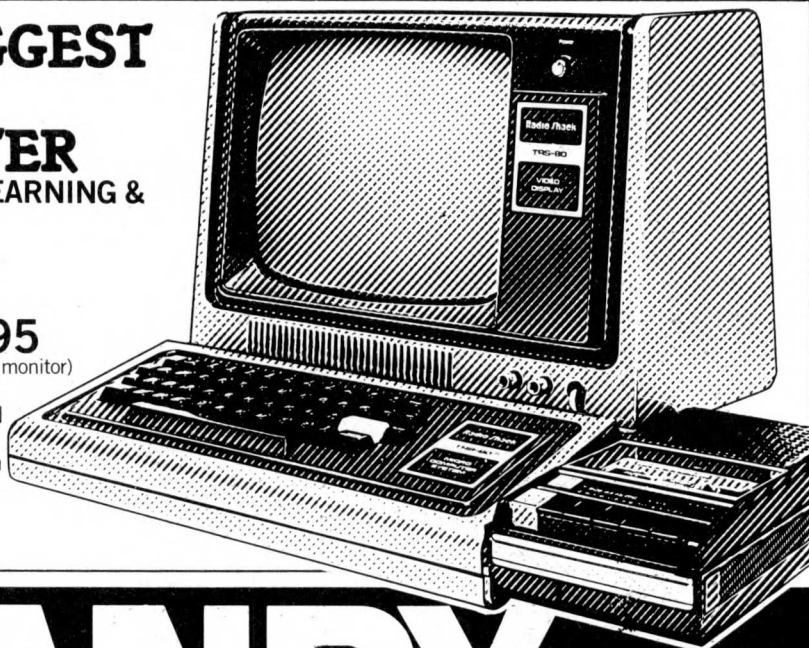

Two years ago Tandy introduced the TRS-80, the wired, tested and ready-to-run computer that more people have bought than any other single computer. It has proven ideal for uses in school, business, lab and home, where a large computer is impractical.

Now available with new improved video monitor!

TANDY
DEALER

TANDY

THE BIGGEST
NAME IN LITTLE
COMPUTERS

Most items also available at Tandy Dealers.
Look for this sign in your area.
Prices may vary at individual stores.

Offers subject to availability.
Instant credit available in most cases.



Access, Barclaycard and Trustcard welcome.
Check your telephone directory for your nearest store.

Gourmet Goodies

Super software from the world's leading microsoftware supplier.

	Software with Manual	Manual Alone	
DIGITAL RESEARCH			
<input type="checkbox"/> CP/M* FDOS — Diskette Operating System complete with Text Editor, Assembler, Debugger, File Manager and system utilities. Available for wide variety of disk system including North Star, Helios II, Micropolis, ICOM (all systems) and Altair. Supports computers such as Sorcerer, Horizon, Cromemco, Ohio Scientific, RAIR Black Box, Research Machines, Dynabyte, etc.	£75/£15		
<input type="checkbox"/> CP/M version 2 (not all formats available immediately)	£95/£15		
<input type="checkbox"/> MP M	£195/£25		
<input type="checkbox"/> MAC — 8080 Macro Assembler. Full Intel macro definitions. Pseudo Ops include RPC, IRP, REPT, TITLE, PAGE, and MACLIB. Z-80 library included. Produces Intel absolute hex output plus symbols file for use by SID (see below)	£55/£10		
<input type="checkbox"/> SID — 8080 symbolic debugger. Full trace, pass count and break-point program testing system with back-trace and histogram utilities. When used with MAC, provides full symbolic display of memory labels and equated values	£45/£10		
<input type="checkbox"/> ZSID Includes Z80 mnemonics, requires Z80 CPU	£50/£10		
<input type="checkbox"/> TEX — Text formatter to create paginated, page-numbered and justified copy from source text files, directable to disk or printer	£45/£10		
<input type="checkbox"/> DESPOOL — Program to permit simultaneous printing of data from disk while user executes another program from the console	£30/£1		
MICROSOFT			
<input type="checkbox"/> BASIC-80 — Disk Extended BASIC Interpreter Version 5, ANSI compatible with long variable names, WHILE/WEND, chaining, variable length file records	£155/£15		
<input type="checkbox"/> BASIC Compiler — Language compatible with Version 5 Microsoft interpreter and 3-10 times faster execution. Produces standard Microsoft relocatable binary output. Includes Macro-80. Also linkable to FORTRAN-80 or COBOL-80 code modules	£195/£15		
<input type="checkbox"/> FORTRAN-80 — ANSI '66 (except for COMPLEX) plus many extensions. Includes relocatable object compiler, linking loader, library with manager. Also includes MACRO-80 (see below)	£205/£15		
<input type="checkbox"/> COBOL-80 — ANSI '74 Relocatable object output. Format same as FORTRAN-80 and MACRO-80 modules. Complete ISAM. Interactive ACCEPT DISPLAY, COPY, EXTEND	£325/£15		
<input type="checkbox"/> MACRO-80 — 8080/Z80 Macro Assembler. Intel and Zilog mnemonics supported. Relocatable linkable output. Loader, Library Manager and Cross Reference List utilities included	£75/£10		
<input type="checkbox"/> XMACRO-86 — 8086 cross assembler. All Macro and utility features of MACRO-80 package. Mnemonics slightly modified from Intel ASM86. Compatibility data sheet available	£155/£15		
<input type="checkbox"/> EDIT-80 — Very fast random access text editor for text with or without line numbers. Global and intra-line commands supported. File compare utility included	£45/£10		
EIDOS SYSTEMS			
<input type="checkbox"/> KISS — Keyed Index Sequential Search. Offers complete Multi-Keyed Index Sequential and Direct Access file management. Includes built-in utility functions for 16 or 32 bit arithmetic, string/integer conversion and string compare. Delivered as a relocatable linkable module in Microsoft format for use with FORTRAN-80 or COBOL-80 etc	£190/£15		
<input type="checkbox"/> KBASIC — Microsoft Disk Extended BASIC with all KISS facilities, integrated by implementation of nine additional commands in language. Package includes KISS REL as described above, and a sample mail list program	£295/£25		
To licensed users of Microsoft BASIC-80 (M BASIC)	£215/£25		
MICROPRO			
<input type="checkbox"/> SUPER-SORT 1 — Sort, merge, extract utility as absolute executable program or linkable module in Microsoft format. Sorts fixed or variable records with data in binary, BCD, Packed Decimal, EBCDIC, ASCII, floating, fixed point, exponential, field justified, etc. etc. Even variable number of fields per record!	£125/£15		
<input type="checkbox"/> SUPER-SORT II — Above available as absolute program only	£105/£15		
<input type="checkbox"/> SUPER-SORT III — As II without SELECT/EXCLUDE	£75/£15		
<input type="checkbox"/> WORD-MASTER Text Editor — In one mode has super-set of CP/M's ED commands including global searching and replacing, forward and backwards in file. In video-mode, provides full screen editor for users with serial addressable-cursor terminal	£75/£15		
<input type="checkbox"/> WORD-STAR — Menu driven visual word processing system for use with standard terminals. Text formatting performed on screen. Facilities for text paginate, page number, justify, center, underscore and PRINT. Edit facilities include global search and replace, read/write to other text files, block move, etc. Requires CRT terminal with addressable cursor positioning	£255/£15		
GRAFFCOM			
<input type="checkbox"/> PAYROLL — Designed in conjunction with the spec for PAYE routines by HMI Taxes. Processes up to 250 employees on weekly or monthly basis. Can handle cash, cheque or bank transfer payments plus total tracking of all year to date figures. Prints emp master, payroll log, payslips and bank giro. Requires CBASIC-2	£475/£15		
<input type="checkbox"/> COMPANY SALES — Performs sales accounting function. Controls payments of invoices and prints sales ledger and aged debtors report. Suitable for any accounting period. Comprehensive VAT control and analysis of all sales invoices. Requires CBASIC-2	£425/£15		
<input type="checkbox"/> COMPANY PURCHASES — Performs purchase accounting function. Controls invoices, credit & debit notes. Prints purchase ledger, aged creditors report and payment advices. Comprehensive VAT control and analysis of all purchases. Interfaces with the NAD system. Requires CBASIC-2	£425/£15		
<input type="checkbox"/> GENERAL ACCOUNTING — Produces Nominal Ledger, Trial Balance, P/L and Balance Sheet. Define your own coding system. Interactive data entry plus optional data capture from Company Sales and Company Purchases. Requires CBASIC-2	£375/£15		
STOCK CONTROL			
<input type="checkbox"/> Maintains stock records, monitors stock levels to ensure optimum stock holding. Details include stock desc., product code, unit, unit price, quantity on hand on order/minimum. Stock analysis reports can be weekly, monthly, quarterly etc. Interfaces with Order Entry Invoicing system. Requires CBASIC-2	£325/£15		
ORDER ENTRY & INVOICING			
<input type="checkbox"/> Performs order entry and invoicing function. Handles invoices for services and consumable items, part orders and part quantities. Sales Analysis report shows sales movements and trends for user-defined period Interfaces with Stock Control, ADD and Company Sales systems. Requires CBASIC-2	£325/£15		
<input type="checkbox"/> ADD — Complete control of all your names & addresses including suppliers, clients, enquiries etc. Assign your own coding system and select all output via the report generator. Will print anything from mailing labels to directories. Requires CBASIC-2	£225/£12		
COMPLETE ACCOUNTING PACKAGE — Combined Company Sales, Company Purchases, General Accounting, and ADD systems			£950/£45
SALES ORDER PROCESSING PACKAGE — Combined Stock Control, Order Entry and Invoicing and NAD systems			£550/£30
STRUCTURED SYSTEMS GROUP			
<input type="checkbox"/> ANALYST — Customised data entry and reporting system. User specifies up to 75 data items per record. Interactive data entry, retrieval and update facility makes information management easy. Sophisticated report generator provides customised reports using selected records with multiple level breakpoints for summarisation. Requires CBASIC-2, 24 x 80 CRT, printer and 48K system	£125/£10		
<input type="checkbox"/> LETTERRIGHT — Program to create edit and type letters or other documents. Has facilities to enter, display, delete and move text, with good video screen presentation. Designed to integrate with NAD for form letter mailings. Requires CBASIC-2	£105/£15		
<input type="checkbox"/> NAD Name and Address selection system — interactive mail list creation and maintenance program with output as full reports with reference data or restricted information for mail labels. Transfer system for extraction and transfer of selected records to create new files. Requires CBASIC-2	£45/£12		
<input type="checkbox"/> QSORT — Fast soft/merge program for files with fixed record length, variable field length information. Up to five ascending or descending keys. Full back-up of input files created	£50/£12		
SOFTWARE SYSTEMS			
<input type="checkbox"/> CBASIC-2 Disk Extended BASIC — Non-interactive BASIC with pseudo-code compiler and runtime interpreter. Supports full file control, chaining, integer and extended precision variables etc.	£75/£10		
MICRO FOCUS			
<input type="checkbox"/> STANDARD CIS COBOL — ANSI '74 COBOL standard compiler fully validated by U.S. Navy tests to ANSI level 1. Supports many features to level 2 including dynamic loading of COBOL modules and a full ISAM file facility. Also, program segmentation, interactive debug and powerful interactive extensions to support protected and unprotected CRT screen formatting from COBOL programs used with any dumb terminal	£400/£25		
<input type="checkbox"/> FORMS 2 — CRT screen editor. Automatically creates a query and update program of indexed files using CRT protected and unprotected screen formats. Output is COBOL data descriptions for copying into CIS COBOL programs. No programming experience needed. Output program directly compiled by CIS COBOL (standard)	£100/£12		
MICRO DATA BASE SYSTEMS			
<input type="checkbox"/> HDBS — Hierarchical Data Base System. CODASYL orientated with FILES, SETS, RECORDS and ITEMS which are all user defined. ADD, DELETE, UPDATE, SEARCH, and TRAVERSE commands supported. SET or FILE is sorted, FIFO, LIFO, next to prior. One to many set relationship supported. Read/Write protection at the FILE level. Support FILES which extend over multiple floppy or hard disk devices.			
<input type="checkbox"/> MDBS — Micro Data Base System. Full network data base with all features of HDBS plus multi-level Read/Write protection for FILE, SET, RECORD and ITEM. Implicit representation of one to one SET relationships. Supports multiple owner and multiple record types within SETS. HDBS files are fully compatible.			
<input type="checkbox"/> MDBS-DRS — MDBS with Dynamic Restructuring System option which allows altering MDBS data bases when new ITEMS, RECORDS, or SETS are needed without changing existing data.			
HDBS-Z80 version	£135/£25		
MDBS-Z80 version	£395/£25		
MDBS-DRS-Z80 version	£455/£25		
8080 Version available at £45 extra			
Z80 version requires 20K RAM. 8080 version requires 24K RAM. (Memory requirements are additional to CP/M and application program.)			
When ordering HDBS or MDBS please specify if the version required is for 1) Microsoft L80 i.e. FORTRAN-80, COBOL-80, BASIC COMPILER, 2) MBASIC 4, XX, or 3) BASIC-80 5.0.			

Software for most popular 8080/Z80 computer disk systems including
**NORTH STAR HORIZON, VECTOR MZ, OHIO SCIENTIFIC,
 CROMEMCO, PROCESSOR TECHNOLOGY, RAIK BLACK BOX,
 DYNABYTE, SD SYSTEMS, RESEARCH MACHINES, ALTAIR,
 EXIDY SORCERER, IMSAI, HEATH, and 8" IBM formats**

- OTHER**
- Software with Manual / Manual Alone
- PASCAL/M** — Compiler generates P code from extended language implementation of standard PASCAL. Supports overlay structure through additional procedures and the SEGMENT procedure type. Provides convenient string handling capability with the added variable type STRING. Untyped files allow memory image I/O. Requires 56K CP/M £195/£20
 - PASCALZ** — Z80 native code PASCAL compiler. Produces optimised portable reentrant code. All interfacing to CP/M is through the support library. The package includes compiler companion macro assembler and source for the library. Requires 56K and Z80 CPU. Version 2 includes all of Jensen/Wirth except variant records £155/£15
 - Version 3 Upgrade with variant records and strings expected 2/80 £205/£15
 - PASCAL/MT** — Subset of standard PASCAL. Generates ROMable 8080 machine code. Symbolic debugger included. Supports interrupt procedures, CP/M file I/O and assembly language interface. Real variables can be BCD, software floating point, or AMD 9511 hardware floating point. Version 3 includes Sets, Enumeration and Record data types. Manual explains BASIC to PASCAL conversion. Source for the run time package requires MAC (See under Digital Research). Requires 32K £135/£20
 - TINY C** — interactive interpretive system for teaching structured programming techniques. Manual includes full source listings £45/£30
 - BDS C COMPILER** — Supports most major features of language, including Structures, Arrays, Pointers, recursive function evaluation, linkable with library to 8080 binary output. Lacks data initialization, long & float type and static & register class specifiers. Documentation includes "C" Programming Language book by Kernighan & Ritchie £60/£10
 - WHITESMITHS' C COMPILER** — The ultimate in systems software tools. Produces faster code than Pascal with more extensive facilities. Conforms to the full UNIX Version 7 C language, described by Kernighan and Ritchie, and makes available over 75 functions for performing I/O, string manipulation and storage allocation. Compiler output in A-Natural source. Supplied with A-Natural. Requires 60K CP/M £325/£20
 - POLYVUE/80** — Full screen editor for any CRT with XY cursor positioning. Includes vertical and horizontal scrolling, interactive search and replace, automatic text wrap around for word processing, operations for manipulating blocks of text, and comprehensive 70 page manual £70/£12
 - POLYTEXT/80** — Text formatter for word processing applications. Justifies and paginates source text files. Will generate form letters with custom fields and conditional processing. Support for Daisy Wheel printers includes variable pitch justification and motion optimization £45/£10
 - ALGOL 60 Compiler** — Powerful block-structured language featuring economical run time dynamic allocation of memory. Very compact (24K total RAM) system implementing almost all Algol 60 report features plus many powerful extensions including string handling, direct disk address I/O etc. Requires Z80 CPU £110/£12
 - Z80 Development Package** — Consists of (1) disk file line editor, with global inter and intra-line facilities; (2) Z80 relocating assembler, Zilog Mostek mnemonics, conditional assembly and cross reference table capabilities; (3) linking loader producing absolute Intel hex disk file for CP/M LOAD, DDT or SID facilities £50/£12
 - ZDT** — Z80 Debugger to trace, break and examine registers with standard Zilog/Mostek mnemonic disassembly displays. Facilities similar to DDT £20 when ordered with Z80 Development Package £30/£7
 - DISTEL** — Disk based disassembler to Intel 8080 or TDL/Xitan Z80 source code, listing and cross reference files. Intel or TDL Xitan pseudo ops optional. Runs on 8080 £35/£7
 - DISILOG** — As Distel to Zilog Mostek mnemonic files. Runs on Z80 only £35/£7
 - TEXTWRITER III** — Text formatter to justify and paginate letters and other documents. Special features include insertion of text during execution from other disk files or console, permitting recipe documents to be created from linked fragments on other files. Has facilities for sorted index, table of contents and footnote insertion. Ideal for contracts manuals, etc. £75/£3
 - POSTMASTER** — A comprehensive package for mail list maintenance that is completely menu driven. Features included keyed record extraction, and production. A form letter program is included which produces neat letters on single sheet or continuous forms. Compatible with NAD files. Requires CBASIC-2 £85/£10
 - XASM-68** — Non-macro cross-assembler with nested conditionals and full range pseudo operations. Assembles from standard Motorola MCS-68 mnemonics to intel hex £115/£15
 - XASM-65** — As XASM-68 for MOS Technology MCS-6500 series mnemonics £115/£15
 - WHATSIT?** — Interactive data-base system using associative tags to retrieve information by subject. Hashing and random access used for fast response. Requires CBASIC £70/£15
 - XYBASIC** Interactive Process Control BASIC — Full disk BASIC features plus unique commands to handle bytes, rotate and shift, and to test and set bits. Available in integer, Extended and ROMable versions.
Integer Disk or Integer ROMable £165/£15
Extended Disk or Extended ROMable £215/£15
 - SMAL/80** Structured Macro Assembly Language — Package of powerful general purpose text macro processor and SMAL structured language compiler. SMAL is an assembler language with IF-THEN-ELSE, LOOP-REPEAT-WHILE, DO-END, BEGIN-END constructs £40/£10

- Software with Manual / Manual Alone
- SELECTOR III-C2** — Data Base Processor to create and maintain multi Key data bases. Prints formatted, sorted reports with numerical summaries or mailing labels. Comes with sample applications including Sales Activity, Inventory, Payables, Receivables, Check Register, and Client/Patient Appointments, etc. Requires CBASIC Version 2. Supplied in source code £185/£12
 - CPM/374X Utility Package** — has full range of functions to create or re-name an IBM 3741 volume, display directory information and edit the data set contents. Provides full file transfer facilities between 3741 volume data sets and CP/M files £125/£7
 - BASIC UTILITY DISK** — Consists of (1) CRUNCH-14 Compacting utility to reduce the size and increase the speed of programs in Microsoft Basic and TRS-80 Basic. (2) DPFUN — Double precision subroutines for computing nineteen transcendental functions including square root, natural log, log base 10, sin, arc sin, hyperbolic sin, hyperbolic arc sin, etc. Furnished in source on diskette and documentation £30/£10
 - THE STRING BIT** — Fortran character string handling. Routines to find, fill, pack, move, separate, concatenate and compare character strings. This package completely eliminates the problems associated with character string handling in FORTRAN. Supplied with source £30/£10
 - BSTAM** — Utility to link one computer to another also equipped with BSTAM. Allows file transfers at full data speed (no conversion to hex), with CRC block control check for very reliable error detection and automatic retry. We use it! It's great! Full wildcard expansions to send *.COM, etc. 9600 baud with wire, 300 baud with phone connection. Both ends need one. Standard and M versions can talk to one another £75/£5
 - STRING/80** — Character string handling plus routines for direct CP/M BDOS calls from FORTRAN and other compatible Microsoft languages. The utility library contains routines that enable programmes to chain to *.COM file, retrieve command line parameters, and search file directories with full wild card facilities. Supplied as linkable modules in Microsoft format £50/£12
 - STRING/80** source code available separately £185/n.a.
 - VSORT** — Versatile sort/merge system for fixed length records with fixed or variable length fields. VSORT can be used as a stand-alone package or loaded and called as a subroutine from CBASIC-2. When used as a subroutine VSORT maximizes the use of buffer space by saving the TPA on disk and restoring it on completion of sorting. Records may be up to 255 bytes long with a maximum of 5 fields. Upper/lower case translation and numeric fields supported £105/£15
 - CBS** — Configurable Business System is a comprehensive set of programmes for defining custom data files and application systems without using programming language such as BASIC, FORTRAN, etc. Multiple key fields for each data file are supported. Set-up program optimizes system to user's CRT and printer. Provides fast and easy interactive data entry and retrieval with transaction processing. Report generator program does complex calculations with stored and derived data, record selection with multiple criteria, and custom formats. Sample inventory and mailing list system included. No support language required £185/15

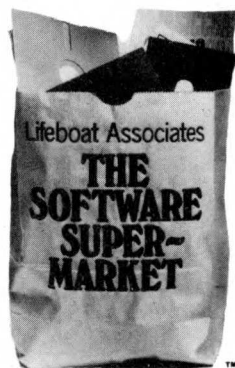

Orders must specify disk type and format, e.g. North Star-Horizon single density.

Add VAT to orders for software (not manuals alone) Add 50p per item postage and packing (minimum £1)

All orders must be prepaid (except COD or credit card) Make cheques POs etc payable to Lifeboat Associates.

Manual costs are deductible from subsequent software purchase

Lifeboat Associates
 32 Neal Street
 London WC2H 9PS
 01-379 7931

Modified version available for use with CP/M as implemented on Heath and TRS-80 Model 1 computers.

User license agreement for this product must be signed and returned to Lifeboat Associates before shipment may be made.

*CP/M is a trademark of Digital Research

**Z80 is a trademark of Zilog Inc.

The Software Supermarket is a trademark of Lifeboat Associates.

EFFECTIVE MARCH 1980

POWERFUL MICROS AT THE RIGHT PRICE

- Multi-User ● Multi-Tasking
- Multi-Language ● Hard Disc Storage ● Word Processing
- Priced from under £5000

Languages supported include – Basic, Cobol, Fortran.
OEM, Educational and Dealer enquiries invited

EQUINOX

COMPUTER SYSTEMS LIMITED
Kleman House, 16 Anning Street
New Inn Yard, London EC2A 3HB
Tel: 01-739 2387 & 01-729 4460

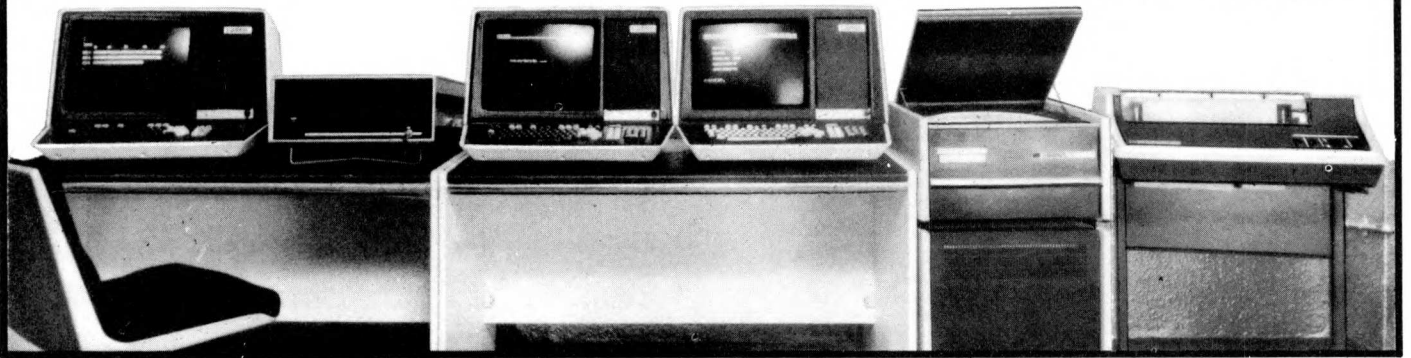

Reconditioned Olivetti Printers incl. paper tape reader/punch and VDUs — Newbury Labs 7000 Series Honeywell keyboards alone

175
385
35

DDM HOBBY CORNER

DDM MICROCOMPUTING

DDM DIRECT DATA MARKETING 44 High Street, Brentwood, Essex CM14 4AJ. Tel: (0277) 229379

230480
230562

Apple

725
815
695
795
840

Microsense Apple
Apple II 16K
Apple II 32K
Disk Drive with Controller
Disk Drive without Controller

165

New Apple Software
Payroll, Stock Control and Comprehensive Accounting Systems.

695
764
833
349
299

OPENING ADDITIONAL SHOWROOM PREMISES IMMINENTLY — PHONE FOR DETAILS

SEND DIRECT TO DDM FOR PRODUCT LISTS & FURTHER DETAILS.

DDM POSTAL

NAME _____
COMPANY _____
ADDRESS _____
PHONE _____
CURRENT MICRO _____
PRODUCT INTEREST _____

Printers **IBM**

450 Digital LA34 Decwriter
550 Digital LA34 Decwriter with tractor feed
695 **PET Growth Products**
525 Disk Systems
35 Pet 3040 Dual Drives
20 Computrunk Dual Drives
55 400 (Old Rom)
800 (New Rom)
Interfaces
DDM's IEEE to RS232 bidirectional interface

Commodore Pet **C**

Commodore Pet
Pet 2001-8
Pet 2001-16N
Pet 2001-32N
Pet 3022 tractor/fed printer
IEEE to Pet Connector
IEEE to IEEE Connector
C2N Cassette Deck

Commodore Business Software
Business Information, A/Cs, Word Processing
Payroll and Mailing Systems.

Full product list available on application — please return the coupon for more details.

ALL PRICES EX. VAT.

the software house

146 OXFORD STREET, LONDON W.1.

To Order simply photostat this page & circle items required and send with your remittance. ALL PRICES INCLUDE 15% VAT where applicable.

PLEASE SEND THE FOLLOWING PROGRAMS FOR MY MICROCOMPUTER:—

APPLE (I = Integer A = Applesoft)

APPLETALKER (I)	£15.00
APPLE LIS'NER (I)	£15.00
CITY MANAGER (A)	£ 9.00
STARWARS + SPACEMAZE	£ 9.00
APPLE 21 (I)	£ 9.00
MICROCHESS TAPE	£12.00
MICROCHESS DISC	£16.50
BRIDGE CHALLENGER (I)	£12.00
DOS 3.2 TUTOR (A)	£34.50
MAIL LIST/LABEL (A)	£57.50
STOCK CONTROL (A)	£80.50
VISICALC	£109.00
AIMS DATA BASE (A)	£140.00
DATA BASE UTILITY (A)	£50.00
FORTH	£40.00
LISP	£34.50
L. GENIUS APPLESOFT	£46.00
L. ADVANCED APPLESOFT	£46.00
KNOW YOURSELF	£ 6.00
SPACE GAMES	£ 6.00
SPORTS GAMES	£ 6.00
STRATEGY GAMES	£ 6.00
CAI PROGRAMS	£ 6.00
SPACE INVADERS	£12.00
APPLE INVADERS	£13.80
CONTRIBUTED V3/5	£69.00
REFERENCE MANUAL	£11.00
HIRES CHAR. GENERATOR	£19.00
SHAPE BUILDER	£19.50
MASTER CATALOGUE	£16.00
STATISTICS	£23.00
DATESTONES OF RYN	£15.00
TEMPLES OF AP SHAI	£26.00
WIZARDS MOUNTAIN	£ 9.00
RELOCATED INTEGER (A)	£14.00

FOR APPLE/TRS 80 and SORCERER ADVENTURE!!!

ADVENTURELAND	£10.00
PIRATE ADVENTURE	£10.00
MISSION IMPOSSIBLE	£10.00
VOODOO CASTLE	£10.00
THE COUNT	£10.00
STRANGE ODYSSEY	£10.00
MYSTERY FUN HOUSE	£10.00
PYRAMID OF DOOM	£10.00

FOR APPLE OR TRS80

* SORCERERS CASTLE	£ 8.50
* KING TUT'S TOMB	£ 8.50
* HOUSE OF 7 GABLES	£ 8.50
* JOURNEY/CENTRE OF EARTH	£ 8.50
(ALL 4 above on disk for)	£28.00
ENCHANTED ISLE	£ 8.50
ATLANTIS	£ 8.50

TRS80

ANDROID NIM	£ 9.00
BEE WARY!	£ 9.00
LIFETWO	£ 9.00
SNAKE EGGS	£ 9.00
THE GREAT RACE	£ 5.00
LYING CHIMPS	£ 5.00
OWL TREE	£ 5.00
TRS80 OPERA	£ 5.00
NEWDOS +	£49.50
MTREK	£ 8.00

PET

ENLARGE (DISPLAY)	£ 6.00
TIME TREK	£12.00
DUCKSHOOT	£ 5.00

This is just a selection from our software range — we have the widest range of software and are adding new items daily. Send for our FREE catalogue.

NEW — APPLE UTILITIES DISC — single disc copy, patch zap etc. £19.50.

BUSINESS APPLICATIONS CONSULTANCY: we can offer help & advice — we specialise in the APPLE/ITT and offer tailored programs, complete systems and advice.

Send for details of our unique PROGRAMMERS COURSE & WORKSHOP (APPLE).

We also distribute the 80-US JOURNAL — a SUPERB magazine for the TRS80 £14.00 p.a.

Programs are in development for the SHARP and most popular micros.

If you don't see what you require — please ask — we regularly import the latest programs from most sources.

NAME.....

MICROCOMPUTER.....

ADDRESS.....

TOTAL FOR PROGRAMS £

(orders under £15.00 p&p 50p)

Cheque/P. Order/Cash enclosed.....

For 80-US subscription tick here

Items over £20.00 in value are sent by recorded delivery.

We welcome outside programs — our standard royalty is 15%.

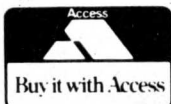

The Softwarehouse is next door to OXFORD WALK (between Oxford Circus and Tottenham Court Road) and is open Monday to Friday 9.30 am to 5.30 pm

TCL PASCAL

Standard PASCAL
with P-code interpreter and linker,
following the ISO/BSI working draft.
Compiler operates in two modes:

Resident in RAM—makes
PASCAL as easy to learn as BASIC

Disc mode—with full set of
PASCAL commands.

Many enhancements to standard
PASCAL. Fully validated. Runs in
32K of RAM.

- TCL PASCAL for CP/M and PET is available now at £120 plus VAT including Manual. Carriage paid.
- TCL PASCAL Manuals are available at £9.50 each. Carriage paid.



Compatible with all systems. IBM format on 5" or 8" discs.
Manual—TCL PASCAL for CP/M.
Runs on TUSCAN, TRITON, 380Z, TEI, TRS80 computers.



Unique features include interface to PET BASIC and clock.
Available now for PET 3032 on 5" disc.
Manual—TCL PASCAL for PET.

**Available from TCL SOFTWARE and all Commodore PET dealers now.*

I am interested in the TCL PASCAL compiler. Please send me:

- The TCL PASCAL Manual for PET CP/M* at £9.50
 The TCL PASCAL Manual and DISC for PET CP/M* at £138.
*Delete as necessary and specify 5" or 8" disc for CP/M.

NAME _____

ADDRESS _____

TELEPHONE _____

TCL SOFTWARE

We mind our language!

TCL SOFTWARE
12 CHAPEL STREET, LONDON NW1 5DH
TEL: 01-402 8137
TELEX: 444198

©TCL PASCAL is copyright of TCL Software. OEM licences available.

'TUSCAN' FROM TRANSAM

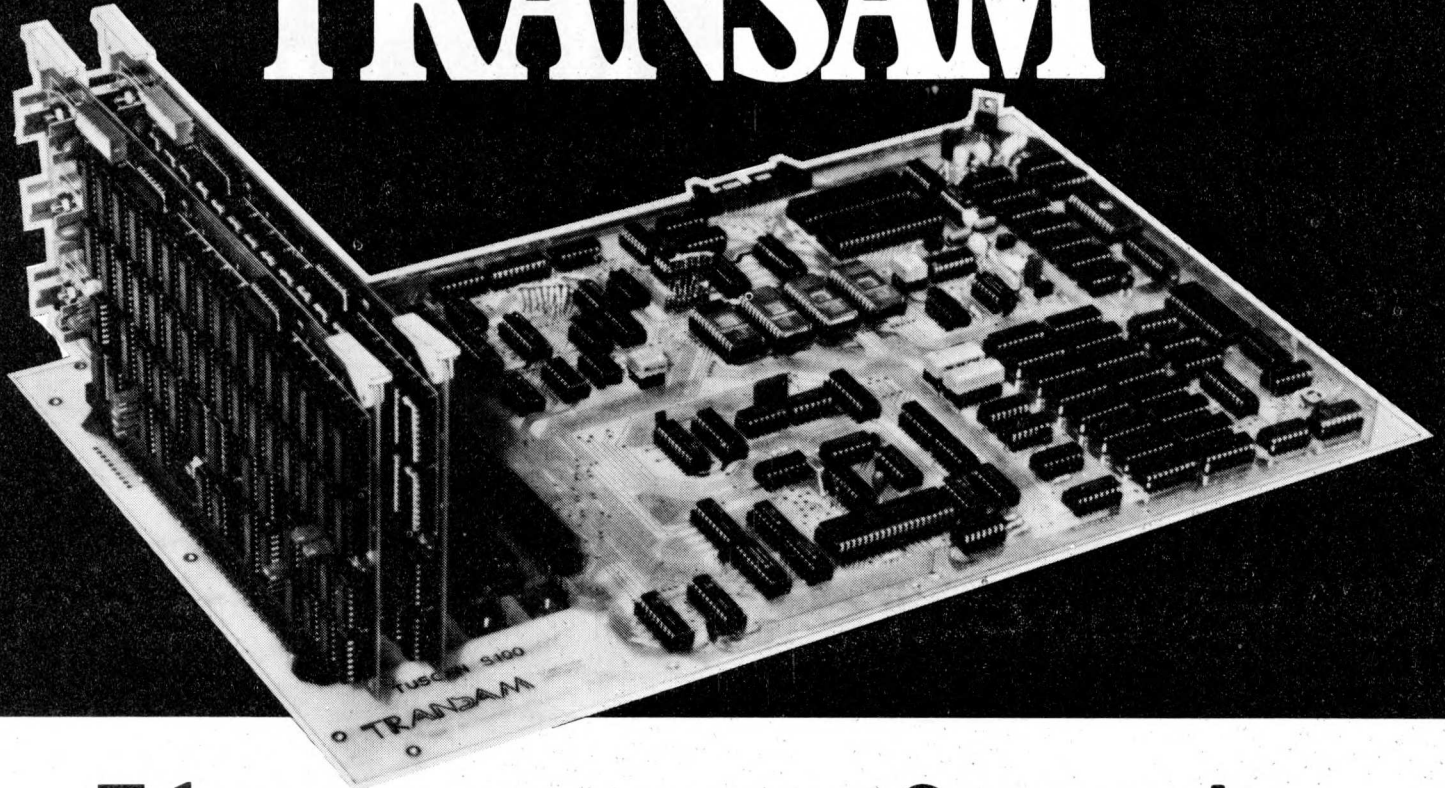

Take a step up to your next Computer!

THE CONCEPT

How many ways are there to build an S100 system? Not many, and all expensive. TUSCAN changes all that.

Five S100 boards on one single board — just for starters. Plus five extra slots for future expansion.

What a combination! Z80 and S100 with the TRANSAM total package of system and applications software.

How do we do it? Our prices start at £195 and you can build up in easy stages to a fully CP/M compatible disc based system. Something to think about!

THE HARDWARE

The first Z80 single board computer with integral S100 expansion. British designed to the new IEEE (8 BIT) S100 specification, the TUSCAN offers total system flexibility. A flexibility available now.

The board holds the equivalent of a Z80 cpu card, 8k ram, 8k rom video and I/O cards with 5 spare S100 expansion slots and offers a price/performance ratio which is hard to beat.

Just compare our price with a commercial S100 ten slot motherboard with this specification.

THE SOFTWARE

TUSCAN offers the user the choice of system monitor, editor, resident 8k basic, resident Pascal compiler or full CP/M disk operating system. All options are upwards

compatible and fully supported with applications software. Both 5¼" and 8" drives are supported in double density.

THE PACKAGE

TUSCAN is available in kit form or assembled. With several hardware and software options to suit your requirements and budget. Attractive desk top case also available holds 2 x 5¼" Drives.

TRANSAM

NOBODY DOES IT BETTER!

Send to Transam Components Ltd., 12 Chapel Street, London NW1

I am interested in the TUSCAN Z80 based single board computer with S100 expansion and enclose a S.A.E. for further details.

Name _____

Address _____

Telephone _____

The best software

TRADER MONITOR ITEM

Arrange for a demonstration . . . and see for yourself.

LONDON

Adda Computers Ltd.,
Ealing.
01 579 5845

Capital Computer Systems,
29-30 Windmill Street,
W1P 1HG.
01 637 5551

Impetus Computer Systems,
Hendon Central.
01 202 9630

L & J Computers,
Kingsbury.
01 204 7525

Lion Microcomputers,
227 Tottenham Court Road.
01 580 7383

Logic Box,
SW1.
01 222 1122

Merchant Systems Ltd.,
72/78 Fleet Street.
01 353 1464

Microcomputation,
Southgate.
01 882 5104

Sumlock Bondain Ltd.,
EC1.
01 250 0505

TLC World Trading,
Charing Cross, WC2.
01 839 3894

SURREY & MIDDLESEX

Cream Microcomputer Shop,
Harrow.
01 863 0833

Da Vinci Computers Ltd.,
Edgware.
01 952 0526

Micro-Facilities Ltd.,
Hampton Hill.
01 979 4546

Petalect Ltd.,
Woking.
048 62 69032

The Henderson Safety Tank Co.,
Croydon.
01 688 7777

Wego Computers Ltd.,
Caterham.
0883 49235

KENT, SUSSEX & HANTS

Ampicon Micro Systems Ltd.,
Brighton, East Sussex.
0273 562163

Business Electronics,
Rownhams, Southampton.
0703 738248

South East Computers Ltd.,
Hastings, East Sussex.
0424 426844

ESSEX

Dataview Ltd.,
Colchester.
0206 78811

Direct Data Marketing,
Brentwood.
0277 229379

Stuart R. Dean Ltd.,
Southend-on-Sea.
0702 62707

OXFORDSHIRE

Oxford Computer Systems,
Woodstock, Oxford.
0993 811976

HERTFORD & BEDFORDSHIRE

Alpha Business Systems,
Hertford.
0992 57423

Isher-Woods Computer Systems,
Luton.
0582 416202

MMS Ltd.,
Bedford.
0234 40601

Buss Stop Computers,
Watford.
0923 40698

E. MIDLANDS, S. HUMBERSIDE & DERBYSHIRE

Arden Data Processing,
Charles Street, Leicester.
0533 22255

Betos Systems Ltd.,
Nottingham.
0602 48108

Davidson-Richards Ltd.,
Derby.
0332 366803

E. ANGLIA, LINCOLNSHIRE & NORTHANTS

H. B. Computers Ltd.,
Kettering, Northants.
0536 83922

Sumlock Bondain (East Anglia),
Norwich.
0603 26259

WEST MIDLANDS, BIRMINGHAM, STAFFORDSHIRE & WARWICKSHIRE

Bytronic Associates,
Sutton Coldfield,
West Midlands.
0675 81448

Camden Electronics,
Small Heath, Birmingham.
021 773 8240

Computer Services Midlands Ltd.,
Erdington, Birmingham.
021 382 4171

Ibex Systems,
Coventry.
0203 86449

McDowell, Knaggs & Associates Ltd.,
Worcester.
0905 427077

System Micros Ltd.,
Shifnal, Shropshire.
0952 460214

Tekdata Ltd.,
Burslem, Stoke-on-Trent.
0782 813631

NORTH WALES & MERSEYSIDE

O.B.E. (Chester) Ltd.,
Queensferry,
Deeside, Clwyd.
0244 817277

Rockliff Bros. Ltd.,
Liverpool.
051 521 5830

THE BRISTOL SOFTWARE FACTORY

for commodore

Integrated Stock-Control, Invoicing and Sales Accounts

Open-Item Sales Ledger System with Nominal Analysis

Integrated, Open-Item Purchase and Nominal Ledger System

MANCHESTER

Cytek (UK) Ltd.,
Old Trafford, Manchester.
061 832 7604

Sumlock Electronic Services Ltd.,
Manchester.
061 834 4233

LANCASHIRE & CHESHIRE

B & B (Computers) Ltd.,
Bolton.
0204 26644

Catland Computers,
Wilmslow, Cheshire.
0625 527166

Fylde Business Machines Ltd.,
Preston.
0772 731901

Magnace Ltd.,
Stockport.
061 483 9903

CUMBRIA

Microputers Ltd.,
Crook, Kendal,
Windermere (09662) 4104

YORKSHIRE & N. HUMBERSIDE

Ackroyd Typewriters Co.,
Bradford 1, W. Yorks.
0274 31835

Microland,
Scarborough,
N. Yorks.
0723 70715

Microprocessor Services,
Hull.
0482 23146

Mitrefinch,
Thirsk, Yorkshire.
09012 2706

Sheffield Computer Centre,
Sheffield.
0742 53519

Yorkshire Electronics Services,
Morley, W. Yorks.
0532 522181

NORTH EAST

Newcastle Computer Services,
Newcastle-upon-Tyne.
0632 615325

R. Ward & Sons,
Gateshead,
Tyne & Wear.
0632 605915

AVON

Bristol Computer Centre,
139 St. Michael's Hill,
Bristol.
0272 23430

Radan Computational Ltd.,
Bath.
0225 318483

GLOUCESTERSHIRE & WILTSHIRE

Beam Business Centres,
Cheltenham, Glos.
0242 45414

Microhex Computers,
Trowbridge,
Wilts.
963 65094

Milequip Ltd.,
Oldcroft,
Nr. Lydney,
Glos.
059 451 624

DEVON & CORNWALL

A. C. Systems,
Exeter.
0392 71718

Devon Computers,
Paignton,
Devon.
0803 526303

J. A. D. Integrated Services,
Plymouth.
0752 62616

Jeffrey Martin Computer Services,
Newquay,
Cornwall.
063 73 2863

SCOTLAND

G. A. T. E. Microsystems Ltd.,
Dundee.
0382 28194

Pilgrim Business Machines Ltd.,
Aberdeen.
0224 28194

Selborne Computer Systems,
Glasgow.
041 954 6669

Thistle Computers,
Kirkwall,
Orkney.
0856 3140

WALES

Croeso Computer Services,
Mumbles,
Swansea.
0792 60624

IRELAND

Medical & Scientific Computers,
Lisburn,
Co. Antrim.
084 62 77533

Software Development Services,
Ballsbridge,
Dublin, 4.
Dublin 685755

ISLE OF MAN

Resource Planning Ltd.,
Douglas,
Isle of Man.
0624 4247

BRISTOL SOFTWARE FACTORY

MICRO HOUSE,
ST. MICHAEL'S HILL BRISTOL
TEL: 0272 23430

What happens when you hit RETURN?

Not a lot, with the standard small computers...and even that takes a long time!

Ohio Scientific computers offer you much more than 'standard' — higher speed, more screen memory, greater flexibility, expandability — and all for less than you expect!

The superior Superboard...

Mutek offer their enhanced version of the popular Superboard: the cased C1 variant, modified to run at double the standard speed, and with more than double the standard display. Double execution speed means that programs in BASIC run at least twice as fast as on the UK101, Pet or Apple — nearly three times faster than on the TRS-80!* And the new display shows 32 lines of 48 characters on most TV systems — twice the area of the UK101, in fact more displayed characters than any other standard microcomputer apart from Ohio Scientific's *Challenger-2* series.

These enhancements take the Superboard right out of the 'toy computing' class of the standard microcomputers — and make *real* computing applications possible. Real-time animation, fast graphics and charting — impossible on the 'standard' computers, realistic on Ohio Scientific systems!

*BASIC execution speeds for 2MHz conversion, derived from comparisons of the Challenger series BASIC with other systems in PCW's Benchtests. UK101, Pet, Apple and TRS-80 are all registered trademarks, of CompShop, Commodore Business Machines, Apple Corporation and Tandy Corporation respectively.



Enhanced C1 4K RAM, 2MHz, 32×48 display £255

Standard C1 4K RAM, 1MHz, 25×25 display £220

4K on-board RAM expansion (8 × 2114 static) £25

Upgrade service for existing C1/Superboard systems to our enhanced specification (ask for details) £40

Software: we stock a wide range of cassette and disc software for Ohio Scientific systems, from a number of sources, British and American, all at very low prices. Catalogue available on request.

a programmable printer...

At last a printer that matches the unique flexibility of Ohio Scientific's small computers. The **Base-2** 800 MST is compact but amazingly versatile and at an almost incredible price:

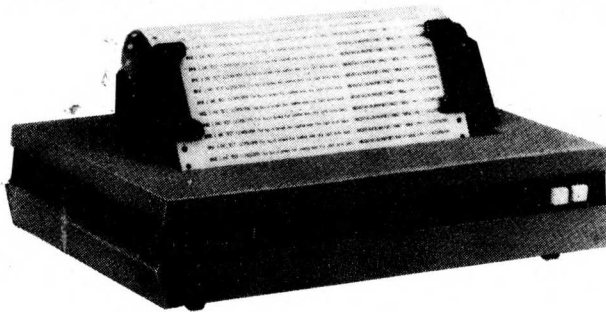

Base-2 printer £395

Every function in the Base-2 is software controlled and available to the user within programs. The only switches on the front and back panels are manual over-riders or start-up conditions — after start-up, everything can be controlled from your program. *Everything* is programmable — even the character set!

Some of the specifications and functions: 96-character set in ROM, user-programmable set in RAM, dot- or byte-plotting graphics modes; space for up to *eight* additional character sets in ROM; software switch between character sets. Six character widths from 8 to 16.5 characters per inch (64 to 132 characters per line); double-width characters. Ultra-fine line spacing control in half-dot increments. Horizontal and vertical tabs. Bidirectional and unidirectional printing. Two-thousand character print buffer for screen-printing. Four built-in interfaces: Centronics parallel, IEEE-488, RS-232, 20ma — sixteen serial baud rates from 75 to 19200. Friction and tractor feed, for up to 9½" tractor paper. And much more...more than *forty* user-programmable functions!

flexibility, expandability...

All Ohio Scientific's Challenger series systems — from Superboard up — are designed for real flexibility, real expandability. Memory expansion, discs, printers, specialist interfaces; 'breadboard' prototyping on-line, voice synthesis, direct 'phone control; ROM software for OEM designs (in machine-code or BASIC!) — it's all practical with Ohio Scientific systems. And even the smallest Superboard can become part of a C3's network, with access to up to 300 million characters of hard-disc storage!

a new monitor...

Available shortly, a new monitor ROM for Ohio Scientific BASIC-in-ROM systems (C1/Superboard, C2), developed by the British OSI user group. Includes screen editor, BASIC trace and line-delete, extended machine-code features for development and USR work; compatible with existing monitor and C1 floppy system. Details available on request; provisional price (with full documentation) — £30.

full technical support

Our prices are some of the lowest around, but that doesn't imply poor technical support!

We give a full after-sales service that includes much more than 'standard'. Along with excellent service facilities we can offer technical advice on both hardware and software aspects of Ohio Scientific range of computers and their applications. We sell the entire Ohio Scientific range, from small Superboard-based systems to multi-processing C3 networks, and we also sell the specialist documentation to go with them — Aardvark's *The First Book of OSI*, giving all details of the firmware structure and processes of the BASIC-in-ROM machines; and the *C1 Technical Guide* and *C4 Technical Guide*, giving complete board layouts and schematics for C1/Superboard, C2 and new C4 systems, including discs, disc drivers and other peripheral boards. We don't just sell machines, we support them, too — and we can undertake most types of technical development (hardware and software) for specialist applications.

First Book of OSI — £6.50; C1 Technical Guide — £4.95; C4 Technical Guide — £9.50. All other prices quoted are excluding VAT.

Mutek — real computing...for less than you expect

Mutek — the independent Ohio Scientific specialists — Quarry Hill, Box, Wilts. Telephone: Bath (0225) 743289

software for

Payroll II

£375

Standard Hardware Requirements:

Apple II computer with Applesoft Basic and 48K memory.

Two Apple minifloppy disk drives or a 'Corvus' Hard Disk system.
132-column printer, connected to the Apple by a serial, parallel, or communications card.

PAYROLL II will hold comprehensive records for up to 200 employees on each minifloppy diskette or Corvus volume. The program will perform wages, Tax, National Insurance, and Pension calculations, and will print detailed payslips, summaries and departmental analyses for up to 185 employees at a time.

All Tax codes are supported.

All types of contracted-in and contracted-out National Insurance contributions are supported: NI schedules A, B, C, D, and E.

Automatic pension contributions on a flat-rate or percentage basis are allowed. Each employee may make contributions on a different basis if the employer so requires. The employer may also choose to make a pension contribution: this will be calculated automatically either as a lump sum per

employee, or as a percentage of each employee's wage.

The taxable wage for each employee may be assembled from the following components:

- * a basic wage, calculated either as a lump sum (a salary) or, when the employee is paid on an hourly basis, as a number of hours multiplied by the employee's basic wage rate.
- * Between one and four overtime payments, calculated as a number of hours multiplied by an hourly rate.
- * Zero, one, or two efficiency payments, calculated on an hourly basis.
- * Four flat adjustments for taxable lump-sum payments that vary from week to week or from month to month.
- * One standing adjustment that is set as an item in each employee's record.

Adjustments to gross may include the following:

- * pension contribution, calculated on a flat-rate or percentage basis.

* Tax, according to employee's Tax code.

* National Insurance, according to the employee's National Insurance letter.

* Three standing adjustments, each similar to the standing adjustment allowed before tax.

* Two flat adjustments, similar to those allowed before tax.

After all the figures for one week (or month) have been entered, payslips are printed in one batch. The system will then print the following:

* A summarised version of each payslip, plus the totals for the entire run.

* A coinage analysis.

* A wages analysis — the total wages paid by each method of payment: cash, cheque, and giro.

* A departmental breakdown of all payments.

When employees leave the firm, their records may be placed on *archive*. In this state, a record may be accessed and printed as normal, but payslips cannot be produced for the ex-employee.

The operator can instruct the program to print out the contents of any record, making easy the production of forms P45, P60, and P11(s).

The user may configure the system to suit the precise needs of his company. A function is provided whereby the operator may set the names of payslips items, record items, and department names. Unused system facilities and payslip items may be 'switched-off' to save the user time.

Holiday pay may be quickly and easily produced by a facility that allows the operator to 'overlay' any number of future weeks' or months' pay in to any employees' payslip. The program ensures that an employee cannot accidentally be paid twice in the same tax-period.

FOUR OVERTIME RATES		COST CENTRE for analyses		PENSION RATES: percentage here, but could be flat-rate		EMPLOYEE'S NAME		NUMBER		EMPLOYER'S PENSION CONTRIBUTION printed only if made	
		MURKATROYD MUSIC LTD		WEEK 1		1 APRIL 1980		HENRIK MISS C.		3	
		SALARY		232.88		ADJUSTMENTS TO GROSS:		NI EMPLOYER		-22.61	
		DS 0.00HRS 1.25T		0.00		TAX (PAYE)		NI EMPLOYEE		-11.14	
		DS 0.00HRS 1.50T		0.00		NI EMPLOYEE		TOTALS TO DATE:		PENSION:	
		DS 0.00HRS 2.00T		0.00		PENSION EMPLOYEE		22 EMPLOYEE		4.66	
		DS 0.00HRS 0.00T		0.00		STANDING 1		42 EMPLOYEE		9.32	
		5		0.00		STANDING 2		GROSS WAGE		26 228.22	
		6		0.00		STANDING 3		TAX (PAYE)		27 114.10	
		FLAT ADJ 1		7 0.00		FLAT AFTER 1		NI EMPLOYEE		28 11.14	
		FLAT ADJ 2		8 0.00		FLAT AFTER 2		NI EMPLOYEE		29 22.61	
		FLAT ADJ 3		9 0.00		TOTAL ADJUSTMENTS		STANDING 0		30 0.00	
		FLAT ADJ 4		10 0.00		21 -129.90		STANDING 1		31 0.00	
		STANDING 0		11 0.00		TOTAL NETT WAGE		STANDING 2		32 0.00	
		TOTAL GROSS		12 232.88		22 102.98		STANDING 3		33 0.00	
		TOTAL NETT WAGE		22 102.98							

EFFICIENCY PAYMENTS only printed if payments are made

METHOD OF PAYMENT: cash, cheque or giro

PAID (CHEQUE) WEEKLY £232.88

BASIS OF WAGE: hourly, weekly or monthly

BASIC WAGE RATE

Fully Integrated Ledger System £855

Gives Management information, ie, aged accounts on individual clients, sales analyses, and trial balance. Profit and loss Balance sheet included.

Sales Ledger II only £315
Purchase Ledger II only £315
Nominal Ledger II only £225

Hardware Requirements:

Apple II computer with 48K memory and Applesoft in ROM. Two Apple Minifloppy Disk Drives, or one Corvus 10MB Hard Disk. 132-column printer with serial, communications, or parallel interface.

General Description

The standard ledger will handle up to 200 accounts with a total of 1000 transactions per floppy disk or CORVUS volume.

The package provides an interactive SALES, PURCHASE and NOMINAL ledger system on a brought-forward basis.

Both SALES and PURCHASE ledgers allow for the entry of INVOICES, PAYMENTS, ADJUSTMENTS (CR and DR), and CREDIT NOTES.

Nominal codes 1 to 70 may be used for posting to the NOMINAL ledger. However, codes 1 to 200 may be used for manual entries to the NOMINAL ledger.

Included in the NOMINAL files are a bank file, sales and purchase control files, and sales and purchase VAT files, all of which are automatically updated with the NOMINAL.

When exiting the SALES or PURCHASE ledgers, the option is given to update the NOMINAL ledger. The NOMINAL ledger updates from the most-previously updated transaction; this means that, although daily ledger entries are made, the NOMINAL need only be updated, say, weekly.

Batch printout (with batch totals) of all, or of selected entries on the ledger is possible.

Reports obtainable are: statements, VAT summary with breakdown for up to five VAT codes, aged accounts, and individual account examinations.

Reports available from the NOMINAL ledger include trial balance and bank reports. Additional functions include PROFIT and LOSS, and BALANCE SHEET reports.

Invoicing

£140

Either stand-alone — or can form part of our General Ledger System.

Cash Flow/Bank Forecast £80

Automatically updates all data following each alteration of an item. Gives column and line totals. Saves a lot of boring work when a Company operates with more than one bank account.

New Word

Processing/Data Base £120

Release date: June

Screen-based editor, powerful global search editing facilities, formatting facilities, address data base facilities and possibility to join sections of text, old and new, for the final printout. FAST AND EASY TO USE.

The above programs work either on Apple II floppy system or a version for 10Mb Corvus hard disc drive is available.

VLASAK

Trade Enquiries Welcomed

Vlasak Electronics Ltd, Thames Building, Dedmere Road, Marlow, Bucks.

Tel: Marlow (S.T.D. code 06284) 74789

Telex 847008 Vlasak G



OPTELCO26 ALBANY ROAD RAYLEIGH ESSEX
RAYLEIGH (0268) 774089 (12am-8pm)
(Personal callers by appointment only)

PETS 'N BITS: 2008S £435 : 2008N £450 : 3016N £615 :
 3032N £669 : 3022 PRINTER ONE ONLY @ £445
 COMPUTHINK 400K £755 : COMPUTHINK 800K £995 : TOOLKIT £45
 CASSETTE UNIT *With Audio Monitor & Tape Counter!* only £55
 'GREEN SCREEN' OR 'BLUE SCREEN' £5.50 (also for MZ-80K)
 SOFTCENTRE SUPERSOUND SOUND BOX £16.75 inc. VAT & Carriage
 (This is not the grotty one that plugs into 2nd cass. port!)
 4K-8K CONVERSIONS £89 : 8K-32K (from) £210 : LIGHT PEN £23.50
 TV INTERFACE £39 : AIM 161 A/D CONVERTOR £125, 'PET SET' £165
APPLE & ITT: 16K EUROAPPLE £649 : 2020 COLOUR 16K £699
 16K UPGRADE £55 : DISK DRIVES £339 CONTROLLER CARD £48
ACT 800 SERIES: 808 from £3950 : 824 from £4950 others are
 P.O.A.

VIDEO GENIE SPECIAL INTRODUCTORY PRICE £358 :
 16K RAM 12K EXT. BASIC

SHARP MZ80K LIST PRICE BUT ONLY (EQUIVALENT) 10% VAT!

PRINTERS: ADCOMP FOR PET, TRS80, GENIE ETC. PLAIN PAPER
 PRINTER WITH U/C, L/C & GRAPHICS. NO EXTRAS REQD:
 X50 £473 : X80 £565 : MODEL FOR SHARP (FULL GRAPHICS) £689
 PR40 (with Pet connector) £215 : ANADEX £499 : LA34 £899
 EPSON TX80 £419 : QUME SPRINT (from) £1995 : T/TYPE 43 £865

ODDS & ENDS: C-12 COMPUTER CASSETTES £3.60/10 (75p carr.)
 VERBATIM (PET/APPLE) DISKS £23/10 : PROFESSIONAL MONITOR £119
 CURVED HEAD DEMAGNETIZER £4 : CASSETTE CARE KIT £1.50 (*both
 only £4 with any new computer!*): TELETXT CONVERTOR - INSTANT
 CONVERSION, ANY SET, THIS MONTH REDUCED TO £179.50!
 'FREEDOM' PHONES from £129.00 : ANSWERING MACHINES ONLY £118

USED BARGAINS: PET 32K (UPGRADE) IMMACULATE £569 : C2-4P
 DISK WITH MONITOR IMMACULATE £785 (LIST £1200) : 8K PET £365
 ELF II, HEAPS OF EXTRAS - LESS THAN KIT PRICES £325

MOST MAKES SOLD/BOUGHT/EXCHANGED/CONSTRUCTED
 WANTED - 'OLD' PETS (EVEN DECEASED PETS FOR VIVISECTION !)
 ADD VAT & CARRIAGE EXCEPT WHERE OTHERWISE STATED

...British S100 BOARDS...(MANUFACTURED IN THE U.K. TO IEEE BY
INTERACTIVE DATA SYSTEMS)

IDS SBMC	Single Board Micro Computer, Z80A, 4MHZ, 1K RAM, up to 16K EPROM, 2 SERIAL PORTS!	KIT £178 A&T £235
IDS 16K SRAM	4 MHZ Static RAM using 2114 chips.	KIT £174 A&T £198
IDS DFDC	Double/single density, Double/single sided Floppy Disc Controller, up to 4 drives.	KIT £177 A&T £198
IDS SFDC	As IDS DFDC but Single Density only.	KIT £109 A&T £140
IDS IOC	2 Serial, 2 Parallel port I/O Controller.	KIT £107 A&T £130
IDS PCI 10	Process Control Interface, opto-isolated, TTL and analogue inputs, relay, TTL and analogue outputs (multichannel)	KIT £195 A&T £223

..£15 OFF ABOVE BOARDS..SPECIAL OFFER FOR CASH ORDERS
EXTENDED TO 10th AUGUST 1980

IDS Z80 CPU	Z80A, 4MHZ CPU board.	KIT £84 A&T £105
IDS TERM 40	Active Termination Board.	KIT £25 A&T £32.50

ALSO

7M.BD	7 slot Mother Board (excluding connectors)	EA £16
15M.BD	15 slot Mother Board (excluding connectors)	EA £24
S100 CONN	Edge connectors for Mother Board (solder tail)	EA £2.90
DP 8000	Anadex dot matrix printer, RS232 interface	EA £495

CHIPS

2114, 200nS low power SRAM	EA £4.75
2716, 450nS Single supply EPROM	EA £19.95
Z80A,, 4MHZ CPU	EA £11.20
2708, 450nS EPROM	EA £6.65
4116, 200nS Dynamic RAM	EA £5.95

CATALOGUE Includes fuller details of above items and more... (Free)

Please add 15% VAT to all prices. P&P 50p under £15. MAIL ORDER ONLY

Mendip Computers

57 Bath Road, Wells, Somerset, BA5 3HS. Telephone 0749 (WELLS) 75249

Write better programs for your pet using THE PET SUBROUTINE LIBRARY



Containing a collection of over 60 useful subroutines, some in machine code, for readers to incorporate into their own programs.

Input/output routines incorporating error checking and validation — high density graphs and barplots — date input and validation — high speed machine code array sort (100 element array of any variable name sorted in a few seconds) — search routines — linked lists — utility programs — check digits — double density graphics — random access files — large sequential file sort — disk file access by machine code — program chaining and menus — disk file utilities and displays — plus many others.

Price book only £10.00 or
 Book plus 3040 format diskette of all subroutines £20.00

THE PET REVEALED

Best selling reference book for the PET. Price £10.00



Cheques payable to Computabits Ltd

COMPUTABITS LTD,

P.O. BOX 13, YEOVIL, SOMERSET. Tel Yeovil 26522

APPLE II PET ITT 2020

Top quality systems

DATABANK IS A BRITISH SOFTWARE HOUSE

DATABANK IS A BRITISH SOFTWARE HOUSE

STOCK CONTROL · SNOOKER
 PAYROLL · NOUGHTS & CROSSES
 BANK ACCOUNT · CROSSWORD
 SALESMAN · SPACE DOGFIGHT
 CASH REGISTER · STARTREK
 LIBRARY INDEX · PHASER
 ASTRONOMY · JET FLIGHT
 STATISTICS · SPACESHIP
 GRAPH PLOT · KLINGON

FLOPPY DISK SOFTWARE



1 Program only £10.
 Any 5 for just £20.
 10 for £30. 18 for £40.
 Including disk & postage etc.

All at lowest prices ever

FREE: Any five of the above programs,
 with either:-
 WORD PROCESSOR £40
 MAILER/LETTER £50 All Inc.

PHONE NOW FOR YOUR DEMONSTRATION

DATABANK	66, Queens Road Loughborough Leicestershire LE11 1HD 0509 217671
-----------------	---

Just fill in the boxes and post us your cheque, now!

APPLE II
 PET
 CBM DISK
 ITT 2020
 COMPUTHINK

NAME.....
 ADDRESS.....

 Postcode.....

CASH REGISTER
 CROSSWORD
 MAILER/LETTER
 LIBRARY INDEX
 DOGFIGHT
 WORD PROCESSOR
 ASTRONOMY
 STARTREK
 STOCK CONTROL
 STATISTICS
 PHASER
 PAYROLL
 GRAPH PLOT
 JET FLIGHT
 BANK ACCOUNT
 SNOOKER
 SPACESHIP
 SALESMAN
 NOUGHTS & CROSSES
 KLINGON
DO PLEASE SEND MORE DETAILS

MACRO-MICROS FROM COMPUTER CENTRE

Tandy and Apple computer owners don't have to throw away their present investment to have 8 inch disc drives ADD a **MEGABYTE** to your EXISTING **TANDY** or **APPLE** machine for under £1000 (+ VAT)



MORE THAN WORDS CAN SAY THE COMPUTER CENTRE WORD CENTRE

- SPECIAL WORD PROCESSING VDU
- 48K BYTES Z80 MICRO
- TWIN 8 INCH DRIVES
- QUME DAISY WHEEL PRINTER
- £4600 + VAT

Our word centre is a purpose designed hardware and software combination which solves your WORD PROCESSING problem. Your secretary will appreciate the IBM type writer layout of the VDU keyboard; and the special function keys for straight forward editing of; the WORDSTAR software package is designed to meet the needs of both the inexperienced 'temp' as well as the 'ace' secretary; the 'golf ball' quality output from the printer with page and heading control, right adjusted text, etc, is what its all about and the QUME does it better!

And when your WORD PROCESSING is finished earlier, there will be time left over to do other computing work as well! This is THE WORD PROCESSING machine that supports BASIC, FORTRAN, COBOL and the best range of BUSINESS PACKAGE software available - because our WORD CENTRE also runs the most widely used micro disc operating system - CP/M

TANDY TRS80 OWNERS

Run up to four 8 inch drives or a mixture of 5¼ and 8 inch drives...AND standard CP/M..... Simple to install plug-in adaptors re-arrange the ROM and RAM in your system to allow a STANDARD CP/M capable of running our FREE 42 volumes of the User Group library and any CP/M software.

APPLE / ITT OWNERS

A plug-in controller lets your system run up to four 8 inch disc drives. We can't offer you a system to mix 5¼ and 8 inch or CP/M but that extra MEGABYTE for under £1000 (+ VAT) may be all that you need!

TANDY TRS80 MODEL 2 OWNERS

Save money on your 8 inch add on drives..... We buy disc drives by the thousand direct from manufacturers, we don't have expensive overheads of high street shops, so we can offer top quality add on drives for less than half price! AND your add on drive can be DOUBLE sided giving ONE MEGABYTE of storage for under £600 (+ VAT)

If you are a buyer for a company or an OEM looking for several MODEL 2 machines as well as drives we can offer BIG DISCOUNTS on BOTH!! Ask for details.

We also offer STANDARD CP/M for TANDY Model 2.

20 MEGABYTE WINCHESTER SYSTEMS
just plug into your existing 8" floppy controller for under £2500. Call for more details.

OFF THE SHELF AVAILABILITY FROM COMPUTER CENTRE

KIT PACKAGES

MINI KIT

The lowest priced CP/MZ80 Micro in UK. Add your power and terminal. Minifloppy 16KB RAM, Z80, CTC, serial + parallel I/O, S100 motherboard, connectors, manuals, CP/M system. Free basic and Algol. Optional two drive case illustrated and power supply £149.00

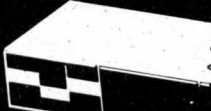

£800

MAXI KIT

8" drive, CP/M disc operating system, 16K bytes, Z80, serial and parallel I/O, S100 motherboard, connectors and cables

Optional power supply kit. £77.00

£911

THE MEGABOX

MEGABOX - S

Twin 8" single sided drives plus Power Supply. Unit in an attractive box

- Up to two megabytes
- Attractive 3 U case
- Fan cooling
- Mains switch

£913



MEGABOX - D

Twin 8" double sided drives plus Power Supply. Unit in an attractive box

£1090.00p

8 INCH DRIVE

SCHUGART COMPATIBLE

Single/dual density 8" disc drive. Assembled and guaranteed

£350

Double sided version £450

MINI FLOPPY

Double/single density hard or soft sector. used for TRS80, North Star etc. Assembled and guaranteed

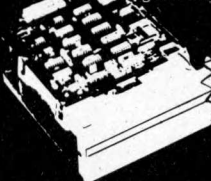

£175

TRS 80 EXPANSION

DISC DRIVE

5 1/4" disc drive + power supply in attractive case



£199

PRICE LIST

OEM PACKAGED SYSTEMS

	ASSEM
OEM1 Z80, 32KB, 1SER, 1PAR, 2 x 1/4 MEG Disks	1970.00
OEM2 Z80, 48KB, 1SER, 1PAR, 2 x 1/2 MEG Disks	2270.00
OEM3 4MHz, 64KB, 2SER, 1PAR, 2 x 1 MEG Disks	3570.00

DISC DRIVES

SA400 mini floppy disc drive	175.00
DRI 7100 8 inch drive (single sided)	350.00
DRI 7200 8 inch drive (double sided)	450.00

VDU'S

Pentland (full spec)	590.00
----------------------	--------

PRINTERS

DRI 6320 (140 cps Max) 132 cpts, Tractor Feed	1500.00
ANADEX 8000	499.00

SOFTWARE

CP/M operating system + 6 manuals + basic E	70.00
Library index (33 volumes available)	2.80
Library copies on 8 inch media	4.40
Library copies on 8 inch media (10 or more)	3.40
Microsoft BASIC	193.00
Microsoft FORTRAN	267.00
Micro focus compact COBOL	376.00
Micro focus forms	75.00
UCSD PASCAL	193.00
Microsoft BASIC compiler	211.00
WORDSTAR	193.00

MPU

	KIT	ASSEM
CB2 Z80A 1EEE S100	112.00	136.00
IDS Z80A CPU BOARD	115.00	115.00
SBC 100 Z80 + serial + parallel	155.00	197.00
SBC 200	182.00	242.00

DISC CONTROLLERS

Tarbell single density	132.00	188.00
Tarbell double density	188.00	244.00
Versafloppy 1 single density	135.00	190.00
Versafloppy 2 double density	184.00	241.00
Nat Mux double density	215.00	215.00
Tarbell Cassette Interface	104.00	104.00

MEMORY

8K bytes Econoram 2 (4MHz) static ram	84.00	100.00
16K bytes Econoram 4 (4MHz) static ram	145.00	178.00
24K bytes static	214.00	259.00
32K bytes static ram	302.00	349.00
Expandoram 2 (Dynamic) 64K population	663.00	713.00
Expandoram 1 (Dynamic) 64K population	366.00	416.00

I/O

2SIO (#2 serial full hand shaking uarts)	105.00	136.00
IO4 2 serial/parallel	86.00	129.00

SPECIAL BOARDS

VDB-8024 (80 cpts x 24 lines) video	194.00	263.00
PB1 2716/2708 eeprom programmer	78.00	122.00
Memtech 3MHz floating point board		280.00
Prototype board		16.60
2708 prom board (ex proms)	52.00	63.00
VB1 16/32x64 video	78.00	107.00
MT3 11 slot motherboard		21.00
S100 extender + logic probe		31.20

Dealer, Educational and Quantity Discount Available.

OEM RANGE



**FROM UNDER
£2000**

- Up to 2 Megabytes of floppy disc storage
- High speed Z80 micro
- Up to 64K bytes fast ram storage
- High level operating system (supports Cobol, Fortran, APL, Basic, Pascal, Wordstar)
- 2 drive minimum system under £2000

Available off the shelf in an attractive case, the Computer Centre OEM 2 provides a powerful main frame computer.

System builders are free to add peripherals to suit the final applications. The operating system provided with the OEM 2 is a powerful upward compatible extension to CP/M and will support up to 128 mega byte disc storage. A 10 mega byte fixed disc is already planned and should be available as an extra during 1980.

Another remarkable extension to the OEM range is the availability of the multi terminal operating system. But with hardware costs as low as the OEM, the market for sharing the system is likely to be small!!!

OEM's are invited to write or call for details

NEW PRODUCTS

Now available from stock, new plug in card cards to enable Tandy owners to run CP/M and/or two 8" disc drives

Full range of power supplies, Firmware, Connectors and IC's

All advertised items generally in stock. Cash with order ensures same day despatch. Add 2% postage and 15% VAT to advertised prices. I enclose cheque for £

Send: Catalogue (please tick)

Name

Address

Send

COMPUTER CENTRE

THE DISCOUNT COMPUTER STORE

9 De la Beche Street, Swansea, SA1 3EX. Tel: 0792 460023 Telex: 48638

**Introducing
MAIL ORDER
from Intex**

**A NEW
SERVICE
FOR YOU!**

**MAIL ORDER DEPARTMENT
CASH WITH ORDER ONLY**

PET		DEMAGNETISERS	
2001-8	£ 495.00	Curved Head (Mains)	4.00
3016	675.00	Cassette (Battery)	12.00
3032	795.00		
C2N Cassette Deck	55.00	WORKBOOKS	
IEEE to IEEE Lead	25.00	TIS WORKBOOKS (NO VAT)	
PET to IEEE Lead	20.00	Set of 6	18.00
3040 Disk	795.00		
Computhink 400K for		CONNECTORS	
8K via exp/PET	825.00	PET USER/IEEE PORT	1.25
For 16/32K	895.00	PET 2nd CASS PORT	.95
800K Unit	1145.00	Covers for USER/IEEE	
24K Expandapet	320.00	PORT Connector	2.50
		D52 RS232 Connectors	
INTERFACES		Male/Female	3.25
Small sys, Serial C	120.00	Covers	2.50
Serial B Bi-Dir	175.00		
TNW2000 Bi-Dir	165.00	KIM	
All IEEE/RS232		KIM 1	99.95
PETSET 1 A/D	166.00	KIM 3B	99.95
Stockists of PETSOFT & COMMODORE SOFTWARE		KIM 4	69.95
		NASCOM	
PAPER		Nascom 1 (kit)	125.00
TCM100 Roll	2.50	Nascom 1 (Built)	140.00
Anadex/PET 80 Col	15.00	Nascom 2 (Kit)	295.00
Teletype 132 Col	25.00	Power Supply (kit)	29.50
PR-40 Roll	1.00		
CASSETTES		SEND FOR OUR FULL SOFTWARE & MAIL ORDER PRICE LIST -	
C12 Cass Highgrade Per 10 in library cases	4.00	DUST COVERS	
DISKETTES		PET (All models)	£5.75
PET 3040 per 10	25.00	PET 3040	£3.50
APPLE " "	25.00	COMPUTHINK DISK	3.00
C/THINK D/D Per 10	35.00	T/T 43 PRINTER	5.75
		Anadex DP8000 Printer	3.50

ALL PRICES ARE EX. VAT.
PLEASE ADD 50p p&p ON SMALL ITEMS £2.50
ON LARGER ITEMS

ALL GOODS DESPATCHED BY RETURN OF
POST OR YOU WILL BE NOTIFIED OF ANY
DELAY & OFFERED AN ALTERNATIVE OR THE
RETURN OF YOUR MONEY



Don't delay
SEND
NOW!



Name

Address Phone

Item No.....

INTEX DATALOG LIMITED EAGLESCLIFFE INDUSTRIAL ESTATE, EAGLESCLIFFE, STOCKTON ON
TEES, CLEVELAND TS 16 0PN, ENGLAND. TELEPHONE: EAGLESCLIFFE 781193 (STD Code 0642).
CABLES INTEXRAD, STOCKTON ON TEES. TELEX 58252.

Intex

Happy Memories

4116	200ns	£3.95	4116	150ns	£5-50
2114	200ns	£4-75	2114	450ns	£4-25
2708	450ns	£4-95	2716	5 volt	£13.50

MEMOREX mini discs soft sectored £19-95 per ten

SALE

We're moving shortly to new premises and don't
want to carry much. Bargains for everyone.

All prices include VAT. 30p postage on orders
below £10. Access & Barclaycard. All orders to:

Dept.PCW

**19 Bevois Valley Road, Southampton,
Hants. SO2 0JP Tel: (0703) 39267**

**Array Processing
from
Silicon Glen
on the
West Coast
of
Scotland**

Video Vector Dynamics Ltd announce what will be one
of the most significant innovations in microcomputing
during the 1980's — The VP 9500 Vector Processor.

For more details contact:

Video Vector Dynamics Ltd
39 Hope Street,
Glasgow G2 6AE
Telephone number 041-226 3481/2

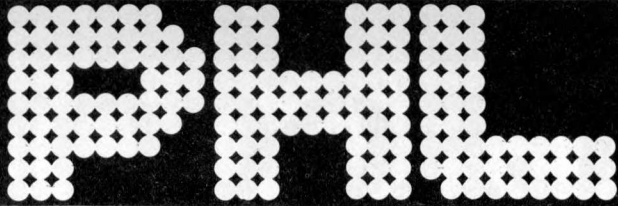

...when you need a dependable supplier, an authorised distributor with a comprehensive range of products at keen prices, backed by large stocks for fast delivery, with full after-sales support. We promise you a rapid response.

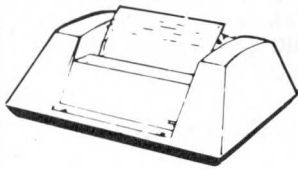

ANADEX DP8000

Exceptional value and high reliability. 84 lines per minute, 112 cps. Parallel and serial interfaces as standard. 96 ASCII set, 9 x 7 font. Variable tractor. Forms handling facilities. 1K buffer store. Options include 2K extra store IEEE interface.

from only **£516**



LEAR SIEGLER ADM-3A

The most popular visual display in the world. 1920 character screen capacity. Cursor addressing. Dual interface. Auxiliary port. Wide range of speed and word formats. Options include Tektronix 4010 compatible graphics.

from only **£570**



TECHTRAN 950

Mass data storage, high speed retrieval and intelligent data collection. Micro-processor control. 200K character storage per diskette. RS232 interface. Switch selectable speeds. Easy file orientated mass data storage. The 951 adds a powerful disc editor, high speed search and editing.

from only **£995**



TELETYPE 43

Versatile, economic and reliable 30 cps, serial interface keyboard printer. 132 or 80 columns. 94 ASCII set, 9 x 7 font. Crisp, high quality printout. Microprocessor controlled. Portable versions. Character set options.

from only **£799**



TYPEWRITER TERMINAL

Two machines for the price of one. Typewriter style friction feed for single documents, letters etc. Pin feed for continuous business stationary. Electric typewriter keyboard layout and touch. Left and right hand margin setting. Crisp, high quality printout.

from only **£825**



**SPECIAL
£739
OFFER**

For a limited period only

DIGITAL LA 34

30 cps desk top terminal/Roll feed, paper widths from 3-14 $\frac{1}{2}$ inches/EIA interface/Selectable character widths, 10, 12, 13.2 and 16.5 characters per inch/Full 96 ASCII character set/7 x 9 dot matrix/Options include a 20mA interface, tractors to accept sprocket feed paper and numeric keypad.

PERIPHERAL HARDWARE LIMITED

Armfield Close West Molesey Surrey Telex 922175

SOUTH
01 941 4806

NORTH
Harrrogate 501263/4

IRELAND
Dublin 952316

PET users!

SAVE UP TO 90% ON PROGRAM DEVELOPMENT TIME

by using **ComPasS**
the new programming aid

PLUS!

- Random access routines
- Effective data handling
- Flexible screen formatting
- Big savings in program testing
- Consistency with standard sub-routines
- Easier program maintenance

ComPasS is an easy-to-use new package containing parameter-driven BASIC programming routines to handle the input and output of data to and from tape and disc files. ComPasS will set you on the right course —and save you time, money and frustration.

Ring CPS or contact your nearest PET dealer.

DEALERS! TWO more NEW packages from CPS

'NEWSBOY' —a system for Newsagents accounting and delivery control (over 70 programs).

'GOLD' —a product costing and invoicing system for Manufacturing Jewellers.

'phone us for more information 021-707 3866



CPS (DATA SYSTEMS) LTD

Arden House, 1102 Warwick Road,
Acocks Green, Birmingham B27 6BH.
Telephone: 021-707 3866
Telex: 312280 CPS G



MICROCOM

For Hardware, Software, Peripherals

PET 2001



from
£475

commodore
authorised dealers

TRS 80



from
£365

From Radio Shack Corp.

APPLE II

from
£695

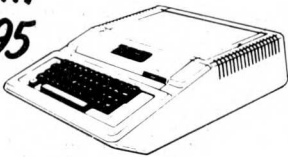

authorised dealers

SORCEROR

from **£740**

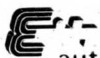
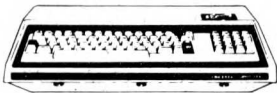

authorised dealers

ADVANCED SYSTEMS



PET 3016 (16K RAM and large keyboard)*
£675.00
PET 3032 (32K RAM and large keyboard)*
£795.00

IEEE/RS232 Serial Interface 'A' Output only £106.00
IEEE/RS232 Serial Interface 'B' Input/Output £186.00
Programmers Toolkit - 10 powerful new commands for your Pet - plug in ROM chip 8K and 16/32K resp £75/£55

BASIC SYSTEMS

PET 2001-8 (PET with 8K memory + integral cassette) £475.00
PET 3008 (8K) with large keyboard £475.00
PET C2N External Cassette Deck £53.00

ACCESSORIES

IEEE-448/Centronics type parallel Interface £35.00
IEEE to Pet Cable £19.00
IEEE to IEEE cable £24.00
PETSET 1 16 Channel AD Convertor c.w. all interfacing requirements £166.00

TRS 80, 4K Level I consisting of Keyboard with 4K memory, Video Unit, Cassette Drive and 240v power supply unit £365.00
TRS 80, 4K Level II (as above with Level II Basic) £425.00

TVJ 232 serial interface £35.00
Centronics Parallel Printer Interface (direct to keyboard) £40.00
TRS 80, Voice Synthesizer £345.00
TRS Voxbox - speech recognition system £135.00
TRS 80, Numeric Key Pad supplied and fitted £49.00

BASIC SYSTEMS

TRS 80, 16K Level II (as above with 16K memory) £499.00
TRS 80, Expansion Interface with 16K RAM £275.00
TRS 80, Expansion Interface with 32K RAM £360.00

ACCESSORIES

Radio Shack Phone Modem £160.00
UHF Modulators (encased with leads for 625 lines) £20.00
RAM upgrade (4-16K, 16-32K, 32-48K) supplied and fitted at our premises (Kit £80.00) £85.00
S100 interface for TRS 80 (6 slots) £375.00
TRS80 CPU 3 speed mod. £26.00

Apple II Plus computer - APPLESOFT

Apple black and white modulator for domestic TV £14.00
Eurocolor card - provides colour on domestic TV £79.00
Parallel Printer Interface Card £104.00
High Speed Serial (RS232C) Interface Card £113.00
Communications Card £130.00
Centronics Card £130.00
Integer Basic Firmware Card £116.00
PASCAL language system - includes language card to provide user with PASCAL, PALSOFT & INTEGER BASIC £299.00

BASIC SYSTEM

extended basic in ROM - (16K RAM) - video output £695

ACCESSORIES

Real time clock/calendar card - 1/1000 sec to 388 days with interrupt, software controllable £128.00
Speechlab - provides voice control for the Apple £127.00
Supertalker - adds human speech output! £136.00
ALF Music Synthesizer Card £180.00
A1-02 Data Acquisition Card £180.00
Graphics Tablet £462.00
AC Line Controller £270.00
RAM Upgrade (16-32K, 32-48K) £69.00
Hobby Prototype Card £20.00
Romplus - u, l/c, mixed text/graphics £105.00

Sorceror (inc UHF Modulator)
16K RAM £740.00

Exidy Video Disk Unit
(High Resolution monitor with Integral 630K Dual Drive) £1790.00

BASIC SYSTEMS

32K RAM £790.00 48K RAM £840.00

ACCESSORIES

Exidy S100 Unit £240.00
Exidy Video Monitor £240.00
CP/M on Disk £145.00

ADVANCED SYSTEMS

TRS 80 Model II with integral 8" floppy disk drive and up to 64K RAM. Expandable up to 3 Megabytes Disk Storage (Available for demonstration - by appointment only). P.O.A.
ACT 800 Systems providing 108K RAM, 46K User RAM, full size screen, high-res graphics, Ultra-fast data access and up to 4-8 MBytes on-line disk storage P.O.A.

Special Offers!

PET BUSINESS SYSTEM

comprising
CBM 3032 Micro
computer, CBM 3040 Dual Disk Drive, CBM 3022
Tractor Feed Printer and all cables £1999.00

News!

WE ARE ON THE MOVE!

Our Head Office is moving to larger and more prestigious showrooms (hopefully mid-May)

JOHNSON HOUSE
75/79 PARK ST,
CAMBERLEY, SURREY, GU15 3PN
☎ (0276) 20446

PUTERS ETC

Consultancy and Competitive Prices.

Registered business name



DISKS

PET	
CBM 3040 (dual drive) 343K User storage*	£795.00
Computhink (dual drive) 400K storage	£895.00
Computhink (dual drive) 800K storage	£1145.00
TRS80	
Shugart drive	£315.00
Micropolis drive	£315.00
Percom FD200 drive 110v	£299.00
Micropolis Dual Drive (394K storage)	£995.00
Corvus Hard Disk (11mB)	£3500.00
APPLE	
Apple Drive - 116K storage 1st drive	£349.00
Apple Drive - 116K storage 2nd drive	£299.00
Corvus Hard Disk (11mB)	£3500.00
SORCEROR	
Exidy - 143K storage	£495.00
Exidy Dual drive (630K storage)	£1195.00
Corvus Hard Disk (11mB)	£3500.00

PRINTERS

PET	
CBM 3022 (80 col with PET graphics - tractor feed)*	£525.00
TRS80	
TRS 80 Screen Printer (text + graphics) (110v)	£345.00
New Radio Shack Micro Printer	£245.00
GENERAL	
Teletype 43 KSR Serial (pin or pinch feed, 132 cols)	£825.00
RACAL Binder Printers - truly professional printers for microcomputers - high speed (up to 280 cps), upper/lower case	P.O.A.
OKI - parallel/serial (pin or pinch feed, 40, 80, 132 cols selectable)	£499.00
Centronics 779 parallel (tractor feed, 132 cols)	£825.00
DOLPHIN BD80P tractor printer (125 cps bi-directional, 40, 80 columns - optional 132: u/l case & graphics). Available with Serial, parallel or IEEE interface	£525.00
Centronics Micro Printer (20, 40, 80 cols selectable)	£395.00
Heath WH 14 serial (80, 96, 132 cols selectable)	£475.00
QUME daisy wheel printers	P.O.A.
TCM100/MICROHUSH Thermal Printer (40 cols) inc. interface for PET/APPLE	£266.00
SILENT PRINTER for APPLE... allows printing of high res. graphics	£349

ETC.

Diskettes 5 1/4" (blank) boxed (min order 10) each	from £3
C12 Cassettes (min order 10) each	£0.35p
Ansaback 'phonemate' telephone answering machine, voice operated twin cassette	£190.00
Pace EZ-PHONE - Cordless Telephone	£225.00
Hitachi Video Monitors 9"/12" resp.	£127/£187

BOOKS - Large range of microcomputer related books and magazines

TERMINALS

Pentland V1, 80 char./24 lines 2 page memory	£580.00
--	---------

PROGRAMMABLE CALCULATORS. TEXAS INSTRUMENTS. Business Programmable Calculators - complete range. Send for list + prices. (We are authorised TI dealers).

IF YOU DON'T SEE IT - ASK IF WE HAVE IT

SOFTWARE

PET

PETSOFT authorised dealers - over 160 programmes on cassette and disk. Send for catalogue.	
STAGE ONE COMPUTERS S/W dealers - PETAID, Stock Control, etc. Send for list.	
74 Common BASIC Programs on one tape	£15.00
PETACT Business Software - Sales and Purchase Ledger, Invoicing, etc.	P.O.A.
CBM DISK-BASED BUSINESS SOFTWARE -	
COMWORDPRO II/COMWORDPRO IV powerful word processor, low/high level resp.	£75/150.00
COMSTOCK - STOCK CONTROL - gives complete stock report	£150.00
COMBIS - BUSINESS INFORMATION SYSTEM - Storage & Retrieval of all types of company records	£150.00
COM ACCOUNTS - Full Financial Business Accounting System incl: Sales, Purchase, Nominal Ledgers	£650.00
COMPAY - Handles hourly, weekly or monthly paid employees	£150.00
COMPLANNER - Personal information tool for the busy executive	£50.00
(We are authorised CBM Business Software Dealers) Send for List.	
GD 1001 - Assembler Development System	£50.00
GD 010 - Lisp. Interpretive Language (Artificial intelligence)	£75.00
CAR INSURANCE QUOTATIONS - computerised car insurance quotation suitable for insurance brokers (TVJ S/W)	£25.00
MORTGAGE QUOTATIONS - suitable for agents/mortgage brokers (TVJ S/W)	£25.00

TRS 80

COMAC III SUITE - computerised accounting for TRS 80 (TVJ SOFTWARE)	£75.00
STOCK CONTROL - complete inventory control - recorder level - P/O's etc.	£115.00
CP/M	£95.00
CBASIC	£75.00
FORTRAN includes compiler, relocatable assembler text editor and linking loader	£95.00
PASCAL - tomorrow's programming language today	£195.00
ELECTRIC PENCIL - powerful word processor allows full cursor movement, insert/delete, string search block movement, adjustable line length, justification on cassette	£45.00
ELECTRIC PENCIL as above - disk version	£95.00
LOWER CASE MOD KIT ONLY/FITTED for Electric Pencil	£8.00/£28.00
DATA MANAGEMENT/REPORT GENERATOR - easily formats disk files, allows entry, edit, delete and list of records and retrieves data for display or calculation on screen or printer	£150.00
RSM-2D DISK MONITOR - powerful system manipulates disk data, has Z-80 break routine	£25.00
ST80D communications software	£60.00
NEWDOS - TRSDOS with corrections and enhancements	£25.00
NEWDOS+ - as above but with further facilities:-	
KBFX, Renum, Screen to printer in one step, DOS commands from BASIC, Level I in II, Superzap, Disassemble, load and save faster, list variables	£49.00
LIBRARY 100 - an assortment of 100 programs	£39.00
SARGON CHESS - 16K Level II - the 1979 Champ Version I	£14.00

APPLE

Microchess 2.0 Chess Disk	£15.00
U-DRAW II - High Resolution graphics editor. Create a figure then rotate, expand, contract etc and store on disk	£27.00
LISP - programming language suitable for research in artificial intelligence	£30.00
3-MILE ISLAND - Complex disk based game simulating nuclear reactor	£27.50
VISICALC - Instant Visual Calculation - provides a powerful planning and forecasting tool	£95.00
APPLE WORD PROCESSOR - Complete text editing, storage and retrieval of text (disk based)	£42.00
LITTLE GENIUS - Comprehensive disk based Apple Soft Tutorial	£35.00

ACT Appeware and MUSE authorised software dealers - Many programs on cassette and disk. Send for list.

SORCEROR many programs available - send for list.

Word Processor Rompac	£120
Development Pac	£70.00

* 5% DISCOUNT ALLOWED FOR EDUCATIONAL ESTABLISHMENTS



T&V JOHNSON (MICROCOMPUTERS ETC) LTD

Member of the TV Johnson Group of Companies

Camberley (Head Office)

165 London Road, Camberley Surrey, GU15 3JS.

☎ (0276) 62506

☎ (0276) 20446

Oxford

148 Cowley Road, Oxford OX4 1JJ.

☎ (0865) 721461

Bristol

48 Gloucester Road, Bristol BS7 8BH

☎ (0272) 422061

Hours of business

Mon-Fri. 9.30 - 5.30

Sat. 9.30 - 1.00

+ Ansaback eves and w/ends.

Telex 858893



PRICES EXCLUDE VAT, FREIGHT & HANDLING SEND OR PHONE FOR PRICE LIST & BROCHURES (All prices correct at time of compilation)

Directors: Dr. R.V. King BA, MIEE
S.G. Johnson, BSc. (Hons.)
T.S. Johnson, ABIBA, ACMB, FBSC, MBIM
A.S. Barton ACII, ABIBA, CdpAF.

Branches at:
Birmingham, Bristol, Edinburgh, Leeds, London, Louth, Newmarket, Nottingham, Oxford, Byfleet, Wokingham.



80 Column by 24 Line Plug-in Compatible Board for the Apple II Computer

SPECIFICATIONS

- * 80 Columns X 24 lines.
- * Upper and lower case data entry using the Apple II keyboard.
- * Includes 128 upper and lower case 5X8 dot matrix ASCII character set and inverse alpha characters.
- * Characters can be user definable.
- * Includes VBC video balance circuit which allows the user to display 80 columns on an inexpensive 8 MHZ CRT monitor.
- * Shift lock feature.
- * Works with Apple Pascal and Apple Basic.

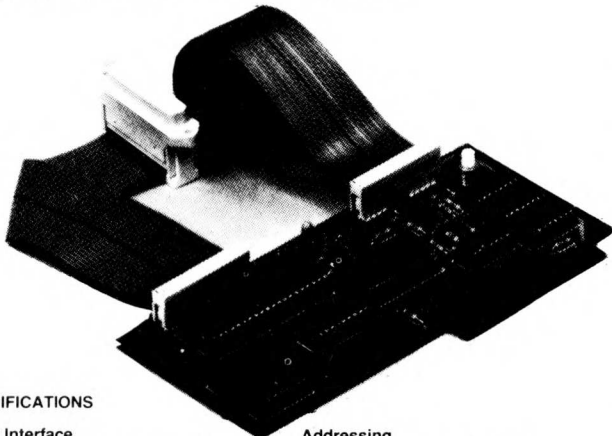

SPECIFICATIONS

Serial Interface

- * One RC-232 interface with EIA receivers and drivers
- * Available handshaking lines --Request--To--Send (RTS), Clear--To--Send (CTS), Data--Carrier--Detect (DCD)
- * Rotary switch selectable baud rates-- 110, 134.5, 300, 600, 1200, 2400, 4800 (9600 and 19200 baud available under software control for printers)
- * External clock input for up to 500K baud
- * Software controlled modes:
 - 7 or 8 data bits
 - Even or odd parity
 - 1 or 2 stop bits
 - 1, —16, —24 baud rate divisor
 - Master reset
 - RTS mode control
- * Double buffered send and receive registers
- * Supports full duplex operation

Parallel Interface

- * Two bi-directional 8-bit ports
- * Four additional interrupt and handshaking lines
- * Interface configuration and data direction controlled by software

Firmware

- * 256 bytes of on-board PROM

Addressing

- * 6 memory mapped registers

Cable Assemblies

- * Serial interface-- 6 inch ribbon cable with DB-25 socket
- * Parallel interface-- 18 inch ribbon cable with uncommitted end

PC Board

- * High grade FR-4 blue epoxy.
- * Double sided solder mask with silk screened parts legend and gold-plated edge connector contacts.
- * Dimensions-- 2.7" x 6.3" (excluding edge connector contacts).

Miscellaneous

- * PROMs and data buffer power-down when not addressed
- * Sockets provided for all ICs

A.I.O.

Nett	Vat	Total
105.00	15.75	120.75

- * Incorporates Pascal and Basic control characters.
- * All monitor-type escapes are valid.
- * Follows protocols of Pascal and Basic operating systems.
- * Compatible with All Apple II peripherals.
- * Effective baud rate greater than 10,000 fast scrolling and clearing.
- * Synchronous operation with Apple II.
- * Can be used with Apple II communication interface board to act as self contained terminal for time-sharing or other applications.

Video Board

Nett	Vat	Total
275.00	41.25	316.25

AIO™ Serial & Parallel Apple Interface

TWO BOARDS IN ONE

The AIO Apple Interface allows maximum flexibility for interfacing your Apple II with peripherals such as printers, plotters, terminals, modems and other computers. The AIO can communicate with both serial and parallel devices. It can even interface with both at the same time. And you won't need to write any software to operate the AIO. It comes complete with the necessary software and on-board firmware to handle serial and parallel communications.



APPLE III

Interested?? Please ring 051-933 5511!!

Please ring Paul Fullwood or Carl Phillips for other interfacing requirements.

Stack Computer Services Ltd
290-298 Derby Road, Bootle,
Liverpool L20 8LN.
051-933 5511.



**COMPUTER
SERVICES
LIMITED**

What will you do with 12-year-old programmers when they reach 16?

Any microcomputer is a major investment for an educational establishment. Many potential users feel that a BASIC only computer is ample for their needs. That may be fine today, but with computer education starting so early you may in a surprisingly short time find you want more than current implementations of BASIC.

The 380Z is a computer that can grow to match your needs.

In the design of the 380Z our target user is the graduate research scientist. This ensures that the expandability and versatility needed tomorrow has been provided for in the computer you buy now.

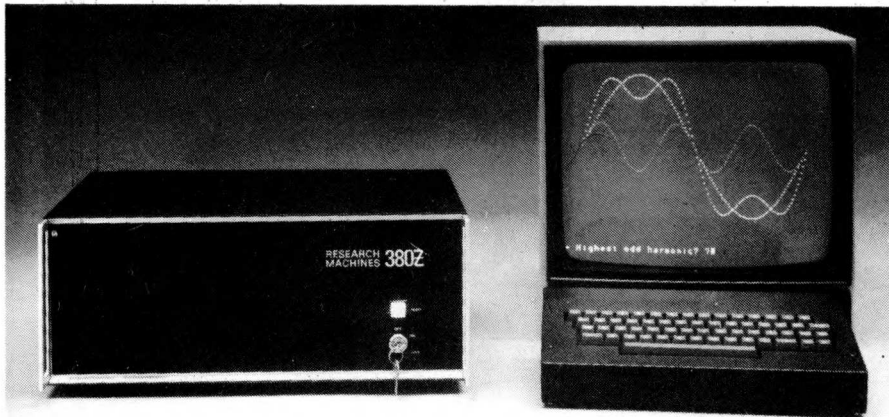

Might you want to add disc storage in the next few years?

If you do:

Given good hardware, software availability completely determines the flexibility and usefulness of your system. There is absolutely no question that a Z80 based micro-computer which uses the industry-standard CP/M* disk operating system has several times more software on the market available to it than non CP/M computers.

Today you can purchase a mature CP/M BASIC, FORTRAN, COBOL or Text Processor for the 380Z. Soon there will be CP/M Pascal and Database Management systems.

CP/M software is several years ahead of software available for non CP/M family machines.

If you don't:

Remember that professionals writing packages for your cassette system will themselves often use a disk 380Z, and the power of their tools will influence what they produce.

For many people a disk machine is too expensive – but at least the 380Z

approach will allow your students to advance.

380Z BASIC is not frozen in ROM. An enhanced BASIC could be loaded in mid 1980 and a BASIC with structured features sometime later.

On the 380Z the memory used by a BASIC interpreter can also be used for other software.

Does our research-oriented design pay off in classroom hardware?

Our scientific graphics was produced for the professional user. Interest in it for classroom use has been surprising.

The 380Z has the best graphics now available on a microcomputer,

allowing multiple resolutions, multiple paging, fading and accurate control over colour. All these features help bring excitement to efforts in computer assisted learning.

Our standard machine comes with low resolution graphics and support for this from BASIC allows you to plot a point directly with a plot command – useful for training and teaching.

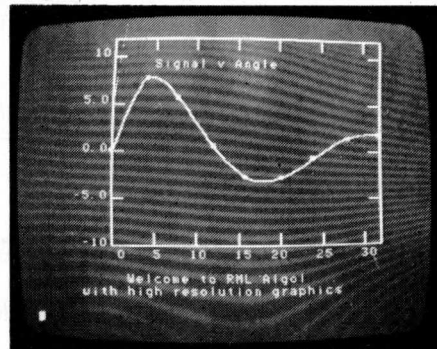

It is worth remembering too that neither our low resolution graphics nor our optional scientific (high resolution) graphics has any limiting effect on your memory usage, and in both you can

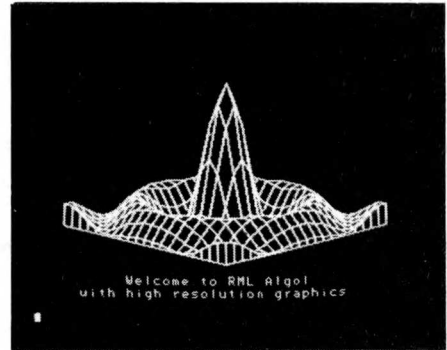

freely mix upper and lower case text and diagrams.

Mains noise can cause system crashes which result in loss of programs and data. All current 380Zs include a mains filter which significantly reduces the chances of this happening.

Don't buy a 380Z on patriotic grounds.

Please only buy it if you would have bought it anyway. But remember, because it is designed and manufactured here you are bound to have better access to us for influence and help than if we were on the other side of an ocean.

Prices range from a 16K cassette 380Z @ £897 to a 56K Dual Full Floppy Disk 380Z @ £3322.

LOWER COSTS

Three things have happened which make it easier to buy a 380Z.

ONE: From 1st November 1979 most prices have been reduced.

TWO: Schools and some colleges can now get a 5% discount on computer orders.

THREE: A new Local Authority quantity discount scheme has been introduced to make it easier for more users to benefit from quantity purchasing.

Please contact the Sales Office for details.

RESEARCH MACHINES

RESEARCH MACHINES Ltd,
PO. Box 75, Mill Street, Oxford, England.
Telephone: Oxford (0865) 49791/2/3.
Please send for full sales information.
Prices do not include shipping costs or VAT @ 15%: * Trademark, Digital Research.

BEE LINES

FIRST PRODUCT FOR NATIONAL RELEASE

The Bee. (Prestel on your Pet)

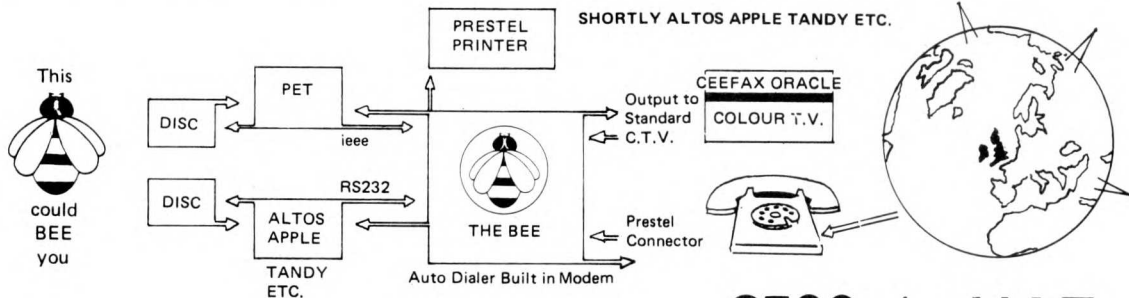

RENTAL CAN BE ARRANGED.
PENDING P.O. APPROVAL

10% SECURES ONE OF FIRST DELIVERIES.
DEALER ENQUIRIES INVITED. PRESTEL IS A P.O. TRADE MARK

£500 plus V.A.T.

Now Available

Orders being taken by Sole Distributors.

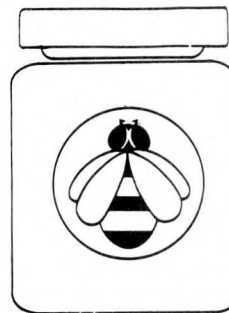
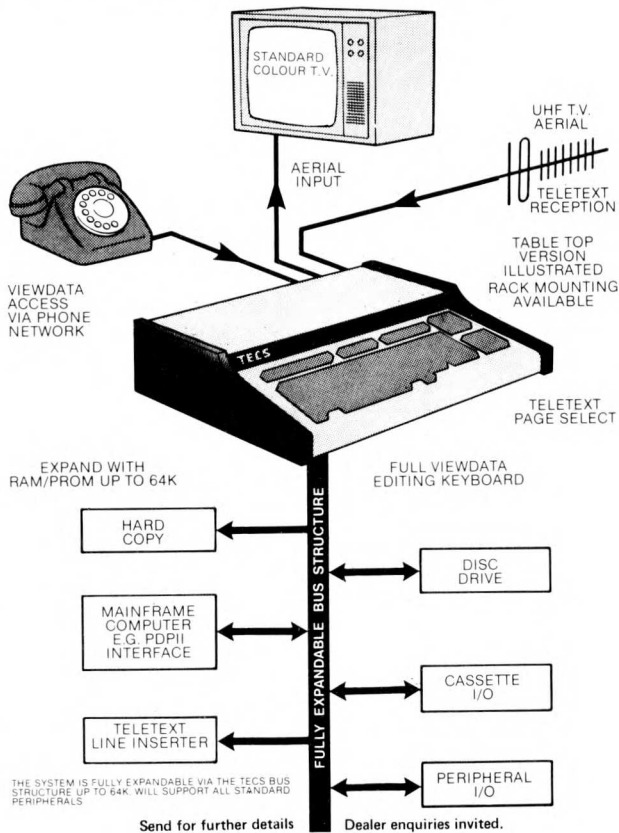

SPECIAL ANNOUNCEMENT
B. & B. will part exchange your software when you buy Bee soft. (Send for details or phone)

JARS SOFTWARE

Have you been stung?

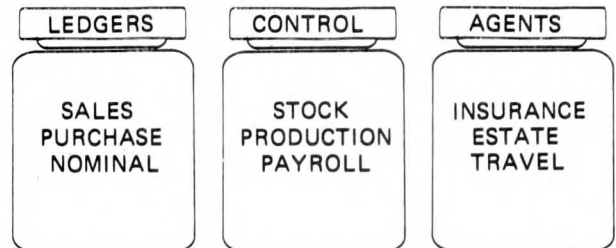

ETC. ETC. ETC.

AT LAST!! PROFESSIONAL SOFTWARE FOR PETS & THE NEW TECS. SEND FOR DETAILS OR PHONE. DEALER ENQUIRIES INVITED.

● **STOP PRESS £150** BB DOS is now available true random access on the Commodore disc drive

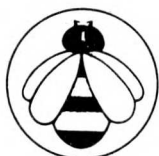

B&B [Computers] Limited

The Consultants for the North West



ALL CHEQUES TO B. & B. (COMPUTERS) LTD.
DELIVERIES OF HARDWARE 60/90 DAYS.
SOFTWARE EX STOCK.

SUITE 1,
124 NEWPORT STREET,
BOLTON BL3 6AB.
LANCASHIRE.
Tel: (0204) 26644, 382741.

Now available on Earth



THE SHARP MZ-80 COMPUTER SYSTEM

Sharp have been associated with many major advances in electronic technology in space and here on Earth. We have introduced the most sophisticated production techniques for electronic circuitry to set world renowned standards of reliability into every product.

That's why the MZ-80K and its range of peripherals is going to change the way you think about microcomputers. The Sharp MZ-80 System now includes the MZ-80K processor backed with the MZ-80FD dual drive, double sided mini-floppy disk unit to give rapid, effective, sequential and random access, to huge amounts of stored information with incredibly fast response times.

Our new MZ-80P3 printer makes a good impression as well. Its fine definition dot matrix

head prints across 80 columns, at 100 characters per second, with full graphics capabilities.

The Sharp MZ-80 System is a new approach to computer applications, and their efficient use by human beings.

Our aim is to make computers and their related equipment relatively simple and therefore better understood and better used by those they are designed to serve.

Whether you are looking for a business system, or a system for educational or personal use—take a look at Sharp, it will change the way you think about computers.

Send me details of the complete Sharp MZ-80 System and the name and address of my nearest stockist

Name _____

Address _____

PCW/7

Sharp Electronics (UK) Limited, Sharp House, Thorp Road, Newton Heath, Manchester. M10 9BE Tel: 061-205 2333



COMPUTER APPLICATIONS

NEW!

**Produced in U.K. and widely used in England and U.S.A.
complete business package**

**INCLUDES EVERYTHING FROM INVENTORY TO SALES SUMMARY
PROMPTS USER AND VALIDATES ENTRIES. MENU DRIVEN**

BUS VER 3.00 TO VER 9T

**APPROXIMATELY 60-100 ENTRIES/INPUTS REQUIRE 2-4 HOURS WEEKLY AND ENTIRE BUSINESS
IS UNDER CONTROL**

* PROGRAMS INTEGRATED	SELECT FUNCTION BY NUMBER.....
01 = * ENTER NAMES & ADDRESSES.....	13 = * PRINT CUSTOMER STATEMENTS
02 = * ENTER/PRINT INVOICES	14 = * PRINT SUPPLIER STATEMENTS
03 = * ENTER PURCHASES	15 = * PRINT AGENT STATEMENTS
04 = * ENTER A'C RECEIVABLES	16 = * PRINT TAX STATEMENTS
05 = * ENTER A'C PAYABLES	17 = GENERAL HELP
06 = * ENTER' UPDATE INVENTORY	18 = ALTER VOCABULARIES
07 = * ENTER' UPDATE ORDERS	19 = PRINT YEAR AUDIT.....
08 = * ENTER' UPDATE BANKS	20 = PRINT PROFIT'LOSS A'C
09 = * EXAMINE' REPORT SALES LEDGER.....	21 = ENDMONTH MAINTENANCE.....
10 = * EXAMINE' REPORT PURCHASE LEDGER.....	22 = PRINT CASHFLOW FORECAST.....
11 = * EXAMINE' INCOMPLETE RECORDS	23 = ENTER PAYROLL (NO RELEASE)
12 = * EXAMINE PRODUCT SALES	24 = EXIT SYSTEM

..... ENTER WHICH ONE?

DATABASE MANAGEMENT INCLUDES

*** FILE CREATE 'DELETE' SEARCH. *** RECORD CREATE 'DELETE' SEARCH'4 OPTION PRINT *** RECORD SORT ANY FIELD ALPHA OR NUMERIC. *** INDEX SEARCH OR GENERAL SCAN'PRINT IN ANY FIELD (EG TOWN OR NAME). *** 4 ARITHMETIC FUNCTIONS TO USE AS CALCULATOR ON LAST 4 FIELDS. *** AUTO CHECK TO PREVENT DOUBLE ENTRY TO FILE MANAGEMENT SYSTEM, DYNAMICALLY ALLOCATING INFORMATION TO MINIMISE DISK SPACE CONSUMPTION.

VERY FLEXIBLE. EASY TO USE

G.W. COMPUTERS U.K. ARE THE PRODUCERS OF THIS BEAUTIFUL PACKAGE
VER 3.00 (EXC PROG 19, 20, 22, 23) = 475.00, VER 4.00 INCLUDES AUTO STOCK
UPDATE = 575.00, VER 5.00 INCLUDES AUTO BANK UPDATE = 675.00, VER 6.00 IN
CORE = 775.00, VER 7.00 (INC 19, 20, 22, 23) NOT YET RELEASED = 875.00, VER 8.00 RANDOM
ACCESS = 900.00, VER 9.00 TRANSLATEABLE = 975.00. +++ EACH LEVEL OVERRIDES LOWER ONE

**WE EXPORT TO ALL COUNTRIES CALLERS ONLY BY APPOINTMENT
CONTACT TONY WINTER ON 01-636 8210**

**89 BEDFORD COURT MANSIONS, BEDFORD AVENUE, LONDON W.C.1.
NOTE!!! All versions, especially 9.00 use broad financial principles and 9.00 is
one 16K core program releasing both disk drives for data storage, as well as
being translateable into any foreign language**

**IMPORTANT!! We also sell the hardware for the above tasks to enable the purchase from one source,
and offer a general file database management system (value 100 pounds) plus 1 years software support
(value 50 pounds) FREE with a total system purchase**

PET + PET + PET + PET + PET + PET +	
CBM 32K 3032	795.00
CBM 3040 DISKS	795.00
CBM 3022 PRINTER	525.00
CBM CABLES FOR ABOVE	45.00
PAPER AND 10 DISKS	57.00
EPSON PRINTER	495.00
SUPERBRAIN + SUPERBRAIN	
TWIN Z80CPU TWIN D'D/DRIVE	
64K RAM AND CRT	1950.00
S100 BUS ADAPTER	250.00
ADD-ON 20 MEG DISK	5250.00
S'BRAIN QUAD. 800K	2500.00
PRINTERS + PRINTERS + PRINTERS +	
PAPER TIGER 195CPS	575.00
TELETYPE 43SR 30CPS	875.00
DEC-LA34 TRACT 30CP	875.00
NEC-SPINWRITER	1650.00
QUME DAISY SPRINTS	1950.00
TEXAS 810 150CPS	1395.00
SPECIALS + SPECIALS + SPECIALS +	
IMS 48K TWIN D'D/D	1500.00
N'STAR QUAD. 7 MEG	1500.00
INTERTUBE III TERML	495.00
COMPUTHINK *800K*	895.00
CRDLESS PHONE INOUT	195.00
TELEPHONE ANSWER	230.00
CORDLESS PHONE IN	80.00

SOFTWARE + SOFTWARE + SOFTWARE	
COMMACCOUNTS	650.00
COMPANY	150.00
COMBIS'COMSTOCK	150.00
WORDPRO II	75.00
WORDPRO III	150.00
VER 3.00	475.00
VER 4.00 STK'BNK	575.00
VER 9.00R'ACCESS	975.00
W'STAR TEXT'PROC	250.00
WORD-MASTER TX'ED	75.00
MBASIC 80	150.00
COBOL 80	320.00
PASCAL Z	150.00
FORTRAN 80	200.00
ED' ASM S'BRAIN	FREE
PASCAL-M	250.00
BYSTAM	75.00
SUPERSORT	120.00
BASIC COMPILER	190.00
DESPOOL	30.00
BYSTAM IMS' N-STAR	75.00
CPM TEXTWRITER	75.00
CPM POSTMATER	75.00
CPM SELECTOR 3	180.00
CPM CBASIC IMS	75.00
CPM MACRO 80	75.00
CPM W'STAR MAILER	310.00
WARRANTY + WARRANTY +	
90 DAY FREE REPLACEMENT	

VARIOUS + VARIOUS + VARIOUS +
WE SPECIALISE IN THE NEW SUPERBRAIN DOUBLE DENSITY TWIN DISK AND QUAD DENSITY 800K TWIN DISK COMPLETE MICRO-COMPUTERS WITH THE FULLEST HARDWARE AND SOFTWARE SUPPORT. ALL YOU NEED WITH THIS SUPERB SYSTEM (HOUSED IN ONE MODULE) IS ANY RS232 PRINTER. IT IS POSSIBLE TO EXPAND THE STORAGE CAPACITY OF THE LARGER 800K WITH UP TO 20 MEG HARD DISK. AS WELL AS LINKING 32 SUPERBRAINS TOGETHER WITH A MULTI USER BASIC THIS UNDOUBTEDLY IS ONE OF THE BEST SYSTEMS OF THE MARKET AT THIS TIME. WHY NOT CALL TONY WINTER AND ASK FOR MORE INFORMATION.

NEW SYSTEM 33 Z8085 48/64K + 2.4 MEG 8" DISK LIKE SUPERBRAIN 4250.00 8 INCH DISKS ALL IN THE.

**SPECIAL INSTITUTION AND UNIVERSITY DISCOUNTS
STOCK AND COMING ROUND. (BARCLAYCARD WELCOME OTHERWISE
CHEQUE WITH ORDER)
CONTACT TONY WINTER 01-636 8210
89 BEDFORD CT MANS, BEDFORD AVE W.C.1.**

ENTER THE COMPUTER AGE

**NOW
TO WIN A TRIP
TO HONG KONG**
See your dealer for
details



See it at the following dealers

VIDEO GENIE SYSTEM £425 inc VAT

3 Line Computing
Hull 445496

Advance Television Services
ShIPLEY 585333

Amateur Radio Shop
Huddersfield 20774

Bredhurst Electronics
Handcross 400786

Briers Polytechnic Bookshop
Middlesbrough 242017

Buss Stop
Watford 40698
Newport Pagnell 610625

Cambridge Microcomputers Ltd
Cambridge 314666

Catronics Limited
Wallington 01 669 6700/1

Cavern Electronics
Milton Keynes 314925

Computer Business Systems
Lytham 730033

Computerama Limited
Bath 28819

Computopia Limited
Leighton Buzzard 376600

Computer and Chips
St Andrews 72569

Derwent Radio
Scarborough 65996

Eiron Computers Limited
Dublin 808575/805045

Eley Electronics
Leicester 871522

Gemsoft
Woking 22881

Leisuretronics
Blackpool 27091

Marlon Microcomputer Services
Northampton 890661

Matrix Computer Systems Limited
Beckenham 01 658 7508/7551

Microdigital Limited
Liverpool 227 2535

Midland Microcomputers
Nottingham 298281

Microtime Products Limited
Watford 38423
Basingstole 56417

Mighty Micro Limited
Burnley 32209/53629

MRS Communications
Cardiff 616936/7

Optelco
Rayleigh 774089

Route 66
New Cross 01 732 8608

SMG Microcomputers
Frasersend 55813

Tryfan Computers
Bangor 52042

University Radio
Nottingham 45466

Ward Electronics
Birmingham 021 554 0708

SOLE IMPORTERS

LOWE ELECTRONICS

BENTLEY BRIDGE
CHESTERFIELD Rd
MATLOCK
DERBYSHIRE DE4 5LE

Trade Enquiries Welcome



Micro U.K.

The business & leisure microcomputer conference

The main event

Micro UK is the conference component of the year's most important business and personal computing show.

Top-line US and European specialists are coming to London to present a comprehensive update on current advances in technology and to discuss the practical aspects of putting together and implementing micro systems successfully.

The multi-stream structure offers the widest possible subject choice and gives each delegate the flexibility to tailor his attendance to suit his own requirements.

The first two days concentrate on the use of micros in industry and commerce and the third day is devoted to a series of half-day teach-ins for the personal computer enthusiast.

Whether you come for one, two or three days, your conference fee buys you entry to the sessions of your choice, unrestricted access to the PCW exhibition (usually £2 per visit) and a chance to meet the speakers face-to-face in a special Micro UK feature.

Outline I

each heading descr

Conference (4 and 5 September)

Technology Stream I

Processors and Memory

memory chips – special purpose chips – bit slicing
– new systems architecture – Motorola 6809 –
Intel 8086 – Zilog Z8000 – 16 bit micros

Storage Systems

diskettes – single/double density – single/double
sided – hard disks – 8" Winchester technology –
fixed/changeable – costs and reliability

Communications

modem technology – PO facilities – data link
controls – high level protocols – local area
networks – Prestel – personal computer network

Systems Review

survey of micro systems – Texas Instruments
TI 99/4 – Apple III – Triumph Adler Alphatronic –
Sinclair ZX80 – other new releases

Technology Stream II

Monitors and Operating Systems

CP/M – MP/M – low level monitors – multi-testing
– multi-user operating systems – utility
program

Languages

BASIC – Business BASIC – Pascal – PL/1 – APL –
language developments

Programming and Quality Control

program design – debugging tools – project control
– program productivity

Micro U.K.

is in conjunction with the third

Programme – as a half-day session

Development Systems

development and programming aids – ROM – EPROM – simulators – testing

Applications Stream

Retail and Distribution

stock control – order processing – point of sale – billing – financial management

Manufacturing

process control – production control – inventory management – job scheduling

Word Processing

special purpose/general purpose hardware – peripherals – displays and printers – cost justification

Professional Office Systems

time recording – client billing – diary management – client services

Teach-ins (6 September)

Game Playing on Micros

DIY Circuit Building

Music and Microcomputers

Micros for the Disabled

Simulation and Business Games

Technology and Concepts for the Businessman

Building your own System

The Personal Computer Network

Meet the experts

As well as the wide-ranging 'traditional' conference sessions, Micro UK offers you a unique opportunity to meet some of the world's leading micro authorities face-to-face and get expert advice on your very own systems and equipment.

It's the next best thing to personal consultancy – and at a fraction of the cost.

This special feature is available on all three days only to Micro UK delegates. Get the full conference brochure now and make sure of your place. Phone the conference office on Uxbridge (0895) 30594 or clip the coupon below.

**The Micro UK Conference Office,
106 Pield Heath Road, Hillingdon,
Middlesex UB8 3NL.**

Please send me _____ copies of the full conference programme.

Name _____

Position _____

Organisation _____

Address _____

_____ Tel. No: _____

PCW

Wego Computers Ltd

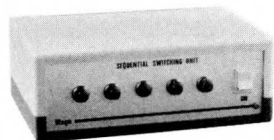

Wego Sequential Switching Unit

Allows up to 5 devices to be connected to the mains, and with one switching operation power up and down all the devices, in the correct sequence.

 CBM approved
£59.55 + VAT



Numeric Key Pad for the Apple.

A 13 digit Key pad (0-9, -, ., ENTER) to run in parallel with the numeric section of the APPLE Keyboard. Supplied with connecting cable, plugs and sockets.

£89.50 + VAT



Mark Sense Card Reader

"A pencil, a card, and this low-cost reader. . . it's the new, fast way to enter data into your microcomputer." Versions available able to communicate with PET, APPLE, TRS-80, or any S100 or RS232 bus. Ideal for business and education applications.

 CBM approved
Prices from £620 + VAT

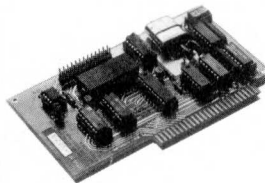

California Computer System Cards for the Apple.

Synch Serial Card	£106.37 + VAT
Asynch Serial Card	£106.37 + VAT
Para-ll Card	£ 79.77 + VAT
Arithmetic Proc. Unit	£265.97 + VAT
Programmable Timer	£106.37 + VAT
IEEE GPIB	£ 99.72 + VAT
ROM/PROM Module	£ 70.89 + VAT

 Sole UK Distributors

Available from your local dealers, or direct from Wego Computers Ltd., 22A, High Street, Caterham, Surrey CR3 5UA. Tel: (0883) 49235 Telex: 8813791

Authorised COMMODORE APPLE Dealers

The new powerful personal computer from Sweden...



... now looking for powerful retailers to be appointed for many areas in UK

Now available from UK stocks

ABC80

The microcomputer which outsells all others in Scandinavia.

Write: Dator Ltd. / Fox Oak / Seven Hills Road / Walton-on-Thames / Surrey kt 124 dg

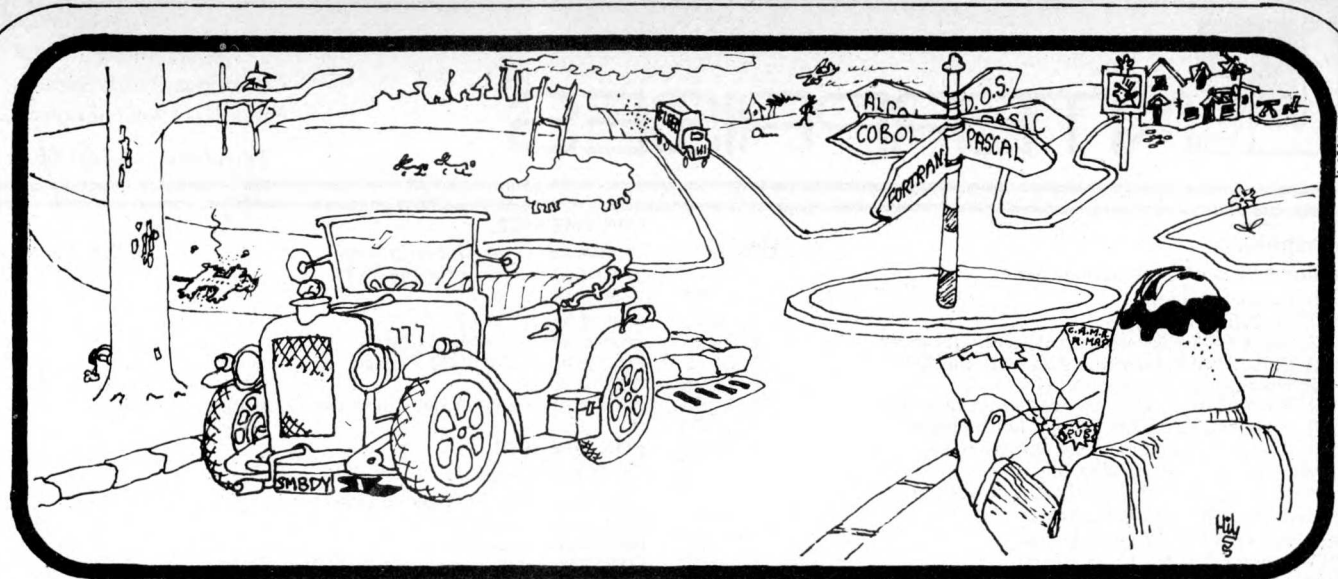

Somebody must know and it's no good asking in the pub

Your business is not exactly the same as any other and neither are its problems. Any solutions are probably unique and must be tailored exactly for you.

You know your business better than anyone else and any system designed should use your knowledge. The micro-computer specialist should show you how to use the computer to meet your business requirements.

You should be able to get the micro-computer which best suits your business. It should be chosen after your requirements are specified.

You and your staff have a right to know all about YOUR system, including helping to program it if you want to. Training is your right – not an additional service.

If microcomputers cannot satisfy your business needs, you want to know – you don't want false promises.

**67 Nova Road, Croydon, Surrey CR0 2TN.
Telephone: 01-688 6013**

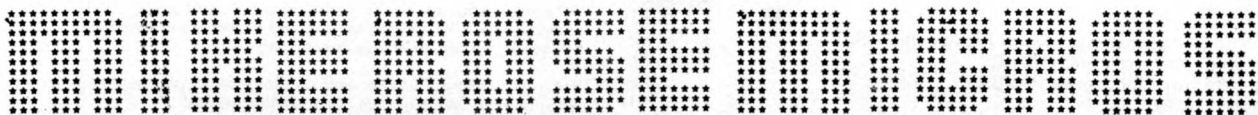

BY OSBORNE

Introduction to Microcomputers Series

Vol 0: Beginners Book	£	5.95
Vol 1: BASIC Concepts	£	6.30
Vol 2: Some Real Microprocessors (without binder)	£	18.95
Vol 2: Some Real Microprocessors (with binder)	£	24.70
Vol 2: Updating supplement set Nos. 1-6	£	18.95
Vol 3: Some Real Support Devices (without binder)	£	11.95
Vol 3: Some Real Support Devices (with binder)	£	17.70
Vol 3: Updating supplement set Nos. 1-6	£	18.95
1 binder (Specify for Vol 2 or 3)	£	5.75
1 Updating supplement (Specify for Vol 2 or 3)	£	4.00
PET and the IEEE 488 (GPIB) bus	£	9.95
6800 Programming for Logic Design	£	6.30
8080 Programming for Logic Design	£	6.30
Z80 Programming for Logic Design	£	6.30
Z80 Assembly Language Programming	£	8.15
6502 Assembly Language Programming	£	8.25
8080A/8085 Assembly Language Programming	£	7.95
6800 Assembly Language Programming	£	7.95

	C Basic	Wang Basic
Accounts Payable and Accounts Receivable	£ 13.15	£ 12.75
Payroll with Cost Accounting	£ 13.50	£ 12.95
General Ledger	£ 12.25	£ 11.95
Some Common BASIC Programs		£ 7.95

GENERAL

See Magazines and Subscriptions!

Microprocessors from Chips to System	£	7.00
Microprocessor Interfacing Techniques	£	9.95
Numbers in Theory and Practice (A BYTE publication)	£	5.50
Cheap Video Cookbook	£	4.30
CMOS Cookbook	£	7.50
IC OP-AMP Cookbook	£	8.95
RTL Cookbook	£	4.25
TTL Cookbook	£	7.50
Ciarcias Circuit Cellar	£	5.50
First Book of Kim	£	7.00
Buyers Guide to Microsoftware	£	2.40
Calculating with BASIC	£	4.95
Computer Programs that Work (In BASIC)	£	2.95
BASIC Software Library: (Listings)		
Vol 1: Business and Games Programs	£	17.50
Vol 2: Maths, Engineering and Statistical Programs	£	17.50
Vol 3: Advanced Business Programs	£	26.95
Vol 4: General Purpose Programs	£	7.95
Vol 5: Experimenters Programs	£	7.95
Vol 6: Miniature Business System	£	32.50
Vol 7: Chess/Medbil/Wdproc Programs	£	26.95
Vol 8: Home owners Programs	£	14.95
Dr Dobbs Journal, Volume 1	£	13.95
Dr Dobbs Journal, Volume 2	£	13.95
Dr Dobbs Journal, Volume 3	£	13.95
Best of Interface Age-software	£	9.95

FOR THE Z80

See Osborne books!

32 BASIC Programs for the TRS-80 C Level II	£	10.10
Introduction to T-Bug CTRS 80 Machine Laing Monitor	£	4.50
Z80 Software Gourmet Guide and Cookbook	£	8.50
Programming the Z80 (ZACS)	£	9.95
Z80 Instruction Handbook (Wadsworth)	£	2.95

FOR THE 6800

See Magazines and Subscriptions!

6800 Software Gourmet Guide & Cookbook	£	7.15
6800 Tracer - An aid to 6800 Program Debugging	£	3.95
Tiny Assembler	£	5.75
RA 6800 ML - An M600 Relocatable Macro Assembler	£	15.95
Link 68 - An M6800 Linking Loader	£	5.50
MONDEB - An Advanced M6800 Monitor Debugger	£	3.50

CONCERNING LANGUAGE

SCELBAL - BASIC Language Interpreter (Source Code)	£	15.00
Instant BASIC	£	6.95
Basic BASIC	£	6.50
Advanced BASIC	£	6.00
My Computer likes me . . . when I speak in BASIC	£	2.75
Users Guide to North Star BASIC	£	10.00
A Practical Introduction to PASCAL	£	3.95
Microsoft BASIC	£	6.50
Secret Guide to Computers		T.B.A.

FOR THE 6502

See Magazines and Subscriptions!

32 BASIC Programs for the PET	£	10.10
Best of Micro, Vol 1	£	5.50
Best of Micro, Vol 2	£	5.50
Programming the 6502 (Zacs)	£	7.95
Programming the 6502 (Foster)	£	6.75
6502 Applications	£	7.95
6502 Software Gourmet Guide and Cookbook	£	7.25

See Osborne Books!

FOR THE 8080

See Osborne Books!

8080 Programmers Pocket Guide	£	1.95
8080 Hex Code Card	£	1.95
8080 Octal Code Card	£	1.95
8080 Software Gourmet Guide & Cookbook	£	7.15
8080/8085 Software Design	£	6.75
8080 Standard Monitor	£	9.95
8080 Standard Assembler	£	9.95
8080 Standard Editor	£	9.95
8080 Special Package: Monitor, Editor, Assembler	£	20.00
BASEX: A Simple Language and Compiler for the 8080	£	5.50

FOR FUN

Starship Simulation

SARGON - A Chess Game (for the Z80)	£	9.50
BASIC Computer Games	£	5.00
More BASIC Computer Games	£	5.50
What to do After you Hit Return	£	8.95
8080 Galaxy Game	£	6.95
SUPER-WUMPUS - A game in 6800 Assembler Code & BASIC	£	4.25
Computer Music Book	£	6.75
Computer Rage (A board game)	£	6.95
Artist and Computer	£	3.95
Games, Tricks and Puzzles for a Hand Calculator	£	2.49
Introduction to TRS-80 Graphics	£	5.75
Take My Computer Please . . . (Fiction)	£	3.25
Introduction to Low Resolution Graphics for Pet, Apple, TRS80	£	5.50

FOR THE NOVICE

See Magazines and Subscriptions!

How To Make Money with Your Microcomputer	£	5.75
From the Counter to the Bottom Line	£	10.00
Your Home Computer	£	5.95
Introduction to Personal and Business Computing	£	5.50
Getting involved with Your Own Computer	£	5.50
How to Profit from Your Personal Computer	£	5.50
Microcomputer Potpourri	£	1.95
Hobby Computers are Here	£	3.95
New Hobby Computers	£	3.95
Understanding Microcomputers and Small Computer Systems	£	6.95
Understanding Microcomputers and Small Computer Systems and Audio Cassette	£	8.75
Getting Down to Business With Your Microcomputer	£	5.50

See Osborne Books!

MAGAZINE BACK ISSUES/SUBSCRIPTIONS

Micro 6502 Journal/12 issues	£1.50/£	13.50
Personal Computing/12 issues	£1.95/£	17.50
Interface Age/12 issues	£2.95/£	25.50
ROM	£	1.95
Dr. Dobbs Journal/10 issues	£1.95/£	15.00
Computer Music Journal	£	3.75
Recreational Computing/6 issues	£1.95/£	10.50
BYTE/12 issues	£2.95/£	25.00
Creative Computing/12 issues	£1.95/£	17.00
Computer II - for the single Board/6 issues	£1.95/£	10.50
Kilobaud Microcomputing/12 issues	£2.75/£	22.00
Compute - for the 6502/6 issues	£1.95/£	10.50
68' Micro/12 issues	£1.95/£	17.50
Magazine Storage Box (Holds 12)	£	1.50
80' Microcomputing/12 issues	£2.25/£	21.00

HOW TO ORDER:

Send cash, postal order, cheque card number to L.P. Enterprises, Room 8, Cambridge House, Cambridge Road, Barking, Essex IG11 8NT. All payment must be in Sterling and drawn against a U.K. bank.

Please note: If you wish to pay by Diners Club credit card, we must have your signature. For any payment by credit card, we need the expiry date of the card and the address that the credit card company knows (although we can send the goods to an alternative address).

All publications are published in the U.S.A. and are stocked in Britain by L.P. Enterprises. Prepaid orders are despatched by return of post, or advice concerning.

For more information on any of these items, please phone, write or visit. (We are open during office hours).

TRADE ENQUIRIES WELCOME

MULTI-USER, MULTI-TASKING MICRO SYSTEMS FROM £5000

For business, education and scientific use.

- Cartridge storage 10MB to 1200MB.
- Comprehensive utilities.
- Word processing.
- Multi-language (languages supported include Basic, Cobol, Fortran, APL, Pascal etc.

OEM and Dealer enquiries invited.

EQUINOX

COMPUTER SYSTEMS LIMITED

Kleeman House, 16 Anning Street,
New Inn Yard, London EC2A 3HB.
Tel: 01-739 2387 & 01-729 4460

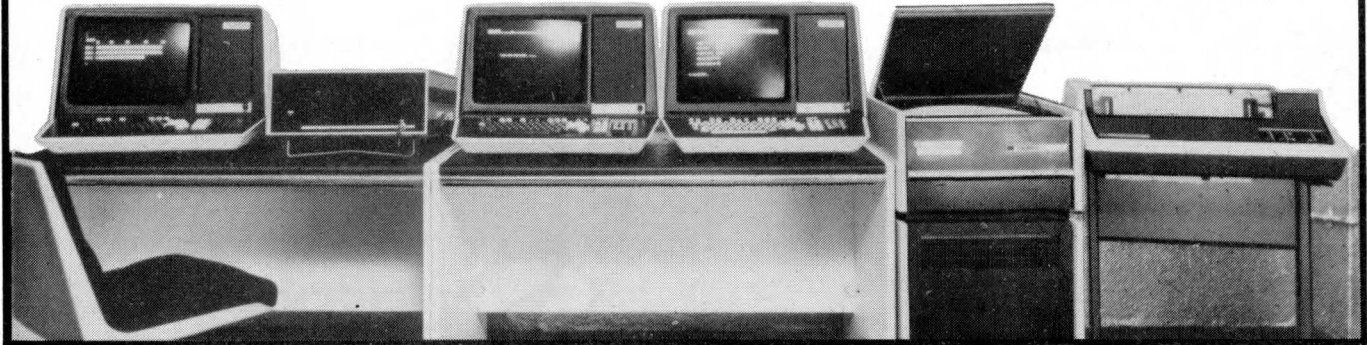

ELIMINATE YOUR BACK-UP PROBLEMS

with our low cost cartridge drive



PRICE
£3950*
PLUS VAT

*One-off OEM price

The Equinox KB10 Cartridge Drive allows S100 microsystems to transfer, read and write data at high speed. Its 5MB fixed and 5MB removable discs eliminate the need to provide separate data back-up. The removable 5MB disc allows for fast back-up and therefore unlimited off-line storage. Without sacrificing high performance, multiple users can operate the Equinox KB10 simultaneously using multi-user software. Equinox provides support for such software i.e., MVT/FAMOS, MP/M and OMNIX. CP/M is also supported.

EQUINOX

COMPUTER SYSTEMS LIMITED

Kleeman House, 16 Anning Street, New Inn Yard,
London EC2A 3HB. Tel: 01-739 2387/9 and 01-729 4460

add £££'s to your **PET** CONVERSION KIT **£35**

Either the \$ sign or the # symbol is replaced by a genuine £ sign in our modified character set ! state \$ or # modification



double vision

An ingenious modification for your PET which adds countless facilities to the display -

- QUAD-RES graphics
- underlining
- double-intensity characters

the possibilities are virtually limitless !

FULL DATA SHEET ON REQUEST

PET PROGRAMS

Renumber	£6	Multiple Choice	£15	Wizard's Lair	£10
Block Renumber	£12	Linear Regression	£25	Tyrant	£10
Assembler Mk3	£12	Life	£8	Air Attack	£6
Shrink	£5	Opinion Poll	£15	Sweeper	£7
Screendump	£5	ASK FOR OUR FREE CATALOGUE		Discomania	£6
Memory Tests	£8			Stockbroker	£8
Supersort	£8			Minefield	£4

PLUS

ALL THOSE LITTLE EXTRAS

- 10 Quality C.12 cassettes £3.95
- 10 Verbatim 5¼ in disks £24.95
- PET/printer interface only £35
- Add-on green screens just £5.50
- User-port soundbox £16.75

Add 15% VAT to all prices



UPERSOFT

28 Burwood Avenue, Pinner, Middx

SALE

Ideal opportunity for small businesses, educational establishments and personal users to buy hardware at fantastically low prices.

Due to reorganisation we have well-known brands of micro systems, printers, peripherals, computer games, memory boards etc which must be cleared off our shelves.

BUY NOW....

Daisy wheel printers, plus stand and accessories for only £1,000!
Disc drives - brand new and boxed - half price!

Get the details now from your local



London
48 Tottenham Court Road
London W185 4TD
Tel. 01-636 0647

Glasgow
Magnet House
Waterloo Street
Glasgow Tel. 041-221 7409
Telex. 779263

Birmingham
94-96 Hurst Street
Birmingham B5 4TD
Tel. 021-622 7149 Telex. 336186

Nottingham
92a Upper Parliament Street
Nottingham NG1 6LF
Tel. 0602 40576 Telex. 377389

Manchester
11 Gateway House
Piccadilly Station Approach
Manchester
Tel. 061-236 4737 Telex. 666168

PROMGLOW LTD

MICRO-SALES, MICRO-LEASE, MICRO-HIRE, MICRO-BOUGHT.

MICRO WITH YOUR REQUIREMENT.

We have the best in Micros, Apple, Intertec Superbrain (rapidly becoming industry standard). Horizon are just some. Low maintenance rate after 1 year guarantee, if you ever need it.

MICROSALES: APPLE II + IN COLOR, WITH OTHER CARDS FOR HOBBYIST, EDUCATIONALIST, BUSINESS, PROFESSIONALS, 64K PASCAL, FORTRAN, APPLE-FORTH AND OTHER SOFTWARE.

INTERTEC SUPERBRAIN
32K/64K AND MORE WITH \$100 EXPANSION INDUSTRY STANDARD CP/M, SYSTEM, TWO Z80 OPERATIONS. TWO QUAD DENSITY OR DOUBLE DENSITY DRIVES NICELY PUT TOGETHER WITH A SCREEN

PCM PASCAL
APL FORTRAN
ASM COBOL

MICRO-CUSTOM DESIGN REQUIREMENTS: LET US IMPLEMENT YOUR IDEAS IN ALL AREAS ASPECT OF COMMUNICATIONS MAPCON REGISTERED CONSULTANTS.

MICROLEASE: TAKE ADVANTAGE OF LEASING, THERE MAYBE PLENTY FOR YOU AND FOR HAVING A MICROSYSTEM.

MICROHIRE: APPLE, HORIZON, SORCERER, PET, TRS 80, SUPERBRAIN. SOME BELOW £12 PER WEEK. NO DELIV. COLLECT CHARGES IN LONDON.

BARGAIN CORNER: SLIGHTLY USED MICRO-COMPUTERS, APPLE, ITT2020, SORCERER, PETS, TRS80, FROM AROUND £300 - £600.

Moving to a new shopping precinct comparable to Westend.

North London Woodgreen, Piccadilly Line
Ring: 01-368 9002. Mon-Sun, Including Evenings
For communication aspects ring: 01-435 4493.

Newsprint is the place where Guy Kewney reports the happenings of the micro world — read on for product news, rumour, gossip, prediction, speculation and fearless exposés.



Thunder clouds

"This proposed rip-off of my ZX80...". Uncle Clive began pre-emptively, "...if it is based on my software, I will act with the full force of the law."

Somebody with £100 to spend could not have bought a usable computer six months ago. In six months time, she or he will be able to choose from two or three; extend that price range to £150 and the number to select from will possibly double.

We owe it all to Uncle Clive Sinclair... and now people are imitating him. The first hint I had of the imitations, I dismissed as bravado from Kerr Borland, the publicising force behind Nascom; the bravado has turned into a prototype machine called the MicroAce. The proposals sound to me like something so similar to Sinclair's ZX80 as to be definable by its differences.

Like Sinclair's machine, it would drive a television screen direct, and use a bare minimum of peripheral chips. It would have twice the memory — 2 kbytes rather than one — and the case would be different. It would have a similar sized circuit board (but with a different layout) and a seemingly identical keyboard built on to it. And the software that will make it work — the read-only memory Basic monitor — would be based on the same principles as those found in the ZX80. People who love a good fight will get their money's worth, because at the time of going to press Clive Sinclair had obtained an Ex Parte (meaning that MicroAce was not represented at the hearing) injunction that restrained the promotion and marketing of the device for the time being until the case can be heard.

First, I must admit that I don't know exactly who is behind it, but Clive Sinclair has named Comp Shop with Product Launch in his injunction. I thought it reasonable to ask Chris Cary (of Comp Shop) if he was involved, because I'd heard that the prototype had been

seen lurking in his New Barnet workshop — and that he was providing the semiconductors. He was behind the well-known 'nearly copy' of the Ohio Superboard, the UK 101, and anyway he is the only known operator with the chutzpah to try to undercut Sinclair on the ZX80 price. Against that, he says it ain't him, Guv, and Kerr Borland (of Product Launch) says it's "some people in Cambridge."

Chris Cary also adds the unreliable suggestion that a second imitation of the ZX80 is being planned. By unreliable, I mean that although he knows it's being considered, he doesn't know if the idea will be followed through. "But somebody has approached me for prices on a list of components which would fit exactly into an imitation ZX80, and there aren't many other things you can build with those chips, in that volume," he pointed out. Sit back and enjoy the fun, folks.

Pascalising PET

The fact that PCW is not written in French doesn't mean that French isn't quite a nice language (in its way). Rather, it reflects the fact that most of the Frenchmen in England who want to read about computers can manage in English.

The fact that there is going to be a version of the programming language Pascal for the PET microcomputer does not prove that Pascal is much more than quite a nice language; instead, it indicates that there are a lot of people who have learned Pascal, and find that the PET's memory limit of 32 kbytes prevents them from using their skill.

Getting a Pascal compiler into PET isn't just a question of writing a program which will run on the Pet and translate Pascal instructions into strings of 6502 code. There's also the small problem of

getting the program to fit inside 32 kbytes, leaving enough room for it to write the 6502 code it generates.

The British micro-kit builder Transam has proved that its abilities lie beyond simple computer design by achieving that feat. That company has covered itself in further glory by winning the contract to get Pascal onto PET — from the PET's builder, Commodore, in the USA.

The new compiler, called TCL Pascal, sells for a comfortable £120 on diskette, complete with a large manual. Details on 01-402 8137.

Fab graphics — fab price

Hewlett Packard is an Official Computer Company that doesn't believe in letting the personal (Provisional) computer companies put anything over on it.

Personal computers have colour graphics (official computers don't). So HP has announced a system — okay, it costs £23,150 — with up to 4913 different colours, and graphics software to draw three-dimension pictures; not just wire-frame representations, but real blocks of shape.

The machine is the system



see Fab Graphics

45C. Details on 0734 61022. Makes you sick, doesn't it?

Pet double vision

A nifty add-on that's coming soon will give your PET quad-resolution graphics. Called the 'Double Vision', it comprises a small PCB and driver program on tape which effectively doubles the PET's video RAM area. The quad resolution graphics are obtained by forming the top half of the character in one RAM area and the bottom half in the other; the display circuitry then switches between the two to display both RAM contents 'simultaneously'. The resulting display does tend to flicker somewhat, although this can be reduced simply by placing a green filter in front of the screen.

Contact Peter Calver on 01-866 3326.

Micrononsense

Despite our protestations last month about Microsense's latest advertising campaign in the national Press, the Sunday Times recently carried their advert containing the blatantly untrue statement that "...only the Apple is supp-

orted by prompt and reliable first line servicing by your local Dealer." As other micro-computers are well supported by their local dealers, PCW has refused to carry this advert and it's alarming to see its continued use in the national Press — the first-time buyer (at whom the ad is clearly aimed) has enough problems without having to suffer this kind of nonsense.

Push out the boat

The Software Supermarket, as program distributor Lifeboat calls one of its manifestations, has followed the good practice of other supermarkets, and is selling magazines at the checkout. Like the magazines that you will find at the Safeway checkout, this one, called Lifelines, is not unconnected with the business: "Each month," says Lifeboat very candidly, "there will be a table listing the array of serious CP/M compatible software products distributed by Lifeboat Associates." It's a catalogue, in fact. This publication costs \$18 for twelve issues in North America, \$40 elsewhere, and \$2.50 for a single copy.

There's nothing wrong in selling one's catalogue, or in making it look as interesting as possible. Calling it a newsletter when it's a catalogue, however, is pushing credibility a bit harder than the buffers will stand. Calling this the 'official organ of the CP/M users group' doesn't excuse it. The only real useful information is contained in a section called BUGS — errors and fixes in Lifeboat supplied software. In my version of business ethics, you notify your customers of faults in your products at your own expense, not by making them pay for your advertising. The faults, after all, shouldn't be there in the first place.

Enter super PET

Here — at last — is the new 80-column PET. Despite Commodore UK's secretive attitude (the machine was launched at Hanover but the British press was banned from even seeing it until the official launch on 14 June) we managed to prise the following details from their reluctant grasp: the green screen is a bumper 12 inches instead of nine and the keyboard has been lowered to keep the overall height increase down to one inch. As you can see from looking at the keyboard, the machine is totally business-oriented: new features include repeat, tab and ESC keys with auto-repeat on the cursor controls. The 25 x 80 screen can be scrolled up or



Here at last... the SuperPET

down and there are facilities for inserting and deleting lines and for defining 'windows' on the screen. The machine, officially known as the 8032, has an 18k Basic in ROM which includes disk operators.

Retail price for the SuperPET (as we'll call it) is £895 excluding V.A.T. Look out for a full Benchtest in PCW soon.

Counting on apple

Putting a Basic interpreter program into a computer effectively turns that computer into a calculator — provided you don't mind hunting around a typewriter keyboard for the signs for +, -, * and /, not to mention the numbers, all along the top line, and the decimal point somewhere else.

On the Apple, Personal Computers has thoughtfully provided a Multi Function Numeric Keypad, which has the ten numeric keys, plus eight of the necessary function keys. Somewhat puzzlingly though, the pad includes two cursor control keys instead of multiply and decimal point. The keypad plugs into any available expansion slot in the Apple II, and the subroutines that control it are contained in read-only memory on the module itself.

It costs £125 — not cheap for a calculator, but then neither is an Apple II cheap for a calculator, and you pay for convenience, not economy. Details: 01-626 8121.

Success

There are something like 15,000 floppy disk drives used for storing UK computer data, supplied exclusively by one firm, CPU Computers. The manufacturer of these

drives, Shugart, has decided that this represents success, and that the 60% of the UK market which it represents in this way, justifies a renewal of the CPU agreement with Shugart, until 1982.

Improved filing

Comsoft reports that its £170 software package, DMS1, which is used to store and retrieve information on the PET, has now sold 100 copies. This success has encouraged the company to write a second, more advanced program called (creatively) DMS2. This DMS2 provides numerical processing, and allows users to play games that were not possible on version 1... compressing and extending or merging files. A PET with 32k and disks is needed. Details on Guildford (0483) 39665.

Easy conversion

Buying a program to run on a Commodore PET with diskettes is a simple process, complicated by the need to know whether the program runs on Commodore's own diskettes drives, or on those made by Computhink and supplied by ACT.

A program which can convert from one to the other is BBDOS, from B & B computers: details on 0204 26644.

Alien fortune

Space Invaders is a game — perhaps I should say concept — which has sold more micro-processors than anything apart from the pocket calculator. It's now selling Atari video computer systems — via a £29 cassette that offers 112 ways of battling

against sneaky, evil arm-waving multi-colour speeding up banks of invaders: it's been on the market a fortnight and the initial order, planned to last six weeks, is sold out. The message for private programmers is clear, don't write a Space Invaders program, because it's been very much done.

Safety first

An encouraging sign when looking at someone else's software salesroom, is the recognition that he who did not write it, will instantly try to do the one thing that really must not be done.

Protection against operator error is more important than ease of operation, and both are more important than sophistication of function: by which you should understand that a program which pays tax and calculates redundancy is of less value than a simple tax payer which makes sure that you aren't accidentally pressing the comma instead of the full stop. Both these features, says Dattel of St Annes on Sea, are the aim of programs supplied by the company.

Programs supplied include the unusual idea of a vehicle profitability package for car fleets of companies, and one for vehicle hire bookings. There is also a payroll (naturally): all run on Z80 based micros with big diskettes and plenty of internal storage.

Down and down

One of the more fairy-tale aspects of this business is that prices continue to tumble. Latest price cuts come from Sharp and Commodore. Sharp have officially announced a new pricing structure for the MZ-80K series, while trade sources confidently expect Commodore to follow suit. Sharp have supplied their new price list while my confident trade source has leaked Commodore's.

First of all, Sharp's are £480 for the 20k model, £529 for the 32k, £549 for the 36k and £599 for the 48k. You must, of course, deduct 14k if you want to use Basic because it's resident in RAM. Other interesting news from Sharp is that they're about to announce an expansion interface which will allow the addition of printers, disk drives, plotters and the like. The expansion box comes at £99 for 5 slots, a matching twin disk drive costs £790 and a suitable printer, £517. VAT must be added to all these prices. Commodore's expected prices are £425 for the 8k small keyboard version, £450 for the 'proper' keyboard, £550 for the 16k and £695 for the 32k. The new 80 column SuperPET with 32k

comes at £895, with a 950k disk drive also at £895. The Commodore 5¼" twin disk drive now costs £695, the 3022 tractor feed printer £425 with the friction feed version costing just £375. Once again VAT must be added.

Cabinet hierarchy

If a computer is to be turned into an intelligent filing cabinet, it will need database management software to keep all the documents in order. Increasingly, such software is becoming available, though the question that then arises is: how can one be sure that it works?

With a program like Star Trek, testing the software is merely a case of spending two or three days continuously at the terminal, trying to decide if the mistakes that are being made are yours or the computer's. With a micro database, as with any sort of database organising software, things aren't so simple.

In the words of Alan Wood of Digitus, "Any fool can demonstrate a database at a show, or even for a couple of hours inside the prospective customer's office, and make it work. It can sit there producing information quickly to a wide variety of questions — but what you don't know is how fast those answers will be coming out in three months' time, when the data structure is getting more complicated."

Generally, the more a database tries to do, the more certain it is to clog itself up.

The good news from Indiana, then, is that Micro Database Systems Inc has released a simpler version of its MDBS software. The big version is now amended and updated and costs \$750 to run on the Z80 micro. But the new, small HDBS system insists that the 'logical data structure' must be hierarchical. It costs \$250, and must be regarded as a better bet — not because of any inherent robustness of the software, but simply because, to use it, the user must have a better idea of what information is actually in the filing cabinet, and how it's organised. Also, of course, you lose less if it doesn't work after three months.

MDBS has now provided a phone number: it is (317) 742 7388

Using the user

A user group for the MVT FAMOS software system has been formed. MVT/FAMOS is described as a 'multi-tasking, multi-user disk operating system which runs on most 8080 and Z80 based microsystems.'

Normally, user groups are established by the company

who supplies what is used. The idea is described as 'better communications', a phrase which the cynic might translate to 'in order to make sure the supplier hears about user problems before the Press does.'

Something which isn't often tried is to bring in user groups as a way of getting prospective customers acquainted with the product. This is because, traditionally, user groups have been people who have spent tens or hundreds of thousands of pounds on the product, and are frightened stiff that the supplier will refuse to maintain the white elephant if they are unkind in their public remarks. They are not averse to telling outsiders how hard it is to use, however.

With micro software, the opposite is true; customers are anxious to explain how easy the product is to use. Equinox, organiser of one such user group, appears to be trying to establish this kind of approach: people who use MVT/FAMOS should of course contact Equinox and join, but people who do not (yet) may find a surprisingly warm welcome from Mike Kusmirak if they want to join in the discussions. Contact him on 01-739 2387.

Stores more

There's little point in dreaming of a more powerful micro — something based on Zilog's Z8000 chip for example — unless you already have two 20 megabyte hard disk storage devices, a virtual storage operating system to drive them, two video screens and a fast printer, and still can't get through the work-load.

If you don't know what virtual storage is, you don't need it. In essence, it resembles the old pantomime trick of Ali Baba and the Forty Thieves. Ten stage thugs trudge from one side of the cavern to the other, and as soon as they're out of sight, belt round behind the curtain to make a second entrance, preserving the illusion of a continuous stream of four times as many pantomime

actors.

In a computer, the idea is to wait until the program in memory has been run from point 0 to point FFFF; then you bring in the next section of the program from the fastest disk you can find, and start at point 0 in memory again. You, the human, won't be able to spot the join, and it's cheaper than twice as much real memory — or actors.

There is a snag: when the operating system is 'swapping' chunks of code from memory to disk and back, one dud memory bit can multiply amazingly fast. A great deal of the traffic may be data traffic, corrupting itself bit by bit.

The phenomenon of virtual storage is one of many reasons why Zilog has decided to launch its Z8001 on a board with parity checks for the 32 kbytes of memory. To prove it, count the memory chips in the top right corner of the board. Nine, not eight. The extra one is a check bit for the eight bits in the standard byte.

Further details of this official Zilog product from 0628 36131. However if you just want a Z8001 micro on a board remember that Ithaca Intersystems has announced one using the S100 bus, which will fit into many standard personal machines. The Zilog one won't, because it's on a 'standard' double Eurocard.

Commodore cull

Possibly the most useful bit of green paper to be published recently is Commodore's list of prices — because it includes a comprehensive list of its dealers. This may be shortened. When you get your list, make a note of the ones which don't have a star beside their names — the dealers, not the prices. As usual, Commodore itself is tactful to the point of obstructiveness when asked for details: but it seems likely that the rumours of impending axe-wielding on dealers are

soundly based.

The stars are the dealers who can supply Commodore Business Software — to do which, they must measure up to certain standards. They must be able to demonstrate, fix, and explain the software: Kit Spencer says that he would like all dealers to be approved to this standard.

Since some of them clearly won't make it, and since many were ad-hoc groupings of people who just wanted a cheap PET each, I'm putting my money on a PET Dealer Pruning operation before next year. And I think it will do more good than harm, if you want my opinion. No?

Newbear news

For people who have a Sharp MZ-80K, knowing how its internal Basic and monitor software actually work can be invaluable. Fortunately, although Sharp doesn't provide this information, Newbear Computing Store does.

According to someone who has seen the Newbear dissection of this software, the reason for the secrecy is probably coyness: "The code is written for an Intel 8080 in a high level language, and it's pretty robust, and it has been slightly modified to run on the faster Z80 micro. But it certainly isn't elegant."

Newbear has also written — or re-written — the ZEN editor and assembler package for the MZ-80K. It has been approved of by Nascom and TRS-80 users in the past: it costs £19.50 plus tax, and details are on 0635 30505.

Cosmic invasion

Cosmic Raiders landed on the editorial desk this week, so to speak. Yet another version of Alien Invaders, this one should please any PET-owning addicts. It runs on any model PET and very good it is too. Unlike Apple's, for example, this one offers ten levels of skill and has a nasty 'second phase' in which individual raiders split randomly in two. Sound effects are said to be excellent.

Congratulations to D Hipkin, who wrote it and to Petsoft who market it at £10.00.

PETstore addition

Commodore approved software is now available mail order, through a new PET dealer, Audiogenic.

The company has now started selling hardware, too: it's announced a £15 switch which allows the user to survive a 'crash' — infinitely preferable to switching off and starting again.

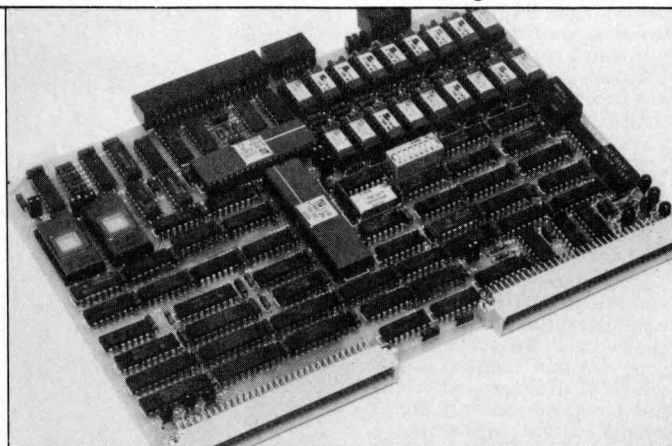

Zilog's 'Ali Baba' board (see 'Stores more' above): note the Z8000 in the centre and the twin rows of nine RAM chips.

Audiogenic claims to be 'always in stock' because it's a tape duplicating service — it can supply a program as quickly as it can run off a copy on the duplicator. It also publishes PET information on Oracle. Details from 0734 595269.

Nascom tool kit

Even the designers of the Nascom 1 never pretended that the built-in program which allowed humans to drive the machine was much of a breakthrough: and the company launched the second monitor, Nas-Sys, without any blushes, as 'making the thing useable.'

For those who want to go further in making Nascom systems useable, a Yorkshire software house has released a Toolkit which does things like HEX (which will convert up to 10 numbers from hex to decimal); HELP which points the cursor at an error; FIND which will hunt down a string: AUTO LINE NUMBER, and APPEND and RENUMBER (which are self-explanatory) and other things — all for £42. You buy two memory chips (2708 EPROMS) for Nascom 2 systems, or a tape for Nascom 1. The company is Bits & PCS, on Wetherby (0837) 63744.

New chairman

A University Chair in micro-electronics has been established in the University of Dundee, by a local firm — NCR. It's attracted the man who designed the micro-system which displayed the House of Commons proceedings to the deaf MP, Jack Ashley: the man is Dr Alan F Newell.

Newell has also been involved in the idea of putting subtitles onto television for the benefit of the deaf, and other aids for the handicapped. He will move from Southampton to Scotland in October.

Zilog GT

Zilog has announced 6 MHz versions of its Z80 and Z8000 processor chips for use in applications demanding extra speed.

The 'go-faster' Z80 is known as the Z80B to distinguish it from the Z80 (2.5 MHz) and the Z80A (4 MHz) while the faster versions of the Z8000 will be known as the Z8001A for the 48-pin, segmented version and the Z8002A for the 40-pin, non-segmented version.

However, before you rush out to buy one to upgrade your existing system in the quest for Ultimate Speed, be warned that you'll probably have to rebuild your system's memory as well. The new processors will require high

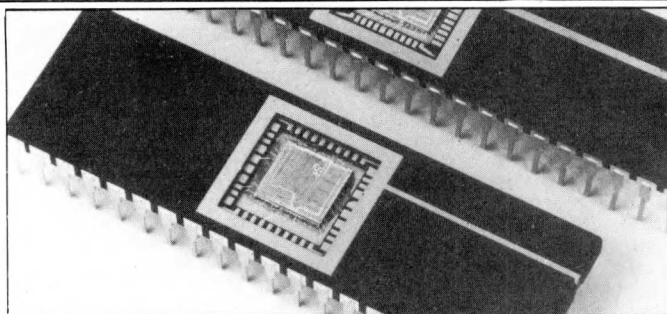

Above: Z8001A. Below: Z8002A.

speed memory chips having an access time of 150 ns, and although these are available you'll need to take more than a little care when using them.

Priorities

At the time when publishing company IPC had fired all its journalists for wanting more than 17% pay rises when inflation was 22%, it sent us a press release showing that its computers get, not only air conditioned rooms to work in, but also anti-static carpets. This, says Illingworth & Company of Halifax, carpet supplier, "eliminates static charges which would otherwise interfere with the information fed into the units." Moral: be a computer, not a journalist. Details about anti-static carpet tiles on 0274 676261.

Why disks?

Chris Cary (again of Comp Shop fame) is incensed that people are saying that floppy disks can't be attached to his UK101 kit. They can, he says, with just a few changes, mainly to the operating software: "but the reward is out of proportion to the price: who wants to put expensive floppies on our cheap computer?" For those who really do, he has the ROMs needed, but you have to argue him into it. Meanwhile he's produced an improved monitor for the kit which allows screen editing.

Comp has decided that diskettes are a good idea on Nascom 2: a drive with controller, power supply and cables costs £450. Because of the design of the Nascom, you can't run disks and the 8K Basic, however. So Cary has provided a Basic compiler with the disks. Details on 01-441 2922.

Apologies to Bob Dylan

How many roads can a man walk down, before he has exhausted the capacity of Highway 1, the software program that computes the width of drainage, where to put telegraph poles if the corner is tight, and what angle the slip-road must join at, every five yards? And can he display the depth of

concrete that will not shatter if the axle-loadings are put up by Government statute?

These are the questions that users of engineering software tend to ask before they will call him a man.

An exhibition of such software will be held next year in March, at Imperial College in London. It's the Second International Conference and Exhibition on Engineering Software, and if stand space is required, contact Engsoft on Southampton (0703) 21397.

Truth will out

In a foolish attempt to gain publicity for his journal, Richard Pawson has printed (in GREEN ink) the astonishing suggestion that people call me the Pink Panther in this business. I wish they did — it would make a pleasant change from some of the unkind names I've been given by people who believed their own publicity material more implicitly than I could. I can inform Printout readers of one interesting fact: I am spoken of in the trade as the man who writes Inside Trader. Now, there's a thing.

Bipolar PROM programmer

The micro produced the EPROM. The requirement of permanent memory led originally to the read-only memory chip. The fact that programs always have errors led to the need for a rechargeable chip — like the soda syphon, it may be more expensive, but if you use

enough, it pays for itself.

Now, the micro is making it easier to program the EPROM: software changes the PROM programmer 'personality' to suit different chips. Only a year ago, the 'personality' change involved putting in a different circuit card. Elex has extended its 'soft personality' programmer, the E-H model 4A (which programmed N-channel MOS PROMs, with a bipolar PROM programmer. Details on Bracknell (0344) 52929.

Good cat

Two dollars gets you a copy of the most comprehensive catalogue I've ever seen. Advanced Computer Products Inc are responsible and inside you'll find listed (and sometimes described) components, games, single boards, personal computers, test equipment and lots more besides.

Send your \$2 to: Advanced Consumer Products Inc., 1310, E Edinger, Santa Ana, CA 92705, USA.

Debating Disks

By storing data on a hard, rigid magnetic surface rather than a soft, floppy one, designers can put a lot more data in, and do it much faster.

But normally, hard disks take up more space than floppies: so the world is moving to mini-hard disks called mini Winchester. Enraged, suppliers of the older cartridge disks are writing to me, insisting that their machines, like the Equinox KB10 offering 5 Mbytes of fixed disk and another 5 Mbytes of removable disk cartridge, are 'more flexible' than new unremovable Winchester.

The argument is that since the new Winchester disks are sealed permanently into their drives, if one has an internal malfunction, all the data will be lost. If there is a removable drive as well, several copies of important data files can be made easily. This may be true. At the same time, I feel I ought to point



See Bipolar PROM programmer.

Buy a microcomputer for under £1,000 and you could be on your own! Unless it's a Commodore PET



Commodore produce Britain's number one microcomputer. But we don't stop there. We also insist on providing comprehensive support throughout our national dealer network.

Our dealers can examine your needs and demonstrate which hardware and software will suit you best. Their trained engineers are always at hand and a 24-hour field maintenance service is available. Your local dealer can tell you more about the following Commodore Services.

Commodore PET
The Commodore PET computer range covers everything from the self-contained unit at under £500 to complete business systems at under £2,500.

Commodore Business Software and Petpacks
Our software range covers hundreds of applications. Business software includes Sales and Purchase Ledgers, Accounting, Stock Control, Payroll, Word Processing and more. In addition over 50 Petpacks are available covering such titles as Strathclyde Basic Tutorial, Assembler Development System, Statistics, plus our Treasure Trove and Arcade series of games.

Commodore Approved Products
Compatible products of other manufacturers with Commodore's mark of approval are also available.

Commodore Courses
Commodore offer a range of residential training courses and one day seminars. An excellent start. And when you have installed your system the PET User's Club Newsletter can keep you informed of new ideas and latest developments.

LONDON AREA

Adda Computers Ltd,
WS. 01-579 5845
Advanced Management Systems,
EC2. 01-638 9319
Byteshop Computerland,
W1. 01-636 0647
C.S.S. (Business Equipment) Ltd,
E8. 01-254 9293
Capital Computer Systems,
W1. 01-637 5551
Centralex-London Ltd,
SE13. 01-318 4213
Cream Microcomputer Shop,
HARROW. 01-863 0833
Da Vinci Computer Shop,
EDGWARE. 01-952 0526
L & J Computers,
NW9. 01-204 7525
Home and Business Computers,
E12. 01-472 5107
Merchant Systems Limited,
EC4. 01-353 1464
Metclean Ltd,
SW1. 01-828 2511
Micro Computation,
N14. 01-882 5104
Micro Computer Centre,
SW14. 01-878 3206
Sumlock Bondain Ltd,
EC1. 01-250 0505
Sumlock Bondain Ltd,
EC4. 01-626 0487
T.L.C. World Trading Ltd,
WC2. 01-839 3894
TOPS TV LTD,
SW1. 01-730 1795

HOME COUNTIES

G. M. Marketing,
ANDOVER. 790922
HSV Microcomputers,
BASINGSTOKE. 62444
MMS Ltd,
BEDFORD. 40601
Elex Systems Ltd,
BRACKNELL. 52929
DBM Direct Data Marketing Ltd,
BRENTWOOD. 229379
Amplicon Micro Systems Ltd,
BRIGHTON. 562163
RUF Computers (UK) Ltd,
BURGESS HILL. 45211
T & V Johnson (Microcomputers
Etc) Ltd, CAMBERLEY. 20446
Cambridge Computer Store,
CAMBRIDGE. 65334
Wego Computers Ltd,
CATERHAM. 49235
Dataview Ltd,
COLCHESTER. 78811
South East Computers Ltd,
HASTINGS. 426844
Alpha Business Systems,
HERTFORD. 57423
Brent Computer Systems,
KINGS LANGLEY. 65056
Isher-Woods Business Systems,
LUTON. 416202
South East Computers Ltd,
MIDSTONE. 681263
Micro Facilities Ltd,
MIDDLESEX. 01-979 4546
J. R. Ward Computers Ltd,
MILTON KEYNES 562850
Sumlock Bondain (East Anglia) Ltd,
NORWICH. 26259
T & V Johnson (Microcomputers
Etc) Ltd, OXFORD. 721461
H.S.V. Microcomputers,
SOUTHAMPTON. 22131
Super-Vision,
SOUTHAMPTON. 774023
Xitan Systems Ltd,
SOUTHAMPTON. 38740
Stuart R Dean Ltd,
SOUTHEND-ON-SEA. 62707
The Computer Room,
TUNBRIDGE WELLS. 41645
Orchard Electronics,
WALLINGFORD 35529

Petalect Ltd,
WOKING. 63901
Oxford Computer Systems,
WOODSTOCK. 811976

MIDLANDS AND SOUTH HUMBERSIDE

Byteshop Computerland,
BIRMINGHAM. 622 7149
CPS (Data Systems) Ltd,
BIRMINGHAM. 707 3866
Camden Electronics,
BIRMINGHAM. 773 8240
Computer Services Midlands Ltd,
BIRMINGHAM. 382 4171
Catlands (Computers) Ltd,
BURTON-ON-TRENT. 812380
Ibek Systems,
COVENTRY. 86449
Jondane Associates Ltd,
COVENTRY. 664400
Davidson-Richards Ltd,
DERBY. 366803
Caddis Computer Systems Ltd,
HINCKLEY. 613544
H.B. Computers,
KETERING. 83922
Taylor-Wilson Systems Ltd,
KNOWLE. 6192
Machsize Ltd,
LEAMINGTON SPA. 312542
Office Computer Techniques Ltd,
LEICESTER. 28631
Lowe Electronics,
MATLOCK. 2817
Betos (Systems) Ltd,
NOTTINGHAM. 48108
Byteshop Computerland,
NOTTINGHAM. 40576
Keen Computers Ltd,
NOTTINGHAM. 583254
Tekdata Computing,
STOKE-ON-TRENT. 813631
Systems Micros,
TELFORD. 460214
McDowell Knaagg & Associates,
WORCESTER. 427077

YORKSHIRE AND NORTH HUMBERSIDE

Ackroyd Typewriter & Adding
Machine Co. Ltd, BRADFORD. 31835
Allen Computers,
GRIMSBY. 40568
Microware Computers Ltd,
HULL. 562107
Microprocessor Services,
HULL. 23146
Holdene Ltd,
LEEDS. 459459

South Midlands Communications Ltd,
LEEDS. 782326
Yorkshire Electronics Services Ltd,
MORLEY. 522181
Computer Centre (Sheffield) Ltd,
SHEFFIELD. 53519
Electronic Services,
SHEFFIELD. 668767
Hallam Computer Systems Ltd,
SHEFFIELD. 663125

NORTH EAST

Dyson Instruments,
DURHAM. 66937
Currie & Maughan,
GATESHEAD. 774540
Wards (Office Supplies) Group,
GATESHEAD. 605915
Elfton Ltd,
HARTLEPOOL. 61770
Fiddes Marketing Limited,
NEWCASTLE. 81517
Newcastle Computer Services,
NEWCASTLE. 615325
Format Micro Centre,
NEWCASTLE. 21093
Triport Associated Systems
Consultants Ltd,
SUNDERLAND. 73310

SOUTH WALES AND WEST COUNTRY

Radan Computational Ltd,
BATH. 318483
Computer Corner,
BAYSTON HILL. 4250
Bristol Computer Centre,
BRISTOL. 23430
C.S.S. (Bristol) Ltd,
BRISTOL. 779452
T & V Johnson (Microcomputers
Etc) Ltd, BRISTOL. 422061
Sumlock Tabdown Ltd,
BRISTOL. 26685
Sigma Systems,
CARDIFF. 34869
Office and Business Equipment
(Chester) Ltd, DEESIDE. 817277
A.C. Systems,
EXETER. 71718
Micro Media Systems,
NEWPORT. 592776
J.M. Computer Services Ltd,
NEWQUAY. 2863
Devon Computers,
PAIGNTON. 526303
J.A.D. Integrated Services,
PLYMOUTH. 62616
Business Electronics,
SOUTHAMPTON. 738248
Computer Supplies (Swansea),
SWANSEA. 290047

NORTH WEST AND NORTH WALES

Tharstern Ltd,
BURNLEY. 38481
B + B (Computers) Ltd,
BOLTON. 26644
Preston Computer Centre,
PRESTON. 57684
Catlands (Computers) Ltd,
WILMSLOW. 527166

LIVERPOOL

Aughton Microsystems Ltd,
LIVERPOOL. 548 7788
B.E.C. Computers,
LIVERPOOL. 263 5738
Rockcliff Brothers Ltd,
LIVERPOOL. 521 5830

MANCHESTER AREA

Byteshop Computerland,
MANCHESTER. 236 4737
Computastore Ltd,
MANCHESTER. 832 4761
Cytek (U.K.) Ltd,
MANCHESTER. 872 4682
Executive Reprographic Ltd,
MANCHESTER. 228 1637
N.S.C. Computer Shops Ltd,
MANCHESTER. 832 2269
Sumlock Electronic Services
(Manchester) Ltd,
MANCHESTER. 834 4233
Professional Computer Services Ltd,
OLDHAM. 624 4065
D. Kipping Ltd,
SALFORD. 834 6367
Automated Business Equipment Ltd,
STOCKPORT. 061-432 0708

SCOTLAND

Holdene Microsystems Ltd,
EDINBURGH. 668 2727
Microcentre,
EDINBURGH. 556 7354
Aethrol Consultancy Services,
GLASGOW. 641 7758
Byteshop Computerland,
GLASGOW. 221 7409
Robox Ltd,
GLASGOW. 221 5401
Mac Micro,
INVERNESS. 712203
Thistle Computers,
KIRKWALL. 3140

IRELAND

Softech Ltd,
DUBLIN. 784739
Medical & Scientific Computer
Services Ltd, LISBURN. 77533

To: Commodore Information Centre,
360 Euston Road, London W1 3BL. 01-388 5702

PCW D1

Please send me further information about the Commodore PET.

Name _____

Position _____

Address _____

Intended application _____

Do you own a PET? YES NO

Commodore

This list covers dealers participating in our advertising.

out that no mini-Winchester system I've ever seen lacks ordinary floppy disks. There are those who say "You can't back up hard disks with floppies." They may be right: if they are, IBM has sold many hundreds of System/32 and System/34 minis on false pretences, because that is exactly how those machines back up their fixed disks — on floppies. Equinox is on 01-739 2387.

Six of one

All books on microcomputers are agreed on one thing: that all other books on micro-computing are hard to read. Sharing this comfortable viewpoint is Petsoft's 'Understanding Your PET/CBM' which Julian Allason (or Daddy, as he is known in the trade) says will be "readily comprehensible by newcomers to computing," and adds: "unlike most currently available books." Ah well. £15 plus 75p postage; or ask a PET dealer if you can see his copy.

Well I never

Pretend that Fortran is actually part of the language Pascal. You are writing Pascal (which allows you to write bits of assembler, too) and suddenly you realise that the next section is something which will be much better expressed in Fortran. If your Fortran is the new Apple Fortran, that is what you can do (if that is what you want to do). Contact Microsense or an Apple dealer. Microsense is on Hemel Hempstead (0442) 63561.

Eh?

Complaints that the contents of the Newsprint pages are unintelligible rankle with me. When it comes to digital-to-analogue, however, I confess: it is unintelligible.

Specialist company Burr-Brown, that can do D/A and A/D with its eyes closed, has published a four page brochure on a recently announced CS450 programmable data acquisition system which, it says, provides a comprehensive yet easily understood explanation of the operation and configuration of the CS450. Read it. If you still don't understand, that proves it's the subject, not me.

Slow but sure

Chip-making giant Texas Instruments is now selling a range of computer boards which have solid state memory, but here the data in the memory doesn't get scrambled if the power fails.

The drawback is that the memory is about 20 times slower than normal semiconductor chips, because it is made of magnetic 'bubble'

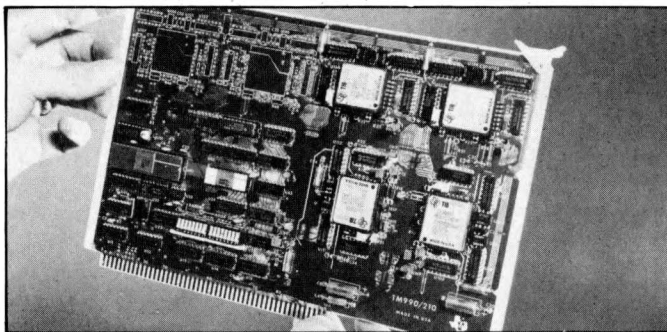

The new TM990/210 bubble memory board (see 'Slow but Sure', below).

circuits — which produce the data they are asked for within an average of four milliseconds.

Since bubbles are still costly compared with diskettes, this board isn't for everybody: however Texas says it is 'confident that the new board series will have attractions for the designer in industrial control.' Details on 0234 67466.

Start nibbling

'NIBBLE' is published by Micro-SPARC of Massachusetts and now you can get it here as well because Tor Business Systems has arranged to take on UK distribution. The magazine is not only useful and fairly chokka with games, etc, it's professionally put together and a pleasant read. Eight issues will cost you £17.50 — Tor are at 114 Tooley Street, London SE1 1TH; phone 01-403 3211/2.

Follow that

Microprocessor design courses for 1980/81 start at Merton Technical College on September 16 with a £50 course in System Design with Micros, lasting two weeks with one day's tuition each week from 9.30 to 5.00.

There's an evening version of this course; a follow-up applications course, and a follow-up to that — an Advanced Micro Workshop. Full details from W R Wittams, 01-640 3001.

Slipping between the cracks

The micro industry cannot afford to have important firms going bust without good reason. Yet, at the time of writing, with Byte Shop memories still raw in our minds, Nascom has been left high and dry by Grovewood Securities, and is floundering around looking for a lifebelt. It happened like this. John Marshall, the owner of Nascom, had no intention of getting into the business when he first commissioned the Nascom 1 three years ago. What he had in mind was a method of getting into semi-

conductor component distribution. Normally, this lucrative business costs a fortune to break into. To distribute Motorola integrated circuits, you have to carry sufficiently large volumes of a wide range of different circuits to be able to meet unexpected orders of medium volume. Initially, before the first flow of orders comes in, this means something like £200,000 worth of goods on the shelves, generating small income with tiny or non-existent margins.

"It was cheaper," Marshall recalls, "to design a single-board computer which might sell between 300 and 500 models, than to try and market the required components direct." When orders flowed in by thousands, Marshall went to his bankers and told them how much money it would take to fulfill the orders.

Anybody who has watched their bank manager panicking at the sight of an unpredicted £20 overdraft will quite readily understand that such establishments don't have the mentality to cope with companies selling 10,000 systems this year when they sold 0,000 last year. Head Office doesn't like it if you don't fill in the 'Last Year's Turnover' and 'Previous Five Years' Turnover' boxes on the form.

Trying to keep up with anxious customers and dilatory suppliers without proper finance has made Nascom a lot of enemies, because many people simply slipped between the cracks.

Without finance, the research effort needed to follow up the unexpected success of Nascom 1 has fallen down.

And even with the Government backed NRDC able and willing to put up £500,000 or so to support new projects, it's been safer to put money into houses than into industry.

When Nascom hit the world shortage of TTL components — the basic building-block chips needed to switch memory address signals and control input and output — it found itself slipping behind its already precarious position. It needed cash to flow in, just to finance the staff it had recruited to cope with the administration problems,

never mind to expand and develop; and it couldn't ship computers because it didn't have all the parts.

Grovewood seem embarrassed by the about-face. When it set up the £1,000,000 deal in the first place, it wasn't keen on publicity, but it did talk about it when asked. Now, the subsidiary of Eagle Star is keeping quiet — which is a real shame. If there are important lessons to be learned, then the industry needs to know what they are. Otherwise, credibility of such soundly based British micro firms such as Rair, Acorn, Research Machines and so on, becomes precarious. At the rate these companies have to grow, hiccups cannot be tolerated.

Meanwhile in the Cabinet, Ministers continue to set a good example to financiers by trying to pull out of the project to set up Inmos as a general purpose memory and micro chip builder.

Adding to the fun, Plessey imports a Norwegian bit-slice Miproc design as its contribution to British excellence: GEC has the second-source option on that revolutionary chip, the Intel 8080 (but has yet to build any) and Ferranti struggles (and fails) to convince the Navy that its F100L micro is even as useable as the 8080.

And just who advises the Government on these matters? Why, Important People from Industry — from such knowledgeable firms GEC, Plessey and Ferranti.

Late news. . . just as PCW was going to press Nascom announced that it had asked its backers, Grovewood Securities Ltd, to call in a receiver.

In an announcement at the end of May, Nascom blamed its financial problems on cash-flow difficulties caused by component supply delays and heavy product development costs.

Last year Grovewood invested £500,000 in Nascom to offset the £250,000 development costs of the Nascom 2 micro-computer. However, the new machine ran into problems immediately after its launch when supplies of the MK 4118 memory chip, for which it was designed, dried up. Nascom had to give buyers a 16 kbyte RAM extension board instead, adding to the company's cash problems.

Before calling in the receiver, Nascom founder and managing director John Marshall investigated alternative sources of finance following a decision by Grovewood not to inject any further capital. The appointment of a receiver will not necessarily mean the end of the line for Nascom; the company has survived for three years in the face of stiff US competition and it's expected that efforts will be made to save it.

CUSTOMER
ADVERTISEMENT

APPLY MICROS
IN THE 1980's

If only buying a microcomputer was as simple as using one

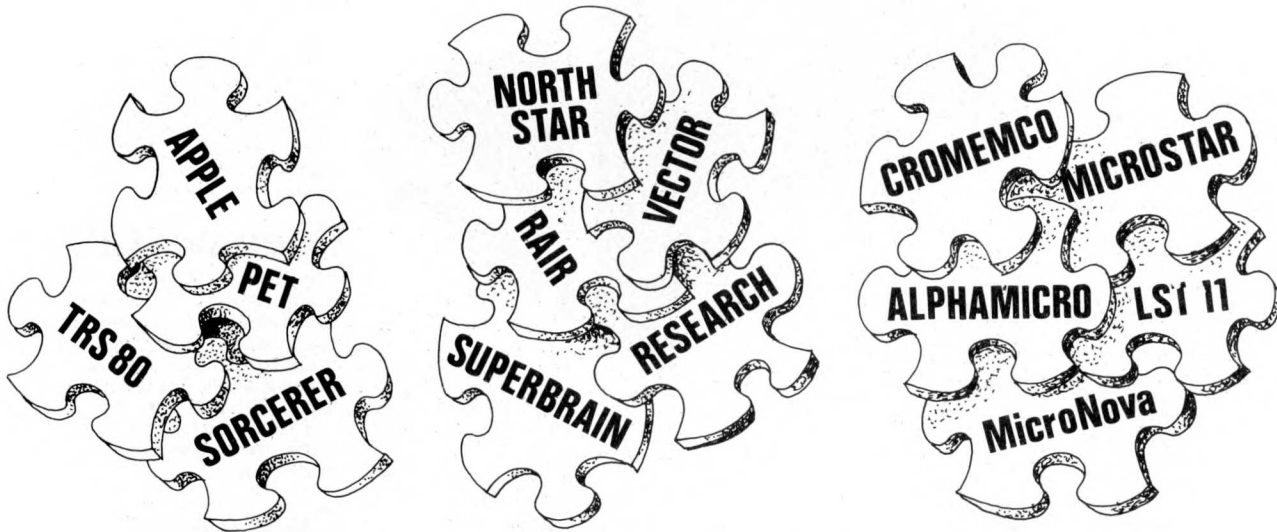

With so many micros to choose from, how do you select the best to meet your needs?

Just look at the advertisements in this magazine. When can you find time to digest them all?

There are millions of chips, thousands of boards and hundreds of peripherals, software systems and application packages. How do you pick the right ones to meet your requirements?

And put them together? And make them work? And add the specials you want?

At Digitus we have computer professionals working full-time putting systems together. Absorbing information. Testing equipment and software. Writing programs. Training users.

At one stop you can commission a complete system to fit your requirements.

Last year we supplied systems for: number processing, word processing, data processing,

graphics and machine control. Advised accountants, surveyors, archaeologists and engineers. Helped DP departments and small business men. Developed software for personnel, incomplete records, order processing, business games, linear programming, process control and terminal emulation. And were retained by other computer companies to advise on micros.

This year we can put even more experience to work so that you can benefit from micro technology ... in comfort.

Come and see us. Spend a few hours discussing your requirements. Attend a training course. Select a machine. Test drive some software.

Solve the micro puzzle. Buy an operational system that fits your needs.

Call for an appointment with one of our consultants.

Digitus

Alan C. Wood Digitus Limited 9 Macklin Street Covent Garden London WC2 Tel: 01-405 6761

ANNOUNCEMENTS

Newbury Labs New Brain

Production is not expected to start until August or September but pre-production prototypes were available for inspection at the official launch at the end of April. While these were not 'together' enough to warrant a full benchtest, PCW still managed to sneak one away for closer inspection.

Hardware

Made in ABS plastic, the first impression is one of ruggedness — it feels like a serious piece of equipment despite being no larger than a normal hard-back book. The keyboard uses query layout at standard typewriter pitch, although the keys themselves are slightly smaller than usual.

Two versions of the New Brain boast an on-board display of 16 x 14 segment characters produced by vacuum fluorescent elements under green/blue perspex. This display, coupled with the fact that the machine contains rechargeable batteries, indicates easy portability... it can be used on the train, in the restaurant, in the garden, or wherever.

Model MB is designed as a mains-powered device which may be disconnected temporarily, while model MBS allows prolonged use away from the mains. The third model in the range, the M, is a mains-only machine without the on-board display.

Internal memory comprises 16k to 24k ROM and either 2k-4k static RAM or 16k dynamic. External memory may be attached via an expansion box and this will be able to take up to 3 MBytes of system ROM, up to 3 MBytes of application ROM and up to 4 MBytes of user RAM. At the moment the Basic can only address a maximum of 40k.

Up to two cassettes drives may be attached and Newbury claims that it hasn't yet found one that doesn't work on this system. Full motor control is provided and the tapes whizz along at 1200 baud — albeit to Newbury's own protocol, once again ensuring minimum compatibility with other machines. Two video interfaces are provided — one for a monitor, the other for the attachment of a UHF modulator and, through that, a domestic television. Newbury describes the modulator as "a bump in the cable." The screens are laid out in a viewdata compatible 24 lines of 40 characters. In fact, there's even a key marked 'Viewdata' so this looks extremely promising although no agreements have yet been reached with British Telecom.

Other interfaces provided are V24, analogue input and out-

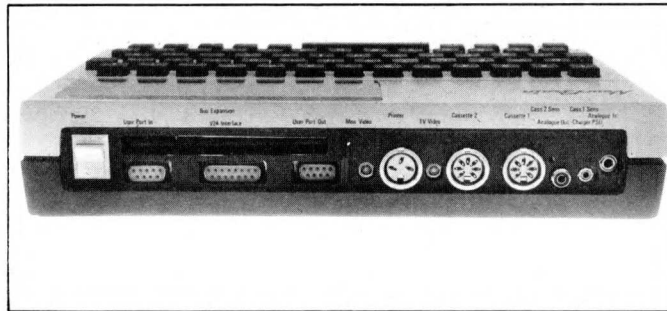

The purposeful rear of the New Brain, showing the wide variety of connections which will make the machine handy for educational/scientific users.



The neat external appearance of the New Brain matches what should prove a neatly thought-out machine, when production versions become available later this year.

put, 8-bit latched output, 8-bit sampled input, a 3-pin DIN printer socket derived from the V24 and, finally, an edge connector allowing attachment of the expansion boxes. Parallel ports, mains socket relay drivers, extra memory, IEEE devices and so on may in turn be connected through the expansion boxes. Newbury's next main hardware project will be to develop an economic disk system and with a firm like DRI backing them I'd say they stand a better chance than most in this area.

Software

At the moment New Brain can only be programmed in Basic, but plans are afoot to develop Pascal, Cobol and assembler languages. Cobol is expected to be first, appearing later this year at a cost of around £100, with Pascal following in early '81. All such enhancements to New Brain will come as plug-in ROMs. In the main the Basic looks pretty standard but it does offer ten digit precision, up to 286 numeric variables, up to 286 string variables, and one or two dimension string or numeric arrays with up to 5575 elements. These were some of the main features that stuck in my mind as

the software right out of the question.

Potential

The New Brain is undoubtedly ideal for the classroom, both for use as a tool and for teaching the rudiments of computing. The analogue input and output facility ensures its use in the laboratory while the promised Pascal and Cobol will secure it a place in computer science courses. I've no doubt either that such professional people as surveyors and engineers will find themselves much attracted by its portability. At £155 I suspect that more than a few will be bought for home use, especially with the promise of interesting attachments via the expansion box. At the moment it couldn't be described as a business machine although, who knows, with disks and suitable ROM-based application packages the New Brain may even come into its own in this area as well.

Documentation

The documentation, like so many aspects of the machine at present, is not complete. All I can say is that the preliminary draft of the Basic manual looks pretty promising — I hope they try it out on a few beginners before committing themselves to a large print run.

Conclusion

When this machine hits the market there's every chance it will offer good value for money. Obviously so much depends on costs and performance that final judgements must wait until the Benchtest is carried out on the commercially available machine. All I will say for now is that it looks promising — very promising.

David Tebbutt



The one we've been waiting for — the new Apple III. See 'Yankee Doodles' (opposite) for details.



YANKEE DOODLES

Tom Williams, Editor-in-Chief of California's Info World, helps PCW circumvent the Apple III information embargo by jetting over this up-to-the-minute report.

Myopia may not be an incurable condition, but it sometimes seems to require radical therapy. I give you the example of microcomputer manufacturers who are convinced that they have achieved the world's greatest hardware design. The fact that this design is different than anything else in existence is claimed to be one of the product's greatest assets, and well it may be from the standpoint of pure technological excellence. But when it comes to selling computers and providing the user community with products that are both useful and versatile, there are other considerations, considerations that require a little 'letting go' on the part of manufacturers.

It is a truism that the S100 bus is not the most refined design for micros. It's also true that, since S100 is not the proprietary design of any one company, there is more hardware and software available for it than for any other micro bus. This is not meant as a promotion for S100, but as an example of a phenomenon that was going on before everyone's eyes, and was misperceived by many to their detriment.

The example is that a major product which has been the result of much investment and design work can positively benefit from the existence of cottage industries. That seems so obvious that it's hardly worth saying. When Heathkit first announced the H-8 computer, they felt that a new cottage industry would spring up around their new Benton Harbor bus the way it had around the S100, simply because their new bus really was a design improvement over S100. That didn't happen, partly because there was not enough volume of Heath computers in the beginning also because the memory arrangements of the H-8 presented additional problems to software designers.

As a counter example, Radio Shack was able to make a success of the TRS-80 because they had a large volume of the machines available at startup, and because the TRS-80 was complete in that it required no expansion or configuration decisions on the part of the buyer before it could be used. Radio Shack has apparently resented the existence of independent manufacturers of peripherals for the TRS-80 and is rumoured to be designing

custom-made chips into its new TRS-80/Color (or TRS-90) which will prevent the easy interfacing of non Radio-Shack devices to the machine. If that rumour is true, it's probably the biggest mistake Tandy could make.

Still more foolish are those companies who base the main software support for their machines on ROM cartridges. At first, this seemed like a novel approach. The first consumer computer to offer such a thing was the Video Brain by Umtech. You haven't heard much about the Video Brain of late, and there's a reason . . . it's no longer made.

It's one thing to provide the main system software in ROM - Exidy was the first to offer cartridges, but only for the language like Basic or assembler - but it's quite something else to expect that all the applications programs will be provided in ROM packages as well. Not even the largest manufacturer can afford the human resources necessary to create the volume and variety of useful software demanded by users. And if there has been any lesson learned these past three years it is that software is what makes a computer valuable. Thus the only alternative is to make it easy for independent authors to write programs for the machine.

This cannot be done for ROM-based applications, because each author would need a development system for the computer in question, and that costs around \$25,000. Texas Instruments and Atari have hedged a bit on this because they originally planned to have most applications programs on ROM. They've since come out with tape and diskette systems, but not the ROM. They seem unsure of their identity and have not attracted independent software vendors, and may be in trouble. The Texas Instruments machine is definitely in trouble and TI engineers who worked on the 99/4 project are said to be circulating their resumes because, currently, TI doesn't have anything in the works in the way of a personal computer.

There is evidence that the smarter companies are coming around to the realization that it's not only in their interest to allow ancillary entrepreneurs to produce both hardware and software products for their machines, it's also in their

interest to aid them in doing so. When unveiling its new Apple III system, Apple said that it would be holding seminars for qualified independent hardware and software producers who wished to market products for the Apple III. Given this attitude and the very positive features of the Apple III, I predict Apple will have much success with this product.

Speaking of the Apple III, although as of the time of writing it had yet to be officially unveiled (its only airing prior to your reading this having been at the National Computer Conference in Anaheim). I recently got an advance peek at the machine and was quite impressed.

The Apple III has a CPU that's built around the 6502A with several other chips such that it executes a superset of the 6502 instructions. It also features relocatable base page register, relocatable stack, an and 128 kbyte address space. The basic machine comes with 96k of RAM and is expandable to 128k.

The Apple III is supplied with a built in 5¼-inch disk drive, and 12-inch black and-white monitor. Apple will be offering it as a complete 'problem solving' system. The first two such configurations to be offered will be a word processor and an 'information analyst'. The word processor will come with a second disk drive, a printer (there are several options), and word processing software. The information analyst will come with the single drive and Visicalc III, as well as a mail list manager and Apple business Basic.

The most impressive thing about the Apple III is the software orientation of its design. The display, which is now 80 characters by 24 rows, can be selected for any of 16 combinations of foreground and background colours. The character generator is in RAM, and is loaded when the operating system boots. This means that the entire set of 128 characters and symbols can be configured in software. A lookup table defines which letter, number, or symbol will be specified as each keyboard code comes in. Thus, any character set - Arabic, Greek, Japanese, Cyrillic, etc. - can be defined in software.

The software definable character set is also very useful in word processing operations. I saw some of the WP software under develop-

ment and various type fonts were being displayed on the screen . . . medium, italic, boldface, etc. These, along with proportional spacing, corresponded exactly to what would appear on the printed page.

I/O is likewise very software oriented. Apple has written a large number of device drivers for most popular peripherals. When the system is configured, the user simply assigns a peripheral to a certain slot and assigns the proper device driver to it. Thus, whenever that device is called, the operating system takes care of slot and driver; the user simply says what peripheral to use.

Apple is also building in a battery-powered clock/calendar that it says will run continuously for three years. It's said to be accurate to one millisecond, and will keep track of year, day, month and time of day.

One other nemesis of Apple users has been cured: the reset button has been placed on the rear edge of the keyboard, and the control key must be pressed simultaneously to reset the machine. In addition, Apple has provided an Apple II emulation software package, which, when loaded into the Apple III makes it look exactly like an Apple II in terms of software and I/O. Thus, all the existing Apple II software can now be run on the Apple III.

Delivery of Apple III systems is scheduled to begin in late July or early August with the Information Analyst priced at about \$4,400. The next will be the word processor around September, which will be priced at \$5,400 to \$7,800 depending on the type of printer chosen.

Technical specifications	
CPU	2 MHz 6502-based with extended addressing
Memory	96-128 kbytes dynamic RAM, 4k ROM
Disks	1-4 minis, 143 kbytes/disk
Screen	Text: 40x24 b&w, 80x24 b&w, 40x24 in 16 colours, user definable characters; Graphics: 280x192 in six colours, 140x192 in 16 colours, 560 x 192 b&w
Video	NTSC b&w or colour, RGB
Audio	Integral 2 inch speaker, six-bit DAC, one-bit square wave, 'beep'
I/O	RS232, two joysticks, printer output

PCW welcomes correspondence from its readers. Be as brief and concise as possible and please add "not for publication" if your comments/questions are to be kept private.

Address letters to: "Communications", Personal Computer World, 14 Rathbone Place, London W1P 1DE.

Sinclair ZX80

A number of readers have contacted PCW regarding long delivery times for the Sinclair ZX80, certainly much longer than the 28 days promised in the early advertisements. To clear the air we wrote an open letter to Clive Sinclair, which we print below, together with his reply. We should add that the 28 days delivery promise has now been dropped from the ZX80 ads.

An open letter to Sinclair Research Ltd:

"We are currently receiving several enquiries per week about the delivery delays on the ZX80.

"We would be grateful if you would let our readers know what the backlog situation is and when orders placed now will be delivered. Please also let us know if the situation varies depending on whether the machine ordered is in kit form or assembled." We received the following reply:

"Thank you for your letter concerning delays on delivery of the ZX80.

"Production has been exactly according to schedule from the start of the programme, but orders were far greater than expected. As a result, delivery is taking eight weeks instead of the four weeks we planned for. Production is rising rapidly, however, so we expect this time to reduce soon.

"There is not much difference in the delivery of kits and built, but kits are a bit easier at the moment.

"We acknowledge all orders by return of post without fail, giving a delivery date, and should this prove unsatisfactory or should the customer change his mind, then we will willingly give a refund at any time."

Clive Sinclair, Sinclair Research Ltd, Cambridge.

Eye wanted

In a 1979 issue of *Creative Computing* I saw an article describing a relatively cheap peripheral which seemed highly desirable and of wide-ranging usefulness — a low resolution (32 x 32) charge coupled device camera, made by Periphical, with very simple voltage requirements and which was very easy to interface with a computer using a simple serial port. All sorts of uses — pattern recognition, movement detection,

OCR, etc. — were mentioned and its cost was under \$200.

I decided to build one myself and received a great shock: nowhere could I find a 32 x 32 (or similar) solid state imaging device for less than a few hundred pounds, let alone a complete camera and interface! Does anyone know of a supplier of a suitable chip (I tried Fairchild, Retican and IP) at a 'hobbyist' price, or does anyone import the US device at a decent price? Given the potential of such cameras attached to computers I'm sure there would be no lack of demand. Dr Steve Abbott, Runcorn, Cheshire.

We know of no UK company which imports these devices — if anyone is importing them we'd like to hear from them. The alternative would be to import one yourself from the States —Ed.

No hazard

I was very pleased to read the independent assessment of the model UV8 high speed EPROM eraser and would appreciate the opportunity to correct the impression about a potential electrical hazard.

The area your reviewer reported as an exposed live line is in fact the solder tag of the 20mm fuseholder and is completely inaccessible to the operator in normal use.

However, I do take the point that the clearance could be improved and the orientation of the fuseholder has now been modified to provide a 5/8" clearance. B. Lumb, Managing Director, Microdata Computers Ltd, Hayes.

Q&A

I have just read my second copy of PCW and hope that you can answer a few questions:

1. Could you print listings of your Benchmark programs as without these the timings are somewhat meaningless;
2. I am buying a UK101 soon; could you recommend a good primer on 6502 machine code programming and a supplier for this book;
3. PCW is obviously the best computing magazine on the market — why isn't it the only one?
4. What nationality is the Anadex company?
5. What's the difference between hard and soft-sectored

disks?

R G Struthers, Dalgety Bay, Fife.

In answer to your questions:

1. We published the Benchmark programs in last December's PCW;
2. We'd recommend Programming the 6502 by Rodney Zaks, Sybex, 1978 but make sure you get the latest edition which has all the corrections. It should be available from most good computer stores;
3. We're working on it!
4. American;
5. There isn't space here to answer this one — see next month's Computer Answers. —Ed.

ZX80 upgrade

As a newcomer to home computing, I have been reading PCW for some months to pick up some background education. I was pleased to read your Benchtest of the ZX80 which will be a good first computer for me but:

- (a) If I buy now will I be able to replace the ROM with the new 8k ROM when it becomes available?
 - (b) Will the present keyboard be suitable? (I am concerned with file handling techniques.)
 - (c) If I expand the memory with 3k static RAM could this be used later with the dynamic RAM when introduced?
- C H Underhill, Kenilworth, Warks,

Sinclair Research tells us that (a) the intention is to make the new ROM a direct replacement for the old; (b) that the keyboard will probably have an overlay containing a new inscription; and (c) the dynamic RAM will replace the static RAM.

Bearing fruit

I would like to make the following comments with regard to the Computer Answers in the April issue — American Purchase of Apple II.

1. Apple say that one needs to change more than just the power supply. They say that the crystal needs to be changed plus also resoldering the 'user jumpers' on the main board.
2. Eurocolour cards are available in the UK.
3. Neither US nor UK Apples come with a modulator; it is an extra for about £18. One bought in the UK will be OK.

Incidentally a modulator is not required with the current colour card.

4. If you really want to be clever try ordering an Apple with a dual-voltage power supply (it will still not have the other mods). This requires at least two months advanced preparation.
 5. Negotiate your price, especially in New York.
 6. If you have to pay £110 for an ITT power supply it's better not to bother — buy your Apple here. Don't forget that there is a sales tax in New York to be added to the quoted price.
- K Leach, Twickenham, Middlesex.

Mike Dennis replies:

1. I agree with Mr Leach. However, there is so much range on the line and field hold controls of some TV sets that these mods are not always necessary.
2. There have been different 'Eurocolour' cards around but I have yet to see one work properly or come with complete documentation.
3. I agree with Mr Leach — as far as vision is concerned a US modulator will work fine with an Apple in this country. I am not sure what you mean by "not required with the current colour card". There must be a modulator somewhere. I assume that you mean on the colour card itself in which case, I agree that you don't need another modulator. However, the only decent colour that I have seen with the Apple is with a direct RGB feed to a colour monitor.
4. No comment!
5. Agreed.
6. You can get ITT power supplies for less than £110 now. I do believe that if you cut the red tape, then it is possible to get a refund of the Sales Tax from Customs when you leave the country. However, I believe that there is some form that you have to get from the shop where you bought it — I suggest that you ask the US Embassy.

Primary probe

We are starting work on a project designed to evaluate the use of microcomputers and the currently available software in primary schools in the area around this college.

The project has been funded in part by the Department of Industry, and to

obtain the fullest benefit from the project we are having to approach industrial concerns for contributions in cash or kind.

Through your columns we would like to ask any individuals or organisations who have appropriate software which they would like us to consider, to forward copies to us.

The results of our work will be published and made available to all primary schools in the UK.

M Thorne & D Wharry, Cardiff.

We've noticed that there are several 'evaluation' and 'research' groups up and down the country. It occurs to us that PCW could act as a clearing house for groups wishing to get in touch with each other. Those interested are invited to write to 'Research', PCW, 14 Rathbone Place, London W1P 1DE. We shall maintain a register and a copy will be available on receipt of an SAE.

May the Forth be with you

On the ever intriguing subject of computer languages I was delighted to see references to Forth being made by John Yale and Sheridan Williams. Your readers may be interested in the Forth Interest Group (fig), a worldwide organisation of Forth fanciers, has produced implementations of Forth for most MPUs. These implementations have been designed at two levels. Experienced Forth system programmers have produced a model glossary of terms, which serves as an outline implementation guide for any micro. Programmers familiar with specific MPUs have then coded implementations of the figForth Model in the assembler language of their respective machines. A general information handout on Forth, details of fig activities in the UK, and figForth implementation listings for the 6502 and 6800 are available from Bill Powell, 16 Vantorts Road, Sawbridgeworth, Herts.

8080/Z80 figForth implementation listings are available from Bill Stoddart, Science Department MPU Courses, Willesden College of Technology, Denzil Road, London NW10 2XD.

Willesden College will be running a one-year Wednesday afternoon Microprocessor Course starting in Septem-

W(1)=	value of having 1 piece on a point
W(2)=	" " " 2 " " "
W(3)=	" " " 3 " " "
W(4)=	" " " 4 " " "
W(5)=	" " " 5 " " "
W(6)=	" " " 6 or more "
W(7)=	" " board position of piece
W(8)=	" " hitting oponent

See Backgammon Beef below

ber, in which using and implementing Forth will be major topics.

Bill Stoddart, Department of Science, Willesden College of Technology, London.

Backgammon beef

With reference to my Backgammon program (May PCW), the weights (lines 80-100) can be adjusted to give a very different game. At the moment PET plays in my own rather reckless manner (I usually lose!) and changing the weights will cause it to play in a different style.

Each move is evaluated by subroutine 3000 and the 'best' chosen — the weights place different emphasis on the various aspects of each move as shown in the list below: Increasing W(7) will cause PET to move its back pieces earlier and adopt 'running' tactics. Increasing W(8) will make it more aggressive and look for hits. Making W(1) more negative will make PET less keen on leaving blots (even on the first of its two moves — not advisable) and so on.

The present weights suit the way I play and are almost certainly not the optimal ones for this program. Jeff Aughton, Birkdale, Cheshire.

PET graphics

Not being a PET owner, I find it difficult to either interpret or implement some of the programs written for the PET, and other machines with a non-ASCII character subset, which you publish. Since I do not know the meaning or function of the specific graphic characters and reverse characters which are reproduced in the listings, it makes understanding how the screen displays work rather a hit and miss affair. I have not seen an explanatory table for these 'non-standard' characters anywhere.— can

you help?

G. Holman, Linton, W. Yorks

We'd be glad to Mr Holman, here's the key — Ed.

☐ Clearscreen ☑ Home

☐ Cursor up ☑ Cursor down

☐ Cursor left ☑ Cursor right

☑ Reverse on ☐ Reverse off

Algol group

While reading your March issue, Raymond Anderson's letter recommending Algol 68 for microprocessors caught my eye. I should like to add that Algol 68 is a consistent and very powerful language — with few of the restrictions that spoil other programming languages.

Unfortunately, I know of no microprocessor based compilers for the language. Compared to Pascal, Algol 68 is difficult to compile — even the subset Algol 68S is by no means trivial.

I have spent some time on the design of an Algol 68S compiler, but the amount of work required is rather daunting. I wonder if any of your other readers have similar interests, and whether they would like to form an Algol 68 implementor's group. If so, I would be pleased to hear from them. I have in mind meetings to exchange ideas, and perhaps a group project to write a compiler.

Melvin Anderson, The Woodlands, Holbrook, Ipswich, IP9 2PT

Safe circuit

Several people have commented on the unusual protection circuit that I use in my computer, especially when I try out home-built boards. The same idea can be used with any power supply. It is faster than a fuse, and essentially forms an electronic circuit breaker. Here it is for your guys.

The 5-volt rectified source is opened before it hits the regulator, and a photo-transistor (any type that can handle the current) is inserted in series. At the output of the regulator, there is a LED with a current-limiting resistance. This LED is placed alongside the phototransistor and a light-tight enclosure (black electricians tape in my case) surrounds the pair. As long as the LED glows — which means that power is being applied to the circuit — the transistor conducts and all is well. However, if I make an accidental short circuit — which is common when playing around with a board — the voltage drops, the LED goes dark, and the transistor unsaturates, thus opening the circuit. The instant that the short is removed, the LED glows, and power is restored.

If your current demands exceed the phototransistor limits, then use the same circuit, except use the phototransistor to drive a high-power transistor connected in series with the dc line.

I have been using a circuit like this for a few years now, and find that it has been a great help — especially at the cost of regulators these days. Keep in mind that some of the 5-volt regulators do have built-in short-circuit protection. I happen to use discrete regulation.

Les Solomon, New York

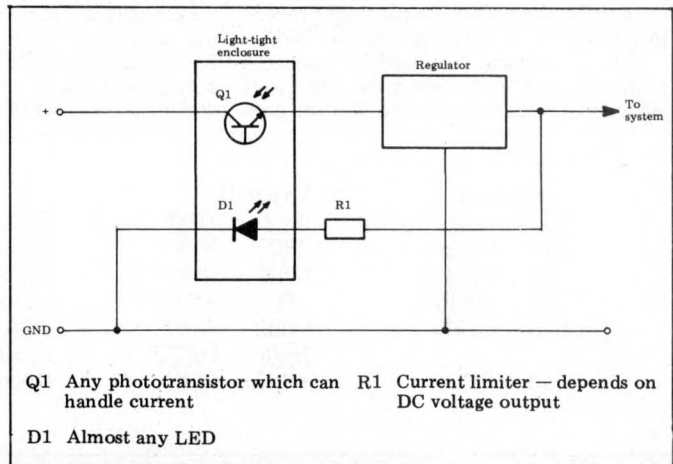

ACORN ATOM

The last year has spawned an ever-growing number of single board computers that offer, in assorted shapes and sizes, the ability to program relatively easily in a high level language and at a reasonable price. The Acorn Atom is part of this group and its recent launch has been accompanied by some very attractive advertisements. In this first-ever Bench Test, Mike Dennis reveals all there is to see of the Atom's totally British design.

Introduction

It only seems yesterday that the original Acorn was launched and since that date many units based on Eurocard size boards have been announced by Acorn to augment the range. The Atom, however, is a departure from this philosophy in so far as it's a self-contained computer in its own right with its own expansion 'sub-set'. This ranges from the basic kit at £120 to a fully expanded Atom for £250; in other words it's designed to appeal to both wide tastes and, perhaps, not so wide pockets.

Hardware

The Atom is packed in a small polystyrene box of quite small dimensions — 15" x 10" x 3". The keyboard is integrally mounted on a sloping front panel and sports a full complement of 60 keys; at about 7lbs the whole issue is surprisingly compact and light in weight. It's in fact quite similar to the TRS-80 in dimensions and suffers from the same drawback of needing an external power supply — something extra to cart around when you have to clear the kitchen table! The overall impression left me cold and disappointed and having seen the superlative photographs in the glossy adverts it merely confirms my opinion that photogenic really means 'looks better on film than in real life'.

The minimum connections required to the outside world are a DC supply of capacity dependent on the system con-

figuration and, for once, a decent professional BNC video socket instead of those abhorrent phono plugs. Hopefully, the production models of the Atom will mount this socket rather more substantially than on the prototype. Program storage is on cassette and a seven-pin DIN plug is provided for that. Further expansion is facilitated by bringing out various bus lines and other signals to a 64-pin Eurocard type connector (one that's a standard feature of all Acorn products). However, before you can use this facility you have to install some additional buffer components inside (the sockets are already there) — but that's not mentioned in the sales blurb. The DC input plug is of a relatively obscure design and hopefully Acorn will supply suitable leads both for this and for the video.

The Atom is available in either a kit or an assembled version; the model I had for review was a production prototype and therefore already assembled. I can't foresee any difficulty in construction as the component density is not particularly high. Unfortunately, the assembly instructions weren't available at the time of this test.

The minimum system consists of the 8k Basic in ROM and 2k of RAM giving a cost of £120 in kit form or £150 assembled. Of the available 2k of RAM, 512 bytes are used for the screen memory and 1k for the system, leaving only 512 bytes available for programs. That's not a lot of room, but a further 10k of static RAM (2114s) can be added to the

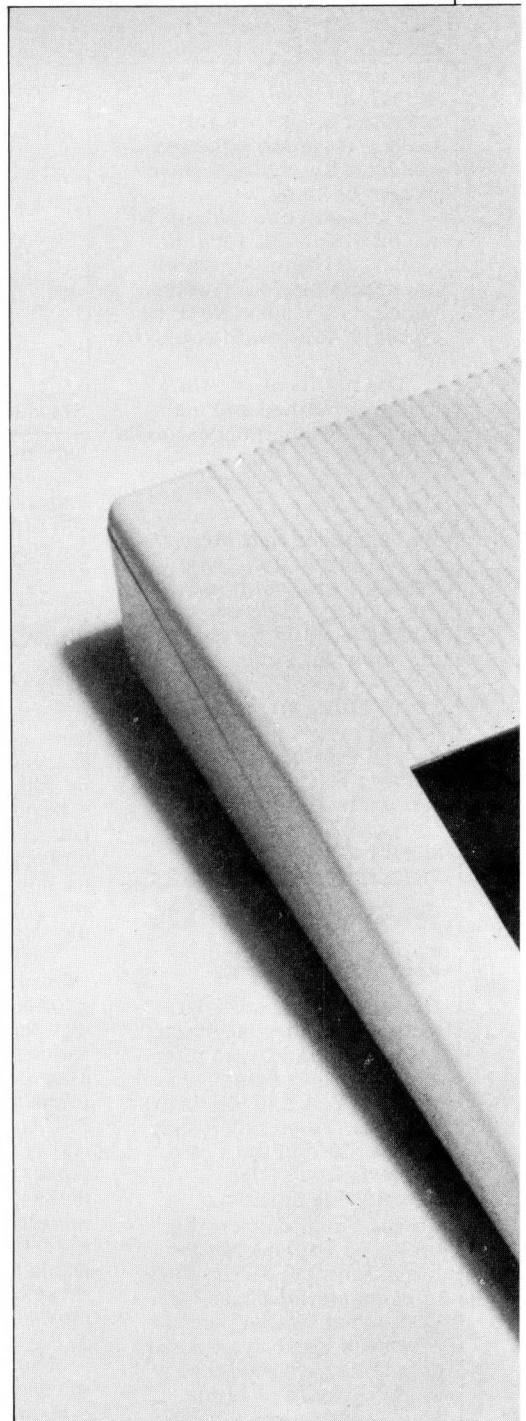

Simple, neat, perhaps a little plain in outline. . . the Acorn Atom.

Atom giving a total on-board RAM capacity of 12k. The price of 1k of RAM from Acorn is £9.50 and so you would do well to look through the adverts to compare prices. The other point regarding this extra expansion is that it doesn't all appear to be available for program space as a contiguous block.

The memory map is a bit weird and depends on the system configuration — See Fig 1. The unexpanded 2k Atom uses the 512 bytes from 8200H to 8400H as program space but when any expansion takes place (from 2800 upwards), the Basic sniffs out this new RAM and uses that to store programs instead. This in turn releases the previously used 512 bytes at 8200H for use by the system's high resolution graphics. There are thus two main areas of RAM

Unexpanded	Expanded	
0000 — 0400	0000 — 0400	System RAM
8200 — 83FF	2800 — 3C00	Program space
8000 — 81FF	8000 — 9800	Graphics space
A000 — AFFF	A000 — AFFF	Spare ROM space
C000 — CFFF	C000 — CFFF	BASIC
	D000 — DFFF	Floating point
F000 — FFFF	F000 — FFFF	Operating system



in the fully expanded system, a 5k block from 2800H to 3C00H and a 6k graphics memory from 8000H to 9800H, and at first sight you can't use any of the graphics memory for program storage. However, buried in the manual is a reference to shifting the program area; changing a byte at location 18H from 29H to 82H will start program execution at address 8200H. This is a very good method of effectively providing a pseudo-turnkey system as you can use a spare 4k slot at A000H to install a ROM with some Basic program stored in it, change the data at 18H to A0H and run the program. There's no reason why you couldn't have several Basic programs in RAM and execute whichever one you choose merely by changing this byte. The one drawback that I see — and cannot find any easy solution to — is how to combine the two areas of memory together into one effectively continuous block for very long programs. Another fact is that the full 6k of graphics mem-

ory is required for high resolution graphics... a point that is made none too clearly in Acorn's adverts.

The existing firmware can be expanded by a 4k ROM with all the floating-point handling routines, and colour routines — again, a fact that the adverts don't make particularly clear. However, this ROM costs only an extra £20, which is good value for money. The last aspect associated with expansion is the question of the DC supply required. The Atom technical description specifies 8 V at 800 mA for an unexpanded Atom and there's an internal regulator. A fully expanded system needs +5V at 1.8 A from an external supply and, presumably, the internal regulator is not moved — the manual isn't clear.

The remaining major chips in the system are the 6502 processor, an optional 6522 VIA (Versatile Interface Adaptor) that, incidentally, is needed in order to interface a printer, an 8255 that I presume looks after the keyboard and a

6847 video display generator to handle the screen video and graphics. Any data sheet on the 6847 will indicate that all the various clever graphic modes that the Atom offers are in fact nearly all done for you by this chip. But it suffers from the disadvantage of being designed for the NTSC standard and so generates a 60 Hz field rate as opposed to our own 50 Hz. The upshot of this is that you will almost certainly have to adjust the vertical hold of your TV set. This is of no great importance if the control has sufficient range but a lot of TV sets that apparently lock satisfactorily are in fact near the limit of their range with the result that some slight vertical jitter may be visible. Also, many TV sets have this control mounted inside the cabinet and so frequent tweaking to watch 'Crossroads' is out. I would also like to have seen to what degree of success Acorn has managed to produce a decent colour picture from this chip, but unfortunately my Atom didn't have the

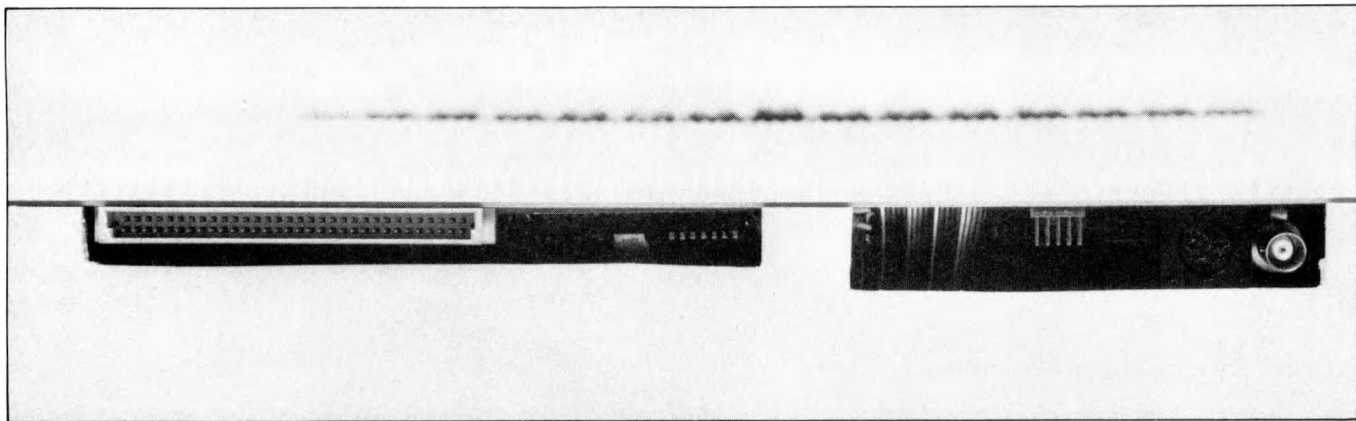

First ever backside view of an Atom! Note the Acorn edge connector to the right.

necessary option.

The final chip (in the review sample) was a 68B54 ADLC or Advanced Data Link Controller; it's installed in the Atom as an optional extra when the Atom is to take part in the 'Cambridge Ring'. No, this isn't East Anglia's answer to Bayreuth but a communications concept that links several computers together.

After switch on, if you follow the instructions in the manual, then you may never get a picture because sometimes there is a totally meaningless jumble that no TV set will lock on to in a month of Sundays. At a guess, I'd say that the initialisation routine of the VDG wasn't always happening — possibly as a result of a power-on reset not always working. Hitting BREAK is the answer whereupon 'ACORN ATOM', a prompt and a cursor appear on the screen. The display format, a rather weedy 32 x 16, was effectively fixed the day Acorn decided to use the 6847 VDG. The chosen character set is fairly standard and lives inside 6847, but without lower case. It also uses the square 'O' that I personally think looks wrong on the screen.

The keyboard has a number of useful features like direct cursor control and a copy key. This is extremely useful as it simplifies correction of programs; you can shift the cursor to the beginning of the errant line, press COPY and REPEAT together, whereupon the cursor will beetle along the line and effectively re-enter it into the program store. When you reach the erroneous code in the line, you simply retype it and then press COPY and REPEAT again to finish entering the line. If you've ever used the Apple then you'll know what I mean. All the keys themselves have a very silky feel to their action . . . a pity then on my machine that several failed to operate reliably unless given a good thump.

Another aspect of the display that's potentially quite good is the fact that all numbers are right justified with an eight digit character field. Unfortunately, the 32 characters per line means that the maximum number of columns you can have in a line is limited to only four. The number of characters per field can be altered with the @ key but I found that altering it from the standard value of eight generally detracted from the overall legibility of the display. Unfortunately there is no TAB function. I found the legend on the @ key rather amusing as it appeared to have been made from two Letraset characters . . . I hope Acorn are getting some engraved

keys made! The other feature of the display is the fact that carriage returns hardly ever happen and 10 PRINT "123" 20 PRINT "ABC" will result in a display of "123ABC" — the first of many inconsistencies with standard Basic. Since carriage returns seem few and far between, the prompt flits about the screen and you're never quite sure exactly where it will pop up next.

Reverse or inverse video and certain double-function keys are accessed with the aid of either SHIFT lock or the normal SHIFT keys; however the positioning of the SHIFT LOCK key could have been improved as it was too easily to hit it when aiming for SHIFT. Since SHIFT LOCK has a toggle action, quite a few inverse characters appeared!

Program or data storage on cassette is quite versatile and I shall go into that in greater detail later on. Fairly comprehensive setting-up routines are provided to optimise the cassette recorder volume control, although the manual isn't too specific as to whether it means playback or record; actually, they do mean playback. The replay side of the Atom is insensitive as my own recorder pushes out quite a few dB of signal and should have been more than enough to drive the Atom. I found I had to drive the tape well into overload in order to get sufficient signal to load programs reliably. Acorn is not alone in this aspect and it's about time computer manufacturers who rely on cassettes for storage woke up to the fact that there's a wide range of sensitivity and output level among cassette recorders. The input side of any computer needs an adjustable high gain to cater for this and a test-tape

to be supplied with each computer.

Other system commands include a comprehensive LISTing facility, albeit at a relatively slow scroll and display speed. There is no AUTO line numbering, nor RENUMBER, although a program to do this is given in the manual — a bit fiddly. One joke in the manual is section 1.7 Editing: "One powerful feature of the Atom's text and program storage is that stored lines can be modified very simply by typing the same line number followed by the new version . . . To delete a line, simply type in the line number followed by return . . ." WOW! In fact, there is no delete facility so you'll have to enter an awful lot of line numbers. That's hardly what I'd call 'powerful editing features'.

Software

The minimum system comes complete with an 8k Atom Basic — which includes an assembler and operating system within that space. As can be seen from the memory map, it's split into two 4k blocks. Firmware expansion is, as I said earlier, a simple matter of plugging a 4k EPROM into slot D000H.

As can be seen from the Benchmarks, Acorn's claim for high speed execution is certainly met, at least when integer Basic is used. Table II shows the actual timings. A closer examination of the individual programs shows that from Benchmark 3 onwards some of the routines will cause rounding up to occur by integer Basic. The timings, when repeated using the floating point routines, were much slower and not particularly exciting. However, the most interesting fact to emerge from running these programs was my initial difficulty in getting some

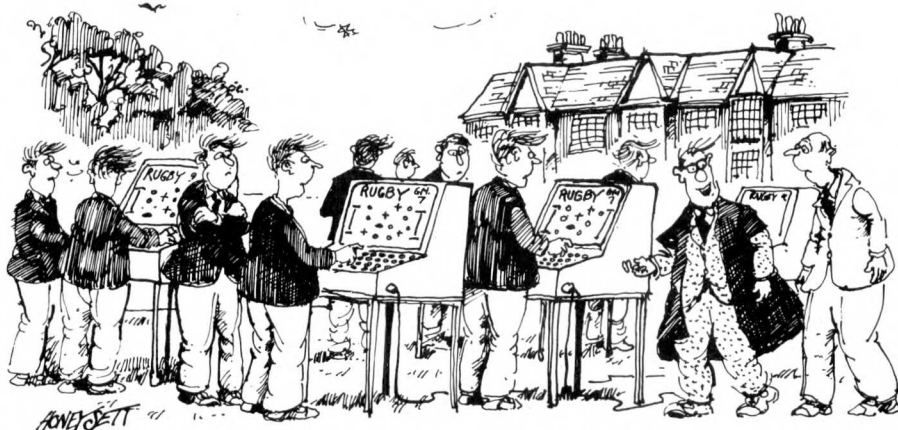

"The headmaster's very keen on new technology, but he still believes in the good old fashioned virtues of outdoor sport."

```

1000h IF?D=0 RETURN
1010 D!4=!D-1;D?6=D?1;D?5=D?2;D-D+4;GOSUBh
1020 MOVE(F-D?-4+D?V*N-N), (D?V?A*2);PLOT1, (D?-4*2-1),0

```

Figure 2

of them to run at all. Normally I run them without any problem so you can imagine my surprise when some of them started giving error messages. A trip into the manual solved the immediate problem but fundamentally revealed that Atom Basic is non-standard in many, many ways.

There are only 27 integer numerical variables allowed (@ to Z), stored in four bytes each with 32-bit precision. The maximum figure quoted that they can represent is 2,000,000,000 but in reality 2,147,483,647 is the true maximum — which will give you some idea as to how they are stored. This is a distinct improvement on most integer Basics with their maximum of 32,767, but 27 variables is not very many. You can't have A1,A2 etc. None of the variables are cleared at RUN time which can cause problems unless you rigidly define them in your program. These variables are then built on by appending seven different characters before the variable letter. These are S,?,!,#,&,% in floating point and the letter again in arrays — which makes program listings unnecessarily complicated (see the listing in Fig.2, taken from the manual). Other non-standard features became apparent the more I delved into all the variable options. Note that string variables are \$A and not A\$, that it's LEN(A) and not LEN(A\$), that you must DIM all string variables before you use them and that it's DIMA(10) and not DIM \$A(10) and that you can only have 27 string variables. Well, that's not quite true because there's a bit of a faux-pas in the Basic in that you can't have the same variable as an integer variable *and* as a string variable; if you use up all 27 variables as numbers then you can't have any strings! Fortunately you can have floating point variables which don't have the same effect, but even so it's a bit of a drop-off.

The ? prefix is a substitute for PEEK and POKE and the function it performs depends on the context in which it is used:

PRINT?A is the same as PRINT PEEK A while

?A=13 is the same as POKE A,13.

The manual describes this as "a more elegant way" but I leave it for you to decide which is the easier to comprehend especially as ? crops up again but this time in the string section for:

```

10 $A="MIKE DENNIS ASSOCIATES"
20 PRINT A?3

```

will print the E from MIKE. Apparently you can use PRINT?A instead, which will give the same result. Confused?

The ! or 'pling' as the manual calls it is used in 'word arrays' and stores numeric variables in four-byte chunks. The advantage of these over the normal array is that the vector to each array can be passed as a variable to a sub-routine — which is quite useful. Remember ?, well it can also be used to store 'byte-vectors' which stores elements in one-byte chunks — all great stuff.

Two of the remaining prefixes,# and &, are used in hex to decimal conversion and the idea is very sound. Machine

codes and addresses are in hex: Basic considers everything as a decimal and you have to convert between the two either by hand or with a Texas Programmer.

The Atom cheerfully accepts either format with these two prefixes and converts between the two for extra convenience. For example:

```

PRINT # 8000 will print 32768 and
PRINT&32768 will print 8000;

```

PRINT& # 8000 will print it in hex!! This is a very worthwhile feature of the Atom. Unfortunately, the last prefix,%, has two different functions, depending on whether it refers to integer or floating point. That's not strictly true, because in integer you'll find it between two variables whereas in floating point it will occur before — but it is easy to get confused.

That means a total of six possible prefixes before a variable, which makes program comprehension (not to mention portability) very, very difficult. I'd also have thought that all these prefixes made it unsuitable for teaching. Now perhaps I'm being a bit reactionary; if I'd never heard of Basic and perhaps had been programming in 'Softo' for a long time — then someone introduced me to the Atom — well, I just might have leapt up and down and thought it the best thing since sliced bread. But Basic *per se* has been around for a long time and with relatively uncomplicated variables (thems with \$s and thems without). As a consequence, the Atom seems more and more like an ego trip for a Cambridge don.

Arrays are also limited to one-dimension. This time 26 arrays can be used and they are accessed by prefixing each variable with itself, i.e. AA. Multi-dimensional arrays are out although Acorn does provide a fudge routine to get round this problem; but surely the point is that these days you shouldn't have to.

I've already mentioned the position of the \$ sign in strings and other differences as well. CH"A" will print the decimal equivalent of the ASCII code for A and should not be confused with CHR\$(A) in normal Basic for its real equivalent is ASC(A\$). CHR\$ is not provided and neither is SPC — so formatting tables will be a real pig.

Concatenation is \$A+LEN(A)=\$B and not A\$+B\$. Substring handling is:

\$A+N equivalent to RIGHT\$(A\$,N)

\$A+N=" " equivalent to LEFT\$(A\$,N)

Two lines of program are needed to do a MID\$. One-dimensional string arrays are available but you have to write a short program to dimension them, unlike other computers which dynamically alter the string array space to suit each appropriate string. Neither READ nor DATA statements are provided and, yes, you've guessed it, Acorn supplies a program that you have to type in to perform what should normally be a simple function. I hope you're following all this because "Atom Basic . . . has all the normal functions you would expect plus many other powerful extensions making it easier for you to operate . . ." I offer you a short excerpt from a program given

in the manual and leave the final decision on the ease of programming to you (see Fig.2 again).

There are other inconsistencies such as ; to delimit multiple statements on a line instead of the usual : (that's used in the Exclusive-OR statement) but perhaps I ought to talk about the good points.

The best of these is that you can enter assembler mnemonics as program lines within a Basic program and when the program is run, the assembler part will be assembled and an assembler listing printed out. Should you so wish, the program will jump to the start of the assembled program with the LINK command and a return to other parts of the Basic program can be made with equal ease. Any parameters that Define Byte and Define Word in a normal assembler are set up prior to assembly by other lines in the Basic program and passed as variables to the assembler. Labels are allowed but if a reference to a label is made before it has been defined then an Out of Range error is flagged that can be fixed by RUNNING again. Although this is often handled automatically by normal assemblers it is of no great disadvantage to have to enter RUN twice with the Atom. The real power of this assembler lies in its being interactive with Basic and therefore being able to use all the power of Basic conditional branching — which means that the Atom can handle conditional assembly with ease. Macros can be handled just as easily, particularly as another good feature of the Basic is that GOSUBs can be referenced to a label, i.e:

```

1000s (LSR A; LSR A; LSR A; LSR
LSR A )

```

```

1010 RETURN

```

can be called by the simple expedient of GOSUB s. The only real criticism of the assembler that I could find was the inability to comment on individual lines. It even supports breakpoints!

Other interesting features are the DO . . . UNTIL loop, which is fairly obvious, and WAIT; this command waits for the next vertical sync pulse in the VDG and so provides an accurately timed reference point with which to synchronise. It's not just a simple time delay of 17 ms as the overall delay would then depend on the time taken to execute other instructions. WAIT is better than that and, used as an element in a timing loop, it effectively pads out the loop to exactly 17 ms — which is quite a useful feature.

Data storage on cassette is quite powerful and there are several commands that can put all the different variables to tape and load them back. One important point mentioned in the manual is that when data is saved on a cassette then the program reading the data back must not take any longer than the time taken for the initial saving, otherwise bits and bytes will come off the tape and be missed by the program. This is inherent in any cassette system that doesn't have its tape transport mechanism under program control and is not intended to be a criticism of the Atom. In fact I would say that the Atom is one of the few single-board computers that allows you to create a decent data-base on cassette.

The other good point is that all the program commands are designed to be compatible with any future disk system, thus obviating the need to rewrite any

BASIC COMMANDS

ABS	AND	BGET	BPUT	CH
CLEAR	COUNT	DIM	DRAW	END
EXT	FIN	FOR...NEXT		FOUT
GET	GOSUB	GOTO	IF	INPUT
LEN	LET	LINK	LIST	LOAD
MOVE	NEW	OLD	OR	PLOT
PRINT	PTR	PUT	REM	RETURN
RND	RUN	SAVE	SGET	SHUT
SPUT	STEP	THEN	TO	TOP
DO...UNTIL		WAIT		

\$%&#!?:'`

FLOATING POINT COMMANDS

FIF	FINPUT	FPRINT	FUNTIL	STR
FPUT	=	!	ABS	ACS
ASN	ATN	COS	EXP	FLT
HTN	LOG	SIN	SQR	TAN
VAL				

programs when you upgrade.

The floating point routines are also interesting in their own right as they feature ARCSIN, ARCCOS and ARCTAN — which is quite unusual for a small computer. The accuracy of the floating point package is also exceptionally good and it's a pity it doesn't support degrees in addition to radians. Other facets of this package have been discussed elsewhere and I shall now turn to the graphics section.

There are many options available to the user, ranging from coarse graphics with mixed text and a low memory overhead through to high resolution graphics with no mixed text but a high memory overhead. Commands are available to move, plot and draw either black lines on white, white on black or even to produce a form of three-tone picture with a mid-grey option. The actual line movement can be done relative to the last position, or some other references, and the whole facility is very comprehensive. The only criticism is the fact that in the high resolution mode, the effective display area shrinks noticeably to about two-thirds of its previous size and a crude white frame of chunky proportions surrounds it which detracts from the overall effect.

Expandability

Apart from the internal RAM there is the further option of connecting up any of the other boards in the Acorn range. However you would be well advised to check with Acorn with regard to loading of the lines etc and also *exactly* what extras are needed in the way of buffer chips. Another fact that you should be aware of is that, due to the peculiar memory map, it's possible that some of an 8k static memory board will not be 'seen' by the Atom as it conflicts with the Atom's memory which takes precedence. This is even more of a problem with the 32k dynamic RAM board that

BENCHMARKS

	Integer	Floating Point
BM1	0.8	
BM2	5.5	
BM3	10.0	30.5
BM4	11.5	27.0
BM5	14.5	30.00
BM6	20.0	
BM7	31.5	
BM8		26.0

they supply, for only 23k is actually available on the Atom, so wasting 9k, which is ludicrous. Hardware expandability is therefore reasonable but not as good as it could have been if it weren't for that weird map.

Documentation

The Atom comes with a very chunky book that starts off extremely well. It's billed as a beginner's course in Basic and machine code programming and generally it's very good and gives plenty of examples. However a lot of the programs could be better documented and a greater variety offered. There are far too many mathematical programs that will leave the average punter cold; he doesn't want to know about Sierpinski curves and to put the following sentence in a beginners' book is just plain stupid: "This method has the advantage over the standard pivotal condensation technique that for integer coefficients the answers are exact integers or fractions". What did I say about an ego trip for a Cambridge don? There are no page numbers and without the index it's very difficult to find your way around. Also, there are several programs which use commands that haven't been explained before and therefore are very confusing. The programming analogy of making a cake is super and makes 'yer pivots' look even more soppy. Error handling codes are available at the back and although they aren't all there (I got 89, which doesn't exist according to the book) this is in hand.

Generally, though, despite the maths overkill, a good effort which must have taken a long time to prepare. The technical manual is under preparation and if the standard of Acorn's documentation is anything to go by, then it should be good.

Potential use

Clearly the Atom has been aimed at the educational market. Its business applications are severely limited and I would like to see someone actually try and use it for some of the applications that Acorn suggests in its sales blurb. I can see it going into the educational field partly because of the 'Ring' and partly because on paper it seems to offer a lot of facilities for the money — which will probably prove attractive to impecunious education authorities. Personally, I think that as a beginner's tool it has

far too many features to aid clear thinking and comprehension.

Conclusion

The Atom certainly offers many facilities; in particular, the combined assembler and Basic is particularly attractive. However, the very extent of these features makes it unwieldy to use at times — a fact borne out by the difficulty in following many of the program examples given in the manual. The incompatibility with virtually every other Basic (it really does seem as if someone has sat down and said "this is the way it should have been done") means that the beginner will be out on a limb when it comes to finding off-the-shelf programs to use. However, the many features it offers will undoubtedly prove attractive to some. It really is a shame; there are some excellent ideas in the Atom but spoilt by some basically unsound thinking at the system level as to which way computers are going in general and how to implement the ideas. I also think you should look closely at just what is offered by the various kits and options as it all sounds a bit rosy at times when you read the brochures.

My thanks to Acorn's Chris Turner for the supply of the machine and for answering all my questions.

TECHNICAL SPEC.

CPU	6502
Video Display	32 x 16, comprehensive graphics with expanded colour option promised.
RAM	2k minimum, 12k maximum
ROM	8k minimum, 4k floating point, room for another 4k
COMMS	cassette interface, can be used in Cambridge Ring
KEYBOARD	60 keys, direct cursor control, Copy key
BUS	Acorn's own 64-way Eurocard socket.
Disk	Not tested
Printer	Not tested

At a glance

FIRST IMPRESSIONS

Looks	***
Setting Up	****
Ease of Use	*

HIGH LEVEL LANGUAGES

Basic	**** (see text)
-------	-----------------

PERFORMANCE

Processor	****
Cassette	***
Disk	N/A
Peripherals	N/A

EXPANDABILITY

Memory	*
Cassettes	N/A
Disks	N/A
Bus	***

COMPATABILITY

Hardware	**
Software	
Documentation	***
Value for Money	****

*****	excellent
****	v. good
***	good
**	fair
*	poor



**BENCH
TEST**

THE DDE SPC/1

by Sue Eisenbach

Introduction

Taking on for a moment my role as a programming teacher — with a commitment to structured programming — it disturbs me that virtually all the schools that teach this noble art use Basic . . . a language without structured constructs. Proponents of Basic, however, argue that any other language is far more difficult to teach, requiring knowledge of editors and operating systems. Well, the Danes faced this dilemma by developing a structured Basic called Comal (Common Algorithmic Language), and this is where the Danish company, Dansk Data Elektronik come in. They've arranged for their British subsidiary, Digital Data Electronics Ltd. (DDE), to market in the UK their SPC/1 range of micro-computers. The machine is programmed in Comal rather than the more usual Basic.

Hardware

The review system consisted of an SPC/1 computer, a Soroc IQ 120 VDU and a Texas 810 printer. The computer itself is extremely lightweight, contained as it is in an attractive aluminium box (dimensions 22.2h x 44.3w x 33.7d cm). The front, top, and back panels unscrew to reveal a frame and the inside of the computer. Visible are two BASF mini disk drives, a thirteen slot motherboard containing six nearly square (13cm) boards, a power supply and a quiet fan. On the back of the box is an on/off switch (no reset button), a printer socket and a VDU socket. Ian Brunchmann, the DDE representative who delivered the system said that I was being lent a rather old machine and that anyone who bought one now would get a slightly larger box which will hold three drives and have a seventeen slot motherboard. The system bus has 100 pins but is not designed to the S100 specification. It can handle interrupts from up to 64 sources and cope with up to eight DMA channels. The CPU card contains a 2 MHz 8085A (a 5 MHz version is also available), two serial ports for a VDU and printer, a bootstrap loader in 2708 PROM and an AM9511DC arithmetic processor. Although the other benchmarks ran rather slowly on this system, benchmark eight, which tests the speed of mathematical functions (and used the arithmetic processor), was fast. The two RS232 ports

can be set for transmission rates between 300 and 9600 baud.

The memory occupies three boards, the first a refresh module that can refresh any number of memory modules, and the other two both 32k dynamic RAM boards. The memory ICs are TMS 4116s and can be organised into one or two switchable banks. The bank-switch facility enables the system to address up to one megabyte of memory. Banks can be switched in or out in 3 microseconds.

The disk controller board interfaces up to three 5" drives or up to four 8" drives. The disk controller used is Intel's FDU 1791-A. The final board supplied in the review machine is a DMA control module which is said to speed up transfers between memory and disks to 4 to 16 microseconds per byte and memory to memory transfers to 660,000 bytes per second.

The BASF disk drives are single density single sided and have a capacity of 90k. When I copied disks, although the disk lights switched on and off, the typical 'click, click, click' of heads moving up and down was absent. When I asked Ian Brunchmann about this he said the heads were not lifted until 20 seconds after access and so during a disk copy the heads wouldn't go up and down. I wasn't overly successful when using these drives . . . surprising considering I'd had no trouble using BASF drives previously. The first untoward incident was that the door to the second drive stopped shutting properly. Accessing files from that disk frequently resulted in a 'disk not ready' error message. On closer examination I saw that one of the pins holding the door on had worked its way up and when pushed back in place the problem was solved. The next incident occurred when the system failed to boot from the first drive. Fortunately it booted from the second drive, at which time it became clear that the first drive was not functioning. I pulled the system apart (everything is quite easy to get to) and saw that the belt had slipped off. After putting it back on, the system worked fine — for a while. Then the second drive stopped working. I pulled the system apart again, but this time could see nothing to fix (the read/write head didn't move); I had to continue working on a one disk system. Having to spend a

fair percentage of my time using the single disk system I soon got to realise its severe limitations.

I don't have any explanation as to why the drives are so bad, because BASF have quite a good reputation. Perhaps it's because the review machine seems to have spent a great deal of time in transport (via plane and car), and it was rather old to boot.

The Soroc VDU supplied with the review machine is included in the basic price, but the sales literature does state that the system can be purchased without it. It has a 'qwerty' keyboard in the centre, a cursor and numeric pad on the right side and special keys on the left. There's an upper case shift lock, which is convenient because most of the software treats upper case and lower case characters differently. The VDU has been well interfaced with the SPC/1. For instance, ↓ rubs out a character, HOME rubs out from the cursor to the end of the line while RUBOUT deletes a whole line. The layout of the keys is convenient with one exception . . . CR, ESC, and RUBOUT are in very close proximity. As ESC generally aborts the current process, returning the user to the operating system, it's not all that difficult to produce disastrous results with the slip of a finger. There's no repeat key, but holding any key down will cause it to repeat. This feature was not particularly well implemented since on some keys (, and a and s) repeated characters resulted from normal typing while with others (cursor control keys) it was easier to hit the key several times. I assume that a new IQ 120 would not have the uneven touch of a VDU that has been lent to a variety of people.

In the literature, an alternative to the Soroc is offered — a graphics board for use with a monitor and keyboard (like Research Machines). The graphics board has a 256 by 256 point resolution, with point 0,0 in the centre of the screen. According to the sales literature, the graphics can be easily accessed from assembler language, Comal and Pascal. Assembler subroutines can be called that implement Turtle Graphics (from UCSD Pascal). The calls are straightforward and can be interspersed with the normal displaying of ASCII characters. The Texas 810 printer had a few modifications. Danish characters replaced both square and curly brackets.

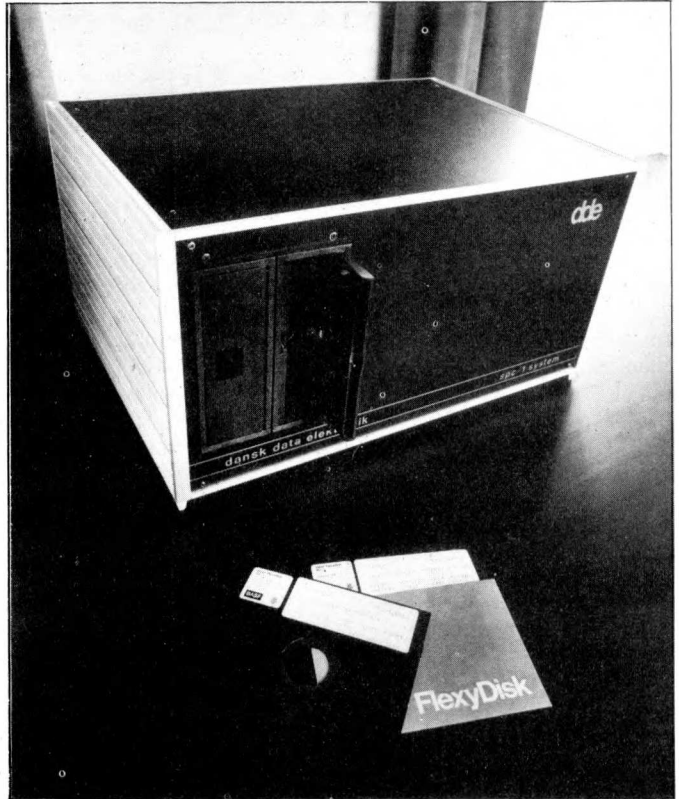
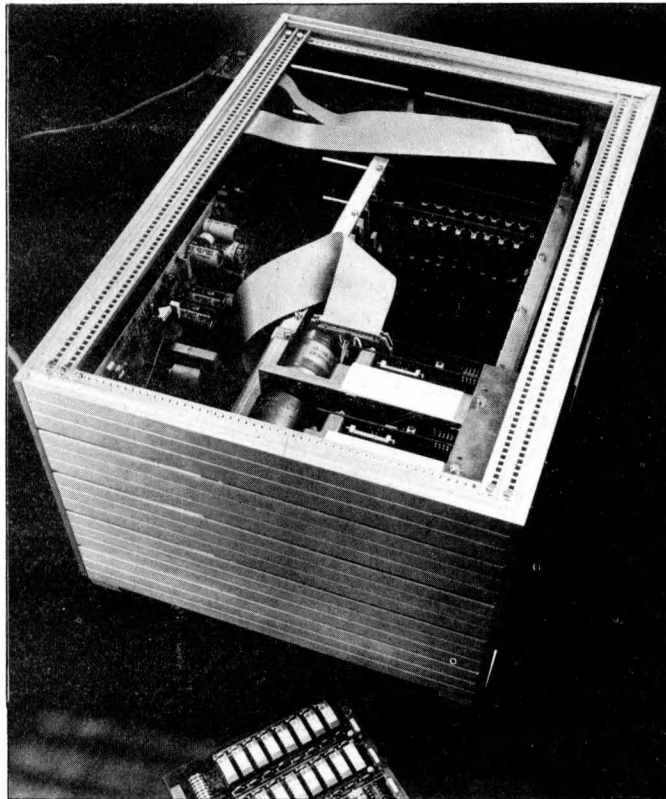
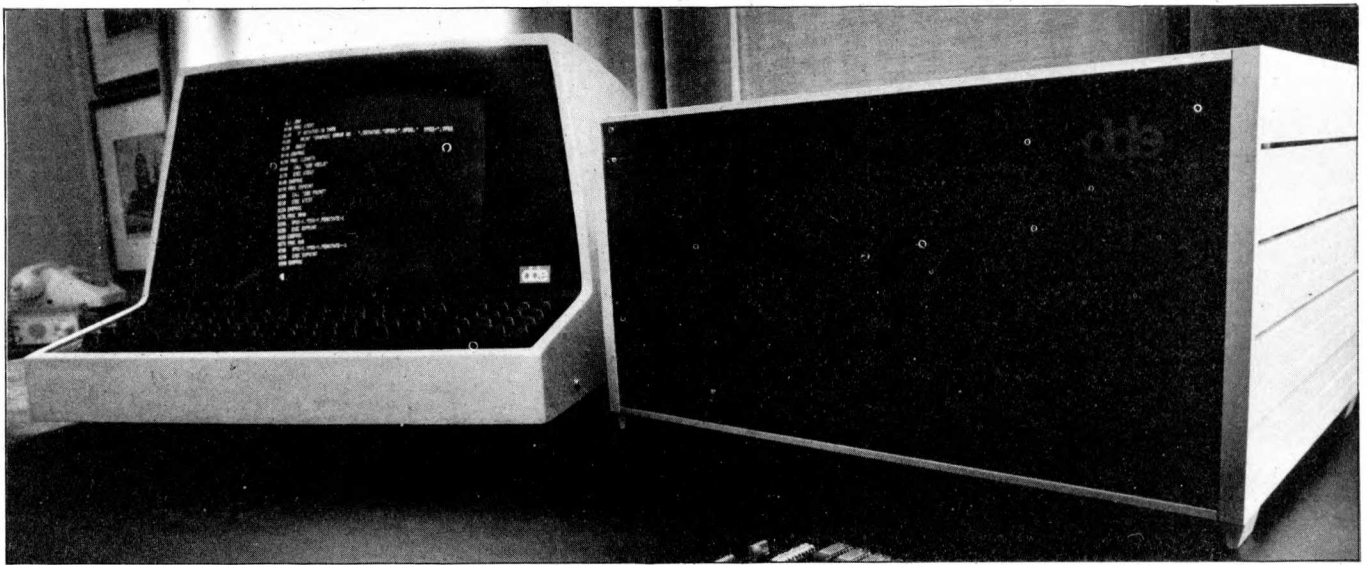

Ian Dobbie

Top: A Soroc VDU with the integrated processor and disk drives unit. Below left: a look inside the SPC/1; centre picture are the drives, to the left is the power supply and to the right, the boards and other available slots; a memory board has been extracted. Below right: a clearer view of the processor/disk unit.

Unfortunately the review system was set up to expect an Anadex printer and so it was not always happy with some of the control codes sent to it.

System software

Two operating systems were provided with the review machine, the first being a dedicated Comal system. This is fairly similar to any dedicated Basic system; upon booting, Comal is loaded into memory. All messages in this system are in lucid and reasonably helpful English. This is the operating system included in the basic price and it gives no facilities for using the SPC/1 for any reason other than programming in Comal.

The second operating system provided with the review machine is called MIKADOS — DDE's 'modular-multi-programmed real time disk operating system'; it runs on DDE's previous

computer system, the ID-7000, as well as on the SPC/1 systems. Unlike the other operating systems that I've seen on microcomputers, this has clearly been designed for a larger, hard disk, multi-user computer system and pared down for a floppy based, single user system. It's slower and more tedious to use than a specifically designed single user system and has several features which are completely useless in this environment. For instance, the documentation talks of re-entrant code, controlling synchronisation and scheduling, swapping priorities for processes and message exchanges.

To communicate with the operating system the user must first type ESC, at which time a '>' appears on the screen. If this is forgotten, any further typing produces no response at all. During the execution of most programs, typing

ESC will abort the current process (whereas typing ESC when in Comal aborts the current process but leaves the user in Comal). The intrinsic functions of this operating system are re-entrant 8080 subroutines. For most of the functions a user might want there exist programs that contain calls to these subroutines. These utility programs come on three disks, and are called by typing their name after a '>' and include:

- PLINI — a disk initialiser
- KATLG — a directory listing with several options
- PKOPI — a disk copier
- FCOPY — a file copier
- KOMPR — A disk compacter
- RENAME — for files
- FPURG — for purging files
- MONITOR — for executing a control file (like CP/M's SUBMIT)

PROM — for writing into PROM
 TXTUD — for writing to a printer
 EDIT — a line orientated editor

One of the difficulties with the review machine was that a single 90k disk was not large enough to hold all the utilities I needed plus the files I was working on. Even when it was running, several of the utilities would not load from the second drive. And so a set of utilities that is probably easy to use on a hard disk based system required extensive disk shuffling on the review machine. Particularly irritating is that neither KATLG nor FPURG are system resident utilities and so have to be loaded before use. All utilities are in conversational mode (some in Danish, some in English) so several questions have to be answered before execution can occur (although default answers can sometimes be given by pressing <CR>).

The manual states that at system generation the user creates 'logical disks' such that one or more logical disks are located on a physical disk. The review system came with logical disks equal to physical disks. So I presume this is a hangover from the hard disk system.

A logical disk comprises a file catalog and a file area where the maximum number of files is specified at system generation. A file consists of a primary file plus up to 25 linked extension files. Before a file is written to disk, the user must choose the number of sectors that it will contain. Viewing a KATLG listing of a disk shows where each primary file and extension is located. When a file is purged its space is not released for re-use until the disk is compressed. On the review machine, disks FPURG and KOMPR unfortunately were not on the same disk.

I had a 'taste' of multi-user SPC/1 when I decided to print several files on the printer and then delete them. I used TXTUD for printing the files. I then used FPURG to delete the files. When I came to the last one I got a message saying I couldn't purge the file as another user was still using it. I tried compressing the disk and again failed; since it was in use this same program could not be moved. Upon re-booting the system I had no trouble deleting or compressing the wayward file.

The editor is line orientated. If the

first character is a space then the following text is taken as input, otherwise the first character is taken as a command. The cursor keys can be used within a line. 'Right' and 'left' move the cursor, while 'up' inserts spaces and 'down' deletes characters. As far as line editors go, the cursor control keys make for easy editing. It's not an easy editor to use, however, as its memory buffer is far too small. After entering about ten lines of text it needs to access the disk. Also, whenever a line before the current one is required, disk accessing frequently takes place. This accessing might be acceptable on a hard disk system but is tedious when entering text on a floppy based system.

Three commands are treated by the operator communication module. These are .LI for choosing the list device (VDU or printer), .FE for choosing where to output error messages and .RU for loading and running named programs. The operator communication module is a resident part of MIKADOS and hence available from main memory.

A non-dedicated Comal system is available that appears to the user like the dedicated Comal. Like all the other language translators it can be accessed by typing its name after '>'. The MIKADOS bootloader is entered automatically upon booting up (which can occur from either drive. The system can also be set up to boot from a given file other than Comal or MIKADOS (e.g. a dedicated Pascal system).

Comal

Comal was designed in 1974 by Borge Christensen and Benedict Lofstedt to be a structured extension of Basic. The documentation states that all Basic facilities are retained in 16k Comal. This compatibility with Basic would be more helpful if there were a standard (say 8k) Basic to be compatible with. (Comal is close enough to Basic to enable the running of the benchmarks, unlike CBasic which required alterations to obtain results.)

As it is, different manufacturers produce different languages called Basic. In fact most micro Basics (including those from the Microsoft stable) show

the strong influence of DEC whereas Comal looks as if it is based on Hewlett Packard's Basic. So programs written in other micro Basic's probably won't run in Comal. The biggest differences lie in string handling facilities. In Comal all strings must be dimensioned. DIM A\$(5) declares a string five characters long. If NAMES="SUSAN" then A\$(1) is S while A\$(3,5) is SAN and A\$(3:2) is SA. Although these string handling functions are neater than MID\$, etc. from Microsoft, they will hinder programs being transferred from one micro to another. (Ian Brunchmann tells me that he has written procedures to transfer from Microsoft string handling to Comal string handling.)

Most micro Basics store each line upon input and only during execution does the interpreter try to make any sense of it. The Comal interpreter, on the other hand, attempts to translate each line upon input (sometimes called semi-compiled). If it can't translate a line, and Comal is quite strict, a 'beep' is emitted, a detailed error message appears on the top of the screen and the cursor is placed on the character suspected of being incorrect, ready for editing. The user can 'escape' but cannot 'return' out of the line until it is correct. Typing just a line number is not legal Comal, so the standard Basic deletion doesn't work. Rather, DELETE line number is required. Regardless of the spacing used when typing in a program, when listing a program all statements within control structures are indented.

The Comal reserved word table shows the similarity with Basic. The Comal extensions include:

1. Sixteen character variable names (variables are not declared and are always global)
2. Three loop structures — taken from Pascal
 - (a) FOR-NEXT — looks like a Basic FOR-NEXT but the test is at the top rather than at the bottom
 e.g. 10 FOR I=10 TO 1
 20 PRINT I
 30 NEXT I
 doesn't print anything whereas in Basic, '10' is printed
 - (b) REPEAT-UNTIL loop with any

GOTO Page 115

COMAL RESERVED WORDS

STATEMENTS

DIM	DEF	LET	FOR	NEXT	WHILE	ENDWHILE
REPEAT	UNTIL	EXIT	IF	THEN	ELSE	CASE
GOTO	ON	GOSUB	RETURN	PROC	ENDPROC	EXEC
REM	INPUT	READ	DATA	RESTORE	STOP	END
CALL	CHAIN	CLEAR	CURSOR	OUTPUT	RANDOMIZE	
PRINT	PRINT USING					

FILE SYSTEM

CREATE	OPEN	GET	PUT	STATUS	ENDFILE	CLOSE
--------	------	-----	-----	--------	---------	-------

STANDARD FUNCTIONS

ABS	INT	SGN	SQR	SIN	COS	TAN	ASIN
ACOS	ATN	EXP	LN	LOG	RND	CHR	ORD
LEN	TAB	STATUS					

COMMANDS

AUTO	CATALOG	CREATE	DELETE	EDIT	GET	HELP	CONTINUE
LET	LIST	LOAD	NEW	OUTPUT	PRINT	PUT	PUTOLD
RUN	SAVE	SAVEOLD	SIZE	STOP	RENUMBER		

Unique in concept - the home computer that grows as you do!

New! - The Acorn Atom



£120 An outstanding personal computer kit plus VAT and p&p.

Also available ready-built
£150 plus VAT and p&p

The ATOM - a definitive personal computer. Simple-to-build, simple-to-operate. But a really powerful full-facility computer. And designed on an expandable basis. You can buy a superb expanded package now - tailored to your needs. Or, you can buy just the standard Atom kit, and, as you grow in confidence and knowledge, add more chips. No need to replace your equipment. No need to worry that your investment will be overtaken by new technology. As you need more power, more facilities, you can add them!

*The picture shown demonstrates mixed graphics and characters in three shades of grey provided by the Standard Atom.

The standard ATOM kit includes:

- Full sized QWERTY keyboard ● Rugged polystyrene case
- Fibreglass PCB ● 2K RAM ● 8K ROM ● 23 integrated circuits
- Full assembly instructions including tests for fault-finding. (Once built, connect it to any domestic TV and power source)
- Power requirement: 8V at 800 M A. ATOM power unit available.

See coupon. PLUS FREE MANUAL written in two sections - teach yourself BASIC and machine code for those with no knowledge of computers, and a reference section giving a complete description of the ATOM's facilities. All sections are fully illustrated with example programs.

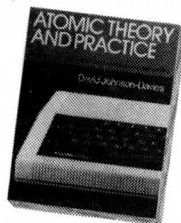

The ATOM concept

Adding chips into sockets on the PCB allows you to progress in affordable steps to large-scale expansion. You can see from the specifications that the RAM can be increased to 12K allowing high resolution (256 x 192) graphics. Two further ROM chips, e.g. maths functions, can be added directly to the board giving a 16K capacity. In addition to 5 I/O lines partly used by the cassette interface, an optional VIA device can provide varied I/O and timer functions and via a buffer device allow direct printer drive. An optional module provides red, green and blue signals for colour. An in-board connector strip takes the ATOM communications loop interface. Any number of ATOMs may be linked to each other - or to a master system with mass storage/

hard copy facility. Interface with other ACORN cards is simplicity itself. Any one ACORN card may be fitted internally. So you can see there are a vast number of modular options and additions available, expanding with your ability and your budget.

The ATOM hardware includes:

- Memory from 2K to 12K RAM on board (up to 35K in case)
- 8K to 16K ROM (two 4K additions) ● 6502 processor ● Video Display allows high resolution (256 x 192) graphics and red, green and blue output ● Cassette Interface - CUTS 300 baud
- Loudspeaker allows tone generation of any frequency
- Channel 36 UHF Modulator Output ● Bus output includes internal connections for Acorn Eurocard.

The ATOM software includes:

- 32-bit arithmetic (±2,000,000,000) ● High speed execution
- 43 standard/extended BASIC commands ● Variable length strings (up to 256 characters) ● String manipulation functions
- 27 32-bit integer variables ● 27 additional arrays ● random number function ● PUT and GET byte ● WAIT command for timing ● DO-UNTIL construction ● Logical operators (AND, OR, EX-OR) ● LINK to machine-code routines ● PLOT DRAW and MOVE.

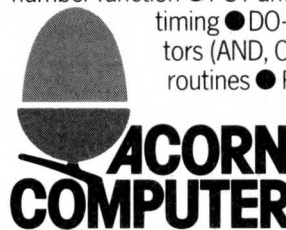

ACORN COMPUTER 4a Market Hill, CAMBRIDGE CB2 3NJ

Your ACORN ATOM may qualify as a business expense. To order complete the coupon below and post to Acorn Computer for delivery within 28 days. Return as received within 14 days for full money refund if not completely satisfied. **All components are guaranteed with full service/repair facility available.**

Please send me the following items:

Quantity	Item	Item price inc. VAT+p&p	TOTALS
	ATOM KIT 8K + 2K (MIN)	@ £140.00	
	ATOM ASS 8K + 2K (MIN)	@ £174.50	
	ATOM KIT 12 + 12K (MAX)	@ £255.00	
	ATOM ASS 12 + 12K (MAX)	@ £289.50	
	1K RAM SETS	@ £11.22	
	4K FLOATING POINT ROM	@ £23.30	
	PRINTER DRIVE	6522 VIA @ £10.35	
		LS 244 Buffer @ £3.17	
	MAINS POWER SUPPLY (1.5 amps)	@ £10.20	
		TOTAL	

To: Acorn Computer Ltd., 4a Market Hill, CAMBRIDGE CB2 3NJ

I enclose cheque/postal order for £ _____

Please debit my Access/Barclaycard No. _____

Signature _____

Name (Please print) _____

Address _____

Telephone No. _____

Registered No: 1403810. VAT No: 215 400 220

PCW/7/80



Will IBM team up with Madame Tussauds to produce 'living' replicas of our dead relatives? This chilling spectre of a future in which loneliness and depression are countered by 'plastic pals' is just one aspect of ANIMISTICS as proposed by Neil Frude — lecturer in Clinical Psychology at University College, Cardiff.

ANIMISTICS



The scene is a man alone in the evening in a large computer installation, overturning teletypes, smashing equipment, destroying irreplaceable data tapes; he's not a life-time Luddite of the new school, but a highly-trained operator with many years experience in programming and systems operation. The frustration he feels when things don't operate to plan is an exaggeration of the emotion which many people experience when faced with the repeated failure of a system or a program. Such a scene has been realised a sufficient number of times, with predictably disastrous consequences, for IBM to now be financing large-scale research by psychologists into 'user-friendliness' in micro-based systems.

American psychologists Karl Scheibe and Margaret Erwin left a tape-recorder running in a room in which subjects played games with a micro. The spontaneous comments which emerged ranged from the affectionate to the downright hostile. The machine was referred to as 'it', 'you', 'he' and 'Fred' (never as a female) and, say the experimenters, "the use of profanity was common". These psychologists concluded that the computer is very easily cast in the role of another person. Adrian Hope, writing in *Everyday Electronics* described an unconventional operation

with the Texas Instruments voice synthesiser 'Speak and Spell'. To expand the vocabulary there is provision for an additional plug-in ROM, accessible by a 'module' button on the keyboard. It appears that if this is pressed when a module is not inserted then the machine invents words and phrases. "So pathetic is the garbled sound", writes Hope, "that only the hardest heart can fail to feel sorry for the confused electronics burbling as if in final, demented death throes."

Each of these emotional and 'personal' effects of machines and programs is incidental to the design of the systems involved. Such reactions are secondary, and often unwanted. If we try to humanise a machine then the effects are far more devastating and may be very easy to achieve. Take the simplest of 'programs' in which there is displayed on a VDU the question "WHAT IS YOUR NAME?" with provision for a string variable input. The user types in "JOHN" and the machine, using this string, then prints "THANK YOU, JOHN, NOW LET'S HAVE SOME FUN!" Now no machine is likely to run out of memory on that program, and it doesn't take a two-month programming course to write the software, yet the psychological effect on the naive user is

often profound. With appropriate skill (and they are the skills of the playwright rather than of the high-grade programmer) the user, child or adult, is easily seduced into further interaction. Statements and reactions by the machine can arouse feelings of humour, affection, hostility, boredom, excitement and, in principle, the whole range of human emotions.

So far there has been relatively little interest in 'humanising' machines. Perhaps those interested in recent developments are more intrigued with the technological potential rather than the human potential of new technology. This will certainly change as machines increase in number and reach further than the 'hard core' of technologists and business systems people, as micro applications swamp into more and more fields and as the economic rewards of mass sales to the technically unsophisticated become apparent. Chips may now be invading homes in the form of calculators, television games and watches but there is a far greater potential market for pets (with the lower case 'p'). When this is realised, then we can expect the parallel development of 'micros as calculators' and 'micros as companions'. This scenario has no need to await future technological developments but would

involve rather a growth of interest and a realisation of current potential together with a leap, or several leaps, of the imagination. It needs psychologists, playwrights, technologists and programmers to cooperate to produce the viable companion. The prospect is both exciting and frightening, yet economic pressures make its realisation seem inevitable. The dream of every chip salesman should be microcircuits, warm and fur-covered, contentedly purring away in every old lady's lap, looking up once in a while, speaking words of reassurance and of its love and need for her, and reminding her to take her tablets at the right time.

If such a prospect seems laughable then we should bear in mind some of the psychological factors which will contribute to its becoming a fact. The viability of the 'intimate machine' rests on two psychological premises, the desire for (and indeed the real benefits of) intimacy and the tendency of people to treat inanimate objects possessing certain vital features 'as if' they were animals or people. These characteristics together ensure the viability, for a large number of potential customers, of the 'plastic pal', the 'micro friend'.

When social scientists conduct 'happiness surveys' to determine the correlates of happiness, and when they ask people about the most important things in their lives, it emerges that the people who are most happy are those with several friends and social contacts, particularly very close ones, and that people say that they value most highly (even above wealth and health) their relationships with other people. Psychologists have provided lists of those factors in social contact which seem to be of particular value, to help people and to make them happy. These factors, such as 'feeling close to', 'feeling responsible for' and 'feeling known by' the other person have been further analysed so that we understand something of the particular behaviours and interactions which foster such feelings. These analyses might well provide the psychological groundwork for any attempt to simulate such actions of the 'other person' in a machine form. The practical benefits of intimate contact are undoubtedly great and we can link this with the fact that those without such regular interaction seem psychologically vulnerable. Single people, the widowed and the divorced are at greater 'risk' of mental breakdown, depression, suicide and alcoholism.

Recent studies have indicated that relationships with pets may go at least some of the way towards satisfying the need for intimacy. The sad fact is that not everybody has a family 'on tap' — there are many lonely and isolated people, particularly among the old, and there is now good evidence to suggest that some people gain from their cats and dogs, budgies and tortoises many of the psychological rewards which most of us obtain from satisfactory relationships with other people. Now the limited behavioural repertoire of some of these creatures would have suggested that they would *not* be likely to prove satisfying as companions and the fact that they *do* brings us to the next psychological premise in our argument — that people tend to 'read into' creatures and objects characteristics which are typical of higher forms. This process has been labelled 'animism' and it has been the



subject of considerable study by psychologists and anthropologists.

In the 1940s the psychologist Michotte built a contrivance by which two shapes were seen as coming together at various speeds and 'colliding' with various patterns of reaction. What Michotte found was that people tended to interpret these visual patterns not only in a 'causal' way (they saw a 'billiard ball effect', a 'pushcart effect' and so forth) but also a 'human' or 'animistic' way. Thus one object might be said to push another one 'deliberately' or 'viciously'. There was then a tendency to attribute motives, emotional expression and intentionality to simple moving shapes. In other experiments short pieces of cartoon film have been produced, and once again it is easy to get people to report 'high level' interpretations — they ascribe 'animistic' qualities to simply moving geometric patterns. It seems, too, that particular shapes often bring out a specific emotional response. A skilled cartoonist need only draw a few lines to create a baby rabbit or 'Bambi' figure, which is not only easily recognisable but also 'appealing' and of course doll manufacturers successfully recognise this tendency and turn it into product and cash.

It's not just visual presentations that produce such emotional reactions, either. Quality of voice, the nature of statements being made, physical warmth and softness or furriness may all produce positive emotional responses. If we combine several such characteristics then the overall psychological result is greatly magnified. Anthropological interest in animism has stemmed partly from the view that it is a characteristic feature of the 'primitive mind'. Certainly it is found most strongly in primitives and children, but that is not the end of it. The experiments described above indicate that the tendency exists, albeit in a somewhat quiescent form, in all of us. A few years ago one successful marketing company in the States launched the 'Pet Rock', an executive toy, expensively packaged and with instructions for care

and feeding. The joke sold well. Scratch an executive, it seems, and you'll find a primitive. We can, however, overcome the sophisticated which may normally hide the animistic tendency by matching it with sophisticated technology. Some of the possibilities here are indicated in fictional creations which capture the popular imagination. There has long been a fascination with 'humanoid' automata; they are mentioned in Homer's *Iliad* and they are the stock-in-trade of much of today's science fiction, both in print and on the screen. Stars such as R2D2, Hal of '2001' and several of the characters of the 'Hitch-hiker's Guide to the Galaxy' endear themselves to viewers and listeners by virtue of their 'personality'. Their fascination does not lie in their formidable computing power but rather in their typically 'human' utterances and foibles.

There are lessons to be learned from close examination of the characteristics of these popular creations. Almost all of these androids are conceived of as male, they are all primarily task-oriented or problem-solving machines with merely incidental personality rather than being specifically contrived humanoid companions, and they are mechanically rather primitive with a surfeit of whirring cams and flashing lights. Some of their voices are far more stilted and sound far more artificial than the best of the voice synthesisers available currently. In a word they are in many ways too 'hard' and would be unlikely, were they realised, to be immediately acceptable as companions. The problems of 'softening' the technology, however, are not difficult and are largely surmountable with currently available methods. What is needed is imagination, research into mass-user acceptability and a belief that there are likely to be vast social and economic pay-offs.

Softening the hardware

It's undeniable that there is a 'machine

barrier'. People feel initially self-conscious and uncomfortable 'relating' to a machine. The same kind of self-consciousness is often found when one is discovered talking to a cat. Yet (in private at least) some people talk to their cats all the time. If they overcome the 'animal barrier' involved in treating animals 'humanly' then they can probably also be seduced into treating machines in the same way. The 'human-ness' of sophisticatedly programmed machines with appropriate software is likely to be far greater than that of any animal, although the barrier, it is true, is likely to be more formidable, at least initially.

What hardware features would the ideal micro companion possess? What should it look like, feel like and sound like? Presumably people would relate more easily to a body shape which they were familiar with and so a human or animal form would seem to be most appropriate. A soft skin or fur covering would feel pleasant to the touch and a suitable body temperature could be maintained. Above all, the ideal companion would *not* look like today's computer, no shiny metal parts, no VDU or flashing lights. Facial features could be customised so that no two machines actually looked alike (computer controlled production would make this easy and cheap) and voices could be tailored in a similar fashion so that no two sounded exactly alike. The state of the art in voice synthesis is now adequate for this aspect of the production of a good companion though the voices produced are a bit harsh and school-masterly. The user would want less perfection, more pauses, splutters, repetitions, coughs and giggles. We would expect 50% of production to be of female voices (and we would naturally want to combine these with female body shells unless we have a consumer with rather particular needs.)

The possibility would exist for producing a model which not only looks human but which looks like a specific person, someone famous perhaps, or an absent member of the family. The psychological effects here are quite unexplored. Would schools keep an appropriately programmed Shakespeare replica in the cupboard to teach English? Perhaps there would be legislation to prevent the simulation of a person until 50 years after their death as in the existing copyright laws. The chilling thought of a lonely person sitting in conversation beside the fireside with a replica of a deceased spouse does little to assuage fears as to the possible social impact of the application of technology in the way we are envisaging. It may even give us cause to ponder the desirability of consciousness-raising in the present form; yet the elements for these developments are lying about us in separate packages and it cannot be long before somebody will put them together. There is, after all, a lot of money to be made.

At this stage it seems that realistic locomotion is one aspect of the hardware side of things which is not readily achievable. Maybe the first generation of companions will be relatively sedentary. Other body movements may be complex but are not difficult in principle, as witnessed by the more successful of the achievements of the automata makers in the 18th and 19th centuries. Indeed automata making has a very

ancient history and testifies to a long-established desire to create realistic humanoids. The then 'new technology' of clock-making gave rise to a great leap forward in the production of such machines in the 17th and 18th centuries and we can expect a similar and much greater impact-making leap with today's new technology. The problem with sophisticated machines of the old era was that they were hand-produced and made on a 'one-off' basis. The mass-produced automata were far simpler toys with very limited movements. Today, of course, it's possible to produce in quantity even the most sophisticated machines with a very much extended repertoire of movement. In St. Petersburg in 1799 the Academy of Sciences offered a prize for the first machine which could realistically produce the five vowel sounds. We can imagine the contraptions which were produced, all bellows, bladders and reeds but nevertheless designed and constructed with a great deal of care and ingenuity. If yesterday's automata makers had had the opportunity to employ today's technology then their productions would have been truly astonishing. The old automata engineers were not content, however, to merely produce effective functional mechanisms; they took great pains to incorporate them into life-like models. This made them far more awesome and intriguing to a public which queued and paid to see those 'miracles of the modern age'.

Softening the software

The production of attractive and realistic dolls provides a vehicle for the output and display of the control systems which are the forte of contemporary technology. The animistic potential of an appealing voice and moving body is fulfilled only when what the machine *does* and *says* is realistic and appealing, too. Already there are successful attempts to simulate 'human' conversation, though in a limited form and via a VDU and teletype, in counselling and psychiatric programs such as Weizenbaum's ELIZA and in medical diagnostic programs. It's true that these have a very limited repertoire and generally work by searching for and recognising key terms. However, we probably overestimate the degree of complexity and the extent of the repertoire of normal social conversation. Certainly people do a great deal of isolated term-spotting

and 'filling in', and we just don't know how sophisticated an informal conversational program would have to be in order to be pleasurable and user-acceptable. Conversation with young children or with the senile can be difficult and arduous but may, nevertheless, be pleasurable. The *type* of errors which the machine would produce would certainly be somewhat different from those which children make, however, and it remains to be seen whether people's reactions to these would be of the same kind. What is certain is that errors in social chatting are not of the same practical importance as in task-oriented interactions; they may be amusing and easily tolerated, or perplexing and difficult to live with. It's likely that people would accommodate to the limitations of the machine, as they do with young children and other people with low comprehension, and alter their speech patterns so that they produce statements which will be understood. There is a natural process by which linguistic style is 'shaped up' in accordance with the perceived effects of former interactions, and of course we would expect the machine software to contain the potential for a similar accommodation and 'learning from' the input style of the speaker or teletype user.

The style of informal speech is not, of course, that which we see in the transcripts of a carefully written play (unless it's by a playwright of the Pinter school) but contains much repetition, pausing, restatement and imprecision. Thousands of recordings of 'ordinary' conversations have been analysed by linguists and psycholinguists and it's not difficult to produce a simulation of the style. But such a level of analysis need not in fact be necessary and the problem might be successfully solved in a more direct fashion by the programmer with a good ear and some of the skills of the dramatist and by a program with the right degree of flexibility and randomness. Without formal analysis a 'try it and see' approach would be employed.

Next we come to the 'personality' of the machine as implemented in the programming. The computer simulation of personality has a relatively long history. Loehlin's program ALDOUS recognises situations, reacts 'emotionally' and in various versions is a decisive or hesitant reactor. There is also RADICAL ALDOUS, CONSERVATIVE ALDOUS and SAINT ALDOUS. We see here a good opportunity for the customisation of programs. The machine should be basically sympathetic and 'good' but

GOTO Page 119

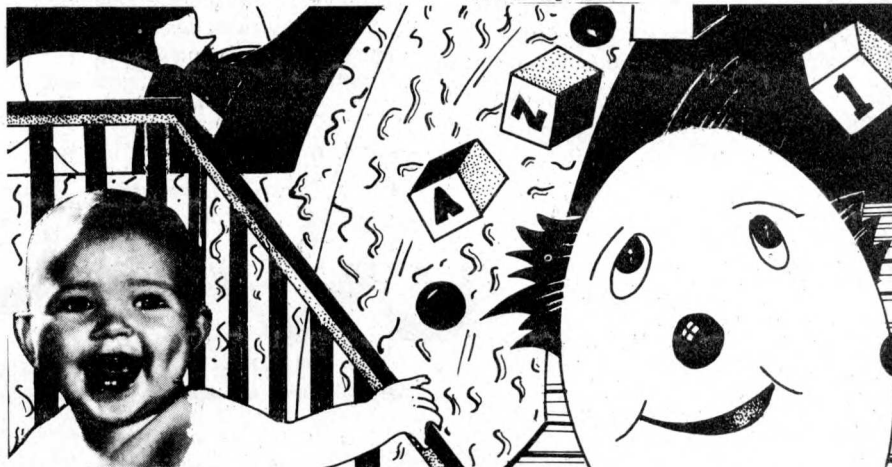

AT LAST!

Appleware

The best of
British and American
**APPLE
SOFTWARE**

ACT Appleware brings you 70 classic programs from the worlds leading suppliers of Apple software. Many have already become best sellers in America. So send today for a free copy of the most exciting Apple software catalogue ever. We promise

to keep you on the mailing list.

Appleware is backed by the resources of the ACT Group, Britains leading computing company. Contributing software houses include Programq International, Personal Software, Automated Simulations, Speakeasy Software and P.D.I.

Disk programs include:

Applepie Text Editor £30
Alien Invaders £8
Apple Database £23.50
Talking Disk (Speech Synthesis) £14.95
Apple FORTH £39.95
Assembler/Editor (in machine code) £45

Try them at your Apple Dealer. Also available by mail order direct from ACT Appleware.

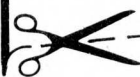

Send a free catalogue to

Name

Address

Post code

I have an Apple II ITT2020
 No Apple

Appleware

Radclyffe House, 66/68 Hagley Road, Edgbaston, Birmingham B16 8PF
Telephone 021-455 8585 Telex 339396

COMPUTER ANSWERS

Each month Sheridan Williams and his panel of consultants answer readers questions. Topics may be hardware — from kits to mainframes, or software — from differential equations and statistics to file handling or sorting; the choice is yours. Send your questions direct to Sheridan Williams at 35 St Julians Road, St. Albans Herts.



Power problems?

Can I buy an Apple floppy-disk system for my Eurapple II in America? Could problems arise with the conversion 220/110 volts and 50/60 Hz?
Hans Dolk, SHAPE Technical Centre, The Hague.

You will have no problem in buying an Apple disk drive from the States. The drive is powered from the Apple's DC supply so you don't need to worry about mains voltage or frequency. Make sure that you get a controller board (unless you already have one) and also a floppy disk with the latest DOS on it — and don't forget the manual.
Mike Dennis.

Trouble of a sort

I've written a package for my business and basically I'm very pleased with it. I use floppy disks to store customer records and frequently need to print these records in alphabetical order. I now have nearly 1000 records and hold these in customer number order. I use a method that sorts onto a second disk, which I can then keep, but the sort seems to take hours. Can you help with a faster routine?
P. Abbott, York.

You don't give a name to your sorting technique, but it's probably a version of the 'bubble' or 'ripple' sort. The majority of books and novice programmers use the 'bubble' sort, which must surely be the slowest sort ever invented. The reason for its popularity is probably twofold; it's very easy to understand, and only takes a few lines of coding. It has the annoying property that if we double the number of items being sorted, it will quadruple the sort time. On this basis if it takes one second to sort ten numbers, it will take four seconds for 20 numbers, and so on until it takes 16000 sec for 1200 numbers. Over four hours! Part of the problem lies in the fact that we are usually using interrupted Basic which serves to slow down processing anyway.

What we require is a far

more efficient sort. One that can be recommended for speed is called the 'quicksort' (clever, eh?). The quicksort only doubles the sort time for double the number of items being sorted. Using our previous example, if it takes one second to sort 10 numbers it will take two seconds for 20 numbers and 160 secs for 1200 numbers, which is just over 2.5 minutes. It would take too long to explain how the quicksort works but here is the coding. In this example it will sort N numbers in ascending order in the array A(1) — A(N). It requires the B array as working storage, but this array only needs 24 elements to sort 5000 numbers so there is not a lot of extra space needed:

```
10 DIM A(N), B(INT(LOG
(N)/LOG(2)+1),2)
1000 REM ** quicksort sub-
routine **
1010 S=1
1015 B(1,1)=1: B(1,2)=N
1020 L=B(S,1): R=B(S,2):
S=S-1
1030 I=L: J=R: X=A(INT
(RND(1)*(R-L)+0.5)
+L)
1040 IF (A(I))>=X THEN
1050 ELSE I=I+1: GOTO
1040
1050 IF X>=A(J) THEN
1060 ELSE J=J-1: GOTO
1050
1060 IF I>J THEN 1080
1070 W=A(I): A(I)=A(J):
A(J)=W: I=I+1: J=J-1
1080 IF I<=J THEN 1040
1090 IF J-L>=R-I THEN
1140
1110 IF I>=R THEN 1130
1120 S=S+1: B(S,1)=I:
B(S,2)=R
1130 R=J: GOTO 1170
1140 IF L>=J THEN 1160
1150 S=S+1: B(S,1)=L:
B(S,2)=J
1160 L=I
1170 IF L<R THEN 1030
1180 IF S>0 THEN 1020
1200 RETURN
```

Having decided that this is the sort to use, let's look at the problem a little more deeply. If we have 1000 customer records each of length 100 ch, say, we would require over 100k of memory in which to sort the records. It's unrealistic to sort in memory because it's quite likely there will not be enough space. We will consider two alternatives: 1) sort entirely on the disk; 2) sort the record keys in memory and then access the records in that order. Method (2) will be faster as it takes far longer to swap records on the disk than it does to swap them in memory.

Method (2) will require that you read into an array the first four characters of the key field, followed by the record address. For example, if the disk file holds as record

1, WATERS & CO LTD etc, and record 2, BLOGGS MOTORS etc, then in the array D\$(1) will hold WATE1 and A\$(2) holds BLOG2. We must restrict the number of characters to a suitable figure to allow the total amount of records to fit into memory. That means, at eight characters per record we will only need around 10k of memory to hold 1000 records. For example to read record Y from disk and store it in array element X we would use:
READ/1@Y,T\$: A\$(X)=LEFT\$(T\$,4)+STR\$(Y): X=X+1

Because Basic is so different in various versions the statement READ/1@Y,T\$ means read from file number 1 (disk file already defd maybe as OPEN/1,'CUST.DAT') at record number Y (direct access address) into string T\$.

Once the array has been sorted the following program would print the file in sorted order:

```
100 DIM A$(1000)
110 OPEN/1,'CUST.DAT'
120 FOR X=1 TO 1000
130 Y=VAL(MID$(A$(X),
5))
140 READ/1@Y,T$
150 PRINT T$
160 NEXT X
170 CLOSE/1
```

Advantages of this method are that the file remains intact, and that sort is quick. Method (2) requires that the file itself will be sorted and hence it's best to sort a backup copy of the file in case the system crashes in mid sort. This method has the advantage that a file of any size can be sorted, and that the sorted file can be kept as a permanent file if needed. The program is very similar to that above and the changes are as follows:

```
1030 I=L: J=R: READ/1@
(INT(RND(1)*(R-L)+
0.5)+L),X$
1040 READ/1@I,Y$: IF Y$<
X$ THEN I=I+1: GOTO
1040
1050 READ/1@J,Z$: IF
X$<Z$ THEN J=J-1:
GOTO 1050
1070 WRITE/1@I, Z$:
WRITE/1@J,Y$: I=I+1:
J=J-1
```

I hope these hints may help people who are struggling with sorts. If the above programs do not run then it's because of errors in transcription, please write if you have any difficulties.
S.W.

Bar codes

I am a teacher, and would like to link a bar code reader to a 380Z micro. Do you know a source for a) a design (circuit diagrams, etc) and b)

a specification for the bar code itself?
D Benzie, Pershore, Worcs.

Bar code is a way of storing machine-readable digital data on the printed page, as a stripe of alternating black and white bars. It's read by scanning with a hand-held wand, which contains both illumination and a point-focus light sensor. The alternating light level is detected, amplified and converted to digital logic levels. The bar code is self-clocking, so varying scanning speeds can be compensated for and digital data recovered. Depending on the code in use, there may be formatting of the data to indicate direction of scan, (which allows the stripe to be read in either direction), and to provide error detection by parity or check digit.

There are many different codes, designed for various applications. Some are proprietary and some are in the public domain. Uses include cheap mass distribution of software (Paperbyte), library books (Telepen, Plessey), groceries (UPC, EAN) and stock control and data entry (Code 39, Codabar and others). The best code for general experiments is Paperbyte, especially since it gives access to *Byte's* software books. Details of the code and loader routines in 6800,6502 and 8080/Z80 assembler are in *Bar Code Loader* by Budnick, (LP Enterprises, 01-591 6511), but no wand data. *Byte*, December 76, contains the original format trials and some wand ideas and circuits. A clever circuit by Moseley is in *Byte*, May 78.

There are some annoying mechanical and optical problems in building a wand. The sensitive area must be about the same size as the minimum bar, 1/72 inch for Paperbyte, so you can get light into and out of a pinhead spot. Paper is very abrasive, so the tip must be hard or replaceable. The wand must be robust, since they tend to get trapped in drawers or swung by their cables.

You may be interested in some commercial products. SCAN-A-MATIC has the S27101, a T018 size coaxial source-sensor with .010" resolution at £16.25; there's also a range of code pens, and decoding electronics for several commercial codes. The pen has a sapphire tip and cheapest is the internal subassembly (needs a simple barrel and cable) at about £60. SKAN-A-MATIC is at 40/41 Castle Street, Brighton.

Hewlett-Packard have a T05 reflective sensor, HEDS-

THE BYTESHOP & COMPUTERLAND

Still the biggest 6 in the country

London

48 Tottenham Court Road
London W185 4TD
Tel. 01-636 0647

Birmingham

94-96 Hurst Street
Birmingham B5 4TD
Tel. 021-622 7149 Telex. 336186

Nottingham

92a Upper Parliament Street
Nottingham NG1 6LF
Tel. 0602 40576 Telex. 377389

Ilford

426/428 Cranbrook Road,
Gants Hill,
Ilford, Essex IG2 6HW
Tel. 01-554 2177

Manchester

11 Gateway House
Piccadilly Station Approach
Manchester
Tel. 061-236 4737 Telex. 666168

Glasgow

Magnet House
Waterloo Street
Glasgow
Tel. 041-221 7409 Telex. 779263

Your six main computer centres, stocked up with new equipment for 1980. Complete systems carefully chosen for their reliability and availability. Plus the widest range of software for business, education and industry. For expert advice on which system suits you best call into one of the Big Six.



6 &

1000 at £17.83, and a wand, HEDS-3000, at £61.99; unfortunately I've had no data on this as yet.

Len Warner
(Kelek Systems Ltd.)

APL~eyed

I've heard people who work with mainframe computers using terminals referring to a new language called APL. Can you tell me something about this language. Is it like Pascal?

I'd like to know if it is available on micros and in particular whether it can be used on a Tandy TRS-80, as it sounds as if it has some good features.

L. Davies, Cheshunt.

APL (it stands for A Programming Language . . . no kidding, that's absolutely true!) originated as a logical and mathematical notation. Don't let that put you off . . . it's now an extremely powerful general purpose programming language. It's come to the fore in the last few years, mostly for time-sharing applications on mainframes and the larger minis.

Like Pascal, it lends itself, and tends to push the programmer into, writing short sub-programs (called 'functions') which are called by an equally short master program. But whereas Pascal often forces you into doing things, such as the 'modular' programming described above, APL only encourages you to do so. If you want to do it differently, you can. Structured programming is common in APL — but not unavoidable!

Perhaps you've already noticed that I've been bitten by the APL bug and that's something experienced programmers rarely recover from! Probably it's because APL is powerful, concise, and, once you've got the hang of it, simple. The power comes from two main factors.

The first is that it has a lot of very useful 'operators' (somewhat misleadingly called 'Primitive Functions') and a simple but effective data structure. In APL a simple variable is defined by the system as a multi-dimensional array, which can hold numeric or alpha-numeric values without further definition. Variable names are usually at least eight characters long, making for easy to read programs, as with Pascal or Cobol. Functions are also called by name. Unlike Pascal or Cobol, there's no need for a long initial 'definition' section to the program. Another powerful feature shared by APL with these other two languages, is the ability to use 'local' variables, whose value is set only within one 'function', or 'global' variables, working throughout the whole program.

The other factor contri-

buting to the power of APL is that the 'primitive functions' can be used to build up an almost unlimited range of user functions, which can all be called by name (rather as in Forth where new entries can be made to the 'dictionary'). Thus, while there is only one 'primitive' data structure, other structures corresponding to those in Pascal, and yet others not found in that language, can be readily defined.

To give an idea of another feature of APL, its compactness, compare defining and summing a run of numbers in Basic and APL:

```
In Basic
100 Z=0
110 FOR N=1 to 100
120 X=2*N
130 Z=Z+X
140 NEXT N
```

```
In APL
Z←+/2 i100
```

APL has only just recently become available in this country for use with micro-computers. The Superbrain features it as standard, and it's available to run under CP/M. The only snag is that the interpreter (APL is always interpreted) takes up a fair amount of memory — typically you need 36–40k for the operating system and APL together. So this leaves you with 28k at the most for working memory. But APL is so compact that you can do a lot more with this space than you'd think. One effect of the size of the interpreter is that a floppy mini-disk system is really needed . . . even 36k is an awful lot to load from tape! A convenient feature of having the disk, which APL automatically takes advantage of, is that there is room to do a complete memory dump; the SAVE command stores the entire contents of the working memory on the disk — the program, functions in use, data, variables, the lot. So you can even stop in the middle of a run (if the phone rings, or a meal's ready!) and then reload later and carry right on! Of course, you can also save individual programs (and 'functions'), and write to data files in the usual way (remember, it's all operating under standard CP/M).

As regards APL on a TRS-80, in theory this should be possible, as CP/M is available for the Tandy. Assuming that you have a Model I, then even with the maximum memory of 48k you wouldn't have much working memory spare. Of course, with a Model II with up to 64k there should be no problem in that respect. I'm not sure whether an APL interpreter is yet available over here on TRS-80 format disks. One place you could get more information on this would be AP Ltd, of Chester.

The one thing that is likely to prove a headache when putting APL on a TRS-80 is

the special character set used by APL for the 'primitive functions'. This causes no problems within the computer and peripherals, as the standard ASCII codes are used, but, at the least, you will need a chart to show you which keys to press when entering the programs.

When it comes to displaying the program a special VDU or printer will be required. APL character generator chips are available for some VDUs while dual purpose ASCII/APL VDUs are also on the market. There is also at least one reasonably priced printer that can be obtained in this country which can print these characters. Of course, APL programs use the normal characters for the program output; it's only for listing the programs that the special characters are needed.

P.L. McIlmoyle.

Which programmable?

Please could you advise me on the respective merits of the HP-67, Casio fx502-P, and TI-58 programmable calculators as regards number of program steps, value for money etc., since I am considering replacing a Sinclair Cambridge Programmable which is somewhat the worse for wear.

C. Marriott, Llandudno.

You have chosen an interesting range of programmable calculators to compare, in that Texas Instruments TI-58 does not store information externally on magnetic media, the Casio fx502P can make use of a domestic tape recorder to store programs and data, while the Hewlett Packard HP-67 includes a built-in magnetic card system.

As regards the number of programming steps, the Hewlett Packard has 224, the Casio 256, while the TI-58 weighs-in at 480. The situation is complicated by the number of steps not necessarily being directly comparable — some calculators can pack more program per 'step' than others — while there is usually a trade-off between program steps, and data storage. So the number of steps is not everything. Indeed, if you use long programs needing large numbers of steps then the ability to avoid having to re-enter the program by hand each time you use the calculator is very important. Here the HP-67 scores, with its built-in magnetic card memory system. The Casio also scores by having both a non-volatile memory, that retains the program even when it's switched off, and the ability to store program and data on magnetic tape cassettes on a domestic tape recorder — via a £25 adaptor. The TI-58 memory goes once

it is switched off and as the rechargeable battery only runs for a few hours you will almost always have to re-enter your programs. Texas also make the TI-59 which overcomes this problem by using magnetic cards like the HP-67, at a comparable price.

As well as the card-reader, the HP-67 has another distinctive feature (in common with normal Hewlett-Packard practice) — the use of a Reverse Polish Notation (RPN). This means that, for example, if you want to multiply 6 by 3 you would have to enter 6, 3, X, in that order, rather than 6, X, 3 as with most calculators. Some people prefer RPN, some find it impossible to get used to, while most soon adjust to it.

As for value for money, one problem is that calculators are widely discounted, so it's not easy to be sure one is comparing like with like. Also, some published prices include VAT, others don't! However, basing the comparison on widely advertised discount prices, and adding on VAT, puts the TI-58 at about £70, the fx502P at £75, plus £25 for the adaptor, and the HP-67 at £220. Even if you don't already have a cassette recorder, the all-up price for the fx502P with recording facilities comes out at about £130. A special feature of the TI-58 is the availability of interchangeable plug-in 'program modules', which offer pre-prepared programs in various fields such as Maths, Electrical Engineering, Structural Engineering, and Applied Statistics. These cost some £20 each.

Your final decision as to which calculator to buy will, of course, rest on a careful weighing-up of which factors are most important to you for your application. Just on price, the TI-58 scores, and even more so if the 'program modules' are of value to you. Against it is the lack of the ability to store your own programs and data. It's worth mentioning here that Texas has now brought out the TI-58C, which, for about £20 extra, retains the contents of memory, both programs and data, when switched off.

The Casio fx502P offers the ability to store programs and data on a magnetic tape cassette, but this will (assuming you already have a tape recorder) cost you some £30 more than the TI-58.

At the top end of the range is the card-programmable HP-67, also featuring RPN, at three times the cost of the TI-58. If you don't like the RPN, or want a slightly larger card-programmable calculator, then you should also consider the TI-59. It could also be competitive with the HP-67 on price.

GATEWAYS TO LOGIC

As fully paid up members of the New Microcomputing Front, it befalls all of us at one time or another to pass on some of our knowledge to the uninitiated — teacher to pupil, parent to child, or just plain person to friend.

To the untrained, having knowledge may be one thing — being able to instil it into someone else is quite another. Derrick Daines, Deputy Head of Carsic School, Sutton-in-Ashfield (and of course the new organiser of Young Computer World) tackles this tricky area in a new series that, although originally aimed at teachers, can clearly be used by anyone. The first part begins this month.

Introduction

The 1970's have been unprecedented in their speed of technological innovation. Never before have new devices and new ways of doing things flowed in such abundance from the research centres of the world. It was bound to happen, of course. There are more scientists living and working today than in all the previous history of mankind put together. Since they're not all devising new perfumes or plastic throw-aways, then by the law of averages they are certain to come up with some pretty far-reaching discoveries and inventions sooner or later.

Perhaps the one field in which this has been most marked has been in electronics and especially in the wholesale integration of circuits in the silicon chip. More than anything else, the chip seems to have caught the imagination of the world — and with justification, for it will have the most profound effects upon our lives, affecting every single one of us, even those who have never heard of it.

If we look back at history, it's clear that the world of 50 years ago was totally different from today. Then very few could have foreseen the collapse of the Empire, the at least partial demise of the Church, the undermining of family life, the lawlessness of our city streets and the open sale of pornography. Few could have foreseen television, the boom of the Universities, strawberries in mid-winter, heart transplants, men on the moon, hand-held calculators, wall-to-wall carpeting or even cheap and almost universal central heating. To be sure, a few men forecast a few of these things, but they were laughed at for their pains or else had their work confined to the pages of sensationalist magazines.

Change is getting faster. If it seems that the pace of innovation reported in the press is breathtakingly fast, you don't know the half of it. Considering scientific inventions alone, every week some 1600 new patents are taken out, 900 of them in English. The outpourings of books, magazines, papers and reports of every kind is measurable by the ton. This is the information explosion you may have heard about. One result of it all is that nobody can hope to stay abreast of developments, even in their own field of expertise. Time was when a person left the University

equipped with a sufficient capital of knowledge to last him for life; now few people may justifiably call themselves expert without frequently attending courses and seminars. Everyone is running like mad to stay where they are. Small wonder that the average person feels disoriented, gives up, drops out, or resorts to vandalism or even violence.

If knowledge is increasing so fast that many are unable to keep up with it, what hope is there? Take another look at the silicon chip. Just at a time when science is moving so fast it's outstripping anyone's ability to absorb it; just at the time when central government is proliferating so rapidly that even the highest-placed find it hard remembering how many quangos there are; just when the power to control our own destiny seems to have slipped away from all of us; just when all this has happened, the silicon chip has arrived to give back all that we have lost and much, much more.

By itself the chip will do nothing. It's an inanimate object requiring additional, peripheral devices with which it can control its environment and through which it can be controlled. Above all, it requires the human brain. The chip therefore gives us the opportunity for control. Through it we can work an automated mine or fly a spaceship to Jupiter, effect the juxtaposition of words in a poem or the most complex library catalogue. It follows therefore that not only must we know something of the silicon chip, but also something about these peripherals.

It's reasonable to suppose that if a savage were to be given a motor car, he would shelter in the lee of it and admire himself in the wing mirror for a long

time before he discovered that the door opened. It's also obvious that if ever he got the machine moving, his skill would be enormously improved were he not to labour under the delusion that 10,000 devils were trapped under the bonnet. The public at large is just beginning to open the door to the world of the silicon chip microprocessor and starting from now everyone leaving school must of necessity have been given a thorough grounding in the subject. Eventually the public will learn to drive — rather nervously — but if the chip itself remains a mystery, then at one and the same time too little and too much will be expected of it — rather like the savage who on one hand is content with 15mph, but who on the other is expecting the car to leap into a tree.

It's not necessary for everyone to know how to program a computer and still less is it necessary to know how to solder the bits together — any more than it's necessary for everyone to know how to repair a car. However it is necessary for everyone to have some idea of the basic principles and that is what this series intends to provide. All of the ideas presented are known to work and are ready for implementation, now.

There's nothing difficult about any of them. Some are suitable for toddlers while others will need to be imparted later; all have the one aim in mind of teaching the principles involved in the new technology. I hope that everyone may find within these pages something of interest, especially members of my own profession who, by following the suggestions made, may walk into their classrooms and lecture halls tomorrow morning and start training our youngsters for their technological future.

CHAPTER 1: LOGICAL TOYS

It's no accident that the 1920s saw the growth and proliferation of mechanical toys such as Meccano, Trix, etc. . . it was a time when mechanisation was booming. The world was excited by the prospects and youngsters were (and always are) quick to absorb the excitement around them. Such toys proved a painless way of absorbing mechanical principles and play has always served the function of instilling ideas in the young.

The toys of today are at a crossroads . . . on the one hand they have become

more and more mechanical, and on the other they incorporate some very sophisticated electronic circuitry. They've also become more and more expensive, although parents seem quite willing to go on spending large amounts for them, possibly because size of outlay seems to have become confused with parental concern. It's not at all uncommon for quite young children to be given calculators, cassette tape recorders or even portable television sets; very soon computers will fall into

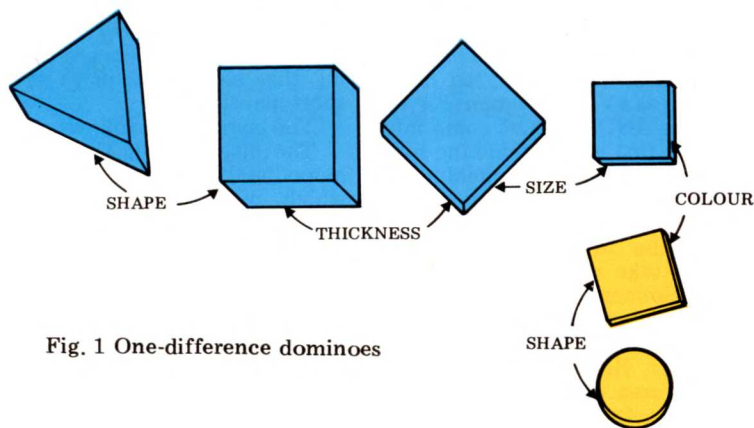

Fig. 1 One-difference dominoes

the same category. Dolls must be expensively dressed and may also have short vocabularies, while toys for boys mimic the functions of spacecraft, Daleks and the like. All of these toys suffer from one basic defect—they make too little demand upon the child; (s)he's got little to do but sit back and admire. Needless to say, such toys don't last long. They either break down or run out of battery power, only to be discarded — and rightly so.

It cannot be stressed too strongly that to be successful a toy must stimulate the imagination of the child, must involve him/her in creative play and must in some measure presume the child's adult role. It must of course also be rugged.

There'll always be room for good mechanical toys such as Meccano, just as there will always be room for good mechanics, but it's interesting to note that there is more than one computer on sale right now at considerably less cost than the No.10 Meccano set. Several electronic construction-type sets of plug-in modules are available that will make up into radios, burglar alarms and the like; there are also sets designed to teach the principles of computing. These electronic toys and trainers will be dealt with later in the series.

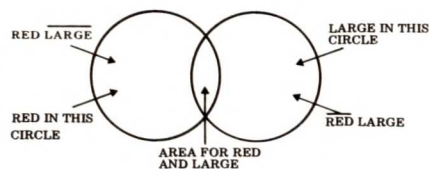

Fig. 2 Two-circle Venn diagram

For the younger child there is a set of toy bricks available that ought to be in every home, nursery, infant, and primary school as well as many secondary schools. I refer to Logic Blocks (I wish someone would think up a snappier name for them — Logiblox, perhaps?). As a toy they're first-class, while as a teaching aid, they're terrific.

Logic Blocks were invented by Professor Dienes, Director of the Department of Psycho-Mathematics, University of Sherbrooke, Quebec. In some ways I wish they weren't! If anything is guaranteed to kill a toy stone-dead, it's the news that it was invented by a professor. And as for him being a professor of something called Psycho-Mathematics, well, I ask you!

Don't let it put you off. They're enormous fun and they're not expensive. The basic set is intended to be used

on the table-top, but there's also a pocket size available and a demonstration or 'floor' size, which comes in a box some 18" by 12".

As originally designed, Professor Dienes' blocks come in three different colours — red, yellow and blue — two sizes, two thicknesses and four different

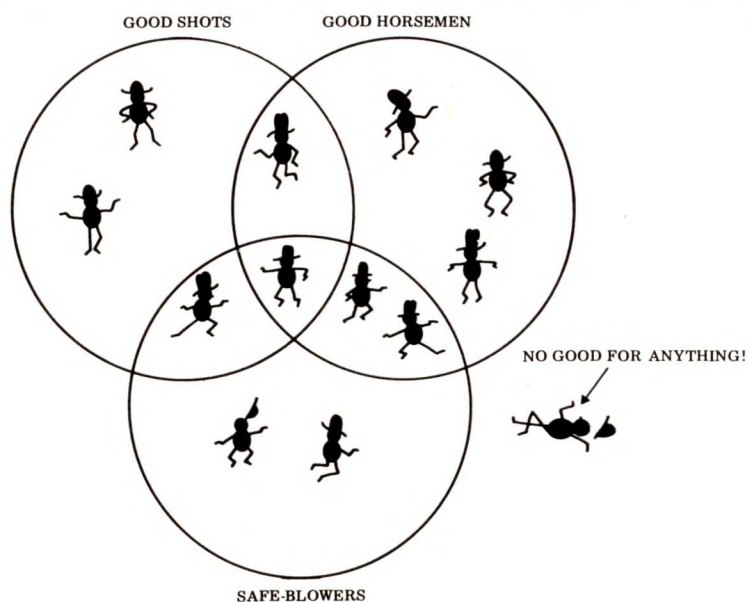

Fig. 3 — A 3-circle Venn diagram

shapes — square, rectangle, triangle and circle. Every block differs from every other block in one or more aspects so that we have a thick large yellow circle, a thin large yellow circle, a thin large yellow square and so on. It's tolerably obvious that 48 blocks make the set.

Other types, more suitable for very young children, make up their sets from different tree profiles, house shapes, various modes of transport or different types of people. The latter has two sexes, three colours and sitting, kneeling, walking or standing profiles. One manufacturer has added a hexagon to the basic set. . . all are made of high-impact plastic. A list of suppliers will be found at the end of this feature.

There is of course no reason why the larger pieces shouldn't be given to babies or toddlers to play with, since they're non-toxic, have no sharp edges or corners and can't be swallowed; but it's with the growth of language that they come into their own. For a full treatment of the subject, the reader is referred to "Learning Logic, Logical Games" by Z.P. Dienes and E.W. Golding, published by ESA in con-

junction with the University of London Press, 1971. Here I shall confine myself to just a few examples and point to some extensions of the main ideas.

After a period of free play, training continues with the child being asked to 'tidy them up.' This involves a sorting process, perhaps putting all the reds in one pile, the blues in another and the yellows in a third. There are of course many ways of sorting. There could be two piles only — one of thick, one of thin, or one of small, the other of large — or four piles of differing shapes. Some children might want to separate the large shapes from the small, which should be praised. It's a process however that could ultimately lead to each block being in its own pile and if this shows signs of happening some collectivisation must be insisted upon. The advantages of the game are obvious in that the child is learning to discriminate colours (easy), sizes (harder), shapes (harder still) and thicknesses (tricky). More than that he is learning the language, with the parent or teacher repeating key words for him

such as RED, LARGE, THIN, and so on, up to TRIANGLE or even RECTANGLE (OBLONG should be discouraged). Shades of Piaget, we can even talk about MORE in this pile and LESS in that; the possibilities for language development are enormous.

Gradually we introduce the word NOT, (a block is red, or it is NOT red), and the concept IF . . . THEN. (IF the block is small THEN put it on the table.) Other important words are

Fig.4

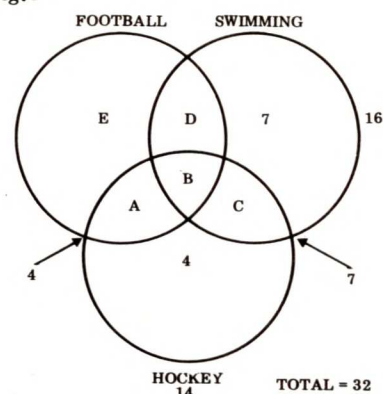
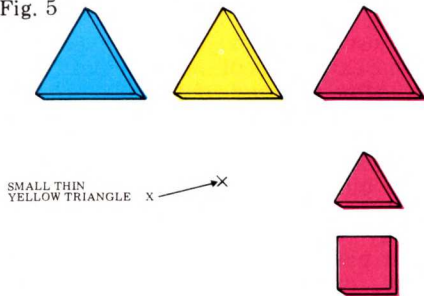

Fig. 5



SOME, ALL, DIFFERENCE, SET, EITHER, OR, NEITHER, NOR and so on. All are vitally important concepts.

The first simple logic sorting games lead on to the use of the word and concept OR (build a house with blocks that are red OR thick); followed by AND (build a house with blocks that are red AND thick.) Even junior school children have difficulty in distinguishing between AND and OR, but come to that, so do a lot of adults!

Try taking a piece away from the jumbled set while the child has his/her eyes shut. The object of the game is, of course, for the child to decide (not guess) which piece has been removed — and they can get astonishingly fast at it.

Another basic game is One-Difference Dominoes. The blocks are shared out among the players and one piece is laid in the middle as a starter. Each child in turn lays one piece to left or right that has one and only one difference from the piece adjoining (Fig.1). Encourage the child to describe the piece he lays down and also seek confirmation from the others that the piece is legal.

One-Difference can lead on to Two-Difference or even Three-Difference Dominoes — which is not nearly so difficult as it sounds. The game can also be played in four directions from the starting piece; or the children can be instructed to make a train — a complete loop. Given a few basic games as a start, children will play for hours and even invent their own games.

Fig. 6

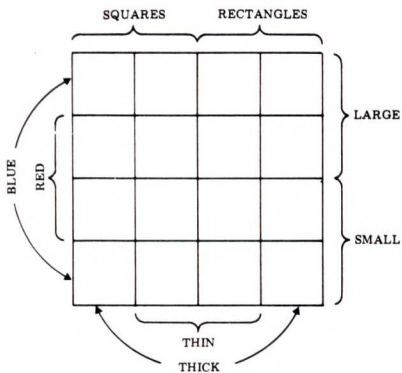

Sorting games achieve a new dimension with hoops. Chalk circles will serve, while for the affluent there are plastic mats available with large circles printed on them. The mats take chalk very well and can be sponged clean; ordinary hoops, however, are a good substitute. We start with one hoop, putting all the blocks with a given attribute inside it and then pose the question, "What do we know about those blocks outside the hoop?" We may get the answer, "Nothing," or long lists, but the teacher should aim to elicit that they are NOT (whatever attribute is inside the hoop.)

Play goes on to two, three or four hoops and all the time language and concepts are being developed. Then one day, we overlap two hoops to make what's known as a Venn Diagram (Fig.2). This is where AND and OR come into their own. At first we continue the sorting games, with the teacher labelling the hoops round their edges with whatever attribute of block is to go in each — thereby utilising the AND area. Then the children can take over, applying their own labels. Sooner or later two mutually-exclusive labels will be applied, as for instance where one is labelled RED and the other, BLUE. Obviously, the central AND area cannot be used since we have no blocks that are red and blue at the same time.

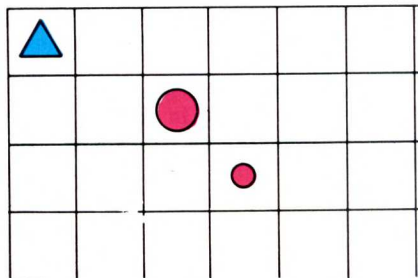

Fig. 7

Venn diagrams with hoops can conveniently be extended to three or four hoops, but this is the practical limit. Even so, it's surprising the complexity of problems that may be solved with three- or four-hoop Venn diagrams.

Fig. 8 The Black Box



When the children reach the age of 9 or 10 the problems can be abstracted from these graphic concepts and numbers substituted. We can talk about putting a rope round people attending a party — these have red hair, these have big feet, these have had too much to drink; little pin men help. Another way is to talk about a gang of cowboys (Fig.3). Draw the men and encircle them as shown. There are good horse-men, good shots, and those able to blow a safe. One man in the middle is the boss, while any outside are no good for anything in this situation... cooks perhaps. Questions are then posed — how many men can handle horses? (7) How many are good shots? (5) How many can ride and shoot? (2) How many can ride or shoot? (10) How many cannot blow a safe but can shoot? (3) How many are rotten shots? (8). Given a certain scenario, how would the children deploy their men, if they were the boss? Countless questions of this type are possible and the children love it.

Note to the general reader — if all this seems like kids' stuff to you, here is a problem recently solved by a class of 10- and 11-year-old children:

In a certain class of 32 children, 16 like swimming and 14 like hockey, while 7 swim only and 4 play only

hockey. If 4 like hockey and football, while 7 like hockey and swimming how many footballers are there, assuming that each child plays at least one sport mentioned?

The answer is as follows:

The diagram (Fig.4) shows the data immediately available, with the order in which we deduce the others shown alphabetically. A and B total 4, B and C total 7. Since there are 14 hockey players and 4 are known to play nothing else, A plus B plus C must equal 10. The only way in which these conditions can be satisfied is for A to equal 3, B to equal 1 and C to equal 6. We may now deduce from the total of swimmers that D must equal 2. From the total class number we can work out that E is 9. Footballers total A plus B plus D plus E, which is 15.

At this point the reader might well be wondering what this is all about. What possible relevance is there to our technological future? What are we training?

The short answer is that we are training logical thought. Primitive thought is largely confined to thinking in pictures... what is desired is pictured in the mind; logical thought must proceed by the mental use of words. (Emotion is a driving force, but as a rule of thumb, the more powerful the emotion, the more likely it is to preclude logic.) Now far too many children arrive at the secondary school unable to think at all, except pictorially; a fact long recognised and worked on by people such as Edward de Bono.

The trouble lies with our training — and especially that part that deals with logic and the non-acceptance of the exclusivity principle. The exclusivity principle is based on the 'exclusive or'; either something is, or it is not; that block is red or it is not red. Every time a mother says, "EITHER you do so-and-so OR I will smack you," and then relents, she is undermining the exclusivity principle. She is actively teaching that sometimes, with a little wheedling, things can be both at the same time. It's odd that when the OR is seen to lead to something desirable, we feel compelled to keep our promise, yet when the OR is nasty or undesirable, we feel no such compulsion. No wonder there's a breakdown of law and order! I'm not necessarily advocating stricter sentencing or anything like that; just that we should not present the EITHER... OR without the determination to carry it out. If you say a thing, mean it!

Machines are totally logical and in order to understand (let alone manipulate) them we must be totally logical too. And that's where the biggest shock is coming.

Fig.9 A selection of Trackway Gates and One Dock

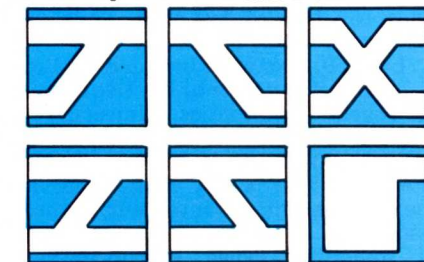

More block games

If the teacher can make or obtain a matrix of six squares by eight, (s)he has the

Make your micro

MIGHTY



Get the most out of your microcomputer with Graham-Dorian Business software.

At any given time, your hardware is only as useful as the software you run in it. Our programs let you realise the full potential of your hardware

Graham-Dorian provides highly detailed and well documented programs. All pretested on the job. Each so comprehensive that it takes little time to learn to run a program — even for someone who's never operated a computer before.

Graham-Dorian programs are on-line now working for us and others around the world. They are ready to go to work immediately or to be tailored for your more specific needs. Each package contains a software program in BAS and INT film form plus a user's manual and hard copy SOURCE LISTING.

Programs are compatible with most major computers using CP/M disk operating systems, and come in standard 8" or on various mini-floppy disks.

Graham-Dorian stand behind dealers with technical advice.

Yes, there's a world of difference in business software. Graham-Dorian has more per-package capabilities and more packages (with new ones added every few months).

The Graham-Dorian line now includes these packages:

- Nominal Ledger
- Purchase Ledger
- Sales Ledger
- Job Costing
- Order Entry & Invoicing
- Payroll
- Manufacturing Inventory
- Manufacturing Job Costing
- Wholesaler Inventory
- Retailer Inventory
- Cash Register
- Apartment
- Surveying
- Dental

CBASIC-2*

Ask your dealer for a demonstration soon.



Graham-Dorian Software Systems

A division of Graham-Dorian Enterprises

& Terodec (Micro Systems) Ltd.

17 The Gallop, Yateley, Camberley, Surrey.

Tel: (0252) 874790/(0344) 51160

*GDS are appointing UK Dealers and European Distributors. Enquiries and applications invited.

*CBASIC-2 is a trade mark (copyright 1980) of Compiler Systems, Inc. GDS are the European Distributor for CBASIC-2.

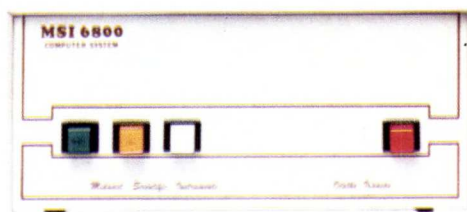
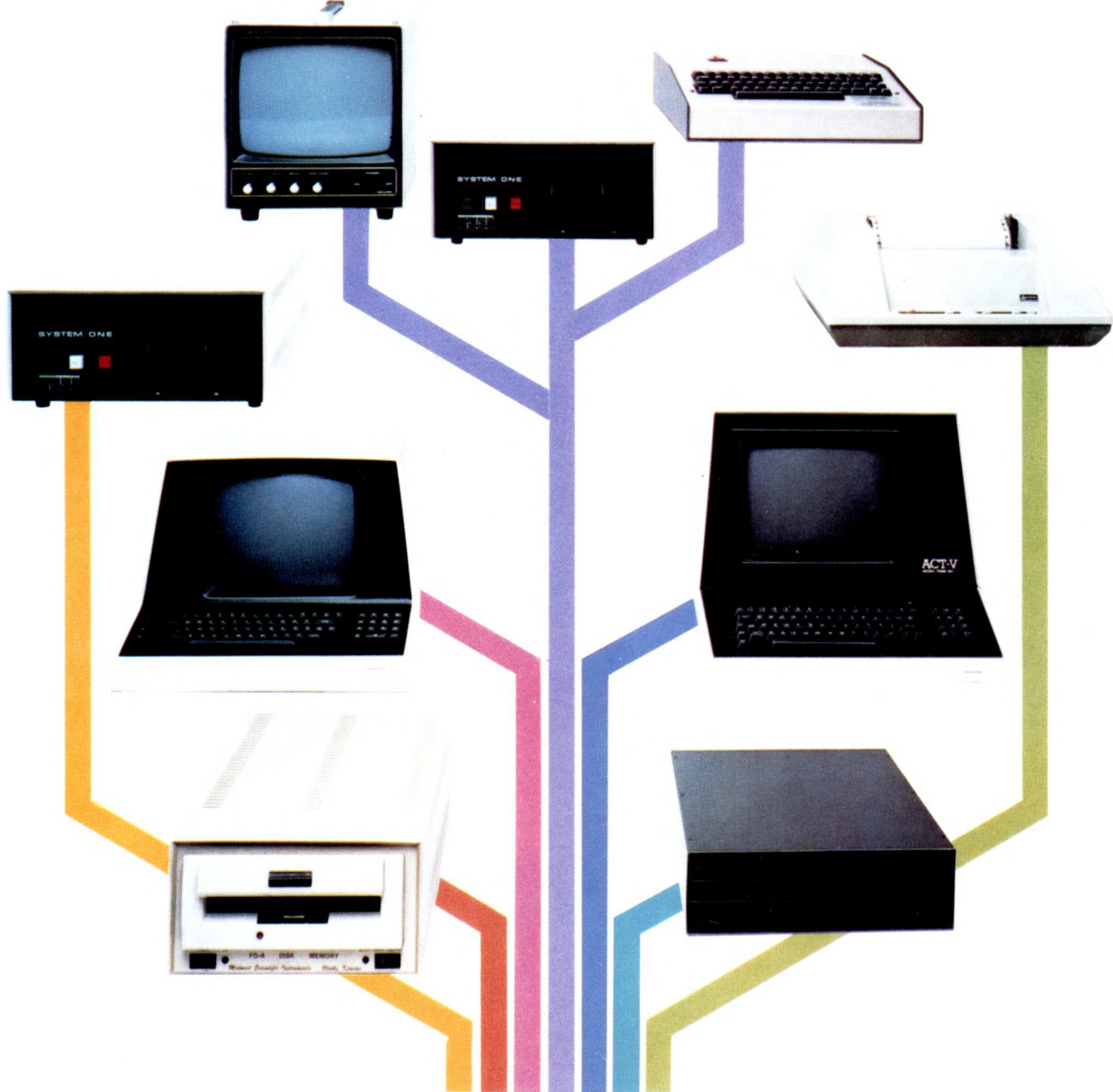

MSI 6800: At the root of every good system.

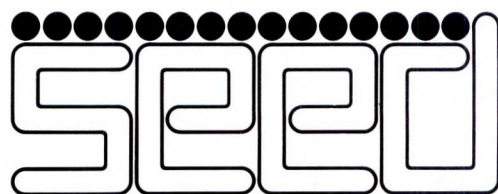

Strumech Engineering Electronic Developments Limited
Portland House, Coppice Side, Brownhills, Walsall, West Midlands. Telephone (279) 4321

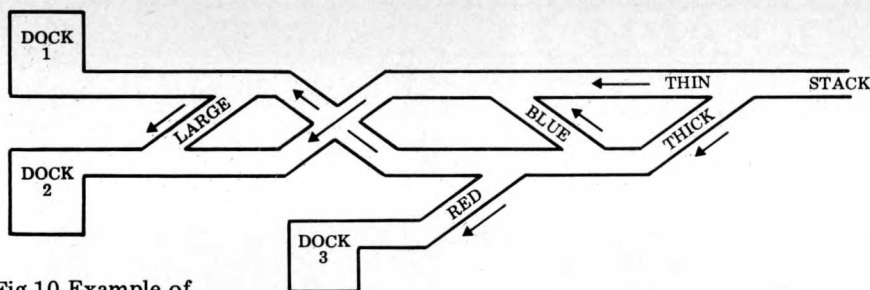

Fig.10 Example of tracks in use

tool with which to extend the children's use of logic.

Begin by asking them to lay out the blocks in such a way that any one can be found very quickly — which implies some sort of order. Commonly, children will lay them out in three rows of colour or four of shape, but they are told that only one block is allowed per square. There are several acceptable methods. Alternating rows of the same shape with different size is good, as is four rows of each size. Other acceptable methods will be found.

Another way of tackling the same thing is to start a game of One Difference Dominoes on a corner and then ask for a suitable piece to go into the angle of the corner such that it has one difference from the piece to the North of it and one difference from the piece to the East (Fig.5). From this it's obvious that the process may be repeated until all the blocks have been laid

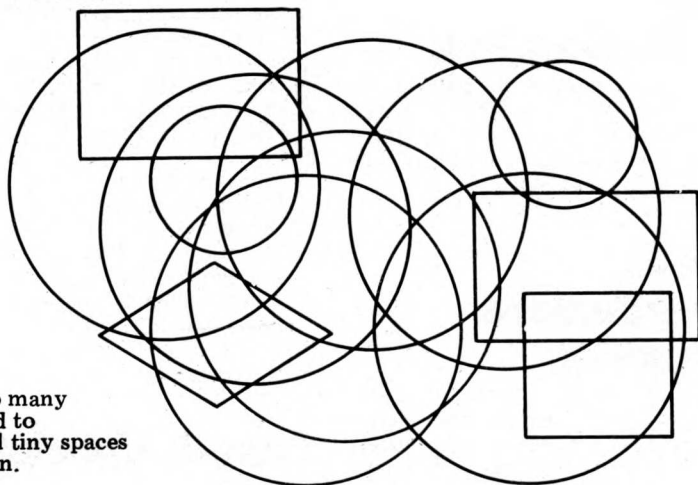

Fig.11 Too many shapes lead to clutter and tiny spaces to colour in.

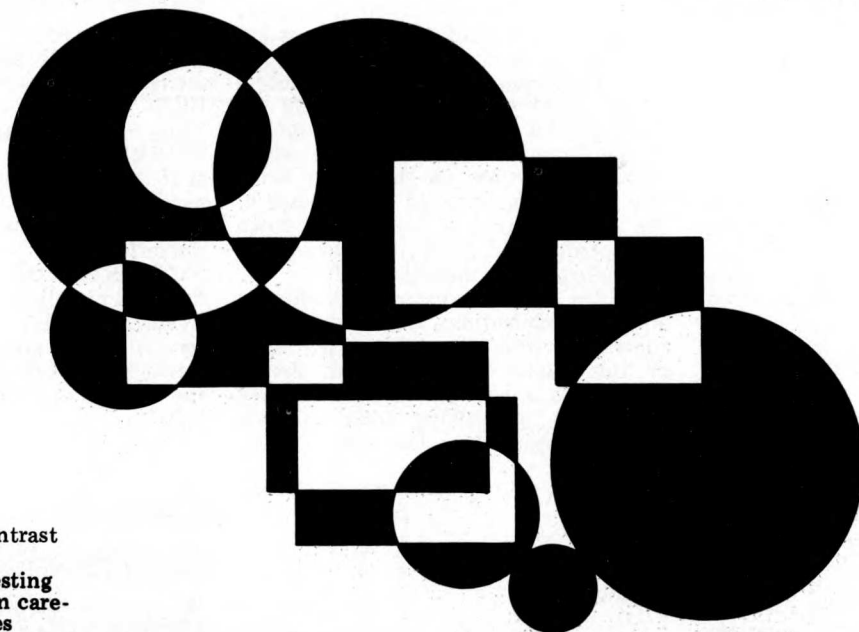

Fig.11A The bold contrast of black on white emphasises the interesting shapes produced from carefully spaced templates

advantages vis-a-vis Venn Diagrams. Since both are logical and capable of giving insights into logic problems, both are important to us as teachers — although it's clear the Venn Diagrams are easier to understand for the young child.

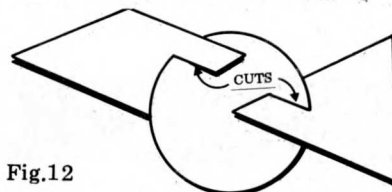

Fig.12

With the notion of a Black Box we are getting closer to the machine, and indeed we can call it a machine if we wish. The idea of any Black Box is that we don't know what it is that goes on inside in any detail, but we do know the overall effect, since this is observable (Fig.8). We make or draw a Black Box and label it with its effect, and then invite a forecast from the children as we feed each block of the set through the box or machine. With the example given, it may take an astonishingly long time for all of the children to realise that nothing happens to the blues, for instance, while for a considerable time many will wish to turn reds to yellow. A lot of practice may be needed.

Machines or Black Boxes can be cascaded in twos, threes or even fours, as the children get better at using them (as judged from the accuracy of their forecasts). No real purpose is gained by extending it beyond this, however. Trackways are better and lead naturally to flowcharts (Fig.9).

Trackways are available commercially (see list of suppliers), but it's no great effort to make one's own. Obtain a bundle of thick cards of a standard size — say 6 inches square. Carefully draw a gate on each as per the figure and for clarity, paint the rest of the area. Always call it a gate, not branch or road or what-have-you because it has much in common with an electronic gate — as we will see later.

All we need to start with is one gate, a dock and a pile of logic blocks. For normally right-handed people it's best to have the dock on the left and start with the pile on the right. The idea is that we take each block in turn down the track until we reach the gate — where

GOTO page 119

FRIENDS AND ENEMIES

There's many a slip 'twixt brain and chip and in this new series of articles, David Hebditch will be looking at some of the more revealing examples of design incompetence at the human interface. On the brighter side, he'll also be suggesting ways of making systems more user friendly.

Have you ever actually cursed at the sight of your system displaying

```
*** SYNTAX ERROR ***
```

without it saying what is actually wrong?

Have you Apple programmers missed RETURN and hit RESET at the critical stage in a program — more times than you've had hot dinners?

Do you ever feel like bouncing your TRS-80 out of the window when the keyboard bounces at the wrong moment?

If your reply to all the above questions is 'no', then you are allowed to stop reading for ten seconds to recall the most quirky and unfriendly thing about any computer or program which you use regularly, for the point behind this new series is to make systems as friendly to their users as possible.

Now there is more to this than just displaying 'HELLO' at the beginning of the program and the topics I shall be covering include:

Keyboard Design

Display format and facilities

Printer features and functions

Design of input messages

Design of output messages

Design of screen layouts

Dialogue style

Error handling and reporting techniques

Use of graphics

Advanced dialogue techniques

This list divides itself up nicely into two parts. The first three items concern the hardware and (unless you are a home-brew enthusiast) you cannot do much about them. However, they are included for two major reasons:

1. If you are buying a system with integral keyboard display facilities (or a VDU to use with a micro like the Black Box, Cromemco or Horizon), then knowing about these things could influence your decision and ensure that your choice is going to work well in practice.
2. The general standard of 'human factors engineering' or 'ergonomics' in display terminals is appalling; I believe most manufacturers could benefit from a little feedback on this particular subject.

The rest of the checklist is more concerned with software and the way in which the user interacts *via* the keyboard and display with a particular control program or application package. Unlike the previous factors, here is a situation where (usually) you *can* do something about the problem. Not only is this series written for the program-

mer, it'll also be of interest to users. In the latter case, they may well be involved in the design of new applications programs and in the selection of 'off the shelf' packages.

The purpose of this introductory article is to raise readers' sensitivity to human factors in computer systems and to help do this I shall be calling upon my 'Black Museum' of bad examples. I am going to use some which come from much bigger computers than the average micro; even IBM, the Jolly Grey Giant, can screw up this sort of thing. Let's start with some keyboard examples:

Case 1: The Perilous Pair

Apple's daft oversight in putting the RESET key right over RETURN is a classic. Reset keys are best off round the back of something — or at least well away from the main keyboard.

Case 2: Non-standard keyboards

A classic case here is the original PET keyboard which was much smaller than the usual typewriter arrangement and used funny keys to boot (if you got angry with it).

The new Sinclair ZX80 is another example . . . it employs no keys at all.

What can be more disconcerting than size is the location of keys. PET succeeded in making *programming* easy by putting a lot of the graphics characters in the lower case shift. On the Apple however they are in the upper shift. The Superbrain is weird in this respect; the double-quotes is somewhere down the bottom right hand corner instead of on the top row — unforgivable!!

In the age of converging computer and communications technologies, it's somewhat ironic that the two sides of this major historical trend should have made a balls-up of the relatively trivial job of getting their numeric keypads compatible. Just look at this:

Data Standard	Telecommunications Standard
7 8 9	1 2 3
4 5 6	4 5 6
1 2 3	7 8 9
0	* 0

Perhaps we should consider ourselves lucky that they got 40% of it the same! What do you put on the keyboard of a micro which has Prestel interface? If you make it the data standard (because you use that more), how are you going to use your Prestel television at home? Once decisions on this scale have been made, it's just about impossible to get them reversed. We could be as stuck with these layouts as we are with the QWERTY keyboard.

Case 3: Tandy tremors

It really is amazing what we can adapt to when faced with no choice. The quality of video generators in some systems is little short of disgusting. Even on expensive VDUs screen quality is often poor. Things to watch out for are:

- Screen shake (a la Tandy)
- Fuzzy characters in the corners of the screen
- Variation in character size between the centre and corners of the screen
- Funny shaped characters (e.g. no lower case descenders on the Super-brain)
- no lower case and so on.

Case 4: Unhelpful error messages

I know that error messages take up a lot of space, but I want to scream when I see larger systems display:

```
ERR
```

```
True, sometimes you get
```

```
***ERR
```

as if the much-abused asterisk had some psychic power. The next example should go in the *Guinness Book of Records*:

```
SYNTAX ERROR
```

```
followed closely by
```

```
INVALID DATA
```

an all-time great (but unhelpful) message. Error messages should be clear and explicit. I once saw a system come up with

```
NEGATIVE TRANSPARENCY
```

```
Figure that one out!!
```

Case 5: Unfriendly Input

This one is rapidly becoming a classic ANSWER YES OR NO

(NO=0, YES=1);

That might have been acceptable in the days when Basics had little or no string handling, but not any more.

Another annoying example which is easy to do on the Apple (the bits in italics are what the user keys) is:

```
DO YOU WISH TO PROCEED: YES
***STRING DIMENSION ERROR IN
3340
```

READY

Sick isn't it? All that happened was that the programmer forgot (or couldn't be bothered) to dimension the input string which defaulted to a length of one.

Case 6: The pseudoerror

Consider this sequence (the user is trying to enter a date):

```
ENTER DATE: 12/8/46
```

```
ERROR - DATE MUST BE DD.MM.
YYYY
```

```
ENTER DATE: 12.8.46
```

```
ERROR - DATE MUST BE DD.MM.
YYYY
```

```
ENTER DATE: 12.8.1946
```

```
ERROR - DATE MUST BE DD.
MM.YYYY
```

```
ENTER DATE: 12.08.1946
```

```
DATE ACCEPTED.
```

Phew! What a relief! Actually the date is wrong; what the user wanted to enter was 12/9/46 and the program could not or would not find that. So what were all the messages about? Well, the original date was only wrong because the program (or rather the programmer) decided it was only acceptable in one form. For most people 12/9/46 is perfectly reasonable, so why shouldn't the program accept it? These are what I call 'pseudo errors'.

Case 7: Word processing

One of the major problems with most of the word processing systems that are based upon general purpose micro-computers is that they've been developed by data processing specialists. There's an easy way of discovering if this is the case; write for details and if the covering letter you receive back with the brochure has been printed right-justified or (even worse) printed on a matrix printer, then get suspicious. It shows that the supplier is completely out of touch with the whole area of word processing. Even if the letter has come out of the system, it should still look as though it was produced by a sexy young thing on an IBM Selectric typewriter. Word processing makes special demands on both system peripherals (VDU or serial printer) and the dialogue. For these reasons, I shall later be allocating a complete article to the ergonomics of word processing.

Having said what I have about the attempts of data processing people at word processing, perhaps I should redress the balance by mentioning that Olivetti (who have been making and selling typewriters for donkey's years)

have a special purpose word-processor which works with an awful single-line display. Word processing through a key-hole! Try moving a paragraph . . .

Case 8: CP/M and Command Languages

What chances are there for end users if systems designers and programmers are unable to develop good system-level dialogues for themselves? The classic case is IBM's Job Control Language (JCL). This is so unfriendly that I've known some top people in the industry give up programming in despair. JCL just got in the way; it made the system harder to use rather than easier.

Things have moved on a lot since then, and micro systems are considerably easier to use than the average main-frame. But this is no excuse for complacency and I shall be reviewing some of the more popular command languages for disk-based micro-computers.

My reasons for reviewing all these examples of the malevolent human factor in micro systems is that the recognition of bad design is an essential first step towards learning techniques of good design. So, rather than finishing on a down note, I'll now consider those features that should exist in a user friendly system.

The following are ten key factors which can be used as an aid to assessing the human factors quality in an interactive computer based system.

1. Do the users judge the system to be easy-to-learn and easy-to-use?

This must be determined by the user (or would-be user) rather than by the system developer. If it takes longer than about one hour to learn the rudiments of the system, then it's probably too complicated. The 'ease-of-use' criterion covers everything from response times, through consistency of coding and syntax to clarity of system messages.

2. Is the system easy to extend and modify?

The cost of keeping computer systems in step with application requirements has become a major component of overall dp costs. The only way in which this problem can be overcome is to ensure that the original software is designed in such a way that it can readily be extended or modified. Furthermore, such changes need to be possible within the structure of the existing *dialogue*; if the established formats and procedures are altered then operational activities will be disrupted.

3. Is the system designed to avoid errors as well as detect them?

Does the system operate in such a way as to encourage and assist the input of good data as well as preventing the input of bad?

4. Is the system efficient and economical?

Can data be entered and files manipulated with the minimum number of key-depressions compatible with the

ease-of-use and ease-of-learning criteria?

5. Is the system effective?

This is not the same as 'efficient'; the most efficient system can be totally ineffective when it comes to solving the business problems for which it was intended.

6. Is the system adaptive?

Artificial intelligence techniques have now reached a level of maturity which justifies their introduction into routine commercial applications. A particular case is the development of systems which are able to learn from experience; by analysing patterns of good and bad data (as determined by the user) to decide for themselves what is good or bad. Such techniques can also be applied to making the dialogue itself more adaptive to the idiosyncrasies (or needs) of individual users.

7. Is the system helpful?

If the system can learn from the user, can the user learn from the system? Usually error messages are directed at telling the user what he cannot do. A smart system always provides constructive advice. In many cases, this can be implemented through the use of HELP facilities.

8. Can the system be 'personalized'?

When we talk about 'the user' we usually mean 'the user group' or some notional 'average user'. Of course, the thing that makes people more interesting than computers is that they are not produced to some standard specification and the range of their experience and skills will vary considerably. How easy is it to modify the system to meet the needs of each *individual* user? Does the system do this automatically?

9. Is the system user-modifiable?

One way of overcoming the program maintenance problem described earlier is to provide facilities whereby the user can make simple modifications by himself (without doing any programming). We are now beginning to see the introduction of parameter-driven software but much simpler mechanisms can be incorporated in dialogues which enable changes to be made where they are most likely to be required.

10. Were the users (actual or potential) involved in the design of the system?

No one has yet discovered a means of forcing users to accept a system with which they do not identify. The key question is — do the users describe it as 'our system'?

This new series will I hope encourage developers to produce systems which meet the above criteria; I hope, too, it will help users to ensure they get the system they have in mind.

I recently received the following message from an IBM System/34; KBD-0000 HELP KEY NOT ALLOWED NOW

If you have ever introduced such a message in one of your systems, you have failed. Think about it.

I would be pleased to hear from any reader who can offer examples of both good and bad human factors in systems design. Write to me c/o The Editor, PCW.

APPLE AND CREAM

by David Tebbutt

Introduction

Steve Kemp, one-time shift leader on a large computer installation, went into the intruder alarm business some four years ago, thinking his computing days were numbered. Soon, however, business had grown to such a size that he and partner Bill Gainford began to feel the need for their own computer — if only they could afford one. Imagine then Steve's joy when he was called to install burglar alarms in some very well-known microcomputer stores. He found that while he had been busy getting his business off the ground the price of computing had been dropping at such a rate that he could now afford one of his very own; partner Bill agreed on going ahead, leaving Steve to the gory details.

The company

A1 Security Systems is a small ten-man firm specialising in intruder alarm systems for home or business premises. Based in Harrow, they install, repair and service equipment anywhere in Greater London and the Home Counties and, at the time of writing, have some 500 customers on their books. Most people enter into a maintenance agreement which involves A1 visiting them at regular intervals to service the installation. A small number of clients don't have maintenance agreements but A1 still keeps an eye on the interval between visits and sends a reminder letter if a system check is due.

Three main types of protection are offered — perimeter, trap and volumetric. Perimeter protection involves a series of wires, magnetic switches and inertia sensors which trigger an alarm if an intruder attempts entry. Trap protection is provided by a series of pressure sensitive mats and door contacts, while volumetric systems comprise an arrangement of beams aimed at the area to be protected. Any interference of the beam's echo is detected by the sending device and the alarm sounded.

The way it was

As Steve's business grew so did the paperwork . . . indeed it had reached a point where there was literally no end to the day's work. All statements were being written by hand, and in total that was consuming three days out of every month; VAT returns were the traditional headache taking an enormous amount of time and effort, and daily maintenance schedules had to be typed to ensure that the engineers actually arrived at the right premises to service the alarms. There were, of course, many other aspects of the

business in which sheer volume of paperwork threatened to engulf Steve, but that wasn't all — the work was eating up something like £120,000 of materials each year, all of which needed controlling. Items frequently went out of stock because of the difficulty of remembering when to place orders to take into account delivery lead times and consumption. One option would have been to increase the number of staff, but this would have meant moving into larger premises, with all the associated expense, not to mention the cost of an additional person. Clearly, something had to be done and it was with this realisation that Steve found himself looking longingly at Apple's, Commodore's and Tandy's offerings.

The decision

Once Steve had developed the taste for microcomputers he couldn't really wait for one of his own. He had reached the stage where he was working solely on the admin side of the business with no time to go out installing alarms any more. While this didn't upset him greatly, he did feel that his job was getting boring and some of the fun was going out of life. He sat down and tried to think of the most beneficial uses to which he could put a computer in the business and decided that, above all, a word processing system would be very handy to help him thrash out installation specifications far more quickly. After all, there are only so many variables in a burglar alarm specification — the rest is common paragraphs. One of A1's clients turned out to be the Cream Microcomputer Shop in Harrow. Run by Alan and Jackie Savage, it specialises in ITT, Apple and Commodore products as well as a range of books, software and computer accessories.

Remembering this, Steve toddled along to Cream and was promptly persuaded that the ability to control his stock, maintenance contracts and sales ledger would be a better place to start, with the word processing coming along later. Steve saw the sense of the proposals and, once shown the packages available on the Apple, he was quite convinced. He realised that the level of service to his clients would rise — partly through having the stock available and also because the computer could remind him whenever anyone was due for a maintenance call. He would also be able to maintain accounts far more easily because, with a computer system, data need only be captured once whereas with a manual system one has to continually re-enter the same figures in different ledgers. He also saw the computer as a far more secure way of holding sensitive

information about clients and their types of installations. Finally, of course, he noted that a computer represented a significant tax loss. Apart from these wholly rational reasons for purchase there is some feeling that once Jackie — the 'wife' part of Cream's team — had spun her feminine wiles, he actually stood no chance of escape anyway!

That was why Steve bought a computer, but why Apple? Well, he found the compactness and modularity of the equipment a distinct advantage, especially as he works in rather cramped offices. This, he figured, would allow him to scatter the various parts of the computer around a bit (in fact, his monitor ended up on a shelf and his printer on a brace of filing cabinets). The other main influencing factor was the sheer professionalism of the packages offered. All in all he felt confident with the whole deal, the packages, the equipment and the support offered by Cream.

Getting under way

One Wednesday in early January Steve convinced partner Bill of the need to buy. Bill agreed and by Saturday Steve had paid around £4100 for software and equipment. It was early days for Cream then and they had yet to reach the hallowed status of authorised service centre for both Apple and Commodore products; they, themselves, had to put the money for Steve's machine 'up front'. Steve understood this but when he told Bill what he'd done, Bill wanted to cancel the order. Steve procrastinated slightly and the next day he was rewarded by Cream announcing the arrival of the equipment.

On the following Wednesday it was installed and Steve began loading the sales ledger details; on Friday the machine fell over and he lost all the records he'd loaded. Most of Saturday was spent studying the manuals! Steve had learnt in a rather unfortunate way the need to take security copies.

He started again and spent the next two weeks of evenings and weekends loading his sales ledger file with customer details — some 500 records. The next task was to load details of all the maintenance contracts. Unfortunately, just as he was tapping in the 200th record, the system reported that he'd run out of disk space. Gulp! He had to start again — again. This time though it was the package that was at fault . . . there was something wrong with the record deletion function. Steve has now had to stop deleting records while the package is modified.

By the beginning of February everything was on disk, security copies had been taken and the computer

INSTALLATION

Ian Dobbie

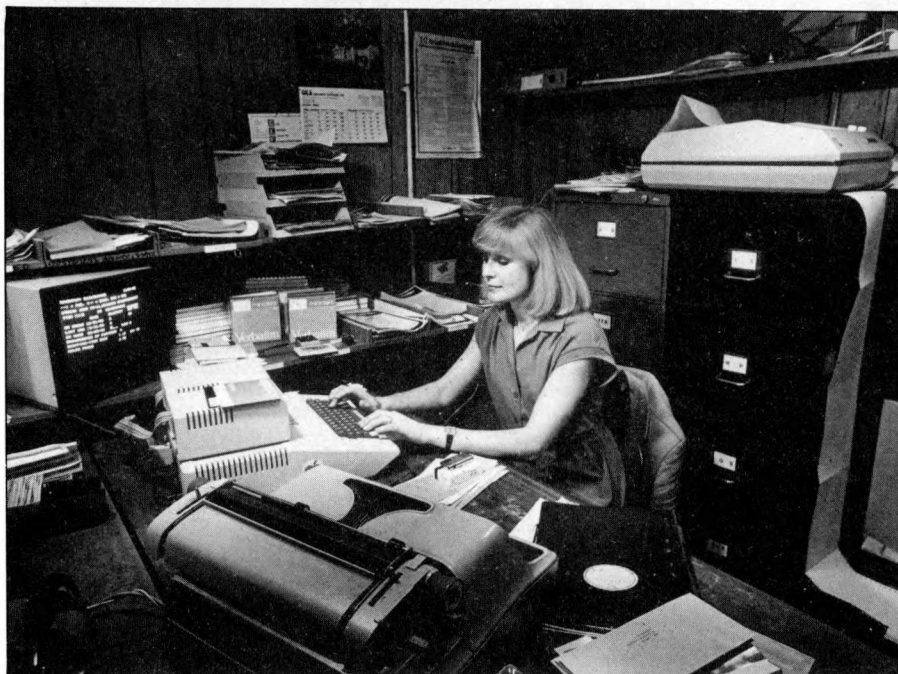

Note how this Apple has blended, chameleon-like, into its background. The modular approach is clearly an advantage in this particular environment.

system was being run parallel with the manual system (careful checks being made between the two). Now and again a discrepancy would crop up but almost always it would be an oversight in the manual system. On the whole Steve is very happy with the way the computer and the packages are handling the work. A1's company year starts on the 1st June and at that point he will have stopped running the manual system and be totally dependent on the Apple for his sales ledger, stock control and maintenance systems.

The system

The system is built around four master files — sales, maintenance, stock and suppliers. The sales ledger is used to maintain records of all customers who have entered into a maintenance agreement. The maintenance file contains details of every alarm installed whether the customer has a maintenance contract or not. The stock records speak for themselves (at the moment this file contains details of the most important 200 stock items although it's expected to develop to the system limit of 800). Finally, the supplier records are simply that — a brief note of each supplier's details; the file doesn't form part of a purchase ledger.

There is some duplication of information between the maintenance and customer files but, for Steve, this is preferable to having a completely integrated tailor-made system. From previous case studies the message has been clear . . . that the key to a successful microcomputer system lies in simplicity. An added bonus is that the customer can implement his system one application at a time, thus spreading the workload over a sensible period.

At the moment Steve is using three packages — The Cashier, which is an American store ('shop' in English) management system, Computech's Sales

Ledger and also their Disk Utility package.

The computer system that Steve uses is a 48k Apple II with Applesoft, two disk drives, a Hitachi black and white monitor and a Printerm 879 dot matrix printer. He had a number of early teething problems which were swiftly sorted out by Cream and Microsense but one intermittent fault remains on the printer, causing it to produce absolute gibberish from time to time.

Taking the Cashier package first — this was written for Apple by one Stephen M Williams and converted in the UK to suit the British way of working. Unfortunately, not all the conversion work was successful — for example, to start with, name and address sorting caused a great deal of confusion. Steve says that once you've figured out the way it works then you can live with it, but it was a real nuisance at the beginning. Other than minor irritations (which have nothing to do with the original package) the Cashier system is very good. It allows Steve to enter all his daily customer transactions, as well as stock receipts and issues. He can produce orders on suppliers, change stock prices and print daily, monthly and year to date totals of cash and sales. All these facilities, and more, are offered by the Daily Transaction module of the Cashier package.

Other modules enable maintenance of the data files and the index file — which keeps control of invoice and purchase order numbers, cumulative sales figures as well as system constants such as configuration details, VAT rates and passwords. The system also contains a printing module which allows the production of the following reports: stock checklist; turnover report; backordered items; item movements since the last run; and customer name and address list; these will print in any sequence and according to any

selection criteria. This last report is most useful to Steve because he can print details by area of customers due for maintenance, thus greatly simplifying the daily task of preparing job sheets for his engineers. It's worth mentioning that, in order for this system to work, the addresses have to be held with the street first followed by the building number in the last five characters of the field. For example, the report will group together all of the 'Broadway' records with the building numbers in ascending sequence. Steve says that the only thing you have to be careful of is that you always enter the names of streets, towns and counties in exactly the same format.

Looking now at the file details, each customer record contains the name, address, telephone number and date of last visit. This last field was intended to mean the customer's last visit to the shop but Steve uses it to show when the alarm was last serviced. The supplier record contains a key, the name and address, the telephone number and the date of the last activity.

The stock record is the largest in the Cashier system, containing the following fields:

- Item Number
- Supplier Key
- Manufacturer's Stock Number
- Item Description
- Unit Cost
- Selling Price
- Stock On Hand
- Last Change Date
- On Order Quantity
- Last Order or Delivery Date
- Last Order Quantity
- Last Order Date
- Customer Back Order Quantity
- Minimum Stock Level
- Minimum Purchase Order Quantity
- Turnover Quantity To Date
- Sales Value To Date

Should the stock level drop below the minimum during any transaction then the computer hoots and flashes a re-order warning on the screen.

All in all this is a very useful package which, space allowing, I'd love to spend more time on. Instead, though, I shall move on to the Sales Ledger package which Steve uses to control the money side of the business.

Like the Cashier, the Sales Ledger package is a nice meaty one with lots of facilities, this time designed for the UK marketplace by a British company — Computech. The system allows the posting of invoices, credit notes, cash received and cash payments. All transactions are held on disk to enable production of full statements and audit trails. From time to time the Transaction File needs to be purged to free some disk space, so Steve ensures that all the transactions are safely copied to a security disk beforehand.

The package has a few odd quirks, some of which are being corrected by Computech at the time of writing. One of them manages to clear the turnover to date each time an account is rendered — perhaps there is a reason for it, but I'm blown if I can think what. On the statement run it produces statements even when the account balance is zero — a bit of a nuisance, not to mention a

Personal Computer

World

FEATURE INDEX

Index to current volume, up to, and including, last month. (Previous volumes were indexed in March and April 1980 issues).

Hardware Projects		Economic simulation	3-3
Z80 Homebrew	3-1	Modem evaluations	3-5
Selective PROM copier	3-3	5th West Coast Faire report	3-5
TV to Monitor conversion	3-3	Wave Synthesis on Nascom 1	3-5
MK-14 Expansion	3-4	Overcoming PET printer problems	3-5
Teleprinter conversion	3-5	Random numbers	3-5
Benchmark Evaluations		Sound to colour conversion	3-3
Luxor ABC 80	3-1	American report	3-3
WH 89	3-2	Simple approach to programming	3-3
ACT System 800	3-2	Communication aid for disabled	3-4
Panasonic JD 700U	3-3	Imphex — intelligent game PET	3-4
Sinclair ZX-80	3-4	House of Commons report	3-4
Challenger C2 4P	3-4	Interrupt handling	3-6
Texas TI 99/4	3-5	Case Study — Compucolor installation	3-6
Altos ACS 8000-2	3-5	Poem	3-6
Hewlett Packard HP-85	3-5	Power supplies explained	3-6
Benchmark Timings summary	3-5	Power supply design	3-6
TRS-80 Model II	3-6	Program structuring in Basic	3-6
Sintrom Periflex 630/48 Series	3-6	Sandbach school system	3-6
PASCAL	3-1,2,3,4,5	Package evaluations (systems)	3-6
David Levy's Games	3-1,2,3,4,5	Sales Ledger	3-1
On the line	3-1,2,3	Purchase Ledger	3-2
Viewdata	3-4,5	Payroll	3-3
Prestel Report	3-6	Word Processing	3-4
Pascal Part 10 — Concluded	3-6	Information retrieval & databases	3-5
Games — Guessing the odds	3-6	Integrated accounts packages	3-6
IEEE interface — Part 2	3-6	Indexes	
Fact Sheets (Fax)		Back Issues 1-1 to 2-4	3-2,3
6800 opcodes	3-1	Back Issues 2-5 to 2-8	3-4
6502 opcodes	3-2	Programs	
Personal Opinion (Interrupt)		BASIC Star Wars	3-1
The end of work? Lord Avebury	3-1	PET Alien Attack	3-1
Protest against technological determinism	3-3	Revas (conclusion) Reverse assembler for Z80	3-1
Who needs the CRA?	3-4	Planet name generator — 6800	3-1
Schools computing — David Firnberg	3-4	Naming Nascom files	3-2
Stating the obvious	3-5	380Z Pictures	3-2
Micros in big businesses	3-5	Fuel tank calculations — PET	3-2
Evaluations (Checkout)		PET large numeral generator	3-2
Video Genie	3-2	PET tank battle	3-2
Vector Graphic		BASIC string handling routines	3-2
Flashwriter II	3-2	MK-14 scrolled messages	3-3
Apple II Symtec light pen	3-3	6800 Keyword retrieval system	3-3
Microdata UV8		PET Kaleidoscope	3-3
EPROM eraser	3-5	Efficient character storage	
Softy intelligent EPROM programmer	3-6	Z80 Assembler	3-3
Exatron stringy floppy	3-6	UK101 Dodgems	3-4
Calculator Corner		TRS-80 Fox and hounds	3-4
TI 58/9 Pseudo opcodes	3-1	MZ 80K Sine wave addition	3-4
Casio Fx 502P Brag	3-1	PET Backgammon	3-5
Casio Fx 501/2P Master Pack	3-2	UK101 Nedge	3-6
TI 58/9 Economics Simulations	3-2	PET Horse race	3-6
Programming efficiency	3-3	BASIC Renumber	3-6
Casio random number generator	3-3	UK101 Dogfight	3-6
HP 41C review	3-4	MK14 Frequency counter	3-6
Artificial Intelligence	3-5	North Star Maths test	3-6
Accounts on TI-59	3-5	PET Sweeper	3-6
Data Packing	3-6	PET Delete/Renumber	3-6
Special Features			
Computer Retailers' Association	3-1		
Christopher Evans tribute	3-1		
Show chess results	3-1		
The British Computer Society	3-2		
Astrology — case study	3-2		
IEEE-488 bus explained	3-2		

Personal Computer

World

BACK NUMBERS

THINK OF THE FUTURE-LOOK BACKWARDS!

PCW has long been regarded as by far the most authoritative journal in its field.

Every issue published has contained a wealth of detailed technical information on all aspects of the rapidly growing Personal Computer Market.

Demand for our limited stock of back numbers has also become something of a rapid growth industry!

Consequently, early back numbers of PCW are going to be increasingly difficult to get hold of, so make absolutely certain of getting yours by checking the coupon at the foot of the page.

Volume 1 No. 1 May 1978
Nascom 1/77-68: The Mighty Micromite/A charity system

Volume 1 No. 2 June 1978
Research Machines 380Z/Computer in the classroom/The Europa Bus.

Volume 1 No. 3 July 1978
Buzzwords — A to Z of computer terms/Pattern recognition/Micro music

Volume 1 No. 8 December 1978
Computers and Art/3-D Noughts and Crosses/Mickie — the interviewing micro.

Volume 1 No. 10 February 1979
Review — the Attache/Word on word processing/Micro assembler for the 6800/Sinclair to MPU interface/Draw pictures, written in Tandy Level II

Volume 2 No. 1 May 1979
Small computers for small organisations/Sorcerer graphics/Chess Programming Hints/Parkinsons Revas.

Volume 2 No. 2 June 1979
MSI 6800/Witbit — disassemble your programs/The Multi-lingual Machine/Polytechnical Processing.

Volume 2 No. 3 July 1979
Vision link: Interfacing and Software for the Superscamp VDU/Pet Preening/Extended cursor graphics for the TRS-80.

Volume 2 No. 4 August 1979
The North Star Horizon/High Speed Cassette Interface for the SWTP 6800/Garage Accounting program/Apple Medical Application.

Volume 2 No. 7 November 1979
PCW Show issue/6800 Bug/Hard disc security/Detecting literary forgeries/Benchmark — the Challenger C3

Volume 2 No. 8 December 1979
Micro-controlled toys/NASCOM — words and music/Systems — stock control/Benchmark — the Micro-mation Z-Plus.

PLEASE NOTE THAT THE FOLLOWING ISSUES ARE SOLD OUT

VOLUME 1 Nos. 4, 5, 6, 7, 9, 11, 12

VOLUME 2 Nos. 5, 6

ALL OTHER ISSUES MAY BE ORDERED USING THIS FORM.

Any one issue 95p; Any two issues £1.75; Any three issues £2.50; Any four issues £3.00. All additional issues @ 50p each. Binders @ £2.95. All prices include post and packing. Cheque or P.O. payable to (PCW) SportsScene Publishers Ltd., 14 Rathbone Place, London W1P 1DE. Please allow up to 3 weeks for delivery and don't forget to state clearly your name and full address with your order. Please send me the following copies of PCW. I enclose a cheque/P.O. for £

Volume 1	Volume 2	Volume 3
1 2 3 8 10	1 2 3 4 7 8	1 2 3 4
<input type="checkbox"/> <input type="checkbox"/> <input type="checkbox"/> <input type="checkbox"/> <input type="checkbox"/>	<input type="checkbox"/> <input type="checkbox"/> <input type="checkbox"/> <input type="checkbox"/> <input type="checkbox"/> <input type="checkbox"/> <input type="checkbox"/>	<input type="checkbox"/> <input type="checkbox"/> <input type="checkbox"/> <input type="checkbox"/>

Name _____

Address _____

*Tick appropriate boxes

INSTALLATION

waste of trees! Also on the statement run, if the paper screws up the program can't be restarted from where it went wrong, it has to be re-run from the beginning . . . more trees! As with the Cashier programs the bugs are irritating but maybe not terribly serious, depending on your point of view. Without doubt both packages make up for their shortcomings in all other respects.

CompuTech's Disk Utilities have proved very useful and, without going into too much detail, they are as follows:

SPACE	Reports the space remaining on any disk
LABEL	Reads, writes or updates a disk identifier
RDISC	A non-destructive read test. Steve uses it whenever he gets a media error.
TDISC	A destructive read/write test — used if the disk fails the RDISC test.
ZAP	Zeroes all unused sectors — used after disk initialisation.
DCOPY	The most useful function — copies a disk bit for bit, performing a read after write check as well.
DPATCH	A naughty facility which enables modification of data held on disk.

In addition to the above, the package contains a disassembler and a couple of

memory dumping programs.

These three packages enable Steve to look after his immediate system needs. He plans next to get a purchase ledger accounting system going, followed by a word processing system to enable him to prepare survey reports, quotations and standard letters.

One final point regarding these packages — they're all very well documented. CompuTech even manages to add a little humour into the proceedings with comments like "Should you type 'GO TO HARROGATE' or some such expression . . .", or "In case you forget what you're doing, like entering cash, or eating an apple . . .". Not everyone's cup of tea admittedly, but I found it refreshing.

Conclusions

Asked to identify the disadvantages of his system, Steve is hard pressed to find any. He does say that media errors are a constant risk and that security copies of all vital information must be taken regularly. He also says that the taking on of files is an enormous workload which shouldn't be underestimated. He expects it to be a full year before all his records are on the system.

On the benefit side he understandably has more to say. Summarising his thoughts, the two most significant benefits are first, he can now offer his customers a far higher level of service and second, he can see the day coming when he will be able to go home at

night knowing that all the administrative work is up to date.

He advises people thinking of buying their own system to look around before committing themselves to a supplier or a system — a sentiment which Cream wholeheartedly endorses. Had he listened to one computer store, he would have spent £5500 instead of £4100 and he would still be waiting for the package to be written. On running the system he suggests: do read the manuals first; do take regular security copies of all important information; do double check what you're keying in — it's much easier to correct errors at this stage than later when all sorts of files have been updated.

Compared with last month's case study, this implementation has been very straightforward with few hiccups. Steve's previous computing experience has clearly helped, but the fact that he went for proven packages must have been the key to this very smooth implementation. It has meant, of course, that he has had to bend his business to the machine's way of working but this doesn't seem to be as much of a problem as some people might think.

A1 Security Systems will be found at 37 Station Road, North Harrow, Middlesex. Telephone 01-427 1993 or 01-863 6916.

Cream Microcomputer Shop is at 380 Station Road, Harrow Middlesex, HA1 2DE. Telephone 01-863 0833.



L&J COMPUTERS

3 CRUNDALE AVENUE, KINGSBURY NW9 9PJ 01-204 7525

THE "PET" SPECIALISTS



NEW LOW, LOW 'PET' PRICES!!

Pet 8K (large keys)	£420
Pet 16K	£499
Pet 32K	£630

Ext. cassette decks (+ counter) £55
PET Friction Feed printers £450

AVAILABLE FROM STOCK

Printers	Disc Drives
PET 3023	PET 3040
PET 3022	Compu 400K
Centronic 779	Compu 800K
Teletype 43	

**TRY US!
YOU WILL NOT BE
DISAPPOINTED**

Sundries
Tool kits
Disks
Paper (roll & tractor feed)
Labels

WE HAVE ACQUIRED A REPUTATION FOR:

KNOWING WHAT WE ARE
TALKING ABOUT.
HAVING A FIRST-CLASS
BACK UP SERVICE.
KEEPING OUR WORD ON
DELIVERY AND PRICE'
SUPPLYING SYSTEMS
THAT SUIT THE JOB.

32K

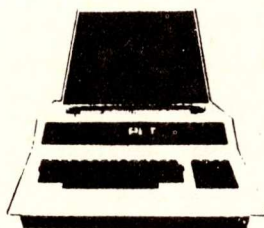

THE SYSTEMS WE SUPPLY & INSTAL ARE COMPLETE
ESTIMATES GIVEN FREE WITH NO HIDDEN EXTRAS
FULL BACK-UP: GUARANTEED EXPERTISE.

SOFTWARE

As well as a full range of Petsoft and Commodore Software, we have some highly reliable "Home-Brewed" programs available.

STOCK CONTROL & INVOICING £60
(Handles up to 500 items — 32k) (180 on 16K). Stock depleted on invoicing, search etc. Cassette, disk (& print option).

STOCK TAKING £230
Basic program which can be tailored to suit most trades. Beautiful print-out!

OUTSIDE SERVICES (For Mini-Cabs etc.) £220
Weekly or monthly invoices — cheque writing facility — optional deductions. (16 or 32K + disk + printer).

MACHINE HIRE £420
Covers hiring of machines, customers, due & overdue. Hiring Charges: Machine History: Printouts for all Sections. Ideal for Typewriter & Plant Hire Firms.

CASH BOOK £90
Enter daily/weekly amounts — printout and totals, weekly/monthly analysis, totals and balances.

**COMMODORE BUSINESS SOFTWARE &
BRISTOL "TRADER" STOCKIST**

**SPECIALISED SOFTWARE APPLICATIONS
UNDERTAKEN, RING FOR DETAILS**

PERSONAL SHOPPERS WELCOME
Phone & Mail Orders accepted.

ALL GOODS SENT SAME DAY WHEREVER POSSIBLE
Recorded delivery by post: or Securicor.**





The Big One

See you at The Wembley Conference Centre
22-24 July, 1980

Last year's Show broke all records and made headline news in many newspapers. The 1980 Show with its comprehensive exhibition, international conference and one day seminars adds up to the most significant microcomputer event ever held.

Conference and Seminars

Please tick the topics which are of interest to you in the list below. To avoid disappointment you are advised to telephone your delegate registrations which will be accepted awaiting your written confirmation.

- | | |
|---|---------------------------------|
| <input type="checkbox"/> Microelectronic Applications
International Conference | Tuesday/Wednesday
22/23 July |
| <input type="checkbox"/> Microprocessors in Industry
Non-technical | Tuesday
22 July |
| <input type="checkbox"/> Micro Systems in Business
Non-technical | Wednesday
23 July |
| <input type="checkbox"/> Micros in Education
A special invitation to teachers everywhere
Non-technical | Thursday
24 July |
| <input type="checkbox"/> "Future Computing"
by Dr. Portia Isaacson and Dr. Egil Juliussen from the USA
- a seminar of interest to everyone in the computer industry. | Thursday
24 July |

Exhibition Visitors Tickets

Admission to the exhibition will be by ticket only (£1.50 inclusive of VAT) available at the door.

Tickets are available from the Online Offices at a pre show price of £3.00 for 3 tickets (minimum). This offer closes on 15 July. All ticket requests must be accompanied by a cheque/postal order and suitable S.A.E.

I request _____ exhibition tickets at £3.00 for 3. (minimum 3 tickets). I enclose a stamped addressed envelope and remittance of £ _____

Name _____

Position _____

Organisation _____

Address _____

Online Conferences Ltd., Argyle House, Northwood Hills HA6 1TS
Telephone: Northwood (09274) 28211

PCW



RESEARCH MACHINES 380Z HIGH RESOLUTION GRAPHICS

The world of computer graphics takes a step nearer general availability thanks to the falling cost of memory and the new high resolution graphics card from Research Machines for the RML 380Z. Sheridan Williams reports.

I have to admit that I thoroughly enjoy reviewing equipment, and testing the hardware and software. But on this occasion, reporting on the Research Machines 380Z with high-resolution graphics board, the crunch comes in trying to do justice to the HRG board in words; graphics are, after all, a very visual aspect of computing. For this reason all the remarks made about the graphics are subjective — although I have scattered this review with photographs to try and illustrate what I mean. A problem that could not be overcome was that of movement. This system is powerful enough to allow virtually continuous movement of pictures; for instance animation, consisting of around 10 changes of picture per second, gives a flickering but obviously moving picture. How does one show *that* in print?

Research Machines make only one computer system — the 380Z and although it's not my brief to review the whole system, I should mention a few aspects in order to make this review readable to those who are unfamiliar with the machine.

The 380Z is widely used throughout Britain by schools and colleges. It's considered to be one of the most suitable systems that can be used in education, for reasons that are largely beyond the scope of this article. Briefly, however it can be bought in any version starting with the 16k cassette based system and leading up to a 64k 8" floppy disk system with the high resolution graphics board; it can be expanded in easy stages as and when money allows.

The 380Z supports Basic, Algol, and Fortran and is building up a collection of applications software, although where you'll find it is a sticky point at the moment. The machine uses the disk based CP/M operating system so A level students can learn a good deal from it. I know many other micros have these advantages, but I'm not here to argue the particular pros and cons of the 380Z.

The standard graphics capability of the 380Z is now termed low-resolution, although it has an 80 x 60 display. It uses the Prestel/Ceefax/Oracle system of displaying shapes and pictures, these being made up of a 3 x 2 grid for each character position. This is combined with an ideal plotting notation (in Basic) to make quite a powerful graphics capability in its own right.

Plotting in Basic is done using the PLOT X,Y,C command. The screen origin i.e. PLOT 0,0,C is conveniently placed at the bottom left-hand corner. . . far better than the *top* left corner. Also graphs may be plotted without having to fiddle the Y coordinate. The third parameter is the ASCII code of the character to be displayed. For example PLOT 10,30,65 will place an 'A' in position x = 10, y = 30.

The high-resolution graphics pack-

age now extends these capabilities in two versions, both available from the standard HRG board — medium resolution with 160 x 96 points and high resolution with 319 x 192. This compares with 360 x 192 on an ITT 2020 and 280 x 192 on an Apple.

The package I received comprised the graphics board, some software on disks and, of course, a manual. I quickly fitted the board into a 56k mini-floppy disk 380Z according to the very clear

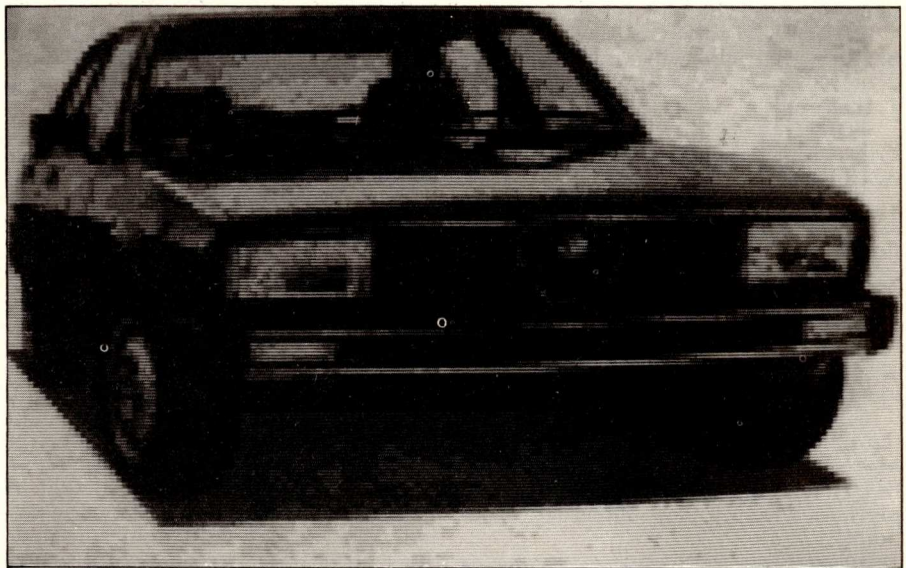

fitting instructions and within five minutes everything was working.

Although I specifically asked for Basic (which I thought would be of more interest to readers than either the Fortran or Algol versions which are also available) I was also given some programs written in Algol and was able to run them; I couldn't write any as I had no Algol compiler. Basic version 4 (an enhanced version, that's due for general release shortly) includes some very useful features that relate to both the high resolution graphics, and to ordinary Basic:

GET is a command that will look at the keyboard to see if a key has been pressed. It has several forms: GET() with no parameter, the system will wait until a key is pressed; GET(0) will look at the keyboard buffer before returning; GET(0) to GET(32767) will wait for that many hundredths of a second before returning; and GET# 10 will GET from device 10.

PUT is similar to print and will output characters, for example PUT 12 will clear the screen; PUT 12,"HELLO", 255 will clear the screen then display 'HELLO' followed by a white blob.

The low resolution graphics have been enhanced too:

LINE X,Y,I will draw a line from the previous position to position x,y at intensity I. If I is 0 a blank (invisible) line will be drawn.

POINT(X,Y) looks at the point x,y on the screen and will return a 0,1 or 2 or the ASCII code for the character at that point.

POINTS(X,Y) works as above but returns the actual character rather than its ASCII code.

PLOT X,Y, "text" is now quite legal as it has always been in Tiny Basic, but not in 9k Basic; also, plotting outside of the 0-79 for X and 0-59 for Y range will not produce an error message.

The rest of the commands refer to the high resolution graphics. As you will see they are very comprehensive and are identified by the CALL statement:

CALL "RESOLUTION", R,B Must be the first call to HR graphics. R=0 means high resolution and R=1 means medium. B is the number of bits per 'pixel' (a pixel determines the intensity of a point).

CALL "PLOT", X,Y,I Plot a point at X,Y with intensity I. I may have a value from -15 to 15 depending on the resolution and the value of B in the RESOLUTION statement.

CALL "LINE", X,Y,I Draws a line from the current position to the point X,Y, at intensity I.

CALL "FILL", X1,Y1,X2,Y2,I Fills a rectangle specified by the points X1,Y1 and X2,Y2 at intensity I.

CALL "COLOUR", I,N has other versions and can be used to specify colour settings.

CALL "SETCOL", I,N is similar to COLOUR except that the effect of this call is delayed until a call to VIEW is made.

CALL "VIEW" Transfers the colour changes as specified by the SETCOL statement.

CALL "UPDATE", P,V In medium resolution there are two pages of memory which can be written to or displayed independently. P specifies which page is to be written to by subsequent calls to PLOT, LINE, and FILL. There can also be 2 or 4 views of each page of memory depending which mode you are in.

CALL "DISPLAY", P,V specifies which page and view are to be displayed.

CALL "CLEAR" clears the current page and view.

CALL "OFFSET", X,Y changes the coordinates of the bottom left hand corner from 0.0 to X.Y, and can be useful when plotting with the origin in the centre of the screen.

CALL "GLOAD", A and "GSAVE", A are available only on disk systems and allow the saving of pictures on or the loading of pictures from disk.

Many people will feel that Algol and Fortran could provide faster drawing capabilities than Basic because they are compiled not interpreted. In fact this is not so as the CALL statement links a machine code subroutine into Basic — which of course will run at full machine speed. Line drawing is virtually instantaneous and filling rectangles is quite fast, too. I see no disadvantages to Basic for accessing these graphics.

I was supplied with quite a range of programs with which to assess the system's capabilities and I've included pic-

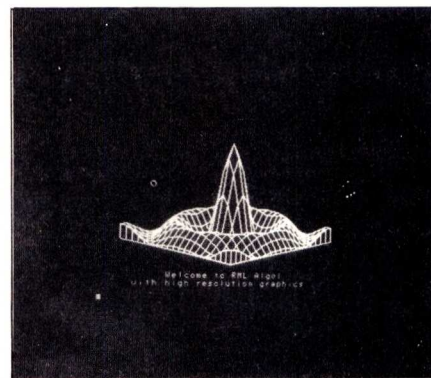
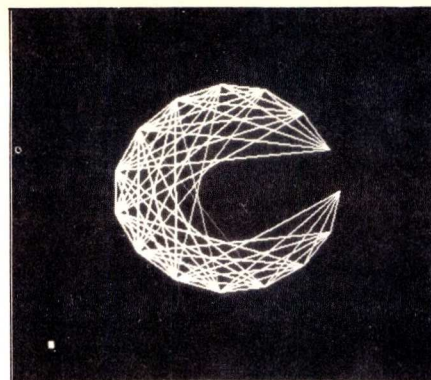

tures of some of my favourite ones, although they were all impressive.

WW2 This is a program written in Algol which allows you to produce handwritten text on the screen. The speed at which it does the writing is equivalent to a slow but careful writer. The user can adjust the resolution, slope, size and gaps of the text. I used this program quite a lot, trying all the parameters with interesting effects. I hope one day this can be produced as hard copy.

DEMO A collection of programs showing all the facilities of the high resolution graphics.

REVOLUTION Written in Basic, this shows a moving picture, or rather a revolving shape. It fills eight separate pages and then displays them in sequence giving the impression of movement.

CUBISM Written in Basic, it will draw cubist pictures although the effects are somewhat lost in black and white because many of the colours appear the same.

The picture constantly changes which makes it fairly compulsive to watch, especially in colour.

STAR Written in Basic it draws n pointed stars. Each point of the star is joined to every other point.

3D Certainly the most interesting of all and written in Algol. Because I wasn't provided with source code I'm afraid I couldn't look at the program — only the object (intermediate) code. The program displays a church as a three-dimensional line drawing, and then (slowly at first) rotates it while zooming back. Later it changes from orthogonal to isometric projection and then zooms again. This program certainly shows off the graphics to good effect.

There were many other programs supplied but I thought instead I'd spend some time writing a couple of my own to find out how easy it was to use. My first attempt was to display an analogue clock face, together with real time movement. As I didn't have the real

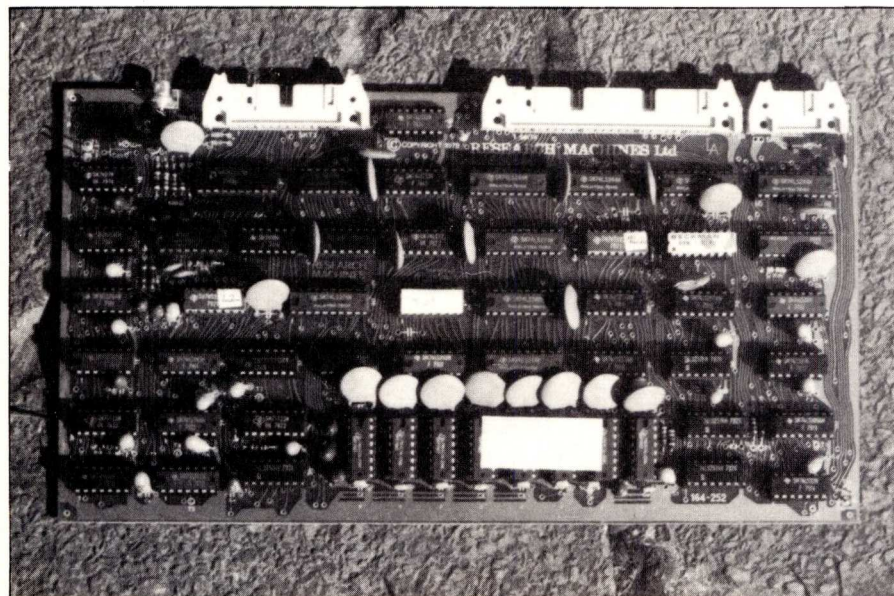

RML's high resolution graphics board for the 380Z.

P.C.W. Review
380Z H-R Graphics
by
Sheridan Williams

380Z H-R Graphics
by
Sheridan Williams

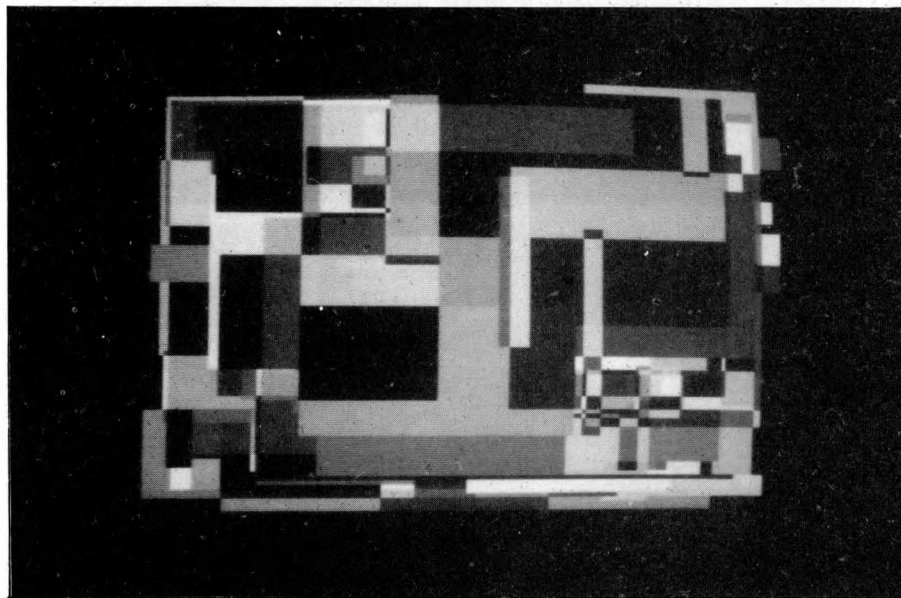

time clock board I had to find the correct display rate by trial and error. I also tried writing the program using only one page or view, whereas in hind-sight it would have been easier to be plotting the next increment in time while displaying the previous one. I started with the 'second' hand, and concluded that if the second hand posed few problems then I would incorporate the hour and minute hands later — using different colours for each of the hands.

I started by drawing a circle in HR, which was easy; then I displayed the numbers 1 to 12 in their correct positions using low resolution, again quite easy. Next step was to draw a straight line from the centre of the clock face around the face in increments of six degrees, thus stepping the hand in one second intervals. This would be easier than 'sweeping' the hand round. At the same time as plotting the hand I had to 'unplot' its last position. This wasn't too difficult and after about an hour I had quite a good working stop-watch. I discovered that by not unplotting the hand I got an effect similar to that used on clocks on TV showing elapsed time at football matches. I then enhanced this to show marks in the white swept area every one second. The verdict after writing this program is that the graphics

are fairly easy to get used to, but they do give you sleepless nights.

The next task was to modify an existing low resolution program. I chose a program that plots mathematical functions. It's one that has been in constant use by me as a teaching aid and is quite impressive already in its low resolution mode. It'll plot any function whether expressed in cartesian, polar, or parametric form and will scale the output to fit the screen exactly.

Some of the plots are fascinating, especially the polar ones like spirals, cycloids etc. The modifications took very little time and soon I was left with a superb tool (*What can I say? — Ed.*) I've included a picture of a square wave as an example of its plotting capabilities.

Among the programs supplied by Research Machines were a set of four programs by Chelsea College and marketed by publishers Edward Arnold: they are currently on display at the Science Museum in London. The four programs are orbit simulation, siting of windmills for best efficiency, isolation of chemical elements using certain tests and pond life ecology. They were all good and adapted to the HR graphics; apart from the orbit simulation, each of the remainder could be used for many hours in the classroom, provided suitable notes are

available.

Another application for the graphics, provided a disk system is available, is the ability to save pictures for later use. Briefly, a picture is transferred from graphics memory to a previously reserved area of main memory called a cache. The memory required is declared within the program as a byte array, and this cache data is transferred to and from disk using the facilities built in to Basic, Algol and Fortran.

The manual supplied with the graphics was quite good; it leads you through the whole package in easy steps and gives short examples at each stage. I found only three errors and surprisingly, this helped me to learn more quickly (because I needed to think why the programs didn't work). I'd even recommend that Research Machines leave them in and put a note at the side saying that there are a deliberate errors, and that the correct version is at the end of the manual. The appendix contains some sample programs which for me were very helpful.

The manual also tells you how to use the graphics board as an additional 16k of memory when it isn't being used for graphics: it occupies a 16k segment from 7C00H to BBFFH inclusive and in order to switch from graphics to memory mode bit 4 of port 0 needs to be set.

A point brought out in this review is the necessity for a good monitor display. With the resolution of plotting available, even the slightest distortion can show up. You may not notice it in the enclosed pictures because of the camera angle, but even on a high quality Hitachi 17" monitor the screen distorts in the bottom left hand quarter of the screen. Taking measurements of plotted lines of the same length indicates around 10% distortion — which shows up in circles especially. This is a minor point but one which requires consideration if any measurements are being taken from the screen.

I thought that while reviewing the high resolution graphics it would be a good idea to test a flat-bed graph plotter as well — after all you don't need the HR graphics if you have a plotter, and most plotters have resolutions that are better than the graphics tested. Plotters would not, however, be as good for displaying information. With this in mind I approached Bryans Southern Instruments Ltd of Mitcham, asking to test their 'Computergraph' plotter. . . unfortunately they didn't even acknowledge my letter; maybe I'll be able to review it later.

The HR board costs £299 for black and white, plus another £100 for colour. It'll work on any 380Z with 16k of memory although 20k is virtually essential. Research Machines will modify any existing C4100 machines that are still around for a small nominal charge.

The HR graphics board greatly extends the usefulness of the 380Z and I came away with entirely favourable impressions. Educationalists will have to get their fingers out now and start developing some useful software for it. I'd be interested to see results and indeed I could make anything good available to other users at a nominal charge — some of the proceeds to go to the author of course.

PLOTTING IN THREE DIMENSIONS

Malcolm Banthorpe offers a simple program for evolving three dimensional representations of trigonometrical and other functions on any computer which can plot graphics to a reasonable degree of resolution. The program listing shown is written for an ITT 2020, but can be used on many other computers with very little modification.

The program originally evolved out of an investigation into possible means of representing three dimensional curved surfaces on a VDU. A wide variety of functions can be plotted as long as their range of values is restricted, as described later. The results are frequently surprising (at least to a non-mathematician like me), sometimes beautiful (having an almost organic form) and nearly always interesting.

To understand how the program works, imagine a disc (Fig. 1) crossed by a series of parallel chords. If the disc is viewed obliquely it can be represented in two dimensions by an ellipse (Fig. 2). The vertical displacement f of point P from the chord AB is a function of the distance r of the point Q (which lies on AB) from the centre of the disc. Now (if you're still with me), imagine a series of such points plotted along each chord, f always being a function of r , e.g. $f = \sin(r)$. The result would be a family of overlapping curves. The program determines whether or not each point *would* be visible *if* we were actually viewing a three dimensional surface. Reference to the photographs should help to clarify how this actually works out in practice. As you can see, the program uses a series of curves parallel to the frontmost half of the circumference of the disc rather than a series of chords. This simplifies the programming and gives an arguably better display.

If you've been able to follow the explanation so far, the program listing

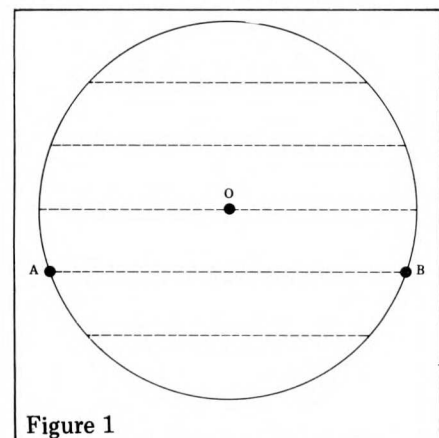

Figure 1

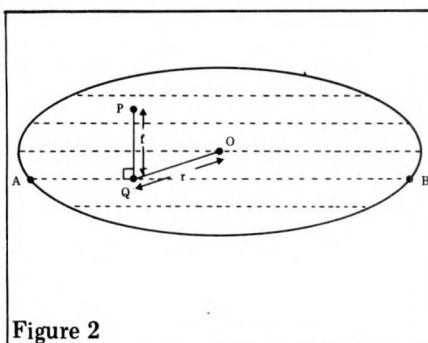

Figure 2

should be more or less self-explanatory. The function to be plotted is written as line 80 and can be changed as required. Line 75 ensures that R will always lie

somewhere in the range 0 to 1. Care should be taken so that F will evaluate within the range -1 to 1 as R varies from 0 to 1.

Notes for use on other computers

The program has been written as far as possible in 'standard' Basic. The only possibly unfamiliar terms are as follows: HGR sets high resolution graphics mode HOME clears the four line text area of the screen

HCOLOR = 3 sets the plotting colour to white

VTAB (24): List 80 prints the function being plotted, at the bottom of the screen. (This may be omitted, parti-

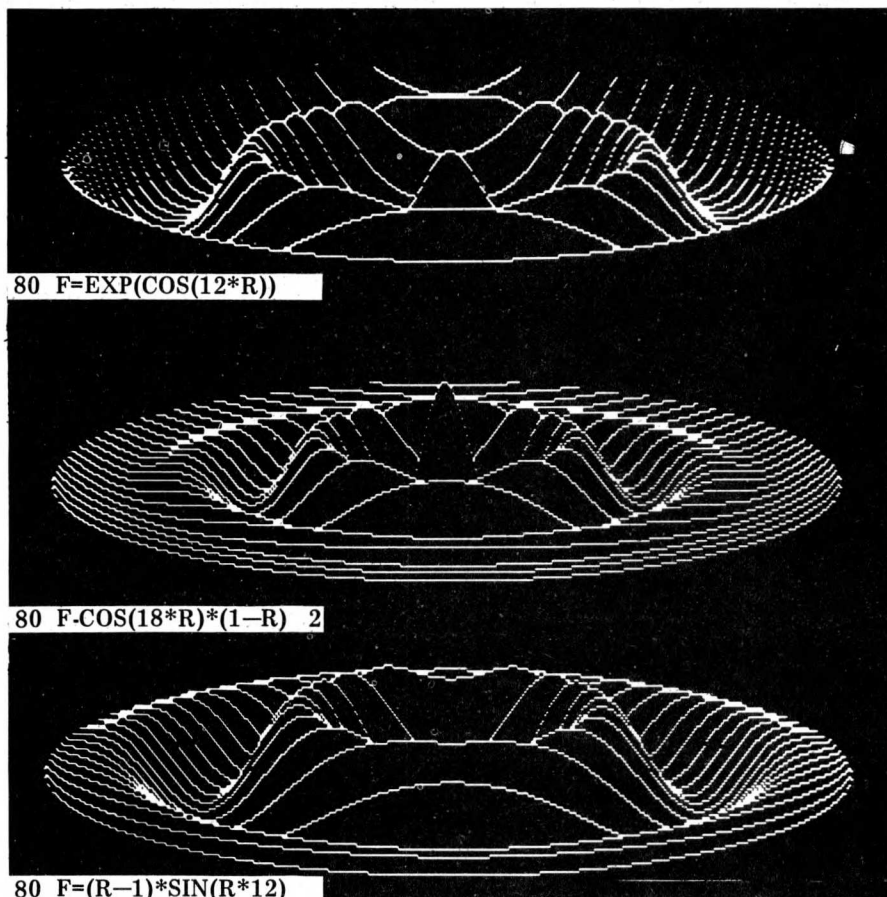

cularly if resolution is limited, so that the whole screen can be used for plotting.)

HPlot is equivalent to PLOT or SET in other versions of Basic. On computers lacking such a function, it will be necessary to write a routine to POKE a character to the appropriate screen location.

H and V in line 10 must be set to the horizontal and vertical resolutions of the system. Hence to run the program on an Apple II the only modification required is to set H to 279 in line 10.

As mentioned earlier, the program can run on many different computers but obviously the higher the resolution of the graphics, the better the display. A TRS-80 should give worthwhile results and tests with ITT's low resolution mode (40 x 40) have indicated that PET should also be suitable for experimentation, particularly if a 'double density' (80 x 50) routine can be employed. On lower resolution systems best results will be obtained plotting simple curve functions.

Line 105 assumes that the point with coordinates 0,0 is at the top left hand corner of the screen. If, as on some systems, it is at the bottom left-hand corner then line 105 should be changed to:

105 M = Y: Y = Y1 + Y

This will prevent the image from being 'upside down'. However, as the surface displayed has no objective reality outside the computer, the question of just which side should be 'up' is open to debate. Have fun... and I'd be interested to see the results of any further experimentation.

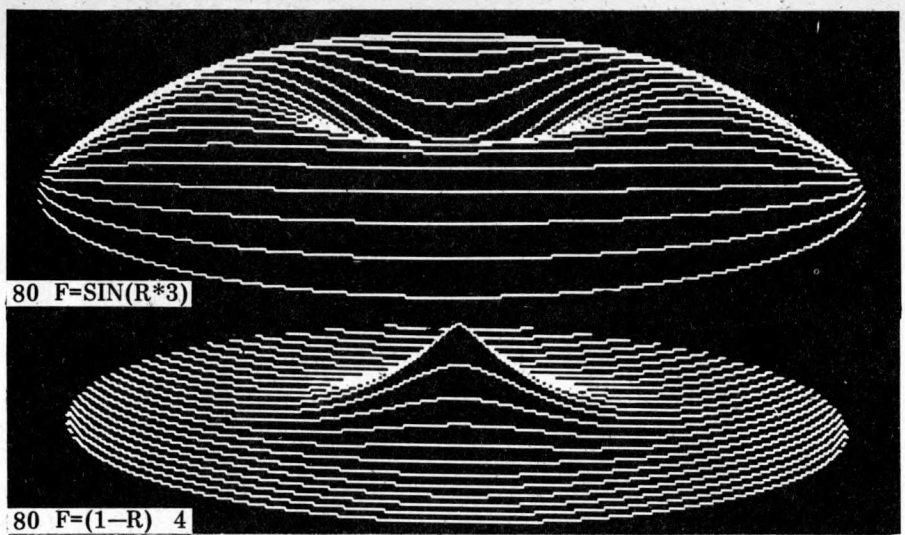

```

1 REM THREE-DIMENSIONAL PLOTTER
2 REM COPYRIGHT MALCOLM BANTHORPE 1980
3 REM
10 HGR: HOME: HCOLOR = 3: H = 359: V = 159
20 VTAB(24): LIST 80
30 X1 = H / 2: X2=X1 * X1: Y1 = V / 2: Y2 = V / 4
40 FOR X = 0 TO X1
50 X4 = X * X: M = -Y1
60 A = SQR ( X2 - X4)
70 FOR I = -A TO A STEP V / 10
75 R = SQR ( X4 + I * I) / X1
80 F = ( R - 1) * SIN ( R * 12 )
90 Y = I / 5 + F * Y2
100 IF Y <= M THEN 120
105 M = Y: Y = Y1 - Y
110 HPlot X1 - X, Y: HPlot X1 + X, Y
120 NEXT I: NEXT X
130 END

```



WORLD MICROCOMPUTER CHESS CHAMPIONSHIP

A major attraction at the Third Personal Computer World Show will be the first ever official World Microcomputer Chess Championship, held under the auspices of the International Computer Chess Association.

The Championship is open to both commercial and non-commercial entrants, with a first prize of £500 for the highest-placed non-commercial contestant.

For further details, write immediately to David Levy,
c/o Personal Computer World, 14 Rathbone Place, London W1P 1DE.

The 3rd Personal Computer World Show

The Third Personal Computer World Show is at the Cunard International Hotel, 4 - 6 September.

STOCK CONTROL 2

Mike Knight of Mike Rose Micros presents a selected report on available documentation.

Our more dedicated readers will know that I first reviewed Stock Control packages in December last year. However, in this business nothing stands still (no matter how much we would sometimes prefer the opposite) so, with this in mind — and coupled with the fact that inevitably some products were passed by the first time around — I'm taking another look at the packages available.

It's essential for any business which sells goods to maintain an efficient stock control system; too much or too little stock can spell disaster and getting the balance right is one of the important ingredients of success and profitability! This month I'm going to look at what the packaged market has to offer in this important field.

Objectives

The basic objectives of an inventory/stock control system are to maintain and update records of stock items used in the manufacture, supply or maintenance of goods offered for sale.

From the management point of view however, apart from the ability to add, remove or change any information on an item, by far the most important aspect will be the provision of management information and linkages with other business functions.

Functional requirements

What should we expect from a stock control system?

1. The ability to create, delete and amend stock items. Additionally the movement of stock in or out should be recorded.
2. If our business depends on the transportation of our goods to our customer, either at home or abroad, then details such as location, weight and size of stock items will be essential for the production of despatch notes, delivery plans, customs declarations etc.
3. Whether we 'grow our own' or buy in items, we probably want to have information on the source of goods for use in purchase or manufacturing orders.
4. If we operate an 'off the shelf' business we will want to see details of orders taken to enable us to allocate goods to our customers.
5. Whether we manufacture or buy-in goods we will probably need to be able to group products for analysis purposes.
6. We will certainly need to see prices, VAT and discount information held within the system for use in stock valuation, invoice production etc.
7. And, finally, we will expect enough information to allow us to produce analytical management reports to en-

able us to keep well ahead of developments and take fast action should anything go amiss. In the next two sections, I shall look at nine packages to see how they measure up to the requirements; some of these were reviewed last December — in those cases I'll comment on any changes made since then.

Evaluations

PETSOFT STOCK WITH INVOICING

This is available from Petsoft Micro-computer Software, Birmingham (021-454 5348) or any of their countrywide dealers. The cost is £75 and the minimum hardware required to run it is a 32k PET with Computhink Disk Drives and a printer. The all-in cost is £1950. The package comes supplied with clear operating instructions and Petsoft are always happy to give advice and guidance either by phone or letter.

PETSOFT STOCK CONTROL

This is also available from Petsoft and its dealers. The cost is £50 and it has the same minimum hardware requirements as Stock with Invoicing. These packages are very similar, the main difference being the invoicing facilities. Petsoft rely on their dealers to provide installation and training for all of their packages although they'll correct any bugs free of charge. Petsoft do not undertake any customisation themselves but their dealers are usually in touch with local software houses and will recommend customers accordingly. The clear operating instructions supplied with this package are fine for the first time user, but not really detailed enough for the already initiated.

Finally, no details available as yet, but Petsoft plan a mid-May release for their new Superstock.

STOCK CONTROL SYSTEM — MICROTEK

This is available from Microtek Computer Services, Orpington (Orpington 26803) and has been designed to run on two different types of hardware. The minimum configuration is a North Star Horizon with 40k RAM and two double density floppy disks — for a single user system. It will also run on the IMS 8000 for multi-user applications. Microtek has a basic program

whose file structure can be altered to suit the user's requirements — at a cost from £250. The cost of minimum hardware is £1795. Free advice and guidance is provided on a continuous basis and full installation and training is available. Microtek offers full software maintenance and can arrange, too, for hardware maintenance. The company's packages are all fully integrated and they reckon to provide a full business system from £4500.

S.N.I.P.

This is the 'I' or Inventory control module of the S.N.I.P. package — a fully integrated Sales, Nominal, Inventory and Purchase system. I've looked at both the Purchase ledger (February 1980) and the package as a whole in Integrated Accounts (June 1980). This module costs £450 as a stand alone item, and the full deal costs £950. The system is supplied with full operating instructions, systems specification and security disks and the documentation is ideal for the first time user. The minimum configuration needed is a 32k North Star Horizon with 360k diskette, VDU and printer for around £3725. The package can be obtained from Benchmark Computer Systems Limited, St. Austell (0726 61000) or their dealers in Liverpool, Microtech Computer Services Ltd. At the time of writing, Benchmark are looking for more dealers, so it might be worth asking if there is one in your area.

TRADER

This integrated Stock-Control, Invoicing and Sales Accounts package is available from Bristol Software Factory (0272 23430) or any of their 84 dealers countrywide. There are two versions — the dual disk at £300 and the quad disk at £360; both are designed to run on the PET 3000 Series. Minimum hardware requirement is 32k PET, dual disk drives and printer for £2160. The package is supplied with an instruction set which is very clear and concise and full instructions are held within the program. Bristol Software Factory provides any back-up so far as corrupted files or bugs are concerned and the price of the package does include any necessary customisation. Installation, training and maintenance is left to the dealer and and so

SYSTEMS

may vary. Standard stationery designed especially for the Trader system is available direct from Bristol Software Factory. The capacity of the system is dynamically distributed between stock items and sales accounts up to a maximum of 2200 for the dual drive version and 4400 for the quad drive version.

ADVANCED BUSINESS SYSTEM — STOCK CONTROL

This package is available from Isher-Woods Business Systems, Luton (0582 416202) and their dealers in Birmingham, Bradford and London. Supplied on disk, it costs £350 as a stand alone item, although it's also available as part of an integrated Stock, Invoicing and Sales System for £1000. It's designed to run on a 32k PET with dual disk drives and printer for around £2000 and can take expansion up to 1 Mbyte. Isher-Woods will supply a complete system including hardware and software; hardware training is included in the price. They don't feel that software training is necessary as the programs are all menu driven and are supplied with an 'idiot's guide' to the system; however, should the need arise they will be only too pleased to help. All packages come complete with a lifetime guarantee

against bugs, corruption etc. and Isher-Woods maintain an SOS service both by phone and on site if required. They also offer a feasibility study service for those who need it — at a cost of course!

The following packages were reviewed in December 1979 and any changes are noted below:

APPLE STOCK CONTROL SYSTEM

No changes here. It's available from Microsolve, London (01-951 0218).

STOCKPACK STOCK CONTROL SYSTEM

This package is now available in extended TSC Basic, making it much faster to use. It can now be run on a multi-user system. Cost for the basic system (allowing for 700 stock items) is £25; it rises according to the increase in the number of stock items. Prices are available on request from South West Technical Services (Computer Workshop) London (01-491 7507)

GRAFFCOM STOCK CONTROL

Graffcom are in the process of updating their entire suite of programs and are hoping to hold the prices constant. I can't report on any changes at the time of going to press but Graffcom will be

happy to answer any enquiries (01-734 8862).

Known but not reviewed

Amplicon, Brighton (0273 608337)
Basic Computing/Micropute, Keighley (0535 65094)
Commodore Systems, Slough, Berkshire (0753 7411)
Graham-Dorian (Terodec), Camberley (0252 874790)
Great Northern Computer Services, Leeds LS1 4DL (0532 450667)
T & V Johnson Microcomputers, Camberley, Surrey (0276 62506)
L & J Computers, London (01-204 7525)
Microdigital, Liverpool (051-227 2535)
Micro Management, Frinton, Essex (02556 4592)
Tridata Micros Ltd, Birmingham B5 6BS (021-622 1754)
Vlasak Electronics Ltd, Marlow, Bucks (062 84 74789)

NB: A month before going to press the above companies were asked by letter to submit all relevant information on their stock control systems. Vlasak sent insufficient data for inclusion, none of the others have so far replied.

TASKS	Petsoft stock with invoicing	Petsoft Stock Control	Microtek	S.N.I.P.	Trader	Advance Business System	Apple	Stockpack	Graffcom
Create new item	*	*	*	*	*	*	*	*	*
Delete old item	*	*	*	*	*	*	*	*	*
Amend existing item	*	*	*	*	*	*	*	*	*
Write-off missing item								*	
List all items		*	*	*	*	*	*	*	*
Stock check list	*		*			*			*
Issue stock	*	*	*			*	*	*	*
Receive stock	*	*	*	*	*	*	*	*	*
Allocate stock	*	*			*		*		*
List allocated stock		*							
Stock valuation report	*	*	*	*	*	*		*	*
Stock enquiry				*	*	*	*	*	*
Stock shortages list	*	*					*	*	*
Purchase invoice list			*						
Purchase orders			*	*	*				
Selected product group list			*	*					*
Movement analysis report	*	*	*	*	*	*	*		*
Period end procedures	*	*		*	*	*			*
Forward orders			*	*		*		*	
Stock orders			*	*	*	*	*	*	
Create sales invoice	*		*		*	*			
VOLUMES									
Items per master file									
minimum:	1200	1200		1000	1	2000	800	700	450
maximum:	2400	2400			2200	8000			6200
COSTS									
Package (£)	75	50	250+	450	300	350		75	400
Machine (£)	1950	1950	1795+	3725	2160	2000+			2600
Total (£)	2025	2000	2045+	4175	2460	2350+	3000	3400	3000

The New DDP Video Monitor . . .

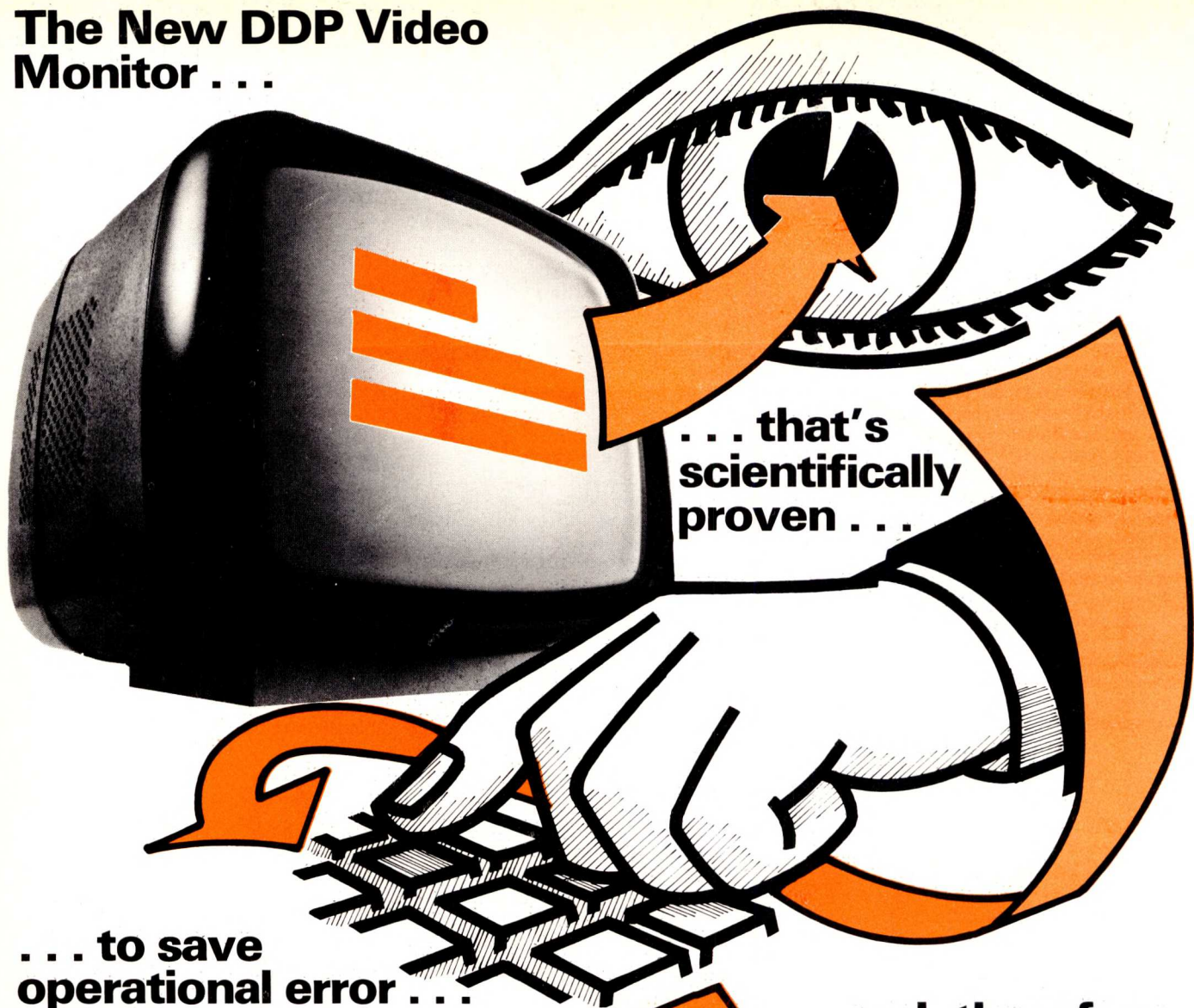

... that's
scientifically
proven ...

... to save
operational error ...

At last, from DDP, here's the video monitor that eyes and ears all over Britain have been waiting for. Eyes, because as alternatives to black and white tubes, green and revolutionary new orange tubes are optionally available. Ears, because now you're going to enjoy the sound of silence - from your service engineer.

But to take first things first, we mention a few colourful facts. After Scandinavian scientists had proved how close-range human vision could benefit from working with orange light, orange tubes quickly replaced green as standard for most Scandinavian videos. A few years behind, we in Britain still belong to the Green Screen Club - but as indifferent members when it comes to monitors. With DDP's new monitor, however, you can experience Scandinavian sophistication. And all the difference it makes to operating profits when allowance is made for operator fatigue.

Inside our monitor you'll discover its second big advantage.

More easily overlooked, but just as important to long-term operating profitability is the unique modular circuitry. The resin-block circuits will outperform conventional systems and delight engineers when, aeons into the future, servicing is eventually required.

And the cost? Bearing in mind the big 12 inch screen, you'll be amazed at our recommended retail price of £140 (ex. VAT). Generous DDP volume discounts are equally astonishing, but most surprising of all is how quickly we can deliver. To find this out, though, you'll need to make a phone call . . .

... and, therefore,
your time ...

... and money.



DDP Video Monitor Orderline: (0268) 727563



Distributed Data Processing Ltd.

Essex House, Cherrydown, Basildon, Essex SS16 5AQ

BEST OF BOTH WORLDS

The most expensive parts of a microprocessor system are the memory, peripherals, power supply and the boxes that hold them; for any fairly large system, the cost of the processor itself is almost insignificant. Thus with powerful Z80 chips now available for under £10, when the time comes (as inevitably it must) to add another 8k of memory, why not also add a different family of processor. The extra cost involved will be small when compared with the benefits it will undoubtedly bring. R. M. Yorston explains . . .

Why, you may ask, should I add a second processor to my system when the one I already have spends most of its time in a loop waiting for input from the keyboard? There are two main reasons. Firstly, there's the increased flexibility in being able to run the machine language of two different processors; this eliminates the need for laboriously translating useful software written for one micro to run on a system designed around another. By adding a Z80 to my 6800 system, I'm able to use readily available 8080/Z80 software with only minor patches for input/output routines (which would probably be required even on a Z80-based system).

A second advantage is that the system throughput may be increased without the difficulties and expense required to increase the speed of a single processor. The difficulties arise because of the care needed in the design of boards and backplane to work at the high clock frequencies which have to be used. The expense comes in when you buy the fast memory . . . essential if you're to take advantage of the processor speed. With two processors working at slow speeds, these problems do not arise. However, the advantages are replaced with the difficulty of writing software which will share the burden of work fairly between processors — so that each is working as near to its full capacity as possible.

The 6800 system sees the Z80 board as 8k of static RAM and a write only control latch. The Z80 is held up whenever the 6800 requires to access either of these. (The control latch functions are given in Table 1.) Switching of control between the two processors is achieved using a signal (B) derived by IC2a,b,d and IC8b from the active low enables for 1XXX, 2XXX and A206H and two of the outputs of the control latch. These outputs allow the RAM to be deselected and effectively removed from the address space of the 6800. The Z80 is not affected. This feature may be used to permit switching of 4k memory blocks and thus extend the memory of the 6800 beyond 64k. The signal (B) goes low when the master processor attempts to access the RAM or the control latch, unless the RAM has been deselected. (The output IC2d (A) goes low for a valid RAM

access.) The RAM enables are derived off the Z80 board using a 74LS154 (Fig. 2). The A206H enable is obtained from the TTY card in my system (an ETI System 68), but any other suitably decoded address may be used.

The main system data bus and the Z80 are separated by the buffers IC2,3. IC2 is enabled when the switching signal (B) goes low and IC3 when it goes high. The inversion required to enable IC3 is provided by one section of IC12, a 74LS158 inverting 2-1 line data selector. Thus only one of IC2,3 is switched on at a time.

The address and control lines to the memory are switched through IC10,11, 12,13. Normally the Z80 address lines A0-12 are connected to the correspond-

ing internal lines A10-12. The read/write line to memory is then obtained by ORing together the Z80 control lines MREQ and WR. The memory block select is connected to the Z80 A15. Because of this partial address decoding the Z80 sees the memory as residing in the first 8k, and at all other 8k blocks in the lower half of its address space. A15 is pulled high by R4 to guarantee that the memory is deselected when the Z80 address lines are floating. When the 6800 has control of the memory, its address lines A0-11 are used. A12 is provided by the 1XXX enable. Thus the main system sees the 8k of memory at 1000H-2FFFH. If 0XXX and 1XXX were to be used instead of 1XXX and 2XXX the memory would be the first 8k for both processors. However, if

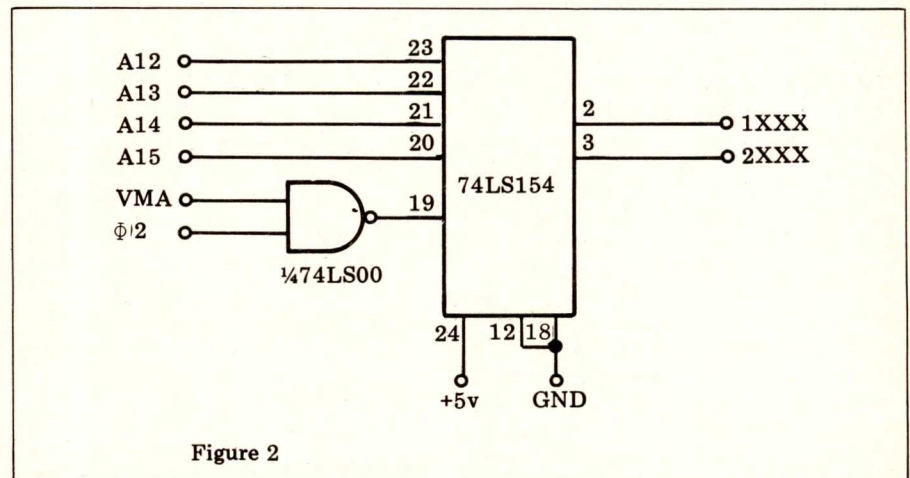

Figure 2

Table 1

b7	b6	b5	b4
1 NOT USED	DESELECT UPPER 4k	DESELECT LOWER 4k	DISABLE INTERRUPT
0 NOT USED	SELECT UPPER 4k	SELECT LOWER 4k	ENABLE INTERRUPT

b3	b2	b1	b0
1 NORMAL OPERATION	NORMAL OPERATION	NORMAL OPERATION	NORMAL OPERATION
0 WAIT	RESET	NMI	INT

both were to be operated simultaneously, this would lead to conflicts between the Z80's restart routines and the 6800's locations used for direct addressing. The memory block select is just the signal (A) described above. The read/write line is just the corresponding signal from the master system bus.

The control latch consists of two 74LS75s (IC4,5). The clock signal to these is obtained by NORing together the A206H enable and the read/write line. Four of the latched bits go directly to control inputs of the Z80. Two more are used for the memory deselection function. One output is used and the final one is gated with the Z80 HALT output to provide a maskable interrupt to the master system. When it's required to interrupt the 6800 the Z80 executes a HALT instruction which stops further program execution and pulls the HALT output low. If the other input to IC7c is also low the signal is passed through to the 6800 IRQ line by the open collector gate IC8c. The bus request line of the Z80 is tied high by R3 in the present design. If desired, BUSRQ may be connected to the unused control latch output.

The clock signal for the Z80 is derived from the $\Phi 2$ line of the 6800 system. The signal is gated by IC7a with the output of monostable IC9 and then applied to the Z80 clock input via IC8d. The resistor R5 is required to provide the necessary high clock voltage. A7409 rather than a 74LS09 is used to sink the current from this resistor. The monostable is triggered by signal (B) when the 6800 wishes to access a location on the board. The pulse from IC9 holds the clock input of the Z80 high until the 6800 is no longer using the memory or control latch.

The timing diagram (Fig.3) shows how the Z80 clock is stretched when the signal (B) goes low. The minimum monostable period, t_{min} , is determined by the requirement that control should not be returned to the Z80 until $\Phi 2$ has gone high in the cycle after the 6800 access. This allows the Z80 to complete any memory access which was in progress when the master took over the bus. The minimum period is thus $1\mu s$, assuming a 1 MHz clock. The maximum period is fixed by the specifications of the Z80 which demand that Φ should be low for at least 180 ns. Meeting this requirement gives $t_{max} = 1.82\mu s$. The monostable should thus be set up with a period of about $1.41\mu s$. This value is not very critical, though, and allows a tolerance of $\pm 29\%$.

If the 6800 performs a valid memory access of the Z80's 8k block on each cycle the monostable will keep being re-triggered and Φ will remain high. This should pose no problems, as the Z80 is static by design and, unlike the 6800, does not forget its data if the clock is stopped. However, the specifications only guarantee a high clock pulse width of $200\mu s$. Such an extended period of access is very unlikely. Even if the 6800 were to be executing a program from

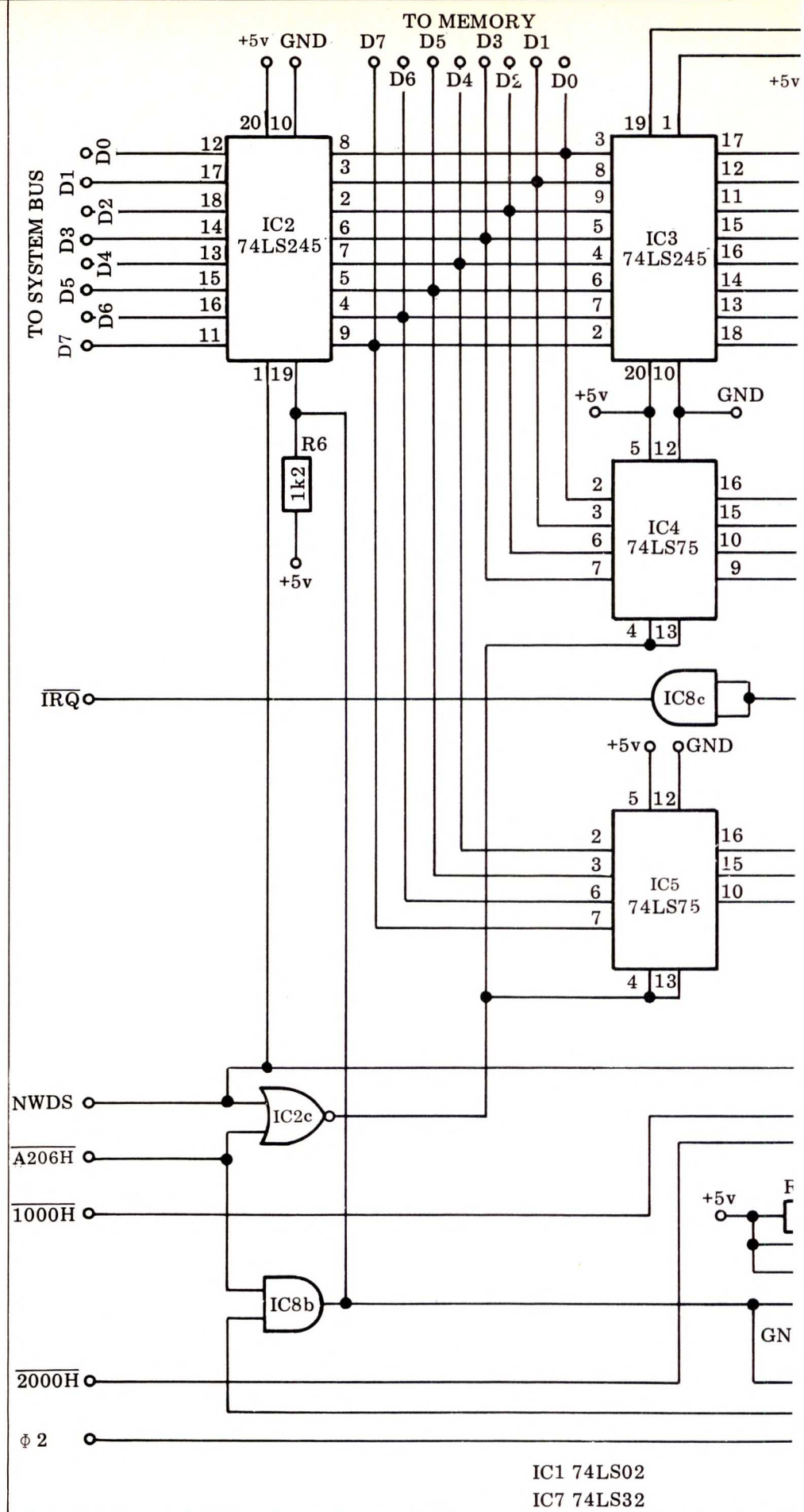

the Z80 memory there are many opcodes which contain cycles used for internal operations and therefore do not access external memory. These cycles would allow the Z80 to continue processing,

albeit at reduced speed.

The circuit was constructed on a Eurocard size Veroboard. The 8k memory is on a separate Eurocard — as supplied by Transam for their Triton

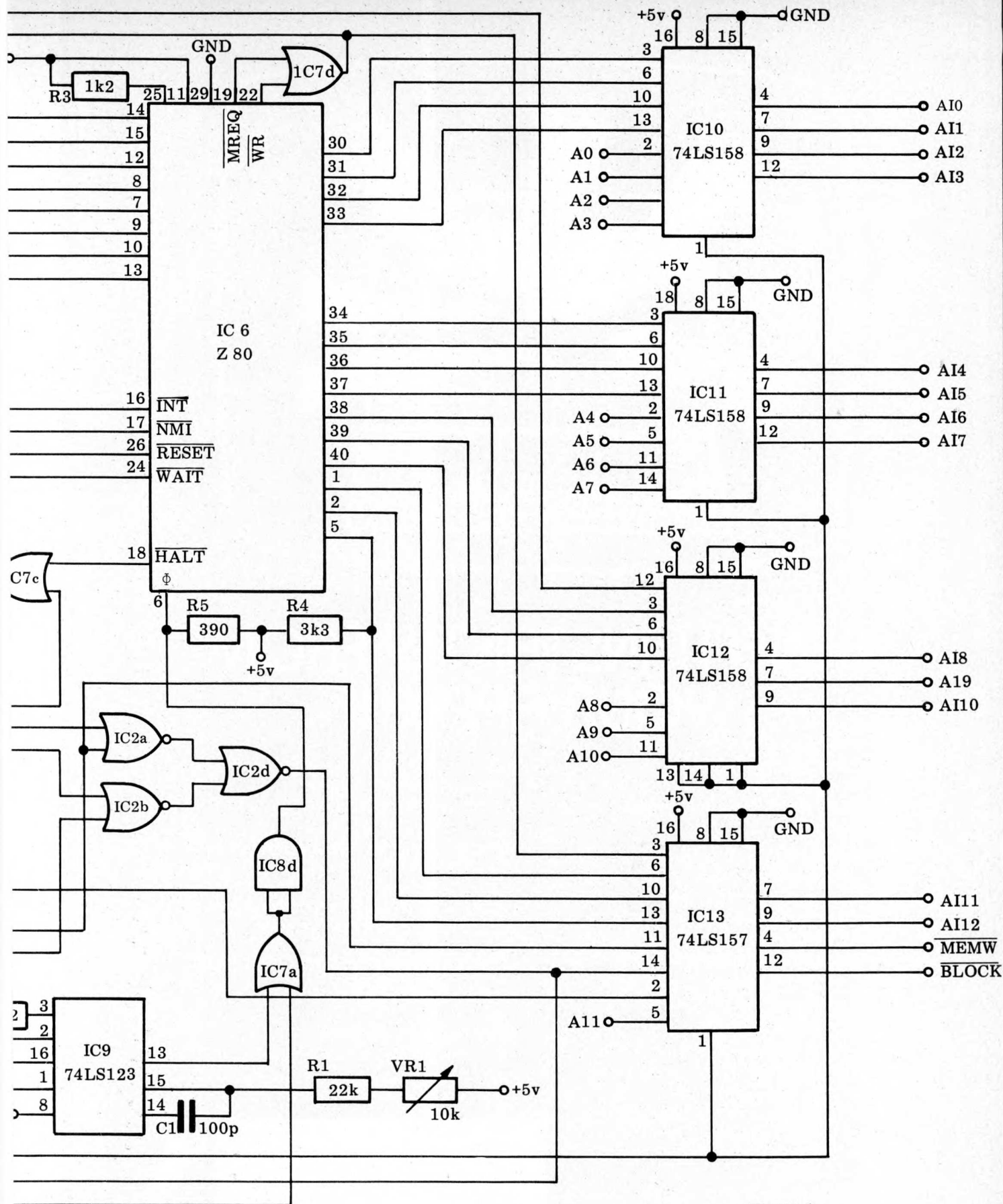

Figure 1

IC8 7409

computer. The Z80 board is connected to this by two ribbon cables that terminate in 16 pin DIP plugs. Notice that it's not necessary for the address and data lines of the Z80 board to be con-

nected to the correspondingly numbered lines of the memory board. This simplifies the wiring of the interconnections.

Lack of space on the board prevented the use of the full capabilities of the

Z80. In addition to the partial address decoding mentioned above there's no provision for the use of input/output instructions or for jamming a restart instruction on the bus following an inter-

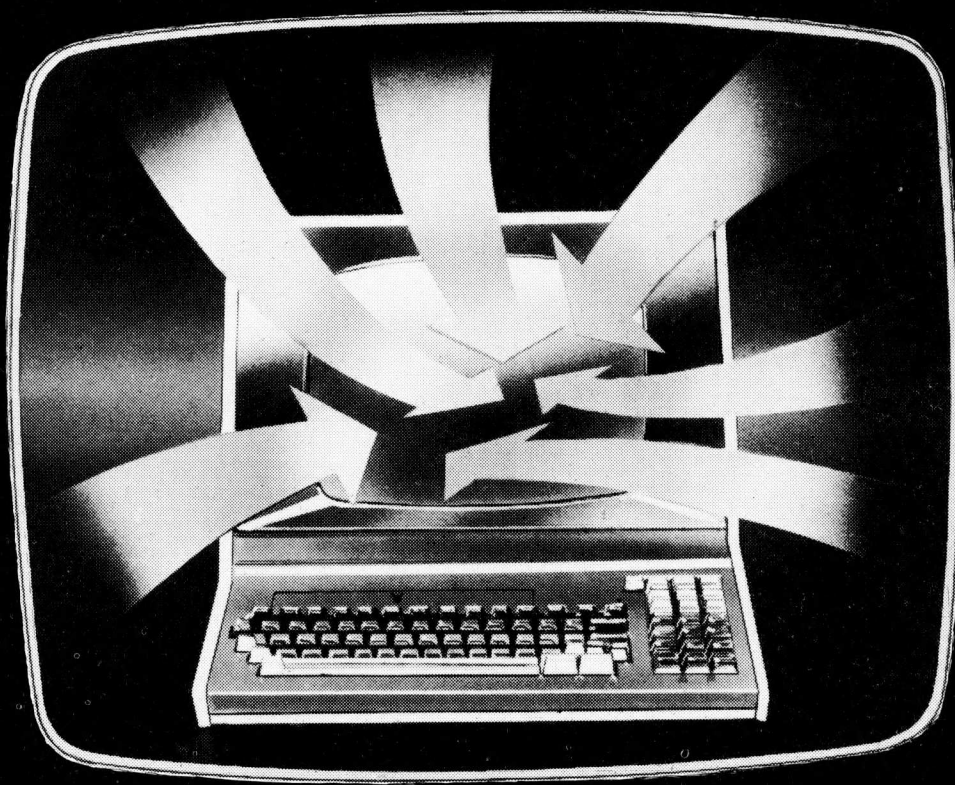

BENEFIT INSTANTLY FROM YOUR APPLE II

Customer records – Direct mail –
Membership lists – Subscription files –
Inventory data – Employee records –
Rental contracts.

TRENDISK/1 is an all purpose data handling package which is easy to use without being laborious and verbose. **Trendisk/1** enables you to benefit immediately from your new micro and - **WITH NO PROGRAMMING EXPERTISE:**

- Define new files and specify what data is to be held in each record
- Add records to the file
- Delete or amend existing records
- Reference records using any item of data
- Search for records with parameters such as 'SIZE greater than 12 and COLOUR = RED and PRICE is less than £20.00'
- Browse through the file record-by-record printing selected details
- List information from the file
- Generate reports
- Print address labels
- Analyse/Adjust numerical data
- Resequence the file using any item.

- Use of standard file formats makes development of 'add-on' programs easy.

Trendisk/1 runs on Apples with 32K of RAM (48K with Applesoft in RAM) with at least one diskette drive. The package supports Centronics-compatible printers using the parallel interface card.

Diskette – Five Programs Only **£75.00** (incl. VAT)

Send now for your **free**
Personal Computer Data Card!

For our 24 hour telephone ordering service call
0423 711878, or complete the coupon:



Name _____
Address _____

Please send me Trendisk/1 at £75.00 incl. VAT

Please send me your product catalogue (tick)

Please send me a Data Card

Signature _____

  CHEQUE (tick)

Credit Card No.

Send to: **Microtrend Ltd.,**
P.O. Box 51, Pateley Bridge,
PCW Harrogate, North Yorkshire HG3 5DP

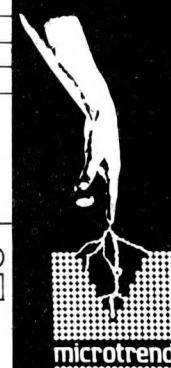

rupt request. The latter means that the maskable interrupt may only be used in mode 1, in which a restart to 0038H (RST 7) is performed. Also the Z80 has to work well below its maximum speed, at only 1 MHz. Although this is the same clock rate as the master 6800 it results in the Z80 working more slowly since each Z80 instruction requires more clock pulses for its execution than a corresponding 6800 instruction. This fact is not widely appreciated, and the mistaken impression is sometimes given that the 6800 is an inherently slower processor — because its maximum clock rate is 2 MHz rather than the 4 MHz of the Z80.

The program of Listing 1 provides a simple means to start the execution of a Z80 program. The CPX instructions are included to give the Z80 the three cycles it requires to perform the reset. Since the 6800 routine provided resides in the Z80's memory block it's not possible to use NOP instructions to provide the delay because these would not allow clock pulses through to the Z80. The 6800 next sets up the control code for normal execution with interrupts enabled and then enters a wait for interrupt state. This effectively turns off the 6800 until the Z80 signals that it requires attention by generating an interrupt. After processing the interrupt the 6800 returns to its waiting state. Following the reset the Z80 starts execution of the program at location 0H. In a more complex application, in which the two processors were to run simultaneously, the WAI instruction could be replaced by a jump to the 6800's program.

Since the Z80 has no peripherals, all its communication with the outside world must be dealt with by the master processor. Two simple interface routines are given in Listing 2. The first of these sets up a flag in location 0005H (1005H to the master processor) and then interrupts the 6800 by executing a HALT instruction. The 6800 interrupt routine of Listing 3 examines the flag location. If it finds the value FFH it calls the keyboard input routine and stores the character thus obtained in the same location. It then generates a non-maskable interrupt to the Z80 to remove it from the HALT state. The Z80 NMI routine is a dummy, consisting of just a return from interrupt instruction. The Z80 then picks up the character and returns to the calling program.

The second interface routine stores the ASCII character in the (A) register at location 0005H and interrupts the 6800 which then, finding that the flag byte is not FFH, outputs the character using a standard monitor routine. It's possible to use a similar technique of communicating via the value stored in 0005H (1005H) to call any of the standard 6800 monitor routines from a Z80 program. One point to note is that if it is required to transfer a 16-bit value from one processor to the other through memory locations, the upper and lower bytes must be interchanged. This is

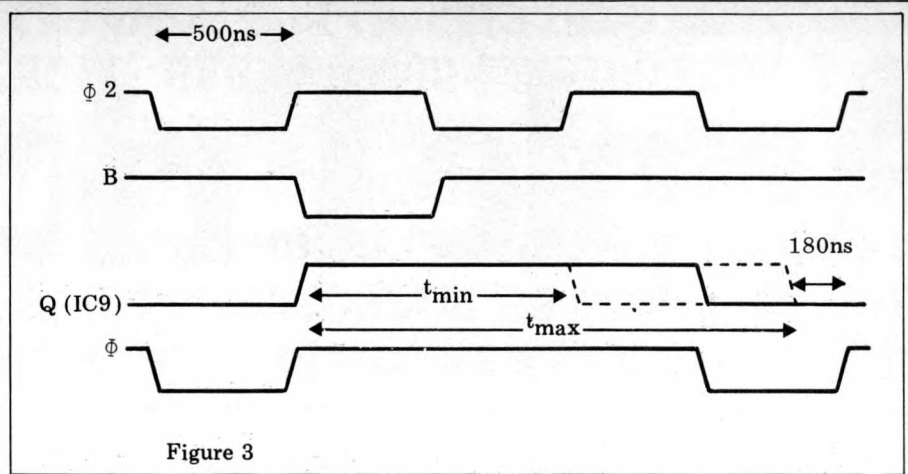

Figure 3

necessary because the 6800 stores 16-bit values with the most significant byte first, followed by the least significant while the Z80 reverses this order.

What possible applications are there for a multiprocessor system? The standard response to such a question would be that the applications are only limited by your imagination. This may frequently be taken to mean that the author has no idea what to do with the thing! I find the main use of the system is in running Z80 software which would otherwise be of no use to me. I now have a Z80 chess program and a text

editor, in addition to my library of 6800 software. The text editor is interfaced to a coresident 6800 self-assembler which allows me to enter and edit source code using the Z80 and then assemble the resulting text file from memory with the 6800. The switching between processors is not apparent to the user.

All applications of the multiprocessor so far have involved only one of the two processors being active at any given time. One possibility currently being investigated is that of playing Space War with the 6800 while the Z80 chess program ponders its next move!

Listing 1

1040	8EA07F	EXEC80	LDS	#\$A07F
1043	CEA206		LDX	#\$A206
1046	861B		LDAA	#\$1B
1048	A700		STAA	0,X
104A	860F		LDAA	#\$0F
104C	AC01		CPX	1,X
104E	AC01		CPX	1,X
1050	A700		STAA	0,X
1052	0E		CLI	
1053	3E	LOOP	WAI	
1054	20FD		BRA	LOOP

Listing 2

0008	3EFF	RST1	LD	A,0FFH
000A	320500		LD	(5),A
000D	76		HALT	
000E	3A0500		LD	A,(5)
0011	C9		RET	
0018	320500	RST3	LD	(5),A
001B	76		HALT	
001C	C9		RET	

Listing 3

1068	B61005	INT68	LDAA	\$1005
106B	81FF		CMPA	#\$FF
106D	2608		BNE	PRINT
106F	BDE1AC		JSR	INEEE
1072	B71005		STAA	\$1005
1075	2003		BRA	DONE
1077	BDE1D1	PRINT	JSR	OUTEEE
107A	860D	DONE	LDAA	#\$0D
107C	B7A206		STAA	\$A206
107F	860F		LDAA	#\$0F
1081	CE0000		LDX	#0
1084	AC00		CPX	0,X
1086	B7A206		STAA	\$A206
1089	3B		RTI	

Apple Price List

Product Code	Description	Retail Price (£)
HARDWARE		
A2S1016P	APPLE 16K VIDEO OUTPUT ONLY	695.00
A2M0003	DISC DRIVE WITHOUT CONTROLLER	299.00
A2M0004	DISC DRIVE WITH CONTROLLER	349.00
A2M0016	16K ADD ON RAM	69.00
CARDS & ACCESSORIES		
A2B0001	PROTOTYPE/HOBBY CARD	15.00
A2B0002	PARALLEL PRINTER INTERFACE CARD	104.00
A2B0003	COMMUNICATIONS CARD	130.00
A2B0005	HIGH SPEED SERIAL INTERFACE CARD	113.00
A2B0006	PASCAL LANGUAGE SYSTEM	299.00
A2B0007	CENTRONICS CARD	130.00
A2B0009	APPLESOFT FIRMWARE CARD	116.00
A2B0010	INTEGER CARD	116.00
MHP-X003	MOUNTAIN HARDWARE CLOCK/CALENDAR CARD	160.00
MHP-X006	MOUNTAIN HARDWARE SUPERTALKER	171.00
MHP-X007	MOUNTAIN HARDWARE ROM PLUS BOARD	116.00
MHP-X015	MOUNTAIN HARDWARE ROMWRITER	101.00
E2B100	EUROCOLOUR CARD	79.00
E2B101	APPLE BLACK & WHITE MODULATOR	14.00
E2B102	A1-02 DATA ACQUISITION CARD	180.00
10-5-16	ALF MUSIC SYNTHESIZER CARD	142.00
10-5-17	ALF TIMING MODE INPUT BOARD	14.00
13-3-2	ALF ALBUM MUSIC DISKETTE NUMBER ONE	12.00
13-3-4	ALF ALBUM MUSIC DISKETTE NUMBER TWO	12.00
13-5-5	ALF ALBUM MUSIC DISKETTE CHRISTMAS	12.00
A2M0015	HEURISTICS SPEECH LAB	122.00
A2M0019	PROGRAMMERS AID 1	27.00
A2M0027	AUTO START ROM PACK	38.00
A2M0029	GRAPHICS TABLET	462.00
E2B104	HEURISTICS CONTROLLER 70	52.00
E2B105	HEURISTICS SPEECHLINK 2000	160.00
E2B107	IEEE INTERFACE	212.00
SOFTWARE		
A2D0005	CONTRIBUTED SOFTWARE VOL 3-5	60.00
A2D0006	CONTRIBUTED SOFTWARE VOL 1-2	27.00
A2D0009	MICROCHESS 2.0 CHESS DISK	15.00
A2D0010	DISC UTILITY PACK	15.00
A2D0012	APPLE BUSINESS CONTROLLER PROGRAM	340.00
A2D0013	APPLE POST PROGRAM	27.00
A2D0018	APPLE BOWLING DISCETTE	9.00
A2D0025	APPLE CASHIER PROGRAM	194.00
A2D0026	APPLE WORD PROCESSING PROGRAM	42.00
A2T0013	MICROCHESS 2.0 CHESS CASSETTE	15.00
E2D001	VISICALC DISC & BOOK COMPLETE	95.00
DOCUMENTATION		
A2L001A	APPLE II REFERENCE MANUAL	11.00
A2L0002	6502 HARDWARE MANUAL	9.00
A2L0003	6502 SOFTWARE MANUAL	9.00
A2L0005	APPLE II BASIC PROGRAM MANUAL	6.00
A2L0006	APPLE II REFERENCE MANUAL	6.00
A2L0012	DOS 3.2 MANUAL	6.00
A2L0018	APPLE II BASIC TUTORIAL MANUAL	6.00
GENERAL ACCESSORIES		
A2D0000	(10) BLANK APPLE DISCETTES	32.40
A2M0009	VINYL CARRYING CASE	16.00
AD/LB	MINI DISC LIBRARY BOX	2.64
MD5172	DISCOFLEX FILING CASE—MINI	12.64
APP1	APPLE DESK TWO TIER	145.00
APP2	PRINTER TABLE	92.00
APPLETEL	APPLETEL SYSTEM	595.00
DUST/APP	DUSTCOVER FOR APPLE II	5.35
E2B013	APPLEJUICE RESERVE POWER SUPPLY	148.00
PRINTERS & ACCESSORIES		
A2M0034	SILENTYPE 80 COLUMN GRAPHICS PRINTER	349.00
A2C0001	10 ROLLS OF THERMAL PAPER FOR SILENTYPE PRINTER	28.00
HUSH100/A	MICROHUSH 100 PRINTER C/W APPLE INTERFACE	266.00
HUSHPAP	16 ROLLS THERMAL PAPER 80FT LONG	22.00
HUSHPAP/E	2 ROLLS THERMAL PAPER 80FT LONG	5.00
TIGER/G	PAPER TIGER PRINTER WITH GRAPHICS OPTION	598.00
TIGER/C	CONNECTOR CABLE FOR TIGER PRINTER	9.00
TIGER/D	GRAPHICS SOFTWARE FOR TIGER PRINTER	20.00
TIGER/P	TIGER PAPER 2,000 SHEETS 11" x 9 1/2" S/PART	35.92
TI810	TEXAS OMNI 810 PRINTER	1450.00
LP5	PAPER 2000 SHEETS 11" x 15" S/PART	14.06
LP9	PAPER 3000 SHEETS 8" x 12" S/PART	14.85
VIDEO MONITORS		
VM129	12" BLACK AND WHITE VIDEO MONITOR	189.00
VM910	9" BLACK AND WHITE VIDEO MONITOR	127.00
VM906	9" HIGH RESOLUTION BLACK AND WHITE VIDEO MONITOR	148.00
VM/C	CABLE FOR VIDEO MONITOR	9.00

Prices exclusive of carriage and VAT and are correct at time of going to press. Available from Apple Dealers all over the UK—for your nearest please contact Microsense Computers. Dealer/OEM enquiries welcome.

micsensense computers limited

Finway Road, Hemel Hempstead, Herts HP2 7PS
Tel (0442) 48151 and 41191
Telex: 825554 DATEFF G

SOLE UK DISTRIBUTOR
apple computer

*Apple is a trade mark of Apple Computer Inc., Cupertino, C.A., USA



SIGNING ON

The first of an irregular series of reports aimed at keeping PCW readers updated on microcomputer communications in general and the Personal Computer Network (PCN) in particular — presented by David Hebditch.

Reaction to the PCN project has been good, which is more than could be said for my progress in getting the network properly established. Shortly after the launch at the PCW Show last year, I moved house but the Post Office failed to move with me. As a consequence, developments of essential software were delayed.

However, interest has been encouraging and already more than a hundred readers have expressed a willingness to participate in the network activities. A preliminary profile of these would-be communicators proves very interesting.

As Table 1 shows, 27% of participants are PET users compared with 16% with Tandy TRS-80s, 13% with Nascoms and only 10% with Apples. Although this may approximately reflect the penetration of the UK marketplace achieved by each of these suppliers, it doesn't relate to the availability of communications features on those systems. For example, the PET is the least easy to interface to a modem and full-duplex IEEE/RS232 interface boxes usually cost £185 or more without including full modem control. On the other hand, the Apple II does have 'official' serial interface for as little as £110, (depending on the mood of the dealer). As with the PET interfaces, however, this does not include full modem control facilities. The fact remains that it is much easier to get started in low-level data communications on the Apple than it is on the PET.

Similarly the TRS-80 has no Tandy-provided RS232 arrangement (although an acoustic coupler is available in the United States). I'm not too sure of the availability of serial interfaces for the TRS-80 from alternative suppliers; perhaps readers could enlighten me.

I understand that a very sophistic-

ated (but low cost) communications interface will be available for the Nascom very soon.

Nearly 40% of the PCN participants have some kind of communications capability already (interface and modem or acoustic coupler and the rest plan to 'go-on-line' as soon as it is economically/technically feasible for them to do so.

Seven participants are from outside the UK (Holland, West Germany and Norway) and there's a fair sprinkling of Radio Hams and disabled people.

On the question of economics, a small annual fee of about £2 should serve to cover administrative costs. For participants wishing to make use of the PCN Service Centre, a one-time set-up charge of about £10 and a usage charge of £2 per hour seems likely. I'd appreciate some feedback on the acceptability of these rates.

In the meantime, I'm in need of some voluntary assistance in the development of the Service Centre software for such activities as Electronic Mail, Teleconferencing and so on. The prerequisite is experience with DEC RSTS-E and Basic-Plus along with the necessary hardware to dial-up and operate at 300 bit/s. The centre is in Central London and is available 24hrs/day 7 days/week. If you are willing and able to help out, please write to me c/o The Editor. In addition to 'Network Notes', I will contact PCN participants directly.

Commodore Pet	27%
Tandy TRS-80	16%
Other complete systems	14%
Nascom 1 and 2	13%
Homebrew and other kit systems	12%
Apple II	10%
Nothing	8%

Table 1

Noise

'Noise' will appear as part of 'Network Notes' and will contain short news items and snippets of interest about the communications scene (sometimes called 'gossip').

Someone recently applied for type-approval for the Apple, and succeeded; it seems that the Post Office have conceded the point about switching power supplies. However, someone else was less lucky with the PET which the Post Office refused to clear for connection to telephone lines (the applicant was *not* Commodore and the company's UK HQ at Slough are reported to be furious as they try to find out who it was who screwed up).

Still on type-approval, it's interesting too that Tandy are one of the companies involved in selling telephone handsets which can only be used in direct breach of Post Office regulations. And when their much-awaited TRS-80 communications adapter becomes available, will Tandy bother with the approval procedure?

The soon-to-be-published Green Paper detailing the Government's proposals for changing the 1969 Post Office Act includes measures for scrapping the Post Office monopoly on modems and it's been suggested that they may not even bother to compete in an open marketplace. Meanwhile the Post Office is reputed to be fighting hard against HMG plans to allow private-sector value added services such as packet-switching and electronic mail systems.

In spite of approval problems, it's rumoured that Commodore will soon be test marketing in the UK a dual RS232 interface unit with full modem control and software selectable features.

Please register me as being interested in Personal Computer Networking.

Name: _____

Address: _____

Telephone No: _____

Computer System: _____

I do not yet have a communications interface, but would like to be kept informed of developments:

Tick

I have the following type of communications interface:

I can transmit at the following speeds Tick
 110 bit/s
 300 bit/s
 1200 bit/s

I have a Post Office modem:

I use an acoustic coupler:

I can act as an originating station:

a receiving station:

both:

Other comments: _____

Date: _____

Signature: _____

THE ADVANCED ACT DISK SYSTEM

It turns your Pet into a business system



Supports a wealth of Business Systems

Sales Ledger £300

Powerful package. Integrated with Analysis.

Purchase Ledger £300

Comprehensive facilities. Integrated with Analysis.

Analysis Package £300

Sales performance by territory; calculation of commissions; analysis of purchases.

Stock Control £300

Parameter driven; on-line enquiries; comprehensive range of reports.

Invoicing £300

Parameter driven; invoices tailored to user requirements; automatic typing.

Payroll £50

For up to 200 employees.

Wordcraft™ £325 Simply the ultimate word processor for the PET.

+ A FULL RANGE OF PETSOFTE PROGRAMS

Advanced Disk Hardware

- 1 Ultra fast-loads and auto verifies a 32K program in 5 seconds from a cold start.
- 2 Up to 800 Kbytes on-line — dual density double sided.
- 3 Powerful Disk Operating System — 9 additional commands and 7 extra disk instructions to the PET's own Basic.
- 4 Compatible with 16K and 32K new ROM PETS.
- 5 Random and sequential file access and support.

- 6 Comprehensive manual and utility disk.
- 7 Languages — Microsoft Basic, 6502 Assembler, Forth, Fifth, Pilot and Cesil.

400 Kbyte Disk Unit £895.

800 Kbyte Disk Unit £1,145.

PET is the trademark of Commodore. Prices exclude VAT and are correct at time of going to press.



ACT (COMPUTERS) LTD.
Radclyffe House, 66-68 Hagley Road,
Edgbaston, Birmingham B16 8PF
Tel: 021 455 8686 Telex: 339396

ACT
TOTAL
COMPUTING

ACT (COMPUTERS) LTD. Radclyffe House, 66-68 Hagley Road, Edgbaston,
Birmingham B16 8PF. Tel: 021 455-8686. Telex: 339396.

Please rush me details of: The advanced ACT disk unit.
 The PET business system collection. The Petssoft catalogue.

Name: _____
Company: _____
Address: _____
Tel. No.: _____

COMPUTER GAMES

by David Levy



BLUFFING AND PSYCHOLOGY

It may sound strange to suggest that a deterministic animal such as a computer is capable of performing in a psychologically motivated manner, but those of us who believe that Artificial Intelligence is here to stay will argue that if you can do it, so can a computer (or microcomputer) program. This month's article is devoted to a discussion of the ways in which the 'thought' processes of a game playing program may be modified to perform in a manner that takes advantage of its opponent's psychological makeup.

Michie's work

I have referred, in an earlier article, to Donald Michie's paper *A Theory of Evaluative Comments in Chess*. In this paper Michie makes use of the fact that in a two-person game tree, it is not absolutely accurate to assume that the opponent will always make the best move at his disposal. Players are liable to make mistakes, and Michie's paper is centred around this fallibility. A strong player, in chess or any other game, will often encounter a situation in which the best move, based purely on deterministic considerations, is not the move most likely to maximize a player's chance of success. Let us consider a concrete example which I

witnessed in an international chess tournament.

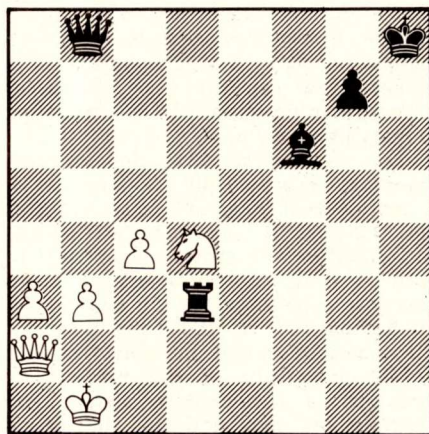

The position was something like this. Both players had been very short of time and had been making their moves at great speed. White is clearly losing, and had his opponent not been in time trouble he would probably have resigned. But White tried one last chance. He played 1 Qa2-h2, giving check. The first thing that I should mention is that these two players were using a very large chess board and set. This had a bearing on White's plan, because he hoped that his opponent's gaze would be attracted

to the black king, and that he would not notice the fact that the queen, way over on the other side of the board, was attacked by and attacking the white queen. Had Black not noticed this fact, he would have moved his king and allowed White to capture his queen on the next move, whereupon White would have won. In fact Black did notice, and knowing his opponent rather well he had been half expecting this surprising queen check on h2, so without a moment's pause Black captured the White queen and our hero resigned. He had not lost anything by trying the ludicrous queen check, because his position was totally lost; he was merely hoping for a one in ten thousand chance.

Moving into the realm of tree searching, we shall now consider a similar example in terms more familiar to the reader.

A player has two moves at his disposal, M_1 and M_2 . He is good enough to see that if he makes move M_1 the result of the game will inevitably be a draw. So the expected result from making move M_1 is 0.5.

If he makes move M_2 the player sees that his opponent can defeat him, but only by finding a 15-ply deep continuation that is very difficult to spot. Otherwise, our player will win. He assesses the probability of his opponent finding this 15-ply win as being 0.1. The expected result from making move M_2 is therefore

$$(0.1 \times 0) + (0.9 \times 1) = 0.9$$

So even though, with correct play, M_1 is theoretically better than M_2 , our player will be better off making move M_2 .

Michie analyzes his tree in the following manner (I am using a simpler example). See Box 1.

Let us assume that we are growing a 2-ply tree, with terminal positions P_{11} P_{12} and P_{13} ... etc., and terminal scores S_{11} S_{12} S_{13} ... etc., respectively. The program considers its possible move from the root position P_0 to P_1 , and notes that its opponent will then have the choice of making the moves M_{11} M_{12} and M_{13} . Let us say that the program estimates the chance (or probability) of its opponent making move M_{11} to be C_{11} , the chance of its opponent choosing M_{12} to be C_{12} , and the chance of move M_{13} to be C_{13} . Then instead of assigning to position P_1 a score of S_1 which is the *minimum* of S_{11} S_{12} and S_{13} , the program assigns a value of

$$S_1 = (C_{11} \times S_{11}) + (C_{12} \times S_{12}) + (C_{13} \times S_{13})$$

and it is this score which is backed-up to P_0 (remember that the program, which 'thinks' at even depths, will always make the move with highest expected score). This part of Michie's method will work perfectly well for a normal minimax search, but in an alpha-beta search there is the problem that a large number of branches are pruned from the tree so an accurate, backed-up expected score is impossible to achieve. Possibly one could attempt an approximation for alpha-beta searching, but this could lead to extremely unreliable results.

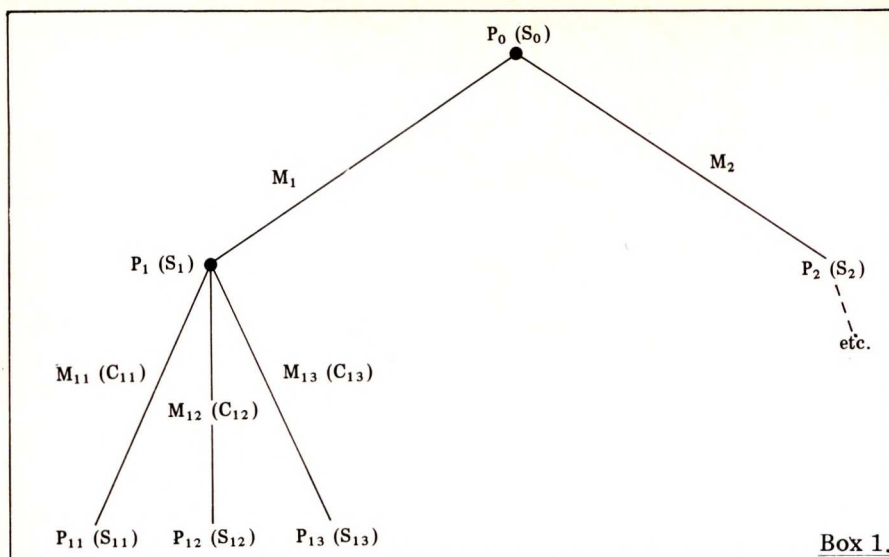

Discernability

Consider the plight of an imperfect player trying to decide which move to make in a game. There are three aspects of his situation that may affect his decision:

(1) How strong a player is he? If he is very strong then he will nearly always make the best move. If he is very weak then he will often make the wrong one.
 (2) How obvious is the right move? If you and I are playing chess, and you capture my queen, it is fairly obvious, even to a weak player, that I must recapture your queen unless there is something special about the position. In a "quiet" position, in which neither side has any direct threats or simple captures, the correct move is far more difficult to perceive, because there may be a number of moves of roughly equal merit.

(3) What extraneous (psychological!?) factors affect the decision? If the correct move is a queen move and our player suffers from some peculiar sexual fantasy that precludes certain types of queen move, it is likely that he will fail to play the correct move. These three factors combine to affect discernability — the ease of finding the right move. Michie has devised the following model for discernability in chess

$$d = (M + 1) \frac{r + 3}{r + 3}$$

where M is the player's rating in kilopoints on the international rating scale (Bobby Fischer's M is roughly 2.8, David Levy's is 2.3, the average of all those who can play chess is 0.8.

r is the number of ply that a terminal evaluation has been backed up.

e is a small number chosen to avoid the expression becoming infinite for $r = 0$.

Michie's formula is derived from the fact that discernability is directly related to playing strength and inversely related to the number of plausible or possible moves ('plausible' being a function of playing strength). He further argues that the probability of a player whose discernability is d , making a move leading to an expected score of u , will be given by

$$p \propto d^u$$

Using these expressions, it would be possible for a strong chess program to plan its play according to the rating of its opponent, taking greater risks against weaker opponents and being cautious against strong ones. At the start of a game it would need to be told its opponent's rating, or if it were extremely sophisticated it could estimate its opponent's strength by performing regression analysis on the moves he made as the game progressed, thereby enabling it to update its estimate of his rating on a move-by-move basis.

How to psych your opponent

A good player will sometimes use psychology to help him win games. He will make moves that are probably not the very best, but which will be difficult or unpleasant for his particular opponent to meet. In chess, for example, a player who is equally at home in quiet, clear positions or in sharp, tactical skirmishes, will himself choose quiet play against a tactical genius but sharp moves against a quiet player. How can this be achieved by a computer program, particularly when employing an alpha-beta search?

Let us assume that the program examines every 1-ply position with a search that analyzes only captures and checks. If the program counts the number of moves examined in each of these capture searches, it can compute a measure for the complexity or 'turbulence' of the 1-ply position. This measure might be some fraction of the logarithm of the number of positions in the capture search. The program can then add this turbulence score to the 1-ply position so that when conducting the full tree-search the program assigns greater scores to the moves that lead to more complex positions, which in turn will encourage the program to head for this type of position. If the program's opponent dislikes 'quiet' positions, the program should subtract the turbulence measure, thereby encouraging it to play into quiet positions. It would even be possible for the program to psycho-analyze its opponent during a game, by measuring his tendency to head

for quiet or complex situations. It could then act accordingly, avoiding positions that suited its opponent's style of play, and aiming for positions that would be less pleasant for the opponent to face.

Bluffing

In some card games it is important to try to mislead your opponent(s) some of the time. In others it is absolutely essential. The human player does this by bluffing, which in reality is little more than creating extra opportunities for the opponent to make a mistake. When you bluff at the card table you are not, in one sense, making the objectively best play, because your opponent may catch you out and punish you. So from a strict minimax point of view, a bluff is not a valid notion, because minimax depends on the assumption that each player will make the best move at his disposal, thereby indicating that all bluffs will be called.

On the other hand, everyone knows that in order to be a successful poker player it is essential to bluff from time to time. This is done for various reasons, one of which is that if your opponent believes you he will pass with the winning hand, thereby allowing you to win the money despite holding inferior cards. There is also the point that if you are caught bluffing once or twice in a session, your opponents will be more inclined to call your big bets when you really do have a powerhouse, thus increasing your overall profits from good hands. The big question, of course, is how often and when should a player bluff? The human will plan his bluff on an intuitive basis, the computer program must do so in a more scientific manner. Let us now consider how a program might determine whether a bluff is likely to prove profitable.

Rummy

In one form or another, rummy is one of the most popular card games in the world. Let us assume that our program is playing a game of Compu-Rummy, which has the following rules: Each player is dealt 12 cards and tries to form "melds" — groups of three or more cards of the same denomination (three queens, four aces, etc.), or three or more cards of the same suit in sequence (4, 5, and 6 of hearts). Each player in turn may pick up a card from the face-up pile or from the face down pile, and must then discard a card onto the face-up pile. When a player has melded all of his cards he wins the hand.

To play this game well it is important to remember which cards have been thrown by your opponent, as these give an idea of which cards he is collecting (or rather which cards he is not collecting, which information can be used by subtraction to estimate which cards he is collecting). There are many ways in which a Compu-Rummy program might work, a simple idea is for the program to use an evaluation function to decide which card to discard after it has made a pick-up. The most important feature in this evaluation function will almost certainly

be the number of melds or part melds remaining in his hand after a discard. The program might score n points for an n -card meld, and 1 point for a 2-card part meld that might later become a 3-card meld. In order to decide which card to throw on the face-up pile, the program computes a score for the cards remaining in its hand after each of the 13 possible discards, and it then makes the discard leading to the position (or holding) with the highest score. If two or more discards appear to be of equal value, the program can employ additional features in its evaluation function to discriminate between these discards. Since the loser in a hand of Compu-Rummy is penalized by the number of points contained in his unmelded cards, it would be advisable for the program to throw high point cards rather than low point cards.

These two heuristics are the most obvious features of a Compu-Rummy evaluation function. But there is another important aspect of rummy, which is known in the trade as "advertising". If you are hoping to make a meld that runs from the 3 of clubs to the 7 of clubs, but you are missing the 5 of clubs, you might be able to entice your opponent into discarding the 5 of clubs by making the discard of another 5, if you hold one. Your opponent, seeing (for example) the discard of the 5 of diamonds, will immediately assume that you are not collecting fives, and unless he has seen you pick up the other clubs in your potential meld he will be quite likely to consider the 5 of clubs a safe discard, should he hold this card in his hand or pick it up at a later stage. This type of play is made by all skilled rummy players, and should be included in a Compu-Rummy program. The simplest way to implement a bluff of this type is to give a small bonus for discarding a card that is close to a card that you hope to pick up. You might score 0.5 points for discarding a card of the same denomination as the card you need, or a card of the same suit but one pip removed, and it would then be sensible to score 0.25 for a discard that was of the same suit but two pips removed from a desired card. One problem with an algorithm of this type is that your opponent will, if he is intelligent, soon learn what is going on, and will modify his play accordingly. So the frequency with which advertising is encouraged should vary, and in a sophisticated program it may even be adjusted dynamically as the game progresses, to take into account the manner in which the opponent is playing. An intelligent computer program can monitor its opponent's play and modify its own strategy accordingly. I have touched briefly on the subject of learning programs in an earlier article, and next month I will discuss learning techniques in more detail.

Poker

In my opinion, poker is the most skilful card game of all. I have played poker for many years and I enjoy it even more than chess. Part of the reason for my enjoyment comes from the psychological struggle that takes place

SITUATION: Open pair facing a possible flush.

PLAYER: Ben Joe Fred Tim Dave Henry Mike
 PROB OF CALLING: 0.3 0.6 0.7 0.4 0.3 0.5 0.2

Box 2.

Investment = 100 Amount currently in the pot = 100
 Probability of opponent calling the bet = p
 Probability of opponent calling the bet = $1 - p$
 Expected income = Expected gain - Expected loss
 = $(1 - p) \times 100 - p \times 100$

Box 3.

at the poker table, and most of this struggle emanates from the bluffing aspect of the game. Bluffing in poker must be handled in a scientific manner, because each situation will depend on how much money the program stands to win or lose by its attempted bluff. Let us first look at a simple situation in a hand of 5-card stud poker.

Joe: ? 5 7 A K (all hearts)

Ben: ? 6 6 8 9

\$100 currently in the pot.

To understand this example it is not really necessary for the reader to know the rules of poker. A brief description of the implications of this situation will suffice.

The game is played by dealing each player one card face down and one face up. A round of betting takes place, and all those who remain in the hand then receive another face up card, and indulge in another round of betting. This continues until the fourth face up card and its round of betting, and once everyone has put the same amount of money in the pot, the player with the best cards wins.

In the above hand, Joe and Ben are the only players remaining in the pot when the final cards are dealt. It is Joe's turn to bet, and he can either "check" (putting no money into the pot and allowing Ben the option of betting), or he can bet the limit of \$100. Joe's hidden card is the queen of clubs which gives him a useless hand, but Ben does not know this. So far as Ben is concerned, Joe might have another heart, in which case he has a hand known as a flush, which will win irrespective of whether or not Ben has more than a pair of sixes. What thoughts will pass through Joe's mind when he thinks about whether or not to try a bluff?

Reducing the hand to its simplest terms, Joe may put in \$100 knowing that if Ben calls the bet Ben will win. But if Ben is bluffed into thinking that Joe has that fifth heart, Ben will pass the \$100 bet and Joe will pick up the \$100 currently in the pot. If Joe is human he will use intuition to make his decision. He has been playing poker with Ben for some time so he knows how Ben usually reacts in situations of this type. The intelligent computer program must simulate this intuitive process in some way.

The following simple algorithm should prove rather effective in some situations, but it is by no means intended to be exhaustive. Anyone intending to write a poker program will need to think of a very large number of typical situations - here I am dealing with only one. (See Box 2.)

By monitoring the players, the pro-

gram builds up a picture of what each of them has done when having an open pair (such as Ben's pair of sixes) against a possible flush, and the player with the possible flush has bet the limit. The program has noted that Fred likes to live dangerously and call 70% of such bets while at the other end of the scale Mike is very conservative and will be less likely to call. When the program reaches this particular situation, and holds four face-up cards of the same suit, it can decide whether or not to bluff in a probabilistic manner. (See Box 3.)

For Ben the probability of his calling the bet is 0.3, so the expected income is $70 - 30 = 40$. For Joe the probability is 0.6, so the expected income is $40 - 60 = -20$. So the program would not try to bluff in this situation against Joe, but it would against Ben, and it would determine whether or not to try a bluff against the other players in a similar manner. If you are writing a poker program and your computer system supports a cassette or disk, it will be possible for you to retain the information learned during one playing session for use in the next. Of course it is quite possible for one or more of the program's opponents to change his style from one session to another, but it is always useful to have some reference point at the start of a game. For players with unknown characteristics, the program will employ fixed estimates, stored in a table, which can be updated during a playing session as the program learns how each player acts at the poker table. It will also be possible for an intelligent program to make certain generalisations: for example, since Joe is quite likely to call a possible bluff in a parallel but as yet unrecorded situation (the probability of the bettor having a cast-iron cinch being roughly the same as his having a flush when showing four cards of the same suit). Again this is largely a matter of learning.

Task for the month

Those of you who completed the earlier tasks involving noughts and crosses programs, will find this month's exercise somewhat trivial, but nonetheless instructive.

Write a noughts and crosses program to play a perfect game by means of exhaustive tree search. Test this version of the program against a program that moves at random, playing a number of games and noting the percentage score.

Modify the program to use Michie's method of backing up expected values, based on the assumption that the opponent will be moving at random, and play this version of the program against the random version. The results should indicate that slightly imperfect play can result in a better score than perfect play!

M68000 -MOTOROLA'S SWEET SIXTEEN

News has been coming in thick and fast recently about Motorola's forthcoming addition to the new range of 16-bit super micros, the M68000. But with something approaching a six month wait before any sort of general availability, has it arrived too late? Nicholas Jarman largely dodges that question and instead casts an appreciative eye over its capabilities.

The Intel 8086 was the first of the new 16-bit micros to appear, closely followed by the Zilog Z8000. At the moment there is still no physical sign of Motorola's contender, so presumably Intel and Zilog are rubbing their hands with glee. The only dampener for them is that the M68000 is almost certainly the most powerful of the three; in fact at one stage when some of the big manufacturers saw the advance specifications, it was said that Motorola just wouldn't be able to make it. It now looks, however, as if the scepticism was ill-founded for sample devices are already spreading round the world.

Internal Operation/Layout

The M68000 internal structure is that of a 32-bit micro, making it very efficient with long word operations. There are 17 32-bit registers (apart from a 32-bit program counter and a 16-bit status register) comprising eight data registers for 8, 16 and 32 bit data and seven address registers. All 17 registers can be used as index registers and there is also a specific user and supervisor stack pointer.

There are two modes of operation, user and supervisor. In user mode certain instructions are illegal and areas of memory can be locked out by a memory management unit. When in this mode a switch to supervisor mode always occurs when an interrupt, bus error etc is received. In supervisor mode all instructions are available and the full status register can be accessed. This arrangement is similar to that of the Z8000.

A trace mode can be set in supervisor mode which causes a branch via a trace vector after execution of every instruction — very useful for program debugging! The lower 512 words of memory are reserved for a vector table containing 255 vectors, of which 192 are

reserved for user interrupt vectors.

Interrupts, bus errors etc. all cause what Motorola calls 'exception processing', of which there are three levels of priority. In order of decreasing priority, Group 0 contains — Reset (highest), Bus Error, Address Error; Group 1 — Trace, Interrupt, Illegal Instruction and Privilege Violation; Group 2 (all equal priority) — TRAP, TRAPV, CHK, Zero Divide. All the exceptions cause branching via the appropriate vector, except for certain occurrences of Bus Error. If a Bus Error and a Halt signal are received simultaneously, the processor will re-run the current memory access on the negation of HALT.

Instruction set

There are 56 basic instruction types and 14 addressing modes, and although this doesn't seem like many instructions, it's deceptive as there are many variations. For example MOVE caters for loading

register(s), storing register(s), moving data in memory etc. The total number of useful instructions exceeds 1000! The addressing modes are extremely comprehensive and no programmer could envisage needing more. The format of the instructions is astonishingly simple and easy to use. With other micros you have to learn the code for each individual instruction — e.g. Load register (indexed) might be 0A and load register (immediate) FE. Not so with the M68000 . . . All you need to learn are the numbers for the 56 basic instructions and the numbers for the addressing modes. The complete instruction is then made up of the code for the instruction, the data size, addressing mode and register number (if required). Dead simple!

Speed

The speed of the M68000 is also something to be marvelled at. It's faster than the 8086, the Z8000 and the PDP11/45 — and it can't be a lot slower than the PDP 11/70! It's twice as fast as the Z8000 on a 16-bit multiply (35 instruction cycles compared with 70 — maximum).

Omissions

Unlike the Z8000 the M68000 does not have on-chip refresh and multi-micro control. It could be that Motorola does not want to be seen to be abandoning its traditional approach in favour of

FUNCTION CODE OUTPUTS

FC2	FC1	FC0	Cycle Type
L	L	L	(Undefined Reserved)
L	L	H	User Data
L	H	L	User Program
L	H	H	(Undefined Reserved)
H	L	L	(Undefined Reserved)
H	L	H	Supervisor Data
H	H	L	Supervisor Program
H	H	H	Interrupt Acknowledge

L = Low H = High

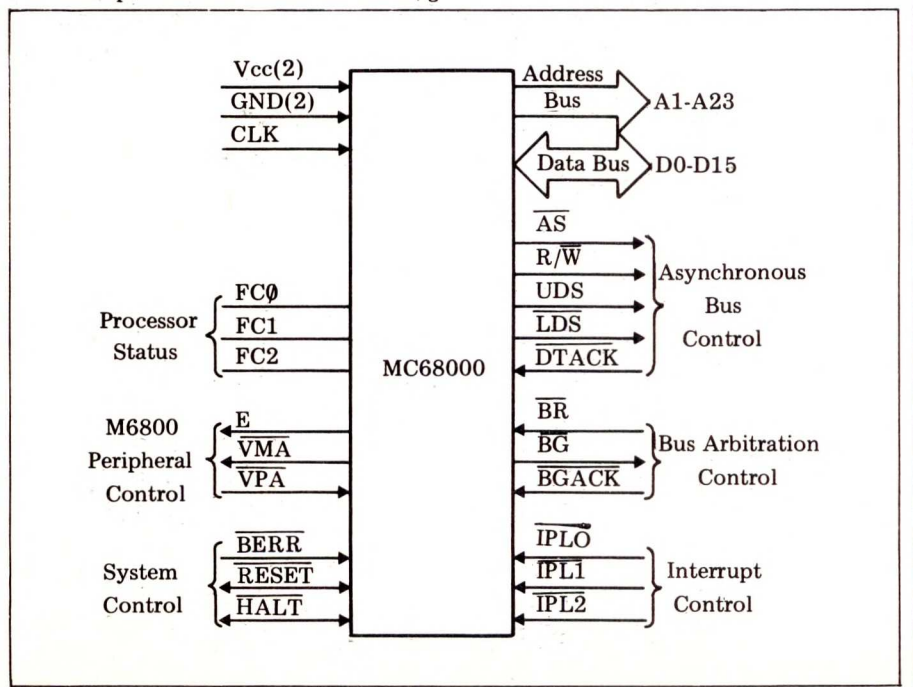

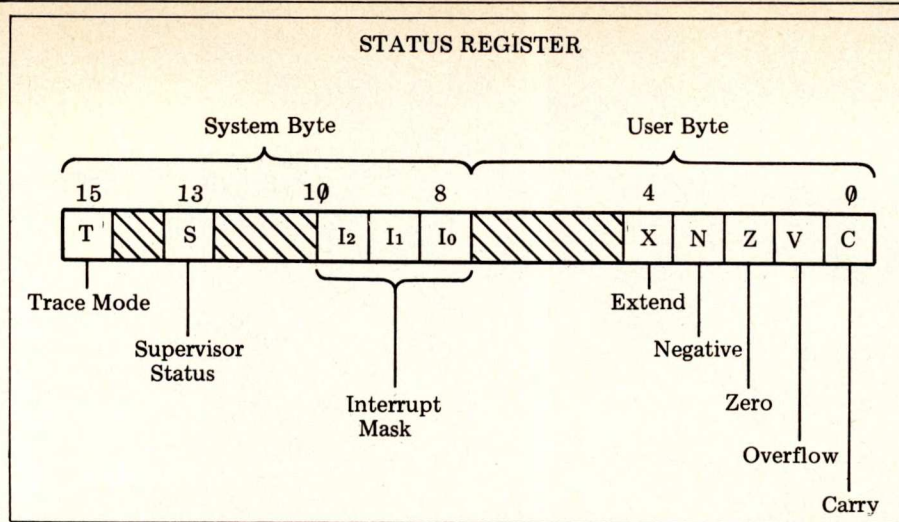

somebody else's. I feel, however, that there has been a preference towards getting as much computing power into the CPU as possible — at the expense of other features that can easily be added on with a few external chips. (Try extending an instruction set with a few external chips!) What Motorola has aimed at is producing the most powerful single chip CPU in the world. Possibly the plan has succeeded.

Hardware

The M68000 has definitely been designed for large systems, although a small system could easily be based around it. The processor is contained in a 64-pin package (long!) which is needed because none of the signals are multiplexed, thus increasing speed and ease of use. It requires +5V and a single phase clock (up to 8MHz). . . an internal cycle is defined as two clock cycles (250ns).

DATA ADDRESSING MODES

Mode	Generation
Register Direct Addressing Data Register Direct Address Register Direct	EA = D _n EA = A _n
Absolute Data Addressing Absolute Short Absolute Long	EA = (Next Word) EA = (Next Two Words)
Program Counter Relative Addressing Relative with Offset Relative with Index and Offset	EA = (PC) + d ₁₆ EA = (PC) + (X _n) + d ₈
Register Indirect Addressing Register Indirect Postincrement Register Indirect Predecrement Register Indirect Register Indirect With Offset Indexed Register Indirect With Offset	EA = (A _n) EA = (A _n) A _n ← A _n + N A _n ← A _n - N, EA = (A _n) EA = (A _n) + d ₁₆ EA = (A _n) + (X _n) + d ₈
Immediate Data Addressing Immediate Quick Immediate	DATA = Next Word(s) Inherent Data
Implied Addressing Implied Register	EA = SR, USP, SP, PC

NOTES:

EA Effective Address
A_n Address Register
D_n Data Register
X_n Address or Data Register used as Index Register
SR Status Register
PC Program Counter
() Contents of

There are 23 address lines giving 16 Mbytes of direct addressing; individual bytes are accessed via the UDS and LDS signals. A valid address is indicated by AS and the addressed device responds with DTACK (Data Transfer ACKnowledge). This also acts to stretch memory cycles (if necessary) by not being negated until the memory is ready. Memory read, write, read-modify-write cycles take 4, 5 and 9 clock cycles respectively. A great feature of the M68000 is its ability to interface directly with standard M6800 peripherals. If, at the beginning of a memory access cycle, a VPA signal is received, the processor switches to the M6800 form of addressing. VMA is taken low and E is equivalent to M6800 $\Phi 2$ (1MHz). Hence VPA can be derived from the address decoding logic on any M6800 peripheral boards. FC0 to FC2 are outputs that show the type of processing currently being

d₈ Eight-bit Offset (displacement)
d₁₆ Sixteen-bit Offset (displacement)
N 1 for Byte, 2 for Words and 4 for Long Words
← Replaces

done in the CPU; IPL0 to IPL2 are inputs devoted to interrupts. Seven levels of interrupt are available (level 0 = no interrupt), level 7 being the highest priority. With all seven levels of interrupt the vector address for the service routine can either be supplied by the interrupting device — or else an autovector can be used. To my knowledge this is the most advanced form of interrupt handling available on a micro. On reception of an interrupt, an interrupt acknowledge code is placed on FC0-FC2 and a read cycle is entered with the interrupt level on the lower three bits of the address bus. The processor then expects the vector address to be placed on the data bus and DTACK to be given. If this does happen then the processor jumps to the location pointed to by the contents of

INSTRUCTION SET

Mnemonic	Description
ABCD	Add Decimal with Extend
ADD	Add
AND	Logical And
ASL	Arithmetic Shift Left
ASR	Arithmetic Shift Right
BCC	Branch Conditionally
BCHG	Bit Test and Change
BCLR	Bit Test and Clear
BRA	Branch Always
BSET	Bit Test and Set
BSR	Branch to Subroutine
BTST	Bit Test
CHK	Check Register Against Bounds
CLR	Clear Operand
CMP	Compare
DBCC	Test Cond, Decrement and Branch
DIVS	Signed Divide
DIVU	Unsigned Divide
EOR	Exclusive Or
EXG	Exchange Registers
EXT	Sign Extend
JMP	Jump
JSR	Jump to Subroutine
LEA	Load Effective Address
LINK	Link Stack
LSL	Logical Shift Left
LSR	Logical Shift Right
MOVE	Move
MOVEM	Move Multiple Registers
MOVEP	Move Peripheral Data
MULS	Signed Multiply
MULU	Unsigned Multiply
NBCD	Negate Decimal with Extend
NEG	Negate
NOP	No Operation
NOT	One's Complement
OR	Logical Or
PEA	Push Effective Address
RESET	Reset External Devices
ROL	Rotate Left without Extend
ROR	Rotate Right without Extend
ROXL	Rotate Left with Extend
ROXR	Rotate Right with Extend
RTE	Return from Exception
RTR	Return and Restore
RTS	Return from Subroutine
SBCD	Subtract Decimal with Extend
SCC	Set Conditional
STOP	Stop
SUB	Subtract
SWAP	Swap Data Register Halves
TAS	Test and Set Operand
TRAP	Trap
TRAPV	Trap on Overflow
TST	Test
UNLK	Unlink

Whether you're a software engineer looking for the best hardware — an educationalist requiring versatility and the ultimate in reliability — or an OEM demanding flexibility, the finest documentation available, and 'realistic' margins — Zenith Data Systems is your automatic choice.

Z89 Series Microcomputer.

This highly advanced Microcomputer is the star of the Zenith range.

Specification includes:
Floppy disc storage. 48K RAM.
'Intelligent' video terminal.

Two Z80 Microprocessors. Choice of operating systems including CPM.

Standardised communication, RS 232. Prices from £1570

Z11A Series 16-bit computer.

Based on the powerful new KD11-HA CPU (LSI — 11/2) it offers you the speed and versatility of a minicomputer at

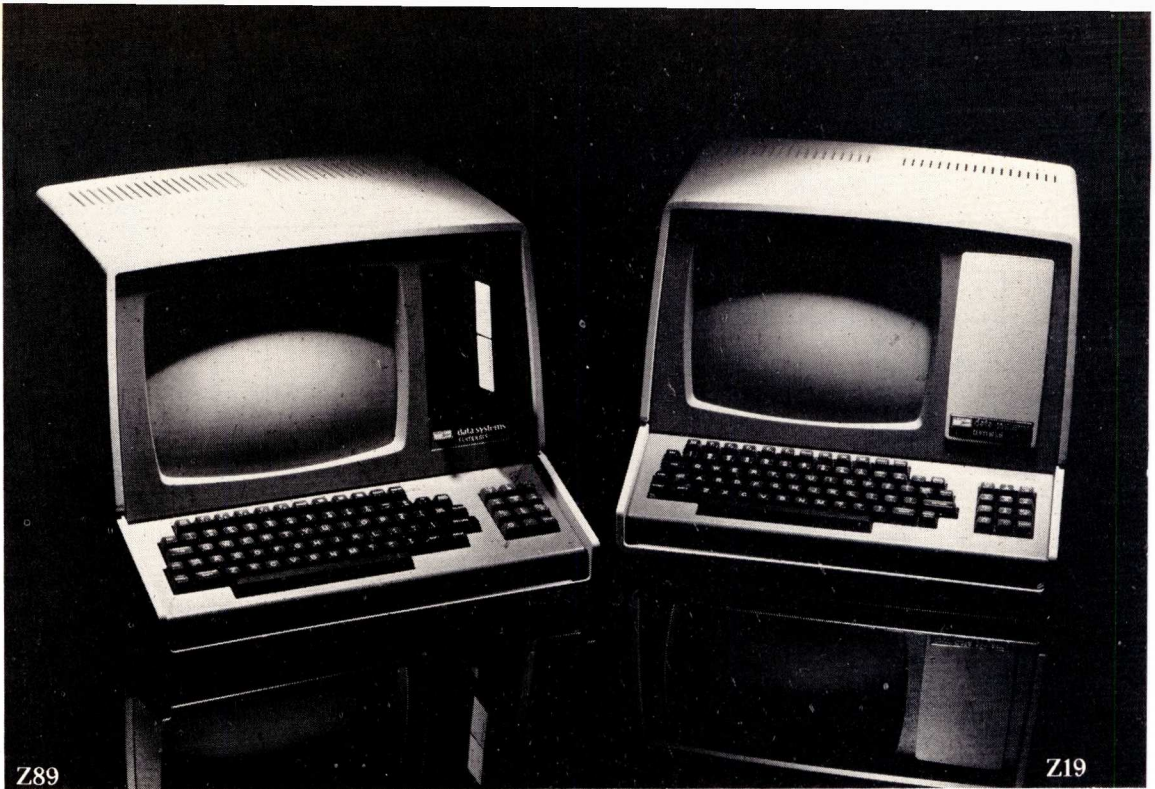

Z89

Z19

The Professionals

a microcomputer price. With memory* to 32K words (64K Bytes). Seven additional I/O positions. PDP 11/03 compatible.

Systems from £4359.

*Memory boards available from £562 per 16K.

WH14 Serial Printer.

Microprocessor based electronics makes it capable of a wide variety of uses in most computing applications.

It features 5 x 7 dot matrix. Impact print. Operator/software selectable line width — 132, 96 and 80 characters per line. And sprocket paper feed with adjustable spacing.

Price. £510

Z19 'Intelligent' Video Terminal.

Z80 based, it is capable of a multitude of high-speed functions. It has an easy-to-read, high

resolution CRT. Heavy duty keyboard. 128 characters. Addressable cursor, relative and direct. Versatile edit functions. And E.I.A. RS 232/c at 110 to 9600 baud. Price. £735

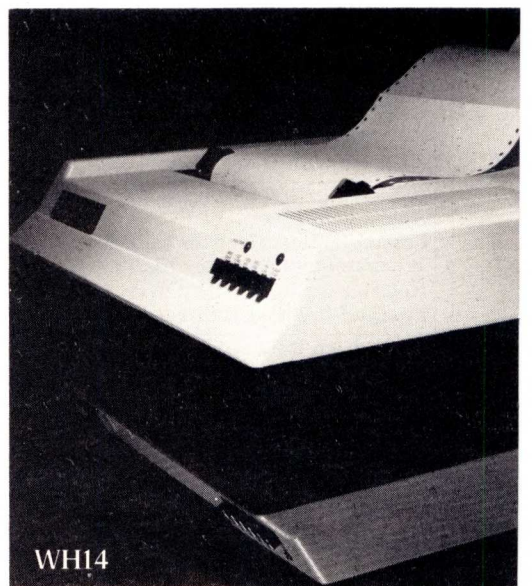

WH14



Z11A



Zenith data systems

THE ULTIMATE IN MICROCOMPUTERS

If you'd like more information about any, or all of the Zenith Data Systems range, just contact us at Zenith Data Systems Division, Heath Electronics (U.K.) Limited, Dept (PCW 7), Bristol Road, Gloucester GL2 6EE. Telephone (0452) 29451

All prices are exclusive of VAT and delivery charges.

Generous OEM discounts available.

the memory location whose address is on the bus. If this does not occur then the CPU assumes an autovector and jumps using the autovector corresponding to the interrupt level.

BERROR is an input that can signify a non-responding device or an illegal access determined by an external memory management chip. The effect this signal has depends on certain conditions already described. Both the RESET and the HALT lines are bi-directional, allowing external devices to be reset via the reset instruction. An internally generated halt is caused when

a Bus Error signal is received on two consecutive memory accesses. When this occurs an externally generated reset is required to restart the CPU. This feature provides useful protection in the event of a catastrophic system failure!

Summary

The strong points of the M68000 seem to be its simple, easy to learn instruction format and its useful range of instructions (including control of both stacks and queues), coupled with the ability to maintain linked stacks. With floating point instructions on the way,

writing high level languages will be a piece of cake! This sort of instruction should enable more efficient programming and the introduction of many mainframe techniques.

Bus arbitration is also very comprehensive, allowing simple control of a multi-master bus. The direct interface to M6800 peripherals must appeal to a lot of people, as it will mean that most of their existing equipment could easily be used in a M68000 system, thus eliminating a lot of annoying and expensive duplication of costs.

And yet all this extra power results
GOTO page 119

VARIATIONS OF INSTRUCTION TYPES

Instruction Type	Variation	Description
ADD	ADD	Add
	ADDA	Add Address
	ADDQ	Add Quick
	ADDI	Add Immediate
	ADDX	Add with Extend
AND	AND	Logical And
	ANDI	And Immediate
CMP	CMP	Compare
	CMPA	Compare Address
	CMPM	Compare Memory
	CMPI	Compare Immediate
EOR	EOR	Exclusive Or
	EORI	Exclusive Or Immediate
MOVE	MOVE	Move
	MOVEA	Move address
	MOVEQ	Move Quick

Instruction Type	Variation	Description
	MOVE	Move from Status Register
	MOVE from SR	Move to Status Register
	MOVE to SR	Move to Condition Codes
	MOVE to CCR	Move User Stack Pointer
	MOVE USP	
NEG	NEG	Negate
	NEGX	Negate with Extend
OR	OR	Logical Or
	ORI	Or Immediate
SUB	SUB	Subtract
	SUBA	Subtract Address
	SUBI	Subtract Immediate
	SUBQ	Subtract Quick
	SUBX	Subtract with Extend

LITTLE GENIUS

If you find self-instruction manuals difficult to follow, then meet our Little Genius.

Little Genius floppy diskettes are the fastest, easiest way to master your micro.

Little Genius will save you time and effort, teaching you to exploit all your micro's facilities.

Courses now available:

1. Applesoft basic
2. Advanced Applesoft
3. Using your Apple
4. Pet basic
5. Advanced Pet basic
6. Palsoft basic
7. Advanced Palsoft
8. Using your 2020



For further information ask your local dealer or contact:

Peter Brown at Suite 504, Albany House,
324 Regent Street, London W1R 5AA.
Telephone 01-580 6361.

INTEGRATED SMALL BUSINESS SOFTWARE ISBS

Professional Business Packages for Microcomputer systems include:

- PAYROLL
- STOCK CONTROL
- ORDER ENTRY & INVOICING
- COMPANY SALES
- COMPANY PURCHASES
- GENERAL ACCOUNTING
- NAME & ADDRESS SYSTEM

Available as individual modules or complete system to run on RAIR BLACK BOX, NORTHSTAR, HEATH, CROMEMCO, DYNABYTE, IMS 5000/8000, ALTOS, ALTAIR, SUPERBRAIN, MICROMATION and most other 8080 based systems.

Contact Lifeboat Associates, 32 Neal Street, London WC2 or your nearest dealer.

GRAFFCOM 52 SHAFTESBURY AVENUE
SYSTEMS GROUP LONDON W1 01-734 8862

STAY ON THE LEADING EDGE

It isn't easy! Few industries are changing as rapidly as microelectronics. We ought to know — *Personal Computer World* is Europe's leading micro magazine and in living up to that claim, each month PCW brings you reports on the latest hardware, software, education and business developments, answers your questions and gives you the most interesting features and programs.

Not only were we Britain's first micro publication but we were also the first to sponsor our own exhibition in the UK. So if you want to keep on the leading edge of micro technology come to the Third Personal Computer World show at the Cunard International Hotel, London, 4 — 6 September.

Last year's PCW show was a great success and this year it will be bigger than ever! The Show will feature a massive display of the latest hardware, software and literature, courtesy of manufacturers and dealers from around the world. You'll be able to take part in or watch the first official World Microcomputer Chess Championship and attend Micro UK, a three-day event of conferences, seminars, teach-ins and round table 'meet the expert' discussions. Further details of the Microcomputer Chess Championship are available from David Levy, c/o PCW. Use the reply card for further Show information or tickets, or write directly to Timothy Collins, Montbuild Ltd., 11 Manchester Square, London W1M 5AB.

The 3rd Personal Computer World Show

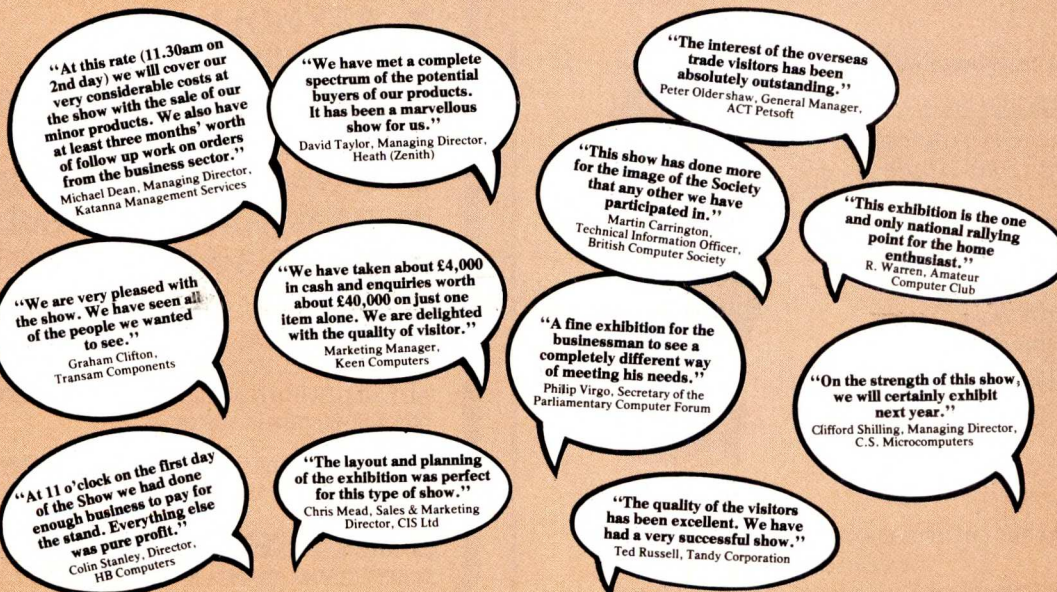

Can your business, research project or teaching laboratory be made more efficient? Yes. Today's users demand complete, high performance micro computer systems. Expandable to meet future needs and with software capable of immediate application.

The North Star Horizon is the answer. A cleverly balanced configuration: Z80A processor with 12 slot S100 chassis, one parallel and two serial interface ports. Now with double or quad capacity too.

The compact design gives you value for money and economy of space. The Horizon will not break your bank or your desk top.

Quick delivery and nationwide service are only part of the attraction. Add to this the wealth of software available, including the well known CP/M, and you can see why the Horizon has already sold in thousands.

The reason for its success is simple.

The North Star Horizon reflects your needs.



For technical specification and details of your nearest dealer contact Britain's leading North Star Supplier.

 **comart**

PO Box 2, St. Neots, Cambridgeshire.
Tel: (0480) 215005. Telex: 32514.
COMART G.

**North Star Horizon
reflects a new age in computing**

Britain's first com puter kit.

The Sinclair ZX80.

£79.95

Price breakdown
ZX80 and manual: £69.52
VAT: £10.43
Post and packing FREE

Please note: many kit makers quote VAT-exclusive prices.

You've seen the reviews... you've heard the excitement... now make the kit!

This is the ZX80. 'Personal Computer World' gave it 5 stars for 'excellent value.' Benchmark tests say it's faster than all previous personal computers. And the response from kit enthusiasts has been tremendous.

To help you appreciate its value, the price is shown above with and without VAT. This is so you can compare the ZX80 with competitive kits that don't appear with inclusive prices.

'Excellent value' indeed!

For just £79.95 (including VAT and p&p) you get everything you need to build a personal computer at home... PCB, with IC sockets for all ICs; case; leads for direct connection to a cassette recorder and television (black and white or colour); *everything!*

Yet the ZX80 really is a complete, powerful, full-facility computer, matching or surpassing other personal computers at several times the price.

The ZX80 is programmed in BASIC, and you can use it to do quite literally anything from playing chess to managing a business.

The ZX80 is pleasantly straightforward to assemble, using a fine-tipped soldering iron. It immediately proves what a good job you've done: connect it to your TV... link it to an appropriate power source... and you're ready to go.

Your ZX80 kit contains...

- Printed circuit board, with IC sockets for all ICs.
- Complete components set, including all ICs - all manufactured by selected world-leading suppliers.
- New rugged Sinclair keyboard, touch-sensitive, wipe-clean.
- Ready-moulded case.
- Leads and plugs for connection to domestic TV and cassette recorder. (Programs can be **SAVED** and **LOADED** on to a portable cassette recorder.)
- **FREE** course in BASIC programming and user manual.
- Optional extras**
- Mains adaptor of 600 mA at 9 V DC nominal unregulated (available separately - see coupon).
- Additional memory expansion boards allowing up to 16K bytes RAM. (Extra RAM chips also available - see coupon).

*Use a 600 mA at 9 V DC nominal unregulated mains adaptor. Available from Sinclair if desired (see coupon).

The unique and valuable components of the Sinclair ZX80.

The Sinclair ZX80 is not just another personal computer. Quite apart from its exceptionally low price, the ZX80 has two uniquely advanced components: the Sinclair BASIC interpreter; and the Sinclair teach-yourself BASIC manual.

The unique Sinclair BASIC interpreter offers remarkable programming advantages:

- **Unique 'one-touch' key word entry: the ZX80 eliminates a great deal of tiresome typing. Key words (RUN, PRINT, LIST, etc.) have their own single-key entry.**
- Unique syntax check. Only lines with correct syntax are accepted into programs. A cursor identifies errors immediately. This prevents entry of long and complicated programs with faults only discovered when you try to run them.
- Excellent string-handling capability - takes up to 26 string variables of any length. All strings can undergo all relational tests (e.g. comparison). The ZX80 also has string input to request a line of text when necessary. Strings do *not* need to be dimensioned.
- Up to 26 single dimension arrays.
- FOR/NEXT loops nested up to 26.
- Variable names of any length.
- BASIC language also handles full Boolean arithmetic, conditional expressions, etc.
- Exceptionally powerful edit facilities, allows modification of existing program lines.
- Randomise function, useful for games and secret codes, as well as more serious applications.
- Timer under program control.
- PEEK and POKE enable entry of machine code instructions, USR causes jump to a user's machine language sub-routine.
- High-resolution graphics with 22 standard graphic symbols.
- All characters printable in reverse under program control.
- Lines of unlimited length.

Sinclair
ZX80



Fewer chips, compact design, volume production - more power per pound!

The ZX80 owes its remarkable low price to its remarkable design: the whole system is packed on to fewer, newer, more powerful and advanced LSI chips. A single SUPER ROM, for instance, contains the BASIC interpreter, the character set, operating system, and monitor. And the ZX80's 1K byte RAM is roughly equivalent to 4K bytes in a conventional computer - typically storing 100 lines of BASIC. (Key words occupy only a single byte.)

The display shows 32 characters by 24 lines. And Benchmark tests show that the ZX80 is faster than all other personal computers.

No other personal computer offers this unique combination of high capability and low price.

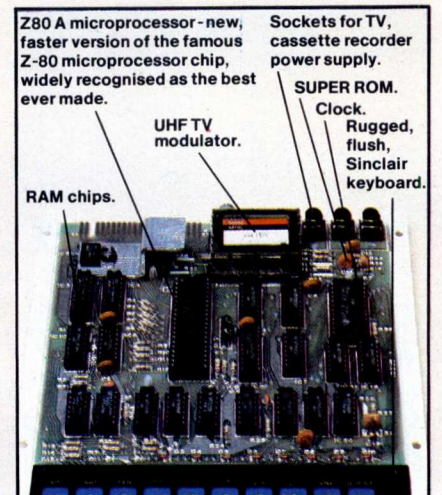

plete

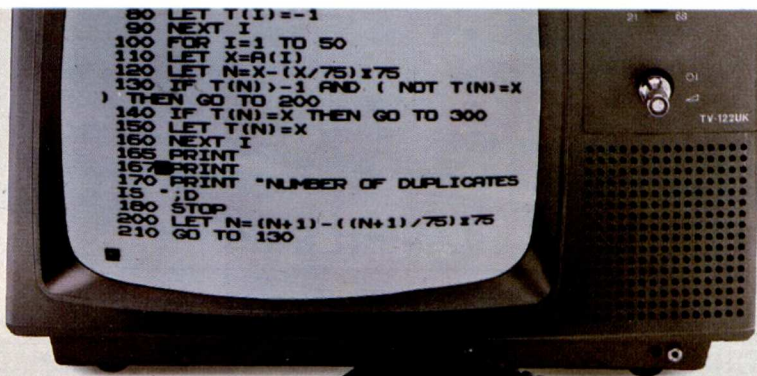

The Sinclair teach-yourself BASIC manual.

If the specifications of the Sinclair ZX80 mean little to you - don't worry. They're all explained in the specially-written 128-page book free with every kit! The book makes learning easy, exciting and enjoyable, and represents a complete course in BASIC programming - from first principles to complex programs. (Available separately - purchase price refunded if you buy a ZX80 later.) A hardware manual is also included with every kit.

The Sinclair ZX80. Kit: £79.95. Assembled: £99.95. Complete!

The ZX80 kit costs a mere £79.95. Can't wait to have a ZX80 up and running? No problem! It's also available, ready assembled, for only £99.95.

Demand for the ZX80 is very high: use the coupon to order today for the earliest possible delivery. All orders will be despatched in strict rotation. We'll acknowledge each order by return, and tell you exactly when your ZX80 will be delivered. If you choose not to wait, you can cancel your order immediately, and your money will be refunded at once. Again, of course, you may return your ZX80 as received within 14 days for a full refund. We want you to be satisfied beyond all doubt - and we have no doubt that you will be.

**sinclair
ZX80**

Science of Cambridge Ltd

6 Kings Parade, Cambridge, Cambs., CB2 1SN
Tel: 0223 311488.

ORDER FORM		To: Science of Cambridge Ltd, 6 Kings Parade, Cambridge, Cambs., CB2 1SN.	
		Remember: all prices shown include VAT, postage and packing. No hidden extras. Please send me:	
Quantity	Item	Item price £	Total £
	Sinclair ZX80 Personal Computer kit(s). Price includes ZX80 BASIC manual, excludes mains adaptor.	£79.95	
	Ready-assembled Sinclair ZX80 Personal Computer(s). Price includes ZX80 BASIC manual, excludes mains adaptor.	£99.95	
	Mains Adaptor(s) (600 mA at 9 V DC nominal unregulated).	8.95	
	Memory Expansion Board(s) (each one takes up to 3K bytes).	12.00	
	RAM Memory chips - standard 1K bytes capacity.	16.00	
	Sinclair ZX80 Manual(s) (manual free with every ZX80 kit or ready-made computer).	5.00	
NB. Your Sinclair ZX80 may qualify as a business expense.		TOTAL	£
I enclose a cheque/postal order payable to Science of Cambridge Ltd for £ _____			
Please print			
Name: Mr/Mrs/Miss _____			
Address _____			
			PCW

SUPERBRAIN from SUN

THE GROUP WITH OVER 100 YRS
CUMULATIVE HARDWARE AND
SOFTWARE EXPERIENCE IN THE
COMPUTER INDUSTRY

NOW WITH

■ TWO QUAD DENSITY FLOPPIES (788K)

OR TWO DOUBLE DENSITY FLOPPIES (320K)

■ TWIN Z80A MICROPROCESSORS

■ 64K RAM

■ CP/M OPERATING SYSTEM

RECOMMENDED PRICES £1950 (320k)
£2550 (788k)

*Remember, as major distributors of Intertec Products
we provide our dealers with:*

- EXTENDED "NO QUIBBLE" WARRANTY
- FULL SUPPORT SERVICE

*Competitive Maintenance Agreements
Repair Service
In House Software Division
Business Packages*



Dealers Enquiries Welcome

Write or phone for the name and address
of your nearest dealer:

138 Chalmers Way, North Feltham Trading Estate,
Feltham, Middlesex. Tel: 01-751 6695

SUN COMPUTING SERVICES LTD

SUPERBRAIN is a registered trade mark of Intertec Data Systems.

L.J. ELECTRONICS ANNOUNCE:-

The complete microprocessor learning system:-
'EMMA', 6502 based microcomputer, at £125.
Peripheral hardware modules, set of 8 for £375.
Micro systems power supply, at £189.
Complete with comprehensive manuals, giving step by step tuition
and many hours of applications programming exercises.

L.J. ELECTRONICS LTD.,
FRANCIS WAY,
BOWTHORPE,
NORWICH.
Tel: 0603-746340.

With the advent of office computerisation, the great God 'productivity' seems set to invade the white collar world. Malcolm Peltu reports the possible consequences . . .



The Politics of IT

"If Karl Marx were living now he would not have written *Das Kapital*, he would have written *Die Information*."

Jan Freese, Director General of the Swedish Data Inspection Board uses this quote by a Swedish MP to highlight the essentially political nature of the impact of Information Technology (IT) in his book, *International Data Flow*. In Britain, the main focus of attention in this political debate has been the Chip Shock Horror of mass unemployment predictions. However, a myriad of other issues are beginning to be unearthed.

The question of computers /micros and employment is in fact the latest chapter in the long running saga of automation and the question of working life. Charlie Chaplin's *Modern Times*, made in 1936, graphically exposed the inhumanity of automation, with the human worker becoming a cog in a production machine. In social sciences jargon, Chaplin was attacking 'Taylorism', a technique of 'scientific management' (based on the theories of Frederick W Taylor) which became popular in the 1920s and 30s.

Taylorism promoted the belief that there is an optimum method of organising working methods, which can be analysed scientifically using measurements such as those gained by time-and-motion studies. Taylorism gives little emphasis to worker participation in decision making. The idea is that management defines the 'best', ie. the most cost-effective and productive way of operating . . . that staff then carry out their pre-determined tasks and are rewarded financially.

After the second World

War, the 'Human Relations' movement began to get a grip of the working environment, stressing 'job enrichment', personal motivation and satisfaction as important goals, in addition to the pure financial/productivity work relationships fostered by Taylorism.

The de-humanising and de-skilling impact of the first wave of automation occurred in the manufacturing industries. Most of the job enrichment ideas have been applied to white collar office, professional and administration work, although there have been many experiments in manufacturing industry, particularly in Scandinavia, where production is based on worker 'cells' that give worker involvement in job design to help overcome the alienating results of Tayloristic production lines.

The shadow of Taylorism now looms over the office. New IT techniques like word processors, office information systems and computerised telephone and electronic message exchanges for the first time enable white collar productivity to be measured in the same way that manufacturing output rates can be quantified. 'Improved productivity' has become the sales catch phrase for advanced IT office systems. Whatever the impact of the electronic office on the quantity of employment, there's little doubt that it could greatly affect the quality of working life. Unless care is taken to start this process by giving weight to the human factors in the working environment there could be an unthinking and painful resurgence of Taylorism; this time however the unions are organised, forewarned and antagonistic to attempts to turn office workers into white collar cogs.

This aspect of the quality of working life was given scant attention in the early flush of waffle about the silicon ship. The unions' desire to have a say in the introduction of technology through negotiated technology agreements is now bringing IT into the forefront of industrial relations negotiations. A good starting

point for gaining an insight into the 'work-humanisation' philosophy is the book *The Quality of Working Life in Western and Eastern Europe*. Although it slips frequently into socio-technical jargon (even the Quality of Working Life is abbreviated to QWL) it provides an historical perspective to current developments and covers a wide range of related issues.

The 15 contributors to the book are active practitioners and researchers on the subject and are generally committed to an ideological belief that worker participation in decision making is a Good Thing.

Professor Geert Hofstede of the European Institute of Advanced Studies in Management Techniques puts the political perspective bluntly: "Management must be willing (or forced by circumstances) to let some control be taken away from it". He characterises employers and managers as a 'ruling elite' and the QWL enthusiasts as a 'revolutionary elite' who could trigger a third industrial revolution based on the humanisation of work. He accepts however that the revolutionary elite are frequently out of touch with the workers and are generally content with a gentle palace revolution in co-operation with management. Worker participation, he believes, will eventually breach the palace walls.

Although other contributors may not express themselves in as strong political terms as Professor Hofstede, this sentiment is generally echoed and should be taken into account when reading the book (which has a high propaganda content for particular QWL methods). There is, however, considerable discussion on how to provide objective criteria for judging the benefits of more participative approaches to work design and the sections on Eastern Europe show that the problems — and attempted solutions — are not confined to the West.

Those who fear that any discussion about worker participation in the introduction of technology is a Trojan Horse containing a band of Luddite Reds will quickly become paranoid after reading *Is a Machine*

After Your Job, a Socialist Worker Party's publication by Chris Harman; it's subtitled 'New Technology and the struggle for socialism'. This is unadulterated propaganda. It provides, however, a reasonable potted summary of the nature of IT and its potential impact and uses.

Despite its strident tone — perhaps because of it — this is an important contribution to the discussions on IT because it vividly highlights the negative 'gut' fears that lurk behind the responses from the 'responsible' trade union movement. In general, trade unions have welcomed the application of new technology but have asked for participation in its introduction and suggested that a framework be created to encourage its innovation while minimising the human costs and giving staff the benefits of improved productivity.

Harman, however, points out (in bold type) that "Workers of one sort and another have the power to impede the introduction of the new technology. The employing class cannot work it without us". Even if workers do not use this power to further the Socialist Workers Party cause, it's clear that new technology will be used as a weapon in many industrial relations battles — and Harman provides a crude insight into the fears and reactions that may predominate.

In the numbers game which predicts the levels of unemployment that may result from IT, the potential for the generation of new jobs is a strong card played by the optimists. Last year, these optimists, including the British government, jumped with delight on a report produced by the Massachusetts Institute of Technology (MIT) which said that two-thirds of new jobs in the US were created by firms employing fewer than twenty people. This seemed to boost the idea that new innovative companies could balance the predicted job losses with job gains.

Less publicity has been given to a report published by the Centre for Environmental Studies (CES) called *The Job Generation Process in Britain*. Using detailed employment data from the

Keenstar

Now the sky's the limit!



Keenstar. A great new range of exciting products that will enable you to exploit your micro to the maximum. Our reputation as one of the country's leading microcomputer consultants and supplier of leading brands is enhanced still further by this latest addition to our extensive range of micros, peripherals, software and services.

Micros such as Apple, Pet, North Star Horizon and Sharp. Fast and reliable printers from Annadex and Quom. Bespoke and packaged software. And a level of service second to none. From single applications to expandable systems. From full system design through installation, commissioning and staff training to outstanding after-sales-service.

Send off for the new Keenstar catalogue and you will see over 200 interface boards, special applications software and associated products. All designed to let you take the lid off computing. Why go elsewhere when you'll find all you need to build your microsystem under one roof. It's a roof to us, but with the advent of Keenstar there's no ceiling to your system! While you're waiting for your catalogue just browse through the tiny fraction of what is available listed below. Now that Keenstar's arrived you can really let your imagination loose.

SI00 HARDWARE

K 20001 N 450ns static RAM Board	241.13
K 20002 N 300ns static RAM Board	269.50
K 20003 N 200ns static RAM Board	275.00
K 20004 N 2200 Mainframe	295.00
K 20005 N WireWrap Board	30.00
K 20006 N Solder Tail Board	30.00
K 20007 N Extender Board	30.00
K 20008 N 8080 CPU Assembled	180.00
K 20009 N Z-80 CPU Assembled	220.00
K 20010 N Memory Mapped Video Interface	160.00

K 20011 N I/O Mapped Video Interface	180.00
K 20012 N 80 x 24 Video Interface (2MHz)	295.00
K 20013 N 80 x 24 Video Interface (4MHz)	330.00
K 20014 N 80 x 51 Upgrade (2MHz)	70.00
K 20015 N 80 x 51 Upgrade (2MHz)	70.00
K 20016 N Parallel I/O Interface	110.00
K 20017 N 2P + 2S I/O Interface	175.00
K 20018 N Music Synthesiser (4)	220.00
K 20019 N Prototyping Board	65.00
K 20023 N 2708/2716 EPROM Programmer	180.00
K 20024 N 4K1702 EPROM Board	110.00
K 20025 N 16K 2708 EPROM Board	130.00
K 20026 N Active Terminator	55.00
K 20027 N 15 Slot Motherboard	140.00
K 20028 N Extender Board	30.00

APPLE HARDWARE

K 11502 A Sony Colour TV. S/colour	349.00
K 21001 A ROM/PROM Board	65.00
K 21002 A Programmable Timer	130.00
K 21003 A BCD Analogue to Digital	120.00
K 21005 A WireWrap	20.00
K 21006 A Solder Tail Board	20.00

K 21007 A Extender	20.00
K 21008 A Etch Board	20.00
K 21009 A Asynchronous serial card	130.00
K 21010 A Synchronous serial card	130.00
K 21011 A P.I.a.	110.00
K 21012 A Arithmetic Processor	280.00
K 21013 A Lower Case Adaptor	55.00
K 21014 A Apple Serial/Parallel Interface	130.00

NORTH STAR SOFTWARE

K 02001 O Word Star	255.00
K 02002 O Wordmaster	75.00
K 02003 O Supersort I	125.00
K 02004 O Supersort II	105.00
K 02005 O Supersort III	75.00
K 02006 O Whatsit? (N. Star)	95.00
K 02007 O Whatsit? (CP/M)	125.00
K 02008 O CP/M	95.00

PET SOFTWARE

K 03001 O 6502 Assembler	20.00
K 03002 O Microchess	15.00
K 03004 O Gammon Gambler	15.00
K 03005 O Time Trek	15.00
K 03006 O Graphics Pak	15.00
K 03007 O Stimulating Simulations	15.00
K 03008 O Bridge Partner	15.00

PRINTERS

K 01030 P Anadex DP 8000	575.00
K 1083 P Qume 45 RO	2280.00

APPLE BUSINESS SOFTWARE

K 01137 B Visi Calc	95.00
K 01176 B Desktop Plan	95.00
K 01182 B CCA Data Management	95.00

K 01183 B Whatsit?	99.00
K 01186 B Easy Writer - Original	95.00
K 01885 B Easy Writer Pro	180.00

TERMINALS

K 11711 T Cifer (Wordstar terminal)	1150.00
-------------------------------------	---------

APPLE SOFTWARE

K 01136 S Apple-Pip (disc Doctor-Apple)	95.00
K 01138 S Microchess	15.00
K 01138 S Warlords (tape)	7.00
K 01139 S Bridge Challenger	15.00
K 01178 S Checker King	15.00
K 01179 S Gammon Gambler	15.00
K 01180 S Bridge Partner	15.00
K 01181 S Stimulating Simulations	10.00
K 01184 S Apple-Doc	20.00

5b the Poultry, Nottingham NG1 2HW
tel: 0602 583254
telex: 37297 (keenco)

28 Lower Addiscombe Road
Croydon CRO 6AA
tel: 01-680 4646



Keen Computers

Please rush me the new Keenstar catalogue.

Name _____

Position _____

Organisation _____

Address _____

PCW JUL.

BOOKFARE

Midlands, particularly Leicestershire, the CES researchers, Steve Fothergill and Graham Gudgin, conclude that while small firms are important job generators in the long run, it would be a 'disaster' if the MIT study was used as the basis for British policy. For a start, they found that, in manufacturing industry, the small firms contributed only 8% of new jobs in the US and showed a net growth of only about 3% between 1969 and 1976 (taking losses as well as new jobs into account). British industry follows a similar pattern. The bulk of small new firms in the UK are in the service area and, given the crucial importance to the British economy of exporting manufactured goods, Fothergill and Gudgin argue against an over-reliance on a simplistic belief in small firms. Whichever way, the figures they provide are fascinating.

Whether or not IT contributes significantly to unemployment, there's no doubt that there will be much of it (unemployment) around in the next few years. An interesting set of papers

on the 'culture of unemployment' is contained in a special issue of the *New Universities Quarterly*. The social and psychological experience of unemployment, responses to high unemployment from the educational system and the growth of the 'black economy' — or moon-lighting jobs 'on the side' — are discussed thoughtfully and with much good research.

The political consequences of IT are not limited to the workplace, or even within national boundaries. As Jan Freese points out: "Computer and telecommunications technologies have no limits. Neither political nor geographical boundaries constitute an obstacle to the flow of data. No customs official, however zealous, can stop the information which, via satellite, races at incredible speeds between countries and continents".

The Swedish government is so concerned about the political implications of international data flows and the vulnerability of computer systems to misuse that it has established a committee within the Ministry of Defence to study the

implications of allowing computer systems to fall into 'enemy' hands during some external or internal conflict. This committee concluded that it was not in the interests of Sweden that data processing operations outside the country affecting Swedish citizens, business and government should take place without Swedish control: "For certain types of data and particular applications, vulnerability risks are so high that processing abroad should not be permitted. . . . The use of computer power abroad should in principle be preceded by consultation" the committee concluded.

In his concise booklet, Freese explains why there is a growing international move towards establishing guidelines covering worldwide data flows. These guidelines are likely to include a clause which insists that information should be 'traded' with other countries only if the country in which the data is stored or processed has data protection laws. Britain, however, is one of the few Western countries without at least a draft bill on data protection. This leaves the door open for

Britain to become a haven for 'dirty data washing' — in turn posing trading threats to British companies.

IT therefore sends its tentacles out into the entrails of new political conflicts as well as burrowing down into some old sores. Perhaps it will take an electronic Charlie Chaplin to bring to life the human (or dehumanising) face of IT.

Featured in Bookfare were: The Quality of Working Life In Western and Eastern Europe edited by Cary Cooper and Enid Mumford (Associated Business Press, £15.00).

International Data Flow by Jan Freese (Input Two-Nine and Studentlitteratur, £3.35).

Is A Machine After Your Job? by Chris Harman (Socialist Workers Party, PO Box 82, London E2 8DN 40p).

New Universities Quarterly, Volume 34 No 1, Winter 1979/80 (Basil Blackwell, Oxford, £3.50).

The Job Generation Process In Britain by Steve Fothergill and Graham Gudgin (Centre for Environmental Studies, London, £2.00).

KNIGHT'S T.V. & COMPUTERS

108 Rosemount Place, Aberdeen
Tel: (0224) 630526.
Telex: 739169.

No. 1 FOR SHARP
UNBEATABLE PRICES ON THE MZ-80K
WITH 20 K USER RAM £459
WITH 24 K USER RAM £477
WITH 36K USER RAM £539
WITH 48K USER RAM £585

Dear Microfans,

We use the Sharp ourselves for amateur radio applications — sending computer generated television pictures and tracking communication satellites. We really are at home with Sharp and have been selling their high technology products for the last seven years. Due to the huge demand we have dramatically reduced the price of the MZ-80K microcomputer, the 20K user RAM model now costs only £459 and at £585 the 48K model has to be the best ever value for money.

Remember we don't charge £5 or £10 per games program — if you buy your MZ-80K from Knights we will supply you with 50 free programs. These vary from games, business, scientific, educational, to complicated programming aids. These are some of the titles: Startrek, 3D Maze, Space Invaders, Space Fighter, B52 Attack, Teach Tables, French lesson, Morse Tutor, Mortgage, Sin and Cosine graphs, disassembler, memory dumper, music, electronic organ, exploding atoms, etc. We also supply free the best RENUMBER for the Sharp — load it once and recall it at any time.

With the approval of Sharp's Microcomputer division manager, Mr. Paul Streeter, we are running the International Sharp User Group. Membership costs £3 (free if you buy your MZ-80K from Knights) and each member receives a free Space Invaders program and copies of the User Group Newsletter which details Sharp developments around the World. We already have members in the UK, Eire, Japan, Australia, America, Sweden, Germany, Belgium, and France and feel that the International Sharp User Group will play an important part in the development and use of the MZ-80K. The latest newsletter details how to copy the basic and explore the monitor program, shows how we use the MZ-80K to assist in servicing television sets, and details the new printer (£517) and disc system (£780). The newsletter also explains the use of the machine language loader and the new assembler, text editor, relocatable loader and symbolic debugger system which has just been released and costs £45.

If you are thinking of a microcomputer write, telephone, or telex us for full details. We have been giving personal service for 40 years and welcome your queries. We accept payment by cash, cheque, credit card, bill of exchange, promissory note, or will invoice to anywhere on receipt of an official order.

Happy Computing,

Graham Knight (for KNIGHTS TV AND COMPUTERS)

P.S.: If you already own a Sharp but did not buy it from us join the User Group, write for our program list, get a discount on them and on any other Sharp Radio, Television and soon CB products.

P.P.S. Add VAT to all above prices.

Interested in the PET?

IN THE LATEST ISSUE!

THE CBM JUMBO
Jim Butterfield reports exclusively for PRINTOUT on the most-awaited announcement to come from Commodore.

THE COMPANY THAT JACK BUILT
Richard Pawson did what few others have done — secured a lengthy interview with Jack Tramiel, Mr. Commodore himself.

THE HANOVER FAIR
Each year, it's the world's biggest unveiling. And PRINTOUT was there to see what Commodore was showing.

WHO DO YOU WANT TO BE?
Terry Hope ventures into the world of 16K and 32K fantasy games. Savaged and mauled, he reports on what he found there.

PETS & PIECES
The irrepressible Gavin Sanders takes his usual monthly meander round the PET scene.

PEEK & POKES
Yet another collection from Inside Trader of the things you want to know about the PET scene but never manage to find out.

PERSONAL ELECTRONIC TRANSACTIONS
Gregory Yob, acknowledged PET master, takes you round some more unexpected corners in the gentle art of PET programming.

HOT LINE
News and reports from all over, covering the things you want to know.

TOMMY'S TIPS
Tommy Turnbull, PRINTOUT technical correspondent, with an interesting and unusual way of aligning figures on-screen.

PRINTOUT is a magazine devoted solely to the PET/CBM computer. Whether you are already a PET owner, or just interested, PRINTOUT is your best source of information on the PET.

Ten times a year PRINTOUT breaks the latest news stories from the fast moving PET world. And because we specialise we cover them more fully. PRINTOUT was first to publish details and pictures of the new 8000 SuperPETs, and first to print a full evaluation. (Don't ask how we got hold of one!)

PRINTOUT's hardware and software reviews could save you a small fortune—we never pull our punches, especially about business software.

PRINTOUT also tells you about the latest peripherals—speech synthesisers, voice recognition, high resolution graphics, even colour!

PRINTOUT can help solve your programming problems too; each issue we publish pages of readers questions with answers by our resident panel of PET experts.

PRINTOUT is professionally produced, lavishly illustrated on glossy paper and packed with information. Last issue ran to 36 pages plus a special supplement on the London PET show. We are independent of Commodore.

PRINTOUT costs just 95p an issue or £9.50 for a years subscription.

PET is the trademark of Commodore

Subscriptions are for a full volume only and start with the first issue of that volume.

PRINTOUT

Greenacre, North Street, Theale, Berks RG7 5EX

I enclose: 95p for the latest issue £9.50 for one years subscription (UK only)
 £14.50 for one years subscription (o'seas) £10.50 for one years subscription (Eire)

My name is

My address is

Post code

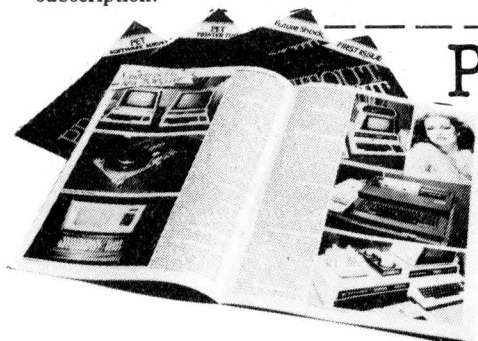

with Derrick Daines

Pressure points

"Dad, can I have five pounds?"

My father choked on his dried egg omelette and when he had recovered, bellowed, "Five pounds?" To be sure, that was more than his weekly wage, but I thought that his reaction was a bit extreme.

"Yes, dad. I'll pay you back. I want to buy a record player."

"What do you want one of those things for?"

"Well, I — er — I want to play any music I like, Dad."

"Ho, yes? Right — I'll have Bing Crosby singing La Traviata." (You've guessed by now that this was a long time ago, right?)

"I don't think he's made that one yet."

My father pounced. "Ha — there you are, then!" End of conversation, not to mention my attempt to get funding. To this day I'm not quite sure as to what point he thought he was making, but it was clear that he thought that he had won a great victory.

I mention this incident because my father's attitude towards record players is mirrored by the present-day attitude some people have towards the home computer. I've every sympathy with youngsters trying to get funding and, substituting modern references, the conversation that I had with my father must have been repeated umpteen times over requests for a home computer.

"What do you want one of those things for?" is a perennial question and, even now, in the wisdom of my years, I'm not sure how it should be answered. To say that you want a home computer to play games with is to invite derision, or acid comparisons between the cost of a computer and a ping-pong balls; to say that you'd just like it is to open the floodgates or sarcasm — "Ask for the Eiffel Tower, why don't you? I'm sure you'd just like that, too!"

Of course, you might counter by demanding why your honoured parent drinks his three pints every night, but it's not a course that I'd recommend unless you enjoy picking yourself up off the floor!

You could argue that you want your home computer to keep files and write letters — that sounds like a good modern business proposition, right? Wrong. He counters immediately that he writes letters and keeps files without the aid of a computer, thank you very much, and what's good enough for him, etc., etc.

If you make the sort of mistake that I made, you'll say something like, "Well, computers can do anything, Dad!" Then he'll jump: "Right — get it to pick the Derby winner."

The difficulty now as always is that of peering into the future. My father could not have foreseen the multi-million-pound industry spawned by the humble record player and never in his wildest imaginings could he have thought that a single successful record would earn more for its backers than he earned in a lifetime of hard work.

The potential of the computer is

incomparably greater than was the potential of the record player, but getting some people to see that is a terrible task.

So what does a youngster do if he wants his dad to buy him a home computer? Well, I'll tell you. Get hold of any issue of a newspaper or magazine that carries lots of advertisements for jobs — *Computer Weekly* is very good — and get him to compare his own wage or salary with that of programmers, systems analysts, computer salesmen and the like. Keep clear of the door — otherwise he'll trample you down in his rush to buy!

That's my tip for this month. I'd be interested, by the way, to hear of any other ploys that youngsters have used to persuade reluctant parents to cough up.

Letters

One interesting letter came from O. Garland (14) of London which I think is worth quoting in full. He writes:

"I find it both incomprehensible and annoying that the *Sunday Times Magazine* is running a competition entitled 'Young Computer Brain of the Year'. However, far from wanting someone who can use a computer with skill, they are asking for 2500 words of waffle!

"I hope I never find such an ambiguous competition on your worthy pages." (Aw, gee! We're all red in the face.)

Seriously, I think that Mr. Garland has a good point. The competition is ambiguous. The ability to write an essay — even a brilliant essay — on computing does not of itself indicate the ability to use a computer well and, therefore, would not entitle the winner to be called Young Computer Brain of the Year.

Mind you, I can also see the viewpoint of *The Sunday Times*. With pretensions to being the leader of the nation, what

else could they call the competition?

Barry Graham (16) of Chigwell, writes that if the reason the message facility is not implemented on Prestel at present is because of the threat to conventional mail, then the sooner that the PO is split, the better. He adds that he can see why the PO is behind the times. (So can we, but to get them to see that we can see is impossible!)

He makes a very good point: "I would have thought that . . . it could charge for every message left in Prestel, just as it can charge for certain information."

Precisely. See for instance the State-side computer networks.

Jonathan Dick of Bristol and Kevin Jones of Lytham St. Anne were among those who wrote offering their help as program referees. Thanks lads, we'll be in touch.

It makes a pleasant change to record a letter from Don Walton of Huntingdon. I gather that Don is a teacher in a primary school and is using a PET for lessons disguised as games. Great stuff, Don! (See my bit last month.)

Programs received

ALIEN ZAP — Colin Hughes of Luton (12)

MZ-80K SUBROUTINES — Len Tucker of Manchester (17)

EMPIRE — G.D. Owens of Chesterfield
CAT AND MOUSE — Don Walton of Huntingdon

Once again, many thanks to all of you.

Competition

Entries for our logo competition are rolling in thick and fast. I'm sure that nobody likes a competition to go on too long, so I'm drawing this one to a close on 31 July, which nicely coincides with the end of term, near enough.

PET CAT & MOUSE by Don Walton

```

100 REM*****
110 REM*****CAT AND MOUSE*****
120 REM*****D. WALTON*****
130 REM*****1980*****
140 REM*****
150 PRINT "*****CAT AND MOUSE."
160 FOR=1TO1000:NEXTT
170 PRINT "*****DO YOU WANT INSTRUCTIONS?
180 PRINT "*****TYPE 'Y' FOR YES: 'N' FOR NO.
190 GETK$:IFK$="" THEN190
200 IFK$="Y" THEN:GOSUB1000
210 GOSUB940
220 PRINT "*****SELECT SPEED OF MOUSE.
230 REM-SETTING THE BOARD
240 PRINT"J"
250 FORG=0TO39
260 POKE33248+G,67
270 POKE33368+G,67
280 POKE33488+G,67
290 POKE33608+G,67
300 NEXTG
310 FORH=0TO360STEP40
320 POKE33287+H,71
330 NEXTH
340 FORE=0TO240STEP40
350 POKE33368+E,89
360 NEXTE
370 FORK=1TO4
380 POKE33402+K,96
390 POKE33488+K,96
400 NEXTK
410 POKE33288,42
420 POKE33318,94
430 POKE33605,87
    
```

IT'S HERE! SHARP'S POCKET MICRO

This time there's no argument, the pocket computer *has* arrived; indeed it says quite clearly on the case 'Sharp Pocket Computer'. No matter that it still looks like a pocket calculator, for closer inspection reveals a QWERTY keyboard and (the real clincher) its use of Basic. Dick Pountain celebrates this oft-predicted occasion by conducting a Calculator Corner-type Bench-test.

Hardware

Your wise and (as it turned out) far sighted columnist remarked some time ago when testing the Sharp EL-5100 alphanumeric calculator that in some ways it represented a step towards the pocket computer. It appears in fact to have been a dry run for the PC-1211, for both sport the same oversize LCD display and share a generally similar layout.

The display holds 24 characters, each formed on a 7 x 5 dot matrix — which gives good legible numerals and uppercase letterforms. The only small gripe here is that the zero is distinguished from the 'O' merely by a small tail (i.e. 0) rather than the more positive Ø found on most computers. The input buffer holds 80 characters and so the display scrolls automatically to the left when its capacity of 24 is exceeded.

The keyboard is a miniature of a full QWERTY (uppercase only), including punctuation symbols, shift and cursor left/right keys; there's a separate numeric keypad of standard calculator format and the ENTER key is equivalent to RETURN or CR.

A MODE key enables you to set the machine to one of four operational modes; annunciators in the display indicate these as DEF, RUN, PRO and RESERVE.

In the RUN mode, the PC-1211 may be used for manual calculations. However these are performed courtesy of the Basic and the only major difference between making calculations on this and on a normal micro is that the PRINT command isn't required. So to perform $\text{LOG}(2 + \text{SIN } 47.5)$ you type it in just like that. Depressing ENTER causes the answer to appear at the right of the display. If you make an error in entering, you can edit with the cursor and the expression can be recalled after evaluation by pressing the + or - keys. Unlike a micro, the arithmetic is full ten digit floating point, with a range of $10^{-9} < x < 10^9$ (as on any good scientific calculator). Operation is algebraic with 15 levels of parenthesis and priority as in Basic.

You'll search the keyboard in vain for the maths functions since these have to be entered by name, via Basic. The full list is SIN, COS, TAN, ASN, ACS, ATN, LN, LOG, EXP, INT, ABS, SGN (signum), DMS, DEG, RAD and GRAD. Square root is granted its own $\sqrt{\text{key}}$, as is the power function, \uparrow .

The only major scientific calculator functions missing are hyperbolics — which can easily be programmed. You may feel that three keystrokes to execute SIN is a bore, but read on.

Any of these functions (and indeed any others you can think of, and know a formula for) may be assigned to a single key. The RESERVE mode allows 18 of the alphabetic keys to each have a function reserved to its SHIFT position. So SHIFT A could be SIN; SHIFT S could be $A * A + B * B$ etc. These reserve functions are not programs as such; they require no line numbers, must be single expressions and are stored in a separate memory which is retained when program and data memory are cleared. A keyboard overlay is provided on which to write these assignments.

The remaining DEF and PRO modes are discussed later under 'Software'.

The PC-1211 is provided with 1424 bytes of RAM plus 26 'fixed' memories (10 digit) and 48 bytes of RESERVE mode memory. All of this memory is continuous, non-volatile, protected... in other words it stays put when you switch off. Battery life is quoted as 300 hours, non-rechargeable.

The 26 'fixed' memories are assigned letters of the alphabet and may be used like ordinary calculator memories in manual mode using Basic variable notation, i.e. $A=5$ puts 5 into memory A.

The final point of hardware interest is the cassette I/O port. As on the Casio 502 this records program and data onto domestic cassettes via an optional cradle, the CE121. Unlike the Casio however this adaptor has a remote lead, so a suitable recorder may be started and stopped under program control.

So far, Sharp has made no promise about a printer for the PC-1211, but it's conceivable that the software exists to be able to run one through the I/O port at a later date.

Software

The PC-1211 runs a subset of Basic which will be familiar to PET or MZ-80K users. It does however have some unique features which are worth remarking on (I must also apologise to calculator owning readers who aren't familiar with Basic; the next bit will be pretty dull).

The 1424 bytes of user RAM are available in PRO mode to write Basic programs. After a line has been entered, the interpreter signals its acceptance of the line by putting a colon after the line number and spacing the instructions (if you didn't). Basic instructions are all stored as one byte (as with the Sinclair ZX80) and when being edited, can be deleted with a single keystroke. Moreover they may be assigned to a key in RESERVE mode and entered with a single keystroke.

Line numbers are limited to the range 0-999, each line holding a maximum of 80 characters. Multi-statement lines are permitted with a colon separator (unlike the ZX80) and usually, labels of up to seven characters are permitted in addition to line numbers (e.g. 100: "A": or 700: "HYPER"). If a single character label is placed in a program, that portion of the program may be assigned to an alphabetic key in the DEF mode, and executed by that key.

That portion of the 1424 bytes of RAM not being used for program storage may be utilised as additional memories (8 bytes per memory, 178 maximum). Just how much is available is revealed by the MEM command, which initiates a display such as 668 STEPS, 83 MEMORIES (if, for instance, 756 steps have been used up). This work space memory is unusual in that it's treated by the computer as a one-dimensional array, together with the 26 fixed memories.

A variable may be defined as X or as A(24); these two expressions address



CALCULATOR CORNER

Box 1

All timings are in seconds

	Sharp PC-1211	Casio Fx502p	MZ-80K	Sinclair ZX80	PET
BM1	224	26	1.4	1.5	1.7
BM5	710	220	25.4	12.7	21
BM8	192	88	10.2	—	12.3

the same memory since X is the 24th letter. A(79) may only be addressed as such — since it's not one of the 26 fixed memories; if program space encroaches far enough A(79) may not even exist. Indirect addressing is allowed, e.g. A(D) depends on the contents of D. Indirect addresses may be nested to 15 levels, though I can't imagine why you'd want to define A(A(A(A(A(A(A(A(X))))))))). Relative memory addressing is also provided, e.g. A(2*3+4) addresses A(10) or A(A+2x) offsets address A by the value of 2X; you can, by the way, omit the multiplication sign when handling variables.

String variables are defined in the same way, e.g. X\$ or A\$(24). They hold seven characters each, but the same memory cannot be defined as a string and a numerical variable; so with A\$, there's no A (or A(1)). No string functions are provided and neither is there any means of converting a numerical datum into a string, or vice versa. Strings may only be entered, stored and displayed, though string comparisons are possible.

Display is by PRINT or PAUSE commands; unusually, PRINT halts execution (which must be manually restarted via ENTER or CONT) so therefore PAUSE, which displays data for about one second and then continues execution, is more useful. Format control for numerical data is by PRINT (or PAUSE) USING “###.##”; the hashes specify the number of digits and position of the point.

Loop control is by standard FOR... TO... STEP... NEXT commands. Unconditional jumps are by GOTO, which can take a line number, a variable, an expression, or a label as its destination, e.g. GOTO A, GOTO (2B-7), GOTO “HELL”. This extra use compensates for the lack of ON... GOTO... Conditional jumps are performed by the IF... test (THEN is optional and functions exactly as GOTO). IF may be accompanied by a logical test, arithmetical expression, string comparison or a string variable and followed by any execution statement; the latter is skipped if the prior statement is 'false' (A string variable is 'false' if empty, an arithmetical expression if ≤ 0).

Subroutines are called by GOSUB — which has the same extended meaning as GOTO (there is no ON... GOSUB). Four levels of subroutine nesting are permitted (and the same number of FOR... NEXT loops). Boolean operators are not named, but * may mean AND and + may mean OR as in $X < 2 * Y > 5$. BEEP n produces n pathetic little squeaks from a built-in piezo generator or similar device.

Finally AREAD is a useful command which automatically READs into a variable when executing a program in DEF mode, thus replacing an INPUT

and the accompanying ? and halt of execution. This is a calculator-type feature which allows data to be entered by single, labelled keystrokes.

In general, this is a creditably comprehensive Basic for such a tiny machine and one in which you can feel comfortable very quickly. Editing facilities are identical to PET (in one dimension!) with a cursor moveable left and right and two keys for line advance and retreat. Unlike PET, both these functions go into fast step if held down for more than one second. The DEBUG command allows single step tracing, including display of intermediate results. Error messages are of six types, covering syntax, open loops, exceeding memory available, exceeding depth of nesting, tape operation error, and incompatible numerical formats; the flashing cursor points to syntax errors. Programs may be listed in toto, by groups or single lines and even indirectly, e.g. LIST (A+2). There must be a use for that!

Tape operations are straightforward, though as so often happens, loading is rather sensitive to the control positions of the recorder; a little fiddling will be necessary to get clean loads. The tape instructions are CSAVE, CLOAD, CLOAD? (i.e. verify), PRINT#, INPUT# (for data files) and all may take a seven-character file name; the PC-1211 searches for named files. Reserve functions may be CSAVE as well. The CHAIN 'file name' command loads a program segment from tape and, overwriting the program which called it, runs it immediately. Thus a long program may be split into several sections, CHAINED, and run in its entirety without manual intervention.

Summary

There's no doubt that the PC-1211 is a computer. The features that make it give way to Sinclair, Acorn and PET, etc are: a) limited, non-expandable memory, b) limited display capabilities, c) lack of string manipulation ability and d) lack of machine code access via PEEK, POKE or USR.

The big question is, has Sharp produced a mere toy computer, to amuse wealthy Basic freaks (at a rumoured price of around £125) or is there some genuine application for this machine?

Given its limitations, data and text processing are just not on, so it must be intended to serve as a flexible professional calculator, in competition with TI, Casio and Hewlett-Packard. How therefore does it compare?

Using Basic has its pros and cons. On the plus side it's more 'human' than the hieroglyphic assembler dialects of the competition. In particular, the string handling and input facilities make more comprehensive prompting available, and

with much greater ease than with the HP-41C's rather odd-ball alpha handling. This is very important in complex applications (I've lost myself many a time in programs which I wrote!). The volume of 'typing' demanded by Basic is not a real problem, given the RESERVE mode, and the QWERTY keyboard works well despite its minuscule size.

On the minus side, Basic is wasteful of program space. My experiments show that equivalent programs are 3.5 times longer on the Sharp than in Casio dialect (on average). Given this figure, it's possible roughly to compare the real capacity of the PC-1211 against its rivals. For the equivalent of 256 Casio steps, the Sharp would have 92 free memories, the Casio, 22, and the TI-59, 87 (that's slightly overfair to the TI-59 as its instructions are less fully merged than Casio's). On the other hand, with 26 free memories (the 'fixed' ones) the Sharp would have 406 'equivalent' program steps to the TI-59's 799 and Casio's 256. With the TI partitioned to its maximum 100 memories it has 159 steps left to the Sharp's 237 'equivalent' steps (829 actual).

This should have thoroughly confused you — as it has me — but it seems to show that when a lot of data memory is required, the 'naked' PC-1211 has a clear lead over the 'naked' TI-59. When a lot of program is required, the situation is reversed, but with bulk cassette storage and the CHAIN command, the sky's the limit for the Sharp. Given also the non-volatile memory, it's clear that the PC-1211 has a very high real capacity, not far short of a fully expanded HP-41C but of course lacking the printing facility.

The final minus however is not easily overcome, and that is speed. The Sharp's interpreter is painfully slow. I ran three of PCW's standard Bench Marks (BM1, BM5 and BM8) against their translated equivalents on my Casio. The results (with PET, Sinclair and Sharp's MZ-80K thrown in for comparison) are tabulated in Box 1.

Timings like these mean that certain types of recursive or iterative procedures are out of the question on the grounds of time alone, even though they seem otherwise to be practical. I didn't have time to compare the TI-59 but as reported in my earlier test, this runs between 1.5 and 5 times slower than the Casio, according to function.

Conclusion

Although the Sharp PC-1211 is a well thought out pocket computer, the prospective owner needs to think quite carefully about what exactly will be required of it. I personally would love to own one, and I feel the rumoured price of £110 plus £15 for the cassette interface makes it fairly attractive compared to the HP-41C. It comes with a quite comprehensive instruction manual that's written in worse-than-usual English and a sizeable library of program listings covering maths, finance, engineering and science

GOTO Page 123

PAST MOVES

Kevin J.O'Connell takes over a regular page in the magazine to report events and news from the world of micro chess. Kevin is President of the Western European zone of the World Chess Federation and Director of two software companies specialising in intelligent games. He's also a prolific writer of books on chess.

In this new series about developments in the field of computer chess, I shall concentrate on micros — but not to the exclusion of new ideas and important events that happen to involve a 'large micro' like an Amdahl or Cyber IC! To begin, this month I think it appropriate to take a brief run through the history of programming computers to play chess.

1937-1945 Konrad Zuse, who was probably the first ever chess programmer, started, and did not fall far short of completing, a chess program. See K. Zuse, *Der Computer — mein Lebenswerk*, verlag Moderne Industrie, 1970.

1948-1950 Claude Shannon wrote, presented and published his famous paper: *Programming a Computer for Playing Chess*. Zuse may have been first but it's Shannon's paper (and its subsequent influence) that marks him out as the father of computer chess.

1951 The first game 'played by computer'. Alan Turing wrote two programs, but did not complete them sufficiently to be able to run them on Manchester University's Ferranti Mark 1. However, two games at least have been preserved which were played by laborious hand simulation.

1956-1957 A program to play a reduced version of chess, excluding the bishops, on a 6x6 board was developed at the Los Alamos Scientific Laboratory in New Mexico. Running on the quaintly named Maniac computer, the program performed an exhaustive 4-ply search in an average of 12 minutes or so. For real chess, about three hours per move would have been required.

1958 The first program to play proper chess. This was developed at the Massachusetts Institute of Technology by Alex Bernstein and others. Running on an IBM 704, which could perform some 1 billion calculations per day, it took about eight minutes to produce a move. The program searched to a depth of 4-ply, examining only the best seven moves in any position, these moves themselves being selected by up to eight decision routines.

1959 Alan Newell, John Shaw and Herbert Simon, working at what is now Carnegie-Mellon University in Pitts-

burgh, published 'Chess Playing Programs and the Problem of Complexity'. The significance of their work was the development of the alpha-beta algorithm for tree searching. Rated as one of the greatest advances in the field of computer chess, this algorithm is now very well-known. If you need more information on it, then consult p.85 of the March 1980 issue of PCW.

1961 The first well publicised program written in the Soviet Union made its debut, a description of the work being published in one of the bulletins of the World Championship Match between Tal and Botvinnik. This year is more significant for the involvement of two World Chess Champions. Dr Mikhail Botvinnik began to write on the subject of computer chess and started work on an algorithm. Dr Max Euwe became involved in a EURATOM research project in Italy. Thus the gap between the worlds of chess and computers began to be spanned, with many benefits subsequently accruing to both sides.

1961-1962 Alan Kotok wrote, under the guidance of John McCarthy, a chess program for his bachelor's thesis at MIT. The program performed a variable depth search.

1966 Kotok's program, further developed by McCarthy, played a four game match against a program developed at the Institute of Theoretical and Experimental Physics in Moscow. An outstanding success for the Soviet program, which won two and drew two games, the event was more significant for the publicity and attention it drew to the field; it paved the way for a proliferation of computer chess tournaments.

1966 Starting at the end of the year a program was developed on a PDP-6 at the Artificial Intelligence Laboratory of MIT. The program was written primarily by Richard Greenblatt. The program, named MacHack VI, was made an honorary member of the US Chess Federation.

1968 The famous Levy bet was born at a Machine Intelligence Workshop in Edinburgh. The bet was that no program would be able to beat Levy in a match by the end of August 1978.

1970 The first chess tournament for

computer programs. This was held as part of the annual conference of the Association for Computer Machinery; it later developed into the annual US Computer Chess Championship.

1974 The first World Computer Chess Championship was held in Stockholm. It was won by KAISSA (USSR) with CHESS 4.0 (USA) in second place.

1975 The start of personal computing. Also oft-voiced idea began to take shape at MIT with the construction of a machine devoted to computer chess.

1977 The first commercial chess computer appeared on the market: Chess Challenger from Fidelity Electronics. A stone-age machine by today's standards, it was not able to play legal chess.

1977 The 2nd World Computer Chess Championship in Toronto was won by CHESS 4.6 ahead of Kaissa.

1977 CHESS 4.6 challenged Levy to a 2-game match which was played on April Fools' Day in Pittsburgh. Levy won the first game.

1977 The first game ever won by a computer program against a Grandmaster opponent — CHESS 4.6 beat Michael Stean, Britain's number 2.

1978 The final challenge under Levy's bet was made by CHESS 4.7 and a 5-game match was played in Toronto which Levy won by 3½-1½, thus concluding the bet except for one minor detail — Mr Kozdrowicki has a 'debt of honour' to pay.

1978 The first PCW micro chess tournament was held in London.

1980 Anatoly Karpov, the World Chess Champion, gives a simultaneous display against 25 chess computers in Bad Kissingen, West Germany. One of his opponents, the Chess Champion Super System III, obtained a winning position against him, although it subsequently lost.

1980 The first World Micro Chess Championship will be held in London as part of this year's PCW show. It will be followed, a couple of weeks later, by the 3rd World Computer Chess Championship in Linz, Austria.

Technical Data

CPU	8085A 2 MHz or 5 MHz with AM9511 floating point processor
Memory	32k to 1024k dynamic RAM
Keyboard] Soroc IQ 120
Screen	
Cassette	N/A
Disk Drives	2 BASF drives, 5" single sided, single density
Printer	Texas 810
Bus	100 pin
Ports	2 serial RS232 ports
System Software	MIKADOS operating system
Languages	Assembler, Comal, Pascal

number of statements in the body of the loop

(c) WHILE-ENDWHILE loop — with any number of statements in the body of the loop

3. Conditionals — similar to Pascal

(a) IF-THEN-ELSE-ENDIF where any number of statements can come after a THEN or ELSE and nesting can occur up to 44 levels deep

(b) CASE-OF-WHEN . . . WHEN . . . ENDCASE picks out one of several statements to execute depending on the control variable. If none of the statements are appropriate, then Comal allows for an alternative statement to be executed.

4. Although GOSUB-RETURN is allowed in Comal, it's only there for compatibility with Basic. Rather, subroutines can be declared with PROC-ENDPROC and called with EXEC. Procedures can have parameters which can be called by reference or value. To call a procedure by value it's necessary to pass an expression (with a constant as the first term) to the procedure. If a procedure is called EXAMPLE, to pass X by reference requires the call EXEC EXAMPLE(X) whereas to pass X as a value parameter requires a call such as EXEC EXAMPLE (0+X). Procedures can be declared anywhere within a program (including within another procedure) and never go out of scope. Functions are not supported.

5. The file system supports direct (fixed length records) and sequential (variable length records) access disk files. The status of each file can be ascertained with a STATUS instruction.

6. The CHAIN instruction allows one program to automatically load another.

7. The EDIT command allows easy in line editing using the four cursor control keys. The EDIT instruction within a program is a combination of PRINT and INPUT.

e.g.
 500 ANSWER\$="NO"
 510 REPEAT
 520 PRINT "Do you want to continue?"
 530 EDIT ANSWER\$
 540 IF ANSWER\$="YES" THEN
 550 EXEC GAME
 560 UNTIL ANSWER\$="NO"

will print out NO with the cursor positioned over the N. If the user presses <CR> ANSWER\$ retains its

value — NO. If, on the other hand, the user wants to answer YES to the question when 'Do you want to continue?' NO' comes on the screen, typing YES will overwrite the NO on the screen and give ANSWER\$ the value YES.

8. The CURSOR statement allows the cursor to be positioned anywhere on the VDU and DDE has also implemented UCSD style turtle graphics in Comal.

9. IN and OUT allow control of I/O ports in Comal.

10. CALL can be used to call assembler language routines. (Note there's no POKE or PEEK.)

Ian Brunchmann tells me that there is a standards committee meeting in Denmark to decide on 'standard Comal'. DDE Comal is already very close and any differences will be implemented to bring it into line. He also thought that textbooks would come out once the standard was set.

Comal is not a block structured language, but it does allow a user to develop well structured, easily readable programs with the same ease as unreadable Basic programs.

Other languages

Besides Comal, DDE have four other language translators. These are: an assembler, a Comal-B interpreter and two Pascal systems. Although the SPC/1 is based on the 8085 the assembler is for 8080 code. It translates Intel 8080 mnemonics into relocatable code in two passes. The assembler has a primitive macro facility — if it specifies an operation code which is neither an op code nor a directive, it searches for a file with that name and if found inserts it at the current point of assembly.

Benchtest Time in Seconds

1	4.83
2	6.20
3	14.74
4	13.86
5	14.72
6	41.14
7	58.11
8	2.56

Disk Tests Time in Seconds

1	3.39
2	73.59
3	137.66
4	29.38
5	81.01

Comal-B, which occupies 4k bytes of space above the 16k required for Comal, is also of greater precision; and it has two data types not found in Comal: INTEGER and DBLREAL (double real). Integers occupy two bytes and must be declared in an INTEGER statement. Double reals give a precision of 13 significant digits, occupy eight bytes and are declared in DBLREAL statements. Reals, the only numbers in Comal, occupy four bytes, provide a precision of six digits and aren't declared. Comal-B will support mixed type calculations but these operations carry heavy time overheads. The ASC function is used for converting extra data to numerical data. The CHR function has been expanded to take up to three arguments. The first is the value to be converted, the second the number of digits to the left of the decimal point and the third the number of digits to the right of the decimal point.

DDE Pascal is a modified version of UCSD Pascal. Programs are entered using the MIKADOS editor and compiled into P-code. If this translation is successful, the user can then use the P-code interpreter to execute the program. Although DDE use UCSD translators they have decided against using UCSD's rather cumbersome operating system. DDE Pascal is a full Pascal (although the user is given the option to create a smaller interpreter leaving out those functions not required) containing all the UCSD string functions (including UCSD string extensions), direct access files and segmentation. DDE has also added a few features of its own (reminiscent of Comal). There are intrinsic procedures for editing a string on an output device, character manipulation (I think it's strange to have both string functions and character array functions). CHAINing of programs and basic input/output operations. DDE have altered the character set to include six Danish letters. Brackets have also been changed, so instead of [] DDE Pascal uses (.). Comments can only be written between (* *).

The second Pascal system differs from the first primarily in the precision of its reals. In extended precision Pascal E, reals are held in 8 byte BCD code and numbers have 13 significant digits. Pascal E supports SQRT, EXP, LN, TAN, SIN, COS and ARCTAN not supported in the first Pascal system. READREAL and WRITEREAL are also supported for formatted I/O of reals. DDE's Pascals both support turtle graphics.

Potential

The SPC/1 has several potential markets. It's attractive enough for business but as there are no business application packages available in English, its sale as a turnkey business system is unlikely (although DDE are working on a word processor and have several business packages in Danish which will be translated

GOTO Page 121

Britain's most up-to-date and comprehensive guide to the selection of microcomputer equipment, compiled for PCW by Richard Olney of Heuristic Consultants.

Machine (Price from)	Main Distributor/s (No. of Dealers)	Hardware	Software	Miscellaneous (Documentation)
ABC 80 (£790)	CCS Microsales: 01-444 7739 (TBA)	16-40K RAM: Z80A; C: 12", 16x40 b&w VDU; 4680 bus; IEEE 488; RS232 port; option — dual 5¼" F/D (160K, own DOS), £895	DOS: BASIC:	Graphics loudspeaker with 128 effects: Viewdata compatible: (S)
ACT System 800 (£3950)	ACT: 021 455 8686 (50)	48K RAM: 6502; dual 5¼" F/D (800K): 12", 30x64 VDU: 1 S/P: 1 P/P	MDOS: BASIC: A; P/L/M: <i>Forth: Fifth: Cesi: Pilot</i>	Fully IBM compatible K/B: high resolution graphics: available with dual 8" F/D (2.4MB), £4950: (E)
Alpha Micro (£8,200)	Alpha Micro (UK) Ltd 01-250 1616 (TBA)	64K-16M RAM: 16 bit: dual 8" F/D (2.4MB): 6 S/P: modular	multi-user O/S: BASIC: M/A: Pascal: U	Expands to 1200 MB, 32 terminal system: (E)
Altos ACS 8000 (£3,398)	Logitek: 02572 66803 (TBA)	64K RAM: Z80: 1K ROM: dual 8" F/D (1MB): 2 RS232: 1 P/P	CP/M: <i>BASIC: Fortran: Cobol: Pascal: M/A</i>	(S&H)
Apple II (£695)	Microsense: 0442 41191 (190)	16-48K RAM: 6502; 8I/O slots: option — single 5¼" F/D (116K) £349	O/S: BASIC: <i>Pascal: games:</i>	280x192 high res graphics: integer BASIC in 6K ROM (S)
Athena 8285 (£7955)	Butel-Comco Ltd: 0703 39890 (TBA)	64K RAM: 8085A: dual 5¼" F/D (644K): 12", 25x80 VDU: 150 cps printer: RS232C port: options — dual 8" F/D (2MB)	AMOS: T/E: BASIC: <i>Cobol: Fortran: Pascal: APL: M/A</i>	Extended ASCII K/B with numeric pad: graphics: many fully integral configurations possible: (S)
Atom (£120)	Acorn: 0223 312772 (N/A)	2-11K RAM: 6502: Full keyboard: C int: T.V. int: 20 I/O lines: 1 P/P	BASIC in 8K ROM: A: Cass OS	High resolution graphics on bigger model: colour monitor O/P: loudspeaker (B)
Attache (£7,000)	R.H.Thorpe Ltd: 0276 29492. R.J.Spiers Ltd: 0603 416573 (TBA)	48K RAM: 8080: dual 8" F/D (616K): 9", 16x64 b&w VDU: 180 cps printer	ExBASIC: <i>Fortran</i>	(S)
Billings BC-12FD (£4,295)	Mitech: 04862 23131 (TBA)	64K RAM: Z80A: dual 5" F/D (640K): 12", 24x80 b&w VDU	DOS: BASIC: <i>Fortran: Cobol: A</i>	8" F/D (2MB) to replace 5", £6,000: additional dual 8" F/D, £2,750 (S)
Canon BX-1 (£3,850)	Canon Business Machines (UK) Ltd: 01-680 7700	64K RAM: 6800: Single 5¼" F/D (65K): 12", 25x80 VDU: 5xV24 ports: options — single 5¼" F/D (65K), £1,500	DOS: ExBASIC: A:	Also supplied with integral thermal printer instead of VDU: (S&H)
CBS Mk 2&3 (£5900;£8648)	Compelec: 01-636 1392 (N/A)	64K RAM: Z80: dual 8" F/D (1MB): 12", 24x80 VDU; 132 col, 30 cps printer: 2 S/P: 1 P/P	CP/M: BASIC	Mk. 2 with 2MB F/D, £5,900. Can upgrade to Mk.3 — £8,150 (11MB H/D and 4 more S/Ps): Desk mounted: Up to 44MB H/D possible, £4,529 extra: multi user system with 208K RAM, £10,648: (S&H)
Challenger 1P & C2 (1P, £238; C2, £404)	CTS: 0706 79332; MBM: 01-980 3993; Mutek: 0225 743289; Millbank Computing: 01-549 7262. U-Microcomputers: 0606 853390. Byte Shop: 01-518 1414	4-32K RAM: 6502: C int: RS232 port:	O/S: BASIC: A: <i>ExBASIC</i>	D/A conv: col capability: 8K microsoft BASIC in ROM: option — dual 5¼" F/D (160K), £550: for C2, dual 8" F/D (1.15MB) and 20MB H/D: runs OSI business software on 8" F/D. (S)
Challenger C3 (£2,334)	As above	32-56K RAM: 6502, 6800, Z80: dual 8" F/D (1.15MB): 2-16 S/P	OS65U: BASIC: <i>CP/M: Fortran: Cobol</i>	Also C3B & C3P H/D modules: 74MB for about £10,000: (S&H)
Comma VO3 (£4,200)	Comma: 0277 811131: (N/A)	32K RAM: LSI 11: dual 8" F/D (512K): 4 serial DLU11S ports: modular	<i>RT11 O/S (£750): BASIC: Cobol: Fortran</i>	Many configurations possible: (H)
Compucolor II (£998)	Abacus: 01-580 8841: (6)	8-32K RAM: 8080: 13", 32x64 8-colour VDU: single 5¼" F/D (51K): RS232 port	ExBASIC (ROM): A	16K module, £1,078: 34K, £1,209: maintenance and programming manual available: (I)
Compucorp 625 (£6,000)	Compucorp: 01-952 7860: (17)	60K RAM: Z80: dual 5¼" F/D (700K): 9", 16x80 b&w VDU: 40 cps printer: 1 RS232 port	A: BASIC: U	Also 655 model with 320K F/D capability and 12", 20x80 VDU — £4,345 (B)
Comp Workshop System 1 (£1,600)	Comp Workshop: 01-491 7507 (N/A)	32K RAM: dual 5¼" F/D (170K): 9", 16x64 b&w VDU: modular	A: BASIC: <i>Fortran: Flex: Pascal: Pilot</i>	This is an example configuration from a fully compatible modular range: (E)
Cromemco System 2, System Z2H, System 3 (£1,995/£4,998/£3,293)	Comart: 0480 215005; Datron: 0742 585490; Microcentre: 031 225 2022 (20)	64K RAM: Z80: dual 5¼" F/D (346K) Sys 2 and Z2H... dual 8" F/D (1.24MB) Sys. 3: S/P: P/P	CDOS: <i>BASIC: Cobol: Fortran; Multi-user BASIC: A:</i>	All systems expandable to multi-user (2-7 users), £3,455 £6,400: 11 and 22MB options: also dual 8" F/D (996K) on Sys. 2 and 3: (E)
DAI (£998 48K)	Data Applications (UK): 0285 2588 (TBA)	12-48K RAM: 8080: C int: 24x60 VDU int: RS232 port: Over 20 industrial ints: 2 C ints	BASIC (ROM): U (ROM)	Up to 255x335 resolution graphics: 3 notes and noise generator: PAL output to TV: games paddle
Diablo 3000 (£9450)	Business Computers Ltd: 01-207 3344 (TBA)	32K RAM: 8085: dual 8" F/D (1.2MB): 12", 24 x 80 b&w VDU: 45cps printer	DOS: DACL: A: U:	Selection of business packages supplied in price: (S)
Digital Microsystems DSC-2 (£3525)	Modata: 0892 41555 (10)	64K RAM: Z80: dual 8" F/D (1.14MB): 4 RS232 ports: EIA port	CP/M BASIC-E: <i>CBASIC: Cobol: Fortran: Pascal</i>	14 or 28 MB H/D available or additional F/D units: (H)
Durango F-85 (£8,250)	Comp Ancillaries: 07843 6455 (12)	64K RAM: 8085: dual 5¼" F/D (1MB): 9", 16x64 green VDU: 132 col 165 cps printer: N/P	O/S: <i>DBASIC</i>	Takes up to 5 work stations: fully integrated system: options — additional dual 5¼" F/D (1MB) and 12 MB H/D: (S)
Dynabyte DB8/1 (£1,500)	Dynabyte UK/Europe Ltd: 0723 65559 (6)	32-64K RAM: Z80: S100 bus: 2 RS232 ports: 1 P/P	CP/M: BASIC: <i>Cobol: Pascal</i>	Expands to multi-user system: option — dual 8" F/D (1MB), £2,000: also DB8/2 with dual 5¼" F/D (400K), £3,000 (E)
Equinox 200 (£7,500)	Equinox: 01-739 2387 (N/A)	64-256K RAM: Z80: 10MB H/D: 1 S/P: 1 P/P	CP/M: <i>CBASIC: cobol: Fortran:</i>	Multi-user MVT/FAMOS available in place of CP/M: (S/H)

List of Abbreviations

A Assembler	F/D Floppy disc	M/A Macro assembler	S/P Serial port
B BASIC	G/C Graphics card	N/A Not available	T/E Text editor
C Cassette	H Hardware	N/P Numeric pad	TBA To be announced
E Extensive	H/D Hard disc	O/S Operating system	U Utility
	I Introductory	P/P Parallel port	
	Int Interface	S Software	

Please note: Software items listed in *italic* are not included in the basic price of the equipment. All prices are *exclusive* of VAT.

Machine (Price from)	Main Distributor/s (No. of Dealers)	Hardware	Software	Miscellaneous (Documentation)
Euroc (£7,995)	Eurocalc Ltd: 01-405 3113 (TBA)	64K RAM; 8080A: dual 8" F/D (1MB); 15", 25x80 b&w VDU; 132 col 140cps printer	CP/M: CBASIC: A: U:	A year's maintenance and stationery supply inc: (S)
Executive Minicomputer	Binatone 01-903 5211	See Video Genie		
Exidy Sorcerer (£749)	Liveport Data Products 0736 798157 (27)	16-48K RAM: Z80: RS232: 1P/P: S100 connector: 30x64 VDU 1/O: option — dual 5 1/4" F/D (630K), £1200	O/S: ExBASIC (ROM): Editor: A: CP/M: Algol: Fortran	High resolution graphics capability: 32K version, £799: 48K, £849: User programmable character set: (I)
HP 85 (£2,240)	Hewlett Packard Ltd: 0734 784774 (16)	16-32K RAM: C.P.U.: 5" 16x32 b&w VDU: C (200K): 64 cps printer: RS232 port: 4 P/P	BASIC:	Full dot matrix graphics: N/P: compact portable unit: (S)
IMS 5000 (£1,935)	Equinox: 01-739 2387 (20)	32-64K RAM: Z80: dual 5 1/4" F/D (320K)	CP/M: CBASIC: Cobol: Fortran:	3 drives option: (S&H)
IMS 8000 (£3,515)	As above	64-256K RAM: Z80: dual 8" F/D (1MB)	CP/M: CBASIC: Cobol: Fortran: MicroCOBOL	Multi-user MVT/FAMOS available in place of CP/M: (S&H)
IMSAI VDP 42 (£3,900)	Computermarket: 0603 615089 (TBA)	32-64K RAM: 8085: dual 5 1/4" F/D (400K): 9", 24x80 b&w VDU: 1 S/P: 1 P/P	IMDOS (CP/M comp): A: ExBASIC: U: CBASIC: Cobol: Fortran	Supports 8 additional F/D drives: also available, VDP 44 with F/D (780K), £4,400: (H)
IMSAI VDP 80 (£6,200)	As above	32-64K RAM: 8085: dual 8" F/D (1.2MB): 12", 24x80 b&w VDU: 1 S/P: 1 P/P	IMDOS: A: ExBASIC: U: CBASIC: Cobol: Fortran	(H)
ITT 2020 (£867)	ITT: 0268 3040 (15)	16-48K RAM: 6502	Monitor: A: ExBASIC: Dis A:	360x192 high res graphics: Ex-BASIC in 6K ROM: options — single 5 1/4" F/D (116K), £425; 16K RAM, £110; RS232 port, £96: 32K system, £931: 48K system, £995: (B)
LSI M-One (£5995)	LSI Computers: 04862 23411	8K RAM: 8080: dual 8" F/D (1.2MB): 12", 24 x 80 b&w VDU	FMOS: A	A choice of standard business package included in price: (S)
LSI M-One Model 5 (£9900)	As above	16K RAM: 8080: dual 8" F/D (2.4MB): 2x12", 24x80 VDU's: 120cps bidirectional printer	FMOS: A	One of the VDU's is for inquiry only: (S)
LX-500 (£3,500)	Logabax Ltd: 01 965 0061 (13)	32K RAM: Z80: dual 5 1/4" F/D (180K): 12" 25x80 b&w VDU: 100cps printer	DOS: BASIC: A	Other printers available: (S)
Megamicro (£6,080)	Bytronics: 0252 726814 (5)	256K: 8080A: dual 8" F/D (1MB): 12", 20x80 b&w VDU: 120cps printer: 2 S/P: 2 P/P	CP/M: U	(H&B)
Microstar 45 Plus (£4800)	Microsense; 0442 41191 (30)	64K RAM: 8085: dual 8" F/D (1.2MB): 3 S/P: RS232 port	STARDOS: CP/M: BASIC: Cobol: Fortran	(E)
MSI 6800 (£1,203)	Strumech: 05433 4321 (5)	16K RAM: 6800: C: 9" 16x64 b&w VDU: 1 S/P	BASIC: Mini A: U	Up to 8 serial or parallel ints possible: (S&H)
MSI 6800 System 1 (£2,175)	As above	32K RAM: 6800: dual 5 1/4" F/D (160K): 9" 16x24 b&w VDU: 1 RS232 port	DOS: BASIC: U: A: Fortran	As above: option — dual 8" F/D (624K), £1,640: (S&H)
MSI 6800 System 2 (£7,500)	As above	56K RAM: 6800: single 8" F/D (312K): 10MB H/D: RS232 port: 9", 16x64 b&w VDU	DOS: BASIC: Multi-user BASIC: A	Rack mounted: options — dual 8" F/D (624K), £1,640; 10MB H/D, £4,250: (S&H)
MSI System 7 (£5,200)	As above	56K RAM: 6800: dual 5 1/4" F/D (640K): 9", 16x24 VDU: 1 P/P	DOS: BASIC: A	Choice of FDOS, SDOS or Flex: also option — 10MB H/D: (H&S)
Nanocomputer (£420)	Midwich: Waltham Cross 29310 (TBA)	4K RAM: 2K ROM: Z80: C int: 8 digit LED: K/B: RS232 port: 4 P/P	Machine language: BASIC: A: T/E:	Designed for hardware education: expandable to 64K RAM system with F/D: (E)
North Star Horizon (48K, £4,650)	Comart: 0480 215005; Comma: 0277 811131; Equinox: 01-739 2387 (20)	24-56K RAM: Z80A: dual 5 1/4" F/D (360K): 15", 24x80 b&w VDU: 150 cps printer: 2 1 P/P	DOS: BASIC: CP/M Cobol: Fortran: Pascal	(E)
Oxford Mini-computer	Binatone 01-903 5211	See Video Genie		
Panasonic JD740U; JD840U (£4550, £5500)	Teletrix: 01-262 3121 (10)	56K RAM: 8085A: 2-4K PROM: dual 5 1/4" F/D (570K) JD740U: dual 8" F/D (2MB) JD840U: 12", 24 x 80 b&g VDU: 3xRS232 ports.	CP/M: BASIC: Microcobol	Also available — JD700U with 140K disc capacity, £4175; JD800U with 1/2 MB disc, £4750 : (S)
Pascal Microengine (£2,080)	Pronto: 01-599 3041 (TBA)	64K RAM: MCP 1600: 2 RS232 ports: 2P/P: options — dual 5 1/4" F/D (1MB), £1550: dual 8" F/D (2MB), £1950	BASIC: Pascal	CPU has user written word set: : (s)
Periflex 630/48; 1024/64 (£2500; £3300)	Sintrom: 0734 85464 (5)	48K RAM, 630/48: 64K RAM; 1024/64: Z80: dual 5 1/4" F/D (630K), 630/48: dual 8" F/D (1MB), 1024/64: 2xRS232 ports: 1 P/P: Options — dual 5 1/4" F/D (630K) £859; dual 8" F/D (1MB) £1025	CP/M: BASIC: Fortran: Cobol: A	One day installation training on site included in price (S&H)
PET 8k, 16k, & 32k (£450, £550 & £695)	Commodore: 01-388 5702 (150)	8-32K RAM: 6502: C: 9", 25x40 VDU: IEEE 488 port: option - dual 5 1/4" F/D (353k), £695: same but (800k), £895	O/S: BASIC (in 8k ROM) Forth: Pilot	Disk controller for 8k model £30. Now 8032 with 80 column screen (32k) £895: (I)
Powerhouse 2 (£1,175)	Powerhouse Micros: 0422 48422 (TBA)	32-64K RAM: Z80A: 5", 27x96 b&w VDU: 1 P/P: RS232 port	FDOS: BOS: BASIC: ExBASIC: (14K EPROM), £260	Graphics card available, £190: option — dual 5 1/4" F/D (700K): (I)
Rair Black Box (£2,300)	Rair: 01-836 4663 (N/A)	32-64K RAM: 8085: dual 5 1/4" F/D (160K): 2 RS232 ports	CP/M: BASIC: Cobol: Fortran: M/A	16K RAM expansion, £250; dual 5 1/4" F/D (520K) £1,000: (H)
Research Machines 380-Z (£1,048)	Research Machines: 0865 49791 (N/A)	16-56K RAM: Z80A: C: RS232 port:	Tiny BASIC: graphics: A: ExBASIC: CBASIC: Cobol: Fortran: Algol: CP/M: U:	Designed for education: high res graphics being developed: options — dual 5 1/4" F/D (168K), £895 and dual 8" F/D (1MB), £1,695: 56K version, £1,654: (S)
SDS 100 (£4,290)	Airamco: 0294 57755 (11)	64K RAM: Z80: dual 8" F/D (1MB): 12", 24x80 VDU: S100 bus: RS232 port: N/P: 1 P/P	CP/M: A: ExBASIC: Cobol: Fortran	Facility for 8K PROM: (E)

IN STORE

DIRECT
ACCESS

Machine (Price from)	Main Distributor/s (No. of Dealers)	Hardware	Software	Miscellaneous (Documentation)
S.E.E.D. System One (£2,175)	Strumech: 05433 4321 (4)	32-56K RAM: 6800: dual 5¼" F/D (160K); 9", 16x24 b&w VDU: RS232 port	DOS; BASIC: U; Fortran: Cobol: M/A	Up to 8 I/O ports: max of 4 F/D drives: option — dual 8" F/D (624K): (E)
Semel 1 (£2,900)	Strutt Electrical: 0822 5439 (N/A)	16-64K RAM: Z80: single 8" F/D (250K); 12", 24x80 b&w VDU: RS232 port	BASIC: Cobol: Fortran	Supports up to 8 drives option — single 8" F/D (250K), £500: (I)
Sharp MZ-80K (£480)	Sharp Electronics (UK) Ltd: 061-205 2333 (50)	6-34K RAM: Z80: C: 10", 24x40 b&w VDU: option — dual 5¼" F/D (280K), £780	BASIC (in 14K ROM) A	Graphics: loudspeaker: 18K RAM version £529; 22K £549; 34K £599: (B)
Sinclair ZX80 (£100)	Science of Cambridge: 0223 311488 (N/A)	1-16K RAM: 780-1: C int: T.V. int: full K/B: 44 pin expansion port	4K BASIC in ROM	CPU is NEC 3.25 MHz version of Z80A: available as kit, £80: mains adaptor £9: (S)
Sirocco (£3,900)	Elvingate Computers: 069 245189 (TBA)	64K RAM: Z80: dual 5¼" F/D (940K); 12", 24x80 VDU: RS232 port	CP/M: CBASIC: Cobol: MBASIC: Fortran	Direct memory addressing: memory mapped VDU: free standing keyboard: option — 10MB H/D: (S&H)
Smoke Signal Chieftain 1 (£3,050)	Windrush Micro Designs 069 245189 (TBA)	32-64K RAM: 6800: dual 5¼" F/D (160K); 12", 24x80 VDU: 112 cps printer: RS232C port	DOS: BASIC: DBASIC: RBASIC: A: Fortran: U	Also Chieftain 3 with dual 8" F/D (1MB), £3,950 (E)
Solitaire WP & BS200 (£6,750 & £7,950)	Solitaire KPG: 01-995 3573 (TBA)	64K RAM: 8085: 14" VDU (with own CPU): 45 cps printer: CPU port: dual 5¼" F/D (700K) with "WP", and dual 8" F/D (960K) with "BS200"	DOS: BASIC (optional on the "WP")	All Solitaire systems are compatible: graphics on 11x13 dot matrix: (S)
Solitaire/HBS100 (£9,500)	As above	64K RAM: 8085: 10MB H/D: 14" VDU (with own CPU): 200 cps printer: CPU port	DOS: BASIC	Up to 8 interface terminals can be used: also HBS200 with 20-80 MB of H/D: HBS100 limit is 40MB: (S)
Sord M100 ACE (£2,650)	Midas Computer Services Ltd: 0903 814523	48K RAM: Z80: single 5¼" F/D (143K): 12", 24x64 col VDU RS232 port	O/S: BASIC	With colour graphics: 8K ROM: option — single 5¼" F/D, £300: (I)
Sord M223 (£3,500)	As above	64K RAM: Z80: single 5¼" F/D (350K): 12", 24x80 b&w VDU: S100 bus: RS232 port	O/S: BASIC	Other configs possible: extra F/D, £450: (I)
SPC/1 (£3,755)	Digital Data: 01-727 6668 (TBA)	64-1024K RAM: 8085A-2: dual 5¼" F/D (180K): 24x80 b&blue VDU: 2xRS232 ports: options — single 8" F/D (1MB) £1090; 20 MB H/D £7650.	Mikados: COMOL: Pascal: A	Large choice of extras and peripherals, with 32K RAM and single F/D (no Pascal) £1995: (S)
Superbrain (£1,995)	Icarus: 0632 29593 (TBA)	64K RAM: 2xZ80: dual 5¼" F/D (320K): 12", 25x80 b&w VDU: S100 bus: RS232: TRS80 port	CP/M: A: BASIC: Cobol: Fortran: APL Pascal	Limited graphics: mainframe int available: options — dual 5¼" F/D (320K): dual 8" F/D (2.4MB): 8-120 MB H/D: (S&H)
System 80 (£1,505)	Nascom: 02405 75155 (20)	16-48K RAM: Z80A: single 5¼" F/D (280K) 80 cps printer: TV: int: RS232 port: option — single 5¼" F/D (280K) £240	CP/M: 8K BASIC	Choice of EPROM firmware (extra): colour graphics £140 (kit): (S&H)
Tandberg EC10 (£5,000)	Tandberg: 0532 35111: (N/A)	50K RAM: 8080A: single 8" F/D (250K): 12", 25x80 b&w VDU: RS232 port	ExBASIC (24K): Multi-user BASIC: A: U: Cobol	(S&H)
Tandy TRS 80 Level 1 (£380)	Tandy: 021 556 6101 (200)	4-16K RAM: Z80: C: 12", 16x64 b&w VDU	BASIC: A:	BASIC in 4K ROM: upgradable to level 2: (I)
Tandy TRS 80 Level II (£515)	As above	4-48K RAM: Z80: C: 12", 16x64 b&w VDU: RS232 int: 1 P/P	BASIC: M/A: Fortran	16K machine includes N/P: 4-16K upgrade, £120 (£85 without pad): max config, £1,005: option — single 5¼" F/D (78K), £478 (max of 4): (I)
Tandy TRS80 Model 2 (£2290)	As above	32-64K RAM: Z80A single 8" F/D (500K) 12", 24x80 VDU: 2S/P 1P/P	DOS: BASIC	Keyboard has numeric pad: 64K version, £2250: (S)
TECS (£1,600)	Technologies: 051 724 2695 (TBA)	16-56K RAM: 6800: 8K PROM: RS232 port: C int	BASIC: T.DOS: Prestel: Monitor:	256 ch graphics: Prestel compatible: plugs into standard TV: option — dual 5¼" F/D (320K), £800: (S&H)
TEI 208 (£3,841)	Abacus: 01-580 8811 (5)	32-60K RAM: 8080/8085: dual 5¼" F/D (320K): 9", 24x80 green VDU: 3 S/P: 3 P/P	CP/M: BASIC: Cobol: Fortran: Pascal: Algol	(S&H)
TEI 212 (£4,886)	As above	32-60K RAM: 8080/8085: dual 8" F/D (1MB): 15", 24x80 green VDU: 3 S/P: 3 P/P	CP/M: BASIC: Cobol: Fortran: Pascal: Algol	(S&H)
Terodec DPS 64/1-4 (£3,014)	Terodec (Micro-systems) Ltd: 0344 51160: (TBA)	64K RAM: Z80: dual 8" F/D (1MB): 12", 24x80 b&w VDU: 2 S/P: 3 P/P	CP/M: BASIC: Cobol: CBASIC: Fortran: Algol: Pascal	TMZ 80, enhanced model in integral work station, £5,495 (with 4MB F/D): DPS 64 with 2MB F/D is £3,319: options — dual 8" F/D (1MB), £1,150: dual 8" F/D (2MB), £1,455: (S&H)
TI99/4 (£750)	TI: 0234 67466 (TBA)	16K RAM: 26K ROM: 9900: 24x32 b&w VDU: 2 C int: RS232 port	OS: BASIC	Various peripherals available soon; can run 16 colour TV screen: (S)
Triton L8.2 (£611)	Transam: 01-402 8137 (N/A)	32K RAM: 8080: C int 16x64 VDU int: 1 S/P: 1 P/P	OS: A: Pascal: M/C: BASIC: CP/M	Graphics: 5¼" or 8" F/D are available: (S&H)
Vector Graphics MZ (£2,595)	Almarc: 0602 625035: Sintrom Microshop: 0734 85464: Metrotech 0895 57780: (5)	56K RAM: Z80: dual 5¼" F/D (630K): 3 S/P: 2 P/P	DOS: BASIC: A: CP/M2: Algol: CBASIC: Cobol: Fortran: Pascal	Includes PROM burner: also System B with graphics and N/P, £3,195: (E)
Video Genie EG 3003 (£378)	Lowe Electronics: 0629 2817: Binatone: 01-903 5211 (N/A)	16K RAM: Z80: 500 bps C: 32x64 TV int: extra C int: 1 P/P	BASIC: M/A: Fortran	BASIC in 12K ROM: graphics available: F/D under development: Binatone call their 16K model "Executive Minicomputer" and a 4K version, "Oxford Minicomputer" — prices TBA: (I)

List of Abbreviations

A Assembler	F/D Floppy disc	M/A Macro assembler
B BASIC	G/C Graphics card	N/A Not available
C Cassette	H Hardware	N/P Numeric pad
E Extensive	H/D Hard disc	O/S Operating system
	I Introductory	P/P Parallel port
	Int Interface	S Software
		S/P Serial port
		T/E Text editor
		TBA To be announced
		U Utility

Please note: Software items listed in *italics* are not included in the basic price of the equipment. All prices are *exclusive* of VAT.

IN STORE

DIRECT ACCESS

Machine (Price from)	Main Distributor/s (No. of Dealers)	Hardware	Software/Firmware	Miscellaneous (Documentation)
Zenith WH-11A (£4,359)	Heath Ltd 0452 29451 and 01-636 7349 (N/A)	LSI 11: 16-32K RAM: 25x80 VDU: S/P: P/P	O/S: <i>BASIC: Fortran</i> : A: U:	PDP 11 compatible: option — dual 8" F/D (512K): (S&H)
Zenith Z89 (£1,490)	As above	16-48K RAM: Z80: single 5¼" F/D (102K): 12", 25x80 b&g VDU: RS232	<i>BASIC: A: H.DOS: CP/M: MBASIC: CBASIC: Fortran</i>	3 drives option: (I)
Zentec (£5,700)	Zigal Dynamics Ltd: 02405 75681 (1)	32-64K RAM: 2x8080: dual 5¼" F/D (512K): 15", 25x80 b&w VDU: RS232 port	O/S: A: U: <i>BASIC: Micro Cobol</i>	User programmable character set: option — dual 8" F/D (1MB): (S)
Zilog MCZ 1/05 (portable): MCZ 1/20A (£4200, £4800)	Micropower: 0256 54121: Memec: 084421 5471 (N/A)	64K RAM: Z80: dual 8" F/D (600K): RS232 port: MCZ 1/20 A only... 1P/P: option—10MB H/D, £7100	RIO: O/S: <i>Cobol: BASIC: Fortran: Pascal</i> 1/05... M/A: U 1/20A... PLZ: U	Available desk top or rack mounted: Debug in 3K PROM: 1/20A runs multi-user Cobol and has up to 5 terminals and 40MB possible: (S&H)
Z Plus (£4,000)	Rostronics: 01-874 3665 (TBA)	32-64K RAM: Z80: dual 8" F/D (1MB): 2 S/P: 2 P/P	CP/M: A: U: <i>BASIC: Cobol: Fortran: Pascal</i>	(S&H)

SINGLE BOARDS

Machine (Price from)	Main Distributor/s (No. of Dealers)	Hardware	Software/Firmware	Miscellaneous (Documentation)
Acorn (£65)	Acorn: 0223 312772 (N/A)	1.1/8K RAM: 6502: EPROM socket: Hex K/B: C int: 8 digit LED display: up to 16 ports: options — Eurocard 64 way connector: VDU card: Full K/B card	¼K monitor: <i>BASIC</i>	Kit: programmable address linking: on board 5V regulator: available assembled, £79 (S&H)
Aim 65C (£265)	Pelco: 0273 722155 (4)	1-4K RAM: 6502: 12K ROM: full K/B: 20 char LED display: 20 char thermal printer: Cx2: RS232 port.	A: Dis A: T/E: 8K monitor in ROM	Available as S100 system with A or BASIC in ROM (£480) from Portable Micros (0280 702017): they also have briefcase version (£750) (E)
Comemco SC (£260)	Comart: 0480 215005 (17)	1K RAM: Z80A: 8K EPROM sockets: RS232 port: 3 P/P: option — S100 bus.	<i>Monitor and control BASIC in EPROM</i>	5 program interval timers: can put own BASIC programs in EPROM (E)
ELF II (£114)	Newtronics: 01-348 3325	1/4K RAM: RCA 1802: Hex K/B: 2 digit LED: TV int: C int: RS232 port: options — 4K RAM, £69; full K/B: VDU card	1K monitor: A: Dis A: T/E: <i>BASIC: 244</i>	TTY, n-line decoders: low resolution graphics (high resolution available) kit (H)
Explorer (£295)	Newtronics: 01-739 1582 (15)	4K RAM: 8085: Hex K/B: RS232 port: S100 bus: C int: options — 6 slot S100 £32; 8K EPROM sockets £50.	2K monitor: <i>CP/M: BASIC</i>	Programmable 14 bit counter: kit (S&H)
H8 (£262)	Heath: 0452 29451 (TBA)	4K RAM: 8080A: Octal K/B: 6 digit LED: speaker: options — single 5¼" F/D (102K), £399; 16K RAM, £314; C int, £72	1K monitor: <i>BASIC in RAM: FORTRAN: T/E: A: U:</i>	Kit (S&H)
Hewart 6800S (£299)	Hewart: 0625 22030 (N/A)	16K RAM: 6800: full K/B: VDU int: 2xC int: 1 S/P: 2 P/P: option — 16K RAM, £90	1K monitor: A: T/E	Can be upgraded with 6809 (H)
Hewart 6800 MkIII (£152)	As above	1K RAM: 6800: VDU board: options — single 5¼" F/D (75K), £350; PROM programmer, £32; calculator board, £32	1K monitor	(H)
Mk 14 (£39.95)	Science of Cambridge: 0223 311488 (N/A)	8060: 1/4-2K RAM: Hex K/B: 7 char LED: options — VDU int (32x16 with graphics), £29; C int, £6; PROM prog, £10, 2K memory expansion, £15	Machine code	Designed for control applications rather than high level computing expansion (H)
Microtan 65 (£69)	Tangerine: 0353 3633	1K RAM: 6502: 16x32 T.V. int: options — TANEX board, 7K RAM, 6K ROM, 8K BASIC; 3S/P	1K TANBUG monitor: <i>BASIC</i>	Optional 64x64 pixel graphics:(E)
Nascom 1 (£165)	Nascom: 02405 75155 (20)	4K RAM: Z80: full K/B: TV int: 2 P/P: 1 S/P	2K monitor: <i>BBASIC: tiny BASIC: A: T/E: U</i>	Now available as Nascom 2 with 8K RAM and 8K microsoft BASIC in ROM, £295 : (S&H)
77/68 (£90)	Newbear: 0635 30505 (N/A)	4K RAM: 6800: LED: C int: VDU int.	1K Monitor: <i>BASIC:</i>	Expandable to racked Nascom compatible system: (E)
SBC 100 (£135)	Airanco: 0294 57755 (11)	1K RAM: Z80: 8K ROM: S100 1 S/P: 1 P/P: option — voltage regulator	<i>1K monitor: DOS in ROM</i>	Kit: available assembled, £196 (E)
Superboard (£188)	MBM: 01-981 3993 (N/A)	4-8K RAM: 6502: 10K ROM: full K/B: VDU int: C int: options — RS232: single 5¼" F/D (100K), £316; 8K RAM, £188	<i>BASIC in 8K ROM:</i>	Available with 32K RAM and single 5¼" F/D, £867 (S&H)
SYM-1 (£160)	Newbear: 0635 30505 (N/A)	1-4K RAM: 6502: bps C int: VDU int: 2x6522 ports: option — TV int.	4K monitor: <i>BASIC: A</i>	Can be expanded to 64K RAM (S&H)
Triton 4.1 (£286)	Transam: 01-402 8137 (N/A)	2K RAM: 8080: 3K ROM: full K/B: 16x64 VDU or TV int: C 1 S/P: option — 2K RAM, £30	1K monitor: 2K <i>BASIC: U</i>	64 character graphics: 8 levels interrupt: kit (S&H)
Triton 5.1 (£294)	As above	2K RAM: 1K VDU RAM: 8080: C int: T.V. int	1¼K monitor: 2¼K <i>BASIC: A: Dis A: 8K BASIC: Pascal</i>	Graphics facility: disc interface running CP/M, about £200: (S&H)
Triton L5.2 (£296)	As above	¼K RAM: 8080: C int: 16x64 VDU int: keyboard: 1S/P: 1P/P	1.5K monitor: 2.5K <i>BASIC</i>	Graphics: kit form: easily expandable
Tuscan (£170)	As above	8K RAM: 8K ROM: Z80: 6xS100 slots: RS232 int: T.V. int: C int	8K monitor: or 8K <i>BASIC</i>	DD disc controller, £195: graphics: (S&H)
UK 101 (£219)	Computer Shop: 01-440 7033	4K RAM: 6502: full K/B: 16x48 VDU or TV int: C int: RS232 port: option — 4K RAM, £49	1K monitor: 8K <i>BASIC: Dis A: U</i>	Graphics: will run Superboard software (S&H)

List of Abbreviations

A Assembler	F/D Floppy disc	M/A Macro assembler	S/P Serial port
B BASIC	G/C Graphics card	N/A Not available	T/E Text editor
C Cassette	H Hardware	N/P Numeric pad	TBA To be announced
E Extensive	H/D Hard disc	O/S Operating system	U Utility
	I Introductory	P/P Parallel port	
	Int Interface	S Software	

Please note: Software items listed in *italics* are not included in the basic price of the equipment. All prices are *exclusive* of VAT.

The classified service that's FREE to readers (but not companies, please). Advertisements 50 words maximum to: PCW Transaction File, 14 Rathbone Place, London W1P 1DE.

For sale

UK101. . . 6k, full working with programs (inc Ass/Ed), offers around £250, buyer collects. A. M. Saunders, SPH, Essex University, Colchester, Essex

6809. . . single board S100 processor with 1k RAM, 1k ROM with space for 10k, 2400 baud cassette interface, I/O, keyboard inport, RS232 level shifters, with full documentation, £130. Ring Aaron James, 01-959 4851.

Acorn. . . Basic comp. assemb, tested with VDU kit and mains adaptor. New job — no time for hobby. Save almost £18 on list, £180. Collect London (City) or Purley, J Hanzal, 01-600 6222 ext 254 or 01-660 6132

T159/PC100C. . . complete with statistics module, documentation, carrying case/dust cover, manual for creating TI programmer emulator, blank magnetic cards, diagnostics and printer paper. Bargain at £250. Ring Tim, 01-504 1127 (evenings).

PET. . . 16k, 1 year old, large keyboard, very good condition. Mr. Williams on 01-226 4856

PET 2001. . . 8k hardly used, with software and manuals. £400 or offer. Ring 01-567 6401.

Exidy Sorcerer. . . 16k, video monitor, Cognivox voice synthesiser/speech recogniser/music & sound effects producer. Full manuals & £50 worth of software on cassette (mainly games), £800. Very good condition. D Mok, 33 St Cross Rd, Winchester, Hants SO23 9JA.

TRS 80 Level II. . . 16k. Complete system with manuals and variety of programs (system copy, Level III, Air Raid, etc), £470 ono. Ring 021-360 8395 after 6pm.

For sale. . . 8k PET, 24k Expander, PR40 printer, Computhink disk drive, external keyboard, extensive software, £1400. Ring 01-948 2847 or 01-894 7149

Nascom 1. . . 16k, Veroframe, case, Super Tiny Basic, literature, £145 plus p&p. Bias PSU, 5 V, 10 A, 12 V, -5 V, -12 V, sense line, £60 plus p&p. Ring Kings Lynn 572825, evenings.

Hazeltine H2000 VDU. . . 27x24 display, RS232 I/O, ports for printer and cassette drive, in excellent condition, £300. Ring 01-888 7841.

OSI SUPERBOARD II. . . 8k with case, UHF modulator, software & PSU. Offers around £230 or p/x Casio 502P. Phone Kim on 01-290 0201, daytime.

Powertran. . . Comp 80 scientific computer fully built and tested with 4k RAM and UHF modulator. £200. Ring Mike Gill on 0484-44176, evenings.

Nascom 1. . . T2 monitor, 5 amp PSU, buffer board, 8k RAM, all mounted in smart case with high speed cassette interface, 4-slot motherboard, games tapes & all documentation. £230 — may consider split. Ring Bob on Kettering (0536) 3154.

Compukit 6k. . . 5 months old, fully working with games tape, £250. Ring 021-783 4270.

Nascom 1. . . large capacity power supply, CUTS interface, professionally built, B-bug, digital cassette recorder, nicely cased, all documentation, £190. Ring Uxbridge 36755 evenings or letter to Room S10, Clifton Hall, Brunel University, Kingston Lane, Uxbridge (ask for Mr Panha).

PET 2001. . . 8k plus various programs, excellent condition, £425. Ring 0977-85697 (day) or 84731 (evening).

Compukit 101. . . 4k, built and tested, extended monitor, £200 or offers for quick sale. Alan Morris, 73 Christchurch Drive, Camberley, Surrey, Camberley 31166.

Ohio C2. . . CPU board with 8k Basic, 4k RAM, RS232/20 mA, 44 way bus, case & PSU, £130. Olivetti TE318 working with above, £130, KIM 1 with PSU and KB, £85, 12" green monitor in VDU case £50, ASCII keyboard in case, £20. 1/2" tapes — offers. Ring 0274 47235.

Nascom 2. . . 16k RAM board, PSU, graphics ROM, manual, £43 £430. Also IBM Selectric typewriter with solenoids and articles on conversion, £230. Owner moving. S. Noyes, 6 Osborne Road, Clifton, Bristol BS8 2HA.

Compukit UK101. . . 8k Micro-soft Basic with manual & large selection of games on tape, built but uncased, only six months old, cables and all plugs plus 19 C15 blank tapes, £270. Ring 0274 27635 after 6pm or write to 29 Wingfield Mount, Bradford, W. Yorks.

Sixteen 4027-N4. . . memories totalling 8k, suitable for Nascom and other micros, £25 for all sixteen or £14 for eight (4k). Ring 0702-218662.

Microprocessor. . . Crofton/Motorola 6800 family, Ohio Superboard, keyboard, power supply, VDU etc, kit, barely used, not set up, books, carton of electronics and computer magazines, £200 or nearest offer. Ring 01-741 2857 evenings/weekends, ask for June.

Texas T159. . . programmable calculator, magnetic cards, adaptor, manuals, boxes, all as new, £120. Colin Payne, John Cheyney House, Windsor Road, Slough.

PET 2001. . . 8k with many books and tapes, fully serviced and complete with latest ROMs. Will negotiate at around £420. Ring John, Hastings 752736 (evenings if poss).

Megabytes of storage. . . professional computer 1/2" tape decks, Ampex TM7, superb pieces of engineering. Precision Instrument Co PI-1207 and PI-1217, all with manuals and believed in good working order. Haggle around £110 each or would swap for S100 cards or what have you? 01-778 3600, evenings.

Nascom 1. . . 3 A PSU, Nas-Sys monitor, all in black case, one month old, bought in error, cost £220, first offer over £175 secures. Ring Reading (0734) 473542.

PET Invaders. . . machine code program with sound — explosions — only £5. I. Mercer, 25 Loweswater Drive, Loughborough. LE11 3RR.

SWTP update. . . forces sale of 16k RAM board. Full working order, 250 ns chips, runs on 1 MHz 6800 and new 6809, also suit MSI SS50, £125 ono. Ring 0223-842735, evenings.

ITT 2020. . . (Apple), 16k, Palsoft in ROM, colour UHF output, excellent condition, seven months old, includes tapes and Microchess, nearest offer to £600. Ring 051-334 2405 evening or weekends.

Ex-equipment. . . aluminium backplane, already socketted, sold by Maplin for £80, could be converted to four or five motherboards, £40 ono. Ring 061-761 4566 evenings.

PET 2001. . . 8k with games, software, Forth, TIS workbooks, £400 ono or exch TRS 80. Ring Ware (0920) 67519 evenings.

Viscount M70 organ. . . 2 manuals plus special effects — piano, rhythm units, etc — with stool, headphones & sheet music, value £750. Will exch for PET, Tandy, Apple, cash either way. Ring 01-455 1652.

Mk 14. . . with new monitor, cassette interface and high quality (not S of C) keyboard, £40. Ring J. Bowden, 041-339 0319 (Glasgow).

Superboard II. . . PSU, modulator, 7k RAM, case, cassette, tapes, software, works perfectly, £220. Ring Leeds 755273 after 6pm.

Nascom. . . 8k Basic ROM, runs merrily at 4 MHz, full documentation, £30. Would like to hear from other Nascom 2 users, Ring Melton Mowbray (0664) 67854, ask for Mark.

PET 2001. . . 8k, 10 months old, only used at home, complete with software, cassette case, cover, magazines, books, £430. Ring Dave Mulcahy on 0582-416444 day or 0582-65300 evenings (Luton).

Wanted

PET system required. . . if you have a PET to sell please contact Denis Costigan, 24 Boulton Road, Cheltenham, Glos GL50 4RZ, or ring 0242-32455

Vol 1. . . issues 4 and 5 of PCW wanted to complete a set. A. J. Travis, 1 Perth Street, Lancaster LA1 3DR.

TRS 80 Level II. . . wanted to borrow/hire, minimum 16k. First time potential buyer would like to try one for a week or so, willing to pay reasonable rental. London, near Holland Park. Ring Fred on 01-405 6347 (business hours).

DIARY DATA

London, England	Intel Microcomputer Fair. Intel Corporation UK Ltd., Duncan House, Eldene Drive, Swindon SN3 3TU. Tel: 0793 26101	June 24
Newcastle Upon Tyne, England.	BIZTRONIC — Mini/Micro Computers, Word Processors and Business Machines Exhibition Company., 7 Market Street, Altrincham, Cheshire WA14 1QW. Tel: 061-928 0406.	July 3rd — July 4th
Manchester, England	MICROFAX — Exhibition and Conference on Micro Technology. Bancroft Hewitt Ltd., 3rd Floor, 121 Princess Street, Manchester M1 7AG. Tel: 061-236 4612.	July 15th — July 16th
London, England	1980 Microcomputer Show. Online Conferences Ltd., Cleveland Road, Uxbridge, UB8 2DD. Tel: 0895 39262	July 22 — July 24
Birmingham, England	Computer Graphics '81 Exhibition. Online Conferences Ltd., Cleveland Road, Uxbridge. UB8 2DD. Tel: 0895 39262	Aug 11 — Aug 13
Philadelphia, USA	Personal Computing 80. (America's largest East Coast micro show). PCAF '80 c/o Philadelphia area Computer Society, Box 1954, Philadelphia, Pa 19105	Aug 21 — Aug 24
Salford, Lancashire	1980 Salford Microprocessor and Microcomputer Exhibition. Dr E A Flinn (Exhibition Director), Dept. of Electrical Engineering, University of Salford, Salford M5 4ET. Tel: 016-736 5843	Sept 2 — Sept 4
London, England	The 3rd Personal Computer World Show. Montbuild Exhibitions Ltd., 11 Manchester Square., London W1M 5AB. Tel: 01-486 1951	Sept 4th — Sept 6th
London, England	Electronic Displays '80. Network, Printers Mews, Market Hill, Buckingham, Mk18 1JX. Tel: (028 02) 5226/5227	Sept 9 — Sept 11

ANIMISTICS

Continued from Page 59

perhaps also have occasional moods of obstinacy or naughtiness. It should be predictable but *not too* predictable, vary through the day and accommodate to some extent to the mood of the user. It should be a willing chess opponent when required and also occasionally suggest a game, and take both wins and defeats 'in character'.

The initial contact between user and machine may well be stilted but this will change as intimacy develops. First encounters are always very important and skilful programming would be required to ensure smoothness. There are, of course, already a number of programs which are designed to overcome even an initial hostility of a user. They spot hostile statements and swear words and 'give as good as they get', attempting to win over the aggressive and unsympathetic person interacting with them. These attempts to enable the machine to 'make friends and influence people' display a good deal of the psychological insight and subtlety which may well become typical of this new area of 'soft' software.

As interaction with the user progresses, the machine should adapt and settle and become more 'at home' and more 'in tune', changing from the initial hesitancy which characterises a first meeting with a stranger to the relaxed mode which is more typical of an established friend. It should build up a representation of the user's personal world, remembering his likes and dislikes, stor-

ing some information from past interactions and recalling aspects of their previous life together. The user will thus become more predictable to the machine while at the same time the machine becomes more predictable to the user.

The practical uses of companion machines are, of course, numerous. They will act as entertainers, comforters, memory-aids, calculators, teachers, guard-dogs and telephone-answering machines. They will read aloud texts from newspapers and books, play games, make suggestions for meals and call a doctor when the user is ill. They will add interest to life, provide an opportunity for care and nurturance and be an ever-present tonic against boredom and loneliness.

Initial doubts about the viability of real 'personal contact' between human and machine may be dispelled when we see the pleasure and apparent intimacy which people show with their pets, and attribution of personality and motive on the basis of the often limited and non-interactive behaviour of these animals. The evidence suggests that, despite the 'machine barrier', within hours, or perhaps even minutes, of suitable man-machine interaction many of the initial inhibitions are readily overcome. The uniqueness of the 'experienced' machine which has been living with its user, the subtle reactivity and personality which can be displayed, and the blend of predictability and unpredictability which will characterise these companion systems seems to offer every chance that they will more than adequately provide for many of the functions which pets, human acquaintances and maybe even

intimates currently fulfil.

We may regret that anybody could have use for such a 'person substitute' yet it's undeniable that many people (and for some functions maybe *most* people) do have spaces in their lives which a suitable machine could help to fill. How the realisation of this current and near-future potential will affect the social order can hardly be imagined, but the effects will certainly be profound. We know a great deal about human needs, we know that many social needs are not being fulfilled by many people, we know many ways in which they can be satisfied and it seems probable that some at least can be satisfied by silicon. Although many people are bound to find the idea repugnant and an insult to the nature of man, the forces of the market place will ensure that the necessary links are made between existing modules and existing skills to soon produce the companion machine. The implications are devastating, we should be talking about it, we had better be prepared.

PCW anticipates that as controversial an article as this one by Neil Frude is bound to provoke considerable reaction from readers. Should this be the case there may well be the opportunity to produce a 'follow-up' article, based on that response. Of particular interest will be:

- (1) Contributions of short programs in the Animistics field (and maybe a prize for 'the best').
- (2) Anecdotes relating to personal experiences — especially with children.
- (3) Ideas on 'machine softening'
- (4) Comments on the social implications of what has been suggested.

Motorola's Sweet Sixteen Continued from Page 99

in no extra difficulties in system design. More and more of the complications of circuit design seem to be disappearing into fewer LSI and VLSI chips.

Motorola has made it clear that it expects to extend the instruction set in the near future, to include instructions like FIX and FLOAT (floating point to integer and vice versa); it also expects to bring out a 16MHz version. But what about now? Small quantities of the M68000 are expected on the market in the next few months, but at the

moment all the chips are going to the big firms for evaluation — not surprisingly in view of the new competition in this extremely valuable market. However, as soon as second-sources get into production the supply position is bound to improve. I was told by one of Motorola's distributors that they had achieved 98% functional chips from the very first masks — an astounding achievement for a chip of this complexity!

A memory management chip is also mentioned in the advance spec on the

M68000 but no one, not even in the labs at Motorola UK, could tell me anything about it, so I doubt if it can be appearing at all this year. But who cares? If you can get your hands on an M68000 you'll be too heavily occupied to think about anything else for some time to come!

My thanks to Hawke-Cramer for helping to obtain information for this article. Technical details are based on data derived from Motorola Advanced Specification Data Sheets.

Gateways to Logic Cont. from Page 69

a choice of routes is open to us. Which route we take depends upon the function of the gate and unless otherwise specified, we go straight on. When all the blocks have been delivered into their respective docks, we obtain a description of each pile from the children. Change the function of the gate and ask for a forecast. Alternatively, ask for the gate that will deliver certain conditions of block. Children love this game and can be heard revving imaginary engines as they drive the blocks from East to West. The more able children will easily cope with several gates and three or more docks (Fig.10).

I hope that I've said enough to illustrate the enormous usefulness of Professor Dienes' blocks. Ideally, every child should have his/her own table-top set (the pocket size get lost too easily) but failing that, each set can be used by four children at once. Of course, every classroom ought to have at least one

large demonstration set.

Next month, Derrick Daines turns his attention towards the usefulness and implementation of Boolean Algebra.

List of suppliers

Hestair Hope Ltd, St Phillip's Drive, Royton, Oldham OL2 6A9 . . .

will supply logic blocks and a binary selection box.

ESA Creative Learning Ltd, Pinnacles, PO Box 22, Harlow, Essex CM19 5AY . . .

. . . suppliers of logic blocks, also logic people, trees, houses and logic cubes, of the Bullmershe type (similar to Dienes'); also Trackways.

EJ Arnold & Sons Ltd, Butterley Street, Leeds LS10 1AX . . .

logic blocks and also multiway dice in plastic.

Invicta Plastics Ltd, Oadby, Leicester . . .

Venn diagram mats in plastic, matrix mats ditto, logic blocks and people.

Taskmaster Ltd, Morris Road, Leicester LE2 6BR . . .

number sentence cubes.

Note: Since writing the text of this series, the familiar suppliers of electronics kits (such as Philips) have ceased production, mainly because of Japanese and Korean competition. This particular market is now in a state of flux, with new products appearing (and disappearing) rather rapidly. At the time of writing, Heathkit (Gloucester) produce the only one of which we are aware. Older kits may still be found in toyshops, but no guidance can be offered.

Kits designed to teach about micro-processing are still about. Edukit is marketed by Modus Systems Ltd, 29a Eastcheap, Letchworth, Herts SG6 3DA. No doubt there are others. Readers are advised to shop carefully.

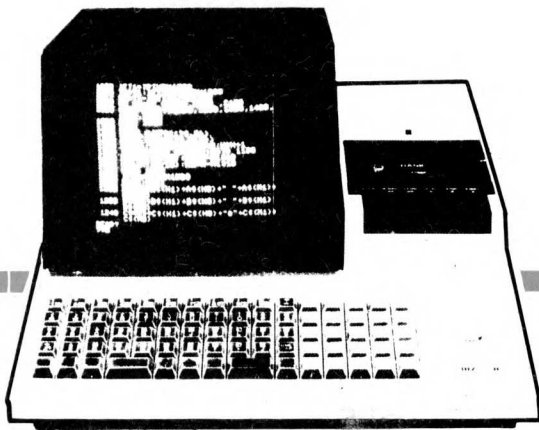

SHARP MZ80K

THE FIRST
DESKTOP
COMPUTER
TO STRIKE

THE
FULL RANGE OF SHARP GAMES
ON CASSETTE NOW AVAILABLE
RIGHT CHORD!

AT LAST!
THE MICROPROCESSOR THAT BRINGS
SOUND TO YOUR PROGRAMME.
COME AND LISTEN TO THE DIFFERENCE

NOW AVAILABLE

AT
COMPUTERIST
SOUTH EAST ESSEX FIRST COMPUTER
SHOWROOM AND BOOKSHOP

THE COMPUTERIST

642 London Road,
Westcliffe-on-Sea, Essex
Telephone Southend 335298



Small
Systems
Engineering
Limited

IEEE-488/PET INTERFACES

NEW ...

£186

TYPE B200 Bi-directional serial interface

C.B.M. Disk compatible, software selectable
Baud rates, switchable code conversion,
RS 232C input and output handshake.

Type C

£120

Serial interface - output only
PET disk, compatible, RS232 C Handshake
(Printer Busy), switch selectable Baud rates,
Listen Address link selectable.

**All type C interfaces now incorporate
switchable code conversion to match
print to PET screen display.**

Type G.P.I. A.P.

£249

Micro-based, bidirectional with buffering.
The General Purpose Interface allows free use
of PET's INPUT # statement without hangup
problems. Software changeable BAUD rates
optional features include: Second Serial
I.O. Port, 20 mA Loop I.O.

Addressable parallel (disc compatible) for Centronics, Anadex etc.

£106

Also available with switchable code conversion.

Non addressable parallel

£45

TV/Video monitor interface

£35

Pet Memory Expansion Boards internally mounted.

24K

£328

32K

£432

S100 BOARDS

Dynamic Memory Boards

IEEE-S100 Specification Timing
Transparent on Board Refresh
4Mhz Z80 Operation with no wait states.
Fully tested and Burned In
Bank Select versions available -
North Star, Cromemco and Alpha Micro
I.O. Port Bank select
Bank Size to 64K in 16K increments

Size	Standard	Bank Select
64K	£449	£595
48K	£398	£539
32K	£346	£483

P&T IEEE-488 Interface

Provides S100 computers with IEEE-488 £350
Controller, Listener, Talker, Capability

SOFTWARE

PETE PET intelligent terminal
package £200

NEW ...

BISYNC 80

IBM 3780 emulation software for
CPM Micros £425

**Please note our new address and phone
number!**

24 Canfield Place · London · NW6 3BT

· Telephone: 01 328 7145/6 · Telex 8813085 (Abacus)

into English if there is any customer demand).

The SPC/1 can be used for equipment control and for data logging as both the hardware boards and the high level software instructions are already part of the DDE repertoire. The biggest potential for the SPC/1 must be in the education market. Comal and Pascal are both in line with modern programming philosophies. The greatest drawback as an educational machine used to be its lack of graphics but, since Turtle graphics are now being implemented, an SPC/1 with a monitor and graphics (rather than a Soroc IQ 120) should be suitable.

Documentation

Ten nicely bound manuals were provided with the review machine. All are well laid out, have detailed tables of contents and are paginated. Provided were:

Introduction to MIK and MIKADOS operating systems

MIKADOS User's Guide

MIKADOS Utility Programs and Subroutines

A Short Survey of the Commands of the Editor

ID-Comal (in Danish and promised in English)

The Comal Programming Language-A Short Description

Comal-B System Description

ID-Comal Assembler Interface

User's Guide to Assembler and Linker

Pascal User's Guide (comes with the Jensen/Wirth Pascal User Manual & Reports)

Unfortunately I found most of the manuals either too superficial or too technical. The short descriptions of Comal and MIKADOS are probably sales literature rather than manuals, although MIKADOS is a straightforward operations system to use, not requiring any assembler language programming in order to use the editor, file system, Comal or Pascal.

I learned how to use it from Ian Brunchmann and, even when comfortable, could not locate any clear instructions in any of the manuals. In the introduction to the MIKADOS User's Guide one reads "The reader is expected to have a basic knowledge of 8080 programming... indeed, the manual is filled with detailed instructions on how to call a wide variety of 8080 subroutines. Although this level of description is ideal for the person who wants to configure his own SPC/1 system, it's not the level of detail to which British users of disk-based micro systems are accustomed. For example, the first chapter is about the sending and receiving of semaphores while the second is about I/O drivers.

The Pascal User's Guide is more useful although it does expect the reader to be familiar with Wirth's Pascal. Included are several sections taken from the UCSD manual. I wasn't impressed with the overall level of accuracy in the manuals. Although they appear to be regularly updated, they don't actually

describe the review system. The chapter on I/O drivers lists all the VDUs, printers and disk drives for which there are currently drivers, but doesn't include any of the peripherals provided with the new machine. I typed in one of the sample Comal programs and it didn't run as expected. The operator's commands require a "." as the first character but this isn't mentioned. The utility program TXTUD is not mentioned in the documentation - there was no way to alter any parameters to prevent it wasting paper.

As DDE obviously take documentation seriously (besides the nice layout the English is fine) I hope that they both clear up the inaccurate details and write an operating system manual that doesn't assume familiarity with machine code.

Expansion

Both the hardware and the software of the SPC/1 have been designed for use as a multi-user, hard disc based system; therefore expansion should be straightforward. The seventeen slot motherboard should be large enough to plug in any boards desired. Memory can be expanded to one Mbyte of RAM or PROM in sixteen banks and up to four 20 Mbyte cartridge driven can be added. The 2 MHz 8085 can be replaced with a 5 MHz microprocessor. An expanded system can support up to eight users.

Prices

The basic system consists of a box plus one disk drive that can hold 90 kbytes (and room for a second drive), a power supply and a 17-slot motherboard with four boards, CPU board, RAM refresh module, 32 kbytes RAM card and a disk controller. Also included in the basic system are a Soroc IQ 120 terminal with cables, a disk containing a dedicated Comal system and four empty disks. The 2 MHz version of the basic system sells for £1995 while the 5 MHz version costs £2545.

Below are prices for some of the DDE range of hardware and software, which include a 12-month warranty.

16k Dynamic RAM	£ 405
32k Dynamic RAM	590
4 ports asynch/synch	270
8 Channel DMA	305
Graphics B/W video inc. software	590
A/D converter 8ch/10bit	495
D/A converter 4ch/10bit	355
8" 250k disk drive (IBM compat), master	1815
8" slave drive	860
5" 90k expansion drive	450
5" 280k disk drive, master	1000
5" 280k expansion drive	630
20M cartridge disk system	7000
20M cartridge expansion drive	4700
Texas 810	1865
MIKADOS operating system + utilities	460
Pascal software (single or double prec)	275
Comal-B	200
Comal Assembler Interface	95

MICROMART

ANCO COMPUTER SERVICES LTD.

We offer a complete service. We are agents for the Z-Plus Microcomputer System. We can supply a wide range of packages - Payroll/Purchase Ledger etc. We provide full consultancy and Software Service.

4 Benton Road
Ilford Essex IG1 4AT
01-554 4164 (24 hrs)

SPEED - VERSATILITY - ECONOMY



Designed originally for logic wiring applications, it is now accepted and used extensively throughout industry, education and research. ROADRUNNER is used by hobbyists, students, technicians, designers and engineers, to carry out work on - *P.C.B. REPAIRS *ANALOGUE BREADBOARDING *SIMPLE LOGIC WIRING *COMPLEX INTERCONNECTING OF MICROS AND MEMORIES.

EURO INTROKIT £15.73. PROJECT INTROKIT £8.80. PENCIL WITH LOADED BOBBIN £2.44. WIRE DISTRIBUTION STRIPS: GLUE FIX 20pin 6" LONG £2.80. ADHESIVE £0.36 TUBE. PRESS FIX 20pin 7" LONG £2.92. SINGLE EUROCARD HIGH DENSITY 3 PLANE (36 x 16 PIN DILS) £4.50. DOUBLE EUROCARD, WITH CAPACITY OF 84 x 16 PIN DILS £7.25. PROJECT CARD HIGH DENSITY S-SIDED 20 x 14 PIN DILS £2.85. BOBBINS: BLUE 4pin £2.12. GREEN 4pin £2.12. PINK 4pin £2.12. GOLD 4pin £2.12. 1 OF EACH COL £2.20. TINNED COPPER WIRE 4pin £2.12. RECOMMENDED SOLDERING IRON FOR ROADRUNNER HOBBYIST £4.80.

Please add 40p for p & p + 15% VAT to all orders.

FOR FURTHER INFORMATION ON ROADRUNNER PRODUCTS

SEND LARGE S.A.E. TO:-

T.J. BRINE ASSOCIATES

56B, HIGH STREET, HASLEMERE, SURREY.

IN ADDITION TO ROADRUNNER WE PROVIDE A SPECIALIST MICRO-PROCESSOR PRODUCT DEVELOPMENT SERVICE. PLEASE PHONE 0428-53850 FOR MORE DETAILS.

EXIDY SORCERER

in the
MIDLANDS
contact

Midland Microcomputers
Nottingham (0602) 298281
for all your hardware and software requirements.



MICROTYPE

STAK-PAK

CASSETTE STORAGE SYSTEM FOR EASY PROGRAM FILING.

- * Each drawer section takes 2 cassettes.
- * Drawers lock together vertically.
- * Each twin pack comes with 2 C10 digital cassettes.
- * Each 'pak' is complete with index cards, cassette and drawer labels.

FIVE TWIN PAKS (10 CASSETTES) FOR £6.60 INC. VAT & P&P.

Send cheques or Postal Orders to:

MICROTYPE, PO Box 104,
HEMEL HEMPSTEAD,
HERTS HP2 7OZ.

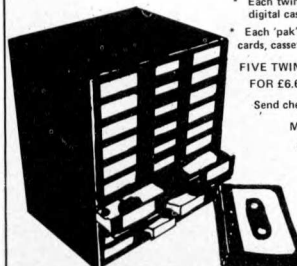

MICROMART



UPERSOFT

— WE TRY HARDER

All the extras for your machine in our latest catalogue. Rascal-Zonal C12 cassettes (10 for £3.95); Verbatim 5 1/4 in. diskettes (10 for £25), 8in single density (10 for £32) or double-density (10 for £39); PET parallel interface £39 or £65 with decoding; ribbons, paper etc. etc. PLUS nearly 40 great PET programs at £1-£12. Post free but add 15% VAT to all prices.

SUPERSOFT 28 Burwood Avenue, Pinner, Middx.

***** STOP PRESS *****

PET GAMES PACK: 17 GREAT GAMES FOR JUST £25

VETS FOR PETS

Anita Electronic Services (London) Ltd. are specialists in the repair and service of Commodore Pets.

We offer a fast on-site service, or alternatively repairs can be carried out at our workshops should you wish to bring in your Pet.

Pet maintenance contracts are available at very competitive prices. Trade inquiries welcomed.

For further information, tel or write to:

John Meade
Anita Electronic Services
15 Clerkenwell Close, London EC1
01-253 2444

We also specialise in the repair of all makes of office equipment.

DOUBLE VISION

80 columns x 24 lines

video display
with upper and lower case
(plug in board)
Compatible with

Apple II

Apple II plus

PASCAL.

Built in light pen capability
Shift lock feature
full 96 ASCII character set

fantastic value £165.00 + VAT

Leicester Computer Centre Ltd.,
109 Queens Road, LEICESTER
LE2 1TT Tel. 0533 708483.

50 HZ
SUPER BOARD
NOW FROM ONLY

£159.95

Plus P&P & VAT

Includes 8K BASIC, 4K RAM
KEYBOARD etc
FITTED MODULATOR EXTRA

CTS 1 Higher Calderbrook,
Littleborough, Lancs, OL15 9NL
Tel: Littleborough (0706) 79332
anytime

Memory map

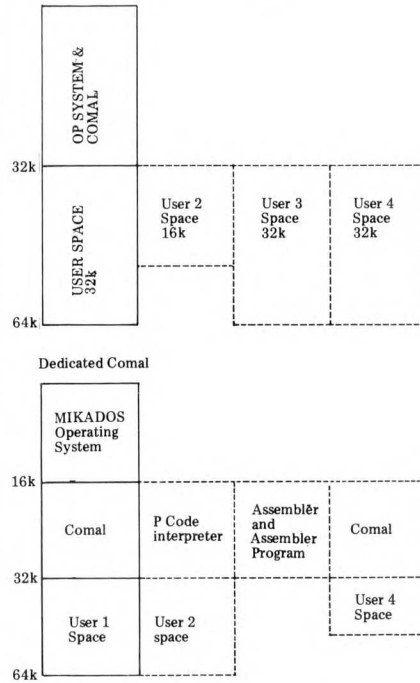

Conclusion

The DDE SPC/1 is a bus-based Danish computer system which has been designed independently of the American influence on either software or hardware. In its present state it's aimed at both the education and the program development markets.

With a 5 MHz 8085A microprocessor and hard disks, I think the multi-user SPC/1 offers a competitive micro alternative to some computing problems that to date have been solved by minis. The review machine was a pared down version of a multi-user system, shoehorned into a single-user configuration. Utilities required in this configuration took rather more time to use than comparable utilities on most single user setups. The major drawback of the single-user system must be the price... even standard hardware (e.g. BASF drives) are not competitive. Against this background is Comal, the structured Basic language. I certainly prefer it as both a teaching

and a programming language to Basic.

Editor's Note: Since this review was written, DDE have dropped the single precision Pascal. They have also added the following features: Direct input; 16 byte message exchange between programs; up to 2k memory allocation; and access to assembler subroutines.

At a glance

FIRST IMPRESSIONS

Looks	****
Setting Up	****
Ease of Use	**

HIGH LEVEL LANGUAGES

Basic	N/A
Cobol	N/A
Fortran	N/A
Pascal	****
Comal	****
System Software	**

PACKAGES

N/A

PERFORMANCE

Processor	***
Cassette	N/A
Disk	*
Peripherals	****

EXPANDABILITY

Memory	*****
Cassettes	N/A
Disks	*****
Bus	***

COMPATIBILITY

Hardware	*
Software	*

DOCUMENTATION

VALUE FOR MONEY

**

*****	excellent
****	v. good
***	good
**	fair
*	poor

PROGRAMS

Y.C.W. Program Continued from Page 109

```

● 440 M=33318
  450 L=33288
  460 M=33318
● 470 GOSUB790
  480 GOSUB790
  490 TI$="000000"
● 500 IFTI$<"000001" THEN500
  510 IFL<33325 THEN:P=1
  520 IFL=33325 THEN:P=2
  530 IFL=33485 THEN:P=3
  540 IFL=33451 THEN:P=4
  550 IFL=33571 THEN:P=1
  560 IFL=33605 THEN:PRINT"Q"*****
● 570 IFP=1 THEN:L=L+1:Z=L-1
  580 IFP=2 THEN:L=L+40:Z=L-40
  590 IFP=3 THEN:L=L-1:Z=L+1
  600 IFP=4 THEN:L=L+40:Z=L-40
  610 IFPEEK(L)=94 THEN840
  620 POKEL,42:POKEZ,96
  630 GETA$
  640 IFR$<>B$ THEN490
● 650 FORD=1 TOB
    
```

PET PROGRAMS

EDITOR Now reduced in price, this is a must for anyone handling data or symbolic program files on tape or disc. Allows full editing and print-out using single letter commands such as Find, Replace, Delete, Move, Save, etc.
Tape £15.00 Disc £17.00

RADIO This is a design aid for anyone designing radio receivers. It designs all the tuning components for minimum tracking error.
Tape £12.00 Disc £15.00

KEYBOARD TUTOR The first 9 lessons in a programmed learning course on touch typing. This is a MUST for anyone with the large keyboard. Adapts to your week points and adjusts to your speed as you learn.
Tape £12.00 Disc £15.00

Send for full list of software, (S.A.E.) to Circle Software 33 Restrop View, Purton, Swindon, Wilts. SN5 9DG.



Target Electronics

16 Cherry Lane, Bristol BS1 3NG
Telephone: 0272 421196

NASCOM IMP PLAIN PAPER PRINTER



The Nascom IMP (Impact Matrix Printer) features:
● 60 lines per minute ● 80 characters per line ● Bi-directional printing ● 10 line print buffer ● Automatic CR/LF ● 96 characters ASCII set (includes upper/lower case \$ # % &)
● Accepts 8 1/2" paper (pressure feed) ● Accepts 9" paper (tractor feed) ● Tractor/pressure feed ● Baud rate from 110 to 9600 ● External signal for optional synchronisation of baud rate ● Serial RS232 interface



NASCOM DISTRIBUTOR



Large selection of aluminium boxes & Instrument Cases
Phone in your Access or Barclaycard order Catalogue 25p post paid

ITT 2020 16K Palsoft & Integer Basic.
UHF Modulator. Games paddles, Lots of tapes. Full literature. Free disc controller (worth £43) Only three months old. Save over £100.
First £595 secures.

Tel. 0494 711431 Day
024029 273 Evenings.

**WATSON & EWEN
SALES LTD.**

SOFTWARE FOR THE NEW ROM PETS

Send for free list of games and utilities. MYCROFT specialises in fast efficient machine-code programs at sensible prices eg.

TRACE

Displays the BASIC line being executed along with the values of any variables or expressions you select, in three lines of reverse video anywhere on screen. One line a second or single step. £4.50

COLONY 2

Now you can play Conway's absorbing game of Life on four times the playing area previously available. Use of double density graphics allows colonies up to 78 x 48, processing at over two generations a second. £5.50

COMMAND KEY

Our most popular program. A SMC byte routine that gives auto-repeating keys and adds a command level shift to PET for single key entry of 62 BASIC words. A template is provided. £3.50

RENUMBER

You can select the start number, the step size and where renumbering is to begin. It handles ALL references, including those to non-existent lines and occupies only 750 bytes. £5.00

Prices inclusive. Mail order only. Supplied on quality cassettes.

MYCROFT

262 Francis Chichester Way, London SW11 5HY

PROGRAMS

of keying in! If you must send us a hard copy then use plain white paper and put a new ribbon in your printer to give a clear, black impression.

Many readers omit all spaces etc from their listings to save memory space; these listings are quite difficult for others to decypher, however, and where possible you should aim for maximum legibility by including all spaces. If your RAM doesn't allow this then save a second version on cassette with the original, this time with spaces included and split it into two if necessary — explain what you've done in a covering letter.

Generally we don't like to print long programs in the programs area of the magazine — we'd prefer a variety of shorter programs each month rather

than a single, long one. However, that doesn't mean we don't want long programs! If you've written a lengthy one then we'd like to see it; accompanied by a suitable write-up, it might make a separate feature in its own right.

One or two other points: don't include a description of your program as REM statements within the program itself — describe it on a separate sheet. Pack it securely, using a Jiffy bag for a cassette and a hard envelope for a disk. If you want your cassette or disk returned then enclose a SAE!

So it's up to you now to come up with something original. We keep hearing (and saying) that the micro-computer offers endless potential so let's see something of that potential expressed as programs in PCW.

PET Golf

by J. Aughton

Another excellent program from the program.
writer of our recent Backgammon

READY.

```

10 REM **GOLF BY J. AUGHTON
40 Z$=" ":FORI=1TO39:Z$=Z$+" ":NEXT
50 B$=" ":FORI=1TO40:B$=B$+"*":NEXT
60 N=0:K=32928:P1=0:A1=0:TR=1
70 DEFFNA(X)=INT(X*8ND(1))
80 DEFFNB(X)=INT((8-9*8ND(1))/7)
100 PRINT"ITAB(16)* GOLF *";
110 PRINT"WELCOME TO THE LINKS! THIS";
115 PRINT" IS AN 18-HOLECOURSE OF PR";
120 PRINT"OFESIONAL STANDARD (COURS";
125 PRINT"E RECORD IS 2 UNDER ),SO P";
130 PRINT"LEASE REPLACE DIVOTS AND";
135 PRINT" SHOW COURTESY TO YOUR FEL";
140 PRINT"LOW GOLFERS.
145 PRINT"HAVE A GOOD ROUND-SEE YOU AT THE 19TH !!
150 PRINT"WHAT IS YOUR HANDICAP";
160 INPUT:IFH>=0ANDH<=30THEN190
170 PRINT"PGA RULES HANDICAP 0-30":GOTO150
190 PRINT"DIFFICULTIES AT GOLFA
200 PRINT" 1.HOOKING
210 PRINT" 2.SLICING
220 PRINT" 3.POOR DISTANCE
230 PRINT" 4.TRAP SHOTS
240 PRINT" 5.PUTTING
250 INPUT"YOUR WORST";F=INT(F)
260 H=INT(H):IFF>0ANDF<6THEN290
270 PRINT"DON'T BE SHY":GOTO250
290 PRINT"SELECTION OF CLUBS";
300 PRINT"YARDAGE CLUBS NO.
310 PRINT"280-290 1-4 WOODS 1-4
320 PRINT"200-190 1-5 IRONS 11-15
330 PRINT"100- 0 6-9 IRONS 16-19
340 PRINT"TO FADE OR DRAW THE BALL";
350 PRINT" TYPE F OR D WHEN ASKED
360 PRINT"TO HIT STRAIGHT TYPE RETURN
370 PRINT"*** WARNING ***
380 PRINT"DON'T HIT IT TOO HARD
390 GOSUB9000:GOSUB1700:GOSUB9000
400 REM GENERATE HOLE
410 Z=K:G=102:N=N+1:READD,P:PRINT"
420 FORI=1TO18:PRINTB$:NEXT
430 PRINT"HOLE";N: S=4:A=0
440 PRINT"DISTANCE";D:"YDS. ","PAR";P
450 T=K+280:E=1:FORI=1TO40:FORJ=1TOS
460 POKET,32:T=T+40*E:NEXTJ:T=T-40*E
470 U=FNB(1):S=S+U
480 IFS<40RS>8THENS=S-U:GOTO470
490 T=T+40*FNB(1):E=-E:NEXTI
500 S=3:T=T+79:FORI=1TO5:FORJ=1TOS
510 O=160:IFI=3ANDJ=2THENO=43:O=T
520 POKET,O:T=T+40*E:NEXTJ:T=T-40*E
530 U=FNB(1):S=S+U
540 IFS<3THENS=S-U:GOTO530
550 T=T-1+40*FNB(1):E=-E:NEXTI:O=69
555 FORI=1TO8:FNA(8)
560 S=K+O+FNA(9)+40*FNA(15)
570 IFPEEK(S)=32THENPOKES,87
580 NEXT:IF0=69THENO=55:GOTO555
590 POKEK+360,148
600 X=0:Y=19:V=75:W=(O-K-37)/20:L=1
605 IFD>450ANDD<550THEN1200
    
```

PROGRAMS

```

610 IFRND(1)>.6THEN1100
620 PRINT"XXXXXXXXXXXXXXXXXXXX"
640 GOSUB2000
650 PRINT"WHICH CLUB DO YOU CHOOSE";
660 INPUT C:C=INT(C)
670 IF(C<0ANDC<5)OR(C>10ANDC<20)THEN700
680 PRINT"NO SUCH CLUB IN THE BAG":GOSUB2500
690 GOT0640
700 QQ=0:IFC<15THENB=100:GOTO1500
710 PRINT"YOU MAY NOW GAUGE YOUR DI";
720 PRINT"STANCE BY %AGE (0-100) OF ";
730 PRINT"FULL SWING..YOUR CHOICE";
740 INPUT B:IFB>0ANDB<=100THEN760
750 PRINT"I SAID 0-100! WELL!";GOTO740
760 B=B/100:IFF=3THENB=B*.85
770 IFL=2THENB=B*AA:IFC<3THENB=B*.7
790 GOSUB2500:REM DISTANCE
800 M=309-FNA(12)-(H+30)*.7-C*.8
810 M=INT((B*M*.75/D)+.5):Q=0
820 A=A+1:PRINT"XXXXXXXXXXXX";CHR$(A+48)
830 IFRND(1)>.3+H/90THEN880
840 Q=(H+30)*(RND(1)+.1)*.7/500
850 IFF>2THENU=.5:GOTO870
860 Q=Q*.15:U=.9:IFF=2THENU=.1
870 IFRND(1)>UTHENQ=-Q
880 IFV=XTHENV=PI/2-X-SGN(Y-W):GOTO890
885 T=ATN((Y-W)/(V-X))+Q-QQ
890 U=X+SGN(V-X)*INT(M*COS(T)+.5)*TR
900 V=Y-SGN(V-X)*INT(M*SIN(T)+.5):X=U
905 TR=1
910 IFX>790RY<00RY>35THEN1300
920 S=K+INT(X/2)+40*INT(Y/2):T=PEEK(S)
930 U=126:IF(YAND1)=1THENU=123
940 IF((XAND1)=1AND(YAND1)=1)THENU=108
950 IF((XAND1)=1AND(YAND1)=0)THENU=124
960 POKEZ,G:POKES,U:G=T:Z=S
970 FORI=1TO9:POKES,G:FORJ=1TO99:NEXTJ
980 POKES,U:FORJ=1TO99:NEXTJ:NEXTI
1000 GOSUB2500:IFX=VANDY=WTHEN1600
1010 IFG=1600RG=43THEN6000
1020 IFG=102THENL=2:GOTO7000
1030 IFG=87THEN7500
1040 IFG=193THENL=4:GOTO8000
1050 IFG=174THEN8500
1060 L=1:GOTO640
1100 U=K+103+FNA(11):T=1:FORI=0TO4
1110 IFPEEK(40*I+U)=32THENU=U+480:T=-1:GOTO1130
1120 NEXT
1130 FORI=1TO12:POKEU+T*40+FNA(5)-FNA(8),193:NEXT:GOTO620
1200 C=K+12+FNA(8):U=1
1210 IFRND(8)<.5THENC=C+13:U=-1
1270 FORI=1TO18
1280 POKEC,174:IFRND(1)>.4THENC=C+U
1290 C=C+40:NEXT:GOTO620:REM WATER
1300 IFX>90THEN1360:REM O.O.B
1320 IFX>79THENX=79
1330 IFY>0ANDY<36THEN1410
1340 IFY>35ANDY<48THENY=35:GOTO1410
1350 IFY<0ANDY>-11THENY=0:GOTO1410
1360 GOSUB2000
1370 PRINT"TOO MUCH CLUB-LOST BALL"
1380 PRINT"PENALTY 36 STROKES":A=A+6
1390 GOSUB2500
1400 PRINT"O":GOTO6490
1410 GOSUB2000
1420 PRINT"OUT OF BOUNDS-DROP BALL"
1430 PRINT"PENALTY 31 STROKE":A=A+1
1440 GOT0920
1500 PRINT"FADE OR DRAW";
1510 INPUT"X-O-O-O":A$
1520 IFA$="F"THENQQ=.15
1530 IFA$="D"THENQQ=-.15
1540 GOT0760
1600 PRINT"O YOU HOLED OUT !!!!XO
1610 PRINT" LUCKY!!":GOTO6400
1700 PRINT"O NOTATION USED
1710 PRINT"O
1720 PRINT"O=ROUGH
1730 PRINT"O=TRAPS (KEEP OUT!)X
1740 PRINT"O=FAIRWAYX
1750 PRINT"O=GREENX
1760 PRINT"O=THE HOLEX
1770 PRINT"O=THE TEE (OF COURSE!)X
1780 PRINT"O=O-WATER (LOST BALL!)X
1790 PRINT"O=O-TREESX":RETURN
2000 PRINT"O";Z$;PRINTZ$;PRINTZ$;
2010 PRINT"O";:RETURN
2500 FORI=1TO2000:NEXT:RETURN
6000 PRINT"OON THE GREEN IN";A
6010 IFRND(1)>.6THENJA=1:GOTO6060
6020 IFRND(2)>.5THENJA=1.27:GOTO6040
6030 PRINT"O"TAB(15)"O SLOW GREEN":JA=.73:GOTO6060
6040 PRINT"O"TAB(15)"O FAST GREEN"
6060 KK=K+320:M=1:T=1:IFF=5THENM=3
6070 GOSUB2500:GOSUB2000
6080 FORI=40TO79:POKEKK+I,99:NEXT
6090 POKEKK+29,93:POKEKK-11,225
6100 POKEKK-10,160
    
```

MICROMART

WHAT "Turns a board into a real computer"?

MICROCASE!

We make cases for micros.
Stylishly designed.
Beautifully made.
Room for extensions + PSU.

**SUPERBOARD
COMPUKIT
NASCOM 2**
or UNCUT FOR OEM USE

From your dealer or write to:
MICROCASE
Simple Software Ltd
15 Havelock Road
Brighton BN1 6GL.

★ SPECIAL LIMITED OFFER ★

PROGRAMMERS TOOLKIT £40 + VAT

16/32K PET ONLY

DISKWISE LTD
THE Apple agents for
Devon & Cornwall.
Complete business systems
from £2250 ex VAT

**EXCLUSIVE HOTEL
MANAGEMENT SYSTEM**
(inc Booking & Guest billing)
& TV RENTAL
MANAGEMENT
Dealer enquiries welcome
DISKWISE LTD.
TREKENNER,
LAUNCESTON
TEL 05797 628

STOP PRESS: SUPERBOARD II,
UK 101, TRS 80 COMPATIBLE

**COLOUR
YOUR
NASCOM!**



DAZZLING COLOUR GRAPHICS FOR
NASCOM 1 & 2

Genuine bit-addressable "pixel" system for straight-forward programming of pictorial or mathematical functions.

8 Colour display plus 8 colour independent background facility. Full documentation with FREE SOFTWARE: powerful sub-routines for vector generation, demonstration program for animated effects. All runs in Nascom 1 without expansion. Complete with UHF Colour Modulator for operation with normal colour TV set. Superior design allows connection to most other micro-processor systems — send us diagrams etc of your board & video circuitry for free advice. Don't be fooled by the price: this is a top quality product which will transform your computer.

KIT AVAILABLE FOR **£45** + VAT
LIMITED PERIOD AT

READY BUILT & TESTED £59 + VAT

**WILLIAM
STUART
SYSTEMS Ltd**

Dower House, Billericay Road,
Herongate, Brentwood,
Essex CM13 3SD.
Telephone: Brentwood (0277) 810244

SMALL TURNKEY SYSTEMS

Applications specialists with CROMEMCO/CENTRONICS/CIFER systems in:

- Financial Planning
- Budgeting
- Schedule Order Handling
- Invoicing
- Ledgers
- Information Index

TANDY/CENTRONICS in Builders Commercial Systems in BASIC — source available Expandable to:

- Multi-user systems
- 10 Mb Hard discs

We aim to solve YOUR problems.

Supply : Support : Service

Contact: Alan Perry

01-272 3530 or 01-263 1951



WESTFARTHING COMPUTERS

Thinking of a computer?

Independent professional advice can save your firm thousands and ensure you get a useful, reliable system. We charge a consultation fee but do not take commissions on sales, so our recommendations are unbiased. National service.

Phone Helston (03265) 4098 for brochure.

Also complete systems supplied, with local software and hardware experts.

MICROCOMPUTER CONSULTANTS

OHIO SCIENTIFIC

AT UNBELIEVABLE PRICES

Phone for up to the minute quotations

**SUPERBOARD II
620 EXPANSION
CHALLENGE 1P
DISC DRIVE FOR ABOVE**

Quotations for Specialist/Industrial Applications

Software bought and sold for Superboard, komputik pet, Nascom and Research Machines. Send Tape/Listing for approval. Good Commission Rates

Send S.A.E. for List

Prices include VAT + Postage

**MICROCASES £29.90
2114L RAM 4K £32.00
12 Data Cassettes £5.50
PSU Kit for Superboard £17.25**

Callers by appointment

Easicomp Ltd.

day 0508 46484

Evenings and weekends 0603 416352
57 Parana Court, Sprowston, Norwich

MINE OF INFORMATION LTD

1 FRANCIS AVENUE,
ST ALBANS AL3 6BL
ENGLAND

Phone: 0727 52801
Telex: 925 859

**MICROCOMPUTER
CONSULTANCY &
BOOK SELLERS**

PROGRAMS

```

6110 I=INT(D*SQR((X-V)^2+(Y-W)^2)/31)
6120 IFD>58THEN D=56+FNA(3)
6130 POKEKK+29-INT(D/2),81
6140 PRINT"YOU ARE";D;"FEET FROM THE PIN"
6150 INPUT"CHOOSE PUTTING STRENGTH (0-13)
        ■■■■■■":C
6200 IF C<0AND C<=13THEN A=A+1:GOTO6240
6220 PRINT"J";Z$;"TJ":GOTO6150
6240 E=C*(4+M*RND(1))-2.5+(RND(1)*(H+30)/40)*M:E=INT(E*.8)
6250 FOR I=1 TO E:D=D-1:S=INT(KK+29-D*T/2)
6260 FOR J=1 TO I:NEXT J
6270 POKES,81:POKES-T,32
6280 IFS<KK+29THEN POKES+29,93
6290 NEXT I:REM **MIGHT RUN OFF GREEN
6300 IFD<0THEN T=-T:D=-D
6305 IFS<KK+29THEN FOR I=1 TO 99:NEXT:POKES,93:GOTO6400
6310 GOSUB2500:GOSUB2000:GOTO6140
6400 GOSUB2500:REM PUTTING
6410 PRINT"YOU'RE DOWN IN":A;
6420 ON(A-P+3)GOTO6460,6450,6440,6430,6490
6430 PRINT"-KEEP YOUR HEAD DOWN":GOTO6500
6440 PRINT" A PAR-NICE GOING":GOTO6500
6450 PRINT"-A BIRDIE:WELL PLAYED!":GOTO6500
6460 IFF=3THEN6480
6470 PRINT"-A GREAT BIG EAGLE!!!":GOTO6500
6480 PRINT" A HOLE IN ONE !!!!!
6490 PRINT
6500 P1=P1+P:A1=A1+A:IFF1=A1THEN6550
6510 A$="UNDER":IFA1>P1THEN A$="OVER"
6520 PRINT"YOU ARE":ABS(P1-A1);
6530 PRINTA$;" PAR AFTER":N;"HOLES
6540 GOTO6560
6550 PRINT"LEVEL PAR AFTER":N;"HOLES
6560 PRINT"!!!":GOSUB9000
6570 IFN<18THEN400
6580 REM E.O.G.
6590 PRINT"*** GAME OVER ***!!!
6600 ONINT((A1-P1)/5+2)GOTO6730,6700,6660
6610 PRINT"YOU'VE HACKED YOUR WAY";
6620 PRINT" ROUND BADLY. BESTTAKE";
6630 PRINT" SOME LESSONS BEFORE YOU";
6640 PRINT" DIG UP THISCOURSE AGAIN
6650 GOTO6900
6660 PRINT"AN AVERAGE ROUND-YOU";
6670 PRINT" SHOULD IMPROVE NEXTTIME";
6680 PRINT"SEE THE CLUB PRO FOR A";
6690 PRINT" FEW TIPS":GOTO6900
6700 PRINT"CONGRATULATIONS! YOU P";
6710 PRINT"LAYED A GOOD ROUNDI LI";
6720 PRINT"KE YOUR STYLE":GOTO6900
6730 PRINT"AN UNDER PAR ROUND!!
6740 PRINT"NEXT TIME YOU PLAY TRY ";
6750 PRINT"A HIGHER HANDICAP
6900 END:REM ** PHEW !! **
7000 REM ROUGH
7010 GOSUB2000:IFABS(Y-17)>10THEN7030
7020 AA=.75:PRINT"IN LIGHT ROUGH":GOTO7040
7030 AA=.5:PRINT"YOU ARE IN HEAVY ROUGH
7040 GOSUB2500:GOTO640
7500 GOSUB2000:REM TRAP
7520 PRINT"** BUNKERED **":GOSUB2500
7530 GOSUB2000
7540 INPUT"WHICH CLUB":C:C=INT(C)
7550 IFC>11AND C<20THEN7590
7560 PRINT"YOU WON'T GET OUT WITH ";
7570 PRINT"THAT":GOSUB2500
7580 GOSUB2000:GOTO7540
7590 INPUT"% AGE SWING":B
7610 M=68+FNA(17)-(19-C)*5-(100-B)*.4
7620 IFF=4THENM=M*.7
7625 IFRND(1)<.4THENM=M/3
7630 IFM>25THENM=0:B=1:GOTO810
7635 GOSUB2000
7640 PRINT"YOU FLUFFED IT":GOSUB2500
7650 A=A+1:GOTO7500
8000 REM TREES
8010 GOSUB2000:PRINT" IN THE TREES
8020 PRINT"YOU CAN ONLY HACK OUT SIDWAYS
8030 TR=0:GOSUB2500:GOTO640
8500 REM WATER
8510 GOSUB2000:PRINT" ** SPLASH !!! **
8520 PRINT"IN THE STREAM-LOST BALL
8530 GOSUB2500:GOSUB2000:GOTO1300
9000 PRINT"PRESS ANY KEY TO CONTINUE
9500 GETA$:IFA$=""THEN9500
9600 RETURN
9900 DATA367,4,445,4,314,4,189,3,520,5
9910 DATA331,4,468,4,375,4,177,3,424,4
9920 DATA562,5,336,4,208,3,447,4,298,4
9930 DATA543,5,385,4,478,4
    
```

TRS-80 Graphics

by R A Develyn

This program introduces two more either the letter '@' or ':' to reveal the 'shift' keys to allow a range of graphic graphic. A 'bogus' cursor is provided characters to be produced. Prefix any which uses the following controls: letter or a number from 1 to 6 with SPACE Moves the cursor one space for-

PROGRAMS

ward. If the end of screen is reached then it is cleared and the cursor returned home.

↑ Moves cursor up one line. If the cursor is already on the top line it displays '↑'

Shift '↓' Moves cursor down a line. If the cursor is already on the bottom line it

displays '↓'

Shift '<' Backspaces cursor erasing as it goes. If cursor is on top left-hand corner it shows '<'.
Listing courtesy of London Computer Centre

Listing courtesy of London Computer Centre

```

10 CLS
20 FOR X=15360 TO 16383
30 A=0:A$="":A#=INKEY$:IF A$="" THEN POKE X,95:GOTO 30
35 A=ASC(A$)
40 IF A=91 AND X)=15424 THEN POKE X,32:X=X-64:GOTO 30
45 IF A=60 AND X(<)15360 THEN POKE X,32:X=X-1:GOTO 30
47 IF A=33 AND X(<16319 THEN POKE X,32:X=X+64:GOTO 30
50 IF A=64 THEN GOSUB 100
55 IF A=58 THEN GOSUB 120
60 POKE X,A
70 NEXT X
80 GOTO 10
100 B=69
110 GOTO 125
120 B=101
125 A=0:A$="":A#=INKEY$:IF A$="" THEN 125
130 A=ASC(A$):IF A>48 AND A<55 THEN A=A+10
140 A=A+B
150 RETURN
    
```

UK101 Black Box

by C McGregor

This is based on Waddingtons game and sits in just 4k if the instructions are removed. Very nice, all instructions in

the program.
Listing courtesy of Comp Shop

```

4 REM BLACK BOX
5 REM
6 REM
7 REM*****
8 REM* C. MCGREGOR AND J. RALSTON :1979 *
10 CLEAR
20 FOR I=1TO16:PRINT:NEXT
30 PRINT" WELCOME TO BLACK BOX"
35 PRINT:PRINT:PRINT:PRINT:PRINT
40 FOR I=1TO1750:NEXTI
50 FOR I=1TO16:PRINT:NEXT
60 INPUT"DO YOU REQUIRE INSTRUCTIONS?(Y OR N)";Q$
70 IFQ$(0)"Y"ANDQ$(0)"N"THEN60
80 IFQ$="Y"THENGOSUB60000
85 FOR I=1TO16:PRINT:PRINT"THINKING":PRINT:PRINT:PRINT:PRINT:PRINT
90 REM*MATRIX*****
100 DIMA(10,10)
105 FOR I=0TO10:FOR J=0TO10:A(J,I)=0
106 IF I=0OR I=10OR J=0OR J=10 THENA(J,I)=2
107 NEXTJ:NEXTI
110 REM*INPUT NO OF ATOMS*
115 N=1
117 INPUT"HOW MANY ATOMS DO YOU WISH TO FIND";X
118 IFX(10RX)81THEN117
119 REM*RANDOM POSITION GENERATION****
120 FOR I=1TOX
130 K=INT(RND(10)*9+1):J=INT(RND(20)*9+1)
132 IFN=2THEN140
135 IFJ=10RJ=9OR K=10RK=9 THENN=N+1:GOTO130

136 IFJ=10OR K=10 THEN130
140 IFA(J,K)=9 THEN130
150 A(J,K)=9
160 NEXTI
200 FOR I=1TO16:PRINT:NEXT
990 REM*SCREEN DISPLAY INITIAL SET UP*****
1000 S=53324
1001 FE=54270
1002 ST=64
1003 Q=0
1005 FOR I=STOFESTEPST
1008 N=0
1009 IFQ=0OR Q=20RQ=12OR Q=14 THEN1036
1010 FOR J=10TO26STEP2
1015 IFQ=10RQ=13 THENPOKE(I+J),49+N:N=N+1:GOTO1030
1020 POKEI+J,91:POKEI+J+1,93
1030 NEXTJ
1033 IFQ(30RQ)11 THEN1036
1035 POKEI+7,46+Q:POKEI+30,46+Q
1036 Q=Q+1
1037 IFQ=15 THENQ=0
1040 NEXTI
3000 REM*KEYBOARD POLLING*****
10900 POKE530,1
11000 MO=0:AL=0:QT=32:QU=32:HT=2
19010 HT=2
19999 PL=53460:HN=53460
20000 POKE57088,127:TE=PEEK(57088)
20002 IFHT=0 THENPOKE53495,161
20003 IFHT=2 THENPOKE53495,32
20006 IFTE=127 THENMO=MO-1
20007 IFTE=191 THENMO=MO+1
    
```

MICROMART

380Z SOFTWARE
(Supplied on Cassette)

Machine Language Programs:
DISSASSEMBLER – a fast reverse assembler for machine language programs. A must for program modification when listings are not available. £16
WORD PROCESSOR – a powerful 4k program for writing and modifying text. Cassette storage of text, limited only by memory size. Printer output. £19
COS 2.3 and COS 3.0 versions available.
Basic Programs:
CURSOR – gives good control of cursor for drawing diagrams in graphics mode. £5
ROULETTE – the gambling game. £5

FOX INDUSTRIES (COMPUTER DIVISION)
DONCASTER AIRFIELD, S.YORKS.
(0302 57695)

THE INTRUDERS FOR NASCOM 1 OR 2

There is now a NASCOM version of the addictive pub game SPACE INVADERS. Full feature game with extra facilities including 3 levels of skill and practice mode. 3.5K object code runs under any monitor in 5.5K.

Send SAE for full details or for immediate delivery of this superb game send only £10 for object code on tape with object listing and instructions, stating which machine is in use.

Contact:
J. ATKINS, 37 WELLINGTON RD.,
MAIDENHEAD, BERKS. SL6 6DH

APPLE & ITT 2020 BUSINESS SOFTWARE

Professionally written packages now available with comprehensive manuals, built-in validity checks, interactive enquiry facilities, user options, satisfying accountancy, Inland Revenue and Customs & Excise requirements. On diskette under DOS 3.2 in Applesoft with SPACE utility. Not adaptations. Written for Apple System. Support all printer interfaces. Sales, Purchases and General Ledgers £295-00 each. Manual only £3. Payroll £375. Manual only £4. General Ledger supports Incomplete Records, Jobs Costing, Branch and Consolidated Accounts, etc. General Ledger Applications Manual £10. Prices exclusive of V.A.T. From our shop or your nearest stockist.

COMPUTECH SYSTEMS
168, Finchley Road, London NW3,
Tel: 01-794 0202

TOPMARK Computers

dedicated to
APPLE II



Simply the best!

Full details from Tom Piercy on
Huntingdon (0480) 212563

MICROMART

EPROMPT ERASER



- CLEARS UP TO 32 CHIPS IN 30 MINS ON 200-250V A.C.
- CONTINUOUS 253.7nm BEAM, SAFE & SIMPLE, GUARANTEED

* £39 C.W.O. £40 NETT 30 DAYS: ALL INCLUSIVE ! *

TRADE ENQUIRIES INVITED FOR SUBSTANTIAL DISCOUNTS
ALL ORDERS AND ENQUIRIES POST-FREE TO:

TEX MICROSYSTEMS LTD.

FREEPOST, ST. ALBANS, HERTS. AL1 1BR
ST. ALBANS 64077/TRING 4797

HORIZON BUSINESS SYSTEMS

Incomplete Records, Sales,
Purchase, Nominal Ledger,
Letter Writers, Stock Control,
etc.

We write packaged or bespoke
software for

North Star Horizon

MICROSYS LIMITED

58 High Street, Prescott,
Merseyside L34 6HQ.

Tel: 051 426 7271

APPLE or 2020

80 char. x 24 row video board upper &
lower case. Plug into slot 3 & update your
basic disc with supplied master.

English video output a b/w monitor.

£210 + p/p + VAT = £244.95

Pascal update disc = £20 + VAT.

Blink/non blink cursor. Supports light Pen.
Updates old F8 rom to new type editing
functions.

Ideal for professional applic.

Mail Order:

D.M.S. ELECTRONICS

South Anston, Sheffield S31 7EX
0909-78-3918

CARDIFF MICRO CENTRE

PETs

+

SHARP MZ-80s

+

HEWLETT PACKARD

+

COMPUTER BOOKS

SIGMA SYSTEMS

54 Park Place
Cardiff 21515/34869

PROGRAMS

```
20008 IFTE=223THENAL=AL-1
20009 IFTE=239THENAL=AL+1
20010 IFTE=247THEN30000
20020 IFMO(0DRM)10THENMO=5:GOTO20000
20025 IFAL(0DRAL)10THENAL=0
20026 ZX=PL+64*MO+2*AL
20027 IFPEEK(ZX)=91ANDHT=2THENMO=10:AL=10
20028 POKEHN,QT:POKEHN+1,QU
20040 HN=PL+MO*64+2*AL
20045 QT=FEEK(HN):QU=FEEK(HN+1)
20050 POKEHN,62:POKEHN+1,60
20060 FORI=1TO150:NEXTI
20070 GOTO20000
30000 REM*INPUT OF BEAM AND MODE SELECT*****
33000 IFMO=0ANDAL=10THEN20000
33010 IFMO=10ANDAL=10THEN20000
33100 IFMO=0ANDAL=0THEN35700
33105 IFMO=10ANDAL=0THEN38000
33110 IFHT=0THEN36000
33150 IN=PL+MO*64+AL*2:POKEIN,5:POKEIN+1,7
33200 A(MO,AL)=7
33299 REM*BEAM MOVEMENT*****
33300 IFAL=10THENJ=MO:K=9:C=0:D=-1
33400 IFAL=0THENJ=MO:K=1:C=0:D=1
33500 IFMO=0THENJ=1:K=AL:C=1:D=0
33600 IFMO=10THENJ=9:K=AL:C=-1:D=0
33700 N=6
33800 IFA(J,K)=9DRA(J,K)=90THENGOSUB55000:GOTO35000
33900 IFA(J,K)=2THENA(J,K)=7:GOSUB56000:GOTO35000
34000 U=ABS(D):V=ABS(C)
34100 IFA(J+U,K+V)=9DRA(J+U,K+V)=90THENJ=J-C:K=K-D:C=U:D=V
34200 IFA(J-U,K-V)=9DRA(J-U,K-V)=90THENJ=J-C:K=K-D:C=U:D=V
34300 IFA(J,K)=7THENPOKEIN,5:POKEIN+1,7:GOTO35000
34400 J=J+C:K=K+D:GOTO33800
35000 MO=0:AL=0
35010 GOTO20040
35700 REM
35710 IFHT=0THENHT=2:GOTO20000
35720 HT=0
35730 GOTO20000
36000 REM
36010 IFMO=0DRM=10DRAL=00DRAL=10THEN20000
36050 POKE53559,181
36100 P7=PL+MO*64+AL*2
36160 R5=QT
36170 IFR5=42THEN50000
36300 POKEP7,42:POKEP7+1,42:A(MO,AL)=A(MO,AL)*10
36400 GOTO20040
38000 WR=0:FORI=1TO9:FORJ=1TO9
38010 VN=PL+I*64+J*2
38020 IFPEEK(VN)=42THENYZ=YZ+1
38100 IFA(I,J)=90THENWR=WR+1:POKEVN,161:POKEVN+1,161
38200 IFA(I,J)=9THENPOKEVN,161:POKEVN+1,161
38300 NEXTI:NEXTI
38310 IFYZ-X)00THENPRINT"CHEAT:- YOU DON'T DESERVE IT BUT,":GOTO38420
38400 IFWR=XTHENPRINT"WELL DONE SIR.":GOTO38420
38410 PRINT"HARD LUCK, YOU HAD ";X-WR;" WRONG."
38420 PRINT"WANT ANOTHER TRY?"
38430 YZ=0
38500 PRINT"TYPE 1=ANOTHER GAME"
38600 INPUTWQ:IFWQ=1THENRUN10
38650 POKE530,0
38700 END
50000 A(MO,AL)=A(MO,AL)/10
50100 POKEP7,91:POKEP7+1,93
50200 POKE53559,32
50300 GOTO20040
55000 POKEIN,187:POKEIN+1,187:RETURN
56000 EX=PL+64*J+K*2
56010 FORI=1TO10
56020 POKEEX,32:POKEEX+1,32
56030 FORO=1TO50:NEXTO
56040 POKEEX,5:POKEEX+1,7
56050 FORO=1TO50:NEXTO
56060 NEXTI
56070 RETURN
59999 REM*INSTRUCTIONS*****
60000 PRINT"YOU ARE ASKED TO DETERMINE HOW MANY ATOMS YOU"
60005 PRINT"WANT TO TRY AND FIND. THEY WILL THEN BE SPACED"
60010 PRINT"RANDOMLY THROUGHOUT A 2-DIMENSIONAL, 9 x 9"
60020 PRINT"LATTICE. YOU HAVE TO FIND THEM BY INPUTTING"
60030 PRINT"BEAMS OF LIGHT. TO DO THIS YOU HAVE AT YOUR"
60040 PRINT"DISPOSAL A MOBILE CURSOR WHICH RESPONDS TO THE"
60050 PRINT"KEYS 1 THRO' 4 BY MOVING UP,DOWN,LEFT,RIGHT"
60070 PRINT"RESPECTIVELY. WHEN YOU HAVE REACHED THE POINT"
60080 PRINT"ON THE PERIMETER FROM WHICH YOU WISH TO INPUT"
60090 PRINT"A LIGHT BEAM, PRESS KEY 5.
60100 PRINT" IF THE BEAM IS ABSORBED THEN ";CHR$(187):CHR$(187):
60105 PRINT" WILL APPEAR"
60120 PRINT"AT THE INPUT. ON THE OTHER HAND, IF THE BEAM"
60130 PRINT"IS REFLECTED THEN ";CHR$(5):CHR$(7);" WILL";
60135 PRINT" APPEAR AT BOTH THE"
60140 PRINT"INPUT AND, WITH A FEW FLASHES, WHERE THE BEAM"
60150 PRINT"EXITS(IF DIFFERENT) FROM THE LATTICE."
60155 INPUT"PLEASE TYPE 'O'(P.T.O.):";D$
60156 PRINT
60160 PRINT" TO REGISTER A GUESS YOU MAY ENTER THE"
60170 PRINT"LATTICE BY FIRST POSITIONING THE CURSOR"
60180 PRINT"AT THE TOP LEFT HAND CORNER AND PRESSING"
60190 PRINT"KEY 5. A ";CHR$(161);" WILL APPEAR IN THE"
60200 PRINT"TOP RIGHT HAND CORNER OF THE SCREEN WHILE IN"
60210 PRINT"THIS MODE. WHEN YOU HAVE LOCATED YOUR CURSOR"
60220 PRINT"ON THE SUSPECTED ATOM SITE, PRESS KEY 5 TO"
60230 PRINT"REGISTER THE GUESS. THIS MAY BE ERASED IN"
60240 PRINT"THE SAME WAY IF A CHANGE OF MIND TAKES PLACE."
60250 PRINT"TO RETURN TO BEAM INPUT MODE, GO TO THE TOP"
60260 PRINT"LEFT CORNER AND KEY 5. ONCE YOU ARE SATISFIED"
60270 PRINT"YOU HAVE GUESSED THE POSITIONS OF ALL THE"
60280 PRINT"ATOMS, LOCATE THE CURSOR OVER THE BOTTOM"
```

PROGRAMS

```

60290 PRINT"LEFT HAND CORNER AND PRESS 5.
60300 INPUT"P.T.O." :0$
60305 IFO$( )"O"THEN60250
60306 PRINT:PRINT:PRINT:PRINT:PRINT:PRINT
60307 PRINT"SOME POINTS OF POSSIBLE AMBIGUITY:-"
60308 PRINT:PRINT
60310 PRINT"A BEAM INPUT ADJACENT TO AN ATOM SITUATED"
60320 PRINT"ON AN EDGE, WILL BE REFLECTED OUT THE WAY"
60330 PRINT"IT CAME IN."
60340 PRINT"A BEAM ABSORBED AFTER A REFLECTION WILL"
60350 PRINT"PRODUCE AN ABSORPTION SYMBOL AT ITS INPUT"
60360 PRINT"LASTLY, BEWARE MULTIPLE REFLECTIONS."
60365 PRINT:PRINT
60370 PRINT"GOOD LUCK! TYPE GO WHEN READY"
60380 INPUT0$
60390 IFO$( )"GO"THEN60370
60400 RETURN
    
```

Robot Nim for PET

by Bob Chappell

We include this program, not because it is fast (it isn't), but because the graphics are great fun. Listings courtesy of Lion House

```

5 REM**BOB CHAPPELL**14/5/80***
10 DIMA(3,5)
22 PRINT"ROBOT NIM
24 PRINT"DO YOU WANT INSTRUCTIONS (Y/N)";:INPUTA$
26 IFA$="N"THEN70
30 PRINT"THE GAME IS FOR 2 PLAYERS."
32 PRINT"THE AIM IS TO LEAVE YOUR OPPONENT WITH
34 PRINT"ONLY 1 ROBOT LEFT ON THE SCREEN.
36 PRINT"YOU TAKE TURNS AND ON EACH TURN SAY
37 PRINT"WHICH ROW (1-3) AND HOW MANY ROBOTS YOU
39 PRINT"WISH REMOVED FROM THAT ROW.
41 PRINT"YOU MAY ONLY REMOVE THE LEADING ROBOT
43 PRINT"WHEN HE IS THE LAST LEFT IN THE ROW.
45 PRINT"FOR SOUND EFFECTS,CONNECT AN AMPLIFIER
47 PRINT"AND SPEAKER TO PINS M(CB2) AND N(GROUND)
49 PRINT"OF THE USER PORT USING A 15-500 RESISTOR
60 PRINT"PRESS SPACE KEY WHEN READY"
62 GETA$:IFA$=" "THEN62
70 PRINT"AA=59467:BB=59466:CC=59464
78 FORK=1TO3:FORJ=0TO5:A(K,J)=0:NEXT:J
80 P=1:T=1:S$=" ":FORJ=1TO6
90 PRINT"TAB(T);:GOSUB100
96 T=T+7:NEXT:GOTO120
100 PRINT"      S$=" " :RETURN
120 T=1:S$=" ":FORJ=1TO6
130 PRINT"TAB(T);:GOSUB100
136 T=T+7:NEXT
160 T=1:S$=" ":FORJ=1TO6
170 PRINT"TAB(T);:GOSUB100
176 T=T+7:NEXT
200 P$="1" :IFP=2THENP$="2" :PLAYER 2.
205 RR=0:Z$=" " :PRINTZ$:P$;:INPUT"ROW,NUMBER";:R,N
210 IFR<1ORR>3ORR<1ORR>5THEN215
212 GOTO230
215 PRINTZ$:PRINT"      " :GOTO205
230 X=0:FORJ=1TO5:IFA(R,J)=0THENX=X+1
240 NEXT:IFX<NANDA(R,0)=1THEN215
242 IFN<XTHEN250
243 IFN=1ANDR(R,0)=1THEN215
244 IFN>1THEN215
245 RR=1
250 X=0:FORK=1TO3:FORJ=0TO5:IFA(K,J)=0THENX=X+1
254 NEXT:J
256 IFX=NTHENPRINTZ$ " :GOTO200
270 IFP=1THENP=2:GOTO290
280 IFP=2THENP=1
290 B$=" " :IFR>1THENB$=B$+" "
292 IFR=3THENB$=B$+" "
295 IFRR=1THEN4000
300 T=0:X=0:FORJ=1TO5:IFA(R,J)=1THEN360
304 GOSUB330:GOSUB999:GOSUB310:GOSUB332:GOTO350
310 FORK=1TO5:PRINT$TAB(T);:FORK=1TO30:NEXT
320 PRINT$TAB(T);:FORK=1TO30:NEXT:NEXT:RETURN
330 FORYY=1TO10:M$=" ":PRINT$TAB(T);:M$;:GOSUB2000
331 M$=" " :PRINT$TAB(T);:M$;:GOSUB2000:NEXT:GOSUB1000:RETURN
332 M$=" " :PRINT$TAB(T);:M$;:GOSUB1000:RETURN
350 X=X+1:IFX=NTHENJ=5
360 T=T+7:NEXT:GOSUB1000
370 FORYY=1TO10:PRINT$TAB(T);:M$;:GOSUB2200
375 PRINT$TAB(T);:M$;:GOSUB2200:NEXT:GOSUB380:GOTO400
380 PRINT$TAB(T);:M$;:GOSUB2200:RETURN
400 FORL=1TON:TT=0:T=1:X=2:GOSUB1000
402 FORFF=1TO5:IFA(R,FF)=0THENFF=5:GOTO405
404 TT=TT+7
405 NEXT:PRINT$TAB(T);:M$;:GOSUB1000
410 C$=B$+" " :PRINTC$>";:GOSUB2100:PRINT">";:GOSUB2100:FORJ=1TO5
420 IFA(R,J)=1THENFORK=1TO7:PRINT">";:X=X+1:GOSUB2100:NEXT:T=T+7:GOTO430
425 A(R,J)=1:J=5:T=7
430 NEXT:PRINT:GOSUB500:NEXT:GOTO700
500 GOSUB2300
502 PRINT$TAB(T);:M$;:GOSUB2200
510 E$=" " :FORK=1TOX:E$=E$+" " :NEXT:PRINTC$E$:IFL=NTHENRETURN
520 GOSUB605:GOSUB1000:GOSUB380:RETURN
605 PRINT$TAB(T);:M$;:GOSUB2200:RETURN
700 GOSUB605:FORYY=1TO10:PRINT$TAB(T);:M$;:GOSUB2200
701 PRINT$TAB(T);:M$;:GOSUB2200:NEXT:GOSUB1000:GOSUB605
705 X=0:FORK=1TO3:FORJ=0TO5:IFA(K,J)=0THENX=X+1:R=K
710 NEXT:J
720 IFX<1THENPRINTZ$ " :GOTO200
722 B$=" " :IFR>1THENB$=B$+" "
723 IFR=3THENB$=B$+" "
725 FORYY=1TO10:PRINT$TAB(T);:M$;:GOSUB2200
    
```

MICROMART

HORIZON BUSINESS SYSTEMS

Incomplete Records, Sales, Purchase, Nominal Ledger, Letter Writers, Stock Control, etc.

We write packaged or bespoke software for

North Star Horizon
MICROSYS LIMITED
 58 High Street, Prescott,
 Merseyside L34 6HQ.
 Tel: 051 426 7271

µHex EPROM PROGRAMMERS

426 2508/2708/2758/2516/2716
 Dual and Single supply Eproms. £95

416 2704/2708/2716 Dual only. £65

480 2704/2708 Kit £35. Built £40.

All programmers require only standard power supplies. The 426 & 416 are cased and have push-button selection. Program any length block into the Eprom. Software included. Range covers Z80, 8080, 6800 and 6500. State machine.

PIO, PIA INTERFACE MODULES

Available for Z80/8080 and 6800/6500.

Prices include carriage. Please add VAT SAE for further product information.

MICROHEX COMPUTERS

UNION STREET, TROWBRIDGE, WILTS.

Which Way?

• If you're lost in the Micro Maze and don't know which way to turn... turn to us.

• For impartial advice from an independent consultant... consult us.

• For bespoke software designed to meet your needs... you need us.



37 Purbrook Gardens
 Purbrook, Portsmouth
 (Waterlooville 53775)

To advertise in
MICROMART
 Please ring **Jacque Hancock**
 on 01-631 1682

COMPUTER APPRECIATION

86 High Street, Betchingley,
Redhill, Surrey RH1 4PA.
Tel: Godstone (0883) 843221
The used COMPUTER specialists



APPLE II MICROCOMPUTER SYSTEM with 32K bytes, single floppy disc drive, colour board, 9in B/W monitor. CENTRONICS 101A 165 cps printer £1500.00
TELETYPE model ASR 33. Fully refurbished machines always from stock £350.00
TELETYPE Model KSR 33. Various options available at £150.00
TELETYPE Model KSR 33. Printing terminal RS232 and 20 mA version available. £150.00.
DATA DYNAMICS Model ASR 390 terminal. RS232 interface. Under 500 hours on clock. £425.00.
OLIVETTI Model 318 terminal with RS232 interface and reader/punch. ASCII coded with high quality upper case printout. Free stand and accessories. £130.00
OLIVETTI Model 328. As above but refurbished and with excellent quality upper/lower case. With stand and RS232 interface. £250.00.
ITEL Model 1051 Terminal. With golfball typewriter, tape reader/punch and RS232 interface. NEW LOW PRICE £375.00
ITEL Model 841. Similar, but WITHOUT interface, £250.00.
G. E. TERMIPRINTER 30cps Terminal featuring RS232 interface £325.00
TEXAS Silent 700 Terminal £350.00
DIABLO HyType daisy-wheel printer with serial interface and paper tractors £650.00
IBM Model 735 Selectric I/C (Golfball) typewriter £195.00
ODHNER accounting machine incorporating BRAND NEW correspondence coded IBM Selectric 72 typewriter. £175.00
CDC VDU with RS232 interface, printer output 12x80 display £145.00
RECORDING DESIGNS Ltd. Model MTD 10510 7-track NRZI Tape Drive. BRAND NEW in original box with accessories etc. £450.00
PERTEC Model 6640-9-25 9-track P. E. tape drive £495.00
CALCOMP T80 exchangeable disc drive of 80 megabyte capacity. In ex-demo condition (current list price £4,000). £975.00
DIABLO Model 31 high density (2.5 mbyte) cartridge disc drives now available. These are directly compatible with the DIGITAL RK15 and will cable directly to most RK11 type controllers for PDP/LSI 11. Fixed and removable both available at £495.00 and £650.00 respectively.
VERMONT Model 1004-S Memory Drum £75.00
UNIT DATA INCREMENTAL MAGTAPE RECORDER/REPRODUCER, £50.00.
RENA Matrix printer ASCII code. 132 column, 120 cps £275.00
PRINTEC Model 100 LINE PRINTER. 100 cps. Parallel TTL interface and ASCII code £195.00.
CENTRONICS Model 101A printer. With standard and serial interface 165cps operation £650.00
ICL 8K x 12 MOS memory cards. BRAND NEW £35.00.
GNT 50 cps compact desk top tape punch £75.00
MOTOROLA 80 col. card reader with RS232 interface £150.00
TREND HSR 500 optical paper tape reader £225.00
TREND PTS paper tape reader/punch in self-contained box £375.00
LSI 11/2 processor boards, BRAND NEW and dated 79/80 £395.00

* All equipment may be viewed at our premises, but by appointment please.

* VAT and carriage extra all items.

PROGRAMS

```

726 PRINTB#"0012 - ":GOSUB2200:NEXT
727 GOSUB1000:GOSUB605:GOSUB1000
735 PRINT"000000"
740 IFF=2THENP$="PLAYER 1 "
750 IFF=1THENP$="PLAYER 2 "
760 PRINT"0"PF$"IS THE WINNER!!!"
770 PRINT"0000ANOTHER GAME (Y/N)";:INPUTG$:IFG$="Y"THEN70
780 PRINT"0000GOODEBYE!0000":END
998 FORK=1T050:NEXT:RETURN
999 FORK=1T0100:NEXT:RETURN
1000 FORK=1T0500:NEXT:RETURN
2000 LL=INT(50*NRND(1)+205):GOSUB3000:RETURN
2100 POKEAA,16:POKEBB,20:POKECC,55:GOSUB998:POKECC,0:POKEAA,0:RETURN
2200 LL=INT(140*NRND(1)+45):GOSUB3000:RETURN
2300 NN=INT(100*NRND(1)+100):FORJJ=1T08
2310 POKEAA,16:POKEBB,55:POKECC,NN:GOSUB998:POKECC,0:POKEAA,0
2320 NEXT:RETURN
2400 FORKK=1T012:LL=INT(100*NRND(1)+55):GOSUB3000:NEXT:RETURN
3000 POKEAA,16:POKEBB,20:POKECC,LL:GOSUB998:POKECC,0:POKEAA,0:RETURN
4000 T=1:FORYY=1T010:PRINTB#"0012 o ":GOSUB2200
4020 PRINTB#"0012 - ":GOSUB2200:NEXT
4025 GOSUB1000:GOSUB380:GOSUB1000:GOSUB605:GOSUB999:GOSUB380:GOSUB1000
4030 GOSUB1000:GOSUB1000:GOSUB605:PRINTB#"0012 + ":GOSUB1000
4040 GOSUB1000:GOSUB330:GOSUB310:GOSUB332:GOSUB1000:GOSUB1000
4060 GOSUB2200:PRINTB#TAB(T)" . 0001 . 0001 . 0001 . . 0001 . 0001 . ."
4070 GOSUB999:PRINTB#TAB(T)" 0001 0001 0001 0001 0001 0001 ."
4080 A(R,0)=1:GOTO705
    
```

UK 101 Graph plotter

by J R Camp

Here's a neat way of producing graphs using a series of horizontal lines, ideal for those machines without user defined graphics. In this case the characters are

from 128 to 135 inclusive, these being each of the horizontals on an 8 x 8 pixel.

Listing courtesy of Comp Shop

```

5 REM CLEAR SCREEN
10 FOR C=1 TO 15:PRINT:NEXT
20 FOR X=-23 TO 23
30 Y=X*3
35 REM SCALE THE Y AXIS (23*3)=12167
40 Y=ABS(7.5*(Y+12167)/12167)
45 REM SELECT GRAPHIC CHARACTER
50 T=INT((Y-INT(Y))*8)
60 Y=INT(Y)*64:X1=X+23
70 POKE 54221+X1-Y,(128+T)
80 NEXT X
85 REM MARK X AND Y AXES
90 POKE 53284,140:POKE 54244,140
100 POKE 53709,128:POKE 53755,128
110 GOTO 110
120 REM CTRL C TO EXIT PROGRAM
130 END
    
```

LEISURE LINES

With J. J. Clessa

Quite a surprise this month. I thought the turkey puzzle was a bit too easy (in fact one or two people actually wrote in to say just that), but out of the 80 answers received, almost half got it wrong.

The correct solutions were: Last bird eaten — No.63; Xmas dinner 1985 — No.76. Of course there're no guarantees as to what state the birds would be in by that time, but as vegetarians, we don't care.

The winner, selected by random methods, was Miss or Mrs Joan Williams of Kidderminster. Ten C-90 blank cassettes will be posted to you forthwith — congratulations Joan.

Quickie

Not one for health addicts. A man buys a carton of 200 cigarettes, and every day he smokes seven cigarettes less than the day before. Eventually the day arrives when his quota is down to one cigarette — which happens to be all that there is left of the original carton. How many a day was he smoking when he bought the carton?

Sorry, as usual no answers, no prizes.

Prize puzzle

Two numbers, A and B are made up from the digits 0 through 9 using each digit once and once only, and such that the cube of one number is equal to the square of the other — i.e. $A^3 = B^2$. What are the numbers?

Answers please on postcards (I'm still throwing letters in the bin!) . . . I don't even mind what kind of postcard you use. I've had one or two complaints that, by the time some people receive their PCWs, there's just no way they can get the solutions back in time. Okay, from now on I'm going to 'add an issue' to the closing dates. That means this Leisure Lines closes on 31st July, results to be printed in our October edition. Send the solutions to: Puzzle No.11, PCW, 14 Rathbone Place, London W1P 1DE.

Prize of the month

Everyone knows how PCW likes to give people plugs as often as possible. Well, this month is no exception . . . the winner of Leisure Lines No.11 will be receiving twenty 13 amp mains plugs.

BLUDNERS

Last month's TRS80 Model II review contained one error (repeated 3 times).

The £ signs in the 'Reserved Words' box should have been # symbols.

Buy here at discount prices!

Save money-

☆ Full after-sales service in our own workshops

☆ One year guarantee on all machines

Leasing available to companies

Up to 1-6Mb for PET!

and 'on-line' with the Computhink Disc System

*Allows powerful business programmes using 16 Extra BASIC commands. *Easy to connect and use - plugs directly into 16/32K PETs, detailed manual supplied. *Simple startup (no difficult procedures to remember) as Disc Op. System in ROM. *Ready to run - useful programmes supplied free; full set of professionally written business packages available - Sales and Purchase Ledger, Stock Control, Payroll etc.. *Real-Time processing, Engineering and Commercial boundaries overcome with full language support - Business BASIC, Assembler, FORTRAN, COBOL, PASCAL, FORTH, FIFTH, PLM, PILOT & CESIL.

24K Memory expansion with dual disc for old ROM 8K PET £275 for new ROM 8K PET £320

Basic 400K dual disc system

only **£840**

800K £1,095
1.6 Mb £2,190

Credit terms available

The only 16k complete computer for under £400

Keyboard computer, power supply, UHF modulator and all cables to plug into your own TV set and cassette recorder and go!! 16K of user RAM for decent size programmes and data, sophisticated level II Microsoft BASIC. Complete with level I and level II programming manuals. What more could you ask?



Now! Numeric keypad included

TRS-80

£381⁷⁴

Expansion interface £199.09
4K level I computer £251.30

This must be today's best buy!

Get into print this easy way!

Fast! Immaculate! Silent!

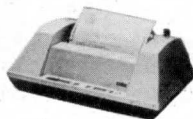

Anadex DP 8000 dot-matrix printer

*Speedy 112 ch/s bidir. *Fits A4 page - up to 80 cols. *Up to 4 copies. *Precision form-filling with sprocket feed. *Special headings using double-width chars. *Modern paper format to match A4 filing systems. *Other paper sizes with adj. sprocket. *Full punctuation, U/L case, £ sign, 96-ch. set. *Reliable - strongly built, 100 M.ch. head.

Knock down price!

£499

Interfaces -
Pet £45 Ohios £10
TRS-80 £40 Sorcerer £8
Apple £45

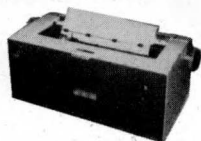

IBM golfball printer ideal for word-processing

*Forget expensive Spin-Wheel printers - the Golfball produces equal quality at up to 15 ch. per sec. *Match various typewriter styles with IBM interchangeable heads. *Completely reliable - each machine rebuilt by IBM trained engineers and fully guaranteed. *Precision form-filling possible with 15 in. pin-feed platen.

Limited supply!

£595

Interfaces -
Pet £45 Ohios £10
TRS-80 £35 Sorcerer £8
Apple £45

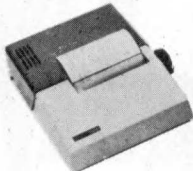

TCM 100 Thermal Printer

*Stop disturbing others with noisy printout! *Neat, clear, 96-ch.set, U/L case & symbols. *Matches Pet/Apple line lengths. *Fast, 40 ch/s bidir. *Reliable - robust - only two driven parts. *Plug in and go, built in PSU, detailed manual. *Thermal paper 4 1/2 in wide x 80 ft, less expensive than electro-sensitive paper.

A snip!

£249

Interfaces -
Pet £45 Ohios £10
TRS-80 £40 Sorcerer £8
Apple £45

While stocks last



PET 2001-8N (8K RAM New large keyboard)

£469

2001 - 16N (16K RAM and new large keyboard) £590
2001 - 32N (32K RAM and new large keyboard) £690

External cassette deck, suitable for all Pets £53
CBM dual drive mini floppy £745
Tractor feed printer with Pet graphics £499
Pet high-res. graphics 200 x 270 £259

You can afford to start computing now! - with the Ohio CI-P

As imported, fully tested, complete with 4K RAM, but unconverted to UK std. (conversion instructions supplied).

£199

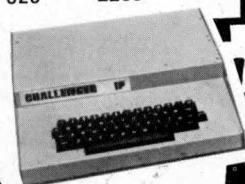

Add £24 for converted model. Extra 4K RAM £39.

*Powerful programming possible - 6502 processor, fast 8K Microsoft floating-point BASIC (easy to learn). Superior utilities, 53 key key-board, giving upper and lower case, user-definable keys, gaming and graphics chs. Ultra-fast and powerful machine code from keyboard. *No intricate soldering or metal work. Computer supplied assembled in ready-made case. *Reasonable sized programmes in 4K RAM. *Expandable to 24K RAM in case, drives discs, printer; available items include Assembler/Editor and Extended Monitor. *Programme interchangeability/reliability - Kansas City tape interface. *Save programmes on own cassette recorder - all cables supplied.

- at a lower price than equivalent kits!

COMPUTERAMA

LTD.

Your dealer for Bath, Bristol and S.W.

Tel: Bath (0225) 28819

We stock components, test instruments, tools etc.

TANDY DEALER

9000 TRUSTCARD VISA

AMERICAN EXPRESS

master charge

BARCLAYCARD VISA

Computerama Ltd.
5 Cleveland Place East
London Rd, Bath, Avon

Credit card orders accepted by telephone for immediate despatch.

Lots of software - ask for list!

Please add £10 Securicord delivery on computers etc plus 15% VAT on all prices

PCW 4

VECTOR GRAPHIC COMPLETE SYSTEMS

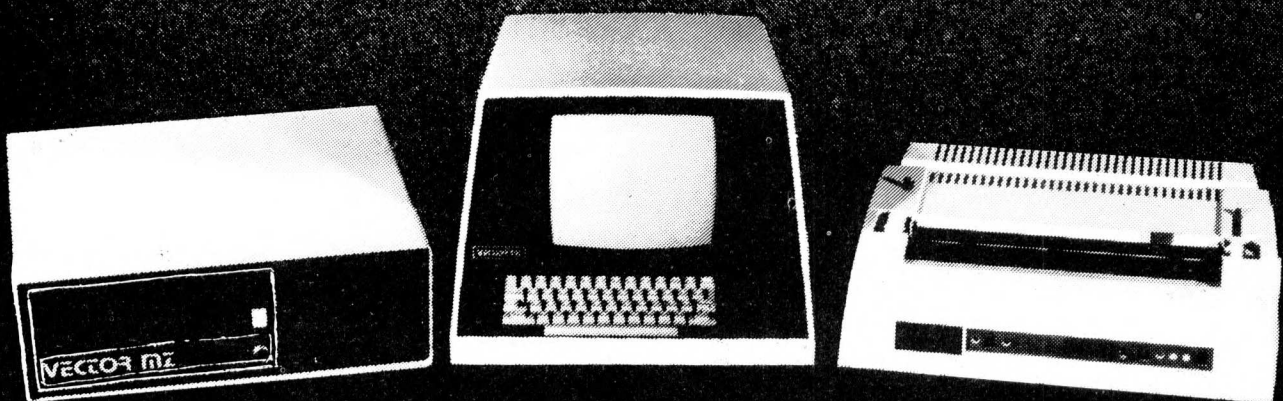

Micro-computers for research, laboratory work, word processing, business systems, Schools, Colleges, Universities and Industry. At Almarc, when you buy Vector Graphic Micro-computers, you get Almarc's experience of over 200 systems installed throughout the U.K. and their back-up of full service facilities carried out by experienced staff. Plus an ever growing list of compatible software including:
Pascal, Fortran, Cobol, APL, Algol, C Basic Compiler, etc.

Vector MZ Spec

- ★ 56K Bank Selectable Ram.
- ★ 3 Serial Ports, 2 Parallel Ports.
- ★ Twin Disc Drives, 630K Capacity.
- ★ 280 CPU, with Fast 4MHZ Clock.
- ★ Prom Programmer (2708).
- ★ Interrupt Handling on I/O Board.
- ★ 18 slot Motherboard.

Vector System B

- ★ Vector Mindless Terminal.
 - ★ Flashwriter II Video Board (24 x 80).
 - ★ MDOS + CP/M2 Operating System.
- Plus Microsoft Version, 5 basic options.
Plus many S100 Bus add-ons, such as Extra Memory, A/D-D/A Boards, High Resolution Graphic, etc.

We will be pleased to demonstrate any of the Vector Graphic Systems, please contact:

ALMARC
DATA SYSTEMS LTD

906 Woodborough Road, Nottingham. Telephone: (0602) 625035

Specialists in Vector Graphic Equipment.

SEE US AT THE
'ONLINE' MICRO SHOW, WEMBLEY
JULY 22nd to 24th
STAND No. 23



COMPUTER WAREHOUSE

NOW OPEN
MONDAY-SATURDAY
9.30-5.30

THE CHIPS ARE DOWN
MOSTEK, INTEL, NEC, MOTOROLA
I.C. PRICES SLASHED!

A massive purchase of brand new "state of the art" data processing equipment enables us to offer the following chips at never, and we mean never to be repeated prices.

8085A-2	Central Processor	£11.99
8155C	256x8 Static Ram	£8.95
8253C	Programmable Interval Timer	£8.95
8255A	Programmable Peripheral Interface	£9.95
8259A-8	Programmable Interrupt Control	£4.75
8755A	2Kx8 Eprom 16 1/0 Lines	£34.50
2716	5volt Single Rail 2Kx8 Eprom	£10.25
2708	1Kx8 Eprom	£4.95
4116	16K Dynamic 250ns Rams 8 for	£28.50
2102	1K Static 450ns Rams 8 for	£6.75
1702	256x8 Eprom	£3.75

And Remember All Chip Prices Include V.A.T.

All above I.C.s are brand new or removed from new unused socketed P.C.B.s. Eproms supplied washed.

All full spec. and guaranteed

HIGH DEFINITION 9" VIDEO MONITOR

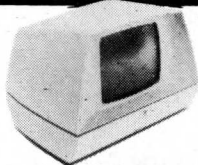

This superb ex computer video monitor was originally used as an information display on large computer systems. It features all silicon electronics, attractive style, housed in shatterproof two colour A.B.S. case with controls under flap. 240v operation, 625 lines, 75 or 50 ohm composite video input 50 Hz - 20 mhz frequency response. Supplied complete in good condition but untested and unguaranteed.

Connect direct to your M.P.U. at only Enquire for carriage charge

£47.50

HY GRADE SMOOTHING CAPS

MULLARD - PLESSEY - MALLORY - SPRAGUE			
1500mf	100v 60p*	3300mf	40v 50p
3300mf	63v 70p*	1mf	600v MYLAR 28p
10,000mf	15v £1+	22,000mf	16v £1.10+
100mf	250v 45p	2100mf	200v £2.50+

*Ex equipment tested +P.P. 40p

SEMICONDUCTOR 'GRAB BAGS'

Amazing value mixed semiconductors, include transistors, digital, linear I.C.'s, triacs, diodes, bridge recs. etc. All devices guaranteed brand new, full spec. with manufacturers markings, fully guaranteed. 50 + BAG £2.95 100 + BAGS £5.15

MUFFIN FANS

Keep your equipment Cool and Reliable with our tested ex-equipment "Muffin Fans" almost silent running and easily mounted. Available in two voltages. 110 V.A.C. £5.05 + pp 65p OR 240v A.C. £6.15 + pp 65p DIMENSIONS 4 1/2" x 4 1/2" x 1 1/2"

ELECTRONIC COMPONENTS & EQUIPMENT
66% DISCOUNT

Due to our massive bulk purchasing programme which enables us to bring you the best possible bargains, we have thousands of I.C.'s, Transistors, Relays, Cap's., P.C.B.'s, Sub-assemblies, Switches, etc. etc. surplus to our requirements. Because we don't have sufficient stocks of any one item to include in our ads., we are packing all these items into the "BARGAIN PARCEL OF A LIFETIME" Thousands of components at giveaway prices! Guaranteed to be worth at least 3 times what you pay plus we always include something from our ads. for unbeatable value!! Sold by weight

2.5kls £ 4.75+pp £1.25 5kls £ 6.75+pp £1.80
10kls £11.75+pp £2.25 20 kls £19.99+pp £4.75

DYNAMIC RAM SCOOP!

INTEL 1103A 18 pin DIL 150 ns IK Rams guaranteed full spec. complete with data.

8 for £2.99 16 for £4.99
32 for £8.50 64 for £13.99
18 pin DIL sockets 8 for £1.60

SHUGART SA800

8" Floppy Disk Drives
from £150.00 + VAT
as new £225.00 + VAT

SUPERVALUE P.C.B. SPECIAL

Another great buy. Board contents include 62 Digital I.C.'s all located in 14 pin D.I.L. sockets. Original cost over £90, our price only £4.95+PP 65p.

OPTO SMASH!

TIL 302/MAN 77 segment LED readout common anode direct drive (via resistors) from 7447 £1-10 each
TIL 119/OC72 Darlington opto isolator 3 for £1.00
TIL305 0.3 7 x 5 matrix LED alphanumeric readouts £3.75 each.
PHOTO TRANSISTOR Fairchild FPT-100 NPN silicon 30v, 25ma. 4 for £1.00.

DISPLAY I.C. AND TRANSISTOR BARGAINS NEVER CHEAPER

All I.C.'s and Transistors by well known manufacturers and fully guaranteed. No fall outs. Comprehensive data on I.C.'s 15p per type.
2N4351 N channel MOS FET.
2N4352 P channel MOS FET.
60p each £1.00 per pair.
HIGH VOLTAGE NPN POWER SWITCHING transistors BVcbo 600v BVceo 500v BVebo 15v Ic 5 amps Pc 125 watts HFE 60 typ ft 2.5 mhz ideal invertors, etc. TO3 £1.60 each 4 for £5.40.
BF258 NPN 250v @ 200ma 45p each 3 for £1.08.
I.R. BS801 2.5 amp 100v bridge rec. P.C. mount long leads 35p each 4 for £1.08.
IN4998 4 amp 100v P.C. mount diodes long leads 14p each 10 for £1.10.
LM309K + 5v 1.2 amp regulator £1.10 each 6 for £5.35.
AGFA C10 computer grade cassettes complete with library cases 68p each, 10 for £5.50
IN4004 SD4 1 amp 400v diodes 7p each 18 for £1.00.
I.R. 12 amp BRIDGE RECS. 400 volt £1.25 each.

POWER DARLINGTON SCOOP!

MJ1000 NPN 60v 90w 8 amps TO3 95p each
2N6385 NPN 80v 100w 10 amps TO3 £1.25 each
MJ4030 NPN 60v 150w 16 amps TO3 £2.25 each

DECADE 0-9 THUMBWHEEL SWITCHES. Stackable, gold plated contacts, dim. 33 x 43 x 8 mm. 90p each, 10 for £5.50.

Miniature Continental Series 12VDC 4c/p on plug in relays £1.30 each.

Greenpar 50i BNC Chassis. socket single hole fixing 65p

C90 Audio Cassettes screw type construction 45p each 3 for £1.00.

Bulbs 24v 14 watt white frosted S.B.C. 8 for £1.00.

Bulbs 12v 100 watt clear, base similar S.B.C. 45p each.

S.B.C. Bulb Holders All steel cad. plated panel mount easily fixed via nut and round hole, ideal disco displays, scoreboards, etc. 4 for £1.10.

VMOS VMP1 Siliconix TO3 power FET 0-60v, DC-200 mhz will drive direct from CMOS etc, £1.50 each, full date 30p.

Heavy Duty Flat Insulated Earth Braid 100-200 amp braided tinned copper in heavy clear PVC sheath 50p per metre. £6 for 15 metres + PP £1 per 15 metres.

BULGIN miniature 6 way male chassis mount socket and matching free plug 60p each, 2 for £1.10.

Red L.E.D.'s full spec. 0.2" 14p each, 10 for £1.25.

Red L.E.D.'s 0.125" 10p each 10 for 80p

Dynamic Stick Mics 600m with built in on/off switch complete with lead and min. jack plug £1.15 each, 10 for £10.00.

TO5 HEATSINKS "Thermaloy" black anodised press on aluminium finned type 18p each, 8 for £1.00.

I.B.M. I/O GOLFBALL TYPEWRITERS

Still the cheapest way to superb quality print, when interfaced they will print at 15 C.P.S. and give indistinguishable copy as if typed by a highly paid secretary! A large range of type fonts make them ideal for all word processor applications, and even without the computer they still function as a quality electric typewriter. Supplied in 2 grades.

1) Good general condition with I/O mechanics/ £295.00 + VAT
electrics may require modification for full correspondence use. Complete with interface data- + CARR

2) Serviced, modified, and ready to go via aculab interface complete £355.00 + CARR + vat

ACULAB parallel to IBM inter- £165.00 + CARR
face for Apple, Sorcerer, TRS80, etc. + VAT

BARGAINS GALORE!

In our walk round Warehouse
NOW open Monday to Saturday 9.30-5.30

FREQUENCY	CASE	PRICE
100 KHZ	HCB/U	£2.95
1.00 MHZ	HCB/U	£2.75
1.00 MHZ	HCB/U	£2.35
1.00 MHZ	HCB/U	£2.25
2.50 MHZ	HCB/U	£2.25
5.00 MHZ	HCB/U	£2.25
8.00 MHZ	HCB/U	£2.25
10.00 MHZ	HCB/U	£2.50
11.20 MHZ	HCB/U	£1.75
20.00 MHZ	HCB/U	£2.80
33.339 MHZ	UART Xtal 38 40 KHz	
SAE for latest XTAL stock list.		

ELECTRONICS
Dept. P.C.W. 64-66 Melfort Rd., Thornton Heath, Surrey. MAIL ORDER
Telephone 01-689 7702 or 01-689 6800 INFORMATION

Unless otherwise stated all prices inclusive of VAT. Cash with order. Minimum order value £2.00. Prices and Postage quoted for UK only. Where post and packing not indicated please add 40p per order. Bona Fide account orders minimum £10.00. Export and trade enquiries welcome. Orders despatched same day where possible. Access and Barclaycard Visa welcome.

In stock now test equipment, microprocessors, teletypes, transformers, power supplies, scopes, sig. gen's, motors, peripheral equipment, I.C.'s, tools, components, variacs, keyboards, transistors, microswitches, V.D.U.'s sub-assemblies + thousands of other stock lines. Just a mere fraction of our vast range, is displayed below: 100's of bargains for callers.

SUPER 77 KEY KEYBOARD KIT

We've done it again! We've purchased a large quantity of CP CLARE top quality keyboard read switches plus full QWERTY keypad sets and thrown in a PCB to enable you to customise the keys just as YOU want them, just add and wire an encoder chip and you can arrange ASCII, BAUDOT, anything! Adding up to a quality keyboard which would normally cost around £100.00. Supplied with layout and assembly info at only £26.99 + £1.50pp.

HOW TO GET HERE

Victoria, London Bridge or Holborn Viaduct to Thornton Heath. 1 minute from Thornton Heath Station.

POWER SUPPLY UNITS

5 VOLT 2.5/8 AMP TTL Made for TTL this compact ex computer systems unit features a 10 amp transformer, DC outputs of 5 volts @ 2.5 amps and 7.5 volts @ 5 amps are available. The 5v output is fully regulated and smoothed with electronic current limiting. May be easily modded for 5 volts @ 7-8 amps. Sold complete with circuit, believed working but untested. £8.25 + £1.60pp.

5 VOLT 3 AMP Ex computer systems, complete on one small chassis, features full regulation and crowbar over voltage protection.
£8.50 + pp 80p

PRINTERS

CENTRONICS 101A 132 column Matrix printer, serial/parallel input £525 + VAT
DATA PRODUCTS 300-1100 L.P.M. 80 column Barrel printer, standard T.T.L. parallel interface £650 + VAT
Many other printers available from £45.00

KEYBOARDS

★ 76 KEY ASCII CASED ★

At last a coded 76 key cased ASCII keyboard at the right price. Housed in an attractive light grey case, this unit was originally made for ICL for use in airport reservation systems so only the BEST parts were used. It has everything, we think, to meet your most exacting requirements, numeric keypad, upper and lower case, cursor controls, single 5 volt rail, serial and parallel data outputs, plus eight LEDs mounted on the case. Supplied with circuits, believed brand new, but may have minor scratches on cases.

Only **£43.50** + £1.60pp

★ LOW PRICE CHASSIS ★



A special bulk purchase enables us to offer the above keyboard at a lowest ever price. 49 coded keys encoded into a direct TTL compatible 7 bit output. Features such as delayed strobe, 5 volt D.C. single rail operation and rollover protection make this an absolute must for the MPU constructor! Supplied complete with connection diagram and edge connector, at a secondhand price of only

£20.00 + P.P. £1.60

SUPER CASED VERSION Same as above spec. but housed in attractive two tone moulded, free standing case. Unit also includes an all TTL parallel to serial converter (no details) etc.

£27.50 + P.P. £1.85

TOROIDAL TRANSFORMERS

HP 240v pri. sec. 2 x 30v @ 4 amps 2 x 18v @ 1 amp £11.00+p.p. £1.95 dimensions 4 1/2" x 2 1/2"
PR 240v pri. sec. 15.0 15 @ 2 amps dimensions 3" x 2 1/2" £4.95+p.p. 99p
TM 240v/110v pri. sec. 15.0 15 8vA dimensions 2 1/2" x 1" £1.95+p.p. 30p
All voltages measured off load.

Plugs, Sockets & Connectors Cannon 'D' Range

Ways	Plug	Socket
9	£1.03	£1.26
15	£1.17	£2.01
25	£1.72	£2.58
37	£2.35	£4.14
50	£2.90	£5.46

25 way ex-equip. plug on socket £1.25
Amphenol 57 series 36 way plug £3.25
Edge connectors, gold plated—

0.1'DS	85 way	£3.99
0.1'DS	45 way	£2.45
0.15'DS	56 way	£3.25
0.156DS	36 way	£2.00

All connectors easily cut to size
1000's of other connectors ex stock

INNOVATIVE

TRS-80 SOFTWARE

FROM THE PROFESSIONALS

NEW!

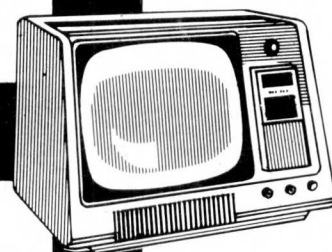
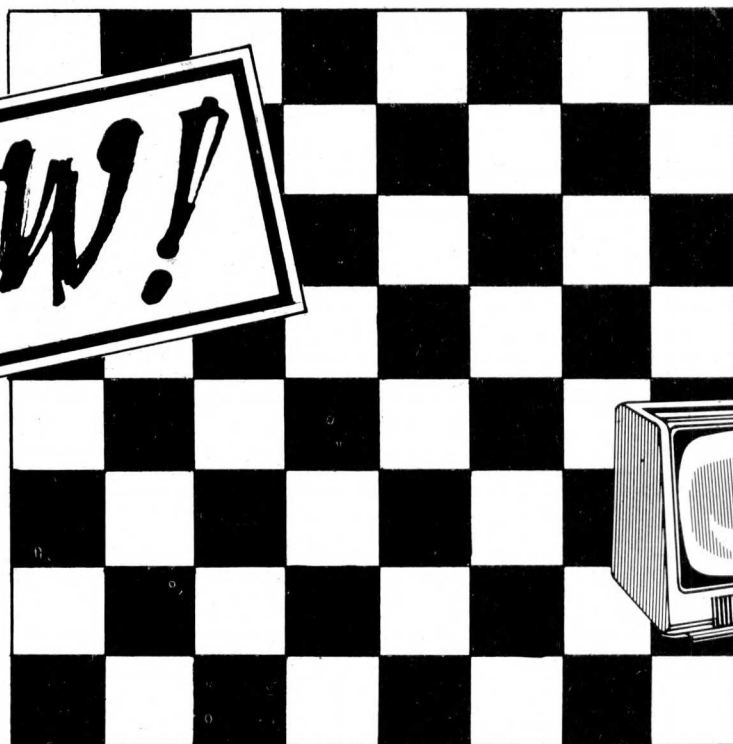

DRAUGHTS

Now for the TRS-80 Model I, following on in the same tradition as the chess playing games of Micro-Chess, Z-Chess and the Sargons, is a new program for playing computer Draughts. Standard rules are followed including Huffing and Crowning. Excellent graphics with a solid black and white chequered pattern board. You can choose from 6 levels of play - it seems to be pretty well unbeatable at the highest level. The computer response time for this machine language program is exceptionally good, varying from less than 1 second to 80 seconds. A special feature allows the player to instruct the computer to play a particularly aggressive game. Levels of play may be changed during play. Supplied on cassette for a 16K or greater memory size or on disk for 32K up. A further example of our continuing search for English written software, we are shortly to sell this program in the USA where no comparable program exists.

£14.95

Inclusive of VAT. Add £3.45 for Disk.
Both plus 75p P & P.



Send large SAE (27p) for our current catalogue of TRS-80 software. Add £1.85 for a binder

A.J.HARDING (MOLIMERX)

28 COLLINGTON AVENUE, BEXHILL-ON-SEA, E. SUSSEX. TEL: (0424) 220391

TELEX 86736 SOTEX G FOR A. J. HARDING



PRINTER SUPERMARKET

COMPLETE SYSTEMS

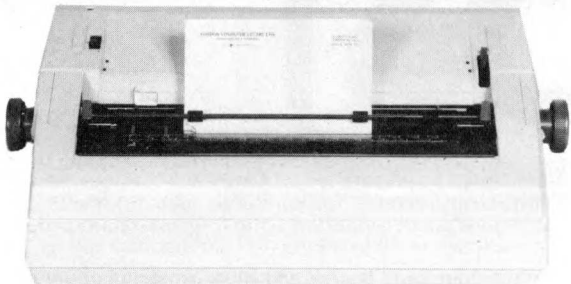

60 CHARACTERS PER SECOND RICOH RP-1600 THE FASTEST DAISY WHEEL PRINTER. £1290

FAST, heavy duty commercial DAISY WHEEL printer, with high quality printout, coupled with low noise necessary for office environment. Nationwide service by NEXOS. 90 day warranty provided at your premises.
124 char: upper/lower case. • 10/12 chars: per inch giving 126 or 163 columns. • 15 inch wide frintion platen. • /reverse Top of the form, BOLDING, underline, and host of other features. • Centronics type parallel interface as standard. options: serial interface 60 • PET interface 65 • APPLE interface 75.

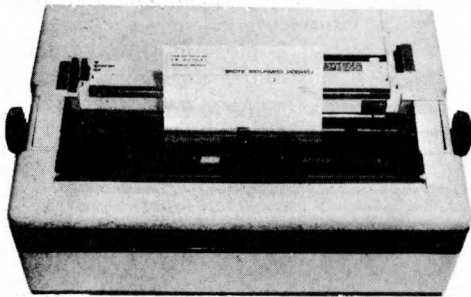

OKI MICROLINE 80/132. THE QUIET PRINTER YOU CAN LIVE WITH £495

THE QUIETEST DOT MATRIX AVAILABLE. 40, 80, OR 132 COLS PER LINE • EXCELLENT PRINT QUALITY • 3 WAY PAPER HANDLING: LETTERHEADS, FANFOLD, OR PAPER ROLLS • GRAPHICS • IDEAL FOR SOFTWARE WRITTEN FOR LARGE 132 COL PRINTERS • CONTINUOUS RATING PRINTING DAY IN AND DAY OUT • CENTRONICS PARALLEL STANDARD. OPTIONS: RS-232, PET, APPLE. DEALER ENQUIRIES INVITED

NEW MAXI ANADEX WITH GRAPHICS £895

Takes up to 13.5 inch wide paper • Upper/lower case with decenders • £ sign • 132 or 175 chrs/line with double width printing • Fast 150 CPS bi-directional logic seeking printing • Heavy duty print head giving 650 million chrs print life • serial, Parallel and Current Loop interfaces built in • Host of other features found on printers costing twice as much.

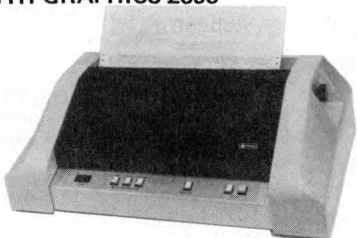

EPSON TX-80 £395

DOT-MATRIX PRINTER PET GRAPHICS. PRINTS 80 COLUMNS ON PLAIN PAPER AT 90 CHARACTERS/SECOND. ADJUSTABLE TRACTOR • UPPER/LOWER CASE • DOUBLE WIDTH PRINTING • MICRO CONTROLLED • SELF TEST • HEAVY DUTY PRINT HEAD USING JEWELL BEARINGS FOR LONG LIFE • MADE BY SHINSHU SEIKI AN AFFILIATE OF SEIKO WATCH CO OF JAPAN. INTERFACE: CENTRONICS PARALLEL, OPTIONS: PET, APPLE, AND SERIAL.

ANADEX DP-8000 NEW LOW PRICE £475

FAST 112 CHARACTERS PER SECOND • BOTH RS-232, AND CENTRONICS PARALLEL INTERFACES BUILT IN • UPPER/LOWER CASE WITH £ SIGN

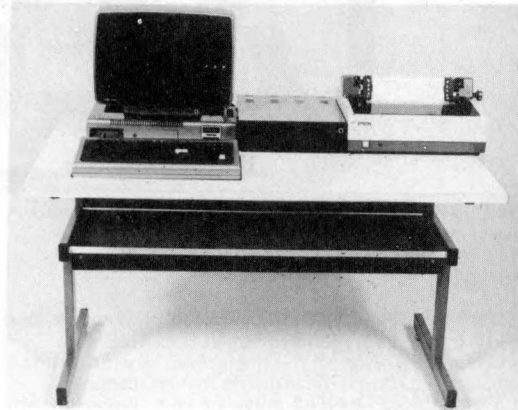
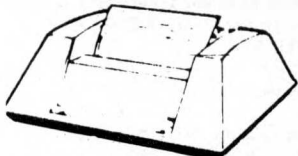

NEW TRS-80 MODEL 1 48K SYSTEM WITH DUAL DISC DRIVES. £1250

NEW GREENSCREEN VDU, WITH ROCK STEADY DISPLAY, REDESIGNED 32K EXPANSION INTRFACE WITH TROUBLE FREE DISC OPERATION, TWO 40 TRACK TEAC DISC DRIVES, COMPLETE WITH CABLES. TRIDATA SALES, PURCHASE, INVOICING, PAYROLL PACKAGES AVAILABLE.

WITH DESK AND EPSON PRINTER £1750

NEW SUPERBRAIN £1875



NOW WITH CP/M 2.2, & INCREASED DISC STORAGE. TWIN Z 80-A 4MHZ • 2 DOUBLE DENSITY DISC DRIVES, GIVING 320 K STORAGE • 64 K RAM. • HIGH RESOLUTION 12 INCH CRT. 80 x 24 LINES UPPER/LOWER CASE • 2 RS-232 PRINTER PORTS • CPM 2.2 OPERATING SYSTEM • MBASIC, COBOL, FORTRAN, PASCAL, WORD PROCESSING & ACCOUNTS PACKAGES AVAILABLE. DEALER ENQUIRIES INVITED

TRS-80 MODEL £1999



STATE OF THE ART SECOND GENERATION COMPUTER. OVER 10,000 ALREADY SOLD IN USA, 8 SLOT BUS ENSURES EXPANSION OF HARD DISCS & OTHER PERIPHERALS, 76 Key professional keyboard, self test on POWER UP. TRSDOS & LEVEL III BASIC STANDARD. CP/M AVAILABLE AS OPTION, making a wide range of accounting, educational, scientific & word processing packages instantly usable. NATIONWIDE SERVICE THROUGH 180 TANDY STORES & COMPUTER CENTRES.

LOW COST WORD PROCESSOR I

BASED ON TRS-80 LEVEL 2 16K, CASSETTE RECORDER, ELECTRIC PENCIL SOFTWARE, UPPER/LOWER CASE MOD, PRINTER INTERFACE AND OKI DOT MATRIX PRINTER. COMPLETE READY TO GO £1095. FREE MAILING LIST PROGRAM. WORD PROCESSOR II SAME AS ABOVE BUT WITH 48K, 2 DISC DRIVES AND RICOH DAISY WHEEL PRINTER £2575

WORD PROCESSOR III

BASED ON SUPERBRAIN COMPUTER SHOWN ABOVE. WITH RICOH PRINTER & "MAGIC WAND" THE ULTIMATE IN WORD PROCESSING. LETTERS AUTOMATICALLY FORMATTED WITH ADDRESSES FETCHED FROM SEPARATE FILE. COMPLETE SYSTEM £3395 INVOICING, STOCKCONTROL, SALES LEDGER, PURCHASE LEDGER, PAYROLL AVAILABLE FOR ABOVE COMPUTERS. FROM £250 PER PACKAGE.

PRICES QUOTED ABOVE DO NOT INCLUDE VAT. PHONE OR CALL FOR FURTHER DETAILS OR DEMONSTRATIONS.

LONDON COMPUTER CENTRE LIMITED

43, GRAFTON WAY, OFF TOTTENHAM COURT ROAD, LONDON W1
TEL: 01-388 5721 OPENING HRS: 11-7 MON-FRI, 12-4 SATS.

MICRO SYS LTD
58 HIGH STREET
PRESCOTT
MERSEYSIDE TEL: 051 426 7271

NOTHERN DEALERS

HORIZON SOFTWARE LTD
REGENT HOUSE
16 WEST WALK
LEICESTER LE1 7NG TEL: 0533 556550

ALTOS

The ALTOS ACS 8000 range of business/scientific micro computers creates a new standard in quality and reliability in high technology micro computers.

High Technology

Floppy Disk System The ACS 8000 single board Z80 floppy disk based micro computer utilises the ultra reliable Shugart 8 inch, IBM compatible, disc drives, double density — single sided, and providing 1 M. byte of data storage. Featuring the ultimate in high technology hardware: a fast 4 MHz.Z80CPU, 65 kilobytes of 16 K dynamic RAM, 1 kilobyte of 2708 EPROM, an AMD 9511 floating point processor (OPTIONAL) a Western Digital floppy disc controller, a Z80 direct memory access (OPTIONAL), Z80 parallel and serial I/O two serial RS232 ports, 1 parallel port) and a Z80 CTC Programmable Counter/Timer (real time clock). In essence, the best in integrated circuit technology.

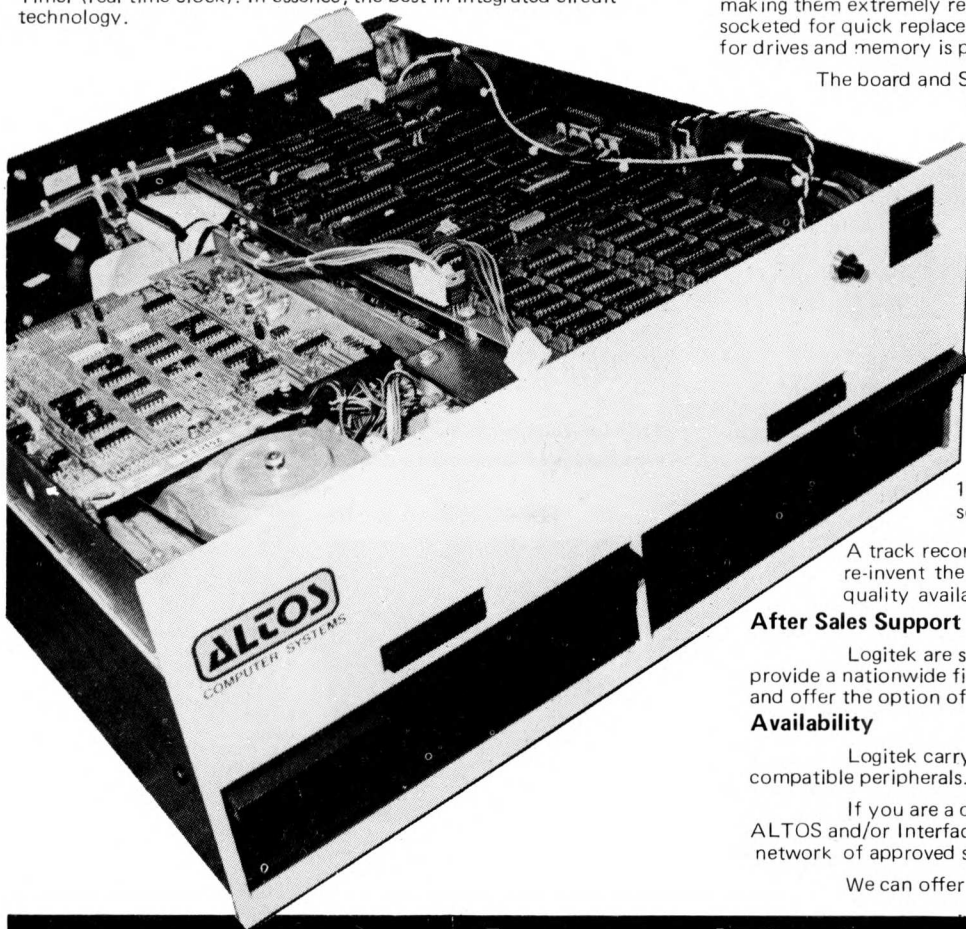

Hard Disk/Multi User Systems The Winchester hard disk/multi user systems are now available supporting up to 4 simultaneous users and providing a maximum of 58 Megabytes of hard disk data storage.

The systems are truly flexible and allow expansion of the ALTOS floppy disk system to keep pace with the users requirements.

Still single board, features include * a high speed I/O section with up to six serial ports and one 8 bit Parallel port * up to 208K of on board RAM.

*High speed (4 MHz) D.M.A. control as standard.

Yes, mini power and at micro cost too.

Built-in Reliability

The ACS 8000 range are true single board micro computers making them extremely reliable and maintainable. All electronics are socketed for quick replacement. Complete diagnostic utility software for drives and memory is provided.

The board and Shugart floppy disk drives are easily accessible and can be removed in less than ten minutes.

Quality Software

Unlimited versatility. The ACS 8000 range support the widely accepted CP/M and MP/M operating systems plus basic (Microsoft and CBasic), Cobol, Pascal, and Fortran IV. All available now.

Logitek in conjunction with its own microsoftware house, Interface Software Ltd. of Camberley are able to supply a wide range of proven 'off the shelf' business software including general accounting, word processing, stock control, mailing list etc.

There are already over 1000 micro computer installations using this software.

A track record which we consider speaks for itself. Why re-invent the wheel' when there is standard software of this quality available now?

After Sales Support

Logitek are supported by DDT Maintenance Ltd. who provide a nationwide field maintenance service for ALTOS products and offer the option of maintenance contracts.

Availability

Logitek carry deep shelf stocks of ALTOS hardware and compatible peripherals.

If you are a dealer who may be interested in promoting ALTOS and/or Interface Software by joining the fast growing network of approved suppliers, contact Logitek.

We can offer you something rather special now.

Approved Dealers

SCOTLAND: Aethrotol Consultancy Services, Tel: 041-641-7758/9. Robox Ltd., Tel: 041-221-5401. Peter MacNaughton and Associates, Tel: 073-888-267.
NORTH EAST AND YORKSHIRE: Shermac Computers, Ltd., Tel: 0632-837405. Monitor (Data Processing) Ltd., Tel: 0423-60670. Metrodata, Tel: 0532-623788.
Derwent Electronics Ltd., Tel: 0904-53990. Sheffield Computer Centre, Tel: 0742-53519. NORTH WEST: Computer Business Systems, Tel: 0253-730033.
Minicom Business Machines, Tel: Kirkham 686617. B & B Computers Ltd., Tel: Bolton 26644. Kewill Systems Ltd., Tel: 0706-44337.
MIDLANDS: East Midlands Computer Services, Tel: 0602 267079. Evans Jackson, Tel: 0522-30371. Microspecific, Tel: 0572-2528.
Saba Computer Systems Ltd., Tel: 021-643-2021. CLE-COM, Tel: 021-444-3618 or 021-472-8233. SOUTH WEST: Validata Services, Tel: 0225-705957.
Opco Ltd., Tel: 0285-75225. BEDFORD: Starwest Computer Services, Tel: 0234-57135.
SOUTH EAST INCL. LONDON: Boyd Microsystems Ltd., Tel: 01-950-0303. Computer Systems Analysis, Tel: 02813-85389. Silicon Chip, Tel: 0753-70639.
Micro Market, Tel: 01-979-9824. Systematika, Tel: 01-485-3634. Logic Box, Ltd Tel: 01-222-1122. Profac Computer Services Ltd., Tel: 0276-25247.
Kewill Systems Ltd., Tel: 09322-22448. Action Computer Services Ltd., Tel: 01-502-1311. EAST ANGLIA: Proloc Computer Services Ltd., Tel: 0502-714038.
SOUTH: Software Development Services, Tel: 0962-68956. Wendmore Management Services Ltd., Tel: 04895-6318.
CHANNEL ISLANDS: Jersey European Airways, Tel: 0534-44171.

LOGITEK

LOGITEK, E.I.C. Electronics Ltd. All enquiries to: Portland St. Chorley, Lancs. Tel: 02572-66803
also at: 30 Kelvin Ave., Hillington Industrial Estate, Glasgow, G52 4LH.

Floppy Disk Systems AT LOW COST

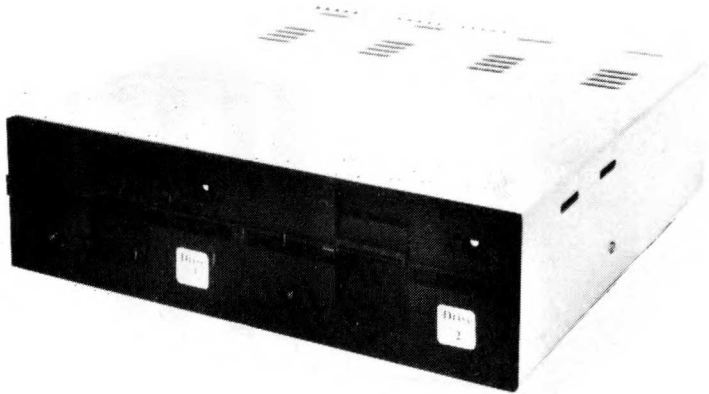

FOR THE APPLE® II and ITT® 2020

- * Mains Powered Dual Disk Unit.
- * 2 Disks Each Giving 116K Bytes.
- * Completely compatible with Apple® II and ITT® 2020 Disk controller cards.

Height: 92 mm Width: 149 mm
Length: 300 mm Weight: 7.8 Kg.

DUAL DISK UNIT £498

FOR THE TRS80, SWTP, SUPERBRAIN,
NORTH STAR HORIZON, HEATHKIT ETC. ETC.

40 Track single disk unit	£236
77 Track single disk unit	£345
40 Track Dual disk unit	£440
77 Track Dual disk unit	£645

- * Mains powered disk systems
- * Shugart SA400 Interface compatibility
- * Daisy chain up to four drives

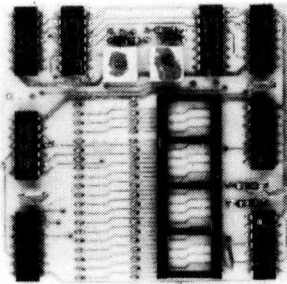
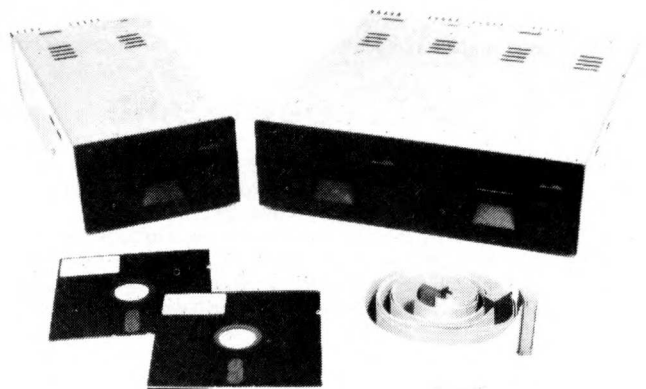

FOR TRS80 USERS

The PERCOM DATA SEPARATOR eliminates read and verify errors on the inner (higher numbered) tracks of your Disk Systems. Plugs into the expansion interface. No soldering – takes 5 minutes to fit.

£20 WITH FULL INSTALLATION INSTRUCTIONS

TRS80 DISK CABLES:	2 Drive Cable	£22.50
	4 Drive Cable	£34.00

Call your nearest dealer for a demonstration:

London Computer Store, 43, Grafton Way, London W1. Tel: 01-388-5721

Katanna Management Services, 22 Roughtons, Galleywood, Chelmsford, Essex. Tel: 0245-76127

Sevet Trading, 14, St. Paul's Street, Bristol 2. Tel: 0272-697757

EWL Computers Ltd., 8, Royal Crescent, Glasgow Tel: 041-332-7642

Data Plus Computer Services, 67, Bridge Street, Manchester. Tel: 061-832 3265

**CUMANA LTD., 35, Walnut Tree Close, Guildford,
Surrey. GU1 4UN.
Tel: (0483) 503121
Telex: 859680 (Input G)**

*Please add VAT to all prices.
Delivery at cost will be advised
at time of order.*



XITAN SYSTEMS

*LOOK AT THESE
NEW PRICES*

CROMEMCO SYSTEM 3

£4,412.00 for this system with vdu.

The ideal business system. System includes a full 64K fast RAM, dual full-size floppies (Persci 277), RS232 interface/20mamp loop for console device, parallel printer port (Centronics/Anadex compatible), 21 slots for expansion, Lear Siesler 24 lines or 80 chars vdu, and ... CROMEMCO's CDOS operating system with their 14 digit BCD extended disk Basic — ideal for those accurate large numbers required by successful businesses. CDOS is CP/M functionally equivalent, with many extra facilities. Optional extras from Xitan include Fortran, Cobol, Text Formatting, Z-80 macro-relocating assembler and DBMS at £59.00 each. CIS interactive screen handling Cobol at £425.00 (recommended to serious business users), Cromemco S100 boards, CP/M (we are an authorised oem distributor of Digital Research's CP/M) for the System 3, Wordmaster, Wordstar, Supersort, and CPM374X utilities.



COMING SOON! ... Full 7-terminal multi-user operating system from Cromemco for System 3 users. Up to 48K per user, all running independently. This operating system has to be seen to be believed. It will run any of the Cromemco provided and supported software packages, in any combination. Features include partition rescue facilities, allocating more memory to users, real-time clock for time/date stamping of jobs and disk queueing techniques. Buy your System 3 now, expand later as you need it.

S100 BRITISH COLOUR BOARD

We are proud to offer the first BRITISH S100 Colour board. Manufactured by a local Southampton company — Hi-tech, we can thoroughly recommend this product. Features include true PAL colour generation for high-definition on your television or colour monitor, 15+ colours and black/white with 6 additional grey scales, 24 lines with 40 characters per line, with standard character set plus 44 numbers and symbols, and 64 computer selected graphics symbols. Symbols include fractions and the £ symbol. Plotting is available at 80 x 72 resolution. Single or double-height characters, with flashing on an on/off duty cycle of 3-1. The board is memory mapped on any 2K boundary, with its I/O port set at any of the 256 available on the S100 bus. Just plug into your S100 system and colour television and go! Driver software and documentation provided. Price £295.00ex vat cash with order. Please specify if for television or 75 ohm monitor.



ON DEMO NOW! The Cromemco Z2-H.

For only £5,380.00 set the reliability and quality of Cromemco, coupled with the capacity of the new IMI 11 megabyte hard disk drive. This is incredible value for money. Specification includes transfer rates of up to 10 times faster than the fastest standard floppy disk, DMA controller for up to 7 hard disk units, and the new extended CDOS operating system. Systems available in three configurations: — A) The Z2-H complete integral system, 64K RAM, Z80A cpu, two double-sided mini-floppies, RS232 console port, parallel printer port, power supplies, cables, case and 12-slot S100 motherboard (7 slots free). B) Additional hard disk subsystem for existing system 2 or system 3 users consisting of one hard disk, DMA controller, power supply, case and cable. C) As unit B but with two hard disks. Prices: Unit A) £5,380.00
B) £4,330.00
C) £7,420.00

Xitan Systems also supplies and stocks vdus, printers, NORTH STAR HORIZON computers, Commodore Business Machines PETs, S100 boards, and books. We are here to demonstrate the range of quality microcomputer systems available for use today. Ring up for an appointment now! You'll not be disappointed. We have Osborne's Sales Ledger and Payable Ledger in source form for use on Cromemco System 3 with CBASIC2, and we can offer a customising service on these programs. Additional software includes Microsoft Basic Interpreter and Compilers, Cbasic, Macro80, and CP/M for the North Star Horizon.

Xitan Systems Ltd., 23 Cumberland Place, Southampton SO1 2BB.

Tel: (0703) 38740

Hours Tue-Sat 9.30 am to 5.30 pm



COMPLETE COMPUTER SYSTEMS



BUY — FROM CCS Microsales

THE A B C of MICROCOMPUTERS

A — IS FOR APPLE

- The Apple is great in a business environment, with our commercial systems software.
- An Apple based Word Processing System is available for only £1990, including software.
- File management/database systems available.
- For the technically minded there are CCS boards, including Arithmetic Processor, ROM, IEEE 488 interface, Synchronous and Asynchronous Serial Interface, and an A-D converter.
- * 18 months guarantee included

B — IS FOR A BIGGER BASIC

- The ABC 80 has a 16K BASIC in ROM, is very fast, has excellent editing facilities, and is beautifully made.
- KEYBOARD, screen and digital cassette for only £738
- The ABC80 can be a PRESTEL terminal, a terminal to a modular development system OR a PDP II or an IBM mainframe.
- 35 I/O and special purpose boards allow the ABC 80 to interface with test instruments OR to control machines.

C — IS FOR COMMODORE

- 8K with original keyboard now only £375.
- New keyboard PETS available on all sizes, (8K £399, 16K £499 & 32K T.B.A.).
- PET dual disc (340K) or Compu/Think dual disc (800K) available (3040 disc £649). Also PET printer.

NEW EXTRA LOW PET PRICES

* on purchases exceeding £900

HIRE — FROM CCS Microhire

- The leading microcomputer hire company.
- Available are: Apple, PET, Exidy Soccer, Seed System One/ MSI 6800, NASCOM/MICROS, and the Tandy TRS 80.
- Peripherals also available, and software!
- New monthly rates — £79 to £99 per month (8K to 48K).

CCS Microsales

and

CCS Microhire

WE HAVE RELOCATED! Visit or contact us at our new showroom

7 The Arcade
Letchworth
Herts

Tel No. (04626)-73301
Telex 261507 (Ref 3244)

S Software for TRS80®

ACCEL Compiler for TRS80 BASIC

Speeds execution of correct Level 2, BASIC programs by compiling the common statements to Z80 machine-code.

- Develop and debug normally.
- Compile for production work.

ACCEL (16K) Great value at.....£19.95

DLOAD	Load program segments.....	£4.95
ZBUG	Debug Z80 programs.....	£11.95
TSAVE	Prepare system tapes.....	£4.95
RENUM	Renummer BASIC programs.....	£5.95
FGRAPH	Fast Graphics.....	£4.95
XREF	Program cross-reference.....	£5.95
SDUMP	Symbolic dump.....	£2.95
LIFE	(16K) 48 x 64.....	£3.00
USRN	Multiple USR calls.....	£2.95



Southern Software programs are self-relocating, load-anywhere, machine-code, well documented. They run in 4K Level 2, unless otherwise stated.

SOUTHERN SOFTWARE PO Box 39, Eastleigh, Hants. SO5 5WQ

Due to expansion we are pleased to announce the opening of our new Computer Shop in Edgware.

We specialise in this system.



Call in and see these systems:

Word Processing. Stock Control/Invoicing.
Incomplete Records. Accounting Systems Information.
Retrieval. Payroll. Games. Programming Tutorials
and many others.

If you don't see what you want we will probably be able to get it for you.

Pet prices start from £495.00

We also stock the QUME Sprint 5 Daisy Wheel printer for the best quality word processing. Also call us for the latest second hand equipment supplies.

Open Mon-Sat
9 - 5.30

Easy parking at rear of shop.
Entrance Whitchurch Lane



Davinci Computer Shop
65 High Street
Edgware
Tel. 952 0526



INTELLIGENT ARTEFACTS LTD

DISCOUNT PETS

8K PET WITH LARGE KEYBOARD £445
16K £535 32K £650 CASSETTE £54
DUAL FLOPPY £730 PRINTER £390
CABLES £25 OR £10

BASE 2

PRINTER 800ST £375 TRACTOR FEED;
STEPPING MOTOR; 3 INTERFACES;
3 CHARACTER SETS; FULLY PROGRAM-
MABLE

TEXAS TI 99/4 £569

THIRD GENERATION MICROCOMPUTER —
OPTIONS INCLUDE SPEECH SYNTHESIZER,
JOYSTICKS, ROMPAK SOFTWARE

EXPAND YOUR AIM 65

SEAWELL LITTLE BUFFERED MOTHER
WITH EXTRA 4K RAM £150
ALSO 16K RAM, PROTO-BOARDS ETC.
DISK SYSTEM COMING SOON

S100

16K STATIC RAM £150
VOICE I/O — P.O.A.
TECHNICAL BACKUP FROM MAPCON
ENGINEERS

PRICES ARE EXCLUDING VAT

INTELLIGENT ARTEFACTS LTD
Cambridge Road, Orwell, Royston, Herts.
Telephone: Arrington 689

INTELLIGENT ARTEFACTS LTD

BUSINESS SYSTEMS

FOR SMALL COMPANIES
COMPLETE WITH SOFTWARE

£3300 +VAT
comprising

NORTH STAR HORIZON

PRINTER, VDU, READ TO GO.
FULL LEDGER SOFTWARE WITH
PROFESSIONALLY TESTED MANAGEMENT
ACCOUNTING:

PAYROLL £55
ACCOUNTS PACKAGE £510
JOB COSTING £110

HARD DISK VERSION

WITH 18MB WINCHESTER DISK
£6,600 +VAT
SOFTWARE TAILORING SERVICE

INTELLIGENT ARTEFACTS LTD
Cambridge Road, Orwell, Royston, Herts.
Telephone: Arrington 689

KINGSTON

KINGSTON — KRK 1

A hardware repeat key for the PET number/cursor pad — a boon to the busy programmer and the ambitious games programme writer. Aided by the detailed instruction programme the average PET owner can upgrade his machine in a couple of minutes without fear of a fatal 'no-no'. **£17.50**

KINGSTON — KRK 2

Initially the KRK 2 was conceived as a definitive full keyboard repeat key. However, Kingston ingenuity has optimized on their patented board accessing techniques to allow two invaluable features to be added:

The first, a warm keyboard reset from otherwise fatal crashes. The second, a selectable keyboard tone which allows touch entry at otherwise impossible speeds. We can say with confidence that this unit is an absolute must for any PET user who wants to get the best from his machine. **£35.00**

KINGSTON — KC 1

A totally new concept in PET's communication with the outside world. At long last the programmer is free from the limitations of the IEEE bus. INPUT, PRINT, LOAD and SAVE to an external RS232 device are now possible without recourse to ingenious/tedious software. A comprehensive on-board firmware package allows all manner of hitherto impossible functions to be achieved including keyboard selectable configuration with full modem control. **£135.00**

KINGSTON — KC 2

Having achieved one level of impossibilities, we knew someone would need more so here it is —

Simultaneous access to two RS232 serial devices or networks with all the features of the KC 1 and more besides. With this device we give PET users serial RS232 I/O capabilities, which the owners of much more expensive machines would envy. **£150.00**

KINGSTON — KSB 1

A twenty-way RS232 multiplexing/switching box with 'mind-blowing' potential — Applications of the unit are legion and range from simple networking through multiple disc sharing to multidevice complexes based on a single processor. **£350.00**

CMC ADA 1200

A low budget IEEE 488/RS232 unidirectional interface, with a proven record of reliability (Field failure rate better than .1 percent). Since the unit is not addressable it is not recommended for use with the Commodore Disc. **£65.00**

CMC ADA 1400

An addressable IEEE 488/RS232 unidirectional interface, which is proving even more reliable than the ADA 1200 from which it was developed. While it was designed to offer only standard RS232 output it is sufficiently 'beefy' to cope with a number of less demanding current loop applications without modification. **£90.00**

CMC SADI

SADI — The microprocessor based serial and parallel interface for the Commodore PET. SADI allows you to connect your PET to parallel and serial printers, CRT's, modems, acoustic couplers, hard copy terminals and other computers. The serial and parallel ports are independent allowing the PET to communicate with both peripheral devices simultaneously or one at a time. In addition, the RS232 device can communicate with the parallel device. Special features for the PET interface include:

- Conversion to true ASCII both in and out.
- Cursor controls and function characters specially printed.
- Selectable reversal of upper and lower case.
- PET IEEE connector for daisy chaining.
- Addressable — works with other devices.

Special features for the serial interface include:

- Baud rate selectable from 75 to 192000.
- Half a full duplex.
- 32 character buffer.
- X-ON, X-OFF automatically sent.
- Selectable carriage return delay.

Special features for the parallel interface include:

- Data Strobe — either polarity.
- Device ready — either polarity.

Complete with power supply, PET IEEE cable, RS232 connector, parallel port connector and case. **£175.00**

CMC AIM 161

A low budget IEEE 488 16-channel analogue to digital convertor for the competent programmer who wants to 'do his own thing'. With a 5.12 volt reference voltage the unit is normally accurate to better than .5%. **£90.00**

CMC PETSET

An AIM 161 specially configured for plug-in and switch-on use by the less technically graced user. The unit has a number of helpful extras including an input connector board allowing simple screw connection to the outside world. **£135.00**

CMC APPLESET

Similar to the PETSET, saving that the unit is configured for use with the APPLE. **£135.00**

CMC TANDYSET

Similar to the PETSET saving that the unit is configured for the TANDY TRS80. **£135.00**

CMC XPANDR 1

Analogue to digital conversion of up to 128 channels can be achieved by simply connecting as many 16-channel AIM 161 units as you need through this smart board. **£40.00**

**T
N
W**

Corporation

TNW 2000

With over 2,000 units sold, this IEEE 488/RS232 interface can truly be said to be tried and tested. Features include the conversion of both PET and true ASCII, daisy chaining and full address selection.

- Standard RS232.
- Current Loop.

£135.00
£150.00

TNW 3000

A bi-ported, bi-directional IEEE 488/RS232 interface offering everything the discriminating programmer could ask for. Features include independent crystal controlled Baud rate on both ports and fully implemented RS232 with extensive control line options allowing responsive throttling. **£220.00**



SSM — A10

Two powerful APPLE interface boards in one:

The first an RS232 serial with three handshaking lines (RTS, CTS and DCD), rotary switch selection of nine standard baud rates from 110 to 19200, including 134.5 for selectrics and the modes of serial communication under software control.

The second a double bi-directional parallel with four additional interrupt and handshaking lines, and interface configuration under software control. **£105.00**

NOTES

- Every Kingston product is carefully burned in and tested before dispatch.
- Kingston's guarantee, warranty and service undertakings are probably the best in the business — If you would like to see what real customer concern is all about, then send for a copy of our standard Guarantee Form!
- All prices quoted by Kingston are inclusive of packaging and shipping, but do not include V.A.T. — Please add 15% V.A.T. to any order.
- We have a number of new and exciting products 'in the pipeline' including:
 - A family of rugged, low budget EPROM programmers and duplicators.
 - A number of new cost effective printers, including daisywheels and single and double pass (better quality) matrix.
 - A low cost TRS expansion.
 - A flexible/expandable industrial control system.
 - Emergency standby power units, ranging from a .5 KVA baby to a 9.5 KVA mainline system.

If you have an interest in any of these items, give us a call. As you might expect from a company which prides itself in being different, we maintain an engineer on call eighteen hours a day, seven days a week to help you.

KINGSTON COMPUTERS LTD
Scarborough House, Scarborough Road, Bridlington. Telephone 0262 73036



IF

..... you want the best service
 you need professional advice
 years of experience impress you
 you are trying to find the best computer equipment
 as well as the finest software

MICROSOLVE

is the Company to contact

MICROSOLVE COMPUTER SERVICES LTD

3rd Floor (rear),
 MIDDLESEX HOUSE,
 29-45 High Street,
 EDWARE,
 Middlesex.
 (exit 4 M1/20 mins. West End).
 (prices ex. VAT)

01-951 0218/9/0

We cover a full range of equipment including
 the APPLE II (from £695/16K); the
 MICROSTAR multi-user system (from £4,950)
 and the powerful ALPHA MICRO which will
 run 1 to 22 terminals — the most cost
 effective system available today.

WE OFFER A COMPLETE SERVICE which
 encompasses advice, systems design, sale
 and installation of computer and peripherals, as
 well as tailor-made software, where necessary.
 There are fully documented ACCOUNTING
 and WORD PROCESSING PACKAGES etc., for
 Accountants, Solicitors, Manufacturers,
 Retailers, Medical Practitioners in fact all
 business applications.

ALSO in stock are PRINTERS, VDUs,
 CONTINUOUS STATIONERY, DISKETTES,
 DISK BOXES, all from the best names
 in the computer world — TEXAS, LEAR
 SEIGLER, TALLY, QUME, PAPER TIGER etc.

So if you either wish to buy a computer to
 program yourself or take advantage of our service
 TELEPHONE NOW FOR AN APPOINTMENT.

MICROSOLVE MICRO SOLVE

Personal demonstrations available at all times in our new showrooms at
 30 Lake Street. Also a large range of personal computers, books and
 magazines. Barclaycard and leasing available.

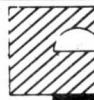

CompUtopia LIMITED

30 Lake Street, Leighton Buzzard, Bedfordshire
 Tel: (0525) 376600 24 hour Answering Service.

apple



SOFTWARE	
Computech Purchase Ledger	295.00
Computech Sales Ledger	295.00
Computech General Ledger	295.00
Computech Payroll	375.00
Computech Utilities	20.00
Plus Software from Databank and many more.	
HARDWARE	
Apple 16K Video Output	£695.00
Disc Drive with Controller	349.00
Disc Drive w/o Controller	299.00
Pascal Language system	299.00
Integer Card	116.00
Eurocolour Card	79.00

PERIPHERALS

PRINTERS

Texas Instruments Omni 8 810 Printer	£1450.00
Paper Tiger Printer with Graphics	598.00

MONITORS

VM129 Hitachi 12" B&W Video Monitor	187.00
VM910 Hitachi 9" B&W Video Monitor	127.00

ACCESSORIES

Floppy Disk 5¼" Hard & Soft sectored pack of 10	30.00
Floppy Disk 8" Hard & Soft sectored pack of 10	35.00
C12 Computer cassettes pack of 10	4.00
Computer Stationery on request	

ACORN

A complete range of single
 boards and accessories
 available.

System 1 Kit	£65.00
System 1 Assembled and tested	79.00
System 2 Kit	285.00
System 2 Assembled and tested	320.00
System 3 Kit	670.00
System 3 Assembled and tested	735.00

EPSON

PRINTERS

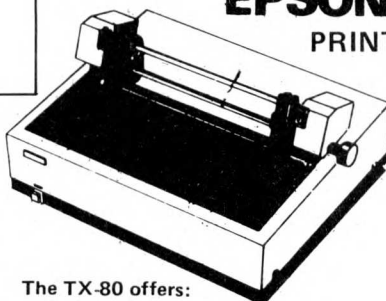

The TX-80 offers:

- 96 Ascii char. set and Pet
- 80 col 150/125 char/sec
- Condensed line, Enhanced print
- 5x7 dot matrix, 6x7 dot matrix
for graphics

Prices starting from £395 including delivery

Interface boards and cables available for
 Pet, Apple, TRS 80, 1EEE488 and serial
 etc.

DEM Prices available.

THE VIDEO GENIE SYSTEM EG 3003



At last, value for money
 in microcomputers.

£425 incl VAT

- *16k User RAM plus 12k Microsoft BASIC in ROM
- *Fully TRS 80 level II software compatible
- *Huge range of software already available
- *Self contained, cassette, PSU & UHF modulator
- *Simply plugs into video monitor or UHF TV
- *Full expansion capability for disks & printer

L.S. CHIP PRICES

74LS02	0.22
74LS08	0.22
74LS10	0.22
74LS32	0.30
74LS74	0.50
74LS86	0.45
74LS93	0.85
74LS100	0.20
74LS132	1.15
74LS138	1.05
74LS175	1.00
74LS191	1.30
74LS244	2.65
1488P	0.95
1489P	0.95

MEMORY CHIPS

5116	each	6.40
	for 8	48.00

apple[®]/ III USERS

8" DISK DRIVES 1 MEGABYTE ON-LINE

Available either as:

- | | | |
|-----------------------------|---------------|-----------------|
| 1. COMPLETE SYSTEM | £ 1533 | + V.A.T. |
| 2. ½ MEGABYTE SYSTEM | £ 1233 | + V.A.T. |
| 3. CONTROLLER ONLY | £ 285 | + V.A.T. |

FARMPLAN / SVA
Netherton
Ross-on-Wye
Herefordshire

Tel: 0989 4321



Scotland's Complete Microcomputer Service

now supply and support:

HARDWARE:

Apple II Systems and Peripherals
Commodore Business Systems
A wide range of VDUs, printers, etc.

SOFTWARE:

Incomplete Records Accounting
Sales Ledger
Purchase Ledger
Nominal Ledger
Stock Control
Payroll
Word Processing
Database

Software can be tailored to your requirements or written completely to your specifications.

Our service is comprehensive, ranging from advice on system selection through installation and implementation, to operator training and comprehensive Hardware and Software maintenance.

You don't have to take our word for it.

Call us and arrange a demonstration.

GATE MICROSYSTEMS LTD.,
THE NETHERGATE CENTRE,
66 NETHERGATE,
DUNDEE.
TEL: (0382) 28194.

TANGERINE

COMPUTER SYSTEMS LIMITED

"MICRON" the latest line in superb products from TANGERINE.

- 6502 based microcomputer
- VDU alpha numeric display
- Powerful monitor TANBUG
- 8K RAM
- 32 parallel I/O lines
- 2 serial I/O lines
- RS 232 C/20mA loop, with 16 programmable Baud rates
- Four 16 Bit counter timers
- CUTS cassette recorder interface
- Data bus buffering
- Memory mapping control
- 71 Key ASCII Keyboard, including numeric keypad and with auto repeat
- Including metal cabinets for both keyboard and modules
- Including power supply

IOK Microsoft BASIC

- All the usual BASIC commands
- Integer and real numbers
- Integer and real arrays
- Intrinsic functions ABS, INT, RND, SGN, SIN, SQR, TAB, USR, ATN, COS, EXP, LOG, TAN.
- User defined functions
- READ and DATA statements
- Dump and load programs for cassette recorders
- Program editing command
- String function for text I/O
- BASIC can call user machine-code sub routine
- User machine-code interrupt handler interfaces with BASIC

£375.00
inc. VAT
&
P&P

For full details send 12p stamp to
Tangerine Computer Systems Limited,
Forehill, Ely, Cambs. Tel: (0353) 3633

Name

Address

TANGERINE

COMPUTER SYSTEMS LIMITED

SUPPORT MEMBERS OF THE COMPUTER RETAILERS ASSOCIATION. . .



THEY WILL SUPPORT YOU.

For further details on the associations aims, membership, code of conduct etc.

Please contact: Mrs H. Gibbons, C.R.A., Owles Hall, Buntingford, Hertfordshire. (0763) 71209.



Micro-Computer Centre for the MIDLANDS

Nascom and Commodore Specialists

A full range of micro computers and peripherals are available, whether buying or browsing we can give helpful and friendly advice.

Commodore Business Systems are suitable for the professional office, the small business or the sole trader. We will be pleased to give advice and a demonstration.

Nascom 2 systems can be fully built and tested to order. We are sole distributors for the **Micro Type case** for Nascom 1 and 2, also stockists of the **William Stuart colour graphics** and full range of 'add-ons'.



Business & Leisure Micro Computers

16 The Square, Kenilworth, Warwickshire CV8 1EB.

Tel: (0926) 512127

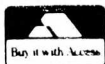

The complete range
of computer systems under one roof

Commodore
System



HB COMPUTERS LTD

22 NEWLAND STREET, KETTERING NORTHANTS.

Tel. (0536) 83922 & 520910 Telex 341297

DATRON of SHEFFIELD

for
Cromemco the ultimate name in micros



DATRON import direct from Cromemco, California.
 DATRON can supply Nationwide.
 DATRON can provide maintenance nationally
 DATRON can give you the realistic prices.
 DATRON have in stock:-

SYSTEM 2 64 K £ 2095

SYSTEM 3 64 K £ 3398

10 M HARD DISC £ 5373

DATRON can supply Systems 2 and 3 with
 Multi-Tasking facilities. (Hard Disc soon)
 DATRON easily accessible - in the centre of
 the country.

Write or telephone for FREE colour brochure on System 3 or Z-2H.

We use Cromemco for our own business, why not call in for a demonstration.

Demonstrations. 9am - 5pm Monday - Saturday.



BOOKS from DATRON

all books in stock at press date

The BASIC Handbook	David Lien	£11.00
Illustrating BASIC	Donald Alcock	£2.50
Basic BASIC	Donald M. Munro	£2.00
The Little Book of BASIC Style	Nevison	£5.75
Some Common Basic Programs	Osborne	£7.95
32 BASIC Programs for the PET	Rugg & Feldman	£9.75
A guide to BASIC Programming	Spencer	£8.85
A guide to PL/M Programming	McCracken	£7.95
PASCAL An Intro. to Methodical Prog.	Findlay & Watt	£4.95
Introduction to PASCAL	Welsh & Eider	£6.95
Programming in PASCAL	Gragono	£6.95
Primer on PASCAL	Conway et al	£7.10
Struct. Prog. & Problem Solving with PASCAL	Kiebertz	£8.40
Problem Solving using PASCAL	Bowles	£7.95
An Introduction to Programming and Problem Solving with Pascal	Schneider	£5.20
COBOL for Business Applications	Philippakis	£10.25
COBOL with Style	Chmura & Ledgard	£5.40
Learning COBOL Fast	de Rossi	£6.45
FORTAN Techniques	A. Colin Day	£2.95
FORTAN Fundamentals	J. Staingraber	£3.45
Problem Solving & Struct. Prog. in FORTRAN	Friedman & Koffman	£9.95
An Intro. to Prog. & Applications with FORTRAN	Hull & Day	£8.45
Z80 Micro Handbook	W. Barden	£6.95
Z80 Programming for Logic Design	Osborne	£6.30
Z80 Micro. Prog. & Interfacing Bk. 1	Nichols & Rony	£7.75
Z80 Micro. Prog. & Interfacing Bk. 2	Nichols & Rony	£8.50
Z80 Instant Programs	J. Hopton	£7.50
Z80 Programs (cassette)		£10.00
Z80 Assembly language Prog.	Leventhal	£8.15
Z80 Programming for Logic Design, Programming the Z80	Osborne	£6.30
Mostek Z80 Micro Software Programming Guide	Zaks	£8.95
6502 Assembly language Prog.	Leventhal	£8.25
6502 Applications Book	Sybox	£8.95

Programming the 6502	Zaks	£7.95
Programming a Micro (6502)	Foster	£7.25
PET Work Books Vol. 1-6		£18.00
6502 Assembly Language Programming, The Best of Micro, Vol. 1	Leventhal	£8.25
Vol. 2		£5.50
		£6.50
The PET Revealed		£10.00
Intro. to Personal & Business Computing	Zaks	£5.45
Peanut Butter & Jelly Guide to Micros	Willis	£6.45
A Career in Computing	Penney	£4.25
Philips Guide to Bus. Computers & the Electronic Office	Enticknap	£3.50
Computer Games	Nahigian & Hughes	£8.40
Basic Computer Games	Creative Computing	£5.50
More Basic Computer Games	Creative Computing	£5.50
Game Playing with BASIC	Spencer	£5.50
How to Build a Computer Controlled Robot	Loofbourrow	£5.95
TTL Cookbook	Lancaster	£7.15
CMOS Cookbook	Lancaster	£7.50
TV Typewriter Cookbook	Lancaster	£7.25
Cheap Video Cookbook	Lancaster	£4.95
Best of Byte		£8.45
Best of Creative Computing Vol. 1		£6.95
Best of Creative Computing Vol. 2		£6.95

P&P free U.K. Overseas add £1

Phone in your Access
 Barclaycard No
 0742 585490
 or complete this
 order form

Send s.a.e. for full list. Prices correct at
 going to press. Add 12p insurance on
 books if required.

Please supply

I enclose - £

Cheque/Postal Order No.

Barclaycard/Access No.

Name:

Address:

DATRON MICRO CENTRE
 DATRON INTERFORM LTD

2 Abbeydale Road, Sheffield S7 1FD.
 Telephone 0742-585490. Telex 547151.

Philips Mini-Digital Cassette Recorder.

CASSETTE RECORDER

The Mini-Digital Cassette Recorder (Mini-DCR) can operate in the following modes: Idle, Read, Write, Backspace and Rewind. Complementing the quality and reliability of the Mini-Digital Cassette Recorder are Philips mini-cassettes certified for digital data recording applications. These mini-cassettes use tape which is certified for freedom from drop-outs. Mini-cassettes have been widely used for program loading in Philips office computers during the last four years, and over half a million are already in service. Low cost, low power consumption and compact size of the Mini-Digital Cassette Recorders mean they are ideal for program loading and updating applications as well as providing a highly convenient data capture facility.

Ample capacity for program loading and data interchange is provided by the 128 k byte capacity, and the high data transfer rate of 6000 bits/sec allows quick reading and writing of programs and data.

PRICES INCLUDING MANUAL
MINI D.C.R. £95 ea. + VAT
INTERFACE from £42.50
INCLUDE £2.25 FOR CARRIAGE ETC.

Manual available separately price £10.00. Refundable on receipt of order.

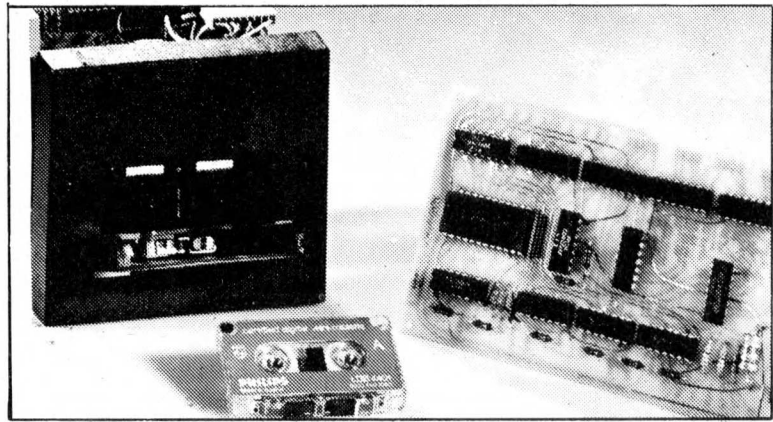

INTERFACE BOARD

This compact interface board was designed specifically for the purpose of interfacing the Philips Mini DCR to a Micro-computer. Power consumption is very low, enabling it to be powered from the micro-computer that it is serving. Flexibility of the system was held as paramount, address decoding can be changed simply by moving links.

By using subroutines held in the micro-computer to control the system the user can make his controlling program to suit his own particular needs and can be as simple or as complicated as necessary.

CURRAH

COMPUTER
COMPONENTS

79 Crowland Rd. Hartlepool Cleveland.
TS 24 2JN. Phone 0429 / 871900

Superboard II

8k MICROSOFT BASIC 4k RAM
- comes ready built (no hidden kit repair charges)
fully expandable to 32k dual floppy
system with printer.

Standard Superboard 50Hz **£159.95 + VAT**
610 Expansion Board 8k RAM **ONLY £159.95 + VAT**

IP CD3P Minifloppy Disc, Cased, PSU, 2 copies DOS **ONLY £275 + VAT**

4k RAM **ONLY £24 + VAT**

Plastic Case, Beige **ONLY £26 + VAT**

Challenger IP-Metal Cased, Superboard, PSU modulator **ONLY £219 + VAT**



50Hz version
- NO FLICKER

Super Print 800

80 COLUMN HIGH PERFORMANCE IMPACT PRINTER

The ideal companion for PET, APPLE, TSR80, Exidy, Superboard, Compukit, Ohio Challengers and most micro's

Rugged metal enclosure makes it ideal for home computing, small business systems, data logging etc.

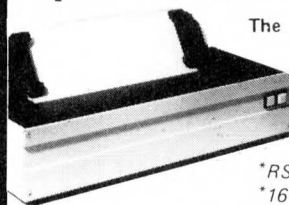

Probably the most highly featured printer for the lowest cost!

- *RS-232, 20mA, IEEE 488 and Centronics I/O
 - *16 Baud Rates to 19,200
 - *60 Lines per minute - Bidirectional
 - *5 print densities 72,80,96,120 or 132 Chr/Line
 - *Self Test Switch *2k Buffer
 - *Tractor and Fast Paper Feed/Graphics
- Model 800 MST **ONLY £399 + VAT**

Low price PETS

- large keyboard
16k - **£549 + VAT**
32k - **£649 + VAT**



ZT DRIVING COMPUTER



NEW

*MPG Instant *MPG Average *Gals. used since fillup *Miles to empty *Elapsed time
*Time to empty **ONLY £77.50 + VAT**

SOFTY

INTELLIGENT EPROM PROGRAMMER

Connects directly to TV. Develop, Copy, Burn, Verify 2708, 2716 and with modification 2516.

ONLY £120 + VAT Built & Tested
£100+VAT Kit. £20+VAT BuiltPowerSupply

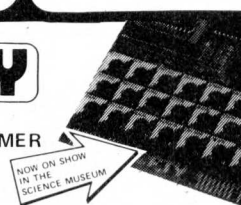

NOW ON SHOW IN THE SCIENCE MUSEUM

VIDEO GENIE based on TRS80

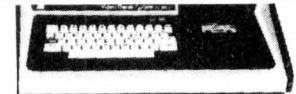

Utilises Z80, 12k level II Basic, 16k RAM, Integral Cassette Deck, UHF O/P, all TRS80 features **ONLY £369 + VAT**

STRINGY FLOPPY



NEW

Combines economy of cassette with speed & reliability of disc. (TRS80 exp.int.not req.) **ONLY £189 + VAT (inc. 20 wafers (Tapes)**

!!!! SPECIAL SCOOP !!!!

Verbatim Discs in fives

5 1/4" - **£1.85 (each) + VAT**

8" - **£2.20 (each) + VAT**

Mighty Micro

In association with Watford Electronics

BUY IN CONFIDENCE: In the event that we are unable to deliver your goods within 7 days, we do not bank your remittance until such time we have the goods to despatch. If on receipt of your order, the goods do not meet with your satisfaction, return within 7 days for full refund. All goods covered by manufacturers guarantee.

Please add VAT at 15%. Carriage extra, will advise at time of order. Official orders welcome. Product details on request. Trade and export enquiries welcome.

33 CARDIFF ROAD, WATFORD, HERTS. Telephone: (0923) 38923

PO Box 17, 61 NEW MARKET SQ, BASINGSTOKE, HANTS. (0256) 56417

Mail Order and Enquiries to Basingstoke



MEET THE FAMILY



... THERE MUST BE ONE HERE FOR YOU

The Exidy family is a sophisticated range of products designed to meet the ever increasing variety of computing needs, including home and business uses, educational and laboratory applications, industrial process control etc.

The Exidy range has been designed with built-in growth capacity to take the risk factor out of computer investment. The Sorcerer Computer now has a memory expansion capability from 8K up to 48K within its own cabinet, enabling the system to grow with your needs plus the ability to add many additional plug-in facilities such as disk drives and pre-programmed ROM PAC's.

The standard configuration includes a 63 key typewriter-style keyboard and a 16 key numeric pad. Remote control for dual cassettes. Serial RS232 and parallel interfaces, Z80 processor, 4K resident operating system, 8K Microsoft BASIC in separate plug-in ROM PAC cartridge, 64 character x 30 line display, 128 upper/lower case ASCII character set and 128 user defined graphic symbols, operators manual, introduction to basic programming, connecting leads. All Exidy equipment is backed up by a 12 month warranty covering both parts and labour.

The Word Processing ROM PAC features auto wraparound, dynamic cursor control, variable line length, global search and replace, holding buffer for re-arrangement of text, right justification, line width and line to line spacing, underlining or boldfacing, text merging and a macro-facility permitting tasks such as formletter typing, multiple column printing of automatic forms entry.

Or send coupon
for further information to:

SOLE DISTRIBUTORS

Geoff Wilkinson
LIVEPORT DATA PRODUCTS
The Ivory Works, St. Ives, Cornwall.
0736-798157

Now contact your nearest dealer:

The NORTH
BASIC COMPUTING, Oakville, Oakworth Road, Keighley, W. Yorkshire. 0535 65094
E. S. MICROCOMPUTERS, 7 Berkeley Precinct, Eccleshall Road, Sheffield S11 8PN. 0742 668767
GLYSTHYDON LTD., Nook Farm, Rake Lane, Warton, Preston, Lancs. 0772 633138
MICRODIGITAL, 25 Brunswick Street, Liverpool L2 0BJ. 061 277 2535
MICROPUTE, 7 Westbourne Grove, Manchester M20 8JA. 0625 612 759
MAGNUM CONSULTANTS, 57 Fairburn Drive, Garforth, Leeds. 0532 867897
T.W. COMPUTERS, 293 London Road, Hazelgrove, Stockport. 061 4568187

MIDLANDS
M & R SYSTEMS, 20 Norwich Road, Wisbech, Cambs. 0945 5900
MIDLAND MICROCOMPUTERS, 1 Cherry Wood Drive, Aspley, Nottingham. 0602 298 281
GRIFFIN & GEORGE Birmingham, Manchester, London, Eastkilbride 01-997 3544

LONDON and the SOUTH EAST
MICROBITS, 34b London Road, Blackwater, Camberley, Surrey. 0276 34044
SLOUGH MICROSHOP, 120 High Street, Slough, Berks. 0753 22855
HOME & BUSINESS COMPUTERS, 445 High Street, Manor Park, London E12. 01-472 5107
E. M. G., 30 Heathfield Road, Croydon, Surrey CR0 1E4. 01 688 0088
INFORMEX LTD., 8-12 Lee High Road London SE13. 01-318 4213
N.I.C., 61 Broad Lane, Tottenham N15. 01-808 0377
TVJ MICROCOMPUTERS, 165 London Road, Camberley, Surrey CU15 3JS. 0276 62506
C.C.S. MICROSALES, 7 The Arcade, Letchworth, Herts. 046 26 73301

WALES and the WEST
ELECTROPRINT, 5 Kinsdown Parade, Bristol BS6 5UD 0272 292375
G W P ELECTRONICS, 55 Cobham Road, Fern Down Industrial Estate, Wimborne, Dorset. 0202 893838
TRYFAN COMPUTERS, 3 Swifts Buildings, High Street, Bangor, Gwynedd LL57 1UW. 0248 52042
TVJ MICROCOMPUTERS, 48 Gloucester Road., Bristol 0272 422061
LIVEPORT. DATA PRODUCTS, The Ivory Works, St. Ives, Cornwall 0736 798157

PLEASE SEND DETAILS OF THE EXIDY RANGE

NAME _____

ADDRESS _____

TOMORROW TODAY

at
Birmingham Computer Centre

Commodore official distributors



3016, 3032, 3008 PETS
The reliable value for money system with after sales support, instruction and training facilities and a wide range of programmes.



3040 DUAL DRIVE FLOPPY DISC
The latest in disc technology. Low cost with reliable data transfer.

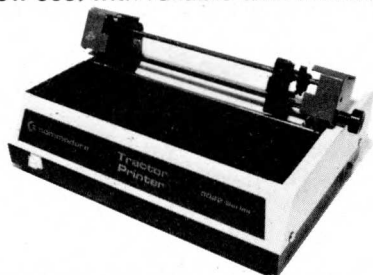

3022 PROFESSIONAL PRINTER
The high specification printer. Prints all PET characters onto paper and accepts labels, printed forms, cheques etc.



Apple authorised distributors
The sophisticated quality system with a reputation for advanced design and innovation.

**Camden Electronics, First Floor,
462 Coventry Road, Small Heath,
Birmingham B10 0UG.
Telephone 021 773 8240
Open Mon.-Sat. 9.30-6.00 p.m.**

A MEMBER OF THE COMPUTER RETAILERS ASSOCIATION

Explorer/85

Professional Computer Kit

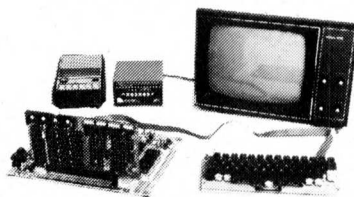

AT
£295 + VAT

FLEXIBILITY: Real flexibility at LAST
The EXPLORER/85 features the Intel 8085 cpu
100% compatible with all 8080A and 8085 software. Runs at 3MHz.
Mother Board (Level A) with 2 S-100 pads expandable to 6 (Level C).

MEMORY
2K Monitor ROM
4K WORKSPACE/USER RAM
1K Video RAM
8K Microsoft BASIC in ROM

**WITH
ONBOARD S-100
EXPANSION**

INTERFACES
STANDALONE FULL ASC11 Keyboard Terminal, 32/64 characters per RS-232/20Ma Loop. 4, 8bit: 1, 6 bit 1/0 ports, programmable 14 bit binary counter/timer. Direct interface for any S-100 Board.
FULL Buffering decoding for S-100 Bus pads, wait state generator for slow memory. Each stage has separate 5v 1A regulator for improved isolation and freedom from cross talk. P.S.U. requirements: 8v 6.3v AC. Runs with North Star controller and Floppies/CPM: EXPLORER/85 is expandable to meet your own requirements with easy to obtain S-100 peripherals. EXPLORER/85 can be purchased in individual levels, kit form or wired and tested OR as a package deal as above.

Hitachi Monitor 9" £127

16k Dynamic RAM Kit

Expandable to 64K on one S-100 board in 16K increments, designed for NO wait state operation utilizing the most advanced RAM controller.
16K RAM Kit £139.00
16K RAM Expansion Kits each £89.50

NOW : - EXPLORER/85 with NORTH STAR FLOPPY DISCS

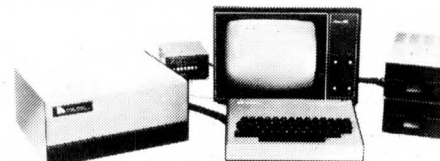

32K £599
48K £698
56K £787
North Star Double Density Disc System, 3-drive controller and a Single 5 1/4" Drive with regulator, 180K byte . . . £500
Twin Drive System £600

PETS CENTRE

LATEST PET's WITH LARGE KEYBOARD

8K	£475	*RRP £795 for 32K
16K	£575 +VAT	
32K	£675	

BASE 2 PRINTER £450
PROGRAMMERS TOOLKIT, £50

Full range of software available.



SEND SAE FOR COMPREHENSIVE BROCHURE

Please add VAT to all prices. Please make cheques and postal orders payable to NEWTRONICS or phone your order quoting BARCLAYCARD, ACCESS number.

We are now open for demonstrations and Sales, Monday-Saturday 9.30am. 6.30pm. Near Highgate Underground, on main A1 into London



Newtronics



255 ARCHWAY ROAD, LONDON N. 6

TEL: 01-348 3325

Buying Computers?

Commodore PET 32K
£675.75 plus VAT



Sharp MZ-80K
£520.00 plus VAT

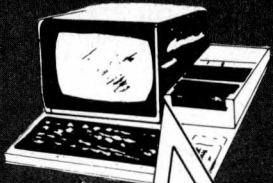

ITT 20/20 16K
£623.00 plus VAT

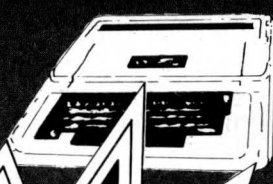

ACT 808 inc dual
disk drive
£3950.00 plus VAT

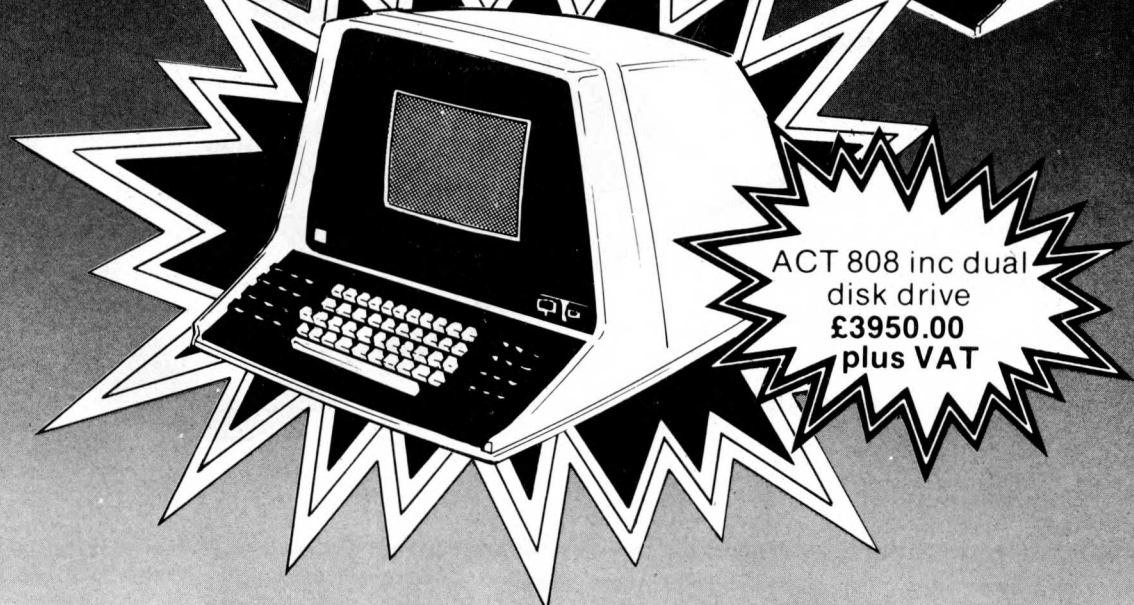
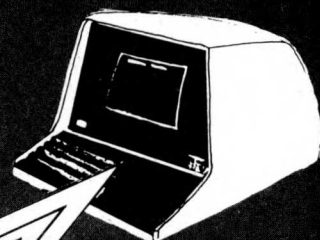

We'll give you more than a good deal

Under one roof in London's West End you can find:

HARDWARE:

A comprehensive range of hardware to meet most applications - and budgets, with terms to suit you.

SOFTWARE:

Probably the widest range of off-the-shelf software in the UK. Try out the packages and choose the one that suits you, or take advantage of our consultancy services and we will analyse, recommend, demonstrate, modify and install the programs for you.

CONSULTANCY SERVICES:

To apply micro computer systems to business, education or the home, make an appointment with our trained professionals for friendly advice based on extensive experience of discussing problems with many others like you.

MAINTENANCE AND REPAIR CLUB:

A maintenance and repair club that guarantees microcomputer users minimum downtime at very attractive premiums.

REFERENCE MATERIAL:

A library of publications covering all aspects of the microcomputer world,

including back issues of this and other important periodicals.

Whether you are an experienced micro user or a novice, looking for a system for the home, business or pleasure, the **LION MICROCOMPUTER CENTRE** is the single source to meet all your requirements.

CALL IN ANY TIME. We are open six days a week, for you to take advantage of the good deal you get when you buy from **LION**.

The above prices do not apply to account sales.



LION MICRO-COMPUTERS

SMALL COMPUTERS-TO MAKE YOUR BUSINESS BIGGER
Lion Computer Shops Ltd, Lion House, 227 Tottenham Court Road,
London W1 (First Floor). Telephone: 01-637 1601.
Telex: 28394 Lion G.
Open 9 to 6, Monday to Saturday (Thursday to 7).



Packaged Information Processing Systems

We offer a variety of turnkey systems based on APPLE II and MICRO STAR.

It is our endeavour to give a complete service from problem determination through to the supply of computer based solutions. We will solve the problem either with a tailor made suit of programs, or a ready written package from another famous software house.

We can also supply three excellent DEVELOPMENT SYSTEMS, namely NASCOM, ACORN and NORTH STAR HORIZON



Phone for further details or...

Come along and see all of the above equipment, plus a wide range of peripherals, which are now on display in our new offices and showroom.

AT

15 Sandhill, Quayside, Newcastle Upon Tyne
Tel: 0632 614939

£39.50*

Professional ASCII Keyboards



MODEL KB 756

FULLY ASSEMBLED & TESTED
CASE AVAILABLE

Accessories Available include:—

Edge Connector	KB15P	£1.95*
Numeric Key Pad	KB710	£7.50*
Plastic Case (Black)	KB701	£12.75*
DC to DC Converter	DC512	£5.00*

* U.K. Orders add 15% VAT on Order total.

FULL DATA SHEET ON REQUEST

Citadel Products Limited.

Dept. PCW 50 High Street, Edgware,
Middlesex HA8 7EP. Telephone 01-951 1848

**CARTER
KEYBOARDS**

INTERACTIVE Data Systems

Interactive Data Systems

14 Buckman Close - Greenleys - Milton Keynes - MK12 6AB
Telephone (0908) 313997

DATA PROCESSING SYSTEMS — INDUSTRIAL CONTROL SYSTEMS
Sales — Design — Manufacture

THE BRITISH S100.

At last you can buy a range of S100 boards manufactured to the highest standards in the U.K., compatible with the new I.E.E.E. S100 specification and competitive in price with anything the Americans can throw at us.

Z80 CPU. A basic 4MHz CPU board with all the logic and buffers required to drive the S100 bus.
Kit £84 A & T £105

SBMC A 4MHz Z80 single board microcomputer featuring 2 RS232 ports (or 20mA) with full handshaking, 1K of scratchpad memory, up to 16K of EPROM and a 4 channel counter/timer/vector interrupt.
Kit £178 A & T £235

16K SRAM This is a 16K static memory board utilising the industry standard 2114 memory chip.
Kit £174 A & T £198

FDC Any combination of 8" and 5", single or double sided floppy disk drives can be handled in single or double density with this board.
Kit £177 A & T £198

TERM 40 Active termination board for reduction of crosstalk and ringing in the bus.
A & T £32-50

Information
PCI Process Control Interface, 8 channels relay isolated output, 8 channels opto-isolated input, 8 bit TTL I/O, 4 x 8 bit D/A, 8 x 8 bit A/D.

VIDEO Video Keyboard terminal RS232 Serial Interface.
24 x 80 characters £250

Details from the Distributors:—
MENDIP COMPUTERS
57 Bath Road, Wells, Somerset, BA5 3HS.
Telephone: (0749) 75249

INTERTRONIX
83 West Street, Farnham, Surrey GU9 7EN.
Telephone: (0252) 722011

NB

NewBear
in 1980

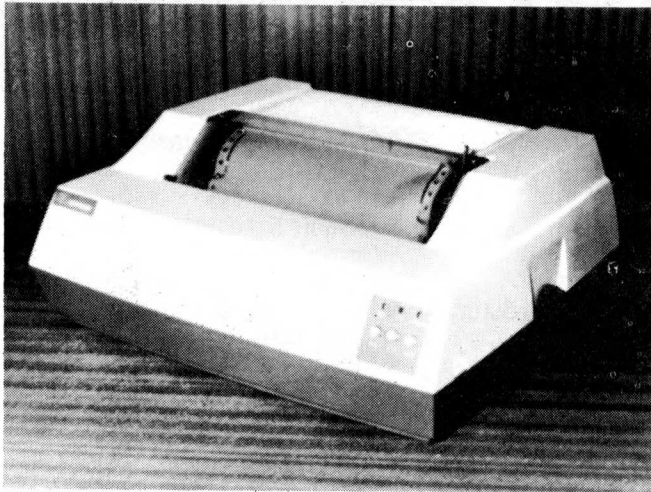

8300 RM PRINTER

80/132 ch per line (switchable); 125 c.p.s.; 2K Buffer; V24 RS232/ Current loop interface; Speed switchable between 110-9600 baud; Double width char. available under software control; sprocket feed; 7 x 9 dot matrix; Paper width 4.5" to 9.5".

Price £525 + carriage

SPECTRONICS U.V. EPROM-ERASING LAMPS

- PE14 Erases up to 6 chips, takes approx. 19 mins . £ 56.00
- PE14T Erases up to 6 chips, takes approx. 19 mins . £ 76.58
- PE24T Erases up to 9 chips, takes approx. 15 mins . £111.22
- PR125T Erases up to 16 chips, takes approx. 7 mins . £237.84
- PR320T Erases up to 36 chips, takes approx. 7 mins . £384.09

U.V. EPROM ERASING CABINET

- PC1000 Erases up to 72 chips, takes approx. 7 mins . £842.83
- PC2000 Erases up to 144 chips, takes approx. 7 mins . £1227.69

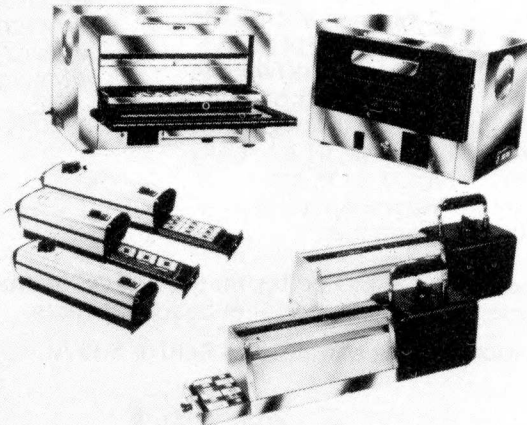

SHARP MZ80K From £480

Z-80 based CPU; 4K bytes monitor ROM; Internal memory expansion up to 48K bytes of RAM; 14K extended BASIC (occupies 14K bytes of RAM); 10" video display unit — 40 characters x 25 lines; 80 x 50 high resolution graphics; 78 key ASC11 keyboard alphabet (capital & small) plus graphics, Built in music function; Fast reliable cassette with tape counter-1200 bits/sec.; 50 pin universal BUS connector for system expansion-printers, floppy discs etc.

- | | | | |
|---|--------|---|--------|
| Zen Assembler/Editor | £19.50 | Sharp Basic Listing | £30.00 |
| Machine code tape and manual | £19.00 | Sharp Monitor Listing (fully commented) | £15.00 |
| Assembly code tape and manual | £45.00 | Sharp basic manual | £ 7.00 |

Look!

- SPECIAL OFFER** £
- 2708 5.99
 - 4116 5.99
 - 2716 (5v) 18.50

BOOKS

	AUTHOR	PRICE
The S100 and other Micro-buses	Poe	£ 5.15
Software Development	Jones	£14.45
Computers & Commonsense	Hunt	£ 3.95
Architecture of Small Computer Systems	Lippiatt	£ 4.50
Principles of Data-base Management	Martin	£12.99
16-bit Microprocessor Architecture	Dolhaff	£16.70
6502 Assembly Language Programming	Osbourne	£ 6.95
Introductory Experiments with Digital Electronics and 8080A Book 1	Rony	£ 8.40
Book 2	Rony	£ 8.40
Microcomputers for Business Applications	Barden	£ 5.80
Handbook of Microprocessors, Microcomputers and Minicomputers	Lenk	£11.65
Introduction to Microprocessors	Levanthal	£ 9.45
The VNR Concise Encyclopedia of Mathematics	Gellert	£15.35
Micro Program Software Development	Duncan	£13.45
Handbook of Electronic Analysis Using Programmable Calculators	Murdock	£19.90

GAMES

32 Basic Programs for the PET	Rugg	£ 8.90
Game Playing with Computers	Spencer	£10.20
Game Playing with Basic	Spencer	£ 4.20
Star Ship Simulation	£ 5.10
SARGON	£ 9.50

BASIC

The Basic Handbook	Lien	£11.00
Learning Level II	Lien	£11.00
Basic with Business Applications	Lott	£ 8.40
Illustrated Basic	Alcock	£ 2.50

Z80 BOOKS

Introduction to TRS80 Graphics	Inman	£ 5.75
Z80 Instant Programs (book) for Nascom	Hopton	£ 7.50
Z80 Instant Programs (cassette) for Nascom	Hopton	£10.00
Z80 Assembly Language Programming	Osbourne	£ 8.15

6502

Programming the 6502	R. Zaks	£ 7.95
6502 Applications Handbook	R. Zaks	£ 7.95

Terms: Official Orders (min. £10). Barclaycard & Access welcome. Add 15% to hardware prices. Book prices include p & p. Send for Catalogue and new May Booklist. All mail order to Newbury.

Mail Order & Head Office: 40 Bartholomew Street, Newbury, Berks. Tel: 0635 30505

Manchester Showroom: 220-222 Cheadle Heath, Stockport. Tel: 061 491 2290

Birmingham Showroom: 1st Floor Offices, Tivoli Centre, Coventry Road, Birmingham. Tel: 021 707 7170

The Software Solution



We all know that a computer system is only as good as the software and that much of the applications software hitherto available has proved to be the weak link. Written in Microsoft basic for use with CP/M based hardware, Interface Software is probably the most comprehensive and robust application software currently available, which really will transform your micro-computer into an effective problem solving tool.

Applications Software

- Nominal Ledger
- Sales Ledger
- Purchase Ledger
- Payroll
- Incomplete Records
- Word Processing (Wordstar)
- Mailing Address Etc.,

Systems Software

- CP/M
- MP/M
- MBasic 5.0 (CP/M) Interpreter/Compiler
- CBasic (II) Interpreter/Compiler
- Fortron 80 Compiler
- Cobol 80 Interpreter/Compiler
- Pascal 8 (UCDS) Interpreter
- Z80 Macro Assembler

Recommended by Logitek for the ALTOS microcomputer and Rostronics for the Micromation but of course suitable for any CP/M based machine.

For more details contact Jim Reid or Sue Archer at:-

DEALER ENQUIRIES WELCOME.



INTERFACE SOFTWARE LIMITED,
100, PARK STREET,
CAMBERLEY,
SURREY.
Telephone (0276) 27982.

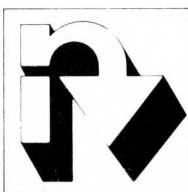
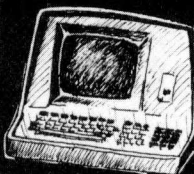
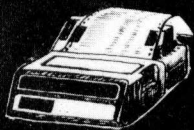

centralex

CENTRALEX-LONDON LTD
8-12 Lee High Rd, London SE13
Tel: 01-318 4213/4/5/6/7
9.30 am - 5 pm Mon to Fri -
Evenings and weekends by
appointment

A comprehensive range of Microcomputers Equipment, Peripherals, Software and Services for those who value Professional Standards, Guidance and Continuing Support for Hardware and Software.

APPLE
TEXAS
MICROPOLIS
DIABLO
MICROLINE

PET
OHIO SCIENTIFIC
CENTRONICS
QUME
HITACHI

ITT 2020
CROMEMCO
ANADIX
DEC
LEXICON

EXIDY
MICROSTAR
INTEGRAL
DATA GENERAL
ETC. ETC.

HORIZON
SHUGART
TELETYPE
EPSON

INFORMEX-80 Printer

£399+VAT

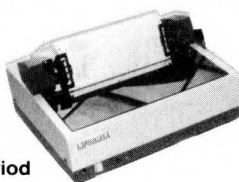

Special offer - for a limited period

For PET, APPLE, EXIDY, TRS80, ETC
A high quality, high speed printer
(125 cps) Upper and lower case letters
plus graphics as standard
Interface and cable for TRS80, PET,
APPLE or RS 232 £69 + VAT
Tractor feed option only £39

**ALSO Training, Consultancy, Systems Design,
Programming and Software**

PAYROLL - INVOICING - STOCK CONTROL -
SALES/PURCHASE LEDGER - VAT - MEDICAL
RECORDS - EDUCATIONAL & ENGINEERING
PROGRAMMES - HOTEL RESERVATION - ESTATE
AGENTS - BUILDING MAINTENANCE - COBOL -
FORTRAN - ETC.

Maintenance Contracts including stand-by equipment during repair periods - Free Delivery Nationwide - Terms arranged - Credit Cards and official orders accepted.

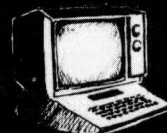
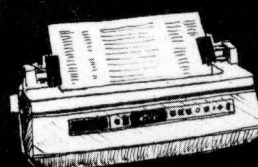
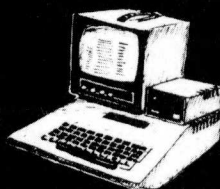
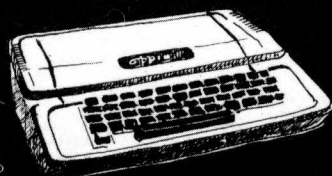
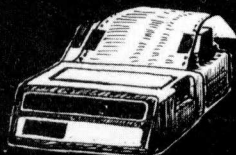

NEW

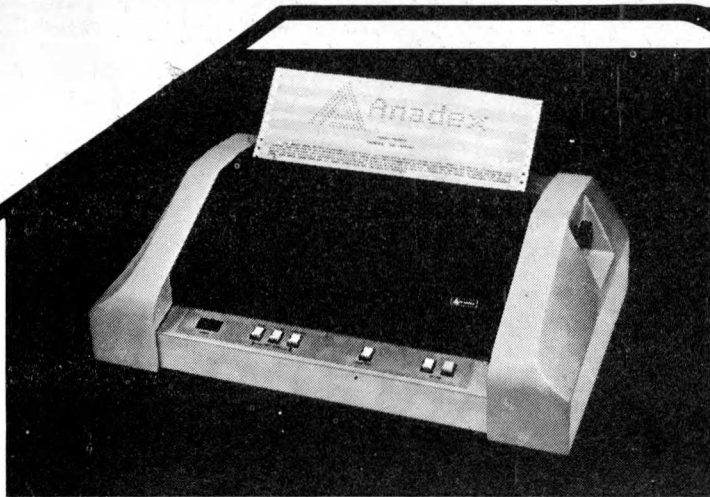

ANADEX 9500 Series from STACK

GENERAL SPECIFICATIONS

Number of Columns:

Character Spacing:

Printing Rate:

throughput-minimum
maximum

DP-9500

132 or 175

10 or 13.3 cpi

selected by data

source or by internal switch

150 or 200 cps

60lpm

200 lpm for 10 ch lines

DP-9501

132 or 220

10.or 16.7 cpi

120 or 200 cps

50lpm

Features

- *132, 175 or 220 columns, 120, 150 or 200 characters per second
- *50-200 lines per minute, bi-directional printing with line scanning logic
- *150 M characters print head life
- *650 M characters with heavy duty head
- *Tractor feed, multiple copy plain paper
- *7 x 9, 9 x 9 or 11 x 9 matrix with optional graphics capability
- *Special character sets available as options
- *6 or 8 lines per inch, selectable
- *10, 13.3 or 16.7 cpi, selectable
- *Communications control selectable

Interfaces

Parallel bit (1 KHz max data rate), RS-232C and 20-60 mA current loop. All three included as standard, switch selectable.

Baud Rates

50, 75, 110, 135, 150, 300, 600, 1200, 1800, 2200, 2400, 3600, 4800, 9600*

*RS-232C only
Switch selectable.

Character Font

Standard 96 character ASCII set with true descenders and underlining selected by RS code. Double width printing selected by SI code. Alternative character sets available as plug-in EPROMS.

DP-9500

£895

plus VAT

DP-9501

£995

plus VAT

Printing Method

9-wire dot-matrix, impact, bi-directional with line scanning logic.

Ribbon

Black ribbon in replaceable cartridge. Life expectancy in excess of 6 million characters.

Additional Features

Other operating features set by internal switches or by the data source include (a) 10 second time-out, (b) parity bit recognition, (c) byte length, (d) X-ON, X-OFF operation, (e) STX/ETX operation. Internal switches also provided to select (i) Truncate or wraparound print mode and (ii) Automatic line feed.

Physical

Width 26.6" (67.6cms), Depth 15.4" (39.2cms), Height 8.3" (21.0cms).

Graphics

Plug-in option enables printing of continuous graphics under control of data source, with resolution of 72 dots per inch vertically and 60 (DP-9500) or 75 (DP-9501) dots per inch horizontally.

Buffer

500 bytes of FIFO as standard. Optional 2K additional.

Paper (Fan-Fold)

Tractor fed, any width to maximum of 15.6" (397mm).

Interfaces for 9500 Series

PET Parallel £45

Parallel Addressable £106

RS232 £89

RS232 Character Switchable £132

APPLE Parallel £130

RS232 Serial £113

Please ring Graham Knott or Jeff Orr
for other interfacing requirements.
Prices exclude VAT.

Stack Computer Services Ltd

290-298 Derby Road, Bootle,

Liverpool L20 8LN.

051-933 5511.



Your key.

To MICROCOMPUTERS

This coupon will bring you details of our new complete home computer course. You will learn all the basic principles of computer technology and receive full instruction on computer functions and programming. Tuition is carried out at your own pace on your own home computer and is supervised by our qualified computer staff.

FREE BROCHURES

Send today for a brochure on this exciting new course.

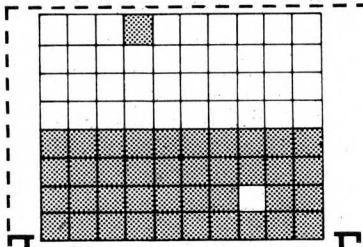
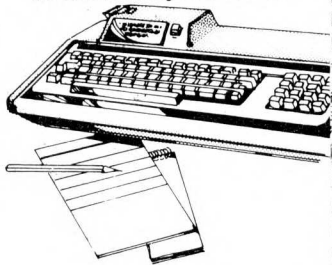

TUTORCOURSE
HOME COMPUTER

Please rush me details of your HOME COMPUTER COURSE

Name _____

Address _____

Block Caps. Please

Post now, without obligation to:

British National Radio & Electronics School.

P.O. Box 156, Jersey, Channel Isles

DISCOUNT PRICES!

TOP QUALITY MONEY-BACK GUARANTEE ALL FACTORY PRIME

MICROPROCESSOR IC'S

Z80	9.75	6800	7.95
Z80A	11.95	6802	11.50
8080A	5.50	6502	9.50
8085A	11.95	6504	9.50
28001	189.00	6505	9.50
28002	139.00	2901	8.95

UARTS

AY-5-1013A	3.95	AY-3-1015A	5.10
AY-3-1014A	6.50	TR1602A	3.50

LINEAR

LM 301A	32	LM 340T Series	1.15
LM 307A	25	LM 387N-8	99
LM 307N-8	32	LM 393N-8	99
LM 307H	25	LM 3900N-14	58
LM 308H	75	LM 3909N-8	99
LM 311N-8	59	LM 7300C-14	99
LM 319H	90	LM 747CN-14	19
LM 320K Series	1.35	RC 1556NB-8	1.25
LM 320T Series	1.15	LM 4250CH	95
LM 323K	4.95	CA 3130T	2.25
LM 339N-14	98	LM 4136N-14	95
LM 340K Series	1.35	LM 383T	1.25

SOCKETS

Low Profile		Wire Wrap #3		Low Profile		Wire Wrap #3	
8 Pin	14	49	29	22 Pin	28	99	69
14 Pin	16	57	37	22 Pin	16	99	69
16 Pin	20	61	41	24 Pin	36	110	85
18 Pin	10	89	59	28 Pin	39	139	110
20 Pin	28	99	69	40 Pin	55	175	140

MEMORY • RAMS • PROMS • EPROMS

LIMITED QUANTITIES

2114L-450 ns	4.50	2101-450 ns	1.95
2114L-200 ns	5.95	2102-250 ns	1.10
404-450 ns	4.25	2102-450 ns	99
4116-200 ns	7.95	2111-450 ns	2.95
4116-150 ns	12.95	2112-450 ns	1.95
4096-5	3.50	2147-85 ns	19.95
MC145604 AC	4.75	2708-450 ns	8.95
AM 9060 CDC	2.95	2716-450 ns	25.95
5101-3	4.95	2732-450 ns	79.95

TV/SOUND GENERATORS

SN76477	Complex Sound Generator	2.95
AY-3-8910	GI Sound Gen. (Add \$5.00 for manual) 64 Pgs.	11.95
AY-3-8500	European TV Game	4.95

SPECIALS OF THE MONTH

While Supply Lasts

ECL 10146L RAM 1024x1-29 ns	6.95
AM 3705 PMOS 8-Ch. Multiplexer	8.95
MM 500H Dual 25-Bit Shift Register	4.99
TR1671 Asyn/Sync. Receiver - Transmitter	16.95
95H90 Hi-Speed Div 10/11 Prescaler	10.95
MCT6 Dual Opto-Isolator 1500V	99
ICL 7107 CPL 31-Digit A/D Conv. LED	11.50
AY-5-2376 Keyboard Encoder 88 Keys	10.50
AY-5-3600 Keyboard Encoder 90 Keys	9.95
1488 or 1489 Liner Driver/Receiver	99
18-Pin Low Profile Sockets End Stackable	10

HOW TO ORDER. U.S. Funds only. Order by phone, mail or TWX. \$25 minimum. Prices valid through last day of cover date. Add 10% for shipping and handling. Guaranteed satisfaction. Some items subject to prior sale. We are not responsible for typographical errors. We also handle **Volume Orders.** Contact us for your IC and Computer Shortages.



YOUR EXPORT EXPERTS!
OVER \$1,000,000.00 INVENTORY

1401 E. Borchard
Santa Ana, CA 92705
(714) 953-0604
TWX/TELEX 910-595-1565

HARDWARE KITS

ExpandoRAM Kit (NO RAM CHIPS)	129.00
ExpandoRAM Kit (NO RAM CHIPS)	129.00
Versafloppy Flexible Disk Drive Controller Kit	139.00
SBC-100 Single Board Computer Kit (2.5 MHz)	159.00
Z80 Starter Kit	188.00
ExpandoPROM Kit	97.00
Add-On RAM (16K Devices) 4116 (25 Onsec)	47.00
VDB-8024 Video Display Board Kit	198.00
ExpandoRAM 11 Expandable RAM Board Kit (NO RAM CHIPS)	129.00
Versafloppy 11 Flexible Disk Drive Controller Kit	192.00
PROM-100 PROM Programmer Board Kit	110.00
MPB-100 Z80 Central Processing Unit Board Kit	138.00
Add-on RAM (16K Devices) 4116 (200 nsec).	69.96
SBC 200 Single Board Computer Kit (4 MHz)	177.00

MICRO - PRO

WORDSTAR VERSION	£230.00
WORDMASTER	£65.00
TEXTWRITER	£35.00
DATASTAR	£160.00
SUPERSORT I	£110.00
SUPERSORT II	£90.00
SUPERSORT III	£65.00
C BASIC III	£50.00

ATTENTION!

ALL NASCOM 1 OWNERS

Coming shortly

Top end monitor on jump re-set and board that will allow Nascom 1 to run software written for CP/M environment! Vectors may be written from tape into bottom end RAM allowing software written for B.BUG, NAS. BUG T2, T4 and NAS SYS to be run. Also comparable BIOS for CP/M will be available for use with NASCOM System 80 Disk Controller Board.

WRITE TODAY FOR FULL DETAILS!

Uk Distributor



Unit A2, 9 Longford Avenue,
Kilwinning Industrial Est. Kilwinning
Ayrshire KA13 6EX
Tel: 0294 57755. Telex: 779808



SIRTON COMPUTERS

76 Godstone Road, Kenley (Nr Croydon)
Surrey CR2 5AA
Tel: 01-668 0761/2

MIDAS S100 SYSTEMS

MIDAS 1:	From £895
MIDAS 2:	From £1880
MIDAS 3:	From £2460
MIDAS 4:	From £6300

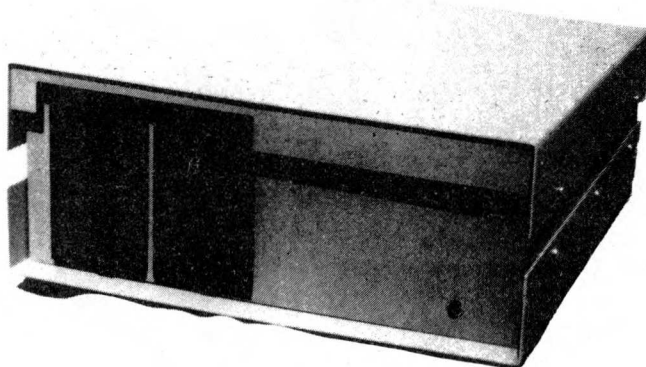

- Our versatile Z80 Microcomputers are available as standard units or custom configured to your exact specification from a comprehensive range of stocked S100 boards.
- Disc storage capacity of the MIDAS 3 can be 2M Bytes, expandable to over 20M Bytes with a Winchester Hard Disc Unit in our MIDAS 4 range.
- MIDAS runs under CP/M and MP/M is also available. Other Software includes M-BASIC, C-BASIC, FORTRAN, COBOL, CIS-COBOL, PASCAL and Word Processing.
- A MIDAS 3, with 64K RAM and 2M Bytes storage on two 8" drives with two Serial I/O Ports and CP/M 2 only £3200.
- Printers, VDUs and other peripherals stocked to give complete package systems at keen prices.
- Business Packages include Accounts, Sock Control, Purchase Ledger etc etc.
- OEM and Dealer enquiries welcome.

ITHACA DPS-1

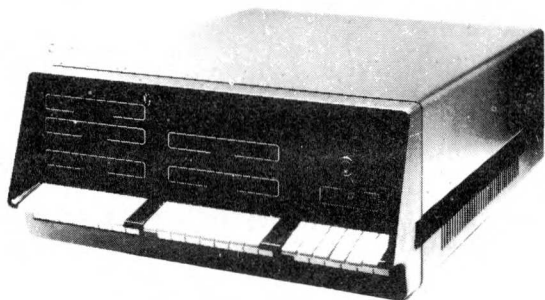

With 4 MHz MPU-80 (Z80) CPU from £895. All Ithaca boards and many others available to make complete system. Also companion dual 8" Disc Drive Enclosure.

WRITE OR PHONE FOR CATALOGUE
SIRTON COMPUTERS WAS FORMERLY SIRTON PRODUCTS

SMG MICROCOMPUTERS

39 Windmill Street,
Gravesend, Kent.
Tel: 55183



HARDWARE
Pet systems with
Commodore
or Computhink drives,
ITT Apple and Video Geni
all on display
+ disks, tapes, books
and games.

SOFTWARE
SMG STOCK CONTROL
SMG ACCOUNTS
(can integrate fully with SMG STOCK CONTROL)
also stockists of GRANT BUSINESS SYSTEM.

FOR ALL YOUR MAIN REQUIREMENTS
FROM ONE SUPPLIER
JUST LIFT THE PHONE...

0252-518022/518717

Continuous Stationery — all types pre-printed
including letterheads.
Listing Paper — all sizes. Continuous labels —
plain and printed. Printer ribbons, Pet,
Anadex etc.,

3M Data Recording Products
ACCO Continuous Stationery filing systems

A FEW OF OUR OUTSTANDING BARGAINS

- 3M Personal Digital Computing
 - Cassettes 10min
47p each, minimum order 10
 - Individually boxed 30min
53p each, minimum order 10
 - 5¼" Mini Diskettes, 100% error free,
storage box. £2.25p each, minimum order 10
as above but in plastic library
case £2.46p each, minimum order 10
 - 8" Diskettes, 100% error free, storage box,
(state type)
 - From £2.60p each, minimum order 10
 - as above but in plastic library case
 - From £2.85p each, minimum order 10
 - * NEW LINE — Smart Diskette binder,
anti static, holds 20. 5¼" £15.25 each
as above but for standard 8" Diskettes £17.25 each
- Add 80p post & packing for each item ordered, all despatched
within 24 hours.
- 11 x 9½" Plain listing 60 gsm, boxed 2000 sheets only
£14.00 per box.
 - * ACCO paper binders, a must for all stationery filed or
regularly used, from £1.86 each
 - * NEW LINE — Genuine A4 size continuous letterheads,
for FREE quotation for letterheads or any other form,
send sample and state quantity required.

PERSONAL CALLERS & TRADE ENQUIRIES

Clearsons Ltd.

Lynwood House 1 Camp Road Farnborough
Hampshire GU14 6EN

Nascom specialists

FULL RANGE STOCKED

PROGRAMMERS TOOLKIT

SUPPLIED IN 2708 EPROMS FOR NASCOM ROM BASIC
GIVES YOUR NASCOM THE FOLLOWING COMMANDS

AUTO	APND
RENU	HEX
DELE	DUMP
FIND	OFF
HELP	INKEY
STEP	KEY BOARD REPEAT
PRINTER HANDSHAKE	

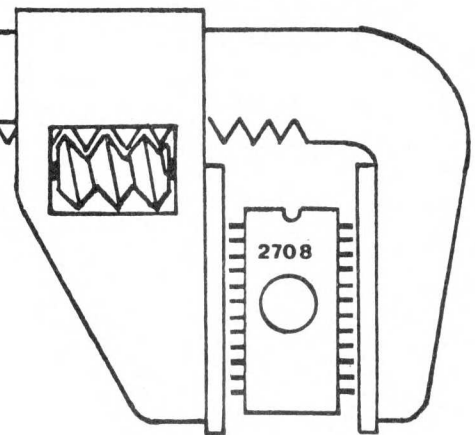

Only £42.00 INCLUDING V.A.T.

Add-ons

CONTROL KEY PAD £26.56
HEX KEY PAD £42.83
PORT PROBE £14.95

BUILT SYSTEMS
S.A.E. FOR DETAILS

18 Rye Garth, Wetherby,
West Yorkshire LS22 4UL



0937 63744



**PRINTER
BREAKTHROUGH**

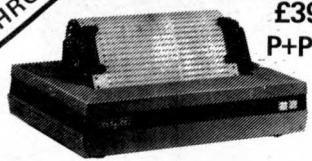

IF YOU FIND A BETTER PRINTER AT A BETTER PRICE - BUY IT

NEW ONLY £395 P+P£5 'BASE 2' MODEL 800 MST Complete with 2K terminal buffer, treater, tractor and high speed paper feed.

80-COLUMN IMPACT PRINTER
LOWEST IN PRICE - HIGHEST IN PERFORMANCE

INTERFACES WITH ANY MICROCOMPUTER

- FEATURES**
- *Reliability
 - *Low Cost
 - *Compact Size
 - *60 Lines per Minute
 - *115/230VAC, 50 or 60 Hz.
 - *72, 80, 96, 120 or 132 Characters/Line
 - *Self-test Switch
 - *Auxiliary User Defined Character Set
 - *RS-232, 20ma, IEEE 488 and Centronics I/O
 - *16 Baud Rates to 19,200

- Plus:**
- a) 2K Terminal Buffer
 - b) Fast Paper Feed/Graphics
 - c) Tractor Mechanism

8K LOW POWER RAM KIT-S 100 BUSS SALE

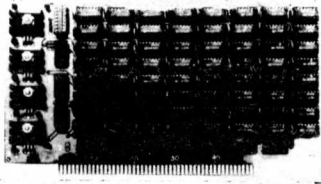

PRICE CUT! £99+V AT
ASSEMBLED AND FULLY BURNED IN

ALL BOARDS ARE TESTED AT 4MHZ. 21L02 (450 NS RAMS)
Thousands of computer systems rely on this rugged, work horse RAM board. Designed for error-free, NO HASSLE, systems use

16K STATIC RAM BOARD-S 100 BUSS 4 MHZ

BOARD FEATURES

- 1 Addressable as four separate 4K Blocks
- 2 ON BOARD BANK SELECT circuitry (Cromemco Standard). Allows up to 512K on line!
- 3 Uses 2114 (450NS) 4K Static Rams
- 4 ON BOARD SELECTABLE WAIT STATES
- 5 Double sided PC Board, with solder mask and silk screened layout. Gold plated contact fingers
- 6 All address and data lines fully buffered
- 7 PHANTOM is jumpered to PIN 67
- 8 LOW POWER under 1.5 amps TYPICAL from the +5 Volt Buss
- 9 Blank PC Board can be populated as any multiple of 4K

OUR #1 SELLING RAM BOARD! Assembled + Tested Not a Kit

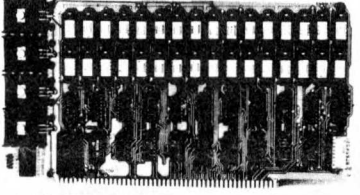

S-100 Z80 CPU CARD

Perfect for OEM's **WIRED! NOT A KIT!** £110 + VAT
4 MHZ

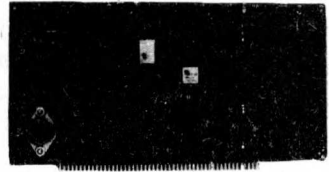

ASSEMBLED AND TESTED! READY TO USE! Over 3 years of design efforts were required to produce a TRUE S-100 Z80 CPU at a genuinely bargain price!
BRAND NEW!

- * 2 or 4 MHZ Operation
- * Generates MWRITE, so no front panel required
- * Jump on reset capability
- * ROMS Signature emulated for S-100 compatibility
- * Top Quality PCB, Silk Screened, Solder Masked, Gold Plated Contact Fingers

Software for TRS80 Tiny' Pascal FOR TRS-80

Now you too can have Pascal! The famous Chung-Yuen 'tiny' Pascal has been specially designed for the TRS-80! The full power and elegance of 'tiny' Pascal is at your command. Programs written in 'tiny' Pascal run at least 4 times faster than the same program in BASIC! 'Tiny' Pascal is also a great way to learn Pascal programming, & fun too.
Best of all, you only need a 16K Level II TRS-80! No disk is required. The 'tiny' Pascal operating system is self-contained and very easy to use.
'Tiny' Pascal is a subset of standard Pascal & includes: RECURSIVE PROCEDURE/FUNCTION, IF-THEN-ELSE, REPEAT/UNTIL, 'PEEK' & 'POKE', WHILE DO, CASE, MORE! (Plus full graphics for your TRS-80).
You can save and load programs to and from tape in both source and compiled form. You get all this and more, plus a user's manual for £29.95 + VAT
DISK VERSION NOW AVAILABLE £39.95 + VAT

Anglophone

At last you can take complete advantage of your TRS-80 voice synthesizer. Forget about cumbersome phonetic codes. With 'Anglophone' you can simply use ordinary English. Completely interfaces with BASIC, or just about any other programming language. 'Anglophone' applies sophisticated pronunciation rules to transform normal English spelling into speech using the TRS-80 Voice Synthesizer. Minimum hardware: Level II, 16K, Voice Synthesizer. Comes complete with user's manual and test program. **£39.95 + VAT**

Talking Terminal

The 'Talking Terminal' program turns a TRS-80 into a talking computer terminal. The 'Talking Terminal' program receives input from a remote computer and converts it to spoken words. Its many user options include: Instant Replay, spelled speech, silent or pronounced punctuation and more. Minimum hardware: Level II, 16K, Voice Synthesizer, RS-232c board and expansion interface. **£125 + VAT**

16K EPROM CARD-S 100 BUSS £55 + VAT

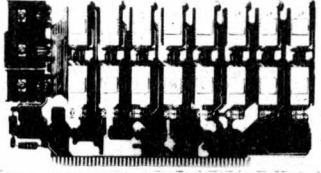

ASSEMBLED AND FULLY TESTED **FIRST TIME OFFERED!** **BLANK PC BOARD - \$28**
USES 2708's!
OUR 450 NS 2708's ARE £4.25 ea + VAT WITH PURCHASE OF KIT
Thousands of personal and business systems around the world use this board with complete satisfaction. Plus 16K of software on line at ALL TIMES! Kit features a top quality soldermasked and silk-screened PC board and first run parts and sockets. Any number of EPROM locations may be disabled to avoid any memory conflicts. Fully buffered and has WAIT STATE capabilities

MICROCHIPS AT MICRO PRICES

All devices are brand new, factory prime and full spec.

MEMORIES

2114	low power 450 NS	1.25
2114	High performance 250NS	2.95
4118	low power 300 NS	3.25
4118	low power 250 NS	18.95
4116	200 NS	3.85
2708	450 NS	4.50
2716	(Intel Type) single 5 V	12.75

NEW

4315-45L	4K CMOS RAM	12.95
	low power 450 NS	
2532	32K EPROM	39.95

NEW SYSTEMS

Z8001	16 Bit CPU with segmented address space to 8 Megabytes	£125.00
-------	--	---------

Z8002	16 Bit CPU with non segmented address space to 64K bytes	£95.00
-------	--	--------

Z8000DM	A single board micro computer that interfaces directly to any Zilog micro system. It contains a	
---------	---	--

Z80002 CPU, 16K words of Dynamic RAM, a dual channel serial I/O port, 32 parallel I/O lines and a wire wrap user area.	75150	1.25
	75154	1.25
	75182	1.95
	75322	2.50
	75324	3.25
	75325	3.25
	75361	2.50
	75363	3.50
	75365	2.95
	75451	50p
	74491/2	75p
	8T26	1.75
	8T28	1.75
	8T95	1.75
	8T97	1.75

WD9000B
The Pascal Micro engine chip set. A set of 5 chips including the 16 bit CPU which will directly execute Pascal generated P code (UCSD P-machine instruction set - Revision 2.0). The only CPU in the market designed to directly execute a high level language at speeds five times faster than most typical computer systems. **£199.00**

WD090A
Single board micro computer containing WD9000 chip set, 64K bits (32K words) CPU's, sided 8 inch disk drive. **£1695.00**

6402	7.95
6504	7.95
6505	7.95
6800	6:95
6802	9.95
8080A	4.75
8085A	10.95
Z80	7.95
Z80A	9.95
Z8001	125.00
Z8002	95.00
WD9000	199.00

INTERFACE ICs
DM8123 1.25

SUPPORT DEVICES

6520	4.95
6522	7.95
6532	8.95
6551	10.95
6810	3.75
6820	4.25
6821	4.25
6850	4.25
6852	4.25
8212	3.95
8214	3.95
8216	3.95
8224	3.95
8228	3.95
8251	4.95
8253	10.50
8255	4.75
8257	10.50
8259	11.95
MC14412VL	7.97
EAROM	
ER3400 4K 650 NS	15.95

UARTS

AY-5-1013A	2.95
AY-3-1015D	3.98
IM6402IPL	3.98

CHARACTER GENERATOR

RO-3-2513 UC	4.50
--------------	------

'SAMS' BOOKS AT MICRO PRICES

Computers and Programming Guide for Engineers	8.75
TTL Cookbook	6.45
CMOS Cookbook	6.95
Microcomputer Primer	5.45
IC Timer Cookbook	6.75
IC OPAMP Cookbook	8.75
The 8080A Bugbook Microcomputer Interfacing & Programming	7.25
How to Programme Microcomputers	5.95
Getting Acquainted with Microcomputers	5.95
The Z-80 Microcomputer Handbook	5.95
Using the 6800 Microprocessor	4.75
The Cheap Video Cookbook	3.95
IC Converter Cookbook	9.45
Fundamentals of Digital Computers (2nd ed)	6.75
DBGU: An 8080 Interpreter Debugger	3.50
Microcomputer-Analog Converter Software & Hardware Interfacing	6.45
Introductory Experiments in Digital Electronics and 8080A Microcomputer Programming & Interfacing - Book 1	8.45
Introductory Experiments in Digital Electronics and 8080A Microcomputer Programming & Interfacing - Book 2	7.45
Introductory Experiments in Digital Electronics & 8080A Microcomputer Programming & Interfacing - Books 1 & 2	14.95
Microcomputers for Business Applications	5.95
BASIC Primer	5.95
The S-100 and Other Micro Buses	3.95
Z-80 Microprocessor Programming & Interfacing - Book 1	9.45
Microcomputer Interfacing with the 8255 PPI Chip	9.45
Z-80 Microprocessor Programming & Interfacing - Book 2	9.45
8080/8085 Software Design - Book 2	8.75
Electronic Telephone Projects	6.45

Z-80 PROGRAMMING MANUAL
By MOSTEK, or ZILOG. The most detailed explanation ever on the working of the Z-80 CPU CHIPS. At least one full page on each of the 158 Z-80 instructions. A must reference manual for any user of the Z-80. 300 pages.
ONLY £9.95

ORDERING INFORMATION: Postage free orders over £50, otherwise add 50p. Add 15% VAT to total.

MICROBYTE

UNIT 9-10 1st FLOOR E BLOCK
36 MOUNT PLEASANT LONDON WC1X OAP

Telephone 01-278 7369 - 01-837 1165
Telex 895 3084

**It's been called
a technical masterpiece.**



**We'll show you how to master it
in half an hour.**

The Sharp MZ-80K is the perfect beginner's computer for small business, educational or personal use. Maybe you've always wanted to find out more about computers, but were a little confused, even frightened by them.

Well at Petalect, you'll find the Sharp MZ-80K is simple to operate and uses a standard cassette for programming. It will make education more fun and your business more efficient.

Call in, or send for full details now.

PETALECT

Electronic Services Ltd

Distributors for ACT 800. Dealers for CBM Commodore and Sharp MZ-80K
Dept. PESL 33/35 Portugal Road, Woking, Surrey GU21 5JE
Telephone (04862) 21776/63901

Please send full details of your specialist services and computer systems.

Name _____

Company _____

Position _____

Address _____

Tel. No. _____

hi-tech electronics

1 Richmond Gardens, Highfield Southampton SO2 1RY
Telephone (0703)555072

OUR S 100 **COLOUR** VDU BOARD

WILL MAKE YOUR FRIENDS GREEN WITH ENVY AND OUR COMPETITORS SEE RED AND ANY OTHER OF OUR SPLENDID RANGE OF COLOURS

- HIGH DEFINITION, FULLY INTERLACED 625 LINE PAL COLOUR VDU BOARD
- 20 COLOURS AND GREY-SCALE TONES, INCLUDING RED, GREEN, BLUE, YELLOW, MAGENTA, CYAN, BROWN, PURPLE, ETC.
- 24 LINES OF 40 CHARACTERS, MIXED GRAPHIC AND ALPHANUMERIC
- COLOUR GRAPHICS RESOLUTION OF 80x72
- UPPER AND LOWER-CASE, DEFINITION OF 10x14
- ALL CHARACTERS CAN FLASH AND HAVE ANY HUE
- SEPARATE BACKGROUND AND FOREGROUND COLOURS
- 256 DIFFERENT GRAPHIC CHARACTERS
- SELECTABLE DOUBLE-HEIGHT CHARACTERS AND TWO PAGE MEMORY
- 1K MEMORY, MAPPED TO ANY 2K BOUNDARY
- 64 PORT - PROGRAMMABLE INSTRUCTIONS
- MONITOR, OR UHF OUTPUTS, RGB TO ORDER
- TELETEXT AND PRESTEL COMPATIBLE CHARACTER SET
- BRITISH DESIGNED AND MADE

NOW AVAILABLE

- PROGRAMMABLE 13A MAINS DISTRIBUTION BOX, FULLY ISOLATED, FITS TTL 8 BIT LATCHED PARALLEL OUTPUT PORT FROM YOUR COMPUTER, AND CONTROLS 3 ON/OFF AND 1 32-LEVEL DIMMER SOCKETS **£69.00**
- S100 COLOUR VDU BOARD, UHF OUTPUT **£295.00**
- S100 COLOUR VDU BOARD, MONITOR OUTPUT **£295.00**
- S100 16K MEMORY BOARD, 250 nS **£210.95**

PRICES INCLUDE P&P - BUT NOT 15% VAT

COMING SOON:

- S100 TELETEXT TUNER/DECODER, S100 MUSIC SYNTHESISER, ETC.

**You've heard about it
Read about it — HERE IT IS**

**AVAILABLE EX-STOCK
COMPLETE KIT AS PER
MANUFACTURER'S SPECIFICATION**

With provision for 8K on board expansion. Excludes 4118 x8+

INCLUDES FREE 16K EXPANSION
VALUE £140 includes ALL parts with every kit

**NASCOM-2
ON DEMONSTRATION NOW**

£295 + 15% WITH
VAT FREE
16K EXPANSION WORTH £140

AVAILABLE ONLY FROM US ON THE COUPON BELOW

**OPTIONAL EXTRAS
3 AMP POWER
SUPPLY** VAT 15%
£29.50 Post £1.50
For NASCOM-2

8 OFF 4118*
For NASCOM-2
Purchasers
£80 EX STOCK
+ VAT

RS232 COMPATIBLE

80 COLUMN PRINTER brand new
List price £550 If sent by carrier £5 extra

OUR PRICE
£325 + VAT
15%

FULL MANUFACTURER'S WARRANTY — DON'T DELAY. ORDER TODAY

Please send me my **NASCOM-2 KIT** with the **FREE 16K EXPANSION** for **£295 + VAT**.

I enclose remittance

to cover

Name & Address

In stock NASCOM-1 . TANGERINE . TRS80 as previously advertised



HENRY'S

Computer Kit Division
404 Edgware Road, London, W2, England
01-402 6822



aculab Ltd

> ACULAB 735, a fully self-contained interface for IBM 735 output golfball typewriters

The ACULAB 735P INTERFACE is a self-contained controller for IBM I/O typewriters and printers. The 735P accepts standard 7-bit parallel ASCII data and provides all of the handshake protocol, code conversion and solenoid voltages to run the printer at full speed using any correspondence or ASCII golfball to produce letter quality printing at 15 chars/sec .. £155.00 + VAT

The TRS-1 PARALLEL PORT DECODER plugs into the bus connector on the TRS-80 keyboard and decodes the port used by the ELECTRIC PENCIL and the LPRINT and LLIST commands in TRS-80 BASIC. .. £55.00 + VAT

The IEEE TO PARALLEL PORT CONVERTER plugs onto the PET IEEE bus connector and converts it into a parallel printer port. It also converts PET's unique version of ASCII to standard ASCII and provides a switch to give UC/LC compatibility with the new PET .. £45.00 + VAT

The ADDRESSABLE IEEE PARALLEL PORT DECODER has all of the features of the converter but may be set to answer to any of the available addresses on the PET IEEE bus and so be used along with the PET disc or any other bus compatible devices .. £66.00 + VAT

These last three devices are all fitted with 2 metres of heavyweight cable and a metal shrouded Centronics compatible connector.

aculab Ltd.
24 Heath Road,
Leighton Buzzard, Beds.
LU7 8AB

For further information
Telephone. 0525-371393.

COMAL on the SPC/1

COMAL is an extended and structured form of BASIC with constructions such as:

REPEAT-UNTIL WHILE-ENDWHILE
IF-THEN-ELSE CASE-ENDCASE
and including built-in file system, named procedures and many other features.

**The SPC/1 Small Professional Computersystem,
100% modularity, 100% quality,
true multi-processing and the ability to expand.**

Starting at £1995 + VAT for a single-user, ready to run system including the micro with on 5¼" disc drive, VDU, 32K bytes of RAM and COMAL real-time interpreter.

Expanding to an 8-user system with up to 80 Megabytes of cartridge disc storage — and capable of running COMAL, Pascal and Assembler at the same time under what must be the most sophisticated operating system on the market.

Phone (01) 727 6668
for more information on the
SPC/1 microcomputer system
from
digital data electronics Ltd

dde



KRAM

KEYED RANDOM
ACCESS METHOD

Now available in the UK!

KRAM is quite simply a revolution in microcomputer disk access techniques, and another FIRST for the PET! Just plug the KRAM ROM into your 16K/32K PET, load the rest of KRAM's machine language logic from disk (just like DOS), and with the ten commands illustrated below you have complete control of your disk data, either directly by individual key, or sequentially in forward or reverse ASCII order. KRAM is a development of "VSAM" mainframe techniques. KRAM is fast, compact, and does not interfere with BASIC. You'll wonder how you managed without it! Get cracking — get KRAM!

CREATE KCS="CREATE O:MAILFILE,120,15,1: SYS 24600
This example tells KRAM to create an indexed file called MAILFILE on the disk in drive zero, with a record length of 120 characters and a key length of 20 characters which starts at position 1 of the record. KRAM looks at the RESERVED variable KCS to identify the function and its parameters; the SYS call tells KRAM to execute the function. The record length can be any value up to 254 characters and the key up to 48 characters, a total of 302. KRAM packs as many records into the 255 character disk block as necessary.

OPEN KCS="OPEN O:MAILFILE": SYS 24579 This tells KRAM that we will want to make accesses to the file called MAILFILE on the disk in drive zero. KRAM returns in location zero (peek (0)) the file number by which this file can be accessed during the rest of the program.

ADD KCS="ADD 1,NAS,ADS": SYS 24591 This tells KRAM to add to file number one the data in variable ADS whose key is NAS. For example in a mailing list, the key NAS might be the name 'SMITH A.J.' and ADS might be the address '120, HIGH STREET, ANYTOWN'. Any normal double character string variable can be used to denote the key and the record.

GET KCS="GET 1,NAS,ADS": SYS 24582 This tells KRAM to get from file number one the data belonging to the key NAS and put it into variable ADS. In our example, if NAS was 'SMITH A. J.', KRAM would read the address '120, HIGH STREET, ANYTOWN' from file and put it into variable ADS. If we weren't sure of the exact surname, we could give KRAM the key 'SM' and it would get for us the next alphabetically higher name beginning 'SM', together with its address! Or if we gave KRAM a blank key, it would find the first name and address on file.

READ KCS="READ 1,NAS,ADS": SYS 24585 This tells KRAM to read the data belonging to the next highest key following the name in NAS, and put it into variable ADS. In our example, a complete file of names and addresses could be read in alphabetical order, starting at any name in the file, simply by executing successive READ commands! For instance, having got Mr A. J. Smith from file, executing the READ command as above would get us 'SMITH M.' in NAS together with his address in ADS.

READ - KCS="READ-1,NAS,ADS": SYS 24585 This works like READ except BACKWARDS! It tells KRAM to read the data belonging to the next lowest key preceding the name in NAS, and put it into ADS. For instance, having read 'SMITH M.' with the forward read, executing the backward read as above would get us 'SMITH A.J.' in NAS together with his address in ADS.

PUT KCS="PUT 1,NAS,ADS": SYS 24588 This tells KRAM to rewrite to file number one the data in variable ADS which belongs to key NAS. For instance, if we wanted to change Mr A.J. Smith's address, we would simply set NAS equal to 'SMITH A.J.', ADS equal to his new address, and execute the PUT function.

DELETE KCS="DELETE 1,NAS,ADS": SYS 24594 This tells KRAM to delete from file number one the key contained in NAS and its associated data contained in ADS. In our example, to delete Mr A. J. Smith from the file, we would simply set NAS equal to 'SMITH A.J.', ADS equal to his address, and execute the DELETE function. KRAM will release for further use the disk space made available by the deletion.

CLOSE KCS="CLOSE 1": SYS 24597 This tells KRAM that file one is finished with for now. KRAM updates the BAM on disk, but the file can still be used without another OPEN command.

INITIALIZE SYS 24600 This function is used at the beginning of each program to clear KRAM's work areas and buffers.

The examples above illustrate the use of KRAM in a mailing list application, with disk access times from less than one second. KRAM can of course be used in any application program with the Commodore disk where programmer time, user time and disk space are at a premium.

Each KRAM package includes a ROM which plugs into the middle ROM socket of the 16K/32K Pet, a demonstration disk with a mailing list program and a 40-page User Reference Manual. KRAM is available by post (cash with order) price £115 including VAT, or by credit card phone the KRAM 24 Hour Order Desk on 01-546 7256; or see your nearest dealer. (Quantity discounts available).

Calco Software

Lakeside House, Kingston Hill, Surrey KT2 7QT 01-546-7256

Mainframe software at a micro price

Silly summer offers from Kansas

For TANDY TRS80 16k
(and the Video Genie)

Kansas quality software carries
an unconditional guarantee

Return first class post service

Kansas

Kansas City Systems,
Unit 3, Sutton Springs Wood,
Chesterfield, Derby
Tel 0246 850357

SIX OF THE BEST!

£34's of games for 12 quid!

Amazing Maze Pin Ball Bounce Fire-One!
Touchdown Robots Suicide Plane

At just £2 a game it's the cheapest software package in the country
Everyone with full graphics to give hour upon hour of enjoyment

INFINITE STAR TREK

A new and faster version makes this the best 'Trek'
you can buy, and it's on offer at £7—saving a fiver!

Infinite Star Trek was the top seller from the Kansas stand at the
Personal Computer World show, and has now been improved
virtually beyond recognition by the following features

- * Faster response times
- * Orders direct on Inkeys
- * Alert on Inkeys
- * Direct access to LR Sensors—Warp—Impulse during program
- * Easier Impulse manoeuvre for docking and orbit
- * Video scan of full quadrant situations
- * Failing Energy warnings
- * Visual Status check of Klingons destroyed and planets orbited
- * Klingons harder to destroy—no longer a forgone conclusion!

Now a most intelligent game needing no small amount of skill
and hours of concentration

FILE IT FOR A FIVER!

File 101—well under half price—£5

This is the all-purpose File, allowing 101 separate files of up to five
items each, to be called or altered at will

Apple extras that won't break the bank!

**Talk to Apple VOICE
RECOGNITION CARD**
4 Demo Programs. Manual
Quality Microphone.
Full Guarantee.
£99

TRS80 LEVEL 1
Complete one off
as new.
£250

**MICROPRODUCTS
PARALLEL CARD**
A low cost parallel card.
£25

**SUPER SOUND
GENERATOR** Like ALF
but half the price.
Complete musical
tutor — quite
sensational.
£90

**SPARE DISK
CONTROLLER CARDS**
£35

**SPARE GAMES
PADDLES**
£10

**CENTRONICS
779 PAPER
STACKERS**
£5

PRINTERS Axiom 801
For Apple II or PET an excellent
listing printer.
80/40/20 column. 96 characters.
120 lines per minute.
Parallel ASCII. Reverse printing.
2K Buffer. 2K User Prom Memory.
Software Select 3 character sizes.
2 FREE ROLLS OF PAPER.
FREE INTERFACE.
£220

These special prices
for a limited period only.

Phone 01 626 8121 between 9.30 a.m. and 5.30 p.m.,
Monday to Friday, to avoid disappointment.

All prices excluding VAT

Personal Computers Ltd.

194 - 200 Bishopsgate, London EC2M 4NR. Tel: 01 626 8121 Telex: 888264

Erase Eproms in 8 minutes for under £100

£97 delivered in U.K.
+ V.A.T.

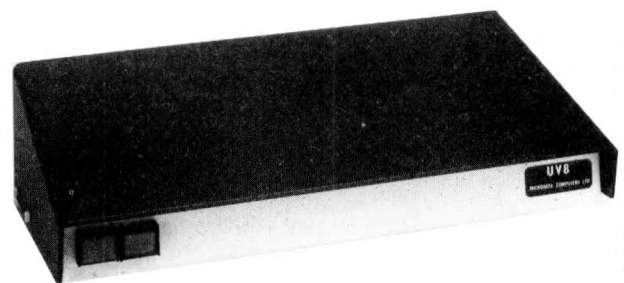

The high speed, high capacity model UV8 sets new performance and
price standards.

- * Cuts typical erasure times by a factor of 5
- * 8 MINUTE SOLID STATE TIMER
- * Capacity up to 14 EPROMS
- * 2708 type erased in 4 to 7 minutes
- * High intensity 254 NM UV source
- * Safety interlock automatically starts timing sequence
- * Audio tone signals erasure cycle complete
- * Internal switch to extend erase time.

MICRODATA Computers Ltd, Belvedere Works, Bilton Way,
Pump Lane Industrial Estate, Hayes Middlesex.

Telephone (01) 848 9871 (6 lines)

Telex 934110



We think you could do better with a NEW MODEL 3 MICROCOMPUTER CASE. If you own a SUPERBOARD, UK101, Nascom 1 or Nascom 2, MICROTYPE have the professional answer.

Look at these features:

- *Made in strong, black ABS plastic together with all fixing screws and full assembly instructions.
- *Space for expansion boards (up to 5 for Nascom), colour add-ons, etc.
- *Room for force-feed fan ventilation.
- *Space for numeric pad and additional keys, etc.
- *Flat top for T.V. monitor, papers, also recessed to hold cassettes.
- *Ribbed base for screw fixing of boards without scratching worktops.
- *Recessed back for cables and connectors.
- *Can be sprayed with conventional car paints without cracking or peeling.

All this for just £24.50 + £1.50 P&P + VAT.
Send cheques or postal orders for £29.90 to:-



MICROTYPE

P.O. Box 104, Hemel Hempstead, Herts. HP2 7QZ.

Please type when ordering. S.A.E. for details.

ARE YOU ILL-TREATING YOUR PET?

IS YOUR PET TIRED, LISTLESS & IRRITABLE ?
THEN FEED IT MORE NOURISHING SOFTWARE
FROM THE NEW

Softcentre

RANGE

DOZENS OF EXCITING, INTERESTING & EDUCATIONAL PROGRAMS, MOST WITH SUPERB GRAPHICS & MANY WRITTEN BY JIM BUTTERFIELD

**GAMES = BUSINESS = EDUCATION
SCIENTIFIC & UTILITY**

SEND STAMP FOR CATALOGUE TO DISTRIBUTORS

OPTELCO
(SOFTWARE DEPT.)

**26 ALBANY ROAD
RAYLEIGH ESSEX**

(FREE VOUCHER WORTH £2 WITH CATALOGUE)

AREA AGENCIES & OVERSEAS DISTRIBUTORS INVITED

PROGRAMMERS! HAVE YOU WRITTEN REALLY ORIGINAL PROGRAMS OF OUTSTANDING QUALITY ? WE PAY GOOD ROYALTIES FOR THE RIGHT MATERIAL - SEND CASSETTE FOR ASSESSMENT AND YOU WILL RECEIVE ANY OFFER WITHIN A WEEK !

P.S. LOTS OF SOUND & PRINTER PROGRAMS IN THE RANGE

SOFTY Software Development System **EX-STOCK**

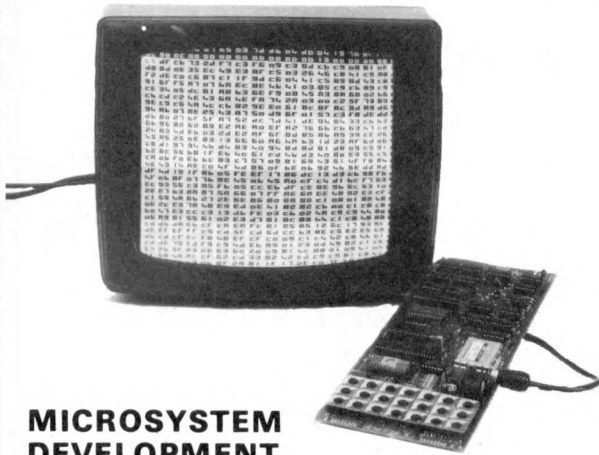

MICROSYSTEM DEVELOPMENT USING SOFTY

SOFTY is intended for the development of programs which will eventually become software residing in ROM and forming part of a microsystem. During the development stage of a microsystem, SOFTY will be connected in place of the firmware ROM via a ribbon cable, terminated in a 24 pin DIL plug.

Data may be entered into the SOFTY RAM via the **serial port, parallel port, direct memory access, or the keypad**, and manipulated using the **assembler key-functions**. When the program has been entered, the internal microprocessor can be 'turned off', and the external/microsystem and its resident microprocessor allowed to access and run the program in SOFTY's RAM and/or programming socket. In this way modification can be made until the required program is complete — **the contents of the RAM being clearly visible as a 'page' on TV or monitor**. 4 pages are available, 2 of the Data RAM and 2 of the programming socket.

In the end, when the program is complete and working, the DIL plug is removed and replaced by an EPROM device programmed by SOFTY. **SOFTY is able to program the 2704/2708/2716 family** which have 3 voltage rails

To help in the process of program development SOFTY has various assembler key-functions, which include — **block shift without overwriting, block store, cursor control, match byte and displacement calculations (for jumps, etc.)** A **high speed cassette interface** is also provided for storing working programs and useful subroutines. Software is supplied for serial data transfers — which means that you can write an assembler for your favourite MPU in BASIC on your Superboard, UK101, NASCOM, etc. and transfer the hex code directly to EPROM via SOFTY. The serial transfer program runs in the scratchpad and can be easily loaded from cassette, or the programming socket. Besides software development and EPROM programming, SOFTY has other uses — as a **training aid**, or as a **control computer** in its own right, with up to **2K bytes firmware, 1K of RAM, 22 I/O ports and Direct Memory Access**.

SOFTY Kit-of-parts (including zero insertion force socket for EPROM programmer, ribbon cable and 24 pin D.I.L. header plug for connection to the system under development).

Price £115 (inc. VAT, p&p)

SOFTY power supply kit £23 (inc. VAT, p&p)

SOFTY built and tested £138 (inc. VAT, p&p)

Write or telephone for full details

SOFTY CONVERSION CARD —

Enables SOFTY to program the single rail EPROMs 2508, 2758, 2516, (INTEL 2716), 2532.

Selection of device type and 1K block are by 4 way pcb slide switches. Programming socket is zero insertion force. Supplied ready built with Dip Jumper for connection to SOFTY. £46.00 (inc VAT, p&p).

MODEL 14 EPROM ERASERS

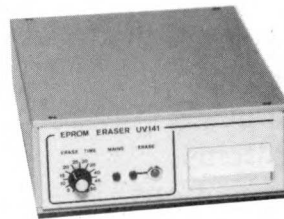

MODEL UV141 EPROM ERASER

- Fast erase times (typically 20 minutes for 2708 EPROM)
- 14 EPROM capacity
- Built-in 5 to 50 minute timer to cater for all EPROMs
- Safety interlocked to prevent eye and skin damage
- Convenient slide-tray loading of devices
- MAINS and ERASE indicators
- Rugged construction
- Priced at only £89.70 (inc VAT, p&p)

MODEL UV140 EPROM ERASER

Similar to Model UV141 but without timer
Low price at only £70.73 (inc. VAT, p&p)

WRITE OR TELEPHONE FOR FULL DETAILS OR SEND CHEQUES / OFFICIAL COMPANY ORDERS TO:

GP Industrial Electronics Limited

(Retail Sales), Skardon Place, North Hill, Plymouth
PL4 8HA. Telephone: Plymouth (0752) 28627
TRADE AND EXPORT ENQUIRIES WELCOME

Sales Ledger
Nominal Ledger
Inventory & Invoicing
Purchase Ledger

- * easy to use
- * fully documented
- * simple operator interface
- * alphanumeric stock Part Numbers
- * fully integrated or stand alone
- * full validation and range checking

The system is generated to meet individual customer requirements.

A typical double density two disk system will hold:---

- 200 accounts
- 99 rep/agents
- 150 nominals
- 500 nominal transactions
- 75 supplier orders
- 100 suppliers
- 500 account transactions
- 99 sales codes
- 99 nominal heads
- 350 stock items
- 200 order transactions
- 300 supplier transactions

Price: £950 plus VAT

PAYROLL: £350 plus VAT

TIME LEDGER: £250 plus VAT

DEALER ENQUIRIES WELCOME

**BENCHMARK COMPUTER
SYSTEMS LIMITED**

Tremena Manor, Tremena Road,
St. Austell, Cornwall PL25 5QG
Telephone: 0458/43418
0761/62435: 0726/61000

BIRMINGHAM Computer Centre

HIGH SPEED **NEW** MATRIX
NOW WITH PET GRAPHICS PRINTER

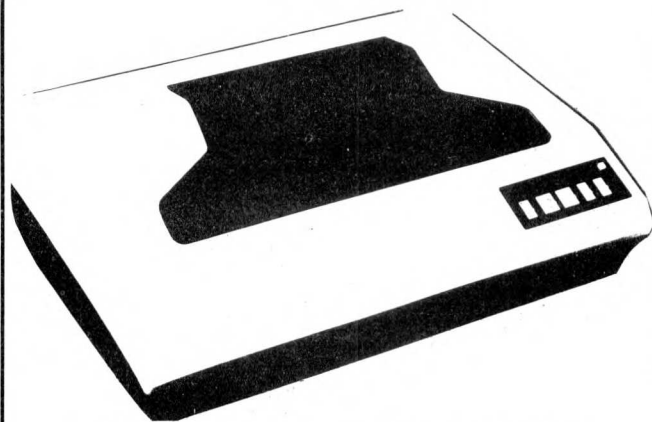

Full ASC II 96 Character Set plus Graphics
plus 750CH Buffer 2K.
Extra Buffer available
UNI – or Bi-Directional
IEEE or Parallel Interface Plugs
direct into PET.
No Interface needed
£525

COMMODORE 3022 PRINTER

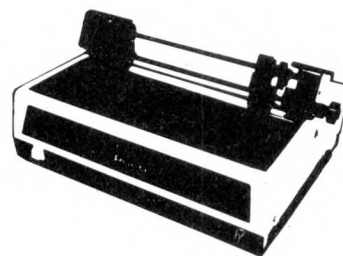

★ **NEW LOW PRICE** ★
Tractor Feed – Genuine C.B.M.

*Camden Electronics
First Floor
462 Coventry Road
Small Heath, Birmingham B10 0UG
Phone: 021-773 8240*

Dyad Developments are pleased to

announce that they have been appointed UK Distributors of

COMPUCOLOR II

The CompuColor Corp, are now supplying them with their up to date systems and these have been found to be exceptional in performance and reliability. These second generation machines represent the most sophisticated and powerful small computers available today and at only half the cost of their counterparts.

WHAT YOU GET

- 13" colour video monitor
- Built in disc drive RS232C port, selectable Bdr
- High resolution graphics
- Two character sizes
- Extended Basic with DOS
- Vector plotting
- And much more

Typical Prices

8K User RAM	£ 998
16K " "	1078
32K " "	1198
Additional Disc Drive	310
Soundware (music)	30
Assembler	15
Text Editor	15

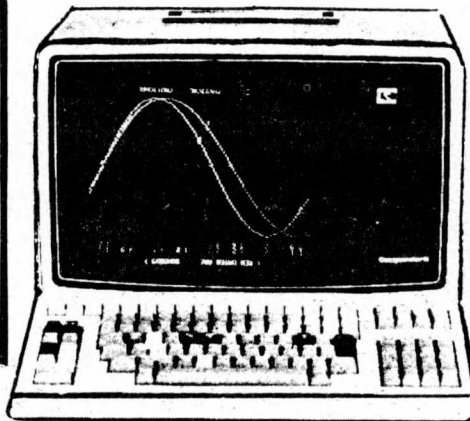

DEALER INQUIRIES WELCOMED prices excl. VAT

The Priory - Great Milton - Oxon - OX9 7PB - Tel (08446) 729

MICRO CONTROL

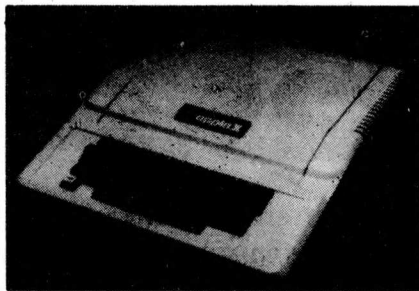

LEASING FACILITIES AND FINANCE AVAILABLE
RING FOR QUOTE

SPECIAL INTERFACES
We can design and produce special interface systems at reasonable cost

COMING SHORTLY
COLOUR FOR PET TRS80

PART EXCHANGE
We offer generous P.X allowances, ring for quote

All prices exclude VAT

224, EDGWARE ROAD
LONDON W2 1DN
TEL (01) 402 8842



Official Dealers - Apple II - Microstar - CompuCorp

PRICE LISTS

APPLE II (128K) VIDEO OUTPUT	780.00
HIGH SPEED SERIAL CARD	110.00
CLOCK CARD	140.00
LIGHT PEN	185.00
VOICE RECOGNITION CARD	127.00
LOWER CASE GENERATOR	40.00
EPROM BURNER & SOCKET ADAPTOR	98.00
PROTOTYPING BOARD	20.00
PAL CARD	72.00
B/W MODULATOR	20.00
PROGRAMMERS AID NO. 1	28.00
APPLE II MODULATOR OUTPUT	770.00
DISK DRIVE WITH CONTROLLER	388.00
DISK DRIVE	355.00
DOS 3.2 MANUAL & DISKETTE	18.00
APPLE PASCAL	285.00
AUTO START ROM	40.00
GAMES PADDLES	17.80
SUPER TALKER	180.00
APPLE II INTEGER BASIC MANUAL	3.98
APPLESOFT BASIC MANUAL	5.75
8022 PROGRAMMING MANUAL	8.80
APPLE II PLUS COLOUR (PAL)	819.00
8022 HARDWARE MANUAL	8.80
BLANK CASSETTE (IC19)	0.85
MICROPRODUCTS PARALLEL PORT	40.00
8" FLOPPY DISK SYSTEM (1.2 MB)	2260.00
DISK BASED ASSEMBLER	30.00
VINYL CARRYING CASE	25.00
MICROCHESS 2.0 CHESS DISC	18.00
16K ADD-ON MEMORY	89.00
APPLESOFT FIRMWARE CARD	110.00
INTEGER FIRMWARE CARD	110.00
PARALLEL PRINTER CARD	110.00
COMMUNICATIONS CARD	132.00
APPLE II REFERENCE MANUAL	5.75
BASF FLOPPY DISKETTE	3.80
APPLESOFT FIRMWARE CARD	888.00
CENTRONICS 770 PRINTER	132.00
CENTRONICS PRINTER CARD	132.00
HITACHI 8" B/W MONITOR	23.00
TRENDCOM 100 PRINTER	23.00
TRENDCOM PAPER (80 FT)	4.25
TC 3 TRENDCOM 100 I/F	48.00

APPLE PASCAL TM

This Hardware/Software package provides a very powerful tool for the serious user. High speed hires "Turtle" graphics, fast editor, Compiler, Relocatable Assembler, Excellent System Utilities, Superb documentation £289.

NEW!

DIGITAL COLOUR CARD

Apple II or ITT 2020
Mixed Colour Text!!!

Complete software control allows 15 fully-saturated colours in Graphics and Text modes. Simple plug-in system. Existing Software Compatible Designed and Manufactured by us Complete System. £148.00 Monitor Mod Kit £27.00

12-BIT RESOLUTION

A/D Conversion

Our new A/D cards offer high 12-bit resolution with a fast conversion time, 4 inputs on board expandable to 8.

Max. Sensitivity 10 uV F.S.D.
Demonstration Software Supplied.

Turn your apple to a fast analogue data acquisition system X, Y plotter etc.

12-Bit System £174.
8-Bit System £116.



small systems presents

PET COMPATIBLE DAISY WHEEL PRINTER

S.S.E. RICOH RP40

Printing Speed - 40 C.P.S.
 Character-set - 96 characters, metal faced printwheel
 Choice of typefaces
 Line width - 136 characters (10 characters per inch)
 Line width - 163 characters (12 characters per inch)
 Form width - 16"
 Integral PET IEEE-488 Addressable Interface (Disc compatible)
 240v 50Hz
 Micro-Processor controlled
 Reputation for high reliability
 Options -
 Pin Feed Platen
 Acoustic cover
 Form Tractor
 RS232 C Interface, Centronics Interface

Complete word processing systems - Commodore PET, Software and RP40 Printer also available.

HIGH QUALITY PRINTING AT LOW COST £1590.00 inc. PET INTERFACE



Small Systems Engineering Limited
 2/4 Canfield Place - London - NW6 3BT Telephone 01 328 7145/6 Telex 8813085 (Abacus)

Kemitron Electronics Limited

CHOOSE FROM OVER 20 DIFFERENT BOARDS
 SINGLE BOARD SYSTEMS TO 64K + DISK
 8060, 8070, Z80.

CPU's

1. Simple Z80 (MZ-A-1) £7.95
 A fully buffered micro-processor which can be used with dynamic memory; provision to add wait states for slow memory.
2. Z80 + power-on jump (MZ-B-3) £8.95
 Fully buffered, for use with dynamic memory. At power-on program execution can start at any 4K boundary, including on-board EPROM, which can be switched out under software control.
3. 8060 micro-controller (SC-MP-2) £8.95
 Micro-processor + 2K EPROM + 128 bytes RAM + 23 I/O lines + patch areas.
4. Single step 8060 (MP-A-7) £8.95
 Fully buffered, decoded Halt flag, provision for hardware single step or single cycle and to add wait states.
5. Multiprocessor 8060 (MPP-1) £8.95
 Fully buffered board for up to four 8060's in multi-processor configuration.

Other best sellers:

Tape interface (TP-A-2) £7.95
 Uses tones of 1200 and 2400 Hz, sine wave synthesis error reduction techniques from receiver.

Disc interface (DC-2) £165.00
 Floppy disc interface for soft-sectored 5 1/4" and 8" disc drivers, uses popular 1771. Supplied built and tested only.

MINIMUM SYSTEM (Built & Tested)	64K DISC SYSTEM (Built & Tested)
MZ-B-3 £79	MZ-B-3 £79
MX-A-1 (2K memory) £55	Boot PROM £20
SIO-2 (twin RS232) £79	4 MX-D-2 (16K memory) £380
PSU £79	SIO-2 £79
Case/rack £114	PSU's £195
Software £20	Case/rack £180
£426	2 8" disc drives £700
	DC-2 £165
	CP/M (DOS) £75
	Cables etc. £75
	£1948

Prices exclude V.A.T. Full details on request. C.W.O. only.
 Kemitron Electronics Limited,
 21-23 Charles Street, Hoole, Chester CH2 3AY
 Tel: Chester 21817.

Now!

Typewriter Quality Printing

on your microcomputer for **£960 +VAT** or Easy Terms



The CPS 3982 is a fully re-conditioned IBM 3982 'golf ball' printer with special CPS electronics designed for use with your microcomputer.

90 day warranty and nationwide maintenance service agreement available.

Features

- Interchangeable golf ball print head (mathematical font available)
- 132 print positions
- Serial port 110 Baud via 25 way 'D' socket (RS 232 type)

Options:-

- Pin feed platen
- PET IEEE interface
- APPLE Serial interface card

For more information and easy terms facilities
 'phone 021-707 3866 Telex 312280 CPS G



CPS (DATA SYSTEMS) LTD
 Arden House, 1102 Warwick Road,
 Acocks Green, Birmingham B27 6BH

CPS are PET and APPLE Dealers

PortaTel

SMASH

14" COLOUR MONITOR PRICES

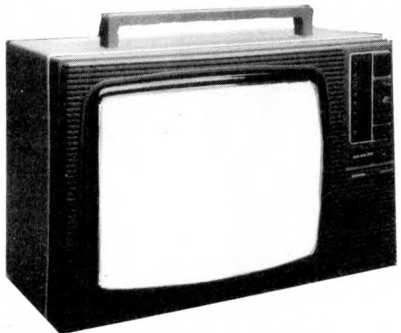

SKANTIC 3781 14" CTV

Display of American Standard Video TEXAS TI 99/4 home computer etc.

£299 plus VAT

OFF AIR PAL & NTSC 14" MONITOR

FULLY GUARANTEED
 PAL VIDEO AND LARGER SIZES AVAILABLE

PortaTel Conversions Limited

25 SUNBURY CROSS CENTRE
 SUNBURY ON THAMES MIDD
 TEL. No. SUNBURY (09327) 88972
 VIDEO CONVERSION SPECIALISTS

ACCESS & BARCLAYCARD WELCOME

ADVERTISERS INDEX

Acorn Computers	56	CPS Data	21/166	Keen Computers	106	Personal Computers OBC/162	
Aculab	161	CRA	146	Kemitron	166	Petalect	160
Advanced Computer Products	156	Cumana	137	Kingston Computers	141	Petsoft	2/3
Airamco	156	Currah	148	Knights	107	PHL	21
Almarc Data Systems	132	Databank	17	L&J Computers	75	PIPS	152
Appleware	48	Dator	32	L.J. Electronics	104	Portatel	166
B&B	26	Davinci	140	Lifeboard Associates	6/7	Printout	108
Bell	25	DDM	8	Lion Microcomputers	151	Promglow	36
Benchmark	164	DDP	84	Little Genius	99	Research Machines	37
Bits & Pc's	158	Digital Data	161	Liveport	149	Science of	
BNR & ES	156	Display Electronics	157	Logitek	136/154	Cambridge	102/103
Bristol Software	12/13	Equinox	8/35	Lowe Electronics	29	Sharp	27
Business & Leisure	146	Farmplan	143	LP Enterprises	34	Sirton Products	133
Byte Shop	36	Gate Microsystems	144	Mendip	16	Small Systems	120/166
Calco	161	GP Industrial Electronics	163	Microact	92	SMG Micros	158
Camden Electronics	150	Graffcom	99	Microbyte	159	Softwarehouse	9
Carter	152	GW Computers	28	Microcentre	165	Southern Software	140
CCS	139	Happy Memories	20	Microcontrol	162	Stack	24/155
Centralex	154	A.J. Harding (Molimerx)	134	Microdata	162	Strumech (SEED)	68
Clearsons	158	Heath	98	Microsense	90	Supersoft	36
Comart	62/101	Henry's	160	Microsolve	142	Sun	104
Commodore	41	Hitech Electronics	160	Microtrend	88	Tandy	4/5
Comp Shop	168/IBC	HL Audio	150	Microtype	163	Tangerine	144
Computerama	131	Home & Business	146	Micro UK	30/31	Terodec	67
Computerbits	16	Intelligent Artifacts	140	Mighty Micro	148	Transam	10/11
Computer Centre	18/19	Interface Data	152	Mike Rose Micros	33	TVJ Microcomputers	22/23
Computermania	165	Interface Components	145	Mutek	14	Video Vector	20
Comutist Dair Electronics	120	Intex Datalog	20	Newbear	153	Vlasak	15
		Kansas City Systems	162	On Line Conferences	76	Wego	32
				Optelco	16/163	Xitan	138

CHIP CHAT

Luddites rule. . . absurd news reaches us from the great publishing empire of IPC that any word-processor produced copy sent in by contributors to a certain monthly micro magazine has to be re-typed on an ordinary typewriter before being sent to the printers. Apparently these ink-stained worthies refuse to touch anything which has been tainted with Technology — 'Bumper' Harris says: "How impractical!" (*Ho Ho — Ed*). . . 13 May was a lucky day for Mike Knight of Mike Rose Micros and 'Squire' Julian Allason. Both became proud fathers to, respectively, a girl and a boy. The Squire promptly named his offspring James Robert — our first JR of the year. . . First Tandy, now Sharp and Commodore; all around eyebrows are rising as fast as prices are falling; have YOU looked inside your cornflake packet lately? . . . All change time — Hi-Fi heavyweights, Laskys, have bought Microdigital and the Liverpool Software Gazette. . . Could this be the breakthrough in biodegradable chips? Bewildered child heard outside famous London toyshop complaining of sand trickling from the bottom of

his new micro toy! "The toys felt insubstantial without it", says spokesman Harris. Hot news from Hanover — in a spot check of brands, Frau Gerfingerpoken was unable to detect any difference between the Siemens Personal Computer 1000 and the new Apple III; "Mein Gott, vot haff ve here" she is unreliably reported to have said. . . Commodore shake-up time; out go the whizz kids who make the company what it is (whatever that is), up goes Kit Spencer to Global Marketing Supremo . . . CRANK, a society devoted to cracking passwords and delving into the depths of databases, is being investigated by the fraud squad. It's hinted that they may have tired of 'just looking' and have instead taken to modifying file contents. . . Aspiring ruler of the world, IBM, is reported to have given up the unequal struggle and withdrawn their models 50 and 60 electronic typewriters from the US market. Our source tells us that these uncompetitive machines are likely to be sold off in South America — while the jolly grey giant ponders the success of Messrs Olivetti and Xymec. . . From the underworld; small and not surpris-

ingly un-named software houses with good products are planning on seeking 'professional help' in duffing up rip-off artists who steal their wares — they see no legal way out of the problem. . . Commodore again; paranoia seems to be striking Silicon Gulch about the growing army of plug compatibles; first it was holes drilled in PCBs and solder-filled sockets — now they are rumoured to be tweaking the software to make life

difficult for people like Skyles (Programmers Toolkit), Computhink (Disks) and MTU (Music and graphics). Seeing these guys are probably responsible for a lot of the PET's popularity, could big 'C' be cutting off its nose — along with its directors?

Congratulations to "Spangles" Cary who, despite his hectic schedule, found time to get married at the end of May.

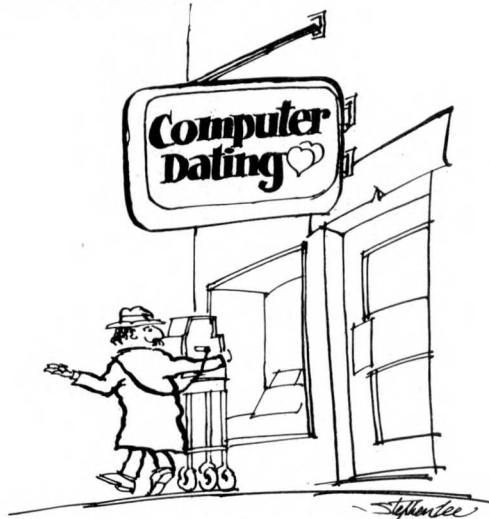

8MHz Super Quality Modulators	£4.90
6MHz Standard Modulators	£2.90
C12 Computer Grade Cassettes 10 for	£4.00
Super Multi-rail P.S.U. +5 -5 +12v	£29.50
ETI Breakout Game - Chip and PCB	£9.90
S100 Expansion Motherboard for Nascom I	£39.00
Anadex Printer Paper - 2000 sheets	£25.00
Floppy Disks 5¼" Hard & Soft Sectored	£3.50
Floppy Disk Library Case 5¼"	£3.50
Eprom Boards	£63.00
8K Static Ram Boards - S100	£110.00
Cartridges for Grandstand	£11.99
George Risk Ascii Keyboard	£39.00
Cartridges for Atari	
- Full Range in Stock	£13.90
Interface PET IEEE - Centronics Parallel	
Not decoded	£49.00
Decoded	£77.00
Interface to Centronics parallel for TRS80	£75.00
Verocases for Nascom 1 & 2 etc.	£22.50
Keyboard Cases	£9.90
Electric Pencil for TRS80	£29.00

SPECIAL SCOOP

GET YOURSELF A PRINTER FOR YOUR PET AND SAVE A FORTUNE

only **£399** + VAT

Full Pet Graphics including cables. Ready to go.

EX-STOCK.

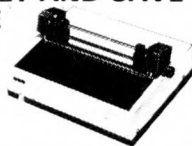

HITACHI PROFESSIONAL MONITORS

9" - **£129**
12" - **£199**

- **Reliability** Solid state circuitry using an IC and silicon transistors ensures high reliability.
- **500 lines horizontal resolution** Horizontal resolution in excess of 500 lines is achieved in picture center.
- **Stable picture** Even played back pictures of VTR can be displayed without jittering.
- **Looping video input** Video input can be looped through with built-in termination switch.
- **External sync operation** (available as option for U and C types)
- **Compact construction** Two monitors are mountable side by side in a standard 19-inch rack.

A PROFESSIONAL WORD PROCESSING SYSTEM AND IT'S A COMPUTER AS WELL.

ALL FOR ONLY **£3250** + VAT including Word Pro and Cables.



£1750 + VAT
RRP £2200

PET 32K - This is the standard 32K Pet from Commodore. Reverse video and graphics allow the WordPro Package to give simple clear and easy to read displays.

2040 Disk Drives Twin disk drives allow large high speed storage for your letters, or paragraphs. Plugs in the back of the PET.

NEC Spinwriter NEC's high quality printer uses a print "thimble" that has less diameter and inertia than a daisy wheel,

only **£356** + VAT



TRS80 LEVEL 2 16K

Fully converted to UK T.V. Standard. Comes complete with easy to follow manuals. UK Power Supply - Cassette Leads - Sample tapes. Special box to enable you to plug into your own TV. Recommended for first time-buyers. Just plug in and go. Full Range of Software Available. Model with numeric key pad £389 + VAT. 4K Level I - machine only £251 + VAT.

NEW REDUCED PRICES

8K **£449**
16K **£549**
32K **£649**

+ VAT



The PEDIGREE PETS

RRP £795 for 32K. Very popular for home & business use. 8K Microsoft Basic in ROM. 8K Pet 32K & 16K with new improved keyboard. All with green screen. Extra cassette deck **£55** Full range of software available.

32K

£690 + VAT

EXIDY SORCERER

For Personal or Business Use.

32K or 48K memory. 8K Microsoft Basic in ROM. Dual Cassette I/O, RS232 I/O, Parallel I/O (Centronics). Expansion available through optional extra S100 Motherboard. 69 Key keyboard including 16 key numeric pad.

S100 EXPANSION - **£199**

48K

£790 + VAT

RRP **£859** for 32K

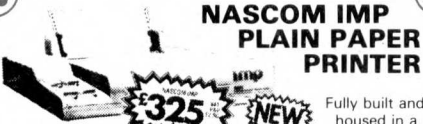

NASCOM IMP PLAIN PAPER PRINTER

Fully built and housed in a stylish enclosure for just **£325** plus VAT. Interfaces with all micro computers.

The Nascom IMP (Impact Matrix Printer) features are listed below:

- 60 lines per minute.
- 80 characters per line.
- Bi-directional printing.
- 10 line print buffer.
- Automatic CR/LF.
- 96 character ASCII set (including upper/lower case, \$, #, ., E).
- Accepts 8½" paper (pressure feed).
- Accepts 9½" paper (tractor feed).
- Tractor/pressure feed.
- Baud rate from 110 to 9600.
- External signal for optional synchronisation of baud rate.
- Serial RS232 interface with parallel option available soon.

only **£295** + VAT

Expand your TRS80 by 32K. 32K Memory on board. Centronics parallel port. Disk controller card. Real time clock. Requires Level II Basic. Interface for 2 cassette decks. Complete with power supply.

TRS80 EXPANSION INTERFACE

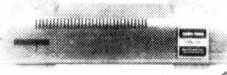

RRP **£540**

only **£499** + VAT

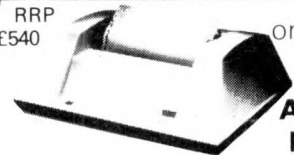

ANADIX DP8000

Super Quality - Low cost printer. Tractor Feed with full 96 ASCII character set. Accepts RS232C at band rates between 100 and 9600 and Parallel Bit data. Attaches either directly or through interfaces to Pet, Apple, TRS80, Sorcerer, Nascom, Komputik etc.

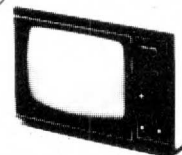

video 100
12" BLACK & WHITE LOW COST VIDEO MONITOR

RRP **£79**

only **£69** + VAT

- Ideal for home, personal and business computer systems
- 12" diagonal video monitor
- Composite video input
- Composite video input
- Compatible with many computer systems
- Solid-state circuitry for a stable & sharp picture
- Video bandwidth - 12MHz + 3DB
- Input impedance - 75 Ohms
- Resolution - 650 lines Minimum
- Central 80% of CRT; 550 Lines Minimum beyond central 80%.

NASCOM-2 MICRO-COMPUTER

only **£295** + VAT

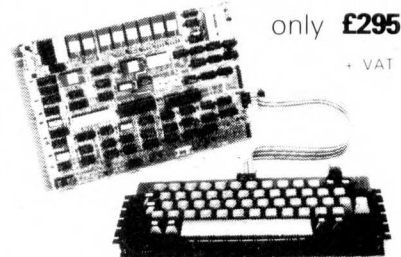

Your choice of freebies with every Nascom 2 purchased from us

either **FREE POWER SUPPLY**
OR FREE GRAPHICS ROM
OR FREE VERO CASE TO TAKE NASCOM 2

Microprocessors Z80A. 8 bit CPU. This will run at 4MHz but is selectable between 1/2/4 MHz. This CPU has now been generally accepted as the most powerful, 8 bit processor on the market.

INTERFACE

Keyboard New expanded 57 key Licon solid state keyboard especially built for Nascom. Uses standard Nascom, monitor controlled, decoding.

T.V. The lv peak to peak video signal can drive a monitor directly and is also fed to the on-board modulator to drive the domestic T.V.

I.O. On board UART (Int.6402) which provides serial handling for the on-board cassette interface or the RS232/20mA teletype interface.

The cassette interface is Kansas City standard at either 300 or 1200 baud. This is a link option on the NASCOM-2. The RS232 and 20mA loop connector will interface directly into any standard teletype.

The input and output sides of the UART are independently switchable between any of the options - i.e. it is possible to house input on the cassette and output on the printer.

PIO There is also a totally uncommitted Parallel I/O (MK3881) giving 16, programmable, I/O lines. These are addressable as 2 x 8 bit ports with complete handshake controls.

Documentation Full construction article is provided for those who buy a kit and an extensive software manual is provided for the monitor and Basic.

Basic The Nascom 2 contains a full 8K Microsoft Basic in one ROM chip with additional features like DEEK, DOKE, SET, RESET for simple programming.

With free 16K RAM board.

COMPUKIT UK101

EUROPE'S FASTEST SELLING ONE BOARD COMPUTER



- ★ 6502 based system — best value for money on the market.
- ★ Powerful 8K Basic — Fastest around
- ★ Full Qwerty Keyboard
- ★ 4K RAM Expandable to 8K on board.
- ★ Power supply and RF Modulator on board.
- ★ No Extras needed — Plug-in and go.
- ★ Kansas City Tape Interface on board.
- ★ Free Sampler Tape including powerful Dissassembler and Monitor with each Kit.
- ★ If you want to learn about Micros, but didn't know which machine to buy then **this is the machine for you.**

Build, Understand and Program your own Computer for only a small outlay.

KIT ONLY **£199** + VAT
NO EXTRAS NEEDED

AVAILABLE READY ASSEMBLED & TESTED
READY TO GO FOR **£249** + VAT

Specially designed case for CompuKit in orange/black. With room for accessories. **£29.50** + VAT

6502 Assembler/Editor for CompuKit **£14.90** + VAT

The **CompuKit UK101** comes in kit form with all the parts necessary to be up and working, supplied. No extras are needed. After plugging in just press the reset keys and the whole world of computing is at your fingertips. Should you wish to work in the machine code of the 6502 then just press the M key and the machine will be ready to execute your commands and programs. By pressing the C key the world of Basic is open to you.

This machine is ideal to the computing student or Maths student, ideal to teach your children arithmetic, and is also great fun to use.

Because of the enormous volume of users of this kit we are able to offer a **new reduced price** of **£199** + VAT

NEW MONITOR FOR COMPUKIT UK101 • In 2K Eprom 2716
• Allows screen editing • Saves data on tape
• Flashing cursor • Text scrolls down **£22.00** + VAT

THE NEW TRS80 SURPRISE — MODEL II

Fast and expandable!

Model II operates at twice TRS-80's high speed.

In addition to either 32 or 64 thousand characters (bytes) of internal Random Access Memory, one built-in 8" floppy disk stores an additional one-half million bytes, including the Disk Operating System. And you can easily expand up to a four-disk system for up to two-million bytes of storage.

Model II features upper and lower case letters. Its built-in 12" high-resolution video monitor displays 24 lines of 80 normal characters. The professional 76-key keyboard (with "calculator" keypad) includes advanced functions such as Control, Escape, Caps, Hold, Repeat. The keyboard is detachable and moveable for convenient data entry.

You get the enhanced Level III version of TRS-80's already-famous Level II BASIC language and "TRS-DOS" operating system, automatically loaded in memory when you "power up." (About 24K of RAM is used by this software.)

Each time you power up, Model II thoroughly tests itself to insure proper operation. Your chosen program can appear immediately, without any intermediate steps or questions to answer.

Versatility ... plug-in expandability

Built-in input/output capabilities include two RS-232C channels, and one Centronics parallel port. Future expansion is provided for through four plug-in slots for optional PC boards.

64K 1-Disk Model II **£2250.00** + VAT

1 DISK EXPANSION Room for 3

500K per Drive gives total of 1.5M Byte — 1 Drive plus Cabinet **£799** + VAT

Just Plug In

WE ARE NOW EX-STOCK

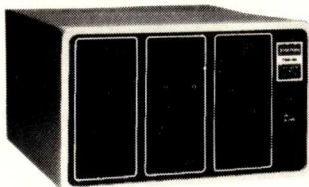

Why do people buy more from COMPSHOP than anywhere else?

- ★ **LARGER STOCKS** — we hardly ever run out
- ★ **GOOD SERVICE** — we give extended warranties on all our products.
- ★ **EXCELLENT REPAIR SERVICE** — Through Compucare we repair and maintain most makes of personal computers.

LAST YEAR WE SUPPLIED TO THE PUBLIC — LARGE & SMALL
16,000 Television Games & 7,000 Computer Systems

NEW TV GAME BREAK OUT

Has got to be one of the world's greatest TV games. You really get hooked. As featured in ETI. Has also 4 other pinball games and lots of options. Good kit for up-grading old amusement games.

MINI KIT — PCB, sound & vision modulator, memory chip and de-code chip. Very simple to construct. **£14.90** + VAT
OR PCB £2.90 MAIN LSI £8.50 Both plus VAT

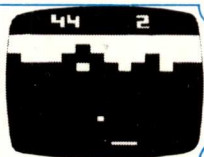

THE ATARI VIDEO COMPUTER SYSTEM

£99.00 + VAT

Atari's Video Computer System now offers more than 1300 different game variations and options in twenty great Game Program™ cartridges!

Have fun while you sharpen your mental and physical coordination. You can play rousing, challenging, sophisticated video games, the games that made Atari famous. You'll have thrill after thrill, whether you're in the thick of a dogfight, screaming around a racetrack, or dodging asteroids in an alien galaxy. With crisp bright colour (on colour TV) and incredible, true-to-life sound effects. With special circuits to protect your TV.

Cartridges now available All at **£13.90** each + VAT

Basic Maths, Airsea Battle, Black Jack, Breakout, Surround, Spacewar, Video Olympics, Outlaw, Basketball, Hunt & Score*, Space War, Sky Diver, Air Sea Battle Codebreaker*, Miniature Golf.

Extra Paddle Controllers — **£14.90** + VAT

*Keyboard Controllers — **£16.90** + VAT



COMP SHOP
"Europe's Largest Discount Personal Computer Store"

Please add VAT to all prices — Delivery at cost, will be advised at time of purchase. Please make cheques and postal orders payable to COMPSHOP LTD., or phone your order quoting BARCLAYCARD, ACCESS, DINERS CLUB or AMERICAN EXPRESS number. CREDIT FACILITIES ARRANGED — send S.A.E. for application form.

14 Station Road, New Barnet, Hertfordshire, EN5 1QW Telex: 298755 TELCOM G

Telephone: 01-441 2922 (Sales) 01-449 6596

OPEN - 10 am - 7 pm — Monday to Saturday

Close to New Barnet BR Station — Moorgate Line.

★ **NOW in IRELAND** at: 80 Marlborough St., Dublin 1. Tel: Dublin 749933

COMP COMPUTER COMPONENTS
(Part of the Compshop Ltd. Group)



We are now entering our fourth financial year of dealing solely in the personal computer market – in fact, we started it! Over this period, Personal Computers Limited have formed a group of graduate specialists who will help you in the fields of word processing, financial planning, statistics, economic modelling, forecasting, accounting systems, foreign exchange, banking and oil exploration. We also do rather well with computer graphics and highly recommend the graphics tablets and our plotter for Apple.

We can also offer two excellent items of software – Format 40 and Visicalc – at a combined price of **ONLY £189**, and the Super Sound Generator for only **£90!** (excl. V.A.T.)



8" Disk Drive (above left)

Our 8" disks are still as popular as ever – 2 drives give you 1.2MB with all the reliable security of Shugart Technology. Easily interfaced to Apple, uses the same D.O.S.

A.I.O. Serial and Parallel Card (above centre)

Three hand-shake lines (R.T.S., C.T.S. and D.C.D.). Firmware for serial interfaces on-board, software for parallel printer available, 2 bi-directional 8 bit parallel ports, plus 4 additional interrupt and hand-shaking lines.

Light Pen (above right)

A much sought after product which we introduced to the U.K.

80 Character Card (below left)

... opens up the real commercial world for all Apple owners.

Paper Tiger (Below centre)

132 character line, plus graphics, 8 character sizes, ordinary paper, multiple copy, upper and lower case 96 character, parallel/serial, form control.

Centronics 730 (Below right)

A substantial, robust printer from a major manufacturer. 3 way paper handling system, 100 character per second. Special low-cost including interface. 96 characters.



Items pictured

Sharp MZ – 80K

A new generation of personal computer, self contained, versatile and starting at only **£570** (excl. VAT). Explore the Zilog Z80 now the easy way. Disks and printer available shortly.

Numeric Keypad

... with 8 function keys is a must in all financial applications.

TCM 100 & TCM 200

... both now have graphics as well as their own power supply, essential with this type of printer.

Qume Sprint 5

The quality word processing printer. Clean, clear executive reports the way you want them. Can print up to 5760 points per square inch – or even print in 2 colours.

This is what we do..

and we do it rather well!



Personal Computers Limited
194-200 Bishopsgate, London EC2M 4NR. Tel. 01 626 8121

For further information, please complete this coupon and post to:-
Personal Computers Limited, 194-200 Bishopsgate, London EC2M 4NR

NAME _____
ADDRESS _____
SPECIAL INTEREST _____