

PERSONAL COMPUTER WORLD

50p U.S.\$2.00

SO I GOT A
WORD
PROCESSOR
—
STATPACK

AUGUST 1979

Europe's first magazine for personal computers for home and business use

I Love Computers, but...
What Sort of Sort?
Garage Accounting Program



Horizon: A Review

**THE SECOND GREAT
PC W SHOW
...
see inside**

Keen Computers take you into the future with the Apple II



Apple II 16K	985.00
Additional 16K Ram	100.00
Applesoft Rom	110.00
RS232 Card	110.00
Printer Card	110.00
Disk Drive and Controller	425.00
Disk Drive W/Ot Controller	375.00
Speech Lab	165.00
Apple Clock	165.00
Printers from	350.00

Software Packages are available for most business applications. A few are:-
Word Processor, Information Retrieval, Incomplete Records Accounting, Sales Ledger, Order Entry Invoicing, Management Information, and a variety of Statistical Packages, Games, and others.

Keen Computers
5b The Poultry
Nottingham
Tel: 0602 583254
Telex 37297

PERSONAL COMPUTER WORLD

Europe's first magazine for personal computers for home and business use

UK 50p
US \$ 2.00

Vol. 2 No. 4
August 1979

CONTENTS

ISSN: 0142 0232

EDITORIAL	5	WHAT SORT OF SORT? <i>Dr. William B. Samson</i> An invaluable article for anyone who needs simple and powerful sorting subroutines	51
PUBLISHER'S LETTER	5	GARAGE ACCOUNTING PROGRAM <i>W.H. Davies</i> Park this program in your computer	55
LETTERS	9	THE READER'S DILEMMA <i>Sheridan Williams</i> .. And an Open Reply to the Reader	57
PUZZLE DAZZLE No. 3; Results	10	BUYING A COMPUTER FOR A SMALL BUSINESS <i>M.D. Nott</i> Stimulating . . . funny . . . helpful	61
TIDBITS	13	GIVE US THIS DAY OUR BUSINESS PROCESSOR <i>Mark Fillingham</i> A businesslike prayer	63
I LOVE COMPUTERS, BUT <i>Chris Howland</i> Your friendly computer . . . one hand on its heart, the other in your pocket	17	PARKINSON'S REVAS; <i>Continued</i>	65
APPLE MEDICAL APPLICATION A Harley Street obstetrician gets delivery of an Apple. But it's no baby	21	PCW BOOK REVIEW <i>Michael James</i>	67
THE NORTH STAR HORIZON <i>Martin Healey, Paul Woodward and Mike Rees</i> A PCW Review	23	PCW OPEN PAGE <i>Mike Lord</i> Another inimitable, concise, precise contribution from the author	68
SO, I GOT A WORDPROCESSOR <i>Edward P. Hawthorne</i> Micros might make publishing a cottage industry	29	BUZZWORDS <i>Peter Reynolds</i> It's taken H'zz to get here	73
ON YOUR MARK, GET SET <i>Clifford Clark</i> Another PCW Special for the Beginner	35	ADVERTISERS' INDEX	59
HIGH SPEED CASSETTE INTERFACE <i>David R. Isaac</i> Complete with listing; for the SWTP 6800	39	David Hebditch's On The Line will be continued in the next issue.	
STATPACK <i>Colin Chatfield</i> Continued	45		
SCALE <i>Gillian Richmond</i> An article for schools and beginners, written by a schoolgirl	47		

Editorial and Advertising Office:

62A Westbourne Grove, London W2
Phone: 01-229 5599 (Publisher)
01-727 8758 (Editorial)
01-229 5589 (Advertising & Subscriptions)

Publisher:

A Zgorelec

Editor:

Meyer N. Solomon

Editorial Assistant:

David Bannister

Policy Adviser:

Peter Crofton-Sleigh, FRAS

Consultants

John Coll, Mike Dennis, Neil Harrison, Charles Sweeten,
Patrick Sutton, Michael James, R. W. Davy, David Hebditch,
Sheridan Williams, Stephen Castell, Dr. D.J. Hand.

Art: Sauveur Laurent Sant, Kathryn Hamme

Secretarial:

Vanessa Blackburn Kiddle

Layout Consultant:

David G. McFarlane

PCW Photography: Yoshi Imamura, Peter McGee

Typesetting & Artwork: Gilfillan

Cover Photo: Yoshi Imamura

CONTRIBUTORS:

We welcome interesting articles written simply and clearly. You need not be a specialist to write for us. MS should not be more than 3000 words long, lines double spaced, with wide margins. Line drawings and photographs wherever possible. Enclose a stamped self-addressed envelope if you would like your article returned.

Manufacturers, suppliers and dealers are welcome to contribute technical articles, and send product information, but we are pledged to an independent viewpoint and will publish evaluations and reasoned criticism or praise, space permitting. Naturally there will be right of reply. Views expressed in articles are not necessarily those of Personal Computer World.

We may make arrangements to offer our readers products at special prices, for a limited period, in line with the policy outlined above.

Published monthly by Intra Press, 62A Westbourne Grove, London W2. Phone 01-229 5599. Contents fully protected by copyright. All rights reserved. Subscription rates: Britain £8 for 12 issues. Prices include postage. USA - \$10 for six issues. \$20 for 12 issues. Continent and elsewhere £9.80 for twelve issues. Prices include postage. Printed by Keats Printing Limited, 12 Fouberts Place, London W1V 1HH. Sole UK Distributors Seymour Press Ltd., 334 Brixton Road, London S.W.9., England. Distribution to specialist shops by Intra Press.

HORIZON

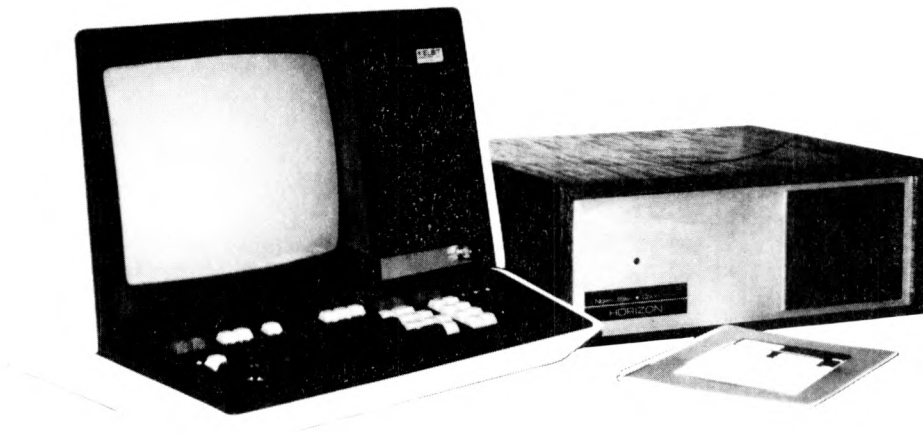

For Business, Scientific and Educational Uses.

PROFESSIONAL HARDWARE

Use of the North Star Horizon for a short period will enable you to appreciate the professionalism in the product. There's a solid well-built chassis, a good power supply, a quiet fan and an attractive wooden case. There's a Z80A processor running at 4MHz with the 250ns static RAM boards.

There are dual integral Shugart minifloppy drives (capacity of about 360 KB on line, with an option for a further two drives), enabling easy and quick handling and copying of programs and data files.

And of course, there's the 12 slot S-100 bus which enables you to plug in many types of peripheral boards, including a hardware floating point board for increased "number crunching" performance.

PROFESSIONAL SOFTWARE

North Star Computers built their professional reputation around their powerful, but simple, Disc Operating System and Disc Extended BASIC Interpreter.

The latter contains, in addition to the usual BASIC commands, random and sequential access disc files, strings, string operators, multiple dimensioned arrays, formatted output, machine language CALL, memory EXAMine and FILL, line editor, program chaining and more.

The CP/M operating system is also available as an option and provides access to a Macro Assembler, C BASIC Compiler and FORTRAN-80 and COBOL-80 Compilers. A standard UCSD PASCAL has now been implemented.

TYPICAL APPLICATIONS SOFTWARE

- Financial
- Mathematical
- Statistical
- Educational
- Games
- Sales Ledger
- Purchase Ledger
- Stock Control
- Payroll
- General Ledger
- Estate Agents Package
- Incomplete Records
- Employment Agents

HORIZON with dual drives, 24K RAM and standard serial port — £1823. Extra 8K 250ns static memory — £155. Extra serial port — £45. Parallel port — £45.

COMPLETE HORIZON BUSINESS SYSTEM (hardware) with 24K RAM, dual mini-floppy drives, VDU and 30cps printer — £3616; 32K RAM, dual mini-floppy drives, VDU and 150cps printer £4658.

Prices exclude VAT and carriage.

Dealer, OEM and Educational Discounts available.

EQUINOX

COMPUTER SYSTEMS LTD.

"KLEEMAN HOUSE"

16 ANNING STREET, NEW INN YARD,
LONDON EC2A 3HB.

Tel: 01-739 2387/9 01-729 4460

Editorial

Changing of the guard

This is the last issue under my editorship. Saying good-bye and expressing sentiment without appearing sentimental is a tricky process, but I am compelled to say that you, readers, are exceptional people. Your curiosity and intelligence is matched by your warmth and good humour, and I shall miss you all.

For myself, one of my favourite sayings over the past eighteen months has been, "I'm under great stress . . . and enjoying every second of it". I'm only too aware that, more often than was comfortable, I fell short of my ideal of what an editor should be: the representative of the magazine's readers, and guardian of their interests. But I have done my best.

Publisher's Letter

The market for micros, and magazines dealing with them, continues to expand, and a publication such as PCW has to keep pace. This means a need for better packaging, better marketing and tighter organisation; greater resources must be called upon. So PCW has been taken over by H. Bunch Limited, an organisation with the necessary know-how and an outlook in keeping with the spirit of PCW. The magazine is now in very, very good hands.

SUBSCRIPTIONS

When PCW started publication, we had a special six-issue offer. When these subscriptions expired, we sent out reminders.

The renewal rate was 70%!

PCW reader loyalty is becoming a byword in publishing. If you're having difficulty in obtaining PCW at your newsagent, take our subscription. You can find the details at the foot of P.3.

STOP PRESS! £1,500 CASH – FIRST PRIZE

Second PCW Microprocessor Chess Tournament

Following the success of the first PCW Chess Tournament last year, we are pleased to announce that our second tournament will take place at the PCW show in London, November 1st – 3rd, 1979.

It is hoped that some financial support may be available for private entrants from outside the U.K., to defray travelling expenses, and there will be at least one cash prize. The highest placed programs will be eligible to compete in the first World Microprocessor Championships which will be held at the 1980 PCW Show.

Detailed rules and entry forms will be available in due course. Prospective entrants are requested to write to

David Levy (c/o Personal Computer World, 62a, Westbourne Grove, London W2) who will be acting as commentator and tournament manager.

SPONSORSHIP INVITED FOR 2nd & 3rd PRIZES

Losers - Weepers

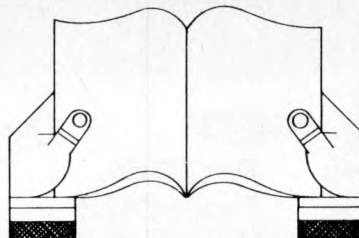

BINDERS - KEEPERS

Half the worried people you meet today are not preoccupied with pollution, perversion or persecution. It's worse than that – they've lost a copy or two of PCW and don't know where to find replacements.

So keep *your* copies of PCW in a beautiful bright blue binder. £2.95 worth of smart security.

Binders are now available. Orders already received get priority.

Payment by cheque or postal order £2.95 (includes p+p) made out to Intra Press. Please allow 28 days for delivery. "Binders", PCW, 62A Westbourne Grove, London W2.

CHANGE OF MANAGEMENT AND ADDRESS

PERSONAL COMPUTER WORLD

As from the September issue, Personal Computer World will be managed and published through the Bunch Books organisation.

The new address for all correspondence, both editorial and advertising, will be: Personal Computer World, 14 Rathbone Place, London W1P 1DE.

New Editors will be Bruce Sawford and Dave Tebbutt. Stephen England, previously PCW's advertising consultant, has been appointed Advertising Manager.

A. Zgorelec, the founder of PCW, will continue to liaise closely with the magazine on a consultancy basis.

There will undoubtedly be changes made, mostly in the way the magazine is presented. We are out to make PCW the best Personal Computer magazine in the world. Readership participation has always been an essential facet of PCW and we intend to keep it that way. Watch out for the 'new look' front cover on the September issue.

See you next month.

How to get more out of a pinta. Comma Systems have done it.

We've done it for a dairy.

We've done it for furniture stores.

We've done it for estate agents and
businesses all over the country.

We've supplied them all with a
computer system – now called the Comma
Systems Aquarius. A professional integrated
computer system based on the North Star
Horizon that can be simply plugged in and used
by anybody.

Extend your accounting abilities or provide them
where they do not exist, the Aquarius will cover
all your business needs from invoicing to trial
balance and can also be expanded into order and
word processing.

And we can do it for you – at less than the cost
of many a new company car!

So contact us today and get more out of
your business.

Hardware only package

North Star Horizon with 4MHz Zilog Z80A
processor, 24K RAM, and standard serial
port plus integral dual double-density
floppy disks **from £1868.**

Total System

Complete North Star-based Comma
Systems Aquarius with 32K RAM, dual
double-density disks, delivered and
installed with full operator training and
software package for payroll, sales
invoicing, and full accounting, plus
Newbury video display terminal,
DEC LA34 printer and one year's
maintenance. **£5950.**



COMMA SYSTEMS

COMPUTER MARKETING
MICRO SOFTWARE SYSTEMS
West Horndon Industrial Park
West Horndon Essex CM13 3XJ

Telephone No:
Brentwood (0277) 811131



WE'LL SHOW YOU EVERYTHING

Because we've got the biggest and widest range of micro-computers, there's more for you to bite on at a Byte shop.

So you're not only sure of finding exactly what you want: you can take the opportunity to experiment before you buy.

And because we're backed by the huge financial resources of a major



investment group, we'll be here tomorrow as we are today. All over the UK.

So whether you want a micro-computer for your home, your business, for industry, for education — or if you'd just like to find out which model you get on best with — you'll find a



visit to a Byte Shop a new and invaluable experience.

You can call at a Byte Shop any time from Monday to Saturday.



the **BYTE SHOP** Ltd

The Byte Shop
426/428 Cranbrook Road,
Gants Hill, Ilford, Essex
Telephone: (01) 554 2177
Telex 897311

Branches at:
LONDON (WEST END):
48 Tottenham Court Road —
tel (01) 636 0647

NOTTINGHAM: 92a Upper
Parliament Street —
tel (0602) 40576

MANCHESTER: 7-8 Corn
Exchange Building,
Fennel Street —
tel (061) 834 0220

Letters

Fuzz Buzz (cont'd.)

Please note the following errata in the 'Buzzwords' section of February:

EPROM:— *Erased Programmable Read Only Memories*. The program can be erased, usually with U.V. light. See for example the Intel memory design handbook page 8-1.

Electrode The point at which the form of conduction changes e.g. from electron flow in a metal to ionic as in batteries, or from electron flow in a metal to free electrons as in a valve. Your definition of electrodes would include, for example the terminals of a transformer, but no-one would call these electrodes.

Editor An editor is not necessarily Interactive as you state

K (capital) = 1024

k (lower case) = 1000

Please don't write 4k8 for 4K x 8 bit as in electronics 4k8 means 4.8k.

May I also point out an error in the article 'Concepts of programming' in January's issue.

In that article Barry Woollard states that there are two kinds of High Level Language, interpretive and compiled. In fact these are 2 ways of *implementing* a language and there are cases of both kinds of implementation being available for the same language at the same installation.

J.S. Linfoot,

Flat 10, Pembroke Court, Rectory Road, Oxford OX4 1BY.

PCW But see the "8080A Bugbook", by Rony, Larsen & Titus, pg. 67, where EPROM means "electrically programmable". PCW

Relocating your (Grosser) Pet

Having changed from an 8K to 32K Pet, I found that the Maze programme (Page 45 May 1979 PCW) would not run. In order to get it to run, it is necessary to change the Peek + Poke numbers as follows:

Original 8K machine	New 32K machine
80	582
84	586
85	587
86	588
89	591

J. Bloore

8 Woodlawn Grove, Kingswinford, Brierley Hill, West Midlands DY6 9QE.

His Pet needs a Vet

I have just upgraded my Pet system by selling my 8K and buying the new 16K version with a "real" keyboard. To anyone contemplating a similar change, may I issue a word or two of warning.

- 1) There have been a number of changes in the memory map, and a number of programs using PEEK + POKE will no longer work.
- 2) The lower case/graphics POKE has been changed so that POKE S9468, 14 gives lower case/upper case, but they are reversed and now work like a typewriter — so programmes with lots of instructions in UC/LC will have to be changed round.
- 3) There is now a complete Hex monitor — residing between FDII & FPB0 which will load and save Hex programmes on tape, although the new Manual says it is available on tape.
- 4) This new Manual is full of: errors of fact, of grammar; and misprints.
- 5) Commodore seem uninterested in explaining & listing the differences. They said that there might one day be a conversion programme to change all programmes. Well, we know what their delivery promises are like, don't we! When did they first promise the printer for?

So now I am left with a number of programmes I have bought that don't work, Commodore say in effect "Hard Luck". Perhaps someone who knows will help.

Even the programmes published by Commodore in the Pet Users Club newsletter don't all work now.

P.S. Are there any clubs in Portsmouth, Winchester, Chichester, Guildford, Haslemere or at any rate within 20 miles of Petersfield? If not, I will be happy to meet any readers in this area to discuss probabilities.

Peter R.A. Dolphin

27 Kimbers, Petersfield, Hampshire GU32 2JL

Clothing the Dandy

I would like to start a TRS-80 software exchange for users of this machine.

The sort of thing I hope to start would be a central point for users and producers of original TRS-80 programs. I have the facilities and the spare time to sort and test any programs etc. I feel that this would be useful, as I have noticed a shortage of software for the TRS-80 at low prices and feel sure that many of the purchasers of this machine feel the same. I can run and copy programs in any TRS-80 format (LEV 1, LEV 2, DISK, and SYSTEM TAPES).

So if you can say a bit about it all and ask anyone interested in either helping to run or using such a service to write to me I would be very grateful. It would help if you do give me a word to say that S.A.E.'s would be appreciated.

Chris Cain,

ENG WING, R.A.F. West Drayton, Middlesex.

PCW There is no lack of professional software for the TRS-80, as is evidenced by advertisers in the magazine. Nevertheless, Chris Cain has a point worth putting PCW

In Extremis?

I do not, as Mr. Price suggested, miss the point of medical confidentiality, but disagree with the extremes to which it is taken. (See PCW Letters, March '79).

I see no valid reason for failing to provide all *medical* data to a large data-base, keeping out of the data base only patient identity (name and address etc.) but including a reference number so that if the central computer reports to the Doctor his reference number 14256 shows symptoms that in 9 cases out of 10 resulted in death within 1 month, the doctor can then determine whom to urgently call into hospital.

It may be beneficial for each Doctor to have his own personal micro-computer. It would not be inconsistent to feed a large main-frame with "statistics" collected on the small computers. Please give us the best of both worlds!

A.J. Borer D.Eng.M.I.E.E., B.Sc.

22 Deerfold, Astley Park, Chorley, Lancs.

Flattery will get you most places

Many thanks for a really good magazine, which I find most useful on the software side for technique and handy routines. As an engineer/programmer only recently moved in to the micro field from a mini-mainframe environment, I find the enthusiasm and open-mindedness of your (and similar) publications most refreshing!

One note of dissatisfaction has crept in today, however, when I received two binders for PCW that I recently ordered. Firstly, they were sent in separate packages (surely un-economic for you!) and secondly, I was charged 4p extra postage on both parcels! (A little un-economic for me!) Nevertheless, I can now stack all my copies of PCW proudly on the bookshelf!

A footnote for your south coast readers — my employers' company, Amplicon Electronics Ltd., long into LSI-11 systems, has now formed Amplicon Micro Systems Ltd. We are opening a new showroom in Ditchling Road, Brighton, and will be selling Commodore PETs, discs and printers, together with a wide selection of tape and disc based software.

One new product probably of interest is a complete stock control system for the PET, disc and printer, written almost entirely in machine-code by a friendly local software house, Anagram Systems. We shall be marketing this system in September at around £3000.

Once again thanks for a terrific mag. — keep up the good work.

Peter Wood,

11 Burrell Close, Partridge Green, Horsham, Sussex RH13 8BH

PCW Hope you got our 8p refund! PCW

Occam's Razor

There has been considerable discussion about both 'aligning the decimal point' and 'right-hand justification' of numbers in versions of BASIC that do not have the PRINT USING or other formatting control.

This would appear to be the simplest way:

Alignment of Point

```
DEF FNA(X) = -LEN (STR$(INT(X))) - (ABS(X) < 1)
```

Right Hand Justification

```
DEF FNA(X) = 1-LEN(STR$(X))
```

To use either of the above functions simply write:—

```
PRINT TAB(Y+FNA(X)); X
```

which will either align the point or righthand justify the number in the Yth position.

NOTE some BASICs may require the following function in place of the first one above:— $DEF FNA(X) = -LEN(STR$(INT(X))) + (ABS(X) < 1)$

Sheridan Williams, PCW Consultant,

114, Beech Road, St. Albans, Herts. AL3 5AU.

PCW William of Occam was a medieval philosopher who put forward the principle (Occam's Razor) that entities should not be multiplied unnecessarily PCW

Personalising DOS

This program allows the user to change the names of the Apple II DOS commands to suit his or her own taste. For example, one might wish to abbreviate CATALOG to CAT. The program is

based on information contained in an article by Andy Hertzfeld, published in the February 1979 issue of MICRO.

In a 48K system the command names are held in a table between SA7E0 and SA863, the last character of each string is denoted by setting the most significant bit. Note 10 explains how to modify the program for smaller systems. The program works by overwriting this area of memory with a new table in the correct format.

After running the program and testing the new command names, use BSAVE or its replacement to save the table on disk (it is \$ 83 bytes long), then add a line to your 'HELLO' program to BLOAD it each time the disk is booted.

Program Listing

```
10 LOC = 42976
20 FOR I = 1 TO 28
30 READ CO$
35 IF LEN(CO$) = 1 THEN 80
40 FOR J = 1 TO LEN(CO$) - 1
50 POKE LOC, ASC(MID$(CO$, J, 1))
60 LOC = LOC + 1
70 NEXT J
80 POKE LOC, ASC(RIGHT$(CO$, 1)) + 128
90 LOC = LOC + 1
100 NEXT I
110 END
120 DATA INIT, LOAD, SAVE, RUN, CHAIN, DELETE, LOCK
130 DATA UNLOCK, CLOSE, READ, EXEC, WRITE, POSITION
140 DATA OPEN, APPEND, TITLE, CATALOG, MON, NOMON
150 DATA PR #, IN #, MAXFILES, FP, INT, BSAVE, BLOAD
160 DATA BRUN, VERIFY
```

Notes

- 10 LOC is used as a pointer to the current location in the table. SA7E0 - 42976(10). For a system with nK of RAM (where $n < 48$) subtract $(48-n)*1024$ from this value.
- 30 CO\$ contains the current command from the data list.
- 35 This test is necessary as Applesoft executes a FOR...NEXT loop at least once.
- 80 Bit 7 of the final character is set before the POKE.
- 120-160 These are the standard DOS command names - replace them as desired, but do not increase the total number of characters.

S.J. Withers,

43 Watercall Avenue, Stivichall, Coventry CV3 5AW.

Computer Club

We would like to start a school's computing magazine as forum for software, games exchange, utility programs, tutorial programs exchange for the ILEA RSTS computer and the 380Z microcomputer, having recently acquired the latter; and intend using it with the Text Editor to produce the magazine.

Having once operated the RSTS without the Polytechnics' permission we probably know more about it than any other school (all strictly legal please!) Any charge will be minimal covering the cost of producing it. We would like any contributions: articles, programs, ideas, and we would like to get in touch with other 380Z users.

Our main purpose would be to exchange programs, ideas, and provide a medium for the solution of problems.

We implore PCW to start a school's computer users page!

Burlington Danes School Computer Group

Dane Building, Du Cane Road, Hammersmith W6 0TY

PCW Young people, your wish is our command PCW

A marked improvement

I read with interest Mr Clark's program (On Your Mark, Get Set; May 1979), and whilst it is a good idea as far as it goes, could be very much improved by a little extra work.

```
0F12 C4 0D LDI X'0D
0F14 35 XPAH 1
0F15 C4 00 LDI X'00
0F17 31 XPAL 1
0F18 C4 00 LDI X'00
0F1A 01 XAE
0F1B C1 80 LD 1+E
0F1D E4 FF XORI X'FF
0F1F C9 80 LD 1+E
0F21 01 XAE
0F22 F4 01 ADDI X'01
0F24 D4 07 ANDI X'07
0F26 01 XAE
0F27 8F 01 DLY 1
0F29 90 F0 JMP -16
```

In Mr. Clark's program, the byte is loaded from the keyboard, and then displayed. This means that the user is looking for a light switching off. It is many times easier to look for a light switching on, so in the above program, locations 0F1D/E complement the byte before it is displayed.

Also in Mr. Clark's program, only one set of keys could be tested at once. To be used properly the program had to be stopped, have location 0F19 changed, then restarted again. The program above does this for you. The byte is loaded from the keyboard, displayed, and then instead of restarting the program, the value of E is taken out, has 1 added to it (locations 0F22/3), then lines 0F24/5 ensure that it is always between 0 and 7. The value produced is now put back into E.

The resulting display is blank, until any key is pressed, when a segment lights up corresponding to the key pressed.

Because this program does increment the keyboard scan itself, and does not have to be altered, this means that the program may be burnt into PROM as part of an overall diagnostic routine.

J.C. May

3 Chiltern Drive, Waltham, S. Humberside, DN37 0DY.

Results of Puzzle Dazzle No.3

David C. Broughton

This problem asked for a method of comparing two signed 8-bit numbers in registers A and B of an 8080 or Z80 microprocessor, without disturbing the contents of any register. The following solution for a Z80 was submitted by four readers. It makes use of the parity flag which, in a Z80, is also used as an overflow flag.

```
CP B ; Set flags to result of A-B
JP PO,NOVER ; Skip next instruction if no overflow
OR A ; else set flags to content of A
```

NOVER:...

At label NOVER the result of the comparison is in the sign flag, allowing the programmer to write JP M,ALTB for example. The zero flag is also set if A=B.

I am grateful for this solution, for it is new to me and has immediate practical application in my chess program. Thank you PCW readers.

The solution is of 5 bytes. Mike Blandford points out that, as a subroutine, it is only 4 bytes:

```
CP B
RET PO
OR A
RET
```

No one sent a correct solution in 8080 code so I give my own 9-byte version:

```
CMP B ; Result in carry flag if signs same
PUSH PSW ; Save A and flags on stack
XRA B ; Bit 7 set if signs different
RLC ; Rotate bit 7 into bit 0
XTHL ; Original carry now bit 0 of L. H=old A.
XRA L ; Bit 0 of A now required test
RRC ; Put it in Carry. Carry set if A < B.
MOV A, H ; Restore A
POP H ; Restore HL
```

The first three correct solutions received were from Mike Blandford, Terry Bronilaw and M.R. Edwards who each receive £5.

Pet Expansion



Computhink
Dual drive
minifloppy

Complete with 4K disk operating system in ROM, plugs into Expandapet memory. Adds 15 new commands to Pet's Basic to give full disk extended Basic. Loads 8K in 2.6 seconds. Automatic reorganisation of free space. Utility Disk

£833 + V.A.T.

Expandapet memory
Powered by Pet's own powersupply and mounted internally in 5-10 minutes without special tools.

16K..... **£261** + V.A.T.

24K..... **£320** + V.A.T.

32K..... **£374** + V.A.T.

All units are fully built and tested.

Apple II



Apple II was the original with full colour high resolution microcomputer Basic, and it is still the best. With a very wide range of expansion available, including disk drive, interface cards, voice recognition card, light pen and many others.

Apple II has been well tried and approved by the public (over 200,000 sold) because of its thoroughly professional design and high quality engineering. You cannot get better value for money. Please send us a large s.a.e. for further details.

£820 + V.A.T.

With 16K user RAM only
(inc. PAL card)

New 7khz 16 channel A to D board p.o.a.

Super Board II



**NEW
LOW
PRICE
!!!!**

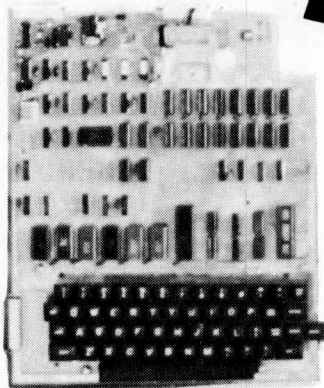

This 6502 based microcomputer comes with a full 8K Microsoft basic in ROM. Full keyboard. 4K static user RAM (on board expandable to 8K). Kansas City standard interface for use with an ordinary cassette recorder. Machine code monitor and I/O utilities in ROM. Direct Video access with 1K dedicated RAM (besides 4K user RAM) and full graphics set.

Fully built and tested only needs a 5V 3amp power supply and T.V. Monitor or R.F. modulator to be up and running.

NOW only **£229.00** + V.A.T.

Apple II & TRS80 Memory Expansion

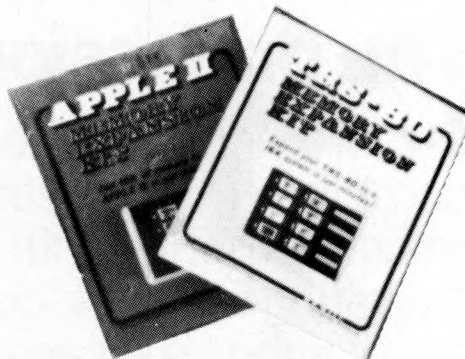

Save Over £100

TRS 80 and Apple II memory expansion kits. Fully guaranteed and with full specification 4116 16K RAMs.

Kits come with full instructions and new jumper sets where necessary. Fitting takes 5-10 minutes, or bring along your Apple or TRS 80 and we will fit it for you for £5.

16K upgrade kit **£85** + V.A.T.

LOTUS SOUND

4 MORGAN STREET
LONDON E3 5AB

TELEPHONE: 01-981 3993
TELEX: 261426 ATN. LOTUS SOUND



Cromemco System Three



The professional one.

Our Cromemco System Three combines the industry's finest micro-computer with the best operating systems, compilers and applications packages available. We'll deliver anywhere in the UK and can arrange maintenance at your premises. On 24 hours call-out if you wish. Interested? Write or call today for our full colour brochure.

Compare these features—

- **Fast Z-80A microprocessor** — guaranteed operation at 250 nano second cycle time, nearly twice the speed of most others.
- **S-100 bus** — the industry's standard.
- **CDOS** — Cromemco's disc operating system, includes all the facilities of CP/M and more besides. Runs the CP/M Users' Library.
- **21 card slots** to allow for unparalleled system expansion, and cards for daisy-wheel or dot-matrix printers, analogue-digital conversion, even a card for programming PROMs.
- **The industry's most professional software**, including COBOL, Fortran IV, 16K extended Basic, Z-80 Macro Assembler, Word Processing Package, Data Base Management System. Each at the remarkable price of £59 from MicroCentre.
- **Enormously expandable** — up to 16 million bytes memory can be addressed; 11 megabyte fixed disc drives available.
- **Multi-user operating system** — supports a printer and 7 terminals each with up to 32K memory.
- **Rugged, professional all metal construction** for rack, bench or floor mounting. Quality cabinets and desking available.
- **Price £3293** for 64K computer, two 8 inch floppy discs, RS-232 interface, 220 volt operation, complete with CDOS operating system ready to use.

Micro Centre Telephone: 031-225 2022
 Complete Micro Systems Ltd. 132 St. Stephen St., Edinburgh EH3 5AA

Tid Bits

PRODUCTS . . . COMPANY NEWS . .

Pet for Beginners

A short introductory text on using and getting the best out of the Commodore Pet has been written by two lecturers at the new University of Ulster. The booklet does not make any attempt to teach programming, except incidentally, but concentrates on techniques and routines that have proved useful in exploiting Pet's many facilities.

Send £1.00 per copy or write for further details to:
**Seamus Dunn and Valerie Morgan, The Education Centre,
The New University of Ulster, Coleraine, N. Ireland.**

New from Cromemco



Featuring:

Fast Z80A 4MHz processor; 11-megabyte hard disk drive; Two floppy disk drives; 64K RAM memory; RS-232 special interface; Printer interface; Extensive software available. (See Tidbits, PCW, July)

A New Company

Pitech & Co. Ltd., of 19 Market Place, Durham, DH1 3NL has been newly formed to market Microcomputer Equipment Software etc.

The new Company specialises in marketing the ITT 2020 together with the necessary software aimed at the small business market.

They are also able to supply PET, North Star Horizon, Cromemco, Nascom etc. in Co. Durham and the surrounding area.

EXIDY INTRODUCES

Word Processing ROM PAC™ Software

Exidy Incorporated, manufacturers of the Sorcerer computer product line, has introduced its word processing computer system at the National Computer Conference and Summer Consumer Electronics Show.



The heart of the system is the Word Processing ROM PAC™ cartridge, which transforms the company's Sorcerer computer into a dedicated word processing system.

The software will support an inexpensive modified Selectric typewriter or the high performance Diablo/Qume proportional spaced output printers.

New from Ithaca Intersystems Inc.

Ithaca Systems Inc. has introduced the following new products:

- DPS1 Mainframe incorporating an S100 bus with front panel and power supply.
- PASCAL/Z true compiler.
- More S100 boards: high density graphics board, analogue I/O, etc.

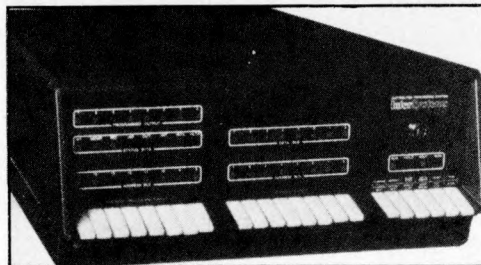

Ithaca Systems Inc., is, also, setting up a European subsidiary, based in London, to support growing OEM and dealer networks providing full local technical and marketing support. Jim Wood has joined as European Marketing Manager.

Another appointment is that of Kells Elmquist, principal author of the new IEEE S100 standards spec as Senior Design Engineer.

Further information is available from:

**Jim Wood, 58 Crouch Hall Road, Crouch End, N8 8MG
Tel: (01) 341 2447**

Eprom Eraser Costs Less

A compact low-cost UV irradiator unit operating at 2357Å, erasing up to 32 devices at a time in typically 30 mins, yet runs cool with low ozone emissions.

Priced at £34.95 inc.

Details:

**Tex Microsystems, 126 New House Park, St. Albans, Herts.
AL1 1UP.**

Newbear Cut SYM-1 Prices!

The SYM-1 is a fully assembled, single board microcomputer based on the 6502 "chip" (as used in the PET and KIM from Commodore) and is produced by Synertek Systems Corp. in the USA.

The price including full documentation is now down to £160 plus VAT and 8K Basic in ROM is down to £75 plus VAT.

For further details contact:

**Jon Day, Newbear Computing Store
40 Bartholomew Street, Newbury RG11 5LL
Telephone: (0635) 30505**

(SYM-1 was reviewed in the March 1979 issue of PCW)

Algol 60 for Z80 Microcomputers

Research Machines Limited announce the RML Algol compiler for Z80 microcomputers which support CP/M, such as the Research Machines 380Z. The Algol is fully operational on a system with as little as 21k of memory and one minifloppy disk drive. The compiler implements most of the features of the Algol 60 report.

For further information:

Research Machines, P.O. Box 75, Oxford. Tel: 0865 49792

Family Affair

Computerland, Nottingham, is leading the way toward a better understanding of micros. It is holding a "Computers for Pleasure Weekend" for the family on 14 - 16 September, at the Victoria Hotel, Nottingham.

Enquiries to:

**The Manager, Victoria Hotel, Milton Street, Nottingham.
PCW recommended**

New German Designed Micro

Powerhouse Microprocessors Ltd., of Hemel Hempstead has been formed as a new company to manufacture a West German designed microcomputer, called the Powerhouse 2. The company has sales rights throughout the world, with the exception of certain European countries.

The Z80 based Powerhouse 2 packs 48k byte of memory, a 5 inch VDU and a 53 key keyboard into a good looking and compact (11 x 17 x 7 in., 14 lb; 280 x 431 x 178 mm, 6.4 kg) housing. Facilities include BOS, DOS, serial interfaces, flexible screen logic (6-96 characters, 1-27 lines) and compatibility with all standard computers and terminals.

The Powerhouse 2 is capable of controlling three Powerhouse mini floppy discs with a total capacity of 1M byte.

Options include: 14k of Basic in EPROM, IEEE 488 interface, true XY graphics and integral mini cassette drive (40k byte).

Two hundred original Powerhouse units have been sold so far, mainly to OEM's and expert users. Applications include: real time process control, desk top computer for scientific and engineering calculations, commercial systems, automation of

EQUINOX 300

A powerful multi-user
multi-tasking
multi-language

16-bit microcomputer time-sharing system

- supporting
- * BASIC
 - * LISP
 - * PASCAL
 - * Floppy discs
 - * Hard discs

including a powerful Text Formatter,
Assembly Language Development System
and disc-based Sort utilities.

Priced from under £5,000

Write or phone for further information

EQUINOX COMPUTER SYSTEMS LTD
16 Anning Street,
New Inn Yard
London E.C.2.
(Tel: 01-739 2387/8/9)

TRS-80 micro floppy disk system price £290



Capacity up to 250,000 bytes per side of diskette (double density)

Housed in a smart black case the unit will stand adjacent to the computer and is completely self contained with internal power supply and simple user interface.

Based upon the Perteq FD200 Microfloppy Disk Drive, the unit is directly interface compatible with the Schugart Model SA400 disk drive and has been fully proven by the Tandy Corporation on the TRS 80 micro-processor.

For multiple drives on one computer, up to four units can be driven in a daisy-chain fashion. An LED indicator shows which unit has been selected by the computer.

ELECTRONICS COMPUTER CENTRE

118 Wandsworth High Street, London SW18
Tel: 01-870 4805 Telex: 8813089 (Interprem)

Send stamped addressed envelope for complete price list including discount books.

PHILIPS VIDEO COMPUTER G7000 – £139* VIDEOPACS MOSTLY – £10.25*

COMPLETE RANGE OF GAMES INCLUDING A
BEGINNERS COMPUTING COURSE

Ohio Scientifics

Superboard II

EX. STOCK

£229

+ VAT

Standard Features

- Uses the ultra powerful 6502 microprocessor
- 8K Microsoft BASIC-in-ROM
- Full feature BASIC runs faster than currently available personal computers and all 8080-based business computers
- 4K static RAM on board expandable to 8K
- Full 53-key keyboard with upper-lower case and user programmability
- Kansas City standard audio cassette interface for high reliability

Full 8k basic and
4k RAM built &
tested

SOFTY £79.50 + VAT (kit)

Development and training aid

- * Copies and Burns EPROMS
- * Develops firmware on TV
- * Learning aid—write software and see what the micro does on screen.

full details on request



*PRICES EXCLUDE 15% VAT – FULL DETAILS ON REQUEST

VIDEOTIME PRODUCTS

56 Queens Rd, Basingstoke
Hants RG21 1REM

Tel: (0256) 56417. Telex: 858747



APPLE II comes to Glasgow

Why not call and see the fantastic Apple II the finest micro currently available.

Demonstration without obligation.

We also have in stock the following top quality items.

Nascom 1, including all available expansion.

Digivision Monitor Kits – If you are thinking seriously about a monitor for your micro we have the best. Beware of cheap imitations which may use T.V. tubes. Ours use professional quality tubes which we have on demo. The difference has to be seen to be fully appreciated. Nine and 12 inch in stock now.

Price £100 + VAT

High Speed Tape Cassette Interface. Comes complete with instructions showing how to interface to Nascom giving 'normal' and high speed operation. 300, 600, 1200, 2400 baud. At the highest speed this will load our 8K basic in about half a minute.

Price (Kit) £17.50 + VAT

8K Tape Basic. The best basic yet written for Nascom. Fully floating decimal point. Complete with all documentation.

Price £35.00 + VAT

Brand New Product. Chiptester. Converts Nascom to a super powerful I.C. tester. Plugs in to existing ports. Send now for full details.

Also newly arrived. Totally new games to play on any standard Nascom. Send for full details prices, etc.

Callers welcome **STRATHAND** Callers welcome



44 ST. ANDREW'S SQ.
GLASGOW G1 5PL
041-552 6731



Tel. order welcome with Access and Barclaycard
Now on Telex 777268. 24 Hours Service

"COMPUTERS FOR PLEASURE"

A Family Computer Weekend

On 14th-16th September 1979 Computerland and the Victoria Hotel have organised a computer weekend in Nottingham. Four-star accommodation at the extremely low price of £31.70 per person! Children sharing with parents pay only £17.70.

- All meals plus accommodation (private bathroom, colour TV), from Friday evening to Sunday lunch, fully inclusive.
- Talks and demonstrations on a wide range of Personal Computer Systems.

- Ample 'hands-on' time for you to examine the systems in detail.
- FREE attachments with systems ordered from Computerland (Nottingham) Ltd. during the weekend.

Use this opportunity to compare machines under one roof, question experts in detail, learn to program, play computer chess, show the children (and the wife!) how a computer can be used in **your** home or business!

Please tear off and return the slip below for full programme, other details and registration form. Accommodation will be limited so first come first served!

To: The Manager, Victoria Hotel, Milton Street, Nottingham.

Please send full details and registration form to:

Name _____

Address _____

I am over 18.

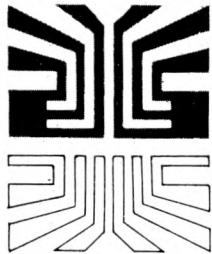

Small Systems Engineering Limited

62 CAVENDISH STREET, LONDON W1M 7LD
TELEPHONE: 01-637 0777. Telex: 8813085 ABACUS

SUPPLIERS OF PET MEMORY BOARDS AND INTERFACES THROUGHOUT EUROPE

IEEE-488/RS232C SERIAL INTERFACE

- Full IEEE address decoding, RS232C or 20MA Loop output,
- Switch selectable Baud Rate, Crystal controlled Baud Rate timing, Lower case Printing
- Boxed units complete with connectors, full operating instructions and sample programs supplied
- Serial Interface A, output only: **£106**
- Serial Interface B, input & output: **£186**

PET INTELLIGENT TERMINAL SOFTWARE PACKAGE

A software package which, in conjunction with an Interface B enables the PET to operate as an intelligent terminal. **£100**

TV/VIDEO MONITOR INTERFACE

- Video and UHF output (plugs into TV aerial socket) **£35**

IEEE-488/CENTRONICS TYPE PARALLEL INTERFACE

- Low cost unit without IEEE address decoding
- Also suitable for Anadex DP-800 Printer **£45**

FULLY ADDRESSABLE PARALLEL INTERFACES

Available August: **£120**

PET MEMORY BOARDS

Internally mounting memory boards - also available with E-PROM sockets: 24K - **£328**; 32K - **£432**

P & T-488 S-100 IEEE-488 INTERFACE

- Interfaces S-100 computers to the IEEE-488 instrumentation bus.
- Functions as a 488 controller, talker or listener.
- Three software packages available:
 - North Star DOS/BASIC Interface
 - CP/M Interface
 - Custom systems interface package **£325.00**

Available now:

COMPUCOLOUR II MODEL 3

- 13" 8-Colour CRT, 8080 Microprocessor
- 16K extended disk BASIC in ROM
- 71-key detached keyboard
- 84K RAM memory for user programs
- 64 characters per line by 32 lines per page
- Special graphics package with 128 x 128 point plotting
- Built-in mini-floppy disk drive
- 50 pin bus
- RS-232 I/O port for serial printers, etc. **£1,058.00**

TERMS: All prices Ex. VAT. Please make C.W.O. Cheques payable to: **SMALL SYSTEMS ENGINEERING LTD.** Post and package (includes SECURICOR delivery): **£5** All goods supplied under 90 days warranty.

ZUGUNSTEN VON:

How some Companies can send you Computer love letters . . . if they think you're a good customer.

NICHT ÜBERTRAGBAR

614457257 2 2282 614457257 99
 HERRN
 JOHN HOWLAND
 LATEBURGERSTR 294
 5000 KOELN 51

BITTE TRAGEN SIE EIN GESCHENK EIN FÜR:

Herr Frau Fräulein (Bitte in Druckschrift)

Vorname										Name									
Straße										Nr.									

I LOVE COMPUTERS, BUT...

The not so private Computer

Chris Howland

The other day I received an unusual letter.

"Dear Mr. Howland", it read. "We have computerised information concerning your financial situation and find it satisfactory. Therefore, should you at any time wish to take out a mortgage or other form of loan, we will be glad to co-operate with you or even act as your guarantors should you so require. Yours faithfully, etc. etc. etc."

I literally flew into the car and drove to my bank. The manager happens to be a friend of mine (yes, I know I'm lucky!) and he sat watching me quietly as I did my little bit.

"There must be a leak — there's a spy out there," I said pointing to the door, "and it's up to you to find out who it is or I'm going to take my money somewhere else!"

At this point we both had to laugh, but that's another story. In any case, I came away entirely satisfied that the system used in the bank makes it almost impossible for any one employee to obtain a complete picture of a client's financial situation.

Back home, I decided to consult my computer. No, not my friend in the office but the one I always carry around with me between my ears. I read the letter again. It looked like a computer job alright — you know what I mean — too well-typed to be true, and with hints of perforations above and below.

Then something else struck me.

At the top, I read *John Howland* instead of *Chris*. This isn't really a mistake because my first name is John and I've no idea why my parents decided to do it all the wrong way around. Obviously, the computer didn't either. Then I read the address and suddenly there were little lights flashing all over the place. You see, I live in Alteburger Strasse but the address on this letter said Lateburger Strasse. I remembered that I'd once received a letter with a similar mistake and that various postmen had written remarks such as 'not known here' or 'return to sender' on the envelope, so that, by the time it finally reached me, it was going grey with age.

I don't know how a hound feels when it gets it's first sniff of a fox's trail, but I experienced a sort of tingling all over.

"The car!" I shouted and bounded towards my filing cabinet.

You see, many months ago, I had received another astonishing letter. This one had contained the log book of an exclusive car all neatly made out in my name. This was a bombshell. Never in my life had I ever won anything for free, either in a raffle or a casino, yet here I was with a brand new car right out of the blue.

Until I opened the 'log book' and read: "This car could be yours if you take out a subscription to xxxxxxxx xxxxxxxx magazine!" Talk about a let-down! Nevertheless I took out a

subscription just for a giggle, which is about all it was worth!

But I'd kept that 'log book', which was why I was frantically searching through my files. Finally, I had it. John Howland, Lateburger Strasse.

Then the detective in me got going. My grandmother once told me never to throw a piece of paper away because it might someday come in useful. I took her unusual advice with the result that I now have quite a selection of useless printed matter collected in a series of files all marked 13. I began to go through these and the hound in me began to tingle again. There were pages and pages of advertising matter all addressed to John Howland in Lateburger Strasse. Obviously the Post Office had twigged this one long ago. And Granny had been right!

Finally I caught my fox — or at least part of it. Some years ago, I had joined a Continental Motoring Association and it was *their* wrongly addressed letter which had originally confused my postman. This association prints a monthly magazine and the publishing firm *just happens* to be the same one which issues the other periodical which nearly gave me a free car. Do you begin to get the message?

Where is the connection, however, between an incorrect name, a misspelled address and my finances?

From here on I can only conjecture. I've narrowed it down to above five sources of information, but there could easily be dozens, if not hundreds more.

Firstly, I buy my food in a fully computerised wholesalers. They are so computerised, in fact, that they itemise every article and, at the hit of a button, can tell whether I have bought Danish or Russian caviar and when. I use caviar purely as an example. If I buy Danish I'm just using it to garnish hard-boiled eggs, but if I invest in Russian, I'm either celebrating a birthday, or a good contract or I'm trying to impress someone who might *give* me a good contract.

An obvious question: do these wholesalers have my date of birth? Answer: yes. So if I buy Russian caviar shortly before my birthday this has little significance except that it implies that I still have enough cash for the splash. But if I buy it at any other time (apart from my wife's birthday which is also on the list) it could mean good news or probable goods news. On the other hand, if I don't buy any form of caviar on either date I might be in a worse shape than I was at the same times last year.

Second, petrol. I buy most of mine at a local station and receive a

computerised bill once a month. Here we could have another indication of my finances because when I'm on the road, I'm earning money; and when I'm not, I'm not!

Third, the doctor. If you're a private patient in Germany, you receive your bill from a central organisation and not from the Doc himself. Sure, he wants the money alright (and he gets it too!) but he doesn't want to be bothered with paperwork.

Fourth, the faulty address. Here, unlike in England, you always put your address on the back of the envelope and your letter will eventually be returned unopened if the recipient has moved. However, as the law requires him to register his new address within two weeks you can easily trace him if you care to go to the trouble; but, as long as your letter isn't returned, you can reasonably assume that he has received it.

Fifth, the date of birth. This, combined with your various names, helps to pinpoint you. In former years an adult could simply write "over 21" when a form asked him for his age but this practice is unfortunately dying out. Now they even want to know *where* you were born!

When they called me up in 1946 they paid me four shillings a day, which meant that I was completely

broke every Wednesday. Later, on being promoted, I received more than double and it was like being in Heaven, until I realised that I was getting broke every Wednesday just as before. Perhaps I was taking buses instead of walking, or eating steaks instead of hamburgers. In any case, more money was going out than before and I hadn't noticed it. But a computer would have!

Now back to those points I mentioned earlier.

He's eating well, he's doing a lot of travelling, he hasn't been to the doctor nor has he moved house. Then compare these figures every month. The slightest variation will give a clue to his general condition and each clue will help to form a pattern. The rest I'll leave to your imagination.

Recently a law was passed in Germany controlling the swapping of computerised data. But for one person at least, this law has come too late. His name is JOHN CHRISTOPHER HOWLAND and his address is either LATEBURGER or ALTEBURGER STRASSE number . . . come to think of it. I'll stop there. If you want any further information, plug into your nearest data bank.

Perhaps you might even like to send me a birthday card!

5 ways to buy a computer in West London.

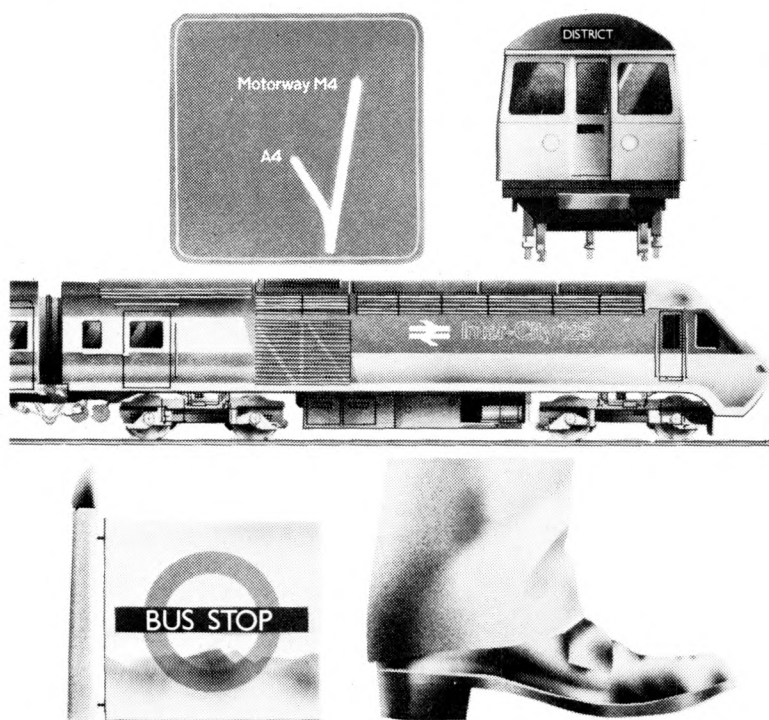

Now in West London you can buy the Pet, Apple and Nascom.

But that's not all.

Add to that the in-depth knowledge and wealth of expertise that only experienced computer professionals can provide, and working with you we'll deliver a system that's right for you.

Whether its software packages, tailored business systems or even games you're looking for, it's reassuring to know you can rely on us for maintenance, engineering support, and even finance.

So, if you're local to Ealing why not drop in for a demonstration?

And if you're not, we're conveniently accessible for the motorist, and bus, tube and rail travellers.

Adda Computers, 17-19 The Broadway,
Ealing, London W5. Telephone: 01-579 5845/6
Open 09.00-18.00 Monday to Friday
10.00-16.00 Saturdays

adda

we add up to a great deal.

MacroFloppyTM goes twice the distance

Micropolis is rapidly becoming the industry standard in 5¼" floppy disc drives; they have been shipping double density drives for over 2 years, thus proving their outstanding reliability and performance.

By completely reassessing the engineering involved in 5¼" floppy disc drives, and using the most modern technology available, Micropolis achieve a formatted density of 315K bytes per single sided unit.

Starter system

The 1041/1 Macrofloppy system includes a 143K byte double density drive with S100 controller card, MDOS and BASIC with a comprehensive manual.

This unit will successfully add on-line disc storage to a wide range of S100 computers at an unbeatable price per byte.

Add to your **Cromemco, North Star, Vector Graphic, Sol, Poly 88, Sorcerer, etc.**

Fully assembled, tested and burnt-in unit
£439.00

Optional regulator for S100 raw power
£14.00

Also available

A full range of hardware and software including:

Mains powered add-on 143K bytes
(Also suitable for **Tandy** expansion interface)
£399.00

Single drive 315K byte system
£663.00

Twin drive 630K byte system
£1159.00

CPM
£100.00

North Star compatible operating system
£35.00

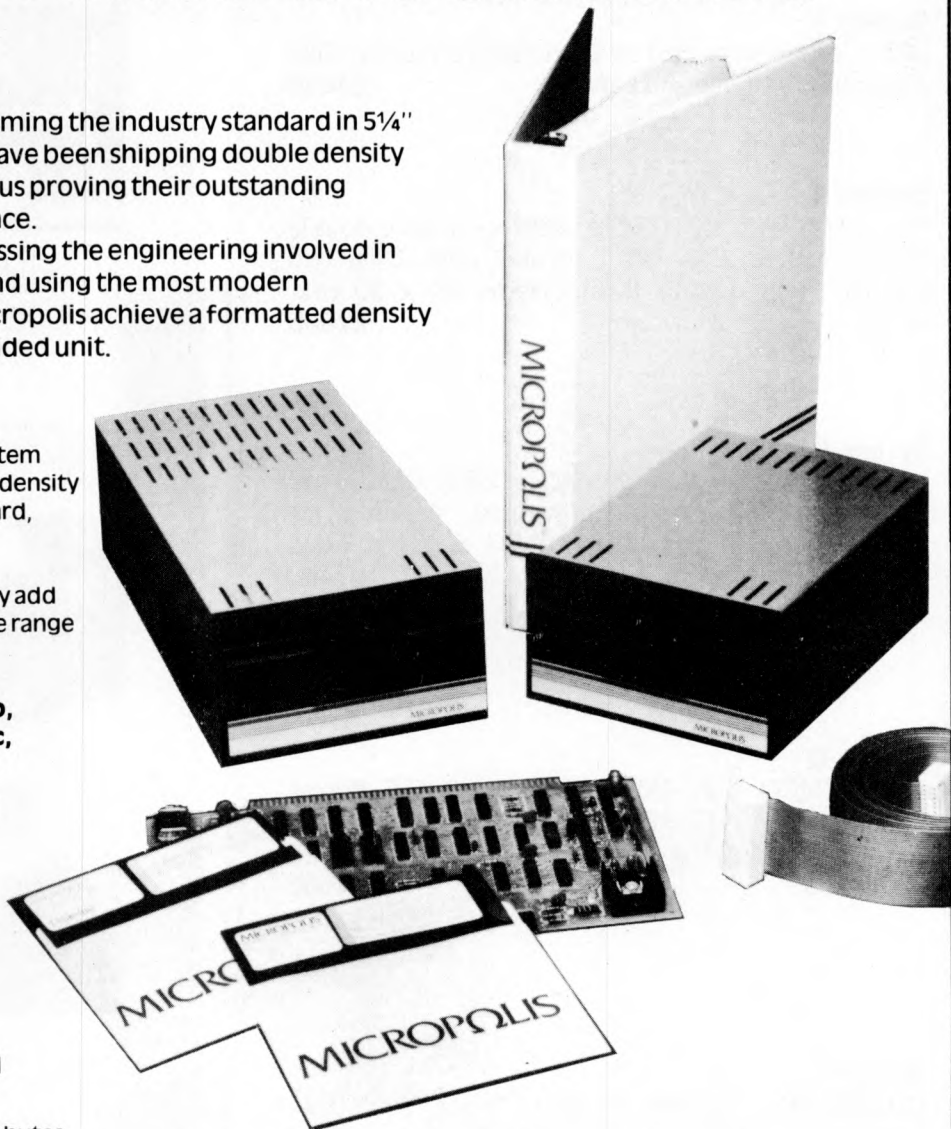

Dealer enquiries welcome
Ring Reading 85464 for further details



SINTROM MICROSHOP

14 Arkwright Road, Reading, Berks RG2 0LS
Tel: Reading (0734) 85464
TELEX: 847395 CABLES: SINTROM READING

XITAN SYSTEMS

The South's Premier Microcomputer Supplier.

**WE SUPPLY SYSTEMS – LOOK AT THESE
TYPICAL CONFIGURATIONS!**

System A

32K Commodore PET + Commodore model 2040
Dual floppy drives and cable **£1610**

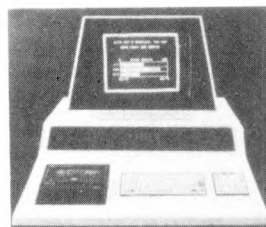

System B

NORTH STAR HORIZON, 32K Ram, dual double
density drives, 2 serial, 1 parallel port, DOS and
BASIC, High quality Brand Name 24 x 80 char
VDU **£2505**

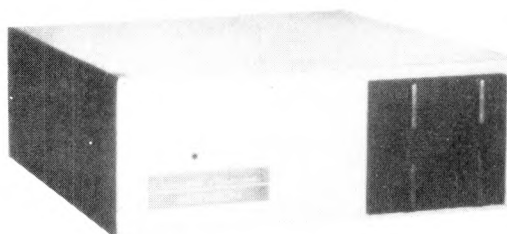

System C

CROMEMCO System 2, 4MHz Z80, 64K Ram,
dual minifloppies, 21 connectors, 1 serial, 1
parallel printer port, CDOS 1.07 and Extended
Disk Basic, High quality Brand Name VDU etc.
£3020



System D

CROMEMCO Z-2, 4MHz, 1 MEGABYTE floppy
disk storage, 64K Ram, 3 serial ports, 2 parallel
ports, CDOS 1.07 and Basic, High quality 24 x 80
char VDU **£4600**

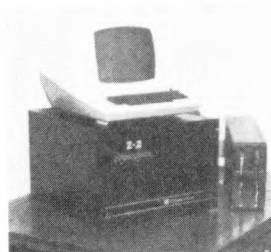

System E

CROMEMCO System 3 (the "Rolls ROYCE")
64K Ram, 4MHz, 1 MEGABYTE floppy disk
storage, 1 serial and 1 parallel printer port, High
quality Brand Name 24 x 80 char VDU etc, includ-
ing CDOS and BASIC **£5710**

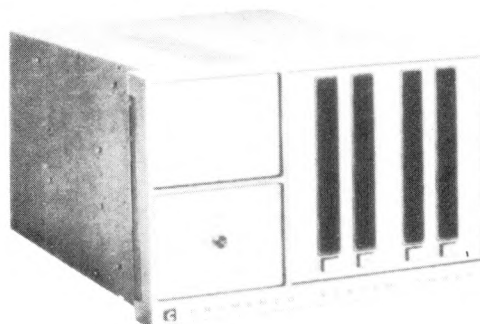

We supply Centronics, Teletype 43 and Diablo Printers, plus the normal range of ancilliary equipment. CP/M for Cromemco and Horizon systems is available from us, as well as Microsoft Fortran, Tex etc.

23 Cumberland Place, Southampton SO1 2BB Tel: (0703) 38740 Tues - Sats.

PCW CASE STUDY

Apple

Medical

Application

PCW This Case Study is in the words of a Harley Street Obstetrician and gynaecologist who remains anonymous for reasons of professional ethics relating to publicity PCW

A system based on the Apple II computer, complete with two minifloppy disc drives, Axiom thermal printer, and software was installed at a cost of just over £3,500.

The doctor began in the National Health Service and has been in private practice for the last six years in Harley Street. Two years ago he moved into improved offices.

He reflects here on his experiences.

I had no experience of computers at all prior to purchasing the Apple computer. My secretary and I were operating a manual billing system which entailed a lot of double-checking and was generally a time-consuming job. Realising that I had a sizeable administrative problem the larger my practice grew, I spoke to some friends in the business world who suggested I should look for a cheap minicomputer which I could use to store information on tape and call up as required.

I then saw an article in a local newspaper about Apple, so I called up Mike Sterland of Personal Computers Ltd, the UK distributors of the Apple II computer, and explained my problem to him. As I did not know how to program the machine myself I needed to find a software house to write the applications software for me.

Fortunately Mike Sterland had a list of software houses specialising in Apple II, and he put me in touch with Stanton Smith of Microsolve Computer Services of Edgware. Microsolve had a range of standard application packages for payroll, ledgers and invoicing but I needed something quite specifically geared to my requirements, so I sat down with Stanton Smith and spent three hours or so discussing exactly what I

wanted with him. He then went away and returned a few days later with a complete systems design.

The next step was to order the equipment while Stanton went back to write the actual software programs on his own machine.

The applications software comprises three main modules: **patient records**, a **billing system** and a **monthly and annual expenses system**.

At the time I decided against buying a large printer because I felt that, professionally, it was more presentable to type out bills from a print-out.

In the patient records module, each patient is given a particular number which is entered in a manual master index file, a book which sits on my desk, with patient name kept in alphabetical order. The search for a patient's records is made alphabetically from the book in order to find the appropriate number which is then entered through the Apple Keyboard to get the details stored on the disc.

The disc is updated from a daily record of the practice's activity which has been written onto a sheet. These activities are coded into salient points, for example, CO for consultation, OP for operation, AN for anaesthetic, PA for pathology, and so on.

The main reason this type of record is required is that where one is dealing with 800 to 1000 patients a year, as I am, it is impossible to keep all the details in one's head, specially if a patient has been absent for any length of time. This can give rise to an embarrassing situation as records can be difficult to find or go missing altogether.

The billing system comprises a master disc with the names and addresses of up to 900 patients, and an accounts file disc. The following menu of options appear on the television screen:

1. Update patient name/address
2. Update bills and payments
3. Report printout of outstanding bills
4. Update case history
5. Exit from system

Each option in turn triggers in a submenu as follows:



An Apple a day keeps the doctor in play. Supplied by Personal Computers Ltd. of Bishopsgate, the Apple II sits unobtrusively on a desk top in a corner of the practice. The software was written by Microsolve Computer Services of Edgware and is now marketed on a 'packaged' basis.

The Apple II computer system plugs into a standard domestic television set through the use of a PAL card. The use of a colour television set allows one to generate colour graphics patterns if required.

1. Update patient name and address

1. Input/amend patient name and address
2. Exit from program

2. Update bills and payments

1. Input new patient bill
2. Input new payment on consultation
3. Display/amend patient bill
4. Display/amend payment on consultation
5. Exit

I am currently discussing modifications with Microsolve, to provide a printout of all money paid as well as owing in order to help my accountant in preparing my financial accounts.

3. Printout report of outstanding bills

1. Print o/s bills not written off
2. Print o/s bills with reminders
3. Print bills written off
4. Print all bills
5. Exit

4. Update case history

1. Input/amend initial case details
2. Input new further visit details
3. Display/amend further visit details
4. Print full patient history
5. Exit

The practice's expenses system comprises the following menu:

1. Initialise file(s)
2. Input/amend month of year
3. Input/amend expense description

4. List/amend expense(s) for month
5. List/amend expense(s) for year
6. End

In selecting the system, I looked at other systems on the market available for around £600 but none seemed adequate for what I wanted. The speed of access for information is a very important factor and a system based on cassette tape storage is not fast enough. I find the pressure to enter information to the system every night enough as it is, and cassette tape would make nonsense of any speed benefits, quite apart from problems of tape distortion. Used as a toy, it is another matter, but this is a serious application.

To be sure there have been problems with disc drive and printer interface cards, but their speed and ease of use more than balance this out. Anyway the system is only as good as the people using it.

From the time it was ordered, the system took 12 weeks to be shipped from the United States. One of the beauties about it is that software could be developed on another machine while I was awaiting delivery.

The machine arrived end December 1978 and I started using it in January. I mastered most of the beginners' faults within a week. The only problem is the location of the

reset button so close to the carriage return key. This can be most irritating if the wrong key is depressed but fortunately the software allows for quick recovery. Apple should set the reset button somewhere out of the way.

Apart from that the system tells you when you've done anything wrong without destroying everything: it is designed for a relatively unsophisticated user. My advice to those contemplating the purchase of a similar computer system is a) spend a long time on the systems design as this will save many headaches later, b) try to build in expansion to the system right at the start if possible, and c) use an expert to help you unless you are yourself an expert on computer systems.

Overall I feel I have what I wanted. Eventually I plan to employ someone part-time to take over the accounts from my secretary and feed in the information to the system. For the small businessman who can afford it, it provides enormous benefits. The market is still in its infancy but I can see the medical profession using this type of system in a big way given the way prices have been dropping. In another 15 to 20 years many more doctors will be using computers.

PCW We hope to have case studies on the uses of other machines as well. PCW

COMPLETE COMPUTER SYSTEMS (CCS)

PRESENT the ABC80

Zilog Z80A microprocessor, the ABC 80's brain.

Professional keyboard of Swedish standard.

12" black-and-white TV screen. Displays capitals and small letters, digits, figures and diagrams. Room for 24 lines of 40 characters each.

Built-in graphic mode. Uses 64 different graphic symbols.

Program memory. 16 K BASIC of ROM, 16K bytes of RAM. 2K Monitor in ROM. 1K Picture RAM.

Loudspeaker. 128 different sound effects. Can be used to provide alarms or other signals.

Built-in real-time clock for timing.

V-24 jack for connecting to a telephone modem so that you can communicate with other computer systems via the public telephone network.

46/80 Bus for connecting peripherals such as floppy-disk units, printers, plotters, measuring instruments etc.

Cassette memory for storing programs and data. Fast winding in both directions.

True quality is just what you'd expect and get from Sweden. Designed by a manufacturer with nine years' experience in mini/microcomputers.

At last a machine that has tackled all the problems of other machines in its class:

1. Excellent steady results on a 12" T.V. monitor.
2. Quality professional keyboard (Keytronics). Very neat appearance.
3. A real digital-computer tape unit. No more fiddling with volume settings on audio-cassette decks.

ALL THIS . . . PLUS 16K BASIC in ROM

We believe this is the biggest BASIC in ROM on the market. It has: 20 Commands/Operators that aren't in Tandy TM Level II; 25 not in Applesoft TM Basic; 27 not in PET TM Basic and 32 not in Exidy Standard TM Basic.

200 programs available in BASIC.

price £759.00 (provisionally)

Available from U.K. importers

CCS MICROSALLES Tel 01-444 7739
22 WESTSIDE
68 FORTIS GREEN
LONDON N2 9EN

and CCS MICROHIRE
FREEPOST (soon at 7, The Arcade)
HERTS SG6 4YA

THE NORTH STAR HORIZON A Review

Martin Healey, Paul Woodward and Mike Rees

Introduction

North Star are one of the many American companies that came into the computer business on the back of the ALTAIR systems. They saw the market for S100 bus "plug-ins". In particular, North Star were about the first company to pick up the new Shugart mini floppy diskettes. Most microcomputers were cassette based and, while standard 8" floppies were soon introduced, the mini-floppy offered an attractive in-between. Thus around 1975 they designed an S100 bus controller for mini-floppies. Undoubtedly North Star's continued success is founded on the fact that this was a very sound and well made card, giving the company credibility. We have in fact used a North Star mini-floppy disc controller on an ALTAIR for some years now and it in fact forms the basis of our standard Word Processing system. The disc system came with a BASIC interpreter and very rudimentary Disc Operating System. Within its scope this software was sound, but very limited; there was for instance no Assembler/Editor and the file structure was trivial at best.

The company produced other add-on S100 bus products such as an interesting Maths board, but they have really come to the fore now with a complete computer system, the HORIZON. This system integrates the disc hardware and computer, but not the VDU, into one chassis. This is one of the first systems to adopt this obvious approach, along with Cromemco, VECTOR GRAPHIC, RAIR, etc. The concept is sound since it reduces the nett cost

of boxes, power supplies, etc., provided one is aiming for a disc based system. The physical size of the mini floppy is also more suited to integrated packaging, although there are examples using 8" diskettes; eg. Cromemco System 3. Most full sized diskette systems are still separately boxed, since the integrated systems can be bulky. Obviously, with double-sided, double-density and even quad-density diskettes maturing, the concept will be even more pertinent.

The Horizon does not include a terminal, utilising a serial I/O port to a conventional VDU; similarly for a printer.

North Star do not have exclusive dealerships in the UK, so that the system can be purchased from a number of sources. I (Martin Healey) have had previous dealings with COMART, and EQUINOX kindly lent me a system to conduct this review. Both companies have been most helpful and knowledgeable about their product.

Like most American micro-computer companies, North Star announced the HORIZON long before it was ready for marketing. This caused quite considerable frustration, but the machines are now generally available. They are available with none, one or two diskettes. The overheads of packaging make it an expensive *diskless* system, not competitive with, say, the APPLE. Single disk systems should never be seriously considered and can only serve as a stop-gap for the amateur enthusiast while he saves up for the second drive. Originally introduced as a single density (90KB per drive) diskette system, a double-density version is now available. This will

clearly totally replace the single density machines. There could be some cheap single density controllers going on the second hand market soon!

With the HORIZON have come upgrades to the North Star software which, however, is still BASIC oriented. Needless to say most alternative software packages have been adapted and can be separately purchased.

Hardware

The first impression is a very good one. It seems that North Star's original high quality manufacture has been retained. The box is most attractive physically with the disk drives mounted vertically, side by side to the right. The power-on and reset switches are as for convention on the rear, and my only complaint is quite trivial and is that power-on lead is stuck slap-bang in the middle of the front panel. The system tested had an outside cover made of wood, with a veneer finish, quite an interesting and attractive variant. COMART apparently prefer an optional blue metal case, but I liked the wood one better.

Inside, the good impression continues. The chassis is strong and well finished. The mother board runs front to back in the bottom of the chassis alongside the diskettes. The power supply is mounted behind the disk drives. The S100 motherboard provides slots for 12 cards, stretching from the front about 2/3 depth of the chassis. The number of S100 connectors and card guides actually fitted depends upon your order. The last 1/3 of the motherboard contains the control circuits and I/O ports. This is a most interesting variant on the standard S100 systems in which all circuiting is mounted on cards. The North Star approach clearly reduces basic production costs, although it is possibly more difficult to add the optional parts if these are not ordered from the outset.

The power supply is rather robust, providing the normal +16V, -16v and 8 volt smoothed but unregulated D.C. lines. The mains input is fused and includes an A.C. line filter. Unfortunately, I could find no data on the current rating of the power supply. All I can report is that the transformer stayed cool when feeding the 6 cards in the system I tested. I have, however, doubts about a chassis of this sort supporting any old combination of boards. I suggest anyone contemplating using a high number of cards should first check with the dealer. Thus, for instance, the heat generated from the 4 x 8KB static RAM cards I tested must be 4 or 5 times as high as from 2 x 16KB North Star dynamic RAM cards. I have faith that the power



The *Horizon* is sold by Interam, Equinox and Comart

supplies and the good sized fan will cope with most situations. I must also add that the fan runs very quietly, an essential requirement in an office environment, e.g. word processing. There are an ample number of holes in the back panel to mount input/output sockets.

The **motherboard** circuitry is quite extensive, including features often needing 1 or 2 cards in other S100 systems. The circuitry is of course directly interfaced to the S100 bus. It also carries voltage regulators to provide +12v and +5volt for its own circuits and the V24 serial post. Separate voltage regulators are also provided for the disc drive logic, since the drives are integral with the chassis.

The motherboard includes 2 serial I/O ports, 2 parallel I/O ports (1 input, 1 output), Interrupt control circuits and a real-time clock. One of the serial ports and the parallel port pair are options. All the selectable features in the I/O system, e.g. baud rates, are determined by a number of jumper connections soldered onto the "headers" — plugs which fit into sockets on the board. There is a very wide range of options available, all well described in the detailed literature. When a completed system is supplied, these are pre-set, but a kit builder or anyone adding the options will need quite a bit of studying to get this right.

The serial ports are configured to full V24 (RS232) standard, including modern control. They employ the INTEL 8251 USART chip, so a most interesting variant is that the system can be used for synchronous as well as the normal asynchronous transmission. Very few users will have any opportunity to use anything other than asynchronous mode, but

the variant may appeal for such advanced communications concepts as, say, IBM 3780 emulation. In asynchronous mode the Baud rate can be selected from the on-card baud rate generator (using the normal 16 x baud rate clock) for speed, between 75 and 9600 bits/second. In synchronous mode clocking would normally be provided by the Modem. The older 20mA current-loop mode is available by replacing the TTL to V24 driver chip by a special "header" containing the current loop driver . . . good luck! If full V24 mode is used then MODEM control signals must be answered. This required interconnection of certain pins in the 25 pin D-type plug if a conventional VDU is employed. This can be avoided by an alternative setting of one of the control "headers" on the motherboard, abandoning the modem control at the plug level. This should be the normal setting for most users, but North Star must be complimented on the advanced thinking which has provided such a versatile interface.

The parallel input and output ports are latched and could be used to interface a single printer. A more complex printer would require more ports, however. For example, we use 3 out and 2 in for a parallel Diablo Daisywheel printer interface. Only TTL signal levels are catered for, so that any device connected to these ports should use flat strip cable of length below 6 feet or so.

A feature of the original S100 bus specification was the allocation of 8 pins to interrupt requests: V10 to V17. These were extended to a total of 10 possible interrupt requesting lines by the direct Z80 related signals PINT and NMI (non-maskable interrupt). Logic on the Horizon motherboard allows certain events to be

jumper-selected to pull any of these lines low (active), so as to request an interrupt. On the motherboard, four interrupting devices are configured; serial ports 1 and 2, the parallel port and the real-time clock. Individual features of a port are grouped to one interrupt, i.e. receiver-ready, transmitter-ready, sync-detect and transmitter-empty for a serial port all raise the same interrupt request. Note, however, that the vectored interrupt lines on the S100 bus are only interrupt *requests*; another card must supply the corresponding RST instruction insertions; in this case, the CPU card (see later). Interrupt driven I/O is *essential* for multiple terminal work.

One of the above mentioned interrupts can be generated by a real-time clock on the motherboard. The clock flag can optionally be read under program control. The clock rate must be set by jumper connections on the board (not by programmed instructions). The clock pulse time intervals range from 3.3280 millise to 27.263 sec in intervals of powers of 2. Like the pulses for the USART's, the timer is derived from the 2 MHz S100 bus clock, and so is mains frequency independent.

There are two directly addressable ports allocated to the motherboard itself. One is used to report the current status of the devices on the board; the other is a CPU output port so that various functions on the motherboard can be software controlled, in particular enabling and inhibiting the interrupt request logic.

The North Star CPU card *continues the high standard of innovation*. It features a ZILOG Z80A processor running at the full 4 MHz clock, although a 2MHz option is provided. Even at 4MHz the S100 bus 2MHz clock is maintained. Obviously designed for use in the Horizon, the card supports jumper-selectable options to allow operation with most other S100 bus mainframes, including those with front panels. (These require slightly different S100 bus control signals — so much for a "standard"). On a card using the Z80, much of the logic is dedicated to expanding the processor control signals to suit an older design. With such a radical new design as the Horizon, North Star must have been tempted, following RAIR, to abandon the S100 bus and use a simpler, cheaper construct. In the end, moving much of the standard I/O circuitry to the motherboard, and retaining the S100 bus for other cards, has achieved a compromise.

As well as the CPU, the processor board supports an on-board ROM option, auto-start circuitry and vector interrupt handling. The ROM

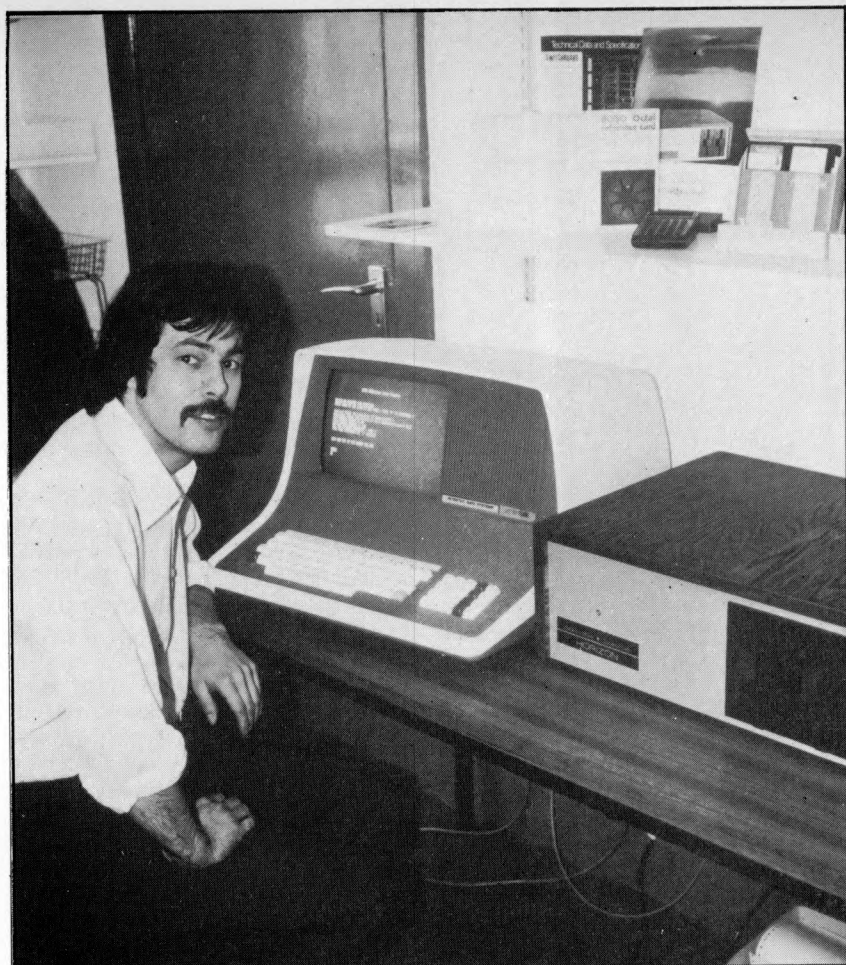

Horizon System at Interam

option uses a 2708 EPROM (1KB) with jumpers to select the address anywhere in the 64KB address space, but on a 1KB boundary; e.g. 53KB but not 53.5 KB. This does not appear to be used on the HORIZON, since the Bootstrap loader is in ROM on the disc controller card. It's obvious use is for interrupt routines.

The auto-jump circuitry is *superb*. Activated either by power-on or by the reset button, the circuit causes a full 3-byte Jump instruction to be executed. This allows the start address to be located at *any* address in the 64KB range. It doesn't use an RST instruction (as do most systems) which then requires 3 bytes of ROM to store a Jump instruction for full range of start address. The actual start address is jumper selected on one of the "headers" plugged into the card, E900H for the standard North Star Bootstrap.

"Vectored interrupt" is a slight misnomer. Remember that the V10 to V17 lines previously discussed only *request* interrupts. This CPU board provides corresponding action. Whenever the CPU issues an Interrupt Acknowledge signal, the logic on this board detects the highest priority interrupt request line which is active and uses this to "jam" an equivalent one byte RSTn instruction (RST 0 - V10, etc), causing a

branch to location $8 \times n$. The Z80 is capable, by setting an internal register, of providing full vectored interrupt, responding with unique branch addresses to 256 interrupts by "jamming" a 1 byte vector address, rather than the simpler single byte RSTn instruction. This is not used, obviously to retain 8080 compatibility.

The CPU board provides a facility for inserting wait states to enable the 4MHz Z80 to be used with slower memories. The EPROM on the CPU card automatically uses Wait states, if used.

The system I tested was supplied with two 16KB Industrial Microsystems static RAM boards — real industry standard workhorses. I have also used a system with North Star's own boards. These boards have had a chequered history and early delivery problems of the Horizon were largely related to these boards; now I hear all problems are resolved.

The North Star RAM boards I checked were more interesting. They used 16KB dynamic, 200 nanosecond access time RAM's using a 4×8 array of 4KB chips with on board refresh so as to work with Z80 or 8080 CPU's at full speed. There were also spare sockets for further chips to extend the word length from 8 to 9 bits. This card then provided parity check logic so that error

checking at run time could be implemented as a further option. The card also supported bank switching logic. For those readers who have not met this technique, *bank switching* is a crude form of memory management. A card is made inactive unless selected. In this way multiple cards can share the same addresses, so that on one program can run in one physical memory, while a separate program, using the same address, can run in another physical memory. This will greatly accelerate the availability of multi-programming software. The multi-programming executive controls which bank in associated with which program. The selection mechanism is controlled by allocating an output post, appropriate bits of which select one of eight possible cards. This I/O port detect logic is built onto the North Star boards. In principle, such a computer could now support 8×64 KB memory, although the CPU can still only use one 64KB space at a time. The boards also supports an optional "phantom" control so that ROM addresses can be overlapped with RAM addresses, e.g. Bootstrap. I have reliable information that a 32KB board is due for release.

There are two disc controllers available for the Horizon, a single-density and a double density. Both use the same Shugart SA400 drive. An existing single density system can be field upgraded by replacing the controller card. I was warned that there may be some selectivity in drives supplied, but this sounds a little far-fetched. Possibly newer drives are upgraded on the originals. However, we transferred the double-density controller to our old ALTAIR system with no problems.

The single density controller is the old-established product on which North Star made their name. The new one is also a single card, still constructed from MSI chips rather than a LSI controller, but a totally new design. With this new card the software can set the drive up to handle *both* double and single density recording. Thus a utility is available to read a file or a complete disc recorded on an old single density diskette and write it double density. Double-density is achieved by doubling the recording density on the diskette. The diskettes are still hard-sectored with 10 sectors per track, 35 tracks; each sector now stores 512 rather than 256 bytes. Since the recording density is doubled, the bit transfer rate is also doubled. This will however only give a marginal improvement in response times, since head positioning times and rotational latencies are still the same. The new controller supports four drives, compared to three on the older systems.

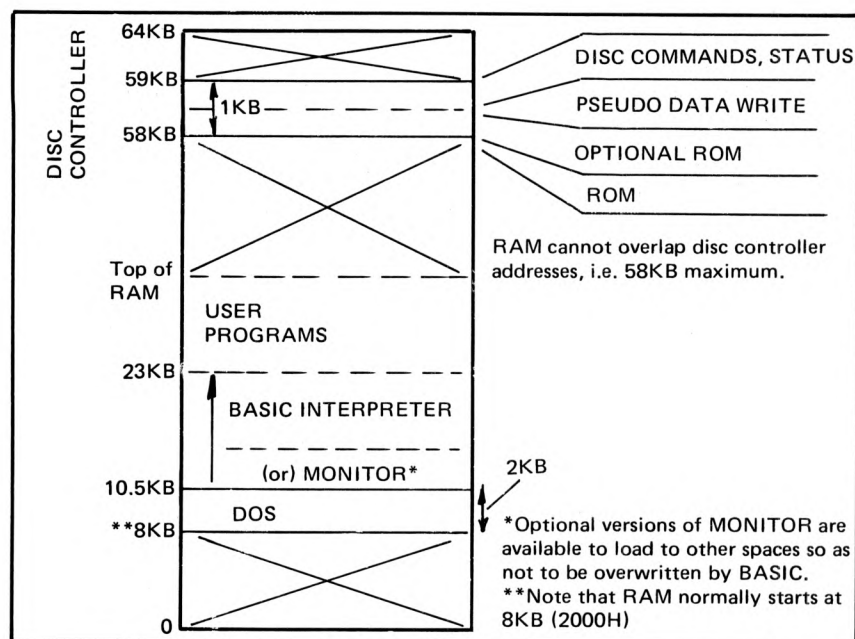

Figure 1.

Both controllers have the Bootstrap program and basic disc drive function software fitted into ROM's (not EPROMS) on the card.

System Software

The North Star software is best described as adequate. As far as I am aware it is reliable, but is nothing like so refined as the de-facto industry standard, CP/M.

As previously mentioned, the disc handling "primitives", e.g. load head, move to specific track, etc, and the bootstrap loader, are permanently stored in ROM's on the disc controller card, as indicated in Figure 1. The disc controller uses memory mapping techniques, effectively occupying 1KB of address space starting from location E800 H (58K); this start address is determined by a ROM on the controller card, not jumpers; and is fixed in all North Star software. The controller software however is most intriguing. The older controller supported a 256 byte ROM program at E900H; the new one is for some reason moved down to E800H. Writing a data byte to the controller is achieved by issuing a pseudo-read operation with address EAxH; when the EA position of the address is detected, the other 8 bits of the address, xx, are copied into a shift-register and the controller disc write operation initiated. Similarly, reads to locations EByyH cause the byte yy to be interpreted as one of a set of commands to control the diskettes. This simple technique means that software need only set the EA or EB in CPU register D and the data byte into register E, and execute a memory read instruction (LDAX D) ignoring the data returned to the accumulator by the instruction.

Status words in the controller are also treated as memory addressed locations, as is the data read port.

The standard system diskette contains a disk-operating system (DOS), which is loaded into memory by the bootstrap operation. DOS utilises the controller primitives to provide a user-orientated interface to the system by interpreting commands issued at a console terminal. DOS also supports a simple file structure so that units of software can be stored and retrieved by name (files) rather than physical track and sector addressing. DOS only supports allocation of consecutive sectors to a file, the size of which is therefore fixed when created, as opposed to the sophisticated sector allocation algorithms used by CP/M. DOS does however have a function for compressing files, rewriting them to reclaim spare sectors created by deletions. DOS is designed as standard to load into RAM starting at location 2000H (8K) to 29FFH; i.e. DOS occupies 2½KB. With normal systems the first RAM card can be set to start at 8KB. Lower address space would be used by any systems using RST instructions.

DOS can be used to load a MONITOR program to give enhanced terminal features such as direct display and changing of memory locations. The Monitor program is 2KB big. The standard version loads from 2A00H, immediately above DOS. Alternative versions are available to load into other locations so that, say, the Monitor and BASIC could both be resident in RAM.

BASIC is the other main North Star software product. This also loads above DOS from 2A00H and is about 12.5 KB big. Any RAM above address 23KB is used for

BASIC programs. (N.B. Don't waste 8K of your RAM by starting it at location 0 unless you need the bottom 8K for some specific reason.)

North Star BASIC is of a reasonable standard, but no better. What is implemented appears to be well done, but compared to say MITS BASIC it has a low level specification. In earlier versions, to save a BASIC program a file had to be previously created. If you had forgotten to do so, you had to exit BASIC and return to DOS, create a file and then use a DOS Command to restart BASIC. This has now been incorporated into the new version of BASIC.

The weakness of the BASIC lies in two areas, string handling and file handling. The file handling is related to the simplicity of the DOS file structure. Random files for instance have to be accessed by computing the position of the first byte in the record. Although there have been improvements in the latest version it leaves a lot to be desired for, say, commercial applications. String handling barely exists. String lengths are determined the first time they are involved in an executed statement and cannot be changed later. Different versions of BASIC are available with other than the standard 8 digit accuracy arithmetic on special order. Both integer and floating point variables are not supported. North Star BASIC also uses a variant of the FORTRAN style print formatting rather than the more common "PRINT USING" technique.

On the plus side North Star BASIC supports calls to machine code routines and multi-dimensional arrays. The best feature, however, is a multi-line function, allowing input variables to be changed with each call to the function as in a proper FORTRAN subroutine; BASIC subroutines use the same variables as the main program. By use of a PRINT # n type of statement one program can read and write to multiple terminals, but not multi-user BASIC.

DOS is quite modular in construction so that special user I/O routines for individual terminals can easily be incorporated. We were able, for instance, to add a line printer driver which supported a Diablo daisy-wheel printer, through our own S100 bus parallel interface card. Thus, since BASIC (for instance) uses DOS I/O facilities, the Diablo could be used as a line printer by Basic programmes.

There are two quite different versions of DOS for the single and double density systems. We are very conversant with the single density version since the drivers for the North Star controller are an integral part of our word processing system.

Imagine our surprise (and chagrin) when we found that the controller was completely different and our software had to be upgraded on the new system. Some routines which were in ROM on the controller card are now embedded in DOS. Obviously, if one buys a new controller, the new version of DOS comes with it. All interfaces into DOS (BASIC for instance) are still compatible. One feature of the new DOS is the ability to run single or double density, including a utility to read old DOS diskettes to new double-density versions. Single density diskettes created by the new DOS will run under the older single density system.

Anyone who used the older North Star software will be aware that documentation was not their strong point! All is now changed with the Horizon. *The documentation is as good as any available on a micro-computer system* and is a major plus-factor for potential North Star users. The importance of good documentation cannot be overstressed.

The Horizon system has attracted numerous independent software vendors. A quick read through adverts in an American personal computer journal will reveal multi-user upgrade to DOS, Assemblers, Editors, etc. Far more interesting however is the implementation of CP/M, which

leaves the way free for access to a variety of Assemblers, Compilers and other goodies. Lifeboat Associates have been offering CP/M for older single density North Star systems for about \$150 for some time. I have just however obtained a version to run on the double density diskettes. A 90 KB diskette is rather limiting for real program development; but 180 KB, with a real file structure like CP/M, is *very healthy indeed*.

With the full MACRO assembler facilities, the Horizon and CP/M can make a good program development system. Note however that it will still not fully compete with the INTEL and ZILOG MDS products which, in addition to Assemblers, support high-level languages (PL/M, PL/Z, CORAL) and In-Circuit Emulation (ICE) hardware and software. An engineering department with a full MDS, however, can look to machines like the HORIZON with CP/M to expand their facilities.

North Star have announced that they will shortly be releasing their own implementation of PASCAL.

Conclusion

The product is well produced, well priced and above all well placed in the market. It does not attempt to compete with COMMODORE in the

simple system market. Conversely anyone seriously considering diskette systems will find that this product is probably cheaper, and certainly better packaged than, say, a PET with add-ons. The main competition comes from established market leader, PERTEC (formerly MITS) although they tend to be further upmarket still at the moment, and possibly also from VECTOR GRAPHIC, using the intriguing Quad density MICROPOLIS diskettes. In the UK, RAIR with the BLACKBOX, and RESEARCH MACHINES with their new BASF diskette system, are both more expensive, but include more extensive software (CP/M for instance is the standard RAIR Operating system).

I am still to be convinced that minifloppies are man enough for commercial applications, in which area I prefer the potential increased reliability of 8" diskettes. The 5" system, particularly since the disc drive can be integrated like in the HORIZON, are however much cheaper. We shall see.

With specific reference to the Horizon, the software supply, particularly because of the high quality documentation, is excellent for general purpose use. For commercial applications, however, an upgrade to CP/M and BASIC-M is needed to get the superior file and string handling.

ALMARC specialists in VECTOR GRAPHIC

VECTOR MZ

- S-100 bus
- 18 slot motherboard
- 4MHz Z80A CPU
- 48K ram
- Twin drives — 630k total storage
- One serial & two parallel ports
- 12K prom/ram board with monitor
- MDOS operating system
- Z80 assembler
- Basic interpreter

Price £2300.00

VECTOR MINDLESS TERMINAL

- S-100 video board
- 12" high resolution screen
- 24 lines x 80 cols.
- IBM typewriter style keyboard
- Numeric pad
- Graphic capabilities

Price £550.00

VECTOR SYSTEM B

- MZ COMPUTER SYSTEM
- MINDLESS TERMINAL
- CP/M & MZOS (Free)

Price £2850.00

SOFTWARE FOR THE MZ:

CP/M
CIS COBOL
FORTRAN-80/MACRO-80
PASCAL
APL
CBASIC
XITAN (development packages)
WORD PROCESSING

GLIB:

Graphics software developed by Video Vector Dynamics, for use with Vector's High Resolution Graphics board, running from Fortran or Macro-80. Full software support is provided.

FASTLIB:

Hardware/software package developed by Video Vector Dynamics to upgrade the performance of the MZ (running Fortran) to something comparable to most 16 bit mini-computers! (Uses a 16 bit floating point processor chip.) Full software support is provided.

Prices: GLIB £200.00 FASTLIB £495.00.

High Resolution Graphics £150.00 (needs 8K memory £140)

All prices exclusive of VAT

Contact:

ALMARC DATA SYSTEMS LTD.,
29 Chesterfield Drive, Burton Joyce, Nottingham.
Telephone: 0602 248565

DYNABYTE

MICRO COMPUTERS

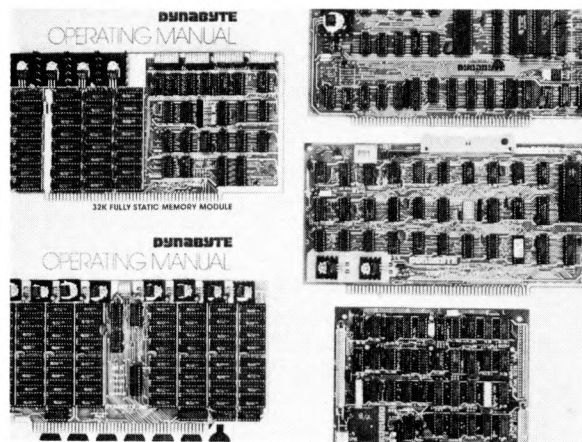

You Can Depend On It.

DYNABYTE UK/EUROPE. 25 PARK ROAD, SCARBOROUGH, YORKS, ENGLAND.
Phone: 0723-65559 – Telex: 52317

UK Distributors:

Merseyside: ZYTEL, Brookfield Drive, Aintree. 051-523 4011. Telex: 628608
ZYTEL, 2 Alexander Drive, Heswall. 051-342 4443 Telex: 627371

UK & European Distributorships available. Contact Mr. T. W. Miller (Chairman)

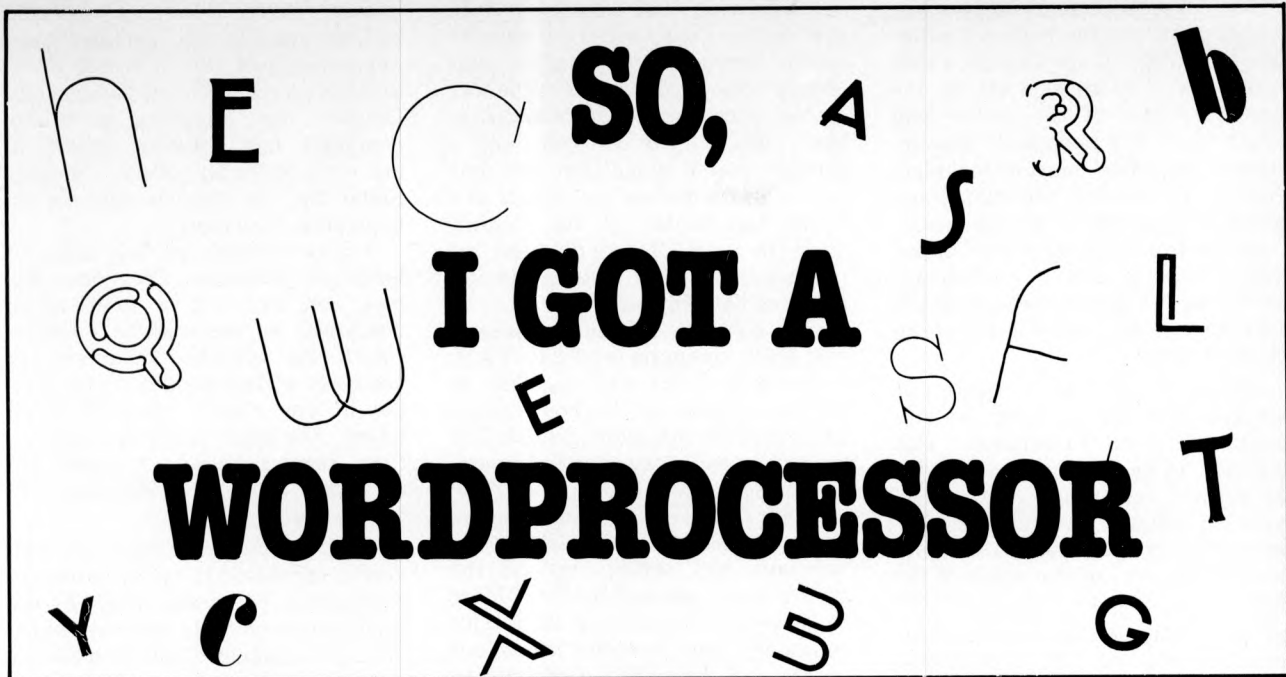

Edward P. Hawthorne

My computer and I are in a state of armistice. We have stopped fighting each other but are not yet at peace.

It all started just about a year ago. I felt that wordprocessors had reached a stage of development when it would be worthwhile investigating whether they could help me to do some of my work more effectively.

Much of my work results in reports, occasional articles and, even more occasionally, books. Hitherto, these have been dictated although I prefer to write direct so that I get immediate visual feed-back of previous sections. The original manuscript then goes through two or even three stages of correction and re-typing. Initially, the alterations are extensive but the penultimate version needs only minor correction and, of course, even the final version often has some typing errors.

All this results in a great deal of unnecessary typing and delay — quite apart from cost.

As a first step, I taught myself to type using all my fingers in the conventional method. As yet, I do not touch type too accurately, and even my present efforts are shot through with errors. However, my secretary could read the corrected first draft more readily than when it had been handwritten, and much time was saved.

The next step was to produce the finished report using my input corrections only, so saving someone else the trouble of retyping perfectly good sections and paragraphs. This can often be done with scissors and a good copying machine but it is still a time consuming business. Could a wordprocessor speed up the whole process and even enable me to produce the final version?

Ideally, what I wanted was to be able to think straight onto a keyboard, make substantial alterations to the text, correct the spelling and other minor mistakes easily, store the text for subsequent alteration and then produce a good quality print-out. In other words, be able to interact directly with the machine.

Specification

At this stage I began to prepare a specification. It was clear that my basic requirements centred around two types of product:

REPORTS, running to upwards of 3 or 4 pages of A4 size; both single and double-spaced; having very heavy rewriting during the initial preparation; going through two or three phases of alteration; and needing good quality typeface for the final version. This would cover the requirements for other types of general script, for example for publications, although the printing quality could be lower.

LETTERS, usually not exceeding a single A4 size page; having some rewording but mainly requiring correction of typing errors and lay-out to produce accurate finish in good quality print. Letters were most unlikely to be repetitive, although there would be some standard phrases, and a hard copy would always be needed for filing.

I then expanded this into a more detailed list split into four phases:

1. **Necessary straightaway, such as:**
 - i. Upper and lower case.
 - ii. Alter characters.
 - iii. Insert and delete.
 - iv. See as much of an A4 page as possible and be able to recall up to three previous pages without delay.
 - v. Underline.
2. **Desirable but not immediate, such as:**
 - i. Store deleted paragraphs temporarily.
 - ii. Number pages.
3. **Expansion of system into other uses, such as:** for accounting records, address filing, calculations and graph plotting, etc.
4. **Long-term, such as:** linking to Prestel.

In all, there were twenty-five items in the list but these were modified as I went along. Even now, I still come across items that should have been included — not that I would necessarily have finished up with a different system!

Working out this initial specification is a vital exercise for any prospective user. It not only prevents one being bemused by all the goodies on offer but focuses attention on the most important element in a wordprocessor — *namely, that it is a man-machine system*. Both you and the machine should be able to change your respective ways of working. If you won't adapt, you will not get the best out of the machine. If its facilities cannot be altered you will most certainly work inefficiently, and probably get very frustrated.

The Hardware

With this specification in my hand, I started to look around the market. The microprocessor exhibitions were of great value in giving me an overview of the current equipment, although I rapidly reached a state of mental indigestion and confusion.

One thing was immediately obvious. I couldn't afford even the simplest standard office model which all secretaries will shortly be clamouring for.

I then decided that the only thing to do was to try and cobble a system together. In this, I have been encouraged and enormously helped by an enthusiastic band of experts. Just as well! Apart from attending a course on Algol fifteen years ago, I knew nothing about programming and not much more about microprocessors.

An important factor in reaching this decision was the cost of a printer. Many people, starting on a new project, tend to concentrate on the innovative part of the system and forget about the apparently conventional items which must be included. Despite the obvious attractions and apparent cheapness of the computers, I started from the *other* end of the system, arguing that if I could not get the right kind of print-out at the right price, I might as well forget the whole exercise.

Matrix printers were ruled out because they did not give the full depth of print I required. This appeared to be obtainable only with the golfball or the new daisy wheel types of printer. The new price of these printers was equal to or more than 75 per cent of the whole of the rest of the system. However, IBM golfball computer typewriters have been coming on the secondhand market steadily for some years and are available at, by comparison, a ridiculously cheap price — provided you are prepared to take the risk inherent in mechanical wear and tear. Most of these machines have been used in accounting computer systems and have usually been worked pretty hard.

I decided to take the gamble. Here again, I was greatly helped by the genuine interest of two or three people. My machine appears mechanically to be in good condition; it was well overhauled; the solenoids and wiring were good and it proved to be a straightforward job to add the interface circuitry.

Having settled on the printer, my next step was to look at the computers. Finding my way through this jungle was quite an experience. M6800, Z80, SCAMP; MSI, SWTP; S-50 or S-100 bus; cassette or disc; ROM, RAM, EPROM. Signs of the zodiac — full of mystery and all pointing in different directions! Of one thing, no-one was in doubt. There is a much better chip, board, system 'round the corner'. Bound to be cheaper too.

To some extent the jungle dissolved of its own accord. I needed a fair amount of software in order to meet my specification. In the end, I discovered that there was no option but to go for a system capable of using the TSC software. At that time, this was the only wordprocessing programme sufficiently developed to meet my needs.

This committed me to the M6800 standard. My experiences are therefore coloured by the limitations imposed by this system and, no doubt, some of the problems which I encountered would not be present in other systems now coming on the market.

Cassette or disc? This was a difficult decision. I plumped for cassette mainly because I really had no clear idea of what I would need in the way of 'off computer' memory and storage. Cassette was cheaper, and I thought that it would give me time to learn how to use the system as a whole and gamble on discs coming down in price. But it did lead me into some irritating trouble and still unsolved handling problems.

The complete system comprises a MSI 6800 computer with 24K RAM, a Newbury VDU with integral 96 ASCII character set keyboard giving 24 lines of 80 characters, an IBM 735 typewriter and a cassette tape recorder. The software is based on the combination of the TSC Text Editor and Word Processor programmes. The purchase and setting up of the system was organised by Tim Moore of NewBear. Throughout, he and his colleagues have provided marvellous service and responded cheerfully to my plaintive cries for help. I trust that others who may be tempted to fall for wordprocessors get as good service from their suppliers.

Came the great day. Although I had tried the system out before installation in my office and I had some notes on what to do to make it go, I immediately fell into the first of a series of traps set for the micro-beginner . . .

Everything was powered up; I typed the start instruction — and nothing happened. Suddenly, I realised that I hadn't set the recorder to play. Press the switch — still nothing happened. I began the routine all over again — and again. And then I pressed the wrong switches and wiped out part of the programme on the cassette.

Since then, I have written out a set of checklists and follow them through carefully each time. Well, more or less, and when I don't check I frequently make a mistake!

This, of course, is all part of the

learning curve. I had not expected to learn quickly but, equally, I had not anticipated that it would be so difficult to comprehend the manuals. Despite my attending a micro-computer familiarisation course at my local technical college, I quickly found that the manuals were written by experts for experts.

I also suffered my fair share of hardware problems. Computer failures consisted of: a fault which developed in the cassette interface circuit, the complete failure of the processor voltage regulator and a failure of one chip in the 16K RAM board. The latter was more nuisance than disaster because I could still use nearly half of the memory until I got a new chip.

Initially, mains interference frequently corrupted the main processor programme. Worst was caused by the typewriter, especially when switching off. But a more difficult interference to trace was that coming through the mains circuit. These interferences have been overcome by fitting separate filters to both the typewriter and processor.

The Cassette tape recorder caused the most irritating problem of all. This was a £30 new machine, with remote control and counter — apparently perfectly good. First, its mains transformer failed and had to be replaced. Then some other untraceable fault appeared, together with a loose screw! But even when it was working it would neither record perfectly nor play back without corrupting the data. For a long time we suspected the interface and spent many hours checking it out, trying spare interfaces. We also tested different types of tape.

The recorder problem became even worse after we raised the data rate to 600 baud (see below). It was then I discovered that the frequency response of this recorder was limited to 6000Hz. Changing to a recorder with a response up to 13000Hz has

```

.NR A 0
.NR B 0
.AU +1
.DM IA
.SP
.LM 8
.LN 47
.AR
.IF !*A-9 .SA
.IF #A-9 .SB
..
.DM SA
:SI -5
#A.
..
.DM SB
:SI -6
#A.
..
.DM IB
.SP
.LM 15
.LN 40
.SR
:SI -7
#B.
..
.DM EI
.AR
.SP
.LN 55
.LM 0
.IN 0
..

```

Consecutively numbered sub-sections.

.IA Arabic numerals starting at 1.
Left margin at column 8.

.IB Roman numerals starting at 1.
Left margin at column 15.

.EI ALWAYS TYPE TO END INDENTS
Puts line length back to 55,
left margin and indents to 0.

Fig. 1. Sample of Macro Sub-Routine for numbering Sub-Sections.

```

I then expanded this into a more detailed list
split into four phases:
.IA
Necessary straightaway, such as
.IB
Upper and lower case.
.IB
Alter characters.
.IB
Insert and delete.
.IB
See as much of an A4 page as possible and be able to recall
up to three previous pages without delay.
.IB
Underline.
.IA
Desirable but not immediate, such as
.NR B O
.IB
Store deleted paragraphs temporarily.
.IB
Number pages.
.IA
Expansion of system into other uses,
such as for
accounting records,
address filing,
calculations and
graph plotting,
etc.
.IA
Long-term, such as linking to Prestel.
.EI

```

Fig. 2. Section of Text as actually Typed In

cured the problem. It is often said that cheap tape recorders are good enough for computer use. This may be true if you don't mind some errors, but when you want accurate data handling day-in and day-out, my experience suggests it pays to use a recorder having a high-grade circuit.

The typewriter has functioned well so far, except for one occasion, when it seemed unable to respond smoothly to the input signals. Consequently, it overprinted and sometimes refused to change to upper case. This was solved with a touch of oil applied to the right linkage. Hence the warning above to be careful that the moving parts are not badly worn.

Software

The wordprocessing software programme consists of four parts:

- The Text Editing System developed by Technical Systems Consultants and marketed by South West Technical Products whose UK distributor is Computer Workshop in London.
- The Text Processor also developed and marketed in the same way as the Editing System.
- Software for linking the above two programmes, developed by Ed.Smith's Software Works in California.
- A set of sub-routines written specially for my system to organise the peripherals and link all the software together.

The general arrangement and capabilities of the TSC Editor and Processor programmes have been well described by Charles Sweeten (*PCW* Feb. 1979 Vol. 1, No. 10, p34-37).

The Text Editor is essentially a line processor. That is, it deals with the text line by line. Hence, one can insert and delete lines; move, copy, replace one or a block of specified lines; find, change or delete characters or strings of words; use tab settings; and so on.

After all is written and corrected, the typewriter will print out an exact

copy of what is on the VDU screen. Thus, a text which has been subjected to extensive alterations will probably require considerable retyping if the print-out is not to look very scrappy.

The Text Processor does all the cleaning up for you. It takes your scrappy lines and fits them neatly into lines of specified length with left and right justified margins; automatically spaces out your lines and paragraphs; types only your specified number of lines per page; places your titles on the right, centre or left — e.g. addresses to the left and the date on the right; and so on.

It is perfectly possible to use the Editor programme alone for a large range of work, such as audio or copy typing, in which only minor corrections to the text are required and one can accept the appearance of the output as from a normal typewriter.

The advantage of the full processor programme is the capability which it provides to make major changes in the text, and to produce a pre-determined lay-out on the page.

The real power of this software, however, lies in the scope that it gives the user to devise his own set of programmes which can then be defined by a single command. These are called 'macros' and are typed in as, for example, ".DM IA" which in my system will call up automatic indentation and indexing in arabic numerals of sub-sections of the text. An example of such a sub-routine is shown in Fig. 1.

Fig. 2. shows how the numbered sub-sections of 'Specification' above were actually typed in. Note that it was only necessary to type the commands ".IA" and ".IB" to produce the correct numbering in arabic and roman numerals, the indexing and the line spacings. (Perceptive readers will notice that this sub-routine does not produce the most desirable lay-out; it is good enough for my purposes).

Fig. 2. also illustrates the point referred to above concerning the tidying up of scrappy lines. The subsection "Expansion of system . . . graph plotting, etc." is shown as it might appear on the screen following very heavy correction and alteration, using the Text Editor programme only — several lines of short and erratic length. The great advantage of using the Wordprocessor programme as well, is that it sorts all this mess out automatically into the correct line and page lay-out.

Even this simple macro took me some time to work out correctly and I have a long way to go before I have fully mastered all the possible functions offered by these programmes. The command routine which I have compiled to process letters and reports, such as this article, uses 17 macro sub-routines and contains a total of 121 commands. From experience, I can echo Sweeten's comment that "if you intend to do something else which is not very simple indeed, then you would be wise to obtain help, or expect to take some time in mastering the difficulties".

The length of the learning curve should not be underestimated although, in my case, some of the difficulties which I encountered were partly of my own making. My computer is a system for work and I used it as such from the very first day. Consequently, I spent too little time in mastering the subtleties of the software. For a long time, my failure to devise an efficient method of operating caused me considerable frustration but, gradually, the machine and I reached a compromise. Provided I use my checklists, it will get on with its bit of the work without interfering with mine!

No wordprocessor programme will cover everybody's requirements. As yet, I have not got a fully satisfactory method of underlining. This involves backspacing the typewriter and problems arise in organising this move properly under certain conditions. Nor does there seem to be a satisfactory way of breaking a line into two separate lines without re-typing one part of it. No doubt these deficiencies will be overcome in due course; but their presence emphasises the importance of drawing up as full a specification as possible before commitment to either hardware or software.

Using the System

My wordprocessor is used virtually daily although the number of hours per day varies widely. The computer itself is rarely switched off. It is worth drawing attention to four of the lessons learned from the experience so far.

Checklists

It may be particular to my set-up that I have found that it is essential to use a checklist for getting the system going, feeding in the programmes and, especially, for finding what to do when I have made an error. When the typewriter is busily banging its head against the end of the carriage and refusing to stop or the cursor won't back to reset, it is a great temptation to panic and press all the buttons and switches in sight.

Gradually, I have evolved a checking method using lists of actions and flowcharts. The former make sure that I follow through the correct sequence. I find the flowcharts of most use in tracing through what action to take when the machine has apparently decided to do its own thing.

Productivity

Having got over the settling-in period of the learning curve, I have started to think about productivity improvement. There are three aspects: the machine, the human and the man-machine combination. So far, I have really only tackled two issues: one for the machine and the other for me.

The computer interface rates were originally set at 300 baud for transmission between computer and tape recorder and between computer and VDU screen. This rate corresponds to about 30 characters per second. Although it took 25 minutes to play in the main processor programme, this was only necessary every few days. The rate at which the display appeared on the screen was well over my typing rate and I was not unduly concerned at the leisurely way the lines scrolled up the screen on a print-out; I could read them as they appeared.

The rot set in when an expert pointed out how slow it all was and that both computer and VDU were equipped with a set of switches to speed things up. The result is that now the computer-tape recorder rate is 600 baud and the computer-VDU works at 9600 baud.

The latter change has really paid off. The display appears virtually as a line at a time and is up the screen too fast to read. The snag is that an extra action has been introduced — the computer has to be switched from the one speed to the other and, of course, I sometimes forget to do so prior to recording my work on cassette! Nevertheless, my advice to would-be users is to go for the highest transmission rates you can get with accuracy.

The second aspect of productivity which I am beginning to tackle is my own efficiency — first of all, by

standardising lay-outs so as to make maximum use of the macro facilities and, secondly, by evolving a filing system.

In filing, one problem is to locate a section of the text which I have already typed into the computer memory without having to go through the whole input. The "Find" instruction works splendidly but I cannot always remember the right keyword so I usually make a note also of the main line numbers for different sections in the text.

A more serious problem is to locate a file on the tape. At present I do this by using the counter on the cassette recorder. This is satisfactory when there are only a few files on each tape but I realise that the time is coming when a piece of software will be useful in reducing the time spent in finding and playing back a specified recording. Perhaps by then, I will have my disc.

Ergonomics

This is a man-machine issue and is one which I have not yet tackled in detail, partly because there are some aspects about which I can do little anyway at this stage.

My screen and keyboard are in one unit. I am coming to the conclusion that it would be better if I could angle and locate them separately. I use bifocals and actually find it easier to read the text on the VDU without my glasses. Others might not be able to do this and would find that the bifocal division tends to come in the middle of the screen.

This, of course, is partly related to posture and the type of chair used. These are very much personal factors but should not be overlooked when considering the physical layout of the system.

Another aspect of the lay-out is the availability of the switches, typewriter, cassette file and recorder. It is essential to have some of these within easy reach but I have found it beneficial to have to get up every now and then and move around.

Other Applications

Obviously, my system is capable of greater things than mere word-processing. It could handle many of the chores in a business or home. It could do accounts, do calculations and, no doubt, be linked to other computers. It could eventually receive information from Prestel or other databanks. Maybe, I will use it for games; and my wife for planning her shopping.

So far, however, I have done none of these things except to find out how to input a character onto the screen and add simple numbers in hex! Getting software adapted and

working is time-consuming and I have serious doubts as to whether I will ever master the technique of writing my own programmes. My next step, therefore, is to investigate the "Basic" software and see what that can do for me.

In due course, we may be able to buy programmes from bookshops or borrow them from libraries. Meanwhile, it is worth joining the network of enthusiasts, such as the ACC, who are always willing to take an interest in one's problems and to whom, in turn, one can often contribute ideas and experiences.

Conclusions

The user has a great deal to learn about wordprocessors. It is therefore very important before purchase to draw up as detailed a specification of one's requirements as possible. After purchase, one should be prepared for a long learning curve and adaptation of one's method of working.

As a result of my own experiences, I am undertaking a survey of users' requirements. The intention is to assist potential users to prepare their specifications and I hope that readers who already possess or operate wordprocessors will send me details of their own needs and experiences.

It is some measure of my own satisfaction with wordprocessing that I resent my system being out of action. I find it extremely frustrating to have to go back to working with a perfectly good spare electric typewriter. It is noisy and I am much more jittery about making typing mistakes. It is so much easier to correct them on the wordprocessor.

For potential users, I would briefly summarise my conclusions on this project as follows:

Make sure you have some good friends who can help you to get sorted out on software and who will be able to maintain both it and your equipment. User groups can be very helpful.

Work out what you want your system to do but don't be afraid to change your ideas as you learn more about it all.

Be prepared for a long learning curve. If you have never been near a computer, attend a course on the fundamentals of the hardware and programming. This at least will give you the jargon and probably help you to get more out of your system.

Make sure the operating instructions are well written and easily used. Computers can be like aircraft. They both crash if their operators don't follow the book.

PCW Edward Hawthorne is the author of "The Management of Technology", published by McGraw-Hill Book Company (UK) Ltd. Good as general background reading for engineers, scientists and technologists, it has some genuinely original insights. PCW

P.E.T NEWS

PET BOOM IN BRITAIN!

AUTHORISED PET COMMODORE DEALERS

Birmingham

Camden Electronics
021-773-8240

CPS (Data Systems)
021-707-3866

Taylor Wilson Systems
Knowle (056-45) 6192

Bolton

B & B Consultants
0204-26644

Bournemouth

Stage One Computers
0202-23570

Bradford

Ackroyd T/W &
Add M/C
0274-31835

Brentwood Essex

Direct Data Marketing
0277-229379

Bristol

Bristol Computer Centre
0272-23430

Sumlock Tabdown
0272-26685

Cambridge

Cambridge Computer
Store
0223-68155

Cardiff

Sigma Systems
0222-21515

Colchester

Dataview Ltd
0206-78811

Derby

Davidson Richards
0332-366803

Durham

Dyson Instruments
0385-66937

Edinburgh

Micro Centre
031-225-2022

Exeter

A.C. Systems
0392-71718

Grimsby

Allen Computers
0472-40568

Hemel Hempstead

Data Efficiency
0442-57137

Hove

Amplicon Micro Systems
0273-720716

Leeds

Holdene
0532-459459

Liverpool

Dams Office Equipment
051-227-3301

Rockliff Bros
051-521-5830

**THE
PET 4K
COMPUTER
at
£450 (+VAT)
it's got to
be
Britains
best buy!**



Why the PET is the number one Personal Computer

The Self Contained PETS

The self contained PET models 2001-4 and 8 come complete with TV screen, keyboard and built-in cassette deck as well as the computer circuitry. They are simply plugged into any 13 amp mains and no special knowledge is needed for running standard programs — over 200 of which are available on cassettes.

The Big Memory PETS

The BIG MEMORY PETS contain the same main features as for the 2001-4 and 8 models except that they incorporate a full typewriter size keyboard and have larger internal memory of 16K and 32K bytes RAM respectively.

Professional Printers

High specification printers can print onto paper all the PET characters — letters, numbers and graphics. A tractor feed model has the advantage of accepting mailing labels, using standard pre-printed forms. The only connections required are an A/C lead and PET connecting leads. The PET is programmable, allowing the printer to format print and it accepts 8 1/2" paper giving up to four copies.

Dual Drive Floppy Disc

The Dual Drive Floppy Disk is the latest in Disk technology with extremely large storage capability and excellent file management.

The Floppy Disk operating system used with the PET computer enables a program to read or write data in the background while simultaneously transferring data to the PET. The Floppy Disk is a reliable low cost unit, and is convenient for high speed data transfer. Due to the latest technological advances incorporated in this disk,

a total of 360K bytes are available in the two standard 5 1/4" disks. Only two connections are necessary — an A/C lead and PET interface lead.

Software and application areas for PET

There are a large number of programs that can readily be used with the PET. Personalised programming is available from many Authorised Dealers. Over 200 programs are now available from Commodore and other software suppliers for the PET. Popular program titles include Stock Control, Statistics, Payroll, Strathclyde Basic Course, Chess, Lunar Landing and Education Packs.

FOR THE COMMERCIAL USER

The Commodore PET offers for the first time a really cost effective business computer for use in Accountancy, Statistics, Stock Control, Payroll, Invoicing etc.

FOR THE SCIENTIST AND THE LABORATORY

PET has a comprehensive set of scientific functions making it a far superior tool to the best programmable calculators. PET interfaces directly with hundreds of laboratory instruments. PET is an ideal industrial and commercial controller.

FOR THE EDUCATIONAL WORLD

The extensive basic language makes PET an ideal tool for teaching computer programming. Programs can be written to "tutor" the user (pupil) in almost any discipline, including BASIC itself. And, of course, the PET can be used to take care of school records, exam results, attendance figures etc.

IN THE HOME

The PET is an extremely creative and instructive learning medium of the future for young and old alike. There are also large numbers of entertainment programmes available including chess and space games.

Phone about PET now!

**CALL YOUR LOCAL AUTHORISED DEALER or in case of difficulty contact:
COMMODORE SYSTEMS DIVISION
360 Euston Road, London. Tel: 01-388-5702**

London E2
Ragnarok Electronic
Systems
01-981 2748

London EC1
Sumlock Bondain
01-253 2447

London N14
Micro Computation
01-882 5104

London NW4
Da Vinci Computers
01-202 9630

London SW14
Micro Computer Centre
01-876 6609

London W5
Adda Computers
01-579 5845

London WC1
Euro-Calc
01-405 3113

London WC2
TLC World Trading
01-839 3893

Manchester
Cytok
061-832 7604

**Sumlock Electronic
Services**
061-834 4233

Matlock
Lowe Electronics
0629-2817

Morley, W. Yorks
Yorkshire Electronic
Services
0532-522181

Norwich
Sumlock Bondain
0603-26259

Nottingham
Betos Systems
0602-48108

Oxford
Orchard Electronics Ltd.
Wallingford (0491)-
35529

Plymouth
J.A.D. Integrated Services
0752-62616

Preston
Preston Computer Centre
0772-57684

Reading
CSE Computers
0734-61492

Southampton
Business Electronics
0703-738248

Symtec Systems
0703-37731

Xitan Systems Ltd.
0703-38740

Sunderland Tripont
Associated Systems
0783-73310

Woking
P.P.M.
Brookwood (04867)-80111

Petalect
04862-20727

Yeovil
Computerbits
0935-26522

North Scotland
Thistle Computers
Kirkwall (0856)-3140

Northern Ireland
Medical & Scientific
Lisburn (08462)-77533



Introducing the personal computer you've waited for.

The Exidy Sorcerer.

LOOK AT THESE FEATURES

16K £760
32K £859
add 8% VAT

The Sorcerer Computer is a completely assembled and tested computer system ready to plug in and use. The standard configuration includes 63 key typewriter-style keyboard and 16 key numeric pad dual cassettes I/O with remote computer control at 300 and 1200 baud data rates. RS232 serial I/O for communication, parallel port for direct Centronics printer attachment, Z80 processor, 4K ROM operating system, 8K Microsoft BASIC in separate plug-in ROM Pac™ cartridge, composite video of 64 chars x 30 lines, 128 upper/lower case ASCII character set and a 128 user-defined graphic symbols, up to 32K on-board RAM memory, operators manual, BASIC programming manual and cassette/video cables, connection for S100 bus expansion unit giving access to the spectrum of exciting and useful peripheral devices, such as Floppy disk drives, voice recognition/synthesis battery back-up board in case of power failure, additional memory boards, E-PROM cards give you the facility to program and re-program your own ROM memories etc. This is the most useable and flexible system that's now available to the home and business user at such a low price.

* WORD PROCESSING, COBOL, FORTRAN etc

* PLUG IN ROM CARTRIDGES

* WORKS WITH NORMAL TV

* S100 EXPANSION UNIT

* CASSETTE INTERFACE

* Z80 CPU

* 32K RAM ON BOARD

* A REAL BUSINESS MACHINE

please make cheques and postal orders payable to JADE
phone your order quoting ACCESS or VISA number
for technical information or advice phone 0736 66565

Supplied by - Factor One Computers

JADE

17 Market Place, Penzance, Cornwall.

TRS 80 SOFTWARE

from the leaders in innovative software

We were first for the TRS-80 with Re number Basic

We were first with software Level 1 in Level II

We were first with the Howe Monitors 1, 2 and 3.

We were first with the Newdos

And we are going to go on being first

SEND SAE FOR LIST

A.J.HARDING
(MOLIMERX)

28 Collington Ave.,
Bexhill, E. Sussex.
Tel. (0424) 220391



WHICH BRITISH SYSTEM CAN OFFER THE FOLLOWING

- COLOUR — Aerial input, Alphanumeric and Graphics
- CEEFAX — B.B.C. Television Teletext service
- ORACLE — I.B.A. Television Teletext service
- BASIC — ROM — Resident interpreter
- MONITOR — Motorola 6800 Machine Code.
- VIEWDATA — Instant information service.

T.E.C.S.

TECHNALOGICS
EXPANDABLE
COMPUTER
SYSTEM

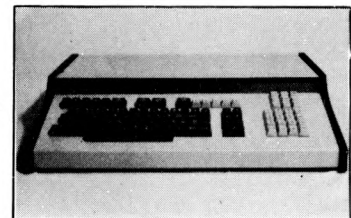

PRICES START FROM AROUND £360
RACK MOUNTED AND TABLETOP VERSIONS (illustrated)

— THE LOGICAL DEVELOPMENT EVERYONE HAS BEEN WAITING FOR.

Please send large S.A.E. for details to:

TECHNALOGICS

(Dept. PCW)
8 EGERTON STREET,
LIVERPOOL L8 7LY

MK14. PSEUDO RANDOM NUMBER GENERATOR

On your mark, get set

Clifford Clark

This article brings into use the control features demonstrated in the previous MK14 experimental and diagnostic programs (PCW May '79). Part of the read only memory (ROM) is brought into use and incorporated in the program. Other useful information about the MK14 microcomputer circuitry (hardware) and its relationship to the program instructions (software) is demonstrated and explained.

The program is purposely written in the sledge-hammer style, i.e. short cuts such as auto-indexing and like memory space saving features are not used. This enables new-comers to visualise clearly the various sequences separately.

The MK14 Manual contains a listing of the monitor program. This is resident in the fixed part of memory and is essential for loading and running programs. Because it is fixed or permanent memory it cannot be changed or written into but only read from therefore it is designated 'read only memory, (ROM). To beginners, this fixed region of memory might appear to be forbidden territory, but this is not the case. Any part suitable for a user program can be read and used as required. Take for example the section of ROM which indicates "Error" in the dis-

play. On page 43 of the Monitor listing the starting address for this routine is location 0083. This could be read into any user program to show a wrong procedure.

Digital computers only process ones (1) and noughts (0) so it is necessary that some arrangement be made to convert these ones and noughts into decimal and hexadecimal notations.

The CROM routine listed on page 44 of the MK14 Manual is available for this task. In the Pseudo Random Number Generator program which is developed in this article, use is made

of the part of the CROM 'Hexadecimal Number to Seven Segment Table' which deals with the decimal numbers (0-9). This table converts 4-bit Binary Coded Decimal (BCD) numbers into the appropriate 8-bit code to be able to display the number in a seven segment LED unit. This conversion is explained in detail in the program commentary.

Getting the Program Essentials Together

At the start the specifications are listed. This is done by first stating the objective of the program. When this is stated other questions will then arise and further requirements will become obvious. For example: 'Has the program to be started from a particular address each time a result has been obtained?' or 'Is it to be a looping program with key or external interrupt control?' etc. The general outline of action is then sketched out as a block diagram (algorithm). This is an essential step

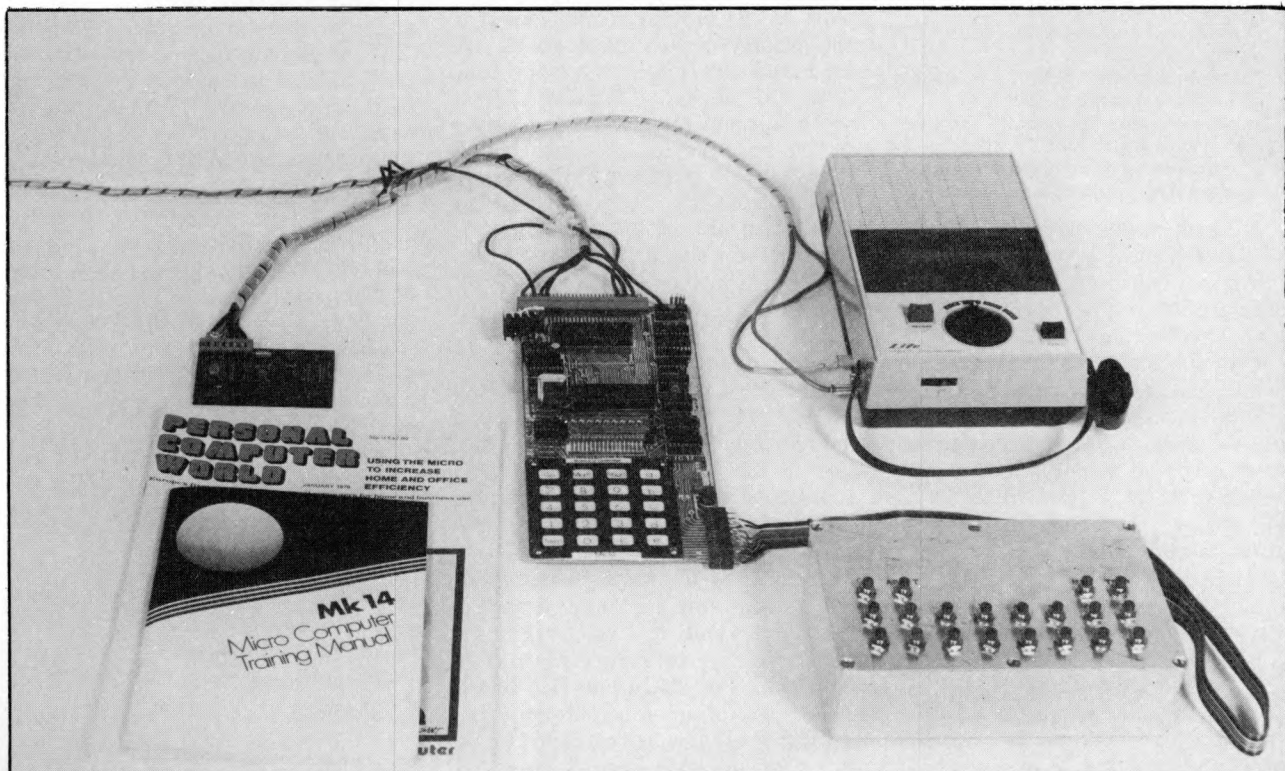

Photo: Geraldine Mellen

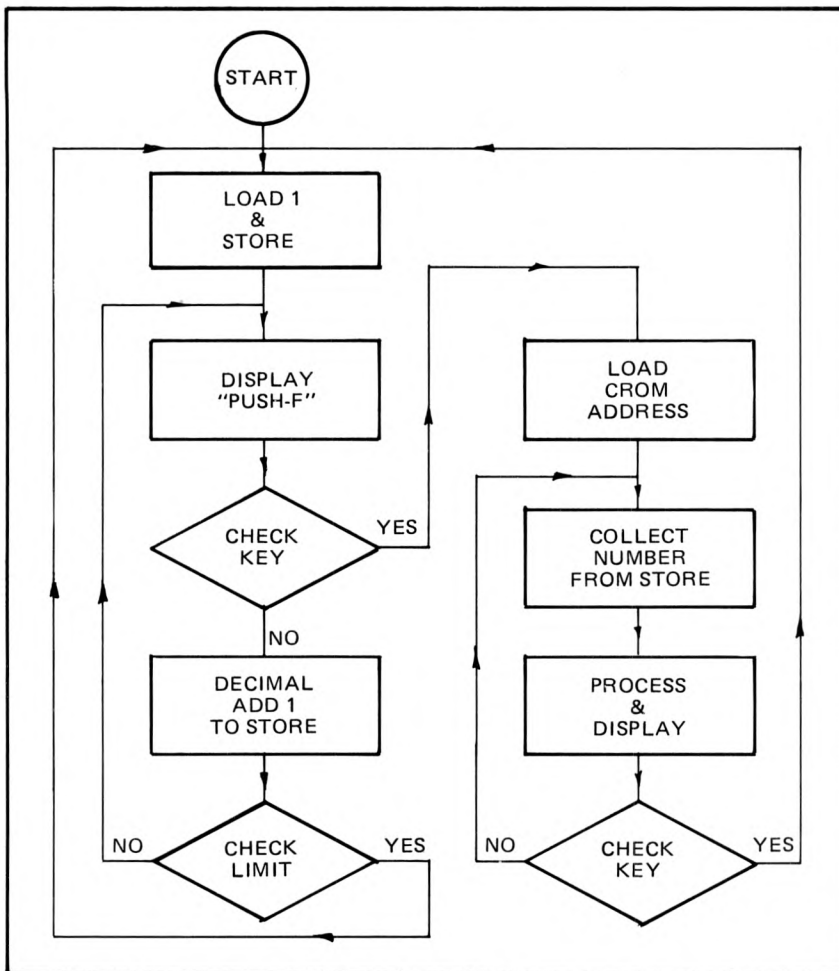

Figure 1.

which saves time because it enables one to get the program steps in the correct sequence.

The PRNG program ideas were listed this way:-

- Basic objective . . . produce random number of two decimals.
- Output . . . number displayed in LED units.
- Number Generator action . . . simple count up to maximum set.
- Additional requirements . . . display legend in counting loop.
- . . . stopped by one designated key.
- . . . restarted another designated key.

A block diagram was then drawn and altered until it became obvious which sections preceded and which followed. The final result was the algorithm shown at Figure 1.

With the algorithm finalised it was then a matter of deciding on the location in memory and the starting address. The MK14 basic kit was being used, so location OF20 was chosen to allow a few vacant memory spaces in front for possible future modifications. This is always good practice even though the end of the program might not be in sight!

PRNG Program Commentary

The starting address is location OF20 and the first four bytes load

number one into the accumulator to start the count up and then store it in location OF58.

The next six bytes put the display address into pointer register No. 3 so that it is available for displaying and also the key sensing actions. Reference to the algorithm indicates that the display legend instructions are next and this requires twenty four bytes to display "PUSH-F". Each seven segment byte code appropriate to the required letter is loaded and then 'sent to' or stored at the display address ranging from ODO0 to ODO7 (if all locations are used). A full table for the alphanumeric codes was shown in the MK14 article PCW May. The bytes OF42-OF45 seem to be of no apparent use and a waste of memory space but they are essential in this program to prevent a spurious display. If key sensing instructions immediately follow a display instruction in the MK14 microcomputer it is necessary to make sure that the display latching circuitry has returned to zero state. To appreciate this particular effect, when the program has been loaded and running correctly, omit the latch zero instructions by substituting O8 (no operation) in locations OF42-45. There are other ways around this 'ghosting' effect but the main aim of this program is to keep it simple so

that each separate action can be easily visualised.

OF46-OF4B are six bytes used to check for key F action. This is carried out by loading the contents of the key address into the accumulator and then the contents are exclusive OR'd with the code EF.

So the initial program listing started off:-

```

OF20 C4 Load immediately into AC
OF21 O1 Decimal number 1.
OF22 C8 Store number in AC at
OF23 ?? (displacement calculated later)
OF24 C4 Load
OF24 C4 Display address
OF24 C4 into
OF24 C4 Pointer register
OF29 33 number 3.
OF29 33 number 3. etc.
    
```

Where displacements are needed, leave blank until the full program is laid out and then remember that all calculations are from the memory address containing the displacement number to the referred address WITH THE EXCEPTION OF TRANSFER INSTRUCTIONS (JUMPS). Transfer is always to the address MINUS ONE of the location to be next activated. The overlooking of the minus one in transfer address calculations probably accounts for the most commonly occurring mistake (bug) in programming the MK14.

Key Control

The keys to be used in controlling the program have to be fitted into the instruction sequences. The choice of the designated keys is arbitrary and is the legend to be displayed. The key "GO" was chosen because it seemed the most appropriate to re-run a program. The key "F" for function seemed to suggest itself as well as being at the bottom right hand corner of the author's keyboard. Decisions like these are for the programmer to decide unless one is compiling to required specifications. MK14 users will gain good experience by altering the key control locations and forming their own display legend. The key location addresses and hexadecimal identifications for all keys were illustrated in PCW May. The necessary information for the PRNG is given in the program commentary.

(All key address contents are FF with no key action. F key down results in the change to EF) The result of the exclusive OR action is:-

Contents	Loc.	No Key	Key F
ODO7		11111111	11101111
EF		11101111	11101111
Ex. OR AC		00010000	00000000

Therefore Zero AC signals Key F.

So the AC is tested for zero and if zero the program transfers to the display digits routine. If AC is not zero

comart

... the specialists



The system builder has many options but few real choices. Hardware should be easy to use, figure and understand, yet still be part of a wide and ever-increasing range of standard modules. Development systems should have powerful software and keep projects on that all-too-short time-scale. Comart can offer just that. As S100 specialists, Comart's catalogue of computers ranges from single card computers to multi-user systems, memory modules, analogue single or parallel interfaces. From EPROM programmers, erasers to floppy discs and systems.

Development systems place high-level language compilers of FORTRAN IV and COBOL in the hands of the designer – as well as powerful macro-assemblers.

Debug and trace help ensure safety and repeatability in the final product.

If you are looking for cost-effective hardware and dependable software just ask for our latest technical information.

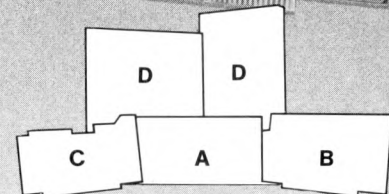

A the Comart Micro Box
B a single card computer
C just one example of an interface board – the analogue converter
D software for the Cromemco Z2-D Development System

Contact us direct or call your nearest Comart dealer

The Byte Shop, Ilford, Essex. Tel: 01-554 2177
Cambridge Computer Store, Cambridge Tel: (0223) 68155
Microcomputermart Ltd., Manchester Tel: 061-832 2269
Crayworth Ltd., Camberley, Surrey Tel: (0776) 34044
Digitus Ltd., London W.1. Tel: 01-636 0105
Holdene Ltd., Leeds Tel: (0532) 459459
Isher-Woods Ltd., Luton, Beds, Tel: (0582) 424851
Newbear Computing Store, Newbury, Berks (0635) 30505
Xitan Systems Ltd., Southampton Tel: (0703) 38740

comart specialists in microcomputers

Comart Ltd., P.O. Box 2, St. Neots, Huntingdon, Cambs, PE19 2AF Tel: (0480) 215005 Telex: 32514

HIGH-SPEED SOFTWARE CASSETTE INTERFACE FOR THE SWTP 6800 SYSTEM

David R. Isaac

Dept. of Applied Physics & Electronics, University of Durham

This article describes a software approach to the problem of interfacing a microprocessor system (in this case the SWTP 6800 system) to an audio cassette used for data storage. This alternative to the more conventional hardware methods offers several distinct advantages. Since the system is software based (the only hardware requirements being the cassette player and two ports of a PIA), its most obvious attraction is low cost. Unlike dedicated hardware cassette interfaces, total control over speed is available and the system is capable of data transfer rates up to about 2000 baud. With the parameters given in the listings, a rate of 1600 baud is obtainable.

Figure 1 illustrates the hardware configuration. A PIA is plugged into row 4 in the motherboard and output to the mic. socket of the cassette recorder is taken directly via a screened lead from the most significant bit of the 'A' side of the PIA. Incoming data from the cassette player is received via another screened lead connected from the extension speaker socket to the most significant bit of the 'B' side. Good results were obtained using medium quality audio cassettes and with the volume and tone controls on the cassette player both set to maximum.

Data is stored on the cassette as a frequency shift keyed signal. Logic levels '0' and '1' are stored as single cycles of 2800 and 1400 Hz respectively which represents an average bit rate of 1600 baud. Data is sent as a MIKBUG formatted tape headed by a string of 200 ASCII nulls and terminated with an ASCII 'S9' end of file pattern. The 'save' and 'read' programs are shown in Figures 2 and 3 respectively, and have been given arbitrary origins, although both programs are fully relocatable. By storing the programs in PROM, the risk of overwriting them is eliminated.

To save an area of data on cassette tape, first enter the beginning address of the area in locations A002 and A003 and the final address in locations A004 and A005. Set locations A048

and A049 to the start address of the SAVE program, switch the cassette player on to record and enter G. When the transfer of data is complete, the system automatically returns to MIKBUG.

To read data from the cassette, first set locations A048 and A049 to the start address of the READ program, start the cassette rolling a little before the data begins (to allow it to pick up speed) then enter G. When the end of file pattern is read from the tape the system returns to MIKBUG. Should an error be encountered during playback, an 'E' will be printed on the teletype; the tape should be stopped, rewound slightly and a G should again be entered. Note that there is no need to reset the program counter before doing this.

This cassette system has been used for several months and has been found to be very reliable. The data transfer rate is more than five times that of Kansas City standard system which results in a considerable time saving for long programs. A change of speed can be effected by changing the frequencies of the two FSK tones. This is done by altering the timing loop parameter at location 50D0 in the SAVE program, and the mean number of samples per half-cycle at location 600B in the READ program.

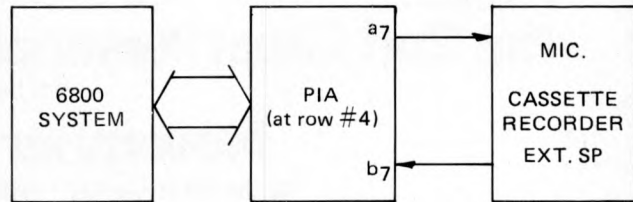

Figure 1. Hardware Configuration

```

TITLE:  SAVE

LOC  OBJECT CODE  SOURCE STATEMENTS
*
*          NAM  SAVE
*
*          TRANSMIT ROUTINES
*
* This program sends mikbug formatted data as
* an FSK signal through one port of A Pia.
* A logic '1' is sent as one cycle of 1400 Hz;
* A logic '0' is sent as one cycle of 2800 Hz.
* Bega, Bega + 1 and Enda, Enda + 1 Contain the
* first and last addresses respectively of the
* data area to be saved.
*
*
8010      PIAAD  EQU  $8010  PIA ADDRESS
          * MIKBUG RAM ADDRESSES:
AOO2      BEGA  EQU  $A002  DATA START ADDRESS
AOO4      ENDA  EQU  $A004  DATA END ADDRESS
AOOE      TEMP  EQU  $A00E
AOOF      TW    EQU  $A00F
AO11      MCONT EQU  $A011
AO12      XTEMP EQU  $A012
          * END-OF-FILE PATTERN:
AO20      OD    ORG  $A020
AO20      OA    MTAPE2 FCB $D,$A,0,0,0,0,$53,$39,4
AO22      OO
AO23      OO
AO24      OO
AO25      OO
AO26      53
AO27      39
AO28      O4
          * MIKBUG ROM ADDRESSES
EOE3      CONTRL EQU $EOE3
E134      MTAPE1 EQU $E134
5000      CE FFO4  START LDX #FF04  PROGRAM ORIGIN
5003      FF B010 STX PIAAD  INITIALISE PIA
          * SEND 200 NULLS
5006      C6 C8   LDA B #200
5008      4F     NULLS CLR A
5009      8D 67  BSR SEND
500B      5A     DEC B
500C      26 FA  BNE NULLS
          * MIKBUG "PUNCH" ROUTINE:
500E      FE A002 PUNCH LDX BEGA  START ADDRESS
5011      FF A00F          STX TW    SAVE IT

5014      B6 A005 SEN11 LDA A ENDA+ 1
5017      B0 A010      SUB A TW+1
501A      F6 A004      LDAB ENDA
501D      F2 A00F      SBCB TW
5020      26 04       BNE SEN22
5022      81 10       CMP A #16
5024      25 02       BCS SEN23
5026      86 0F       SEN22 LDA A #15
5028      8B 04       SEN23 ADD A #4
502A      B7 A011     STA A MCONT FRAME COUNT THIS RECORD
502D      80 03       SUB A # 3
502F      B7 A00E     STA A TEMP BYTE COUNT THIS RECORD
          * SEND C/R, L/F, NULLS, S, 1 (START OF RECORD):
5032      CE E134    LDX #MTAPE1
5035      8D 34      BSR PDATAL
5037      5F         CLR B ZERO CHECKSUM
          * SEND FRAME COUNT
5038      CE A011    LDX #MCONT
503B      8D 38      BSR SEND2
          * SEND ADDRESS
503D      CE A00F    LDX #TW
5040      8D 33      BSR SEND2
5042      8D 31      BSR SEND2
          * SEND DATA
5044      FE A00F    LDX TW
5047      8D 2C      BSR SEND2 SEND ONE BYTE (2 FRAMES)
5049      7A A00E    DEC TEMP DEC BYTE COUNT
504C      26 F9      BNE SEN32
504E      FF A00F    STX TW
5051      53         COM B
5052      37         PSH B
5053      30         TSX
          * SEND CHECKSUM
5054      8D 1F      BSR SEND2
5056      33         PUL B RESTORE STACK
5057      FE A00F    LDX TW
505A      09         DEX
505B      BC A004    CPX ENDA
505E      26 B4      BNE SEN11
          * IF FINISHED, SEND END-OF-FILE
5060      CE A020    LDX #MTAPE2
5063      8D 06      BSR PDATAL
5065      7E E0E3    JMP CONTRL RETURN TO MIKBUG
5068      8D 24      PDATA2 BSR SENDIT
506A      08         INX
506B      A6 00      PDATAL LDA A X
506D      81 04      CMP A #4
506F      26 F7      BNE PDATA2
5071      39         RTS
5072      8D 1A      SEND BSR SENDIT
5074      39         RTS
          * SEND 2 HEX CHARS: UPDATE CHECKSUM
    
```

Continued on page 42

Scenes from last year's stunningly great event....

THE REAL SHOW FOR REAL PEOPLE!
 The Show that makes other Shows look like
 Sunday School outings.

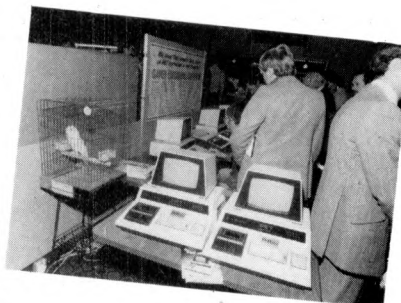
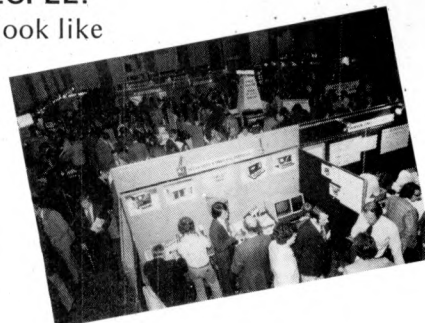
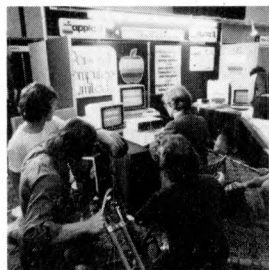

Now... the 2nd Great Personal Computer World Show

will be held on

November 1-3rd 1979

at the West Centre Hotel, Lillie Road, London.

*Excitement . . . hard-headed practicality . . . discovery . . .
 business . . . the Show that's serious but not solemn.*

- **PCW** readers are truly the shapers of the future of computing in Europe, exhibitors will be taking the opportunity of presenting their latest products.
- The **Features Area** will have: The **PCW** Chess Championship . . . a robot or two . . . individual machines . . . innovations . . . Computer art . . . anything interesting that comes up between now and November . . . the Amateur Computer Club . . . Special School's Section. The Show will be vital, cheerful — and very profitable for visitors and exhibitors alike.

And for the first time in Europe!
David Hebditch, PCW Consultant,
 demonstrating practical communications
 with personal computers

- **PCW** gives and will be giving consistent support to exhibitors. A comprehensive,

detailed catalogue of products of every size and description will appear in the **October** and **November** issues of **PCW**.

- A three day **Conference** (1st — 3rd November) will be held during the Show.
Day One (Nov. 1st) The Small Computer and the Businessman.
Day Two (Nov. 2nd) Computer Applications.
Day Three (Nov. 3rd) Computing for the home and the amateur.

Over thirty stands have been booked so far . . . with the publicity campaign only just beginning.

Over five hundred enquiries from readers already . . . with information only just being released.

The Second Great Personal Computer World Show

- Please book me Admission tickets @ £1.00 (15% discount for groups of 10 and over).
- Please send me Conference details.

Name _____ Address _____

All enquiries to :- Personal Computer World
 14 Rathbone Place
 London W1
 Tel 01 637 7991

THE RESEARCH MACHINES 380Z COMPUTER SYSTEM



THE RESEARCH MACHINES 380Z A UNIQUE TOOL FOR RESEARCH AND EDUCATION

Microcomputers are extremely good value. The outright purchase price of a 380Z installation with dual mini floppy disk drives, digital I/O and a real-time clock, is about the same as the annual maintenance cost of a typical laboratory minicomputer. It is worth thinking about!

The **RESEARCH MACHINES 380Z** is an excellent microcomputer for on-line data logging and control. In university departments in general, it is also a very attractive alternative to a central mainframe. Having your own 380Z means an end to fighting the central operating system, immediate feedback of program bugs, no more queuing and a virtually unlimited computing budget. You can program in interactive BASIC or, using our unique Text Editor, run very large programs with a 380Z FORTRAN Compiler. If you already have a mini-computer, you can use your 380Z with a floppy disk system for data capture.

What about Schools and Colleges? You can purchase a 380Z for your Computer Science or Computer Studies department at about the same cost as a terminal. A 380Z has a performance equal to many minicomputers and is ideal for teaching BASIC and Cesium. For A Level machine language instruction, the 380Z has the best software front panel of any computer. This enables a teacher to single-step through programs and observe the effects on registers and memory, using a single keystroke.

WHAT OTHER FEATURES SET THE 380Z APART?

The 380Z with its professional keyboard is a robust, hardwearing piece of equipment that will endure continual handling for years. It has an integral VDU interface — you only have to plug a black and white television into the system in order to provide a display

**380Z/56K complete with DUAL FULL
FLOPPY DISK SYSTEM FDS-2**

£3266.00

380Z/16K System with Keyboard

£965.00

RESEARCH MACHINES Computer Systems are distributed by RESEARCH MACHINES LTD., P.O. Box 75, Chapel Street, Oxford. Telephone: OXFORD (0865) 49792. Please send for the 380Z Information Leaflet. Prices do not include Carriage or VAT @ 15%.

unit — you do not need to buy a separate terminal. The integral VDU interface gives you upper and *lower* case characters and low resolution graphics. Text and graphics can be mixed *anywhere* on the screen. The 380Z has an integral cassette interface, software and hardware, which uses *named* cassette files for both program and data storage. This means that it is easy to store more than one program per cassette.

Owners of a 380Z microcomputer can upgrade their system to include floppy (standard or mini) disk storage and take full advantage of a unique occurrence in the history of computing — the CP/M™* industry standard disk operating system. The 380Z uses an 8080 family microprocessor — the Z80 — and this has enabled us to use CP/M. This means that the 380Z user has access to a growing body of CP/M based software, supplied from many independent sources.

380Z mini floppy disk systems are available with the drives mounted in the computer case itself, presenting a compact and tidy installation. The FDS-2 standard floppy disk system uses double-sided disk drives, providing 1 Megabyte of on-line storage.

*Trademark, Digital Research.

Versions of BASIC are available with the 380Z which automatically provide controlled cassette data files, allow programs to be loaded from paper tape, mark sense card readers or from a mainframe. A disk BASIC is also available with serial and random access to disk files. Most BASICs are available in erasable ROM which will allow for periodic updating.

If you already have a teletype, the 380Z can use this for hard copy or for paper tape input. Alternatively, you can purchase a low cost 380Z compatible printer for under £300, or choose from a range of higher performance printers.

```

5075 EB 00 SEND2 ADD 3 O,X UPDATE CHECKSUM
5077 A6 00 OUT2H LDA A O,X SEND 2 HEX CHARS
5079 8D 05 OUT2HA BSR OUTHL OUT LEFT CHAR
507B A6 00 LDA A O,X
507D 08 INX
507E 20 04 BRA OUTHR OUT RIGHT CHAR & RETURN
5080 44 OUTHL LSR A
5081 44 LSR A
5082 44 LSR A
5083 44 LSR A
5084 84 0F OUTHR AND A #$F OUT RIGHT BCD DIGIT
5086 8B 30 ADD A #$30
5088 81 39 CMP A #$39
508A 23 02 BLS SENDIT
508C 8B 07 ADD A #$7

*
* GENERATE FSK SIGNAL AND SEND THROUGH PIA
*
508E 37 SENDIT PSH B
508F FF A012 STX XTEMP SAVE XREG
5092 C6 08 LDA B #8 BIT COUNT
5094 8D 29 BSR ZERO SEND START BIT
5096 0D SEC
5097 49 NEXBIT ROL A GET NEXT BIT
5098 24 04 BCC SKIP JUMP IF ZERO
509A 8D 14 BSR ONE SEND A '1'
509C 20 02 BRA OVER
509E 8D 1F SKIP BSR ZERO SEND A '0'
50A0 0D OVER SEC
50A1 5A DEC B
50A2 26 F3 BNE NEXBIT NEXT BIT
50A4 8D 0A BSR ONE SEND STOP BIT
50A6 86 00 LDA A #0 PIA---> LOW
50A8 B7 8010 STA A PIAAD
50AB FE A012 LDX XTEMP RESTORE XREG
50AE 32 PUL A AND STACK
50AF 39 RTS

* BIT=1; TRANSMIT CYCLE OF LOW FREQUENCY
ONE PSH A SAVE ACCA
AGAIN LDA A #0 PIA---> LOW
BSR DELAY TIMER
BSR DELAY AND AGAIN
50B7 86 FF LDA A #$FF PIA--> HIGH
50B9 8D 0F BSR DELAY
50BB 8D 0D BSR DELAY WAIT AGAIN
50BD 32 PUL A RESTORE STACK
50BE 39 RTS
* BIT=0; TRANSMIT CYCLE OF HIGH FREQUENCY
ZERO PSH A SAVE ACCA
BACK LDA A #0 PIA--> LOW
BSR DELAY TIMER
LDA A #$FF PIA--> HIGH
BSR DELAY RESTORE STACK
PUL A
RTS
* FREQUENCY CONTROL DELAY LOOP
DELAY PSH B SAVE ACCB
LDA B #8 DELAY COUNTER
STA A PIAAD OUTPUT TO PIA
DEC B DEC LOOP COUNT
BNE LOOP1 LOOP AGAIN
PUL B RESTORE STACK
RTS RETURN
END
    
```

SYMBOL	VALUE	OVER	
AGAIN	50B1	PDATA1	50A0
BACK	50C0	PDATA2	506B
BEGA	A002	PIAAD	5068
CONTRL	EOE3	PUNCH	8010
DELAY	50CA	SEND	500E
ENDA	A004	SENDIT	5072
LOOP1	50CD	SEND2	508E
MCONT	A011	SEND11	5075
MTAPE1	E134	SEN22	5015
MTAPE2	A020	SEN23	5026
NEXBIT	5097	SEN32	5028
NULLS	5008	SKIP	5047
ONE	50B0	START	509E
OUTHL	5080	TEMP	5000
OUTHTR	5084	TM	AOOE
OUT2H	5077	XTEMP	AOOF
OUT2HA	5079	ZERO	AO12
			50BF

TITLE: READ

```

LOC OBJECT CODE SOURCE STATEMENTS
*
*
* RECEIVE ROUTINES
*
* This program demodulates the fsk signal from
* the cassette player by comparing the number
* of samples per 1/2 cycle with a threshold (mean)
* value. The received data is stored directly
* into ram. If a non-hex char is received or
* a checksum error is detected, an 'E' is typed
* on the terminal before returning to mikbug.
* A return to mikbug without the 'E' indicates
* that all data has been successfully transferred.
*
*
8012 PIAAD EQU $8012 PIA ADDRESS
* MIKBUG RAM ADDRESSES:
AO0A CKSM EQU $AO0A
AO0B BYTECT EQU $AO0B
AO0C XHI EQU $AO0C
AO0D XLOW EQU $AO0D
AO12 XTEMP EQU $AO12
AO20 CNTR EQU $AO20
AO21 MEAN EQU $AO21
* MIKBUG ROM ADDRESSES
EOE3 CONTRL EQU $EOE3
E1D1 OUTCH EQU $E1D1
6000 ORG $6000 PROGRAM ORIGIN
6000 CE 0004 LDX #80004 INITIALISE PIA
6003 FF 8012 STX PIAAD
* SET MEAN NO. OF SAMPLES PER 1/2 CYCLE:
6006 8B 0E LDA A #80B
6008 B7 A021 STA A MEAN
* BEGIN SEARCHING FOR DATA:
600B 8D 68 LOAD3 BSR READ1 FETCH A CHAR
600D 81 53 CMP A #'S IS IT AN S ?
600F 26 FA BNE LOAD3 NO;LOOK AGAIN
6011 8D 62 BSR READ1 YES; GET NEXT CHAR
6013 81 39 CMP A #'9 END-OF-FILE ?
6015 27 26 BEQ LOAD21 YES; READING COMPLETE
6017 81 31 CMP A #'1 START OF RECORD ?
6019 26 F0 BNE LOAD3 NO; LOOK AGAIN
6018 7F AO0A CLR CKSM ZERO CHECKSUM
601E 8D 2E BSR BYTE READ 1 BYTE
6020 80 02 SUB A #2
6022 B7 AO0B STA A BYTECT
* BUILD ADDRESS:
6025 8D 19 BSR BADDR
* STORE DATA:
6027 8D 25 LOAD11 BSR BYTE
6029 7A AO0B DEC BYTECT
602C 27 05 BEQ LOAD15
602E A7 00 STA A X STORE DATA
6030 08 INX
6031 20 F4 BRA LOAD11 GET NEXT BYTE
6033 7C AO0A LOAD15 INC CKSM
6036 27 D3 BEQ LOAD3
* ERROR DETECTED:
6038 86 45 LOAD19 LDA A #'E PRINT ERROR MESSAGE
    
```

```

603A BD E1D1 JSR OUTCH
603D 7E EOE3 LOAD21 JMP CONTRL RETURN TO MIKBUG
* BUILD ADDRESS:
BADDR BSR BYTE GET A BYTE
STA A XHI MSBYTE
BSR BYTE GET A BYTE
STA A XLOW LSBYTE
LDX XHI ADDRESS WE BUILT
RTS
* INPUT 1 BYTE (2 FRAMES):
604E 8D 10 BYTE BSR INHEX READ HEX CHAR
6050 48 ASL A
6051 48 ASL A
6052 48 ASL A
6053 48 ASL A
6054 16 TAB
6055 8D 09 BSR INHEX READ HEX CHAR
6057 1B ABA
6058 16 TAB
6059 FB AO0A ADD B CKSM
605C F7 AO0A STA B CKSM
605F 39 RTS
* INPUT HEX CHAR:
6060 8D 13 INHEX BSR READ1
6062 80 30 SUB A #$30
6064 2B D2 BMI LOAD19 NOT HEX; ERROR ?
6066 81 09 CMP A #$09
6068 2F 0A BLE INLHG
606A 81 11 CMP A #$11
606C 2B CA BMI LOAD19 NOT HEX; ERROR ?
606E 81 16 CMP A #$16
6070 2E C6 BGT LOAD19 NOT HEX; ERROR ?
6072 80 07 SUB A #7
6074 39 INLHG RTS
* SAMPLING AND TIMING ROUTINES:
6075 37 READ1 PSH B SAVE ACCB
6076 FF A012 STX XTEMP AND XREG
6079 4F START CLR A
607A 5F CLR B
607B 0D SEC
607C 8D 13 SBIT BSR LOOK LOOK FOR START BIT
607E 25 FC BCS SBIT NOT FOUND; LOOK AGAIN
6080 36 NEXBIT PSH A SAVE ACCS
6081 37 BSR
6082 8D 0D PUL B LOOK
6084 33 PUL B RESTORE ACCS
6085 32 PUL A
6086 49 ROL A GET RECEIVED BIT
6087 5C INC B 8 BITS FOUND ?
6088 C1 08 CMP B #8
608A 26 F4 BNE NEXBIT NO; FETCH NEXT BIT
608C FE A012 LDX XTEMP RESTORE INDEX REG
608F 33 PUL B
6090 39 RTS
* FETCH A BIT:
6091 7F A020 LOOK CLR CNTR SAMPLE COUNT
6094 86 80 LDA A #$80 SELECT INPUT LINE
6096 B1 8012 LOOP1 CMP A PIAAD START OF CYCLE ?
6099 26 FB BNE LOOP1 NO; LOOK AGAIN
609B 7C A020 LOOP2 INC CNTR YES; INC SAMPLE COUNT
609E 01 NOP
609F B1 8012 CMP A PIAAD INPUT STILL HIGH ?
60A2 27 F7 BEQ LOOP2 YES; KEEP LOOPING.
60A4 B6 A020 LDA A CNTR TOTAL SAMPLE COUNT
60A7 B1 A021 CMP A MEAN COMPARE WITH MEAN
    
```

60AA 2D 02		BLT	HF	IF LESS THEN HI FREQUENCY			
60AC OD	LF	SEC		RETURN '1' IN CARRY			
60AD 39		RTS					
60AE OC	HF	CLC		RETURN '0' IN CARRY			
60AF 39		END					
					INLHG	6074 MEAN	AO21
					LF	60AC NEXBIT	6080
					LOAD11	6027 OUTCH	E1D1
					LOAD15	6033 PIAAD	8012
					LOAD19	6038 READ1	6075
					LOAD21	603D SBIT	607C
	SYMBOL	VALUE	CKSM	AOOA	LOAD3	600B START	6079
			CNTR	AO20	LOOK	6091 XHI	AOOC
	BADDR	6040	CONTRL	EOE3	LOOP1	6096 XLOW	AOOD
	BYTE	604E	HF	60AE	LOOP2	609B XTEMP	AO12
	BYTECT	AOOB	INHEX	6060			

NEW EUROPLUS APPLE II

for Business & Education

NOW INCLUDES AUTOSTART/
RESET PROTECT/APPLESOFT IN ROM

16K £830

32K £920

48K £1010

FULL BUSINESS & EDUCATIONAL
SOFTWARE AVAILABLE

MICROSTAR

64K RAM MULTI-USER,
MULTI-TASK BUSINESS COMPUTER
1.2m/2.4m/4.8m/10m characters of disc
storage from **£4,950.**

FULL BUSINESS SOFTWARE
AVAILABLE + INCOMPLETE RECORDS
WE ARE SPECIALISTS IN PACKAGES
AND TAILOR-MADE SOFTWARE FOR
BUSINESS APPLICATIONS
H.P. & LEASING AVAILABLE

MICROSOLVE

Microsolve Computer Services Ltd.

125 - 129 High Street, EDGWARE, Middlesex

Tel: 01-951 0218

nr. M1 exit 4/20 mins from London W.1.

EQUINOX 300

A powerful multi-user
multi-tasking
multi-language

16-bit microcomputer time-sharing system

supporting

- * BASIC
- * LISP
- * PASCAL
- * Floppy discs
- * Hard discs

including a powerful Text Formatter,
Assembly Language Development System
and disc-based Sort utilities.

Priced from under **£5,000**

Write or phone for further information

EQUINOX COMPUTER SYSTEMS LTD

16 Anning Street,

New Inn Yard

London E.C.2.

(Tel: 01-739 2387/8/9)

PHREAKSTEIN



SIRTON PRODUCTS SP

13 WARWICK ROAD, COULSDON, SURREY CR3 2EF Tel: 01-660 5617

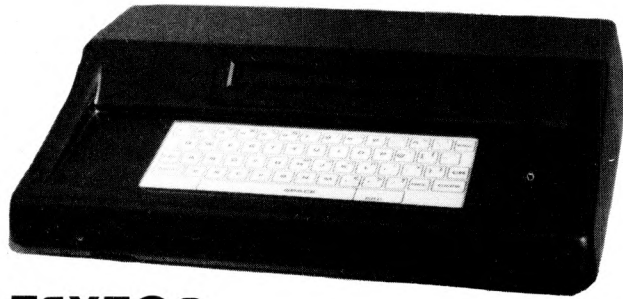

DON'T BORE YOUR COMPUTER WITH DATA PREPARATION!

Let it run programmes that work for you while the TEXTOR is used to edit programmes and data off line.

TEXTOR has 2K of user memory, text editing facilities, and transmits and receives via serial link to your Computer

TEXTOR

MIDAS

MIDAS S.100 SYSTEMS

Substantial Mainframe to house your S100 system, with optional 5" or 8" disc drives. Special systems built to your requirements from Z80 CPU and other S100 boards held in stock

Mainframes from £228

MIDAS 1 : Z80 System from £625 (built)

MIDAS 2 : Z80 Disc System from £1100 (built)

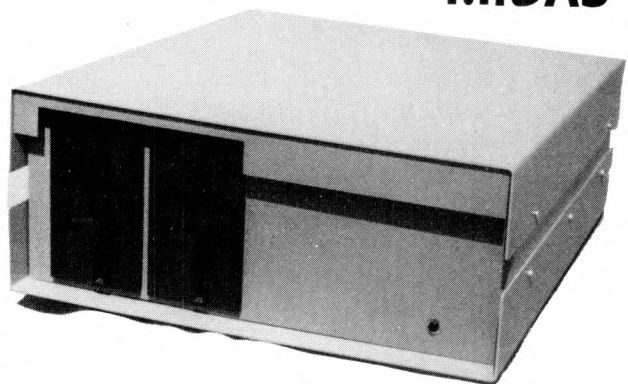

The ITHACA DPS.1

Professional versatile computer system with comprehensive front panel facilities and 20-slot motherboard. Units have substantial power supply etc. and come with 2 or 4 MHz Z80 CPU. BUS conforms to the IEEE S100 standard.

DPS.1 from £695

STOP PRESS!

Siemens 8" Drives @ £325

EPROM Erasers (240V) @ £38.00

Suppliers for:
JADE INC.
CROMEMCO
S D SYSTEMS
ITHACA AUDIO
ETC & SSM
GODBOUT
& others

Comprehensive Range of S100 Boards Stocked

Bare Boards — Kits — Built & Tested

VIDEO RAM
 ROM
DISCS CPU
PARALLEL/SERIAL I/O

WRITE OR PHONE FOR CATALOGUE

SOFTWARE

BASIC
CP/M DOS
Z80 ASSEMBLER
MONITOR
BIOS

STATPACK

Colin Chatfield

LIST STAT 9 PART OF STATPACK WRITTEN BY COLIN CHATFIELD
MICRO-AID, LLOYDS BANK CHAMBERS, CAMBORNE, CORNWALL.

```

0005 REM STAT9 - RELATIONAL STATISTICS
0020 Z9=1: REM OUTPUT PORT #
0080 LINE= 132: DIGITS=0: GOSUB9380
0100 ? TAB(22);"RELATIONAL STATISTICS"
1000 GOSUB 9600
1010 ? "YOUR ARRAY IS ";A;"X ";B;"?CHR$(8);"?". ";A*B;"ITEMS."
1110 INPUT " CARRIAGE RETURN WHEN READY",A$
1120 GOSUB 6000
1200 GOSUB 9360
1210 IF LEFT$(A$,1)="N"THEN1240
1220 IF LEFT$(A$,1)<>"Y"THEN1200
1230 INPUT " IF RELATIONAL STATISTICS ENTER 'Y' ",A$
1232 IF A$="Y"THEN1120
1234 CHAIN STAT1
1240 GOSUB 9300: ?TAB(20);"STATPACK END": END
6000 REM RELATIONAL STATISTICS
6010 GOSUB 9380
6020 ? " ENTER COLUMN #'S TO BE CONSIDERED - MAJOR ONES FIRST,";
6030 INPUT " FOLLOWED BY OTHERS UP TO THREE IN ALL ",C1,C2,C3
6100 INPUT " ENTER LOWEST & HIGHEST VALUES FOR 1ST COL # ",L1,L4
6110 INPUT " ENTER LOWEST & HIGHEST VALUES FOR 2ND COL # ",L2,L5
6120 INPUT " ENTER LOWEST & HIGHEST VALUES FOR 3RD COL # ",L3,L6
6130 GOSUB 9300
6140 ? #(Z9),"COL #","VALUE","OCCURENCES","Z":#(Z9)
6150 FOR V1=L1TOL4: FORV2=L2TOL5: FORV3=L3TOL6
6200 FOR I=1TOA: IFC(I,C1)=V1THEN T1=T1+1: GOTO6220
6210 GOTO 6260
6220 IF C(I,C2)=V2THEN T2=T2+1:GOTO6250
6230 GOTO 6260
6240 IF C3=0 THEN6260
6250 IF C(I,C3)=V3THEN T3=T3+1
6260 NEXT I: IFA8=1 THEN6340
6300 ? #(Z9),C1,V1,T1,T1/A*100
6310 IF T2=0 THEN#(Z9),"COL # ";C2;" , VALUE # ";V2;" = ZERO":A7=1:GOTO6360
6320 ? #(Z9),C2,V2,T2,T2/T1*100
6330 IF C3=0 THEN6340
6340 ? #(Z9),C3,V3,T3,T3/A*100
6360 T1=0:T2=0:T3=0:IFA7=1 THENGOSUB9310:GOTO6380
6370 A8=1:NEXTV3:GOSUB9310:A8=0
6380 A7=0:NEXTV2:GOSUB9310:NEXTV1
6390 GOSUB 9310: GOSUB9300: RETURN
9000 REM SUB PROGRAMS
9300 FOR K=1TO5:#(Z9):NEXTK:RETURN
9310 FOR K=1TO5:#(Z9),"-":NEXTK:#(Z9):RETURN
9360 INPUT " ENTER 'Y' FOR MORE, 'N' FOR NONE ",A$: RETURN
9380 ? CHR$(25);?CHR$(25);?CHR$(22);?CHR$(12):RETURN
9400 B2=0:IFB=1THENB2=1:GOTO9430
9600 OPEN #10, STATF1 FOR INPUT: FIELD #10,F=6
9610 OPEN #20, STATF2 FOR INPUT: FIELD #20,A=6,B=6
9640 SET #10=1:SET#20=1:GET#20
9650 DIM C(A,B),B3(A)
9660 FOR I=1TOA:FORJ=1TOB:GET#10:C(I,J)=F:NEXTJ:NEXTI
9683 INPUT " ENTER 'Y' FOR VISUAL OF DATA",A$:IFA#<>"Y"THEN9690
9685 ? :FORI=1TOA:FORJ=1TOB:#C(I,J):NEXTJ:#:NEXTI:#
9690 CLOSE #10:CLOSE#20:RETURN

```

THE GHOST
#

RELATIONAL STATISTICS
ENTER 'Y' FOR VISUAL OF DATA Y

```

3 2 0 0 2 3 1 1 50 5 0 0 0 1 0 0 0 0 0
3 1 0 0 2 4 1 1 100 2 0 2 0 0 0 0 0 0 1 0
3 1 0 1 0 1 1 1 100 3 3 2 0 1 0 1 0 1 1
3 1 0 1 0 2 1 1 2 1 0 2 0 0 0 1 0 1 0
3 1 0 0 2 3 1 3 2 1 0 0 0 0 1 1 0 0 0
3 1 1 0 0 2 1 1 50 2 0 0 0 0 1 1 0 1 0

```

YOUR ARRAY IS 6 X 19. 114 ITEMS.
CARRIAGE RETURN WHEN READY?
ENTER COLUMN #'S TO BE CONSIDERED - MAJOR ONES FIRST,
FOLLOWED BY OTHERS UP TO THREE IN ALL ? 2,6,10
ENTER LOWEST & HIGHEST VALUES FOR 1ST COL # ? 1,2
ENTER LOWEST & HIGHEST VALUES FOR 2ND COL # ? 1,4
ENTER LOWEST & HIGHEST VALUES FOR 3RD COL # ? 0,5

COL #	VALUE	OCCURENCES	Z
2	1	5	83.3333333
6	1	1	20
10	0	0	0
10	1	0	0
10	2	0	0
10	3	1	16.6666666
10	4	0	0
10	5	0	0

2	1	5	83.3333333
6	2	2	40
10	0	0	0
10	1	1	16.6666666
10	2	1	16.6666666
10	3	0	0
10	4	0	0
10	5	0	0

2	1	5	83.3333333
6	3	1	20
10	0	0	0
10	1	1	16.6666666
10	2	0	0
10	3	0	0
10	4	0	0
10	5	0	0

2	1	5	83.3333333
6	4	1	20
10	0	0	0
10	1	0	0
10	2	1	16.6666666
10	3	0	0
10	4	0	0
10	5	0	0

2	2	1	16.6666666
COL # 6 , VALUE # 1 = ZERO			

2	2	1	16.6666666
COL # 6 , VALUE # 2 = ZERO			

2	2	1	16.6666666
6	3	1	100
10	0	0	0
10	1	0	0
10	2	0	0
10	3	0	0
10	4	0	0
10	5	1	16.6666666

2	2	1	16.6666666
COL # 6 , VALUE # 4 = ZERO			

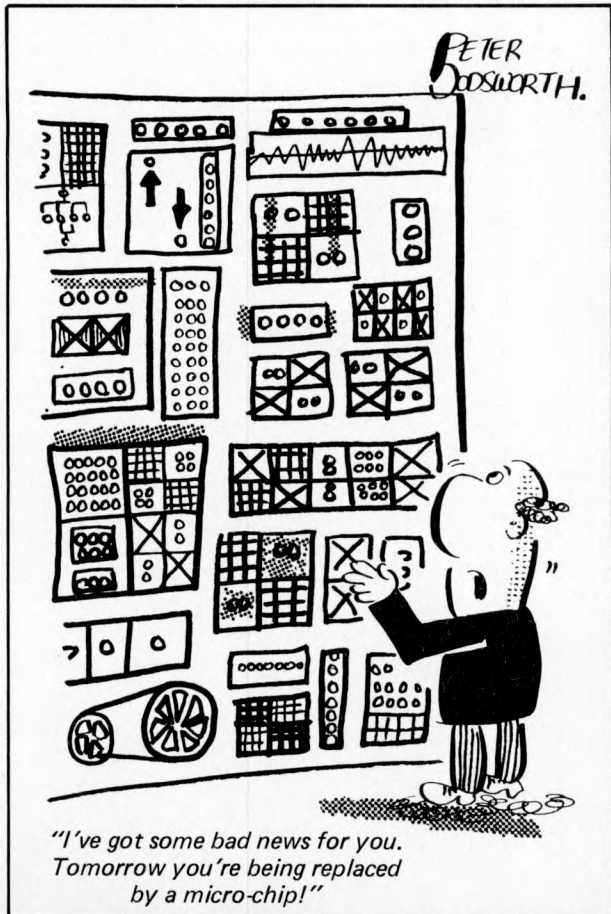

All Systems Are Not Created Equal

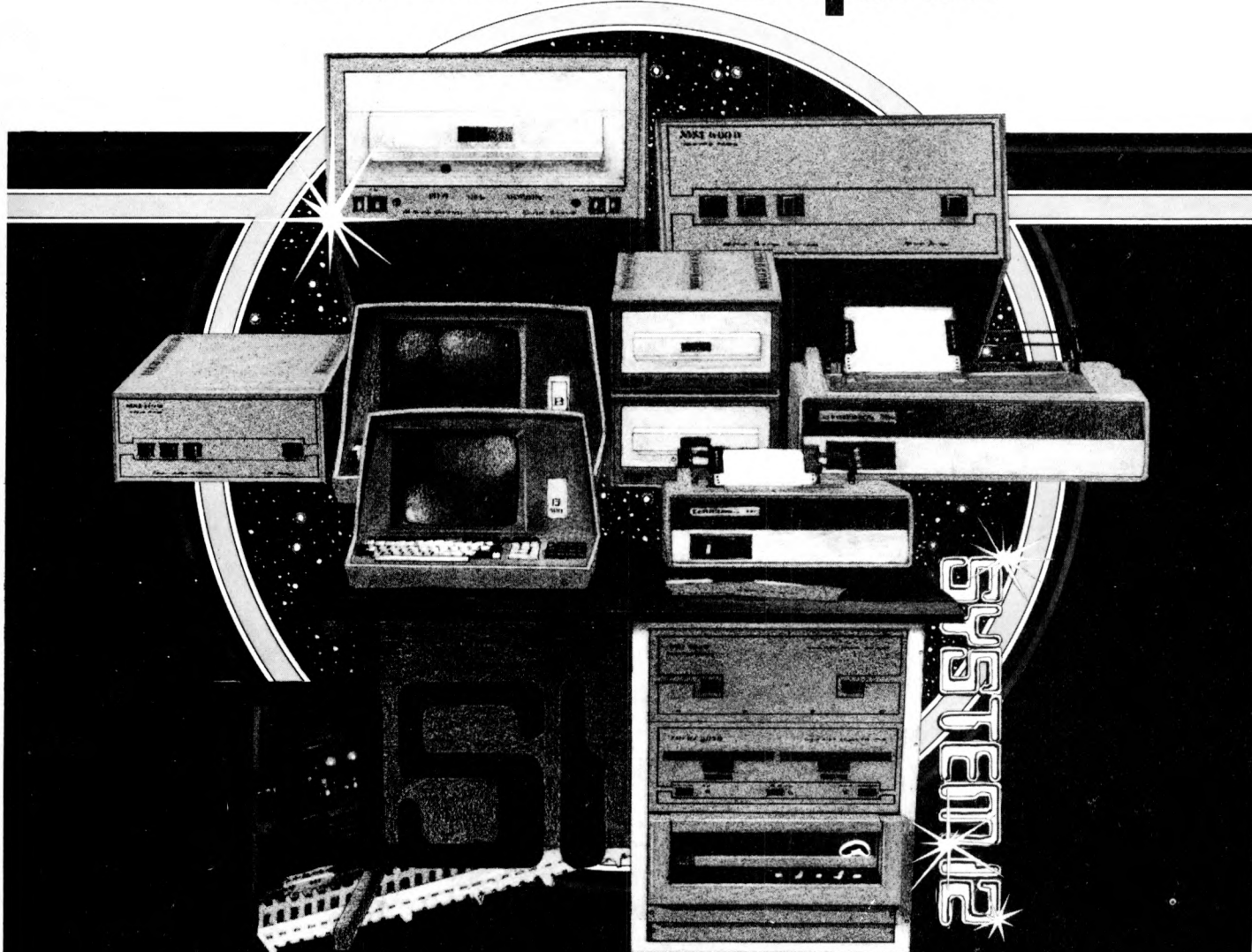

Your computer application is unique. It differs from all others. It is because not all applications are equal that MSI has developed a variety of computer systems.

At the heart of every MSI System is the powerful MSI 6800 Computer, one of the fastest and most versatile available. Depending on the System you select, the MSI 6800 has from 16K to 56K of RAM. Mass memory storage in MSI Systems range from 315K bytes in the System 1 to over 10 megabytes in our most powerful System 12.

In addition to the computer and memory subsystem, MSI Systems include a CRT terminal and high speed character printer. The System 12 is housed in a compact desk unit.

As with hardware, computer software is not always created equal. Since there are a myriad of programs available, MSI offers a choice of Operating Systems for use with your MSI Computer System. Of course, our favourite is MSIDOS, but we offer the powerful SDOS operating system as well. All MSI Systems will support the other software products associated with each operating system.

MSI also has a variety of software programs including a Multi-User Basic program capable of supporting up to four users.

MSI Systems are currently being used in a broad spectrum of personal, scientific, educational, professional, and business situations. In addition to our Systems, we

can supply you with individual components for personal and OEM use. All MSI System components are available, some in kit form.

Write or call us for more information about MSI Systems and products and the name of your nearest MSI dealer.

seed

Strumech Engineering
Electronic Developments
Portland House,
Coppice Side, Brownhills,
BRO 4321 Telex: 335243

SCALE

A GENERAL PURPOSE GRAPH SCALING AND PLOTTING PROGRAM

Gillian Richmond

L VI, Norwich High School for Girls.

At our school we have found a need for a general purpose program which will accept, as input, any two quantities (variables) to be plotted whose maximum values are requested, followed by the co-ordinates of the points to be plotted on the graph. Typically, these points might have come from a science experiment e.g. the relationship between length and time period for a pendulum, where the data is available as pairs of co-ordinates. We have used this program to see whether data generated in an experiment is following an expected trend, before committing the points formally to paper. This program can easily be incorporated as a subroutine within larger programs, and we hope that it will prove useful in other schools.

The main problem in plotting the points manually is in deciding a suitable scale for the graph along both axes. The program does this automatically by deciding that there shall be between 5 and 10 lines or columns (depending on which axis) between tick marks, and then labelling the axes accordingly.

The program was originally written for the Research Machines 380Z using PLOT commands to display to a VDU; but it has been changed to give an output on a printer, and it uses commands which should be standard in all versions of BASIC. It was written for a 40 column printer but it can easily be modified for wider carriages, if required. (e.g. lines 530, 540, 700, 710, 770). So as not to elongate the resulting graph it was decided that no more than 50 lines of printer output should be used. This can also easily be modified (e.g. lines 290, 300, 460, 900) to match alterations of the number of columns used for a wider carriage.

Program Details

Input

Line numbers 150-190 request initial information, i.e. units to be plotted on each axis, maximum values on

each axis and the number of co-ordinates to be plotted. In line 200 an array is dimensioned to store the co-ordinates which must be entered in ascending order for the X co-ordinate. This is the co-ordinate which will correspond to lines rather than columns on the printer output. Data input can be in decimal or standard form within the limits 10^{-10} to 10^{+10} (as explained in the scaling details).

Scaling

The axes are scaled separately, horizontally (X) axis first (lines 260-490) and the vertical (Y) axis (lines 500-740). The methods used are in principle the same for both axes.

In line 280, H represents the maximum value to be plotted, lines 280-290 check whether H is between 1 and 50. If H is not between these limits, the subroutine between lines 430-470 is entered, where H is multiplied by powers of 10 between 10^{-10} and 10^{+10} (C in line 430). The value

of C which makes H come between 1 and 50 is noted. This is the first of our scaling factors.

On return from line 460, line 300 is entered where a certain number of lines are apportioned to each integer value on the axis. Lines 310-320 check whether the number of lines of printer output to each integer value, i.e. to each tick mark, is between 5 and 10, meeting the previous requirement of 5-10 lines to each tick mark.

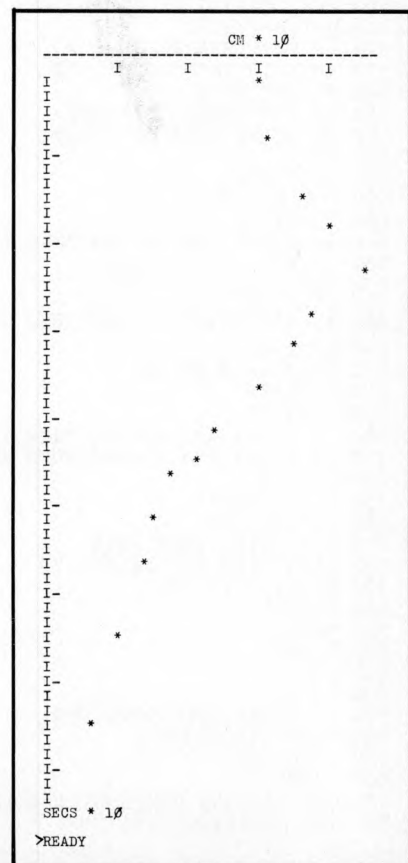

N.B. It is because of this limitation chosen on the values of C that the program can only accept data whose values lie between 10^{-10} and 10^{+10} , but for most applications this is perfectly adequate. If wider limits are required lines 430 and 670 should be changed.

This gives between 10 and 5 tick marks on 50 lines of printer output. If this condition is not met further scaling is done between lines 350-420, until it is met. All scaling factors are combined in line 480.

The vertical (Y) axis is then treated in a similar way in lines 500-740.

Output

Final output starts at line 750 and

continues to the end of the program. Plotting of data points is done conventionally using TAB statements in the subroutine lines 990-1040; but, obviously, this results in small rounding errors.

```

100 REM SCALE - GILLIAN RICHMOND
110 PRINT TAB(17)"SCALE"
120 PRINT TAB(17)"====="
130 PRINT:PRINT
140 CLEAR 100
150 INPUT "UNITS ON HORIZONTAL AXIS";H;
160 INPUT "UNITS ON VERTICAL AXIS";V;
170 INPUT "MAX VALUE ON HORIZONTAL AXIS"
;H
180 INPUT "MAX VALUE ON VERTICAL AXIS";V;
190 INPUT "HOW MANY CO-ORDINATES";N
200 DIM A(N,1)
210 PRINT "CO-ORDS IN ASCENDING ORDER OF
X PLEASE"
220 FOR I=1 TO N
230 INPUT A(I,0),A(I,1)
240 NEXT I
250 PRINT:PRINT
260 REM SCALING HORIZONTAL AXIS
270 A=1:B=1:C1=1
280 IF H<1 THEN GOSUB 430
290 IF H>50 THEN GOSUB 430
300 H1=INT(50/H)
310 IF H1<5 THEN GOTO 350
320 IF H1>10 THEN GOTO 390
330 H2=H1
340 GOTO 480
350 FOR A=1 TO 6
360 H2=H1*A
370 IF H2>=5 AND H2<=10 THEN GOTO 480
380 NEXT A
390 FOR B=1 TO 10
400 H2=H1/B
410 IF H2>=5 AND H2<=10 THEN GOTO 480
420 NEXT B
430 FOR C=-10 TO 10
440 C1=10↑C
450 C2=H*C1
460 IF C2>=1 AND C2<=50 THEN H=C2:RETURN
470 NEXT C
480 H3=A/B/C1
490 H2=INT(H2)
500 REM SCALING VERTICAL AXIS
510 D=1:E=1:F1=1
520 IF V<1 THEN GOSUB 670
530 IF V>40 THEN GOSUB 670
540 V1=INT(40/V)
550 IF V1<5 THEN GOTO 590
560 IF V1>10 THEN GOTO 630
570 V2=V1
580 GOTO 730
590 FOR D=1 TO 6
600 V2=V1*D
610 IF V2>=5 AND V2<=10 THEN GOTO 730
620 NEXT D
630 FOR E=2 TO 10 STEP 2
640 V2=V1/E
650 IF V2>=5 AND V2<=10 THEN GOTO 730
660 NEXT E
670 FOR F=-10 TO 10
680 F1=10↑F
690 F2=V*F1
700 IF F2>=1 AND F2<=40 THEN V=F2
710 IF F2>=1 AND F2<=40 THEN RETURN
720 NEXT F
730 V3=D/E/F1
740 V2=INT(V2)
750 REM LABEL VERT AXIS
760 PRINT TAB(20) V$;"*";V3
770 FOR I=1 TO 38
780 PRINT "-";
790 NEXT I
800 PRINT
810 U=0
820 U=U+V2
830 IF U>=40 THEN GOTO 860
840 PRINT TAB(U)"I";
850 GOTO 820
860 PRINT
870 REM MARKING HORIZONTAL AXIS AND
880 REM PLOTTING DATA

```

```

890 J=1
900 FOR I=1 TO 50
910 PRINT "I";
920 IF I/H2=INT(I/H2) THEN PRINT "-";
930 IF J>N THEN GOTO 950
940 IF INT(A(J,0)*H2/H3)=I THEN GOSUB 990
950 PRINT
960 NEXT I
970 PRINT H$;"*";H3
980 END
990 REM SUBROUTINE TO PLOT DATA
1000 T=A(J,1)*V2/V3
1010 IF T>=40 THEN GOTO 1040
1020 PRINT TAB(T)"*";
1030 J=J+1
1040 RETURN

```

RUN

SCALE
=====

```

UNITS ON HORIZONTAL AXIS? SECS
UNITS ON VERTICAL AXIS? CM
MAX VALUE ON HORIZONTAL AXIS? 80
MAX VALUE ON VERTICAL AXIS? 50
HOW MANY CO-ORDINATES? 15
CO-ORDS IN ASCENDING ORDER OF X PLEASE
? 3,30
? 8,33
? 15,37
? 19,40
? 24,46
? 28,40
? 33,35
? 37,30
? 42,26
? 44,22
? 48,18
? 53,16
? 57,14
? 65,11
? 75,8

```

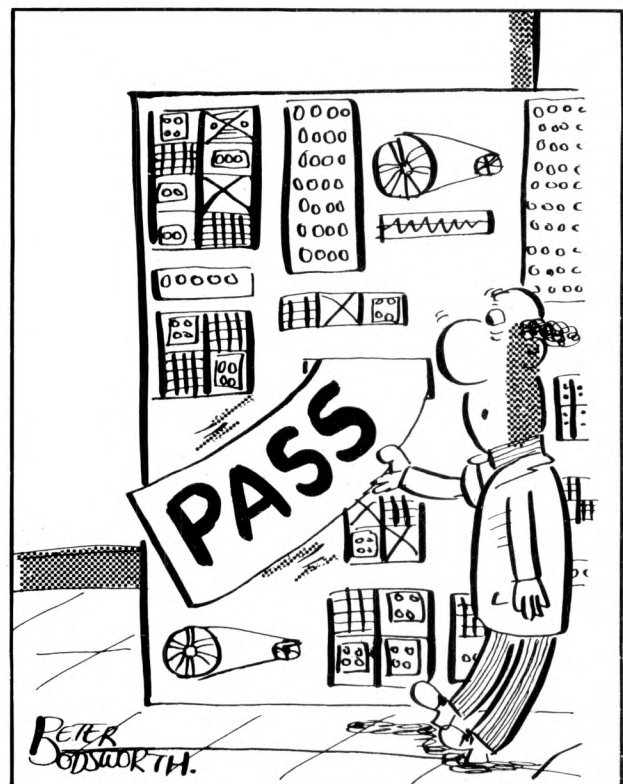

HEAVY DUTY PRINTER

FOR

PET · SWTP · HORIZON · APPLE
SORCERER · CROMEMCO · ETC

ANADEX D.P. 8000

80 COL.
FAST 112 CPS
BIDIRECTIONAL-
PRINTING.
VERY GOOD PRINT
QUALITY UPPER/LOWER CASE. £ SIGN.



COMPLETE WITH PLUGS, CABLES & 500
SHEETS OF PAPER

READY TO GO **£575 + VAT**
FOR PETS, ALL ABOVE + INTERFACE
DELIVERY
EX. STOCK

Also available:

COMPLETE BUSINESS SYSTEMS **£2700**
DIABLO HYTERM 1620 **£2000**

Write or phone for further details or demonstration

LONDON COMPUTER STORE

43 GRAFTON WAY

Off Tottenham Crt. Rd., London W.1.

01-388 5721 OPEN 11-7 Mon-Fri 11-4 Sats.

MORE NEW BOOKS FROM LP ENTERPRISES

Buyers Guide to Microsoftware	£ 2.40
32 BASIC Programs for the PET	£10.10
Program Techniques: Simulation	£ 4.25
Ciarcias Circuit Cellar	£ 5.50
Microcomputer Potpourri	£ 1.75
8080/8085 Software Design	£ 6.75
Introduction to TRS-80 Graphics	£ 5.75
Computer Music	£ 6.75
Take My Computer Please . . . (light hearted fiction)	£ 3.25

Send S.A.E. for details of our complete range of books,
magazines, subscriptions and software.

How to order: Send cash (sterling on a U.K. Bank) or
Credit card no. with order to L.P. Enterprises, Room
PW/NB, 313 Kingston Road, Ilford, Essex IG1 1PJ.
Telephone orders or enquiries welcome 01-553 1001

ENTERPRISES

North Star ★ COMPATIBLE SOFTWARE

ALLEN ASHLEY ENTERPRISES

PDS Program Development System for 8080 or Z80 computers. PDS is an exceptionally powerful assembly development package. It includes an unified assembler/editor, a macro assembler with a relocating linking loader, a string oriented text editor and trace debugger/disassembler. PDS supports full Z80 code favouring Intel type mnemonics **£ 65.00**

The following is a list of source modules compatible with PDS:-

MODULE	FUNCTION	REQUIREMENTS	
ALPHSORT	High speed alphabetic sort	None	£ 10.00
NUMRSORT	High speed numeric sort	None	£ 10.00
FPPACK	BCD floating point arithmetic	None	£ 10.00
FOURIER	Fast Fourier transform	FPPACK	£ 10.00
MINV	Matrix inversion	FPPACK	£ 10.00
MATPED	Matrix product	FPPACK	£ 7.50
RATPOL	Rational function and utilities	FPPACK	£ 7.50
SORT	Square root	FPPACK	£ 5.00
TRIGS	Sine, cosine, TAN, ATAN	FPPACK, RATPOL	£ 10.00
LOGEXP	Exponential, logarithm, y ^x	FPPACK, RATPOL	£ 10.00
FPIOP	Floating point I/O	None	£ 10.00
FORMAT	Formatted floating point output	None	£ 7.50
INFILES	North Star disk handler	None	£ 10.00
INOPS	Integer multiply/divide	None	£ 5.00
The complete set of modules (listed above)			£ 59.00

EZ-80 — A tutorial on the PDS Z80 instruction set. Assembly language commands are interpreted individually and the resulting effect on register contents and flag status is displayed. **£ 15.00**

REGENT — Disk disassembler, generates source file compatible with EDIT and the MACRO Assembler in PDS. **£ 15.00**

HDS — Hybrid Development System. Permits easier interfacing between assembly code routines and North Star BASIC **£ 30.00**

CDS — Compiler Development System. The CDS BASIC compiler enables portions of North Star BASIC programs to be compiled into assembly language to achieve increased speed and to protect proprietary sections of code. Includes COMPILER (which translates a subset of BASIC into machine code), IBASIC (an integer BASIC interpreter), and a set of interface routines which couple the assembly language program to North Star BASIC. Requires PDS and HDS. **£ 65.00**

BYTE SHOP OF WESTMINSTER

NORTHSHARE North Star BASIC Time Sharing package. Supports 2 — 4 users sharing the same copy of North Star BASIC. **£ 32.00**

DIGITAL RESEARCH

CP/M — General purpose Disk Operating System. **£ 90.00**

MAC — Macro Assembler. Powerful macro assembler for operation under the CP/M Operating System. **£ 75.00**

SID — Symbolic Instruction Debugger. **£ 70.00**

TEX — TEXT formatter. Enhanced version of CP/M editor, ED. **£ 70.00**

DESPOOL — Spooler for CP/M. Permits simultaneous printing of data from disk while user executes another program from the console. **£ 35.00**

INFORMATION UNLIMITED

WHATISIT — Interactive data-base management system using associative tags to retrieve information by subject. Hashing and random access is used for fast response. Also available at same price, a modified version (by Interam) which supports cursor addressing and printer output. **£ 45.00**

MICRO MIKES

4/5 SHARE — General purpose interrupt driven, bank switching timesharing system for the North Star Horizon computer. **£ 37.00**

CSUB — Common SUBroutines for North Star BASIC to facilitate easy, rapid creation of application software and data bases. Includes cursor addressing routines for Interam: Inter-tube II VDU and numerous useful routines, making BASIC a much more structured language. **£ 30.00**

MICROSOFT

Disk Extended BASIC — New version, ANSI compatible with long variable names, WHILE/WEND, chaining, variable length file records etc. **£175.00**

FORTTRAN-80 — ANSI '66 (except for COMPLEX) plus many extensions. Includes relocatable object code compiler, linking loader, library with manager. Also includes Z80 assembler and cross reference utilities. **£245.00**

COBOL-80 — ANSI '74 Pseudo-compiler with relocatable object runtime package. Format same as FORTRAN-80. Complete ISAM, interactive ACCEPT/DISPLAY, COPY, EXTEND etc. **£345.00**

MICROPRO

WORDMASTER — Has super-set of CP/M's ED commands including global searching and replacing, forward and backwards in file. Provides full screen editor for users with serial addressable-cursor terminal. **£ 99.00**

MICRO WORLD

MASP — Micro Automatic Spooling Program. MASP is a transparent foreground/background system for the North Star Disk system. It allows the user to run BASIC programs at the same time that he is printing files that were previously SPOOLED. **£ 45.00**

NORTH STAR

UCSD PASCAL development system includes an editor, compiler, debugger and file handler. Requires 48K RAM. **£ 37.00**

PAS-AUX Auxiliary package for above, includes an assembler and utilities **£ 25.00**

NSSE/NSUG . . . HUNDREDS OF PROGRAMS FROM MONOPOLY TO PILOT

NSSE — North Star Software Exchange disks (currently 13 disks in library). Each disk costs £4. Set of thirteen **£ 45.00**

NSUG — North Star User's Group disks (currently 45 disks in library). Each disk costs £4. Set of fourty-five **£150.00**

NSUG/NSSE Directory listings (directory listings of all NSSE and NSUG disks, currently 58 disks). **£ 1.00**

ORGANIC SOFTWARE

TEXTWRITER II — Word Processor/Text Formatter for North Star CP/M users. Supports on-line input from disc data files and when combined with a powerful editor, such as WORDMASTER, it's performance rivals any other word processing system on the market. **£ 59.00**

SOFTWARE WORKS

INVENTORY-2 — Sophisticated inventory package with order entry, requires minimum 32K RAM and two disc drives. **£ 75.00**

SOFTWARE SYSTEMS

CBASIC-2 Disk Extended BASIC — Non interactive BASIC with pseudo code compiler and runtime interpreter. Supports full file control, chaining, integer and extended precision variables etc. **£ 65.00**

SURF COMPUTER SERVICES

MARYELIN — Text/Word Processing system that runs under North Star DOS. Contains the best features of the North Star BASIC editor, string handling features of large computer editors, and word processing capability. **£ 30.00**

The above software is supplied on North Star compatible minifloppy disks. Please be sure to specify the density mode you require (releases 1 - 4: single density, release 5: dual density). Prices are correct at time of going to press, and are exclusive of VAT @ 15% and postage & packing (add 75p). Please send S.A.E. for full details.

Available soon: Applications software, including General Ledger for incomplete records, Accounts Receivable and Payable, Payroll, Hotel packages and more. Software products are being continually added to our range, so please enquire about software products not listed above.

INTERAM COMPUTER SYSTEMS LTD.

59 Moreton Street, Victoria, London SW1
Telephone: 01-834 0261/2733 Telex: 925859

INTERAM

SORCERER™

Now becomes a professional word processor...as well!



The Sorcerer Computer is a completely assembled and tested computer system ready to plug in and use. The standard configuration includes 63 key typewriter-style keyboard and 16 key numeric pad, dual cassette 1/0, with remote computer control at 300 and 1200 baud data rates, RS232 serial 1/0 for communication, parallel port for direct Centronics printer attachment, Z80 processor, 4K ROM operating system, 8K Microsoft BASIC in separate plug-in Rom Pac™ cartridge, composite video of 64 chars 30 lines, 128 upper/lower case ASCII character set and a 128 user-defined graphic symbols, up to 32K on-board RAM memory, operators manual,

BASIC programming manual and cassette/video cables, connection for S100 bus expansion unit.

The Word Processor Pac creates, edits, re-arranges and formats text. Features include auto wraparound, dynamic cursor control, variable line length, global search and replace, holding buffer for re-arrangement of text, right justification, line width and line to line spacing, underlining or boldfacing, text merging and a macro-facility permitting tasks such as form letter typing, multiple column printing or automatic forms entry.

NOW CONTACT YOUR LOCAL DEALER →

OR SEND COUPON FOR FURTHER INFORMATION

PRICES	£
8K Sorcerer	650.00
16K Sorcerer	760.00
32K Sorcerer	859.00
630K Dual Disc Drive	1,200.00
143K Single Disc Drive	500.00
S100 Expansion Unit	210.00
Line Printer	850.00
Video Display	240.00
Development Pack	70.00
Word Processing Pack	70.00
Technical Manual	8.95
Daisywheel type printer	1,900.00
Word processing pack	80.00
Video/disc unit	1,800.00
16K Memory expansion	110.00

- LANCASHIRE**
051-2272535 MICRODIGITAL 25 Brunswick St., Liverpool L2 8J
- WEST YORKSHIRE**
0535 65094 BASIC COMPUTING Oakville, Oakworth Rd., Keighly
- SHEFFIELD**
0742-668767 E.S. MICROCOMPUTERS 7 Berkley Precint, Ecclesall Rd., S11 8PN
- NORTH WALES**
0248-52042 TRYFAN A/V SERVICES 3 Swifts Bldgs., High St., Bangor, Gwynedd
- AVON**
0272-292375 ELECTROPRINT 5 Kingsdown Parade, Bristol BS6 5UD
- NORTH HANTS**
0536-83922 H.B. COMPUTERS LTD. 22 Newland St., Kettering
- LONDON & Counties**
- BERKSHIRE**
0635-30505 NEWBEAR COMPUTING STORE 40 Bartholomew St., Newbury RG14 5LL
- KENT**
01-300 0380 INFORMEX 61 Harland Avenue, Sidcup, DA15 7NY
- SURREY**
0276-62506 T. & V.J. MICROCOMPUTERS 165 London Rd., Camberley

ff Wilkinson, **FACTOR ONE Computers Ltd.** 11-17 Market Place, Penzance.
 Please send me details of the SORCERER COMPUTER
 Tel: (0736) 66336 or 66565
 Name _____
 Address _____
 No. _____

WHAT SORT OF SORT?

Dr. William B. Samson

*Department of Mathematics and Computer Studies,
Dundee College of Technology*

Microcomputers being used for Business applications present special problems which are not so apparent when large scale computers are used:

1. They are slow.
2. The main memory (RAM) is small.

This means that it is important to try to strike the right balance between program size and speed when designing a business system.

Most business systems require sorting at some stage and in many cases this will prove to be the most time consuming part of the process. The aim of this article is to compare some of the commoner internal sorting algorithms. It should be noted that these algorithms are *not* suitable for sorting files which are *larger than the available* RAM. The sorting of large files will be the subject of a future article.

The sorting algorithms below are written in BASIC. They use only statements which are common to all the full BASIC interpreters with which the author is familiar. They will not necessarily be suitable for integer BASICs.

For a full, theoretical account of sorting, the reader should refer to Knuth's 'The Art of Computer Programming', Volume 3.

The algorithms below were developed on an SWTPC 6800 with 16K bytes of RAM. They can be made more efficient for particular machines by using non-standard features such as multiple statement lines, machine code subroutines and so on.

Four algorithms are described below:

- (a) The Bubble Sort
- (b) The Straight Selection Sort
- (c) The Straight Insertion Sort
- (d) The Quicksort

Each algorithm is designed to sort an array of N numbers and includes a routine for inputting the numbers and one for printing them out, so that you can test them for speed and accuracy on your own machine.

It is not a difficult matter to rewrite these algorithms as subroutines. The reader should ensure, however, that his array of numbers is called A and that it is dimensioned appropriately. This is of particular importance for the Quicksort, as we shall see below. In addition, if these numbers are keys of records and the associated records are to be sorted too, then the records must be held in a separate array (or arrays) with the same dimension as A . Every time the elements of array A are moved, the corresponding elements of the record array(s) must be moved in the same way.

The Bubble Sort

Neighbouring elements of A are compared and switched if they are in the wrong order. A number of passes is made in this way until the elements are arranged in ascending order.

```

0010 DIM A(255)
0020 PRINT "HOW MANY NUMBERS";
0030 INPUT N
0050 PRINT "ENTER THE NUMBERS"
0060 FOR I=1 TO N
0070 INPUT A(I)
0080 NEXT I
0090 LET B=N
0100 LET T=0
0110 FOR J=1 TO B-1
0120 IF A(J)<=A(J+1) THEN 170
0130 D=A(J)
0140 A(J)=A(J+1)
0150 A(J+1)=D
0160 T=J
0170 NEXT J
0180 IF T=0 THEN 210
0190 B=T
0200 GOTO 100
0210 FOR I=1 TO N
0220 PRINT A(I)
0230 NEXT I
0240 END

```

Fig. 1. Bubble Sort

The Straight Selection Sort

The array, A , is searched for its highest element and this is switched with the last element of the array. The next stage switches the second highest element and the second last array

element and so on.

```

0010 DIM A(255)
0020 PRINT "HOW MANY NUMBERS";
0030 INPUT N
0050 PRINT "ENTER THE NUMBERS"
0055 FOR I=1 TO N
0060 INPUT A(I)
0065 NEXT I
0070 FOR J=N TO 2 STEP -1
0075 B=A(J)
0076 X=J
0080 FOR R=J TO 1 STEP -1
0090 IF A(R)<=B THEN 110
0100 X=R
0105 B=A(R)
0110 NEXT R
0120 D=A(J)
0130 A(J)=A(X)
0140 A(X)=D
0150 NEXT J
0160 FOR I=1 TO N
0170 PRINT A(I)
0180 NEXT I
0190 END
    
```

Fig. 2. Straight Selection Sort

The Straight Insertion Sort

The elements of the array are considered in turn (starting with the last one) and each is placed in its correct position relative to the elements which have already been considered. The other elements of the array are shuffled around to make room for the one being dealt with.

```

0010 DIM A(255)
0020 PRINT "HOW MANY NUMBERS";
0030 INPUT N
0050 PRINT "ENTER THE NUMBERS"
0055 FOR I=1 TO N
0060 INPUT A(I)
0065 NEXT I
0080 FOR J=2 TO N
0090 I=J-1
0100 A=A(J)
0110 IF A>=A(I) THEN 140
0115 A(I+1)=A(I)
0120 I=I-1
0130 IF I>0 THEN 110
0140 A(I+1)=A
0150 NEXT J
0160 FOR I=1 TO N
0170 PRINT A(I)
0180 NEXT I
0190 END
    
```

Fig. 3. Straight Insertion Sort

The Quicksort

This is by far the fastest sort when large number of random elements are to be sorted. The first element is considered and by a series of comparisons and switches, it ends up in its final position. All values to the left are less than or equal, and all values to the right are greater than or equal to the element under consideration. The array is therefore partitioned into two parts, the left and the right. The process is repeated for one of these parts and the subscripts of the first and last elements of the other part are stored away in a stack (S) for future consideration. When the number of elements to be sorted becomes less than a certain value (M)

then straight insertion sorting is used because it is faster for small numbers of elements. The value of M can vary from machine to machine, depending

```

0010 DIM A(202),S(10)
0020 REM S IS STACK
0030 REM INITIALISE STACK,
      P IS POINTER
0040 FOR I=1 TO 10
0050 S(I)=0
0060 NEXT I
0070 P=1
0075 M=10
0077 A(1)=-1E99
0080 PRINT "HOW MANY NUMBERS";
0090 INPUT N
0100 PRINT "ENTER THE NUMBERS"
0110 FOR I=1 TO N
0120 INPUT A(I+1)
0130 NEXT I
0135 A(N+2)=1E99
0140 REM SET UPPER AND LOWER
      BOUNDS
0150 L=2
0160 R=N+1
0170 REM M IS THE LIMIT FOR
      STRAIGHT INSERTION
0175 REM STEP Q2
0180 IF R-L<M THEN 590
0190 I=L
0200 J=R
0210 K=A(L)
0220 REM STEP Q3
0230 IF K>=A(J) THEN 260
0240 J=J-1
0250 GOTO 230
0260 REM Q4
0270 IF J>I THEN 300
0280 A(I)=K
0290 GOTO 450
0300 A(I)=A(J)
0310 I=I+1
0320 REM Q5
0330 IF A(I)>=K THEN 360
0340 I=I+1
0350 GOTO 330
0360 REM Q6
0370 IF J>I THEN 410
0380 A(J)=K
0390 I=J
0400 GOTO 450
0410 A(J)=A(I)
0420 J=J-1
0430 GOTO 230
0440 REM Q7
0450 IF R-I<I-L THEN 520
0460 S(P)=R
0470 P=P+1
0480 S(P)=I+1
0490 P=P+1
0500 R=I-1
0510 GOTO 180
0520 S(P)=I-1
0530 P=P+1
0540 S(P)=L
0550 P=P+1
0560 L=I+1
0570 GOTO 180
0580 REM Q8 STRAIGHT INSERTION
0590 J=L
0600 J=J+1
0610 IF J>R THEN 700
0620 K=A(J)
0630 I=J-1
0640 IF A(I)<=K THEN 680
0650 A(I+1)=A(I)
0660 I=I-1
0670 GOTO 640
0680 A(I+1)=K
0685 GOTO 600
0690 REM Q9
0700 IF P=1 THEN 770
0710 P=P-1
0720 L=S(P)
0730 P=P-1
0740 R=S(P)
0750 GOTO 180
0760 REM PRINTOUT
0770 FOR I=2 TO N+1
0780 PRINT A(I)
0790 NEXT I
0800 END
    
```

Fig. 4. Quicksort

on the speeds of execution of various instructions, but is usually about 9 or 10.

Although the quicksort is very fast the algorithm carries a number of disadvantages:

- (a) It is much longer than the others considered (63 lines of sorting) and so uses up valuable RAM.
- (b) The algorithm, as written, requires that the first element of the array (A(1)) be smaller than any of the elements being sorted (-1E99) and the final element (A(N+2)) be larger than any of the elements being sorted (1E99).

This means that the N elements under consideration are in A(2) to A(N+1) which means a little extra fiddling for the user.

The stack array S is used to store the start and end subscripts of the sections of the array A which are still to be sorted. The number of elements in S must be greater than or equal to the log (base 2) of N. The stack dimensioned in the program, S(10), will be sufficient for up to 1024 elements. It must be increased if more elements are to be sorted.

Comparison of Algorithms

The four algorithms have been compared on the SWTPC 6800 and Figure 5 shows their relative speeds for various numbers of random elements (generated using RND). It is clear that the time taken to sort the N elements is roughly proportional to N² in the case of bubble, straight selection and straight insertion while it is roughly proportional to N in the case of the quicksort.

If the quicksort is ruled out on the grounds of size or complexity, then of the other sorts, straight insertion appears to be the most generally useful, being the shortest algorithm and faster than the other simple algorithms for most purposes.

REFERENCE

KNUTH, D.E.
The Art of Computer Programming, Vol.3, (Sorting and Searching), Addison-Wesley, 1973

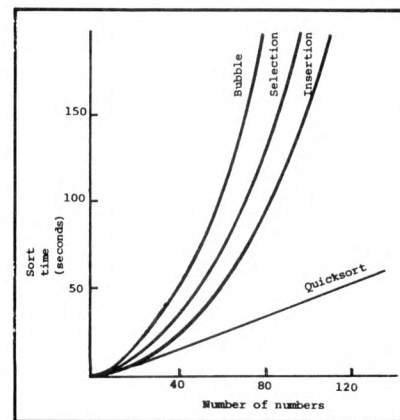

Fig. 5. Showing sort time against number of records for the SWTPC 6800

MICROMEDIA SYSTEMS

Consult the experts
(Wale's leading Microsystems House)

- EQUINOX 300
- NORTH STAR HORIZON
- CROMEMCO
- MICROSTAR 45
- COMPUCOLOR II
- COMMODORE PET

We supply a complete range of peripherals to suit the above including Texas, Elbit, Teletype, Diablo, Cifer, etc, plus a large selection of computer books.

Sophisticated application software available either packaged or bespoke.

Hire and leasing facilities available.

We are currently running a series of one-day Seminars; ring for details.

MICROMEDIA (SYSTEMS),
14 Chepstow Road, Newport, Gwent NP1 8EA
Tel: (0633) 841691/50528/63310

HOLDENE LTD For

- HORIZON & CROMEMCO
- COMMODORE PET
- ITT 2020
- MICRO COMPUTERS



HAZELTINE V.D.U.'s



SOFTWARE & SERVICE

FROM:

10 BLENHEIM TERRACE
WOODHOUSE LANE,
LEEDS 2
Tel: (0532) 459459

82A WATER LANE
WILMSLOW,
CHESHIRE.
Tel: (0625) 529486

G.W.COMPUTERS LTD

This is how your business appears on the screen

A complete Business Program Package free with the purchase of a 32-40K computer system.
Approx 60 entries * updates require only 2-4 hours weekly and your entire business is under control.

***PROGRAMS ARE INTEGRATED**

- 01= ENTER NEW NAMES/ADDRESSES
- 02= *ENTER/PRINT INVOICES
- 03= *ENTER PURCHASES
- 04= *ENTER A/C RECEIVABLES
- 05= *ENTER A/C PAYABLES
- 06= ENTER/UPDATE STOCKS REC'D
- 07= ENTER ORDERS REC'D
- 08= EXAMINE/UPDATE BANK BALANCE
- 09= EXAMINE SALES LEDGER
- 10= EXAMINE PURCHASE LEDGER
- 11= EXAMINE ORDER BOOK
- 12= EXAMINE PRODUCT SALES

WHICH ONE (ENTER 1 TO 24)

SELECT FUNCTION BY NUMBER

- 13= PRINT CUSTOMER STATEMENTS
- 14= PRINT SUPPLIER STATEMENTS
- 15= PRINT AGENTS STATEMENTS
- 16= PRINT VAT STATEMENTS
- 17= PRINT WEEK/MONTH SALES
- 18= PRINT WEEK/MONTH PURCHASES
- 19= PRINT YEAR AUDIT
- 20= PRINT PROFIT/LOSS ACCOUNT
- 21= UPDATE ENDMONTH FILES
- 22= PRINT CASHFLOW ANALYSIS
- 23= ENTER PAYROLL
- 24= RETURN TO BASIC

EACH PROGRAM GOES IN DEPTH TO FURTHER EXPRESS YOUR REQUIREMENTS.

FOR EXAMPLE (9) ALLOWS: a. list all sales; b. monitor sales by stock code; c. invoice search;
d. amend ledger files; e. total all sales.

THINK OF THE POSSIBILITIES, AND ADD TO THOSE HERE IF YOU WISH

Note programs 19, 20, 22, 23 not linked at time of going to press; estimated completion July. Price for current package £275 plus VAT, improved version - inc. aged debtors analysis etc. £375, or full listing plus manual to be typed-in on most computer systems £150. Barclaycard enquiries welcome.

Hardware systems tailored to your requirements (SWTP and PET) from £600 to £5,000 approx. Above package is intended to work with processor, twin-floppy and printer. All 30 programmes written in BASIC, easy to modify. 5 1/4" mini diskettes £2.65 + pp.

G.W.COMPUTERS LTD

A subsidiary of GRAMA (Winter) Ltd.

21B Dryden Chambers,
119 Oxford St., London W1.

Happy Memories

21L02 450ns 83p 2114 450ns £5.25 4116 250ns £7.90
 21L02 250ns £1.00 2114 250ns £5.75 2708 450ns £7.50

TRS-80 16K Memory Upgrade Kit: £74.50

S100 16K 250ns Static RAM Kit: £209 With 4K £86.25
 8K £126.70

Low Profile) Pins: 8 14 16 18 20 22 24 28 40
 DIL Sockets) Pence: 10 11 12 16 17 19 21 27 37

Our new shop is now open at the address below. We shall be stocking a wide range of items to interest all those of you who are building or plan to build your own microcomputer, why not pay us a visit? We are open from Mon. to Sat. 10 to 6 and often much later. We stock a range of books covering fundamentals through to advanced topics (like games)

We are NASCOM distributors for the South Coast. Do-it-yourself with our range of wire wrapping aids and materials from the O.K. corral, or Box-it-yourself with a Vero enclosure after Soldering-it-yourself with Antex.

Our stocks are rapidly increasing; please write or call for latest lists of available products. We welcome your suggestions for stock lines. What do you find difficult to obtain? (We know about buffers)

Please add 20p p&p to all orders less than £10 in value. Cheque or P.O.s payable to 'Happy Memories'. Access or Barclaycard orders may be telephoned 24hrs a day

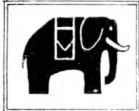

Prices quoted include VAT at 15%

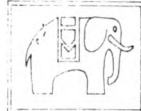

19 Bevois Valley Road, Southampton, Hants. SO2 0JP Tel: (0703) 39267

U NO THE ELF BUT DO YOU KNOW OUR PRICES?

- *Basic Computer Kit **£79.95**
 - or wired and tested **£99.95**
 - Cabinet & Flexiglass cover **£22.00**
 - *Constructors/Users Manual **£ 4.00**
 - 4K Static Memory Board **£63.00**
 - or wired and tested **£83.00**
 - ELF II Expansion Power Board **£15.00**
 - ELF II Tiny Basic Generator **£12.00**
 - *R.F. Modulator **£ 3.00**
 - Giant Board Kit **£32.00**
 - Giant Board Kit wired and tested **£52.00**
 - *Power Supply Transformer **£ 5.00**
 - *Micro Processor/Computer Book **£ 4.00**
 - Pro ASCII Keyboard Kit **£53.00**
 - Pro ASCII wired and tested **£73.00**
 - Pro ASCII Keyboard steel cabinet **£15.00**
 - ELF Bug Monitor **£12.00**
- *SUGGESTED MINIMUM INITIAL ORDER**

Please tick items required, add 15% VAT to total cost, enclose your cheque, print your name, address and telephone number below and post complete to **C.A.V.S. Ltd., 171 Chase Side, Enfield, Middlesex, EN2 0PH.**

Name Tel. No.
 Address

GODBOUT Computer Products

Alpha Micro/Altair/Cromemco/Imsai/North Star/Polymorphic Etc.

LTT ELECTRONICS has one of the largest stocks of Godbout computer products in the U.K. Only by bulk purchasing and minimising sales overheads can we afford to sell at what amounts to trade prices.

For example:	Kit	Ass.
Econoram II, 2MHz 8K bytes	£ 80	£ 99
Econoram IV, 4MHz, 16K bytes	£150	£169
Econoram VII, 4MHz 24K bytes	£230	£249
Econoram XIII, 4MHz 32K bytes, bank select	£315	£339

QUALITY DISKETTES (Verbatim or Scotch, subject to availability) also stocked for most microcomputers: Apple, Cromemco, Tandy, Vector Graphic etc. (soft sector mini-floppy), Altair, Micropolis etc. (16 sector, hard sector mini-floppy), IBM, DEC, Prime, Cromemco etc. (soft sector floppy).

Pack of ten disks - **£19**, Carton of ten packs (100 disks) **£175**

All prices given include postage and packing (overseas add £10) - Just add V.A.T. (presently 15%). Send SAE for details.

Quantity discounts available on application. Credit terms available to large companies and government establishments.

MAIL ORDER HOTLINE: 01-828 1785

MEASUREMENT systems & controls incorporated

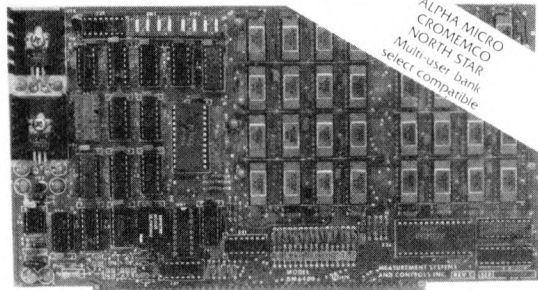

Model DMB-6400 Series dynamic 64k byte RAMS incorporate the features which are standard in the DM-6400 Series and adds the following capabilities:

- ALPHA MICRO, CROMEMCO and NORTH STAR output port bank select compatible.
- Four (4) 16k byte, functionally independent memory banks.
- Memory bank size can be incremented to 64k bytes in 16k increments.
- Eight (8) 64k byte banks of memory per output port.

Model DM-6400 Series dynamic 64k memory boards feature IEEE S-100 compatible timing and on board transparent refresh.

- Memory selectable and deselectable in 4k byte increments.
- 25 MHz on board crystal oscillator for independent timing.

DMB-6400 and DM-6400 Common Features:

- 4 MHz Z80 operation with no wait states.
- Tested and burned-in.
- Low power - 8 watts maximum.
- Reliable, expandable memories.

ONE YEAR GUARANTEE

64K-£395 48K-£316 32K-£237 16K-£158



Small Systems Engineering Limited

62 CAVENDISH STREET, LONDON W1M 7LD
 TELEPHONE: 01-637 0777 Telex: 8813085 ABACUS

SUPPLIERS OF PET MEMORY BOARDS AND INTERFACES THROUGHOUT EUROPE

GARAGE ACCOUNTING PROGRAM

TRS-80 LEVEL II DISK BASIC

W.H. Davies

Introduction

This program is written in TRSDOS DISK BASIC and is intended for those readers who possess a TRS-80 Microcomputer System and have added either one, or two, Floppy Disk Drives to their system. It does not take account of the availability of a Line Printer, as such peripherals often cost more than many amateurs, or even small traders, can afford. However, for those who require a print-out, relevant PRINT statements should be changed to LPRINT.

Although it is written with the TRS-80 in mind the program may be altered quite easily to suit other Disk Basics. It occupies just under 2K bytes, but the amount of RAM required when the program is operational will depend upon the number of data records inputted when it is running. Hence the CLEAR 8000 statement in Line 100 at the beginning of the program; this statement should be changed to suit individual needs, or when the VDU displays 'OUT OF STRING SPACE'.

Operation

The Random Access Technique is used because the RANDOM FILE offers distinct advantages over those Files which use sequential access. The latter Files store data in ASCII format whereas Random Files provide the facility for immediate retrieval of the desired data and can be written to, or read from, whenever required. Data can also be modified to change existing information and then written back to disk.

Sample procedures for writing and reading data are given below. It

should be noted that pressing the (BREAK) key when the prompt 'TYPE 1 TO WRITE, 2 TO READ' appears will STOP the program and all data entered up to that point will then be stored on disk to be retrieved as and when required. It is also possible to change a sub-record within a Physical Record at any time without any effect on the data contained in the other sub-records.

Sample Run No. 1

```
> RUN
Type 1 to Write, 2 to Read? 1
Enter the Logical Record Number? 1
Sub-Record Number 0
Physical Record Number 1
Name ? F.H. Winterbottom
Account Number ? 112113
Phone (Home) ? 0242 54321
Phone (Office) ? 0242 12345
Date In ? 05/27/79
Vehicle ? Cortina Mk.2. 1600
Red (1970) LLZ 123J
Job Number ? 1234
Hours Worked ? 4.5
Hourly Rate ? 9.323
Cost of Parts ? 12.95
Enter Logical Record Number? (Break)
```

Sample Run No. 2.

```
> RUN
Type 1 to Write, 2 to Read? 2
Enter Logical Record Number? 1
Enter VAT Rate. eg. 8, 10, 12.5 15 etc?
12.5
Sub-Record Number 0
Physical Record Number 1
Name F.H. Winterbottom
Account Number 112113
Phone (Home) 0242 54321
Phone (Office) 0242 12345
Date In 05/27/79
Vehicle Cortina Mk.2. 1600
Red (1970) LLZ 123J
Job Number 1234
Hours Worked 4.5
Hourly Rate 9.323
Labour Charges 41.95
Cost of Parts 12.95
VAT Due at 12.5% 6.86
ACC Rendered 61.76
Enter Logical Record Number? (Break)
```

The two examples show the Write and Read sequences; in practice of course several entries of data would be written — or read — at one time. It could be that an intended user of this program may wish to have a different order of data, but this should present no problem.

In conclusion I would recommend TRS-80 owners to peruse or obtain TANDY's latest Manual on TRSDOS & DISK BASIC (Cat. 26-2104), this gives detailed information on the use of Random Files and is much more helpful than their previous preliminary manual on this subject.

GARAGE ACCOUNTING PROGRAM

```
100 PRINT: CLEAR 8000:CLS:PRINT
110 PRINT:INPUT"TYPE 1 TO WRITE, 2 TO READ";N
120 OPEN "R",1,"GARAGE"
130 ON N GOTO 200,400
200 PRINT:INPUT"ENTER LOGICAL RECORD NUMBER ";LR:PRINT
210 IF LR = 0 THEN 100
220 GOSUB 600:PR = INT((LR-1)/2)+1
230 GET 1,PR:PRINT"PHYSICAL RECORD NUMBER ";PR:PRINT
240 PRINT"NAME";TAB(20);:INPUT N$:LSET N$ = N$
250 PRINT"ACCOUNT No.";TAB(20);:INPUT A$:LSET A$ = A$
260 PRINT"PHONE (HOME)";TAB(20);:INPUT H$:LSET H$ = H$
270 PRINT"PHONE (OFFICE)";TAB(20);:INPUT P$:LSET P$ = P$
280 PRINT"DATE IN";TAB(20);:INPUT D$:LSET D$ = D$
290 PRINT"VEHICLE";TAB(20);:INPUT V$:LSET V$ = V$
300 PRINT"JOB NUMBER";TAB(20);:INPUT J$:LSET J$ = J$
310 PRINT"HOURS WORKED";TAB(20);:INPUT W:LSET W$ = MKS$(W!)
320 PRINT"HOURLY RATE";TAB(20);:INPUT R:LSET R$ = MKS$(R!)
330 PRINT"COST OF PARTS";TAB(20);:INPUT P:LSET P$ = MKS$(P!)
340 PUT 1,PR:GOTO 200
400 PRINT:INPUT"ENTER THE LOGICAL RECORD NUMBER ";LR
410 IF LR = 0 THEN 100
420 PRINT:INPUT"ENTER VAT RATE. EG. 8, 10, 12.5, 14 ETC";T
430 GOSUB 600:PR = INT((LR-1)/2)+1
440 GET 1,PR:PRINT"PHYSICAL RECORD NUMBER ";PR:PRINT
450 PRINT"NAME";TAB(20);N$
460 PRINT"ACC.No";TAB(20);A$
470 PRINT"PHONE (HOME)";TAB(20);H$
480 PRINT"PHONE (OFFICE)";TAB(20);P$
490 PRINT"VEHICLE";TAB(20);V$
500 PRINT"DATE IN";TAB(20);D$
510 PRINT"JOB No.";TAB(20);J$
520 PRINT"HOURS WORKED";TAB(20);CVS(HW$)
530 PRINT"HOURLY RATE";TAB(20);CVS(HR$)
540 PRINT"LAB CHARGES";TAB(20)USING"#####.##";CVS(HR$) * CVS(HW$)
550 PRINT"COST OF PARTS";TAB(20)USING"#####.##";CVS(CP$)
560 PRINT"VAT DUE AT ";T;"%";TAB(20)USING"#####.##";T/100 * (CVS(HR$)
* CVS(HW$) + CVS(CP$))
570 PRINT"ACC RENDERED";TAB(20)USING"#####.##";(T/100 * (CVS(HR$)
* CVS(HW$) + CVS(CP$))) + CVS(HR$)* CVS(HW$) + CVS(CP$)
580 GOTO 400
590 END
600 SR = LR-2 * INT((LR-1)/2) - 1
610 PRINT"SUB-RECORD NUMBER ";SR
620 FIELD 1, SR*115 AS D$,20 AS N$,6 AS A$,12 AS H$,12 AS P$,
37 AS V$,10 AS D$,6 AS J$,4 AS HR$,4 AS HW$, 4 AS CP$
630 RETURN
```



NewBear



NEW BASF 5¼ ins disk drives

BASF 6106 - slimline
Double density **£220.00** VAT

BASF 6108 - slimline
Double density
Double sided **£279.50** VAT

MEMORIES DOWN IN PRICE
4116 only £8.50

2102-1	£0.85	2708	£6.99
2102L-1	£0.99	SWATBUG	£16.00
2112	£2.25	MC 6803L7 (MIKBUG)	£13.65
2114	£6.99		plus VAT

WE STOCK

VERO. OK TOOLS. JIM PAK. NASCOM. SYM-1.
ITHICA AUDIO. 77-68 BEAR BAGS. SORCEROR.
HORIZON AND MUCH MORE...

INTEGRATED CIRCUITS

Microcomputing I.C.'s

MC 6800	£7.15		
MC 6821	£4.63		
MC 6850	£6.74		
MC 6810AP	£3.61		
MC6840	£12.72		
MC8602P	£2.88		
MC 14536P	£3.69		
MC3459	£2.43		
Z80 CPU 2.5MHz	£8.99		
Z80 PIO 2.5MHz	£7.99		
Z80 CTC 2.5MHz	£7.99		
Z80A CPU 4MHz	£13.99		
Z80A PIO 4MHz	£10.00		
Z80A CTC 4MHz	£10.00		
SC/MP11	£8.88		
(INS 8060N)			
INS 8154N	£8.18		
8080A	£6.00		
6502	£12.00		
6522	£6.58		
6532	£12.56		

NEW

100.0	KHz	£3.25
200.0	KHz	£4.20
204.8	KHz	£3.25
1.0	MHz	£3.50
1.008	MHz	£2.80
1.8432	MHz	£2.80
2.0	MHz	£2.60
4.0	MHz	£2.60
5.0	MHz	£2.60
10.0	MHz	£2.60
13.478	MHz	£3.25
36.0	MHz	£3.25

plus VAT

INTEGRATED CIRCUITS

Character Generators

74S 262	£13.70		
2513 (U)	£6.50		
2513 (L)	£6.50		
MCM 6571P	£6.71	6402	£4.50
9368 (7 segment display decoder)	£2.45	AY-5-1013	£4.50

plus VAT

UARTS

Send for New Hardware Catalogue & booklist

DEVLIN MODULAR 60 KEY KEYBOARD

Pet replacement

Mounted on PCB
X-Y matrix £38.50
Matching Hex keypad £7.20

Send for details

GAMES BOOKS

101 Basic Computer Games	D.AHL	£6.50
Star Ship Simulation		£5.10
Game Playing with Computers		£10.20
Game Playing with Basic	D. Spencer	£4.20
SARGON-A Chess Computer Program in Z80		
ASSEMBLY LANGUAGE		£9.50

PASCAL BOOKS

Pascal: User Manual & Report	Springer-Verlag	£5.52
Problem Solving Using Pascal	Springer-Verlag	£7.84
Programming in Pascal	P. Grogono	£7.50
A Practical Introduction to Pascal	A. Addyman	£3.50

PRACTICAL APPLICATION BOOKS

Programming the 6502 (SYBEX)	£8.00
The 6800 Microprocessor	£3.60
8080A BUGBOOK	£6.95
Data Acquisition Handbook	£2.00
77-68 Construction Manual	£7.50
Fundamentals of Digital Computers	D. Spencer £7.50
National Semiconductors Interface Circuits Data Book	£2.75
Programming a Micro 6502	C.C.Foster £7.95
Semiconductor Circuit Design Vol 1	T.I £6.50
Semiconductor Circuit Design Vol 2	T.I £6.50
Semiconductor Circuit Design Vol 3	T.I £6.50
Semiconductor Circuit Design Vol 4	T.I £6.50
Semiconductor Circuit Design Vol 5	T.I £7.95

TERMS AND CONDITIONS

Minimum official order £10.00
Postage & packing 30p on Hardware
Hardware price plus VAT.
Callers welcome Mon-Sat 9.00-5.30
but please phone us first on 0635 30505.

Barclaycard & Access Welcome

ALL MAIL ORDER TO NEWBURY

INTRODUCTORY OFFER
MODEL 700 VDU

- Assembled and tested
- 64 characters x 16 lines
- Upper case only
- 110-1200 baud

£299 with video monitor

Newbear Computing Ltd.,
40 Bartholomew St, Newbury, Berks.
0635 30505

Visit our Northern office at 2A
Gatley Rd, Cheadle, Cheshire.
Tel 061-491-2290

24 HOUR DELIVERY IN MOST CASES

PRICES SUBJECT TO CHANGE

THE READER'S DILEMMA



PCW We are well aware that there are very many people who would like to use small computers but cannot get a "handle" on how to go about it. This article is a small contribution to helping towards an understanding. It is by no means comprehensive or complete, for no article or book can ever be. When it comes to the crunch, there is no substitute for application, persistence and practice. PCW

I'm a reader of your magazine, but a computer novice. My job is selling supplies of inks and papers for photocopiers and duplicators over a wide area.

Regular repeat sales are a mainstay of the business, and contacting customers when they are about to re-order increases our chances of retaining the business.

Maintaining records of one or two hundred customers is difficult, and I've been thinking of the advantages of a micro-computer as a sophisticated filing system.

Ideally, when a customer places an order I would key in a projected date for their next order. (It might also be possible to check on the dates of previous orders as a guide to making the estimate).

With the system running properly, I would be able to key in the date and receive a list of calls to be made. It could also be used as a diary for appointments, errands and deadlines.

Would the use of codings enable the main body of information on customers to be broken down in different ways? For example, to be

able to get a list of all copier owners in a certain area, or of the top 20% of our customers, or of all the owners of a certain type of machine, would be invaluable.

I would be very glad to know how much of the above could be done with the popular micro's such as the PET, TRS-80 and Apple II, or how much bigger the machine would have to be.

Would I need to get deeply involved in DIY programming (I don't want to) or buy expensive software to do the job? How much would it cost to send the machine?

If you can advise, or put me in touch with someone who can, I would be very grateful for your help.

Phil Symons

Open Reply to the Reader

Sheridan Williams

Thank you for your interesting letter; it outlines the very common need amongst small businesses for an 'intelligent' filing system. Most of the questions you have asked are fundamental to many data processing programs. Consider that computers are really only used for scientific and business applications. The majority of applications fit the latter category, and your proposed requirement is fairly typical of a general computer based filing system. As you are probably aware computers have many advantages over manual filing systems; these are: reduction in manpower, speed of response, accuracy, up-to-date records and, usually, a saving in cost. Many of the above advantages create customer goodwill, provided nothing goes wrong.

Hardware

You state that you have one or two hundred customers, whose records you wish to keep. The system that you decide on will vary slightly according to your precise requirements, but it appears that you will need not much more than 50K bytes of backing store to hold your customer file. A lot depends on the way that you organise the file and the information on it, so this figure is only a guide.

This minimum requirement puts

you in the middle of a very highly competitive market place, and amongst the computers worth considering come the three that you have mentioned — Commodore PET, Tandy TRS-80, Apple (ITT); slightly upmarket are the Vector Graphics MZ, Horizon and many others.

It is essential that you consider purchasing a disc system, and I would not recommend a cassette based system for several reasons. Cassettes are unreliable, even the fastest work at an incredibly slow

rate, files must be serially organised, programs take ages to load, expansion later on is essential. There are a number of mini floppy disc drives that allow storage in excess of 300K on a single side of a 5¼ inch floppy disc. This would appear more than adequate for your requirements. However, unless it is vital to save £300 I would suggest that you purchase a dual floppy disc drive for the sake of convenience.

Your complete system requirement will probably be as follows: Central processing unit (CPU) with at least 16K of usable store, this probably means a 32K system if the language compiler/interpreter is not in ROM; a dual floppy disc drive; a reasonably fast printer with a good typeface.

The Commodore PET, Tandy TRS-80 and Apple all have the necessary peripheral devices available. The Horizon and Vector MZ are more sophisticated systems, have

the advantage of different language capabilities. Also, they can support several terminals enabling you to have several data entry and data acquisition points throughout your building. A typical large system based on either the Horizon or MZ would offer you computing power well into the future, but of course will be more expensive initially.

There are many still larger systems available and the suppliers could offer you software support. We are then in the £5000 to £10000 bracket and hence talking about facilities way in excess of your present requirements.

Software

The hardware side of your problem is relatively easy. It is the software that could cause you problems. As I see it, you have the following ways of getting a program written:—

1. Write it yourself.
2. Get a friend to write it for next to nothing.
3. Buy a program and tailor it to suit your requirements by either method 1 or method 2.
4. Engage a professional to write the program.
5. Approach your local college or school and get an 'A' level computer science student to write it for you, as his compulsory project.

Each of the above ways has advantages and disadvantages as follows:—

1. It could take you up to one year to learn a suitable language well enough to write your own programs. There are courses available on introductory, intermediate and advance programming in BASIC given by Sumlock Bondain and Computer Workshop in London but these are not very local for you.
2. Friends with sufficient programming experience are few and far between, and considering that it could take over 50 man-hours to program, including debugging, and this would be spread over many weeks — even friends tend to become intolerant if put-upon to this extent.
3. It could be difficult to find a program on which to start the tailoring. It may take a long time to understand the original program and may be quicker to write your own program from

scratch. I personally would not choose this option.

4. If money is no object this is the best way. You should have back-up support and a guarantee; and a working system within one month. It is expensive though. I have approached two companies — Sumlock Bondain, 15 Clerkenwell Close, London, EC1R 0AD Telephone 01-253 2447/8; and Almarc Data Systems, 29, Chesterfield Drive, Burton Joyce, Notts. Tel: 0602 248565 both of whom quoted similar rates for the software. Around £500 for the program and £250 per week to tailor the program for your needs.
5. This alternative is very interesting because it is not often considered. 'A' level Computing Science students are required to provide a fully documented project for their final examination. This must be a practical application. I know several students who would jump at the opportunity to write your system for you. Approach your local school or college and ask to speak to the teacher/lecturer in charge, who will advise you. The major disadvantage to this method is that you will have to wait until next June before the project is complete. **(PCW And what you get is what you'll have to use. PCW)**

If you consider doing it yourself then you will have to study techniques for file manipulation. This is not difficult, but I'm afraid experience cannot be learned over-night. Points worth considering are: The file will contain 200 records (say), these should be given a code number which will allow identification of certain types of record (eg. area codes), they will allow customer records to be broken down in various ways. Another relevant question is whether you store a complete customer record including name and address, together with all the relevant ordering information on the master file; or should you use a reference file for the names and addresses. The program will probably be best written as a 'suite' of programs, and a 'menu' printed first asking which program is required:—

Example:

CUSTOMER FILE

Which of the following do you require?

1. Delete a customer record.

2. Add a customer record to the file.
3. Update or amend a customer record.
4. Change area codes
5. Amend for price increases.
6. List of customers due for visits. etc. etc.

SYSTEM ONE	
Based on Commodore	PET 2001-16N
	16K £730
or	PET 2001-32N
	32K £860
Dual disk drive £800	
Printers: Teletype 43 (inc. keyboard)	
132 columns 30 ch/s	£1000
or Anadex DP8000 80 column 112 ch/s	£575
Total Price £2100 — £2700	
SYSTEM TWO	
Based on the Horizon	16K plus dual disc drive £1800
or	32K plus dual disc drive £2200
Elbit VDU £600	
Printer: Centronics 779 80 column 60 ch/s	£950
Total Price £3300 — £3700	
SYSTEM THREE	
Based on the Vector Graphics MZ	48K with dual disc drive £2500
Elbit VDU £600	
Printer: Centronics 779 80 column 60ch/s	£950
Total Price £3850	

All quoted prices are approximate. Because I have only given three suggested systems, it is not that I don't recommend any others but that I found the quoted suppliers readily helpful and willing to demonstrate at a moment's notice.

Yes, you can hire microcomputers but the cost is at least £5 per day. This is only worthwhile to evaluate a particular machine, and not worthwhile in the long term. After 6 months' rental you could have bought a small system.

Good luck with whatever you decide to do and don't forget to let PCW know when the system is operational and we can then come down and visit you. Your experience in setting up such a computer controlled sales network will undoubtedly help others.

a digitizer adds another dimension

The Bit Pad computer digitizer converts graphic information into digital form for direct entry into a computer. By touching a pen like stylus or a cursor, to any position on a drawing, diagram, photograph, or other graphic presentation, the position co-ordinates are converted to digital equivalents.

- Bit Pad interfaces with almost any micro computer.
- Bit Pad consists of a 15" sq. digitizer tablet (11" sq. active area), a stylus, and a controller cabinet.
- Bit Pad costs only £450 (excluding VAT). Fill in the coupon and we will send you full information and details.

Terminal Display Systems Ltd., Hillside, Whitebirk Industrial Estate, Blackburn BBI 5SN, Lancs., England

Send to: Department CPPW, Terminal Display Systems Ltd., Hillside, Whitebirk Industrial Estate, Blackburn BBI 5SN, Lancs., England.

Name

Address

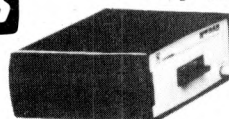

Microscopic Network Architecture
 Structural Geology
 Cont... Exam marking
 Teaching... onal research
 Measuring E... ment Military
 Menu Market re... Geographical
 Cartographic Archeological... Town Planning
 Orthodontics Design Geo... Statics Traffic
 Radiology Microscopy Arty... Architecture
 Structural Civil M...
 Process Control Gra...
 Teaching Games...
 Measuring Biology...
 Menu Market research...
 Archeological Ar...
 Design Geology...



CRYSTAL ELECTRONICS
CC ELECTRONICS

CRYSTAL/CC ELECTRONICS 'NASCOM' SOFTWARE

XTAL BASIC – SPECIFICATION

This is an "8K Basic" Interpreter written for the Nascom 1 system.

1. **COMMANDS:**— Call Clear CLoad Cont CSave Read.. Data.. Restore Def.. Fn Dim Edit End For.. To.. Step.. Next Gosub.. Return Goto If..Then Input List Nas Pop New On..Goto On.. Gosub Out Poke Print Rem Run Speed Stop Wait SPC() Tab () Print @
2. **VARIABLES:**— Names must start with a letter, but can be up to any length. First two characters used to distinguish one variable from another. Strings of up to 255 characters, also Multi-Dim. Arrays and String Arrays. Numbers range from +/- 1E+/-38, with an accuracy of six significant figures.
3. **FUNCTIONS:**— ABS ASC ATN CHR\$ COS EXP INT LEFT\$ LEN LOG MID\$ PEEK POB RND RIGHT\$ SGN SIN SIZE SIZE\$ SOR STR\$ TAN VAL
4. **OPERATORS:**— ARITHMETIC: + - * / ** ("To the Power of")
RELATIONAL: <> <> >= <=
ARITH-LOGICAL: And or Not
STRING: + (Concatenation)
5. **CASSETTE COMMANDS:**— CSave CLoad for Saving and Loading Programs. Also CSave@ Cload@ for saving and loading of Numerical Arrays.
6. **SPECIAL COMMANDS:** EDIT — Powerful Line Editor. CALL — Machine-Code Subroutine Call, NAS — Return to 'Nasbug' Under Software Control, OUT, INP & WAIT — For Control of I/O Ports.
7. **COMPATIBILITY:**— Tape Routine Provided for Use with T2 Monitor. Fully compatible with T2, T4 & B-BUG Monitors.
8. **SIZE:**— Actually Fits in 7K of RAM (1000H — 2BFFH), but recommend >= 16k expansion Ram in your system.
9. **AVAILABILITY:**— On C12 Cassette Tape, with documentation.
10. **PRICE:**— £35 + VAT

40 MAGDALENE ROAD
TORQUAY, DEVON, ENGLAND
Tel: STD 0803 22699

ADVERTISERS' INDEX

A.J. Harding (Molimerx)	34	London Computer	
Adda	18	Store	49
Almarc	27	Look In	61-65
Bristol Computer Centre	74	Micro Centre	12
Byte Shop	8	Microcomputers Etc.	6
Christian Audio	54	Micromedia	53
Comart	38	Microsoftware	7
Comp Shop	78, 79	Microsolve	43
Complete Computer		NewBear	56, 59
Systems (CCS)	22	PCW Show	40
Computastore	77	Personal	Back
Computerland	16	Computers	Cover
Computer Workshop	66	PET News	33
Crystal Electronics	59	Pop Shop	69, 70
Dynabyte	28	Research Machines	41
Equinox	15, 43	Rostronics	15
Factor One	34, 50	Sintrom Microshop	19
Gamma Winter	53	Sirtan Products	44
Happy Memories	54	Small Systems	
Holdene	53	Engineering	16, 54
Integrated Circuits		Stack Computer Services	77
Unlimited	60	Strathand	15
Interam	49	Tandy	71
Ithaca InterSystems	75	Technalogs	34
Keen Computers	2	Terminal Display Systems	58
L & J Computers	72	V & T Electronics	72
LP Enterprises	49	Videotime	15
LTT Electronics	54	Vlasak	72
		Xitan Systems	20



NewBear Books



Please contact NEWBEAR for a complete catalogue of books.

NEWBEAR, 40 Bartholomew Street, Newbury, Berkshire RG14 5LL

Telephone: Newbury (0635) 30505

Introduction to Microcomputing		Instant Freeze and Dried		Practical Microcomputer	
Volume 0. The Beginners Book	£ 5.95	Programming in Basic	£ 7.20	Programming (6800)	£17.56
Volume I. Basic Concepts	£ 5.95	Illustrated Basic	£ 2.25	The 6800 Microprocessor	£ 3.60
Volume II. Some Real Products	£18.95	Beginning Basic	£ 4.95	D.N. 4 Definite description of the	
Volume III. Some Real Support		Learning Basic Fast	£ 6.30	6800 Instruction Set	£ 1.50
Devices	£11.95	Advanced Basic	£ 6.00	Z80 Books	
Understanding Microcomputer		Microcomputer Basic	£ 6.60	Z80 Programming for Logic Design	£ 5.95
and Small Computer Systems	£ 7.56	The Basic Workbook	£ 4.50	Z80 Technical Manual	£ 4.00
Introduction to Computers	£11.15	Discovering Basic (a problem		Z80 P10 Technical Manual	£ 2.75
Introduction to Computers in		solving approach)	£ 4.90	Z80 Programming Manual	£ 4.50
Business	£10.45	The Users Guide to North Star		Z80 Microcomputer Handbook	£ 7.25
An Introduction to Personal		Basic	£10.00	Practical Microcomputer	
and Business Computing	£ 5.75	Basic with Business Applications	£ 5.56	Programming (Z80)	£23.96
Getting Acquainted with Micros	£ 7.95	Basic and the Personal Computer	£10.36	Pascal	
Home Computers — A Beginner's		A Guided Tour of Computer		Pascal	
Glossary and Guide	£ 4.95	Programming in Basic	£ 4.16	Pascal: User Manual & Report	£ 5.52
Getting Involved with your Own		Basic Basic (An introduction to		Problem Solving Using Pascal	£ 7.84
Computer — A Guide for	£ 4.75	Computer Programming in	£ 5.40	Programming in Pascal	£ 7.50
Beginners		Basic Language)		A Practical Introduction to Pascal	£ 3.50
Introduction to Computer		Advanced Basic Applications	£ 6.00	6502	
Programming	£ 3.84	and Problems		The Best of Micro 6502 Journal	£ 5.99
The First Book of		6800 Books		Sym Reference Manual	£ 7.50
Microcomputers	£ 3.60	6800 Programming for Logic Design	£ 5.95	Sym Programming Manual	£ 7.50
A Consumers Guide to Personal		6800 Assembly Language		First Book of Kim	£ 7.00
Computing and		Programming	£ 5.65	6500 Hardware Manual	£ 7.50
Microcomputers	£ 5.65	Using the 6800 Microprocessor	£ 5.65	6500 Programming Manual	£ 7.50
Basic Books		77-68 6800 Microprocessor	£ 7.50	Programming the 6502 SYBEX	£ 7.95
Introduction to Basic	£ 6.50	6800 Software Gourmet Guide		Fortran	
Beginning Basic	£ 2.95	Cook Book	£ 7.95	Elementary Computer	
Introduction to Basic	£ 1.95			Programming in Fortran IV	£ 6.30
Some Common Basic Programmes	£ 6.45			Fortran with SF/R and WATFEV-S	£ 6.95
Payroll with Cost Accounting in					
Basic	£ 9.95				

DIODES/ZENERS			
QTY.			
1N914	100v	10mA	.05
1N4005	600v	1A	.08
1N4007	1000v	1A	.15
1N4148	75v	10mA	.05
1N4733	5.1v	1 W Zener	.25
1N4749	24v	1W	.25
1N753A	6.2v	500 mW Zener	.25
1N758A	10v	"	.25
1N759A	12v	"	.25
1N5243	13v	"	.25
1N5244B	14v	"	.25
1N5245B	15v	"	.25
1N5349	12v	3W	.25

SOCKETS/BRIDGES			
QTY.			
8-pin	pcb	.16 ww	.35
14-pin	pcb	.20 ww	.40
16-pin	pcb	.25 ww	.45
18-pin	pcb	.30 ww	.95
20-pin	pcb	.35 ww	1.05
22-pin	pcb	.40 ww	1.15
24-pin	pcb	.45 ww	1.25
28-pin	pcb	.50 ww	1.35
40-pin	pcb	.55 ww	1.45
Molex pins	.01	To-3 Sockets	.35
2 Amp Bridge		100-prv	.95
25 Amp Bridge		200-prv	1.50

TRANSISTORS, LEADS, etc.			
QTY.			
2N2222M	(2N2222 Plastic .10)		.15
2N2222A			.19
2N2907A	PNP		.19
2N3906	PNP (Plastic)		.19
2N3904	NPN (Plastic)		.19
2N3054	NPN		.55
2N3055	NPN 15A 60v		.60
T1P125	PNP Darlington		1.95
LED Green,	Red, Clear, Yellow		.19
D.L. 747	7 seg 5/8" High com-anode		1.95
MAN72	7 seg com-anode (Red)		1.25
MAN3610	7 seg com-anode (Orange)		1.25
MAN82A	7 seg com-anode (Yellow)		1.25
MAN74	7 seg com-cathode (Red)		1.50
FND359	7 seg com-cathode (Red)		1.25

9000 SERIES			
QTY.		QTY.	
9301	.85	9322	.65
9309	.50	9601	.30
		9602	.45

MICRO's, RAMS, CPU's, E-PROMS	
QTY.	
8T13	2.50
8T23	2.50
8T24	3.00
8T97	1.75
74S188	3.00
1488	1.25
1489	1.25
1702A	4.50
AM 9050	4.00
ICM 7207	6.95
ICM 7208	13.95
MPS 6520	10.00
MM 5314	4.00
MM 5316	4.50
MM 5387	3.50
MM 5369	2.95
TR 1602B	3.95
UPD 414	4.95
Z 80 A	22.50
Z 80	17.50
Z 80 P10	10.50
2102	1.45
2102L	1.75
2107B-4	4.95
2114	9.50
2513	6.25
2708	11.50
2716 D.S.	34.00
2716 (5v)	69.00
2758 (5v)	26.95
3242	10.50
4116	11.50
6800	13.95
6850	7.95
8080	7.50
8085	22.50
8212	2.75
8214	4.95
8216	3.50
8224	4.25
8228	6.00
8251	7.50
8253	18.50
8255	8.50
TMS 4044	9.95

- T T L -							
QTY.		QTY.		QTY.		QTY.	
7400	.20	7492	.45	74H20	.25	74LS76	.70
7401	.20	7493	.35	74H21	.25	74LS86	.95
7402	.20	7494	.75	74H22	.40	74LS90	.85
7403	.20	7495	.60	74H30	.30	74LS93	.85
7404	.20	7496	.80	74H40	.35	74LS96	2.00
7405	.35	74100	1.15	74H50	.30	74LS107	.90
7406	.25	74107	.35	74H51	.30	74LS109	1.50
7407	.55	74121	.35	74H52	.20	74LS123	1.95
7408	.20	74122	.55	74H53	.25	74LS138	2.00
7409	.25	74123	.55	74H55	.25	74LS151	.95
7410	.20	74125	.45	74H72	.35	74LS153	1.15
7411	.25	74126	.45	74H74	.35	74LS157	1.15
7412	.25	74132	.75	74H101	.95	74LS160	1.15
7413	.45	74141	.90	74H103	.55	74LS164	2.90
7414	.75	74150	.85	74H106	1.15	74LS193	2.00
7416	.25	74151	.95	74L00	.30	74LS195	1.15
7417	.40	74153	.95	74L02	.30	74LS244	2.90
7420	.25	74154	1.15	74L03	.35	74LS259	1.50
7426	.25	74156	.70	74L04	.40	74LS298	1.50
7427	.25	74157	.65	74L10	.30	74LS367	1.95
7430	.20	74161/9316	.75	74L20	.45	74LS368	1.25
7432	.30	74163	.85	74L30	.55	74LS373	2.50
7437	.20	74164	.75	74L47	1.95	74S00	.45
7438	.30	74165	1.10	74L51	.65	74S02	.45
7440	.20	74166	1.75	74L55	.85	74S03	.35
7441	1.15	74175	.90	74L72	.65	74S04	.35
7442	.55	74176	.95	74L73	.70	74S05	.45
7443	.45	74177	1.10	74L74	.75	74S08	.45
7444	.45	74180	.95	74L75	1.05	74S10	.45
7445	.75	74181	2.25	74L85	2.00	74S11	.45
7446	.70	74182	.75	74L93	.75	74S20	.35
7447	.70	74190	1.25	74L123	1.95	74S22	.55
7448	.50	74191	1.25	74LS00	.40	74S40	.30
7450	.25	74192	.75	74LS01	.40	74S50	.30
7451	.25	74193	.85	74LS02	.45	74S51	.35
7453	.20	74194	.95	74LS03	.45	74S64	.15
7454	.25	74195	.95	74LS04	.45	74S74	.70
7460	.40	74196	.95	74LS05	.45	74S112	.60
7470	.45	74197	.95	74LS08	.45	74S114	.85
7472	.40	74198	1.45	74LS09	.45	74S133	.85
7473	.25	74221	1.50	74LS10	.45	74S140	.75
7474	.30	74298	1.50	74LS11	.45	74S151	.95
7475	.35	74367	1.35	74LS20	.45	74S153	.95
7476	.40	75491	.65	74LS21	.45	74S157	.98
7480	.75	75492	.65	74LS22	.45	74S158	.80
7481	.85	74H00	.20	74LS32	.50	74S194	1.50
7482	.95	74H01	.30	74LS37	.45	74S196	2.00
7483	.95	74H04	.30	74LS38	.65	74S257 (8123)	2.50
7485	.75	74H05	.25	74LS40	.70	8131	2.75
7486	.55	74H08	.35	74LS42	.95		
7489	1.05	74H10	.35	74LS51	.75		
7490	.55	74H11	.25	74LS74	.95		
7491	.70	74H15	.45	74LS75	1.20		

C MOS							
QTY.		QTY.		QTY.		QTY.	
4000	.15	4017	.75	4034	2.45	4069/74C04	.45
4001	.20	4018	.75	4035	.75	4071	.25
4002	.25	4019	.35	4037	1.80	4081	.30
4004	3.95	4020	.85	4040	.75	4082	.30
4006	.95	4021	.75	4041	.69	4507	.95
4007	.25	4022	.75	4042	.65	4511	.95
4008	.75	4023	.25	4043	.50	4512	1.50
4009	.35	4024	.75	4044	.65	4515	2.95
4010	.35	4025	.25	4046	1.25	4519	.85
4011	.30	4026	1.95	4047	2.50	4522	1.10
4012	.25	4027	.35	4048	1.25	4526	.95
4013	.40	4028	.75	4049	.65	4528	1.10
4014	.75	4029	1.15	4050	.45	4529	.95
4015	.75	4030	.30	4052	.75	MC14409	14.50
4016	.35	4033	1.50	4053	.95	MC14419	4.85
				4066	.75	74C151	2.50

I ² L, LINEARS, REGULATORS, ETC.			
QTY.		QTY.	
MCT2	.95	LM320K24	1.65
8038	3.95	LM320T5	1.65
LM201	.75	LM320T12	1.65
LM301	.45	LM320T15	1.65
LM308	.65	LM323K	5.95
LM309H	.85	LM324	1.25
LM309 (340K-5)	1.50	LM339	.75
LM310	.85	7805 (340T5)	1.15
LM311 (8-14 Pin)	.75	LM340T12	.95
LM318	1.50	LM340T15	.95
LM320H6	.79	LM340T18	.95
LM320H15	.79	LM340T24	.95
LM320H24	.79	LM340K12	1.25
7905 (LM320K5)	1.65	LM340K15	1.25
LM320K12	1.65	LM340K18	1.25
LM320K15	1.65	LM340K24	1.25
LM3900	.95		
LM75451	.65		
NE555	.45		
NE556	.85		
NE565	1.15		
NE566	1.25		
NE567	.95		
TA7205	6.95		
76477	2.95		
95H90	9.95		

CABLE ADDRESS: ICUSD

Telex #697-827 ICUSD SDG

HOURS: 9 A.M. - 6 P.M. MON. thru SUN.

INTEGRATED CIRCUITS UNLIMITED

7889 Clairemont Mesa Blvd. • San Diego, California 92111 U.S.A.

NO MINIMUM

COMMERCIAL AND MANUFACTURING ACCOUNTS INVITED

ALL PRICES IN U.S. DOLLARS. PLEASE ADD POSTAGE TO COVER METHOD OF SHIPPING.

ORDERS OVER \$100 (U.S.) WILL BE SHIPPED AIR NO CHARGE.

PAYMENT SUBMITTED WITH ORDER SHOULD BE IN U.S. DOLLARS.

ALL IC'S PRIME/GUARANTEED ALL ORDERS SHIPPED SAME DAY RECEIVED.

CREDIT CARDS ACCEPTED:

Phone (714) 278-4394 BarclayCard / Access / American Express / BankAmericard / Visa / MasterCard

SPECIAL DISCOUNTS

Total Order	Deduct
\$35-\$99	10%
\$100-\$300	15%
\$301-\$1000	20%

BUYING A COMPUTER FOR A SMALL BUSINESS

M.D. Nott

Writers write. Computer men compute . . . and small business men just (barely) run small businesses.

All the articles I read seem to be based on the assumption that small business men are a breed of person who know where they are going, how and why, and as far as computers are concerned — 'oh, they know what they are as well', and are just waiting till the time is right.

I think it might help if you know something. We are just plain and straightforward play-the-percentage gamblers, and that's all. We just work out the odds.

What does that mean? Well, in any given situation, fast or slow, we try to work out what courses of action are open to us and take the one that appears least wrong. Because if you have been in business more than three years you absolutely know that you can't be right whatever you decide.

So how does that involve computers? Well, to show you, I will have to cite my case and mix in a few of my business associates' cases as well.

I am now the possessor of an 8K

PET, indigestion, headache, an engineering business (or I think that's what it is), some started programs, a lot of inventions and a bike (the car broke down).

I had to do a quotation for a large racking installation and another for a shelving installation, and having settled down to do the design work (from 10pm till 2 or 4am, I'm the designer), I found the specification to be a bit tight, so calling for very accurate structural steelwork design. So on my 15th run of the first

framework, it seemed the fault lay in my inability to check in detail back through the calculations of 50 or so formulae to find the bit that needed altering; to bring the strength up, or the price down, or both. In addition, on the shelving quote my research had shown that there were no figures available for the strength of the tube I was requested to use, and so I would have to start right at the beginning. What is the beginning? Well, you need size, thickness, mass per metre, area of section, moment of inertia XX & YY, and eight more of 35 different sizes of tubes before you can start to design.

So guess what I went looking for — a good programmable calculator. I ended up with an 8K PET on the assurance of the salesman that it would come with complete and proper information and instructions that would enable me to put it straight to work. (Now you know why I am writing this).

So what did I get? One 8K PET (I was lucky, off the shelf!) and one PET user's manual 2001-8 first edition, and that was it. So of course first I sat down to read the manual, then I sat down to read the manual, so then I sat down with the computer to work my way through the manual, then I sat down to read the manual.

LOOK IN

NORTH STAR COMPATIBLE SOFTWARE

INFORMATION UNLIMITED

WHATSIT Data Base Management System can support a disc-resident data base and process enquiries (as well as updates) in a real-time conversational mode **£55.00**

MICROSOFT

FORTRAN-80 — ANSI '66 (except for COMPLEX) plus many extensions. Includes relocatable object compiler, linking loader, library and manager, Z80 assembler and cross reference list utilities **£245.00**

Disk Extended BASIC — New version, ANSI compatible with long variable names, WHILE/WEND, chaining **£175.00**

ORGANIC SOFTWARE

TEXTWRITER II affords complete word processing capability for North Star systems under the CP/M Operating System **£59.00**

The above software is supplied on 5.25" diskettes. Prices are exclusive of VAT @ 8% and postage & packing (add 75p). Please send large SAE for details.

INTERAM Computer Systems Ltd.
59 Moreton St. Victoria, London SW1

01-834 0261/2733

INTERAM

380Z SOFTWARE

BASIC programs guaranteed for 6 months, Using BASG, BASGF, BASGP, BASGC Cassette, listing or paper tape (no parity) supplied.

16K programs

£8 STARTREK destroy the Klingons in your allotted time.

£5 PONTOON allows doubling, splitting of pairs, five card tricks.

£5 POKER bluffs very well.

£4 ROULETTE allows any number of players.

£5 MASTERMIND 1 you guess the computer's code. Variable 1-30 columns

£4 MASTERMIND 2 guess the computer's code before it guesses yours. Restricted to 5 columns only with no repeated digits.

£4 KING rule a country for 8 years managing the economy.

£3 DARTS Darts training program. Computer is a dummy opponent. You will still need a dartboard. As published in *PCW*.

£3 MOON land the LEM on the Moon

£3 POLY. FIT fits a polynomial of any degree to a set of points.

£3 SIMULT. EQN. solves any set of linearly independent equations.

USING THE 380Z's GRAPHICS

£8 ROBOT CHASE On a par with Startrek as an addictive game. Requires skill. Gives a rating depending on your ability.

£4 HANGMAN Yes, boring old hangman with over 200 words, expandable.

£6 PLOT will plot any function in polar, parametric or cartesian form. Superb mathematical tool. Fascinating to watch.

£3 PATTERNS Suite of demonstration programs. Many good ideas.

IF YOU HAVE 32K STORE then try

£10 SUPER STARTREK with black-holes, computer assisted warping.

FOR THOSE WITH 32K AND THE REAL-TIME CLOCK BOARD THERE ARE:-

£8 ROBOTS As for ROBOT CHASE but with an extra real-time option.

£6 MOON LANDER Land on any planetary body in real-time.

Both of the above programs need BASIC, which is an interpreter based on BASGF but also allowing BASIC to access the clock, and having a keyboard scanning function similar to PET's GET command. BASGC is supplied free when purchasing both of the above programs, and is **£4** purchase individually.

DISCOUNT 10% on two or more items
20% on five or more items
30% on ten or more items

All items are post free.

Also, written in machine code — MOI Mini Pilot **£6**

F DONOVAN
114, Beech Road, St. Albans,
Hertfordshire AL3 5AU



The Author's rack for the PET

On the 4th day I was beginning to get somewhere. I had worked out how to get the INPUT working without getting a SYNTAX ERROR. It took 14 days to work out what that meant. I then took another 7 days to write the program, 2 days to test it, and 7 hours running to do my estimates.

So, what am I saying about small businesses and small computers?

1. A small businessman/woman is a very busy person trying to do about 40 jobs, such as planner, designer, buyer, accountant all at once, and

never actually completing any to their satisfaction.

2. At their present state these small computers are not, but do, present themselves as toys.

3. All the people involved in selling small computers have to start being honest in their comments as to what is possible to achieve with them.

4. All necessary extras must be included in the sale price.

5. Dealers and manufacturers should realise that the computer is the perfect aid to teach people about itself.

6. Most important is what the small businessman wants of a small computer, and my conversations show it to be this:—

- check quantities; check pricing enter VAT to VAT
- v)a) Time sheets — calculate wages, tax, etc.
update 1,2,3, update VAT (expenses)
- v)b) Materials used — update 1,2,3; decrement stock
- vi) From 1,2,3,4,5, print invoices to customers.
- vii) From 1,2,3,4,5,6, print statements to customers.
- viii) Do all printing at night so that at the start of the day the boss can check them and alter as necessary.
- ix) Keep up-to-date turnover, overheads, wages, materials, vehicles, expenses, VAT, bank balance, etc.
- x) Print recommendations to pay bills.
- xi) Have all this information available all day to answer telephone and internal enquiries.
- xii) Be available as a super calculator
- xiii) Say good morning and good night.

When a man is in the office the phone keeps ringing with customers making sometimes technical, sometimes logistical enquiries, and on each call you have to make a series of quick and sometimes arbitrary decisions, and this is the area into which a small computer fits, with the following organization:—

- i) Job number initialisation
- ii) Materials order 1, 2, or 3 start sequence
- iii) Advice note/packing note — update stock
- iv) Materials invoice — update 1,2,3, verifying against 1,2,3,

I know the programming is difficult but not impossible. So we want an honestly represented aid, not a new master, to help us, not to invent more time consuming problems.

PCW The author's electrical & mechanical business goes under the name of D. Franklin, and is at 89 The Plain, Thornbury, Bristol BS12, 2AG. PCW

LOOK IN

DIRECT FROM U.S.A.

We import direct and save you money. Try our Challenger IP with Basic and graphics for only £320, or AIM65 for only £220. Complete S100 business systems from £1500.

INTELLIGENT ARTEFACTS LTD.
Cambridge. Telephone 022 020 689



TReS Bien!

The Real System — TRS 80

- 16K Level II (Keyboard with 16K memory, VDU, Cassette Recorder) £ 575.00
- 16K Level II, all above + Interface + Anadex DP 8000 Printer £1195.00
- 48K Level II, as above + expansion interface + 2 Disk Drives £1695.00

Large Selection of Software for the TRS80 available now:

- Electric Pencil £40.00
- Library 100; 100 programs and 5 cassettes £30.00
- Mailing list £40.00
- Level III Basic £15.00
- Statistics £15.00

LONDON COMPUTER STORE,
43 Grafton Way,
London, W1

Phone: 01-388 5721

You decide — we deliver.



THE NEW uHEX 480 EPROM PROGRAMMER 2704 and 2708

Control programs for Z80, 8080, 6800, 6500. Please state machine.

Programs permit programming any length block into the eprom, so even unexpanded machines can now program eproms.

Needs only +5v, +12v, -5v.

Host computers require a PIO (PIA) complete kit ONLY £35 or ready built and tested £5 extra.

PIO, PIA INTERFACE PANELS Available for Z80/8080, 6800/6500

THE uHEX 416 DELUXE EPROM PROGRAMMER Push Button Selection for 2704, 2708, 2716. STILL ONLY £65

uHEX ERASER £35

All prices inclusive. SAE for further information about these products.

MICRO HEX COMPUTERS 2, Studley Rise, Trowbridge, Wilts.

NLC SOFTWARE

Software for TRS-80 Available immediately!

- e.g. • 3-D Noughts & Crosses
- Hangman • Mastermind • Nim
- Business Package: • Payroll
- Under development: General Ledger and Stock Control

Send SAE for details to:

27 Cavendish Crescent, Elstree, Herts WD6 3JW

ANNOUNCING:

A ONE DAY INTENSIVE COURSE including: Basic Programming, Systems, etc. (50% of programming time spent using Micro's)

16 OCTOBER 1979

EUROCREST HOTEL, WEMBLEY £34.50 (inc. LUNCH & VAT)

LIMITED NUMBERS

ENQUIRIES, PROGRAMMES & APPLICATION FORMS FROM

L & J COMPUTERS 01-204 7525
3 CRUNDALE AVENUE,
KINGSBURY, LONDON NW9 9PJ

THE JOURNAL OF THE MICROCOMPUTER INVESTORS ASSOCIATION

MICROCOMPUTER INVESTOR

INVESTORS WHO USE MICROCOMPUTERS

FOR AN INFORMATION PACKET, SEND 11.00 TO:
MCIA, 902 ANDERSON DR., FREDERICKSBURG, VA 22401
BACK ISSUES ARE NOW AVAILABLE

MIKE DENNIS

"Blackberries",
Sheriff's Lench,
Evesham,
Worcs,
WAH 55A.

tel ~ 0386 870891

Hardware & software consultant
Training courses

Give Us this Day Our Business Processor

Mark Fillingham

Mark Fillingham gained more than 4½ years of data processing experience on ICL and IBM machines in Army installations in the UK and Canada during his career in REME. His insights, gained as Chief Programmer of one of the major systems on the REME computer installation, are now being put to work in his executive appointment in a Christian charity.

PCW Opinions in this article are not necessarily those of our magazine PCW

In D.R. Worsley's article "Are Small Businesses Ready to Buy" (PCW April '79) he skilfully analysed some of the psychological and practical reasons why, in general, the answer at present seemed to be 'No'. In this article, written by someone with previous mainframe data processing experience, some further pointers are offered to manufacturers and distributors as to how to bridge the various mental and practical gaps that stand in the way of progress in a potentially enormous market. The background to this article derives from the author's attempts to evaluate what would be the 'best buy' for two small charities in which he is interested.



Small businesses understand office machinery

Whilst some of Mr Worsley's remarks about the inadequacies of the office systems of small businesses may be true, many small businesses are currently small because in the current climate this is the most profitable size to be. By the trimming of staff and the automation of as much routine work as possible a small organisation may achieve a great deal of work from a small number of people.

LOOK IN

WANTED! WANTED! PETS!

Used PETS and Peripherals wanted for cash or part exchange. Best prices paid for all Machines.

FOR SALE

Secondhand PETS from £425. New PETS, HORIZONS, All Peripherals supplied at competitive prices.

FOR HIRE

Why not hire that machine? PETS, TANDY, and HORIZONS available.

PET 8K £3.75 per day
TRS-80 4K £3.75 per day
TELETYPE 43KSR £6.00 per day
HORIZON P.O.A.

Contact: **Richard Mortimore** or **Chris Phelps** at **MICRO-FACILITIES**
01-979 4546

INTRODUCTION TO MICROCOMPUTERS

by Adam Osborne

Vol 0 Beginners £ 5.40
Vol 1 + errata £ 5.90
Vol 2 + binder £17.50
Vol 3 + binder £14.50

MINE OF INFORMATION LTD.
1 Francis Avenue, St. Albans
Tel: 52801 Telex: 925859

NASCOM 1 SOFTWARE

If NASCOM supply your hardware, let us supply the software. All our programs are supplied on cassette tape with an Assembler/Hex listing, instructions and "how-it-works" description.

Send for free catalogue of programs and accessories

ANDREWS COMPUTING LTD.
21 Limetree Drive, Fardon, Chester

SS-50 USERS

CAN YOU AFFORD DISCS?

If not, is 1 Megabyte on a C60 cassette enough?

Load 8K BASIC in 16 Seconds!

- **FC-1A** . . . 4800 Baud Cassette interface £ 50.00
Also supports 300 Baud KC format (optional)
- **COS-1S** . . . Operating System for above £ 20.00
Dir; Save; Load; Run; named files etc.
- **RT-1A** . . . Real time clock board £ 50.00
- **AD-DA1A** . . . 8 bit D/A-A/D board £ 30.00
- **AD-12A** . . . 16 Channel, 12 bit A/D board £ 90.00

The above are assembled SS30 boards with software.

SS-50 Boards

- **PROM-8A**. 2708 Prom Board (2708 extra), assembled, tested £ 80.00
- **PP-1A** 2708 Prom Programmer, assembled, tested £ 85.00
- **PIA-5** 10" parallel 8 bit ports, assembled, tested £ 75.00
- **CI-1A** Power Control interface, assembled, tested £ 60.00
- **RAM-16B**, 16K, 2114 static RAM Bare Board £ 30.00
- **PROM-32B**, 32K, 2716 PROM, Bare Board £ 30.00
- **EXT-50** Extender Board £ 16.00
- **PROT-1** Prototyping Board £ 16.00
- **STRBL** Strubal Compiler, inc. editor, assemb., XREF £150.00

Specify Miniflex or SSB.

Prices exclude VAT, p+p FREE
Send large SAE for catalogue:

TOOBYFOR LIMITED
3rd Floor, 7 Euston Place,
Leamington Spa, Warwickshire.

COMPUSTAT

Continuous Stationery for the Micro Computer

All sizes of listing paper stocked. Specialists in the preparation of Printed Continuous Stationery — Design Service available —

Listing paper & OTC Stocked for the Anadex (9½") printer.

Phone or write for a quotation to Miss Allen

01-520 6038
63 ORFORD ROAD, LONDON, E17 9NJ.

People are expensive to hire, difficult and expensive to dispose of and, by the nature of the frailties of the human frame, unreliable. Office machinery, power cuts aside, if it is up to its task, suffers none of these faults. Small businesses thrive on the efficient use of good office machinery and many appreciate that an investment in machinery that may cost several thousand pounds will, over a period of years, be a better investment than additional staff.

The micro computer as a piece of office machinery

In many ways the typical micro system is the ultimate piece of office equipment since it is able, through its software, to undertake a whole range of tasks. This has been concealed to some extent by the whole approach of manufacturers and retailers. Some manufacturers such as Hewlett Packard, Wang, and IBM have configured systems simply for word processing and have sold them for this one task. For large businesses they are probably worth it, if there is any truth in the statement that the true cost of a typed business letter produced by a secretary is £5. No-one, as far as I have been able to discover, has offered a complete *integrated* software/hardware package that will

handle all the other tasks that a small business could put on such a machine.

Before all the manufacturers and distributors start complaining, there is no doubt that there is on the market most, if not all, of the necessary software and hardware necessary to make up a suitable configuration for almost any business. That is not the same thing at all. The emphasis on the present marketing attitudes seem to be that everyone is keen to sell hardware ("because that's where the mark-up is to be found") and then it is up to the user either to find his own software or to write his own. This again is something of a gross overstatement, but although it is clearly not the policy in the minds of those that sell, it is too often the policy that is perceived by the potential user.

"There's no money in software" may be the entrepreneur's dictum (though having seen the prices asked for some software one is tempted to question this) but hardware without software turns a piece of office machinery into a kind of science-fiction esoteric toy. I have yet to see anything approaching a detailed software specification in all the material I have dredged, with some difficulty, from the various advertisers in PCW. In a proper specification one would expect to see the hardware require-

ments for a given package (eg. xK bytes of memory for a word processing package, n addresses for a given mini-floppy mailing system, etc.) as well as the more obvious criteria for the specific function. Even the most chaotic small businessman should have a fairly clear idea of the number of people on his mailing list, for example. Ideally, he should thus be able to read straight out of the catalogue what system he needs to buy to fit his requirement. He couldn't care less whether it was a Z80 MPU or had an S100 bus any more than he knows the horsepower rating of the motor in his electric typewriter.

A more commercial approach

To suggest that a more commercial approach is required may offend the average reader of PCW, but the unleashing of a flood of sales by this means would benefit by reducing the cost of his equipment. A more commercial approach would involve, as was picked up by Mr Worsley, a thorough examination of the needs of small businesses. For example, a typical mailing system for a small business with, say, 2000 customers (changing at 50 to 100 a year) and 4 mailings per year would be charged, by a computer bureau producing its address labels, perhaps £50 per year

LOOK IN

NORTH STAR HARDWARE

	Kit	Ass
Horizon-0-0K	£ 475	£ 650
Horizon-1-16K-D	£ 995	£1265
Horizon-2-16K-D	£1245	£1575
Horizon-1-32K-D	£1125	£1445
Z80A Processor card	£ 145	£ 175
Hardware Floating Point card	£ 195	£ 215
16K RAM card	£ 225	£ 275
32K RAM card with parity	£ 375	£ 425
HRZ-SIO Serial port	£ 29	£ 45
HRZ-PIO Parallel port	£ 29	£ 45

OTHER MANUFACTURERS

Morrow Switchboard I/O card	£ 125	£ 155
Heuristics 20S Speech card	n/a	£ 145
Heuristics 50 Speech card	n/a	£ 225
Solid State Music PROM card with textool sockets	£ 85	£ 135
Parasitic Engineering Equinox 100 (stock clearance)	n/a	£ 475
Parasitic Engineering Equinox (w/o CPU front panel)	n/a	£ 325
Amp S-100 (IMSAI type) gold plated edge connector	n/a	£ 3
ELBIT DS1920 Model 30 (New model) VDU	n/a	£ 725
INTERTEC Intertube II VDU (employs Z80 & 6K EPROM)	n/a	£ 575

All prices given are exclusive of VAT (presently 15%) and carriage, and are correct at time of going to press.

Educational and OEM terms are available on request. Please send 12p stamp for full details.

INTERAM Computer Systems Ltd.
59 Moreton St. Victoria, London SW1

P.A.Y.E. & NAT.INS. contributions programme, for **PET COMMODORE**. With all other deductions, gross & Net Pay, a Complete Payroll.

Will do any payroll in one run and may be - Printed Out for all your Employees. Price on cassette with a listed programme **£25**.

SAE for full list of business programmes ledger, invoice.

R. JACQUES

16 MARKET PLACE, HEXHAM.
Tel: 3423

KITSWITCH: Hex-Keyboards easily wired for any format, up to 25 low bounce keys, P.C. board, Ribbon Cable, Connector. **£10.25** send for details **185 Musley Hill, Ware, Herts.** Tel: Ware (0920) 61944

DATA BANK

Our aim is to provide best quality software at the lowest possible price.

Each of our programs are fully tested by our computer staff, and we have versions for most of the popular mini-computers.

Software is supplied in the form of print out, with full documentation.

We have a standard charge of **£4** per program. (20% discount on 5 or more).

Our range is extensive, covering: Science, Business, Education, Games, Graphics and is expanding constantly.

Wanted: Your programs, we will pay **£10** for the copyright of any programs suitable for our purposes.

So buying or selling, S.A.E. to:

DATA-BANK (Mail Order Only).
66, Queens Road, Loughborough,
Leicestershire. Tel: 0509 217671

The World's Most Powerful 8-bit Microcomputer



Featuring the world's most powerful MPU —
the Motorola MC-6809

Two types of central processor are available for use in your system. The standard /09 has a maximum random access memory (RAM) capacity of fifty six thousand (56K) bytes. It can have as many as eight input/output (I/O) devices such as terminals, printers, etc, attached. This capacity is adequate for business systems requiring up to four terminals and two printers. If the application involves moving large amounts of data, or scientific and engineering calculations, our larger CPU should be used.

The S/09 CPU has a maximum RAM memory capacity of 384K bytes. It is normally supplied with 128K bytes of memory which can be expanded to 256K, or 384K by adding additional memory arrays. This CPU will support up to 16 I/O devices.

Both CPU's are designed around the Motorola MC6809 microprocessor. This is the most powerful eight-bit microprocessor available.

The MC6809 has more addressing modes than any other 8-bit processor. It has powerful 16-bit instruct-

ions, and a highly efficient internal architecture with 16-bit data paths. It is easily the most powerful, most software efficient, and the fastest 8-bit general purpose microprocessor ever.

The greatest impact of the Motorola MC6809 undoubtedly will be software related. Ten powerful addressing modes with 24 indexing submodes, 16-bit instructions and the consistent instruction set stimulate the use of modern programming techniques, such as structured programming, position independent code, re-entrancy, recursion and multitasking.

C/09 CPU	£1050 + VAT
CS/09 128K	£2100 + VAT
/09 board (will directly replace existing SWTPC processor board)	£ 195 + VAT

CT-82 Terminal



- ★ Software function controls
- ★ 56-key "Cherry" keyboard
- ★ 12 key numeric or cursor control pad
- ★ 128 control functions
- ★ Graphics capability
- ★ User programmeable character sets
- ★ Software selectable Baud rates (50-38, 400)

£550 + VAT

Write or telephone for latest brochure including 16MB disc and new printer range.

SWTPC

Southwest Technical Products Co.

CW

Computer Workshop

38 DOVER STREET · LONDON · W1X 3RB · Telephone: 01-491 7507 · Telex: 268913

PCW Book Review



Michael James

USING COMPUTERS IN PHYSICS
 J.R. Merrill, 1976
 258 pages, (Houghton Mifflin Co.)
 8" x 10" £4.35

This is a collection of programs to solve various problems in physics. Each program is given in both BASIC and FORTRAN, so there should be few difficulties in getting any of them to work, no matter what computer you have. The range of topics covered is far too large for me to discuss each in turn, but the following list should give some idea of what can be found.

- Mechanics — Motion, scattering, three body motion, coupled oscillators.
- Thermodynamics — PVT surfaces, state functions.
- Statistical physics — Gases, Ising model.
- Electric Fields — Plotting field lines
- Laplace & Poissons Equ. — Electrostatics
- Magnetic fields — Plotting field lines, motion
- Relativity — Lorentz contraction, electric fields
- Circuit theory — Resistors, capacitors, inductors
- Geometrical Optics — Ray tracing
- Fourier Analysis — Dispersive waves
- Wave Addition — Standing waves, interference

- Quantum Mechanics — One dimensional Schrodinger equation
- Nuclear Decay — Decay chains
- Solid State Physics — Reciprocal lattice, phonons.

This is an ideal book for physics teaching from 6th form all the way to 1st-2nd year degree level. My only criticisms are the lack of detailed explanation of many of the methods used, the absence of any coherent discussion of the numerical methods, and the odd way the program listings turn up away from the relevant text. Also, the results of the programs are very often presented as graphs and charts. This is slightly misleading as nearly all the programs produce lists of numbers as their answers and the graphs have to be drawn by hand — a task most would agree is best done by computer. Given a little time, the necessary graphical output could be added to any of the programs, so forming a very pleasant teaching aid.

I have tried a selection of these programs on both a SWTPC 6800 and a VECTOR MZ using CBASIC and have had no problems apart from matrix statements (eg. matrix reads and inversion) which the author assumes are available and are not often found on micro systems. It is also obvious that a larger machine than a micro was used to develop the programs, because one or two take rather a long time to run!

Although I have a few criticisms of the book's text, the programs are invaluable to anyone interested in physics or interested in teaching physics. Excellent value!



TRUMPET, VOLUNTARY

Responding to TIDBITS information or an advertisement?
 Say you saw it in PCW
 Blow your own trumpet.
 Mention your magazine.

PARKINSON'S REVAS

D.W. Parkinson

Continued from Vol.2, No. 3.

```

FB24 38 E3          JR C,NOP          ;JUMP ALSO IF<10.
FB25 0523 ;        ;JUMP RELATIVE
FB26 0524 ;        ;JUMP RELATIVE
FB27 EB 36 4A     EX DE,HL          ;WRITE "JR"
FB28 FB27 36 4A  LD (HL),J'
FB29 0528        INC HL
FB2A FB2A 36 52  LD (HL),R'
FB2B FB2C 11 32 10 LD DE,BUFFER+32;RESET DE
FB2F FB2F 18 18  CP $18          ;UNCONDITIONAL?
FB31 FB31 28 08  JR Z,UCD
FB33 FB33 E6 18  AND $18          ;ISOLATE COND. CODES
FB35 FB35 0534  CALL CCODES  ;WRITE APPROPRIATE ONE
FB38 CD 11 F9    CALL COMMA  ;"
FB3B FB3B 4D 08  CALL BYTE  ;GET OFFSET
FB3E FB3E 4F 08  LD C,A          ;PUT IN C
FB3F FB3F 07 08  RLCA          ;EXTEND SIGN THRU' A
FB40 FB40 9F 08  SBC A
FB41 FB41 47 08  LD B,A
FB42 FB42 2A 03 10 LD HL,(ADDR) ;LOAD CURRENT ADDRESS
FB45 FB45 09 08  ADD HL,BC
FB46 FB46 C3 60 F9 JP LD16B
FB49 FB49 0544  ; EX AF/AF'/JR/JR Z/JR C
FB49 FB49 0540  ; EX AF/AF'/JR/JR Z/JR C
FB49 FB49 0547  EXAETC: POP AF          ;RECOVER OPCODE
FB49 FB49 0548  CP 8              ;JR?
FB49 FB49 0549  JR NZ,JR          ;YES,GO TO THEM
FB4E FB4E 0550  ;
FB4E FB4E 0551  CALL WREX          ;WRITE "EX"
FB51 FB51 21 57 FB LD HL,EXAFM  ;WRITE "AF,AF'"
FB54 FB54 C3 1D F9 JP COPY6
FB57 FB57 41 46 2C 41 EXAFM: DB 'AF,AF', $27
FB5D FB5D 0555 ; WRITE "EX"
FB5D FB5D 0556 ;
FB5D FB5D 0557 ;
FB5D FB5D 0558 WREX: EX DE,HL
FB5E FB5E 36 45  LD (HL),E'
FB60 FB60 23 08  INC HL
FB61 FB61 36 58  LD (HL),X'
FB63 FB63 11 32 10 LD DE,BUFFER+32;RESET DE
FB66 FB66 C9 08  RET
FB67 FB67 0564 ; JP/OUT/EX (SP),HL/DI
FB67 FB67 0565 ;
FB67 FB67 0566 ;
FB67 FB67 0567 JPETC: POP AF          ;RECOVER OPCODE
FB68 FB68 FE D3  CP $D3
FB6A FB6A DA 7B FA C,CJR+1
FB6D FB6D 28 36  JR Z,OUT
FB6F FB6F FE F3  CP $F3
FB71 FB71 28 13  JR Z,DI
FB73 FB73 CD 5D FB CALL WREX          ;WRITE "EX"
    
```

Continued Page 76

PCW OPEN PAGE

THE AMATEUR VIEW

Mike Lord



MORE ON LOW SPEED BUSES

One of the disadvantages of communicating via a monthly journal such as **PCW** is the time between writing an article or letter and a reply appearing in print. This can amount to several months, and meanwhile the original author is left wondering if anyone actually read his piece.

So it was nice to see, in April's **PCW**, the letter from Mr. Siddons responding to the plea for a low speed bus standard which was published in the January issue.

In the meantime, some further thinking had taken place and so, heartened by having caught at least one reader's interest, it may be time to expand on the original article.

First, one should establish whether there is in fact a need for a standard 'low speed bus' in the personal computing world. The argument for this is that it would allow the peripheral manufacturer to produce a standard unit which would work with anyone's processor, relieving him of the necessity to design a range of wierd and peculiar interface boards, and conversely the processor designer wouldn't have to allow for strange boards being inserted in his box. Also, given a standard and clear cut interface, there should be less confusion over the responsibility for a failure in a system made up from units from different suppliers.

The second area to be examined is the actual specification for such a bus. Since writing the original item, the author has become convinced that the best choice must be the IEEE-488 on the grounds that:

- It exists.
- It works.
- It is specified properly.
- It will do the job.

Agreed it is a complicated beast, but then it does provide a comprehensive range of facilities, and it may be that the IEEE specification, in detailing exactly how every feature of the bus shall work, makes it appear to be more complicated than it actually is. And in practice, the dedicated ICs now becoming available mean that an IEEE-488 interface can be implemented with hardly any more difficulty than say a serial RS232C port. Although these controller and interface ICs are relatively expensive at the moment, they have only just been introduced, and one would expect their prices to drop rapidly over the next year or two.

So, in conclusion, a plea to the designers of the next generation of personal computers and peripherals; please include IEEE-488 capability in your next product.

Note; IEEE-488 has been re-published in an expanded form, and copies are available for \$10 + \$2 shipping and handling charge from IEEE Service Centre, 445 Hoes Lane, Piscataway, NJ 08854 U.S.A.

Pascal from Down Under

'Pipe Dream Software' of 28 Palmerston St., Berwick, Vic 3806, Australia, are advertising a suite of programs which will let you use a sub-set of the Pascal language on a 16k Level II TRS-80. Although some Pascal features have been left out, or are only allowed in a limited form e.g. the only data types are 16 bit integers and integer arrays, program listings are provided so the software enthusiast could add features to match the size of his memory.

And from the Netherlands

A bit closer to home, Lucidata of Oosteinde 223, Voorburg 2271 EG (ZH), Netherlands, have developed a Pascal compiler for 6800 users running FLEX Operating System with at least one mini-floppy and 16k RAM.

Growing Groups

Ian Dunkley has written to tell of a new group forming in the *Sheffield* area to cater for both amateurs and small business users. Anyone interested in joining should ring him on (0742) 363337 or write to 1 Prospect Place, Sheffield S17 4HZ.

A.J. Perks of 99 Hillside Rd., Corfe Mullen, *Wimborne, Dorset* is interested in forming a local computer user group with a bias towards the TRS-80. It is hoped that if sufficient interest can be stimulated, and active support from members can be maintained, a worth-while newsletter may be produced. Those interested are invited to write or ring Broadstone 697888.

On the subject of club newsletters, the North London Hobby Computer Club is now producing one inappropriately named GIGO (Garbage In = Garbage Out). As those in touch will know, the NLHCC is now one of the most active clubs in the UK. Based on the Polytechnic of North London, and so able to use many of the Poly's facilities, it has specialised groups for Homebrew, PET, NASCOM and Business Users, and organises regular courses on subjects such as BASIC and Digital Electronics. All this activity has resulted in an average of six meetings a week, and an attendance of around 150 at the main monthly meetings. For more details write to the Chairman, Robin Bradbeer: NLHCC, c/o The Polytechnic of North London, Holloway, N8 8DB.

Another newsletter received recently was that of the *TRS-80 User Group*. The group is independent of Tandy, and the newsletter carries hardware and software tips and news of TRS-80 related products. The group is also organising a software exchange scheme. Anyone wishing to join is invited to contact: B.C. Pain at 40a High St., Stony Stratford, Milton Keynes, telephone: (0908) 564271.

Like many other groups which are based on colleges or universities, the *Southampton Amateur Computer Club* has closed for the summer months, and will start up again in October with regular monthly meetings. Just before going on holiday, the SACC had been offered an IBM 360/40 and were trying to find a suitable site to house it. If they do take it, they would obviously be interested to hear from anyone living locally who has 360/40 experience. For more details of this and other club activities, send a SAE to SACC c/o Students Union, University Road, Southampton SO9 5NH.

Geoff Phillips of 8 Poolsford Road, London NW9 6HP has started a newsletter for owners of *SC/MP* based machines like the *MK14* to help them get to grips with their processor, and to provide a means of communication between users.

Similarly, Jim Cunningham is setting up a club for users of systems such as *Cosmac* and *ELF* which are based on the *RCA 1802*. Those interested are invited to send a SAE to 7 Harrowden Court, Harrowden Road, Luton LU2 0SR.

And, continuing the theme of clubs devoted to specific types of hardware, the *Sorcerer Program Exchange Club* has been formed to act as a clearing house for program ideas and helpful hints on the use of this micro, and is being run by M.P. Hannaby of 65 Trafalga Road, Birkdale, Southport PR8 2NJ.

The *South Yorkshire Personal Computer Group* is now flourishing and holding meetings on the second Wednesday of each month at the University of Sheffield; details from SYPCG secretary Tony Rycroft, 88 Spinneyfield, Moorgate, Rotherham, S. Yorks.

Finally, those wishing to publicise their group are invited to get in touch with Mike Lord at 7 Dordells, Basildon, Essex; telephone: (0268) 411125.

AMATEUR COMPUTER CLUB ON SHOW

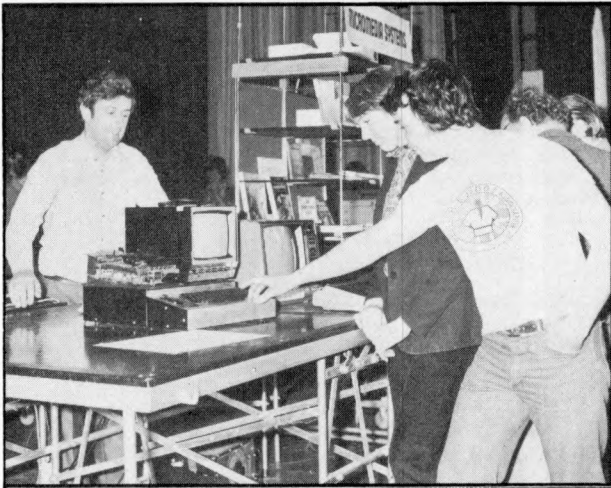

L H Side. *Pete Hesketh, Secretary/Chairman*
R H Side. *Tim Robson; Basic, Karate and Assembler Expert.*

As quite a few of the members of the Gwent Amateur Computer Club are Radio Amateurs it came as no surprise when someone suggested that the Club should get involved with the Mobile

Radio Rally at Barry, South Glamorgan, organised by the Barry College of Further Education Amateur Radio Society.

In the past this event has not had any home computer exhibitors, but this did not stop the Club from having a go. In fact as the only Welsh computer club (go on — prove us wrong) they felt duty bound to enlighten the hordes of Hams as to the interest and fun to be had with microcomputers.

Bob Robson (call sign GW8AGI) was volunteered into being the link-man (his son Tim is the one administering a Karate chop to his Triton in the picture) and came to the next meeting to say that he had reserved 50 feet of display space.

When the day arrived the Club managed to install and demonstrate a Triton, a Nascom, an ETI System 68, a North Star Horizon with floppy discs and a couple of PETs, including one with a bright orange case. Needless to say, with all that high technology connected to one 13 amp plug, there was a low technology disaster and the main fuse blew for part of the building.

In spite of all this there were plenty of people interested and the event was pronounced a success — well, at least one new member joined the club.

For a list of future events, contact the Events Secretary, Hugh Harrison-Allen, Newport 50528.

Peter Hesketh, Hon.Sec., Gwent ACC.

AMATEUR COMPUTER CLUB

Membership forms for the current year have now been despatched. The current annual subscription is £3.50 except for members under 16 or over 65 years of age, where it remains £1.

New applications for membership can be sent to Derek Ellis, Membership Secretary of 82 St. Albans Road, Kingston, Surrey. Please do not send money with your letter as the payments are to be made by giro.

We consider applications from all walks of life be you politician or an (unwilling!) guest of Her Majesty.

*Derek Ellis,
Membership Secretary, ACC.*

POP SHOP

The PCW Open Page Service for amateurs. Buy, sell, exchange —

One-off advertisements only accepted. Not more than 50 words.

FOR SALE

Unused PET 2001 8K plus some software, tapes and books.
£500 ono.

Phone Jack Stacey 01-242 0372 day or 01-837 1843 even.

MK14 kit, complete, brand new £31 (Saves £15) 01-937 3378

NASCOM 1 for sale, built and tested with power supply, stack of programs plus all the documentation, superb vero case is available if required. £190 ono. For more details phone Chris Smith, after 6pm 051-336 1633 (Liverpool/Wirral Area).

NASCOM 1 MICROCOMPUTER FOR SALE

Fitted with 2k Basic Interpreter, Completely Assembled and Working. Power Supply, Astec T.U. Modulator, all documentation, and original Nasbug Monitor all included.

£220

Phone Colin on Alfriston 870081 (E. Sussex)

KIM 1 £50

Enclosure plus for KIM £10

Store plus for KIM (8k RAM plus sockets for 8k EPROM)

£100

George Risk ASCII keyboard in metal Enclosure £60

Newbear Petivid £50

Texas TI 58 Programmable calculator £40

All with full documentation including 1st Book of Kim.

V.J. Day 068-45 4930 Malvern (Evenings)

Elliott 250/203 optical tape reader 250 Characters per second. Will take 5, 6 or 8 hole paper tape. Self contained unit includes run-out sensor and built in fan. Dimensions 25 x 16 x 24cm. £30 ono.

Mr. A. Lister, 37 Park Road, Prestwich, Manchester M25 8ES
Telephone: 061 740 6531 evenings and weekends

ICL HIGH SPEED TAPE PUNCHES 110 Baud VGC £40 ono
Also cased unit containing Punch, Optical Reader 220 Baud and auto tape Feeders. Very modern, very smart.

Ring 061761 4566 (Bury) after 6

MK14 Cased, PSU, High Quality Reedswitch Keyboard, extra RAM, RAM I/O, revised monitor, single step, fully decoded, expansion connector for Data Address and Control Bus. National Semiconductor Programming and Applications Manuals, Kemitron Programming Manual, Assembler + other software.

£60 ono or £100 with VDU Board
Ring 0204 694265 (Bolton)

MK14, extra RAM, RAMIO, Monitor, P.S.U., Cassette Interface, S/S, improved keyboard.

All Assembled, £55.00

Par 4606 (Cornwall)

NASCOM 1 with 8A power supply, 2K B-BUG and scientific calculator. Built into smart case £195

NASCOM 1 with 3A P.S.U., T2 Nasbug, Astec modulator and 10 data tapes, £145

12" Video Monitor/UHF TV £39

Nottingham (0602) 877037 Steve.

PET TAPE LIBRARIAN, professionally written program with full documentation.

Keeps track of the contents of all your cassettes — or anything else for that matter. List, save, read, insert, delete, auto-amend.

For cassette + booklet send £6 to M. Fielden, 14 Slade Road, Portishead, Bristol or SAE for datasheet.

NASCOM SPACESHIP LANDING SIMULATOR; Runs on Standard Nascom-1, allows variation of initial height, speed, gravity and fuel. Full listing with flowchart £2.50, other programs available.

Chris Blackmore

31 Herne Rise, Ilminster, Somerset TA19 0HH

S.O.C. MK14. Built and Working. Fully Socketed, PSU, Additional RAM, Manual and Other Info. Cost £60, sell for £45. Ring Charing (Kent) 2161, Eves. + Weekends.

Tim Pittman (creator of Tiny Basic) thinks the 1802 is a marvellous micro; and so do I. If you agree, contact **Nick Smith, 16 The Fairway, South Ruislip, Middlesex, HA4 0RY.** Get the 1802 moving in Britain!

I still have a few TRS80 Circuits, 4 Sheets large size, send large SAE. Also for Sale: **Boris Computer Chess Unit**, which plays advanced chess games, which talks back. Also includes a Wood Hand Carved Board + Metal Chess Pieces in gold & bronze of high quality. Values at £270 I will sell the lot for **£150. A Bargain Sale.**

P. Turner, 14 York Way, Thetford, Norfolk
Telephone: Thetford 61648

SWTPC 6800 COMPUTER

New, unused, works tested and checked out. MP-A2 (8K ROM) CPU, MP-B2 backplane, I/O, 32K single-board RAM, CT-VM monitor, CT-64 2-pg. screen-read terminal, I/O, AC-30 dual cassette, 2.3 BASIC and CORES, complete documentation. Presently at Peterborough. Only **£895** delivered.

Langdon Proctor, Johannevej 26,
2920 Charlottenlund, Denmark. Tel (01) 63.68.55.

5 Volt Power Supply (Bear-Bag 3) built and running **£15**
Tel: **0775-2359 Keith Bean**

FOR SALE

NASCOM 1 Ready Built, Complete with Power Supply, Processor, Power Supply and Keyboard, beautifully encased. Ready to go — just add T.V.

Must be Seen at **£199**

A.H. Bhatti
139 Wentworth Road, Southall, Middx.
(01-574 5038 after 7pm)

FOR SALE

Burroughs 7 track 556 B.P.I. Data Recorder, with tapes if needed. Best offer over **£90** or w.h.y.

Phone **Hook (025672) 2860** after 6.30pm or weekends

Wanted: Personal Computer World Volume 1, Numbers 5 and 9.

D. Wright, 37 Greswolde Road, Solihull, West Midlands,
B91 1DY.

FOR SALE

IBM Golfball Typewriter, easily converted to Output Printer v.g.c. **£240**

73 Clover Nooke, Old Redbridge Road, Southampton

TRITON COMPUTER Full on Board RAM 4k, complete system with professional 9" video monitor & cassette recorder, **£400.00 complete**

Also **NASCOM 1** fully cased with power supply, T2 & B-BUG **£200.00**

Both Units fully operational.

Phone: **0743 72 3838 (Shrewsbury)**

FOR SALE

TECHNOMATIC, 'P.E.' MEMORY MAPPED VDU, Easily Interfaced to most Micros' and supplied with full data and straightforward interfacing details for MK14. Built and working, with Astec Modulator for Direct Connection to UHF TV.

£40.00

Also Unbuilt PROM Programmer for MK14 as Supplied by SOFC.

£10.00

M.G. Bay
21 Campion Road, Westoning, Bedfordshire MK45 5LB

Two Months Old **PET 32KN**, New Qwerty Board. Hardly used, including two cassette tape decks and many Petsoft + Commodore Programs.

For Sale at **£790.00 ono**
Tel. **01-940 3930**

WANTED PET 2001-8

N. Worthington, 18 Iffley Road, London W.6.
01-748 1074 evenings/weekends

SORCERER 32K C/W tape deck, leads & manuals as new condition. **£750.00**

Ring Kimpton (0438) 832737 evenings
(Mr. C. Thompson)

VIATRON DATA MANAGEMENT STATION

9" Monitor; 73 Station keyboard; Control unit, containing — RAM, ROM, dedicated microprocessor, VDU, and cassette boards, 2 built in read/write data cassette units, and detachable modern power supply. (+ operators manual).

£200.00 ono

Write to: **Mark Wirt, 12 Alleyn Cr. London S.E.21.**

MK14 — Full Working Order, Improved Monitor, Power Supply, Additional keyboard, fully socketed and including edge connectors. **£50 plus postage**

D.R. Thomas

31 Woodcraft Close, Tile Hill, Coventry.
Tel: **Coventry 468346** weekdays after 6pm

FOR SALE

Must sell **Teletype 33R0 friction feed RS232 interface** excellent condition with manuals, spare ribbons and rolls of paper. Also **KSR keyboard**. Offers in the region of **£160** for the lot — might split.

Phone **P. Chamberlain (0293) 515201.**

MK14 Built, and fully working with all I.C.s socketed. Keyboard improved. Four books incl. manual. Buyer collect. **£35**
Ring Folkestone 77314 after 7pm

FOR SALE

ATARI COLOUR VIDEO COMPUTER SYSTEM, Two Sets Paddle Controllers, 1 Set Joysticks, 6 Cartridges — Space War, Combat, Air Sea Battle, Basketball, Video Olympics + Breakout — 6 months guarantee left.

£195.00 ono

Mr. S.K. Woolgrove
23 Tavistock Av, Mapperley Park, Nottingham
Tel: **0602 602081**

FOR SALE

WESTREX BRPE 20 PAPER TAPE PUNCH (ex-equipment) as type mentioned in article **PCW July 1978. £80**

Phone: **M. Sein 01-855 3235** (Evenings/Weekends)

FOR SALE

C.P.U. BOARD. All switches and all L.E.P.s. Mon 1 Board all Socketed. V.D.U. board all socketed all fitted into a vero card frame with a prototype front panel + power supply unit.

£130 will separate

Apply **Mr. J.K. Newman, 2 Carlton Drive,**
Benfleet, Essex.

Phone **0702 556891**

MK14, Tape Interface & Power Supply. **£50.** Ring Steve
(London NW11) **01-458 3932**

Ex. Tel. Engineer and Programmer wishes to gain experience on Z80 with CP/M. Willing to help local small business set up. Weekends and alternate Mondays available for on site.

Expenses only

Phone **Barry Cooke**
Cheltenham (0242) 41584

AS NEW 16K APPLE II with Applesoft Card, Cassette, etc. Hardly used. Owner going abroad. **£975 — 01-351 0639**
after 8pm

FOR SALE

SMALL SYSTEM HARDWARE TRS232 Printer Interface for TRS-80 with 240v power supply and driver software — **£25**
ADVENTURE 3 (Mission Impossible) 16K tape for TRS-80 **£6**

SINCLAIR PROGRAMMABLE, Mains adapter, Program Library — **£12**

SCOTCH COPIER only 200 copies made — **£40**

Tel: **Dave Holloway**

Asthall Leigh 241 (Evenings/Weekends). (near Oxford)

16K TRS-80 Level I/II (switchable) and CLOAD, mods done by TANDY. Some Software including CHESS and T-BUG. **£640**

061-320 8512 Daytime

FOR SALE: OSI Superboard II £230
M. Lawrence Guildford 31234 ext. 262.

PCW Vol 1

KCAB

NUMBER

Sold Out — No. 9
Sold Out — No. 7
Sold Out — No. 5
Sold Out — No. 4
Just a few left of — Nos. 3, 6.

If you think No. 10 will be available in 2 months' time — don't count on it. Nos. 1, 2, and 8 are still in good supply.

Think of the future — Look Backwards!

NEW LOW PRICE FOR LEVEL I BASIC 4K RAM



£375 +VAT

(TOTAL £431.25) OLD PRICE £531.34 inc. VAT at 15%

TRS-80 Microcomputer the world's biggest selling personal microcomputer

This is a fantastic opportunity to own a TRS-80 personal microcomputer. Designed and built by TANDY, the TRS-80 is the world's biggest seller, with over 100,000 in use. The 'silicon chip' revolution is here, now, at your nearest TANDY store. If necessary you simply add-on extra modules to suit your individual requirements. See a TRS-80 at your Local TANDY today.

- * Level refers to version of BASIC computer language.
- * 4K is size of Random Access Memory Capacity.
- * Both Level & RAM can be extended.
- * All systems include 232 page users manual & games cassette program.
- * No prior knowledge of computing is required to use the TRS-80.
- * Fully wired and tested - NOT a kit.
- * Designed and Manufactured by TANDY Corporation.

From August 1st new, low prices will also extend to the following TRS-80 systems.
 26-1003 LEVEL I 16K
 26-1004 LEVEL II 4K
 26-1006 LEVEL II 16K
 Clip the coupon or check at your nearest TANDY store for full details.

26-1001



SAVE £100

TRS-80 Expansion is easy!—Just add the units to suit your needs.



TRS-80 LINE PRINTER
 Prints from 10 to 16.5 characters per inch at speeds from 60 to 110 characters per second. Requires 4K RAM Level II and Expansion Interface. 26-1150 **£1,063.74**
 With tractor feed. 26-1152 **£1,202.16**



TRS-80 MINI DISK SYSTEM
 Gives more data storage and greater operating speeds. 35 tracks. 89,000 bytes per diskette. Transfer rate 12,500 bytes per second. Requires 16K RAM Level II and expansion interface. 26-1160 **£478.10**



TRS-80 QUICK PRINTER
 Produces copy at rate of 150 full lines per minute on 4.75 inch roll and provides user software selection of 20, 40 or 80 characters per line. Requires Level II, Expansion Interface. 26-1153 **£456.80**

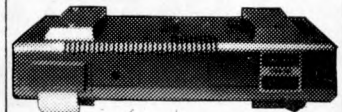

TRS-80 EXPANSION INTERFACE
 Upgrade your system as your needs increase. Contains sockets for additional 16K or 32K RAM, disk controller for up to 4 mini disks, software selectable dual cassette use. Centronics parallel port, real time clock. Requires Level II Basic. 26-1140 from **£243.84**

Offers subject to availability. Instant credit available in most cases. Access, Barclaycard and Trustcard welcome. Check your telephone directory for your nearest store.

OVER 170 STORES AND DEALERSHIPS NATIONWIDE.

KNOWN AS RADIO SHACK IN THE U.S.A. MAKERS OF THE WORLD'S BIGGEST SELLING MICROCOMPUTER TRS80.

TANDY

BRINGING HIGH TECHNOLOGY DOWN TO EARTH

Please send full details and new low prices of TRS-80 systems.

NAME _____

ADDRESS _____

PHONE _____

TANDY CORPORATION, BILSTON ROAD, WEDNESBURY, W. MIDLANDS, WS10 7JN.



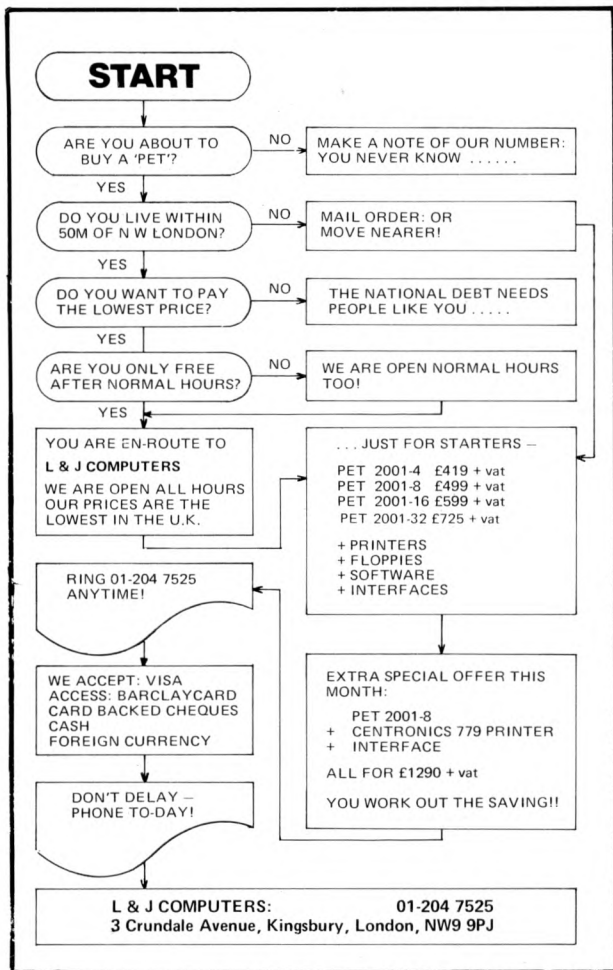

V. & T. ELECTRONICS

CPU CONTROLLED CASSETTE DECK

Connects to any 8 bit IO port & UART, full CPU control of fast forward, reverse, read and write, searches tape under software control for named files at up to 50 inches per second (Z80 software supplied) includes high speed CUTS interface - 2400 baud i.e. 1K bytes in 4.2 seconds. One C60 tape holds 860K bytes, ideal for NASCOM 1. Supplied ready built, not a kit, includes a.c. mains power supply. **£110 + 15% VAT**
Postage & packing £2.00

Please call for demonstration

FULLY Relocatable assembler for NASCOM 1 (easily converted to other systems) supports pseudo-ops + all Z80 opcodes, includes powerful text editor, uses approx. 3½K memory, all work areas programmable. Supplied on tape. **£10 + VAT**

2716 Eproms Intel Ex. Stock **1 off £23.50**
4116 16K Dynamics 200ns **8 off £56.00**
2114 4K Statics 200ns **2 off £10.00**
Z80A **1 off £14.00**
Z80 PIO **1 off £10.00**

NEW!
TRS-80 16K upgrade **£57.00**

We are usually open 7 days a week until very late, please phone first before calling. **Please add 40p p&p.**

**82 CHESTER ROAD,
LONDON N19
01-263 2643**

NEW VLC 8 × 4 Configuration only £4675.

Three reasons why you should buy our computer.



1. It is manufactured in England to an exceptionally high standard— so we can give 12 months material and labour warranty.

2. Its performance is outstanding, transfer rate between disc drive and computer is guaranteed not less than 1 sector per 0.166 seconds. Analogue to digital conversion cards available. Also including a facility for additional V.D.U's.

3. Total Software Business Package at approximately £1,200.

Vlasak Electronics Limited, Thames Building, Dedmere Road, Marlow, Bucks. Tel: Marlow (06284) 74789. Telex 847008. Dealers enquiries welcomed. We are also a main dealer for Apple 2 and PET.

64K Computer VLC 8 × 4 (£1990), 1.2 Megabyte Disk Drive (£1890), 1 VDU inclusive of connecting card (£795), Total £4675. 1 Bi-directional Matrix Printer from £855. connected or 1 Daisy Wheel Printer from £2450 connected. Each additional Disk Drive £1100. Each additional VDU £795.

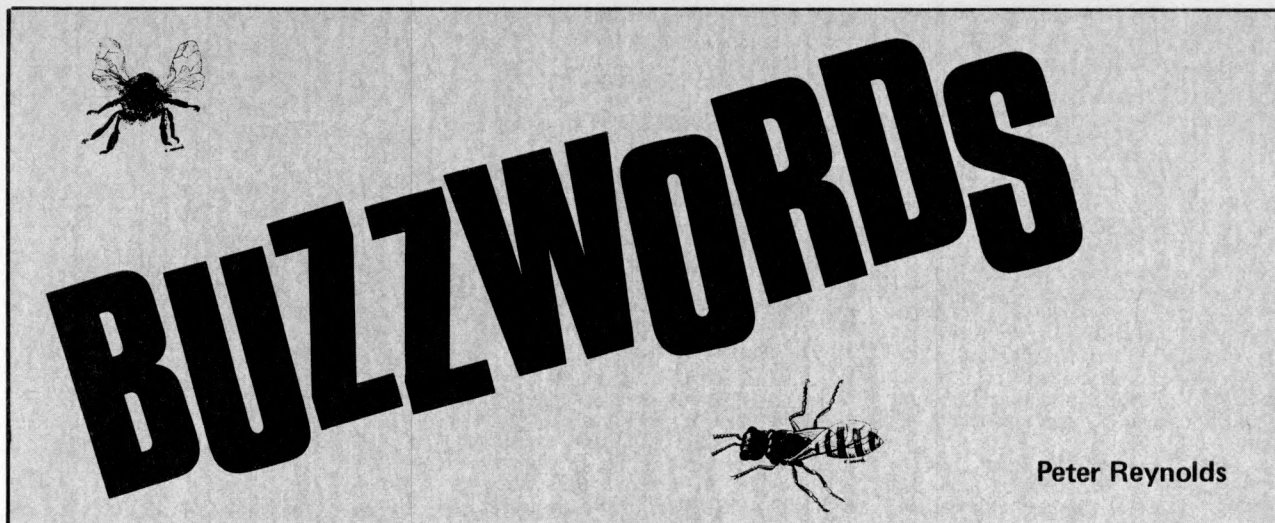

Peter Reynolds

Half-Add. A process of combining two sets of binary numbers to produce a third with 1 bits in those positions where the two *operands* differ and 0 bits where the operands coincide. The process is like addition but ignoring all carry figures.

Half-Adder. Logical circuit, with two outputs (S and C) and two inputs (A and B), which achieves the following relationship between input and output:

Input		Output	
A	B	S	C
0	0	0	0
0	1	1	0
1	0	1	0
1	1	0	1

S denotes "sum without carry" and C denotes "carry." Two half-adders may be used for performing binary addition.

Half Duplex. A system for inter-connection of data transmission devices, such as teleprinters linked by ordinary telephone wires, so that one can send and the other receive, or vice versa, but they cannot both send at the same time. Whatever one sends from a half duplex keyboard is normally displayed or printed locally as well, whereas with a duplex system only what is sent or echoed from the distant station will be shown. Synonymous with *Simplex*.

Halt Instruction. Synonymous with *stop* in a computer program. The program terminates when it reaches this point.

Handshake. An exchange of signals between a computer and a peripheral device which establishes synchronisation for transmission of data.

Hands-Off. Operating without personal attention. The phrase is used particularly of program testing when the programmer hands his work over to a computer operator and in no way attends the machine during the testing process. A print-out will usually be delivered to show the result of the test in some detail and there may also be a listing of the contents of memory at some crucial stage. The programmer working through these papers afterwards will see if any trouble was encountered and, if so, may be able to deduce part at least of the cause. Hands-off working makes it easier to estimate the length of program testing sessions on a computer and is of particular value when machine time is in more critically short supply than the time of programmers. It tends to take the search for programming errors and bugs one step at a time and when the first fault or two have been identified and corrected the next hands-off testing session will probably reveal further snags and so on. By contrast, when a skilled programmer is allowed the run of a machine for some

hours at a stretch he will usually manage to take his work through several successive stages of redevelopment in the course of a single session.

Hands-on. Under direct personal control; normally used of a machine where this method of working might not be expected, for example, in traditional mainframe work where the programmer operates the computer himself and possibly manipulates the console to correct or circumvent minor errors that come to light.

Hang-Up. An unintended stop in running a program.

Hard Copy. A legible copy in conventional characters. For example, when a typewriter is used to feed *input* into a computer, either by direct connection of electrical impulses or by preparing punched paper tape, a conventional record of what is typed is produced simultaneously on ordinary paper; this is known as the hard copy.

Hard Data. Properly established and quantified or identified facts or statements, for example, the items reflected in an audited profit and loss account or balance sheet. By contract *soft data* is less certain or specific, for example, the chairman's announcement that improved results may be expected in the next year.

Hard Error. A computing fault that occurs predictably and can usually be traced to some physical malfunction of equipment. Contrast with *soft error*.

Hardware. A general term applied to all parts of the computer and its equipment — the central processor, memory units and peripheral devices. To be distinguished from *software*.

Hardware Check. A test of data for completeness or accuracy effected by permanent logical circuits in the machine. Contrast with *programmed check*.

Hardware Lock. An electronic arrangement whereby certain parts of a computer are not accessible to, and cannot be influenced by, other programs or by inadvertent action on the part of the operator.

Hardwired. Descriptive of computer facilities (for instance automatic computation of mathematical functions) when they happen to be provided by permanent circuits (or hardware) rather than by sub-routines or software.

Hash Total. A total (or the least significant part of a total) of the various numbers involved in some piece of data transfer which may be taken without regard to whether or not the values derive from true numbers or alphabetic characters which can have a numerical equivalent. A com-

parison of hash totals taken before and after processing will usually indicate whether or not any data has been lost or corrupted in the process.

Head. A device to read, write or erase data in a (typically magnetic) storage medium. This is comparable to the heads in a conventional audio recorder.

Header. Information at the start of a set of records to identify those records before they are processed.

Header Label. Header information typically related to a larger collection of records, such as a complete magnetic tape or disk. The machine-readable code in the label may, for instance, identify the tape or disk number, name and date of last updating.

Head Gap 1). The distance between a magnetic read/write head and the surface of the disc (or other device) it serves.

2). The slot in a read/write head which provides the point of focus of the magnetic reading or writing process.

Heat-Sensitive Paper. Paper coated with a substance which darkens locally in response to heat. Such paper is used in thermal printers, where the matrix print head floats across the platen (or roller) in light contact with the paper but without any impact.

Head Shunt. A tool, typically embodying a lump of copper or other good conductor of heat, temporarily attached to a transistor or other component while it is soldered in position. The shunt absorbs surplus heat from the molten solder which might otherwise damage the component.

Heat Sink. A metal attachment which increases the surface area of a transistor or electronic switch dissipating a large amount of energy as heat and so helps to keep the device within its designed limits of operating temperature.

Henry. The standard unit of electrical inductance (named after Joseph Henry 1797-1878). In practice the inductance of a coil is typically measured in millihenries (one-thousandth of a henry).

Hertz. A standard unit of frequency or periodicity, being one cycle per second. A pendulum beating twice a second has a frequency of 2 Hertz; the usual electricity supply in the U.K. has a frequency of 50 Hz (in the U.S.A. 60 Hz). The term was generally adopted about 1967 in commemoration of Heinrich Hertz, the German physicist who, in 1888, was the first to demonstrate the electrical production of radio waves.

Hesitation (term now rare). A brief and effectively imperceptible interrupt in the main activity of a processor, during which some other work is momentarily advanced.

Heuristics. Achieving a solution by deliberate trial and error.

Hex. Abbreviation for hexadecimal.

Hexadecimal. A numbering system based on the radix 16 (as the decimal system is based on the radix 10 and the binary system on the radix 2). "Hex" uses A, B, C, D, E and F for the values 10 to 15 respectively and is most often met in machine language programs and memory addresses.

High (state). The output of bistable devices can be either high or low, according to the level of voltage present at that point in the circuit. High is generally identified with a voltage of some 40% or more of the nominal line or supply voltage. Low is ideally zero volts and should certainly not exceed an agreed voltage, say 25% of supply.

High Level (Language). Powerful program coding system generating more than one machine instruction for each instruction written by a programmer, for example, BASIC or FORTRAN. High level languages tend to save programming time at the expense of greater use of hardware and slower processing. Interpreters or compilers, provided by the computer manufacturers, are required to make machine-usable instructions from high level language programs and they usually require to be run on a computer above a certain size. Selections of high level languages are sometimes available for smaller computers for example, TINY BASIC.

High Order (bits). The left hand or most significant group of digits in a number, especially when it is expressed in binary or hexadecimal notation. Beware, however, of identifying high order numbers by where they appear: in hexadecimal memory addressing the low order part is normally entered before the high order part.

High Speed Printer. Peripheral device for computer output which prints a complete line of data at a time, at a speed of usually not less than 300 (sometimes 10,000) lines a minute. A typical line of print accommodates up to 132 (or 156) characters. Synonymous with *line printer*.

Highway. A communication *channel* which may be shared by several devices. Synonymous with *bus*.

Hit. The fault condition in a magnetic disc unit when a moving read/write head comes into actual contact with the rotating surface. This can damage the equipment and lead to loss of data.

Hollerith. System of encoding data on punched cards for subsequent sorting, counting and tabulation by electro-mechanical machines. A direct forerunner of the punched-card family of computers. Named after Dr. Herman Hollerith who applied his invention to the US census in 1890.

Home. Base or starting position for the cursor on a visual display screen, typically in the top left corner.

Homebrew (of a computer system) home-made, implying some originality of design and personal wiring, though standard components and units may be included.

Hot. A terminal at a high voltage and therefore dangerous (or unpleasant) to touch.

Housekeeping. Computer program instructions which are necessary for its processing but which do not form a constructive part of any application program; for example, instructions to pack or rearrange data in some form to suit the peripheral devices which happen to be attached. A feature of sophisticated housekeeping software is

that it tends to demand exclusive use of a large area of core which must be disregarded in taking stock of the amount available for normal computing purposes; a multi-programming computer with 64K characters of memory might have more than half this storage committed to house-keeping software.

HT. High Tension, an electrical voltage at say 100 volts or more, possibly much more.

Humidity. The extent of moisture in the atmosphere — normally measured in degrees of relative humidity (RH), since absolute humidity varies with ambient temperature. Material such as punched cards and paper tape can be affected by the humidity in the atmosphere in which it is stored, and it then becomes desirable to transfer it to a humidity-controlled atmosphere to get acclimatised before feeding it into a fast reading or punching machine.

Hunting. The oscillation of some automatically controlled system around a standard value it is seeking to reach without success. A domestic example may be found in central heating radiators which are turned off by an air thermostat only after they have become too hot and are turned on again only after they have become too cold.

Hybrid. A combination of different technologies, for instance the linking of digital and analogue computers for some special purpose, e.g., in industrial process control or an aircraft flight simulator.

Hysteresis. A physical property of delay in completing a change of state. In electronics a notable example is the timing of the build up and subsequent decay of magnetic fields.

Hz. Hertz (abbreviation). A frequency of one cycle per second.

BRISTOL COMPUTER CENTRE



At the Bristol Computer Centre we have a complete range of professional micro-computer systems. Not kits or toys but fast, reliable systems that will get the job done . . . without fuss.

We are the main agents in the South West for Modata, SWTP and Commodore. So we can supply just about any system, for any task — from a 4 k-byte PET to a 28 m-byte advanced Modata hard-disc

communicating system.

And all our systems have a choice of visual display units, printers and other peripherals plus full maintenance support.

Software packages including stock control, order-processing, word-processing, accounts, etc can give you instant control of your business.

Telephone now for a demonstration and see for yourself.

THE
**BRISTOL
COMPUTER
CENTRE**
MICRO HOUSE,
ST. MICHAEL'S HILL,
BRISTOL
TEL: 0272 23430

DPS-1

Introducing the DPS-1 the full IEEE S100 bus computer system from Ithaca Intersystems — the S100 experts.

FOR EDUCATION, INDUSTRY, RESEARCH and all professional uses, including hardware and software development, low cost OEM systems, teaching applications etc.

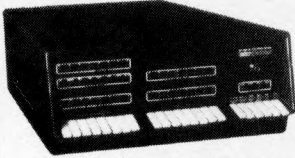

A MINI COMPUTER using MICRO technology at a ridiculous MICRO price!! The front panel with a backplane and power supply accepts S100 bus boards from many manufacturers.

Just look at these professional features!

★ **FRONT PANEL** (we won't ask you to debug our hardware, but we will give you the tools to debug yours!) Has lights and switches to allow inspection and control of addresses and data. Other features include programmed input switches, and output lights, Examine, Examine next, deposit, deposit next, single or slow step (0.1 to 1000 IPS), hardware breakpoint on any data or address byte, repeat instruction and many other hardware diagnostic facilities.

- ★ 30 Amp, 8V power supply. 5 Amps on + 16v rails (all rails are separately fused)
- ★ 20 slot IEEE S100 Motherboard with active termination and shielding between bus lines
- ★ Suitable for 6800, 6502, 8080, 8085, Z80, Z80A processors.
- ★ Guaranteed operation at 4MHz.

The **DPS1** comes as a mainframe with front panel, Motherboard, power supply and 4MHz Z80A cpu board. The system is truly modular allowing the user to build up the system he requires in his own time. S100 boards from a number of manufacturers will plug into the DPS1 IEEE S100 bus.

Just add S100 Memory Boards — S100 disk controller boards — S100 I/O boards — S100 video and/or graphics boards — S100 EPROM boards

All Ithaca Intersystems OEM products including K2 disk operating system and PASCAL/Z on 8" floppy drives will run in the DPS-1.

Fully assembled and tested

- DPS-1 with S100 4MHz Z80 cpu board **£695**
- DPS-1 less S100 4MHz Z80 cpu board **£645**

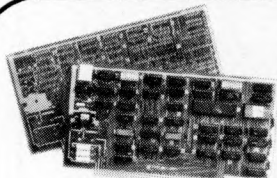

OEM S100 boards from the experts!

8K Static RAM board (45 ons)	Assembled and tested £123.75
8K Static RAM board (25 ons)	£146.25
Z80 cpu board (2MHZ)	£131.25
Z80 cpu board (4MHZ)	£153.75
2708/2716 EPROM board	£63.75
Prototype board (bare board)	£18.75
Video display board (64x16, 128U/L Ascii)	£108.75

New products from Ithaca audio!

High density graphics (1024 x 512 points)	£660.00
Disk controller (up to 4 single or double sided drives)	£131.25
I/O board (serial and parallel outputs)	£210.00
S100 front panel (as used in DPS1)	£245.00
Analogue I/O board	£295.00

Available soon: ZBC-1 Single board computer for OEM market. Available in basic through to fully expanded. 4MHz Z80A, 64K RAM, memory mapped 4K screen buffer, composite video, up to 16K power on EPROM monitor, 4 parallel ports, 2 serial ports, 4 channel counter timer. 1 off **£895** — please phone for a quote for your needs. (quantity discounts available).

Over 15,000 boards delivered worldwide

InterSystems

Software for your S100 system

K2 operating system

8" disk based operating system — distributed on Shugat compatible 8" floppy disk ★ TED — 52 command character orientated text editor with Macros. ★ PIP — File and directory handler. ★ ASMBLE — full Z80 2 pass assembler. ★ HDT—Hex debug tool. ★ QCI—Utility overlay/command decoder. ★ SYSGEN—System builder. ★ COPY— disk to disk file copier. ★ DUP—disk duplicator. **£56.25**

PASCAL/Z The new language for Micros **£131.25**

Runs under K2 operating system.

★ Compiler that produces Z80 macro assembler code — NO NEED for slow run time P-code interpreter. ★ Comes complete with Macro assembler. ★ Produces binary object modules — small and fast.

★ Modules are re-entrant and can be put into ROM. ★ IMBED, TRACE and ERROR debug facilities. ★ Recursion

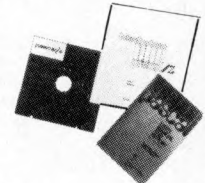

ASMBLE/Z Z80 Macro assembler **£37.50**

★ Full 2 pass Macro Assembler. ★ IF and ELSE — 255 nesting levels. ★ Produces symbol table. ★ Relative jumps.

UP-GRADE KITS

Trying to add computer memory is not much fun if you don't get everything you need. Receiving unprogrammed jumpers and having to program them yourself is not much better. Most important, that's the place where the problems are introduced.

So Ithaca Audio's better idea is the Simple Up-Grade. Each Simple Up-Grade is specially designed to make adding memory foolproof. We include all the parts you'll need; 8 prime, tested 16K RAMs, along

with concise step by step directions and diagrams. And if a personality jumper is required, it's *premade*.

The TRS-80* memory expansion was our first Simple Up-Grade. Now there are two more — for owners of Apple II** and Exidy Sorcerer*** computers. Each kit is 100% guaranteed — if a part ever fails, we replace it FREE. Your Ithaca Audio dealer has them in stock, only £69. Now you can afford to add high quality, high density memory to your



system for remarkably little — far less than you would expect to pay from Radio Shack, Apple, or Exidy directly. These Simple Up-Grades are Ithaca Audio's first step in adding more capability and reliability to your computer at lower cost. Other Up-Grades are on the way to your dealer now.



CONTACT THESE DEALERS

All prices quoted are exclusive of VAT.

NEWBEAR COMPUTING STORE—Telephone: Newbury (0635) 30505 Telex: 848507 **SIRTON PRODUCTS**—Telephone: 01-660 5617
AIRAMCO — Telephone: 0294 57755 Telex: 779808 **COMPSHOP LTD** — Telephone: 01-441 2922 Telex: 298755

UK & EUROPEAN DEALER ENQUIRIES INVITED — CONTACT NEW EUROPEAN SUBSIDIARY

ITHACA *InterSystems*
 (formerly ITHACA AUDIO of New York)

58 Crouch Hall Road, London N8 8HG. UK.
 Telephone: 01-341 2447 Telex: 299568

From Page 67.

```

FB76 21 81 FB      0575      LD      HL,BSPBM ;WRITE "(SP),"
FB79  CD 1F F9      0576      CALL   COPY5
FB7C  3E 20      0577      LD      A,$20 ;SET FOR HL/IX/IY
FB7E  C3 7E F9      0578      JP      REGPR ;WRITE APPROPRIATE ONE.
FB81  28 53 50 29  0579  BSPBM:  DB      '(SP),'
      2C

FB86      0580 ;
FB86      0581 ; DI/EI
FB86      0582 ;
FB86  3E 44      0583  DI:    LD      A,'D' ;WRITE "DI"...
FB88  18 02      0584      JR      *+2
FB8A  3E 45      0585  EI:    LD      A,'E' ;..OR "EI"
FB8C  EB      0586      EX      DE,HL
FB8D  77      0587      LD      (HL),A
FB8E  23      0588      INC     HL
FB8F  36 49      0589      LD      (HL),'I'
FB91  C9      0590      RET
FB92      0591 ;
FB92      0592 ; IN A,$XX
FB92      0593 ;
FB92  21 9E FB      0594  IN:    LD      HL,INM ;WRITE "IN A,"
FB95  CD 21 F9      0595      CALL   COPY4
FB98  CD 23 F9      0596      CALL   COPY3
FB9B  C3 09 FA      0597      JP      IMM ;GET & WRITE PORT NO.
FB9E  49 4E 20 20  0598  INM:   DB      'IN A,'
      20 41 2C

FBA5      0599 ;
FBA5      0600 ; OUT $XX,A
FBA5      0601 ;
FBA5  21 B8 FB      0602  OUT:   LD      HL,OUTM ;WRITE 'OUT'
FBA8  CD 23 F9      0603      CALL   COPY3
FBAB  13      0604      INC     DE ;SPACE
FBAC  13      0605      INC     DE
FBAD  13      0606      INC     DE
FBAE  CD 09 FA      0607      CALL   IMM ;GET & WRITE PORT NO.
FBB1  CD 11 F9      0608      CALL   COMMA ;","
FBB4  3E 41      0609      LD      A,'A' ;WRITE "A"
FBB6  12      0610      LD      (DE),A
FBB7  C9      0611      RET ;DONE
FBB8  4F 55 54      0612  OUTM:  DB      'OUT'
FBBB      0613 ;
FBBB      0614 ; ROTATE & TEST/IN/EX DE,HL/EI
FBBB      0615 ;
FBBB  F1      0616  CBETC:  POP    AF ;RECOVER OPCODE
FBBB  FE DB      0617      CP      $DB ;IN?
FBBE  28 D2      0618      JR      Z,IN ;YES, JUMP
FBC0  DA 4F FC      0619      JP      C,CB ;JUMP IF "CB"
FBC3  FE FB      0620      CP      $FB ;"EI"?
FBC5  28 C3      0621      JR      Z,EI ;YES, JUMP
FBC7      0622 ; EX DE,HL
FBC7  CD 5D FB      0623      CALL   WREX ;WRITE "EX"
FBCA  21 A5 F9      0624      LD      HL,RPRTAB+4;WRITE "DE"
FBCD  CD 25 F9      0625      CALL   COPY2
FBD0  CD 11 F9      0626      CALL   COMMA ;","
FBD3  C3 25 F9      0627      JP      COPY2 ;WRITE "HL" & RETURN
FBD6      0628 ;
FBD6      0629 ; RET/EXX/JP (HL)/LD SP,HL
FBD6      0630 ;
FBD6  F1      0631  RETETC:  POP    AF ;RECOVER OPCODE
FBD7  FE D9      0632      CP      $D9 ;"RET" OR "EXX"?
FBD9  DA 7B FA      0633      JP      C,CJR+1 ;"RET",SO JUMP
FBD9  28 21      0634      JR      Z,EXX ;"EXX",SO JUMP
FBD9  FE F9      0635      CP      $F9 ;"LD SP"?
FBE0  28 0C      0636      JR      Z,LDSP ;YES, JUMP
FBE2  21 A3 FA      0637      LD      HL,CJRTAB+4;WRITE "JP"
FBE5  CD 25 F9      0638      CALL   COPY2
FBE8  21 32 10      0639      LD      HL,BUFFER+32;RESET HL
FBEB  C3 2E FC      0640      JP      LD1+3 ;WRITE HL,IX OR IY
FBEE      0641 ;

```

```

FBEE      0642 ; LOAD SP
FBEE      0643 ;
FBEE  CD 06 F9      0644  LDSP:   CALL   WRLD ;WRITE "LD"
FBF1  21 FC FB      0645      LD      HL,SPM
FBF4  CD 23 F9      0646      CALL   COPY3 ;WRITE "SP"
FBF7  3E 20      0647      LD      A,$20 ;MAKE LIKE HL
FBF9  C3 7E F9      0648      JP      REGPR ;WRITE HL,IX,OR IY
FBFC  53 50 2C      0649  SPM:   DB      'SP,'
FBFF      0650 ;
FBFF      0651 ; WRITE "EXX"
FBFF      0652 ;
FBFF      0653  EXX:   CALL   WREX ;WRITE "EX"
FC02  23      0654      INC     HL ;BUMP ADDRESS
FC03  36 58      0655      LD      (HL),'X' ;ADD ANOTHER "X"
FC05  C9      0656      RET
FC06      0657 ;
FC06      0658 ; LD (BC),A LD (DE),A LD(NN),HL LD,(NN),A
FC06      0659 ;
FC06  CD 06 F9      0660  STIND:  CALL   WRLD ;WRITE "LD"
FC09  F1      0661      POP    AF ;RECOVER OPCODE
FC0A  F5      0662      PUSH   AF ;SAVE IT FOR ST16I
FC0B  FE 22      0663      CP      $22 ;16 BIT?
FC0D  28 2D      0664      JR      Z,ST16I ;YES, JUMP
FC0F  F1      0665      POP    AF ;NO, THROW AWAY SAVE
FC10  CD 2B FC      0666      CALL   LD1 ;WRITE INDIRECT PART
FC13  CD 11 F9      0667      CALL   COMMA ;","
FC16  3E 41      0668  ST1:   LD      A,'A' ;WRITE "A"
FC18  12      0669      LD      (DE),A
FC19  13      0670      INC     DE
FC1A  C9      0671      RET
FC1B      0672 ;
FC1B      0673 ; LD A,(BC) LD A,(DE) LD HL,(NN) LD A,(NN)
FC1B      0674 ;
FC1B  CD 06 F9      0675  LDIND:  CALL   WRLD ;WRITE "LD"
FC1E  F1      0676      POP    AF ;RECOVER OPCODE
FC1F  F5      0677      PUSH   AF ;SAVE
FC20  FE 2A      0678      CP      $2A ;16 BIT?
FC22  28 21      0679      JR      Z,LD16I ;YES, JUMP
FC24  CD 16 FC      0680      CALL   ST1 ;"A"
FC27  CD 11 F9      0681      CALL   COMMA ;","
FC2A  F1      0682      POP    AF ;RECOVER OPCODE
FC2B  FE 22      0683  LD1:   CP      $22 ;REGPR OR EXTENDED?
FC2D  EB      0684      EX      DE,HL ;WRITE "("
FC2E  36 28      0685      LD      (HL),'('
FC30  23      0686      INC     HL
FC31  EB      0687      EX      DE,HL
FC32  3F      0688      CCF ;REVERSE RESULT OF COMPARE
FC33  D4 7E F9      0689      CALL   NC,REGPR ;(RETURNS WITH NC)
FC36  DC 57 F9      0690      CALL   C,LD16A ;EXTENDED ADDRESS
FC39  C3 04 FA      0691      JP      NOTIXY ;CLOSE BRACKETS
FC3C      0692 ;
FC3C      0693 ; 16-BIT INDIRECT STORE LD (NNNN),PP
FC3C      0694 ;
FC3C  CD 2B FC      0695  ST16I:  CALL   LD1 ;DO INDIRECT BIT
FC3F  CD 11 F9      0696      CALL   COMMA ;","
FC42  C3 7D F9      0697      JP      REGPR-1 ;GET OP & PR. REG PAIR
FC45      0698 ;
FC45      0699 ; 16-BIT INDIRECT LOAD LD PP,(NNNN)
FC45      0700 ;
FC45  F1      0701  LD16I:  POP    AF ;GET OPCODE
FC46  CD 7E F9      0702      CALL   REGPR ;PRINT REG PR.
FC49  CD 11 F9      0703      CALL   COMMA ;","
FC4C  A7      0704      AND     A ;CLEAR CARRY
FC4D  18 DE      0705      JR      LD1+2 ;DO INDIRECT BIT

```

TO BE CONTINUED

Jeff Orr and Graham Knott are now offering:

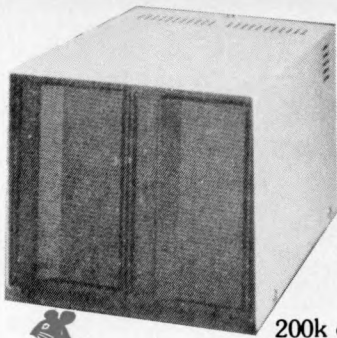

**400k on the
Pet £840**

**directly interfacing
with 32k pet**

200k on each drive
Random and sequential
access



**AIM161
16 way
A/D Converters
£130**

Analogue to
Digital conversion, Suitable for all
8-bit microcomputers
Connectors
available to suit most machines:
Pet, Apple, ITT, Aim etc.

Memory Expansion

24k Expandamem for Pet £320
16k Apple Ram up grade £85

Interfaces

1 EEE to RS232 unidirectional £89
1 EEE to RS232 bi-directional £186
625 video adaptors for Pet £25 complete

We also stock and supply Apple II, ITT 2020, Centronics,
Teletype, Anadex, Paper, diskettes, Cassettes etc.

PHONE US ON

051-924 1125

All prices are +VAT at 15% and
include carriage. Please make
cheques payable to
Stack Computer Services Ltd.

for details of our
catalogue or write

Stack Computer Services Ltd.

1 Westward View, Waterloo, Liverpool L22 6RB

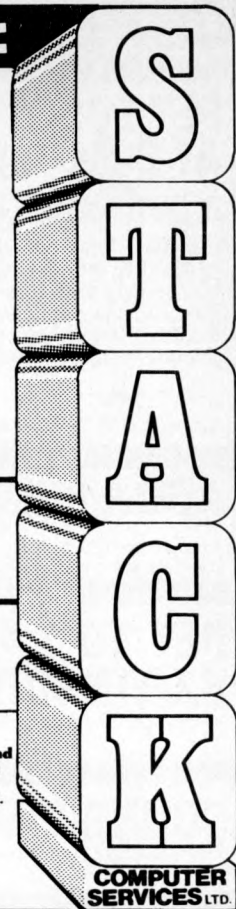

Payroll, Pete and Friends Professional **PET** Software *At last*

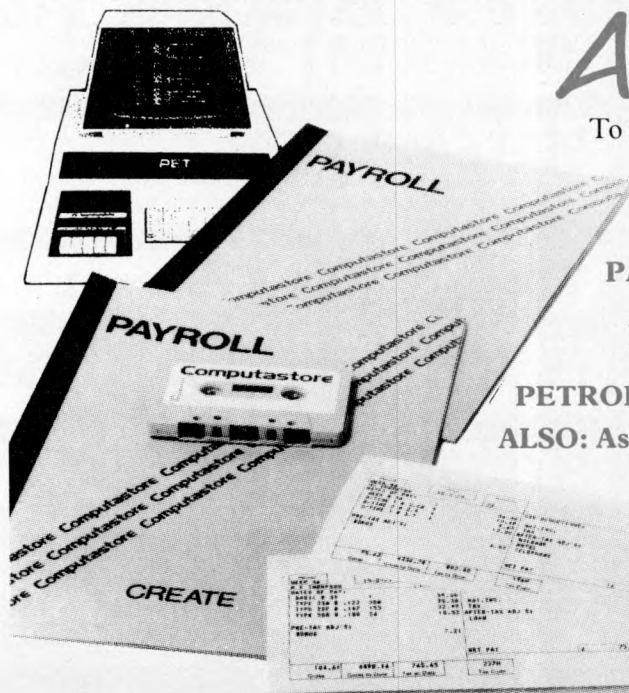

To help you get the most out of your Commodore PET,
Computastore has developed a range of software
packages to cope with the demands of both
Industry and Education.

PAYROLL: Runs on the 8K PET and produces pre-
printed payslips, totals and coin analysis.

PETE: Turns your PET into an intelligent RS-232
terminal for use with a mainframe.

PETROFF: A text formatter to produce neatly typed reports.

ALSO: Assembler, Disassembler, Renumber, Keyboard.

Contact your PET dealer or
Computastore for a demonstration.

Computastore
Software that means business

Computastore Ltd, 16 John Dalton Street,
Manchester M2 6HG. Tel: 061 832 4761

JUST COMPARE OUR CASH AND CARRY PRICES!

PET COSTS LESS AT COMP and it's a pedigree

RRP £550

The No. 1 Personal Computer in the U.K. Affordable for the first time user and the professional check out the PET, the world's most popular personal computer.

8K — £499 16K — £590
32K with GREEN SCREEN — £690 Cassette recorder now in stock £55



EX STOCK

ADD A PRINTER TO YOUR PET

RS232C I/O CARD

Attach to any RS232 printer, modem, acoustic coupler to your PET. Easy to assemble. £89 in kit form. Add £20 for fully assembled and tested.

PET TO S100 FOR MEMORY EXPANSION

Convert the IEEE 488 bus to the well supported S100 bus. Comes complete. Connectors and documentation included. Ready assembled and tested. Our price £89.

SOUND BOXES FOR PET

Fully assembled with documentation how to add sound effects to your programs. £14.90

BEST GAME EVER!

Petball — £5 for program. This game will have you and your family in tears for hours! For full effect buy sound box too! Best seller in U.S.A.

NASCOM IMMEDIATE EXPANSION S100 from COMP —strongly recommended

The only available S100 motherboard kit (fully buffered) that plugs directly into your Nascom. Designed for the insertion of S100 boards (e.g. Static RAM, EPROM and discs etc.).

S100 Motherboard/Buffer (Complete kit + documentation)	£47.50	} Buy both and get 2K Tiny Basic On cassette FREE.
Suitable 8K Static RAM Memory (fully assembled tested and guaranteed)	£125 £110	

MODULATORS UHF Channel 36

Standard 6 meg band width £2.25
High Quality 8 meg band width £4.90 EX-STOCK

UNIVERSAL POWER SUPPLY

Suitable for Nascom I, Nascom II, Superboard and all computers requiring these specifications.
+5V @ 3 amps +12V @ 1 amp -5V @ 500 mills -12V @ 500 mills
Easy to construct — complete with transformer. Our price £24.90

TRANSFORMER

Primary 220V with 2 individual secondaries £5.90
8V —0 —8V @ 1½ amps 16V —0 —16V @ ½ amp

HITACHI PRO MONITORS

Superb definition 9" — £132 12" — £210

THE TRS-80 (SPECIAL SCOOP) Low Priced, Ready to Go!

PLUGS INTO YOUR OWN TV



Use your own cassette

Level-II with 4K RAM

Improved graphics, print formatting, and a faster cassette transfer rate are features of Level-II Basic. £350 + VAT

Level-II with 16K RAM

A combination of 16K RAM and the powerful Level-1! BASIC produces a system capable of handling most demands. £399 + VAT

64 chars x 16 lines — double length characters available at a single keystroke giving 32 chars x 16 lines. Super graphics a 2 x 3 cell arrangement. Masses of software available.

Worlds most popular machine. Fully converted to English Television standard. Rock steady picture — exclusive to COMP.

UK POWER SUPPLY SUPPLIED

KEY BOARD ONLY — Complete with UHF Modulator

RS232C I/O CARD for TRS80

Connect your TRS80 to any RS232 printer. Assembled and tested £55

SOUND BOXES FOR TRS80

Fully assembled with documentation how to add sound effects to your programs. £14.90

ATTENTION ALL NERVOUS TRS80's

Cure the video shakes. Upgrade your video to English Standard. Simple modification. Only £7.50 including easy to follow instructions. Only 15 minutes of your time needed. You owe it to your eyesight. Fitted as standard to all our machines.

NEW! AT LAST 8K BASIC FOR NASCOM 1

COMPLETE ON S100 EPROM BOARD

£160 + VAT EX-STOCK

BEST GAME EVER!

Android Nim — for TRS80. £5 for program. This game will have you and your family in tears for hours! For full effect buy sound box too! Best seller in U.S.A.

TRS80 TO S100 BUS

for memory expansion £95

TV UHF MODULATOR FOR TRS80

Encased ready to use — £15

ELECTRIC PENCIL

Text Wordprocessing package on cassette £59

Please add VAT to all prices — Delivery at cost, will be advised at time of purchase. Please make cheques and postal orders payable to COMP, or phone your order quoting BARCLAYCARD, ACCESS, DINERS CLUB or AMERICAN EXPRESS number.

OPEN — 10am to 7pm — Monday to Saturday
CREDIT FACILITIES ARRANGED



SEND FOR OUR SPRING '79 CATALOGUE - 0-60p

EUROPE'S FASTEST SELLING ONE BOARD COMPUTER —
JUST CHECK THE SPEC'S.

COMPUKIT UK101

LOW COST SUPERBOARD IN KIT FORM



The CompuKit UK101 has everything a one board 'superboard' should have.

- ★ Uses ultra-powerful 6502 microprocessor.
- ★ 50Hz Frame refresh for steady clear picture (U.S.A. products with 60Hz frame refresh always results in jittery displays)
- ★ 48 chars by 16 lines — 1K memory mapped video system providing high speed access to screen display enabling animated games and graphs.
- ★ Extensive 256 character set which includes full upper and lower case alphanumerics, Greek symbols for mathematical constants and numerous graphic characters enabling you to form almost any shape you desire anywhere on the screen.
- ★ 8K full Microsoft Basic in ROM compatible with PET, APPLE SORCERER hence taking the headache out of programming by using simple English statements. Much faster than currently available personal computers.
- ★ Professional 52 Key keyboard in 3 colours — software polled meaning that all debouncing and key decoding done in software.

FULL CONSTRUCTION DETAILS
IN P.E. AUG 1979 EDITION

Delivery date June 1979
at the 1979 MicroComputer Show
Customer orders in strict rotation only.

COMMANDS	NEW	NULL	RUN
CONT. LIST			
STATEMENTS			
CLEAR DATA	DEF	DIM	END FOR
GOTO GOSUB	IF GOTO	IF THEN	INPUT LET
NEXT ON_GOTO	ON_GOSUB	POKE	PRINT READ
REM RESTORE	RETURN	STOP	

EXPRESSIONS
OPERATORS
+ * / ↑ NOT AND OR >> << > < = <=
RANGE 10 ⁻³² to 10 ⁺³²

VARIABLES
A B C ... Z and two letter variables
The above can all be subscripted when used in an array. String variables use above names plus \$. e.g. A\$.

FUNCTIONS	ATN(X)	COS(X)	EXP(X)	FRE(X)	INT(X)
ABS(X)	PEEK(I)	POS(I)	RND(X)	SGN(X)	SIN(X)
LOG(X)	SQR(X)	TAB(I)	TAN(X)	USR(I)	
SPC(I)					
STRING FUNCTIONS					
ASC(X\$)	CHR\$(I)	FRE(X\$)	LEFT\$(X\$,I)	LEN(X\$)	MID\$(X\$,I,J)
RIGHT\$(X\$,I)		STR\$(X)		VAL(X\$)	

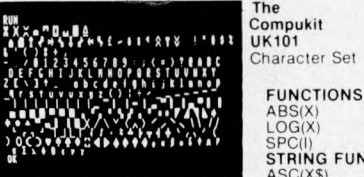
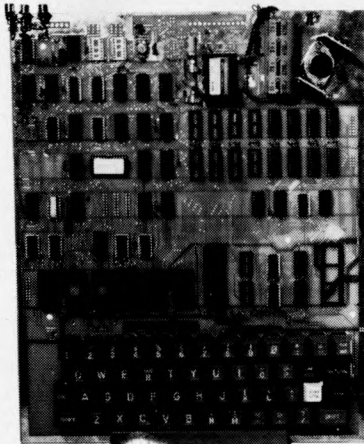

The CompuKit UK101 Character Set

- ★ Video output and UHF Highgrade modulator (8Mz Bandwidth) which connects direct to the aerial socket of your T.V. Channel 36 UHF.
- ★ Fully stabilised 5V power supply including transformer on board.
- ★ Standard KANSAS city tape interface providing high reliability program storage — use on any standard domestic tape or cassette recorder.
- ★ 4K user RAM expandable to 8K on board £49 extra.
- ★ 40 line expansion interface socket on board for attachment of extender card containing 24K RAM and disk controller. (Ohio Scientific compatible).
- ★ 6502 machine code accessible through powerful 2K machine code monitor on board.
- ★ High quality thru plated P.C.B. with all I.C.'s mounted on sockets.

A tape of 10 programs on cassette — educational games, etc. will be supplied free of charge with each kit.

Simple Soldering due to clear and concise instructions compiled by Dr. A.A. Berk, BSc.PhD

NO EXTRAS NEEDED JUST HIT 'RETURN' AND GO.

Build, understand, and program your own computer for only a small outlay.

ONLY £219 + VAT
including RF Modulator & Power supply.
Absolutely no extras.

Due to the new prices of TTL this price will be increased shortly. So order now to beat the price increases and the rush.

SPECIAL CHARACTERS
@ Erases line being typed, then provides carriage return, line feed.
⌘ Erases last character typed.
CR Carriage Return — must be at the end of each line.
Separates statements on a line.
CONTROL/C Execution or printing of a list is interrupted at the end of a line.
"BREAK IN LINE XXXX" is printed, indicating line number of next statement to be executed or printed.
CONTROL/O No outputs occur until return made to command mode. If an input statement is encountered, either another CONTROL/O is typed, or an error occurs.
? Equivalent to PRINT

THE EXIDY SORCERER. SAVE!

SORCERER COMPUTER SYSTEM

The Sorcerer Computer is a completely assembled and tested computer system. Standard configuration includes 63-key typewriter-style keyboard and 16-key numeric pad, 280 processor, dual cassette I/O with remote computer control at 300 and 1200 baud data rates, RS232 serial I/O for communications, parallel port for direct Centronics printer attachment, 4K ROM operating system, 8K ROM Microsoft BASIC in Rom Pac™ cartridge, composite video of 64 char/line 30 line/screen, 128 upper/lower case ASCII set and 128 user-defined graphic symbols, operation manual, BASIC programming manual and cassette/video cables, connection for S-100 bus expansion.



LOOK!

- *32K RAM on board
- *RS232 interface
- *8K BASIC ROM
- *CUTS interface
- *4K MONITOR
- *KANSAS CITY interface
- *S100 BUS
- *User defined graphic symbols
- *280 cpu

16K £260 £725 * 32K £950 £790 * Credit facilities available. * + VAT

THE ATARI video computer system



Atari's Video Computer System now offers more than 1300 different game variations and options in twenty great Game Program™ cartridges!

Have fun while you sharpen your mental and physical coordination. You can play rousing, challenging, sophisticated video games, the games that made Atari famous.

You'll have thrill after thrill, whether you're in the thick of a dogfight, screeching around a racetrack, or dodging asteroids in an alien galaxy. With crisp bright color (on color TV) and incredible, true-to-life sound effects. With special circuits to protect your TV.

Cartridges now available

Basic Maths, Airsea Battle, Black Jack, Breakout, Surround, Spacewar, Video Olympics, Outlaw, Basketball, All at £13.90 each.

Years and years of fun and satisfaction are assured

SAVE £30

£169 ~~£169~~ £138.85

All prices exclude VAT. Our VAT rate is 8%. We will pay any extra. Please quote this number P W1000 when ordering

IBM GOLF BALL SELECTIVE PRINTER

Refurbished to new specifications.

RS232C serial interface. Comes complete on stand — floor mounting. Small and compact. Interfaces to Exidy Sorcerer, TRS80 Apple and ITT 2020, Pet, CompuKit and Nascom.

Complete your word processing system with a top quality printer for only £990.50.

COMP COMPUTER COMPONENTS

14 STATION ROAD, NEW BARNET, HERTFORDSHIRE TEL: 01-441 2922 (Sales)
CLOSE TO NEW BARNET BR STATION — MOORGATE LINE 01-449 6596
OPEN — 10am to 7pm — Monday to Saturday TELEEX: 298755



VISIT OUR NEW SHOP AT 1 WALLCOT BUILDINGS, LONDON ROAD, BATH, AVON.

All Products Ex-Stock Please check availability (Part of the Compshop Ltd. Group).

If you buy the wrong personal computer, you can't re-program your bank account!

Buying a personal computer is not an easy task.

So many people selling them neglect the little things that enable you to get the most from your computer, such as documentation, spares, add-ons and maintenance. We believe that these 'details' are essential. We are the only British company to put all our time and energy into the personal computer market and are in the best position to advise you on your initial purchase and keep you fully informed about all the new developments relevant to your computer.

Personal Computers Limited — *the name of the game.*

Say 'hello' to a graphics **Apple II**



A business **Apple II**



Exclusive to Personal Computers Ltd.
German **Apple II**. Available shortly.



Personal Computers Limited

194-200 Bishopsgate, London EC2M 4NR.
Tel. 01-283 3391

Apple Software Bank
Free membership to all Apple owners
POST TO: Personal Computers Ltd., 194-200 Bishopsgate
London EC2M 4NR.

NAME
ADDRESS