

PAGE 6

ATARI USERS MAGAZINE

XL/XE

Type-in
DEMON ADVENTURE
KLEPHT'S CASTLE

ADVENTURE
SURVEY

ADVENTURE
ANSWERS

DAVE T's DISCO
Great Music

REVIEWS
ZYBEX
THUNDERFOX
TWILIGHT WORLD
ATARI ROMS

ST

WORLD of
ADVENTURE

DUNGEONMASTER
BEYOND ZORK

Sierra's QUEST
Oids
Northstar
Goldrunner II
Many more reviews

ADVENTURE!



◀◀ **LEVEL 9 Interview**

EXPAND THE CAPABILITIES OF YOUR 8 BIT SYSTEM

US DOUBLER

Expanding the 1050 disk drive's strength is what ICD's **US Doubler** is all about. A true performer in the area of hardware modifications, this chip set quickly transforms your Atari into a powerhouse, radiating with innovative features never before possessed by a 1050. Features like true double density for greater storage, single and double density support, an accelerated I/O rate designed to triple your speed when combined with **SpartaDOS** and full compatibility with existing Atari Software. **£29.95**

SPARTADOS

This Disk Operating System has been widely acclaimed as the best DOS for the 8 bit Atari range. **SpartaDOS** from ICD supports everything from 810 disk drives through RAM disks to hard disks. A special menu allows rapid transfer, erasure and locking or unlocking of files using only the Space Bar, Option, Start and Select keys. The utility package supplied also features a 32 character keyboard buffer, intelligent switching between disk densities, a binary file game menu, subdirectories and time/date stamping. **£29.95**

R-TIME 8

The **R-Time 8** is a cartridge which keeps your Atari 8 bit's internal clock running even when your computer is turned off. Supplied with a three year battery its top extension port allows you to use additional cartridges. The **R-Time 8** is very useful when used with **SpartaDOS** - each file that you create or rewrite is instantly labelled with the correct time and date. **£49.95**

P:R: CONNECTION

Now you're no longer limited to Atari compatible printers and modems. The **P:R: Connection** plugs directly into the serial disk drive port of any 8 bit Atari computer and provides the user with a standard Centronics printer interface and two RS-232 serial ports. It also draws its power from your computer which means one less cord fighting for a power point while its compact size leaves your work space virtually clutter free. **£69.95**

The **P:R: Connection's** serial ports use a fully compatible R: handler and resemble those of the 850 interface with the same signals and functions.

RAMBO XL

The **Rambo XL** transforms your 800XL into a mighty 256K computer and makes it memory compatible with the 130XE. Now your XL can support **BASIC XE** extended mode or the standard RAM disk supplied with Atari DOS 2.5. With the RD.COM handler supplied with **SpartaDOS** you get a 192K RAM disk - enough to duplicate a full double density disk in one pass! You must supply eight 256K DRAM memory chips and the DOS of your choice. **£29.95**

SUPRADRIVE AT

The **SupraDrive AT 20Mb** hard disk for the Atari XL and XE series connects directly to the computer's parallel bus, allowing high speed data transfer rates of 8-10,000 bytes per second (approximately 10-15 times faster than the normal Atari floppy drives). The **SupraDrive AT** stores more than the equivalent of 200 single density Atari disks and can access any information within milliseconds. All this adds up to an extremely efficient system for the serious Atari 8 bit owner. The **SupraDrive AT** is supplied with hard disk interface, built-in power supply, manual and **SpartaDOS**. **£689.95**

SUPRA MICROPRINT / ICD PRINTER CONNECTION

Supra's MicroPrint and ICD's **Printer Connection** are Centronics parallel printer interfaces for the Atari 8 bit computers which plug into the computer's serial peripheral port and then directly into your printer. They work with most parallel printers and 8 bit software and include a built-in printer cable. **£29.95**

ACTION!

A programming language so fast and exciting that it had to be called **Action!** Blending the best elements of Pascal and C, **Action!** combines short development time with the execution speed of machine code. **Action!** has proved the most popular alternative to BASIC in the 8 bit Atari world. **£49.95**

MAC/65

A macro assembler and editor for programmers who are serious about assembly language. **MAC/65's** speed and power runs circles around the competition. Includes the powerful DDT - a screen oriented debugging program. **£49.95**

BASIC XL

Fully compatible with Atari BASIC, but with an additional 45 commands. Supports all Atari 8 bit computers. **£39.95**

BASIC XE

A programming language designed especially for the Atari 130XE with all the commands and full compatibility with standard Atari BASIC. **BASIC XE** allows much faster program execution with new floating point routines and the FAST command. Larger BASIC programs than normal are possible through quick access to the 130XE's extra 64K of memory.

A greatly improved editor allows upper or lower case letters, automatic line numbering and renumbering on request. Other features include: Advanced string handling, nine new Player Missile Graphics commands, easier joystick and paddle control and structured programming commands. **£49.95**

 Frontier
Software

ALL PRICES INCLUDE VAT AND DELIVERY

P.O. Box 113, Harrogate, North Yorkshire, HG2 0BE, England. Telephone: 0423 67140

Issue 34 July/August 1988

PAGE 6
P.O. Box 54,
Stafford,
ST16 1DR,
ENGLAND

Tel. 0785 213928

'The magazine for the
Dedicated Atari User'

PAGE 6 is published
bi-monthly on the last
Thursday of the month
prior to cover date

Editor & Publisher
Les Ellingham

Advertising
Nicola Parry

Newstrade Distribution
Seymour
01 733 4444

Printed by
Stephens & George
0685 5351

Typeset by
Hourds Typographica
0785 57700

SUBMISSIONS

PAGE 6 welcomes and encourages its readers to submit, articles, programs and reviews for publication. Programs must be submitted on disk or cassette, articles should wherever possible be submitted as text files on disk. We seek to encourage your participation and do not have strict rules for submissions. If something interests you, write a program or article and submit it! Appropriate payment will be made for all published programs and articles.

All original articles, programs and other material in PAGE 6 is copyright of the author as credited. All uncredited material is copyright PAGE 6. Unless containing the by-line 'All Rights Reserved' any material in PAGE 6 may be reproduced by User Groups and other non-profit making organisations provided that the author's name is included and PAGE 6 is credited as the original publisher. Permission to publish elsewhere should be obtained from PAGE 6 or the author. Editors of newsletters reproducing material are requested to send a copy of the relevant issue to the Editorial address of PAGE 6.

Whilst we take whatever steps we can to ensure the accuracy of articles and programs and the contents of advertisements, PAGE 6 cannot be held liable for any errors or claims made by advertisers.

ATARI ® is a registered trademark of ATARI CORP. All references should be so noted.

KLEPHT's CASTLE by Peter Dean	8
<i>Search for the lost treasures of Atari</i>	<i>TYPE IN LISTING</i>
LEVEL 9 INTERVIEW	12
<i>The in-depth interview with the masters</i>	
THE LEVEL 9 GAMES by John Sweeney	20
<i>A look at Knight Orc, Gnome Ranger and Time & Magik</i>	
BONUS ADVENTURES	23
<i>Two extra adventures only on disk</i>	
BUMPER ADVENTURE HINTS by Garry Francis	24
<i>Hundreds of Adventures answers</i>	
FLYING BY THE BOOK by John S Davison	30
TUTORIAL SUBROUTINES by Ian Finlayson	32
<i>Improve your title screens</i>	
DEMON ADVENTURE by Adrian Cox	63
<i>Someone has released a Demon!</i>	<i>TYPE IN LISTING</i>
DAVE T's DISCO	66
<i>More astounding music!</i>	<i>TYPE IN LISTING</i>
SHELL SORT by Gordon Cameron	67
<i>Another routine for you to use</i>	
FIRST STEPS by Mark Hutchinson	70
<i>Find out how programs are copy protected</i>	
The SOFTWARE REVIEWS	72
<i>Zybox - Thunderfox - Twilight World plus classic re-releases from Atari</i>	
ADVENTURE SURVEY by Garry Francis	78
<i>Virtually every adventure available for your Atari</i>	

ST FILE

What's Happening	37
FORGET-ME-CLOCK	38
The WORLD OF ADVENTURE by John Sweeney	40
<i>A look at what's available on the ST</i>	
WHERE CHAOS REIGNS by John Sweeney	42
<i>Exploring the world of Dungeon Master</i>	
BEYOND ZORK by John Sweeney	44
PROTEXT & POWER BASIC - Mini Reviews	46
Sierra's QUEST by John Sweeney	48
<i>A look at animated adventures</i>	
GAMES REVIEWS	50
<i>Oids - Jump Jet - Leatherneck - Nightmare - Northstar - Casino Roulette - Spitfire 40 - Rockford - Goldrunner II</i>	
SWEENEY's HINTS	60

Editorial	4	Listing Conventions	22
News	6	Resource File	82
SUBSCRIPTION OFFER	7	Update	77
CONTACT	77	BACK ISSUES	81

NEXT ISSUE

BALLBREAKER - a great arcade style listing
M.A.D. the best type in listing ever on the ST!

Plus the return of ST SECRETS, Turbo, Letters and much more!

On sale 25th August.
Editorial copy date 18th July.

SUBSCRIPTIONS

Annual subscription (6 issues)

U.K.	£ 7.00
Europe	£11.50
Elsewhere (Air)	£17.50
Elsewhere (Surface)	£11.50

Disk Subscription (6 issues)

U.K.	£28.00
Europe	£35.00
Elsewhere (Air)	Please
Elsewhere (Surface)	enquire

Cheques/Access/Visa/Eurocard to
PAGE 6, P.O. BOX 54, STAFFORD,
ST16 1DR

Issue 34 July/August 1988

'The Magazine for the Dedicated Atari User'

ISSN No. 0952-4967

THE CREDITS

Full 'official' credits are on page 3, here are the people who made it possible.

Les Ellingham did the Editing

Nicola Parry looked after the ads

The Regular Contributors are ...

Garry Francis
Mark Hutchinson
Matthew Jones
John Davison
John Davison jr
John Sweeney
Paul Rixon

All other contributors for this issue are credited alongside their articles or programs. Thanks to everybody for contributing and thus helping others.

This issue is dedicated to Garry Francis whose support and dedication to the cause over the years has been an inspiration. Garry's writing has always been top class (I don't have to edit it!) and he also sends long letters full of ideas and suggestions to which I seldom have time to reply. Garry has become a long time friend who I have never met, maybe one day one of us will make the 11,000 mile trip! Thanks Garry, this one's for you!

Serious? You bet! But Atari is supposed to fun as well isn't it?

The next issue of PAGE 6 could feature YOUR article or program. So, send it!

PAGE 6 is put together almost entirely with Atari equipment and software. Hardware used: 130XE, 1050 disk drive, 810 disk drive, 850 Interface, modem, NEC 8023 printer, 1040ST, SM124 monitor, Atari SH204 hard disk drive, Epson RX100 printer, Microstuffer Buffer. Software used: Superscript, Turbo Basic, Tele-Talk, Kermit, Print Wiz and several custom written utilities on the 8-bit. STwriter, PC Intercomm, Thunder and Fleet Street Publisher on the ST.

Copy is prepared on a 130XE using Superscript and various custom written programs and then transferred to the ST via 8-bit Kermit and PC Intercomm. It is then spell checked with Thunder and the layout drafted with Fleet Street Publisher. Finished copy is output from the ST to a Konnect 2 cassette machine and then fed into a Monotype Lasercomp typesetter.

Welcome to a special issue of PAGE 6 devoted to Adventures. Many readers have asked for another Adventure special ever since we did the last one a few issues ago. Or was it? It was actually Issue 10 which was almost four years ago! There have been a lot of changes since then, mostly good, some bad but I suppose that's the price of progress, of trying to make the magazine better whilst still retaining the interest in what it's all about. It's been quite a struggle putting this one together, not because we couldn't find enough material, but because we had too much! I wanted to maintain a balance as always so that those not interested in Adventures still had plenty to read but I fear that the Adventures have almost entirely taken over! Still it's only for one issue and maybe only once every four years!

Several features which are missing will return next issue and we have some excellent articles and programs lined up. So, what of this issue? You will find a superb interview with Level 9 in true Page 6 tradition, no space spared! Possibly the longest and most interesting Level 9 interview you will have seen, and one of those hard decisions was which of the other six pages to leave out! There are several Adventure game reviews and a bumper selection of hints and tips from Garry Francis. You'll see his name and John Sweeney's crop up quite often in this issue, a couple of Atari Adventure fanatics who have my grateful thanks and admiration for their dedication. Anyway, read on, you will surely enjoy this Adventure issue even if your interests do not lie wholly within that area.

IT'S A HARD LIFE!

You will all know from the quality of the writing in Page 6 that we are very fortunate in having some really excellent freelance Atari enthusiasts writing for us (as opposed to 'professional' journalists!) but one of the real problems we have had in recent months is finding people to work for Page 6 on all the stuff that needs to be done 'in house' who share that same dedication and enthusiasm. Stafford seems to be an area totally devoid of Atari enthusiasts! Our recently appointed Editorial Assistant departed quite suddenly several weeks ago, unable to take the pressure, leaving

yours truly burning the midnight oil (not quite right, can you burn the 2 0'clock oil?). We had lots of things in the pipeline most of which have fallen behind schedule and we are back in the old situation of not being able to acknowledge contributions, letters and the like. My apologies to anyone who may feel that they have been ignored, you haven't, your contributions are still appreciated and you will get a reply as soon as possible. Hopefully we will sort this out soon, but when you are trying to produce a dedicated magazine with various supporting services and make it better each issue whilst retaining your own interest in the subject, you could do without all the 'behind the scenes' hassles. Maybe it's all too much for an 'ageing hippy'! Maybe I'll pack it all in, but then maybe I won't!

SUBSCRIBE PLEASE!

Selling a magazine through the newstrade is a perilous business especially when you suddenly one month get paid several thousand pounds less than you were expecting! It's a complicated story but that sort of thing can put a small publication like ours out of business unless we can get a lot more support from the people who really care - and that's you! Since going on the newsstands we have lost a lot of subscribers, presumably because it is now easy for you to pick up a copy locally, but we now really do need to get those subscribers back and hopefully pick up some more. From this issue we are introducing regular offers to get you to part with your money in exchange for a years subscription to PAGE 6. If you check the offers out, a subscription need not cost you anything!

Quite aside from any offers, we need your subscriptions to ensure that we can keep on bringing you the sort of articles and programs you want, the sort that no other Atari magazine provides. If we had not lost many of our subscribers you would not have lost any of the regular features from this issue as we would simply have put in another 16 pages and you would have been able to read everything that was written but, as things stand, we can't afford the gamble, so get out your cheque book or credit card and ensure that you continue to enjoy Page 6 for many years to come!

SUNARO

PO BOX 78 MACCLESFIELD CHESHIRE SK10 3PF
Telephone (0625) 25228

Established during 1984 SUNARO are proud of their dedicated ATARI service which promises FRIENDLY EFFICIENCY with REALISTIC PRICES

WHY NOT GIVE US A TRY?

ATARI ST

ARMAGEDDON MAN	15.95
BUGGY BOY	15.95
DUNGEON MASTER	19.95
GUNSHIP	19.95
INDOOR SPORTS	19.95
ONDS	15.95
OUTRUN	15.95
POOL	8.95
PREDATOR	15.95
TEST DRIVE	19.95
TETRIS	15.95
TIME & MAGIK	15.95
VIXEN	15.95

ATARI 8-BIT BUDGET CASSETTES

COPS & ROBBERS	1.95
GRAND PRIX SIM.	1.95
LEAGUE CHALLENGE	1.95
MATTABATTA	1.95
PRO GOLF	2.95
ROCKFORD	2.95
SPEED ACE	2.95
ZYBEX	2.95

ATARI 8-BIT CASSETTES

ACE OF ACES	8.50
BASIL:MOUSE DETECTIVE	8.50
DRUID	8.50
EUROPEAN SUP. SOCCER	8.50
F-15 STRIKE EAGLE	8.50
FOOTBALL FORTUNES	12.75
FOUR STAR GAMES I	6.95
FOUR STAR GAMES II	6.95
GAUNTLET (64k)	8.50
JEWELS OF DARKNESS(64k)	12.75
JINXTER	8.95
LEADERBOARD	8.50
LITTLE DEVIL	6.95
LIVING DAYLIGHTS	8.50
MIRAX FORCE	6.95
NIGHTMARES	6.95
RED RAT DOUBLE 1	6.95
RED RAT DOUBLE 2	6.95
SILENT SERVICE	8.50
SILICON DREAMS (64k)	12.75
SPY TRILOGY	8.95
TIME & MAGIK	12.95
TOMAHAWK (64k)	8.50
TRIVIAL PURSUIT	12.75
WINTER OLYMPIAD 88 (64k)	8.50

ATARI 8-BIT DISKS

ACE OF ACES	12.75
BASIL:MOUSE DETECTIVE	12.75
DRUID	12.75
EUROPEAN SUP. SOCCER	12.75
F-15 STRIKE EAGLE	12.75
FOUR STAR GAMES I	8.95
FOUR STAR GAMES II	8.95
GAUNTLET (64k)	12.75
GEMSTONE WARRIOR	16.95
GUILD OF THIEVES (64k)	16.95
JEWELS OF DARKNESS (64k)	12.75
JINXTER	12.95
LEADERBOARD	12.75
LITTLE DEVIL	8.95
LIVING DAYLIGHTS	12.75
MINI OFFICE II	16.75
MIRAX FORCE	8.95
NIGHTMARES	8.95
PAWN (64k)	16.95
SILENT SERVICE	12.75
SPY TRILOGY	12.95
TIME & MAGIK	12.95
TOMAHAWK (64k)	12.75
TRIVIAL PURSUIT	16.95
WINTER OLYMPIAD 88 (64k)	12.75

S
U
N
A
R
O

ORDER VIA
MicroLink
72-MAG90623

Please add 50p handling to all orders under £5
Cheques/PO's payable to: SUNARO SOFTWARE (P6)
Girobank Transcash to account 664 6638



ARE YOU MISSING OUT?

You've got lots of questions about your computer but don't know who to ask! We do! You're not sure which software is best for your application! We do! You'd like to keep up to date with new releases and be sure they are a good buy, but who's going to tell you? We will! You would love to get to know other Atari enthusiasts, but you don't know how! We do! You want to get some of that 'Public Domain' software you've heard about, but where from? We know! You don't want to feel like you're the only Atari owner in the world, but where can you turn too! Well, we can help! Great, but who are you??

We are the largest (and oldest) Atari Computer Owners Club in the U.K. For just £5.00 per year you get help, assistance, hints, tips, friends, pen pals, access to PD software, up to date information, games, utilities, hardware projects, software reviews, programming tutorials, and a glossy club magazine every quarter.

A club magazine as well!! One of those photocopied things that is unreadable, eh! Well no, it's professionally produced, just like this magazine you're reading. It's called MONITOR, you may have heard of it? Yes, friends of mine have read it and say it's great! How do I join the club and get my copy of MONITOR? Easy just send a cheque or postal order for £5.00 to the address below requesting a four issue subscription. Overseas membership is £8.00 (surface) or £12.00 (Airmail).

You won't be disappointed!!

The U.K. Atari Computer Owners Club
P.O. Box 3, Rayleigh, Essex, SS6 8LR

Independent User Group



£2.99



No 1 in Charts

£2.99



See the review
in this issue

RAVE REVIEWS
ARE NO GOOD
IF YOU CANNOT
GET THE GAMES

HERE'S HOW!

PRIORITY ORDER FORM

Please rush by return of post:

Speed Ace 48K @ £2.99 inc P&P

Zybex XL/XE @ £2.99 inc P&P

Total _____

Name & Address _____

Make cheques + P.O. payable to: ZEPPELIN GAMES LTD.
Send to: Zeppelin Games Ltd, 28 Osborne Road, Jesmond,
Newcastle NE2 2AJ England

ATARI GAMES CENTRES?

Trade magazine Computer Trade Weekly reported a couple of months ago that Atari plan to set up a number of Atari Games Centres specifically to promote the XE and 2600 consoles. If the story is true, it is to be welcomed but it does seem to be a strange case of bolting the stable door particularly as Atari themselves are primarily responsible for killing the horse! To their credit, Atari have recently released a number of the all time 8-bit classics on ROM and some new titles on disk and cassette but it seems that it will not be enough to bring a new resurgence of interest in the 8-bit market. Atari pushed the XE under the carpet when the ST arrived, despite the fact that it was still one of the leading machines for all sorts of use. The advertising and press hype convinced many existing Atari owners that they had old and outdated machines yet that was far from the truth as Atari now seem to want to show!

If the Atari Games Centres get off the ground we will be one of the first to give support but somehow we feel that it will turn out to be just one of those ideas that seemed good at the time.

ATARI MAKES MONEY

Atari's latest quarter results to April 1988 showed sales increasing to \$97.1 million against \$65.1 million for the same quarter last year but net income was almost identical at around \$15.25 million. During the past year however Atari purchased a major retail group in the States to handle its American sales but as that company were running heavily at a loss Atari's net income for the quarter was in fact only \$5.6 million despite the overall turnover reaching \$169 million.

Atari did much better in Europe last year as reported by our Dutch correspondent. At a dealer meeting held in Holland in February a lot of interesting information regarding the European market was released by Atari with Jack Tramiel's consent. Worldwide sales of Atari during 1987 were stated as \$363 million against \$258 million the previous year. Sales in the Benelux countries accounted for 6% of the overall turnover with the product split as 85% ST, 8% XL/XE and 7% other. In Holland a total of 15,000 ST's were sold in 1987 the majority of which were 1040ST's whilst it was stated that in the UK 15,000 520ST's were sold in

December alone against only 800 1040ST's!

Of Atari's worldwide sales in 1987 64% was in Europe with a massive 28% in Germany alone. Sales were also made in the Communist countries of Poland, Czechoslovakia and East Germany although for security reasons only the 8-bit machines are sold there! Sales of the Mega ST have been relatively low in this country although it is reported that in Germany over 15,000 units have been sold, 50% of which were with the laser printer.

NewsScene

MEDIA WHO?

Mediagenic is the new name of one of the most widely known companies in the Atari market - Activision. Apparently, Activision's activities have expanded beyond the games sector and the company executives wanted a name more appropriate to the diverse image of the company. Mediagenic seems a strange choice of name, it sounds to us more like a company selling blank disks than original computer software! Thankfully Activision will be retained as a software label so there will be no confusion amongst us simple folk!

Although known as one of the world's biggest software companies, Activision made a trading profit in the year to March 1988 for the first time in four years! Isn't it surprising when companies that we all assume are enormously successful can continue to lose money for years? Part of the successful turnaround has been due to Activision's U.K. operations where they have established their own development unit based in Southampton. The unit, known as The Software Studios, was set up 18 months ago initially to handle conversions of U.S. programs but has rapidly grown to finding and developing new and original European software.

Activision's future releases will include a number of titles licensed from the arcades including AfterBurner, R-Type, CyberTank, SDI and Timescanner.

WOULD YOU LIKE TO HELP PAGE 6? and get lots of FREE goodies!

The number of newsagents in the country is vast and there is no way we can check to see that PAGE 6 is stocked in the right places or if the shops have sufficient copies, but it is vitally important that we do all we can to ensure sales are as high as possible. We can't possibly do it, but you could!

What we need is a band of dedicated people in various parts of the country who are willing to go into their local main newsagents once or twice a month, check that PAGE 6 is on sale, and report back to us. It couldn't be simpler, we will provide a simple form to complete and return. As a reward for your support we will send you FREE copies of PAGE 6 plus the Issue Disks every issue plus a FREE selection of either the 8-bit or ST Public Domain disks added to the Accessory Shop library each issue - that could be worth a few bob! - and you will have the satisfaction of knowing that you are helping PAGE 6 to continue to support your Atari.

To be a PAGE 6 NEWSHOUND you must be over 16 years of age and be able to visit one or two main newsagents on a few specified days every couple of months and be you must be confident and responsible enough to ask if you don't see the magazine. Obviously we only need one NEWSHOUND for each shop so if someone has got in first, you'll be unlucky, but we do need to cover as wide an area as possible in all the major towns.

To qualify just let us have your name and address and age and details of the newsagents you are able to visit. Remember we are interested only in major newsagents, not your local sweet shop! If selected we will give you full details of just how to go about helping PAGE 6.

Write to PAGE 6, P.O. Box 54, Stafford, ST16 1DR.

SUBSCRIBE!

and it needn't cost you anything!

Take out an annual subscription to PAGE 6 and we'll let you knock the price of your subscription off of either of these two great Adventure games. You pay £7 for a six issue subscription to PAGE 6 and take the full subscription cost off of your choice of game. Couldn't be easier - just like getting a free subscription!

JEWELS OF DARKNESS

What could be more appropriate for this Issue? Level 9's most acclaimed work brought together in an enthralling trilogy. The ideal starter for anyone whose appetite has been whetted for Adventure.

**SAVE
£7.00**

	Regular Price	With Subscription	SAVING
ST	£19.95	£12.95	£7.00
XL/XE (Disk or tape)	£14.95	£7.95	£7.00

The total price you pay including a 12 month subscription to PAGE 6 is £19.95 for the ST version or £14.95 for the XL/XE version

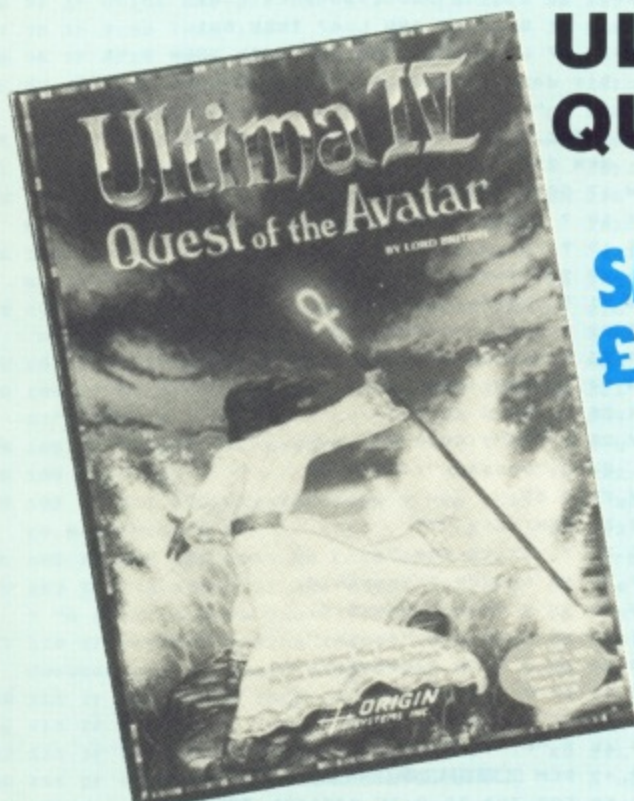

ULTIMA IV QUEST OF THE AVATAR

**SAVE
£7.00**

One of the most widely acclaimed role-playing games available on the Atari. Highly praised in every review (including John Sweeney's four page epic in PAGE 6!). For weeks or even months of enjoyment you can't go wrong.

	Regular Price	With Subscription	SAVING
ST	£24.95	£17.95	£7.00
XL/XE (Disk or tape)	£19.95	£12.95	£7.00

The total price you pay including a 12 month subscription to PAGE 6 is £19.95 for the ST version or £14.95 for the XL/XE version

Existing subscribers may take advantage of this offer by renewing in advance. Please ensure that you clearly state if you are renewing a subscription and quote your subscription number if possible.

Offers open only to UK readers. Please send your remittance of £7 for the subscription plus the appropriate price of the game of your choice to PAGE 6, P.O. BOX 54, STAFFORD, ST16 1DR. Please state clearly which game and which version (ST or XL/XE, tape or disk) you require. Your subscription will commence from Issue 35 unless you state otherwise. Please allow 21 days for delivery.

Klepht's Castle

by Peter Dean

Klepht's Castle is a challenging text-only adventure which takes place in and around a country mansion. The object is to retrieve ten classic Atari games, stolen from you by the arch villain Klepht and hidden in the mansion's rooms and passages.

Various objects can be found which will help you solve the problems and puzzles that stand between you and your 'treasure'. Use your wits and powers of logic and ingenuity to unravel the secrets of the mansion and its garden. Along the way you will meet characters both friendly and hostile ... keep an eye out for one in particular who has a tendency to come and go like a thief in the night!

The game has several features that you might find in 'commercial' games although it is intended to be a 'one-sitting' game and thus, at present, has no facility to save a game to disk or cassette. It does however have RAM SAVE and RESTORE, 'IT' recognition and text compression. The routines which control these will be of interest to anyone starting out on the long trail of adventure writing.

Input is by verb and noun only, e.g. TAKE BAG or REMOVE COAT. Keeping things simple will usually pay dividends. A full list of words can be deduced from the wordbank between lines 300 and 347. If a word outside this range is typed in, the parser will tell you which word cannot be used. Remember the SAVE and RESTORE option and use it before you do anything dangerous.

You will have done well to have completed the game, at the first attempt, in fewer than five hundred turns.

ARE YOU STUCK?

We have the full solutions to three of the Adventures in this issue. Anyone who gets stuck on DEDRIDGE CASTLE, DEMON ADVENTURE or KLEPHT'S CASTLE can come running to us for the solution. Copies are available from PAGE 6 upon receipt of a large stamped addressed envelope. Please state which solution you require and write to PAGE 6 ADVENTURES, P.O. BOX 54, STAFFORD, ST16 1DR.

WARNING: These are full solutions rather than hints, so make sure that you try really hard before sending off for the answers!

Wander around an old mansion and see if you can find the treasure – in this case some of the classic Atari games!

```

EH 0 REM *****
NT 1 REM *      KLEPHT'S CASTLE      *
UO 2 REM *      BY Peter Dean      *
EA 3 REM * ----- *
IX 4 REM * PAGE 6 MAGAZINE - ENGLAND *
EM 5 REM *****
JH 6 POKE 16,64:POKE 53774,64:SETCOLOR 1,
    0,14:SETCOLOR 2,0,0:GOSUB 383
UC 7 RESTORE 495:FOR Z=1536 TO 1566:READ
    A:POKE Z,A:NEXT Z:A=USR(1536)
GT 8 L=79:M=350:O=34:P=1664:T=10:U=70:DIM
    A$(100),B$(4),C$(4),D$(12),IT$(4),OBJ
    $(25),N$(4),V$(4),A(0),B(0)
ZV 9 RESTORE 490:FOR Z=0 TO 0:READ A,B:(
    Z)=A:B(Z)=B:NEXT Z:?
OL 10 TRAP 11:B=0:C=0:D=0:E=0:F=0:RESTORE
    400+L:READ A$,A,B,C,D,E,F
GI 11 IF B(3)=1 AND L=15 THEN E=61
HS 12 IF B(11)=1 AND L=47 THEN B=1
ZH 15 IF L>18 AND L<60 AND A(0) THEN ? "I
    t's dark.":GOTO 55
HY 16 ? "You are ";;FOR Z=1 TO LEN(A$):B$
    =A$(Z,Z):IF ASC(B$)<48 OR ASC(B$)>57 T
    HEN 29
HW 17 GOTO 18+VAL(B$)
MX 18 ? "room":GOTO 30
OS 19 ? "in a ";;GOTO 30
WS 20 ? " the ";;GOTO 30
XW 21 ? " a ";;GOTO 30
PS 22 ? "by a ";;GOTO 30
MA 23 ? "-shaped hedge":GOTO 30
LQ 24 ? "an":GOTO 30
UX 25 ? :GOTO 30
NY 26 ? "in":GOTO 30
LL 27 ? "passage":GOTO 30
QY 29 ? B$:
JR 30 NEXT Z:?"."
OG 35 ? "Exits are ";
BP 36 IF A THEN ? "north,";
BV 37 IF B THEN ? "east,";
HT 38 IF C THEN ? "south,";
RB 39 IF D THEN ? "west,";
VE 40 IF E THEN ? "up,";
JV 41 IF F THEN ? "down,";
XP 45 ? "+":Y=0
SN 49 REM ANYTHING THERE?
ZC 50 FOR Z=0 TO 0:IF A(Z)<>L THEN 54
RR 51 IF Y=0 THEN Y=12:?"You can see ";
OO 52 RESTORE 500+Z:READ OBJ$:X=LEN(OBJ$)
    +1:Y=Y+X:IF Y>35 THEN Y=X:?"
UX 53 ? OBJ$;" ";
AY 54 NEXT Z:IF Y THEN ? "+."
BO 55 IF A(24)=0 AND (L=28 OR L=53) THEN
    ? "The icicle melts!":A(24)=1:I=I-1
HZ 56 IF L=59 THEN 378
  
```



```

JY 57 IF B(15)=L THEN ? "A frustrated art
ist asks, 'Can you paint me a Cubis
t picture?'"
DZ 58 IF B(14)=L THEN ? "A wax figure def
ends the east door."
UU 59 IF B(13)=L THEN ? "A gnome is on Pa
trol."
KF 60 IF B(8)=L THEN ? "A panel's here."
NY 61 IF L=77 AND B(8)=1 THEN ? "Wires ar
e here."
DS 62 IF B(5)=L THEN ? "The juggler asks,
'Have you anything I can use?'"
HM 63 IF B(17)=L OR L=37 THEN ? "A rope h
angs here."
IZ 64 IF B(9)=L THEN ? "A playful cat rub
s against your leg."
ZN 65 IF L=51 AND A(13)<>1 THEN ? :? "Chi
nk! You're a human ice lolly!":GOTO 39
5
RB 66 IF L=53 AND A(12)<>1 THEN ? :? "Hoo
oosh! You've been incinerated!":GOTO 3
95
UH 67 IF L=58 AND A(14)<>1 THEN ? :? "You
're overcome by poison fumes!":GOTO 39
5
JT 68 IF B(2)=L THEN 371
OG 69 REM SIMPLE_PARSER
SC 70 POKE 752,0:ITS=C$:C$="":? :INPUT #1
6,D$:POKE 752,1:B$=D$:GO=GO+1:?:FOR Z
=1 TO 12
TS 71 TRAP 74
NM 72 IF D$(Z,Z)=" " THEN B$=D$(1,Z-1):C$
=D$(Z+1,LEN(D$)):GOTO 74
OY 73 NEXT Z
FI 74 IF C$="IT" THEN C$=ITS
UD 80 TRAP 83:RESTORE 235+A5C(B$(1,1)):FO
R Z=0 TO 6:READ V$,V:IF B$=V$ THEN 85
OX 82 NEXT Z
QT 83 ? "Verb not recognised.":GOTO U
JH 85 IF V<50 THEN GOTO 100+V
PO 87 TRAP 90:RESTORE 260+A5C(C$(1,1)):FO
R Z=0 TO 6:READ N$,N:IF C$=N$ THEN 93
PL 89 NEXT Z
BZ 90 IF V=60 THEN 650
OX 91 IF V=140 THEN 360
XH 92 ? "Noun not recognised.":GOTO U
VC 93 IF V=165 THEN 265
BA 94 IF V=155 AND N>7 AND N<14 THEN 255
YT 95 IF V=50 THEN 150
MB 96 IF N>34 THEN 28
WZ 97 IF A(N) THEN ? "You're not carrying
it.":GOTO U
XK 98 GOTO 100+V
KE 99 REM RESPONSES
LX 100 IF L=11 AND B(8)<98 THEN ? "Alarm
bells ring! You're nicked!":GOTO 395
KG 101 IF B(1)=L THEN ? "The door is in t
he way!":GOTO U
CB 102 IF B(6)=L THEN ? "You must SAY the
password first.":GOTO U
PR 103 IF L=37 OR L=34 THEN 373
FB 104 IF B(13)=L THEN ? "'Oh no you don'
t!":GOTO U
SN 105 IF A THEN L=L+A:GOTO T
QB 106 GOTO 118
RB 107 IF V=7 AND B(14)=L THEN ? "No chan
ce mate!":GOTO U
IL 108 IF V=8 AND L=45 OR L=48 THEN 373
XV 109 IF V=8 AND L=52 AND A(11)<>1 THEN
? "A ghost scares you off.":GOTO U
IT 110 IF V=9 AND B(9)=L THEN ? "Tiddles
savages you to death!":GOTO 395
JR 111 IF V=7 AND B THEN L=L+B:GOTO T
LV 112 IF V=8 AND C THEN L=L+C:GOTO T
NZ 113 IF V=9 AND D THEN L=L+D:GOTO T
NO 114 IF V=10 AND E THEN L=L+E:GOTO T
PV 115 IF V=11 AND F THEN L=L+F:GOTO T
TM 118 ? "You can't go that way.":GOTO U
DK 119 REM INVENTORY
VJ 120 X=0:Y=0:?"You own ":FOR Z=0 TO 0
:IF A(Z) THEN 123
UX 121 RESTORE 500+Z:READ OBJ$:X=LEN(OBJ$
)+1:Y=Y+X:IF Y>36 THEN Y=X:
XZ 122 ? OBJ$;" ";
YF 123 NEXT Z:IF X=0 THEN ? "nothing,":
QQ 125 Y=19:W=0:FOR Z=8 TO 13:IF A(Z)<>1
THEN 129
VH 126 IF W=0 THEN ? :? "and you're weari
ng ":W=1
VP 127 RESTORE 500+Z:READ OBJ$:X=LEN(OBJ$
)+1:Y=Y+X:IF Y>36 THEN Y=X:
YR 128 ? OBJ$;" ";
RL 129 NEXT Z:?" ":GOTO U
WF 130 IF L=4 THEN L=5:GOTO T
OX 131 GOTO 360
FK 132 ? "+":GOTO 395
MF 133 ? 5C:"/100, taking ";G0;" turns.":
GOTO U
KE 135 IF L=75 THEN ? "What's the point?":
GOTO U
HF 136 IF L=15 THEN ? "The water might ex
pand something...":GOTO U
JA 137 ? "Always EXAMINE objects & rememb
er to use SAVE and RESTORE.":GOTO U
UE 142 REM RAM_SAVE/LOAD
OS 143 POKE P,1:FOR Z=0 TO 0:POKE P+1+Z,A
(Z):POKE P+36+Z,B(Z):NEXT Z
KV 144 POKE P+71,L:POKE P+72,I:POKE P+73,
5C:POKE P+74,INT(G0/256):POKE P+75,G0-
PEEK(P+74)*256:GOTO 148
UV 145 IF PEEK(P)=0 THEN 350
IC 146 FOR Z=0 TO 0:A(Z)=PEEK(P+1+Z):B(Z)
=PEEK(P+36+Z):NEXT Z
MT 147 L=PEEK(P+71):I=PEEK(P+72):5C=PEEK(
P+73):G0=PEEK(P+74)*256+PEEK(P+75)
UY 148 ? "OK.":? :GOTO T
PO 150 IF N>34 THEN 350
BX 151 IF I>6 THEN ? "You can't carry any
more.":GOTO U
TO 152 IF N=0 AND L=T AND G0>20 THEN ? "D
on't bother - it's blown out!":GOTO U
QH 153 IF A(N)=L THEN ? "Taken.":A(N)=0:I
=I+1:GOTO U
IL 154 ? "It's not here!":GOTO U
QD 155 IF N>34 THEN 350
NR 156 IF B(10) AND M=6 THEN 375
ND 157 IF L=79 AND N=24 AND B(N) THEN 5C=
5C+10:B(N)=0:G0SUB 390
RG 158 ? "Dropped.":A(N)=L:I=I-1:GOTO U
OD 160 TRAP 650
BE 161 IF N>24 AND M<35 THEN ? "An Atari
classic.":GOTO U
AE 169 GOTO 600+M
JG 200 IF N=35 AND B(8)=L AND A(19)=0 THE
M ? "It comes away to reveal wires.":B
(8)=1:GOTO U
GB 204 GOTO M
HF 205 IF L=77 AND N=37 AND B(8)=1 AND A(
10)=1 AND A(18)=0 THEN 370
BM 206 IF L=77 AND N=37 AND B(8)=1 AND A(
18)=0 THEN ? "Aaaaaaargh!! You're fried
alive!":GOTO 395
GQ 209 GOTO M
HE 210 IF L=13 AND N=39 THEN ? "'Burglar'
s Convention tonight at the mansion.
Wear appropriate dress!":GOTO U
JA 211 IF N=21 THEN ? "'DON'T CATCH THE B
USS' is scrawled on the fly-leaf.":GOT
O U
YB 212 IF L=35 AND N=49 THEN ? "'MUM's th
e word!' - signed 'Sybil'.":GOTO U
KY 213 IF L=2 AND N=38 THEN ? "BASE for e
ntry into high places.":GOTO U
GD 214 GOTO M
GU 215 IF L=2 AND N=40 THEN 350
G5 219 GOTO M
MH 220 IF B(1)=L AND N=40 AND A(3)=0 THEN
? "OK. You can enter.":B(1)=0:GOTO U
GF 224 GOTO M
KV 225 IF B(3)=L AND N=1 THEN ? "A galleo
n appears!":B(3)=1:A(N)=1:I=I-1:GOTO 3
57
GU 229 GOTO M
GO 230 IF B(4)=L AND N=5 THEN ? "'Hope yo
u like oranges!":B(4)=1:A(N)=1:A(15)=
0:GOTO U
SA 231 IF B(5)=L AND N=15 THEN ? "A casse
tte is tossed at you.":B(5)=1:A(N)=1:A
(30)=0:GOTO U
GH 234 GOTO M
TR 235 IF M<14 OR N>16 THEN 358
GR 236 ? "GULP!":A(N)=1:I=I-1:GOTO U
UL 240 IF B(6)=L AND N=41 THEN ? "'You ma
y pass.":B(6)=0:GOTO U
PJ 244 GOTO 360
SD 245 IF B(7)=L AND N=44 AND A(17)=0 THE
M V=7:N=32:GOTO 356
GY 249 GOTO M
LP 250 IF M<8 OR N>13 THEN 358
CS 251 ? "OK.":A(N)=1:I=I-1:GOTO U
ZG 255 IF A(N)<>1 THEN 350
ET 256 ? "OK.":A(N)=L:GOTO U
HA 259 GOTO M
PK 260 IF B(8)=L AND N=4 THEN B(17)=L:A(4
)=1:I=I-1:GOTO T
GM 264 GOTO M
BG 265 IF B(17)=L AND N=4 THEN L=37:GOTO
T
FB 266 IF L=37 AND N=4 THEN L=58:GOTO T
HC 269 GOTO M
VY 270 IF B(10)=0 AND A(2)=0 AND N=6 THEN
? "OK.":B(10)=1:GOTO U
GP 274 GOTO M
QI 275 IF N>34 THEN 350
PZ 276 IF B(11)=L AND N=20 THEN ? "You sm
ash the east 'wall'! ":B=1:B(11)=1
WL 277 IF B(13)=L AND N=24 THEN ? "A dire
ct hit! Your foe clutches his chest
and flees in agony! ":B(13)=1
WM 279 ? "OK.":A(N)=L:I=I-1:GOTO U
JJ 280 IF B(12)=L AND N=35 THEN V=12:N=29
:GOTO 356
PR 284 GOTO 360
BB 285 ? "How?":GOTO U
PA 290 IF B(14)=L AND N=22 THEN ? "The fi
gure melts!":B(14)=1:GOTO U
ZL 291 IF N=23 THEN ? "BOOM!!! You've blo
wn yourself up!":GOTO 395
PH 292 IF N=22 THEN 360
GT 294 GOTO M
CV 295 IF B(15)<>L THEN 350
ZJ 296 IF A(16)<>1 AND N=47 THEN ? "Your
effort is feeble.":GOTO U
XP 297 IF N=47 THEN ? "'Ah! Formidable!'
The artist rewards you with a tape.":
B(15)=1:A(31)=L:?:GOTO T
HF 298 GOTO M
AD 299 REM WORDBANK
UJ 301 DATA BASE,30
JT 302 DATA CUT,105,CLIM,165
JQ 303 DATA D,11,DOWN,11,DROP,55,DIG,145
EW 304 DATA E,7,EAST,7,EXAM,60,EAT,135
XW 305 DATA FORC,120,FILL,125,FIRE,190
CM 306 DATA GET,50,GIVE,130
EK 307 DATA HELP,35
Y0 308 DATA I,20,INV,20
NM 310 DATA KILL,185
NM 311 DATA L,-90,LOOK,-90,LEAV,55
HP 313 DATA M,0,MORT,0
MH 314 DATA OPEN,115
NF 315 DATA PAIN,195
NJ 316 DATA QUIT,32
EX 317 DATA REMO,155,READ,110,REST,45
KS 318 DATA S,8,SOUT,8,SCOR,33,SAVE,43,SA
Y,140,SLID,180,SHOO,190
VV 319 DATA TAKE,50,TIE,160,THRO,175
CI 320 DATA U,10,UP,10,UNSC,100
FY 322 DATA W,9,WEST,9,WEAR,150,WIND,170
OS 325 DATA ANGE,14,APEX,41
YA 326 DATA BOTT,1,BAG,7,BRIC,20,BLUN,23,
BOOK,21,BOUL,32,BLUE,34
XN 327 DATA COIM,5,COAT,13,CROW,3
JK 328 DATA DUST,11,DEFE,26,DOOR,40
TO 330 DATA FLAM,22,FRAC,30,FIGU,46
BT 331 DATA GLOV,10,GIRL,42,GNOM,45,GRAF,
49
DS 332 DATA HILL,44
UR 333 DATA ICIC,24,IVY,35,IMSC,38
GE 334 DATA JERS,9
MT 335 DATA KEY,2
NM 336 DATA LAMP,0
GW 337 DATA MOUS,6,MINE,29,MASK,8,MOLE,44
TG 339 DATA OIL,0,ORAN,15
XK 340 DATA PACM,25,POLE,33,PANE,35,POST,
39,PICT,47

```

Klepht's Castle

55 341 DATA OIK,31
 JG 342 DATA ROPE,4,RAZO,18,RESC,30
 JH 343 DATA SHEE,11,SUIT,12,SPAD,17,SCRE,
 19,STAR,27,SPAC,28
 CO 344 DATA THRO,22,TABL,16,TOPI,43
 CA 347 DATA WALL,36,WIRE,37,WENC,42,WELL,
 48
 CH 349 REM **MESSAGES**
 OS 350 ? "You can't do that.":GOTO U
 KE 356 ? "You find something!":B(V)=1:A(N
)=L
 OK 357 FOR W=1 TO 150:NEXT W: ? :GOTO T
 LA 358 ? "Don't be silly!":GOTO U
 OB 360 ? "Nothing happens.":GOTO U
 RM 370 ? "You disable the alarm but in do
 ing so black out the mansion!":B(O)=99
 :GOTO U
 HO 371 IF A(7)=0 AND A(8)=1 AND A(9)=1 AN
 D A(10)=1 THEN B(2)=1:GOTO U
 OL 372 ? !? "A footman appears and chucks
 you out!":L=2: ? :GOTO T
 CI 373 ? "The door's locked.":GOTO U
 HD 375 ? "The toy scoots off...":IF B(9)
 =L THEN ? "pussy follows!":B(9)=1
 BO 376 A(N)=1:I=I-1: ? :GOTO U
 OP 378 W=0: ? :? "Klepht appears...then di
 sappears!":FOR Z=25 TO 34:IF A(Z)=0 TH
 EN A(Z)=1:I=I-1:W=1
 WR 379 NEXT Z:IF W THEN ? " with your tre
 asure";
 ZL 380 ? "!!":GOTO U
 KJ 383 POKE 752,1: ? CHR\$(125);"Welcome to
 KLEPHT'S CASTLE.": ? :? "Curses! Kleph
 t, a local tea-leaf, has nicked";
 UI 384 ? "your favourite ATARI games!
 Only one thing to do, penetrate his
 'castle' and nick 'em back!":RETURN
 IU 390 IF SC=100 THEN 392
 ZU 391 RETURN
 MF 392 ? "Well done! You have recovered y
 our priceless treasures. Now lock
 'em up before Klepht strikes again!"
 GK 395 ? !? "You scored ";SC;" /100,taking
 ";GO;" turns.": ? :? "Press START for
 another go..."
 EZ 396 IF PEEK(53279)=6 THEN RUN
 UE 397 GOTO 396
 MI 399 REM **LOCATIONS**
 NL 402 DATA st6d8g before3great oak7door
 which bears 6 8scription,16,1,0,7
 RB 403 DATA on3rough track lead8g7through
 3wood. Sun-dappled leaves7catch your e
 ye,0,1,0,-1
 AQ 404 DATA iclear8g. Before you is 3str6
 ge tower,0,0,0,-1
 KQ 405 DATA 82tower. A staircase7spirals
 above you,0,0,-1,0,1
 DM 406 DATA on 6 iron staircase,0,0,0,0,1
 ,-1
 VZ 407 DATA on3platform at2top of 2stair
 s,0,0,0,1,0,-1
 AB 408 DATA on3balcony. Visible is2 roof
 of3great m6sion. A face peers from3gab
 le w8dow,0,-1
 UQ 409 DATA on crunchy gravel,0,-7,1
 ZW 410 DATA igusty driveway fl6ked7by f8e
 examples of topiary,-1,0,1
 LP 411 DATA by wrought-iron gates. They7a
 re flung open 8vit8gly,-1,66,0,1
 MI 412 DATA 1leafy 16e,0,-1,1
 ME 413 DATA at3bend 8216e. On37tree there
 's3poster,-1,0,0,1
 RB 414 DATA at3cross-roads,1,-1,2,3
 QY 415 DATA by3silent pool. An air of7mag
 ic prevails,0,0,-1
 YW 416 DATA on3footpath lead8g south7acro
 ss waterlogged fields,-2
 HD 417 DATA 8 your home village. A well7s
 t6ds on2green,62,-3
 MO 418 DATA ivestibule. A gr6d hall7lies
 ahead; there are 9s to7east 6d west,1,
 2,-16,14
 RT 419 DATA 82ma8 hall. Pa8t8gs7adorn eve
 ry wall. A f8e staircase7dom8ates2midd
 le,0,0,-1,0,23
 MK 420 DATA 1long 9,0,1,0,-2
 CB 421 DATA 82east lounge,1,0,0,-1
 CO 422 DATA 19 18ed with oak7p6els,2,0,-1
 ,1
 HG 423 DATA back 8 time! A comely wench7s
 Miles at you,0,-1
 SE 424 DATA idusty 0. All27furniture is c
 overed up,0,0,-2,1
 CF 425 DATA 19 18ed with m6y7bookcases,0,
 -1,0,1
 TU 426 DATA 1conservatory overlook8g tri6
 gular-shaped gardens,34,-1,0,1
 GF 427 DATA 1smelly 9,0,-1,0,1
 CP 428 DATA 1kitchen. Hot air blasts7from
 ovens,0,-1,1,0,0,5
 HH 429 DATA 82d88g hall. Cutlery7sparkles
 6d3ch6delier shimmers,-1,1,2
 VU 430 DATA 10 of wax effigies,0,0,0,-1
 MP 431 DATA 82west lounge,-2,1
 FY 432 DATA 1long 9,0,-14,0,-1
 ZU 433 DATA 1w8e cellar,0,0,0,0,-5
 KB 434 DATA 10 with lots of space,1,1
 YI 435 DATA 1low narrow 9. Some graffiti
 is carved 8to 6 oak panel,0,1,0,-1
 GN 436 DATA 82serv6t's quarters,0,1,0,-1
 DC 437 DATA 1colourful nursery. The7cei18
 g is open-pl6,1,1,0,-1
 LQ 438 DATA 1small bath0,1,0,0,-1
 IL 439 DATA 82laundry 0,0,0,-1
 YE 440 DATA 1bath0 resplendent withfitt8g
 s of polished brass,0,0,0,1
 HU 441 DATA 82master bed0,0,-1,0,1
 HH 442 DATA on316ding. To2east 67archway
 heralds3sumptuous bed0; 39 leads west,
 0,-1,0,1,0,-23
 TU 443 DATA 1low 9,0,-1,0,1
 AG 444 DATA 8 6 ante-0,0,-1,1
 KV 445 DATA 82gun-0. Cab8ets7overflow wit
 h silver trophies,-1,1,1
 PV 446 DATA 1gallery full of art7treasure
 s,0,1,0,-1
 JF 447 DATA 10 perfect for quiet7reflecti
 on! Instead of walls it has7mirrors,0,
 0,0,-1
 SJ 448 DATA 1glory hole. A ladder7leads u
 p,0,0,1,-1,9
 AI 449 DATA 1low 9. From below 2north doo
 r rise deadly fumes;2wall opposite is
 very cold,1,7,2,3
 KF 450 DATA 8 6 evil 0. A poison7cloud ho
 vers menac8gly,0,0,-1
 OS 451 DATA 10 of permafrost,-2
 IC 452 DATA at2west end of2low79. The nor
 th wall radiates37fierce heat,1,-3,2,3
 SU 453 DATA 10 of fire,0,0,-1
 L5 454 DATA 1supernatural 0. A7ghost cove
 rs 83corner,-2
 UG 455 DATA 82juggler's 0,0,-3
 GI 456 DATA at2end of39. The7east door is
 marked with3'K',1,3,2,-7
 MK 457 DATA 1studio,0,0,-1,0,0,-9
 XR 458 DATA 10 with3table 47big hole 82fl
 oor,-2
 HB 459 DATA 8 Klepht's 0,0,0,0,-3
 LV 460 DATA on3small patio. Deftly-cut7he
 dges border neat gardens,7,1,-34,4
 OU 461 DATA 4column,0,1,0,-1
 WR 462 DATA 4flower-bed,9,1,0,-1
 VQ 463 DATA 4duck5,0,0,0,-1
 RT 464 DATA 4column,0,-4,0,1
 YG 465 DATA 4bed of pl6ts,4,-1,0,1
 MM 466 DATA 4sw65,0,-1
 QV 467 DATA by 6 ornamental pond. Lily7pa
 ds lie motionless,6,3,-7,1
 IK 468 DATA on3path bisect8g2lawn. Nearby
 is3mole-hill,0,-1,0,1
 TF 469 DATA 4crow5,0,-1,-4
 TV 470 DATA on3pathway. The grass has7bee
 n cut with geometric precision,0,1,0,-
 3
 PD 471 DATA by 6 eagle5,0,0,-9,-1
 QF 472 DATA 4peacock5,0,1
 PR 473 DATA 4founta8,2,1,-6,-1
 FU 474 DATA 4pigeon5,0,0,0,-1
 KP 475 DATA outside3circular build8g.7An
 8tercom is here,3,0,-2
 F5 476 DATA on3galleon 8 full sail! Thepo
 ol though won't lend itself to featsof
 great navigation,0,0,0,0,-61
 II 477 DATA by 6 ivy-clad wall,0,0,0,-66
 HR 478 DATA 82summer-house,0,0,-3
 YX 479 DATA 1cosy cottage filled with2par
 aphernalia of3computer-nut,0,0,-62,0,0
 ,0
 NT 490 DATA 1,0,48,2,50,18,8,15,76,23,76,
 55,33,75,15,68,5,58,16,35,16,0,24,47
 NG 491 DATA 78,22,39,26,65,29,1,57,38,10,
 78,0,79,0,79,0,77,0,31,0,53,0,45,0,51
 NP 492 DATA 0,54,1,30,1,34,1,34,1,1,1,1,1
 ,1,1,1,1,78,1,48,1
 NG 495 DATA 104,169,16,141,40,2,169,6,141
 ,41,2,169,15,141,31,6,173,243,2,73,2,1
 41,243,2,173,31,6,141,26,2,96
 IF 499 REM **OBJECTS**
 SF 500 DATA an oil lamp
 RO 501 DATA a bottle
 CC 502 DATA a key
 KY 503 DATA a crowbar
 FL 504 DATA rope
 GP 505 DATA a coin
 EV 506 DATA a mouse
 MV 507 DATA a bag
 IF 508 DATA a mask
 YH 509 DATA a jersey
 YI 510 DATA gloves
 WP 511 DATA a dust-sheet
 UE 512 DATA a suit
 FP 513 DATA a coat
 DM 514 DATA angelica
 FU 515 DATA oranges
 H5 516 DATA tablets
 OW 517 DATA a spade
 IV 518 DATA a razor
 ZG 519 DATA a screwdriver
 OS 520 DATA a brick
 HI 521 DATA a book
 TX 522 DATA a flame-thrower
 XI 523 DATA a blunderbuss
 TB 524 DATA an icicle
 HR 525 DATA 'Pacman'
 VB 526 DATA 'Defender'
 IE 527 DATA 'Star Raiders'
 KC 528 DATA 'Space Invaders'
 LQ 529 DATA 'Miner 2049'er'
 BX 530 DATA 'Rescue on Fractalus'
 RB 531 DATA 'Qix'
 RF 532 DATA 'Boulderdash'
 QX 533 DATA 'Pole Position'
 ZE 534 DATA 'Blue Max'
 EV 599 REM **EXAMINE**
 JZ 600 ? "Burning brightly.":GOTO U
 JS 601 ? "A ship's inside it.":GOTO U
 MG 602 ? "Tiny.":GOTO U
 RT 605 ? "Old currency.":GOTO U
 ZQ 606 ? "Eek! It's clockwork.":GOTO U
 ZI 607 ? "Marked 'SWAG'.":GOTO U
 YX 609 ? "Striped.":GOTO U
 UV 611 ? "Moth-eaten.":GOTO U
 PB 612 ? "Skin-tight asbestos.":GOTO U
 SY 613 ? "Lined with fur.":GOTO U
 BM 614 ? "Anti-poison.":GOTO U
 TI 616 ? "Designer tablets.":GOTO U
 MF 621 ? "Title: 'Old Guns'.":GOTO U
 FT 623 ? "Clogged up.":GOTO U
 XS 624 ? "Sharp & deadly.":GOTO U
 MK 635 IF B(O)=L THEN ? "screwed in place
 .":GOTO U
 MM 636 IF L=77 AND B(O)=0 THEN ? "Bingo!"
 :B(O)=L:GOTO 357
 GJ 642 IF N=42 AND L=23 THEN ? "It's Nell
 Gwyn!":GOTO U
 CF 643 IF N=43 AND B(16)=L THEN V=16:N=0:
 GOTO 356
 TJ 645 IF N=45 AND B(13)=L THEN ? "The an
 imated garden variety.":GOTO U
 EM 646 IF N=46 AND B(14)=L THEN ? "A Mada
 me Tussaud's reject.":GOTO U
 BJ 648 IF N=48 AND L=17 THEN ? "In the st
 one is carved 'Sib's a fib!":GOTO U
 TV 650 ? "Examined.":GOTO U

STACK COMPUTER PRODUCTS

CENTRONICS PRINTER INTERFACE 400, 800, XL, XE (Any 8 Bit Atari)

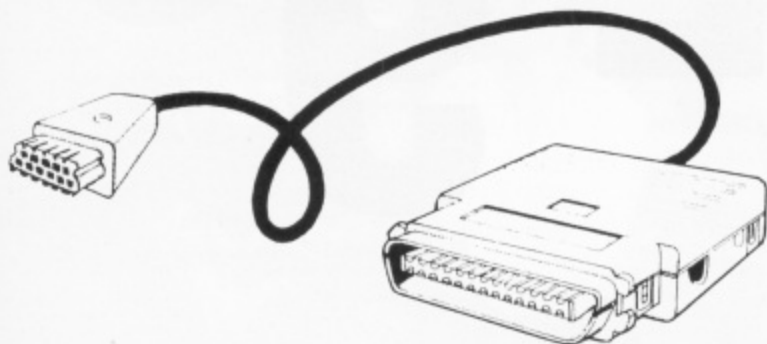

TYPE 72000

£39.95

- ANY CENTRONICS PRINTER
- NO SOFTWARE NEEDED
- ALL CABLES SUPPLIED
- EASY TO USE — JUST PLUG IN AND GO
- TRANSPARENT & CONVERSION FEATURES INCLUDED
- FULL YEARS WARRANTY

FREE 40 PAGE
CATALOGUE ON
REQUEST OR WITH
ORDER

MEEDMORE LIMITED
28 Farriers Way, Netherton
Merseyside L30 4XL
Tel: 051-521 2202



All about Atari — every month!



**ONLY
£1.25!**

- Atari 8 bit news
- Up-to-date reviews
- Exciting features
- Your letters answered

In the exciting June issue of
Atari User you will find:

- A second look at the Eidolon. This time the subject is monsters.
- All the latest games reviews: Grand Prix Simulator, Rockford and many more.
- An in-depth appraisal of four language tutorials for your Atari.
- Build a quizbox — another superb gadget from our electronics genius.
- Clay Pigeon — a fast-action shoot-'em-up arcade game.
- We take a close look at the P:R: Connector, the latest equipment for the 850 interface box.
- Remember Home Filing Manager? Convert your data discs to WP Ascii format.
- Add the professional touch to your disc-based routines with our superb Autorun program.
- Enter the dungeons with the help of Rouloc, our resident adventurer.
- All your programming problems solved by our technical wizard.

All major listings in this issue are accompanied by checksums to help overcome typing mistakes.

PLUS Your chance to obtain the incredible *Atari User Toolkit* which adds 10 new commands to Atari Basic.

Make sure you get every issue before they reach the shops by completing and returning the coupon below.

Please send me the next 12 issues of *Atari User* for £15 starting with the _____ issue.

I enclose a cheque made payable to Database Publications.

Please debit my Access/Visa card no:

□ □ □ □ □ □ □ □ □ □ □ □ □ □ □ □

Signed: _____ Expiry date: _____

Name: _____

Address: _____

Postcode: _____

**Send to: Atari User, Europa House, Adlington Park,
Adlington, Macclesfield, Cheshire SK10 4NP.**

Phone orders: 0625 879920
Telecom Gold: 72-MAG001
Prestel: Key *89 then 614568383

Don't forget to include your credit card number and full address.

A478

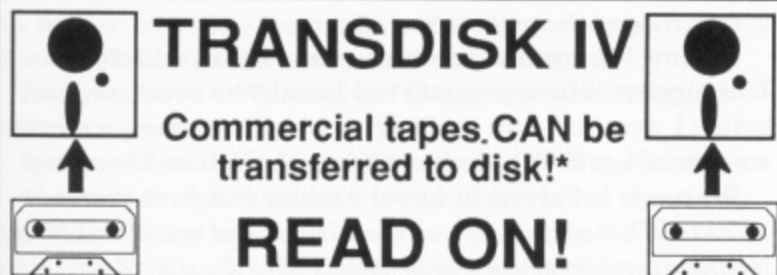

TRANSDISK IV

Commercial tapes CAN be transferred to disk!*

READ ON!

Are you tired of waiting for cassette games to load? Would you like to transfer them to disk for faster, more reliable and convenient loading? You may have heard or read that this is not possible. Well, not only is it possible, but there is a program, Transdisk IV, that will do it all automatically, you require no knowledge of cassette protection techniques! To put it simply, Transdisk IV will read ANY Atari cassette, (single, multi-stage, non-standard format, 64K — no problem!), remove the protection, then place it on to disk for you. Plus, to load and run the new disk version of a cassette program requires just one keypress from a convenient, autorun menu disk.

The cost of this, the most powerful tape to disk utility for the Atari is just, £24.95 inclusive of first class delivery. Also comes complete with comprehensive instructions which were specially written with the cassette upgrader and first time disk user in mind.

Requires: Atari 800XL or 130XE Computer with disk drive and cassette recorder.

Remember, that not only will you save money on upgrades to disk (if they are available) but many games are only available on cassette anyway so Transdisk IV has to be a worthwhile investment!

Send an SAE or phone for more details of this utility.

Make Cheque or P.O. payable to **DIGICOMM** and send your order to:

DIGICOMM
170 Bradwell Common Boulevard, Milton Keynes, BUCKS MK13 8BG.
Tel: (0908) 663708.

Demonstrations arranged for callers by appointment
*For your convenience from the original cassette only.



LEVEL 9

Britain's leading Adventure company is also the only one to have supported the Atari from the beginning so we just had to go and get the definitive interview. Armed with questions set by Garry Francis the Editor set off on the trek to deepest Berkshire. Pete Austin, knowing how easily intrepid adventurers can get lost had sent TWO maps so finding Level 9 was easy but the Level 9 offices were as unusual and interesting as some of the locations in the adventures! Pete and Mike Austin met us on the lawn and after a quick tour of six levels of Level 9 the PAGE 6 interview began by missing out all the routine background that you already know and getting straight down to the really interesting stuff.

Most of our questions were directed to Pete Austin but brother Mike joined in and also answered most of the technical questions.



When you were at Cambridge University you were studying Natural Science. Did you develop your interest in computers from there? Yes, that's right. I had been rather envious at school of people who did the Computer Studies course at the local technical college so when I went to University, although I wasn't actually doing computing, it made it quite easy to get time on a computer. The first program I did was Conway's Game of Life which I had always wanted to do. It started from there.

Most people think that your first program was an adventure but you actually wrote a few programs before you went onto adventures? We didn't start doing adventures until several years after I had finished University. In fact I didn't play any adventures there, what I was actually doing there was Fantasy Wargaming. On the computing side it was writing games like arcade games. I did a Pinball Simulator, 3-D Noughts and Crosses and other sorts of stuff.

Did you continue with your Natural Sciences or give that up when computers took over? I continued with that. My first degree is in Natural Sciences. In fact, I switched over to Psychology which was probably a mistake because Psychology is a load of waffle but I ended up with a degree in it and then stayed for another year to do computing formally.

When you left Cambridge did you go into a regular job? This was before there was any real micro market. There were kit machines coming out and the Z80 was around but not much else. If I had been sensible I would have stayed at Cambridge and gone into Acorn or something similar, like a lot of other people did, although at that time the money paid for that sort of thing was pretty minimal. I joined a Software Consultancy to work for banks in the city. I stayed there for about a year and a half and then went to Perkin-Elmer, who

MASTERS of ADVENTURE

(and nice people too!)

are currently called something like Concurrent Computing, they manufacture minis. I worked on system software for them and then moved on to Hewlett Packard which was definitely a mistake. I went there thinking that they were doing original software but it was in fact just maintenance of stuff that had gone wrong at the prototype stage.

So how long was it from the time that you left University before you started Level 9? About four years before I went full-time on Level 9. I had been doing a certain amount of Level 9 as a hobby back in the Perkin-Elmer days.

Who was involved in Level 9 when you first started? (Mike) When we first started it was Peter and myself and Nick, the three brothers which was in about 1981. We started off writing Arcade Games and Utilities on the good old Nascom and then after about 9 months to a year we wrote the first adventure game which was Colossal of course. (Pete) I found Colossal Adventure at Perkin-Elmer running on one of their machines. I thought that we could do this, in 16K on a micro and in fact we did. The main thing that we got right at that stage was that we actually wrote a system, we didn't write a game but we actually wrote a system which interpreted a database. Virtually, everybody else writing adventures at that time, in fact everybody that I can think of, went and wrote one-off games.

Did you do that as a deliberate policy, actually write a system first? Yes. Well we realised that about half of the work in Adventure games is in the machine code, is in driving the machine and in the compression routines you want and so on and we figured that we could produce sort of a family of games rather more efficiently than a one-off game and this was basically the way to do it. Fairly rapidly, we then realised that you could put versions of the adventure system on other micros and get even greater efficiency and access to a wider market because at that time every man and a dog was bringing out a micro. (Mike) The BBC had just been announced. So we were asking ourselves how can we get this game onto a 6502 if we hard code in ZX80.



The LEVEL 9 team - Mike, Nick, Pete

Going back to Level 9 as just the three of you, you've carried it on as a family business ever since. Has that been a deliberate decision is it just the way things worked out? It's been a deliberate decision. *(Mike)* There are quite a lot of other people who work for us, mostly on a freelance basis. *(Pete)* The big advantage is that you have to specialise in micro companies. It is not possible for one person to do everything. I tend to deal with the design, Mike in the past has tended to deal with Adventure coding and Nick has dealt with machine coding and transporting different games to different machines. It's slightly more complex but that is basically it. Because we are a family we can trust each other, if we weren't related and say Nick left we would be in dead trouble because it would take us a long time to work out how to transport the games onto different machines because all the knowledge is in his head so basically, the stability of the family is essential I think to run the business effectively and efficiently.

Did you have an interest in Dungeons and Dragons when you were at University? Yes.

Is that where Level 9 really started? Well the name Level 9 was designed to indicate a level of quality, it was the highest level that you get with a one digit number. I started with D & D. The form of D & D that we played is very unlike that played elsewhere. I have seen other D & D groups and I don't much like them. We played political D & D where, frankly, if you had to fight your way out of a situation then you had done something wrong. The basic idea was to do bluff and blackmail people in the game and use political intrigue and spy techniques and that sort of thing.

So there was much less Fantasy? Fantasy was a big part. If you watch ordinary people play D & D they go up a corridor, they kick in a door, they throw in the fireball, that wipes out the monsters, they go in and take the treasure then move on to the next dungeon and repeat the process. It's not particularly skilled, it's not particular fun although they seem to enjoy it – you know, I've wiped out the 10th level dragon! – when in fact the poor beast is just waking up when everybody descends upon it and hacks it to bits.

Did you have a particular character and do you still remember it? I had a large number of characters. My favourite one I guess was a character called Sam, who got to be incredibly good at light spells, in fact he provided street lights for the local city. One of the things he did was get a contract for the street lighting which indicates the difference in our D & D, but he was also a Necromancer and he went around wearing darkness surrounded by Zombies, in his other life down the dungeon.

Your first game was called Fantasy? It wasn't our first game, it was our first kind of role-playing game.

What type of game was it? It was a game with about 30 locations. It had people wandering about and essentially it was one of the few games where the other characters were exactly the same as the player and they were all after the gold as well. What made it amusing was that they had quite interesting characters, each had a table of attributes, some of them were cowardly, some of them were strong – that kind of thing and we gave them names. There was one called Ronald Reagan and one called Maggie Thatcher and so on *(Mike)* and there was *Ghengis Khan, etc ... (Pete)* so you could wipe out your least favourite person!

How does it compare with anything available now? I've not seen anything like it. It's the sort of thing that worked very nicely as a hobbyist game or as a sort of experimentation game.

Your first commercial game as Level 9 was Colossal Adventure? *(Mike)* Yes, the first commercial adventure game. *We did quite a lot of arcade games under the Level 9 name. (Pete)* Our first two products were this Fantasy thing and Extension Basic which still looks very good. *(Mike)* Basically, what it did was it took the standard Microsoft Basic on the Nascom which is fairly similar to the 8k basic on the Atari, and made it into an equivalent of the BBC basic in virtually 16k.

Why did you release Colossal Adventure? There were lots of versions around at the time. *(Mike)* I didn't have access to a computer to play it on so I just had to write a version!

Was it based on any particular implementation? I'd played the one at Perkin-Elmer about a year before. *(Mike)* There were a lot of versions on it on mainframes but not on micros at that time.

You made a couple of changes to the game, for example, moving one of the treasures and adding the end rooms. Why did you do that? The only thing that we actually moved is the food which we put in the forest. It was really because there was a lot of forest around, nothing actually to do with the game. We put the extra rooms in because we had told everybody that there would be 200 rooms and when we counted them up there were only 130, so we just had to put the others in!

Ever since then most of your games have had around 200 rooms. That really has been one of the criticisms of Level 9 games, that you have to spend a lot of time wandering about doing nothing. Yes, we didn't realise over the years that our games were taking longer to actually get through because of number of rooms. The number of rooms didn't actually go up it was just that you had to do more rooms. We have overcome that in our new games from Gnome Ranger onwards – it was taking us too long to play them on all the different versions so we now have a policy that you can play this thing, if you know the solution, in about half an hour. *(Mike)* Obviously, we have done this partly by the cutting down of the number of rooms and partly by the way the games are laid out so they are now much more a sort of square map rather than a very long linear one. *(Pete)* I think that most people have become quite bored with mapping. Now, you will get some people writing in saying that mapping is great, I enjoy mapping but I think that after you have played a few adventures you really don't want to map, you want a fairly simple organisation of rooms which is fairly simple, fairly logical – no need to map and we tended to go over to that rather than the labyrinth type of games we were designing three years ago.



Your next game was Adventure Quest. There are some wonderful ideas in that like the four elements in the different regions and the teleports which were quite hard to grasp. Do you think that parts of that didn't get through to people? (Mike) *You can never get everything across to everybody. A lot of people did figure it out. We have had people coming up to us at shows saying so.* (Pete) It is not absolutely necessary for everybody to get every single thing out of the game. I try and design them fairly logically and put in as many different things as I can although there is a danger that you overload the game and it becomes confusing.

Would you do it any other way if you were writing that adventure again? I would make it less linear. Adventure Quest was the first game I actually designed from scratch and it's a very linear game. You go through about eight different zones but you have to do them really in order. Nowadays, I prefer games rather more like Dungeon Quest which is the one I designed after that where you can wander around in a reasonable area and there are groups of puzzles within that. If you get blocked on one group you can go and try another area and that I think is probably the sort of thing I want to design nowadays.

Dungeon Quest was the third one and that completed what you call a Middle Earth Trilogy. You released that with graphics under the Jewels of Darkness, why did you not call it Middle Earth? Well Rainbird chose the name. We were in fact going to release it as the Middle Earth Trilogy or perhaps the Colossal Trilogy.

From there, you went on to science fiction with Snowball. Do you know of 'The Mote in God's Eye'? Were you inspired by that in any way? No. I think I quoted 'The Mote in God's Eye' in the bibliography section purely because it's a good book and Niven designs his science fiction universe properly.

Was that an inspiration to you? No, not at all.

In Snowball the player's alter ego is Kim Kimberley. Is Kim a male or female? Neither. (Mike) *There is actually a reference to that.* (Pete) The theory is that that was one of the things that interested players could find out. Kim was picked to be either male or female but in fact, if you look in the packaging it credits Miss Kimberley's wardrobe (Mike) *although it doesn't actually say that in the game.* (Pete) They do that with science fiction books, you find that cover is nothing to do with what happens in the book so we might have done the same thing in our game.

You advertise Snowball as having 7,000 locations. Does it really have that many? Oh, yes. (Mike) *They are all rooms in which you can leave objects.* (Pete) They've also all got code lights on the ceilings and they are different code lights. Obviously they aren't dramatically different to each other.

Is it possible to visit 7,000 different rooms? Yes and if you had 7,000 objects you could actually drop an object in each room. In fact you can't but you can drop an object in a particular room and it will be seen in that room and nowhere else so they are different.

You next went onto Lords of Time which was designed by somebody else. I believe Sue Gazzard designed the game and coded it. How did that collaboration come about? Sue sent a design in. I didn't like the initial design but she redesigned it and it was quite good. The design that we eventually used from Sue was excellent on detail of background, the puzzles tended to be awfully easy, basically you examined things and gave them to people so I added a few other puzzles, for example the icicle one, and the resulting game worked out quite nicely.

So you are quite happy with that? Yes that is one of the ones that I am happiest with.

Was that going to be part of a trilogy originally? We were hoping Sue would do other designs. She did in fact submit another design but it was very one paced. One of the problems in adventure designs is that first of all you must stick to the subject and a number of people send in designs where they have clearly run out of ideas half way through. My best example of this is someone who sent in a Bermuda Triangle game and the first part, of a three part game, is all about the Bermuda Triangle, UFO's - all good stuff, but then he ran out of ideas and so in part two you just went down into the cave below this island in the Bermuda Triangle and it went back into standard hackneyed adventure stuff. You would be surprised how many designs fall into that problem. The second problem with designs, which is more subtle, is that they do stick to the subject but they stick to it too rigidly so you have 200 rooms all of which are wandering about in some gigantic swamp, for example, and after about the 50th room you get sick to death of this gigantic swamp so you need to have variety but it needs to be all within the one overall theme. Sue's second design was all too one-paced, all too similar. It was an undersea one with Neptune and so on cropping up, the theme was that Neptune's kingdom had been attacked but it was all about going through the ruins of his kingdom. I would have liked the occasional pocket where the kingdom restores everything in its original state and was all nice and cheerful and people were enjoying themselves and so on.



Mike Austin trying to solve an adventure!

Have you had any collaborations since with other people? The games Red Moon, Price Of Magik and Emerald Isle were all based on original ideas from other people. (Mike) *We did quite a lot more work on those.*

Lords of Time has got nine levels. Is that anything to do with Level 9? (Pete) Of course. (Mike) *There are a lot of references to 9 in most games.*

Are there any personal references or tie-ins in other games? (Mike) *Yes. At least one or two in each game.* (Pete) We tend to put in references to the number 9. Personal references, not really. Political references - quite a lot - yes! I try to avoid settling grudges too publicly but you can get rude about people in games. You have to avoid overdoing it because the reader/player is probably not interested.

In Return to Eden, you said the Eden universe is like Larry Niven's 'Future Space'. You also referred to Harry Harrison's 'Deathworld 1' in the documentation. Can you explain the references? The game wasn't copied off other things but there were similarities and people who liked the aggressive vegetation would like the Death World one, other people would like some of the short stories by Larry Niven. In fact, in later games I stopped putting these references in because people claimed when I put

a reference in it meant that I had copied the ideas which I never do, so although I thought it was a good idea I decided to stop doing it.

Red Moon won a lot of awards but some people didn't like it because of the Dungeons and Dragons style of fighting monsters. Why did you introduce that? We were trying out different styles. In fact, in Red Moon the whole point is that killing people is pretty pointless. This is one of these sledge hammer moral messages that we occasionally get in there. If you do kill people they just come back as a ghost and you have to kill them all over again. (Mike) *Some people have finished the game in that way but it is incredibly tedious.*

Specifically on Red Moon, I was quick to discover that you can bury a monster to get rid of it without losing hit points. Was that a bug? Yes. That got left in because we did not realise that the bury bug was in there, it was in the standard system and we didn't realise it was there.

And you could also finish the game without actually solving all the puzzles. Was that intentional? Yes. In all of our games you can solve them without solving all the puzzles. Generally speaking, where puzzles are difficult I provide more than one alternative way of doing it, particularly nowadays. (Mike) *To get a maximum score you need to solve everything.* (Pete) I also quite like putting bonuses in. Even if you go back to Colossal Adventure which was the first one you could finish that and there were a number of bonuses like leaving the magazine in Wits End which you didn't have to solve to get to the end, so it is in the original tradition.

How much of Red Moon was David Williamson's and how much was yours? The map and monsters were his. I took his magic system and made it slightly more consistent because he tended to have arbitrary spells and I put it into a system basically to make it easier to code and easier to use. I put in the spell focus idea for example because it gives you more things to look for. Basically, though, the atmosphere, the setting itself was his as were the majority of the puzzles.

Red Moon had some interesting ideas such as the use of a focus for magic and the way the iron inhibits magic. Were these based on real world magic or are they just inventions? The focus thing is something which is used fairly widely. (Mike) *That's kind of folk lore.* (Pete) The fact that iron inhibits magic is real world magic, a sort of British fantasy idea, it's fairly well known that iron being around is bad for magical creatures and bad for magic.

Do you try and put that kind of semi-factual stuff into your games? I am trying to in the more recent ones. Red Moon and Price of Magic were kind of set in the D & D type environment. If I do Magic now, as I did for Knight Orc, I try to avoid mixing my sources, I'm trying to stick to magic in the British Isles. You won't, I hope, see Egyptian mummies and so on cropping up in our games not unless they are set in Egypt.

The Price of Magic continued in the same vein and seemed to be influenced by the Dark Ages. Did you do a lot of research for it and do you do research for other games? Price of Magic wasn't my game. It was a David Williamson design which I added to so I didn't do the background, hence not much research but for things like Knight Orc and the magic system in that and in games following that and indeed the games I do myself, yes I do research, I make lists of relevant locations, connected ideas and so on.

Are there any plans to do another one to add to the Price of Magic and Red Moon to make another trilogy? Well, we released them with Lords Of Time as a trilogy. The theory is that they are set in a magical equivalent of the earth and there is a large scale battle over these two linked worlds. Our own world, which is in Lords of Time, and its magical

twin which is in the other two and using this idea we have linked the three together into a trilogy already.

Let's go on now to the actual programming side of things. How do you actually start to write an adventure? Could you briefly explain the ideas and the coding? Well we start with a design which has got a map and a play sequence and a list of puzzles and a list of objects. (Mike) *We have a standard adventure system and you can basically just enter the text and wander around from room to room and doors will open and shut and all this sort of thing will happen.* (Pete) To regularise this slightly, I think you start by entering prototype room descriptions, fairly short room descriptions with the exits table, object names and that sort of thing and when that is entered just using the standard adventure as Mike said you can wander about and do things – none of the puzzles are in there of course but you can wander about and check that the game looks alright.

Do you make changes to the design after that stage? (Mike) *Only where we find that things are too difficult to code or for some other reason they won't quite work but that is quite rare. For the most part the design usually works as it stands.* (Pete) Yeah, it usually does. Occasionally, Mike thinks of better ways of doing things.

But basically the adventure is written as a whole before it is actually coded? Yes. It is worth saying that in the later ones when it is finished we play through it and we now have about a months play testing and we do take the results of the play testing quite seriously. This is from Gnome Ranger onwards. (Mike) *Quite often nowadays, we find alternative ways of doing things that we ought to allow.* (Pete) We also, where people find puzzles hard, put hints around the place or make them easier.

How long does it take, typically, to conceive the adventure and get it through to final coding? In lapsed time, it seems to be about a year to get a game out. (Mike) *The different stages – probably design takes about three months, the coding takes about the same and then a month or two of play testing and bug fixing. Additionally, other people are writing the text and drawing pictures and so on.*

When you have finished the design is it as a straight English text description or is it flow-charted and mapped before it goes for coding? There are various bits, there is a map and there is a list of objects which contains a description of what you can do with them. Nowadays, I do a cross between a play sequence and a list of locations in that I try to describe what happens in each location in the order in which you would come upon them in the game. I used to do both a play sequence and a list of puzzles.

I believe that you are currently working on a new game called Lancelot. Can you tell us anything about the inspiration for that? Yes I wanted to do a proper Arthurian game basically because I was afraid, for example, that Melborne House would get the idea and do what they did with Lord of the Rings on it and I thought I had better get in first. Within games, I try and tackle a game from as many different directions as I can. On Lancelot for example, I did a lot of research I got a lot of Arthurian books, I precised the Mort d'Arthur and so on and tried to find out what incidents and settings and so on work in the game. Additionally, I know what features our adventure system has got, it allows you to order people about and have multi-character puzzles and makes that quite natural so I was determined to have a reasonable number of them. The big developments recently are that we are now farming rather more work out to outside people. I used to write the text for example, but over the last year I have found that it is a good idea for me and Mike to do an initial version of the text and then give it to outside authors who add their own gloss and bulk up the descriptions and put

in their own feeling about the world and that greatly improves it. We also use a freelance artist nowadays. Before we had an in-house artist but using freelancers seems to get us a greater variety of styles.

Are these professional people, professional writers? Oh yes, yes. It used to be that you would try and get gifted amateurs and so on but the advantage of using professional people is that they will usually stick fairly closely to a deadline, whereas with amateurs it is a hobby with them, it doesn't really matter. It is fairly important as the pictures and text tend to be the last thing that gets done.

Why are you doing that? Is it to try and get more variety or for another reason? Well, it gets more variety, it gets a better job. When I have written the text I tend to run out of ideas, there are only a number of limited ideas that I have got in each period of time and I have to slow down and take a break and then go back and write some more text and so on. If you give it to outside people, they probably haven't written anything fictional. I mean we use people that write other things but they maybe haven't done anything in the adventure game field so they have got a whole load of ideas stored up which they can use.

So effectively, they are like ghost writers. You take an idea and they develop it? I guess it is. It's kind of like collaboration. The best teams in comedy seem to be collaborators, where one person comes up with an idea and the other person prunes it and so on, and you can get much the same thing using the outside writers. It's not quite like ghost writers in that that implies that the person who is supposed to be the author actually can't write at all and just talks much as I'm doing to you and the other person makes it coherent. It's a slightly more equal partnership than that. The other thing is that it frees me up. If I'm not careful, I find that I'm spending so much time writing the text for one game that I'm behind hand when it comes to designing the next one and its fairly important, particularly now, when we want to try and bring out about five games a year, that I don't do unnecessary work. If there is somebody who can do it as well, or better, then I let them get on with it.

Have you had problems finding people or have you been quite fortunate? We have had some trouble with some people who haven't been quite as good as they ought to be but we now have a fairly settled team. I sub-edit the stuff when it comes back anyway, I don't use it straight so I can put a week

in and sub-edit the text. It doesn't really matter if some of it is rubbish because I can take that out and I can keep the good bits and even the bad bits give me something to chew on.

So it still ends up very much as a traditional Level 9 product? It depends which game. On the Gnome Ranger ones where we used Peter McBride to do the text I tended to give him his head because his style works extremely well for that character. With Time and Magic it was more a traditional game because we used a writer who wasn't quite as varied and didn't have quite as many ideas of her own so it required slightly more polishing when it came back. Lancelot, we have not yet got the text back so I can't comment on that but I think we will need to do a certain amount of work on that to match up the game with the book that we have done to go with it, to make sure it is in the right sort of pseudo-Arthurian style.

The code you use to create the adventures is, I believe, called A-code. Where did A-code come from? (Mike) Back in the very early days when we started to produce Colossal we wanted to find a language that we could port to any computer system so I actually decided to produce a very small but very fast language for a specific adventure that would be basically very fast.

Is it similar to any other language? It is kind of like machine code. The analogy that I tend to use nowadays is the Risc processor. It is like a real micro-processor would be but its hardly interpreted. (Pete) Mike essentially designed and worked out what instructions we needed for adventures, for example, you don't need much maths, you don't use real numbers, you just need integers, and we ended up with a reduced instruction set. We get all the advantages of Risc things, the fact that our programs are very small because the actual instruction length is short and it executes quickly.

Is that something that you developed from scratch? (Mike) Yes, that was the second language I designed.

What about compression of the text, do you do that when it is compiled or do you do that separately? A-code itself is compiled whenever you change the program and that is entirely separate from the text. The run of the game, the actual developing of it pulls the text up and then carries on.

Did you develop the data compression techniques or were they standard techniques? There were mainly two types of data compression - A-Code is one that makes programs about six times smaller than they would be in any other language including machine code and the text is compressed.

What sort of compression do you get? I could quote you anything between 30% of the original and 50%.

Obviously, it varies depending on what the actual text is? Not a lot actually. As long as the text is fairly large it compresses fairly well. Our system is not optimised just to some particular form of text which a lot of course are. One of the reasons I can't tell you an exact figure is that we have the keyword table in with the text for example so the keyword table perhaps takes up less space. It is very hard to explain.

When you add graphics to your adventures who actually designs them for you? (Mike) Nowadays, we have a pair of artists who are drawing on the ST. (Pete) We went in for digitised pictures on Knight Orc and Time and Magic. We are now getting hand-drawn pictures done on the various machines.

So these are just drawn as straight pictures? They are drawn just as you would draw any other picture, yes.

Is there a special graphics editor or anything that has been developed? No. We are getting two artists to both do all the pictures in Lancelot and we will take the best one of each room which ought to give us pretty good quality and we are also using compressed pictures as well. We seem to get about 50% compression nowadays. (Mike) Rather better than that now actually.

Issue 12 PAGE 5

WINDTECH BRC CBM64 SPECTRUM ORIC1 LYNX NARCOSM PIRAT

Trapped in a fiendish Level 9 Adventure?
Your lamp burning low? Every exit guarded?
You need escape plans! Send for one of Level 9's great new clue sheets for help. The clue sheets are free and each answers hundreds of questions. Follow the instructions supplied with your adventure to get one. (Don't forget to send a stamped self-addressed envelope and tell us which game you have.)

NEW REVIEWS: "Level 9 are fast establishing a name for themselves among computer adventurers all the time." "I'm a producer of quality adventure software. All their adventures are fast and fun, but because of a superior coding they have increased the amount of description and the number of monsters packed in 32K of busy memory." —Microtek, 10 May 84
"That might be open to argument. But there can be no doubt that Pete Austin and the team at Level 9 are the Lords of Adventure." —Central Press Reports, April 84
"The Lords of Time and get you into the past!" —Your Computer, May 84

AVAILABLE FROM: WH Smith and good computer shops nationwide.
If you local dealer doesn't stock Level 9 adventures, get him to contact us at: Centraltech, Data Distributors, Parkers 5, Craig, 10 Tech, Little Tye, Microstar, IBM or Windteck.

Level 9 Computing
Colossal Adventure: the original masterpiece adventure with 75 mini-locations.
Adventure Quest: an epic journey across the world continents of Middle Earth.
Bungo Adventure: a truly massive game which compares the Middle Earth Trilogy.
Sneak! Could this be the biggest of adventures of the world?
Lords of Time: an imaginative romp through World History.
I ENCLOSE A CHEQUE/PO FOR £3.95 EACH.

My name: _____
My address: _____

My money is in one of these listed on the list above with at least 30% of memory.
Send to: **LEVEL 9 COMPUTING**
Dept 6, 276, Highlander Road,
High Wycombe, Bucks HP12 5PS.

An early Level 9 advert

Do you use the same pictures on all machines? We have a separate set for 16-bit machines compared to the 8-bit machines. The 8-bit pictures are drawn on the Commodore 64 and the 16-bit ones are drawn on the ST.

But within each group they are the same pictures used on every machine? Yes that is right, we tweak them a bit for the various machines, make sure the palette works properly and so on.

Are the graphics in future going to be similar to The Pawn and Guild of Thieves? Yes. They are presented differently. On the 16-bit machines we have a window and they load into this window so we can have a border around. Magnetic Scrolls basically don't bother with a border. On the 8-bit they just load into memory, although of course the Atari 8-bit doesn't have that. But yes they will be the same sort of style as that.

Your games always have lots of minor bugs. Who actually play tests them? We use a number of outside play testers who we had better not name. We would like to use more play testers but we had a problem with Gnome Ranger whereby the play test version of the Atari ST version was actually pirated and we are getting people writing to magazines with bugs that were on the play test version and we feel slightly annoyed about this. I think that people who pirate games should not write into magazines with bugs particularly if they have pirated a version which was never actually released, so we do get it play tested but we have to restrict the number of play testers for reasons of protecting the market. On the other hand we have to walk this tight rope and make these compromises in getting it tested enough to get the bugs out but not enough so that we get too much piracy.

So the people who play test are they people who have written in? They are people who we have known for a long time. If somebody writes in and says can I play test, there is far too much chance they want copies to pirate. I really don't know how you solve this particular one. *(Mike) The people we are using now have been writing to us for many years and playing games.*

Do you actually have time to play other people's adventures? *(Mike) Yes, sure. The only ones that I find remotely interesting are the Infocom ones which I play a certain amount and usually get stuck on about half way through.*

Have you got any favourite games amongst the Infocom range? *Yes, I love the Enchanter Trilogy, particularly the first two – Sorcerer and Enchanter. I like Suspended, Planetfall and Stationfall.*

(To Pete) Do you have any time to play them? I have a problem with playing games in that I would be accused of copying them. I would go along with Mike in that I have been very impressed by the Infocom ones. I tend not to play them all the way through but I play them enough to get the feel and I also very much like the Sorcery ones, the Trilogy and I like Floyd and Planetfall and so on. I have been less impressed by some of their recent ones but it could just be nostalgia. *(Mike) I like some of their recent ones as well so I don't think it is.*

So Infocom really are your main interest? *(Mike) Of adventure games, yes. (Pete) The problem with Infocom is that you either get stuck or else you finish them very quickly. They have always gone all out for the entertainment and they don't really put enough puzzles in them. There are some games, A Mind Forever Voyaging for example which I did play through because I couldn't believe it (Mike) No, I couldn't believe it either. (Pete) I think it must have had one puzzle in there because I actually got stuck but you get right to the end just examining things. Their games do tend to lack good puzzles but they have extremely good text. Their text is probably unrivalled. The problem has always been though that for a game that has in the past been £30 or £40 which you can*

finish in one day you wonder if it is really worth it. (Mike) I think three hours is my record with an Infocom game. (Pete) £10.00 an hour! We wouldn't mind being paid that but paying someone else that is a bit much.

Do you know Stephen Donaldson's chronicles of Thomas Covenant? Oh yes.

Have you ever thought about writing anything along those lines? Something weighing about 20lbs? Yes, a game you can't actually carry! *(Mike) The first game to be sold in a briefcase. (Pete) Or maybe a wardrobe! Yes I like the Donaldson things. I have a feeling that the rights would be expensive for that so I haven't got involved in that.*

You would obviously be interested in getting the rights to that and certain other books? Oh yes, I would be interested in doing that. I'd be interested in doing Tolkien were it not that a certain other company has taken it and made a bit of a hash of it.

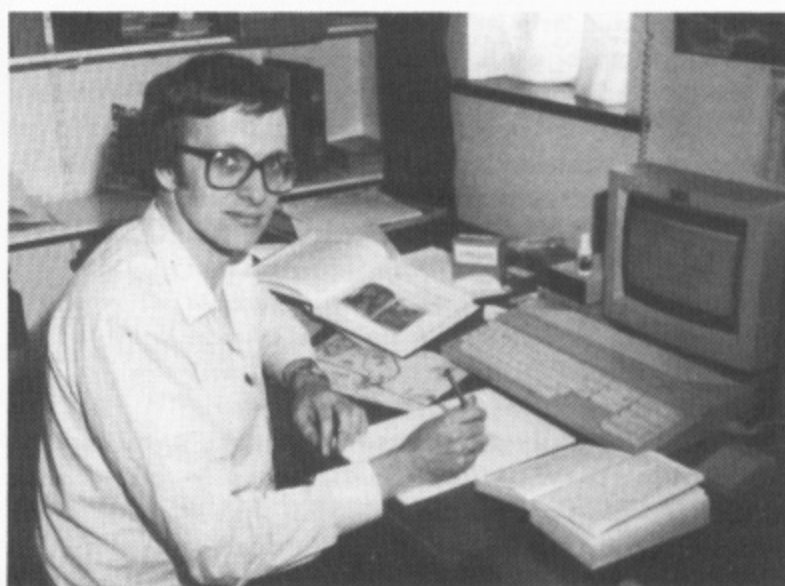

Pete Austin working on Lancelot

Are there any others that interest you, that you may do? I can't comment on that sort of thing can I? If I were to comment someone else would go and steal the idea. I would say though that it is generally better to take something like King Arthur which you don't have to negotiate with people and you don't have to pay a royalty. We are negotiating with another type of theme that you will have heard of, but we originally came up with the idea about the time of the PCW Show and we still haven't got the agreement made. It has all been rather fiddly as to precisely what the rights consist of and so on. That's the major problem if you get involved with rights to modern games. On the other hand, it's a good idea, we want a range of titles, a range of themes.

What have you got planned for the future that you can tell me about? Well the two new ones are Lancelot and Gnome Ranger 2 – those are in the pipe line. In fact, both of those are designed. What I'm designing as the next game, I haven't made the final decision on. *(Mike) There are a number of possibilities.*

Will these be released through Mandarin? I think so, yes. We have got a contract with Mandarin as far as Lancelot – we didn't want to make the mistake that we made with Rainbird whereby we made a contract for four games and then Tony Rainbird who was running it left and the whole relationship changed. Everything changed essentially when Tony Rainbird left. He was the man, as we saw it, who could get things done. If Tony told you something would happen it would, whereas, the BT philosophy seems to be rather more of an institutional one where people don't care to put their necks on the line. Mind you, Tony by putting his neck on the line, ended up leaving so maybe that proved it wasn't right for BT.

So how did the Mandarin deal come about, did you approach them or did they approach you? (Mike) Over last summer we were talking to about a dozen different publishers. We have spoken to virtually all the major names you can think of and had offers from a good number of them. A lot of them would have been alright to work with but we didn't like certain aspects of the way they wanted things to work and the control they wanted to have over the game.

So the important thing is that you retain the control over what you write? (Pete) That's one important thing. The thing that really gave us the most problems at BT is that we produce games on a wide range of machines. It is fairly essential to us that once the first version of the game, which is in fact on the Atari ST, has been agreed, that we don't need to agree all the individual versions after that and that was a big problem with Rainbird. As you will have seen with Knight Orc between the ST version and the Spectrum being released, which was the last one, it was nearly a year. With Time and Magic from Mandarin we got the whole lot released within about a fortnight and it is enormously easier if you can get the game out of the way in a fortnight than if it is dragging on for a year. Mandarin were in agreement with us over the need to get them released because it saves them time if they can get all the versions out at the same time. They have just got to do one lot of advertising and it all hits the streets at one time. (Mike) Basically, what we liked about Mandarin was that they are marketing and publishing people who are interested in computer games but don't actually want to interfere, whereas the majority of other major publishers in the world are still run by ex-programmers who think that they know better.

Rainbird actually did their own hint sheets on some things didn't they? (Mike) Yes and we got very annoyed about that. (Pete) Could you say that we do a Knight Orc clue sheet free and if people they want a Knight Orc clue sheet please ask them to write to us. Ours has very many more clues than the Rainbird one - people can make their own minds up about the quality - but ours has got about 1,000 entries whereas the Rainbird has about 60. (Mike) And all the entries as far as we know are actually correct whereas there are quite a few mistakes in the Rainbird one. (Pete) It's worth saying that Rainbird didn't actually send us a copy of it or tell us what was in it. (Mike) No the first time we actually found out about it was at the Adventurers Convention when somebody came up to me and said why on earth did you do the Knight Orc clue sheet like that and I said what, it's like our other ones. He said no it isn't and I said that I hadn't seen it and asked him to send us a copy. When I got home I asked Rainbird to send me a copy but needless to say they didn't so I got the photocopy through from this person and I was quite appalled by it.

In future, are you going to get greater control over those sort of things? (Mike) More than that, Mandarin tell us what they are trying to do and ask if we think it's a good idea and are very helpful which smooths the relationship along. They have actually consulted us all the way along the line which is wonderful.

Do you get a lot of demand for the clue sheets? Yes
How quickly after the games have come out? About two weeks before. (Pete) Time and Magic was available at the same time that the game was launched. Gnome Ranger was available a few weeks before the game.

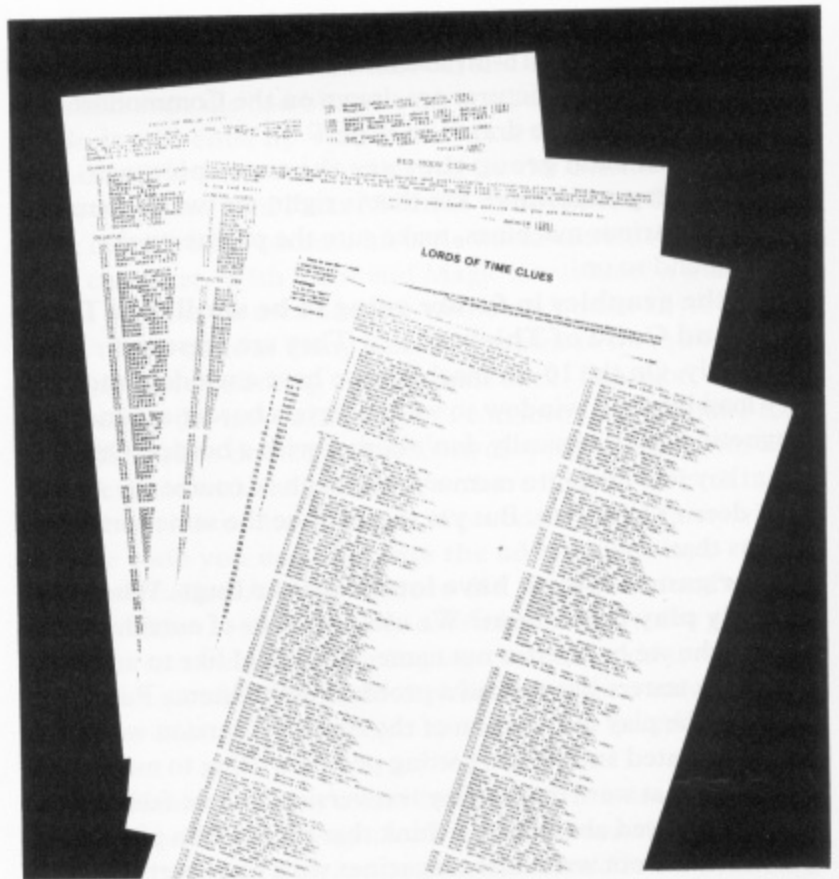
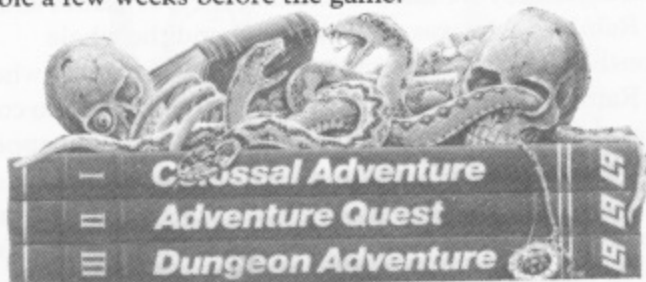

Level 9's comprehensive clue sheets

You actually get people asking for them before the game is available? (Mike) Yes, that does happen quite a lot. (Pete) Yes, it's funny that isn't it? People who buy mail order have been known to ask for the clue sheet at the same time. (Mike) Oh, it's quite common.

With a lot of people, I suppose there is the satisfaction of finishing the game irrespective of how they finish it? I think if you get stuck then it's much better to get a clue sheet and be able to play through the game. I think people do try and play the game without the clue sheet, I rather hope they do anyway as it is a bit of a waste of time if you are just going to follow the clue sheet all the time. (Mike) You can treat it in the same way you can a book. It is still a nice story but you do lose all the challenge. (Pete) In future we are emphasising the story telling element a lot more because going to three part games has given us more text and we are following the same sort of balance that we got in Gnome Ranger where there was a lot more story telling. (Mike) There are still a lot of puzzles in there but the storyline is much more important. (Pete) Yes, that's right.

That's all the questions we have. I hope that you found it more interesting than the run of the mill. (Mike) A good set of questions. Normally, as I say, we have to go through all the background, where we live, why we moved there and so on. It's nice not to have the normal set of background questions.



So concluded a really interesting interview. It was much nicer to talk to a couple of people who are really interested in what they are doing and in care about the enjoyment people get from their games, rather than some anonymous marketing man who knows little about the product but the price. Level 9 are real people!

Just as we were about to go Pete Austin produced a fax with a design for the forthcoming Lancelot. "What do think about that for the Holy Grail" he said. Hold on a minute, you're the clever people, I'm only here asking questions! So I put over a few ideas and Pete listened. Who knows, when you get your copy of Lancelot, and find the Holy Grail it might have Page 6 discretely engraved on it! Fame at last!

THE 1050 SUPER ARCHIVER II £79.95

The 1050 SUPER ARCHIVER obsoletes ALL DISK DUPLICATING DEVICES currently available for the Atari 1050. It ELIMINATES the need for patches, and PDB files etc. Copies are EXACT DUPLICATES of the original and will run on any drive. Without exaggeration the SUPER ARCHIVER is the most powerful PROGRAMMING/DISK DUPLICATING device available for the 1050!!! Installation consists of a plug-in chip and six simple solder connections.....

FEATURES INCLUDE:

BUILT-IN U.S. DOUBLER TRUE DOUBLE DENSITY SUPPORTS EXTRA MEMORY TOGGLE HEX/DEC DISPLAY SECTOR OR TRACK TRACING AUTOMATIC DIAGNOSTICS DISPLAYS HIDDEN PROTECTION ADJUSTABLE/CUSTOM SKEWING	THE ONLY SYSTEM THAT COPIES, CREATES PHANTOM/FUZZY SECTORS 810/HAPPY ARCHIVER COMPATIBLE PRINTER SCREEN DUMP FACILITY BUILT-IN EDITOR - read, write, edit/35 sectors per track AUTO-SPEED COMPENSATION HARDWARE/SOFTWARE EXPANDABLE	BUILT-IN CUSTOM FORMATTER up to 40 sectors per track BUILT-IN TRACK MAPPER - up to 42 sectors per track DISPLAYS/COPIES D/D HEADERS AUTOMATIC FORMAT LENGTH CORRECTION SYSTEM BUILT-IN DISASSEMBLER
--	--	--

*** SPECIAL OFFER ***

PURCHASE 1 SUPER ARCHIVER AND BUY THE SECOND FOR £55.00.

THE DELUXE PHANTOM SECTOR MAKER

Installs quickly into any drive (no soldering required). Makes precise FUZZY or PHANTOM sectors instantly. Fully adjustable capability allows you to FUZZ various portions of any sectors or the entire sector itself will allow you to BACKUP most protected programs which do not contain custom formats using your unmodified drive and will add considerable COPYING POWER to existing HAPPY, ARCHIVER, KLONE II or DUPLICATOR DRIVES. Includes special software which will FIND and DISPLAY valid data. CRC errors and PHANTOM SECTORS all automatically! Copy program works in single or double density and takes advantage of all available memory for making single pass copies!

£39.95

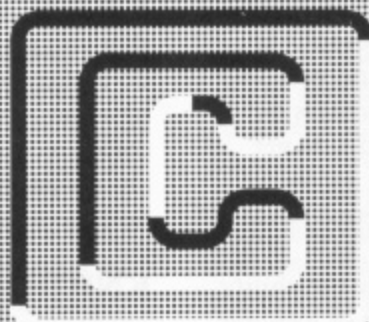

COMPUTERHOUSE

Includes Free 'OMNIMON' MONITOR OPERATING SYSTEM

THE CONTROLLER CARD P.P.B. II

XL
£59.95

XE
£64.95

BREAKAWAY FROM YOUR ATARI'S CONVENTIONAL COMPUTING ENVIRONMENT WITH THE CONTROLLER CARD PROGRAMMABLE PERSONALITY BOARD, AN INTERNAL HARDWARE ADD-ON SPECIFICALLY DEVELOPED FOR THE ATARI 800XL/XE COMPUTERS. The Controller Card allows you to add, from an impressive and expanding library, utilities/enhancements that reside in memory above commercial/home produced software. Activating any of these utilities will temporarily freeze the main program until the utility has completed it's task, or act as an in-line enhancement, and to impress you even further, many of the utilities/program enhancements are currently not available on any other business or home computer system! Take for instance:-
SHQ PRINT SYSTEM - this toolkit will enable you to produce presentation quality graphics output to an Epson or comp. dot matrix printer from graphic printer packages such as PRINTSHOP, TYPESETTER, ENVISION etc. and comes complete with CUPID internal printer interface kit.....

SUPERDUMP IV TOOLKIT - which transfers cassette software to disk and makes disk to disk backups, this system is so powerful that there is NO cass/disk loading protection technic that can stop it, it will even make backups of physically damaged disk protection technics. The system also incorporates our unique SAVE GAME IN PROGRESS facility and a menu/file backup management system... for more info on all the other tools just write or ring us!

ADDITIONAL CONTROLLER CARD SOFTWARE

1029 SNAPSHOT PRINTER	£ 12.95
SHQ NLQ TEXT ENHANCERS	£ 7.95
SUPERDUMP IV TOOLKIT	£ 19.95
SUPERDUMP III TO IV UPGRADE	£ 10.00
CUPID INTERNAL INTERFACE KIT WITH SHQ PRESENTATION GRAPHIC SYSTEM	£ 24.95
HELP MENU EDITOR-DESIGNER	£ 12.95
AUTO-MENU EMULATOR	£ 4.95
SWITCH PACK	£ 9.95

*** LATEST U.S. SOFTWARE RELEASES ***

BUSINESS PRODUCTIVITY	ARCADE GAMES
------------------------------	---------------------

Super simple yet powerful! A MUST for the beginner, fast and convenient for the experienced!

THE "ULTRA MENU/DOS"!

A MENU/DOS program that simplifies your every function! All functions are performed with a single keystroke operation! High speed sector copiers allows you to use 1-4 drives, single to double densities (also SD to SD, DD to DD, DD to SD etc) it makes MACH 10 menus for your game disks (a no sector autorun menu that boots game menus in one second!) allows you to use previously unformattable disks, make multiple copies of files or entire disks, eliminates the need to preformat your disks (in single or double density!) and much much more!

- Displays density of 1-4 drives
- Scrolling menu allows for up to 40 program selections
- Single keystroke operation
- Allows multiple copies for high speed duplication
- Super fast Lock/Unlock/Erase/Renames/Format/Verify/Select and more!
- Mach Ten Menu Maker
- Speed Control readout
- Disk Saver format function
- Autoformat
- Convert SD to DD or DD to SD automatically on a single drive
- Simple drive programming for multiple drive use
- 100% Dos 2.5 compatible

£17.95

80 COLUMN

"RICHMANS' WORD PROCESSOR!"

Now! An 80 column word processor that works with any XL/XE Atari computer. It will also operate on any 400/800 computer having 52K or more of memory (special 4K static ram-packs are available for £39.95 which enhance the memory capabilities of 48K 400/800 computers!) The 80 column RICHMANS WORD PROCESSOR is one of the most powerful yet simple to use word processors currently available for your Atari computer and it displays 80 columns on your screen!

JUST A FEW OF AVAILABLE FEATURES

Super simplicity, true footnotes, subscript, superscript, underline, printer driver creation, page numbering, margin and header adjustments, endfill, tab adjust view and preview, block delete or insert. DOS functions, available memory, merge, colour change (background, luminence and boarder), number of liner per page, a unique - recover an accidentally deleted line facility, and much much more (most of which is automatic or set to a standard default!)

A TRULY GREAT WORD PROCESSOR AT A FANTASTIC PRICE! £39.95

1050	THE "SILENCER"!	810
-------------	------------------------	------------

Dramatically quietens your disk drive and allows you to WRITE to BOTH SIDES of any disk! Eliminates annoying clunk-clunk-clunk while formatting and the LOUD grinding noise when reading BAD SECTORS and REDUCES head wear by approximately 50%. Also allows writing to both sides of any disk WITHOUT dangerous cutting or notching. Five minute installation. No soldering.

Intro price £17.95

14 Romily Court, Landridge Road, Fulham, London SW6 4LL. Tel: 01-731 1276

Partnership: J.L. May, C. Lakey

COD terms available

TIME

for some Level 9

MAGIK!

Level 9 are one of the stalwarts of the adventure genre, they have been producing excellent games now for most of this decade. Like the other main adventure producers they have tried hard to put more and more function into their games. Both of these new ones are extremely friendly: apart from providing nice facilities such as the ability to key ahead, they have also enhanced those parts which help you when you make mistakes. So, as well as normal SAVE facilities to disk or cassette you can also SAVE to RAM so that the SAVE and RESTORE are instantaneous; you can type OOPS to take back the last couple of moves if they were disastrous; and, in Knight Orc, you can't actually die anyway – you are so vile that they throw you out of paradise back into the game!

I played both the games on the 800XL so didn't get to see any of the pictures you get on the ST (but my philosophy is that if you don't NEED the pictures, who cares!) and was extremely grateful for these facilities – adventure writers do seem to love killing you off as often as possible, and I do get extremely frustrated with the amount of time most games make you waste waiting for RESTOREs to complete – RAM SAVE and OOPS make death acceptable!

Other facilities which Level 9 have added include the ability to FIND, GO TO, or RUN TO any object, person or location which you know to exist and know how to reach. This also greatly enhances the game play. They claim that this means that you don't need to draw maps anymore, and, certainly, in each part of each game, it is easy enough to ascertain the names of all the major locations. However I, personally, like to see the relation between the locations, and, indeed, in at least one part of Gnome Ranger, if you don't check every unnamed location you may miss a required artefact.

While some other companies have moved almost entirely on to bigger and better(?) machines, Level 9 not only still fully support the 800 and even squeeze more out of it, they also continue to support tape-based machines. If you do not have a disk drive, then Level 9 are without doubt the best there is. If you do have a disk drive then the games are still excellent value, but do have a few short-comings, some almost certainly caused by their continued support of tape. The tape limitation means that they can not afford as extensive a vocabulary as they would like, nor adequate responses to all that you might try. Sometimes this can be misleading – e.g. in Knight Orc the Humans on the Wall, even after they have been killed AND carted off to Valhalla, can STILL pour boiling oil on you; and in Gnome Ranger one of your friends appears not to understand the word HOLD since if you ask it to HOLD THE HEDGE it tries to pick it up – this is misleading since elsewhere in the game it does correctly understand a request to HOLD something. In both these new games there are lots and lots of other characters of all descriptions, and both games involve lots of problems which you cannot solve by yourself. So, more than in any other games I have seen, you need to learn both how to make friends, and also how to use them!

Level 9 have recently been repackaging all their old games

TWO NEW GAMES ...

as Trilogies. Both these new games have three parts and are billed as such. You should be aware that that does NOT mean that you get as much adventure by buying one of these as you do by buying one of the Trilogy packs. That aside, both the new games are excellent value for money, especially when compared to a lot of the other games on the market. Level 9 always pack their games full of puzzles, atmosphere and humour and these are no exception.

KNIGHT ORC

In this you get to play the part of a rather unpleasant Orc. The game treats you like the dirt you are, from the fact that most of the people you meet immediately want to do away with you, through to little details such as the request to 'stuff' the Knight Orc disk back in after a SAVE.

The first part is fairly simple and straightforward, you merely have to find 10 pieces of 'rope' to enable you to escape back home. This part is not much of a challenge, but is quite a good introduction if you haven't played many adventures before.

The second and third parts are actually two different views of the same land – a technological view and a magical view. You can switch freely from one to another with a single command and there are certain problems which can only be solved in one of the two modes. (This may get a little tedious for the Cassette-based player, who will have to wait for a load – even on disk I found it a little annoying!) To win you must discover twenty spells, and use most of them as well.

It gets rather hard in places, especially when their logic breaks down a little – e.g. if I am frisked and lose all object whenever I die and go to Valhalla, how am I supposed to deduce that other corpses aren't? – especially when I can't PUT or HIDE an object on a corpse anyway! – most strange. But, never fear, Level 9 produce the best Hint Sheets in the business – thoroughly recommended even if you have finished the game – they are full of jokes, red herrings, behind the scene explanations, and of course clues – all carefully encoded so you can't accidentally learn too much. Send a SAE and proof of purchase to Box 39, Weston-super-Mare, BS24 9UR.

N.B. Whatever you do don't get a hint sheet from Rainbird – they have, for some unfathomable reason, produced their

own version. Not only does it leave out most of the information (60 items instead of 1009!), not only is it inadequate anyway, but it actually mixes the questions and answers in such a way that you can't possibly find the hint you want without seeing answers to lots of other items as well - guaranteed to ruin your enjoyment of the game.

GNOME RANGER (The Journal of Ingrid Bottomlow, the Gnome Ranger)

Ingrid thought this was great fun, Ingrid booted up the disk and found herself a long way from home, but by making lots of friends and getting them to help her she soon defeated the wicked witch and moved on to the next part of the journey. Here she met a friendly Alchemist and decided to make some Tea for him; it turned out to be rather difficult as the only tea bush had just withered. Undaunted Ingrid decide to become an expert at alchemy herself and soon, with the help of some rather strange friends, was able to make a nice cup of tea (and it wasn't Advanced Tea Substitute either - it was the real thing - funny how Tea seems so hard to make in adventures!). On the final part of the journey home Ingrid met a rather sad gate which had had all its jewels stolen by tourists; Ingrid explored some very strange places and eventually made friends with nearly everybody and found all the jewels so that the gate would let her through to her home.

Ingrid had great fun solving lots and lots of puzzles with all her friends. She thought it was a very good idea to make it as three separate adventures so that people who weren't lucky enough to have disk drives would be able to play easily, and so that there was lots of room in memory for all the wonderful jokes that Level 9 were clever enough to put in the game.

Ingrid especially liked the part about alchemy. It was great fun mixing everything up to try and make potions, and the books were super with such gems as "A History of Alchemy - Then the era when alchemy was regarded as a social service drew to a close. The alchemists retreated into their thatched cottages, and grew thick privet hedges around their gardens. This process, known as privetisation, took the prophets away from the communities which had once shared them!"

Ingrid thinks you should all go out and buy this one straight away as it is much better than Knight Orc. (Note, I think Ingrid is probably a little biased on this point, but I agree with her anyway!) But Ingrid thinks you should ignore the nasty comments by the people at Level 9 describing her as bossy!

P.S. If you don't think you could stand Ingrid telling you about her adventures in this style, then you had best avoid the game - it's all like that!

KNIGHT ORC and GNOME RANGER
Rainbird/Level 9
ST £19.95
XL/XE £14.95 (Cassette or Disk)

TIME & MAGIK
Level 9/Mandarin
ST £19.95
XL/XE £14.95 (Cassette or disk)

and THREE OLD ONES UPDATED

Back in 1983 Level 9 brought out a new adventure - The Lords of Time. On the back of the box were the words "First in the Lords of Time Saga". Sadly, since it was quite a nice adventure, there was no sequel but two years later Level 9 produced Red Moon, and in 1986 a sequel to it, The Price of Magik. At that time there was no link between the three games!

Now, thanks to the Wonders of Modern Science, a fair amount of Artistic License, a few hours with a good Editor, and a concept known in the comics world as Retrospective Continuity, we have Time and Magik wherein these three adventures have been miraculously transmogrified into a coherent trilogy!

The original 32K 8-bit Atari versions were only available on cassette, and the latter two had fairly primitive pictures. The parser and vocabulary got progressively better through the three games as Level 9 developed their systems, but never really had quite enough room in memory to shine. The new versions do away with the 8 bit graphics and, on the ST, use the diskette to provide much better digitised pictures. That, together with improvements in software technology since 1983, leaves plenty of room in memory.

Level 9 have used this extra memory to good advantage to provide lots more atmospheric text (especially on the ST), more detailed item descriptions, a few extra clues for the areas which they had most queries about first time around, useful facilities such as UNDO and RAM SAVE, plus, on the ST, variable size text to help if your TV isn't quite good enough for 80 columns, and the ability to recall lots of previous instructions to edit and re-enter.

Enhanced parsers, larger vocabularies, and use of more synonyms to allow multiple ways of asking the game to perform an action all add to the quality of these adventures.

What about the games themselves? You'll find full reviews of Red Moon (my very first review!) and The Price of Magik in Page 6 issues 19 and 24 - check elsewhere in the magazine for details of Back Issues!

In a nutshell, they are all excellent fantasy adventures, with quite a few D & D aspects, especially Red Moon and The Price of Magik which I, personally, think are Level 9's best adventures. Lots of puzzles, lots of magic, lots of humour, lots of fun! Packaged together at this price they are definitely superb value for money.

P.S. The Official Secrets club advertised in the manual do provide GENUINE Level 9 Hint Sheets - worth getting even if you have finished the games!

Review by John Sweeney

HOW TO TYPE IN THE LISTINGS and get them right!

The program listings in PAGE 6 are prepared carefully to ensure that they can be typed in as easily as possible. Before typing any listings ensure that you are familiar with the use of the Shift and CONTROL and INVERSE keys as outlined in your computer manual. The listings are prepared to match exactly what you see on screen. Every character that you may see in a listing is included in the chart below for cross reference. By using TYPO 3 you can ensure that you type in the programs EXACTLY as they are printed. Remember a single typing mistake may mean a program will not run.

WHAT ARE THOSE CODES?

Each line of a program printed in PAGE 6 begins with a special two letter code. THESE SHOULD NOT BE TYPED IN. They are used by the program TYPO to check that you have typed each line correctly. IF YOU HAVE NOT ALREADY TYPED IN THE TYPO 3 LISTING PLEASE DO SO NOW. The program can be used as you type in each line of a program or to check an already typed program. The code for each line will match but if you have problems check the listing conventions below carefully, you are most probably typing a CONTROL character incorrectly. TYPO 3 cannot check if a line has been missed so if you have problems in running a listing count the lines in the program and ensure none are missing. If the TYPO codes match and the program still does not run, LIST it to cassette or disk using LIST 'C:' or LIST 'D:filename', switch off the computer, re-boot and then ENTER the program using ENTER 'C:' or ENTER 'D:filename'. Save this version in the normal way.

HOW TO USE TYPO 3

1. Type in the listing carefully for although you can use TYPO 3 to check itself (see 6 below) it may not work if you have made mistakes.
2. SAVE or CSAVE a copy of the program.
3. Each time you want to type in a program listing RUN TYPO 3 first. The program will install a machine code routine in memory and then delete itself. Now type in a line as shown in the magazine excluding the first two letter code and press RETURN.
4. A two letter code will appear at the top left of your screen. If this code matches the one in the magazine carry on and type the next line. Note, the code will not match if you use abbreviations. If you prefer to use abbreviations LIST the line you have just typed, move the cursor to that line and press RETURN. The code should now match.
5. If the code does not match, use the editing keys to correct the line and press RETURN again. Repeat if necessary until the codes match.
6. To check a line you have already typed LIST the line, place the cursor on that line and press RETURN.
7. When you have finished a listing just SAVE or CSAVE it in the normal way.

You can type in a program without using TYPO 3 and then check it by SAVEing or CSAVEing a copy of the program, running TYPO 3 and then LOADING or CLOADing your program and proceeding as in step 6 above.

Always SAVE or CSAVE a program before running it and always use TYPO before telling us that a program will not run.

OUR UNIQUE LINE BY LINE CHECKER WORKS ON ALL ATARI XL/XE and earlier 8-bit machines

```

EI 1 REM *****
AL 2 REM *   TYPO III by Alec Benson   *
      *           June 1985           *
IL 3 REM * A proofreader for PAGE 6   *
      *   based on TYPO II           *
      * published by ANTIC magazine *
EL 4 REM *****
SG 100 GRAPHICS 0
WG 110 FOR I=1536 TO 1791:READ A:CK=CK+A:
      POKE I,A:NEXT I
CG 120 IF CK<>30765 THEN ? "Error in DATA
      statements - Check Typing":END
YM 130 A=USR(1536)
UT 140 ? :? "TYPO III is up and running":
      NEW
MA 1000 DATA 104,160,0,185,26,3,201,69
HG 1010 DATA 240,8,200,200,200,192,36,208
QB 1020 DATA 242,96,200,169,79,153,26,3
RK 1030 DATA 200,169,6,153,26,3,162,0
RR 1040 DATA 189,0,228,157,79,6,232,224
TO 1050 DATA 15,208,245,169,93,141,83,6
KC 1060 DATA 169,6,141,84,6,173,4,228
EU 1070 DATA 105,0,141,95,6,173,5,228
BK 1080 DATA 105,0,141,96,6,169,0,162
KK 1090 DATA 3,149,203,202,16,251,96,0
ZR 1100 DATA 0,0,0,0,0,0,0,0
LD 1110 DATA 0,0,0,0,0,0,32,94
JM 1120 DATA 6,8,72,201,155,240,55,230
TV 1130 DATA 203,133,209,138,72,169,0,133
TW 1140 DATA 208,162,8,10,38,208,6,209
MF 1150 DATA 144,7,24,101,203,144,2,230
RL 1160 DATA 208,202,208,239,133,207,24,1
      65
TM 1170 DATA 204,101,207,133,204,165,205,
      101
AW 1180 DATA 208,133,205,165,206,105,0,13
      3
XH 1190 DATA 206,104,170,104,40,96,138,72
NR 1200 DATA 152,72,162,0,134,207,134,208
GF 1210 DATA 160,24,6,204,38,205,38,206
EA 1220 DATA 38,207,38,208,56,165,207,233
TM 1230 DATA 164,170,165,208,233,2,144,4
SK 1240 DATA 134,207,133,208,136,208,227,
      162
CB 1250 DATA 8,165,207,133,204,165,208,6
XN 1260 DATA 204,42,201,26,144,4,233,26
MB 1270 DATA 230,204,202,208,242,133,205,
      169
BC 1280 DATA 128,145,88,200,192,40,208,24
      9
WV 1290 DATA 165,204,105,160,160,3,145,88
QA 1300 DATA 165,205,24,105,161,200,145,8
      8
MR 1310 DATA 32,69,6,104,168,76,153,6
  
```

Lower Case	Inverse lower	Upper Case or Shift	Inverse Upper or Shift	CTRL	Inverse CTRL
1	!	1	!		
2	"	2	"		
3	#	3	#		
4	\$	4	\$		
5	%	5	%		
6	&	6	&		
7	'	7	'		
8	e	8	e		
9	(9	(
0)	0)		
<	[<	[
>]	>]		
a	A	a	A		
b	B	b	B		
c	C	c	C		
d	D	d	D		

Lower Case	Inverse lower	Upper Case or Shift	Inverse Upper or Shift	CTRL	Inverse CTRL
e	E	e	E		
f	F	f	F		
g	G	g	G		
h	H	h	H		
i	I	i	I		
j	J	j	J		
k	K	k	K		
l	L	l	L		
m	M	m	M		
n	N	n	N		
o	O	o	O		
p	P	p	P		
q	Q	q	Q		
r	R	r	R		
s	S	s	S		
t	T	t	T		
u	U	u	U		
v	V	v	V		
w	W	w	W		
x	X	x	X		
y	Y	y	Y		
z	Z	z	Z		
-	_	-	_		
=		=			
;	:	;	:		
+	\	+	\		
*	^	*	^		
,	[,	[
.]	.]		
/	?	/	?		
■		■			
ESC	ESC	ESC	ESC		
↑	ESC CTRL -	↑	ESC CTRL -		
↓	ESC CTRL =	↓	ESC CTRL =		
←	ESC CTRL +	←	ESC CTRL +		
→	ESC CTRL *	→	ESC CTRL *		
⌘	ESC SHIFT CLEAR	⌘	ESC SHIFT CLEAR		
⌘	ESC DELETE	⌘	ESC DELETE		
⌘	ESC TAB	⌘	ESC TAB		
⌘	ESC SHIFT DELETE	⌘	ESC SHIFT DELETE		
⌘	ESC SHIFT INSERT	⌘	ESC SHIFT INSERT		
⌘	ESC CTRL TAB	⌘	ESC CTRL TAB		
⌘	ESC SHIFT TAB	⌘	ESC SHIFT TAB		
⌘	ESC CTRL 2	⌘	ESC CTRL 2		
⌘	ESC CTRL DELETE	⌘	ESC CTRL DELETE		
⌘	ESC CTRL INSERT	⌘	ESC CTRL INSERT		
■	INVERSE SPACE	■	INVERSE SPACE		

BONUS ADVENTURES

DEDRIDGE CASTLE ADVENTURE by Linda Naysmith

Dedridge Castle is an adventure set in a 'real-life' location around my home in Livingston, Scotland. I wrote it originally for my own children but children of all ages (that includes you!) should find it interesting and, I hope, a little different.

The title comes from the nickname of our local adventure play park and most of the locations in the adventure have been based on real locations around the park. The tunnel is a long narrow footpath which runs between two rows of houses. Along its length can be found a large concrete frog, a crocodile and a hippopotamus. The dangerous stream is the main road and across it there is a pond near which sit two more large frogs. Further West is another play park where two elephants stand beside the slide. The raven, the temple and the talisman are taken from the street names and there is a very small wood to the East. After staying so close to the real situations I could not possibly have missed out one of our most frequent visitors - the ice-cream man!

As the hero in the adventure, you are almost grown-up and you live in a village which nestles between the banks of Dedridge Castle moat and a large forbidding wood. Your little sister has been kidnapped and is believed to be held a prisoner in the apparently long-abandoned castle.

Your parents are naturally very upset and are losing hope of her safe return as the castle moat is wide and deep, the drawbridge is raised and the walls are unscaleable. You remember tales from your recent childhood about a secret tunnel that leads from the castle dungeons into the hills in the South West. It was said to be used as an escape route during many a daring deed when the castle was occupied long, long ago.

In the tales, the secret of the tunnel's entrance was kept by the animals and of course the heroes were able to talk to them because they either found, or were given, a magic talisman. This you dismiss as a load of rubbish, along with fairy godmothers and good wood fairies who perform magic and heal animals in other stories, but the secret of the tunnel might be real enough, after all, a lot of castles did really have escape routes.

You decide to try and find the tunnel with the hope that you will be able to rescue your sister and bring her home and so the adventure begins ...

The adventure understands two word commands and single letter commands for the four directions North, South, East and West. QUIT GAME ends play, SAVE GAME saves current progress, LOAD GAME restores it. INVENTORY will list what you are carrying. Several other words are recognised, if one doesn't work, try another with a similar meaning.

Linda Naysmith is the mother of four children, Jane, Christine, Alex and David and, having been born and raised in York, now lives in Scotland. About four years ago she made the fatal mistake of buying her youngest daughter an Atari computer as a birthday present and became hooked! Linda works part-time in the evenings in a local factory packing Scottish shortbread and then comes home to spend the wee small hours playing adventures and writing programs. PAGE 6 is proud to bring you Linda's first adventure which, in a field dominated by male writers, has a very different and interesting feel to it. Play it, you will almost certainly enjoy it, no matter how old you are!

These two adventures are too long to publish in the magazine in conventional type-in format and are therefore included as bonuses on the Issue 34 disk. The disk is available for £3.95 (£3.50 to subscribers) from PAGE 6, P.O. BOX 54, STAFFORD, ST16 1DR

MOONSTONE

A 100% machine code adventure by Tony Longworth

Merlin has decided to let you become a wizard, only if you can prove yourself. He has sent you on a quest to recover the legendary Moonstone. No one knows for sure where the stone has been hidden, but it's not going to be very easy for you, as many obstacles lie in your way, which you must overcome if you want to become a wizard.

Moonstone is a machine code, text adventure. The world of adventure, is a totally different world than our own. The law of nature and physics do not act as they do in our world. Magic is rumoured to work, and you must always expect the unexpected. Many newcomers to adventure will find it quite a struggle to communicate to the computer. In this adventure it is not possible to converse with the computer in plain English, instead you can only use one or two word commands consisting of a verb, followed by a noun. For example, if there was a dagger on a chair, then to pick up that object you would have to type in GET DAGGER. If you type in GET THE RUSTY OLD DAGGER, the computer would just pick out the first and last word, and respond to GET DAGGER. The computer will only look for the first four letters of a word, thus dagger becomes dagg, shovel becomes shov, and so on. At first, it might seem a little frustrating to condense your sentence into two words. For example, during your adventure, you find a plate of armour, and to put it on you type WEAR ARMOUR. But later on you need to take the armour off and the computer doesn't understand TAKE OFF ARMOUR. The equivalent command is REMOVE ARMOUR.

Below is a table of some of the various commands possible in this adventure. (obj) means the name of an object. Anything else in brackets is the synonym of the command.

INVENTORY (I, LIST)	NORTH (N)
GET (OBJ) (TAKE)	NE
DROP (OBJ) (PUT)	EAST (E)
HELP	SE
EXAMINE (X, SEARCH)	SOUTH (S)
LOOK (L)	SW
WEAR	WEST (W)
REMOVE	NW
QUIT (Q, STOP, END, FINISH)	UP (U, ASCEND, CLIMB)
SAVE	DOWN (D, DESCEND)
LOAD (RESTORE)	

Remember, during your adventure EXAMINE everything. If you're about to do something that will probably be a threat to your life, then SAVE the game position, and if you are killed you can then just LOAD the game back in and continue from where you were. Always map the adventure out on a piece of paper so you don't get lost. In a maze, you can drop objects to mark various positions in the maze when mapping out. Beware of the red herrings. And most of all ... enjoy the adventure, and never give up.

Thanks must go to Bill Wilson and Stew Prichard for play-testing this adventure and helping me to remove all the bugs and spelling mistakes.

Inspiration gained from the following: Monty Pythons Flying Circus ... Adventure (Colossal Cave) ... Frankie Goes to Hollywood ... Douglas Adams ... Steve Meretzky ... Scott Adams ... Brian Howarth ... Alan Beswick ... Page 6 Magazine (probably the biggest inspiration) ... and of course to everyone and everything around me at the time of writing this adventure ... Moonstone will run on any 48k Atari 8-bit computer ...



23. The ANSWERS!

Over the years that I've been writing the Adventure column for PAGE 6, I've been asked for hints on just about everything from Adventureland to Zork III. I haven't always been able to help, but I've certainly tried my best.

As this is a special Adventure issue, I've dug out all the questions and answers I could find in my archives and rewritten them for the benefit of other readers. If you've ever written to ask me for a hint or put a question in the CONTACT column, then you'll probably find it here somewhere. Remember these are mostly hints rather than straight answers so you may still have some work to do, but that all adds to the fun!

Adventure in the Fifth Dimension (A.N.A.L.O.G. Computing magazine)

Q: What use are the batteries, spheroid and teabag?

A: Have you examined the spheroid? Insert the correct battery in it, then look for the ^ ^ ^ symbol in a previously visited location. Hey, that exit wasn't there before! Now you can find a use for the teabag.

Adventureland (Adventure International)

Q: Is there a treasure in the lava? If so, then how do you get it?

A: There sure is! You'll need to blow up something that's fireproof, then exercise your civil engineering capabilities, but I'll be dammed if you think I'm going to tell you any more than that.

Arrow of Death Part 1 (Channel 8)

Q: How do you get into the cave without being killed by the serpent?

A: Wear something that will protect you from its attacks.

Q: What do you do with the rope and hook?

A: Use it to pull something heavy up the scree slope.

Q: How do you get into the giant building without tripping?

A: It doesn't matter about tripping over as long as the giant doesn't wake up. Try drugging his dinner!

Arrow of Death Part 2 (Channel 8)

Q: How do you enter the grill on the stone slab?

A: You don't. You'll have to find another way in.

Q: How do you get past the water in the gorge?

A: You must first find the stone chamber with the iron wheel. Turn the wheel and return to the gorge for a muddy surprise.

Asylum (Screenplay)

Q: How on earth do you map the Asylum?

A: Use large sheets of 5 mm graph paper. Each square represents one room. Draw the walls as you discover new rooms, but don't get too ambitious. Draw only the walls directly in your line of sight. Every time you turn left or right, turn the paper so that it is oriented in the same direction as

Garry Francis recalls thousands of hours of adventuring to bring you answers to 169 (count 'em!) adventure questions from A to Z!

you. Beware of teleport rooms! When the map overlaps or somehow doesn't make sense (such as the six-sided square), you have no doubt passed through a teleport. To find whether a room is a teleport, drop an object and turn 360 degrees. If the object 'disappears', the room is a teleport.

Q: What use is the hypochondriac?

A: Hypochondriacs use drugs!

Q: How do you find the battery?

A: Switch the fuses in the fuse box, then go somewhere that uses a lot of electric current.

Q: How do you find the magnet?

A: Wear a disguise, then go to the phone booth and vandalise the receiver.

Q: How do you find the copper wire?

A: Get the rocket belt and ask for HELP.

Q: How do you find the candle?

A: Remember the footsteps? Try trapping the owner of the footsteps by locking all the relevant doors and see what happens.

Q: Where do you get the guard's uniform?

A: From the guard obviously, but NOT the armed guard! Wander around with the camera until the other guard appears and give him a chance to fulfil his fantasy.

Q: Where do you get the platinum card?

A: From the armed guard, but you must disguise yourself if you don't want to end up in electro-shock therapy. Remember what the loony inmate told you?

Q: What use is the mirror with no reflection?

A: None. It is probably a carry-over from the original TRS-80 version of Asylum which had two mirrors. You had to make the first one disappear by wearing a novelty nose and inserting a round peg. You had to break the second one by hitting a ball with a bat. None of these objects are in the Atari version.

Q: How do you get rid of the exterminator?

A: Keep him tied up!

Q: How do you find the law book?

A: Go to the maze with the revolving doors and find the room with the banana peel, but do not pick it up. Leave the room and enter it a second time.

Q: How do you get the lunch?

A: Let the ants loose upon the picnicker.

Q: How do you get past the terrorist?

A: Have you typed HELP? Examined the knife? Given it to the terrorist? Stabbed yourself with it?

Q: How do you avoid being splattered on the ceiling in the catapult room?

A: Catapult the bomb before catapulting yourself.

Q: Where do you find the jar?

A: It's right slap bang in the middle of the revolving doors! Use the catapult to get there. (It is possible to get the jar without using the catapult, but a bug will prevent you finishing the game.)

Q: How do you get to the Master Mystic?

A: You must have solved all the puzzles in the game up to this point. Walk up to the locked door (you know which one don't you?), press the button on the Star Trek device and move forward.

Q: What do you do to the Master Mystic to end the game?

A: If he smells a rat you'll have to remove your disguise, but take the scroll with you.

The Blade of Blackpoole (Sirius)

Q: How do you get past the carnivorous plant?

A: You need to feed it something found on the other side of the quicksand. Try HELP or TALK TO PLANT for some clues. You'll also need something from the store to help you get it.

Q: Can you get past the monster in the river?

A: Yes indeed. Type HELP or HINT for a clue. You should have bought something from a jovial location earlier in the game. Pour it in the river!

Castle Adventure (Atari Program Exchange)

Q: How do you get through the passage in the King's Chamber?

A: Try the amulet for size.

Q: How do you get through the thick mist in the small stairwell?

A: A little bird told me that you should solve the first puzzle.

Q: What words are needed to pass the wall in the dungeon?

A: You can't have your cake AND eat it too!

Colossal Adventure (Level 9)

Q: How do you get the platinum pyramid out of the Plover Room?

A: You can't get it through the crack. Use a magic word instead. The word is found in the room description.

The Count (Adventure International)

Q: How do you stop the flagpole from breaking?

A: You don't.

Q: What use is the bottle of blood?

A: It would make a refreshing drink if you were a vampire, but you're not. Perhaps red herrings would be more to your liking?

Q: How do you get past the coffin?

A: You don't. Try opening it instead!

Q: How do you find the nail file?

A: Enter the solar oven during the night.

Q: Where is the Count and how do you kill him?

A: Kill the Count? I refuse to answer a question where someone's life is at STAKE! I will, however, give you a hint to his whereabouts. The sign in the crypt says "Positively no smoking allowed here!" and yet there is a pile of extinguished cigarettes! Doesn't that strike you as being a bit odd? And what did the postman deliver on the second day?

Crash Dive! (A.N.A.L.O.G. Computing magazine)

Q: How on earth do you get out of the escape hatch?

A: Carefully read the background story in A.N.A.L.O.G.

Don't HOLD YOUR BREATH waiting for me to give you the answer.

The Curse of Crowley Manor (Adventure International)

Q: How do you open the rosewood chest in the parlour?

A: Unscrew it with the letter opener.

Q: How do you get through the plywood wall in the small storage room?

A: Chop a hole in it with your lumberjack's tool.

Q: How do you get past the numerical lock?

A: Read the old yellowed note in the rosewood chest.

Q: What do you do after passing through the plywood wall and the 'dial' door?

A: When you reach a dead end, summon the person mentioned in the book found amongst the scientific instruments.

The Dallas Quest (Datasoft)

Q: How do you get out of the dark room?

A: You can't get out while it's dark! Ask for a CLUE to see how you should turn dark into light.

Q: Where do you go from the Trading Post?

A: Look at the monkey. He's helped before, maybe he can help again! Also look behind the curtain before pushing on.

The Dark Crystal (Sierra On-Line)

Q: Where is Aughra?

A: In her observatory.

Q: Where is Aughra's observatory?

A: Listen to the babbling brook!

Q: How do you cross the swamp?

A: Haven't you encountered something that floats on water? PLAY LID (anagram).

Deadline (Infocom)

Q: The court feels you have insufficient evidence to prove guilt for the first murder even though you know who committed the second murder. Any clues?

A: Second murder? Heaven forbid! What sort of a detective are you? Perhaps you've gone TOO far!

Dragon Quest (Antic)

Q: Why is it that when you drop the gold you can't find it again?

A: Listen to the barman's tale about the magpie. You CAN find it again if you find the magpie's nest.

Earthquake - San Francisco, 1906 (Adventure International)

Q: Is the manhole significant?

A: Yes. Lift the cover using the crowbar.

Q: How do you get past the fire zone?

A: It may be too hot at first. Move away some distance, return and try again.

Q: What do you need to vault over?

A: The crack.

Q: How do you get past the crack outside the tiled plaza?

A: See the previous question.

Empire of the Overmind (Avalon Hill)

Q: What do you do after talking to the man in the cave and taking the blanket at the beginning of the game?

A: It is essential to read 'The Rhyme of the Overmind' before you start playing as this not only gives you the background story, but also gives you lots of hints. (Tough luck if you've got a pirated copy!) Also make sure you HOLD an object before trying to use it.

Q: How do you conquer Overmind?

A: Drop it in the lava pit!

Enchanter (Infocom)

Q: How do you open the jewelled box?

A: Remove the rope first. As it's no doubt been tied using a →

magic spell, you'll need magic to remove it. There's at least two ways to do this. You could try the KULCAD spell, but then you won't have it later when you really need it. Alternatively, there's another magical item that will cut through the problem.

Q: What is the significance of the four mirror rooms?

A: They are a window onto another world – the world of Zork!

Q: How do you safely get the scroll from the control room?

A: You can't, but one of your animal friends can!

Q: How do you get through the guarded door?

A: You could use the KULCAD spell, but again that's probably not a good idea. Have you ever had a dream of a nondescript room in which a cartoonish figure casually opens a simple wooden door and ascends the flight of stairs beyond? Could this be a message? Who could the cartoonish figure be? And why is it that the door is not an obstacle to him?

Q: What is the purpose of the adventurer?

A: Deja vu? A touch of humour? Somebody to pinch your treasures? He can also help you in many ways.

Q: How do you overcome Krill?

A: It sounds like you're missing a spell. Have you encountered the ancient Terror yet? If not, read the book in the library and work from there. You'll also need to get past the guarded door.

Fantastic Four Part 1 featuring Human Torch and Thing (Adventure International)

Q: Is there any point burning the shack down?

A: No.

Q: How do you burn down the tent?

A: Throw a high flame at it.

Q: Can you remove the tar from Thing?

A: No.

Q: Can you extinguish the wall of fire?

A: Not permanently.

Q: How do you get the bio-gem or light the gas without being blown up?

A: You can't.

Q: What's the purpose of being able to shoot Thing out of the cannon?

A: If you do it properly, it allows you to get into the castle.

Q: How do you get into Dr. Doom's castle?

A: This is really tricky and requires considerable cooperation between your two characters. Starting off as Thing, you must carry the cannon to the entrance of the castle, aim the cannon at the castle, put the gunpowder in, then climb in yourself. Change to Human Torch, fire the cannon at Blob, then throw a high flame at Blob. Make sure you have the graphics on during all this and you'll get some neat (and quite unexpected) animation.

Feasibility Experiment (Channel 8)

Q: What do you do at the dragon's lair?

A: Shield yourself from the dragon's breath, then try fighting it.

Q: What do you do at the mine shaft?

A: Before you do anything, find yourself a key and a dagger to use down the mine.

Q: What do you do at the stone temple?

A: Read the inscription on the altar and pray in the temple.

Ghost Town (Adventure International)

Q: How do you get past the rattlesnake on Boot Hill?

A: The item you need is in the jail.

Q: How do you find the silver cup?

A: Try dancing in the saloon when the time's right.

Q: How do you shoe the horse?

A: You need three items. The first is in the stall. Examine the

compass while holding this item and use your new found knowledge to break into the jail. Here you'll find the second item. Finally, try riding the horse. I know he's not shod yet, but if you SPUR him on, you may be surprised at the consequences – and find the third item to boot!

Q: How do you get to the Indian Village?

A: Ride ol Paint.

The Golden Baton (Channel 8)

Q: How do you give the salted slugs to the crab?

A: FEED CRAB.

Golden Voyage (Adventure International)

Q: What do you do at the strange fountain in the damp cave?

A: Throw the first stone tablet into it. Trust me.

Q: What do you do with the small stones?

A: There are three altogether. One is buried in the jungle, one is inside the stone statue and one is in the hidden chamber. Take them all to the hidden chamber and drop them next to the stone.

Q: What does the inscription on the second tablet mean?

A: Go to a location where you can see the item in the picture, then say the magic word.

Q: What do you do with the stone block?

A: You don't do anything to it directly. However, throw the second tablet into the second fountain and return to the stone block for a pleasant surprise.

Gruds in Space (Sirius)

Q: What do you do on Venus?

A: Lots of things. Start by tying the rope to the tree, then go E and D. Use the object you find here to get past the Venusian, then carry out Deebo's instructions.

The Hitchhiker's Guide to the Galaxy (Infocom)

Q: How do you survive the flying brick in the opening sequence?

A: Don't let Prosser demolish your house! What do protestors usually do? If you've led a life of seclusion or never taken an interest in environmental issues, then read 'The Hitchhiker's Guide to the Galaxy' by Douglas Adams.

Q: What do you do in the Vogon Hold?

A: Consult the guide on a few things such as Babel Fish and Vogons. Obtaining the former leads to a greater understanding of the latter. Let the program lead you through the process of obtaining the Babel Fish, but you'll need your dressing gown and towel, Ford's satchel and the loose pile of junk mail.

Q: How do you prove your intelligence to the screening door?

A: You can't if you've got any common sense! Consult the guide about intelligence, but don't bother trying to solve the puzzle until you have nearly finished the game. By that time you should have an item and not have an item which will convince the door of your intelligence.

House of Secrets (Page 6 magazine)

Q: What do you do with the target?

A: Swallow the tablet to calm your nerves then fire the crossbow while holding the telescope.

The Incredible Hulk (Adventure International)

Q: How do you pull the ring in the first dome?

A: Remember your nightmare before entering the dome.

Kidnapped (SoftSide magazine)

Q: Is there an error in the way the clock reads on the 9th floor?

A: Yes, there is. In line 1960, change T1 to TI, otherwise you'll get times like 15 P.M. Also, in line 1950, add a space between TV and the closing quote, otherwise you can't watch the TV set.

Q: What is the purpose of the locked door on the 6th floor?

A: This is the door to the pantry. That's where they keep all

the red herrings.

Q: Having got to the window of the dining room on the 4th floor, how do you get out the window with the umbrella?

A: JUMP!

The Mask of the Sun (Broderbund)

Q: How do you get the silver bowl?

A: Go to the secret crypt containing the three stone sarcophagi and search it. Talk to the ghostly apparition when it appears, but you must do so before it fades, so type quickly. Listen to what it has to say, then go back and kill the skeleton with the item it refers to.

Q: What do you do in the boulder room?

A: Nothing.

Q: How do you get past the pale green gas?

A: Try every direction. You can do this without getting killed if you type fast. Don't wait for the prompt before you start typing.

Q: How do you find the mask with the blue eyes?

A: After you've got the first mask (the one with the black eyes), search the altar.

Q: How do you get out of the Temple of the Sun?

A: Look at the altar while wearing the second mask.

Q: How do you get out of the maze after the shifting room?

A: Wear the real mask and move in any valid direction. Wear the mask again and move again. Keep repeating this until Roboff appears. It will take quite a number of moves.

Mission Impossible (Adventure International)

Q: If you pour water on the disconnected bomb, it goes off. What do you do to defuse it?

A: Did you read the sign in the Control Room? "No beverages. Please use Break Room." Hmm...

Mordon's Quest (Melbourne House)

Q: Where do you find the iron pyrites?

A: Go SW, U from the enormous stalactite filled cave. Make sure you obey the sign, then go W, W, D. Incidentally, I'd suggest you save the game before carrying out this sequence - just in case!

Q: Where do you find something to help you breathe underwater?

A: Go N, N, NW from the shingle beach and examine what you find there.

Q: How do you open the doors bearing the 'No Entry' sign in the futuristic complex?

A: You can't.

Q: Where do you find the cigar?

A: Go to the metal chamber where you found the crystal orb and try leaving the room in every direction.

Q: How do you get into the catacombs?

A: Do your Clint Eastwood impersonation in front of the Emperor.

Mystery Fun House (Adventure International)

Q: Do you have to get through the grate in the parking lot?

A: Yes. Try removing the bolts with a tool found inside the fun house, then slide it open.

Q: How do you open all the locked doors?

A: You don't. There are five locked doors. You can open the one in the store room with the rusty key, but the others stay permanently locked.

The Payoff (Atari Corp./Bug Byte)

Q: How do you get through the window without the guard catching you?

A: Spread the treacle and stick the newspaper on the window.

Q: Where do you go from the costumiers once you've taken the money from the till?

A: Have you climbed the fence?

Pirate Adventure (Adventure International)

Q: How do you open the crate?

A: There isn't any crate! If you mean the chest, then use the claw hammer to remove the nails and look under the rug.

Planetfall (Infocom)

Q: How do you get past the mutant infested bio-lab?

A: Read the memo in the lab office and follow the instructions. Make sure you are wearing the item found in the desk, push the red button, then hot tail it to the Projcon Office and down the elevator.

Pyramid of Doom (Adventure International)

Q: How do you destroy the iron statue?

A: The mural in the same room says "Seek ye well the HEART of Iron". This is a clever play on words by Scott Adams, but what does it mean? If 'well' is an adverb, it could mean 'Look carefully for the HEART of Iron', but if it's a noun, it could mean 'The HEART of Iron should go to the well'. Similarly, "the HEART of Iron" could mean 'the heart made of iron' or 'the heart belonging to iron' (as in iron statue?). Put it all together and you've got 'Look carefully for the heart belonging to the iron statue' or 'The iron statue's heart should go to the well'. Or both? What do you think?

Sands of Egypt (Datasoft)

Q: How do you get started?

A: Go north until you find a cliff. Go west until you find a shovel. Get it. Go north and clobber the snake. Go east until you find a canteen. The rest is up to you.

Q: How do you get the fronds?

A: Check out the pyramid first.

Q: How do you get to the pyramid?

A: Find some transport.

Q: What use is the camel?

A: Transport.

Q: How do you ride the camel?

A: Feed it first then mount it.

Q: How do you remove the cover in the pool?

A: Examine everything first. Hook scepter to handle, then pull hook.

Q: What do the hieroglyphics in the outer chamber mean?

A: Translate them!

Q: How do you get the ladder through the crack?

A: Due to a bug in the program, you must DROP ALL, then try again and you should be able to get it through. (Refer to the adventure column in Page 6 Issue 13 for an explanation.)

Savage Island Part 1 (Adventure International)

Q: How do you rebuild the raft after it starts coming apart?

A: You need to be on shore to do it. Cut the existing vines and the raft will fall apart. Rebuild the raft with the second set of vines. (You did think to cut a second set of vines didn't you?)

Savage Island Part 2 (Adventure International)

Q: How do you reach the rooms beyond the flickering forcefield before running out of breath?

A: You can't unless you've got a much bigger lung capacity. Somebody else in the game has that capacity. See the next question.

Q: What do you do after meeting Argh?

A: Start by using the flower to knock him out and drag him to the eastern red metal room. Now play around with the control console.

Q: After using the loop to find two rooms (apart from the cramped metal area) and moving the lever in the gym, where do you go next?

A: Use one of the control consoles to fix the flickering

forcefield so that you can get back to the time machine. Use this to travel back to the age of the dinosaurs (the alien device will help here) and blow the tripe out of them!

The Serpent's Star (Broderbund)

Q: How do you get the scrolls off the monks in the monastery?

A: I haven't played this game yet, but I've got some hints which seem to indicate that you DON'T get the scrolls off the monks in the monastery. However, offer tea (or butter?) to the statue of Buddha. This gets you an audience with the Abbot. Ask him about the scrolls and you'll be taken to the library. Don't try to take the scrolls. Leave the monastery and find the wandering monk. Offer him some tsampa, ask him about the scrolls, then accept HIS scroll.

Sleazy Adventure (Atari Program Exchange)

Q: How do you get past the Dirty Alcove?

A: Ask for a HINT, then give something valuable to someone less fortunate than yourself.

Snowball (Level 9)

Q: How do you get the batpack from the video viewer?

A: Use the screwdriver.

Q: How do you get through the trapdoor?

A: There is more than one trapdoor. Use the spanner to open the one in the winch room. Don't worry about the others.

Q: How do you kill the bird?

A: If you mean the nightingale, you can't. Just hide behind the nearest door when you hear one coming.

Soft Porn (Sierra On-Line)

Q: Where is the hammer?

A: Enter the bushes in the lobby of the hotel.

Q: What's the trick to seducing the young lady in the disco?

Flowers, wine and dancing don't seem to work.

A: Maybe that's not enough? Have you tried tempting her with candy?

Sorcerer (Infocom)

Q: What do you do once you've reached the top of the chute?

A: How did you ever get roped into this?.

The Sorcerer of Claymorgue Castle (Adventure International)

Q: How do you get past the chandelier?

A: Look at the ceiling to see where you've got to get to. Use a spell to dissolve the rope, but don't hang around or you'll get clobbered by the falling chandelier. (At least two spells will work, but only one is the 'correct' one.) Finally, step onto the fallen chandelier and use an uplifting spell.

Starcross (Infocom)

Q: Where is the mass detector output referred to by the computer?

A: That's the map that came with the documentation! It's labelled in the upper right hand corner.

Strange Odyssey (Adventure International)

Q: What use is the black hole?

A: A good way to get killed!

Q: What use is the methane snowstorm?

A: I reckon a methane snowstorm would be pretty cold. What could possibly live in such an environment? Return it to its home and see what it does.

Transylvania (Penguin)

Q: Where do you find some flies to catch on the flypaper?

A: Pour the weak acid from the clay hut onto the ancient stump, then look at the stump and follow the directions.

Q: How do you get the key off the goblin?

A: Give the flies to the bullfrog and listen to what he has to say.

Q: What's the story with the unseen force that keeps shaking the ladder?

A: The vampire is the unseen force. If you haven't seen the vampire yet, it's probably because you've been carrying the garlic. Try leaving it behind.

Q: How do you kill the vampire?

A: Go to the castle, but don't take the garlic with you as it keeps the vampire away. Wander around in the castle until the vampire appears, then show him the cross.

Ulysses and the Golden Fleece (Sierra On-Line)

Q: How do you get to see the King?

A: Talk to the guard in the entry hall of the castle.

Q: Is there a key to open the jewel encrusted chest?

A: No. Try using some magic, specifically a magic word found near the wharf.

Q: How do you get past the guard at the docks?

A: Try talking to him.

Q: How do you get past Neptune and Pluto?

A: Read the poem in the instructions. (Tough luck if you've got a pirated copy!)

Q: You can see objects after getting rid of the dragon, but it's not clear what they are. How do you get them?

A: You cannot get any objects after the dragon leaves.

Q: How do you get past the giant wall of fire?

A: Pour some liquid over you. (Oh, what a waste!)

Q: After giving the wine to the Cyclops, he still wants something else. What is it?

A: Tell him what the wine's made of so he can get some more.

Q: Where do you find some food to feed your hungry crew?

A: After escaping from the Cyclops, slaughter the sheep and cook it over an open fire. You'll need some items from the start of the game to build a fire.

Q: What do you do after sailing past the Sirens, killing the Cyclops and freeing the man in the cage?

A: It sounds like you may have bypassed the Island of Sirens without being drawn towards the jagged rocks on the shore. Don't! You need to listen to the Siren's song. Remember your Greek mythology - specifically Homer's 'Odyssey'.

Q: Does the man who gives you the mallet want something in return?

A: No. He is grateful enough to be free of the harpies.

Q: How do you get past the skeletons?

A: Use the enchanted sword.

Q: What use is the lantern and how do you get it started?

A: The lantern serves no useful purpose other than to prevent you buying an object that you really need.

Voodoo Castle (Adventure International)

Q: What is the cast iron pot useful for?

A: Eat the contents and you'll soon find out! You can also try smoking it!

Q: What is the kettle useful for?

A: Examining it could be a moving experience.

Q: What is the soup useful for?

A: It's a little more agreeable than the contents of the cast iron pot.

Q: How do you lift the curse after getting the stick, lamp, knife and clover?

A: You need two more items plus some instructions. Try reading the book for the latter. Still something missing? Try reading the advertising leaflet in the jail cell, but save the game before entering the jail.

Wishbringer (Infocom)

Q: How do you pass the troll at the bridge?

A: Nuts!

Wizard and the Princess (Sierra On-Line)

Q: How do you get past the snake at the start?

A: You should have received a small hint card with your game. Read it! The desert is a maze. There are thirteen rooms which all look the same except for the five with a rock in them. These five rooms are each distinguishable by the position of the rock. Look at the rock in each room and you'll find that all except one have a scorpion under them. Get the rock without the scorpion under it and use it to clobber the snake.

Q: What do you do with the toad (or is it a frog)?

A: It's a frog. Remember your fairy tales!

Zork I (Infocom)

Q: Do insects play a part in things?

A: No.

Q: How do you get upstream?

A: You don't.

Q: How do you use the granite walls?

A: There are two granite walls. A third one is not granite despite the implication of the graffiti on it. When next to a granite wall you can teleport yourself to the other one by saying the name of the room.

Q: Do the words "Hello sailor" mean anything?

A: Yes, but only in Zork III. They may also arise in an amusing scenario in Zork IV (whoops, I mean Enchanter).

Q: When you try to kill the thief with the rusty knife, it turns on you and stabs you in the throat. What's going on?

A: Don't use the rusty knife to kill the thief. There is obviously some evil magic behind it (as its previous owner also found out). If you had your sword with you when you took the knife, the flash of light would have warned you of its danger.

Q: What do you do in the machine room?

A: The machine is used to make something valuable out of carbon, but I can't tell you what. Examine every part of the machine (inside and out), then play around with it. If you still can't work out what to do, pay a visit to the Technological Museum in Zork III.

Q: What's the third thing you need to do to get through the Entrance to Hades?

A: Sir Richard Steele once wrote that "reading is to the mind what exercise is to the body", or something like that.

Zork II (Infocom)

Q: What is the answer to the riddle?

A: What did the farmer say when he saw three holes in the ground?

Q: How do you get past the guarded door?

A: A key would help. And is the lizard doorkeeper REALLY growling at you or is it his stomach?

Q: How do you get the treasures out of the Bank of Zork?

A: Drop all your treasures. Try entering the Safety Depository from different directions, then walk through the curtain of light and observe what happens. You should notice a distinct pattern. Once you understand the pattern, you can collect your treasures and prance on out without any trouble.

Q: How do you find your way around the oddly-angled rooms? Has it got anything to do with baseball?

A: Yes, it does have something to do with baseball. Find the home plate (what would you expect to find at the home plate?), then walk in the directions that you would expect to follow when going for a home run. (I don't know much about baseball, but I think baseball fields are always oriented the same way. The home plate is at the western extremity of the diamond and the pitcher is at the centre. As the pitcher faces the batter, his left side is to the south, hence left-handed pitchers are known as 'south-paws'.) The diamonds show your

progress. The brighter they are, the closer you are to a 'home run'.

Q: What should you get the demon to do for you? Kill the wizard, get his wand or move the menhir?

A: Aw, come on! You can't be serious! If in doubt, why not just save the game and try all three? They'll all work, but I'd recommend the second. The first lacks compassion and the third won't allow you to complete the game.

Q: You can get to the end of the game with the full 400 points, but the game doesn't finish. What's the story?

A: Seeing as you're so close to finishing the game, I think I should leave you in the DARK on this one.

Zork III (Infocom)

Q: How do you get the staff? Has it got anything to do with the broken timber?

A: Exercise some patience and trust at the cliff. It's got nothing to do with the broken timber.

Q: Where do you find the key?

A: In the region south of the lake - providing you can get past the grues.

Q: You can have all seven points, yet the Dungeon Master isn't prepared to see you. What's the story?

A: A point is awarded as an indication that you have the POTENTIAL to find a required object, not for actually finding it. You have probably found (or been very close to finding) all seven objects that the Dungeon Master wants to see, but you didn't have them all with you when you visited him.

There you have it, a monster collection of adventure hints from A to Z. These are all real questions that real people have asked, not contrived questions that I've made up just to fill the space. If YOUR question isn't here, then drop me a line and I'll see if I can help you out, but please write neatly, ask explicit questions, tell me whether you want a hint or a straight answer and include two international reply coupons to cover the return postage.

Garry Francis
26 Baringa Road,
Earlwood,
N.S.W. 2206
Australia



Flying

Flight Simulation Book Reviews

By The Book

by John S Davison

Flight simulator fans can add new dimensions to their flying with these four new books. All are designed for practical use – you actually fly the exercises discussed, sharpening your flying skills and knowledge as you do so. They may seem expensive, but considering the additional use and enjoyment they bring to your simulation software they're well worth the price.

LEARNING TO FLY with Flight Simulator Compute! £12.95

Written by John Rafferty, a real-world experienced pilot, this book provides an ideal introduction to the world of Sublogic's Flight Simulator 2. (FS2). It's split into four main sections using a total of twenty six flights – with real airfields and routes used in traditional FS2 fashion.

Where appropriate, the dialogue you'd have with air traffic controllers is included – an invaluable introduction to the esoteric language used. Real fanatics could even record this onto tape and play it back at appropriate points for extra realism!

You start with basic training, taking you through all phases of a flight including taxiing, takeoff, climb, en-route cruise, approach, and landing. You then go on to building your aviation skills by learning about flight planning, airport traffic patterns, basic radio navigation, short field takeoff and landing, stalls, engine failure, and standard rate turns.

Then you develop precision flying skills, including precision landings and use of VOR and ADF radio aids for flying the USA's Victor Airways system. Finally, you're taught how to fly the professional way under Instrument Flight Rules (IFR) using advanced instrument flying techniques. This involves use of VOR, VOR/DME, DME arcs, NDB, the Instrument Landing System with procedure turns, and back Localizer approaches.

The final part of the book includes Victor Airways charts covering the four main FS2 flight areas, and around 90 actual Instrument Approach Procedure charts covering many of the main airports in FS2.

I found the book very easy and enjoyable to read, (and more importantly, to understand) – even on the most difficult of radio navigation topics. If you want a good introductory book to help you get maximum enjoyment from FS2, then this is it.

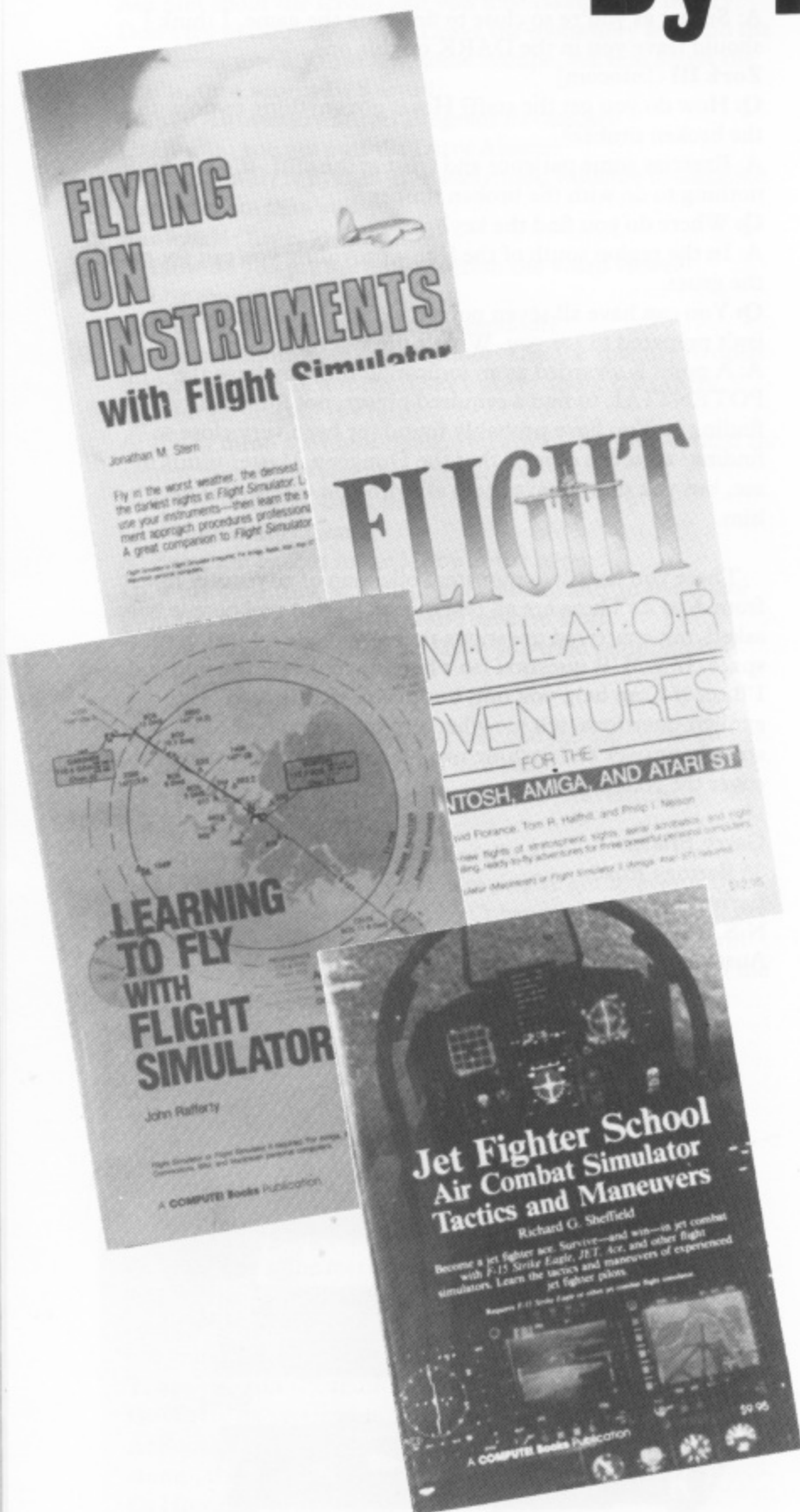

FLYING ON INSTRUMENTS with Flight Simulator Compute Books! £9.95

This book starts by explaining in detail the six basic instruments used in instrument flying and how to fly straight and level, climb, descend, and turn using them. It then covers en-route navigation and Instrument Approach Procedure charts, the latter looking impossibly complex until the book shows you how to interpret them.

Navigation by instruments relies heavily on radio aids, so the book spends much time teaching you how to use the realistic twin VOR, DME, ADF, ILS, communications, and transponder radios fitted to the Cessna, Piper, and Learjet aircraft portrayed in FS2.

The practical exercises in instrument flight start with instrument departures, en-route procedures, and VOR approach and landing. Later chapters cover the more difficult NDB approaches, procedure turns, and precision approaches using ILS. It then goes on to cover variations, such as ILS approaches at night, VOR/DME approaches, circling approaches, DME arcs, ILS approach after glideslope failure, and radar vectoring to final approach.

The book's text covers 83 pages, compared with 55 pages in the IFR section of the book above. In addition this book has over 160 pages of appendices containing takeoff minima, departure procedures and Instrument Approach Procedure charts for many of FS2's airports. For me, these charts alone are worth the price of the book.

I thoroughly enjoyed this book and would recommend it to anyone who's mastered flying FS2 in visual conditions and now wants to learn the secrets of instrument flying.

FLIGHT SIMULATOR ADVENTURES for the Macintosh, Amiga and Atari ST Compute! £12.95

Written by three authors, this book is a straight copy of the format first produced by Charles Gulick. (See Page 6 issues 21 and 26 for reviews.) The main difference is that it's aimed at the ST version of FS2, so unlike Gulick's earlier books it includes flights in the graphically spectacular San Francisco area.

For those unfamiliar with the format, the book consists of a series of 'adventures' acted out using Flight Simulator 2. You're given the parameters to key into FS2's editor to set up each scenario, and then talked through the adventure as you fly it.

This book contains 48 such adventures, ranging over the whole of FS2's 'world' as supplied in the basic package. Some flights are very similar to Gulick's, such as those to well known

landmarks like the Statue of Liberty and Seattle's Space Needle. This isn't important if you don't already own Gulick's books, though.

The adventures cover a wide range of storylines, including straight sightseeing and 'fun' flights, flights with you as an air-taxi operator, mail delivery pilot, 'eye-in-the-sky' traffic reporter, getaway pilot in a jewel robbery, and many others.

Overall, it's a nice way of exploring the world of FS2, but I don't think it's as well produced as Gulick's books. It doesn't include the same level of background information on the areas over which you fly. Nor does it exhibit the same level of warmth, friendliness, and enthusiasm evident in the originals. It's still good fun, though.

JET FIGHTER SCHOOL Compute! £9.95

Richard Sheffield wrote this book with Microprose's F15 Strike Eagle in mind, but the material covered is equally valid with other jet combat simulators. Like the FS2 books, it's designed to help you exploit the simulator to the full thereby maximising your enjoyment.

It's presented in two parts - Ground School and Flight School, covering theory and practice of jet combat flight respectively. The first includes background material on development of the F15, basic performance and manoeuvring characteristics, weapons systems and capabilities, a brief history of its combat experience, and finally basic rules and manoeuvres of air combat.

Flight School puts you in the F15's cockpit trying out some of the theory. You start with learning combat manoeuvres such as aileron and barrel rolls; loops; split-S, Immelman, stall, and break turns; inverted flying; and use of speed brakes.

Having mastered the basics you then go on to learn ten offensive manoeuvres which use them, including head-on and turning attacks; high, low and straight yo-yo's; and rollaway, pitchback, zoom and dive separation. Appropriate weapons to use are suggested in each case, and dive and pop-up bombing techniques are also included. Diagrams are provided showing exactly what the manoeuvre should look like.

You then go on to learn eight defensive manoeuvres to escape from an enemy closing in for the kill. These include high-G barrel roll, low and high speed disengagement, speedbrake reversal, spirals, jinking a head-on incoming missile, and how to hit an enemy behind you.

The last two chapters are written specifically for F15, covering actual combat scenarios used in the program. Many useful tips are given on risk reduction, limping home when damaged, using a two man crew, and other generally useful hints. Finally, each of the seven missions are examined in turn and suggestions made on tactics you might employ to achieve your mission and get back alive.

If you see yourself as a jet fighter 'jock' and want to increase your knowledge and skill in jet combat then this book will show you how. ●

TUTORIAL SUBROUTINES

7. TITLE PAGES

Brighten up your programs by paying a little more attention to the presentation. Ian Finlayson shows you how

There are many amateur programmers who write programs for their own amusement, enjoying the development of the program as much, if not more, than the end result. Many of these programs function very well but lack the finish of commercial programs. Part of the trouble is in the presentation of the program – there seems to be much less interest in making a program attractive to other users than there is in getting the core to work as conceived. You will, however, find that your master work is much more acceptable to your friends and to magazine editors if it has a bit of gloss.

The following items are all important in making your program more presentable:

- Debugging
- Crash proofing
- Introduction and title screen
- Instructions
- Colour
- Sound
- End routines

These items can take almost as much effort as the core program itself. The aim must be to look at your own work objectively and try to make it not only work correctly but to be attractive as well.

DISPLAY LIST

Although the subroutine uses a customised display list there is insufficient space in this short article to go into display lists in detail. If enough interest in display lists is expressed, the Editor might give them a fresh airing in future articles, meanwhile you can find more details in the Atari magazines and books.

To put it very simply a display list is a short list of instructions to a microprocessor called Antic, telling it how to set up the display screen. Normally you do not have to worry about the display list as it is generated automatically when you give a GRAPHICS instruction, but it is not difficult to set up a custom display list to mix graphics modes on the screen. It is possible to mix any graphics modes, character (text) modes and map (pictorial) modes. In the subroutine I have stuck to a mix of GR.0 and GR.2 text modes as they are quick and do not take up too much memory.

THE TITLE PAGE

The title page itself is in the second part of the subroutine. I don't pretend that it is particularly artistic or eye catching, in fact it is rather cluttered. This clutter is brought about because I wanted to fill up the available lines to make it easier for you to overwrite with your own text and to have a good idea where the text will appear on screen.

Experiment with colour as well. The GR.2 lines will come out in different colours if you use lower case or inverse characters, and changing the colour registers with SETCOLOR commands or POKEs can give pleasing results. John Lawford's Colour Tuner in the last Page 6 (Issue 33) could be a help here.

THE SUBROUTINE

Line 31970 – Sets the graphics mode on which the custom display list will be based, then finds the address of the start of the display list (pointed to by the contents of locations 560 and 561).

Line 31972 – The fifth and sixth entries in the display list (at DL + 4 and DL + 5) contain the address of the start of screen data. This location will vary depending on the configuration of your system so the values are saved for reinsertion in the display list later. The temporary variable I is used in the recursive loop which loads the custom display list. TT23 is set to the value in memory location 559 so we can restore it later. It is poked with zero now to turn off the screen. Turning off the screen has two effects; first it allows the computer to run faster, and second it ensures that the new custom screen appears instantly when the screen is turned back on so the process of setting up the screen and then putting the requires text on it is not seen.

Line 31974 – reads an item of data from the list in line 31984. If the item is zero it is the end of the list and we go to 31990.

Line 31976 – pokes the value into the required memory location, starting at DL and filling every location from there till the list is exhausted.

Lines 31978 and 31980 – These two lines put back the values we noted earlier into DL + 4 and DL + 5 so that we go to the right memory location for the start of screen data.

Line 31982 – increments the counter I and goes back to 31974 to read the next data item in the list.

Line 31984 – This is in effect the display list for this custom screen (except for the final zero which is only there to indicate the end of the list). This display list generates the following screen:

- 1 line of Graphics 0
- 4 lines of Graphics 2
- 3 lines of Graphics 0
- 4 lines of Graphics 2
- 2 lines of Graphics 0

Line 31990 – Here we start setting up the title page. Poke 82,0 sets the left margin to zero – this makes life easier when mixing text modes. The default value of two gives a ragged left margin because the double width letters are inset two double spaces while the standard text is only inset two normal spaces. The setcolor commands can be changed to suit your requirements. I have set 2 (background) and 4 (border) to be the same and also 1 (text brightness in GR.0). You may want to set other registers for GR.2 characters including lower case and inverse. Position 0,0 ensures the cursor is in the top left of the screen ready for text entry.

Lines 31991 to 32000 – These are the lines of text. Each line in the program creates one line of GR.0 or two lines of GR.2 text. I have split the GR.2 lines into two halves of 20 characters each so it is quite clear what goes on which line; Basic thinks we are in GR.0 and expects the screen to be 40 characters wide – this means that two GR.2 lines are treated as one line by Basic – we can, therefore, only type the second line of the pair as a continuation of the first. A carriage return anywhere in the first line of the pair will skip over the second. As Basic thinks we are in GR.0 we just use Print (or ?) to put the text on the screen for GR.2 lines as well as GR.0.

Line 32002 – turns the screen back on once all the text has been filled in.

Line 32004 – Looks to see if the START key has been pressed and if so it clears the screen back to standard GR.0, resets the left margin to the normal (2) and RETURNS to the main program.

Line 32006 – loops back to 32004 waiting for START to be pressed.

The subroutine can be run as it stands – although pressing START will give an error message as there is no GOSUB for the RETURN in line 32004.

The easiest way to customise the title page for your own use is to type over the text in my subroutine without changing the length of the text strings. If you experiment freely remember that you can sometimes get into a position where you are not quite certain what is happening with a custom display list like this. This is because the bottom lines of the normal text screen have been pushed off the visible screen by the double height GR.2 lines and the cursor is out of sight. A recovery can be made by pressing BREAK and blindly typing GR.0 followed by RETURN – this restores the standard text screen.

Have fun with your title screens. As always I will try to help with queries if you send a stamped self addressed envelope; also I would be pleased to hear what you are interested in for future articles. My address is: **60 Roundstone Crescent, E.Preston, W.Sussex, BN16 1DQ.**

```

DS 31968 REM **          PAGE 6          **
          ** SUBROUTINE TUTORIAL-7 **
          **          TITLE PAGE          **
KF 31969 REM ** CREATE DISPLAY LIST **
NR 31970 GRAPHICS 0:DL=PEEK(560)+256*PEEK
      (561)
QK 31972 TT21=PEEK(DL+4):TT22=PEEK(DL+5):
      I=0:TT23=PEEK(559):POKE 559,0
HH 31974 READ A:IF A=0 THEN 31990
CI 31976 POKE (DL+I),A
WT 31978 IF I=4 THEN POKE DL+4,TT21
YC 31980 IF I=5 THEN POKE DL+5,TT22
TC 31982 I=I+1:GOTO 31974
MD 31984 DATA 112,112,112,66,96,144,7,7,7
      ,7,2,2,2,7,7,7,7,2,2,65,32,156,0
KR 31989 REM **          EXAMPLE          **
          **          TITLE PAGE          **
WA 31990 POKE 82,0:SETCOLOR 2,9,2:SETCOLO
      R 4,9,2:SETCOLOR 1,0,10:POSITION 0,0
AY 31991 ? " ** WELCOME TO.....
      .....**"
UA 31992 ? " *****";" * P
      ROGRAMME      **:REM LINES 2A AND 2B
YF 31993 ? " * TITLE PAGE *";" *****
      *****":REM LINES 3A AND 3B
WQ 31994 ? " **
          **:REM LINE 4
VK 31995 ? " **          A TUTORIAL SUBROUTIN
      E          **:REM LINE 5
LL 31996 ? " **          FOR PAGE 6
          **:REM LINE 6
KI 31997 ? " *****";" * BY
          **:REM LINES 7A AND 7B
GE 31998 ? " * IAN FINLAYSON *";" *****
      *****":REM LINES 8A AND 8B
QM 31999 ? " ** MAY 1988
          **:REM LINE 9
SY 32000 ? " *****--PRESS ST
ART--*****":REM LINE 10
RE 32002 POKE 559,TT23
VI 32004 IF PEEK(53279)=6 THEN GRAPHICS 0
      :POKE 82,2:RETURN
ZU 32006 GOTO 32002
  
```

NEW ON THE MARKET!

MOUSE HANDLER CAPABLE OF SMOOTH
PRECISION DRAWING

ST MOUSE with no hardware modifications, for use on
any 8 bit Atari, ST MOUSE, Handler Demo Programme

£24.95 inc postage.

(disc or cassette)



FIG FORTH comes with
useful sample programs
and can also be used
with an ST MOUSE with
no hardware modifica-
tions

DO YOU WANT TO SPEED UP YOUR
PROGRAMMING ETC?
Then send now for FIG FORTH, the fast and versatile
language for the 8 bit Atari with a minimum of 48k
memory

FIG FORTH DISC
£14.95 inc postage
FIG FORTH PLUS MOUSE
£35 inc postage

PULSAR
SOFTWARE LTD

Pulsar Software Ltd
4 Church Hill Road
East Barnet, Herts. EN4 8TB
Tel: 01-441 0799

PAGE 6 SOFTWARE

**Coming soon - a range of
utility, application and
educational software for your
8-bit ATARI**

PROGRAMS WANTED

PAGE 6 software is intended to provide a software publishing opportunity for the sort of programs that you no longer see - utilities, education, applications, business and even serious entertainment. Most companies will only take on software that has a large sales potential and that normally means only games. PAGE 6 software wants to make available the best of the rest. We are quite happy to take on software that has a limited market. We'll pay good royalties and look after packaging and promotion, all you have to do is write the software!

PAGE 6 SOFTWARE is seeking software of the kind outlined. If you have something suitable send us a copy. We are even interested in software that has previously been published but is no longer available, provided you own the rights. Get in touch today if you are serious about your Atari and can write serious software.

Available only by Mail Order from:
PAGE 6 SOFTWARE, P.O. BOX 54,
STAFFORD, ST16 1DR
Tel. 0785 213928

★ AVAILABLE NOW ★

10-PRINT

**AN ESSENTIAL PURCHASE
FOR 1029 OWNERS**

- * **10-PRINT will allow your 1029 printer to print in any font resident in memory**
- * **Program listings can have inverse and control characters**
- * **Fonts can be mixed in letters and reports**
- * **NEW improved manual and utilities**

Disk £9.95
Cassette £7.95

★ AVAILABLE NOW ★

TARI-TALK

**TRANSFER ALL THAT VALUABLE
DATA TO YOUR ST**

- * TARI-TALK is a self-contained package that contains all you need to transfer text, data files or programs from your 8-bit Atari to your ST
- * Contains 2 metre interface cable and software. No programming knowledge or experience required.
- * TARI-TALK is the ideal accessory if you have word processing, data base information, filing or programs on your 8-bit that you want to use on your ST
- * No additional interface required

Price £19.95 fully inclusive

★ AVAILABLE NOW ★

SPELL ME

The only program for the 8-bit Atari to teach your children how to recognise letters and spell words

- * Several levels teaching alphabet recognition, spelling and word and picture association
- * Aimed at 3 - 5 year olds or older children with learning difficulties
- * Excellent graphics, 'nursery rhyme' rewards, optional timer and score and much more
- * Unlike many other educational programs SPELL ME is written by a qualified teacher

SPELL-ME Disk £7.95
SPELL-ME Cassette £5.95

Access/Visa orders accepted. All items post free in U.K.

THE ST FILE

July/August 1988

**The WORLD OF
ADVENTURE - ST
STYLE**

**QUEST - a look at the
Sierra series**



DUNGEONMASTER - realm of Chaos

Plus

Level 9 Interview page 12
Level 9 Games page 20
Answers Galore! page 24
Adventure Survey page 78
CONTACT page 77

Reviews

Jump Jet - Leatherneck
Knightmare - Northstar
Oids - Casino Roulette
Spitfire 40 - Rockford
International Soccer
Skyfox - Goldrunner II

H A R D W A R E

COMPUTERS

IBM Amiga A500 and modulator	£499.00
IBM 1541C Disk Drive with free software only	£169.95
Spectrum Plus 2 Computer with free joystick and software	£139.95
Atari 130XE Starter Pack with cassette recorder, joystick and free software	£139.95
Nintendo Games Console with free Super Mario Bros. game	£99.00
Sega Games Console with free "Hang On" game	£99.00

COMPUTERS

Atari 520STFM	£295.00
Atari 520STM + Mouse	£255.00
Atari 520STM + Mouse + SF354 Drive	£355.00
Atari 1040STF	£495.00
Atari Mega ST2	£999.00
Atari Mega ST4	£1299.00

- Mega STs come complete with SM125 High Res. Mono Monitor and now include Blitter Chips

All Atari Computers in stock are still available at old price while stocks last.

MONITORS

Atari SM-124 Mono 12" screen	£145.00
Atari SM-124 Bought with computer	£120.00
Philips CM 8833 Med. Res Colour 14" inc. lead	£285.00

DISK DRIVES

Atari SF354 0.5 Mb Disk Drive	£99.00
Eidersoft 1Mb Disk Drive	£139.00
Cumana 1Mb Disk Drive	£139.00
Supra 20Mb Hard Disk Drive	£599.95

ACCESSORIES

10 * 3.5 SS/DD Disks Branded	£14.95
10 * 3.5 DS/DD Disks Branded	£19.95
10 * 3.5 DS/DD Disks Unbranded	£16.00
Mouse Mat	£4.95

PRINTERS

Micro P. MP 135	£169.00
Citizen 120-D	£199.00
Panasonic KXP-1081	£189.00
Epson LX-800	£275.00
Star LC-10	£249.00
Star NB24-10 printer + Sheet Feed	£654.00
Juki 5520 Colour printer	£573.85
Citizen Overture 110 Laser	£1995.00

Full range of Citizen Printers in stock. Ring for details.

S O F T W A R E

10 BEST ATARI ST ADVENTURES

1) Dungeon Master	£22.45
2) The Pawn	£22.45
3) The Bards Tale	£22.45
4) The Guild of Thieves	£22.45
5) Nord & Bert	£26.95
6) Gnome Ranger	£13.45
7) Space Quest	£22.45
8) Knight Orc	£17.95
9) Plundered Hearts	£22.45
10) 221B Baker Street	£22.45

10 BEST ATARI ST BUSINESS PROGRAMS

1) First Word Plus	£71.95
2) VIP Professional	£206.00
3) Sage Accountant Plus	£206.00
4) Superbase Personal	£89.95
5) Trimbase	£80.95
6) Publishing Partner	£143.95
7) K-Spread 2	£71.95
8) Tempus	£26.95
9) Haboview	£67.45
10) K-Data	£44.95

10 BEST ATARI ST GAMES

1) Carrier Command	£22.45
2) Black Lamp	£17.95
3) Backlash	£17.95
4) Bubble Bobble	£17.95
5) BMX Simulator	£13.49
6) Predator	£17.95
7) Wizball	£17.95
8) Oids	£17.99
9) Defender of the Crown	£26.95
10) Test Drive	£22.45

THE YORK COMPUTER CENTRE, 9 Davygate Centre, York YO1 2SU. Telephone: (0904) 641862

Prospero Fortran for GEM Prospero Pascal for GEM What the reviewers say:

"The latest release of Prospero Fortran is a significant improvement, both in documentation and in use. The workbench works well in providing a very user-friendly environment allowing the user to move smoothly between the editor and the compiler. The package is further enhanced by the good debugging facilities, and the documentation level, which is well above average. The whole thing has a thoroughly professional feel and should suit the beginner and experienced Fortran programmer alike." **ST World**

"The GEM documentation is among the finest I have seen. For each section of the AES and VDI there is an explanatory passage, followed by a detailed description of every call. All of the parameters of the calls are detailed and examples are provided for each one." **Atari Explorer**

"If you use Fortran, this is a program worth the money and worth having. I only wish I could use the workbench with other languages too!" **Page 6**

"The GEM documentation is undoubtedly the best of it's kind I've ever seen, with detailed information on every topic

under the sun....There is no question in my mind that this is a superb package which will more than satisfy existing Fortran users and at the same time prove a perfect and fairly painless introduction to newcomers." **Atari ST User**

"Two weeks and a case of Guinness later I am back with a working program and good news: this is by far the best Pascal-family language (i.e. Pascal or Modula-2) implementation I have ever used - and not only on the Atari ST....I am highly impressed with this product. By now it is the compiler of my choice on the ST. It is not cheap - but well worth it. If you want to do serious programming in a civilized language on the ST, this is an obvious choice." **Current Notes**

Prospero Pascal for GEM and Prospero Fortran for GEM combine a compiler with an editor environment. The programs, complete with 800 pages of documentation, cost £86.91 (Pascal) and £113 (Fortran) from ST dealers or Prospero Software. Also available for Amstrad, Atari & other PCs with GEM.

The full text of these reviews is available on request.

How to buy:

Mail this to Prospero Software Ltd, Department 907, 190 Castelnau, London SW13 9DH, England or fax it to 01-748 9344. Credit card orders are also accepted by telephone on 01-741 8531.

Please send me:

Prospero Pascal for GEM at £86.91 + £13.04*

Prospero Fortran for GEM at £113 + £16.95*

for: Atari ST PC Compatibles

Postage is free on prepaid orders in the UK, £5 per product in Europe, £10 per product for the rest of the world. Please pay by Cheque (UK only), Eurocheque (£100 per cheque maximum), Credit card, or Bank transfer. *VAT in UK only.

Name _____

Address _____

Telephone number _____

I wish to pay £ _____ by:

Cheque enclosed

Credit card:

Type: Visa /Access/Mastercard/Eurocard /

American Express / Diners Club

Number: _____

Expiry date: _____

Please give card billing address if different from

despatch address.

Bank transfer to Lloyds Bank plc, 160 High

Street, London W3 6RA, England, quoting:

Account N° 0267564 Sort code 30-90-06

Prospero Software

7 LANGUAGES FOR MICROCOMPUTER PROFESSIONALS

190 CASTELNAU, LONDON SW13 9DH, ENGLAND TEL 01-741 8531 TELEX 8814396

What's Happening

If you buy one of **Mirrorsoft's** Cinemaware productions at the moment you could end up in Hollywood! The next six releases under the Cinemaware label, starting with **THE THREE STOOGES**, will contain entry forms for a 'Hooray for Hollywood' competition in which the lucky winner and a friend will be flown to Hollywood to be given a tour round the most famous movie studios as a guest of Cinemaware. There will also be 100's of runner up prizes of cinema tickets (the local Roxy, not New York!) and details will be on the special competition packs available throughout the summer.

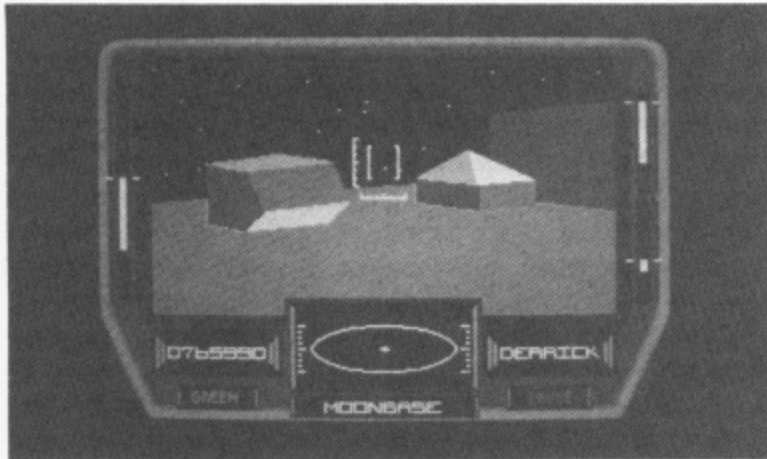

Mastertronic's Ringwars

Recent or coming releases include **ROADWARS** from **Mastertronic** at £19.99, **LORDS OF CONQUEST**, at £19.95, from **Electronic Arts**, a well respected conquer-the-world strategy game which has been available on 8-bit machines for some time. **Novagen** are still working on **DAMOCLES** which should be out in September. **Cascade** have **RINGWARS**, a 3-D space exploration game at £19.95. **STAR FLEET 1** is a space battle simulation from **Intersel** that will set you back £24.95 and put you in command of one of 36 heavy galactic cruisers defending the the Alliance (no not the SDP!) from attack from invading Krellan and Zaldrion warships. More from **Mastertronic** are **MOTORBIKE MADNESS** and **WORLD DARTS** both at £14.99 plus **SIDEWINDER**, an old Atari 8-bit title, at just £9.99.

If you haven't heard of **Atari's** summer offer on the ST yet, you ought to check your savings and pay a visit to your local dealer. The bad news is that a 520STFM will now cost you £100 more at £399 but Atari will include in each 'Summer Pack' over £400 worth of software absolutely free! It's not rubbish either, in fact it includes some of the very best releases around and also one or two games that have not been previously released. Games include **Supersprint**, **Marble Madness**, **Defender of the Crown**, **Rampage**, **Strike Force Harrier** and many more - 22 titles in fact! So if you want to buy a computer that will keep you from visiting your local software supplier for the rest of the year get out those savings.

Whilst ST software continues to pour in from all sides, one of the first companies to produce a serious package for the ST has announced that it is pulling out of the ST market.

Cashlink Software produced one of the first, and one of the few, full accounts packages for the ST but have found that sales weren't up to expectations and so are retreating to the bigger money world of IBM. The original Cashlink cost around £200 on the ST and Cashlink will kindly give you a 'special offer' to upgrade to the IBM version for an extra £295! Guess where the real money still is!

Rainbird have some interesting releases lined up for the summer including follow ups to a couple of their blockbusters. The next one from Magnetic Scrolls is entitled **CORRUPTION** where you will find yourself in a modern adventure set in the world of high finance and intrigue.

Having been framed by your partner and facing a spell in jail you will have to be devious in the extreme to extricate yourself, particularly as an irate drugs baron is also after you! They say this one is for 'hardened adventurers' so be prepared! On a more traditional theme is **LEGEND OF THE SWORD**, a new style of adventure from Silicon Software. Rather than following a character, the game tells of the chronicles of Anar, a mystical sword and shield whose magical aura protected the inhabitants of Anar for many years. With the kingdom plunged into turmoil by invaders you have to find the sword and shield to restore peace. The game is said to be a cross between role-playing and text adventures and has several unique features including over 300 cameo illustrations, icon driven commands and an innovative scrolling map.

VERMINATOR is an arcade style game set in the trunk of an ancient oak tree! You have to get rid of all the wriggling and flying nasties in over 250 different locations in the tree from the roots to the top most leaves! Finally comes one you may have been waiting for - **STARGLIDER II** - the sequel to the now famous Jez Sans masterpiece. Over 80 characters will be encountered in fast animated 3-D graphics set among a vast galaxy of planets with interconnecting tunnels. You will listen and hunt for the Space Whales in the upper atmospheres, blast slithering Pac-Worms and discover the astonishingly graceful Manta Rays. Someone has definitely been reading Arthur C. Clarke, have a read of A Meeting with Medusa before buying the game! All these from Rainbird will be at £24.95.



Latest release from **Frontier Software** is this little beast which looks just like a hard drive with a slot at the front and effectively that is just what it is! The **Supra FD-10** is a 10Mb floppy disk drive that allows unlimited storage by simply using any number of floppy disks. The access speed of the drive is almost as fast as a hard disk which makes the FD-10 an ideal back up device for hard disks users or a useful alternative for anyone contemplating a hard drive. Price is £799.95 inclusive and the special disks required will cost £17.95 each.

BOMB DISPOSAL



The designers, programmers and artists at Classic Software welcome you to a new concept in computerised entertainment. From the moment you first boot up **Bomb Disposal** you will realise that this is no shoot 'em up arcade game, **you** are the trainee bomb disposal expert, who must decide how to defuse a series of explosive devices and stay alive. **WARNING:** This programme is not for the faint hearted.

CLASSIC SOFTWARE

Available only from Classic Software

Send Cheque or P.O. for £19.95 to:

PO Box 8. Sandown, Isle of Wight. PO36 8LT



Credit Card Hotlines



0983 864674

or

0983 405600

DEALER ENQUIRIES WELCOME

DARE YOU TRY ?

FORGET-ME-CLOCK

Frontier Software

£22.95

Reviewed by
Les Ellingham

Unless you are the fortunate owner of a Mega ST you will know the frustration of having all your files dated sometime in 1985 no matter when you saved them! Not helpful. Of course you can install the Control Panel accessory and set the time and date each time you boot up but, like most people, you will often forget. The answer is to install a clock card which will do most of the work for you although you must still remember to use a particular disk to boot up your system.

The Forget-Me-Clock from Frontier Software is currently the most widely available, and cheapest, clock for the ST and can be fitted relatively easily into all models of 520 or 1040ST. Concise fitting instructions are provided and almost anyone should be able to fit the clock in under 15 minutes. Fitting simply involves removing the cover, detaching the keyboard connector, removing a chip which you fit on the clock card and then plugging the clock where the chip used to be. Finally you place the batteries in a suitable location inside the computer and connect them up. I say 'relatively easily' because it is a fairly straightforward procedure but I did find the chip to be an extremely tight fit into the socket on the clock card and great care must be taken not to bend the pins when the chip is first removed. Of your 15 minutes spend 10 minutes removing the chip!

Once installed the time and date are set with the software provided and you must then make sure that each time you boot up you use a disk which has the supplied AUTO-SET program in an AUTO folder. If you forget you can of course run the AUTO-SET program on its own at any time, as all it does is take the correct date and time from the clock and update the ST system clock. All of your files will be saved in correct date and time order and other programs will be able to pick up the correct date and time. There are several public domain clock and calendar utilities you can use for different applications some of which are provided on the Forget-Me-Clock disk.

The Forget-Me-Clock is, at £22.95, one of the cheapest clocks available for the ST and, if time is important to you, should be a worthwhile investment.

A FREE FORGET-ME-CLOCK!

PAGE 6 has FIVE Forget-Me-Clocks to give away to lucky readers, courtesy of Frontier Software. All you have to do is write down FIVE ST products distributed by Frontier Software and send the list to FORGET-ME-CLOCKS, PAGE 6, P.O. BOX 54, STAFFORD, ST16 1DR.

You'll have to be quick, we only have FIVE to give away and they will go to the first FIVE correct entries opened in this office on the 5th July. Get thinking and get writing, but do it quickly!

If you are not that quick, or lucky, you can still get a Forget-Me-Clock at the regular price of £22.95 from Frontier Software. Write to them at P.O. Box 113, Harrogate, North Yorkshire, HG2 0BE or ring them on 0423 67140.

Cut the cost Cut the hassle Cut the coupon!

Compumart
A GREAT DEAL MORE FOR A GOOD DEAL LESS!

DEPARTMENT PA6
JUBILEE DRIVE
LOUGHBOROUGH
LEICS LE11 0XS
TEL: 0509-610444
FAX: 0509-610235

Send Now for your **Free** copy of the Compumart ST Information Pack
and discover a full range of ST Accessories at Super Low Prices

For IMMEDIATE RESPONSE, simply send this coupon to:
COMPUMART · FREEPOST · LOUGHBOROUGH · LEICS · LE11 0BR

A FREE Compumart ST Information Pack

Name

Address

Postcode

Date

PLEASE
TICK

PA6

Enter the

WORLD of ADVENTURE

... ST STYLE



How does the ST adventurer fare when it comes to his or her favourite computer fodder? How many adventures are there on the ST? The first problem is of course defining what is meant by an 'adventure'. I will exclude for the moment the 'Dungeons and Dragons' implementations such as the Ultima series from Origin Systems and Dungeon Master from FTL which although excellent 'adventures' in their own right are not what is usually meant by Computer Adventures. Nor will I include the so-called 'arcade adventures' which are mainly joystick/mouse driven and consist mainly of fighting ones way through mazes, finding artefacts to 'use' elsewhere in the game.

Even so, that still leaves a wide selection of adventures with and without pictures, and with varying levels of interaction with the graphics. I easily located over sixty adventures from over a dozen companies.

IN THE BEGINNING WAS ...

It is all reputed to have started back in 1976 with Willie Crowther and Don Woods producing a game called Adventure. This was soon followed by a group of guys at MIT publishing a game called Zork in 1977, and Scott Adams amazing everyone by managing to fit his first adventure Adventureland into a 16K machine in 1978.

Two of those early games are still available on the ST. Adventure was taken on by Level 9 in this country and renamed **Colossal Adventure**. They tacked a bit on the end (see if you can spot the join!), wrote two sequels (**Adventure Quest** and **Dungeon Adventure**), and over the years, improved the vocabulary and syntax of the games, added pictures, and published the trilogy as **Jewels of Darkness**. Level 9 have produced a number of excellent games over the years, many of which are now available on the ST. They have packaged six of their other old games in sets of three and, at 3-for-the-price-of-1, **Time and Magik**, **Silicon Dreams** and **Jewels of Darkness** are without doubt some of the best buys on the ST adventure market at the moment.

INFOCOM AND ...

The other of those originals which is still around is **Zork**. The MIT guys formed a company called Infocom in 1980 and since then have produced not only **Zork II** and **Zork III**, but 30 other adventures covering virtually every imaginable genre

– Fantasy, Mystery, Science Fiction, Comedy, Tales of Adventure and, recently, Horror and Romance (which, my eleven-year old son assures me, are actually the same thing!). Although the recent games are unclassified Infocom, for many years, classed their games as Introductory, Standard, Advanced, and Expert. If you are a beginner then you could try **Wishbringer** or **Moonmist**, if you want a real challenge then you should try **Deadline**, **Starcross** or **Spellbreaker**.

Infocom adventures are all pure text. They believe in the power of the imagination to provide better pictures than they could, and that a thousand words are worth a lot more than a picture! They have concentrated on improving the capability of the games to understand your input, and thus make the game more fun to play. Although some other companies are catching up in this area I believe Infocom still have the edge. The only catch, in this country, is that Infocom games are a trifle expensive. Look out for special offers or see if you can get a penfriend in the States to send you some – they were doing quite reasonably priced sets of **Zork I, II, and III**, and of the second **Zork Trilogy (Enchanter, Sorcerer, Spellbreaker)** earlier this year over there, and also a trio of **Science Fiction Classics** and a **Classic Mystery Library**.

The recent **Beyond Zork** offers a little graphical help with the mapping, but is still basically a text adventure – and one of their best!

Another of Infocom's recent offerings, **Nord and Bert Couldn't Make Head or Tail of It**, is a set of eight short stories all involving wordplay – cliches, spoonerisms, and other verbal trickeries – good fun if you are into that sort of thing and fancy a bit of variety.

SCOTT ADAMS

The third of the original adventures, Adventureland, is not, to my knowledge, available on the ST. Scott Adams went on to produce over a dozen adventures, adding pictures along the way, culminating in **The Sorcerer of Claymorgue Castle** which I consider his best – albeit a trifle primitive when compared with the later offerings of the other companies. He then went on to produce the **Questprobe** series in conjunction with **Marvel Comics**, some of which are available on the ST. I don't know what went wrong, but they are nowhere near the quality of his earlier work (I suspect he didn't have a lot to do with them – they probably just used his name) and I cannot really recommend any of them.

The fact that both Zork and Colossal Adventure are still around and still popular says a lot for their quality – all serious adventurers should have a go at them!

A number of other companies are also producing new adventures of a very high quality, usually with pictures added. Foremost among these are the UK's own Level 9 (**Gnome Ranger**, **Knight Orc**), and Magnetic Scrolls (**The Pawn**, **The Guild of Thieves**). There are others such as Activision (**Borrowed Time**, **Mindshadow**) and Penguin (**Transylvania**, **Crimson Crown**), but I wouldn't put them in quite the same class. I would class all these as text adventures, since I use a rule of thumb when evaluating the graphics which are provided with adventures: if I turn them off, can I still solve the adventure? (The fact that Knight Orc, for example, comes without pictures on the 800XL, places it firmly in the text adventure category by my reckoning.) Personally, if the game is going to have graphics at least make them integral to the game!

INTERACTIVE GRAPHICS

This now brings us to another range of adventures, those where the graphics form an integral part of the game. Prime examples of these are the excellent games from Sierra: **King's Quest I, II and III**, **Space Quest I and II**, **Police Quest** and **Lounge Suit Larry in the Land of the Lounge Lizards**. In these games you have to use the cursor keys or mouse to manoeuvre your character around the screen in order to solve certain puzzles and reach certain places, as well as entering text commands in the normal way through the keyboard. I found King's Quest III, especially, to be a superb game, and the fact that the three King's Quest games are currently being offered for the price of one makes them an excellent bargain.

The idea of interacting with the screen is also used effectively in **Tass Times** (from Activision) and **Deja Vu** (from Mindscape) where normal text entry is augmented by the ability to use the mouse to point at items in the pictures, and to point at icons to indicate what you want to do with those items. The new **Morteville Manor** goes even further and provides you with pull-down lists of words as well. You issue all your commands without touching the keyboard! Morteville Manor also breaks with the tradition of using text on the screen to respond to your input – instead they use speech synthesisers to let the characters in the story talk to you! I understand Infogramme's **Sidewalk** is likewise all Icon-driven. As I haven't yet played any of these games I can't really comment on how good they are. Time will show whether they are just gimmicks, or whether they will develop into whole new sub-genres of computer adventuring.

THE ADVENTURE OF THE BOOK

There are many other adventures on the market – the ST appears to be well catered for. But I would just like to mention one other company at the moment. That is Telarium. For a company with a wide range of adventures for a number of different machines, they seem to get very little publicity in this country. Their titles include **The Scoop** (Agatha Christie), **Perry Mason: The Case of the Mandarin Murder** (Erle Stanley Gardner), **Nine Princes in Amber** (Roger Zelazny), **Amazon** (Michael Crichton), **Dragonworld** (Preiss/Reaves), **Rendezvous with Rama** (Arthur C Clarke), and **Fahrenheit 451** (Ray Bradbury). But I don't recall seeing a review for any of these in any magazine! Telarium's President, C. David



Seuss, wanted more plot and character development and less 'guessing what word the parser is looking for'. He achieves the latter of these by the simple expedient of enclosing a vocabulary listing with the game, especially useful when in specialised situations such as cross-examining a witness in Perry Mason, or indulging in a sword fight in Nine Princes. To get more plot he collaborated with acknowledged authors (but you probably guessed that from the list!).

Some of the adventures are faithful simulations of existing stories (e.g. Nine Princes), other are specially commissioned sequels (e.g. Dragonworld). To be honest, it doesn't always work. I found Amazon particularly boring – in most cases you have to do just the right thing at just the right time then the plot sweeps along to another decision point. Fahrenheit 451 and Dragonworld are the closest to traditional adventures and well worth trying. I found Nine Princes in Amber especially interesting (I may be biased since I enjoyed all the books) in that you *can* play it just like the books but then you don't win. You have to deviate from the book plot in a number of places to achieve final victory, and there are lots of other endings to find as well – a very cleverly thought out game.

All the Telarium adventures feature a number of happy little tunes, and lots of pictures, small ones and big ones, with text and graphics split either horizontally or vertically to provide a bit of variety. I would recommend trying at least one of them just to experience a different approach to computer adventures. However, because of the way they tend to lead you through the plot they will not be everyone's cup of tea.

So, plenty of variety, with only one catch. The cost. Most of the adventures on the ST seem to cost between £20 and £30 and 60 odd adventures will cost you a lot of money! Buy the three packs, shop around, or hope you get them as presents!

Happy Adventuring!

by John Sweeney

With his last iota of manna (magical energy) Gothmog hurled a poison blast which destroyed the last of the skeletons. We turned and raced down the corridor looking for somewhere safe to rest. At last an open door appeared. We stepped through carefully and froze as we heard an ominous click underfoot. A doorway in the far right hand corner of the room opened slowly as we waited with bated breath to see what would step forth from the shadows. The door opened fully. Nothing happened. The room we had entered was quite small. An alcove straight ahead of us was inaccessible because of a deep pit which opened directly in front of us.

We stepped carefully to the right, avoiding the pit – another click! And with a rumble the doorway in the corner closed again. We examined the floor carefully but could see no more floor pads. Making our way to the door we looked through its bars and found that it led to a small room containing a key. Sonja immediately tried her usual subtle approach of attacking the door with her shield and battleaxe. Useless. Mophus cast his mightiest OPEN DOOR spell at it. All to no avail. Leyla experimented with the pads and found that she could easily open and close the door, but never in such a way that it was open when she was beside it. (Unfortunately the party have to stay in a tight group in one square so you can't leave someone by the door and use someone else to work the pads!)

Gothmog then spotted a lever on the wall by the door. As he pulled it there was a deep hum behind us and turning we discovered a blue haze in the air between us and the pit. He pushed and the haze disappeared, pulled and it reappeared. "Ah, well, nothing ventured ...", someone muttered as we stepped into the haze. ZAP! Where are we? Aha, in the alcove round the corner from the doorway! There was a click as we landed on yet another floor pad! Another rumble – the door was open again – but now we were stuck even further away – completely confined by the pit! Then Leyla found a small

WHERE CHAOS REIGNS

the world of ...

button on the wall. Press it and the pit closes! Quick, cross it back to the first pad – Click – Whoops – that one opens the pit as well as the door!

Hold on a minute! We still can't get the key – to get back to the doorway we either have to cross the second pad that closes the door, or enter the blue haze which sends us back to the alcove! A noise behind us – a fireball flies past and explodes against the wall, we whirl to find four Beholders bearing down on us, eyes blazing – back to the fight lads!

And so it goes on! You have enough information above to work out how to open the door. Can YOU solve it? This is only one of many excellent graphical puzzles which you will find in the depths of Chaos's Dungeon.

You get to choose four characters in Dungeon Master. Their most important characteristics appear as small bar charts at the top of the screen beside their hands. Down the right of the screen you can see their position in the party, the spell syllables they can utter and the contents of their right hands – these are replaced by submenus of available actions when selected, and directional indicators for moving the party around. The main part of the screen shows you the view ahead down the corridors of what your party can see. The graphics are excellent and show all the details of the dungeons – and I do mean ALL – you need to walk up to walls and examine them carefully to find hidden switches and buttons! One of the movement options is to walk sideways – this allows you to scan long walls!

The mouse is used to point to any area of the screen to request an action via the left button. The right button allows you to examine the inventory of each of your characters – this replaces the dungeon view and is also shown in superb graphic detail. Your character is shown as a number of boxes to

accommodate helmet, upper armour, lower armour, leg armour, boots, hand contents, quiver contents, pouch contents, backpack contents, etc.

When the mouse is positioned over the dungeon or inventory area it acts as a hand rather than a pointer. You can pick items off the dungeon floor, put



them in someone's hand or pack, throw them down the corridor, examine them by holding them to a character's eye, eat them or drink them, read them and so on. And all with the absolute minimum of mouse action.

Once you have got used to the system you begin to realise how well thought out it is. FTL have obviously gone to a lot of trouble to make a system that is easy to use and extremely efficient. This is a far cry from the multitude of games which have been written for non-GEM environments and then, when converted to the ST, have had some windows and mouse actions cobbled on to make them look good – they are usually a real pain to play. No, this game was obviously designed with a mouse in mind and is the best use of a mouse I have yet seen in this type of game. Casting spells by choosing from the spell-syllable submenus, choosing an attacker and a method of attack, passing potions between characters and drinking them, all of these have been designed to be easy and fast.

And, boy, do they need to be! This



game takes place in real time – none of the usual ‘He can do that and she can do that, no, maybe that’ and then start the fight and watch the computer play it out. The monsters march (or fly or crawl or ...) up to you and start attacking. You need to have weapons and spells ready and start selecting them immediately. You can give each of your characters one action then you must wait for them to recover – throwing a Shuriken is quite fast, doing a berserker with a battle axe takes longer – as soon as each character is recovered he or she can be given another action: loose an arrow, recite and cast another spell, change weapons, thrust with a sword, blast with a magic staff, the variations are endless.

You can also move the party during a fight, to dodge a blow or a spell, try and get round the back of the enemy for a sneaky attack, back off while you take a quick swig at a healing potion (keep an eye on all your characters’ statistics barcharts!), or just plain run away until you find a door you can close behind you!

So the fights are great, the puzzles are interesting (but not too hard!), the graphics are excellent, the interaction superlative – does it make a good game? Yes, they got that right as well. It starts off nice and easy – just pick up the mouse and start playing. The first level of the dungeon very carefully teaches you how to play by posing you very simple problems and fights so that you learn how to work the system and a bit about how Fantasy Role Playing all works. This aspect of it makes it especially good for newcomers to this type of game – try it and see how quickly you get hooked!

As you go deeper it gets nastier and nastier. There are over ten levels (I won’t spoil it by telling you EXACTLY how many!) to explore with new monsters on every level and plenty of variety between vast open spaces and long winding corridors, with the odd maze or puzzle room thrown in for good measure. Saving and Pausing can be done at any time (HURRAY!). You should always Save before going down a staircase – the new monsters

than the monsters – bows, clubs, rapiers, slings, axes, staves, and magical and named swords of all descriptions – deciding which to use is half the fun! Likewise there are lots and lots of magical artefacts and useful items.



There are also a number of artefacts which do not appear to have any direct use – certain necklaces and crowns for instance – let me know if you find out what they do (if anything!). There did appear to be one minor bug down deep – occasionally some of my characters would die immediately from a fireball which should have only reduced them from 400 hit points to 350! I’m not sure whether this is a bug, or intentional as an occasional direct hit on a vital organ, or whether it is some subtle interaction between my spells and my artefacts – anyone know? Save regularly! (Death does not have to be permanent – you can carry your colleagues bones to an appropriate place if you know how – but check your stats before and after – resurrection is not free – I prefer to Save!)

Examine everything you find, read all the scrolls (they are mainly for learning new spells but have other clues as well), keep getting all your characters to throw spells whenever they have spare mana (as they practice they get better and gain levels – you need every hit point you can get!), give all your characters a go at being at the back, using the Throwing Stars, Poison Darts, Slings, and Bows (again practice means levels (Ninja, in this case) which means hit points), and once you have cleared an area of monsters (albeit briefly – they do tend to keep coming!) make at least a rough map of the area – once you have found the next stairs down you should check for any large areas you haven’t reached – you may have missed a secret door.

Best fun I’ve had for ages. Why can’t they all be as good as this?

Explored by
John Sweeney

DUNGEONMASTER

The monsters are many and varied and all fully animated as they attack you, they will chase you and can be tricked into pits or smashed with closing doors – it really is quite a remarkable game.

And all of this happens just as fast as you can move the mouse. You do need to make sure you are comfortable – I got terrible arm ache the first time until I started using a mouse mat on my lap.

You never need to use the keyboard – but a few keys have been implemented. The first thing I found bad about the mouse was trying to use it and draw a map at the same time – not to worry – they have implemented the arrow keys on the keyboard for just that! The second problem I found was when picking up all my shuriken, daggers and arrows after a fight – redistributing them to the correct characters means just a few too many large mouse movements – they thought of that too! You can use your left hand on the F-keys to switch between your various inventories. To me this all smacks of a game which has been well designed and tested, and where there were inadequacies they have been fixed.

will probably kill you until you learn which weapons and spells will work against them – it is well designed in that respect – if you have successfully solved most of a level you will probably have enough armour and power to survive on the next level, but if you rush down stairs too quickly you will DIE! Contrariwise you do NOT have to completely solve any level – for example there are six keys on the second level (counting the Hall of Champions as Level Zero), but you only need four of them to progress – the other keys give you access to bonus areas. Once you have explored most of a level you can also find extra staircases to make movement back up the dungeon easier – you do need to go up and down occasionally!

Of course there are some puzzles which you DO have to solve – your objective is to find the Firestaff, but once you have that what should you do? Should you bring it out? Try and find Chaos somewhere down below and defeat him? Or should you follow up the rumours about a Power Gem? And what would you do if you found it?

The weaponry is even more varied

BEYOND

Infocom Activision
£29.95

John Sweeney discovers 'Interactive Fiction Plus' for the ST

Sometime around 500 BC Zeno of Elea proposed the following: "Before a body in motion can reach a given point, it must first traverse the half of the distance; before it can traverse the half, it must first traverse the quarter; and so on ad infinitum. Hence, for a body to pass from one point to another, it must traverse an infinite number of divisions. But an infinite distance cannot be traversed in a finite time. Consequently, the goal can never be reached!"

Sometime around 1988 AD Brian Moriarty of Infocom built a bridge based on this principle! The 'body' in this case is YOU, and the 'given point' which you are trying to reach is the other end of the bridge. Even worse, once you have reached the middle of the bridge you will find that the end you started from is now also an infinite number of steps away! You knew you shouldn't have entered the bridge when you read the sign at the entrance warning you that it was 'Zeno's Bridge'!

This is one of the many superb problems which face you at every turn in Beyond Zork, and whether you can spot the paradox or understand Eleatic Monism is less important than your ability to master the magical artefacts you will find scattered around the countryside.

The story so far: A young adventurer made a name for himself as a great collector of treasures and solver of problems. Eventually, after completing his exploration of the Great Underground Empire (Zork I), and escaping the strange domains of the Wizard of Frobozz (Zork II), he ended up as the Dungeon Master himself (Zork III). Meanwhile, on the other side of the Great Underground Ocean, a young magician found equal fame while becoming extremely adept in the use of magic, working his way from Enchanter (Zork IV) up to Sorcerer (Zork V). Round about this time we caught a glimpse of the past adventures of a young lad and a magic stone called the Wishbringer (Zork 0), with hints that this was perhaps the childhood of one of the two aforementioned sages? Then came the Ultimate Adventure – Spellbreaker (Zork VI). The Sorcerer, now master of his guild, is confronted by a terrible evil. His colleagues are transformed into Newts, Salamanders and other reptiles. Magic starts to fail, and in the final confrontation our hero is forced to destroy magic forever in order to save the world.

Hang about! Zorks always have magic. So, now that magic has been destroyed, how can there be another Zork? Simple: BEYOND ZORK actually takes place just BEFORE the end of Spellbreaker! The game opens with various newts and salamanders discussing how they can preserve some of their Magick. The fabled Coconut of Quendor, of which the Wishbringer was a mere seed, must be recovered and removed from this reality to "await the coming of a better age, an age beyond Magick, beyond Science ..." (Could this be a lead in to The Return of the Son of Beyond Zork Part II?)

Anyway, you, a lowly peasant, get chosen for the job.

Armed with but a single Zorkmid (the local coinage) you set off into strange lands to fight deadly monsters, collect mysterious artefacts, and solve some amazing puzzles.

Way back in Zork I you had to fight a Troll and a Thief. What they didn't tell you was that as you gathered treasures you gained experience and got stronger, healthier, and better at fighting. (Actually it DID tell you on the original Mainframe version – but the info got lost

during the conversion to the Micro – presumably you were supposed to deduce it from your general knowledge of D&D?) So while the Thief is impossible to beat at the beginning of the game, once you get near the end he is a pushover!

In Beyond Zork you get to know what is going on. You get 66 points to allocate to Endurance (Hit Points), Strength, Dexterity, Intelligence, Compassion and Luck. You start with Armour Class 1. All of these are measured on a scale of 1 to 99. Once you have chosen your attributes you find yourself alone at the top of a hill. You don't stay alone for long! As you wander the lands of Quendor you will encounter over a score of different 'monsters' most of which will attack on sight and are only interested in helping you to an early grave! Not to mention the numerous non-hostiles with whom you can while away the time in stimulating conversation.

When you first play the game you will find you spend most of your time fighting monsters, working out the lay of the land, collecting treasures, and trading with the various shopkeepers for enough armour, weaponry and magic to keep you alive on your next journey into the wilderness. Once you have succeeded at that you need to work out exactly what all the magical artefacts you have found are capable of doing for you – the land is littered with wands, potions and scrolls.

Here we find one of the differences between Beyond Zork and a 'standard text adventure': it is different every time you play! With the game you get a large colourful map of the area of Quendor which you need to explore. All the important places are shown on the map, but the areas in between them, like the jungle and the marsh are unmapped – they change every time you restart, as do the locations within them of the various puzzles, monsters, magic items and treasures. Once you have solved the problem of survival, your next major task is to work out how things change and how to identify your finds.

Your travel around the game and interaction with the local denizens is greatly enhanced by a number of new facilities. First, a map of your current location is shown in the top right of the screen. You can see where you are, plus all known exits, and the nearby locations. If you need more info you can ZOOM out to get a view of a wider area around you. Without this the varying areas might have been a little tedious! Secondly, you can move from location to location with the numeric keypad. Thirdly, you can define the F-Keys to be any commands that you wish, e.g. ATTACK MONSTER, PARRY,

WAIT, GET ALL. Lastly, you can specify what is to appear in the top left window, normally it shows your current location or your inventory, but you can request a display of your statistics in bar chart form so that you can follow them during a fight – some of the monsters don't just reduce your Hit Points! The use of these facilities gives the game almost an arcade feel (although there is no need for fast reflexes!).

The variety of monsters and the different ways in which they attack you makes these parts of the game great fun. However, after a little playing I was beginning to wonder if this was all there was to it! Never fear – the best is yet to come. Although you may have solved a few of the problems during your initial forays into the wilds, you will eventually come to a point where you have killed all the easy monsters, and explored all the easily accessible areas. Then you start asking yourself: Is there any way to reach the other side of Zeno's Bridge? Is it possible to defeat the Monkey-Grinder who dodges all my blows and magic with the greatest of ease? Is it possible to escape from the Cellar? Will I ever solve the Riddles? Is it possible to reach the Castle despite the sheer cliff walls below it? What ARE all the mysterious compasses and letters on the map for? Assuming I can defeat the Bloodworm and Crocodile, will I ever find a way of stealing the Jewel of Tears without being destroyed by the Idol? Will I ever make friends with the Unicorn or the Pterodactyl, or catch a Minx? Is it possible to get past the lightning into the Fields of Frotzen? Do I need to find a clever way to increase one of my statistics in order to solve some of these puzzles? Can I ever get past the Christmas Tree Monsters who are too numerous to fight?

Christmas Tree Monsters? Yes – from the Original Zork I Instruction Booklet, here at last are the legendary Christmas Tree Monsters, and I quote (from many years ago) "Trying the bizarre can be fun ... a nonsense example: GIVE THE CATERPILLAR TO THE CHRISTMAS-TREE MONSTER. – THE CHRISTMAS TREE MONSTER IS REVOLTED AT THE THOUGHT OF ADORNING ITS BRANCHES WITH A CATERPILLAR." Well now you can finally try it yourself – if only you could find a caterpillar!

The puzzles really are excellent and well up to Infocom's usual high standard – I was stuck for days on some of them – this is without doubt the best game they have produced in the last couple of years. Easy to play, fun to play, lots of humour and excitement, well packaged, well presented, in fact it really is great all

round. Without doubt Infocom have set new standards for 'text' adventures which the competition will find hard to equal.

But that is not all. Another really excellent feature of the game is the fact that many of the problems have multiple solutions! Once you have established a character and found a few artefacts you will find that there are no less than FOUR ways to leave the Cellar, and FIVE ways to get off Zeno's Bridge! Furthermore you don't actually have to 'fight' any monsters at all! Assuming that by 'fight' we mean go blow on blow against some creature with a conventional weapon, then over half the creatures can be defeated without fighting, and another half dozen can be taken out with a couple of your most powerful spells (unfortunately nearly all spells are limited use only!). This leaves a few simple monsters which can be avoided!

Some of the monsters can only be defeated by using logic or magic correctly; with many others you have the option, IF you can find it. I got lots of extra fun after I had finished the game by searching for alternative solutions – it was only then that I finally discovered that you CAN get out of the Cellar right at the beginning of the game!

Although you can play a long way into this game without too much thought, be warned – it ain't easy to finish it! There are traps everywhere which can lead you down blind alleys. If you are stuck then you should restart and not do ANYTHING which is not necessary. There are many actions which seem right but put you in a position where the game is unwinnable; there are a number of sequences where you only get one try – if you didn't get it right you need to go back! This game is MEAN! Make sure you identify EVERYTHING you find or buy – take nothing for granted! And study the Lore and Legends of Quendor

ZORK

carefully – it is full of clues!

One brief grumble – why are there so many items described in the text, and for which it does recognise the words, but which it will not let you examine? Especially the horse which you can refer to while it is alive, but once it is dead and in your way is 'not here'! Not like Infocom at all. A minor flaw in an otherwise perfect game.

Your final recovery of the Coconut of Quendor would appear to coincide fairly closely with the end of Spellbreaker, so is this the end of Zork as we know it? The last thing you hear is "Better take a nap – you're going to need it", so somehow I think that it won't be all that long before we find out what lies "beyond Magick, beyond Science" and beyond Zork...

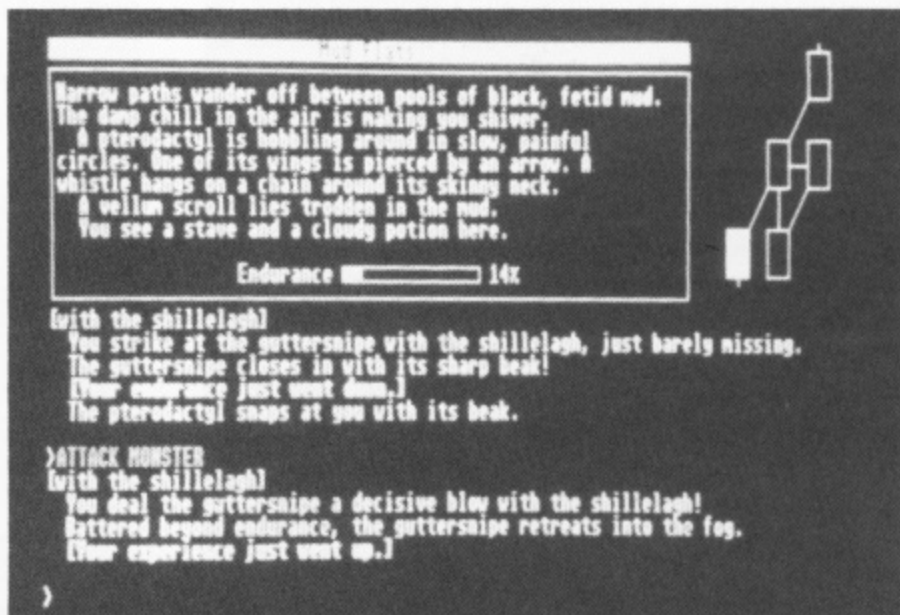

PROTEXT and POWER BASIC

Two highly recommended programs

Coming in the next issue are full reviews of two fine programs that are so highly recommended that I must give you an advance write-up just in case you have that urge to go out and buy some quality software for the summer.

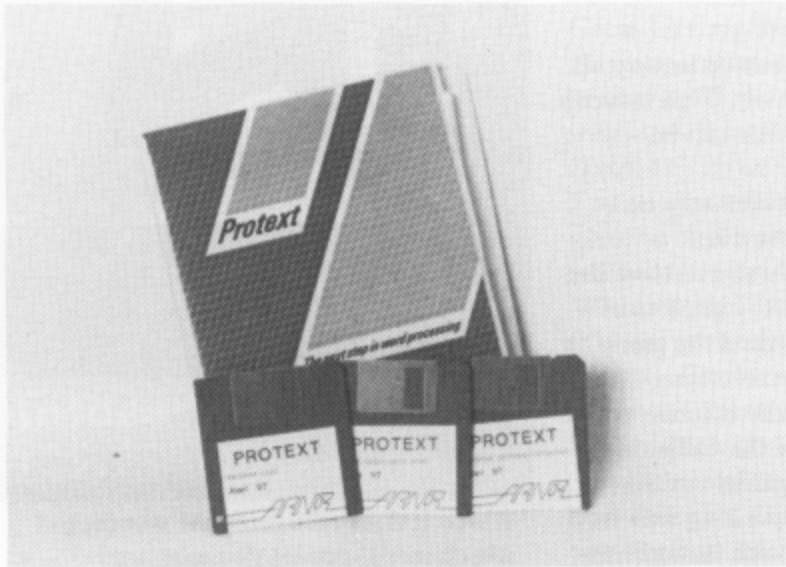

Regular readers will know that I have bemoaned the lack of a decent word processor on the ST for some time but here at last is one that seems to fit most of what I consider essential in a word processor. It still can't do that elusive 'true ASCII' save but in almost every other respect it comes up to scratch and has finally persuaded me that the ST can be used for word processing after all!

Protex does not get encumbered with GEM and is thus much faster than most other word processors. It was developed originally for the Amstrad and this 'business' background shows through clearly, it is an extremely practical easy to use tool free of gimmicks. A true word processor that allows you to get on with the job and do it well. Protex uses two modes of operation - Edit mode, where all the expected word processor facilities are provided and Command mode, in which several unique features are present. The program has an integral spell checker which can operate either on a document being worked on or a saved document and which, at last, contains true English spellings and such useful items as English county names. There are supremely easy to use keyboard macros which may be defined as you see fit, various program configurations which may be called at will, several printer drivers with the ability to easily create your own, sophisticated mail merge and much more. The features are well thought out and practical and it is the type of program that has made the Amstrad much more of a success to business users than the ST. Protex is a program that is simple enough for the every day user yet powerful enough for those whose requirements are much more demanding. As I say the only thing missing is that ASCII save but then if you have POWER BASIC you could quite simply write your own conversion program!

A mini review

by Les Ellingham

The ST has proved to be much more difficult to program than most 8-bit users expected and in my opinion there has yet to be a language that is as easy to use as Atari Basic, but Hi-Soft's Power Basic could be just what all us 8-bit users have been waiting for.

Like a great many owners I shied off programming on the ST for a long while because I simply did not have the time to learn another language or come to grips with Fast Basic or GFA. I had almost given up when Hi-Soft's Power Basic arrived for review. It looked interesting. An editor similar to the familiar Atari BASIC editor (very little GEM encumbrance), use of line numbers or not, as you wish, the ability to run the program without compiling, to insert breaks, stops etc. to test sections of code and when it is all working to simply compile it all to a runnable .PRG file without ever leaving the editor! I sat down with the manual and started to write a program to convert STWRITER files to ASCII, something that I feared I would never do. I wrote in virtually the same way as I would in Atari Basic, or more closely Turbo Basic, and after a couple of problems in understanding string manipulations, had a program that I could run from the desktop within about half an hour! My first ST program and it was relatively easy. I couldn't believe it!

I am sure that most users familiar with Atari Basic will find Power Basic to be very easy to use at its primary level and, with a good book on GEM, should have little problem in producing all those windows and dialog boxes. The program has built in libraries to access all of the features of GEM and contains several example programs and tutorials to help you along

It looks as if this could be the BASIC all the 8-biters have been waiting for and the price is great - just £39.95! Check next issue for the review but if you can't wait I can recommend it anyway. If I can write my first ST program in half an hour, so can you!

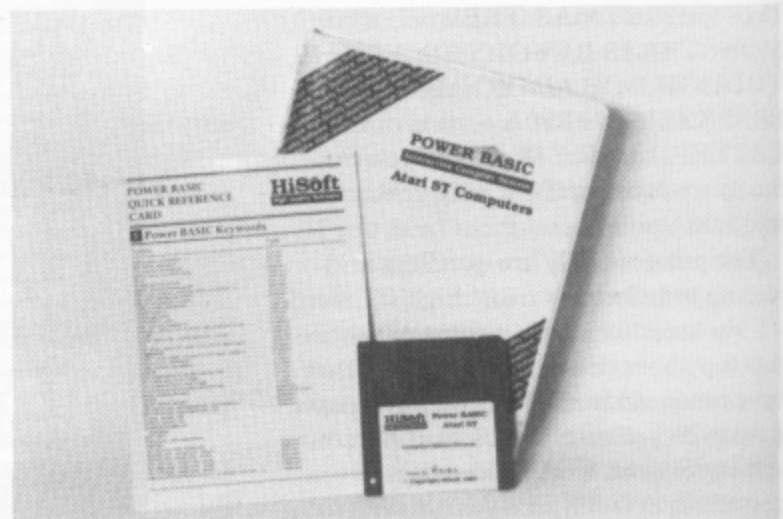



THE LEADING NORTH WEST
SPECIALIST ATARI DEALER



**LADBROKE
COMPUTING
INTERNATIONAL**

33 Ormskirk Road,
Preston, Lancs., PR1 2QP.
Tel: (0772) 21474 (1 line)
(0772) 203166 (5 lines)
Bul/Board (0772) 27236
6.00pm to 9.00pm

DEALER
ENQUIRIES
WELCOME

HARD DISKS

Atari	20mg	£575
Supra	20mg	£575
Triangle	20mg	£499
Triangle	40mg	£699

PRINTERS

9 Pin D/M

Star LC10	£225
Star LC10 Colour	£275
Citizen LP10	£199

24 Pin D/M

NEC 2200	£375
Epson LQ500	£375
Star LC10/24	Phone
Epson LQ800	Phone

Daisy Wheels

Gachen	£199
--------	------

Laser Printers

Atari SLM804 Laser	£1350
Star Laser	£2399

The Star Laser Price Includes

12 months On Site Warranty

The Atari Includes 90 day

Warranty

All Printers Come Complete

With Cables ETC.

Interfaces Are Seperate

UPGRADES

Upgrades are available from stock. 2.5 and 4 Mg upgrade boards are available to fit the old 520 STFM boards only.

Upgrade boards	£135
Boards + 2.5 Mg	phone
Boards + 4 Mg	phone
1 Mg STM (fitted)	£105
1 Mg STFM (kit)	£90

STFM Upgrade fitting service.

£15

If any of the above Upgrades are purchased with Hardware then deduct £5 from total.

Prices will be held as long as possible.

Our Atari trained engineers will repair all hardware in minimum time at competitive rates.

PERIPHERALS

Triangle 1Mg drive	£119
Cumana 1Mg drive	£109
Pro Draw Graphics Tablet	phone
Image Scanner	£89
Hawk Scanner	£1250
CRP Digi Tablets	
A4	£414
A3	£818

ATARI HARDWARE

520 STM's Phone for availability.

520 STFM's Summer Pack

520 STFM + 1Mg internal drive+joystick +over £400 of latest release software for only £399.

1040 STF's £480

While stocks last.

External Modulators for the 1040 STF's £54.99

SM124 mono monitor £139

SC1224 colour £375

Philips 8883 colour monitor £299

Tv's and others phone

Any of above bought with a computer Deduct £10.

BUSINESS SYSTEMS

MEGA ST 2

2048K CPU+3.5" Floppy Drive+SM124 Mono Monitor.£1034.99

MEGA ST 4

4096k CPU+3.5" Floppy Drive+SM 124 Mono Monitor.£1379.99

DTP SYSTEM 1

Mega ST 2
SLM 804 Laser Printer
Additional 3.5" Floppy Drive.
SM 124 Mono Monitor.
DTP Software.£2874.99

DTP SYSTEM 2

Mega ST 4.
SLM 804 Laser Printer.
SH205 20Mg Hard Drive.
SM124 Mono Monitor.
DTP Software.£3449.99

PC2 SD

512k CPU+5.25 Floppy Drive+PCM 124 Mono Monitor.£689.99

PC2 DD.

512k CPU+2x5.25 Floppy Drive+PCM 124 Mono Monitor.£747.49

PC2 HD

512k CPU+5.25 Floppy Drive+30Mg Hard Drive+PCM 124 Mono Monitor.£1092.49

DUST COVERS

Computers	£3.99
Monitors	£4.99
Disk Drives	£2.99
Hard Disks	£4.99
Printers	£7.99

DISKS

3.5 D/S	5.25 D/S	
D/D	D/D	
	96TPI	
Each	£1.50	£0.70
x10	£14	£6.50
x10 + Plastic Lib. case	£15.50	£8.00
x100 + cases	£140	£70
x500 + cases	£650	£330

All Disks are Top Quality SONY products and are covered by an unconditional lifetime guarantee.

We also stock High Quality VHS Video tapes.

Each	£2.99
For 2	£5.80
For 4	£11.40
For 10	£26.00

We also stock a full range of quality P/D ST Software at £3.99 per Disk.

Send S.A.E for catalogue.

MUSIC

We stock Music Software and Hardware for the ST including a range of AKAI samplers and synths. Suitable for Hobbyist and Professional applications.

UTILITIES

AB ANIMATOR £14.99

Animated Graphics Tool for the ST.
Supports GFA and FAST Basics.

Compatible with DEGAS and NEOCHROME files. Full Facilities such as Draw, Fill, Grid Copy etc Includes FREE basic routines and demo progs.

PICSTRIP £6.99

Full screen picture manipulator.
Supports GFA, FAST and ST BASICs.

Compatible with DEGAS, NEOCHROME and AB ANIMATOR.

Grab all or part of a picture in all resolutions.

QUICK LIST PLUS & MASTERMAT £6.99

Directory Database Compiler with customised format and copy protect prog on same disk.

EDUCATIONAL SPELL AND ADD WITH OSCAR £12.99 EACH

Spell teaches keyboard skills, spelling and motor coordination while Add teaches addition, subtraction, multiplication, and division.

TO ORDER Simply send, or phone your order, stating full name, address, VISA or ACCESS No's, Cheque or Money Order.

Make payable to :
LADBROKE COMPUTING INTERNATIONAL.
SEND SAE FOR FULL CATALOGUE.

Our mail order dept. gives the same excellent service to our customers as our premises at the above address has done for the past 8 years. All Software/Hardware has been tested prior to delivery thus ensuring that customers receive working items and the frustration of returning faulty goods is now a thing of the past. This kind of quality service does cost a little more but in the long run it is far cheaper. All prices fully inclusive of VAT, Delivery, there are NO hidden extras. WYSIWYG. For next day delivery add £3. Prices correct at time of going to press.

Sierra started with text adventures way back in 1979. They very soon started pioneering work with graphics which culminated in 1984 with their first 3-D Animated Adventure Game: *King's Quest*. Since then their graphics have gone from strength to strength and their forthcoming *King's Quest IV (The Perils of Rosella)* is supposed to be even better!

In all Sierra's games the graphics really are integral to the game. You have to use the cursor keys or mouse to manoeuvre your character around the screen in order to solve certain puzzles and reach certain places, as well as entering text commands in the normal way through the keyboard. Many of the puzzles are visual, requiring you to find routes around obstacles in the pictures. In all the games you should walk around the whole of any new screen and look at everything. The command LOOK (ROOM or OBJECT) can give different results depending on where you are standing!

The pictures and animation are excellent, but do unfortunately take about twenty seconds each to load. This is not a problem when you first reach a new screen, since there is usually lots to do on each screen, and the responses to your commands are always instantaneous. Waiting for all the intervening pictures to be loaded can, however, be a little tedious if you wish to cross a number of rooms quickly, especially when replaying a part of the game which you have solved. This delay is a limitation of the current technology and you just have to accept it if you wish to play this kind of game – SAVE frequently!

Sierra have obviously put a lot of effort into improving their graphics and animation over the years. Unfortunately they have not been quite so progressive with their input parser. Most of the time it is barely able to cope with VERB NOUN, confuses you by understanding a command in one room but claiming not to understand it in the next, and then amazes you by requiring you to type in a command like HIT THE BALL AT THE WALL WITH THE BAT (TWO prepositional phrases!) which you didn't expect it to understand. Its vocabulary is also extremely limited, which results in spending a certain amount of time in trying to guess exactly which phrase it wants next. You should always make notes if anyone tells you to do something – when you want to do it you probably have to enter EXACTLY what you were told!

Most of the games contain a game within a game: Space

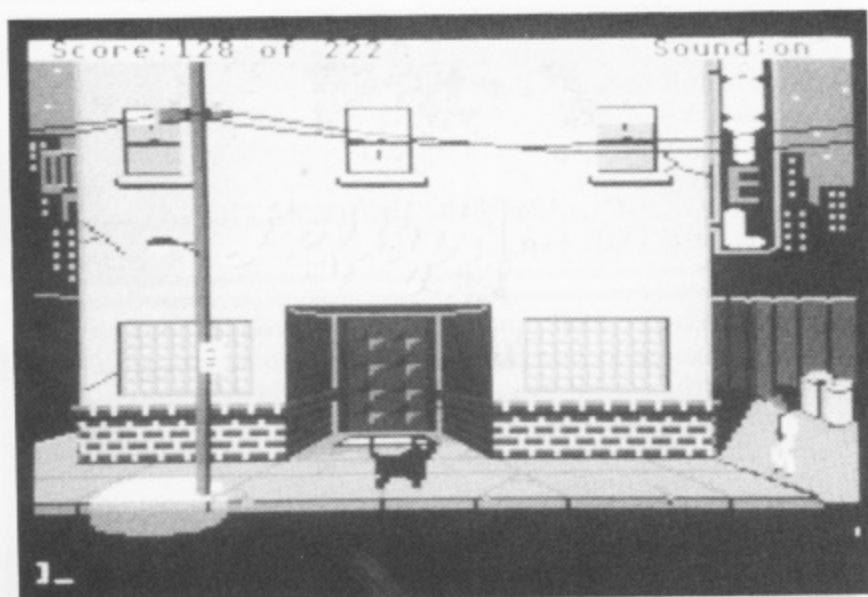

Sierra's

QUEST

3-D ANIMATED ADVENTURES

Quest I has a slot machine, Leisure Suit Larry has blackjack, Police Quest has draw poker. I found the slot machine a little tedious, especially since three skulls activates a death ray (yes, the animated sequence showing the cleaning robot collecting your remains and tipping them out of the back window is rather nice, but is it sensible to have an adventure where you HAVE to SAVE so many times to win?), and the blackjack wasn't a lot better. In both cases you HAVE to play them extensively since you need lots and lots of money.

All the Sierra games are very much stories that you have to live through, which does tend to make them a little sequential and you often have only one problem to solve at a time. If you solve it then the story moves on and you get a new problem. On the other hand they do often have multiple solutions. You don't always spot them when playing through because you only actually need to find one way, but if you compare your solution with someone else's you may be surprised at how much variation there is. When I compared my solution of Space Quest I to the one in ST NEWS (an excellent Public Domain Newsletter on a disk) I found they had solved three of the puzzles in a completely different way. The scoring is highly variable as well – I finished Police Quest with 191 out of 245 – this obviously gives plenty of scope for replaying, trying to find alternative (higher-scoring?) solutions or how to get those last few points. My only real criticism of the games is that there is far too much of the 'Bang, You're Dead' Syndrome – yes, the graphics and text which accompany your many forms of death are excellent, but I get awfully bored doing RESTORE – SAVEs frequently!!!

In the preceding paragraphs I have mentioned a few of the negative points of Sierra's games. As long as you can stand those limitations, then all the games are well worth playing. Apart from being entertaining as adventures, they are all full of humour – it is always worth trying stupid things, occasionally they may actually be useful, but very often you will get a joke or sarcastic comment from the game.

If you like adventures and haven't tried a Sierra one yet, then you are missing out on quite an experience – you should definitely try at least one of them.

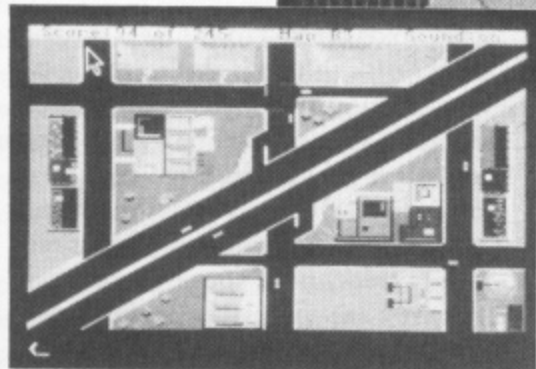
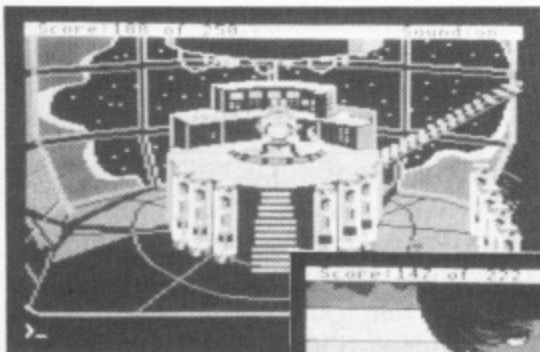

SPACE QUEST & SPACE QUEST II

You are a humble janitor caught up in a Science Fiction Adventure. In Space Quest I your problems include escaping from a doomed spaceship, surviving in a deadly alien desert, making enough money to get off the planet, and chasing and defeating the space pirates who stole the super-secret Star Generator. I must admit I got stuck a couple of times, so thanks to ST NEWS for the hints. In Space Quest II you are abducted by Vohaul (apparently he was behind the plan to use the Star Generator to take over the universe) who wants his revenge. He also wants you out of the way so that you can't foil his new plan which is to flood the universe with hordes of pushy Insurance Salesmen – ARRRRGH! Needless to say, you are faced with countless deadly traps: man-eating plants, hunter's snares, acid pools, dark mazes of tunnels – and finally Sludge Vohaul himself. The traps and the humour are great!

I don't think they've quite equalled King's Quest III with Space Quest, but both games are well worth playing.

POLICE QUEST

This is billed as containing Adult Subject Matter – Parental Guidance suggested. There is quite a bit of violence, a little bad language, quite a few innuendos, and the subject matter does deal with the seamier side of life.

Basically it is like living through an episode of Hill Street Blues – complete with subplots and corny American jokes. You must patrol the city, handling routine cases and gathering information, until you are promoted to Narcotics and follow the deadly (I seem to have used that word quite a lot in this review! – but it definitely fits!) trail to the final shoot-out with the head of the drugs racket – the Death Angel!

There are two modes, the normal one for moving around buildings and other locations, and an overhead view of the city streets for when you are driving one of your cars. Apart from learning how to manoeuvre and where all the interesting places are, you also get involved in car chases to catch traffic violators, drunken drivers and stolen cars. (The only shame is that they made it too easy to crash – SAVE regularly!)

The packaging of all the Sierra games is excellent, but they

really went to town on this one. You get a Map of the City, a Reference Card for the Function Keys which control your car, your weapons, and your radio, a Reference Card to teach you how to play Five Card Draw Poker (and you DO need to learn how to win!) and a Policeman's Indoctrination Guide which not only details the correct procedures (which you MUST follow) for such things as Felony Arrests but also explains what all the codes are that you hear on your radio (so you can work out what "11-98 at Carol's" means!).

Police Quest is extremely sequential – as you complete each task you get told what to do next, you have no choice but to follow the story line, and there are not really all that many puzzles to solve – if you make notes about all you hear and see, understand all the documentation, and do what you are told, then there did not seem to me to be very much scope for actually solving problems. But it is good fun to play and is well worth looking at.

LEISURE SUIT LARRY

The first thing you should be warned of is that this one is *definitely* Adults Only! Apart from anything else, unless you can answer five questions at the beginning of the game to prove you are an adult it won't let you play! Unfortunately, unless you happen to be an AMERICAN adult there is a very high probability that you won't be able to answer the questions! I was fortunate to have been given a printout of most of the answers – I have sent it to the Editor in the hope that he can include it on one of the PAGE 6 public domain disks.

The second thing that old Atari users should be warned of is that this is an EXACT copy of the old game Soft Porn Adventure. Of course that was Text only, so you do get excellent graphics and lots of visual jokes, but you DON'T get any new puzzles. I really do think it was a bit immoral of Sierra not to mention that fact on the box – it's a bit of a rip off if you were expecting something new.

The objective in this game is not to collect treasures or save the universe – it is simply to find as many women as possible and .. uh.. well, you can guess the rest! The graphics include close ups of the various ladies whom you encounter – complete with animated smiles and winks.

Although the subject matter is undoubtedly dubious, the stress is on the word SOFT. There is little to offend an adult – and there is lots of humour throughout the game. Definitely good fun to play.

Review by John Sweeney

SPACE QUEST:
Chapter I – The Sarien Encounter £24.99
SPACE QUEST II:
Chapter II – Vohaul's Revenge £24.99
POLICE QUEST:
In Pursuit of the Death Angel £24.99
LEISURE SUIT LARRY
IN THE LAND OF THE LOUNGE LIZARDS
£19.99

OIDS Mirrorsoft £19.95

*Reviewed by
John Davison jnr*

Your job, in this latest release from Mirrorsoft, is to free the race of android slaves, known as OIDS, from their evil overlords the Biocretes. You must pilot your V-wing fighter through the passages of the Biocrete planetoids finding OIDS to pick up, and shooting Biocrete installations with your Novabombs and Nuclear Pellet Gun.

The best way to describe this game is that it is a cross between Lunar Lander, Choplifter and Asteroids. The basic controls are very similar to Lunar Lander, giving you left and right rotation and thrust. There is also gravity acting on your ship which influences its movement. The Choplifter element is the actual rescuing of the OIDS. First you must

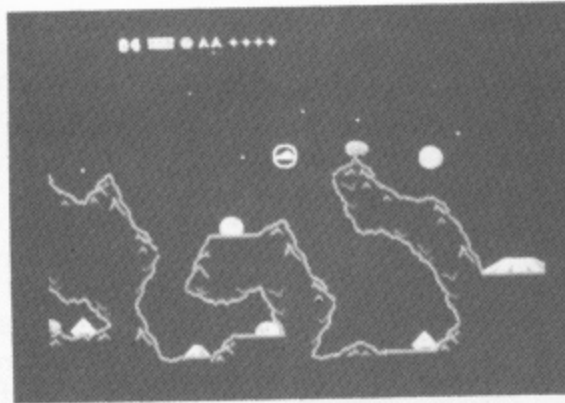

shoot open a Biocrete factory, land on the nearest available flat surface and wait for the OIDS to run to your ship and get on board. OIDS reminds me of Asteroids in just its 'feel'. The way your ship looks, moves and shoots is very similar to the old classic.

The game's graphics are particularly impressive, from the excellent loading screen to the tiny OIDS running around on the surface of the planetoids. When you see the game for the first time you will not think that the graphics are that good, however, once you have played the game for a while you will begin to appreciate the clever little touches which make it just that

little bit more interesting than your average game. My only complaint about it is the way in which the screen scrolls. At first it seems to be quite smooth, but very soon you begin to realise that it slightly but perceptibly 'shudders'. The sound is not particularly impressive, the bare minimum of sound effects are present, but they are quite adequate and suit the game very well.

As well as several different planetoids for you to explore (supplied on the disk), there is also a game construction kit which allows you to build up your own mountainous terrain and place the various buildings and hindrances wherever you want them using simple cut and paste operations. These creations of your own can then be saved out and played in the same way as the supplied levels.

Overall, OIDS is a really excellent game which is extremely playable and highly addictive. The graphics are superb and a lot of thought has gone into making OIDS as interesting as possible. It is definitely worth the very reasonable price of £19.95.

JUMP JET Anco £14.95

*Reviewed by
John S Davison*

Jump Jet was originally an 8-bit program, and was so awful it was irreverently known as 'Junk Jet', however this rework for the ST is much better. Basically, it's a flight/combat simulator based on the Sea Harrier. You have to learn how to fly it, then defend the aircraft carrier on which you are based from enemy air attack. Primary flight controls are via mouse only, a pet hate of mine as there is no natural 'central' position, making accurate flying more difficult. All other controls are available through the keyboard or mouse buttons.

Five difficulty levels are available, the first being for learning to fly the aircraft in calm weather and sea conditions, and without the hassle of enemy attack. Higher levels give progressively worsening conditions resulting in your aircraft being tossed around by air turbulence. You also

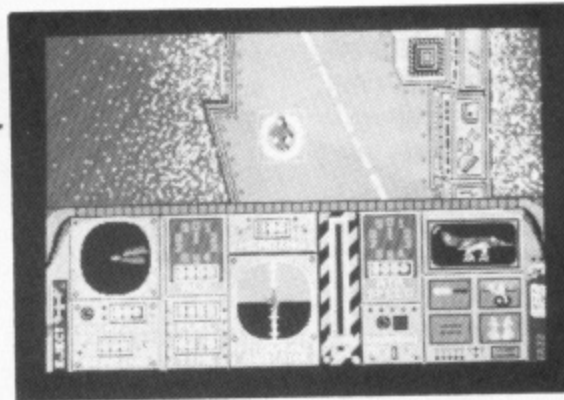

have to be more accurate in your flying procedures, and there are more enemy aircraft to dispose of.

The program displays the usual flight simulator split screen, with the instrument panel in the lower half. The top half shows three different views depending on which phase of the flight you are in. It starts with a plan view of the carrier's deck, showing the Harrier sitting on its landing pad. After takeoff, at an altitude of 50ft, this view changes to show a split side/rear view of the carrier, showing the Harrier's position relative to its pad. Once above 200ft the view changes again to the more usual through-the-windscreen view. The reverse sequence occurs on landing.

Instruments include the usual airspeed, altitude, pitch, roll, heading

and fuel indicators plus a few specialised ones showing position of vectored thrust, flaps and undercarriage, amongst others. You also have a radar screen showing the location of your carrier and incoming enemy aircraft, and this has a realistic looking rotating beam and slowly fading 'blips' just like the real thing. It's important as it's used to guide you within visual range of the enemy, and back to your carrier after combat.

After locating the incoming enemy aircraft you then have to bring him down with a missile or cannonfire. Meanwhile, he's trying to do much the same thing to you, but it's possible to avoid his missiles by dropping chaff to fool his radar. If he gets past you then he'll sink your carrier and the game is over.

Having disposed of all enemy aircraft you have to get back to the carrier and land successfully. This is probably the hardest task of all as positioning over the landing pad is very critical, and the situation isn't helped by having that mouse control.

Overall, Jump Jet emerges as a fairly run-of-the-mill flight/combat simulator, although at the price it is reasonable value and doesn't have much competition.

LEATHERNECK Microdeal £19.95

*Reviewed by
Damon Howarth*

This is one of those upward scrolling commando-style games that contains more than at first may be thought. It has an attractive loading screen showing a selection of Rambo clones with appropriate bullet holes across the screen and has plenty of stirring music to accompany the whirring of the disk drive.

The package seems to be like most other games of the genre until the fact is noticed that up to 4 people may participate in the mayhem at once – that is, providing the optional interface is fitted. Even so the two player mode presents an interesting challenge and offers a chance for teamwork not seen since the inception of Gauntlet. I was impressed by the responsiveness and speed of action even with a screenful of action occurring. The game has an internal control so that those characters

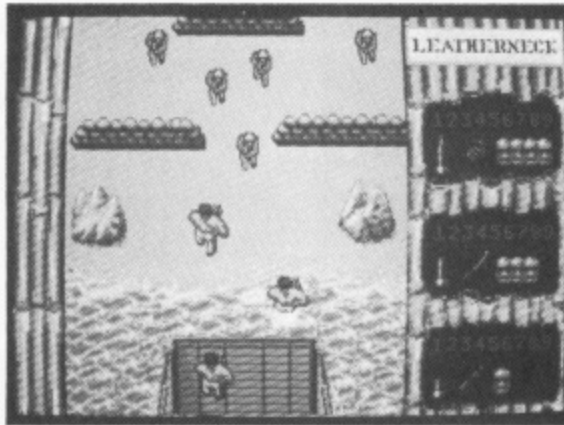

without direct control are killed off in the initial volley from the bad guys. At least that is what was meant to happen, except my copy would not kill man number three, which left me the problem of a character who would not move except by careful pushing by his companions! I later solved this problem by shooting him myself (and gaining several bonus points for such comradely behaviour!!).

The tactics involved in this game include the adequate placing of team members to ensure accurate and enemy-destroying fire and the choice of the correct weapon for the correct job – that is L.M.G. or S.M.G. or the terribly effective grenades. With the weapon's choice goes the thought that

ammo boxes reload everything equally so that there is a great deal to be gained from the thoughtful use of armaments. Since the game has the team option it was gratifying to see that the four soldiers had been individualised so as to aid easy recognition. The sprites are muscular, chunky and of good definition – even the enemy look fearsome. There is enough scenery to hide behind if the going gets tough, although slowing down loses a great deal of initiative.

This game also introduced me to a new idea in loading techniques in so far as the game would appear to be installed onto a permanent RAM disk which survives a soft reset. I am not sure if this is entirely a state of affairs I approve of since it can be a little disconcerting to discover that your next disk on is the same as the last game played and I am sure I remember some warnings from Atari themselves about excessive use of the main switch for hard re-sets. It was also unfortunate that towards the end of the review the game consistently refused to load, leaving just the blank screen in front of me. If these are bugs in the program then Microdeal may have noticed and corrected them, otherwise beware!

KNIGHTMARE Activision £19.95

*Reviewed by
Damon Howarth*

This arcade adventure game is based on the children's TV programme of the same name. The series sets teams of young teenagers against the riddles and problems of Treguard's castle and provides a forum for exceptional computer effects and some good riddles. The linchpin of this is of course Treguard who acts as a sort of occult Leslie Crowther.

Bearing this setting in mind I looked forward to attempting the dread castle in game form. It would appear to be a straight 8 bit conversion and as such all the graphics seem to be somewhat blocky. Owing to the relative speed of its loading there is no loading graphic and so the user starts with a closed book facing him. The pages turn to reveal credits and subsequently the rooms of the dungeon.



The instruction manual contains some possibly helpful poetry and a gamut of incorrect instructions, a glaring example being the how to load the disk section with an autoboot disk! This disregard of machine specifics carries over into the game controls and any new user would be well advised to use the space bar rather than the shift keys specified to obtain access to the limited vocabulary in the game. The control method is cumbersome and involves the selecting of a keyword from a menu and then a second word from a subsequent menu. These combine to form an order to the figure you control which quite often is confirmed as meaningless. Movement is by cursor keys or joystick and some

help is obtainable from the two oracles, one of whom lies whilst the other tells the truth both in riddling ways. As this game is meant to be a graphic-based game I felt it fair to judge some of its merits on this. The action takes place on a perspective background with a reasonable quality of large sprite and some extremely ordinary representations of Treguard and the oracles. I did not feel that this was a strong point of the game.

My actual playing experience with this led me to great frustration, I could find no way to unlock the second door to continue my quest. I tried every combination of words including helping or hindering all that I came across and manipulating every object I found. The end result was always the same and I died repeatedly in the first two rooms. This I find worrying since the puzzle bears no resemblance to the program and would seem to present a challenge of unrealistically difficult level for the audience it is intended for.

My advice on this one would be a very long look at exactly what you are getting and do try and find some help with the initial problem.

NORTHSTAR Gremlin Graphics £19.95

*Reviewed by
Damon Howarth*

Northstar is a highly classified operation taking place in Earth's 25th Century, it creates food for the population but now it has been taken over by interplanetary meanies and, as a cyborg, it is your job to save the universe. Such is the setting for this 'arcventure' reminiscent of so many of the type. It seems to be a basic platform and ladders game with a cyborg hunting extra weapons to destroy creatures that look like offcasts from Darth Vader's space troopers.

The loading screen is brash in colour and betrays the 8 bit Spectrum origins of the game, the controls are simple (which is something I found a change from many modern day games) and the style transported me back to several years ago when I was just starting to discover computer games. So it was

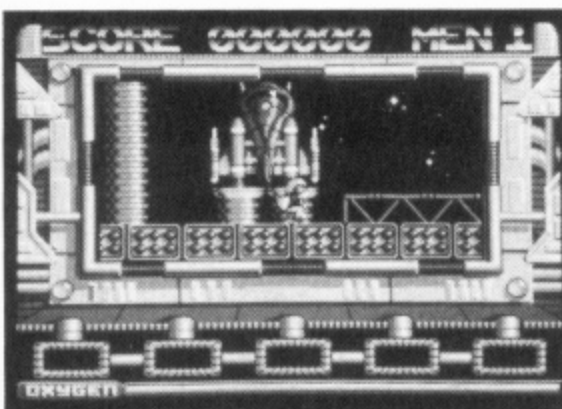

that I entered the game with drastic pre-conceptions. The music however was enjoyable and the spot effects were well placed and judged. The sprites were quite pretty in an inter-galactic sort of a way. The game was colourful and eye-catching and the aliens were fast and vicious. It soon became apparent that the game had a great deal going for it and my pre-conceptions vanished in a hail of laser fire.

It appeared that the most important things for me to acquire were the little blue balloons which contained a variety of useful bonus items. The figures of the protagonists were of a cartoon like quality which lent the game an air of humour. If a level is cleared then the hero is taken down to the next by lift to

meet further terrors. By this time I found most of his four lives were depleted and so new urgency would spur him on.

One of the main difficulties in the game was the fact that the aliens appeared very quickly from places unknown and owing to the amount of leaping that the cyborg needs to do they can be landed on with disastrous results which could be most frustrating. Nevertheless there was always the feeling that the last score could be bettered and that a little more of the map could be explored. Indeed this often proved the case and thus the addictive quality of the game became quite strong.

I find it difficult to sum this game up. Personally I found it very enjoyable. Perhaps this was just due to the fact that it felt like a game from an earlier era, because the game does not stretch the ST to any limits and does not contain any of the frills and techno-wonder that the big name games hold, but it provided a challenge in simple playing limits and held interest for a long period of time. If you happen to be yearning for the old time 8 bit fun-style game then this is for you.

CASINO ROULETTE CDS Software £19.99

*Reviewed by
John S Davison*

If you'd like a flutter at the roulette table, but don't want to risk your hard earned cash, then this program could be just what you need. CDS claim it's a complete simulation of the internationally accepted French style table, so using it should be just like playing the wheel in any big casino.

Up to eight people can play, two of whom can be computer driven participants. Human players are free to use any betting method they choose, but the two computer players use six well-known 'systems' described in the instruction booklet. Judging by their performance these systems are by no means foolproof!

The program is mouse driven, with menu items available to start, save, and load a game; select next person to bet; spin the wheel; clear the table ready for

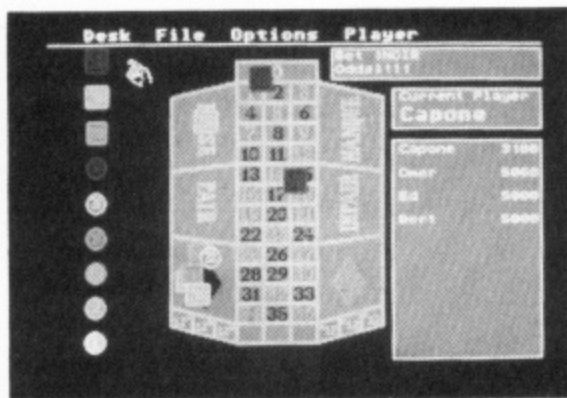

the next round of betting; turn speech on and off and to display various sets of statistics on wheel and player performance. This can be useful for assessing the effects of that new 'can't fail' system you've dreamed up!

The main playing screen shows the table on which your bets are placed; a set of nine chips with values from £1 to £500; and a list of players' names together with their cash balances.

Bets are placed by dragging chips of the required value to the appropriate place on the table. The only trouble with this is that everyone uses the same coloured chips, so when a group of you play it's easy to lose track of which ones are yours. Bets may be any of fifteen types allowed in the French system, covering the range from single numbers

(giving odds of 35 to 1), through various combinations of blocks of numbers down to betting on red or black (paying only even money if you win). As you place your bet, its type and odds are displayed on the screen, and your cash balance reduces correspondingly.

With all bets placed, a click on the Spin Wheel menu item causes a full screen animated picture of a spinning roulette wheel to be displayed, complete with the ball running round its outer section. Surprisingly, the wheel doesn't actually have any numbers marked on it, the winning number being shown when the view switches back to the table a few moments later. At that point the players' cash balances are updated with their winnings (if any!). There's no other indication of who's won what - unlike in a real casino where a winner gets a handful of chips thrown at him by the croupier!

Despite the niggles mentioned above, Casino Roulette works well and is fun to play. If you feel the urge to try your hand at roulette, buy this program first - it'll probably cost you a lot less than playing for real!

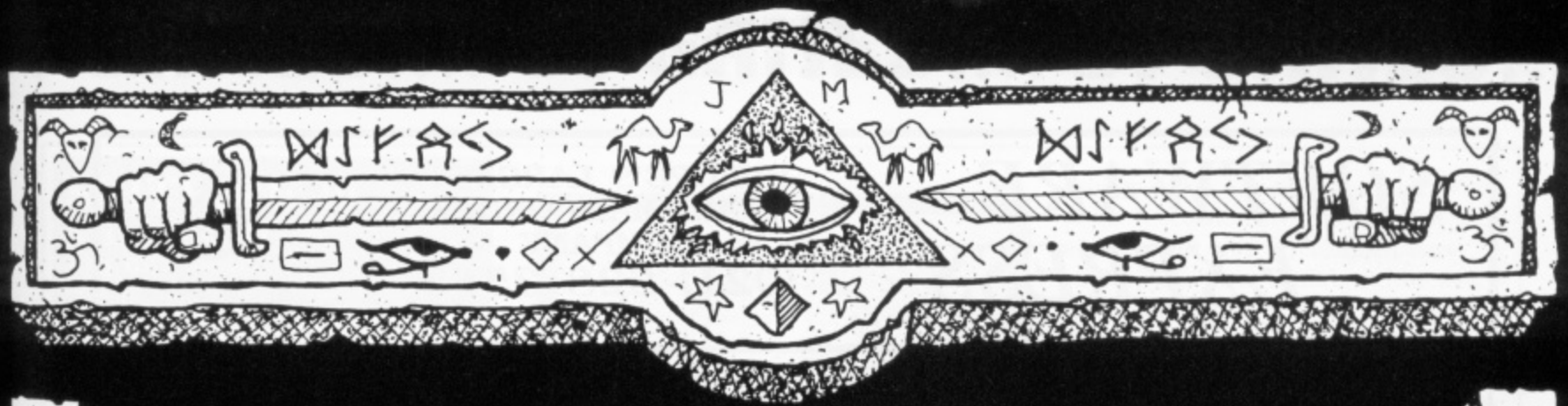

TRIP-A-TRON, A LIGHT SYNTHESISER

IMAGINE that your *ST* is an instrument, a musical instrument which you can play like a piano, producing at will flowing light and iridescent colour instead of sound.

IMAGINE too that you match this display to any music you choose.

THE RESULT is a fascinating and almost hypnotic experience, its pleasure enhanced by the knowledge that the combination is uniquely your creation. And that the light and pattern sequences you have made need not be lost but can be saved and enjoyed whenever you wish.

THIS IS TRIP-A-TRON. It will run on any version of the *ST* from 512K up. It comes in a form which is instantly useable but behind that facade is a comprehensive and fascinating range of controls and variables which allows the adventurous user to experiment creatively, producing unique and amazing effects. On *ST*'s of 1 Meg and up, or combinations of several machines linked via the MIDI interface, *TRIP-A-TRON* becomes a professional's tool, enabling the artist/composer to lay down graphics and music tracks on video tape, for performance purposes.

TRIP-A-TRON offers a new art-form to those with the imagination and inspiration to tame it.

TRIP-A-TRON is on two discs and the package includes a comprehensive manual

Its price is £34.95.

NOTE. If you have the *ST* version of *COLOURSPACE* you can obtain a discount of £10 on *TRIP-A-TRON*, by returning your *COLOURSPACE* disc to *LLAMASOFT* with a remittance for £24.95.

AVAILABLE FROM JUNE 1988



SOFTWARE EXPRESS

EUROPE'S LARGEST
ATARI MAIL ORDER
COMPANY
(021) 328 3585



SUMMER SPECIAL

STAR LC-10 PRINTER

(INC. FREE CABLE)

£199.99

all prices inc. vat next day delivery £5.00 Extra

PHILLIPS COLOUR MONITOR

(INC. FREE CABLE)

£129.99

HEAD OFFICE 514/516 ALUM ROCK ROAD, BIRMINGHAM B8 3HX (021) 328 3585
ALSO AT 212/213 BROAD STREET BIRMINGHAM B15 2JP (021) 643 9100,
9, EXETER STREET PLYMOUTH PL4 9AQ (0752) 265276

SUPERTEC LTD -computer solutions!

ATARI 520 STFM - 1040 STF - MEGA ST2 & ST4
HARD DRIVES - MONITORS - LASER PRINTERS
New ATARI PC1 & PC2 - IBM PC compatible now available

AMSTRAD PC1512 always in stock, we have a full range
of products available. Ask about the new PPC portables!

C *Commodore AMIIGA & PC RANGE*
available - Amiga A2000 & A500

TANDY 1400 LTPC portable in stock, this
machine sets a new standard in portable micro's

star *Laser 8 & the new LC10 dot matrix*
for immediate delivery.

SUPERTEC LTD

CORNWALLIS HOUSE
HOWARD CHASE
BASILDON
ESSEX
SS14 3BB

TEL (0268) 282308



OPEN 9 TO 5 PM MONDAY TO FRIDAY
PERSONAL CALLERS WELCOME - WE HAVE
SYSTEMS ON DEMO FOR YOU TO TRY

PC & ATARI ST based DESK
TOP PUBLISHING systems
from Mirrorsoft (FLEET
STREET PUBLISHER) - TIME-
WORKS DTP - Soft Logik
(PUBLISHING PARTNER)-

Special offers on MEGA ST &
Laser DTP systems!
Call for details



Dont be a DINOSAUR - move to the best and easiest
micro's to use. You can easily pay three times (or more)
as much, for the so called 'INDUSTRY STANDARD'
computers and still not get a system as good.

THIS AD WAS PRODUCED ON AN ATARI LASER!

COMMODORE AMIGA A500 starter pack! only £499.99 inc
VAT & delivery
or A500 + A1084 colour monitor for only £699.99, again this
includes delivery, VAT & the software pack!
Business packs! Mono £688.85 Colour £803.85

PRINTERS - PLOTTERS - MODEMS - DISC DRIVES - HARD DRIVES
- CABLES - MONITORS and SOFTWARE!

We can supply items from the following manufacturers:
Panasonic - Micro Peripherals - Epson - Brother - Philips - Mannesmann
Tally - Roland - Tandon - Miniscribe - Star Micronics - Amstrad - Akhter
- Miracle Technology - Cumana - Eidersoft - and many more.
JUST CALL AND ASK!

COME FOR A CHAT ABOUT YOUR NEEDS,
YOU WONT BE GIVEN THE HARD SELL, BUT
WE WILL TRY TO HELP.

SPITFIRE 40 Mirrorsoft £24.95

*Reviewed by
John S Davison*

Spitfire 40 for the ST is a rewrite of the disappointing 8-bit version (reviewed in issue 28). The difference is unbelievable, mainly due to the vastly improved graphics. Just running the program's 'Demo' mode for a few minutes should be enough to persuade any flight simulator fan to buy the program.

In addition to 'Demo', it also has two other modes of operation. 'Game' mode is designed to give you practice in handling the Spitfire and in combat with the enemy. This isn't as easy as you'd think, as you need to use the technique of 'deflection' shooting, i.e. aiming ahead of the enemy to ensure your bullets and his aircraft arrive in the same place at the same time! You begin in the air close to an enemy aircraft, so you don't have to worry about the difficulties of take-off (or landing) and finding enemy aircraft.

'Simulation' mode has two options - Practice and Combat. Practice allows

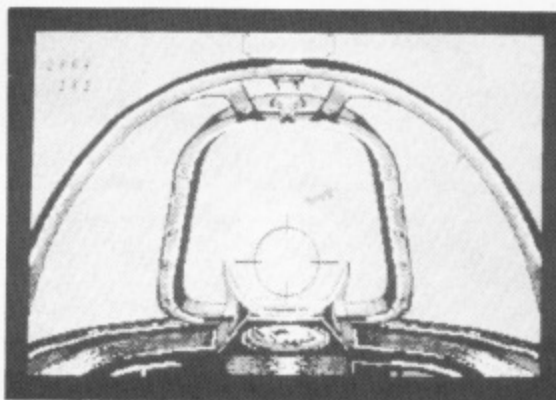

you train yourself in the skills needed for a complete flight, i.e. take-off, general flying, and landing. When you can successfully do all these things you're ready for the full-blown Combat option which adds finding, fighting, and destroying enemy aircraft to the scenario.

Unlike most flight simulation programs, Spitfire 40 has separate through-the-canopy view and instrument panel screens. I found this a nuisance, but you can scroll between them fairly quickly when required. You can also arrange for airspeed and altitude to be displayed on the canopy, reducing the number of times you have to scroll down to the panel and back.

The superb instrument panel graphics have an almost photographic quality, and the view through the

canopy shows a background patchwork of fields occasionally overlaid with airfields and solid three dimensional structures such as factories, churches, and other buildings. With full detail on view the display speed is slowed, so you can use the function keys to progressively reduce detail to get better response.

You'll encounter three different types of enemy aircraft - Heinkel III and Junkers 87 'Stuka' bombers, and Messerschmitt Bf109E fighters, each using different combat tactics in their attempts to outsmart you. They manoeuvre very realistically, especially the Messerschmitt which will try to get behind you. If it does you'll see him in your rear view mirror with guns blazing. Bombers have movable guns so can fire on you from any position. In fact, I found the bombers much harder to deal with, all too often they shot ME down instead - even the supposedly poorly armed Stukas! If you do manage to hit the enemy, his aircraft tumbles spectacularly out of the sky.

In summary, Spitfire 40 is probably the most exciting aerial combat simulator available at present. It has shortcomings as a pure flight simulator, but don't be put off - if you enjoy flight combat/simulation programs you'll enjoy Spitfire 40.

ROCKFORD - THE ARCADE GAME Melbourne House £19.95

*Reviewed by
John Davison jnr*

This is the latest in the series of 'Boulderdash' games starring the lovable little character Rockford. This version has been converted to the ST from the arcade machine 'Rockford' by Arcadia Systems. The basic concept came from the 8-bit machine version, which in its original form was a highly playable game.

'Rockford' gives you four levels of five different worlds. Within these five worlds there are four screens, giving you a total of eighty different playing screens. As in all the other games of this type you must move around the screens picking up objects and solving various problems. Unlike previous Boulderdash releases, the different

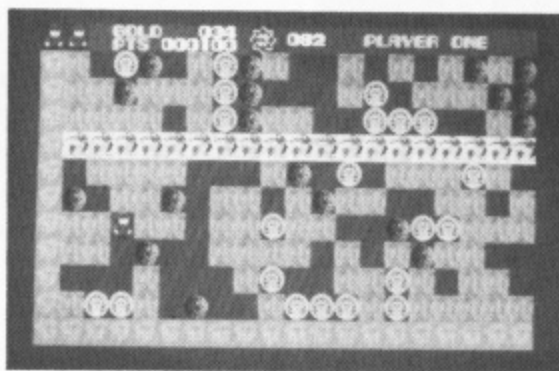

levels are parts of different scenarios which must be completed by taking on the roles of a hunter, a spaceman, a doctor, a chef and a cowboy.

The game's graphics, whilst being very colourful and quite detailed, are a little obtrusive when compared to the original Boulderdash. There are, in my opinion, too many bright and flashing colours which cause the screen to look rather messy. The scrolling of the screens is absolutely terrible, being jerky and painful to the eyes. Instead of scrolling as you move around, the screen only moves as you get very close to one of the edges, and only then does it move by at considerable speed. The

sprites are fairly good although they are not animated terribly well. There are however some nice pieces of animation at the beginning of each level and when you die, at which point an enlarged animated picture of your character is displayed.

The sound is not of the highest standard although it is adequate for the game. The spot effects are not outstanding but reasonable and the tune on the title screen is fairly uninspired and again, only reasonable.

What this game has attempted to prove is that the original 'Boulderdash' can be improved upon, however, in my opinion, it has failed miserably by trying to improve on what was to start with a perfect game. The original was a classic and one of the most playable and enjoyable games around. It was also one of my personal favourites. Rockford has lost this playability and is now no more than a run of the mill scrolling game. I had high hopes for this game because until now all of the Melbourne House releases have been superb. Unfortunately, this one brought disappointment.

INTERNATIONAL SOCCER Microdeal £19.95

*Reviewed by
Damon Howarth*

As I write this, the soccer season draws to a close so International Soccer could be ideal for my withdrawal symptoms. The game provides armchair sweepers a chance to obtain the feel of playing in front of a Wembley crowd without the violence associated with these events plaguing the mind.

International Soccer is most user friendly and provides a one or two player option both of whom have to use joysticks to control the teams and the initial choices as to weather, lighting, wind, team colours and duration of match. The screens are very well devised with the options screen showing two footballers in their strip, allowing the players to view the different colour combinations available. It is quickly obvious that the available colours include the whole ST spectrum

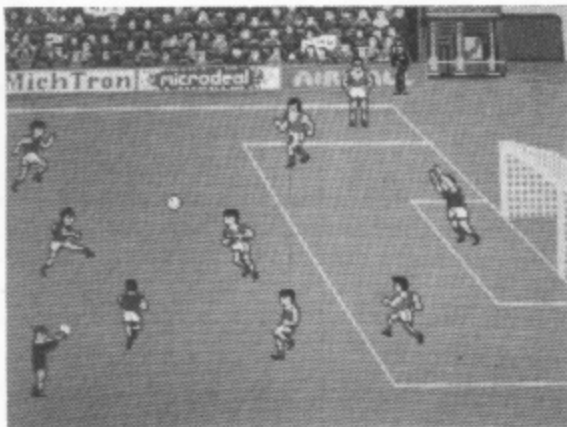

but the computer does not check colour similarities at this point and so some peculiar clashes of strip can be organised.

The stadium blossoms forth in the colours of the teams and if the crowd are watched at less busy times they can be seen executing a Mexican Wave and cheering on their team. The electronic scoreboard takes up a full screen and conveys important messages such as the score, the awarding of a penalty or goal kick and other such useful facts. The game is controlled through the joysticks, either dribbling with the man in possession or tackling with the appointed player. To gain control of a player the fire button needs to be pressed until a white marker highlights his feet. He will move in relation to the

stick and tackle on fire commands. Kicking the ball is resolved at one of three strengths pass, chip, and long clearance. The goalkeepers seem somewhat lacking in response and seem able to bounce balls of their chests rather than take possession.

One of the inherent problems with the game is that the player the computer assumes to be automatically nearest the ball is not necessarily so, as it would seem that relative positions are determined from the attribute file and its peculiar workings rather than by proximity of the ball to a player.

In the one player game the computer provides a fast and difficult opponent but does show unimaginative finishing. There is a constant sound barrage as one of four selectable tunes continues in the background. The sprites are of more than adequate size and the game plays at a fast rate. It is, I feel, better as a two player game rather than as a player against computer contest since the machine will tend to win rather repetitively.

I enjoyed this game and although some of football's basic laws are bent a little it seems to me to be the best of its kind presently on the ST. If you can't wait until August then the game is a must.

SKYFOX Electronic Arts £14.95

*Reviewed by
John S Davison*

Skyfox is another of those games where only you can save the Federation from a fate worse than death. It's been around for a while on other machines and has been hyped up somewhat over its allegedly spectacular graphics, so I was interested to see the ST version.

The basic game plan is very simple - fly Skyfox to find and destroy the enemy motherships which are disgorging tanks and aircraft in an attempt to overrun your base. Once the motherships are dealt with you then have to stop the tanks and aircraft which have already disembarked. Naturally, they don't like this idea much and will try stop you first!

The game looks quite complex at first, but this is really an illusion due partly to the poorly produced instruction booklet. The main screen is

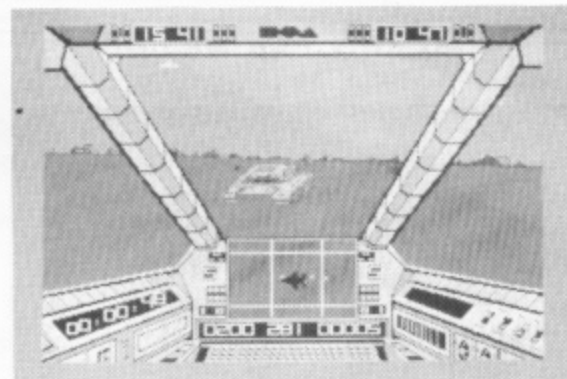

the pilot's view from SkyFox's cockpit, showing instrument panel and through-the-windscreen view. The instruments show current speed, height, direction, position, fuel, shield, and weapon status information, and the radar screen is there to help you locate the enemy.

You can call on the base computer to display a tactical map, showing the position of the base installations you have to defend and the positions of enemy motherships, tanks, and aircraft. By positioning a cursor on this map more detailed information may be obtained about the chosen sector. Skyfox's autopilot may also be set to fly you to that location so you can engage the enemy in battle with your laser cannons, guided missiles and heat

seeking missiles.

There are fifteen different scenarios to choose from. Seven of these offer various aspects of training, allowing you to familiarise yourself with Skyfox's controls, weapons, and guidance systems. In these scenarios there are no motherships to worry about, and your home base can't be destroyed. The combat scenarios start with Small Invasion by just one mothership and if you master this you can tackle a Full Invasion.

Basic control of Skyfox is achieved via mouse or joystick, with keyboard used for selecting weapons, etc. When manoeuvring, the subjective flight effects aren't very good, the horizon tilting only slightly however violent a manoeuvre you think you're making.

Overall, I found the game a disappointment. The much vaunted graphics were not that good, using lots of bright colours and being rather chunky and cartoon-like in appearance. Sound effects were pretty poor too, particularly the laser cannon. In play, the game was strangely unsatisfying and I found I had no great desire to have 'just one more go'. Electronic Arts seem to have slipped up this time.

PRICE PROMISE
IF YOU SEE ANY ITEM ADVERTISED
AT LESS THAN LISTED PRICE
WE WILL MATCH

ATARI 520STFM PACK
INCLUDES ATARI BASIC, MOUSE, MANUALS
PHONE FOR PRICE

ATARI HARDWARE

1040ST	PHONE
1040ST + SM125 Mono monitor	PHONE
12" MED RES COLOUR monitor	£359.95
PHILIPS 8833 COLOUR monitor	£249.95
PHILIPS 8852 COLOUR monitor	£279.95
Mouse Controller	£24.95
Cumana 1 Meg Drive	£129.95

PRINTERS

STAR LC-10	£199.95
STAR LC-10 COLOUR	£229.95
PANASONIC 1081	£179.95
CITIZEN 120-D	£149.95
CITIZEN MST 10E	£249.95
CITIZEN MST 15E	£319.95

All printers come complete with leads

SERIOUS SOFTWARE ARCADE ACTION

GFA BASIC	£38.95	STRIP POKER II	£12.95
GFA DRAFT	£79.95	(X - not suitable for young)	
GFA DRAFT PLUS	£99.95	ROLLING THUNDER	£19.95
FLEET STREET PUBLISHER		FLIGHT SIMULATOR II	
(enhanced)	£84.95		£34.95
SUPERBASE		XENON	£16.95
PERSONAL	£74.95	BATTLESHIP	£12.95
SUPERBASE		TETRIS	£16.95
PROFESSIONAL	£199.95	ROAD WARS	£16.95
1ST WORD PLUS	£63.95	IKIRI WARRIORS	£12.95
FAST BASIC (Disk)	£34.95	OUTRUN	£19.95
LATTICE C	£79.95	OBLITERATOR	£19.95
BOOKKEEPER	£74.95	TERRAMAX	£16.95
		SCRUPLES	£16.95
More titles available		POWER STRUGGLE	£12.95
please ring		ZAPIONS-	£16.95
		CRASH GARRETT	£16.95
		VOID	£16.95
		MUSIC STUDIO	£14.95
		SCRABBLE	£19.95

More titles available

BLANK DISKS

10	20	50	100
£10.95	£21.50	£49.95	£97.00

Trade enquiries welcome

Lockable disk boxes 3.5" holds 80 £9.95

**SPEND OVER £50 ON SOFTWARE
AND GET A FREE CALCULATOR**

**DELIVERY: ALL PRODUCTS GUARANTEED
DELIVERY WITHIN 7 WORKING DAYS
- IF NOT GOODS WILL BE FREE**

**MAIL ORDER HOTLINE (24 hrs)
0942 261344**

SOUND N VISION

11 Silk Street, Leigh, Lancs WN7 1AW
Phone now for details - Tel. (0942) 673689
Cheques and P/Orders payable to: SOUND N VISION
P&P/VAT included
Visitors welcome in showroom. Send SAE for price list

POOLSWINNER II

THE ULTIMATE POOLS PREDICTION PROGRAM

- **MASSIVE DATABASE** Poolswinner is a sophisticated Pools prediction aid. It comes complete with the largest database available - 22000 matches over 10 years.
- **PREDICTS** Not just SCOREDRAWS, but AWAYS, HOMES and NO SCORES.
- **SUCCESSFUL** SELEC guarantee that Poolswinner performs significantly better than chance.
- **ADAPTABLE** Probabilities are given on every fixture - choose as many selections as you need for your bet. The precise prediction formula can be set by the user - you can develop and test your own unique method.
- **SIMPLE DATA ENTRY** All team names are in the program. Simply type in the reference numbers from the screen. Or use FIXGEN to produce fixture list automatically (see below).
- **LEAGUE AND NON-LEAGUE** All English and Scottish League teams are supported, and also the non-league sides often used on pools coupons.
- **PRINTER SUPPORT** Full hard copy printout of data if you have a printer.



PRICE £18.00 (all inclusive)



FIXGEN 88/9

AT LAST: No more struggling for hours to get the fixture list into the computer. FIXGEN has been programmed with all English and Scottish League fixtures for 1988/89. Simply type in the date, and the full fixture list is generated in seconds. Fully compatible with Poolswinner. Yearly updates available.

POOLSWINNER with FIXGEN £19.50 (for both)



COURSEWINNER v3

THE PUNTERS COMPUTER PROGRAM
You can develop and test your own unique winning system by adjusting the analysis formula, or use the program in simple mode. Coursewinner V3 uses statistical analysis of major factors including past form, speed ratings, course statistics, prize money, weight, going, trainer and jockey form etc, etc. It outputs most likely winners, good long odds bets, forecasts, tricasts etc. The database includes vital course statistics for all British courses. You can update the database - never goes out of date. **FULL PRINTER SUPPORT.**

PRICE £18.00 (all inclusive) includes Flat AND National Hunt versions.

AVAILABLE FOR

All supplied on tape ... (Automatic Conversion to disc)
AMSTRAD CPCs
BBCs
COMMODORE 64/128
SPECTRUM
DISCS ... (Add £3.00)
AMSTRAD PCW
IBM Format
COMMODORE AMIGA
ATARI ST

Send Cheques/POs for return of post service to ...



62 ALTRINCHAM RD, GATLEY, CHEADLE, CHESHIRE SK8 4DP. ☎ 061-428 7425
(Send for full list of our software)

SUBSCRIBE

**TWO WAYS TO GET PAGE 6
MAGAZINE ONLY**

Annual subscriptions (6 issues) are available to
PAGE 6 at the following rates

U.K.	£7.00
Europe	£11.50
Elsewhere - Surface	£11.50
Elsewhere - Air	£17.50

Single copies and back issues
at one sixth of the annual rates

MAGAZINE AND DISK

PAGE 6 is also available with a disk containing all of the 8-bit programs for each issue and often BONUS programs not included in the magazine.

U.K.	£30.00
Europe	£37.50
Elsewhere	Please enquire

Single disks and back issue disks
are available for £3.95 (£4.95 overseas)

GOLDRUNNER II **Scenery Disks 1 and 2** **Microdeal** **£19.95 £5.95 each**

Reviewed by
Damon Howarth

It is fifty years on from the time of the original Goldrunner and now the subject is the grandson of the pirate-killing hero of yore. It is his job to recapture the stolen defensive robots from the pirates before they wreak their revenge on a defenceless system. This is the setting for the new shoot em up. The concept of the scrolling game is still there but this time it is a two-way scroll up and down! The control is fairly simple and greatly aided by the fact that a mouse can be used to move the ship about. The speed of response that this generates is of great value in a game of this pace.

The game has speech to urge you on or give coaching if the instruction mode is used. It has a very catchy musical score which has to be turned off if the sound effects are to be used. I found these to be critical at some junctures of the game, and a plethora of other accessories to make the game more versatile are additionally available. Even the high score table has an element of fun about it wherein you are verbally chastised for not entering a name onto the screen.

There is a novelty in this game which precludes your fighter from being destroyed by being shot at and means that by careful flying and very fast reactions it is just possible to avoid the

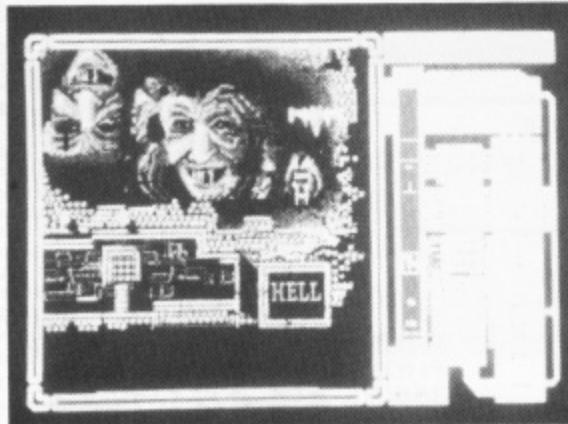

catastrophic effects of being forced into buildings and other destructive solids. A great deal of shooting across some varied backgrounds is needed to enable recovery of the lost robots and quick reactions are needed to make sure they are recaptured and deposited on the transporter pads. The scoring system allows you to win spare ships and as such presents a very playable game that the player can imagine completing.

Of special note in this game is the backdrop that the game is played over. The scenery is of high quality and in this basic game many interesting views can be seen since there is a maze-like quality to the play. Since certain structures can cause you to crash if collided with, and these are not always obvious – once discovered the player is then half-way to solving the problems in the game. A glance at the loading screen shows that a great deal of artistic care and time has gone into developing the backdrop for this game. There is a somewhat surreal feel to the whole piece due to this effect.

The game had many qualities that gave it a 'let's try again' addictiveness, not the least of which was the feeling that the maze was almost mastered.

Unfortunately, for all the show I felt that the game was still a very basic, albeit enjoyable, scrolling shoot 'em up. There seemed to be very few tactical decisions to make and as such the only major problems were how to dock with the mother ship and where to drop the robots once recovered.

The saving grace of the game is the incredible graphics which create the individual platforms or mazes. It is probably these features more than any other that make the game as interesting as it is, so I was very pleased to be able to sample the additional scenery packs which have been issued to complement the main game. Each of the disks has its own theme and provides very different platforms to travel over. Scenery Disk I has the feeling of being created by a modern day Breughel and contains colourful and confusing backgrounds to stimulate jaded eyeballs and reflexes. Gameplay is no different but the alternative positioning of a few blocks make some sectors of this scene feel easier.

My favourite disk though was Scenery Disk II with its depiction of hell and the faces of sinners in torment as a backdrop. The sombre effects from this artwork made a shocking and effective contrast to the garishness of the original. For me this particular disk enhances the game purely by the depth of the art and the evocation of the evil lurking to be defeated. I also discovered that with deft use of the second drive that the scenery disks were interchangeable, thus allowing an almost infinite variety of platform combinations for the game. If you buy Goldrunner II then the scenery disks are a must.

THE PAGE 6 ACCESSORY SHOP

A superb collection of books and covers specially for your ATARI and the best collection of public domain software for the 8-bit and ST. You'll love it.

Ask for our catalog now
Phone 0785 57005

Or write to
PAGE 6 ACCESSORY SHOP
P.O. BOX 54,
STAFFORD, ST16 1DR

1ST STOP for PD SOFTWARE

PAGE 6 began collecting public domain software for the Atari **FIVE YEARS AGO** and was the **FIRST** to gather together PD software for the ST. We have an incredible collection of disks including languages, games, utilities, demos, graphics and much more.

We don't throw in everything, we select the very best, so if you want the best in PD software ask for our catalog.
Write to **PAGE 6, P.O. BOX 54, STAFFORD, ST16 1DR**
or phone us on 0785 57005

MORE ST SOFTWARE...

There's still a lot of ST software coming out and we have been unable to include it all either because it wouldn't fit in or because it was received too late to get out to our reviewers in time. Several of the following will appear in coming issues, meantime read on to see what's about.

BMX SIMULATOR, one of Code Masters' biggest hits comes to the ST for £14.99. Bike riding on the ST can be just as thrilling as Grand Prix racing. **STOCK MARKET** from Tynesoft allows the more serious among you to make or lose a fortune with stocks and shares. It's only a game though and you won't get your £19.95 back! **MASTERS OF THE UNIVERSE** from Gremlin Graphics at £19.99 - what more can we say, everybody must know about these characters based on the comics/cartoons/toys etc. **SHADOWGATE** from ICOM Simulations, distributed by Mirrorsoft tries to follow in Dungeonmaster's footsteps with an adventure in similar style for £24.99. **OBLITERATOR** is the follow up to two well respected Psygnosis games and looks to be as good. £24.95 will help you find out or you could wait for the review next issue. With **THUNDERCATS**, Elite Systems bring you more cartoon action, which the kids will explain to you if you don't know. Take the £19.99 out of their pocket money! **BATTLESHIPS** from Elite is ... battleships! Lots of good graphics but is the old standard worth £14.99? We'll tell you soon. **MAGIC DISK TOOLKIT** from MMG Computer Consultants is one of those disk utility programs which we haven't seen for some time. Lots of features including rescuing duff disks. Everybody should have at least one disk utility and, if this one does what it claims, it must be a good investment at £24.95. **GFA ARTIST** is Michtron's answer to the established art programs but at £49.95 it will have to be good to succeed. One wonders if there is room for another art package? On the more serious side we have **WORDUP** distributed by HB Marketing at £59.95. Again one wonders if there is room for another word processor but this one seems to give you WYSIWYG on your printer as well as on screen which could make it rather special. **FONTZ**, also from HB Marketing, lets you design and use fonts for WORDUP and other programs such as DEGAS and looks excellent value at £24.95. **BEYOND THE ICE PALACE** is a platform type adventure game from Elite with some good looking graphics and it will cost you £19.99 whilst for the same price you can get your own version of the arcade game **BUGGY BOY** for some race thrills and spills. **THE BERMUDA PROJECT** is a 'stunning new arcade adventure' from Mirrorsoft which for £24.99 will get you lost in the Bermuda Triangle to face untold dangers on a mystery island. **IKARI WARRIORS** is another from Elite that has a couple of Rambos on the cover eating grenades! Must be another vertical scroller where you splat everything as messily as possible but it's probably fun and only £14.99. Back on the adventure theme we have **UNINVITED** from Mindscape, distributed by Mirrorsoft at £24.99. Looks to be an interesting graphic adventure with a supernatural theme which could frighten the life out of you! We finally got **UNIVERSAL MILITARY SIMULATOR** from Rainbird along with **CARRIER COMMAND**. Haven't looked at the latter yet but it comes with a stereo music cassette featuring the full theme to the game. If the game is as good as the music, it's gonna be brilliant! Great idea, disk and cassette for £24.95. From Firebird at £19.95 is **PANDORA**, an arcade adventure set on a space ship with excellent graphics. Finally ... there is Jeff Minter's **REVENGE II** which comes from Mastertronic. Full of the Master-Blaster's well known themes and words such as 'synergistic consciousness formed as the sum of sentient Galactic consciousness'. Heavy! Definitely too difficult for CTW to grasp. Just press the fire button!

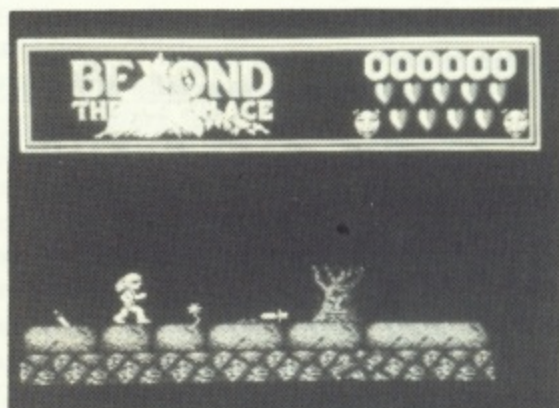
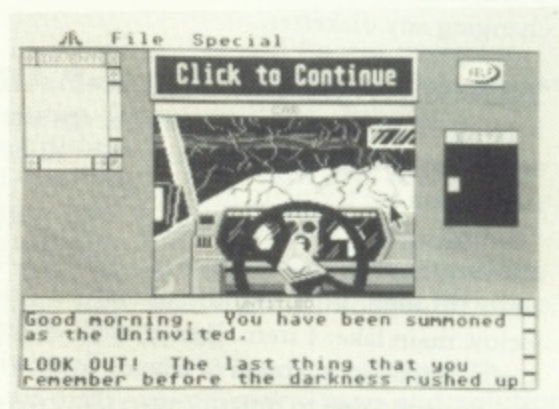
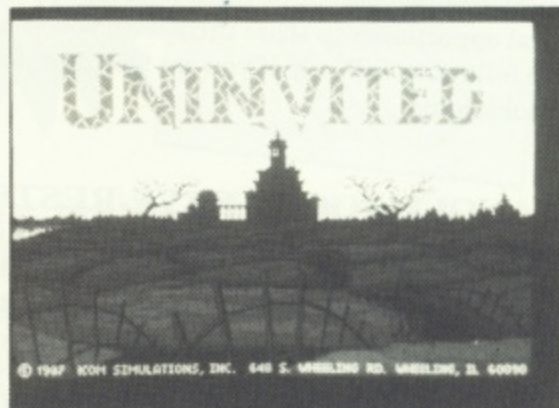
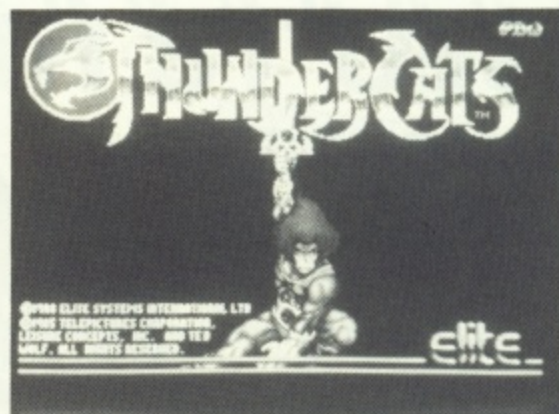

SWEENEY'S

NOTEBOOK

Many of today's adventures, whilst excellent to play, are not very user friendly when it comes to saving games or they seem to have odd bugs that can make it very frustrating to play. When playing or reviewing games I often come across a few tricks that may not be obvious to everyone and this seems an ideal opportunity to share them with you. I hope that some of the following will help if you are finding a particular adventure troublesome.

TANGLEWOOD - SAVE/RESTORE

If you have two drives then SAVE/RESTORE is done using the last one that the game used - you have to guess or remember - at least the recovery is good and you can retry - but do keep your Tanglewood A diskette protected! I use a copy of the B diskette for my saves and every time I load the game I do a RESTART which causes it to access the B drive. Then, most of the time, I can SAVE and RESTORE without changing any diskettes.

TANGLEWOOD - THE R-P AREAS

In all cases you should remember the standard mapping technique of following one 'wall' - it can be extremely useful. Also if you are trying to map an area, don't pick up any items you find - leave them as markers. This is what you need out of the various areas: Forest (east of Control Centre): 1 item + route through. Forest (south of map): 1 place. Swamp: 1 place. Below main lake: 1 item. Below small lakes: 1 item. Main lake surface: routes to 2 parts of island. Somewhere Underground: this is a good one to practice on - there are only 8 locations unless you can get past the creature or the dark - no items. Mines: sorry, you'll need an accurate map of it all if you really want to solve it - great puzzle! Control Centre: lots of items and locations - again, you really will have to map it!

MOEBIUS - SAVE/RESTORE

Each time you start a fight Moebius does an automatic SAVE for you, thus rubbing out your last SAVE. If you have picked a tough fight and die you just get restored to the same point and die again, and again.... If you want to perform a real SAVE then SAVE your position and come out of the game, create a new folder on a spare diskette, and copy BOOK.DAT (the index) plus each of the GAMEN.DAT's which you are using from the B Diskette to your folder. If you die you can copy them back to the B Diskette and restart. You can have lots of folders for different positions. You can tell which GAMEN.DAT's you need by SHOWing them (double-click from desk-top), your character's name is the first thing in the file.

ALTERNATE REALITY - THE DUNGEON - THE DEVOURER

I have been bombarded with queries on this one - all you need to do is drop items until the Devourers stop appearing, then never carry that many items again!

ETERNAL DAGGER - SAVE/RESTORE

This has a strange update mechanism. Your SAVE (Tell The Minstrel) only affects Diskette 1, so if you want a backup you need only copy that one. But the dungeons (Diskettes 2 and 3) are dynamically modified as you explore them. This is especially useful on the Underwater Dungeon - SAVE outside it, go in and clear out as many rooms as you can before you die, then reboot. Your characters will be restored to their healthy status, but the rooms will stay cleared out - you can repeat this process until you clear the way to the Demon World, then reboot and enter the Demon World with healthy characters! (N.B. you won't get to keep any points or artefacts from the Underwater Dungeon.)

ETERNAL DAGGER - BUG ON THE FIRST DUNGEON

If you kill the Necromancer but don't enter the last room, the dungeon is sealed off forever. Resetting the Dungeon does NOT reopen it! Don't worry - there is nothing in the last room which you need to finish the game.

ROADWAR 2000 - THE FIRST PLACE YOU SHOULD VISIT

To start a new game keep restarting until you are near San Fransisco. Get six vehicles as quickly as you can then visit SSI's HQ at San Jose/Mtn View. You get to meet the game author who greatly enhances all your vehicles and gives you a Doctor, a Drill Sergeant, and a Politician!

KNIGHT ORC - THE WALLET

Pick it up immediately you find it. Otherwise a bug in the logic prevents you ever using it.

SPACE QUEST II - DIVING

There is a bug which prevents it understanding HOLD BREATH, you have to type in HOLD BREATHE!

POLICE QUEST - CALLING A TAXI

Remember which number the UK used for the Operator twenty years ago?

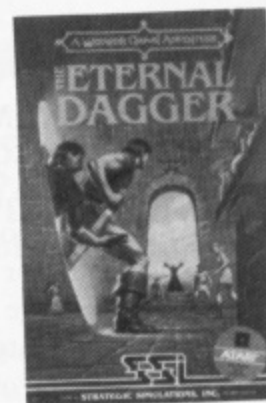
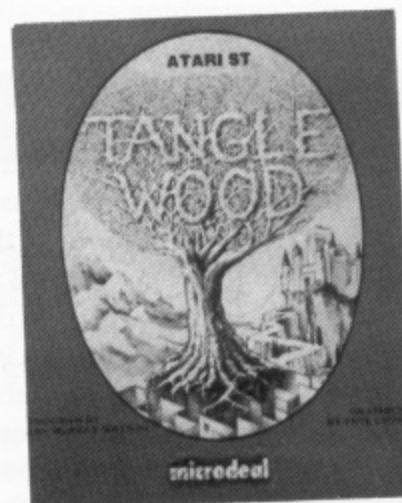

SHACKSOFT

A mail order service for people who know what they want.



ATARI®
Power Without the Price™
ATARI SUMMER PACK
520STFM
INC 1 MEG DRIVE
AND £415 WORTH OF
SOFTWARE FREE
ONLY £385.00

Atari 520STFM inc mouse and five FREE PD discs £279
Atari 520STFM inc SM125 Mon and five FREE PD DISCS £379

AMAZING 1040 DEALS

PLEASE PHONE FOR LATEST PRICE

Atari Mega 2 Inc SM125 Mono Monitor , Five Discs & storage box £899

Atari Mega 4 Inc SM125 Mono £1149

Atari SLM804 Laser Printer £1149

Please call for other Atari system prices

Atari Prices INCLUDE VAT

MOUSE MASTER



Instantly select either your mouse or joystick (or other controller) in port 0. A switch on the top does the swapping for you! Additionally, port 1 is brought out to make all the ports easily accessible.
ONLY £24.95



MONITOR MASTER

Switch between your Mono and colour monitors. Inc Audio output and (Video on STFM)
ONLY £35.00

PRINTERS

Panasonic KXP1081 9 Pin NLQ Printer £175

Micro P MP165 NLQ Printer £225

Star LC10 Multi Font, NLQ Printer £199

Star LC10 Colour Printer Multi font NLQ Printer £259

Citizen 120D NLQ Printer £159

All printer Prices INCLUDE VAT

PHILIPS MONITORS

Philips BM7502 12" CVBS & Audio input Green display £79

Philips BM7522 12" Amber screen £95

Philips CM8833 14" Med res colour with mono switch £259

ALL PHILIPS MONITORS INC LEAD FOR YOUR COMPUTER

PLEASE SPECIFY TYPE WHEN ORDERING

SOFTWARE

WE STOCK A VAST RANGE OF ATARI AND AMIGA SOFTWARE ALL AT HUGE SAVINGS. PLEASE ASK FOR FULL LIST

CONSUMABLES

RIBBONS, DISCS, PAPER, DISC STORAGE BOXES, KEYBOARD COVERS & ATARI ACCESSORIES

Prices subject to change without notice

HOW TO ORDER

ALL PRICES INCLUDE 24 HOUR CARRIAGE BY COURIER

Phone with your ACCESS or VISA number, or send cheque or postal order to

SHACKSOFT

Units 11/12 White Hays South

West Wilts Trading Estate, Westbury, Wiltshire



(0373) 858031 (2 lines)



Track the STars with Atari ST User



The July issue of Britain's top-selling Atari ST magazine focuses on Skyplot, a superb new package for budding astronomers everywhere.

PLUS

- Reviews: Lisp interpreter and Pascal compiler, Superbase Professional, GFA Artist, AB Animator Sprite Designer, Quantum Paint, Juggler, Panasonic printers, K-Expert.
- Listings: Demolition game, ram disc utility, 3D graphic animation demonstration.
- Games: Northstar, BMX Simulator, Impossible Mission 2, Bob Winner, Road Wars, Foundations Waste, Buggy Boy, Spidertronic, Power Struggle, Trantor, Warlock's Quest.
- Features: Music on the ST, adventuring with Brillig, Gallery, Arcade Corner – map and solution to Terramex.

NEW SERIES: Arcade Corner, with full solution and map of Terramex.

Available NOW from your newsagent or larger computer dealers for £1.75.

Alternatively, take out a subscription and receive an Atari calculator, the Atari ST User Compendium disc, and two discs crammed with public domain software – a bundle worth over £17 – completely FREE by using the form below:

Please send me the next 12 issues of Atari ST User for £19 starting with the _____ issue.

I enclose a cheque made payable to Database Publications.

Please debit my Access/Visa card no:

□ □ □ □ □ □ □ □ □ □ □ □ □ □ □ □

Signed: _____ Expiry date: _____

Name _____

Address _____

Postcode _____

Send to: Atari ST User, Europa House, Adlington Park, Adlington, Macclesfield, Cheshire SK10 4NP.

Phone orders: 0625 879920
Telecom Gold: 72:MAG001
Prestel: Key *89 then 614568383

Don't forget to include your credit card number and full address.

A479

Had enough
of
Arcade Games
or
Spreadsheets?

There
is an
Alternative

A company that
specialises in Quality
Strategy, Adventure
and Simulation
software from around
the world

A Company that offers
a quality Mail Order
service for Gamers
in the U K
and Europe

**STRATEGIC
PLUS**
SOFTWARE

Send £1.00 for our
extensive Catalogue
which includes
descriptions and
complexity ratings
for each game

**ATARI 520
1040ST COMPUTERS**

Stellar Crusade (SSI)	£34.99
Empire (Interstel)	£39.95
Kennedy Approach (Microprose)	£24.95
Dungeonmaster (FTL/Mirrorsoft)	£24.99
Beyond Zork (Infocom)	£24.99

Strategic Plus Software

P O Box 8
Hampton
Middx. TW12 3XA

01 979 2987

**ATARI 520
1040ST COMPUTERS**

Ultima IV (Origin Systems Inc.)	£24.95
Bard's Tale (EOA)	£24.95
Phantasie III (SSI)	£24.99
Rings of Zilfin (SSI)	£24.99
COMING SOON: Questron II (SSI)	£24.99



subLOGIC

INFOCOM

SIMULATIONS
CANADA



ELECTRONIC ARTS



MICROPROSE



All prices include VAT and P&P. ALL PROGRAMS ARE ON DISC ONLY.

SAVE ££££'s SAVE ££££'s SAVE ££££'s SAVE ££££'s SAVE ££££'s SAVE ££££'s SAVE ££££'s

**WHOLESALE PRICES - DIRECT FROM THE
WAREHOUSE!**

Importers . . . Manufacturers . . . Distributors . . .
Telephone: 0664 410666

SAVE ££££'s SAVE ££££'s SAVE ££££'s SAVE ££££'s SAVE ££££'s SAVE ££££'s SAVE ££££'s

SAVE ££££'s SAVE ££££'s SAVE ££££'s SAVE ££££'s SAVE ££££'s SAVE ££££'s SAVE ££££'s

STORAGE BOXES



3.50" Lockable - Holds 40	£4.95
3.50" Lockable - Holds 80	£6.95
3.50" Lockable - Holds 120	£8.95
5.25" Lockable - Holds 50	£4.95
5.25" Lockable - Holds 100	£6.97
5.25" Lockable - Holds 140	£8.97

ALL WITH LOCK & TWO KEYS
DIVIDERS & ANTISTATIC!

ACCESSORIES

Mouse Mat	£4.95
BBC Printer Cable	£5.95
Atari etc Printer Cable	£6.95
3.5" Cleaning Kit (fluid)	£4.95
5.25" Cleaning Kit (fluid)	£3.95
Disk Notcher (doubler)	£4.95
12" Monitor Stand	£11.95
14" Monitor Stand	£14.95
Desk Top Copy Holder A4	£14.95
Desk Top Copy Holder A3	£14.95
Space Saver Printer Stand (80 col)	£24.95
Economy Printer Stand (80 col)	£13.95

**!!! FLOPPY DISKounts!!!
THE MORE YOU BUY -
THE MORE YOU SAVE!!!**

3.5" Bulk Packed-					
Price each disk	25+	50+	75+	100+	150+
Single Sided 135 T.P.I.	84p	82p	80p	78p	76p
Double Sided 135 T.P.I.	86p	84p	82p	80p	78p

ALL DISCS ARE SUPPLIED WITH LABELS AND ARE
CERTIFIED 100% ERROR FREE

5.25" Bulk Packed-					
Price each disk	25+	50+	75+	100+	150+
Single Sided 48 T.P.I.	42p	37p	32p	30p	29p
Double Sided 48 T.P.I.	44p	39p	34p	32p	31p
Double Sided 96 T.P.I.	46p	41p	36p	34p	33p
Double Sided Col. 96 T.P.I.	55p	49p	45p	39p	38p
Double Sided Rev. 96 T.P.I.	55p	49p	45p	39p	38p

COLOURED DISKS, COME IN FIVE COLOURS (RED,
BLUE, WHITE, YELLOW, GREEN)

REVERSIBLE DISKS HAVE TWO INDEX HOLES AND
TWO NOTCHES!

ALL DISKS COME WITH ENVELOPE AND LABEL SET
AND HAVE A HUB RING AND FULL GUARANTEE

**BULK PACKED OFFERS -
BEST VALUE IN TOWN**

25 Double Sided 5.25" 96T.P.I. Disks with our storage box	£11.50
50 Double Sided 5.25" 96T.P.I. Disks with our storage box	£17.00
75 Double Sided 5.25" 96T.P.I. Disks with our storage box	£22.50
100 Double Sided 5.25" 96T.P.I. Disks with our storage box	£28.50

You can choose either 50 capacity storage box or 100
capacity storage box to go with your discs.
If you want a 140 capacity storage box just add a
further £2.50

20 Double Sided 3.5" 135T.P.I. Disks with our storage box	£19.95
40 Double Sided 3.5" 135T.P.I. Disks with our storage box	£36.95
60 Double Sided 3.5" 135T.P.I. Disks with our storage box	£49.95
80 Double Sided 3.5" 135T.P.I. Disks with our storage box	£64.95

You can choose either 40 capacity storage box or 80
capacity storage box to go with your discs.
If you want a 120 capacity storage box just add a
further £2.50

ALL BOXES COME WITH LOCK, 2 KEYS, DIVIDERS
AND ARE ANTISTATIC

ALL DISKS COME WITH LABELS AND ARE 100%
GUARANTEED ERROR FREE

MELTON COMPUTER SUPPLIES

PO Box 2, Melton Mowbray, Leicestershire.

☎ 0664 410666 (24 hrs)

Phone for our best price before placing your order
EDUCATIONAL & GOVERNMENT ORDERS WELCOME



All Disks are sent by
Trackback or Courier
Service at no extra cost!

Please ask for
FREE
catalogue

Remember the price you see is all you pay (U.K. only). Prices include VAT and carriage

SAVE ££££'s SAVE ££££'s SAVE ££££'s SAVE ££££'s SAVE ££££'s SAVE ££££'s SAVE ££££'s

DEMON ADVENTURE

Magic can be dangerous in the wrong hands. Anything can happen, even Demons may be released but can they be suppressed again? It's up to you to find out – if you live!

by Adrian Cox

Demon Adventure is a matter of survival. As a servant in the Duke's castle you know that he has experimented with magic but has had very little success, due to his clumsiness. Unfortunately, one of his spells has worked too well and a demon is loose in the castle. You have hidden in a tower room to escape the demon, but you cannot hide there forever. You must attempt to escape alive from the castle, preferably destroying the demon as well.

GETTING STARTED

The program is written in standard Atari Basic and should be fairly easy for desperate adventurers to follow. I have not given a list of variables, as this would make things too obvious when typing the program in.

Type in the program using Typo 3 to check it as you go and save it to disk or cassette. Then RUN the program.

PLAYING THE GAME

The game understands normal two word input such as 'HIT DEMON', 'DROP BUCKET', 'KICK BUCKET'. Useful abbreviations are 'I' for inventory, and single letters for directions, e.g. 'N' for 'WALK NORTH'. Useful commands are 'LOOK', 'EXAMINE', 'LOAD', 'SAVE' and 'QUIT'. Load and save will need a blank cassette or formatted disc. Up to 10 games can be saved on one disc.

HINT

Only one hint I'm afraid – Don't be afraid to try the obvious!

```
EI 1 REM *****
XM 2 REM *      DEMON ADVENTURE      *
NO 3 REM *      by Adrian Cox      *
EB 4 REM *      *****      *
GM 5 REM * PAGE 6 Magazine - England *
EN 6 REM *****
DF 7 REM > INPUT ROUTINE ADAPTED FROM
EH 8 REM > EXPLORING ADVENTURES ON THE
YF 9 REM > ATARI 48K BY PETER GERRARD
MI 10 POKE 82,0:GRAPHICS 0:SETCOLOR 2,1,0
      :SETCOLOR 1,0,10:POKE 752,1:? "SETTING
      UP..."
BK 20 OPEN #1,4,0,"K:"
XT 30 VERBS=54:NOUNS=47
AR 40 DIM C$(27),A$(13),V$(4),N$(4),M$(
      4),O$(NOUNS),P$(34,6),X$(40),S$(15),C
      S$(17),OK$(4),ST$(13)
VK 50 S1$="Don't be silly.":C5$="You can'
      t see it.":OK$="O.K.":ST$="Strange ide
      a."
FZ 70 RESTORE 1000:FOR A=1 TO 34:FOR B=1
      TO 6:READ X:P(A,B)=X:NEXT B:NEXT A
VD 80 RESTORE 900:FOR A=1 TO NOUNS:READ X
      :O(A)=X:NEXT A
VH 90 CP=1:IN=0:DF=-1:DO=0:PL=0:CB=0
UF 100 GOSUB 1350
QH 110 IF DF>0 THEN DF=DF-1
TX 120 IF DF=0 THEN O(20)=CP
KH 130 TRAP 110
SV 140 IF DF=0 AND (CP<>33 OR CB=0) THEN
      ? :? "The demon catches you.":GOTO 700
CH 150 IF DF>0 THEN ? :? "You can hear th
      e demon moving."
EM 160 IF DF=0 AND CP=33 AND CB=1 THEN ?
      :? "The demon is unable to enter the c
      ircle.":
TH 170 GOSUB 240
NB 180 IF VB>19 THEN 210
IU 190 ON VB GOSUB 1240,1350,1870,1880,18
      90,2030,2070,2100,2180,2230,2230,2270,
      2330,2420,2510,2550,2730,2740,3330
LS 200 GOTO 110
GG 210 ON VB-19 GOSUB 3400,2840,2880,2900
      ,2960,3010,3080,3120,3190,3230,3280,35
      80
LW 220 GOTO 110
NX 230 END
CV 240 ? :C$="" :A$="" :I=1
MA 250 ? "What now?":
CO 260 ? "M+":
NU 270 GET #1,Z
OR 280 IF I=1 AND Z=32 THEN 270
IE 290 IF Z>127 AND Z<>155 AND Z<>156 THE
      N Z=Z-128:POKE 694,0
DC 300 IF Z<32 OR Z=127 THEN 270
MV 310 IF Z>95 AND Z<126 THEN Z=Z-32:POKE
      702,64
FL 320 IF Z=156 THEN C$="" :I=1:? "Q":GO
      TO 250
XL 330 A$=CHR$(Z)
IT 340 ZL=LEN(C$):IF ZL>26 THEN 360
ME 350 IF Z<>155 AND Z<>126 THEN C$(I,I)
      =A$:? A$:I=I+1:GOTO 260
```



DEMON ADVENTURE

```

TB 360 IF Z=155 AND ZL>0 THEN ? " ":I=1:
:GOTO 400
EL 370 IF Z=126 AND ZL>1 THEN ? " ":AS;AS
;:CMS=CMS(1,ZL-1):I=I-1:GOTO 260
NH 380 IF Z=126 AND ZL=1 THEN CMS="":I=1:
? " ":GOTO 250
OY 390 GOTO 260
CS 400 M1$="":M0$="":VBS="":VB=0:M0=0:CM=
LEN(CMS):H=0
KI 410 H=H+1:IF H>CM THEN H=CM:GOTO 430
IZ 420 IF CMS(H,H)<>" " THEN 410
GM 430 K=H:I=H:IF I>4 THEN I=4
ST 440 VBS=CMS(1,I)
JS 450 IF LEN(VBS)<4 THEN VBS=LEN(VBS)+1
=" ":GOTO 450
MZ 460 RESTORE 760:REM ****
LR 470 FOR A=1 TO VERBS
PA 480 READ M1$,V:IF M1$=VBS THEN VB=V:GO
TO 500
DK 490 NEXT A
AD 500 H=H+1:IF H<=CM THEN 530
XC 510 IF VB=0 THEN M0$=VBS:VB=1:I=1:GOTO
610
ZF 520 RETURN
YM 530 IF CMS(H,H)=" " THEN 510
UD 540 IF VB=0 THEN ? "I don't know how t
o ";CMS(1,K):GOTO 240
MC 550 I=H
SU 560 H=H+1:IF H>CM THEN H=CM:GOTO 500
PV 570 IF CMS(H,H)<>" " THEN 560
RQ 580 J=H:IF J-I>4 THEN J=I+4
HF 590 M0$=CMS(I,J)
SD 600 IF LEN(M0$)<4 THEN M0$=LEN(M0$)+1
=" ":GOTO 600
VC 610 RESTORE 900
XV 620 FOR A=1 TO NOUNS
ER 630 READ M1$:IF M1$=M0$ THEN M0=A:GOTO
650
DC 640 NEXT A
XV 650 IF H>CM THEN H=CM
YQ 660 IF M0=0 AND M0$<>" " THEN ? "I don'
t understand ";CMS(I,H):GOTO 240
WK 670 IF M0=13 AND OB(1)=0 THEN M0=30
IM 680 IF M0=15 AND OB(3)=0 THEN M0=20
ZU 690 RETURN
YQ 700 ? "You are dead."
ZR 710 ? "Play again (Y/N)?"
NF 720 GET M1,A:AS=CHR$(A)
WY 730 IF AS="N" OR AS="n" THEN POKE 752,
0:END
NT 740 IF AS="Y" OR AS="y" THEN RUN
PA 750 GOTO 720
JB 760 DATA GO ,1,WALK,1,ENTE,1,LOOK,2,L
,2
RM 770 DATA SCOR,3,HELP,4,GET ,5,TAKE,5
AM 780 DATA INVE,6,I ,6,PUT ,7,DROP,7
TL 790 DATA OPEN,8,CLOS,9,SHUT,9,DRIN,10
NJ 800 DATA EAT ,11,CUT ,12,SLAS,12,CHOP,
12
CW 810 DATA CLIM,1,LIGH,14,IGNI,14
SS 820 DATA ATTA,15,KILL,15,HIT ,15
SF 830 DATA EXAM,16,JUMP,17,DIG ,26
ZH 840 DATA PUSH,18,PULL,18,MOVE,18
PL 850 DATA SAVE,19,LOAD,20,REST,20
KZ 860 DATA SAY ,21,SHOU,21,YELL,21
QH 870 DATA RUM ,22,THRO,23,PLUC,24
VA 880 DATA BREA,25,SMAS,25,READ,13,SHOO,
27
WS 890 DATA FILL,28,MEND,29,REPA,29,FIX ,
29,POUR,30,BURN,14,QUIT,31,END ,31
KE 900 DATA M ,S ,E ,M ,U ,D
,MORT
BK 910 DATA SOUT,EAST,WEST,UP ,DOWN
TL 920 DATA BIRD,FEAT,BUCK,SPAD,NOTE,WOOD
QL 930 DATA ASHE,BOW ,ARRO,POLE,CHAL,KNIF
ML 940 DATA BOOK,SCRO,TORC,BUCK,WATE,BIRD
NX 950 DATA BIRC,DEMO,CHES,CURT,BED ,CRAT
NC 960 DATA CIRC,CORP,FIRE,LEVE,SUBS,PORT
IY 970 DATA WELL,TABL,SHEL,MITT,SYMB
FG 980 DATA 0,0,20,27,0,0,0,14,14,23,0,0,
18,0
NG 990 DATA 0,0,24,2,28,28,9,29,7,11,32,3
3,13,23,23,22,21,20,18,0,18
OY 1000 DATA 0,0,0,12,0,0,0,0,0,0,0,3
M5 1010 DATA 0,0,4,0,2,5,0,0,0,3,0,0
UM 1020 DATA 0,8,6,7,3,0,0,0,0,5,0,0
US 1030 DATA 0,9,5,0,0,0,5,10,0,0,0,16
NM 1040 DATA 7,0,10,0,0,0,0,11,9,12,0
ER 1050 DATA 0,0,0,10,0,0
UO 1060 DATA 0,0,1,0,13,10,0,0,0,0,12
AO 1070 DATA 0,15,0,0,0,0,14,16,0,0,0
ZG 1080 DATA 15,17,19,21,0,0,16,18,0,0,0
0
AG 1090 DATA 17,0,0,0,0,0,0,20,16,0,0
DO 1100 DATA 0,0,0,19,0,0,0,16,22,0,24
WF 1110 DATA 0,0,21,0,23,0,0,0,0,0,22
TP 1120 DATA 0,0,0,21,0,0,0,0,0,7,26
FV 1130 DATA 0,0,0,27,25,0,0,0,26,0,0
SY 1140 DATA 0,29,0,0,0,0,0,29,31,29,0,29
SA 1150 DATA 30,32,31,29,31,30,29,31,31,3
0,30,31
PK 1160 DATA 30,0,0,0,34,0,32,32,32,0,
0
AT 1170 DATA 0,0,0,0,11,32
SI 1180 DATA North,South,East,West,Up,Dow
n
JV 1190 DATA A dead bird,Some feathers,A
metal bucket,A spade,A note,A piece of
wood,Some ashes
MC 1200 DATA A bow,An arrow,A metal pole,
A piece of chalk,A knife,An ancient bo
ok,A parchment scroll
JC 1210 DATA A blazing torch,A bucket of
water,Water,Birds overhead,Bones,The d
emon,A wooden chest
SX 1220 DATA A grey curtain,A bed,A crate
,A chalk circle,A corpse,A signal fire
,A lever,A grey substance
FU 1230 DATA A portcullis,A well,A table,
A wooden shelf
EM 1240 IF M0=0 THEN ? "Where to?":RETURN
MF 1245 IF M0>12 AND M0<>37 THEN ? SI$:RE
TURN
LS 1250 IF M0=37 AND CP=33 THEN ? "You're
already there.":RETURN
GB 1260 IF M0=37 AND CP=32 THEN ? OK$:CP=
33:GOTO 1330
OM 1270 IF M0>6 THEN M0=M0-6
HT 1280 IF P(CP,M0)=0 THEN ? "You can't g
o that way.":RETURN
XO 1290 IF CP=28 AND DF=-1 AND M0=2 AND 0
B(20)<>0 THEN DF=2: ? "You hear movemen
t behind you."
IO 1300 CP=P(CP,M0): ? OK$
TY 1310 IF CP=100 THEN 3610
IZ 1320 OB(35)=OB(13)
VX 1330 IF CP=32 THEN OB(25)=32
XP 1340 IF CP=33 THEN OB(25)=33
GT 1350 ? "K";:IF (CP)24 AND CP(28) OR CP
>31 THEN SETCOLOR 2,0,0
ZT 1360 IF CP>27 AND CP<32 THEN SETCOLOR
2,3,0
HG 1370 IF CP<25 THEN SETCOLOR 2,1,0
PR 1380 IF CP>24 AND OB(15)<>-1 AND OB(15
)<>CP THEN ? "It's dark.":RETURN
YE 1390 GOSUB 1480+(CPM10)
QL 1400 ? !: "You can see!"
JK 1410 RESTORE 1190:QM=0
RE 1420 FOR A=1 TO 33:READ X$:IF OB(A)=CP
THEN ? X$:QM=1
AK 1430 NEXT A:IF QM=0 THEN ? "Nothing sp
ecial"
UN 1440 ? !: "You can go!"
JG 1450 RESTORE 1180:QM=0
EY 1460 FOR A=1 TO 6:READ X$:IF P(CP,A)<>
0 THEN ? X$; " ";QM=1
RB 1470 NEXT A:IF QM=0 THEN ? "Nowhere";
TP 1480 ? :RETURN
ML 1490 ? "You are in a small round tower
room.":RETURN
WX 1500 ? "You are on the roof of a tower
and can see for miles.":RETURN
XM 1510 ? "You are part way up a spiral s
tairstaircase.":RETURN
TM 1520 GOTO 1490
RX 1530 ? "You are at the north end of a
long hallway.":RETURN
BP 1540 ? "You are in a burnt out room, b
adly damaged by fire.":RETURN
ML 1550 ? "You are in the main bedroom, w
hich is indisarray.":RETURN
VW 1560 ? "You are by the main stairs in
the centreof the upper hallway.":RETUR
N
TY 1570 GOTO 1850
AC 1580 ? "You are at the south end of a
long hallway.":RETURN
BJ 1590 ? "You are in an old storage room
.:RETURN
PV 1600 GOTO 1510
PL 1610 GOTO 1500
SL 1620 GOTO 1830
OO 1630 ? "You are at the north end of th
e lower hallway.":RETURN
PT 1640 ? "You are by the main stairs in
the centreof the lower hallway.":RETUR
N
WK 1650 ? "You are at the south end of th
e lower hallway.":RETURN
GU 1660 ? "You are in the library where t
he Duke did research for his magical
experiments.":RETURN
RJ 1670 ? "You are in the banquet hall. T
here are deep grooves cut in the floo
r.":RETURN
XH 1680 ? "You are in the castle kitchen.
":RETURN
FN 1690 ? "You are in the courtyard surro
unded by the high walls of the castle
.":RETURN
TA 1700 ? "You are at the gate.":RETURN
FW 1710 ? "You are on the roof of the gat
e tower.":RETURN
JS 1720 ? "You are down the well. The wal
ls are cold and damp.":RETURN
VI 1730 ? "You are on a hidden stairway l
eading to a secret passage.":RETURN
EY 1740 ? "You are in a secret passage in
tended to be an escape route for the D
uke and his family.":RETURN
QG 1750 ? "You are in a tunnel which is b
locked by a rockfall.":RETURN
AJ 1760 ? "You are in the lair of the dem
on. You can feel an aura of evil.":R
ETURN
DS 1770 ? "You are in a maze of twisty tu
nnels withdamp, sticky, red walls.":RE
TURN
UT 1780 GOTO 1770
UW 1790 GOTO 1770
DK 1800 ? "You are in the cellar under th
e castle where the Duke carried out h
is magical experiments.":RETURN
MC 1810 ? "You are in the chalk circle. T
he ground is stained with blood.":RETU
RN
YQ 1820 ? "You are in a dark, damp tunnel
.":RETURN
ZJ 1830 ? "You are in the weapons room of
the castle where the Duke kept h
is collection of antique weap
ons."
BB 1840 RETURN
FE 1850 ? "You are in a panelled room. Th
e walls are covered with marks which
seem to"
NK 1860 ? "have been caused by the claws
of some great beast.":RETURN
TQ 1870 ? "100% for not being killed yet.
":RETURN
JE 1880 ? "Examine everything.":RETURN
LX 1890 IF M0<13 THEN ? SI$:RETURN
ZL 1900 M0=M0-12
ES 1910 IF OB(M0)=-1 THEN ? "You already
have it.":RETURN
AM 1920 IF OB(M0)<>CP THEN ? CS$:RETURN
SB 1930 IF M0=21 OR M0=23 OR M0=24 OR M0=
32 THEN ? "It's too heavy.":RETURN
CJ 1940 IF M0=33 THEN ? "It's fixed to th
e wall.":RETURN
VJ 1950 IF M0=27 THEN ? "It's too hot.":R
ETURN
DT 1960 IF M0=17 THEN ? "How?":RETURN
TL 1970 IF M0=20 THEN ? "The idea of the
game is to survive!":RETURN
SY 1980 IF M0=21 OR M0=29 OR M0=28 THEN ?
"As you reach towards it, the grey
substance reaches towards you."
VQ 1990 IF M0=21 OR M0=29 OR M0=28 THEN 7
00
AV 2000 IF M0>16 THEN ? "You can't take i
t.":RETURN
MJ 2010 IF IM=6 THEN ? "You're carrying t
oo much.":RETURN
BD 2020 OB(M0)=-1:IM=IM+1: ? OK$:RETURN
DT 2030 RESTORE 1190:QM=0: ? "You are carr
ying:"

```



```

TH 2040 FOR A=1 TO 16:READ X$:IF OB(A)=-1
  THEN ? X$:QM=1
JO 2050 NEXT A:IF QM=0 THEN ? "Nothing"
AS 2060 RETURN
LC 2070 IF NO<13 THEN ? SI$:RETURN
MM 2080 NO=NO-12:IF OB(NO)<>-1 THEN ? "Yo
u don't have it.":RETURN
GM 2090 IM=IN-1:OB(NO)=CP?:OK$:RETURN
KJ 2100 IF NO<13 THEN ? SI$:RETURN
MF 2110 NO=NO-12:IF OB(NO)<>CP AND OB(NO)
<>-1 THEN ? C$:RETURN
XB 2120 IF NO<>13 AND NO<>21 AND NO<>24 A
ND NO<>30 THEN ? "You can't open one o
f those.":RETURN
JN 2130 IF NO=13 THEN ? OK$:RETURN
QM 2140 IF NO=24 THEN ? "You try, but fai
l.":RETURN
AM 2150 IF NO=30 THEN ? "How?":RETURN
QJ 2160 IF OB(5)=0 THEN ? "You find somet
hing.":OB(5)=CP:RETURN
PM 2170 ? OK$:RETURN
LH 2180 IF NO<13 THEN ? SI$:RETURN
ND 2190 NO=NO-12:IF OB(NO)<>CP AND OB(NO)
<>-1 THEN ? C$:RETURN
BD 2200 IF NO<>13 AND NO<>24 AND NO<>21 A
ND NO<>30 THEN ? "You can't close one
of those.":RETURN
WJ 2210 IF NO=24 OR NO=30 THEN ? "It's no
t open.":RETURN
OZ 2220 ? OK$:RETURN
KU 2230 IF NO<13 THEN ? SI$:RETURN
MQ 2240 NO=NO-12:IF OB(NO)<>CP AND OB(NO)
<>-1 THEN ? C$:RETURN
GH 2250 IF UB=10 AND NO=17 THEN ? OK$:RET
URN
IM 2260 ? "You'll kill yourself...":RETUR
N
LG 2270 IF NO<13 THEN ? SI$:RETURN
NC 2280 NO=NO-12:IF OB(NO)<>CP AND OB(NO)
<>-1 THEN ? C$:RETURN
RA 2290 IF OB(12)<>-1 THEN ? "What with?"
:RETURN
FC 2300 IF NO<>22 THEN ? "No effect.":RET
URN
CB 2310 ? "The curtain shrivels and disap
pears."
QM 2320 OB(22)=0:P(29,1)=28:RETURN
KN 2330 IF NO<13 THEN ? SI$:RETURN
MS 2340 NO=NO-12:IF OB(NO)<>CP AND OB(NO)
<>-1 THEN ? C$:RETURN
XZ 2350 IF NO<>13 AND NO<>5 AND NO<>14 TH
EN ? ST$:RETURN
WV 2360 ? "It says..."
ZR 2370 IF NO=5 THEN ? "It is very close.
":RETURN
SI 2380 IF NO=14 THEN ? "Throw the remain
s of fire,":? "Burn the means of fligh
t,":? "Then say the word 'Mittam',"
XZ 2385 IF NO=14 THEN ? "To keep him out
of sight.":RETURN
MP 2390 ? "A demon must be destroyed by m
agic. All other methods will fail. The
book gives"
GY 2400 ? "Many reasons for this, all of
them far too technical to detail here
."
AL 2410 RETURN
KV 2420 IF NO<13 THEN ? SI$:RETURN
MR 2430 NO=NO-12:IF OB(NO)<>CP AND OB(NO)
<>-1 THEN ? C$:RETURN
NP 2440 IF NO<>6 AND NO<>2 AND NO<>13 AND
NO<>14 THEN ? ST$:RETURN
YB 2450 IF OB(27)<>CP AND OB(15)<>CP AND
OB(15)<>-1 THEN ? "What from?":RETURN
BL 2460 IF NO=6 THEN ? OK$:OB(15)=OB(6):O
B(6)=0:RETURN
TO 2470 ? "It burns, leaving no trace.":I
F OB(NO)=-1 THEN IM=IN-1
GG 2480 IF NO=2 AND CP=20 AND DF=-1 THEN
? "The demon is woken by the spell and
moves towards you...":GOTO 700
NA 2490 OB(NO)=0:IF NO=2 AND CP=33 AND DF
=0 THEN ? "Your surroundings blur mome
ntarily.":DO=DO+1:RETURN
AK 2500 RETURN
KU 2510 IF NO<13 THEN ? SI$:RETURN
MQ 2520 NO=NO-12:IF OB(NO)<>CP AND OB(NO)
<>-1 THEN ? C$:RETURN
UJ 2530 IF NO<>20 THEN ? ST$:RETURN
RO 2540 ? "You try, but nothing happens e
xcept...":GOTO 700
XF 2550 IF NO<13 THEN ? "You can see noth
ing from here.":RETURN
MC 2560 NO=NO-12:IF OB(NO)<>CP AND OB(NO)
<>-1 THEN ? C$:RETURN
FM 2570 IF NO=5 THEN ? "It's written in b
lood.":RETURN
TU 2580 IF NO=13 THEN ? "A book about dem
ons. There is a strange symbol on the
cover.":RETURN
CD 2590 IF NO=14 THEN ? "An ancient spell
.":RETURN
VQ 2600 IF NO=19 THEN ? "They are human."
:RETURN
V5 2610 IF NO=20 AND DF=-1 THEN ? "It is
totally motionless.":RETURN
KP 2620 IF NO=20 AND DF=0 AND CP=33 AND C
B=1 THEN ? "It is trying to enter the
circle.":RETURN
VE 2630 IF NO=25 AND CB=0 THEN ? "It's br
oken.":RETURN
IM 2640 IF NO=26 THEN ? "It's the Duke.":
RETURN
UP 2650 IF NO=28 AND OB(29)<>0 THEN ? "Th
e grey substance covers it.":RETURN
JE 2660 IF NO=29 THEN ? "It seems almost
alive.":RETURN
SF 2670 IF NO=22 THEN ? "It covers the no
rth exit.":NO=29:GOTO 2660
XV 2680 IF NO=32 AND OB(12)=0 THEN ? "You
find something.":OB(12)=CP:RETURN
EX 2690 IF NO=33 AND OB(14)=0 THEN ? "You
find something.":OB(14)=CP:RETURN
PL 2700 IF NO=24 THEN ? "It looks fairly
weak.":RETURN
NL 2710 IF NO=35 THEN ? "It is a circle w
ith eight arrows radiating from
it.":RETURN
GZ 2720 ? "You see nothing special.":RETU
RN
EW 2730 ? "Whee!":RETURN
LH 2740 IF NO<13 THEN ? SI$:RETURN
ND 2750 NO=NO-12:IF OB(NO)<>CP AND OB(NO)
<>-1 THEN ? C$:RETURN
RM 2760 IF (NO=28 AND OB(29)<>0) OR NO=22
OR NO=29 THEN 1910
UM 2770 IF NO=28 AND P(22,4)=0 THEN ? "Th
e portcullis is raised.":OB(30)=0:P(22
,4)=100:RETURN
EW 2780 IF NO<>23 AND NO<>24 THEN ? "Noth
ing happens.":RETURN
OY 2790 IF P(CP,6)<>0 THEN ? "Nothing hap
pens.":RETURN
CY 2800 ? "A secret passage is revealed."
EK 2810 IF NO=23 THEN P(CP,6)=25
EZ 2820 IF NO=24 THEN P(CP,6)=34
AZ 2830 RETURN
FB 2840 ? CHR$(34);CM$(I,H);CHR$(34)
ZE 2850 IF CP<>33 OR DO<>2 OR NO<>46 THEN
RETURN
XZ 2860 ? "As you complete the spell, the
demon fades from sight and disappe
ars."
NV 2870 OB(20)=0:DF=-1:OB(29)=0:RETURN
FL 2880 IF NO=0 THEN ? "Where to?":RETURN
GO 2885 IF DF<>-1 AND (NO<13 OR NO=37) TH
EN DF=DF+1
RE 2890 GOTO 1240
LP 2900 IF NO<13 OR OB(NO-12)<>-1 THEN 20
70
BE 2910 NO=NO-12:IF NO<>7 THEN 2090
TN 2920 IF CP<>33 OR DF<>0 THEN 2090
KH 2930 IM=IN-1
BH 2940 ? "It disappears when it hits the
edge of the circle."
RV 2950 OB(NO)=0:DO=DO+1:RETURN
LR 2960 IF NO<13 THEN ? SI$:RETURN
NN 2970 NO=NO-12:IF OB(NO)<>CP AND OB(NO)
<>-1 THEN ? C$:RETURN
AQ 2980 IF NO<>1 THEN ? ST$:RETURN
XB 2990 IF PL=1 THEN ? "You've already do
ne that.":RETURN
QR 3000 PL=1?:OK$:OB(2)=CP:RETURN
KL 3010 IF NO<13 THEN ? SI$:RETURN
MH 3020 NO=NO-12:IF OB(NO)<>CP AND OB(NO)
<>-1 THEN ? C$:RETURN
UK 3030 IF NO<>24 THEN ? "You fail misera
bly.":RETURN
FR 3040 IF OB(10)<>-1 THEN ? "You need to
use something stronger.":RETURN
VQ 3050 ? "It is smashed.":OB(24)=0:OB(6)
=11
QK 3060 IF P(11,6)=0 THEN ? "A secret pas
sage is revealed.":P(11,6)=34
AW 3070 RETURN
PT 3080 IF NO<>0 THEN ? SI$:RETURN
KB 3090 IF OB(4)<>-1 THEN ? "What with?":
RETURN
FW 3100 IF CP<>21 OR OB(11)<>0 THEN ? OK$:
RETURN
IC 3110 ? "You found something.":OB(11)=C
P:RETURN
KO 3120 IF NO<13 THEN ? SI$:RETURN
MM 3130 NO=NO-12:IF OB(NO)<>CP AND OB(NO)
<>-1 THEN ? C$:RETURN
AU 3140 IF NO=20 THEN 2510
WY 3150 IM=IN-1
BT 3160 IF NO<>18 THEN ? OK$:OB(9)=CP:RET
URN
BE 3170 ? "One of them is hit and falls.
The rest fly away."
LE 3180 OB(18)=0:OB(1)=CP:OB(9)=CP:RETUR
N
ME 3190 NO=NO-12:IF NO<>3 THEN ? SI$:RETU
RN
DW 3200 IF OB(3)<>CP AND OB(3)<>-1 THEN ?
"You don't have it.":RETURN
WR 3210 IF CP<>24 THEN ? "Nothing here to
put in it.":RETURN
KL 3220 OB(16)=OB(3):OB(3)=0?:OK$:RETURN
ZL 3230 NO=NO-12:IF NO<>25 THEN ? SI$:RET
URN
ID 3240 IF CB=1 THEN ? "Again?":RETURN
QC 3250 IF OB(11)<>-1 THEN ? "What with?"
:RETURN
TI 3260 IF CP<>32 AND CP<>33 THEN ? "You'
re not there.":RETURN
IQ 3270 ? OK$:CB=1:RETURN
AY 3280 NO=NO-12:IF NO<>17 THEN ? SI$:RET
URN
DQ 3290 IF OB(16)<>-1 AND OB(16)<>CP THEN
? "It's not here.":RETURN
YN 3300 OB(3)=OB(16):OB(16)=0
XP 3310 IF CP<>13 THEN ? "It runs away.":
RETURN
SG 3320 ? "The fire is put out.":OB(7)=CP
:OB(27)=0:RETURN
D5 3330 GOSUB 3470
W5 3340 OPEN #2,8,0,X$
IQ 3350 PUT #2,CP:PUT #2,IN:PUT #2,DF+1:P
UT #2,DO:PUT #2,PL:PUT #2,CB
BL 3360 FOR A=1 TO 33:PUT #2,OB(A)+1:NEXT
A
QU 3370 PUT #2,P(7,6):PUT #2,P(11,6):PUT
#2,P(29,1)
AU 3380 CLOSE #2:SOUND 0,0,0,0
BI 3390 RETURN
DL 3400 GOSUB 3470
UH 3410 OPEN #2,4,0,X$
LP 3420 GET #2,CP:GET #2,IN:GET #2,DF:GET
#2,DO:GET #2,PL:GET #2,CB:DF=DF-1
KO 3430 FOR A=1 TO 33:GET #2,P:OB(A)=P-1:
NEXT A
LM 3440 GET #2,P:P(7,6)=P:GET #2,P:P(11,6
)=P:GET #2,P:P(29,1)=P
NV 3450 CLOSE #2
QN 3460 GOTO 1330
OQ 3470 ? "Cassette or disk (C/D)?"
SV 3480 TRAP 3570
DI 3490 GET #1,A:A$=CHR$(A):IF A$="C" OR
A$="c" THEN X$="C":RETURN
MT 3500 IF A$<>"D" AND A$<>"d" THEN GOTO
3490
JM 3510 ? "Position (0-9)?"
GJ 3520 GET #1,A:IF A<0 OR A>57 THEN 352
0
BH 3530 X$="D:DEMON .SAU"
TR 3540 X$(8,8)=CHR$(A)
IO 3550 ? "Position ";A-48
BD 3560 RETURN
DC 3570 ? "ERROR":CLOSE #2:SOUND 0,0,0,0:
RETURN
QA 3580 ? "Are you sure (Y/N)?"
RA 3590 GET #1,A:A$=CHR$(A):IF A$="Y" OR
A$="y" THEN GOTO 710
AN 3600 RETURN
GL 3610 ? "CONGRATULATIONS":? "You have e
scaped.":GOTO 710

```

DAVE T'S DISCO

Welcome back to another music session from Dave T's Disco. Like last time Dave T's tune works in the VBI so you can run other programs or just type away while the music plays. With a little bit of programming you can even use the tunes in your own programs to make them really impressive.

Just type in the listing, make sure that you SAVE a copy first (*important!*) and then RUN it. Type NEW and the program will disappear but the music keeps on going. Great isn't it? As you enjoy these so much we will bring you just one more tune before the disco closes up and moves on. See you next issue!

```

EI 1 REM *****
FI 2 REM *          DAVID T'S DISCO          *
SU 3 REM *          OVERGROWTH            *
RR 4 REM *          by                      *
XS 5 REM *          David P. Thomas       *
ED 6 REM *          PAGE 6 Magazine - England *
GO 7 REM *          *****
EP 8 REM *          *****
NF 9 POKE 710,0:POKE 712,0:?"KPatience"
    .."
SB 10 FOR I=0 TO 3:SOUND I,0,0,0:NEXT I:P
    OKE 53768,5:FOR I=0 TO 20:POKE 120*256
    +I,0:NEXT I
OO 11 POKE 120*256,129
LJ 12 POKE 120*256+5,163
FI 13 POKE 120*256+4,0
NJ 14 POKE 120*256+7,0
MO 15 POKE 120*256+8,163
LU 16 REM *****
LT 17 REM VBI AUDIO DESIGNS FROM DT06
LY 18 REM *****
SA 19 I=0
LC 20 READ Q:IF Q(<)-1 THEN POKE 1536+I,0:
    I=I+1:GOTO 20
LJ 30 DATA 162,100,160,0,169,7,32,92,228,
    104,96,-1
SI 99 I=0
ES 100 READ Q:IF Q(<)-1 THEN POKE 100*256+
    I,0:I=I+1:GOTO 100
KO 101 DATA 32,0,101
LI 102 DATA 32,0,102
AM 111 DATA 174,0,120,202,142,0,120,142,7
    ,210
CX 125 DATA 173,3,120,105,255,141,3,120,1
    ,210
RO 130 DATA 224,120,240,3,76,98,228
RA 140 DATA 162,132,142,0,120
IV 150 DATA 174,2,120,232,142,2,120
WB 160 DATA 189,100,120,141,3,120
GZ 170 DATA 224,16,240,3,76,98,228,-1
QH 180 DATA 162,0,142,2,120,76,98,228,-1
GB 200 REM *****
QT 250 FOR I=1 TO 16:READ Q:POKE 120*256+
    100+I,0:NEXT I
ZM 270 DATA 0,0,0,30,5,5,5,50,10,10,10,30
    ,5,5,15,50
FE 300 I=0
MK 310 READ Q:IF Q(<)-1 THEN POKE 101*256+
    I,0:I=I+1:GOTO 310
UL 320 DATA 174,4,120,232,142,4,120,224,1
    ,240,1,96
SL 330 DATA 162,0,142,4,120,174,5,120,202
    ,142,5,120,142,1,210
NR 340 DATA 224,162,240,1,96
ML 349 DATA 162,170,142,5,120
PJ 350 DATA 174,6,120,232,142,6,120
YT 360 DATA 189,0,115,141,0,210,105,1,141
    ,4,210,109,0,116,141,0,101
LM 370 DATA 224,195,240,1,96
AA 380 DATA 162,0,142,6,120,96,-1
FM 390 I=0
TN 400 RESTORE 420
KS 410 READ Q,M:IF Q(<)-1 THEN POKE 115*25
    6+I,0:POKE 116*256+I,M:I=I+1:GOTO 410
BI 420 DATA 0,0
UM 430 DATA 227,1,191,1,171,2,171,2,191,1
    ,227,1
VO 440 DATA 227,1,191,1,171,2,171,2,191,1
    ,227,1
VO 450 DATA 227,1,191,1,171,2,171,2,191,1
    ,227,1
US 460 DATA 227,1,191,1,171,2,171,2,191,1
    ,227,1
LA 500 DATA 227,1,203,1,191,1,171,1,151,1
    ,135,1,127,1,113,1
ZT 510 DATA 151,1,151,1,151,1,151,1,151,1
    ,151,1,151,1,151,1
TN 520 DATA 171,1,171,1,171,1,171,1,171,1
    ,171,1,171,1,171,1
GV 530 DATA 113,1,113,1,113,1,113,1,113,1
    ,113,1,113,1,113,1
IB 540 DATA 151,1,151,1,171,1,171,1,191,1
    ,191,1,203,1,203,1
AB 550 DATA 151,1,151,1,151,1,151,1,151,1
    ,151,1,151,1,151,1
TU 560 DATA 171,1,171,1,171,1,171,1,171,1
    ,171,1,171,1,171,1
HD 570 DATA 113,1,113,1,113,1,113,1,113,1
    ,113,1,113,1,113,1
IJ 580 DATA 151,1,151,1,171,1,171,1,191,1
    ,191,1,203,1,203,1
VI 600 DATA 227,1,191,1,171,2,171,2,191,1
    ,227,1
VK 610 DATA 227,1,191,1,171,2,171,2,191,1
    ,227,1
UM 620 DATA 227,1,191,1,171,2,171,2,191,1
    ,227,1
VO 630 DATA 227,1,191,1,171,2,171,2,191,1
    ,227,1
YL 710 DATA 253,1,253,1,253,1,253,1,203,1
    ,203,1,203,1,203,1,191,1,191,1,191,1,1
    ,91,1,171,1,171,1,171,1,171,1
YM 720 DATA 253,1,253,1,253,1,253,1,203,1
    ,203,1,203,1,203,1,191,1,191,1,191,1,1
    ,91,1,171,1,171,1,171,1,171,1
YP 730 DATA 253,1,253,1,191,1,191,1,191,1,1
    ,203,1,203,1,203,1,191,1,171,1,171,1
YR 740 DATA 253,1,253,1,253,1,253,1,203,1
    ,203,1,203,1,203,1,191,1,191,1,191,1,1
    ,91,1,171,1,171,1,171,1,171,1
YT 750 DATA 253,1,253,1,253,1,253,1,203,1
    ,203,1,203,1,203,1,191,1,191,1,191,1,1
    ,91,1,171,1,171,1,171,1,171,1
    
```



```

YV 760 DATA 253,1,253,1,253,1,253,1,203,1
    ,203,1,203,1,203,1,191,1,191,1,191,1,1
    ,91,1,171,1,171,1,171,1,171,1
UK 800 DATA 227,1,191,1,171,2,171,2,191,1
    ,227,1
UM 810 DATA 227,1,191,1,171,2,171,2,191,1
    ,227,1
VO 820 DATA 227,1,191,1,171,2,171,2,191,1
    ,227,1
VQ 830 DATA 227,1,191,1,171,2,171,2,191,1
    ,227,1
ZC 999 DATA -1,-1
IG 1000 POKE 25918,I-1
UT 2000 I=0
IS 2001 RESTORE 2011
NL 2010 READ Q:IF Q(<)-1 THEN POKE 102*256
    +I,0:I=I+1:GOTO 2010
CR 2020 DATA 174,17,120,232,142,17,120
KL 2021 DATA 224,2,240,9
OM 2022 DATA 174,15,120,142,2,210,76,31,1
    ,02,174,16,120,142,2,210,162,0,142,17,1
    ,20
HI 2030 DATA 174,7,120,232,142,7,120,224,
    1,240,1,96,162,0,142,7,120
UL 2040 DATA 174,0,120,202,142,0,120,142,
    3,210,224,162,240,1,96
PB 2050 DATA 162,170,142,0,120,174,9,120,
    232,142,9,120
JI 2060 DATA 189,0,117,141,15,120,109,0,1
    ,10,141,16,120,109,0,119,141,39,102
NB 2070 DATA 224,4,240,1,96
KS 2080 DATA 162,0,142,9,120,96,-1
SU 2200 DATA 105,1,105,1,119,1,143,1,159,
    1,179,1,211,1,239,1
SY 2201 DATA 105,1,105,1,119,1,143,1,159,
    1,179,1,211,1,239,1
UU 3000 I=0
JG 3001 RESTORE 3020
FD 3010 READ M,Q,S:IF W(<)-1 THEN POKE 117
    *256+I,M:POKE 110*256+I,Q:POKE 119*256
    +I,S:I=I+1:GOTO 3010
AV 3020 DATA 0,0,0
HY 3030 DATA 57,57,0,57,57,0,57,57,0,57,5
    7,1,57,57,1,57,57,1,57,57,1,57,57,1,57
    ,57,1,57,57,1,57,57,1
MG 3100 DATA 15,10,8
EZ 3110 DATA 10,10,1,15,15,2,15,15,1,16,1
    6,2,10,10,1,15,15,1
FC 3120 DATA 10,10,1,15,15,2,15,15,1,16,1
    6,2,10,10,1,15,15,1
DQ 3130 DATA 10,10,1,15,15,2,15,15,1,16,3
    3,2,10,10,1,15,15,1
BH 3140 DATA 10,10,1,10,10,1,10,10,1,10,1
    0,1,10,10,1,10,10,1,10,10,1,10,10,1
FL 3150 DATA 10,10,1,15,15,2,15,15,1,16,1
    6,2,10,10,1,15,15,1
FD 3160 DATA 10,10,1,15,15,2,15,15,1,16,1
    6,2,10,10,1,15,15,1
EC 3170 DATA 10,10,1,15,15,2,15,15,1,16,3
    3,2,10,10,1,15,15,1
BT 3180 DATA 10,10,1,10,10,1,10,10,1,10,1
    0,1,10,10,1,10,10,1,10,10,1,10,10,1
HU 3300 DATA 57,57,0,57,57,0,57,57,0,57,5
    7,1,57,57,1,57,57,1,57,57,1,57,57,1,57
    ,57,1,57,57,1,57,57,1
WB 3410 DATA 31,32,1,42,43,2,63,64,1,63,6
    4,2,42,43,2
ME 3420 DATA 31,32,1,42,43,2,63,64,1,63,6
    4,2,42,43,2
NI 3421 DATA 31,32,1,42,43,2,63,64,1,63,6
    4,2,42,43,2
MM 3422 DATA 31,32,1,42,43,2,63,64,1,63,6
    4,2,42,43,2
YK 3430 DATA 63,64,0
IX 3440 DATA 15,15,1,7,7,1,15,15,1,7,7,1,
    15,15,1,15,15,1,7,7,1,15,15,1
JA 3450 DATA 15,15,1,7,7,1,15,15,1,7,7,1,
    15,15,1,15,15,1,7,7,1,15,15,1
JD 3460 DATA 15,15,1,7,7,1,15,15,1,7,7,1,
    15,15,1,15,15,1,7,7,1,15,15,1,7,7,1,
    15,15,1,15,15,1,7,7,1,15,15,1,7,7,1,
    15,15,1,15,15,1,7,7,1,15,15,1
MN 3480 DATA 31,32,1,42,43,2,63,64,1,63,6
    4,2,42,43,2
NA 3481 DATA 31,32,1,42,43,2,63,64,1,63,6
    4,2,42,43,2
KE 3482 DATA 31,32,1,42,43,2,63,64,1,63,6
    4,2,42,43,2
OY 3500 DATA 57,57,0,57,57,0,57,57,0,57,5
    7,1,57,57,1,57,57,1,57,57,1,57,57,1,57
    ,57,1,2,3,2
QH 3999 DATA -1,-1,-1
PG 4000 POKE 26200,I-1:M=USR(1536)
LM 5000 GRAPHICS 0:SETCOLOR 2,0,0:SETCOLOR
    R 1,0,12
JI 5010 ? "OVERGROWTH."
EJ 5020 ? "from Dave T 1986"
    
```

THE SHELL SORT

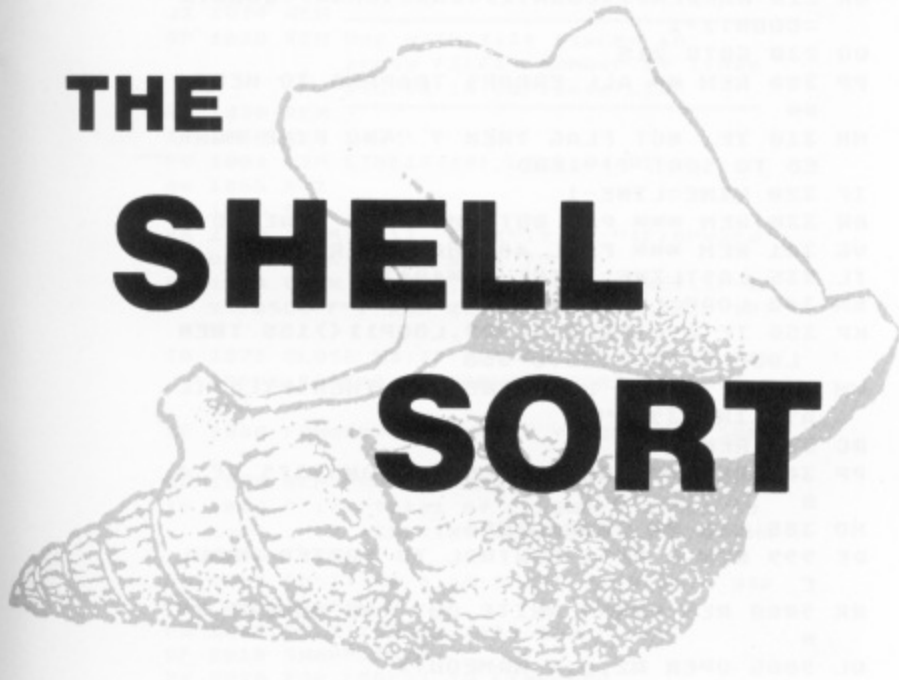

Gordon Cameron returns to explain a more sophisticated sort

In Issue 32 I described the use of the Bubble Sort. It is most useful for the sorting of small lists of data, and for these sizes, it will often outperform many of the more sophisticated sort routines, which need to do more bookkeeping. As the size of the list to be sorted increases, however, so does the usefulness of other types of sort. For large lists, these are much faster and more efficient than the simple Bubble Sort.

The main problem with the Bubble sort is that although values move quickly in one direction, they may move very slowly in the other. Another way of thinking of this problem is that the largest out of place value in the list or sub-list being currently sorted moves quickly to where it should be, whilst the other values move more slowly, often 1 'space' at a time. For even moderately large lists, this makes the Bubble sort inefficient.

A MORE EFFICIENT SORT

The Shell sort was invented by Donald Shell, and instead of comparing ADJACENT items, as in the bubble sort, it compares items with other items a fixed gap away i.e. it compares (and if necessary, exchanges) value X with X + GAP. Using this method, it can be seen that values out of place will move faster in the 'right direction' than with the simple Bubble Sort, which always uses a gap of 1. When no more exchanges can be done with the current gap, it is reduced, and the process continues in a similar manner. The later passes, with smaller gaps thus have less 'work' to do. The final gap is 1, and this procedure is the basic Shell sort idea.

Now is as good a time as any to introduce some jargon. A sequence is said to be 'h-sorted' if, starting at any point, selecting every h'th value yields a sorted sequence. This means, in simple terms, that if, for example that h = 3, then the 1st value is less than the 4th which is less than the 7th etc. Also, the 2nd value is less than the 5th, the 3rd less than the 6th, and so on. An example of a sequence which is 3-sorted is:-

(1 6 10 3 12 11 14 13 12 16 15 14)

As can be easily seen, this '3-sorted' sequence has 3 individual sorted sequences i.e. (1 3 14 16), (6 12 13 15) and (10 11 12 14). In general, an h-sorted sequence has h sorted sub-sequences. Pheww..!

What this means is that the Shell sort actually h-sorts the given sequence with a given value of h. Then the value of h is decreased, and the process continues. In fact, the value of h is decreased by dividing it by a certain constant number at each turn, ignoring the remainder. We finish off with a value of 1, which in effect compares each number with its neighbour. Sounds familiar?? It should do, as this final gap of 1 is very similar to the technique employed in the simple Bubble Sort. All we have to do is choose the starting value for h (the GAP), and the number that we successively divide by.

LET'S TRY AND SIMPLIFY IT

To simplify matters, in my program and example, I have taken a starting value for the gap which is equal to half the length of the sequence. Consecutive gaps are calculated by taking the old gap, and dividing by two (ignoring the remainder). So starting $GAP = INT(Length/x)$, and the following gaps are calculated using $GAP = INT(GAP/x)$, where x is 2. (You may experiment with different values of x, in line 1065. As I mentioned, this is a slight oversimplification, as there are certain sequences of h values or gaps that are known to work well. However, there are an infinite variety of these, and some work better than others, though nobody really knows why. If you are interested, there are many books on the subject..).

AN EXAMPLE SORT

The Shell sort is quite easy to use once you understand the theory, but, if you are like me and prefer hard, concrete examples, read on.

The programs work with characters, but for this example I will use numbers, as the technique is more easily demonstrated in this fashion. I will start with the following sequence, which I will sort into ascending order.

(9 5 8 3 2 1)

The length of the sequence is 6 and in the examples the values which are being compared are in bold, and the arrowhead -> denotes a new list formation, if appropriate.

```

W0 1 REM *****
KE 2 REM * FILE ENTER PROGRAM *
KR 3 REM * for SORT ROUTINES *
TE 4 REM * by Gordon Cameron *
SR 5 REM * ----- *
RQ 6 REM * PAGE 6 Magazine - England *
WU 7 REM *****
AH 10 DIM FILE$(10000),NAMEIN$(14),NAMEOUT$(14),GARBST$(1000),GARBEND$(1000),TEMP$(40)
PT 15 FILE$=" ":GARBST$="":GARBEND$="":COUNT1=1:COUNT2=2:NUM=1:LINE=1:FLAG=0
KU 20 GRAPHICS 0:POKE 752,1:POKE 82,0
JD 25 ? "K":COLOR 160:PLOT 1,2:DRAWTO 38,2:DRAWTO 38,21:DRAWTO 1,21:DRAWTO 1,1
LZ 30 POSITION 6,6:? "Please enter source filename":POSITION 3,7:? "Please include identifier(e.g D1:)":POSITION 8,8
KG 35 INPUT NAMEIN$
YS 40 POSITION 6,11:? "Please enter source filename":POSITION 3,12:? "Please include identifier(e.g D1:)"
UQ 45 POSITION 8,13:INPUT NAMEOUT$
LR 50 PLOT 1,1
DR 100 REM ** ENTER FILE USING GET **
KM 110 TRAP 300
AQ 120 OPEN #1,4,0,NAMEIN$
SH 121 REM ** READ IN START GARBAGE *
RR 123 GET #1,GARBST
DV 124 GARBST$(COUNT1)=CHR$(GARBST):COUNT1=COUNT1+1
BT 125 IF GARBST<>36 THEN 123
VZ 126 REM **** READ IN FILE TO ****
***** BE SORTED ****
LK 127 GET #1,DUMMY:FLAG=1
CQ 128 REM *** NUM IS THE POSITION ALONG THE LINE - LINE IS THE LINE NO. ****
OT 129 POSITION 13,18:? "Reading line 1"
RD 130 GET #1,CHAR
WU 135 IF CHAR=ASC("^") THEN GARBEND$(1)="^":GOTO 200
FV 140 IF CHAR=155 OR NUM=40 THEN 150
TV 145 FILE$((LINE-1)*40+NUM)=CHR$(CHAR):NUM=NUM+1:GOTO 130
EY 150 FILE$((LINE-1)*40+NUM)=CHR$(155):N

```

```

UM=1:LINE=LINE+1:POSITION 26,18:? LINE
:GOTO 130
PY 200 REM *** READ IN END GARBAGE ***
RP 215 GET #1,CHAR
UK 220 GARBEND$(COUNT2)=CHR$(CHAR):COUNT2=COUNT2+1
OQ 230 GOTO 215
PP 300 REM ** ALL ERRORS TRAPPED TO HERE **
HH 310 IF NOT FLAG THEN ? "KNO FILE MARK ED TO SORT !":END
IF 320 LINE=LINE-1
AR 330 REM *** PAD OUT THE LAST LINE TO
VG 331 REM *** FILL 40 CHARACTERS ...
TL 335 LASTLINE=(LINE-1)*40+1
NM 340 LOOP=LASTLINE
KP 350 IF ASC(FILE$(LOOP,LOOP))<>155 THEN LOOP=LOOP+1:GOTO 350
WM 360 IF (LOOP-LASTLINE)<39 THEN FILE$(LASTLINE+39)=" "
RC 370 REM
PP 380 REM ** NOW LAST LINE CONSISTS OF 40
XO 385 REM ** CHARACTERS
DE 999 REM * PASS CONTROL TO SORTER MODULE
NK 9000 REM ***** WRITE OUT THE OBJECT **
*
QL 9005 OPEN #2,8,0,NAMEOUT$
LS 9010 FOR A=1 TO COUNT1-1
HK 9020 CHAR=ASC(GARBST$(A,A))
GT 9030 PUT #2,CHAR
BZ 9040 NEXT A
JA 9045 PUT #2,155
PX 9050 FOR B=1 TO LINE
VH 9055 C=1
LZ 9060 CHAR=ASC(FILE$((B-1)*40+C))
HF 9070 PUT #2,CHAR
GZ 9080 IF CHAR<>155 THEN C=C+1:GOTO 9060
CZ 9090 NEXT B
NR 9100 FOR D=1 TO COUNT2-1
NZ 9110 CHAR=ASC(GARBEND$(D,D))
GS 9120 PUT #2,CHAR
DF 9130 NEXT D
LH 9200 ? "KFINISHED !..."
HG 9210 CLOSE #1:CLOSE #2:POKE 752,0:END

```

We start with $GAP = INT(6/3) = 2$

```

1) 958321
   -> 358921
2) 358921
   -> 328951
3) 328951
   -> 321958

```

In this pass, we *have* executed exchanges, so we must repeat the pass with the same gap.

```

1) 321958
2) 321958
3) 321958

```

We have no exchanges with this pass and gap, so we reduce the gap. Notice that the sequence is now 3-sorted i.e. (3 9), (2 5) and (1 8).

The new gap will now be $GAP = INT(3/2) = 1$

```

1) 321958
   -> 231958
2) 231958
   -> 213958
3) 213958
4) 213958
   -> 213598
5) 213598
   -> 213589

```

We must repeat this process, as swaps have occurred in this pass.

The only swap which will take place in the next pass is the 2 with the 1. The sequence is now fully sorted, but it will take the program one more pass to recognise that there are no more exchanges needed. The final sorted sequence is

(1 2 3 5 8 9)

This process takes 8 swaps in total, compared with the Bubble sort which takes 14, but completes the process with less total comparisons.

DIFFERENCES IN SPEED

The example above is a little contrived, as most sequences are a lot larger. In general, for small sequences such as the above, the difference in time and efficiency between the two sort routines is negligible, but as size increases, the Shell Sort becomes considerably better. For 100 items, the difference is substantial, while for around 1000, the Shell sort may be up to 10 times faster. I did a short test using my bubble and shell routines using 106 lines, each containing a couple of words. The Shell sort took 65 seconds, made 2566 comparisons and 395 swaps, whereas the Bubble sort took 219 seconds, and made 5474 comparisons and 2653 swaps. Note the large difference in number of swaps. (N.B. These tests were conducted using Turbo-Basic, which is much faster than standard Atari basic).

```

PW 1000 REM *****
RP 1010 REM * SHELL SORT MODULE *
NC 1011 REM * by Gordon Cameron *
MK 1012 REM * PAGE 6 Magazine England *
QL 1013 REM *****
JZ 1014 REM
OP 1020 REM Use with file stored in
array FILE$. Number of lines
stored in variable LINE

KH 1030 REM
IO 1060 REM
FV 1064 DIM LINE1$(40),LINE2$(40)
AG 1065 X=2
JM 1066 REM
RX 1070 ? "KShell Sort":? :? "(F)orward
or (B)ack Alpha sort ?"
UV 1074 OPEN #3,4,0,"K":GET #3,KEY:IF KE
Y(>ASC("F")) AND KEY(>ASC("B")) THEN 107
4
TB 1075 CLOSE #3:IF KEY=ASC("F") THEN FRW
ARD=1:BACK=0:? "FORWARD SORT.":GOTO 2
000
AE 1080 FORWARD=0:BACK=1:? "BACKWARDS SORT
.."
HG 1090 REM **** COMMENCE THE SORT ****
IP 2000 ? :? "Total of ";LINE;" lines to
sort.":? :GAP=INT(LINE/X):TRIES=0:SWA
P5=0
FH 2003 POSITION 6,10:PRINT "Trying a gap
of ";GAP;"."
FN 2005 POSITION 22,10:? GAP;" "
OF 2010 SWAPFLAG=0
RY 2020 FOR LOOP=1 TO LINE-GAP
MB 2030 LINE1$=FILE$((LOOP-1)*40+1,LOOP*4
0)
MS 2040 LINE2$=FILE$((LOOP+GAP-1)*40+1,(L
OOP+GAP)*40)
SD 2050 IF FRWARD AND LINE1$>LINE2$ THEN
GOSUB 3000
BE 2060 IF BACK AND LINE1$<LINE2$ THEN GO
SUB 3000
BB 2070 TRIES=TRIES+1
EH 2090 NEXT LOOP:IF SWAPFLAG THEN 2010
UY 2091 GAP=INT(GAP/X):IF GAP>0 THEN 2005
JA 2095 POSITION 6,12:? TRIES;" comparison
ns.":POSITION 6,13:? SWAPS;" swaps."
KC 2096 POSITION 9,20:? "ANY KEY TO SAVE
":OPEN #3,4,0,"K":GET #3,KEY:CLOSE #
3:GOTO 5000
VO 2099 REM ***** SWAP TWO VALUES *****
UR 3000 REM ***** FOR SHELL SORT *****
ZQ 3010 FILE$((LOOP-1)*40+1,LOOP*40)=LINE
2$
ID 3020 FILE$((LOOP+GAP-1)*40+1,(LOOP+GAP
)*40)=LINE1$
WS 3030 LINE1$="":LINE2$=""
EZ 3035 SWAPS=SWAPS+1:SWAPFLAG=1
AN 3040 RETURN

```

```

PW 1000 REM *****
BD 1010 REM * BUBBLE SORT MODULE *
NC 1011 REM * by Gordon Cameron *
MK 1012 REM * PAGE 6 Magazine England *
QL 1013 REM *****
JZ 1014 REM
OP 1020 REM Use with file stored in
array FILE$. Number of lines
stored in variable LINE

KQ 1060 REM
FV 1064 DIM LINE1$(40),LINE2$(40)
JM 1066 REM
YH 1070 ? "KBubble Sort":? :? "(F)orward
or (B)ack Alpha sort ?"
UV 1074 OPEN #3,4,0,"K":GET #3,KEY:IF KE
Y(>ASC("F")) AND KEY(>ASC("B")) THEN 107
4
TB 1075 CLOSE #3:IF KEY=ASC("F") THEN FRW
ARD=1:BACK=0:? "FORWARD SORT.":GOTO 2
000
AE 1080 FORWARD=0:BACK=1:? "BACKWARDS SORT
.."
HG 1090 REM **** COMMENCE THE SORT ****
PT 2000 ? :? "Total of ";LINE;" lines to
sort.":?
YC 2003 POSITION 6,10:? "'Outer' Loop Cou
nt is ":POSITION 6,11:? "'Inner' Loop
Count is "
AA 2004 SWAPS=0:TRIES=0
BC 2005 FOR LOOP=LINE-1 TO 1 STEP -1:SWAP
FLAG=0
KY 2006 POSITION 29,10:? LOOP;" "
JI 2010 FOR LOOP2=1 TO LOOP
VT 2020 POSITION 29,11:? LOOP2;" ":TRIE
S=TRIES+1
RI 2030 LINE1$=FILE$((LOOP2-1)*40+1,LOOP2
*40)
QI 2040 LINE2$=FILE$(LOOP2*40+1,(LOOP2+1)
*40)
SD 2050 IF FRWARD AND LINE1$>LINE2$ THEN
GOSUB 3000
BE 2060 IF BACK AND LINE1$<LINE2$ THEN GO
SUB 3000
YP 2070 NEXT LOOP2
KT 2080 IF NOT SWAPFLAG THEN 2095
VZ 2090 NEXT LOOP
JA 2095 POSITION 6,13:? SWAPS;" swaps mad
e.":POSITION 6,14:? TRIES;" comparison
s made."
JL 2096 POSITION 9,20:? "PRESS ANY KEY T
O SAVE":OPEN #3,4,0,"K":GET #3,KEY:C
LOSE #3:GOTO 5000
VO 2099 REM ***** SWAP TWO VALUES *****
LB 3000 SWAPFLAG=SWAPFLAG+1:SWAPS=SWAPS+1
MB 3010 FILE$((LOOP2-1)*40+1,LOOP2*40)=LI
NE2$
JQ 3020 FILE$(LOOP2*40+1,(LOOP2+1)*40)=LI
NE1$
WS 3030 LINE1$="":LINE2$=""
AN 3040 RETURN
ZQ 5000 REM **** END OF SORT -WRITE
TO DISK *****
VL 5010 ? "KSaving...Please Wait..."

```

USING THE PROGRAMS

There are three listings with the article. The Shell sort and Bubble sort (revised) modules plus a loader. Type in and save these as you would a normal program. The Loader program should be ENTER'ed to merge with the sort you are using or, if you prefer you may type in each sort and loader at the same time and SAVE normally. If you wish to make practical use of the programs, I suggest removing the PRINT statements, as these slow down the processes considerably.

Just a reminder on how to use the program which was explained in the last article. The loader works on files which have lines of maximum length 39, terminated by RETURN. The segment to be sorted must be started with a \$ sign, and end with a ^ (up arrow) sign, both followed by Carriage Returns. You can use Mini Office II, Superscript or whatever, and the program will sort the source file, and write it to disk so that it can be loaded by these word processors. Alternatively, you can use your own programs to write the file.

The sorter modules look for an array FILE\$ which contains the text to be sorted. Each line occupies 40 characters. Hence, you can incorporate these routines into your programs with little modification, to sort whatever you wish, however if you do not want to modify the program, the loader and sorter modules will do all the work for you, so don't worry.

If you are interested, then you may try using an index array which contains references to the main array of text. Swaps are done on THIS array, and not the file itself, and when the file is output the index array is worked through sequentially, and the relevant line of text output. This method is much more flexible, but I leave it to you to try!

Finally, a small tip. If you wish to output the sorted file to the screen, type E: at the prompt for an object file.

Well that's it for this issue. The Shell sort is simple to apply, but for large sequences is a lot more efficient than the Bubble sort. The Quick sort is even more efficient and faster, and this I will hopefully be able to describe in a forthcoming issue!

If you have any problems with the programs, consult Issue 32 of PAGE 6, or write to me at 13 Muir Bank, Scone, Perthshire, Scotland.

References:

Introduction to Pascal 2nd edition by Neill Graham
Computer Algorithm and Methods by S.P. Townsend

Mark Hutchinson's

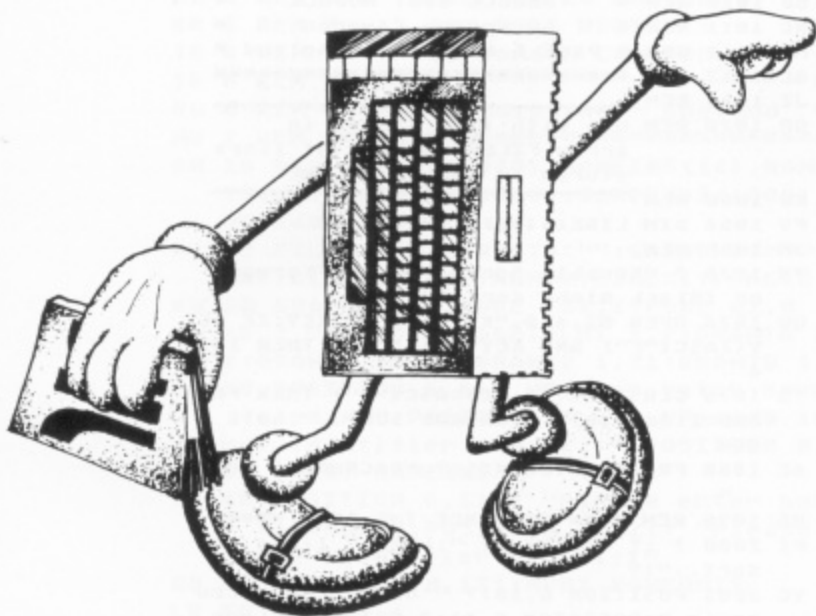

FIRST STEPS

For some reason the readers of this column have been very reticent about writing to let me know what they would like explained, so I will indulge myself with something that has always fascinated me.

Over the past few years, I have had several letters asking me about backup programs. Quite a few people have been mystified as to why DOS, which has a duplicate disk option, cannot copy bought software. I will give you an explanation of how some protection schemes work, but not how to crack them, and about some floppy nasties.

PROTECTION TECHNIQUES

The ATARI drives have a special chip onboard that will read different types of format when told what to look for. It normally cannot write these formats directly and a hardware modification is needed. Software copiers are limited nowadays in what they can do and chip modifications are not cheap.

When ATARI software first appeared, the main protection was the non listable file. This was done by disabling the Break key and System Reset. The way around this was by forcing an untrapped error. A trapped error will rerun from some point within the program but an untrapped error will go to a GRAPHICS 0 screen as normal. By hiding the variables and directory listing, and by compiling Basic programs the listing was kept secret.

Next came the bad sector. This sector had bad data, either by recording at a very high or low speed or scrambling the data by moving the disk during write operation. Later the sector number was removed. This protection was bad for the motors as the drive would continuously try to read or find the sector until time-out, giving out that dreadful noise called 'snarking'. It was finally, and thankfully, superseded. As a protection, it was cracked easily and quickly, except for one software house which made every other sector bad. Try spotting the necessary one out of 360!

Then, all at once, came better and more advanced techniques.

BAD DATA MARKS – Data marks are used to identify the type of data to be found in the sector. Anything other than \$FB is classed as bad data.

CRC ERROR – This is when the cyclic redundancy check does not match the data on a sector.

DUPLICATE SECTORS – When two sectors have the same ID number.

FUZZY or UNSTABLE SECTORS – The data on these sectors seem to change constantly. Also known as phantom sectors.

SHORT SECTORS – Those with less than the normal 128 bytes of data.

OVERFILLED TRACKS – More than the normal 18 sectors per track.

The last four methods are extremely hard to overcome, yet the overfilled track was easily cracked by the old technique of slowing the drive. This could squeeze in about three extra sectors. Hardware mods were still needed to overcome duplicate sectors. A track with a mixture of the above is very hard to crack, but some companies had pre-defined tracks as part of the copy software. This is easily defeated if the packages have protection sectors moved by one sector.

Probably the hardest to crack is the dongle, or hardware key. This is an encapsulated ROM, plugged into an I/O port and read by the program. It will normally self destruct when opened or any attempt is made to read it. A bit too high tech for the ATARI? Not if it is PAPER CLIP from Batteries Included!

A FEW NASTIES YOU MAY ENCOUNTER

We have all read about 'hackers' who break into systems. Many do it to see how far they can get, the cheeky ones leaving messages to say how they did it. Some just break in to loot data, however a few are really evil and will try to destroy the data. Up until recently, many BBS's were not buffered and lost all their programs through such destructive hackers. Even worse was to follow.

WARNING – Downloading from a BBS can be very dangerous to the health of your system! Many programs contain in-built routines to copy themselves onto other disks and multiply. They are often loaded onto a BBS with some interesting name, but with a nasty bit inside. Such a program is called a Trojan Horse, but is more often referred to as a virus and will quietly stay on your disk and then suddenly, and without warning, start to corrupt data. You may not notice this for some time. Indeed, you may think it is a fault of the drive. By this stage a lot of programs may have enough bytes corrupted to be unusable, and all of your backups will be infested. Here are a couple of examples of this type of program.

PROGRAM WORM – First written in the late 1970's, it was used to check network security. It was supposed to travel between computers and replicate itself, however it got out of hand and crashed around 100 systems – mainframes, not desktops. One solution is to send in a 'killer worm' program to destroy the original program. One famous program was 'Killer DOS', the worm in the Apple!

LOGIC BOMB – This originated as an advertising method. A software company would distribute, free of charge, items of

EXPANDING YOUR ATARI

We have had to put a hold on this series for the time being for various reasons, not least of which was that the circuit diagrams for the second part were a bit too complex for the editor to grasp! There were also some errors in the first article which were pointed out by the author and other readers. Thanks go to Jim Foster who provided much information and revised diagrams. Corrections or clearer diagrams are as follows.

software that would cease operating after several runs. Many of these would format the disk and thus wipe the data. This program is well known to big computer firms when a disgruntled employee leaves the job and leaves a software surprise as well.

Believe it or not, these programs started out in life for legitimate uses, to track out old, unused code and destroy or update, for diagnostic testing, limited use freebies for advertising and testing primitive life simulations.

TRYING SOME PROTECTION YOURSELF

Most of the techniques mentioned are beyond the scope of the ordinary user but you can do a little to protect your own programs. If you try these out, make sure you do it with a backup.

Firstly, disable the break key by POKE 16,128 and POKE 53774,128. This can be circumvented by system reset, so POKE 580,1. This will reboot the disk when reset is pressed so you will need an AUTORUN.SYS file. All this will stop the program being listed but not copied.

You can take things a step further by customising your DOS 2.0. Location 4226 is the pointer to the low byte and 4229 is the high byte. I have only tried out the low byte, you can try both. If you are using DOS 2.5, the low byte is 4171 and the high byte is 4274. The default value is 105 and points to 361, so to change the directory use the following formula to change the directory start sector.

POKE 4226, (new sector number + 105 - 361)

Make sure that you have wiped the original directory in sectors 361-368. Better yet, use a newly formatted disk. Go to DOS and save the change by using option H to write DOS to the disk. You could also keep the old directory and change the starting sector, thus allowing only certain files to be accessed, or copy a directory from another disk using a sector copier. Use an AUTORUN.SYS file to boot your program.

I hope that this has been instructive and not too technical. Next month we can start again on the basics, that is if any of you would be kind enough to let the Editor or myself know what you would like to see in this column. Remember, this column is to help beginners. They must help themselves by asking me to explain things that interest them. Some things might be too involved for inclusion here but then, that is why you have my address.

Mark Hutchinson,
1, Hollymount,
Erinvale,
Finaghy,
Belfast,
BT10 0GL

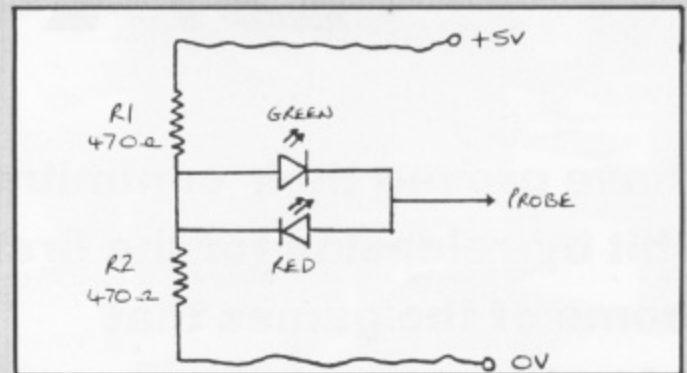

Figure 1 - Logic Probe

Using this circuit the red LED will illuminate if the probe is connected to +5v and the green if connected to 0v. The supply for the logic probe is best taken from the computer by two flying leads fitted with crocodile clips clipped onto any convenient +5v and 0v rails on the computer.

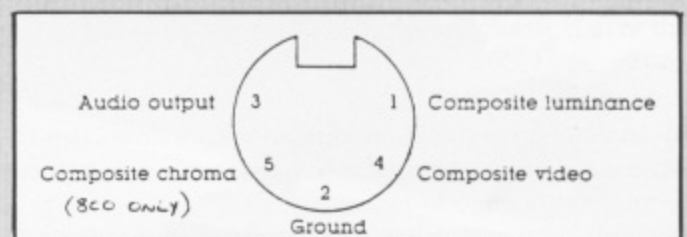

Figure 7 - Monitor Output

It is possible to connect the computer to the AUX input of a Hi-Fi without using resistors but if distortion occurs the circuit above should cure it.

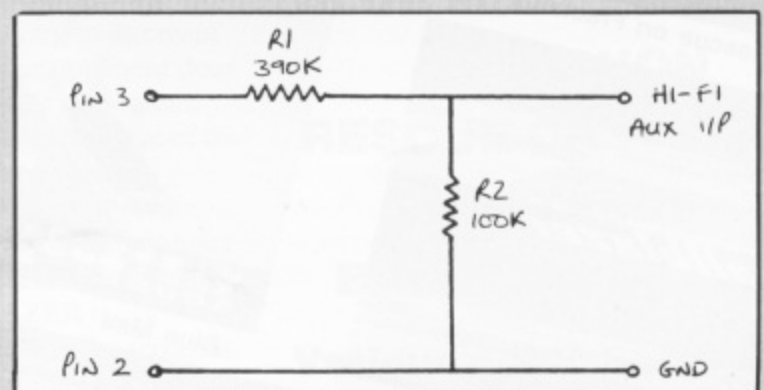
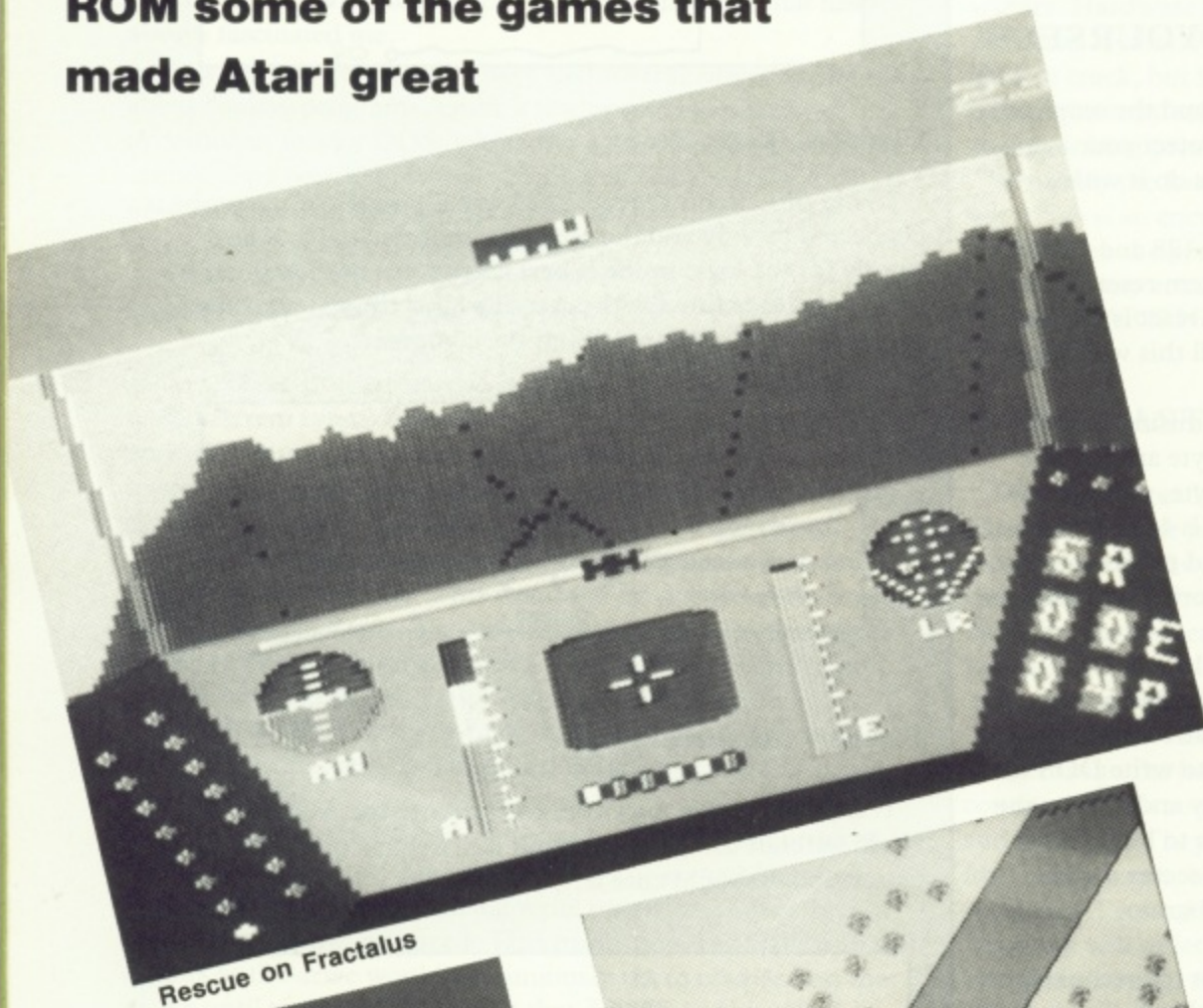

Figure 8 - Hi-Fi input from monitor output

Our apologies to any readers who had problems or frustrations.

ATARI IS BACK!

Atari have proved their commitment to the 8-bit by releasing for the first time on ROM some of the games that made Atari great



Rescue on Fractalus

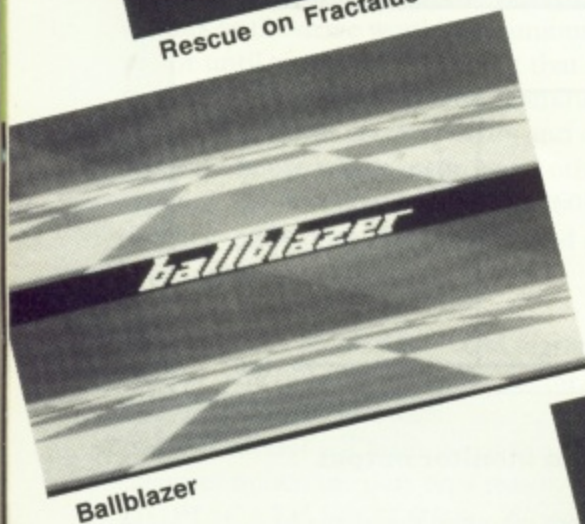

Ballblazer

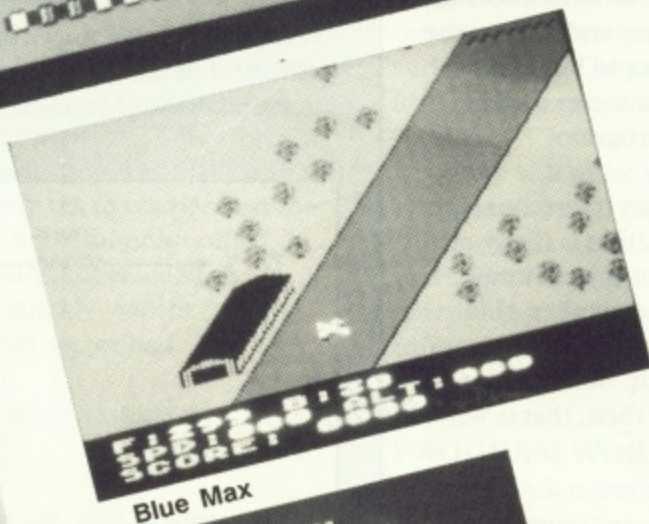

Blue Max



Archon

Last Christmas saw Atari launch their new XE Games System (but little else) – an 8-bit machine based technically around a 65XE computer but supplied in its most basic form without a keyboard. Owners of an unexpanded system must therefore depend solely on cartridge based software, and with this in mind, Atari have been busy converting some of the best ever computer games into ROM format.

The new ROMs are coloured to match the XE range, and don't have the tab activated covers found on the old style cartridges, thus leaving the PCB edge connectors permanently exposed. Each game is attractively packaged in a colourful box with a glossy instruction manual. Among the first games to be re-released by Atari are BLUE MAX from Broderbund, ARCHON from Electronic Arts, and BALLBLAZER and RESCUE ON FRACTALUS from Lucasfilm Games. They have all been modified, where necessary, to require only joystick or console key inputs.

BLUE MAX became famous for its diagonally scrolling graphics, a technique originally pioneered in Sega's Zaxxon, and used in both cases to create a superb 3-D effect playfield. The game is set in World War One, when RAF ace Pilot Max Chatsworth saw his entire squadron cut down by the enemy, and vowed to avenge the loss of his comrades. The Axis powers learned of Max's lone crusade and offered their highest service award – the Blue Max – to anyone who could successfully shoot him down. This earned Max the nick-name 'Blue Max', and in the game you adopt his role and fly his RAF fighter bomber bi-plane through war-torn Europe. Your objective is to destroy as many enemy installations as possible, especially certain primary targets which must be hit for progression onto a subsequent section. Ultimately you must destroy three marked targets in a German city.

Weapons consist of unlimited gunfire and a generous supply of bombs, but these can get damaged if you get hit by ground-fire. Extra supplies of fuel and bombs can be collected by landing on friendly airstrips, where any damage will also be repaired. Initial options include skill level and normal/ reverse controls. Originally, the latter option was incorrectly set, but this fault has now been resolved. BLUE MAX shows very few signs of its age, and I can

recommend it to young and old players alike.

Very few games can claim to be truly unique, but **ARCHON** is just that. It's a mixture of strategy and arcade action for one or two players. The strategic element involves you and your opponent manoeuvring regiments of 18 mythical creatures around a strange board of eighty-one squares. The opposing regiments – known as the dark and the light – are not identical. Each creature possesses unique characteristics and abilities. A creature's strength will increase if it is located on a square of its own colour, but some squares will alternate between light and dark, so skill is required in taking full advantage of the board. The ultimate aim of **ARCHON** is to either destroy all of the opposing side's regiment or to simultaneously occupy five special squares where magic 'power points' are situated.

The fun begins when two opposing creatures meet on the same square. This causes the square to immediately expand and fill the entire screen area, to form the combat zone. You must then use your skill and dexterity to fight the opposing creature to the death, at which point the victor returns to his rightful place on the board, and play continues. **ARCHON** was a top-notch package back in 1983 and still remains one of the best two player titles available today.

Activision caused a sensation in 1985 when they obtained the rights to release a range of Lucasfilm Games titles, a name considered by many to be synonymous with excellence. **RESCUE ON FRACTALUS** was, and still is, arguably the finest 8-bit computer game since *Star Raiders*. Your mission is to rescue stranded Ethercorps pilots shot down by the Jaggies on the extremely unpleasant planet Fractalus. Not only does the air consist of thick cyantric acid but the Jaggies have developed an impressive defence system of gun emplacements and flying saucers. I bet you'd need a Valkyrie Class Fighter with in-built Dirac Mirror Shield and AMB Torpedo system to combat that lot! Well actually, you'll need one with an Etheric Navigation System too!

Far from being a run-of-the-mill shoot 'em up, **RESCUE ON FRACTALUS** is a masterpiece in every conceivable department. The view from the window of your Valkyrie Fighter over the rocky landscape of Fractalus – in 3-D of course



– has simply got to be seen to be believed. No detail has been spared, from the stranded pilots with space suits and helmets to the various lights and dials on the instrument panel of your fighter. Sound effects are equally gratifying. Sixteen levels are initially selectable, but there are plenty more after that and one or two interesting surprises along the way(!). Even if you only ever buy one computer game, make sure this is the one. You won't regret it!

If you only ever buy TWO computer games, make sure the second one is **BALLBLAZER!** The year is 3097 and the location is a null-gravity nexus in the binary star system Kalaxon and Kalamar. That doesn't really matter though, as you're about to engage in the fastest, meanest, classiest sport in the known universe: Ballblazer. Soon you'll be traversing a massive grid in your regulation Rotorfoil, trying to intercept the Plasmorb before your opponent does likewise. When its in your possession, make for the goalbeams at the edge of the grid, line up and fire for a perfect over-the-horizon goal. Five more like that and you'll be worthy of the ultimate title any being can possess: Masterblazer.

Visually, **BALLBLAZER** is completely mind-blowing. The screen is split into two halves, giving each player their own unique 3-D view of the proceedings. Prior to the start, there's a brilliant animated opening sequence showing the Rotorfoils in action. Only the disk version included this originally.

After this sequence, there's some fantastic music – 'Song Of the Grid' – and you may then choose the length of the game, and either a human or droid opponent. Whichever you decide upon, **BALLBLAZER** will give you hours of enjoyment. A true classic if ever there was one!

All of the ROMs mentioned above are available at an RRP of £14.95 each. Expensive, yes, but remember these are all true games of distinction. If any of these titles are new to you, and you're still unconvinced, consult Jim Short's lengthy reviews in PAGE 6 issues 18,19 and 20 if you can get hold of them. Buy them anyway – you won't be disappointed!

Paul Rixon

BLUE MAX
ARCHON
RESCUE ON
FRACTALUS
BALLBLAZER

**Various publishers –
licensed to Atari Corp.**

**£14.95 each
on ROM cartridge**

THUNDERFOX

Introducing yet another gem for the shoot 'em up fraternity, this time brought to you by the boys from Railway Terrace. Not before time, I hear you say. But it seems Atari Corp. have been busy supporting the 8-bit after all, adding the finishing touches to their new game THUNDERFOX, and very impressive is the result.

A heavily defended Space Transporter carries Disilicate Energy Crystals for the approaching Phalon Mothership. Once installed, they will power the dreaded Phalon War Machine (or Zylosian War Machine, depending on whose story you believe!) and this is certain to spell instantaneous destruction for the entire Solar System. Eliminating the Energy Crystals won't be easy, as they're protected by the fearsome Crystal Guardian, who lurks in the far regions of the Thermo-Nuclear Laser Room! Overall access to the Transporter is restricted by two Anti-Gravity Stabilizers and these in turn are defended by various enemy installations and fleets of fighter craft. What a predicament! Sounds like a job for ... Thunderfox!!

The game kicks off with some excellent, original music and this is followed by a sequence showing Thunderfox being launched into action,

from both side-on and overhead viewpoints. At first, gameplay is rather like a simplified version of Tynesoft's Mirax Force, the screen scrolling horizontally over the surface of the Transporter as you attempt to locate the Stabilizers and bomb them five times each in order to destroy them. You only have a limited capacity for carrying missiles, so you must retreat to a loading bay when the initial supply has depleted. There's no need to waste missiles by firing them at enemy craft though - a quick joystick manoeuvre switches over to rapid laser-fire for this purpose.

At first, the task of knocking out the Stabilizers seems impossible, but once you discover the technique, it's a doddle. You'll soon be heading for the Laser Room, where you'll have to guide Thunderfox through a series of animated barriers. Touch one of these, or any of the surrounding walls, and your ship is destroyed, so a steady hand and accurate joystick are essential here. Don't take too long though, or the Radiation will cause an alternative end to the mission. Once inside the Energy Crystal Room, you have to shoot the guardian's pulsating head ten times through a moving wall whilst avoiding the return fire. Again, this seems difficult at first but once you get the hang of it, the task becomes fairly

routine. The opening demo will provide you with some hints.

Success in destroying the Crystal is rewarded by a hefty points bonus and the opportunity to attempt the next level, where the Transporter has taken on new form and colouring. I'm not certain how many levels there are in all, but judging by the first two they are graphically first-rate. The lower third of the screen contains various status information and below this, a long range scanner shows the distance of the Mothership from the Transporter. I've already praised the music, but I shouldn't let the sound effects slip by without a mention, as some very interesting ones are included. I seem to recall some similar effects in English Software's Steeplejack.

If I had to criticize THUNDERFOX, I'd have to say that the three available lives are simply inadequate for a game of this nature, especially since it's very easy to lose a ship by crashing into a ground installation that wasn't clearly marked as being protrusive or otherwise. Even so, the overall package is a splendid effort from Atari Corp., and I hope their endeavors will be justly rewarded. And let's hope there's more to come!

Paul Rixon

Published by Atari Corp. - £4.99 on cassette - 1 player with joystick

TWILIGHT WORLD

This one was written by Matthew Trimby, who also programmed Crystal Raider for Mastertronic. The basic theme hasn't altered, but the author has improved on the graphics and playability aspects a thousand times over.

Unlike the majority of games, TWILIGHT WORLD has no incredible plot involving Aliens or super heroes. The principal objective is simply to guide a nameless character through a series of interconnecting dungeons, in search of the elusive exit. This is invariably blocked by one or more locked doors, so a correctly coloured key must first be found to open it/them. Along the way, sparkling gems may be collected to increase your score, and an extra life is awarded if you manage to find every single one.

Naturally, there are plenty of irritating nasties scattered throughout the

dungeons. Contact with these will put a severe drain on your 'vitality', so it's important to replenish any loss by consuming food icons, dotted sparingly around each-level. For disposing of those particularly obstructive adversaries, you are armed with a 'weapon' (imaginative stuff!!) with which you are able to blast everything in the immediate vicinity. An autofire joystick can be used to good effect, here. If you get really desperate, you can activate your 'alter-ego' once only per life, making your character impervious to adversity for a limited period.

The game boasts eleven different levels plus two alternative settings of difficulty. On the advanced setting, you are obliged to collect all of the gems to complete a level. If you do run out of lives and have to start again, you can opt to re-start on any of the levels you've

previously completed. The dungeons become progressively more challenging, with logic problems and confusing layouts adding to the fun on higher levels. Visually the game is presented in a very competent manner. Your character is big, bold and colourful, and the nasties are well defined and animated. Sound isn't quite so impressive, but it's adequate for the purpose.

TWILIGHT WORLD will be well received by fans of Montezuma's Revenge and similar 'find the key' type games. Although it's not a true 'budget' release, Atari are, at least, moving towards the right lines. Show your support for this one and who knows what will happen ?

Paul Rixon

Published by Atari Corp. - £4.99 on cassette - 1 player with joystick

ZYBEX

THE BEST BUDGET GAME OF ALL TIME?

If someone told you there was a game available with superb graphics, great sound, multiple levels, a two player facility, highscore table and loads more besides, you'd probably expect it to cost ten pounds or more. But you'd be wrong! Zeppelin Games' ZYBEX has all these features, and yet it's priced at under three pounds. So what's the catch? Well, there simply isn't one!

It's essentially a shoot 'em up, but its format is quite unlike anything you'll have seen before. The story centres around two rebels - Rinser and Cassalana - and their desperate attempts to elude execution by reaching the powerful Zybox crystal that will ensure their captors remove the death rings from their necks. Don't ask me why you should want to be helping two rebels, or how the Zybox crystal would aid their plight, because I haven't a clue - and I'm not sure Zeppelin have either!! Anyway, before the rebels can reach the Zybox, they must first penetrate the hearts of many strange worlds, collecting teleport crystals as they go.

This is where you enter into the proceedings. You control one of the characters via a joystick as wave upon wave of Alien beings swoop enticingly down in front of you. A second player can help you dispose of them by controlling a second character simultaneously. If you're feeling really ambitious, you can even control both characters using two joysticks yourself! Some Aliens must be destroyed, others can be avoided by careful manoeuvres. Autofire joystick owners won't be overjoyed to learn that this feature is already built into the weapons in ZYBEX. At the beginning, you are armed only with an Orbit Weapon which delivers an intermittent pulse of bullets. By flying over certain symbols which sometimes appear when you destroy an Alien wave, you can also obtain further weapons, these having differing strengths and methods of destruction. Collecting symbols of the same type will increase the weapon's fire power, but if you get killed, the power of your current weapon is reduced. Weapons are selected using the trigger button to highlight an appropriate icon above the main

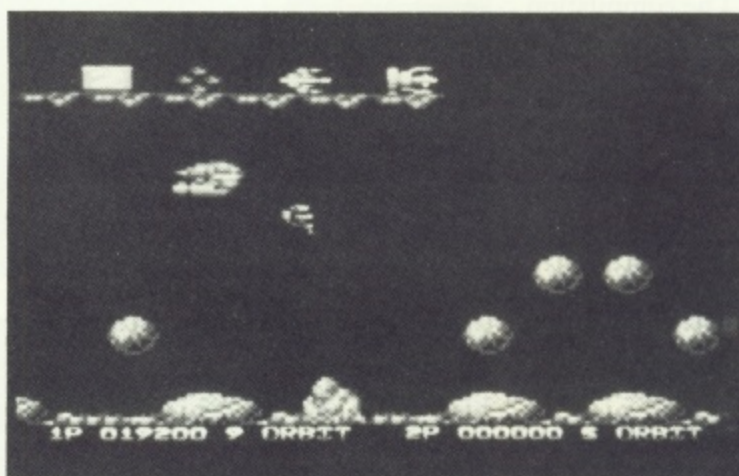

playfield (or below it for player two).

Having completed the first level, you may opt to tackle the next eleven in any order you wish. To enter each of the final four 'restricted' levels however, you need to have obtained three tokens. You can find one token at the end of all the preceding levels, so it doesn't take a mathematical genius to work out that every level will need to be completed ultimately, in any case. Crafty, eh! Bonus points and extra lives can be collected in the same fashion as additional weapons, and believe me you'll need as many lives as you can get! ZYBEX is challenging enough to begin with, but the climax to each level is even more tricky! Even so, when it comes to game addiction, this one really takes some beating!

A great game then, but what of the graphics? In a word: brilliant! Your character is small but well defined and you can even choose his colouring at the start. Most levels feature a horizontally scrolling futuristic landscape, expertly

drawn in high resolution in several shades of a single colour to produce a magnificent backdrop. A status line below shows all the necessary data regarding your score and number of remaining lives. The attacking Alien waves are superbly animated, each in an individual manner. In fact, you could almost mistake the action for the latest revision of Jeff Minter's Colourspace! At the beginning there's a terrific piece of original music and other aspects of the game such as the 'game over' and level indication prompt screens are accompanied by jingles of the same meritable standard.

Zeppelin Games promised to provide high quality 'budget' software, and they have kept to their word. ZYBEX is the sort of game that makes reviewers wish there were more superlatives in the dictionary. What more can I say, except, go out and buy it immediately!

Paul Rixon

Published by Zeppelin Games - £2.99 on cassette - 1/2 players with joystick(s)

FIVE OLD CLASSICS

ATARI COMPILATION TAPE

Atari's compilation cassette was previously marketed as an exclusive component of the 130XE starter pack, but is now available to existing 8-biters via most reputable Atari stockists and Atari Corp. themselves. The compilation contains five 100% machine code titles, mostly dating from the early 1980's when 400/800 computers reigned supreme - TYPO ATTACK, MISSILE COMMAND, CENTIPEDE, TENNIS and STAR RAIDERS.

Heading the line-up is TYPO ATTACK, a deceptively simple but effective attempt to encourage users to develop their touch typing skills. Animated 'Typo' invaders descend from the top of the screen towards eight bases. You have to activate each base's defence system to destroy an incoming invader, by typing in the character that appears below the appropriate one. The characters change periodically, and as the speed of attack increases, you have to rely increasingly on your touch typing abilities rather than searching for the necessary key. TYPO ATTACK is most suitable for young children who will not be deterred by the very simple graphics or annoyed by the bleeping sound effects.

Similar in theme, but greatly superior in implementation is MISSILE COMMAND, for one or two players. Six major cities require defending from Intercontinental Ballistic Missiles, killer Satellites and Bombers. Firing your limited supply of Antiballistic missiles into their paths will temporarily stem their advance, but each level will see the enemy's tactics becoming ever more calculated. It's an uncomplicated routine but demands a well trained trigger finger, and ranks highly in terms of addictiveness. XE Games System owners actually get MISSILE COMMAND built into their machine along with Basic and the O.S., so Atari are obviously quite keen on it. Although it's not mentioned on the inlay, you can also connect up a Trak-Ball and press Control-T to enter TB mode. MISSILE COMMAND is the only game to date offering true Trak-Ball compatibility.

If you've ever thought you might like to inhabit an enchanted mushroom

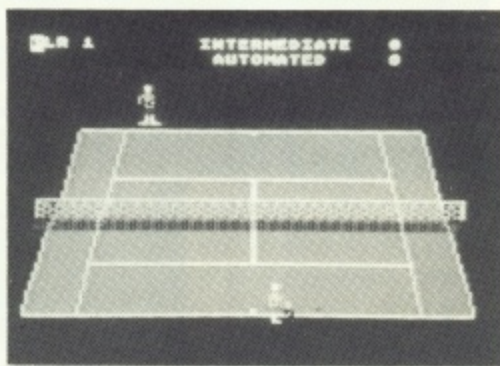
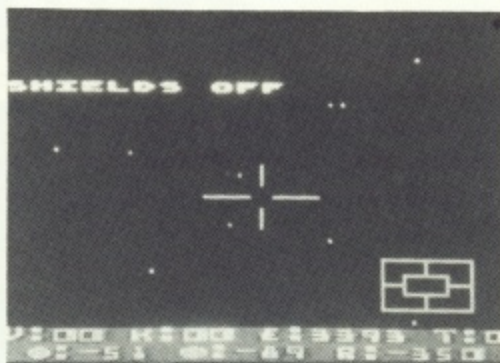

THE BEST OF THEIR TIME STILL UP WITH THE BEST TODAY?

patch, CENTIPEDE might well be the game for you! An evil Centipede descends the screen towards you. Meanwhile, spiders, fleas and scorpions mount vicious attacks as you attempt to blast them into oblivion! Every segment of the Centipede must be destroyed before it reaches the base of the screen, in order to advance onto the following, more difficult, level. Graphics are lifted above mediocre by the cleverly animated Centipede as it meanders across the mushroom patch. CENTIPEDE isn't as entertaining as the Atari coin-op original, but is still quite addictive, and fairly challenging on the higher levels.

And now for something completely different, as they say! TENNIS is still my favourite sports simulation next to Leaderboard (golf), not least because of the clever 3-D effect graphics and realistic ball travel, an innovation at the time of the game's initial release.

TENNIS allows a vast variety of shots from angled volleys to overhead smashes, all selected by the joystick. Additionally, singles or doubles matches can be played against human or automated opponents. Normal Tennis rules and scoring apply, except that the ball is never called 'out' because it will always stay in court until one player misses a return shot. Play TENNIS by yourself or with friends, either way you'll find it's a whole load of fun. It's one of those games that you'll keep returning to long after the latest revision of 'mega-invaders' has been discarded!

Last, but by no means least, STAR RAIDERS is a game that will shortly be celebrating its tenth birthday, having become one of the most raved about mega-games of all time. For many, this was the game that persuaded them to buy their first Atari computer. No wonder it is still held in such high regard.

Humanity is threatened (yet again!) by the evil Zylon empire, and only you can save mankind by hyperwarping through the galaxy in pursuit of Zylon fighters, cruisers and base stars. In addition to the joystick controls, a whole host of keyboard inputs control various facilities such as scanners, shields and automatic tracking devices. As you can imagine, the game becomes immensely challenging on the higher levels, so much so that Byte magazine once published a five page article on how to improve your technique! Some incredible through-the-window starscape graphics put many a modern release to shame, but then you'd expect that of an all-time computer classic. STAR RAIDERS is a definite 'must have' for any self-respecting 8-bit owner.

In conclusion, Atari have on offer five titles, admittedly unsophisticated, that were to provide the inspiration for many of the computer games released this decade. As such, they represent excellent value for money at just under a pound each, a tenth of the current cost if purchased individually. It's nice to see Atari getting their pricing policy right for a change. Now, how about a disk version chaps?

Paul Rixon

Published by Atari Corp. - £4.99 on cassette - 1/2 players with joystick(s)

CONTACT

FOR SALE

ATARI 850 INTERFACE: 850 modem and printer interface with manual and Centronics printer lead £50. Phone Steve on Wrexham 0978 753238

1020 PRINTER: 1020 printer with paper and pens £40. Touch Tablet and cartridge £25. All boxed, condition as new, offers considered. Phone: 0243 373695 after 4 p.m.

XL SYSTEM: 800XL, 1050 disk drive with software, tape recorder with tapes, also Sanyo green screen monitor with plugs, joystick, magazines and manuals. All for £270. Phone Newmarket 669280 after 5 p.m.

COMPLETE SYSTEM: 800XL, disk drive, XC11 recorder, touch tablet, Assembler/Editor cartridge, PILOT programming language, DOS II master disk, De Re Atari, XL graphics book plus various software. Full list and prices by return, SAE please to B. Smith, 45 Regency Square, Brighton, BN1 2FJ

MAGAZINES: PAGE 6 Issues 1 to 31. Offers please. Call 0495 249148 and ask for John.

XL SYSTEM: 800XL, cassette recorder, loads of software, £200 o.n.o. 1029 printer with Atariwriter, £85 o.n.o. Tel. 0483 37279 after 4.30 p.m. and ask for Daren.

ST MAGAZINES: Complete collection of ST UPDATE, ATARI ST USER and ST WORLD up to April '88. Offers. Tel. 0504 352808 weekends, Sean.

ATARI SYSTEM: 800, 1050 disk drive, 410 recorder, disk box, software on disk and cartridge, various manuals including De Re Atari, lots of mags, £150. Tel. 01 643 2295

MAGAZINES: 32 issues of PAGE 6 from Issue 1. 34 issues of Atari User from Issue 1. 16 issues of Monitor from Issue 3. Mapping The Atari - Revised, Compute!'s First Book of Graphics, Compute!'s Second Book of Atari. All in very good condition. Contact David Wade, 44 Havencrest Drive, Leicester, LE5 2AG

XL SYSTEM: 800XL, 1050 disk drive, data recorder, Joysticks, games, disk box. All for £200. Phone after 6.30 p.m. Sarah - Kidderminster 74 7863

BOOKS AND MAGS: Magazines, books and hardware for sale. Antic, Analog, PAGE 6, Monitor. Send s.a.e. for list. Mr H. Field, The Chimes, Bells Lane, Hoo, Nr., Rochester, Kent ME3 9HT

130XE: Excellent condition, hardly used, still boxed £55. Also cartridges, Kaboom, Basketball and others £4 each. Tel. 0832 74037 (Oundle)

MODEM: Pace Linnet Intelligent Modem complete with lead to suit Atari ST, £100. Tel. Roy 0754 5945, evenings

LIBRARY CLEARANCE: ATARI BASIC by Albrecht, Finkel & Brown, £5. GETTING STARTED ON YOUR ATARI by Hartnell & Bunn, £1. ILLUSTRATING BASIC by Donald Alcock, £2. SIXTY PROGRAMS for the Atari, £2.50. Also six Atari manuals - ATARI BASIC, 800XL, 800XL Connection Instructions, 1050 disk drive, DOS 3 and 1027 manual - 50p each or £2 the lot. ATARIWRITER PLUS word processor (unopened) £20. All plus postage and C.O.D. Phone 065 76 363 (Broughton-in-Furness) John Robinson

WANTED

ADVENTURES WANTED: Waxworks (Channel 8), Buckaroo Banzai, The Incredible Hulk, Spiderman (Adventure International), Cloak of Death (Bug Byte), Critical Mass (Sirius), Cyborg (Sentient), Empire of the Overmind (Avalon Hill), The Institute (Screenplay), Warlock's Revenge (Synergistic), Emerald Isle (Level 9). Will buy or swap for adventures of equivalent value. Originals only, preferably disk. Garry Francis, 26, Baringa Road, Earlwood, N.S.W. 2206, Australia.
(Alternatively, if you have any of these that you don't want any more how about giving them to Garry as a thanks for all those great columns? If you prefer, send them to me and I will pass them on. Les Ellingham)

1050 DISK DRIVE: 1050 disk drive wanted. Tel. Andrew on Huddersfield (0484) 534857 after 5 p.m.

1050 DISK DRIVE: Wanted on its own or with a 130XE. Will collect within 40 miles of Colchester. Phone Steve on 0206 323120

1027 PRINTER: Wanted in good working order. Please send sample of print out. Spare ribbons would be appreciated. Price negotiable. Enquiries to I. Robert, 19 Courtil Ollivier, Les Varendes, Castel, Guernsey, Channel Islands.

BEACHHEADS: Beachhead I and II (8-bit) required. Pay £5 each plus postage. Tel. Adam on 0253 735061 after 6 p.m.

MAGAZINES: Wanted - PAGE 6 Issue 1, ANALOG 1, 2, 3, 4, 5, 6, 8, 22, 29. ANTIC Vol.1, Vol.3 No's 5, 6, 8, 9, 12, Vol.4 No 9 and Vol.6 No 6. I can't offer cash because I haven't got much but how about free membership to either of my two user groups (LACE & SIGATARI) per magazine? Glen Leader, 143, Richmond Road, Leytonstone, London, E11 4BT

BOOKS REQUIRED: Atari Assembler by D & K Inman and Computel's Mapping The Atari (Revised or old). Reasonable condition only. Please phone Jonathon on 0827 53500 after 5 p.m. - weekdays.

WEATHER PROGRAMS: Wanted, program and connection details for downloading of Weather Satellites on the Atari 520ST or Atari 800. Tel. Roy 0754 5945, evenings

PAGE 6: Issues prior to 21 in clean condition. Reasonable price plus COD paid. Phone 065 76 363 (Broughton-in-Furness) John Robinson

PEN PALS/CONTACT

FROM POLAND: My name is Bogdan, I am 31 - teacher of P.E. I live in Gorzow Wlkp, Poland. I own a 520 STFM. I am looking for Pen-pals around the world to swap hints and ideas with. Please write to Bogdan Borowczyk, P.O. Box 160, Gorzow Wlkp, POLAND

ST PENPALS: Wanted to swap hints, tips and anything going (especially programming). All letters answered the same day. Please write to Kurt Frary, 278, Aylsham Road, Norwich, Norfolk, Nr.3 2RG

ST CONTACTS: Write to me to exchange hints, tips etc. Christian, 14, Linden Avenue, Halesowen, W. Mids. B62 9EL

PEN PALS WANTED: To exchange hints, tips, clues and views on Atari 8-bit systems. Females preferred. Please write to R. MacLean, 10, Whitelaw Crescent, Queenspark, Nairn, IV12 5DW

FROM TURKEY: Hi, I'm an 800XL user equipped with disk drive and tape recorder. I'm into Adventures and Shoot em ups, If you would like to write please write to Danny Sp, 4. Gazeteciler Sit., C-1 D/6 Levent, Istanbul, Turkey

AMERICAN ST USERS: Correspondents required whose interests include Midi (MT-32) to swap hints, tips and ideas. Write to Euan Anderson, The Cedars, Church Street, Dufftown, Banffshire, Scotland, AB5 4AR. Tel. 0340 20622

PRINTING: Home ST word processing, spreadsheet work and READ.ME files printed out. Also NEO, DEGAS and AMIGA IFF screens printed. Phone 0926 38714 after 5 p.m. or on Sundays for details.

NEW ST USER: Seeks contacts to exchange information, tips etc. (especially on DTP programs). Please write to Glenn Barry, 55, Barn Road, Carrickfergus, Co. Antrim, N. Ireland, BT38 7EU

ST USERS: Are you married to both a wife and an ST? Yet only one complains about the amount of time spent with the other! If so, drop me a line to exchange tips, info, PD software etc. All relevant letters answered from anywhere worldwide. Get writing out there! Ray G. Wood, 14 Winchester Road, Tilgate, Crawley, West Sussex, RH10 5JW

BOGNOR REGIS ATARI CLUB: For anybody under 16 years of age. For more details contact M. Sinden on 0243 820598 after 5.30 p.m.

XL/XE OWNERS: Contacts wanted to swap ideas, hints etc. on role playing/ Adventure/ Strategy games (SSI etc.). Tony, 43c Colvestone Crescent, Dalston, London, E8

WORLDWIDE CONTACTS: Atari users wanted from anywhere in the world to swap hints and tips on programming. I own a 800XL, 1050 disk drive, cassette and printer. I will try and answer all letters. Write to G. Freeman, Meadow Court, Hassop Road, Bakewell, Derbyshire, DE4 1AP

DON'T FORGET!

BONUS ADVENTURES on this issue's disk. Two great adventures available only on the PAGE 6 Issue 34 disk. Get your copy for just £3.95 from PAGE 6, P.O. Box 54, STAFFORD, ST16 1DR or telephone 0785 213928 and use your credit card.

DO IT NOW!

UPDATE

PRINTERS (ISSUE 33): The report on the Citizen 120D printer stated that it comes with a serial interface. In fact there is a choice of interfaces with this model and a Centronics parallel interface is also available. This is the better bet for most people so check before you buy.

REVISION C FOR CASSETTE (ISSUE 31): Author Alec Benson dropped us a line from Australia to advise of a couple of errors, one of which was reported in Issue 32. Line 1160 was omitted (as advised in Issue 32) and line 200 is incorrect. Here are the two correct lines.

```
200 OPEN #1,8,128,"C":? #1;A$:: CLOSE #1
1160 DATA 1,211,9,2,141,1,211,96,0,0,733
```

ADVENTURE

ROUND UP

Do you know how many adventures are available for your Atari? Even if you have played quite a lot, there will be many on this list that you may not have even heard of. They are all genuine adventures that have been, or are, available. Finding some of these, though, could be an adventure itself! The adventures are the standard 'text' adventures and so do not include arcade adventures and the like. Where graphics are available I have indicated by using 'Illustrated'.

You will I hope find the list reasonably complete but I am always interested to know of any other adventures. If any reader knows of others please drop a line to the Editor.

Missing an Adventure? Or just looking for something different? Check our mammoth Adventure survey

Adventure in Time

Phoenix
Text
8-bit disk(?)

Adventure Quest

Level 9
Text
8-bit cassette

Adventureland

Adventure International
Text or Illustrated.
8-bit cassette or disk

After the Fire

Channel 8
Text or Illustrated.
8-bit cassette or disk(?)

Alien Egg

Atari Program Exchange
Text
8-bit disk

Amazon

Telarium
Illustrated.
ST disk

ANALOG Adventure

A.N.A.L.O.G. Computing
Text
8-bit cassette or disk(?)

Arrow of Death Part 1

Channel 8
Text
8-bit cassette

Arrow of Death Part 2

Channel 8
Text
8-bit cassette

Asylum

Screenplay
Illustrated.
8-bit cassette or disk

Ballyhoo

Infocom
Text
8-bit and ST disk

Beyond the Infinite

Channel 8
Text or Illustrated.
8-bit cassette or disk(?)

Beyond Zork

Infocom
Text
ST disk(?)

Birth of the Phoenix

Phoenix
Text
8-bit disk(?)

Black Cauldron

Sierra On-Line
Illustrated.
ST disk

The Blade of Blackpoole

Sirius
Illustrated.
8-bit disk

Border Zone

Infocom
Text
8-bit and ST disk(?)

Borrowed Time

Activision
Illustrated.
ST disk

Breakers

Broderbund
Text
8-bit disk(?)

Brimstone

Broderbund
Text
8-bit disk

Buckaroo Banzai

Adventure International
Illustrated.
8-bit disk(?)

Bureaucracy

Infocom
Text
8-bit and ST disk

The Casebook of Hemlock Soames

Micronovels
Text
8-bit disk

Castle

Atari Program Exchange
Text
8-bit disk

Chinese Puzzle

Atari Program Exchange
Text
8-bit disk

Circus

Channel 8
Text
8-bit cassette

Cloak of Death

Bug Byte
Illustrated.
8-bit cassette

Colossal Adventure

Level 9
Text
8-bit cassette

The Count

Adventure International
Text or Illustrated.
8-bit cassette or disk

The Coveted Mirror

Penguin
Illustrated.
ST disk

Cranston Manor Adventure

Artworx
Text
8-bit cassette or disk(?)

Crimson Crown

Penguin
Illustrated.
ST disk

Critical Mass

Sirius
Illustrated.
8-bit disk

The Curse of Crowley Manor

Adventure International
Text
8-bit cassette or disk

Cutthroats

Infocom
Text
8-bit and ST disk

Cyborg

Sentient
Text
8-bit disk

The Dallas Quest

Datasoft
Illustrated.
8-bit disk

The Dark Crystal

Sierra On-Line
Illustrated.
8-bit disk

Deadline

Infocom
Text
8-bit and ST disk

Death in the Caribbean

Micro Lab
Illustrated.
8-bit disk

Deja Vu

Mindscape
Illustrated.
ST disk

Dragon Quest

Antic
Illustrated.
8-bit disk

Dragonworld

Telarium
Illustrated.
ST disk

Dungeon Adventure

Level 9
Text
8-bit cassette

Earthquake - San Francisco, 1906

Adventure International
Text
8-bit cassette or disk

Emerald Isle

Level 9
Text
8-bit cassette

Empire of the Overmind

Avalon Hill
Text
8-bit cassette or disk

Enchanter

Infocom
Text
8-bit and ST disk

Escape Part 1

AD 400
Text
8-bit cassette or disk

Escape Part 2

AD 400
Text
8-bit cassette or disk

Escape from Pulsar 7

Channel 8
Text
8-bit cassette

Escape from Traam

Adventure International
Text
8-bit cassette or disk

Essex

Broderbund
Text
8-bit disk

Fahrenheit 451

Telarium
Illustrated.
ST disk

The Fantastic Four Part 1 featuring Human Torch and Thing

Adventure International
Illustrated.
8-bit disk

compiled by GARRY FRANCIS

- Feasibility Experiment**
Channel 8
Text
8-bit cassette
- Forbidden Quest**
Priority
Text
ST disk
- Four-in-one Sampler**
Infocom
Text
8-bit and ST disk
- Gateway**
Priority
Illustrated.
ST disk
- G.F.S. Sorceress**
Avalon Hill
Text
8-bit cassette or disk
- Ghost Town**
Adventure International
Text or Illustrated.
8-bit cassette or disk
- Gnome Ranger**
Level 9
Illustrated.
8-bit cassette or disk and ST disk(?)
- The Golden Baton**
Channel 8
Text
8-bit cassette
- Golden Voyage**
Adventure International
Text or Illustrated.
8-bit cassette or disk
- Gruds in Space**
Sirius
Illustrated.
8-bit disk
- Guild of Thieves**
Rainbird
Illustrated.
8-bit enhanced density disk and ST disk
- Gunslinger**
Datsoft
Illustrated.
8-bit disk
- The Hitchhiker's Guide to the Galaxy**
Infocom
Text
8-bit and ST disk
- Hollywood Hijinx**
Infocom
Text
8-bit and ST disk
- The Incredible Hulk**
Adventure International
Illustrated.
8-bit disk
- Infidel**
Infocom
Text
8-bit and ST disk
- The Institute**
Screenplay
Illustrated.
8-bit disk
- Jewels of Darkness**
Level 9
Illustrated.
8-bit cassette or enhanced density disk and ST disk
- Jinxter**
Rainbird
Illustrated.
8-bit enhanced density disk and ST disk
- King's Quest**
Sierra On-Line
Illustrated.
ST disk
- King's Quest II: Romancing the Throne**
Sierra On-Line
Illustrated.
ST disk
- King's Quest III: To Heir is Human**
Sierra On-Line
Illustrated.
ST disk
- Knight Orc**
Level 9
Illustrated.
8-bit cassette or disk and ST disk
- Labyrinth of Crete**
Adventure International
Text
8-bit cassette or disk(?)
- Lapis Philosophorum**
Ariolasoft
Illustrated.
8-bit disk
- Leather Goddesses of Phobos**
Infocom
Text
8-bit and ST disk
- Leisure Suit Larry in the Land of the Lounge Lizards**
Sierra On-Line
Illustrated.
ST disk
- Lords of Karma**
Avalon Hill
Text
8-bit cassette or disk
- Lords of Time**
Level 9
Text
8-bit cassette
- The Lost Kingdom of Zkul**
Talent
Text
ST disk
- Lucifer's Realm**
Screenplay
Illustrated.
8-bit disk
- The Lurking Horror**
Infocom
Text
8-bit and ST disk
- The Mask of the Sun**
Broderbund
Illustrated.
8-bit disk
- Masquerade**
Phoenix
Illustrated.
8-bit disk(?)
- Microworld**
Screenplay
Text
8-bit cassette or disk(?)
- Mid Winter**
Channel 8
Text or Illustrated.
8-bit cassette or disk(?)
- A Mind Forever Voyaging**
Infocom
Text
ST disk
- Mindshadow**
Activision
Illustrated.
8-bit and ST disk
- Mindwheel**
Broderbund
Text
8-bit disk
- Mission: Asteroid**
Sierra On-Line
Illustrated.
8-bit disk
- Mission Impossible**
Adventure International
Text or Illustrated.
8-bit cassette or disk
- Moonmist**
Infocom
Text
8-bit and ST disk
- Mordon's Quest**
Melbourne House
Text
8-bit cassette
- Mortville Manor**
Eidersoft
Illustrated.
ST disk
- Mystery Fun House**
Adventure International
Text or Illustrated.
8-bit cassette or disk
- The Neverending Story**
Datsoft
Illustrated.
8-bit disk
- Nine Princes in Amber**
Telarium
Illustrated.
ST disk
- Nord and Bert Couldn't Make Head or Tail of It**
Infocom
Text
8-bit and ST disk
- Oo-Topos**
Penguin
Illustrated.
ST disk
- Opera House**
Big Nose
Text
8-bit cassette or disk(?)
- Original Adventure**
Robert Howell
Text
8-bit cassette or disk
- The Paradise**
Screenplay
Text
8-bit cassette or disk(?)
- The Pawn**
Rainbird
Illustrated.
8-bit enhanced density disk and ST disk
- The Pay Off**
Bug Byte
Text
8-bit cassette or disk
- Perry Mason: The Case of the Mandarin Murder**
Telarium
Illustrated.
ST disk
- Perseus and Andromeda**
Channel 8
Text
8-bit cassette
- Pirate Adventure**
Adventure International
Text or Illustrated.
8-bit cassette or disk
- Planetfall**
Infocom
Text
8-bit and ST disk
- Plundered Hearts**
Infocom
Text
8-bit and ST disk
- Police Quest**
Sierra On-Line
Illustrated.
ST disk
- Powerstar**
Pandora
Illustrated.
8-bit cartridge
- The Price of Magik**
Level 9
Illustrated.
8-bit cassette
- Prisoner 2**
Edu-ware
Illustrated.
8-bit disk
- Pyramid of Doom**
Adventure International
Text or Illustrated.
8-bit cassette or disk
- The Quest**
Penguin
Illustrated.
8-bit and ST disk
- Quest for Eternity**
Argus Press
Text
8-bit cassette
- Red Moon**
Level 9
Illustrated.
8-bit cassette



ROUND UP

All the Atari Adventures

Rendezvous with Rama

Telarium
Illustrated.
ST disk

Return to Eden

Level 9
Text
8-bit cassette

Rick Hanson

Robico
Text
8-bit disk

Rigel's Revenge

Mastertronic
Illustrated.
8-bit cassette(?)

Saigon: The Final Days

Adventure International
Illustrated.
8-bit disk

The Sands of Egypt

Datasoft
Illustrated.
8-bit disk

Savage Island Part 1

Adventure International
Text or Illustrated.
8-bit cassette or disk

Savage Island Part 2

Adventure International
Text or Illustrated.
8-bit cassette or disk

Seastalker

Infocom
Text
8-bit and ST disk

The Serpent's Star

Broderbund
Illustrated.
8-bit disk

Sherlock: The Riddle of the Crown Jewels

Infocom
Text
8-bit and ST disk(?)

Sleazy Adventure

Atari Program Exchange
Text
8-bit disk

Silicon Dreams

Level 9
Illustrated.
8-bit cassette or enhanced density disk
and ST disk

Snowball

Level 9
Text
8-bit cassette

Soft Porn

Sierra On-Line
Text
8-bit disk

Sorcerer

Infocom
Text
8-bit and ST disk

The Sorcerer of Claymorgue Castle

Adventure International
Illustrated.
8-bit disk

Space Quest

Sierra On-Line
Illustrated.
ST disk

Space Quest II

Sierra On-Line
Illustrated.
ST disk

Spellbreaker

Infocom
Text
8-bit and ST disk

Spiderman

Adventure International
Illustrated.
8-bit and ST disk

Star Voyage

Micronovels
Text
8-bit disk

Starcross

Infocom
Text
8-bit and ST disk

Stationfall

Infocom
Text
8-bit and ST disk

Stone of Sisyphus

Adventure International
Illustrated.
8-bit disk

Stonequest

Lotsabytes
Text
8-bit disk

Stranded

English Software
Illustrated.
8-bit cassette or disk

Strange Odyssey

Adventure International
Text or Illustrated.
8-bit cassette or disk

Sultan's Palace

Atari Program Exchange
Text
8-bit disk

Survival

United Software of America
Text
8-bit cassette or disk

Suspect

Infocom
Text
8-bit and ST disk

Suspended

Infocom
Text
8-bit and ST disk

Tass Times in Tonetown

Activision
Illustrated.
ST disk

Ten Little Indians

Channel 8
Text
8-bit cassette

The Time Machine

Channel 8
Text
8-bit cassette

Transylvania

Penguin
Illustrated.
8-bit and ST disk

Treasure Island

Windham Classics
Illustrated.
ST disk

Trinity

Infocom
Text
ST disk

Twisted

Trapeze
Text
8-bit disk(?)

Ulysses and the Golden Fleece

Sierra On-Line
Illustrated.
8-bit disk

Voodoo Castle

Adventure International
Text or Illustrated.
8-bit cassette or disk

Warlock's Revenge

Synergistic
Illustrated.
8-bit disk

Waxworks

Channel 8
Text or Illustrated.
8-bit cassette or disk

West

Talent
Text
ST disk

Wishbringer

Infocom
Text
8-bit and ST disk

The Witness

Infocom
Text
8-bit and ST disk

Wizard and the Princess

Sierra On-Line
Illustrated.
8-bit disk

The Wizard of Akyrz

Channel 8
Text
8-bit cassette

Wizard's Gold

Atari Program Exchange
Text
8-bit disk

Wizard's Revenge

Atari Program Exchange
Text
8-bit disk

Wombats I

Dynamic Software Design
Text
8-bit disk

Wombats II

Dynamic Software Design
Text
8-bit disk(?)

The Worm in Paradise

Level 9
Illustrated.
8-bit cassette

Zork I: The Great Underground Empire

Infocom
Text
8-bit and ST disk

Zork II: The Wizard of Frobozz

Infocom
Text
8-bit and ST disk

Zork III: The Dungeon Master

Infocom
Text
8-bit and ST disk



PAGE 6 back issues represent an excellent way of increasing the enjoyment of your Atari with articles to enlighten you, programs to type in and reviews of software to guide you. Almost all of the content of past issues will be as fresh and relevant today as when it appeared - increase your enjoyment now, before it's too late! Disks are available for all issues, containing all the 8-bit programs from each issue ready to run, and they often include bonuses not found in the magazine.

ISSUE 20 - GRAPHICS SPECIAL. A super special issue with a graphics theme. Draw some masterpieces with GRAPHICS WORKSHOP and explore your graphics potential with Colour Palette, Picloada, Colour Attributes and CIO Slideshow. An in-depth review of Printshop and Graphics Art Department, the final part of Display Lists and the Adventure column. 11 pages devoted to the ST plus a colour feature ATARI ART and ST GALLERY. And there's more! BLOCKBREAKER is one of the best games to have been published in any magazine. Don't miss it!



DISK AVAILABLE - includes BONUS PICTURES for Graphics Workshop

ISSUE 21 - A packed issue with games, TRAIN CRAZY, REVENGER and FORKLIFT. Utilities SCALEMASTER, QUICK DISASSEMBLER and Measuring Temperature. Programming hints with Doing The Impossible, Error 8 Solved and THE GUIDE TO ERROR CODES. Reviews of Flight Simulator II, Hitchhiker's Guide to the Galaxy, and the latest Adventures. For the ST a DEGAS to NEO converter, Lattice C reviewed and reviews of a whole host of software.



DISK AVAILABLE. All programs ready to go.

ISSUE 22 - More serious users will enjoy SMARTSHEET, a Visicalc like type-in spreadsheet, plus our review of Paperclip whilst gamers will puzzle over TRICKY CUBES and try to survive HIDDEN DEPTHS. The Guide to Error Codes is concluded and there are articles on Fractals, Tape Problems and some less well known Adventures. Loads of reviews and some great new routines for Blockbreaker. ST users will find out how to program Sprites and can read reviews of Time Bandit, Pro-Fortran 77, VIP Professional and more.



DISK AVAILABLE - DOUBLE SIDED! Contains TWO versions of TRICKY CUBES and new versions of BLOCKBREAKER.

ISSUE 23 - Another superb machine language game WATER SKI SCHOOL will test your reflexes. WORDSEARCH will challenge those who like puzzles and other listings include SUPERCLOWN and the utilities XREF and VERIFY. A huge review of Ultima IV heads a comprehensive review section and Going Online Part 1 will let you know if telecommunications is for you. ST owners can discover how to get a bigger screen on their colour monitor and read reviews of Zoomracks, Sierra On-Line adventures and Pro-Pascal amongst others. Also, is it worth adding a 5 1/4" drive to your ST?



DISK AVAILABLE. Contains TWO BONUS PROGRAMS!

ISSUE 24 - The biggest issue so far published! Great ST section with info about ST disks and cartridges and loads of reviews. For 8-bit users there is MUNCHY MADNESS, the best game we have ever published plus a super cheque book utility AUTOCHECK. Plus all about checking your disk drive, another game called FLYING HIGH, more utilities, reviews of RAMBIT, Adventure games and lots more. Too much in this issue to list fully!



DISK AVAILABLE - Don't miss MUNCHY MADNESS, the best game we have published so far!

ISSUE 25 - Another biggie! A must for 1029 printer owners with 3 great utilities including a SCREEN DUMP. A super Japanese chess game called SHOGLI, a type in REVISION C BASIC, a full feature on disks and more. For ST, type in OHELLO, reviews of LEADER BOARD and MEAN 18, Hints and Tips and several other reviews and articles.



DISK AVAILABLE - ALL THOSE 1029 PROGRAMS READY TO GO!

ISSUE 26 - SOLID MODELLING is one of the best non-game programs we have published. Be creative! Other programs include SOURCE WRITER for machine code programmers, FLEXIBLE FINGERS to help you type, NUTS and more. Reviews of TRIVIAL PURSUIT, DVC 65, SPEEDSCRIPT and much, much more. ST users can learn all about HARD DISKS, FAST BASIC, TYPESETTER ELITE, DEGAS ELITE and read reviews on a whole lot more software.



DISK AVAILABLE - DOUBLE SIDED! TWO virtually full sides with BONUS SCREENS for SOLID MODELLING!

ISSUE 27 - Some cracking listings for the 8-bit. In GREAT BRITAIN LTD. you can be the Chancellor and help run the country. COMPUTER GAMMON is a great Atari version of backgammon and there's ANTS IN YOUR PANTS, DISK COMMAND and others. There is a feature on word processing and stacks of reviews. The ST section includes an in-depth review of ART DIRECTOR and a neat little program to put scrolling stars on your screen! Lots of reviews including HABAVIEW, K-SPREAD 2, K-WORD and many more.



DISK AVAILABLE - some L-O-N-G LISTINGS!

ISSUE 28 - Extend the incredible original Munchy Madness with the MUNCHY MADNESS SCREEN DESIGNER, play GREEDY CATERPILLARS with a friend, teach your children with MOST HEART MATHS or make up some crosswords with XWORD. A long feature on flight simulation programs, hints on ZORK and loads of reviews. For ST users, the first in a series of USING GEM from C plus FLIGHT SIMULATOR II reviews, new books from COMPUTE! and a whole stack of reviews.



DISK AVAILABLE - Also contains the winning title screen from our competition.

ISSUE 29 - One that serious 8-bit users have been waiting a long time for - a great full feature database - MJDBASE plus an amazing story maker, STORYBOOK, that allows you to create illustrated stories. Then there's a great game from ANTIC called CLIFFHANGER and an AUTORUN maker and more. Cheat on commercial games with ZAPPING THE RIGHT BYTE and read stacks of reviews. The ST section has a type-in program, SCREEN GRABBER, which allows you to 'snatch' pictures of commercial games to disk, plus the next part in our GEM FROM C series and reviews of Superbase Personal, K-COMM 2 plus lots of games including Barbarian. Another big issue.



DISK AVAILABLE. DOUBLE SIDED. With BONUS story for STORYBOOK and STORYBOOK reader.

ISSUE 30 - A great follow up to Solid Modelling allows you to animate 3-D objects. Try 3-D ANIMATOR. How about a puzzle with LETTER CASTLE or an arcade style shoot-up from ANTIC called DESERT CHASE? Articles include an in-depth look at GUNSLINGER, Genealogy With Your Atari and First Steps on saving screens. Loads of reviews including AUTODUEL and P:R: CONNECTION. The ST section includes the continuing GEM series, CYBERSTUDIO, ZOOMRACKS II and loads of games and serious reviews including GFA BASIC, K-Roget, Jupiter Probe and more.



DISK AVAILABLE. DOUBLE SIDED with BONUS MACHINE LANGUAGE ADVENTURE only available on this disk!

ISSUE 31 - Our massive survey on all the WARGAMES available for the 8-bit Atari heads this issue which also includes a great type-in synthesiser listing called ORIGINAL SYNTH. Other listings include FONT FACTORY, a nice character editor and a challenging game called BOWL TRAP. A feature on SSI, more Tutorial Subroutines, a long feature on THE NEVERENDING STORY, reviews of ROADWAR 2000 and THE DUNGEON plus many more are also in this issue. ST SECRETS, a new series on ST programming begins with a look at sound and the ST reviews section includes IMG SCAN, BASE TWO, TEMPUS and many more.



DISK AVAILABLE - All the extra files for ORIGINAL SYNTH set up ready to run plus all the other listings.

ISSUE 32 - A great card game for 8-bit users called, rather uninspiringly, WHIST plus a two player game of TENNIS and a GRAPH MAKER that works on the 1029 printer. A new series starts on EXPANDING YOUR ATARI and there is an excellent program/tutorial on BUBBLE SORTING. Reviews include THE PAWN, GUILD OF THIEVES, SPARTADOS U.S. DOUBLER and many more. ST users can find out about programming graphics with ST SECRETS and can read all about the TURBO DIZER, PC DITTO plus reviews of Tanglewood, Defender of The Crown, Winter Olympiad, PROSPERO FORTRAN and more.



DISK AVAILABLE - DOUBLE SIDED with BONUS MACHINE CODE ARCADE GAME available only on this disk.

ISSUE 33 - Many readers have said this is our best issue yet with an extensive feature on choosing a printer for your Atari, plus HEAVY METAL, a superb type-in machine language arcade game. Other type-in listings include another game, CRYSTAL CRISIS and two utilities, COLOUR TUNER and SOFTKEY, the latter being a super keyboard 'macro' utility. ST owners can find out more about PROGRAMMING GEM with another article in the series and there are loads of reviews including MASTERPLAN, GUNSHIP and SPECTRUM 512. There's much more in this issue besides, including some great music for the 8-bit.



DISK AVAILABLE - including TWO BONUS GAMES that are not in the magazine and not available elsewhere!

BACK ISSUES

All back issues are £1.20 each in the U.K., £1.95 for Europe or surface mail elsewhere and £2.75 for Air Mail outside Europe.

PAGE 6 Issue disks will run on any 8-bit Atari with 48k or 64k memory. Each disk is just £3.95. Postage is FREE in U.K. Overseas please add £1 per order (for any number of disks).

Please make cheques/postal orders payable to PAGE 6. Send your order to PAGE 6, P.O. BOX 54, STAFFORD, ST16 1DR, ENGLAND.

ACCESS and VISA accepted. Telephone 0785 213928.

THE RESOURCE FILE

The Resource File is a service provided by PAGE 6 to help Atari owners find sources of information, help and supply. An entry in this feature does not necessarily imply an endorsement by PAGE 6 and readers are advised to check for themselves to ensure that the information is still current. We would ask any readers who find information to be incorrect or out of date to let us know so that an entry may be amended or deleted.

RETAILERS

ABC
135 St. Leonards Road
Leicester
LE2 3BZ
Tel. 0533 700190

ATARI WORLD
15, Fennell Street
Manchester
M4 3DU
Tel. 061 834 4941

BRIGHTON COMPUTER EXCHANGE
2, Ann Street
Brighton
BN1 4GP
Tel. 0273 686650

CHIPS
53, Rugby Road
Worthing
Sussex BN11 5NB

COMPUTER ADVENTURE WORLD
Bank Buildings
1A, Charing Cross
Birkenhead L41 6EJ
Tel. 051 666 1132

COMPUTER CAVERN
21, Harris Arcade
Reading
Berks. RG1 1DN
Tel. 0734 474768

COMPUTER CENTRE
174, High Street
Hornchurch
Essex
Tel. 04024 75613

GAMER
71 East Street
Brighton
Sussex BN1 1HQ
Tel. 0273 728681

GLASGOW COMPUTER CENTRE
122, West Nile Street,
Glasgow,
G1 2QZ
Tel. 041 332 8246

HI-FI WESTERN LTD.
52, Cambrian Road
Newport
Gwent
Tel. 0633 62790

INTOTO
1, Heathcoat Street
Hockley
Notts. NG1 3AF
Tel. 0602 410987

JENNINGS STORES
244 - 248, Hertford Road
Enfield
Middx
Tel. 01 804 1767

LADBROKE COMPUTING LTD.
33, Ormskirk Road
Preston
Lancs. PR1 2QP
Tel. 0772 21474

LIVINGSTON COMPUTER CENTRE
17, The Mall
Craigshill Shopping Centre
Livingston
West Lothian
Tel. 0506 36978

MICRO-TRONICS
27a, Market Street
Tamworth
Staffs
Tel. 0827 51480

ONE STEP BEYOND LTD.
11a, Castle Meadow
Norwich
NR1 3DG
Tel. 0603 663796

PEATS ELECTRONICS
197, Parnell Street
Dublin 1
Ireland
Tel. 0001 727799

SILICON CENTRE
7, Antigua Street
Edinburgh
Scotland
Tel. 031 557 4546

SOFTWARE EXPRESS
514 - 516, Alum Rock Road
Alum Rock
Birmingham B8
Tel. 021 328 3585

SOFTWARE EXPRESS
212, Broad Street
Birmingham
B15 2AY
Tel. 021 643 9100

SOFTWARE EXPRESS ATARI CENTRE
9, Exeter Street,
Plymouth,
Devon
Tel. 0752 265276

A.S. WOOTTON & SON
116, Edleston Road
Crewe
CW2 7HD
Tel. 0270 214118

YORK COMPUTER CENTRE
9, Davygate Arcade
Davygate
York YO1 2SU
Tel. 0904 641862

USER GROUPS

ABC
Contact Mike Donoghue, 135, St. Leonards Road, Leicester, LE2 3BZ. Tel. 0533 700190. Retailer and both 8-bit and ST user groups.

A.C.E. USER GROUP
Contact Martin Sharpe, 28, Brooklyn Court, Bradford Road, Cleckheaton, West Yorks BD19 4TJ. Tel. 0274 851131 (24 hours). Monthly meetings, newsletter, trips, discounts etc.

ATARI USER GROUP (IRELAND)
Contact Mike Casey, 3 St. Kevins Park, Kilmacud, County Dublin, Ireland. Tel. 01-881830 or DUBBS 01-885634 (24 hour). Monthly meetings and newsletter.

BESTWOOD 8-BIT USER GROUP
Contact David Taylor, 60 Stevenholme Crescent, Bestwood Park, Nottingham, NG5 5JW. Tel. 0602 209735. 8-bit local users only.

BOURNEMOUTH AND POOLE ATARI USER GROUP
Contact Colin Hunt, 248, Wimborne Road, Oakdale, Poole, Dorset. ST, 8-bit, hardware and software development.

BURY ST. EDMUNDS USER GROUP
Contact Gary Brummage, 22, Ridley Road, Bury St. Edmunds, Suffolk, IP33 3HS. Please send S.A.E. for details.

CROMWELL ATARI USER GROUP
Contact Dave Leggett, 3, Chestnut Close, Brampton, Huntingdon, Cambs. Tel. 0480 50553. All users welcome.

FLOPPYSHOP ST
Contact Steve Delaney, 50, Stewart Crescent, Northfield, Aberdeen, AB2 5SR. Tel. 0224 691824.

The GATEWAY CLUB
Contact Phil Herberer, 164d Radcliffe Road, Lakenheath, Suffolk. Tel. (Eriswell) 2363. All computer club with Atari section. Meets once a month.

GFA INTERNATIONAL NEWS
Contact Barry Capel, 186 Holland Street, Crewe, Cheshire, CW1 3SJ. Magazine for GFA product users on the ST.

LACE (LONDON ATARI COMPUTER ENTHUSIASTS)
Contact Glenn Leader, 143 Richmond Road, Leytonstone, London E11 4BT. Tel. 01 556 0395. XL XE ST users. Great newsletter and PD library.

MACCLESFIELD COMPUTER CLUB
Contact Peter Solomon. Tel. 0625 20782 evenings and weekends. All computer club with Atari section. Meets fortnightly.

MERSEYSIDE ATARI CLUB
Contact Mike Lynch, 24, Oakdene Road, Anfield, Liverpool, Merseyside, L4 2SR. Tel. 051 264 8435. ST ONLY. Regular meetings, newsletter and more.

RAGE HARD A.U.G. (8-bit)
Contact Tony Longworth, 13, Greenfield Road, Little Sutton, South Wirral, Cheshire, L66 1PE. Tel. 051 339 0405. For 8-bit users everywhere. Send s.a.e. for details.

ROCHDALE ATARI COMPUTER ENTHUSIASTS (R.A.C.E.)
Contact The Secretary, P.O. Box 1, Rochdale, Lancs OL12 8TQ. SAE appreciated. All Ataris, meetings fortnightly.

SIGATARI
Contact Glenn Leader, 143, Richmond Road, Leytonstone, London, E11 4BT. Tel. 01 556 0395. For those who don't play games.

ST CLUB
Contact Paul Glover, P.O. Box 20, Hertford, S13 8NN. Mail only(?). Worldwide.

STARLIGHT ATARI CLUB
Contact Douglas Woodcock, 8, Ethnard Road, Peckham, London, SE15 1RU. Tel. 01 639 3109 after 5 pm. Members with disk drive (8 bit)

VTB ATARI COMPUTER CLUB
Contact Christian Delabarre, Hekstraat 7, 9050 Evergem, Belgium. Tel. 091 26.29.29. For XL, XE, ST. Organised talks/visits etc.

WORLD ATARI PENPALS Int. User Group (WAP)
Contact Max Terveen, Magerhorst 8, Alphen a/d Rijn, 2402 LP, The Netherlands. Tel. 01720 45583. Members in USA, Canada, France, U.K., Greece, Germany, Saudi Arabia. Have circulating disk (8-bit and ST). Mail only.

Do you want others to know about your group? Send details as above ONLY (5 words max. on Members!) on a plain sheet of paper headed RESOURCE FILE - USER GROUPS.

That's all you get! We will not publish any other details as meeting times and places tend to change. Appoint someone responsible to handle any enquiries received.

PAGE 6 reserves the right to delete any entry from this feature for any reason. Inclusion does not imply any endorsement by PAGE 6 and PAGE 6 can accept no responsibility for the accuracy or completeness of an entry. Please tell us if you find any entry out of date.

BBS

Name: **GAMLINGAY TBBS**
Number: 0767 50511
Hours: 24 hours
Baud: 300 - 2400
Features: Atari SIG and program library

Name: **THE VILLAGE**
Number: 01 464 2516
Hours: 24 hours
Baud: V21, V22, V22BIS, V23
Features: 8 bit area, ST area, CP M area

Name: **INFOMATIQUE**
Number: 0001 764942 (Dublin)
Hours: 24 hours
Baud: 300 300 and 75 1000
Features: ATARI SIG and program library

Name: **CHARLY**
Number: 0451 31642 from Germany
010 49 451 31642 from England
Hours: 24 hours 7 days
Baud: 300, 8n1
Features: Atari 8-bit and ST areas.
P.D. software. Some German required!

Name: **THE ARK**
Number: 021 353 5486
Hours: 24 hours 7 days
Baud: 300 or 1200 75
Features: 8 bit with Downloads, hints, swaps etc.

Name: **CRYSTAL TOWER BBS**
Number: 01 886 2813
Hours: 24 hours
Baud: 300 to 2400
Features: Atari section which needs your support!

Name: **THE GNOME AT HOME**
Number: 01 888 8894
Hours: 24 hours/7 days
Baud: V23 viewdata
Features: ST area frame *1632.0#.
ST Babble starts on frame *1632.9#.

Name: **CBABBS**
Number: 021 430 3761
Hours: 24 hours/closed Thursdays
Baud: 300
Features: ST/8 bit, Email to USA and Canada

Name: **LEICESTER CENTRAL**
Number: 0533 700914
Hours: 24 hours
Baud: 300 and 1200/75
Features: 8 bit area and ST area

Name: **CHASE ST USER GROUP**
Number: 05438 71562
Hours: 1800 to 0900 weekdays, 24 hrs weekends
Baud: (V21/22/23)
Features: Atari PD, Amiga, MSDOS PD, CPM80

It's time we gave you the BASIC facts ...

BASIC for the Atari ST	HiSoft Basic	Power Basic	GFA Int.	GFA Comp.	Fast Basic	ST Basic 2
Retail price inc. VAT	£79.95	£39.95	£45.95	£45.95	£44.85	-
GEM Editor	✓	✓	✗	No editor	✓	✓
Max string length	No limit	No limit	32k	32k	64k	255 bytes
Max multi-DIM array size	No limit	No limit	64k	64k	No limit	64k
Complete AES & VDI access	✓	✓	✗	✗	✗	✗
Produce stand-alone programs	✓	✓	✗	✓	✗	✗
Assembly language support	Libraries	✗	✗	✗	In-line	✗
Sound commands	✓	✓	✓	✓	✗	✓
Joystick access	✓	✓	✗	✗	✗	✗
Quick reference card	✓	✓	✗	✗	✓	✗
Double precision floats	✓	✓	✗	✗	✓	✓
Multi-statement lines	✓	✓	✗	✗	✓	✓
Multi-line statements	✓	✓	✗	✗	✗	✗
Line numbers allowed	✓	✓	✗	✗	✓	✓
Line numbers optional	✓	✓	Line nos. not allowed	✗	✓	✗

6000 lines per minute!
 Compiler included
 GEM editor with macros
 Code generation
 supplied with source code
 Libraries and menus directly
 and a free CLI
 and Modula-2 compiler
 Compiler & tools package available

- Personal Pascal
- Fast, multi-window GEM editor
 - Full, standard Pascal implementation
 - Completely integrated edit/compile/link cycle
 - Complete GEM support with windows, menus, alert boxes, dialog boxes etc. BIOS, XBIOS calls
 - String management plus STRING type
 - All standard types + LONG_INTEGER & BYTE
 - Random access and sequential file handling
 - Fast, compact code plus link with assembler

- one-pass compiler
- full linker & assembler
- multi-window GEM editor
- very-fast compact code
- full GEM libraries
- create desk accessories
- library manager and linker
- completely standard
- source level debugger

Version 2 £59.95

DevpacST 2
 Full development system
 assembler - 75,000 lpm!
 include code, TEXT, DATA & BSS
 load to memory, include binary
 high-resolution debugger
 with labels
 stepping, conditional breakpoints
 auto-resident debugger
 there is no competition

Saved! Version 2 £29.95

- Saved! Ver 2
- invaluable desk accessory saves you time
 - all the desktop functions in a desk accessory
 - PATH feature is essential for hard disk users
 - plus a host of extra, incredibly useful utilities:
 - TRACKBUF to double your floppy-disk reads
 - UNDEL program to recover deleted files
 - KEEPTIME to preserve data and time over reset
 - reset-resident RAMdisk included FREE!
 - configurable printer spooler included FREE!

DevpacST Ver 2

- complete, integrated
- fastest, professional
- DRI and GST linker
- local labels, assembler
- multi-window, multi
- disassemble to disk
- full expression han
- source-code viewin
- DevpacST 2 - now

AT and UK postage and packing. You can order by post with a cheque/postal order or by credit card/Access/Visa. We always despatch by first class post, usually within 3 days of order.

All prices include VAT
 phone using A

Your **FREE** Software Guide



THE ATARI 8-BIT Software Guide

FOR ATARI 400/800/XL/XE COMPUTERS

OVER 160 TITLES FEATURED!

Welcome to the latest guide to software for the Atari 8-bit (400/800/XL/XE) range of home computers. As you can see, there are plenty of titles to choose from, such as games on cassettes (red headings), ROM cartridges (blue headings), and disks (orange headings), with prices as low as only £3.95! Where a title is available on more than one format, we have included it in all of the sections in which it is available. You will find that certain titles are packaged with both cassette and disk in the same box, at no extra charge. Each title should be compatible with all computers in the Atari 8-bit range unless otherwise indicated. We have tried to make this catalogue as comprehensive as possible, covering a variety of different titles ranging from entertainment to education and productivity. We have also included a section on books which you may find useful when programming or simply finding out more about the enormous potential of your Atari computer. There are 162 titles (books and software) to choose from. We hope that this catalogue is of use to you and that you find something suitable from the wide range of products featured. E&OE.

INDEX

GAMES - CASSETTES

GAMES - CASSETTES £3.95 - £4.95 2-5
GAMES - CASSETTES £7.95 - £9.95 6-9

GAMES - CARTRIDGES

GAMES - CARTRIDGES £7.95 - £9.95 10-12
GAMES - CARTRIDGES £12.95 13

GAMES - DISKS

GAMES - DISKS £7.95 - £9.95 14-17
GAMES - DISKS £12.95 - £14.95 18-21
ADVENTURES - DISKS £4.95 - £9.95 22

EDUCATION & HOME

HOME PRODUCTIVITY 23
EDUCATION & TUTORIALS 24-25

PROGRAMMING LANGUAGES

PROG LANGUAGES & ASSEMBLERS 26-27

BUSINESS PRODUCTIVITY

ART & GRAPHICS 28
SPREADSHEETS 28
WORD PROCESSORS 29

BOOKS

BOOKS £1.95 - £4.95 30
BOOKS £4.95 - £9.95 31
BOOKS £14.95 - £19.95 32

AVAILABLE FROM YOUR ATARI DEALER:

SILICA SHOP

Mail Order & General Enquiries: 1-4 The Mews, Hatherley Road, Sidcup, Kent, DA14 4DX Tel: 01-309 1111
BRANCHES: **SIDCUP:** 1-4 The Mews, Hatherley Road, Sidcup, Kent, DA14 4DX Tel: 01-302 8811
LONDON: Selfridges (1st Floor), Oxford Street, London, W1A 1AB Tel: 01-629 1234 (ext 3914)
LONDON: Lion House (1st Floor), 227 Tottenham Court Road, London, W1P 0HX Tel: 01-580 4839

Compliments
of

SILICA SHOP