

FREE!



NAVIGATE →

Issue 17 | July 2008

P3Zine

Free Magazine For PlayStation 3 Gamers. *Read it, Print it, Send it to your mates...*



EXCLUSIVE!
TNA IMPACT INTERVIEW
We talk to the top TNA superstars

Definitive review inside...

PREVIEWED!



Bioshock

PREVIEWED!

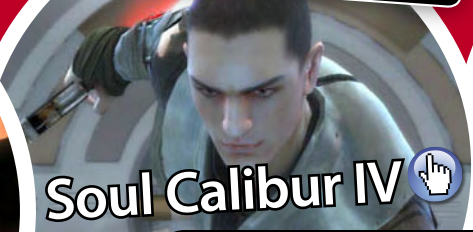

Soul Calibur IV

PREVIEWED!



Beyond Good & Evil 2

REVIEWED!



THE BOURNE CONSPIRACY

CONTROL →





Welcome to P3Zine



The smash that is Guitar Hero returns once more, this time in the shape of a dedicated Aerosmith edition. Axes at the ready you can of course read the full review within these pages. We also have the videogaming take on Jason Bourne - if you're a fan of the films The Bourne Conspiracy is looking like a must-buy.

Looking further ahead Soul Calibur IV is nearly upon us, so this month we take a final gander at what you can expect to whet your appetite prior to the game's arrival next month. And last but certainly not least we have an exclusive preview and interview for the muscular TNA Impact. Enjoy the issue...

MAGAZINE FEEDBACK!
Click here to tell us what you think of the magazine

Dan Hutchinson, Editor
p3zine@gamerzines.com

MEET THE TEAM

There's nowt they don't know about PlayStation



Steve Hill
Is looking forward to Soul Calibur IV



Ian Morris
Is beyond good and evil

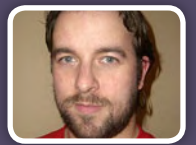

Chris Schilling
Is rocking with Aerosmith

DON'T MISS!
This month's highlights...
The latest & greatest titles on PS3

Guitar Hero: Aerosmith
Massive review

Soul Calibur IV
Hands-on preview

TNA Impact
Preview and interview

BioShock
First-look

QUICK FINDER

Every game's just a click away

- | | |
|----------------------------|--------------------------|
| BioShock | Soul Calibur IV |
| Beyond Good and Evil 2 | TNA Impact |
| Alone in the Dark | Guitar Hero: Aerosmith |
| IL-2 Sturmovik: | The Bourne Conspiracy |
| Birds of Prey | Wolf of the Battlefield: |
| Prince of Persia | Commando 3 |
| Call of Duty: World at War | Echochrome |
| PixelJunk Eden | Metal Gear Solid |
| Red Faction: Guerrilla | Database |
| UFC 2009: Undisputed | |

MORE FREE MAGAZINES! LATEST ISSUES!

DON'T MISS ISSUE 18 SUBSCRIBE FOR FREE!

WARNING! MULTIMEDIA DISABLED!
If you are reading this, then you didn't choose "Play" when Adobe Reader asked you about multimedia when you opened the magazine.

Without the multimedia playing, the magazine will look correct, but you will be missing out on all of the extra content built into each issue, like videos, animated screenshots, annotations, quizzes, competitions and more.

We recommend you close and re-open the magazine and select "Play" when asked about the multimedia to enjoy the magazine as intended.





Publisher: 2K Games
Developer: 2K Games
Heritage: System Shock 2
Link: www.2kgames.com/bioshock
ETA: October

PREVIEW FEEDBACK!
 Click here to tell us what you think of BioShock



Rapture's home to some freaky people, who you'd be best off avoiding.

"BioShock is one of the finest games of last year, if not of all time"



Beautiful environments, a fantastic storyline and top notch gameplay – coming to PS3 soon.

BioShock



Shock and total awe

What is it?

BioShock is, without a shadow of doubt, easily one of the finest games of last year, if not of all time. Big words to be sure, but we know that there's a big enough game here to more than justify those words. An epic under-sea adventure, BioShock drew you into its underwater sanctuary like no other game had, creating an involving, and gripping experience that you simply couldn't put down. Now, after many months of waiting, the game's finally making its way to the PS3, and it's coming this October.

What's it all about?

BioShock is set in Rapture – an underwater haven for scientists, artists, and all other sorts of outcasts from society, where they could practice their craft free of the shackles of 'petty morality'. You wake up inside Rapture, not knowing who you are, where you've come from, or what you've got to do. It's a dangerous place down there, and as Rapture

starts to rust and fall to pieces, you unravel a mystery that'll have you totally hooked from start to finish.

Any more?

The game should have new features, and even more excitingly, the PS3 version will feature new DLC - single player Challenge rooms. Whether we have to pay for this new content remains to be seen, but we can only hope not, in order to make up for the colossal wait we've had to go through.

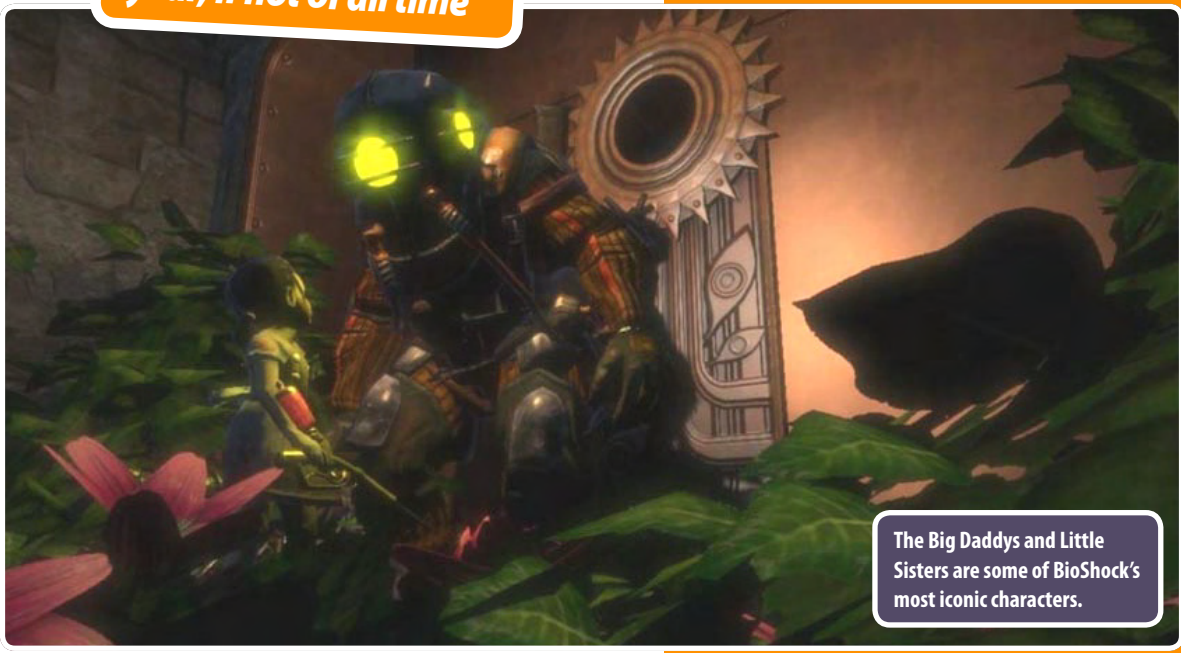

The Big Daddys and Little Sisters are some of BioShock's most iconic characters.



“DESTRUCTIBLE PROPS, GREAT CAMERA
AND MIGHTY MELEE COMBINE TO FORM
THE PERFECT HUMAN WEAPON”

GAMESPY - 4/5

BECOME THE
PERFECT WEAPON.
BECOME BOURNE.

BOURNETHEGAME.COM

ROBERT LUDLUM'S

THE BOURNE CONSPIRACY™

“JASON BOURNE'S QUICK-FISTED HEAD-BUSTING
COMBAT STYLE MAKES THE TRANSITION
TO CONSOLES WITH PANACHE”

GAMESPOT - 8.0/10



ROBERT LUDLUM'S
THE BOURNE
CONSPIRACY™

IN STORES
NOW!

DOWNLOAD THE
DEMO
TODAY!

16+ HIGHMOON SIERRA

bournethegame.com

▶ PLAYBACK OPTIONS:

They made you the perfect weapon. Now they want you dead.
Seamlessly switch from hand-to-hand combat, shooting and
dramatic escapes in this intense, fast-paced action experience.
GO BEYOND THE JASON BOURNE YOU KNOW...

OUT TODAY!

16+
www.pegi.info

*Robert Ludlum's The Bourne Conspiracy™ interactive software © 2008 Vivendi Games, Inc. All rights reserved. "The Bourne Identity" characters, events, story and publishing rights (c) 1980 Estate of Robert Ludlum. All rights reserved. Developed by High Moon Studios. Sierra and the Sierra logo are either registered trademarks or trademarks of Sierra Entertainment, Inc. in the U.S. and/or other countries. All other trademarks are property of their respective owners. Microsoft, Xbox, Xbox 360, Xbox LIVE, and the Xbox logos are trademarks of the Microsoft group of companies. "PlayStation", "PLAYSTATION" and "PS" Family logo are registered trademarks of Sony Computer Entertainment Inc.



PLAYSTATION 3



CONTROL →





Publisher: Ubisoft
Developer: Ubisoft
Heritage: Rayman,
 Beyond Good and Evil
Link: N/A
ETA: TBA



If this is all in-game then we're sold.

PREVIEW FEEDBACK!
 Click here to tell us what you think of Beyond Good and Evil 2



The close-up detail is truly stunning, as you can see here.

"The first Beyond Good and Evil game was one of the best games of the last generation"



Creativity is king in BG&E – after all, how many other games let you play as a pig?



Beyond Good and Evil 2

Return of the pig...

What is it?

To be honest, that's a really good question, for as much as it looks like Beyond Good and Evil 2, it smells like Beyond Good and Evil 2, and it even has the same characters as Beyond Good and Evil, Ubisoft have not yet made any announcements about whether the game's even in development. All we know is that Ubisoft recently released a trailer at their Ubidays event, and that's enough to get our mouths watering.

Why should we be excited?

Beyond Good and Evil was one of the best games of the last generation. An entirely original creation by Michel Ancel – the creator of Rayman the original game was widely respected by critics and fans alike, and gained a huge cult following due to its innovative gameplay and storyline. Following Jade, a female reporter, you had to sneak around a dystopian environment, spying on an evil corporation. It was made enjoyable through its excellent characterisation, unique graphical style, and sense of humour – all of which seem to still be intact for the sequel.

When can we expect more?

As soon as Ubisoft make an official announcement on the future of the game, you can be sure we'll be straight there. We'd imagine a confirmation can't be too far away, with a potential release in 2009. In the meantime, enjoy the trailer online, and just use your imagination!

INCOMING

Another magnificent seven...



IL-2 Sturmovik: Birds of Prey

Publisher: 505 Games | ETA: 2009

Being the fans of flight sims that we are, this one has us very excited indeed. The sublime IL-2 Sturmovik series will soon be making its way to a console near you, with its difficulty level intact, and a hell of a graphical overhaul to boot. This is one pretty game, and we can't wait.

Alone in the Dark

Publisher: Atari | ETA: Autumn

While everyone else is enjoying the wonders of Alone in the Dark, us PlayStation owners have been left in the, ahem, dark for a little too long regarding the game's release date. But, worry no more, as it's recently been announced that the survival horror zombie basher will be making its way to the PS3 this autumn. So, there you go.



Prince of Persia

Publisher: Ubisoft | ETA: Late 2008

We brought you news of this one a while back, but now it's official: there's a new Prince of Persia in development, complete with a new visual style, a new prince, and even an AI-controlled girl that follows you around to lend a helping hand.

Call of Duty: World at War

Publisher: Activision | ETA: Autumn

Taking the series back to the jungle, or more specifically, the WW2 Pacific theatre, Call of Duty: World at War is once again being developed by Treyarch, the people who bought you COD 3. Promising flame-throwers, and a co-op mode, this one could be rather brilliant.

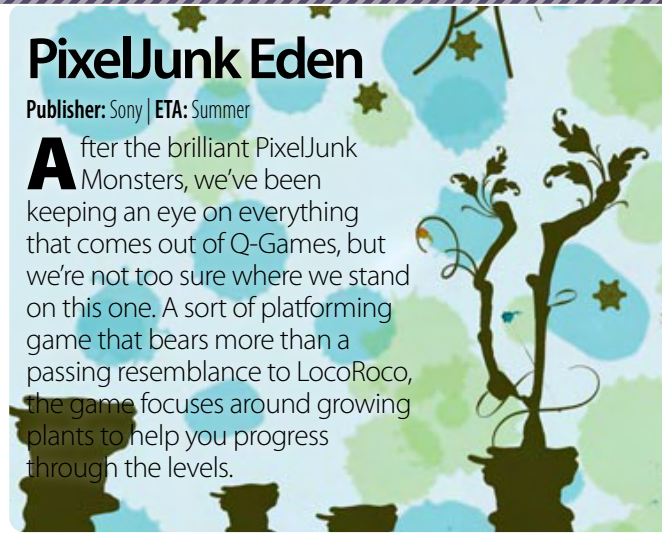

PixelJunk Eden

Publisher: Sony | ETA: Summer

After the brilliant PixelJunk Monsters, we've been keeping an eye on everything that comes out of Q-Games, but we're not too sure where we stand on this one. A sort of platforming game that bears more than a passing resemblance to LocoRoco, the game focuses around growing plants to help you progress through the levels.

Red Faction: Guerrilla

Publisher: THQ | ETA: 2009

Bringing the same destructible environments, the same alien setting (Mars), but presenting it all from a third-person view point, Red Faction: Guerrilla is looking quite different to your normal Red Faction game. With big stompy robots to go around in and blowing stuff up, this is sure to be good.

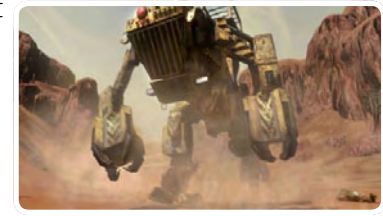

UFC 2009: Undisputed

Publisher: THQ | ETA: 2009

After a brief hiatus, the hard-hitting UFC is making a comeback to consoles, with UFC 2009: Undisputed. Developed by Yukes, who've made more than a few wrestling games in the past, this should be a nice alternative for people who like their grappling games a bit more brutal.



IN THE PIPELINE

AUGUST	SEPTEMBER	NOVEMBER	WINTER
SOUL CALIBUR 4 MADDEN NFL 2009	FALLOUT 3 SILENT HILL: HOMECOMING	SMACKDOWN 2009 RESISTANCE 2	KILLZONE 2 LEGENDS OF WRESTLEMANIA



GUITAR HERO[®]

AEROSMITH[®]

Rise To Rock Royalty

Rise to Rock Royalty with Guitar Hero[®]: Aerosmith[®] and rock out and jam on stage like you never have before with Aerosmith's authentically captured legendary moves. Play the best Rock & Roll tracks of all time including Aerosmith's greatest hits and chart-topping singles from some of the world's best bands.

OVER 40
MONSTER TRACKS, INCLUDING:

-  Sweet Emotion
-  Dream On
-  Make It
-  Love In An Elevator
-  Mama Kin
-  Train Kept A Rollin'
-  Movin' Out
-  Walk This Way (Run DMC)
-  Back In The Saddle
-  Toys In The Attic
-  Nobody's Fault
-  Ragdoll

AND ALSO FEATURING

-  Lenny Kravitz
-  The Clash
-  Joan Jett and the Blackhearts
-  The Cult

AND MORE!!



 **PLAYBACK OPTIONS:**



Walk This Way

JUNE 27TH 2008



PlayStation 2

PLAYSTATION 3

XBOX 360 LIVE

Wii



CONTROL →





Publisher: Ubisoft
Developer: Project Soul
Heritage: Soul Calibur
Link: www.soulcalibur.com
ETA: 31st July

PREVIEW FEEDBACK!
 Click here to tell us what you think of Soul Calibur IV

Soul Calibur IV

Always two there are... a master, and an apprentice

Through churning out quality title after quality title, the Soul Calibur series has built up quite a reputation among fight fans over the years. Wii's Soul Calibur Legends notwithstanding, there hasn't been a duff Soul Calibur game yet, and that's reason enough to get excited about this fourth instalment.

For those inexperienced with Soul Calibur games, the series presents a mix of Tekken, and Dead or Alive, but instead of letting the combatants duke it out with fists, you're armed with huge hulking swords, spears, and daggers instead. With battles taking place on mysteriously floating squares amid highly detailed and visually stunning environments, Soul Calibur has always been a looker, and this remains true for the PS3 debut.

With environments ranging from huge waterfalls to beaten-up ships, you may have a hard time keeping your eyes off the surroundings, but the characters look even better. Already confirmed are series faves Cassandra, Ivy, Taki,

Rock and Yoshimitsu among others, and there'll even be a full character customisation tool, allowing you to adapt the look of your warrior before you take them online.

One of the areas where Soul Calibur has always excelled is in bringing a balanced roster of characters to the table, so you'll be pleased to know that it appears little has changed this year. There's still the intricate set of trade-offs between the huge, powerful characters, and the smaller, lighter opponents, with the size of your weapon (stop sniggering) also adding an extra layer of strategy. Swords, spears, daggers and soul blades all have different pros and cons, and it seems this strategy is only set to get deeper with the inclusion of a new weapon type – lightsabers.

It's recently been confirmed that not one, but two Jedi will be available in Soul Calibur IV, in the form of the 'Apprentice', from the new Star Wars game, and everyone's favourite super villain, Darth Vader. ➤



Looks like it's all over for Sophitia. Unless her ribbons can block lightsabers.



"It's recently been confirmed that two Jedi will be available in Soul Calibur IV"

Lizardman. Inventive name, inventive moves.



We don't have a clue who this is, but boy does he look hard.



> Soul Calibur IV continued

Brilliantly, there's even a Star Wars-themed level to keep the characters feeling at home, and, strangely, both these new additions can also use the Force during battle.

Using the Force in battle may give these two characters an unfair advantage over the other, non-Jedi fighters, and this could bring Soul Calibur's intricate fighting scheme crashing down on its neck. Hopefully, though, the other tweaks to the fighting system will counter this, as there are plenty more to talk about.

Brilliantly, Soul Calibur IV introduces a new way to counter those annoying types who just sit there blocking (you know who you are), as by constantly striking a blocking opponent, you can eventually break through their armour. This even has a visual effect, where chunks of metal go flying, and plates fall off. Weaken their armour enough, and you can unleash a special 'Critical Finish' – a screen filling super-move, that obliterates your opponent. Lovely.

From what we've seen of Soul Calibur so far, this could easily be the best PS3 fighting game yet. Though the addition of Jedis is cool, we're a bit concerned about how it's going to affect the gameplay, but if their track record is anything to go by, we shouldn't be too worried. Look for Soul Calibur IV to plug the summer drought towards the end of July. ●

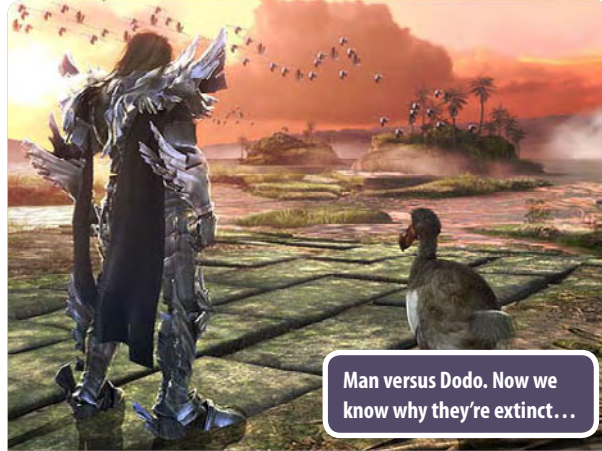

Man versus Dodo. Now we know why they're extinct...

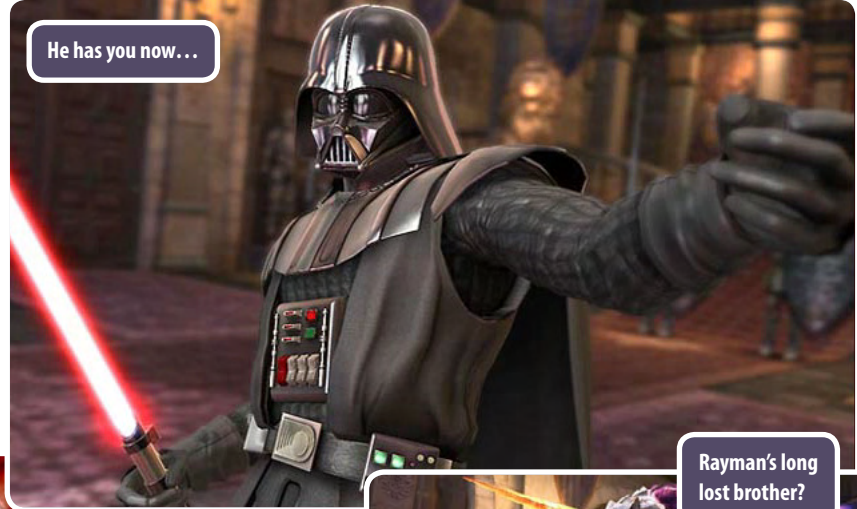

He has you now...

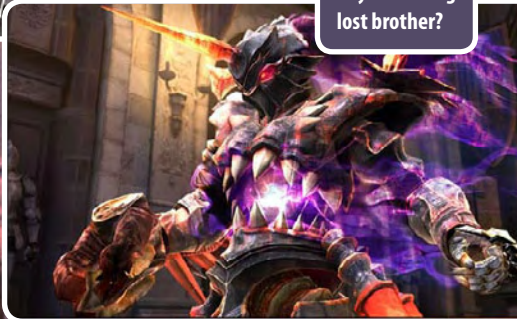

Rayman's long lost brother?



Some of the weapon effects are a bit over the top.

"Soul Calibur IV introduces a new way to counter those annoying types who just sit there blocking"

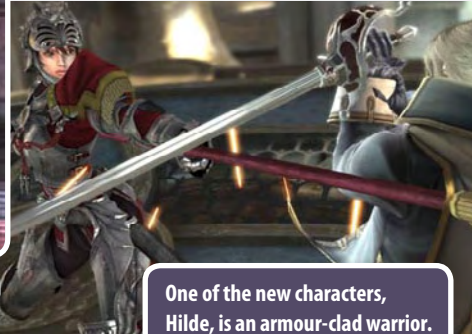

One of the new characters, Hilde, is an armour-clad warrior.



Is that a wardrobe malfunction we see?



Lovely looks, gorgeous gameplay – one to watch this summer



Publisher: Midway
Developer: Midway LA
Heritage: Mortal
Kombat
Link: www.
tnagame.com
ETA: 2nd September

FIRST LOOK

TNA Impact

Feel the vibe of the adrenaline rush

If you're a wrestling fan, you'll probably have heard of TNA, as the organisation now outdraws the WWE in UK TV ratings, and has recently finished a sell-out UK tour. Hot on the heels of this success, Midway and TNA recently held an event in London, giving us a chance to go hands-on with the latest challenger to SmackDown's heavyweight title.

The first thing you'll notice when you pick up the pad is just how stunning everything looks. Having taken full body shots of the actual wrestlers then stretched their image over the models, the representations contained within are the best we've seen in any wrestling game. Ever. When we sat down to talk with AJ Styles, one of TNA's star wrestlers, he told us of the lengths Midway have

PREVIEW FEEDBACK!
Click here to tell us what you think of TNA Impact

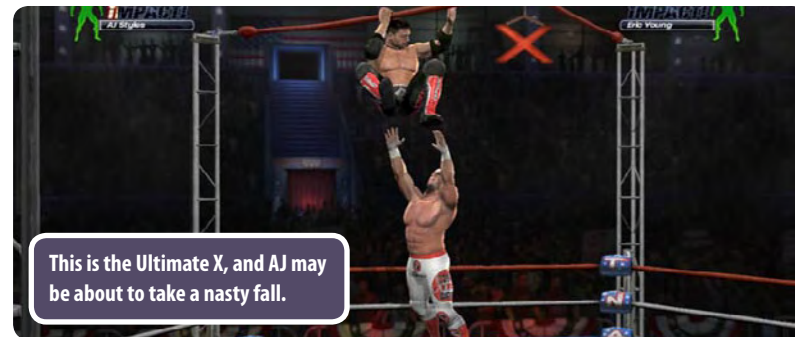

This is the Ultimate X, and AJ may be about to take a nasty fall.

gone to get everything looking right – from painstakingly recreating the scars of each wrestler, to including the blood stain that's on the mat at the Impact zone in Florida. Now that's attention to detail.

Also impressive is just how fluid the animations are, especially in comparison to SmackDown. Impressively, every move in the game has been mo-capped,

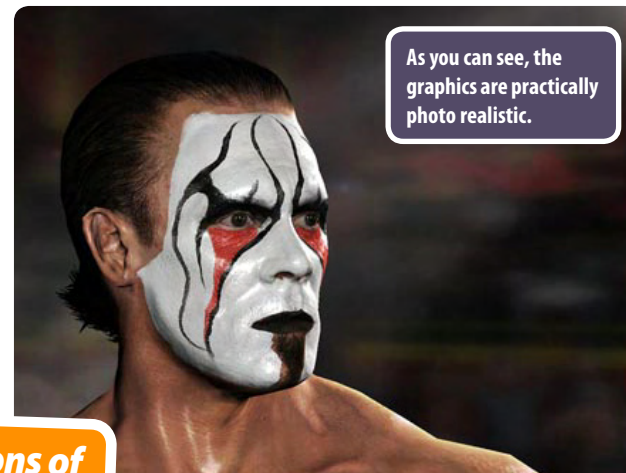

As you can see, the graphics are practically photo realistic.

"The graphical representations of the actual wrestlers are the best we've seen in any wrestling game"

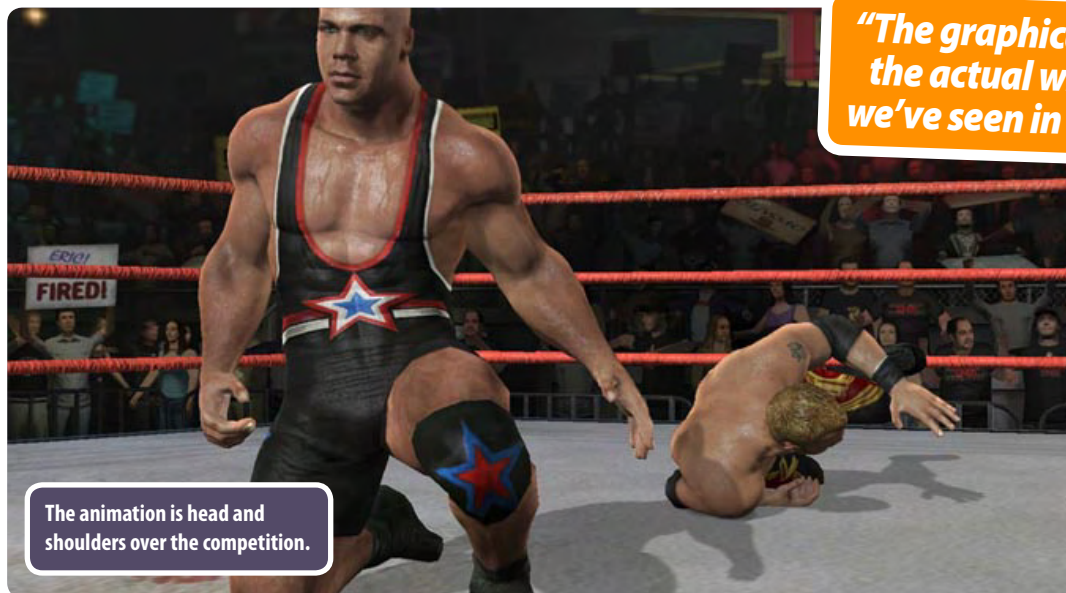

The animation is head and shoulders over the competition.



TNA is basically the WWE on steroids.



> TNA Impact continued

with top TNA stars Samoa Joe, Christopher Daniels and Jay Lethal having donned the suits and performed extensive motion capture sessions over the last two years. At the event, Joe recalled a 'decapitation problem' they experienced during the mo-cap sessions, whereby, when performing a huracanrana with the mo-cap suit on, one of the wrestler's hats would get ripped off. As it didn't know any better, the system recognised this as meaning a huracanrana decapitates you. If only they'd left that one in!

The poster child of match types for TNA Impact is the Ultimate X, a contest which sees two wrestlers fighting to retrieve a prize (either a belt, or an X), which is suspended high above the ring from two crossing ropes. From what we played of this mode, it's set to be every bit as exciting as you could hope. As you shimmy across the ring towards

the centre, you're constantly trying to prevent yourself being pulled off the ropes by your opponent, and fending off these attacks. It's a tense and rewarding experience.

However, it's not all fun and games in the Impact camp. At the moment the game feels far too unbalanced – for example, when you've earned your finisher, you keep it for the entire match, and this lets you just unleash finisher after finisher on your opponent. Equally disappointingly, this means the finishers currently do very little damage – certainly not what you'd expect from a 'finishing' move.

Thankfully, these issues are all just a matter of balancing, and hopefully they can be corrected before the game's launch in a couple of months. With its problems corrected, and its difficulty balanced, SmackDown could be looking at a serious contender to its crown. ●

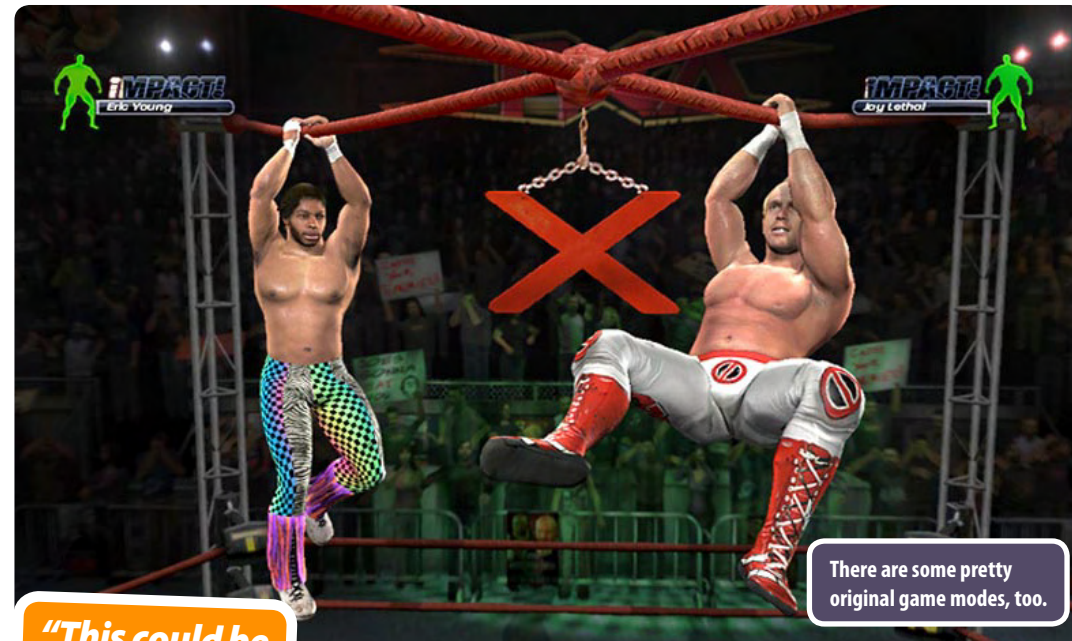

There are some pretty original game modes, too.

"This could be a serious contender to SmackDown's crown"



As TNA don't have such individual PPV sets, they've made up arenas around the world. This is the UK one, as you may imagine.

Scanned, mapped and modelled – the TNA superstars.



The level of detail in the graphics shows every bead of sweat!



P3Zine **TNA IMPACT!**

PERCENTAGE COMPLETE 90% **FIRST IMPRESSIONS** 75%

Could be a contender, but the bugs need sorting first.

TNA IMPACT

Three guys, one game, lots of questions...

At the recent Midway press event in London, we had the chance to sit down with top TNA superstars, X-Division

champ Petey Williams, AJ Styles, and Heavyweight Champ Samoa Joe. Luckily for us, the only wrestling going on was with our questions...



The moves in TNA are a lot more flashy than in the WWE, as you can see by Christopher Daniels' 'whatever this is'.



They may look a bit more muscley than their real-life counterparts, but other than that this is spot on.

You're fresh off your first UK tour, which has been a huge success. How have you found your time in the UK?

AJ: Tremendous! They make it easy to go out there and put it all on the line. When the fans go wild, there's nothing I don't wanna do. It's not your typical house show, where you think, "I'm not gonna go out there and do stupid stuff and get hurt" – you wanna go out there and make sure they get their money's worth.

Petey: It's been a very successful tour. I mean, we sold out every night – we couldn't have been happier. I had a lot of fun with the English fans as they're really respectful. In the US they don't really like Canadians, but over here we're under the same Commonwealth, and you guys respect Canadians in England, so I was really happy about that.

Joe: It's been going really, really well. Everywhere we've been, the crowds have been super receptive. The fans over here are fantastic – it's been a lot of fun.

How early on in the development were you guys brought on-board with the game?

AJ: Pretty much from the beginning. As soon as it started, we were up in LA, looking at what they'd developed. As soon as we were able to get started with the motion capture, they brought us in.

"Everywhere we've been in the UK the crowds have been super receptive. The fans here are fantastic"

> Interview continued

Petey: They asked us our opinions of what we thought of other wrestling games, what we liked and didn't like. You know, there's a lot of stuff where like a guy gets powerbombed and

he's up right away, and that's not right. We were pretty involved from the beginning – the development was like two years.

I guess that probably led to a few painful days doing Ultimate X motion capturing.

AJ: Yeah, it did Not many people know, but the cable up you've got to hang on to rips into your hands. It's not fun, but this is the match you'll have the most fun with in the game.

It looks like it's all been worth it, as the Ultimate X match does

Words can't describe how phenomenal this looks. Simply amazing.

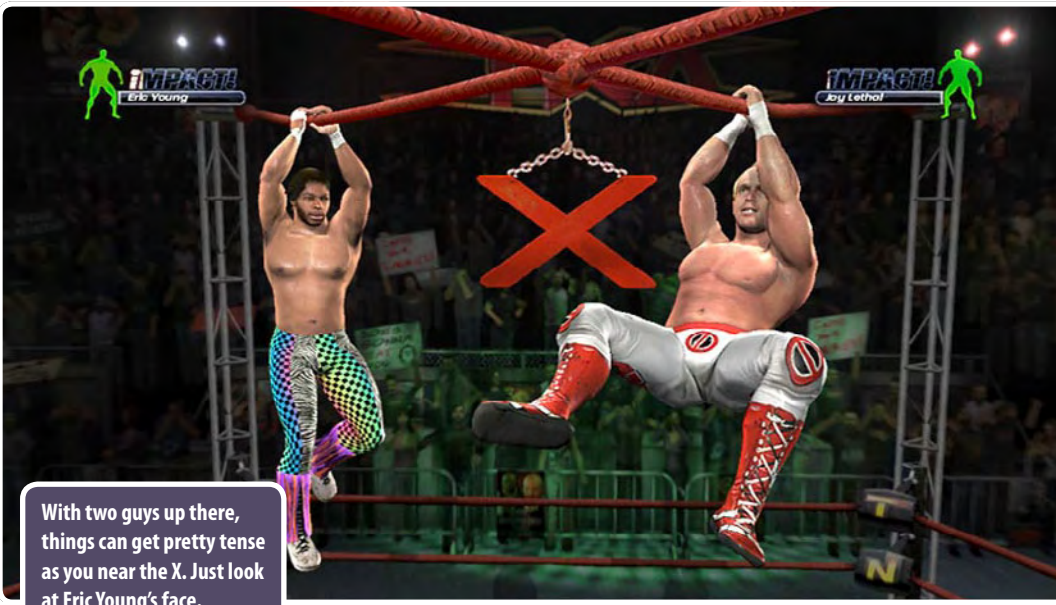

With two guys up there, things can get pretty tense as you near the X. Just look at Eric Young's face.

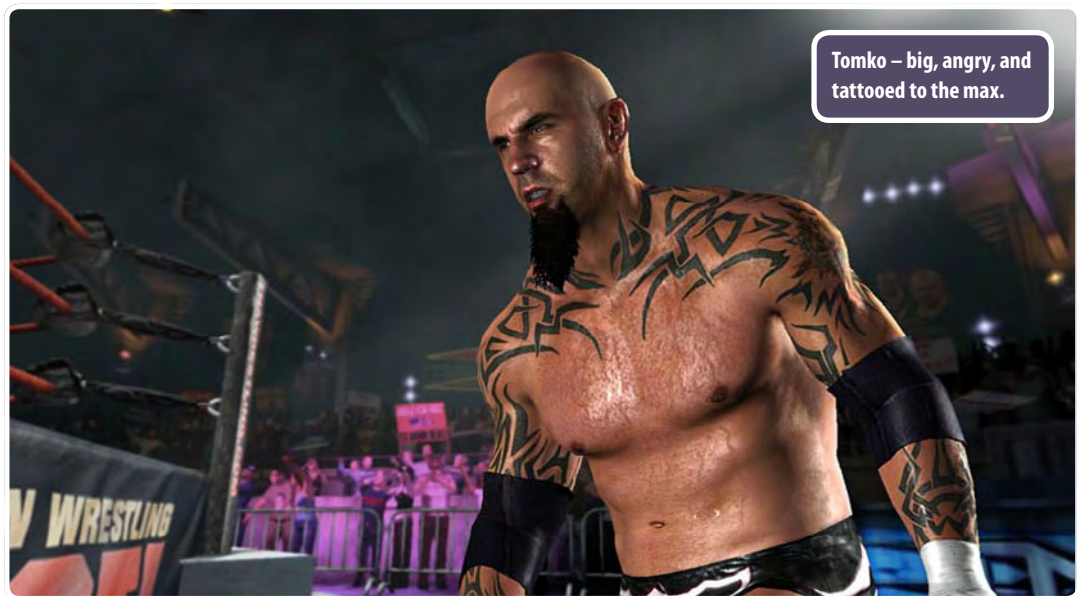

Tomko – big, angry, and tattooed to the max.

seem like a lot of fun in the game – can you fill us in on what goes through your head when you step into a match like that?

AJ: It really is dangerous, when you think about what you've got to do up there. It's hard to get up there and shimmy your way down to the X or belt, or whatever's up there. It takes a lot of endurance – a lot of people don't think about that.

Are you happy with how the game's turned out? I'd presume there's going to be a sequel?

AJ: Yeah, there's definitely going to be a sequel. There's always stuff you wish you can go back and change, but for the most part, I think it's a great game. If there was one thing I could change, then it'd be the character's moves – I'd stick a little bit more of those in, but you've got

to remember that we started from scratch. I think it's still gonna be fun. Everyone should give it a chance and come and find me online, so I can beat the crap outta people! ●



Publisher: Midway
Developer: Midway LA
Heritage: Mortal Kombat
Link: www.tnagame.com
ETA: September 2nd

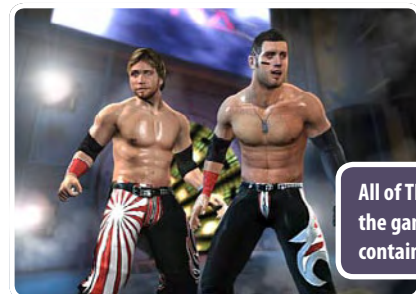

All of TNA's hottest stars are in the game, with the full roster containing around 30 wrestlers.

“Everyone should give it a chance and come and find me online, so I can beat the crap out of you!”



Guitar Hero: Aerosmith

Walk this way... for some rhythm-action rock 'n' roll

Assuming the sentiment was genuine in Aerosmith's 1998 hit I Don't Want to Miss a Thing, then the band themselves would feel a little let down by the latest in the Guitar Hero series, and not only because the ballad is sorely missed in the tracklisting. Jaded, Cryin', Crazy and others are omitted, while Dude Looks Like a

Lady is perhaps the saddest loss of all. Whether or not these songs have enough complexity in the guitar parts to warrant their inclusion is a moot point – without them, it doesn't feel like sufficient tribute to one of rock music's most enduring groups. And surely they could have at least been made available as single-difficulty unlockables?

Carping about the tracklisting aside – and indeed that the game perhaps feels more like an expensive expansion pack than one deserving of a full-price release – Guitar Hero: Aerosmith is a solid addition to the franchise that only disappoints because of what it could have been.

The game follows the standard Guitar Hero tradition of making

"Guitar Hero: Aerosmith is a solid addition to the franchise"

JAM WITH THE BAND

Tyler and Perry invite you to mix it with the big boys



Realism vs Fantasy

Pain for pleasure

Face off

Realism vs Fantasy

Obviously you'll never get to play with Aerosmith in real life (unless you're Slash or something), but Neversoft have done their best to make the experience feel authentic, visiting Max's Kansas City – an early gig venue – and taking footage.

Aerosmith's performance at the Superbowl in 2001 is recreated here.

Roll over screen for annotations

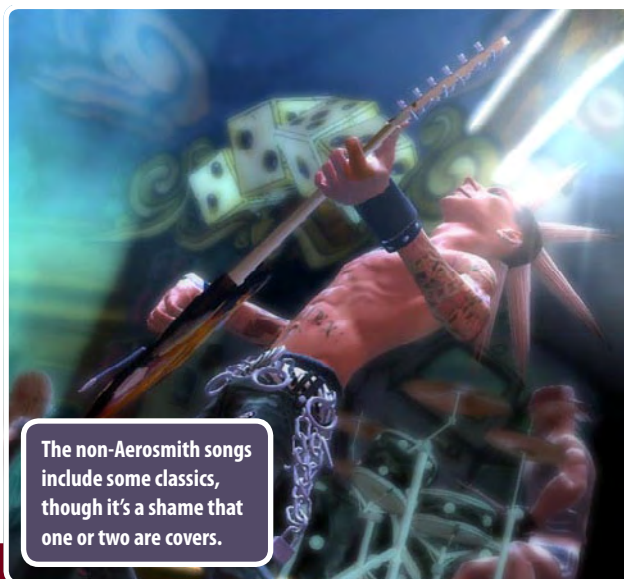

The non-Aerosmith songs include some classics, though it's a shame that one or two are covers.





In an inventive visual touch, some of the venues are based on the covers of Aerosmith's best-known albums.

"Aerosmith have re-recorded four tracks from their debut album especially for the game"

> **Guitar Hero** continued

the player select a guitarist and then charging you with naming your band – because half the time you're not playing as the titular group, but a support act, warming the crowd up before Aerosmith bound on stage for their headline set. The structure is near-identical for each venue you

visit – play a couple of covers, bring on Aerosmith, and rock out as Joe Perry for a couple of classic tracks from the band. Perform well enough, and you'll come back onstage for an encore. Five songs done, and you move on to the next venue and repeat until the game's over.

As for the musical selection, Aerosmith songs tally up to around sixty per cent of the total, with tracks from other bands (apparently selected by the members of Aerosmith) making up the other forty per cent. The likes of She Sells Sanctuary by The Cult and Stone

Temple Pilots' Sex Type Thing are welcome inclusions, while Aerosmith have re-recorded four tracks from their debut album especially for the game. With many more recent songs missing, the music skews a little older than you might expect. Still, when you're jamming to the original Walk This Way or Sweet Emotion, you won't mind. Meanwhile, skyscraping hits like Love in an Elevator and Livin' on the Edge sound better than ever when you're playing along. True, the

WALK THIS WAY

How to become the top of the pops



10 MINS
Mendon Nipmuc High School was Aerosmith's very first gig.



1 HOUR
The first taste of success moves you one rung up the ladder.



3 HOURS
A trip to Moscow surprises the band, as they realise they're big worldwide.



6 HOURS
Struggling to beat Joe Perry to unlock the final few songs – a low point.

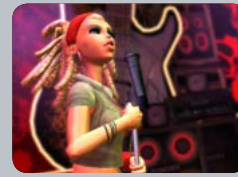

10 HOURS
Tackling Hard or Expert for the big scores, or enjoying a little multiplayer duel.





Could the missing tracks be made available through downloadable content?



Next up for Neversoft is Guitar Hero: Metallica.

> Guitar Hero continued

beat-matching isn't always as intuitive as you suspect it would be if this was Rock Band: Aerosmith, but Neversoft has otherwise made a decent fist of retooling some of these classics for five coloured buttons.

The game's presentation is less flamboyant than the charismatic band themselves, though it's certainly atmospheric throughout, recreating the look of the group well and basing the animation on videos of Aerosmith in performance. This contrast between the comparatively flat and lifeless opening act and the born showmen of the group is very noticeable, and feels strangely authentic – the bigger band take the stage to wild applause, have much more elaborate stage set-ups, and genuinely put on a more visually impressive performance than your selected avatar and their own band.

As you'd expect, the sound is exceptional, with crowd chants gratefully received when you're hitting Star Power notes, and Aerosmith have rarely sounded better than now – assuming you're playing well, that is. And that's less of a problem than on earlier Guitar Hero games. This certainly has a more gradual difficulty curve than Guitar Hero III, with just one irritating sticking point near the end as you enter a guitar battle with Joe Perry – attempting to pick up as many power-ups as possible to put him off his cascading solos.

Brief talking-head clips of the band introduce each venue, and each stage of the Aerosmith story – in truth, these are a little too brief at times, but at least you're not waiting long if you just want to get straight to the music. 10 unlockable

tracks await purchase once you've completed the 31 in Career mode, while guitars and alternate outfits can also be bought. They're pretty standard Guitar Hero extras, but it's still nice that they're in there.

Ultimately, Guitar Hero: Aerosmith has to be seen as a slightly missed opportunity. Though it still has that classic Guitar Hero feel, and remains as wonderfully addictive as ever, it's bound to disappoint its audience in some way. Those who aren't particularly fond of Aerosmith will wish for more tracks from other artists, while massive fans will undoubtedly complain that their favourite song is missing. But once that opening riff to Run DMC's version of Walk This Way kicks in, it's impossible to wipe that cheesy grin from your face. ●

Chris Schilling

PULSOMETER *Signs of life*

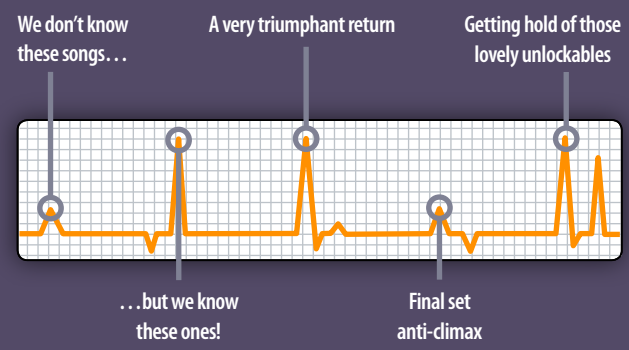

"10 unlockable tracks await purchase once you've completed the 31 in Career mode"

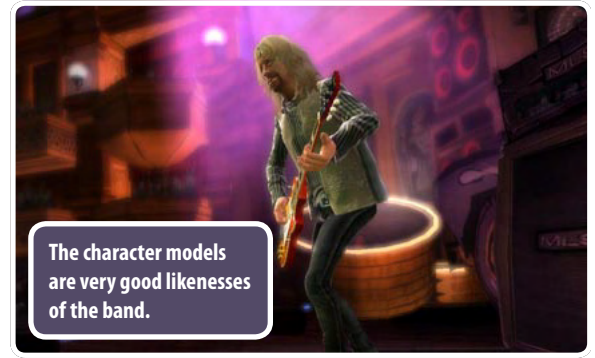

The character models are very good likenesses of the band.

P3Zine Verdict

- + Impressive band performances
- + Mostly decent tracklisting
- Glaring song omissions

80%

Incomplete, but a must for any Aerosmith fan



The Bourne Conspiracy

Publisher: Sierra
Developer: High Noon
Heritage: Darkwatch
Link: www.bourne
thegame.com
OUT NOW

The jetsetting super-spy makes an impressive console debut

For a game as stop-start as The Bourne Conspiracy – peppered as it is with cutscenes of the interactive and passive variety, Quick Time Events, restless camerawork and switches between ranged and melee-based combat – it’s remarkable how it manages to maintain a genuine sense of

momentum. Particularly given its zigzagging timeline – shunting Bourne from present to past and back again with almost alarming regularity. It’s testament to developer High Noon that it never feels like a collection of minigames, even though on paper it probably should. There’s a flow to it, a continuity

“It never feels like a collection of minigames, even though it probably should”

that keeps you playing through checkpoint after checkpoint, chapter after chapter – even when it gets repetitive, you’re compelled to continue. It’s far from perfect, but it draws you in time and time again.

It’s true that those familiar with the films will get the most out of this – the cinematography retains

BOURNE TO BE WILD

His enemies are fierce, but Bourne’s even more violent. Here’s why...



Fighting machine

Blood sport

Bossed around

Fighting machine

Bourne’s heavy attacks see him winding up huge punches to batter his opponents into submission. It’s wise to blend in a few quick jabs, as beefier attacks take longer to execute, and you’re at risk of getting hit while you’re preparing to punch.

Roll over screen for annotations



Occasionally a more sneaky approach pays dividends, allowing you to take out your enemies without raising alarms.

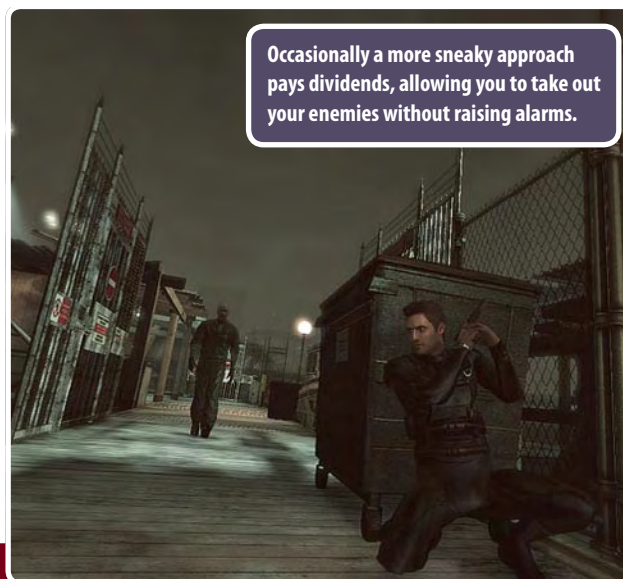

A lightning storm makes for a dynamic backdrop to an early combat sequence.



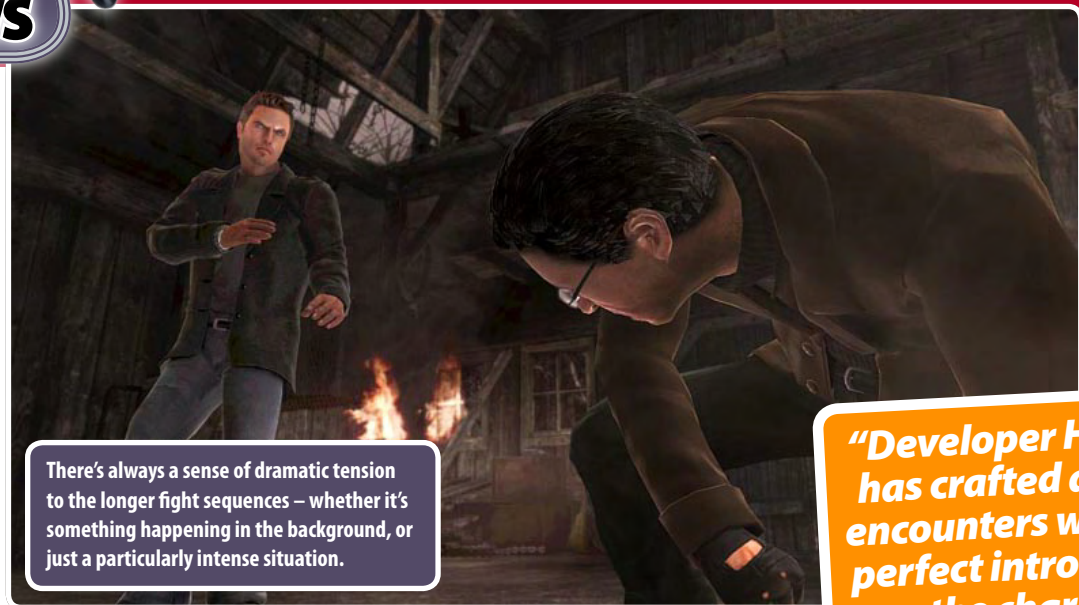

There's always a sense of dramatic tension to the longer fight sequences – whether it's something happening in the background, or just a particularly intense situation.

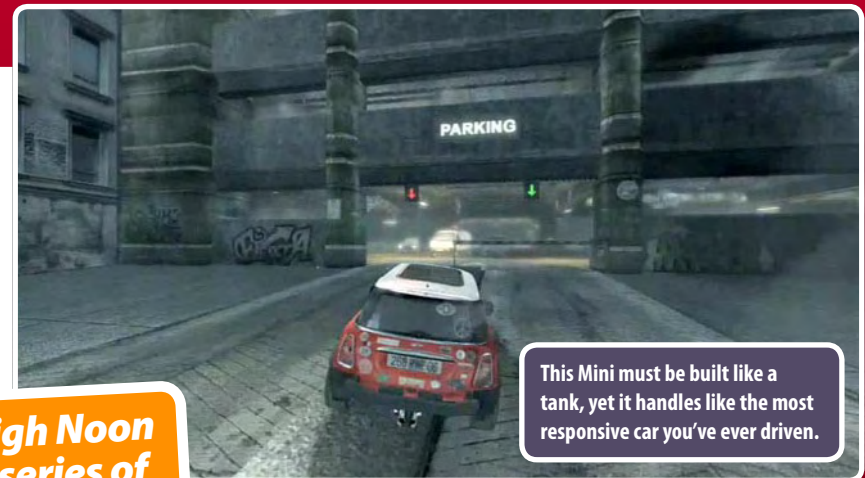

This Mini must be built like a tank, yet it handles like the most responsive car you've ever driven.

“Developer High Noon has crafted a series of encounters which is the perfect introduction to the character”

> Bourne Conspiracy cont.

the urgent, handheld feel of the two sequels in particular. It's done to such a degree that it's a surprise director Paul Greengrass wasn't involved – even if the events covered in Bourne don't make it past the Doug Liman-helmed Identity. Indeed, much of the game is set prior to Bourne's first

filmic adventure, investigating his murky past as a black ops assassin for Operation Treadstone. It's remarkable how well the opening stages of the game ape the rapid-fire, snappily-edited feel of the movies – tricky, given that they're covering episodes of Bourne's life we've not yet seen on the silver screen. Sensibly, Conspiracy starts with the most successful of its three key gameplay types – the brutal fist-fights that have almost become the Bourne trademark.

With assistance from the fight co-ordinator from Supremacy and Ultimatum, High Noon has crafted a series of encounters which is the perfect introduction to the character. Bourne only has three attack buttons – fast attack, heavy attack and block – but these can all

be chained and combined for some truly deadly moves, culminating in huge haymakers and roundhouse kicks which look terrific when executed correctly. As faces bruise, eyes blacken and noses bleed, you'll feel every blow – crunching sound effects and superb animations on the large characters add to the intensity of the scrapping, while the tremendous musical score – which sounds like it's come straight from the films – increases the drama. And the takedowns – hit the Circle button when you've landed enough blows to raise your adrenaline meter – are especially vicious, Bourne often using scenery in inventively brutal ways to drop his assailants.

Reach a group of enemies with guns, and you'll immediately segue

into third-person shooter mode. Most obstacles can be used as cover, and while your opponents aren't necessarily the smartest bunch, they're effective in numbers, and stay out of harm's way for the most part – requiring stop-and-pop tactics, especially on the higher difficulties.

Aiming is a little woolly, and the game could certainly do with a GTA-style auto-aim, but it works fine. Utilise Bourne's adrenaline meter, and you can once again execute takedowns, this time pulling off one-shot kills by tapping the right button in a brief QTE. You'll also have more 'Simon Says' button pressing to do during escape sequences – though you often wish you were under more control, these sections are well-directed, and it's never too long before you're engaging in shootouts and fisticuffs once more.

Just as you're tiring of the running and gunning, the face-smashing punches and stomach-crushing



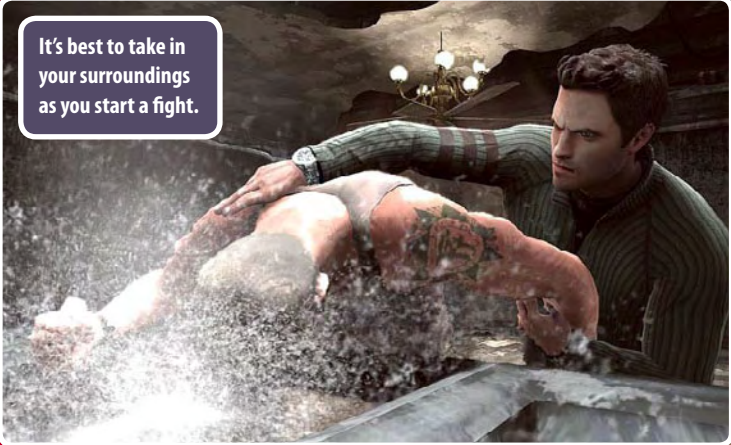

It's best to take in your surroundings as you start a fight.



The game's presentation is generally very slick and polished.

> Bourne Conspiracy cont.

kicks, High Moon throws in a driving level which echoes the memorable chase through Paris in Identity. The car is almost a little too responsive,

though this enables you to drive in an almost superhuman manner – just as you'd expect Bourne to do. It's over rather quickly, and leaves you

wishing there'd been another brief driving interlude earlier in the game to mix things up a little, particularly as a couple of late battles drag on into wars of attrition, testing your patience as much as your reflexes.

Yet these lapses are few and far between in a game that doesn't outstay its welcome, but has enough length and replay value – particularly thanks to the added Accomplishments – to warrant a purchase. As a first attempt at making something from a difficult franchise, it's seriously impressive stuff. Hopefully this debut will lead to more Bourne games, where High Moon can learn from the few small mistakes it's made here (including this PS3 port being slightly weaker visually than its 360 counterpart). Recommended. ●

Chris Schilling



It's occasionally irritating when you're fighting and a more distant foe is shooting you.

PULSOMETER *Signs of life*

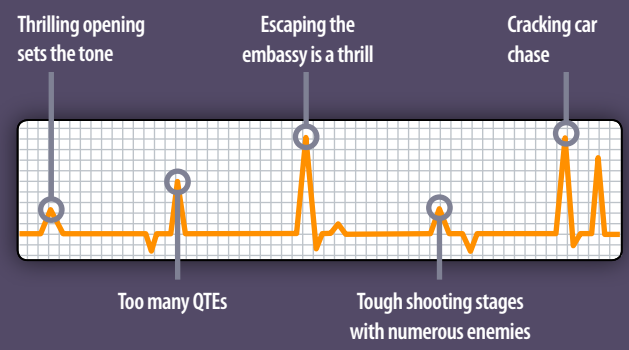

"As a first attempt at making something from a difficult franchise, it's seriously impressive stuff"



There's an impressive amount of destruction throughout.

P3Zine Verdict

A killer licence gets a terrific tie-in

- + Fighting is ferocious
- + Superb soundtrack
- More variety needed

82%

Subscribe to P3Zine

FREE! EVERY MONTH!

The world's best PlayStation 3 mag!

DON'T MISS OUT AGAIN SUBSCRIBE FOR FREE!
Over 40,000 people have already chosen to subscribe to one or more of our GamerZines and now receive notification of each new issue as soon as it's published. Why not join them and ensure you never miss another issue again?



www.gamerzines.com

PlayStation Network

Download 'em today!

Wolf of the Battlefield: Commando 3

Publisher: Capcom
Developer: Capcom
Price: £6.99

It's been almost 25 years since the original Commando hit the arcades, and nearly 20 since its sequel Mercs. So as far as franchise revivals go, the Commando series is one of the most unexpected. But not unwelcome, as we're happy to say that this top-down blaster might not offer anything startlingly original, but it's a solid and enjoyable title, which plays homage to its forebears while also managing to

offer mass destruction on a slightly more epic scale. Explosions are huge, guns feel meaty and powerful, and you even get to drive vehicles round to create even more havoc. It's awesome stuff.

Its twin-stick control scheme works very well, putting it in the same bracket as the likes of Rocketmen: Axis of Evil, but easily beating that anaemic actioner in terms of polish and addictiveness. It looks decent enough, if hardly pushing the hardware, but would you really expect any more than that from a £7 download?

Its only real sticking point is the high difficulty level, which wouldn't be an issue in itself, but it's annoying when you reach the final stage and die, only to have to restart from the very beginning. It might be true to its roots, but that's one old-school mechanic too far. Otherwise, this is well worth the outlay.



P3Zine Verdict

Great retro-tinged shooter

- + Explosive action
- Unforgiving difficulty

79%

Echochrome

Publisher: Sony
Developer: Sony
Price: £5.99

Echochrome's levels see your avatar walking around a series of long, thin platforms, collecting 'echoes' – shadowy human figures. Pick them all up and you move onto the next stage.

Where the puzzle element comes in is how you traverse each stage. It's all about perspective – if there's a hole coming up, you can rotate the stage so it can't be seen. It sounds clever, but it occasionally requires perfect platform positioning, while many stages are solved by accident, simply by spinning aimlessly when you jump.

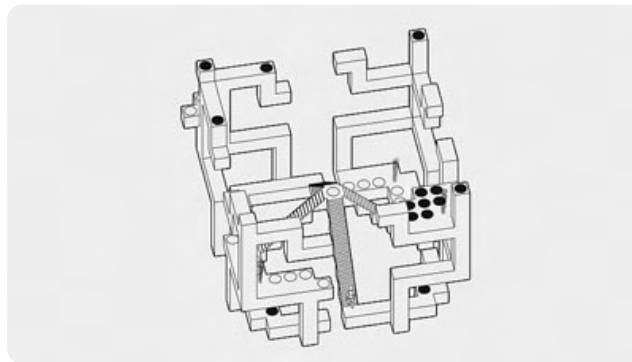

P3Zine Verdict

Too clever by half

- + Terrific concept
- Doesn't meet potential

68%

Metal Gear Solid Database

Publisher: Konami
Developer: Konami
Price: Free

This encyclopedia provides loads of MGS background info. It's probably most useful to those interested in playing MGS4, but who are slightly wary of buying it due to unfamiliarity with the story. Cleverly, the download reads any

MGS4 save data on your PS3 and locks certain information to prevent spoilers. The presentation is a little basic, but it's easy to read, the linking system works well, and as a free download you've got nothing to lose. A must for MGS fans, and a real help for anyone baffled by the series' complexities. Superb.



P3Zine Verdict

An invaluable resource

- + Tons of detail
- More pics please

87%

Afrikan't

Sony denies Europeans access to Afrika

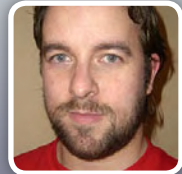

Chris Schilling

Chris is the proud owner of all three 'next-gen' consoles. Every issue Chris will chart the progress of PS3 and commenting on Sony's latest and greatest initiatives.

Rewind back two years to Sony's now infamous E3 2006 press conference. While perhaps not as embarrassing as some people suggested, the conference did not go down well with either critics or gamers. YouTube videos edited the lowlights into amusing packages – emphasising the mistakes, like giant enemy crabs, real-time weapon change, and (of course) that price. Also coming in for some flak was Afrika. Little was known about the game at that time, but many felt the processing power of PS3 wasn't being put to best use in creating footage of a virtual safari.

Back to the present day, and footage of Afrika has been posted on Sony's Japanese site, showcasing a game which looks a little like a

land-based version of Nintendo's terrific underwater exploration sim, Endless Ocean. Evidently you play a photographer who has to capture the best possible shots of the wildlife. There's some third-person landscape navigation to get into position, and then it's a case of lining up your photo and clicking away when the time is right. Visually, it's impressive if not spectacular – it certainly does enough to sweep away the memories of E3 2006. But it's the concept that seems to work really well – it's a game that would seem to hold a good deal of appeal to that ever-elusive casual audience that Sony has managed to court so successfully in the past with PSone and PS2, but which has – comparatively speaking – remained resistant to the allure of PS3. And Sony has confirmed that it has no plans to release Afrika in Europe.

It leads you to briefly consider the possibility that the showing at E3 in 2006 was somehow enough to put Sony off ever releasing Afrika in the west. But other games (Genji, Warhawk) weathered the storms of awkward demonstrations – well, the latter certainly did – and so

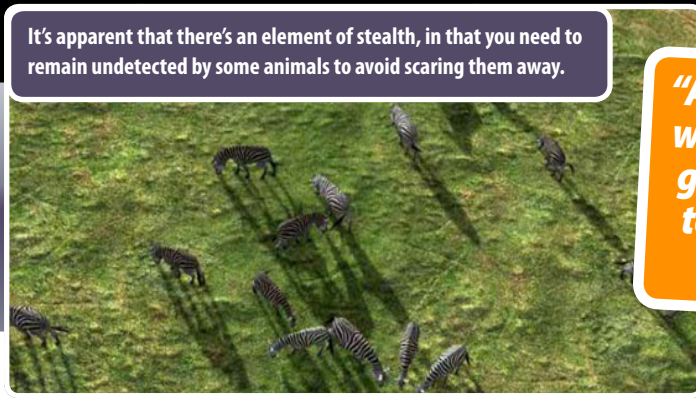

It's apparent that there's an element of stealth, in that you need to remain undetected by some animals to avoid scaring them away.

"Afrika is a game that would seem to hold a great deal of appeal to that ever-elusive casual audience"

There's clearly plenty of third-person exploration in Afrika, as you climb over rocks and mountainous terrain to get the best shot of the animals.



that excuse can't possibly be right. No, it just seems as if Sony doesn't consider it worthy of localising. Perhaps the final game doesn't quite live up to the gameplay footage we've seen so far, but I'm more than a little disappointed that we're not going to be seeing Afrika any time soon, if at all. Hopefully a positive sales performance in Japan will lead to Sony reconsidering its decision, but to be honest, I'm not holding my breath.

A positive front

On a more positive front, it's good to see that PAL PS3 owners are getting their hands on PSN horror game Siren: Blood Curse on the same day as Japanese gamers. Available only as a full-price retail release in the East, Siren comprises four packs of three episodes each – available at £4.99 per pack, or £19.99 for the entire game. Though it's a strange way of releasing episodic content, it's a good thing that those who want to play the game from start to finish will be able to immediately, without

waiting for future episodes – and at a fairly bargainous price too.

What I've experienced of Siren so far leads me to think it'll comfortably be the best in the series – and I was a huge fan of the second game. Indeed, if there's a better downloadable title released all year, I'll be extremely surprised – WipEout HD is perhaps its biggest rival, but there's no word on a concrete release date for that at the time of writing.

Siren is easily the best-looking PSN-only game so far – at £20, it's already looking like a bargain.

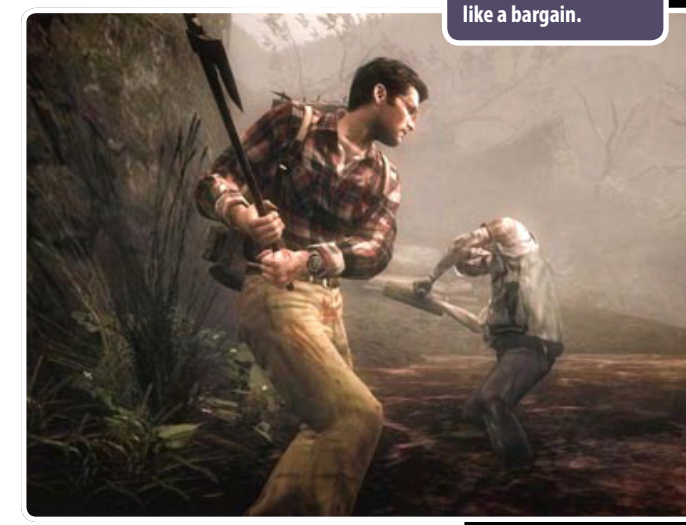

In P3Zine Issue 18

Soul Calibur IV

Reviewed!



PLUS!

Fracture

Hellboy: The Science of Evil

Brothers in Arms: Hell's Highway

Issue 18 Out 14th Aug

MORE FREE MAGAZINES! LATEST ISSUES!

DON'T MISS ISSUE 18 SUBSCRIBE FOR FREE!

WARNING! MULTIMEDIA DISABLED!

If you are reading this, then you didn't choose "Play" when Adobe Reader asked you about multimedia when you opened the magazine.

Without the multimedia playing, the magazine will look correct, but you will be missing out on all of the extra content built into each issue, like videos, animated screenshots, annotations, quizzes, competitions and more.

We recommend you close and re-open the magazine and select "Play" when asked about the multimedia to enjoy the magazine as intended.

Cranberry Publishing Limited

www.cranberrypublishing.com

Publishing Director: Dave Taylor

Email: dave.taylor@cranberrypublishing.com

Editorial Director: Dan Hutchinson

Email: dan.hutchinson@cranberrypublishing.com

Commercial Director: Duncan Ferguson

Email: duncan.ferguson@cranberrypublishing.com

Telephone: 0117 986 6550

Call Duncan to discover how e-publications can work for you!

Contributors: Ian Morris, Chris Schilling

All rights reserved. This publication may be copied in its entirety without modification for non-commercial purposes, for example but not limited to copying to CD-R for a friend, but it may not be offered for download from any website or similar without the prior permission of the copyright holder. You are free to, and encouraged to, link to the original file for download from our website and you can find help on doing so here. While the greatest care is taken in producing this guide, we do not accept responsibility for the loss of any data or any other damage caused by following the instructions in this publication. We always recommend that you keep a backup of your hard disk data and ensure that you check all files for viruses before installing or using any new software. None of the information in this guide is intended as legal advice. All articles are for information purposes only. Websites mentioned in this publication are not affiliated to or controlled by the publisher. We are not responsible for the contents of these sites or any changes made to them. All contents © Cranberry Publishing Ltd 2008. Company registration number: 4987058

Want more PlayStation3?

N4G THE WORLD'S BEST SOCIAL NEWS SITE FOR GAMERS!

news for gamers

<http://www.n4g.com/>

News 4 Gamers is a news website written by gamers for gamers. Each story is submitted by a member of the community and ranked by popularity. You can comment on each article, and even if you're not a fully fledged writer, you can submit news tips for items you've seen elsewhere on the web!

The site has sections for all gaming

platforms including PlayStation 3, Xbox 360, Wii, PC, DS, PSP and more.

When you read a story on N4G, you can click to go straight out to the full story source, making this the ultimate gaming news site, because it gives you access to the stories from all the games sites on the web, rather than just its own.

You've reached the end of the main magazine. What would you like to do?

- Exit this issue and go and download another magazine?
- Exit this issue and subscribe FREE for future issues?
- Exit. Read this month's Xbox 360 Magazine.



CLICK HERE TO CONTINUE TO 360ZINE, OUR XBOX 360 MAGAZINE

