

# MICRO™

THE 6502 JOURNAL

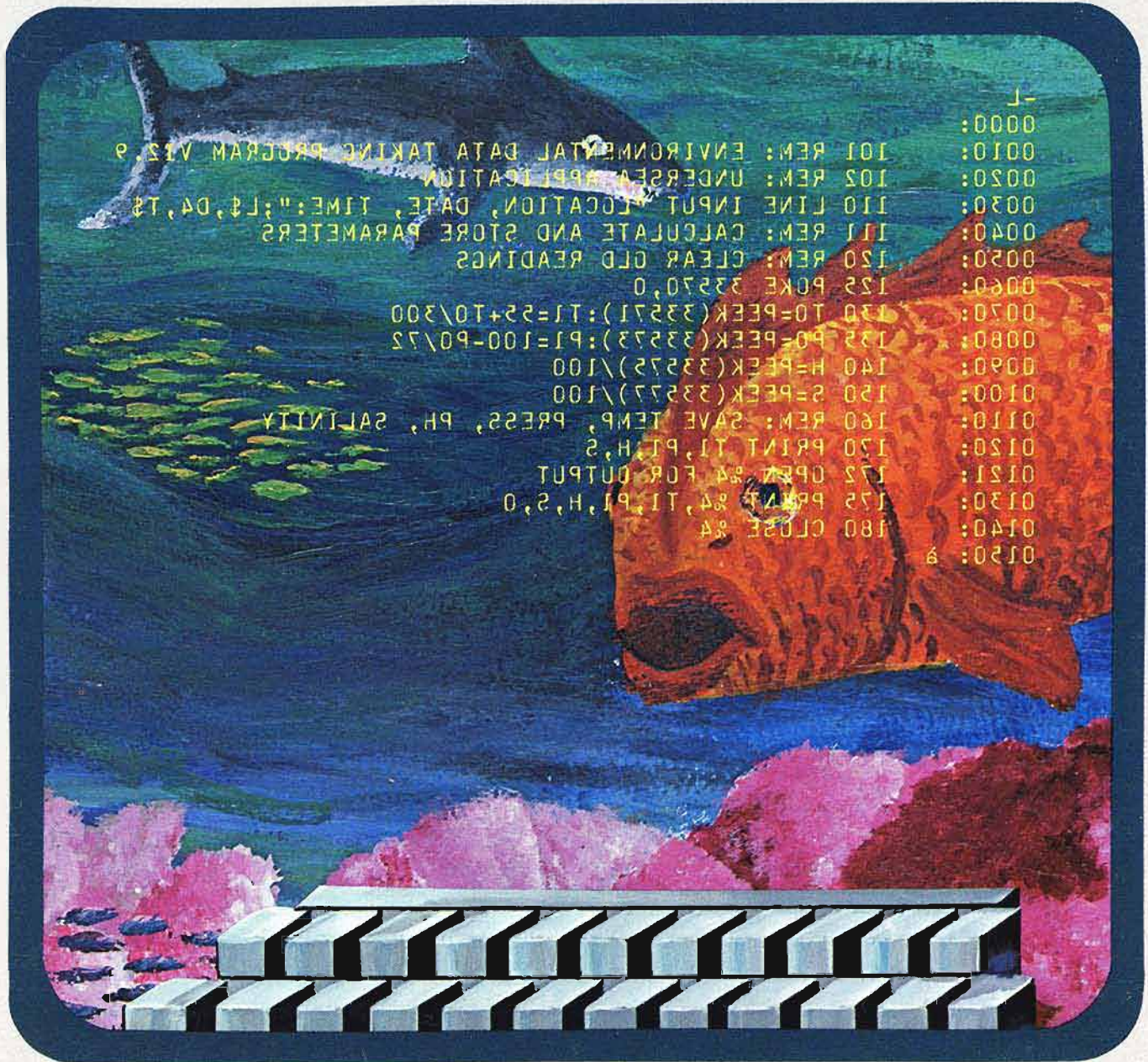

No. 30

November 1980

\$2.00

# PERMANENT RELIEF

Of today's and tomorrow's Word Processing problems



## Apple PIE

+

## Formatter

Apple PIE (Programma International Editor) and FORMAT (text formatter) offer full strength solutions to today's word processing problems. These versatile, powerful programs provide document preparation and word processing capabilities previously found only on much larger computer systems.

PIE is a general purpose, full screen editor that uses control keys and function buttons to provide a full range of editing capabilities such as search and replace, delete, copy, insert, move. Changes may be made directly anywhere on the screen and are shown as they are performed.

FORMAT uses simple instructions embedded in the input text to describe the desired appearance of the final document. It handles centering, underlining, indenting, page numbering,

margins, headers, footers, even form letters, and includes a proofing capability.

These high-quality, cost-effective programs come with comprehensive documentation and run on a 32K Apple II. They are available through your local computer store or direct from Programma International, Inc. at the introductory price of \$79.95\*.

VIDEX VERSION T.M.  
DOUBLE VISION T.M.  
SUPR TERM VERSION T.M.  
STANDARD VERSION

\*December 1, \$129.95.

## PROGRAMMA

3400 Wilshire Boulevard  
Los Angeles, California 90010

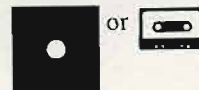
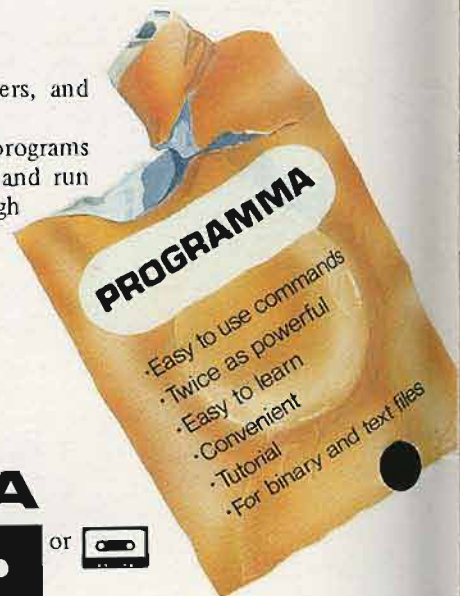

Simple enough for the beginner. Versatile enough for the professional.

# Malibu Microcomputing

**presents: 3 GREAT PROGRAMS FOR YOUR APPLE \* !**

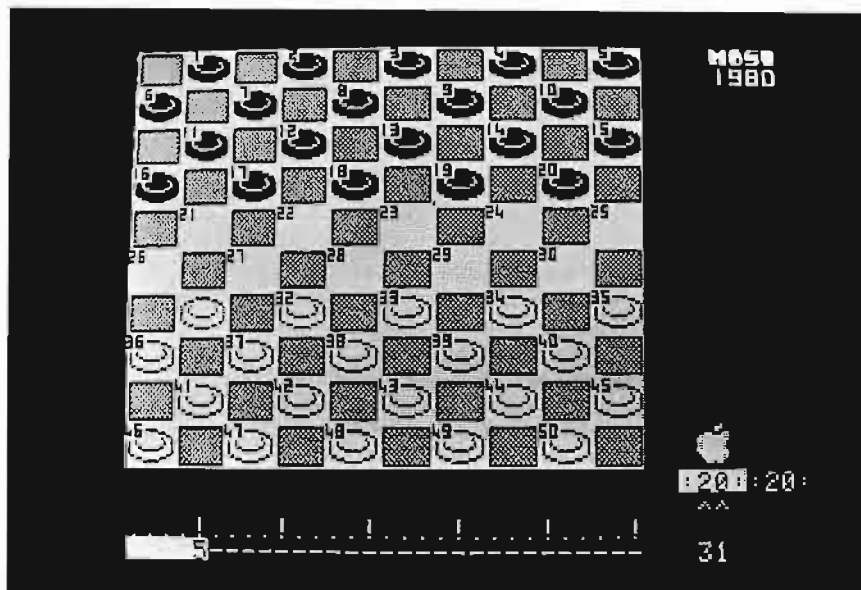

## ULTRACHECKERS™

The most advanced checkers program ever available. Combines superb graphics / sound effects and exceptional ease of operation with advanced artificial intelligence techniques. Checkers are played according to international rules with nine levels of play. Program features "self-demonstration," "advice" and "problem" modes. "Self-demonstration" allows the APPLE to play itself at a speed you control. "Advice" permits you to ask the APPLE to recommend your next move. "Problem" allows special board set-ups for "what-if" questions. Excellent for learning or improving your game! Moves are easily made using cursor control. Complete playing rules and program instructions included.

32K, Machine Language for the Apple II or II Plus

## ## APPLEPRINT ## USING™

**\$29.95 / Disk**

Give your Apple a flexible print capability like the big machines! Format your output by simply using the PRINT ###, ##; variable, statement. ##APPLEPRINT## USING is independent from and does not interfere with the normal Applesoft PRINT statement. Indispensable for financial and business programming. Will pay for itself in no time at all as you save hours of tedious effort formatting reports, lists, tables, etc. Complete instructions and example programs included.

32K, Machine Language for the Apple II Plus

## "LEARNING-FUN" DUO™

**\$19.95 / Disk**

Especially designed for young children. Combines learning with fun! Program 1: "TELL-TIME" interacts with the child in color, and HI-RES GRAPHICS to facilitate learning to tell time. Program 2: "SUPER RACE CAR" is the popular head-on collision type arcade game with simplified two finger control for children. Hours of learning and fun.

32K, Applesoft / Machine Language

**\$14.95 / Disk**

Available at your local computer store

### MALIBU MICROCOMPUTING

**23910A De Ville Way, Malibu, California 90265 • (213) 456-1137**

**DEALER INQUIRIES INVITED All orders shipped same day.**

Software may be ordered directly by calling or writing. Orders may be C.O.D. / Check / Master Charge / Visa. Add \$1 shipping. California residents add 6% sales tax.

Software available in Europe at: SIVEA, 31 Bd. des Batignolles, PARIS 75008.

\* Apple is a trademark of the Apple Computer Co.

# LOWER CASE +PLUS

for the APPLE II  
by Lazer Systems

**\$59.95**  
RETAIL

QUALITY. That's why you bought your APPLE II or APPLE II PLUS Computer in the first place. Why compromise the quality of your computer by purchasing a "cheap" looking Lower Case Adapter? LAZER SYSTEMS announces the **Lower Case + Plus**, the first high quality lower case adapter available for the Apple II.

Compare the features of the top three lower case adapters available for the Apple II:

	Lower Case +	Paymar	Uni-Text
# of Displayable Characters .....	128	96	96
Inverse Upper & Lower Case .....	Yes	No	Yes
FONT SIZE .....	7 x 8	5 x 7	5 x 8
# of On Board Character Sets .....	2	1	1
Basic Software Provided on Disk .....	Yes	No	No
Pascal Software .....	Yes	No	Yes
Optional FONTS Available .....	Yes	No	? ? ?
Single Board Which Works with All Apples .....	Yes	No	No
Expansion Socket for use with Graphics + Plus (a RAM-Based Character Generator) .....	Yes	No	No
TRUE Descenders on Lower Case Characters .....	Optional	No	Yes
Single Board Construction (No inconvenient & unsightly Wire Jumpers) .....	Yes	No	No
Character Generator 2716-EPROM Compatible .....	Yes	No	Yes
Character Set Compatible with Character Set Created by Mountain Hardwares "Keyboard Filter" .....	Yes	No	No
OPTIONAL Character FONTS included on Diskette .....	Yes	No	? ? ?
Extensive User Documentation .....	Yes	No	? ? ?
Compatible with Most Major Word Processors .....	Yes*	No	Yes
High Quality Double Side PC Board with Silkscreen & Soldermask .....	Yes	No	No
On Board Graphics Character Set .....	Yes	No	No
Reset Key Disable .....	Yes	No	No
<b>Suggested Retail Price .....</b>	<b>\$59.95</b>	<b>\$64.95</b>	<b>\$79.95</b>

\*Apple Writer requires optional character generator for proper operation.

As you can see the LAZER SYSTEMS' **Lower Case + Plus** is an order of magnitude better than the competition. YET IT COSTS LESS THAN EITHER OF THE COMPETING UNITS.

Bring your Apple out of the dark ages. Word processing and applications programs without lower case is a bad reflection on your computer. ORDER YOUR **LOWER CASE + PLUS** TODAY!

ORDER FROM: LAZER SYSTEMS

Box 55518  
Riverside, CA 92517

We gladly accept Mastercard and Visa. Include No., Expiration Date, and Signature. Enclose a copy of this ad and take \$5.00 off the retail price of your **Lower Case + Plus**. (Offer good till Dec. 31, 1980). Buy one for a friend as a Christmas present. Better yet, buy yourself one and give your old lower case adapter to a friend!

The following prices include 6% sales tax for California residents, \$2.00 Shipping and Handling for U.S. orders, \$15.00 Shipping & Handling for foreign orders, and \$5.00 discount. No COD's please. Please allow two weeks for personal checks to clear.

Calif.: \$60.25 (with copy of ad)  
Other: \$56.95 (with copy of ad)  
Outside U.S.: \$69.95 U.S. currency,  
certified check (with copy of ad)

Dealer inquiries invited.

P.O. Box 55518 • Riverside, Ca 92517



# November 1980 Issue Number 30

## Staff

**Editor/Publisher**  
Robert M. Tripp

**Associate Publisher**  
Richard Rettig

**Associate Editor**  
Mary Ann Curtis

**Director Sales/Marketing**  
James Anderson

**Advertising Manager**  
L. Catherine Bland

**Circulation Manager**  
Carol A. Stark

**MICRO Specialists**  
APPLE: Ford Cavallari  
PET: Loren Wright  
OSI: Paul Geffen

**Comptroller**  
Donna M. Tripp

## ARTICLES

- 7 **How to Use the Hooks**  
*Using APPLE II's "hooks"*  
by Richard Williams
- 11 **An Ultra-Fast Tape Storage System**  
*Hardware modification to Ohio Scientific's Superboard*  
by John E. Hart
- 17 **SYM-Bell**  
*A telephone memory dialer for SYM-1*  
by Randy Sebra
- 29 **Self-modifying PET Programs**  
*A tutorial with four projects*  
by P. Kenneth Morse
- 37 **Ohio Scientific Users: Stop those S-J ERRORS**  
*Converting graphics error messages into readable letters*  
by E.D. Morris, Jr. and Tim Finkbeiner
- 47 **A Versatile Hi-Res Function Plotter for the ATARI 400 and 800**  
*Exploring color graphics possibilities*  
by David P. Allen
- 53 **John Conway's Game of Life Using Display Devices With Automatic Scrolling**  
*Running Life on Most Any Display Device*  
by Theodore E. Bridge
- 61 **Step and Trace for the APPLE II Plus**  
*Restoring Step and Trace*  
by Craig Peterson
- 65 **AIM 65 File Operations: Writing Text Files with BASIC**  
*Enhancing the value of BASIC*  
by Christopher J. Flynn

## DEPARTMENTS and SUNDRY

- 5 **Editorial: Software Distribution—Part II**  
By Robert M. Tripp
- Cover Description**
- 27 **PET Vet**  
by Loren Wright
- 33 **MICROScope**
- 36 **Microprocessors in Medicine: The 6502**  
by Jerry W. Froelich, M.D.
- 51 **Up From the Basements**  
by Jeff Beamsley
- 72 **The MICRO Software Catalog: XXVI**
- 76 **6502 Bibliography: Part XXVI**
- 79 **Advertisers' Index**

MICRO™ is published monthly by:  
MICRO INK, Inc., Chelmsford, MA 01824  
Second Class postage paid at:  
Chelmsford, MA 01824  
Publication Number: G0TR 395770  
ISSN: 0271-9002

Subscription rates: U.S.	\$15.00 per year
Foreign surface mail	\$18.00 per year
Central America air	\$27.00 per year
So. Amer./Europe air	\$33.00 per year
Other air mail	\$39.00 per year

For back issues, subscriptions, change  
of address or other information, write to:

MICRO  
P.O. Box 6502  
Chelmsford, MA 01824  
or call  
617/256-5515

Copyright © 1980 by MICRO INK, Inc.  
All Rights Reserved



# VersaWriter

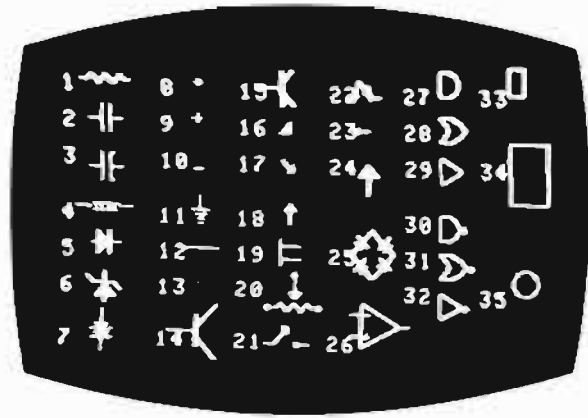
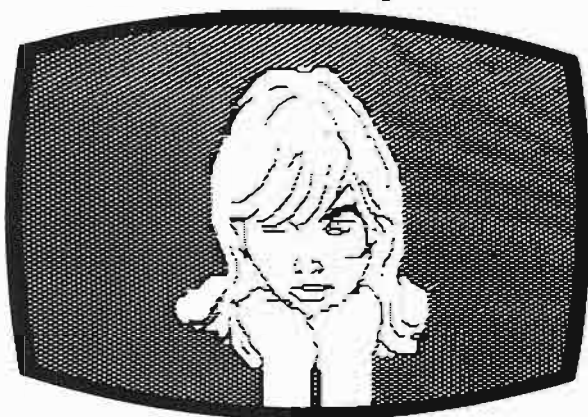

## What is VersaWriter?

■ VersaWriter is an inexpensive drawing tablet for the APPLE II that lets you trace a picture and have it appear on TV display.

■ VersaWriter is a comprehensive software drawing package which lets you color in drawings with over 100 different colors.

■ VersaWriter is a shape compiler that converts anything on the screen automatically into a standard shape table.

■ VersaWriter is a text writer for labeling pictures with text in six colors and five sizes. Use English or Greek, upper or lower case letters.

■ VersaWriter is much more! Draw with brush, create schematic drawings, compute area and distance, edit pictures, save, recall and more.

VersaWriter requires ROM APPLESOFT and 48K memory.

\$249 Suggested Retail

### UNIQUE OFFER

Send us YOUR disk and \$1. We will promptly return the disk with a slide package of 10 color pictures drawn with VersaWriter.

- Enclosed is \$1 and my disk. Send me the slide package.
- Send more information including VersaWriter dealers in my area.

**DEALER INQUIRIES INVITED.**

NAME

ADDRESS

CITY STATE ZIP

# Software Distribution

This editorial is in two parts. Part I appeared last month.

## Part 2

### Some Basic Questions To Consider.

**1. Is your program worthwhile?** Just because you wrote it and think it's great does not mean others will. Show your software to knowledgeable friends, computer club members, and local dealers. Get their honest evaluations, and listen to them. They might persuade you not to bother selling your program. They might convince you that it really is worthwhile. Or, they might even give you some valuable suggestions for improving it.

**2. Is your program unique?** What the world needs now is *not* another checkbook balancing package. If your program is too similar to products already on the market, it will naturally reduce your chances of success. Friends, clubs, and dealers can assist in determining what is available. The major magazines often list software products (the MICRO Software Catalog for example) and carry ads from software houses. Check catalogs of the major software houses. Since you may want to have a software house distribute your material, contact several. They will be able to estimate the value of your material on the current market.

**3. What will your package sell for?** In addition to the procedures suggested above, check in magazines, catalogs and stores on what programs of similar complexity and size are currently going for. In figuring your production costs, remember that printing booklets and copying tapes or diskettes can get expensive in small quantities. Advertising and distribution costs must be included as well.

**4. How should your product be packaged?** First consider how you plan to distribute the material. Mail-order packaging can be minimal. Your customer is not buying the product because of the package. However, store packaging is very important, since your product will be competing with many others for the buyer's attention and dollars.

If all of the above questions—and the list is by no means exhaustive—cause you to have second thoughts about

selling your software yourself—good! Do not rush into selling software blindly. It can be profitable, even lucrative, but it does take time, money, and effort.

**Sell it as an article.** If, after careful consideration, you decide that your particular software is not extremely marketable, but you still believe that it has merit and should be distributed, then how about publishing it? Most, but not all, national magazines pay for material they publish. Most editors prefer articles which include programs. You should consider a number of factors in selecting the magazine to which you submit your material. Is your program the type they normally print? Will the audience of the magazine be interested in your program? Does the magazine pay at competitive rates? Does the publisher pay residual rights, that is, if your work appears in a "Best Of..." or some other reprint form, do you get additional payments? (MICRO's policy is to make residual payments; many other publishers do not.)

If you decide to sell your software as an article, then you may want to re-evaluate your presentation. An article is generally most valuable when it can discuss and describe a technique, methodology, programming trick, or some other aspect of programming which may have value above and beyond the particular application. Your article should emphasize any unique or interesting aspects of the program in addition to presenting the basic information required to use the material. This will maximize both the chance of your article being accepted at top dollar and its usefulness to the reader.

**Summary** If you have a good piece of software that should be shared with others, please do not let it lie idle. If you want to spend minimal effort to get it out to others, then give it away. You can make some money on the right type of software by writing it up as an article. The greatest payoff can be in selling a software package, either directly or through a software distribution company, but that does entail additional work on your part. So, tear yourself away from your micro computer long enough to get your work distributed—at least for personal credit, and possibly for cash.

## The 8502 Microprocessor



Cover Artist  
Liz Jeffrey

Is there something fishy about the cover? You will probably never see a microcomputer such as the Apple, PET, etc. at the bottom of the ocean. They are not intended for such extreme environments. The basic building block of our familiar microcomputer, the 6502 microprocessor, could quite easily be found in such a situation. As we trace our ancestry back to the sea, our microcomputers have evolved from the microprocessor.

The goal of the designers of the various microprocessors such as the 8080, 6800 and 6502 was not to build microcomputers. As the name implies, these devices were intended to be sophisticated process controllers, not microcomputers. Many of the "limitations" of these devices can be understood when the original intent is considered. For example, addressing modes which would permit simple program relocation, a powerful tool in a

general purpose computer systems, are not provided. That makes sense, however, if you consider that a process controller will normally have its program in ROM, making relocatability useless. A number of other trade-offs were made in the design, generally favoring processing over computing. The richness of the I/O capabilities vs. the lack of multiply and divide instructions is another example.

There is nothing inherently wrong with using the 6502 microprocessor in areas beyond its initial design scope. It would be nice, in view of its use as a microcomputer element, if its power for computing could be improved. New products are being released in the 8080 and 6800 lines. It would be nice to see some upgrading of the 6502. A number of suggestions for enhancements have been submitted by MICRO readers, and will appear in the next issue. Rockwell, Synertek, Commodore, are you listening?

## Management Planning & Decision Making

(FOR 32K OR 48K APPLE II WITH APPLESOFT BASIC IN ROM)

# QuikDirt

- ☆ PRODUCTION SCHEDULING
- ☆ INVENTORY CONTROL
- ☆ CAPITAL BUDGETING
- ☆ DISTRIBUTION PLANNING

CONGRATULATIONS...

YOUR APPLE II COMPUTER HAS JUST BEEN PROMOTED INTO "MIDDLE MANAGEMENT"!

SEE YOUR LOCAL COMPUTER STORE OR CONTACT:

..... Nyman associates

421 SEVILLE WAY  
SAN MATEO CA  
94402

☆ SUGGESTED RETAIL PRICE: \$120

## AIM-65

### Accessories

# MCC

**EPROM PROGRAMMER FOR AIM-65**  
\$86.50

Programs 2716, 2516, and 2532 EPROMs.  
Selectable blank check and verify.  
Can copy existing EPROM.  
Software utility routines to relocate your object code to EPROM address.  
Does not interfere with cassette.

**ROM EXPANSION FOR AIM-65**  
\$33.50

Eliminates need to remove Assembler or Basic ROMs.  
"Straight-thru" design retains use of Expansion connector.  
Sockets for up to 8K additional ROMs and EPROMs.  
Available with Zero-Insertion-Force sockets (\$49.00).

**PARALLEL PRINTER PORT FOR AIM-65**  
\$57.00

Interfaces Aim-65 to Centronics Parallel Port.  
Compatible with over 34 printers from different manufacturers.  
Complete with connecting cable.  
Compatible with Aim-65 Monitor, Assembler, and Basic.

**RS-232 INTERFACE FOR AIM-65**  
\$61.00

Interfaces Aim-65 to a wide variety of systems.  
Software selectable baud rate.  
"Straight-thru" design retains full use of Application connector.  
Complete with connecting cable.  
Compatible with Aim-65 Monitor Assembler, and Basic.

20076 CHAPMAN AVE  
ORANGE, CALIF. 92669  
714 633-0245

SEND FOR ADDITIONAL  
PRODUCT INFORMATION  
AT NO CHARGE

CALIFORNIA RESIDENTS ADD 6%



# How to Use the Hooks

There are a lot of great things you can do with your APPLE, once you know how to use the available hooks.

Richard Williams  
4380 Albany Drive #23  
San Jose, CA 95129

The APPLE II allows the user easily to substitute his own input and output routines for the standard ones. Figure 1 shows the basic flow of control when a character is output by the APPLE II. Figure 2 shows how the control path changes when the user substitutes his own output routine for the standard monitor path. By using what are known as "hooks," the user can break the normal flow of control and redirect it to his own routine.

An example of how this can be used is shown in figure 3. Control characters normally do not show on the screen. However, by inserting a routine to change control characters into inverse video when printed, the characters will show on the screen. This is very useful for listing programs containing control characters.

## How It Works

Before doing the actual input or output, the system does an indirect jump, via the zero page, to the actual input or output routine. By changing the jump address, the user can substitute his own routine for the standard zone. For input, at location \$FD18 in the monitor, there is a JMP (KSWL) instruction. KSWL (at \$38) and KSWH (at \$39) contain the address of the input routine with the low byte specified first. Similarly, at address \$FDED, there is a JSR (CSWL) instruction which is the jump to the output routine. CSWL, address \$36, and CSWH, at \$37, contain the address of the output routine. This code can be seen on pages 85 and 86 of the red APPLE II reference manual.

## How to Insert an Input Routine

The normal input routine is KEYIN at address \$FD1B. To replace it with your routine, store its address in KSWL and KSWH. Your input routine needs to do the following:

1. Upon entry to your routine, the accumulator will contain the character replaced by the flashing prompt. You must restore this character on the screen by doing a STA (BASL), Y where BASL=\$28. Do this before altering the A or Y registers.

2. Clear the keyboard strobe, if the character came from the keyboard.

3. Return the character, with the high bit set, in the accumulator.

4. The normal input routine increments the random number seed while it waits for input. You should do this also.

If you wish to get your input from the keyboard, you can do all of these by doing a call to KEYIN (JSR \$FD1B). You can then do whatever

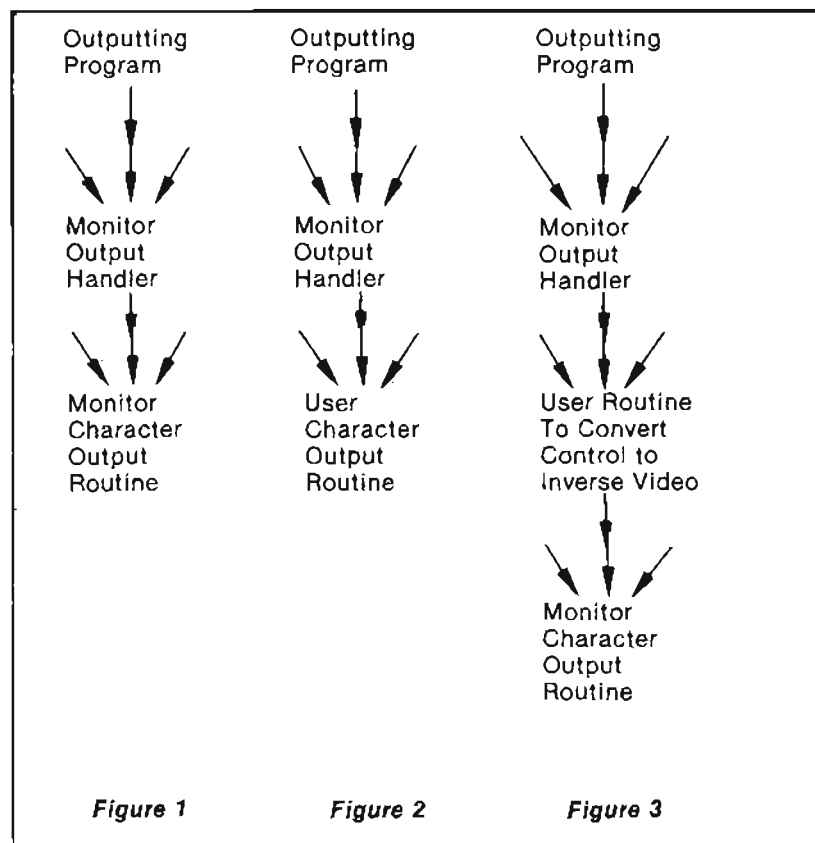

processing that you want on the character, which is in the accumulator, and then return with an RTS. If you write your own routine to replace KEYIN, you should first carefully study KEYIN.

### How to Insert an Output Routine

The normal output routine is COUT1 (address \$FDF0). To insert your routine, store its address in CSWL and CSWH (addresses \$36 and \$37) with the low byte first. The character to be output will be placed in the accumulator before your routine is called. If you wish the character in the accumulator to be printed on the screen after you are done, exit your routine by doing a JMP COUT1. A routine to convert control characters to inverse video is an example of this.

### How to Remove the Routines

The input and output routines can be removed from the hooks by typing IN#0 or PR#0 respectively. Or, if done in a program, a JSR SETKBD (address \$FE89) simulates a IN#0, and a JSR SETVID (address \$FE93) simulates a PR#0.

### Special Notes for DOS Users

If you are using the disk operating system (DOS), you must follow some special rules when attaching or removing your routines. DOS normally sits in both the input and output hooks itself. Consequently, when you alter the hooks, you must call a DOS routine which informs DOS that the hooks have been changed. DOS will then reconnect itself to the hooks, but it will use your routines instead of the standard I/O routines. The routine to do this is at \$3EA.

### Example

The sample program in figure 4 inserts or removes a routine from the input hook.

SOURCE FILE: NEWKEYS

```

00DC:      1 BKSLSH EQU 220      ;ASCII BACKSLASH
008B:      2 CTRLK EQU 139     ;ASCII CONTROL K
008C:      3 CTRLL EQU 140     ;ASCII CONTROL L
008F:      4 CTRL0 EQU 143     ;ASCII CONTROL 0
FD1B:      5 KEYIN EQU $FD1B   ;MONITOR'S INPUT HANDLER
0038:      6 KSWL EQU $38      ;INPUT HOOK ADDRESS
0039:      7 KSWH EQU $39
03EA:      8 MVSU EQU $3EA     ;ROUTINE TO RECONNECT DOS
00DB:      9 RTBRKT EQU 219    ;ASCII RIGHT BRACKET
FE89:     10 SETKBD EQU $FE89  ;SIMULATES IN#0
00DF:     11 UNDRSCR EQU 223   ;ASCII UNDERSCORE

```

```

----- NEXT OBJECT FILE NAME IS NEWKEYS.OBJO
0300:      13      ORG $300
0300:4C OF 03 14      JMP UNHOOK      ;JUMP TO DISCONNECT ROUTINE
0303:      15 *
0303:      16 * THIS PART ATTACHES OUR ROUTINE INTO THE INPUT HOOK
0303:      17 *
0303:A9 16 18 ATTACH LDA #>KEYCHECK ;A= LOW BYTE OF ADDRESS
0305:85 38 19      STA KSWL
0307:A9 03 20      LDA #<KEYCHECK ;GET HIGH BYTE
0309:85 39 21      STA KSWH
030B:20 EA 03 22     JSR MVSU      ;GO DO IT
030E:60      23      RTS

```

```

030F:      25 *
030F:      26 * THIS PART UNHOOKS THE ROUTINE.
030F:      27 *
030F:20 89 FE 28 UNHOOK JSR SETKBD ;DO A IN#0
0312:20 EA 03 29     JSR MVSU
0315:60      30     RTS

```

```

0316:      32 *
0316:      33 * THIS IS THE ROUTINE
0316:      34 *
0316:20 1B FD 35 KEYCHECK JSR KEYIN ;GET THE KEY
0319:C9 8B 36     CMP #CTRLK ;CONTROL Y?
031B:D0 03 37     BNE NOTY
031D:A9 DB 38     LDA #RTBRKT ;MAKE IT A BRACKET
031F:60      39     RTS
0320:C9 8C 40 NOTY CMP #CTRL0 ;CONTROL 0?
0322:D0 03 41     BNE NOTL
0324:A9 DC 42     LDA #BKSLSH ;MAKE IT A BACKSLASH
0326:60      43     RTS
0327:C9 8F 44 NOTL CMP #CTRLK ;CONTROL K?
0329:D0 02 45     BNE CHFDONE
032B:A9 DF 46     LDA #UNDRSCR
032D:60      47     CHFDONE RTS

```

\*\*\* SUCCESSFUL ASSEMBLY: NO ERRORS

300:	LDA	#low address of routine	308:	JSR	\$3EA	;Reconnect DOS
302:	STA	\$38 ;Store it in KSWL	30B:	RTS		
304:	LDA	#high address byte of routine	30C:	JSR	\$FE89	JSR SETKBD to simulate IN#0
306:	STA	\$39 ;Store it in KSWH	30F:	JSR	\$3EA	;Reconnect DOS
			312:	RTS		

Figure 4

To connect your routine, do a 300G from the monitor. To remove your routine from the hook, do a 30CG.

### A Sample Program Using the Input Hook

There are three characters that the APPLE II can understand, but that cannot be typed in from the standard keyboard. They are the backslash (/), the left bracket ([), and the underscore (\_). One way to type in these characters is to make a hardware modification to the keyboard. Another way is to attach a routine to the Input hook that will convert unused control characters to these characters. This program converts the following characters:

Control K to a left bracket ([)

Control L to a backslash (/)

Control O to an Underscore (\_)

To use this program do the following:

Type or BLOAD the program at \$300. Note that this program is written for DOS users. If your aren't using DOS, then replace the JMP \$3EA with RTS instructions.

To connect the routine, do a 303G from the monitor or a CALL 771 from BASIC.

To disconnect the routine, do a 300G from the monitor or a CALL 768 from BASIC.

The sample program uses the output hook to convert control characters into inverse video characters. All control characters except control M, which is the carriage return, are converted.

#### SOURCE FILE: CONVERT

```

FDF0:      1 COUT1  EQU  $FDF0  ;CHARACTER OUTPUT ROUTINE
0037:      2 CSWH  EQU  $37    ;OUTOUT HOOK HIGH BYTE
0036:      3 CSWL  EQU  $36    ;OUTPUT HOOK LOW BYTE
008D:      4 CTRLM EQU  $8D    ;CONTROL M
003F:      5 MASK  EQU  $3F    ;MASK TO CONVERT TO INVERSE
03EA:      6 MVSW  EQU  $3EA   ;RECONNECTS DOS
0080:      7 NULL  EQU  $80    ;NULL CHARACTER
FE93:      8 SETVID EQU  $FE93  ;PERFORMS PR#0
00A0:      9 SPACE EQU  $A0    ;SPACE CHARACTER

```

#### ----- NEXT OBJECT FILE NAME IS CONVERT.OBJ

```

0300:      11      ORG  $300
0300:4C OF 03 12      JMP  UNHOOK
0303:      13 *
0303:      14 * ROUTINE TO CONNECT ROUTINE INTO HOOK
0303:      15 *
0303:A9 16 16      LDA  #>CONVERT ;GET LOW BYTE OF ADDRESS
0305:85 36 17      STA  CSWL
0307:A9 03 18      LDA  #<CONVERT ;GET HIGH BYTE
0309:85 37 19      STA  CSWH
030B:20 EA 03 20     JSP  MVSW
030E:60      21     RTS

```

```

030F:      23 *
030F:      24 * THIS UNHOOKS THE ROUTINE
030F:      25 *
030F:20 93 FE 26 UNHOOK JSP  SETVID ;SIMULATE PR#0
0312:20 EA 03 27     JSR  MVSW ;RECONNECT DOS
0315:60      28     RTS

```

```

0316:      30 *
0316:      31 * THIS IS THE CONVERSION ROUTINE
0316:      32 *
0316:C9 80 33 CONVERT CMP  #NULL ;<NULL CHARACTER
0318:90 0A 34     BCC  GOOUT
031A:C9 A0 35     CMP  #SPACE ;>= SPACE CHARACTER
031C:B0 06 36     BCS  GOOUT
031E:C9 8D 37     CMP  #CTRLM ;RETURN CHAR?
0320:F0 02 38     BEQ  GOOUT
0322:29 3F 39     AND  #MASK ;CONVERT TO INVERSE
0324:4C F0 FD 40 GOOUT JMP  COUT1

```

\*\*\* SUCCESSFUL ASSEMBLY: NO ERRORS

### Summary of Important Addresses for Using the Hooks

Name	Address	Comment			
COUT1	\$FDF0	Monitor character output routine.	KSWL	\$38	Low address byte of input routine.
CSWL	\$36	Low address byte of output routine.	KSWH	\$39	High address byte of Input routine.
CSWH	\$37	High address byte of output routine.	MVSW	\$3EA	Routine to reconnect DOS
KEYIN	\$FD1B	Monitor keyboard input routine.	SETKBD	\$FE89	Simulates a IN#0
			SETVID	\$FE93	Simulates a PR#0

# "COMPUTERS 'R' US"

A CONSUMER COMPUTERS SUBSIDIARY

## UNBEATABLE MAIL ORDER DISCOUNTS



**apple computer**  
Authorized Dealer

**NEW!**  
CALL FOR  
AVAILABILITY  
AND PRICES.



**\$925**  
FOR 16K

**48K**  
FOR ONLY  
**\$1049**

### APPLE II OR APPLE II PLUS

#### APPLE COMPUTER PERIPHERALS

DISK II DRIVE & CONTROLLER CARD With DOS 3.3. List #645	629
DISK II DRIVE & CONTROLLER card	486
DISK II DRIVE ONLY	425
GRAPHICS TABLET	656
SILENTYPE PRINTER w/int. card	515
SSM AIO SERIAL/PARALLEL kit	165
SSM AIO assembled & tested	190
SYMTEC LIGHT PEN SYSTEM	215
SYMTEC SUPER SOUND GENERATOR	225
SVA & INCH DISK CONTROLLER CARD	336
VERSA WRITER DIGITIZER SYSTEM	215
VIDEX VIDEOTERM 80 COLUMN CARD	315
VIDEX VIDEOTERM w/graphics ROM	336
LOBO DISK DRIVE ONLY	385
LOBO DRIVE w/controller card	465
DC HAYES MICROMODEM II	319
DAN PAYMAR lower case kit	56

#### APPLE ADD-ONS

CORVUS 10 MEGABYTE HARD DISK DRIVE SYSTEM w/pwr supply	4396
CORVUS CONSTELLATION	586
18K MEMORY UPGRADE KIT (TRS-80, APPLE II, SORCERER)	60
ABT NUMERIC INPUT KEYPAD (specify old or new kybrd)	115
ALF MUSIC SYNTHESIZER	236
BRIGHTPEN LIGHTPEN	32
GPIB IEEE-488 (1978) Int.	259
ARITHMETIC PROCESSOR card	336
SPEECHLINK 2000 (64 Word Vocab)	215
MAR SUP-R-MOD TV MODULATOR	30
MICROSOFT 7-80 SOFTCARD SYSTEM w/CP/M & MICROSOFT BASIC	299
MICROWORKS-D8-86 DIGISECTOR	329
LAZER lower case adaptor	50
M8R SUPER TERMINAL 80 column card	335

#### APPLE COMPUTER INTERFACE CARDS

PARALLEL PRINTER int. card	145
COMMUNICATION CARD w/conn. cables	185
HI SPEED SERIAL int. card	145
LANGUAGE SYSTEM with PASCAL	425
CENTRONICS PRINTER int. card	185
APPLESOFT II FIRMWARE card	149
INTEGRO BASIC FIRMWARE card	149

#### APPLE II or APPLE II PLUS SOFTWARE

PASCAL with LANGUAGE SYSTEM	425
FORTRAN for use with LANGUAGE SYSTEM	165
CP/M for use with MICROSOFT 7-80 SOFTCARD (Incl.)	299
DOS 3.3	49
THE CONTROLLER General Business System	519
THE CASHIER Retail Management & Inventory System	199
APPLEWRITER Word Processor	85
APPLEPOST MAILING list system	45
APPLEPLOT Graph & Plot System	60
DOW JONES PORTFOLIO EVALUATOR	46
APPLE CONTRIBUTED VOLUMES 1 thru 5 w/manuals	30
VISI-CALC by PERSONAL SOFTWARE	120
DESKTOP/PLAN by DESKTOP COMPUTERS	85
CCA DATA MANAGEMENT SYSTEM by PERSONAL SOFTWARE	85
APPLEBUG ASSEMBLER/DISASSEMBLER	75
APPLE DOS TOOL KIT	65

#### MOUNTAIN HARDWARE ACCESSORIES

A Division Of  
**Mountain Computer**



APPLE CLOCK/CALENDAR card	225
SUPERTALKER SD200 SPEECH SYNTHESIZER SYSTEM	245
ROMPLUS w/keyboard filter	165
INTROUX 10 8SR REMOTE CONTROL SYSTEM	245
INTROUX-10 controller card only	185
ROMWRITER SYSTEM	165
MUSIC SYSTEM (8 voice/stereo)	486
A/D/A 18 CHANNELS	319
EXPANSION CHASSIS (8 slots)	556

### VIDEO MONITORS

LEEDEX VIDEO 100	129
SANYO 9" B&W	165
SANYO 15" B&W	245
PANACOLOR 10" COLOR	329
NEC 12" HI RES COLOR	875
NEC 12" LO RES COLOR	399
NEC 12" GREEN PHOSPHOR(P31)	239

**\$129**

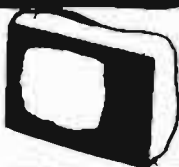
LEEDEX VIDEO 100

ATARI

**16K FOR \$799**

**ATARI 800**  
PERSONAL COMPUTER SYSTEM

#### ATARI ACCESSORIES

400 COMPUTER	479
820 PRINTER (40 col)	459
810 DISK DRIVE	559
410 Program Recorder	59
815 DUAL DISK DRIVE	1199
822 THERMAL PRINTER (40 col)	369
825 PRINTER (80 col imp)	795
850 INTERFACE MODULE	175
ATARI 16K RAM MODULE	155
LIGHT PEN	65
ACOUSTIC MODEM (CAT)	169
COMPUTER CHESS	35
SPACE INVADERS	19
STAR RAIDERS	49
SUPER BREAKOUT	35
3 D TIC TAC TOE	35
VIDEO EASEL	35
MUSIC COMPOSER	49

### PRINTERS

ANADEX DP-8000	775
ANADEX DP-9500	1350
BASE 2	599
CENTRONICS 737	825
MPI 88 T	699
PAPER TIGER IDS-440 w/graphics	895
NEC SPINWRITER	2550
TRENDCOM 200	519
SILENTYPE w/int	515
EPSON TX 80 w/graphics	729
EPSON MX 80 132 col	620



## OHIO SCIENTIFIC



**'699**  
C4P

8K ROM BASIC  
8K RAM EXPANDABLE TO 96K  
32x64 UPPER & LOWER CASE  
256x512 GRAPHICS POINTS  
PROGRAMMABLE TONES  
ANALOG INPUTS  
C4PME (1 DISK DRIVE).....1599

**NEW!**



**\$429**  
CIP MOD II

8K ROM BASIC  
8K RAM EXPANDABLE TO 32K  
COLOR EXPANSION  
48 LINE DISPLAY EXPANSION

### SOFTWARE

	Cassette	Disk
SPACE INVADERS	19	29
SARGON II	30	35
FORTH	N/A	69
OS 85-D V3.3	N/A	79
MDMS PLANNER	N/A	100
GRAPHICS I	N/A	35
DAC I	N/A	45
ASSEMBLER/EDITOR	40	N/A
EXTENDED MONITOR	20	N/A
PASCAL & FORTRAN (4P & 8P only)		450

When ordering please specify system.

### PLOTTERS

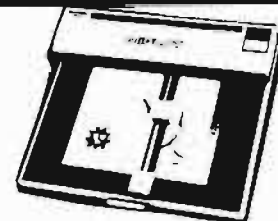

**\$1095**  
only

WATANABE MIPLLOT

for more info please call or write

- FAST DELIVERY
- LOW PRICES
- COURTEOUS SERVICE
- KNOWLEDGEABLE STAFF
- LARGE VARIETY

IN CALIFORNIA, OR FOR BACKORDER OR TECHNICAL INFO CALL:  
**(714) 698-8088**

TOLL FREE ORDER LINE: **1-800-854-6654**

CREDIT CARD USERS PLEASE READ TERMS OF SALE IN ORDERING INFORMATION

ORDERING INFORMATION Phone Orders invited using VISA, MASTERCARD, AMERICAN EXPRESS, or bank wire transfers. VISA & MC credit card service charge of 2%. AE credit card service charge of 5%. Mail orders may send charge card number (include expiration date), cashier's check, money order or personal check (allow 10 business days to clear). Please include a telephone number with all orders. Foreign orders (excluding Military PO's) add 10% for shipping and all funds must be in US dollars. Shipping, handling and insurance in U.S. add 3%. California residents add 6% sales tax. Our low margins prohibit us to send COD or on account. All equipment subject to price change and availability. Equipment is new and complete with manufacturer warranty. We ship most orders within 2 days. Order desk hours are Monday thru Saturday 9-5 PST. Send for FREE 1981 Catalog. WE ARE A MEMBER OF THE BETTER BUSINESS BUREAU AND THE CHAMBER OF COMMERCE. RETAIL STORE PRICES MAY DIFFER FROM MAIL ORDER PRICES. PLEASE SEND ORDERS TO CONSUMER COMPUTERS MAIL ORDER CRU Division, 8314 PARKWAY DRIVE, GROSSMONT SHOPPING CENTER NORTH, LA MESA, CALIFORNIA, 92041

# An Ultra-Fast Tape Storage System

**A simple hardware modification to the Ohio Scientific Superboard and the use of a good home hi-fi tape recorder yield data-transfer rates of up to 9600 baud.**

John E. Hart  
5 Marvin Road  
Wellesley, MA 02181

## Why Tape?

Most hobbyist micros come with a simple, but slow, bulk storage system using a dictaphone-type cassette tape recorder. Because of the rather low reproduction quality of such machines, data rates typically are 300 to sometimes 600 baud (bits per second). For transferring short programs or data files between tape and memory, this is often sufficient. However, at 300 baud, for example, it takes about 1.5 seconds to load a typical line of a BASIC source code. If the program contains only a few lines, the times involved are not objectionable.

Recently, I was working on a compiler for my Ohio Scientific Superboard. It inputs BASIC statements and writes object machine code in the high end of memory. Needless to say, this program, itself written in BASIC, was long. It took almost 15 minutes to load its 350 lines from cassette. Many computer owners faced with similar problems might go to the obvious means of enhancing program retrieval—the disc.

Unfortunately, for many purposes, there are severe limitations with existing disc systems. These limitations, coupled with the fact that I already owned a good hi-fi tape deck, led me to develop a simple, high-speed tape storage system that transfers 16K of BASIC code from tape to RAM in about 15 seconds! This system is almost competitive with disc systems and

has several advantages. The hardware and software required are so simple, it would be easy for anyone owning a good tape recorder to adopt the high-speed system. Since a disc drive costs as much or more than a tape recorder, some people might opt for the latter, and buy a piece of equipment with multiple uses.

Disc systems are of limited use in jobs that require either a large amount of RAM or that require fast execution. For fast execution, I purchased the Ohio Scientific Superboard, because I know of a simple jumper connection that doubles the speed (see the article by J.R. Swindell, "The Great Superboard Speed-Up," MICRO, February 1980, 21:31). Increasing the clock from 1 to 2 Mhz was very important to me, since I do a lot of lengthy calculations. Unfortunately, Ohio Scientific disc systems will not *run* at 2 Mhz without major hardware surgery, and software modification as well. Worse still, the Ohio Scientific disc-operating system 65V uses 9-digits precision arithmetic. This is really not any more useful to me than the standard 6½-digit precision, and moreover, it runs about 50% slower. So in summary, using a disc would cause my jobs to run almost three times more slowly than with tape and normal BASIC in ROM.

I do a lot of calculations on large two-dimensional arrays. Thus, in addition to speed, I need a large amount of RAM for immediate

storage. Since typical disc-operating systems occupy 12K or more of RAM, the execution time is further slowed by the necessity for repeated transfer of 10K blocks of data between RAM and disc. In total, it seemed as if any gain in program and data transfer using the disc would be offset by slow execution. Wouldn't it be nice to store my programs and/or object codes on tape and to transfer them into memory at a rate approaching the upper end of the frequency response of the tape drive? Since a good hi-fi cassette deck with Dolby reaches 10kc in its response, and a good reel-to-reel deck goes above 20kc, theoretically, it ought to be possible to squeeze 4800 to 9600 baud out of these units.

## What is Kansas City Standard Format?

Most computers come with a tape system called Kansas City Standard. In this format, ones and zeros are represented on tape by two different frequencies. This is done because frequency modulation is much less sensitive to noise and tape alignment errors than amplitude modulation, where zeros might be represented by a zero signal and ones by a single pulse or frequency. In fact, a zero is recorded as 8 cycles of a frequency 8 times the baud rate, and ones are represented by 4 cycles of a frequency 4 times the baud rate. Thus, at 300 baud, zeros are short bursts of 2400 hz signal, and ones are short bursts of 1200 hz oscillations.

Baud Rate	Byte Rate (approx)*	0-frequency	1-frequency
300	30/sec	2400 hz.	1200 hz.
600	60	4800	2400
1200	120	9600	4800
2400	240	18200	9600
4800	480	36400	18200
9600	960	72800	36400

\*This depends on the word structure: 7-bit, no parity; 8-bit, with parity, etc.

Table 1

It is perhaps obvious that, if this technique is reliable (and it certainly works very well with cheap recorders), you could try to increase the baud rate simply by employing a tape recorder with a better frequency response. This is in fact the case. A dictaphone-type machine can reliably handle 600 baud (PET already does this); a hi-fi cassette can do 1200 baud; and a good reel-to-reel, operating at 7½ or 15 ips, can do 2400. However, as table 1 indicates, getting much faster data transfer than 2400 baud, with even the best reel-to-reel tape recorder, is probably impossible within the framework of the Kansas City format. The required frequency response is just too high. No audio tape machine has much usable response above 25 kc.

Although it turns out that some gains could be made in Kansas City format by using a good tape machine, unfortunately, in loading BASIC programs from tape, or in loading machine code using the Ohio Scientific there are stumbling blocks. The Microsoft BASIC interpreter does a considerable amount of data massaging as each line of BASIC is loaded. This takes time. A lot of time! Input lines are decoded, and certain errors are trapped and can appear on the screen while a program is being loaded, before it has RUN. The 1-Mhz Superboard will load 600-baud tapes if they are recorded with 8 nulls (for example, NULL8, SAVE, LIST), but falters at 1200 baud. However, if the clock is flipped up to 2 Mhz, the 1200-baud tapes load well, but the 2400-baud tapes fail. Thus fast tape loading cannot be done with Microsoft BASIC. However, it can be done using a simple machine code loader and saver described below. But first, I must outline a simple trick that gets up to 9600 baud with a 20kc response deck.

### How is Kansas City Standard Data Decoded?

Recall that in Kansas City format a zero is 8 cycles and a one is 4. Then, to eliminate or minimize noise, one might simply count the pulse train. A count of more than 6 pulses per bit width (1/ baud rate) would be a zero, a count of less than seven could be one. (You may actually use a counter or, as APPLE does, use a phase-locked loop.) Thus, an extra or dropped cycle would not have much effect. However, this is not how Ohio Scientific decodes. In figure 1, a shows a typical input pulse train obtained by taking the tape play signal and amplifying it beyond the clipping point. In the Superboard, this pulse train is fed into a retriggerable one-shot multivibrator. This device triggers (output goes high) on the positive going edge of each input pulse. The output then stays high for a time dependent on an RC circuit ( $R_1$  and  $C$  of figure 2). Since it is retriggerable, if another input pulse arrives while the output is high, a

new time-delay cycle is started. The time delay ( $t_D = R_1 \times C$ ) is chosen so that retriggering occurs for the higher frequency input (zero), but not for the lower frequency (one). This is shown in b of figure 1. You can see that a certain amount of noise immunity is afforded here, in that tape jitter or pulse stretching has to occur for a fairly long time (1/0-frequency) before the trigger errors occur. The one-shot output is sampled by the serial communications adaptor at the end of the bit input as shown in c of figure 1.

Actually, there is a little more circuitry in-between, but it is not important for our purposes. Most of the data is irrelevant to the final decoding. It is only the last set of pulses just before the sample that determines whether a one or a zero is recognized! This would not be the case if the counting scheme I suggested above had been used. But this shows that by substituting real data in place of the first ¾ of unused pulses, you could multiply the data density and transfer rate by a factor of four. Thus, we could go from 2400 to 9600 baud, while still operating at a maximum frequency of 18.2 kc. You might think that doing this would be just asking for read errors. In truth, for a given program length and 0-frequency, the error probability is unchanged.

### How to Change Baud Rates and Quadruple Data Density

It is necessary to install a 3-pole,

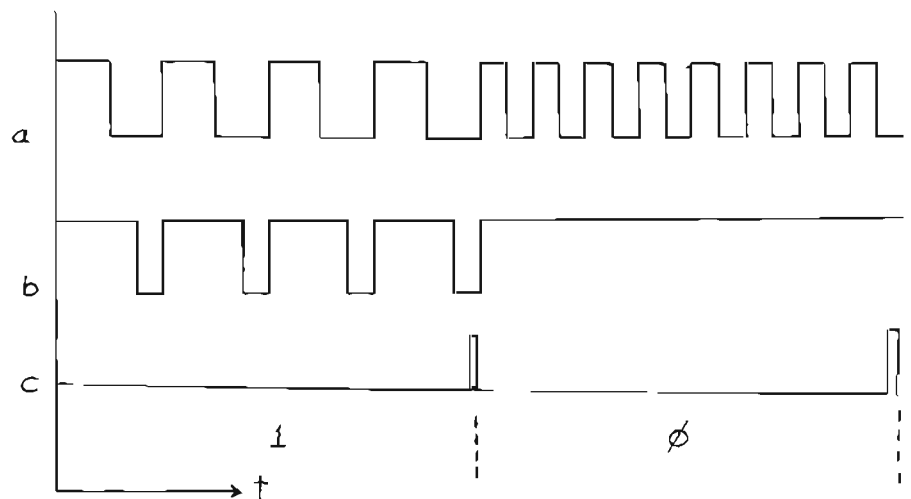

Figure 1

5-position switch, connected as shown in figure 2. This assumes that the reader will want all the options:

1. Normal Kansas City recording at 300 baud (position a)
2. Normal Kansas City recording at 600 baud (position b)
3. Normal Kansas City recording at 1200 baud (position c)
4. Bi-mod\* recording at 4800 baud (position d)
5. Bi-mod recording at 9600 baud (position e)

\*This is what I call the scheme where a zero is 2 cycles (instead of 8), and a one is 1 cycle (instead of 4), or twice the period.

The first three positions give a straightforward modification to the 8- and 4-cycle Kansas City Standard record/play technique. I also retain these modes in my machine, so I can load cassettes recorded this way into my computer and make fast tapes for rapid loading. Also, although I rarely get a read error at 9600 baud, I like to feel secure, knowing I have a backup cassette—just in case... The circuit also includes switch positions for both 4800 and 9600 baud. A good Dolby cassette deck is capable of 4800 but not 9600. I have tried three reel-to-reel decks at 7½ ips and they all worked at 9600, but I cannot guarantee that all units of varying condition will. Thus, if a reader doesn't want to wire in all these options, I would suggest that at least option 1 or 2 and option 4 and/or 5 be included.

Referring to figure 2, the first pole of the switch (S<sub>a</sub>) just taps off the main Superboard clock divider U59 and U30, to send different clock pulses to the serial data transmitter/receiver (ACIA). The second pole (S<sub>b</sub>) selects the appropriate time delay for the retriggerable one-shot U69, corresponding to the clock frequency selected by S<sub>a</sub>. R<sub>1a</sub> and R<sub>1b</sub> as well as C come with the Superboard and are set for 300 baud. Fixed resistors may be used for 600 and 1200, since the device is not very sensitive. I put trimpots in for the higher baud rates, and you might want to do this for all the positions and then set them by trial and

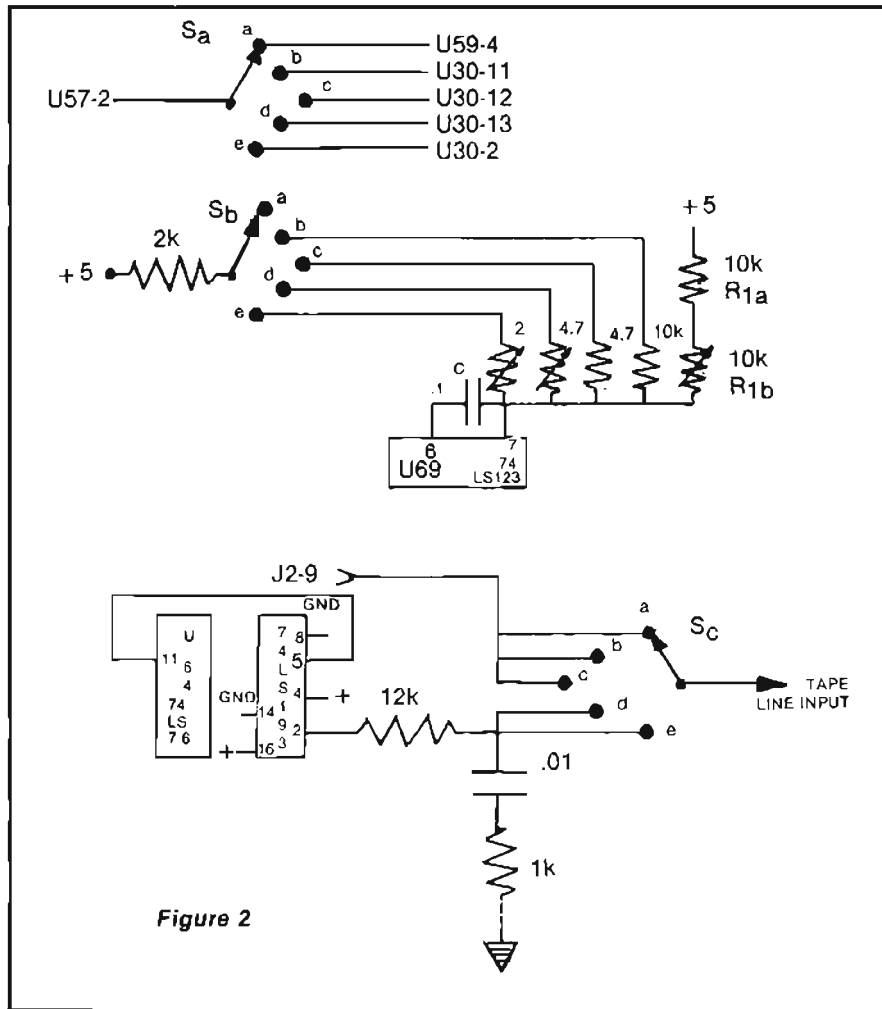

Figure 2

error (for example, load a program) to the middle of the acceptance band.

To get the bi-mode of recording, we take the normal 8- and 4-cycle modulation coming out of U64-11, and count it down by a factor of 4 using a 74LS193 counter. Thus, to get 9600 baud (from 300), I have increased the clock to the ACIA by a factor of 32, but divided the 8- and 4-cycle outputs down to 2 and 1, so that the frequency of the signal going on the tape only increases by a factor of 8. I found it easiest to mount the counter in one of the unused prototype sockets on the Superboard. Finally, pole S<sub>c</sub> of the switch selects between normal 8/4-cycle modulation and 2/1, as shown, and feeds the transmitted data to the line input of the tape deck.

#### Software

To get started at 4800 or 9600

baud, I included a pair of simple machine code programs to store and read tapes. Dump all of the RAM below a given page number and down to ADDR 0000 onto tape. Then, to load a BASIC program, read the tape back in, and because it includes pages zero and one with all the BASIC tables and flags exactly as they were just before recording, the program comes in all ready to run.

You can build on this software. For example, every time you hit BRK-W or BRK-C, a command is sent to the ACIA to format output as 8 bits of data followed by 2 stop bits. With this high-speed scheme, it might be good to command the ACIA to output 8 bits of data, one parity, one stop bit, and check parity on reload. However, you can tell if there is a read error (usually), since for BASIC program, the loader should end up exactly at location 0000 with a 4C hex there. Unless this is the case, a bit has been dropped.

In fact, I have only been able to cause this to happen by making the tape play volume much too small, or by rather heavily touching the reels as the tape is playing back! You may also want to relocate these routines to the back of your memory.

**Some Hints**

This system obviously approaches the limits of standard audio recorders and tape. However, I emphasize again that I have yet to misload a long program that was

properly recorded at 9600 baud. The usual precautions should always be taken. Maintain *clean* tapes and heads. Demagnetize (the heads!). Use the best back-coated, extended-range tape you can get (I like Maxell UD-XL), and do not rerecord over old material. Put each new program on brand new tape to avoid print through. At 7½ ips, the data density is so high that you get about 20 megabytes out of a 1200-ft. tape, so there is little sense in not doing this. Make sure the equalization is correct, and set the record level for optimum high frequency response (an

oscilloscope is useful here).

I hope this technique opens up new horizons. With a stereo recorder, you may immediately think about using the other channel for search or file headers. In any case, the ability to load 16K programs in 15 to 30 seconds, and to have all of RAM available for user storage and programs is an enormous advantage in many situations. And once you have loaded your program, you can switch over, relax, and enjoy some hi-fi!

**To save pages 17 to zero run (G):**

**HIGH SPEED WRITE**

1936	ORG	\$1936	
1936 A9 FF	LDAIM	\$FF	SET UPPER MEMORY START FOR DUMP
1938 8D 48 19	STA	\$1948	LOAD INTO ADDRESS POINTER LOCATION
193B A9 17	LDAIM	\$17	SET UPPER MEMORY PAGE START
193D 8D 49 19	STA	\$1949	LOAD INTO ADDRESS POINTER LOCATION
1940 AD 00 F0	LDA	\$F000	LOAD ACIA STATUS REGISTER
1943 29 02	ANDIM	\$02	MASK BUSY BIT
1945 F0 F9	BEG	\$1940	
1947 AD FF FF	LDA	\$FFFF	FILLED IN BY CODE ABOVE
194A 8C 01 F0	STA	\$F001	WRITE TO ACIA
194D CE 48 19	DEC	\$1948	DECREMENT LOW BYTE OF ADDR.
1950 00 EE	BNE	\$1940	
1952 CE 49 19	DEC	\$1949	DECREMENT HIGH BYTE
1955 10 F9	BPL	\$1940	
1957 4C 00 FE	JMP	\$FE00	JUMP TO MONITOR

**To read in or load pages 17 to zero run:**

**HIGH SPEED READ**

18F0	ORG	\$18F0	
18F0 A9 FF	LDAIM	\$FF	
18F2 8C 11 19	STA	\$1911	
18F5 A9 17	LDAIM	\$17	
18F7 8D 12 19	STA	\$1912	
18FA AD 01 F0	LCA	\$F001	READ ACIA TO CLEAR IT
18FD AD 01 F0	LCA	\$F001	
1900 AD 00 F0	LCA	\$F000	RECEIVE STATUS CHECK
1903 29 01	ANDIM	\$01	
1905 F0 F9	BEG	\$1900	
1907 AD 01 F0	LDA	\$F001	READ ACIA
190A 8D 10 D2	STA	\$D210	WRITE CHAR RECEIVED TO SCREEN
190D 8D 05 D2	STA	\$D205	
1910 8C FF 17	STA	\$17FF	WRITE DATA TO MEMORY
1913 CE 11 19	DEC	\$1911	DECREMENT LOW BYTE OF ADDR.
1916 D0 E8	BNE	\$1900	
1918 CE 12 19	DEC	\$1912	DECREMENT HIGH BYTE
191B 10 E3	BPL	\$1900	
191D 4C 00 FE	JMP	\$FE00	JUMP TO MONITOR

μ





# Skyles Electric Works

**BASIC Programmer's, Toolkit™, Disk-O-Pro™, Command-O™**

## **For PET™ Owners Who Want More Fun And Fewer Errors with Their Programs**

Here are thirty-five commands you'll need, all on dual chips you can install in two minutes without tools, **on any PET or PET system**. 2KB or 4KB of ROM firmware on each chip with a collection of machine language programs available from the time you turn on your PET to the time you shut it off. No tape to load or to interfere with any running programs.

For PET/CBM 2001-8, -8N, -16N/B, -32N/B, 3016 and 3032

### **BASIC Programmers Toolkit™ commands**

**AUTO<sup>ed</sup> DELETE<sup>ed</sup> RENUMBER<sup>ed</sup> HELP<sup>ed</sup> TRACE<sup>ed</sup>  
STEP<sup>ed</sup> OFF<sup>ed</sup> APPEND<sup>ed</sup> DUMP<sup>ed</sup> FIND<sup>ed</sup>**

### **BASIC Programmers Disk-O-Pro™**

**CONCAT<sup>B80</sup> DOPEN<sup>B80</sup> DCLOSE<sup>B80</sup> RECORD<sup>B80</sup> HEADER<sup>B80</sup> COLLECT<sup>B80</sup>  
BACKUP<sup>B80</sup> COPY<sup>B80</sup> APPEND<sup>B80</sup> DSAVE<sup>B80</sup> DLOAD<sup>B80</sup> CATALOG<sup>B80</sup>  
rename<sup>B80</sup> SCRATCH<sup>B80</sup> DIRECTORY<sup>B80</sup> INITIALIZE<sup>BS</sup> MERGE<sup>BS</sup> EXECUTE<sup>BS</sup>  
SCROLL<sup>ed</sup> OUT<sup>ed</sup> SET<sup>ed</sup> KILL<sup>ed</sup> EAT<sup>ed</sup> PRINT USING<sup>BS</sup> SEND<sup>BS</sup> BEEP<sup>BS</sup>**

For CBM 8016 and 8032

### **BASIC Programmer Command-O™**

**AUTO<sup>ed</sup> DUMP<sup>ed</sup> DELETE<sup>ed</sup> FIND<sup>ed</sup> (improved) HELP<sup>ed</sup> KILL<sup>ed</sup> OFF<sup>ed</sup>  
TRACE<sup>ed</sup> (improved) RENUMBER<sup>ed</sup> (improved) INITIALIZE<sup>BS</sup> MERGE<sup>BS</sup> MOVE<sup>BS</sup>  
EXECUTE<sup>BS</sup> SCROLL<sup>ed</sup> OUT<sup>ed</sup> SET<sup>ed</sup> SEND<sup>BS</sup> PRINT USING<sup>BS</sup> BEEP<sup>BS</sup>**

ed — a program editing and debugging command

B80 — a BASIC command also available on Commodore CBM™ 8016 and 8032 computers.

BS — a Skyles Electric Works added value BASIC command.

BASIC Programmers Toolkit™ is a trademark of Palo Alto IC's.

BASIC Programmers Disk-O-Pro™, Command-O™ is a trademark of Skyles Electric Works.

PET™, CBM™ are trademarks of Commodore Business Machines.

Can be placed in main board socket or with precision-engineered interface

Phone or write for information. We'll be delighted to answer any questions  
and to send you the complete information package.



## **Skyles Electric Works**

**231 E South Whisman Road  
Mountain View, CA 94041  
(415) 965-1735**

# ACTION, STRATEGY, AND FANTASY for the **SERIOUS** games player and his **APPLE II**

## **Brain Games - 1** demands ingenuity.

Two players bombard radioactive material with protons and electrons until it reaches critical mass and sets up a **Nuclear Reaction**. **Dodgem** requires you to outmaneuver another player to get your pieces across the board first. **Dueling Digits** and **Parrot** challenges your ability to replicate number and letter sequences. **Tones** lets you make music with your Apple (16K) CS-4004 \$7.95. **Strategy Games** and **Brain Games** are on one disk (16K) CS-4503 \$14.95.

## **Strategy Games - 1** keeps games players in suspense.

You and your opponent trail around the screen at a quickening pace attempting to trap each other in your **Blockade**. A 7 category quiz game will certify you as a **Genius** (or an errant knave!). Beginners will meet their master in **Checkers**. **Skunk** and **UFO** complete this classic collection (16K) CS-4003 \$7.95

## **Know Yourself** through these valid self-tests.

Find out how your life style effects your **Life Expectancy** or explore the effects of **Alcohol** on your behavior. **Sex Role** helps you to examine your behavior and attitudes in light of society's concept of sex roles. **Psychotherapy** compares your feelings, actions, and phobias to the population's norms and **Computer Literacy** tests your microcomputer savvy. A fun and instructional package (16K) CS-4301 \$7.95. **Know Yourself** and **CAI Programs** are on one disk (16K) CS-4503 for \$14.95

# THINK



# IMAGINE



## **You're in command in Space Games - 1.**

Maneuver the TIE fighters into your blaster sights and zap them with your lasers to save the rebel base camp from annihilation in **Star Wars**. **Rocket Pilot** is an advanced real time take off and landing game. High resolution graphics, exploding saucers and sound effects add to the suspense as you repel the **Saucer Invasion**. Finally, a bonus graphics demonstration, **Dynamic Bouncer** (16K) CS-4001 \$7.95. **Space Games** and **Sports Games** are on one disk (16K) CS-4501 for \$14.95

# ACTION

## **Sports Games - 1** puts you in the Apple World Series

Take the field in the **Great American Computer Game**. Mix up your pitches to keep the batter off balance. Move your fielders to snag the ball before he gets to first. Balls and strikes, double plays, force outs, and errors let you play with a realistic strategy. Also in the line up—**Slalom**, a championship downhill ski race, **Torpedo Alley**, and **Darts** (16K) CS-4002 \$7.95. **Space Games** and **Sports Games** are on one disk (16K) CS-4501 for \$14.95

**It's easy to order SENSATIONAL SOFTWARE for your Apple II.**

Send payment plus \$1.00 shipping and handling in the U.S. (\$2.00 foreign) to Creative Computing Software, P.O. Box 789-M, Morristown, N.J. 07960. N.J. residents add \$1.00 sales tax. Visa, Master Charge and American Express orders may be called in toll free to 800-831-8112 (in N.J. 201-540-0445).

# SYM-Bell

Have you ever looked fondly at a telephone memory dialer at your local electronics supply store, but decided that the \$100 plus could be put to better use elsewhere? Well, for about \$10 your SYM-1 or similar computer can do all that commercial dialers do, plus much more.

Randy Sebra  
54 Krouse Court  
Aberdeen, MD 21001

Commercially available, dedicated telephone dialers can cost up to one-third the price of the single board SYM-1 equipped with BASIC. However, with the addition of a simple relay interface, costing less than \$10 and driving software, the SYM-1 can out perform any of these units. The combination of machine language for control, and BASIC for flexibility yields an extremely powerful system. Unlike the commercial systems which are usually limited to a maximum of 32 numbers, the numbers available to the SYM-1 are a function only of the available user memory. Also, this system is capable of doing things beyond the scope of most commercial dialers.

There have been a number of articles in periodicals and books on telephone dialing by computer. However, these have been describing dialing by using the microprocessor to generate Touch Tone™ digits. The only problem with this method is that the telephone system accessed must be compatible with the Touch Tone™ dialing system, and not all areas of the country (or even all areas within any one locality) have this capability. The interface described here generates dial pulses, which are compatible with any system.

Additionally, this method is not restricted to the SYM-1. Virtually any microcomputer with a single available output port that can be accessed by BASIC can be adapted to do this operation.

## Dialing is Simple

Most home telephones use a three wire system. The two line leads are usually the red (ring) and green (tip) wires. The line leads carry the analog conversation signal as well as dialing information for either Touch Tone™ or rotary dialing and the ring signal for the bell. A third wire, not shown (usually the yellow lead) serves as a ground reference. The fourth, fifth, and sixth leads on the current modular plug are not normally used for home systems.

When not in use, the telephone receiver is disconnected from the line by the normally open cradle switch. When the handset is picked up, the cradle switch closes and connects the receiver to the telephone line. The remote switching station senses the active current loop (20 to 40mA at 24 VDC), and issues the familiar dial tone. When the rotary dial is used, it repeatedly breaks and makes a connection in one of the line leads. It is this break/make action that creates dial pulses sensed by the switching station which routes the call to the proper destination.

You can do a simple experiment to see how this works. Pick up the handset from your telephone. Then rapidly tap one of the cradle switch buttons four times, pause, tap once, pause again, and rapidly tap once more. If done properly, you should get a ring, and directory assistance will answer.

## Interfacing With the Telephone

Therefore, by putting a normally closed relay in one of the line leads, dial pulses can be generated by toggling the relay properly. This is shown in figure 1. The circuit takes advantage of the fact that on the SYM-1, the PB4-PB7 outputs from the #3 6522 VIA are buffered so that each is capable of driving a 5-volt relay. The buffer for PB7 is shown in the dotted section of figure 1. The diode across the relay is for transient protection. The voltage variable resistor prevents high voltage transients from being introduced into the phone line, but more importantly, prevents a high voltage transient from a thunder storm or other sources from getting into the interface from the phone lines and wiping out the computer. An alternative to the resistor is two Zener diodes back to back across the lines. The ring signal for the telephone bell is approximately 90VAC, 20HZ at .5 Amps, so the relay used should be able to withstand this in case an incoming call comes in inadvertently while the interface is active.

At this point, it should be mentioned that although the relay and voltage variable resistor isolate the circuitry from the phone line, this direct connection should only be used for privately owned systems. Such a connection to TELCO lines is "illegal", and both the FCC and TELCO frown of this type of connection. There is, however, a way to make a "legal" connection of this type of interface. This will be

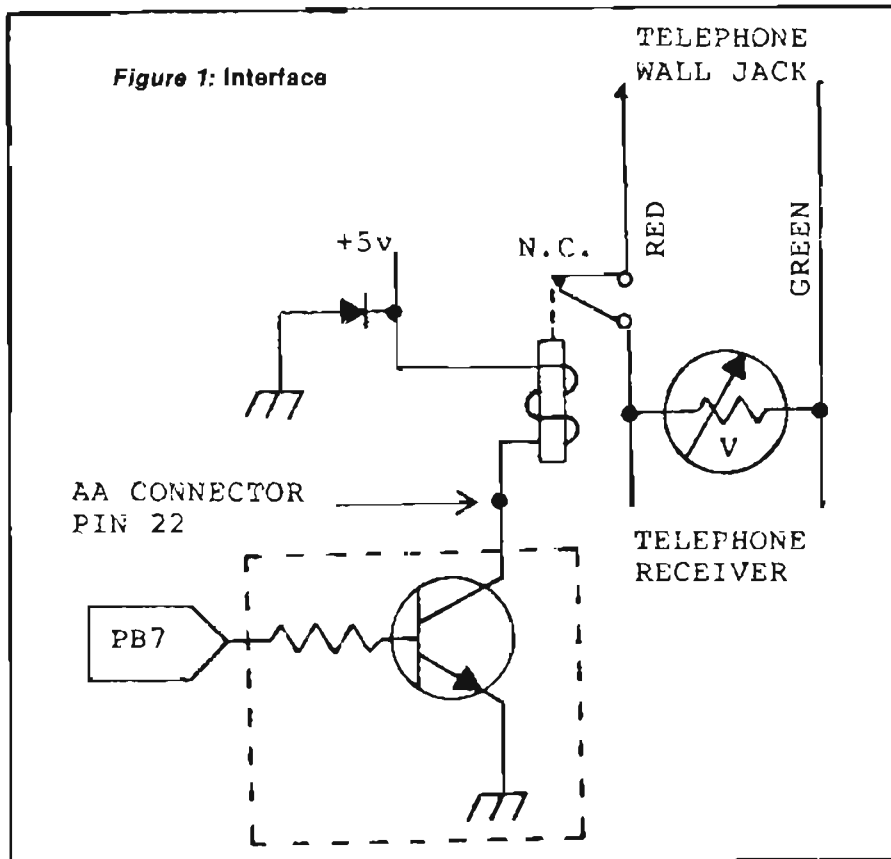

Figure 1: Interface

discussed later, after the interface and software operation are fully understood.

### Machine Language Routines

Table 1 presents the timing requirements for dial pulses. The pulses are sent out in groups depending on the digit dialed; that is, a single pulse for a "1", two pulses for a "2" and so on with ten pulses for an "0". There must be a pause between each digit dialed as shown in the table. In some areas dialing can be done at a 20 Hz rate, and all that is needed is a change in the software timing. Notice that there is a wide tolerance range in the timing requirements. After all, the conventional spring-driven rotary dial that works so well is not quite a crystal controlled pulse generator. For this reason, although the timing loops in the software are close to the nominal values, extreme attention to detail such as counting delays incurred by JSR's and other instructions in machine language and execution times in BASIC was not taken.

Listing 1 presents the machine language routines which drive the relay and operate the elapsed timer. Notice that the general delay routine DELAY uses timer 2 of one of 6522 VIA's in the one shot mode. The routine allows a continuously variable time delay from a few microseconds to over two minutes. The variability is needed for the generation of a number of different delays, including the long .8 sec delay used in the hang up routine, HANG.

The second timing routine which uses the 6522, TIMER, is an interrupt driven routine which uses timer 1 in its free running mode, but with the PB7 output disabled by the setting

of the ACR. The routine uses three page zero addresses, \$F0, \$F1 and \$F2, which do not conflict with the operation of the BASIC program. The interrupt routine it refers to, UPDATE, is similar to many published real time clock routines. It is shorter, however, because there is no need to keep track of hours and it will count up to 99 minutes and 59 seconds before resetting to zero. For telephone conversations, this should be more than sufficient—except perhaps if you have a teenage daughter at home as I do.

When called from BASIC, the routine initializes the timer and sets up the output vector for the on-board LED display. The interrupt routine updates the count of minutes and seconds and outputs the elapsed time each second. The main routine constantly scans the LED display until it senses that a key on the terminal has been pressed. At that time, it stops the timer, resets the output vector, does a hang up and returns control back to BASIC.

The initialization routine is needed because the PB4-PB7 lines are configured on power up and reset as input ports, which would turn the relay on and de-activate the telephone line. The interface should be disconnected from the telephone lines at all times except when the SYM is being used as a dialer, since other SYM programs might use PB7 as an input/output port.

The hang up routine is just a disconnect for the same duration as an interdigital pause. On some systems, this may not be long enough to effect a disconnect, and the time may have to be set as long as two or three seconds.

The dialing routine is merely a variable count pulse generator which generates the proper number

	Nominal value	Range
Pulse rate	10pps	8-11pps
Break time	61%	58-64%
Interdigit pause	800msec	600msec - 3 sec

Table 1: Timing Requirements

of pulses for the digit requested with the proper timing and duty cycle.

The machine language routines were written to occupy the high memory for a 4K system. They can be easily relocated, however, by changing the values which are underlined in the listing.

### The BASIC Program

The interface and machine language routine, as presented so far are of rather limited value. Here is where the versatility of a BASIC driving program comes into play. Listing 2 presents one such program. With this program, it is possible to not only dial a single number with redial capability, but to sequentially dial any combination of numbers from the directory in virtually any order, all with redial and selective hang up capability. Additionally, any call can be timed, with the elapse time being continuously displayed on the on-board LED display, and the total elapsed time printed out at the terminal.

Additionally, the numbers can contain an access pause, identifies by a "." in the number. An access pause is needed when the dialing of one telephone number results in a dial tone for a second number. The most familiar example of this is item 18 in the directory—getting an outside line from a business phone. The digit "9" is dialed, and when the dial tone is obtained, the number is dialed. The program does this operation automatically. The "9" is dialed and the program waits for an entry to dial the rest of the number. For a busy signal, the redial can come after either number. A second example is that of a call diverter used in directory item 19. Some large time-shared computers use this type of set up. A local number is dialed, and a call diverter routes the call to another exchange within the local area of the computer. A second number is then called for the final connection. This type of operation is often much cheaper than a single toll call.

This program, including the machine language routines, in a minimal 4K system can store up to 50 numbers—depending on the length of the numbers and the

Table 2: Sample Run

```
.J 0
MEMORY SIZE? 3866
WIDTH?
```

```
3353 BYTES FREE
```

```
BASIC V1.1
COPYRIGHT 1978 SYNERTEX SYSTEM CORP.
```

```
OK
SAVE X
SAVED
```

```
OK
LOAD M
LOADED
```

```
OK
LOAD D
LOADED
```

```
OK
RUN
 0 POLICE           1 FIRE
 2 DOCTOR           3 LAWYER
 4 SCHOOL           5 PARENTS
 6 WORK             7 WIFE'S WORK
 8 NEIGHBOR         9 BROTHER
10 JANE             11 JOE
12 JOHN            13 SALLY
14 JIM             15 JOAN
16 DORIS           17 BILL
18 HOME            19 COMPUTER
```

```
FIRST PICK UP RECEIVER AND WAIT FOR DIAL TONE.
ENTER THE DIRECTORY NUMBER(S) YOU WISH TO DIAL. YOU MAY
ENTER A SINGLE NUMBER, A SEQUENCE OF NON-CONSECUTIVE
NUMBERS SEPARATED BY SEMI-COLONS, OR A RANGE OF
NUMBERS SEPARATED BY A DASH.
```

```
ANY TIME YOU WISH TO HANG UP, ENTER AN H. TO RE-DIAL THE
PREVIOUS NUMBER, ENTER AN R(HANG UP NOT NECESSARY). TO
CONTINUE AFTER AN ACCESS PAUSE, ENTER C(OR H OR R IF THE
LINE IS BUSY). TO USE TIMER, ENTER A T AFTER THE
CALL IS ANSWERED. WHEN THE CONVERSATION IS OVER,
PRESS ANY KEY TO STOP TIMER AND HANG UP.
```

```
READY 3
DIALING LAWYER 555-3958? R
DIALING LAWYER 555-3958? R
DIALING LAWYER 555-3958? H
RUN AGAIN(Y OR N) Y
READY 5:9
DIALING PARENTS 1-804-559-6741? T
Y
  ELAPSED TIME : 4 MINUTES AND 15 SECONDS
DIALING BROTHER 1-703-556-0924? T
P
  ELAPSED TIME : 2 MINUTES AND 58 SECONDS
RUN AGAIN(Y OR N) Y
READY 10-17
DIALING JANE 555-0226? R
DIALING JOE 555-9328? H
DIALING JOHN 555-1293? H
DIALING SALLY 555-3092? H
DIALING JIM 555-8876? H
DIALING JOAN 555-2783? H
DIALING DORIS 555-5638? H
DIALING BILL 555-9951? H
RUN AGAIN(Y OR N) Y
READY 19
DIALING COMPUTER 555-4900ACCESS PAUSE - USE C,H OR R OPTIONS.C
554-1200? T
G
  ELAPSED TIME : 20 MINUTES AND 33 SECONDS
RUN AGAIN(Y OR N) N
OK
```

length of their identification in the directory. This number can be increased by removing the REMARK statements and using multiple statement lines. Further, if the memory is expanded to 8K, another 200-300 numbers can be added.

Although the program is commented, it's use is best demonstrated by an example. Table 2 shows a sample run. The memory size of 3866 is for a 4K system. The dummy call, SAVE X at the start of the program (with the tape recorder off) is necessary to overcome the fact that when first entering BASIC the system RAM is still write protected, preventing a tape load to operate properly. The machine language routines were saved as file number \$4D, allowing it to be read in by BASIC as file "M". This is always done *before* loading the BASIC saved dialer program file "D", since a LOAD command causes BASIC to do a NEW, which wipes out any current BASIC program.

When the program is started by the RUN statement, it prints the full directory list and complete instructions. After one complete set of operations, the program cycles as long as desired without reprinting the directory or instructions. More numbers can be added to the program if the code for these printings is eliminated.

The first run is that of dialing a single number, "LAWYER". On the first two tries at dialing, the number is busy, and an "R" is entered for a redial. On the third try, the call goes through, and when the conversation is over, an "H" is entered to terminate the connection. The program then cycles for another run.

The second run illustrates the use of the timer and dialing two non-consecutive numbers, "PARENTS" and "BROTHER". Since both numbers are long distance calls, a "T" is entered after each call goes through. This starts the elapsed timer, and the elapsed time is continuously displayed on the LED display. When the call is over, any key is pressed (This is illustrated by using a "Y" the first time and then a "P".) Then the program does a hang up and dials the next number.

The third run demonstrates dialing consecutive numbers. In this example, items 10 through 17 ("JANE"

through "BILL") are called, one after another, until some action has been taken on all of the numbers. Any number of redials ("R" option) could have been done during this sequence.

The last example shows the dialing of a single number containing an access pause, "COMPUTER". The timer is also used to keep track of connect time to the computer. Again, any number of redials could be used anywhere until the connection is completed.

### The "Legal" Connection

There are two approaches to connecting the interface to the telephone without fear of a hassle from the telephone company. The first, although inelegant, is quite effective. If the voltage-variable resistor is removed and the relay is replaced by a solenoid, numbers may be dialed by pulsing the cradle switch directly as in the experiment earlier in the article. There are several problems with this approach, however. First, the solenoid has to be mounted on the telephone with a rather close tolerance so that at one end of its travel the cradle switch is fully closed and at the other end of its travel, the cradle switch is fully open. This limits its use by having to be mounted permanently on the telephone, thereby limiting the telephone's use or else a very accurate, repeatable mounting device must be constructed and set up every time the dialer interface is to be used. Lastly, since the cradle switch is designed only to be used to initiate, answer or terminate a call, it may take quite a beating by repeatedly dialing numbers in this manner. For many applications, however, this may indeed be the best approach in spite of its drawbacks. There is certainly nothing wrong with such a "brute force" approach so long as it totally fulfills the needs of the user.

The second approach is slightly more complicated and definitely much more expensive than the basic interface, but produces some very useful "spin-offs". This is done by using an FCC approved data coupler, also commonly called a Data Access Arrangement (DAA). There are three basic types of these devices. The first, a CDT data coupler, is not suitable for this application since it has control over the voice (or data) mode of a telephone. The other types CBS and CBT have control over all functions of the telephone lines, including dialing and answering.

The DAA serves many functions because it is designed to be an interface between a direct connect modem and the telephone line. Not only does it connect a terminal/modem device to the telephone lines by an isolation transformer, but it has to have circuitry for limiting the signal level going over the telephone lines, thereby limiting the bandwidth of the signal and assuring proper impedance to the lines. In addition, there are relays and circuitry for ring detection, switch hook control and other line functions. These additional functions are there for sophisticated terminal equipment which have, among other things (you guessed it) the capability of auto dialing. The price of a CBT type data coupler is about \$125-\$200, depending on the source, and these are sold mostly by companies that also sell modems. In some areas, they can be rented from the telephone company for about \$5 to \$7 per month. Used CBTs when available, sell for about \$80-\$125.

At this point, one immediately says, "Wait a minute! Even if I can get a used CBT, I'm approaching the cost of an off-the-shelf auto-dialer. What am I gaining here?" Obviously, one still has a much more versatile system than these dialers. But here

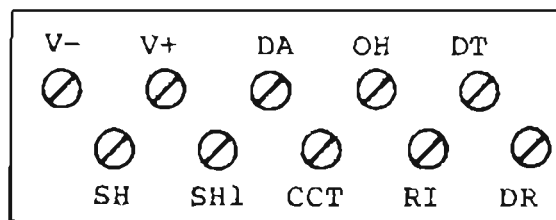

Figure 2: CBT Interface Connections

is where some "spin-off" occurs. Ever since the recent FCC part 68 ruling which allows, among other things, for modem manufacturers to produce FCC approved equipment without having to go through a separate DAA, high quality used modems are coming onto the market at real bargain prices. Also, there are available numerous single board modems which plug directly into S-100 and other bus systems and terminal equipment. What all but a few advertisers of both of these equipment fail to mention is that to legally install them (unless the device is FCC approved), one must have an FCC approved DAA! Therefore, if the purchase of a data communication system is being contemplated, consider this. With judicious shopping for a used high quality direct connect modem, a DAA and using the SYM dialer as a controller, one can come up with a sophisticated data communications system capable of auto dialing, auto answer, auto originate and a few other bells and whistles. Such a system could cost up to \$2000, but by going this route, it can be obtained at a fraction of this cost.

Now to the actual interfacing itself. Either a CBS or CBT type coupler could be used, but the better choice here is the CBT. The CBS is more expensive and uses RS-232 signal levels for control which would add components and complexity to the interface. The CBT uses a switch closure concept for its operation.

Figure 2 shows the user end connections to the CBT. For the purpose of dialing, the only ones of interest here are the V- and OH (Off Hook) connections. When V- and OH are connected this causes the line leads to become active (as is taking the receiver Off Hook), and the CBT takes over control of the line. Therefore, a number can be dialed by pulsing a connection between these two leads. This may be accomplished with the contacts of the relays in Figure 2 connected between the V- and OH connections. Notice what has happened by this revision of the circuit—essentially nothing! The combination of the relay and CBT have exactly the same net effect as the original configuration connected directly to the line. Therefore, the same driving

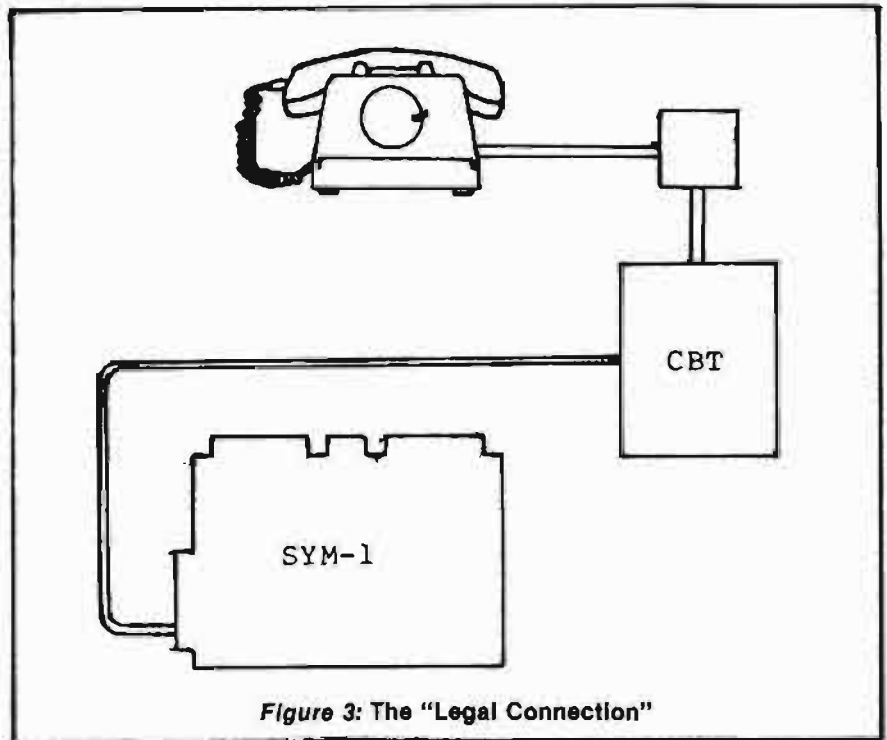

Figure 3: The "Legal Connection"

software can be used, with one exception. In using the basic interface, it has been assumed that the initial off hook condition is done manually after the directory and instructions have been printed out. This is not the case for the CBT, since the initialization call at BASIC program line number 160 now causes an off hook condition, and capture of the telephone line by the DAA. In the ensuing time used for the printing, some telephone's systems may "time out" and issue a whining sound to indicate that the central office has deactivated the telephone line. The telephone must be placed back on hook before normal operation can be continued. Therefore, BASIC line 160 should be changed to line 525 to avoid this potential problem.

The CBT has a modular plug which merely plugs into the wall. In order to plug the telephone and the CBT into the same wall jack a device called a duplex adapter may be used. This is a small device which plugs into a modular jack and allows two plugs to go into it. This type of device can be found in most stores that sell telephone accessories. Its primary use is to allow connection of a telephone to the same jack as an answering machine, hands-off amplifier and

would you believe some types of auto dialers? It should be noted at this time that some DAA's come with a special plug intended for use with a data jack. This is an eight pin modular plug instead of the usual six pin voice plug.

In this case a special adaptor to go from the eight pin to six pin plug must be used. Figure 3 shows a pictorial hookup of the "Legal" Connection.

The above discussion on CBT type data couplers, is at best, cursory. A full discussion on DAA's is enough for quite a lengthy article in itself. Enough information has been presented in order to pulse dial a telephone using this device. Although all data couplers must be, by virtue of FCC standards, functionally equivalent; there are some differences between manufacturers as to how these functions are accomplished internally. Therefore, the user's manual for the particular data coupler to be used should be read thoroughly before working on this interface.

#### System Checkout

Before actually using the interface and driving programs, they should be thoroughly checked out. You

don't really want to have to pay for a phone call to Pago-Pago, do you? A good way to do this is to use an LED and series resistor instead of the relay. At lines 119 and 125 of the machine language routines, change the constant "01" to "0A". This will result in a 1 Hz rate of dialing instead of 10 Hz. The individual pulses can then be easily counted and the operation of the interface can be monitored. Then, when everything is working properly, connect the relay.

### Other Applications

There are many changes which could be made to the presented BASIC program to alter or enhance its dialing capability. For instance, instead of entering a directory number, the program could be changed to accept a directory name. Another possibility is to store a table of basic telephone rates for each number, and by use of the timer, the cost of any call could be automatically computed and printed out. Also, dialing a number not in the directory by keying in the number would still be faster for the user than using the telephone's dialer. For the aid of sightless persons, how about a voice interface to trigger dialing? As you can see, the variations are limited only by the imagination.

Randy Sebra received his BS degree in Physics from Virginia Polytechnic Institute and State University in 1966, and currently works as an operations research analyst for the United States Army. Performing his duties in the analysis of weapons systems, he relies quite heavily on the use of computers.

He tells us, "Experimenting with my SYM-1 at home is not quite the 'busman's holiday' that it may appear at first. In my work I am not able to get into too much hardware, being restricted mostly to digital simulation and mathematical modeling. My SYM-1 gives me the opportunity to get my hands 'dirty' with hardware and interfacing."

### Listing 1

```

1: Machine language routines used with
2: SYM-1 Telephone Dialer. Written by
3: Randy Sebra , APRIL, 1980.
4:
5: OUTBYT EQU $B2FA Monitor, output HEX byte
6: SCAND EQU $B906 Monitor, scan LED display
7: OUTCHR EQU $BA47 Monitor, output ASCII character
8: ACCESS EQU $BB86 Monitor, un-write protect RAM
9: PDBA EQU $A402 Output Register B, system 6532
10: OUTVEC EQU $A664 Output Vector
11: IRQVEC EQU $A67E IRQ Vector
12: ORB EQU $AC00 Output Register B
13: T1LL2 EQU $AC04 Timer 1 Low Counter(read)
14: T1LH EQU $AC05 Timer 1 High Counter(write)
15: T1LL EQU $AC06 Timer 1 Low Latch
16: T2LL EQU $AC08 Timer 2 Low Latch
17: T2CH EQU $AC09 Timer 2 High Counter
18: ACR EQU $AC0B Aux. Control Register
19: IFR EQU $AC0D Interrupt Flag Register
20: IER EQU $AC0E Interrupt Enable Register
21:
22: ORG $0F1A Start of Routines
23:
24: Driving Routine for timer
25:
26:0F1A- 20 86 8B TIMER JSR ACCESS Un-write protect system RAM
27:0F1D- A9 6F LDA $6F Change IRQVEC Vector to
28:0F1F- BD 7E A6 STA IRQVEC interrupt routine at
29:0F22- A9 0F LDA $0F $0F6F
30:0F24- 8D 7F A6 STA IRQVEC+1
31:0F27- A9 EC LDA $EC Load loop counter
32:0F29- 85 F0 STA COUNT
33:0F2B- A9 00 LDA $00 Initialize minutes and
34:0F2D- 85 F1 STA SEC seconds count
35:0F2F- 85 F2 STA MIN
36:0F31- A9 40 LDA $40 Set ACR for timer 1
37:0F33- 8D 0B AC STA ACR free running mode
38:0F36- A9 C0 LDA $C0 Enable interrupt
39:0F38- 8D 0E AC STA IER
40:0F3B- A9 4F LDA $4F Set up timer 1 for
41:0F3D- 8D 06 AC STA T1LL a .05 sec delay
42:0F40- A9 C3 LDA $C3 and start timer
43:0F42- 8D 05 AC STA T1LH
44:0F45- A9 00 LDA $00 Change OUTVEC so
45:0F47- 8D 64 A6 STA OUTVEC that the output goes
46:0F4A- A9 89 LDA $89 to the LED display.
47:0F4C- 8D 65 A6 STA OUTVEC+1
48:0F4F- 20 93 0F JSR DISPLAY Initialize display
49:0F52- 20 06 89 SCAN JSR SCAND Scan the display
50:0F55- AD 02 A4 LDA PDBA Check for terminal key down
51:0F58- 10 F8 BPL SCAN Scan until detected
52:0F5A- A9 40 LDA $40 Disable interrupt
53:0F5C- 8D 0E AC STA IER
54:0F5F- A9 A0 LDA $A0 Change OUTVEC back to
55:0F61- 8D 64 A6 STA OUTVEC terminal
56:0F64- A9 8A LDA $8A
57:0F66- 8D 65 A6 STA OUTVEC+1
58:0F69- 4C B6 0F JMP HANG Do a hang up
59:0F6C- 4C 4C 01 JMP D14C Return to BASIC
60:
61: Interrupt Routine - updates elapsed time
62:
63:0F6F- 48 UPDATE PHA Save accumulator on stack
64:0F70- 18 CLC Clear carry for add
65:0F71- E6 F0 INC COUNT Increment loop counter
66:0F73- D0 19 BNE OUT2 If a second not up, skip
67:0F75- F8 SED Else set decimal mode
68:0F76- A9 EC LDA $EC
69:0F78- 85 F0 STA COUNT Re-set loop counter
70:0F7A- A5 F1 LDA SEC Increment seconds count
71:0F7C- 69 01 ADC $01
72:0F7E- 85 F1 STA SEC and re-store
73:0F80- C9 60 CMP $60 A minute up ?
74:0F82- D0 06 BNE OUT1 If not, skip
75:0F84- A9 00 LDA $00 Else, re-set seconds

```



76:0F86-	05 F1		STA	SEC	count and increment
77:0F88-	E6 F2		INC	MIN	minutes count
78:0F8A-	D8	OUT1	CLD		Clear decimal mode
79:0F8B-	20 93 0F		JSR	DSPLAY	Display elapsed time
80:0F8E-	AD 04 AC	OUT2	LDA	T1LL2	Clear interrupt flag
81:0F91-	68		PLA		Restore accumulator
82:0F92-	40		RTI		Return from interrupt
83:					
84:		Display Routine			
85:					
86:0F93-	A9 20	DSPLAY	LDA	\$20	Write out a space
87:0F95-	20 47 8A		JSR	OUTCHR	
88:0F98-	A5 F2		LDA	MIN	Write out minutes
89:0F9A-	20 FA 82		JSR	OUTBYT	
90:0F9D-	A9 20		LDA	\$20	Write out a space
91:0F9F-	20 47 8A		JSR	OUTCHR	
92:0FA2-	A5 F1		LDA	SEC	Write out seconds
93:0FA4-	20 FA 82		JSR	OUTBYT	
94:0FA7-	60		RTS		
95:					
96:		Initialization Routine			
97:					
98:0FAB-	20 86 8B	INIT	JSR	ACCESS	Un-write protect RAM
99:0FAB-	A9 80		LDA	\$80	Configure PB7 as
100:0FAD-	8D 02 AC		STA	DDR8	an output port
101:0FB0-	A9 00	PBOFF	LDA	\$00	and turn it off
102:0FB2-	8D 00 AC		STA	ORB	
103:0FB5-	60		RTS		
104:					
105:		Hang up Routine			
106:					
107:0FB6-	A9 80	HANG	LDA	\$80	Turn PB7 on
108:0FB8-	8D 00 AC		STA	ORB	
109:0FB8-	20 E4 0F		JSR	DPAUSE	Do a 800 msec delay
110:0FBE-	4C B0 0F		JMP	PBOFF	Turn off PB7
111:					
112:		Dialing Routine - Enter with the number			
113:		of pulses to be dialed in accumulator.			
114:					
115:0FC1-	AA	DIAL	TAX		Transfer # of pulses to Xr
116:0FC2-	48		PHA		and save on stack
117:0FC3-	A9 80		LDA	\$80	Turn PB7
118:0FC5-	8D 00 AC		STA	ORB	on
119:0FC8-	A2 01		LDX	\$01	# of times through DELAY=1
120:0FCA-	A0 BD		LDY	\$ED	Set up timer 2 for a
121:0FCC-	98		TYA		.061 sec delay
122:0FCD-	20 EE 0F		JSR	DELAY	Do the delay
123:0FD0-	A9 00		LDA	\$00	Turn PB7
124:0FD2-	8D 00 AC		STA	ORB	off
125:0FD5-	A2 01		LDX	\$01	# of times through DELAY=1
126:0FD7-	A0 86		LDY	\$86	Set up timer 2 for a
127:0FD9-	A9 9E		LDA	\$9E	.039 sec delay
128:0FDB-	20 EE 0F		JSR	DELAY	Do the delay
129:0FDE-	68		PLA		Restore the # of
130:0PDF-	AA		TAX		pulses counter and
131:0FE0-	CA		DEX		decrement it
132:0FE1-	8A		TXA		Transfer counter back to Ar
133:0FE2-	D0 DE		BNE	DIAL+1	Loop for proper # of pulses
134:0FE4-	A2 10	DPAUSE	LDX	\$10	# of times through DELAY=16
135:0FE6-	A0 C3		LDY	\$C3	Set up timer 2 for a .05
136:0FE8-	A9 4F		LDA	\$4F	sec delay, total= .8 sec
137:0FEA-	20 EE 0F		JSR	DELAY	Do the delay
138:0FED-	60		RTS		Return
139:					
140:		General Delay Routine - Enter with number			
141:		of times through in the X register, low			
142:		and high bytes for timer in A,Y register pair.			
143:					
144:0FEE-	8D 08 AC	DELAY	STA	T2LL	Write to low order latch
145:0FF1-	98		TYA		
146:0FF2-	8D 09 AC		STA	T2CH	Write to high order counter
147:0FF5-	AD 0D AC	CHECK	LDA	IFR	Check interrupt flag
148:0FF8-	29 20		AND	\$20	register for time-out
149:0FFA-	F0 F9		BEQ	CHECK	If not, loop until it has
150:0FFC-	CA		DEX		Decrement times through count
151:0FFD-	D0 F2		BNE	DELAY+3	Loop until through
152:0FFF-	60		RTS		

## Classified Ads

### Be Your Own Astrologer.

Impress your friends. Two BASIC programs for PET (8K or more). ASCALC calculates six attributes including Rising Sign. Over one-half million combinations. DAY/HOUR calculates planetary hours, etc. 43 page book gives interpretations. NO. AST-T2-001 \$15.95. CA res. add 6 %.

ACCESS

P.O.Box 8726

Rowland Heights, CA 91748

### PET Machine Language Guide

Comprehensive manual to aid machine language programmer. More than 30 routines fully detailed. Reader can put to immediate use. OLD or NEW ROMS. \$6.95 plus .75. VISA and Mastercharge accepted.

ABACUS SOFTWARE

P.O.Box 7211

Grand Rapids, MI 49510

### SYM-1 Books by Robert Peck

Monitor Theory Manual \$8.00. Hardware Theory Manual \$6.00. SYM/KIM Appendix to First Book of KIM \$4.25. Send SASE for details.

Datapath

P.O. Box 2231

Sunnyvale, CA 94087

### Integer Pascal System

for the APPLE II. Compiler, interpreter and translator included for \$65.00. Produces 6502 code programs for high speed. 48K and Disk required. Send for free information.

M & M Software

380 N. Armando Z-18

Anaheim, CA 92806

### APPLE Graphic Aid Sheets

LO RES 8.5" x 11" 50 sheets \$2.00. HI RES 22" x 17" 20 sheets \$6.00. Please add \$1.00 shipping.

Boardwalk Products

225 South Western Avenue/M

Los Angeles, CA 90004

### OSI OS 85-D Utility Diskette

Renumber, disassembler, Memory Dump, improved CREATE, single disk Copy, disk Verify, etc. Diskette and manual \$30.00. TX add 5 percent. Catalog free with SASE.

GASlight Software

3820 Byron

Houston, TX 77005

### SYM-1 EXPANSIONS

ROM - Put two 4K ROMS in the U23 socket with the W7AAY RAE-1/2 Board. \$16.00 each, fully assembled, postpaid in USA. RAM - Have up to 8K "on board" with the W7AAY 4K piggyback 2114 RAM board. Bare boards are \$8.00 plus a \$.15 SASE each. Payment must accompany order. Complete instructions are included.

John Blalock

P.O. Box 39356

Phoenix, AZ 85069

## Listing 2

```

100 REM      ** TELEPHONE DIALER
110 REM      ** RANDY SEBRA
120 REM      ** APRIL, 1980
130 REM
140 REM      ** INITIALIZE INTERFACE
150 REM
160 Z=USR(&"0FAB",0)
170 DIM N$(19),T$(19)
180 DATA POLICE,FIRE,DOCTOR,LAWYER,SCHOOL,PARENTS,WORK
190 DATA WIFE'S WORK,NEIGHBOR,BROTHER,JANE,JOE,JOHN,SALLY,JIM
200 DATA JOAN,DORIS,BILL,HOME,COMPUTER
210 DATA 555-0000,555-3333,555-5894,555-3958,555-5683,1-804-559-6741
220 DATA 1-557-9338,1-557-4736,1-557-9939,1-703-556-0924,555-0226
230 DATA 555-9328,555-1293,555-3092,555-8876,555-2783,555-5638,555-9951
240 DATA 9,555-4702,555-4900,554-1200
250 REM
260 REM      ** READ AND PRINT OUT DIRECTORY
270 REM
280 FOR I=0 TO 19 STEP 2
290 READ N$(I),N$(I+1)
300 PRINT I;TAB(5);N$(I);TAB(20);I+1;TAB(25);N$(I+1)
310 NEXT I
320 REM      ** READ NUMBERS
330 FOR I=0 TO 19
340 READ T$(I)
350 NEXT I
360 PRINT
370 REM
380 REM      ** PRINT INSTRUCTIONS
390 REM
400 PRINT "FIRST PICK UP RECEIVER AND WAIT FOR DIAL TONE."
410 PRINT "ENTER THE DIRECTORY NUMBER(S) YOU WISH TO DIAL. YOU MAY"
420 PRINT "ENTER A SINGLE NUMBER, A SEQUENCE OF NON-CONSECUTIVE"
430 PRINT "NUMBERS SEPARATED BY SEMI-COLONS, OR A RANGE OF"
440 PRINT "NUMBERS SEPARATED BY A DASH."
450 PRINT
460 PRINT "ANY TIME YOU WISH TO HANG UP, ENTER AN H. TO RE-DIAL THE"
470 PRINT "PREVIOUS NUMBER, ENTER AN R(HANG UP NOT NECESSARY). TO"
480 PRINT "CONTINUE AFTER AN ACCESS PAUSE, ENTER C(OR H OR R IF THE"
490 PRINT "LINE IS BUSY). TO USE TIMER, ENTER A T AFTER THE"
500 PRINT "CALL IS ANSWERED. WHEN THE CONVERSATION IS OVER,"
510 PRINT "PRESS ANY KEY TO STOP TIMER AND HANG UP."
520 PRINT
530 INPUT "READY ";Z$
540 S=VAL(Z$)
550 B$=STR$(S)
560 L1=LEN(Z$)
570 L2=LEN(B$)-1
580 GOSUB 740
590 REM      ** SINGLE NUMBER
600 IF L1=L2 THEN 700
610 IF MID$(Z$,L2+1,1)<>" " THEN 650
620 REM      ** NON-CONSECUTIVE SEQUENCE
630 Z$=MID$(Z$,L2+2)
640 GOTO 540
650 IF MID$(Z$,L2+1,1)<>"-" THEN STOP
660 REM      ** CONSECUTIVE SEQUENCE
670 S=S+1
680 GOSUB 740
690 IF S<VAL(MID$(Z$,L2+2)) THEN 670
700 INPUT "RUN AGAIN(Y OR N) ";Z$
710 IF Z$="Y" THEN 530
720 END
730 REM      ** DIALING ROUTINE
740 PRINT "DIALING ";N$(S); " ";
750 FOR I=1 TO LEN(T$(S))
760 A$=MID$(T$(S),I,1)
770 IF A$="-" THEN 850
780 IF A$="0" THEN A$="10"
790 IF A$<>"." THEN 830
800 INPUT "ACCESS PAUSE - USE C,H OR R OPTIONS.";Y$
810 IF Y$<>"C" THEN 950
820 GOTO 860
830 A%=VAL(A$)*256
840 D=USR(&"0FC1",A%)
850 PRINT RIGHT$(A$,1);
860 NEXT I
870 INPUT Y$
880 IF Y$<>"T" THEN 950
890 T=USR(&"0F1A",0)
900 S1=PEEK(241)-INT(PEEK(241)/16)*6
910 M1=PEEK(242)-INT(PEEK(242)/16)*6
920 PRINT
930 PRINT "ELAPSED TIME :";M1;"MINUTES AND";S1;"SECONDS"
940 RETURN
950 IF Y$<>"H" THEN 980
960 H=USR(&"0FB6",0)
970 RETURN
980 IF Y$<>"R" THEN STOP
990 R=USR(&"0FB6",0)
1000 GOTO 740
1010 RETURN

```

## Classified Ads

### Test Your Skills

with these 4 fast-paced GRAPHIC GAMES for PET (8K or more): Demolition - race a car around various tracks, Bounce - guide a bouncing ball and knock out targets, Star Fire - blast the winking stars but watch out for the roving sun, and Space War - blast the Volar Ship before it can destroy you. NO. GAM-T4-001 \$9.95. CA res. add 6%.

### ACCESS

P.O.Box 8726  
Rowland Heights, CA 91748

### AIM/KIM/SYM (Programmable)

RS-232 Interface. Fully programmable including BAUD rates! Serial echo mode parity generation & Detection Programmable interrupt parity, framing and overrun detection. Expansion connector provided. Chip select is jumper selectable. Software driver listing included. \$84.95 assembled, \$69.95 KIT.

Fobel Enterprises  
Dept. M

552 E. El Morado  
Ontario, CA 91764

### EMPIRE OF THE STARS

A super, great new strategy game from Infinity Software (a great company) and is available from Horizon Computing (another great company)! Can you, beginning with a single world and a small spacefleet, build an empire spanning the galaxy? Find out for just \$9.95.

Horizon Computing  
P.O. Box 479  
Mendham, N.J. 07945

## Compare Our Prices With Any Others

Rockwell's	AIM-65	1K System:	\$405.	4K System	\$459.
Synertek's	SYM-1	1K System:	235.	4K System	259.
Commodore's	KIM-1	1K System:	175.		

### FOR YOUR SYSTEM'S EXPANSION

*The Computerist, Inc's:*

16K DRAM	\$279.	Proto Plus II	\$42.
32K DRAM	375.	ASK I/O Board	55.
Video Plus II	279.	DRAM & Video Cable	15.
Mother Plus II & Card Cage	115.	Power Supply for SYM-1	39.
		Power Supply and Enclosure for AIM-65	\$119.
		Power Supply and Enclosure for KIM-1	65.

**All products are factory warrantied. Prices include full documentation.**

Send Check or Money Order to:

**Hepburn MCA\***  
12 Grosvenor Street  
Lowell, MA 01851

Please add \$5.00 shipping and handling. MA residents add 5% sales tax.

\* Mini Computers and Accessories

### WANT YOUR COMPUTER BACK?

Let the MICROsport Microcomputer (MMC) take over any dedicated task.

It is the affordable alternative (kits from \$89.00), application units, A & T, from only \$119.00).

It is user-oriented — complete in-circuit emulation allows program development on ANY 6502 based system. It is compact (4½" by 6½" pc board) but powerful (32 I/O 6503 CPU) and works off any AC or DC power supply.

Turn your present 6502 based system into a complete development system with:

- 1 MMC/03D Microcomputer with ZIF sockets
- 1 MMC/03ICE In-circuit emulator for the 6503 CPU
- 1 MMC/03EPA EPROM Programmer complete with software driver.

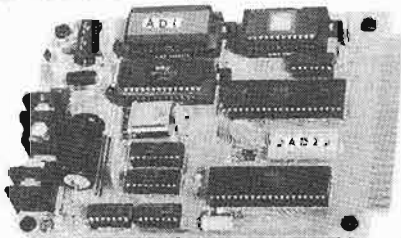

All for only \$250.00! (Offer good until December 1980.)

For more info call or write

**R. J. BRACHMAN ASSOCIATES, INC.**  
P.O. Box 1077  
Havertown, PA 19083  
(215) 622-5495

PET and APPLE II Users

### PASCAL

ABACUS Software makes available its version of TINY PASCAL for the users of two of the most popular personal computers.

TINY PASCAL is a subset of the standard PASCAL as defined by Jensen and Wirth. It includes the structured programming features: IF-THEN-ELSE, REPEAT-UNTIL, FOR TO/DOWN TO-DO, WHILE-DO, CASE-OF-ELSE, FUNC and PROC. Now you can learn the language that is slated to become the successor to BASIC.

TINY PASCAL is a complete package that allows you to create, compile and execute programs written in the PASCAL language. You can save source and object code on diskette or cassette (PET version only). Comprehensive user's manual included. The manual can be examined for \$10 (refundable with software order).

#### REQUIREMENTS

PET 16K/32K New ROMS cassette	\$40
PET 16K/32K New ROMS diskette	\$35
Apple II 32K Applesoft ROM w/DOS	\$35
Apple II 48K Applesoft RAM w/DOS	\$35
TINY PASCAL User's Manual	\$10
6502 Interpreter Listing	\$20



FREE postage in U.S. and CANADA  
All orders prepaid or COD

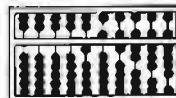

**ABACUS SOFTWARE**

P. O. Box 7211  
Grand Rapids, Michigan 49510

# FREE DISKPAK

## WHEN YOU JOIN THE PREMIER APPLE USER GROUP!

### Apple Pugetsound Program Library Exchange

With 4,000 members, it's the pioneer Apple computer user group. Its proven benefits for novices and experts include:

#### Nine Issues of Call-A.P.P.L.E.

The nation's leading Apple journal soon to enter its fourth year of publication. Each issue is chock full of utility programs, material for the novice, current Apple news, application notes, technical and instructional data.

### Access to Call-A.P.P.L.E. Hot Line

Answers to your technical questions, plus programming hints and general information.

### Special Reduced Prices Through Our Program Library

Exclusive, sophisticated software at very substantial reductions. Special sale items in each issue of

#### Call-A.P.P.L.E. Plus

low club prices for such well known programs as Apmail][, Program Line

Editor, Higher Text, Integer Basic + Plus Ted][ + (Editor/Assembler), Program Global Editor, DOS 3.2 and 3.3 Disk Edit Utilities, and Bargain Priced Library Pak Diskettes.

### Plus Your Choice of a Free Diskpak

All checks for membership postmarked by December 31, 1980 will receive a coupon good for a **free** diskpak: Choose from Diskpaks 5, 12 or 34 or Anthology Volumes I, II or III.

#### I can't wait to get my free Diskpak!

Enclosed is my check for \$40 to cover \$25 Apple-cation fee and first year dues. Send me my coupon, and I'll pick a free diskpak.

#### I'm interested enough to try a test run.

Enclosed is my check for \$3. Please send me the current issue of **Call-A.P.P.L.E.** and an Apple-cation blank. I understand that if I join, the \$3 is credited toward my Apple-cation fee.

#### At least I'm curious.

Send me an Apple-cation blank and more information.

Name \_\_\_\_\_

Address \_\_\_\_\_

City \_\_\_\_\_ State \_\_\_\_\_ Zip \_\_\_\_\_

Phone \_\_\_\_\_

Signature \_\_\_\_\_

Send coupon to Dr. Fred Merchant,  
Secretary, A.P.P.L.E. 304 Main  
Avenue South, Suite 300M,  
Renton, WA 98055. Or call  
(206) 271-4514 for further  
information.

# PET Vet

by Loren Wright  
PET Specialist  
MICRO Staff

On September 22 I took the Amtrak "Night Owl" to Washington, D.C., and I returned on the "Night Owl" the night of the 24th. While there, I attended the Federal Computer Conference at the Sheraton Washington. This conference is aimed at the many government agencies that have occasion to use computers in their work. All of the "biggies" had displays there, but Commodore was the only 6502 microcomputer manufacturer to have a booth. CBM's and PET's were busy demonstrating different business software packages.

On the second day, I had a long talk with Commodore's new Manager of Public Relations, G. Thomas Sheffer. Within the next few months he plans to mail a questionnaire to all PET Users' Club members in order to help determine the future direction and content of the Commodore *Newsletter*. The Users' Club and its *Newsletter*, now the responsibility of Public Relations, should be a reliable source of information for PET owners (Subscription - \$15; 10 back issues - \$15).

Editor, Commodore Newsletter  
Public Relations Department  
Commodore Business Machines  
950 Rittenhouse Road  
Norristown, PA 19403

*The Transactor*, from Commodore in Canada, has long been a valuable information source. Subscriptions start with the beginning of a volume only. The current volume is II, but is nearly completed. Volume I and II are each \$15.

Editor, The Transactor  
Commodore Systems  
3370 Pharmacy Avenue  
Agincourt, Ontario, Canada

## Commodore Product Summary

Commodore sells a wide line of computer products, but even PET owners may be a little confused by all the different model numbers. Starting this month with the computers themselves, I will try to explain the differences. Next month I will cover the peripherals. The new CBM 4040 dual-floppy drive was exhibited at the Federal Computer Conference and will be generally available in late November.

When owners of the other home computers think of the PET, they think of what is now called the PET 2001-8KS. Although this has been out of production since January, many MICRO readers have them, and are very happy with them. These have a small (calculator style) keyboard, an integral cassette recorder, and 2.0 BASIC. The keyboard was difficult for most people to use, and tended to develop reliability problems. I didn't object to the close spacing of the keys, since I have skinny fingers, but I was occasionally frustrated by keys that wouldn't register or ones that "bounced." These are still available, both new and used, at very reasonable prices. Upgrade BASIC ROM kits and full-size expansion keyboards can be obtained.

Commodore currently makes three lines of computers: the PET 2001 series, the CBM 2001 series, and the CBM 8000

series. Both 2001 series contain the 3.0 BASIC, and the 8000's contain 4.0 BASIC.

The principal difference between the PET 2001 and CBM 2001 lines is in the keyboards. PET keyboards are called *graphics* keyboards because, in addition to letters and numbers printed on the key tops, graphics characters are printed on the key fronts. The number keys are in a separate keypad to the right, along with cursor movement keys and the period. Characters used frequently in entering a BASIC program, such as ? \$ % and #, can be typed without shifting. Capital letters and numbers are entered without shifting. When the shift key is pressed, all the graphics characters are available.

PET's and CBM's have two character sets, of which only one can be displayed at any given time. One includes all the graphics characters. The other substitutes lower case letters for those graphics appearing on the letter keys. This means that in order to get lower case letters in this character set, the shift key must be pressed for each—the reverse of normal typewriter operation. When PET's are powered up they are in the graphics character set, and to switch to lower-case character set, the statement "POKE 59468,14" must be executed.

Current production PET models are listed with model numbers and list prices. The N suffix indicates the *graphics* keyboard. 8, 16, and 32 indicate the number of kilobytes of RAM included.

PET 2001- 8N	\$ 795
PET 2001-16N	\$ 995
PET 2001-32N	\$1295

Models in the CBM-2001 line have the *business* keyboard. This is very similar to a standard typewriter keyboard. When powered-up, all letters are lower case, and their shifts are upper case. Numbers appear in their standard positions above the letters, as well as in the separate numeric keypad. Characters such as ! # \$ % and ;, must be shifted, but the period is in its normal position below the L. "POKE 59468, 12" must be executed in order to utilize the graphics character set, and the characters must be looked up in a table, since they don't appear on the keys. This character set configuration and keyboard layout are particularly well suited to word processing and other business applications.

CBM 2001-16B	\$ 995	16K RAM
CBM 2001-32B	\$1295	32K RAM

The CBM 8000 series computers have several differences. 4.0 BASIC differs from 3.0 BASIC primarily in the addition of several disk commands, which make communication with DOS 2.1 a lot easier. The screen is 80 characters wide, and physically larger as well. The keyboard is a business-style keyboard, but with several keys added and others relocated. The advantages of the 8000 series machines for business applications such as ledger and word-processing, should not be overlooked.

CBM 8016	\$1495	16K RAM
CBM 8032	\$1795	32K RAM

**Speed up your PET programming with The BASIC Programmer's Toolkit,™ now only \$39.95.**

Don't waste valuable programming time if there's an easier way to go. Here it is: The BASIC Programmer's Toolkit, created by Palo Alto ICs, a division of Nestar. The Toolkit is a set of super programming aids designed to enhance the writing, debugging and enhancing of BASIC programs for your PET.

The BASIC Programmer's Toolkit has two kilobytes of ROM firmware on a single chip.

This extra ROM store lets you avoid loading tapes or giving up valuable RAM storage. It plugs into a socket inside your PET system, or is mounted on a circuit board attached on the side of your PET, depending on which model you own.

There are basically two versions of PET. To determine which Toolkit you need, just turn on your PET. If you see **\*\*\*COMMODORE BASIC\*\*\*** your PET uses the TK-80P Toolkit. If you see **###COMMODORE BASIC###**, your PET uses the TK-160 Toolkit. Other versions of the BASIC Programmer's Toolkit are available for PET systems that have been upgraded with additional memory.

**How Toolkit makes your programming easier:**

**FIND** locates and displays the BASIC program lines that contain a specified string, variable or keyword. If you were to type **FIND A\$,100-500**, your PET's screen would display all lines between line numbers 100 and 500 that contain **A\$**.

**RENUMBER** rennumbers the entire program currently in your PET.

You can instantly change all line numbers and all references to those numbers. For instance, to start the line numbers with 500 instead of 100, just use **RENUMBER 500**.

**HELP** is used when your program stops due to an error. Type **HELP**, and the line on which the error occurs will be shown. The erroneous portion of the line will be indicated in reverse video on the screen.

These simple commands, and the other seven listed on the screen, take the drudgery out of program development work. And for a very low cost. The BASIC Programmer's Toolkit costs as little as \$39.95, or at most, \$59.95.

Get the BASIC Programmer's Toolkit and find out how quick and easy program development can be. See your local PET dealer or send this coupon in today.

# Increase your PET's IQ for \$39.95.

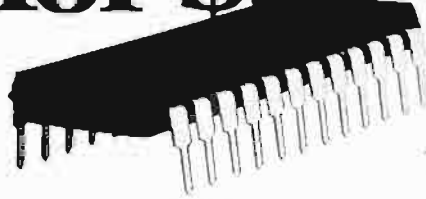

**PALO ALTO ICs**  
A Division of Nestar Systems, Incorporated

PET™ is a trademark of Commodore Business Machines, Inc. The BASIC Programmer's Toolkit™ is a trademark of Palo Alto ICs, a division of Nestar Systems, Inc.

The Toolkit is fully assembled. It is not a kit and requires no special tools to install.

I want to save programming time and money. Send me The BASIC Programmer's Toolkit that will give my PET 10 new and useful commands. Fill in the appropriate line below:

Qty. \_\_\_\_\_ TK-160 Toolkit(s) @ \$39.95 each

Qty. \_\_\_\_\_ TK-80P Toolkit(s) @ \$59.95 each

Want to charge it? Call (415) 493-TOOL, or fill out the form below.

Enclosed is a  money order  check

(If charging):  Bill VISA  Bill Master Card.

Charge Card \_\_\_\_\_ Exp. Date \_\_\_\_\_

Master Card Interbank Number \_\_\_\_\_

Signature \_\_\_\_\_

Please include the amount of the Toolkit, plus \$2.50 for shipping and handling. Please allow 4-6 weeks for delivery. **SATISFACTION GUARANTEED, OR SEND IT BACK WITHIN 10 DAYS OF RECEIPT AND PALO ALTO ICs WILL REFUND YOUR MONEY.**

SEND TO:

Name \_\_\_\_\_

Address \_\_\_\_\_

City \_\_\_\_\_ State \_\_\_\_\_ Zip \_\_\_\_\_

Phone \_\_\_\_\_

MAIL TO: Palo Alto ICs  
A Division of Nestar Systems, Inc.  
430 Sherman Avenue  
Palo Alto, CA 94306  
(415) 493-TOOL

Dealer inquiries invited.

# Self-modifying PET Programs

Use this simple tutorial to write a self-modifying program.

P. Kenneth Morse  
P.O. Box 3367  
Augusta, GA 30902

High-level languages, such as BASIC, typically make it difficult or impossible to modify the program itself as a result of the program's own operation. There is good reason for this, since such changes are usually difficult to detect and debug when they occur inadvertently. Nevertheless, there are times when we might wish to develop programs that do modify themselves. Since "old" 8K PET cassette data files are somewhat unreliable, due to bugs in the operating system, one reasonable application would be to generate (or delete) DATA statements under program control, thus capitalizing on the greater reliability of program tapes.

The methodology for accomplishing this was explained by Mike Louder in "The PET Has a Dynamic Keyboard" (*PET User Notes*, 1978, 1, issue 6, p. 11). The methodology capitalizes on the fact that when a program terminates execution with an END statement, location 525 (158 for "new" ROMs) is checked to see if any unexecuted instructions are in the keyboard buffer (locations 527—536 for old ROMs, 623—632 for new). If so, it executes them. Now, if we could LOAD the keyboard buffer before exiting the program, those instructions would be carried out after the program was over. And if the last instruction were to cause the program to re-start...well, we could then write programs that would modify themselves and continue to run! As it turns out, we can do just that! Here are four projects to help you learn the technique and its limits.

## Project 1

The variable PT may be a bit puzzling. Since location 50003 always has the value "0" with the "old" ROMs and "1" with the 'new' ROMs, we can use

```
PT = PEEK(50003)
```

to adjust addresses automatically, using the formula

```
(ADDRESS) = (OLD ADDRESS)  
+ PT*(adjustment factor)
```

Whenever PT = 0 (old ROMs), the adjustment vanishes, since zero times anything is zero.

```
10 GO TO 50  
20 READ N$  
30 PRINT "THE NAME IS ";N$  
40 STOP  
50 INPUT "YOUR NAME, PLEASE ";A$  
60 PRINT "cddd1000DATA ";A$  
70 PRINT "GOTO 20"; "h"  
80 J=1  
90 REM: LOAD KEYBOARD BUFFER WITH  
    'RETURNS'  
  
100 PT=PEEK (50003)  
110 POKE 525-PT*367,J+1  
120 FOR K=1 TO J + 1  
130 POKE 526 + K + PT*96, 13  
140 NEXT K  
150 END
```

Note: lower case letters in quotes stand for special PET keys:

```
"c" = clear screen  
"d" = cursor down  
"h" = home
```

1. RUN this program by entering the name "JOHN DOE". The results should be:

```
READY.  
1000DATA JOHN DOE  
GOTO 20  
THE NAME IS JOHN DOE
```

```
BREAK IN 40  
READY.
```

2. LIST this program (after RUNNING it), and you will find a new line:

```
1000 DATA JOHN DOE
```

3. Now, enter the immediate command

```
?N$
```

then

```
?A$
```

Note that A\$ has been lost! One complication with this technique is that the program re-initializes all variables when it re-starts by executing the on-screen command. Hence, A\$ is now equal to "". There are two ways to handle this problem: one is to record the value of the variable in a new (or altered) DATA statement, as was done above. The other way is shown in project 2.

## Project 2

Make the following changes:

```
1000 (deleting the DATA statement)  
10 QS=CHRS(34):GOTO 50  
20 REM  
60 PRINT "cdddN$=";QS:A$;QS
```

1. RUN: how does the result compare with Project 1?

2. LIST: note that no DATA statement is present. Yet, the PRINT statement in line 30 was able to recognize as N\$ the name originally entered as A\$.

There is one important point to watch. Several DATA statements may be generated with a single program exit, but only a single line (up to 40 characters) of direct command may be entered.

We are now beginning to identify some rules for self-modifying programs. Before exiting, the program should:

1. Clear the screen.

2. PRINT the BASIC lines to be incorporated into the program on the screen, beginning with the fourth line from the top. Each BASIC line may be up to 78 characters long, and should be single-spaced.

3. Following the BASIC lines, PRINT a single unnumbered line (no more than 40 characters) containing any variables that need to be saved to restore the program to the same point of operation. End the line with a GOTO statement returning control to the main program (not to a subroutine).

4. POKE the value of N (where N = number of BASIC lines + 1) into the keyboard index byte, and POKE the value "13" into each of N bytes in the keyboard buffer.

5. "Home" the cursor.

6. Exit from the program with an END statement.

### Project 3

How many BASIC lines can be created under program control with a single program exit? Make these changes in your program:

```
70 (delete)
80 (delete)
10 INPUT "VALUE OF J ";J
20 PRINT "cddd";
30 FOR I = 1 TO J
40 PRINT I*1000; "DATA ";I;I*I;SQR(I)
50 NEXT I
60 PRINT "LIST"
150 PRINT "b"
160 END
```

### Project 1

```
10 GOTO 50
20 READ N$
30 PRINT "THE NAME IS ";N$
40 STOP
50 INPUT "YOUR NAME, PLEASE ";A$
60 PRINT "DATA ";A$
70 PRINT "GOTO 20";"S"
80 J=1
90 REM: LOAD KEYBOARD BUFFER WITH 'RETURNS'
100 PT=PEEK(50003)
110 POKE 525-PT*367,J+1
120 FOR K=1 TO J+1
130 POKE 526+K+PT*96,13
140 NEXT K
150 END
READY.

READY.
PROJECT 1
READY.
```

### Project 2

```
10 Q$=CHR$(34): GOTO 50
20 REM
30 PRINT "THE NAME IS ";N$
40 STOP
50 INPUT "YOUR NAME, PLEASE ";A$
60 PRINT "DATA ";Q$;A$;Q$
70 PRINT "GOTO 20";"S"
80 J=1
90 REM: LOAD KEYBOARD BUFFER WITH 'RETURNS'
100 PT=PEEK(50003)
110 POKE 525-PT*367,J+1
120 FOR K=1 TO J+1
130 POKE 526+K+PT*96,13
140 NEXT K
150 END
READY.
```

### Project 3

```
10 INPUT "VALUE OF J ";J
20 PRINT "cddd";
30 FOR I=1 TO J
40 PRINT I*1000; "DATA ";I;I*I;SQR(I)
50 NEXT I
60 PRINT "LIST"
90 REM: LOAD KEYBOARD BUFFER WITH 'RETURNS'
100 PT=PEEK(50003)
110 POKE 525-PT*367,J+1
120 FOR K=1 TO J+1
130 POKE 526+K+PT*96,13
140 NEXT K
150 PRINT "b"
160 END
READY.

READY.
```



SAVE project 3 on tape (and VERIFY) before proceeding.

Begin with a value of J=1 and continue, increasing by 1 each time, until you "crash" BASIC or get an error message. When this happens, you know you have one line too many! Each time, the program will LIST its current version. Note how many DATA statements were created each time. To be sure that the program is generating all of the DATA statements each time, type

NEW

and re-enter the original program from tape. Then, RUN, and increase the value of J by 1. (Note: by deleting line 60 and changing "J + 1" in lines 110 and 120 to "J", the maximum number of DATA statements

#### Project 4

```

10 INPUT "VALUE OF J :";J
20 PRINT "J=";J;
30 FOR I=1 TO J
40 PRINT I*1000
50 NEXT I
60 PRINT "LIST"
90 REM: LOAD KEYBOARD BUFFER
      WITH 'RETURNS'
100 PT=PEEK(50003)
110 POKE 525-PT*367,J+1
120 FOR K=1 TO J+1
130 POKE 526+K+PT*96,13
140 NEXT K
150 PRINT "M"
160 END
1000 DATA 1 1 1
2000 DATA 2 4 1.41421356
3000 DATA 3 9 1.73205081
4000 DATA 4 16 2
5000 DATA 5 25 2.23606798
READY.

```

generated can be one greater, but then no immediate commands ... such as LIST or GOTO 10...may be provided under program control.)

#### Project 4

How about deleting lines under program control? Make one change:

```
40 PRINT I*1000
```

SAVE the latest version of the program (including all the DATA statements) as project 4 and VERIFY. RUN the program. When the program LISTS itself, you will note that some or all of the DATA statements (depending on the value of J) will have disappeared. Since you SAVED the set of DATA statements, you can experiment with this program at your leisure.

## 32 K BYTE MEMORY RELIABLE AND COST EFFECTIVE RAM FOR 6502 & 6800 BASED MICROCOMPUTERS

AIM 65-\*KIM\*SYM  
PET\*S44-BUS

- PLUG COMPATIBLE WITH THE AIM-65/SYM EXPANSION CONNECTOR BY USING A RIGHT ANGLE CONNECTOR (SUPPLIED) MOUNTED ON THE BACK OF THE MEMORY BOARD.
- MEMORY BOARD EDGE CONNECTOR PLUGS INTO THE 6800 S 44 BUS.
- CONNECTS TO PET OR KIM USING AN ADAPTOR CABLE.
- RELIABLE—DYNAMIC RAM WITH ON BOARD INVISIBLE REFRESH—LOOKS LIKE STATIC MEMORY BUT AT LOWER COST AND A FRACTION OF THE POWER REQUIRED FOR STATIC BOARDS.
- USES +5V ONLY, SUPPLIED FROM HOST COMPUTER.
- FULL DOCUMENTATION, ASSEMBLED AND TESTED BOARDS ARE GUARANTEED FOR ONE YEAR AND PURCHASE PRICE IS FULLY REFUNDABLE IF BOARD IS RETURNED UNDAMAGED WITHIN 14 DAYS.

ASSEMBLED WITH 32K RAM	\$395.00
& WITH 16K RAM	\$339.00
TESTED WITHOUT RAM CHIPS	\$279.00
HARD TO GET PARTS (NO RAM CHIPS)	
WITH BOARD AND MANUAL	\$109.00
BARE BOARD & MANUAL	\$49.00

PET INTERFACE KIT—CONNECTS THE 32K RAM BOARD TO A 4K OR 8K PET. CONTAINS: INTERFACE CABLE, BOARD STANDOFFS, POWER SUPPLY MODIFICATION KIT AND COMPLETE INSTRUCTIONS \$49.00

U.S. PRICES ONLY

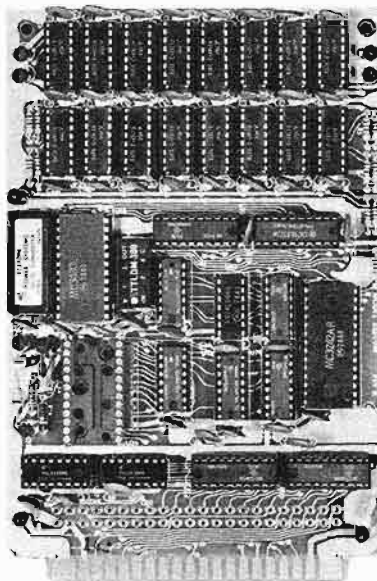

### 16K MEMORY EXPANSION KIT ONLY \$58

FOR APPLE, TRS-80 KEYBOARD, EXIDY, AND ALL OTHER 16K DYNAMIC SYSTEMS USING MK4116-3 OR EQUIVALENT DEVICES.

- ★ 200 NSEC ACCESS, 375 NSEC CYCLE
- ★ BURNED-IN AND FULLY TESTED
- ★ 1 YR. PARTS REPLACEMENT GUARANTEE
- ★ QTY. DISCOUNTS AVAILABLE

ALL ASSEMBLED BOARDS AND MEMORY CHIPS CARRY A FULL ONE YEAR REPLACEMENT WARRANTY

**BETA**  
COMPUTER DEVICES

1230 W. COLLINS AVE.  
ORANGE, CA 92668  
(714) 633-7280

Calif. residents please add 6% sales tax. Mastercharge & Visa accepted. Please allow 14 days for checks to clear bank. Phone orders welcome. Shipping charges will be added to all shipments.

## SPEECH RECOGNITION



**NOW TALK TO YOUR:**

**PET, TRS-80 (LII)  
AIM-65 and SORCERER**

**NEW COGNIVOX SR-100** has 32 word (or short phrase) vocabulary (AIM-65 with 4K RAM, 16 words) Up to 98% recognition rate. Breakthrough price of only **\$119** includes microphone, cassette with software and manual. Version for the TRS-80 (VIO-332) costs \$149 but also has 32 word speech output and music capability, includes all above plus speaker/amplifier. For the Sorcerer in addition to SR-100, we offer COGNIVOX VIO-132 which includes speech output and music and extensive software and costs \$179. Please add \$3 for shipping in the US. Calif. add 6% tax. Foreign orders welcome, add 10% for processing and shipping by air. When ordering, please specify make, model and memory size of your computer.

**VOICETEK**

Dept. M, P.O. Box 388, Goleta, Ca 93017

## SPECIAL INTRODUCTION ONLY \$99.95

FOR THE FINEST PARALLEL INTERFACING ELEMENT FOR THE PET/IBM\*

The P.I.E.-C is a very complete interface. It comes in an attractive case and mounts directly to the computer, thus eliminating the need for extra space in the back for boxes and messy piles of wire. Your system can look professional. The P.I.E.-C has complete address selectability of device numbers 4 through 30. And, there's no need to disassemble your unit to change the address; it's as simple as setting the DIP switch. This selectability allows both your letter-quality printer (NEC Spinwriter, etc.) and your graphics printer to be connected at the same time but used separately by addressing each with a different device#. Now that's real efficiency!!

The P.I.E.-C will convert non-standard PET codes to true ASCII code. It can be switched in or out of service as needed. For instance, if your software does the conversion, just switch the converter off. If you need the conversion for printing from BASIC, just switch it on.

Our interface provides extension of the IEEE-488 port on the PET/IBM. You don't need to buy other cables because our interface uses the same card edge type as the computer. Thus the cable from the floppy disc to the PET/IBM will now connect into the interface.

The P.I.E.-C is interconnected with, and powered by, the printer using a 5' data cable supplied with the interface. This means that there is no power supply necessary as with serial interfaces. The +5V is supplied on pin# 28 of the connector used by all true Centronics standard interfaced printers. This includes the Centronics 779, P1, and many others including the Anadex printers.

Our interface goes beyond the Centronics compatibility. Therefore, it will operate the Anderson-Jacobson AJ841 and the "Paper Tiger" by Integral Data Systems. In fact, it will drive any parallel-input printer that uses 8 data bits and 2 handshaking lines.

If you are interested in the most interface for your money, then place your order today. Our introductory price for the P.I.E.-C interface won't last long. So, don't delay... you may have to pay the list price of \$119.95.

Please specify your PET/IBM type (new or old ROMs) and the brand and model of the printer you will be using. We attach the correct connector on the cable. All orders must be prepaid or COD cash. Add \$5 for shipping and handling. Maryland residents add 5% sales tax.

LENDATA PRODUCTS, P.O. Box 1080, Columbia, Md. 21044

PHONE (301) 730-3257

\*PET/IBM are trademarks of Commodore Business Machines

# APPLE & PET

## MAE

The Most Powerful Disk-Based  
Macro Assembler/Text Editor  
Available at ANY Price

Now includes the Simplified Text Processor (STP)

For 32K PET, disk  
3.0 or 4.0 ROMs or 8032 (specify) — OR — 48K APPLE II  
or APPLE II+ and DISK II

### MAE FEATURES

- Control Files for Assembling Multiple named source files from disk
- Sorted Symbol table — Up to 31 chars./label
- 27 Commands, 26 Pseudo-ops, 39 Error Codes
- Macros, Conditional Assembly, and a new feature we developed called Interactive Assembly
- Relocatable Object Code
- String search and replace, move, copy, automatic line numbering, etc.

### STP FEATURES

- 17 text processing macros
- Right and left justification
- Variable page lengths and widths
- Document size limited only by disk capacity
- Software lower case provision for APPLE II without lower case modification

### ALSO INCLUDED

- Relocating Loader
- Sweet 16 macro library for APPLE and PET
- Machine Language macro library
- Sample files for Assembly and text processing
- Separate manuals for both APPLE and PET

### PRICE

- MAE, STP, Relocating Loader, Library files, 50 page manual, diskette — \$169.95

SEND FOR FREE DETAILED SPEC SHEET

EASTERN HOUSE SOFTWARE  
3239 LINDA DRIVE  
WINSTON-SALEM, N. C. 27106

(919) 924-2889

(919) 748-8446

## OHIO SCIENTIFIC SOFTWARE

**COPY/1 CAN COPY A FULL DISK IN UNDER TWO MINUTES, USING A SINGLE DRIVE, FROM A COLD START.**

No messing around with disk initializing or track zero set up or directory scan, these are all handled by COPY/1. COPY/1 needs 24k RAM; it can make 0 to 255 copies and can start and stop on any tracks. It lists the sector page count following each sector read or write action. It lists disk error type and location. All in full color with sound cues. (Also works fully without color or sound).

Cost \$20 (plus 5% tax, Md. residents) includes disk and mailing.

From  
PRISM SOFTWARE  
Box 928  
College Park, Md.  
20740

Prism Software



# MICROSCOPE

Number 4

## General Ledger for the APPLE II

\$180.00

Small Business Computer Systems (SBCS)

(+ \$20.00 for Osborne Associates' book: *General Ledger in C-Basic*.)

4140 Greenwood  
Lincoln, NE 68504

**1-3. Microcomputers which can use product; System hardware requirements; and System software requirements:** The SBCS General Ledger is designed to run on an APPLE II or APPLE II Plus with 48K of RAM, Applesoft in ROM, 2 Disk II drives on the same controller card, and a printer with either parallel or serial interface card. The manufacturer does not specify whether it will work with APPLE's Language System. APPLE's DOS is also needed (the version number is not specified).

**4. Product features:** This product is a conversion of the popular Osborne Associates General Ledger C-Basic package. It allows you to set up and maintain a computerized General Ledger (G/L) on the APPLE. Included are programs (1) to configure the software to the specific hardware you are using; (2) to set up and maintain a customized Chart of Accounts; (3) to enter postings to the G/L (either directly or through cash journals); and (4) to generate several reports, cash journals (for disbursements and receipts) and two of the four customary financial statements. (The Balance Sheet and Income Statement can be generated; but the Statement of Changes in Financial Position and Statement of Retained Earnings are not generated.) The G/L system allows departmentalizing of reports (useful if your business has several locations or cost centers). There is a wide latitude in formatting the financial statements.

**5-7. Product performance; Product quality; and Product limitations:** The SBCS General Ledger performs well, though its usefulness may be limited by several factors discussed below. The system is well designed (again with certain limitations). Error trapping is excellent. I was not able to "crash" the system, though the documentation specified several conditions where the system may hang. Recovery from these situations is effected by re-booting the system. The current session's data will be lost, but previous data will not be. In converting the Osborne Associates' package, SBCS has speeded up execution and provided for different types of printers. Two separate program disks are provided; one for a Centronics-type interface (parallel) and a second disk for use with serial interfaces. If the printer being used does not have "top of form" capability (such as the Centronics 779), this function is emulated in software. A third disk, containing the sample Chart of Accounts described in the Osborne documentation, is also included. It may be used for practice on the system or may be modified for your particular business, thereby saving you the trouble of having to enter several hundred accounts.

Another addition is provision for two levels of password security. This is a nice touch when you have clerical staff operating the system—staff members cannot obtain a printout of the financial statements without knowing the second-level password.

This product does have several limitations. These result from limitations of the original Osborne software and Applesoft language, not from the conversion done by SBCS. One of the major limitations of this (and almost *all* software on the APPLE II) is that Applesoft limits you to nine digits (\$9,999,999.99). While this may *not* be a problem in your business (after all, a ten-million-dollar-a-year business stretches the definition of "small business"), many businesses maintain "memo" accounts in their General Ledger. These memo accounts usually contain some sort of statistic such as units produced, units sold, etc.

The nine-digit limit may also be a problem, if you are considering using this hardware/software configuration for service bureau work or, as I do, in an accounting or bookkeeping practice. In these cases, it is quite possible that you may have clients who will have 10 million or more in any one account (such as a memo account or sales). SBCS states in both its documentation and advertising, that it is willing and able to tailor the software for special needs. Perhaps SBCS would be willing to patch into its programs one of the existing double-precision routines available for the APPLE II, or you might wait until SBCS brings out a conversion for the APPLE III (APPLE "Business Basic" on the III has 16-digit precision).

The second major limitation of this package is the reports. While there are a multitude of them, there is no actual General Ledger produced. The closest thing to a General Ledger is the report called "G/L Update" which contains most of the information common to computerized G/L systems, but in a format that a person who is used to more conventional manuals or computer-generated G/L's might have dif-

difficulty using. This may or may not be a problem, depending on who will be using the reports. My suggestion is to purchase the Osborne book (*General Ledger C-Basic* version) before buying the software. (You will have to purchase the book anyway, if you do decide to buy the software, as it makes up the bulk of the documentation.) Sit down with your bookkeeper or accountant and see if they can live with the format of the reports.

My last major criticism of this software is that it is extremely easy to enter an unbalanced entry (credits do not equal debits) when using direct-posting entry. Most G/L software makes it very difficult to do this.

This is not a problem when entering transactions through the cash journals, as this type of entry automatically produces the correct off-setting entry. Direct posting would be used to make adjusting entries, and it is extremely easy to make a mistake here. The potential user should be cautioned to double-check each entry when using this mode. An unbalanced entry will result in the G/L being out of balance, necessitating an additional correcting entry.

**8. Product documentation:** Product documentation consists of two books — *The Osborne General Ledger in C-Basic*, which is not supplied with the software, and an additional 32-page manual supplied by SBCS, detailing enhancements to and differences from the C-Basic version. These two manuals comprise over 200 pages of documentation. Unfortunately, most of it is aimed at the programmer, not the user. A user with very little experience in computers and accounting (such as the average small business owner) would have a great deal of difficulty getting this package up and working. A small user's manual (15-20 pages), detailing step-by-step operations, and indexed to be a "computer-side" reference would be a welcome addition. SBCS *does* state that it expects purchasers to have *some* background in computers and accounting. And while I feel that a more user-oriented manual would be nice, the documentation supplied and available is usable (even if inconvenient); and it is much to be preferred over the flimsy or nonexistent documentation I have seen accompanying some other software.

**9. Special user requirements:** Purchasers of this software will find that a background in *both* computers and accounting (bookkeeping) will be useful. The better your background, the easier it will be to install and use this package. A user with *absolutely* no background in either field will probably have some difficulty getting the package up and running. A user falling somewhere in-between the two extremes may have a little difficulty at first, but should eventually get the system running. The error-trapping routines may cause some frustration, but will prevent the user from most disasters.

**10. Price/feature/quality/evaluation:**—This software package will not be suitable for everyone—no packaged software is. For those whose needs will be adequately served, this software at \$200.00 (\$180.00 for the SBCS package + \$20.00 for the Osborne book) represents an excellent value, and is one of the less expensive G/L packages available for the APPLE II.

**11. Additional comments:** There are several excellent General Ledger packages currently on the market (BPI Systems, Apple Controller, Micro-source Ledger Plus among others). Each of these, including the SBCS conversion, has its good points and limitations. The purchaser of a software package owes it to himself *and* the producer of the software to determine whether any particular package will meet the user's needs. SBCS warrants its software against errors for one year. It also offers a 30-day, full-purchase refund, if the user finds that the software is not as documented. These are excellent warranties, but SBCS cannot guarantee that its software is exactly *what your business needs*.

Before buying *any* software sit down and determine, as precisely as possible, what you are looking for. What do I *need* this software to do? What do I *want* it to do? Does this software meet my needs and wants? Try and bring the people who will be using the software (your accountant, bookkeeper, data entry clerk) in on the decision—or at least ask for their opinion. Remember—the more you know about all the factors, the better decision you will be able to make.

*Editors note—The manufacturer comments on the review as follows:* SBCS General Ledger 2.1 (released August 1, 1980) eliminates some of the limitations mentioned in the review. Version 2.1 will support all APPLE printer interface cards and any printer with over 110 columns. If "top of form" is not available, it will be emulated. Version 2.1 runs under 3.2.1 DOS and may be used with the Language System. We will be offering a version for 3.3 DOS as well as the APPLE III Business Basic.

There is, however, one discrepancy in the review. Because of extensive error checking, the user cannot enter any data which will later cause the system to "crash." We are also performing error checking on the hardware, as it is not infallible. The *only* time any data will be lost is in case of a power failure or accidentally pressing "Reset" during a posting session. Then *only* the current posting will be lost. The previous postings made during the current session will *not* be affected. The condition referred to in the review will occur only if a hardware malfunction (such as a disk or printer) is detected which would result in erroneous data being generated. Recovery is as simple as reverting to the backup diskette (after correcting the malfunction).

I agree with the reviewer in that the user should first establish his or her needs. Since the Osborne manuals are readily available, one can easily see if the Osborne methodology will fulfill those needs. If not, then a major disappointment can be avoided. If their needs are *almost* met, the necessary modifications can be discussed in detail.

**12. Reviewer:** Ted Needleman, 67 West Burda Place, Spring Valley, NY 10977

# SBCS

## SOFTWARE

### GENERAL LEDGER offers you

- ★ Virtually complete flexibility in formatting balance sheets and income statements.
- 31-character account names
- 6 digit numbers.
- 10 levels of subtotals for more detailed income statements and balance sheets.
- up to 9 departments.
- ★ A cash journal that automatically calculates the proper off-setting entry and allows a 33-character transaction description.
- ★ A balance sheet and income statement for the current month, quarter, or any of the previous three quarters.

for **MAXIMUM PERFORMANCE** WITH YOUR **Apple II**

We are the authorized center for Osborne/McGraw-Hill providing you with business packages that will do everything the Osborne Software will do in addition to many features we have added.

### BE SURE TO READ THE MICROSCOPE REVIEW OF G/L IN THIS ISSUE!

#### ACCOUNTS RECEIVABLE allows you to:

- Enter invoices at any time.
- Keep track of invoice amounts, shipping charges, and sales tax (automatically computed).
- Accumulate total payments including progress billing information on each invoice.
- Print reports which list unbilled invoices, unpaid invoices, and paid invoices.
- Obtain an aging analysis of unpaid invoices
- Assign your own alphanumeric customer code
- Maintain the date of the last activity for each customer, as well as amounts billed this year and last year.
- Print Customer Statements. (Statements available through SBCS).

★ Accounts Receivable is available independently or can be integrated with the General Ledger program  
*In the final analysis, making your bookkeeping easier is what our software is all about. There is virtually no limit on entries since you may process them as often as you like. These packages will support any printer/interface combination.*

General Ledger requires one hundred ten columns.  
 Accounts Receivable requires one hundred thirty columns.

Suggested Retail:  
 Individually ..... \$180.00  
 Together ..... \$330.00  
 McGraw-Hill manuals (required for documentation) . . . \$20.00 ea.  
 Available from your local Apple Dealer or contact SBCS

**YOU NEED EXPERIENCE WORKING FOR YOU!**  
 Contact or write:

**SMALL BUSINESS COMPUTER SYSTEMS**  
 4140 Greenwood - Lincoln, Nebraska 68504 - (402) 467-1878

# WAIT! DID YOU KNOW THAT...

- There is a new magazine devoted exclusively to reviewing APPLE II software?
- Its name is **PEELINGS II**?
- You have missed 20 valuable reviews per issue?
- Six issues/year are a mere **\$15\***

Dealer Inquiries Invited



945 Brook Circle  
 Las Cruces, NM 88001

Tel. 505/523 5088 (Eve.)

\* FOREIGN ORDERS ADD \$10



### Find Your Way Around The New Apple® DOS With The Dakin5® Programming Aids 3.3®

Dakin5 Corporation, a Colorado software house, is making available to the public 12 utility programs on one 5 1/4 sector diskette, utilizing the new Apple DOS 3.3, which provides 23% more storage.

All of the Dakin5 Programming Aids 3.3 programs are also compatible with the Corvus Disk Drive system.

#### Features

- Remove REM statements, unreferenced (dead) code, and compress code to increase program speed and save memory and disk space.
- Copy any file or program from one diskette to another. Only the name is needed.
- Print or display a line cross reference and variable name cross reference.
- Print or display all or selected records from a text file.
- Display any sector of a given file or program, and then update any data within that sector or specify the sector you wish to update, such as directory sectors and sectors occupied by DOS.

- Create, print and modify your own text and Exec files.
- Perform 20-digit arithmetic.
- Copy a diskette without DOS; initialize without DOS; verify source diskette; verify copied data is the same as the original.
- Use a powerful data entry routine that handles both string and numeric data.

#### Plus Many More Utility Programs for Sophisticated Programmers

Many of these utility programs have been developed and tested for in-house use while producing The Controller™ business package for Apple Computer Inc.

Each programming aids package includes a program diskette and very complete documentation, all attractively packaged in a padded, blue print vinyl 3-hole notebook with silver lettering. An identifying tab separates each program for convenient reference.

See your Apple dealer or contact Dakin5 Corporation, P.O. Box 21187, Denver, Colo. 80221. Telephone: 800-525-0463. VISA or MC welcome.

Apple is a registered trademark of Apple Computer Inc. The Controller is a registered trademark of Dakin5 Corporation.

**DAKIN5**  
CORPORATION

# Microprocessors in Medicine: the 6502

## Part 1

by Jerry W. Froelich, M.D.

The column this month and the next, written together with Jack W. Smith, M.D., will inform readers on various uses of computers in medical education and will provide an example of how the 6502 microprocessor is able to perform tasks in medical education nearly as well as large computer systems. (Dr. Smith is a Clinical Fellow in Pathology, Instructor in Allied Health, and Ph.D. candidate in Computer Science at Ohio State University, Columbus, Ohio.)

Computers in medical education can be divided into three major categories: computer-assisted evaluation (CAE), computer-aided instruction (CAI), and simulations. These categories include testing, statistical analysis of test results, study prescriptions, tutoring, diagnosis and treatment guidance, simulation of processes, and simulation of patient-physician encounters. These serve as an extension of the classroom and not as replacement of the teacher. With the application of small, inexpensive microprocessors, such as the 6502, physicians can now acquire continuing education credits (proof of furthering their medical education to stay current with medical practice) by reviewing programs on their own computers.

The use of computers in medical education thus ranges from simple display of information to a sophisticated interaction with the physician. The discussion presented here covers only a part of that range. This month we will cover the theoretical aspects of "Computers in Medical Education" and next month we will cite examples.

### CAE

CAE uses computers to handle administrative chores. The computer can administer examinations and score them immediately or grade examinations taken at a previous time. It can then make a statistical analysis of a student's performance and offer study prescriptions (references to appropriate material) to aid the student in compensating for deficiencies. Group performance can also be compiled. The interactive capability of the computer is not, however, fully realized in computer-aided evaluation.

### CAI

Generally speaking, in computer-aided instruction, the computer acts as a tutor, privately coaching students and helping them acquire information in a particular subject. The computer disseminates information and tests a student's comprehension and recall. The computer can also teach and test a student on how to interpret information. For example, a CAI program could introduce a student to the physiological, biochemical, and genetic organization of bacteria, viruses, and parasites. After the student has been coached and tested on the basic concepts, the computer could present the student with a number of organisms to classify. Problem areas would prompt remedial instruction, until the student reached a previously established level of learning.

There are several advantages to presenting material in this way: (1) Faculty members are not responsible for disseminating repetitive information and are free to pursue creative endeavors. (2) CAI can be used to supplement traditional educational techniques (lecture and laboratory work), which may suffer because of budget cuts. (3) New knowledge can be incorporated

more easily in the computer data base than in reference books, thus decreasing the time lapse between availability of facts and their transmission to students and physicians. (4) Students can bypass familiar material. This is especially important in medical education where students vary widely in educational backgrounds. (5) CAI is efficient, in that a student can master a subject in less time than is usually necessary with traditional methods. (6) Instruction is individual, based on the specific abilities of the student. His actions produce almost instant, positive feedback or correctional instruction. (7) Multimedia presentation is easily incorporated in this technique. Current projects in CAI involve the use of high-resolution graphic screens and computer-controlled slide projectors, as additional instructional tools.

### Simulations

Educational simulations are of two varieties: simulations of biological processes (physiological, biochemical, etc.) and simulations of patient-physician encounters. Process simulation displays a model of "real-world" events, when the actual event is costly, unmanageable, or dangerous to duplicate. More importantly, a precise model of an event need not exist to simulate the event adequately for educational purposes. Simulations are a convenient way for the student to assimilate information acquired in the classroom.

An example of process simulation would be a computer program that simulates the growth of a cell system. From the computer terminal, the student can manipulate certain variables, such as death rate, mutation rate, and growth rate. The impact of a particular manipulation, in conjunction with other variables of the system, can then be instantly displayed on a computer terminal.

A computer program to simulate the patient-physician encounter can do the following: (1) present a summary of the patient's medical case or accept a case from the student; (2) allow the student to acquire information about the patient through a dialogue with the computer (this interaction would include information about the patient's history, laboratory findings, and physical exam findings); (3) display information on the availability, time, and cost of procedures needed for the patient; (4) ask the student for a preliminary diagnosis and treatment strategy or receive diagnostic and treatment advice; (5) explore the effects of such treatment along with the accuracy of the diagnosis; (6) compare the student's response to the responses of experts.

The patient-physician simulation has several advantages. The student is exposed to the problem-solving nature of clinical medicine. The simulation is without risk to patients: the student is given the opportunity vicariously to participate in patient management where clinical judgement is required. An additional merit is that management can be studied by design, rather than by the availability of patients with particular diseases.

The next column will describe several current systems used in medical education and a specific APPLE application, "APPLE-ED".

Address communications: c/o Massachusetts General Hospital, Boston, MA 02114

# Ohio Scientific Users: Stop Those S- ERROR

Correct the BASIC error message output, put out messages of your own, and more.

E.D.Morris Jr.  
3200 Washington  
Midland, MI 48640

Tim Finkbelner  
3710 Fuller  
Midland, MI 48640

The original Ohio Scientific video board could display only 64 different characters: upper case letters, numbers and punctuation. The current model video board displays 256 different characters: all of the original characters plus lower case and graphics. This created an unwelcome bonus for machines which use BASIC in ROM. The error messages now appear in graphics characters rather than in letters. For example, whenever a syntax error is made, the user sees

?S- ERROR IN LINE 10

The Ohio Scientific graphics manual explains that the correct message is

?SN ERROR IN LINE 10

I make enough syntax errors that I no longer have to look this one up. However, it becomes a real nuisance to refer to the manual for T- or C- errors. The second letter of all the error codes appears as a graphics symbol.

This article describes a patch for Ohio Scientific BASIC in ROM to convert the graphics characters in error messages back into readable letters. Three other short patches are also included that allow your BASIC to be customized in a unique way. The same technique for adding the patch to ROM BASIC is used in each program. The four programs are written in BASIC for the 540

video board. REM statements indicate changes to be made for the Superboard. The BASIC programs read data and create a machine language patch. A disassembly of each patch is also shown. Once the BASIC program is run, it can be NEWed and the machine program will remain untouched. If the computer is cold-started, the POKES to locations 4 and 5 must be redone. All of the patches start at hex location \$0240.

PROGRAM 1

```
10 REM OK REPLACEMENT
20 DATA 169,80,160,2,76,195,168
30 FOR X=576 TO 582
40 READ Q
50 POKE X,Q : NEXT
60 INPUT "NEW MESSAGE " : A$
70 B$=CHR$(10)+CHR$(13)
80 A$=B$+A$+B$+CHR$(0)
90 A=592
100 FOR X=1 TO LEN(A$)
110 POKE A,ASC(MID$(A$,X,1))
120 A=A+1
130 NEXT
140 POKE 4,64:POKE 5,2
```

DISASSEMBLY FOR PROGRAM 1

```
0240 A950 LDA #$50
0242 A002 LDY #$02
0244 4CC3A8 JMP $A8C3
```

Before an error message can be corrected, a way must be found to break into BASIC just when the message is being printed. This is difficult since BASIC is mostly in ROM memory. There is a sneaky way of doing this, as described in the remainder of the article. Note carefully the format of error messages

?S- ERROR  
OK

The "OK" prompt always follows the error message. To output the "OK" prompt, the BASIC interpreter jumps to \$0003. At that address you will find the machine code 4C C3 A8 which means JMP \$003. At that address is found the machine code 4C C3 A8 which means JMP \$A8C3. According to an article in MICRO, November 1979, (18:9), \$A8C3 is a subroutine to print a message. The address of the message to be output is in the A (ADL) and Y (ADH) registers. Since the locations \$0003, \$0004, and \$0005 are in RAM, these locations can be changed to divert the computer to our own subroutine instead.

Before attempting the error correction program, let's try a simpler problem first to demonstrate the technique. Suppose we don't like the "OK" prompt. If the computer can be intercepted on its way to the message routine, the values in the A and Y registers can be changed to point to a new message of our choosing. The first BASIC program

does exactly that. (If you want to convert your Ohio Scientific machine to a PET, run the BASIC program and INPUT "READY" as the new message.) Your new prompt plus appropriate line feeds and carriage returns are stored in \$0250. BASIC's pointers are changed to aim at the new message. Instead of "OK" your computer will respond with "READY" or "I'M WAITING" or whatever you choose.

#### PROGRAM 2

```
10 REM ERROR MESSAGE CORRECTION
20 DATA 72,173
30 DATA 64,215 :REM SUPERBOARD 101,211
40 DATA 201,63,208,8,173
50 DATA 66,215 :REM SUPERBOARD 103,211
60 DATA 41,127,141
70 DATA 66,215 :REM SUPERBOARD 103,211
80 DATA 104,76,195,168,0,0
90 FOR X=576 TO 597
100 READ Q
110 POKE X,Q
120 NEXT
130 POKE 4,64 :POKE 5,2
```

#### DISASSEMBLY FOR PROGRAM 2

```
0240 48 PHA
0241 AD40D7 LDA $D740
0244 C93F CMP #$3F
0246 D008 BNE $0250
0248 AD42D7 LDA $D742
024B 297F AND #$7F
024D 8D42D7 STA $D742
0250 68 PLA
0251 4CC3A8 JMP $A8C3
```

We now have a method of detecting the "OK" prompt, but "OK" appears many times, other than after an error message. Notice that "?" appears on the line above the "OK" whenever an error is printed. After every prompt message, the computer examines the space directly above the "O" in "OK". Whenever a "?" is found, the defective character in the error message appears on the screen two spaces to the right. This graphics character can be changed into the correct let-

ter by resetting the high order bit. Program 2 will detect when an error message appears on the screen and reset this bit to the correct character. Note the three lines which must be changed if you are using a Superboard. The disassembly is for the 540 version. If you make an error while in the SAVE mode, you will see in slow motion that the incorrect character first appears and then is corrected. With this patch in your BASIC you are now free to make all sorts of errors without fear of those funny looking graphics characters appearing. Normal graphics will not be affected.

The same method used to detect an error message can be used to sense a user input. If you enter "ABC" the computer will display

```
ABC
(blank line)
?SN ERROR
OK
```

The user input appears 3 lines directly above "OK". The computer can check this line against a keyword. This scheme can be used to add commands to BASIC. For example, program 3 is a machine language screen clear. Once the BASIC program has been loaded and run, typing a "!" and carriage return will trigger the screen clear program. Line 50 of the BASIC program is the ASCII value of the trigger character. This can be changed to whatever you wish. Changing line 50 to "DATA 35" will allow a "#" to clear the screen.

Program 4 uses a multiple letter keyword which gets stored at \$0260. A message of your choosing is stored at \$0280. When you load and run the BASIC program, you must enter a "KEYWORD" and a "MESSAGE". For example you might enter "KILOBAUD" and "I LIKE MICRO BETTER". Whenever the "OK" prompt appears, the computer will search for a match to your keyword. If a match is found, your message will be output to the screen. Responding with a message is not particularly useful, except to amaze your friends. However, once you understand the technique of keyword detection, the machine program can be altered to do your bidding. You can even write a program which requires a secret password before it will run.

#### PROGRAM 3

```
10 REM SCREEN CLEAR
20 DATA 72,173
30 DATA 192,214 :REM SUPERBOARD 37,211
40 DATA 201
50 DATA 33 : REM ASCII TRIGGER
60 DATA 208,35,138,72,169
70 DATA 32,162,0,157,0,208,157,0
80 DATA 209,157,0,210,157,0,211,157,0
90 DATA 212,157,0,213,157,0,214
100 DATA 157,0,215,232,208,229
110 DATA 104,170,104,76,195,168
120 FOR X=576 TO 622
130 READ Q
140 POKE X,Q
150 NEXT
160 POKE 4,64:POKE 5,2
```

#### DISASSEMBLY FOR PROGRAM 3

```
0240 48 PHA
0241 ADC0D6 LDA $D6C0
0244 C921 CMP #$21
0246 D023 BNE $026B
0248 8A TAX
0249 48 PHA
024A A920 LDA #$20
024C A200 LDX #$00
024E 9D00D0 STA $D000,X
0251 9D00D1 STA $D100,X
0254 9D00D2 STA $D200,X
0257 9D00D3 STA $D300,X
025A 9D00D4 STA $D400,X
025D 9D00D5 STA $D500,X
0260 9D00D6 STA $D600,X
0263 9D00D7 STA $D700,X
0266 E8 INX
0267 D0E5 BNE $024E
0269 68 PLA
026A AA TAX
026B 68 PLA
026C 4CC3A8 JMP $A8C3
```

#### PROGRAM 4

```
10 REM INSERT MESSAGE ON CUE
20 DATA 72,152,72,172,63,2,185,96,2,217
30 DATA 192,214 :REM SUPERBOARD 37,211
```



40 DATA 208,12,136,208,245,104,104  
 50 DATA 169,128,160,2,76,195,168  
 60 DATA 104,168,104,76,195,168  
 70 FOR X=576 TO 607  
 80 READ Q  
 90 POKE X,Q  
 100 NEXT  
 110 INPUT"KEYWORD ";A\$  
 120 A=608  
 130 POKE 575,LEN(A\$)-1  
 140 FOR X=1 TO LEN(A\$)  
 150 POKE A,ASC(MID\$(A\$,X,1))  
 160 A=A+1:NEXT  
 170 INPUT"MESSAGE ";A\$  
 180 B\$=CHR\$(10)+CHR\$(13)  
 190 A\$=B\$+A\$+B\$+CHR\$(0)  
 200 A=640  
 210 FOR X=1 TO LEN(A\$)  
 220 POKE A,ASC(MID\$(A\$,X,1))  
 230 A=A+1:NEXT  
 240 POKE 4,64:POKE 5,2

DISASSEMBLY FOR PROGRAM 4

0240 48 PHA  
 0241 98 TYA  
 0242 48 PHA  
 0243 AC3F02 LDY \$023F  
 0246 B96002 LDA \$0260,Y  
 0249 D9C0D6 CMP \$D6C0,Y  
 024C D00C BNE \$025A  
 024E 88 DEY  
 024F D0F5 BNE \$0246  
 0251 68 PLA  
 0252 68 PLA  
 0253 A980 LDA #80  
 0255 A002 LDY #02  
 0257 4CC3A8 JMP \$A8C3  
 025A 68 PLA  
 025B A8 TAY  
 025C 68 PLA  
 025D 4CC3A8 JMP \$A8C3

μ

# SOFTWARE FOR OSI

**Video Games 1.....\$15.**  
 Three games. Head-On is like the popular arcade game. Tank Battle is a tank game for two to four. Trap! is an enhanced blockade style game.

**Video Games 2.....\$15.**  
 Three games. Gremlin Hunt is an arcade-style game for one to three. Gunfight is a duel of mobile artillery. Indy is a race game for one or two.

**Adventure: Marooned In Space.....\$12.**  
 An adventure that runs in BK! Save your ship and yourself from destruction.

**Dungeon Chase.....\$10.**  
 A real-time video game where you explore a twenty level dungeon.

**Board Games 1.....\$15.**  
 Two games. Mini-gomoku is a machine language version of five stones gomoku. Cubic is a 3-D tic-tac-toe game. Both with graphics.

**Disassembler.....\$12.**  
 Use this to look at the ROMs in your machine to see what makes BASIC tick. Reconstruct the assembler source code of machine language programs to understand how they work. Our disassembler outputs unique suffixes which identify the addressing mode being used, no other program has this!

**Super! Biorhythms.....\$15.**  
 A sophisticated biorhythm program with many unique features.

**C1 Shorthand.....\$12.**  
 Use only two keys to enter any one of the BASIC commands or keywords. Saves much typing when entering programs. Written in machine language.

For all BASIC-in-ROM systems. Selected programs available on disk. Color and sound on video games.

Send for free catalog listing many more programs.

**Orion Software Associates**  
 147 Main Street  
 Ossining, NY 10562

OSI

SOFTWARE FOR OSI

OSI

We Have Over 100 High Quality Programs For Ohio Scientific Systems

ADVENTURES AND GAMES

**Adventures** - These interactive fantasies will fit in BK! You give your computer plain english commands as you try to survive.

ESCAPE FROM MARS

You awaken in a spaceship on Mars. You're in trouble but exploring the nearby Martian city may save you.

DEATHSHIP

This is a cruise you won't forget - if you survive it!

Adventures \$14.95 Tape or 5 1/4" Disk  
 \$15.95 8" Disk

STARFIGHTER \$5.95

Realtime space war with realistic weapons and a working instrument panel.

ALIEN INVADER 6.95 (7.95 for color and sound)

Rows of marching munching monsters march on earth.

TIME TREK \$9.95

A real time Startrek with good graphics.

**New Monitor ROM \$39.95.** Gives BASIC in ROM machines full edit features and more. Supports Video Mods. Send for documentation.

And lots, lots, lots more!

TEXT EDITORS FOR ALL SYSTEMS!!

These programs allow the editing of basic program lines. All allow for insertion, deletion, and correction in the middle of already entered lines. No more retyping.

C1P CURSOR CONTROL (Text Editor) \$9.95

Takes 166 bytes of RAM and adds, besides text editing, one key instant screen clear.

C2P/C4P CURSOR \$9.95

Takes 366 BYTES to add PET like cursor functions. Enter or correct copy from any location on the screen.

SUPERDISK \$24.95 for 5" \$28.95 for 8"

Has a text editor for 65D plus a great new BEXEC\*, a renumberer, search, a variable table maker and Diskvu - lots of utility for the money.

We also have 25 data sheets available such as:

IMPLEMENTING THE SECRET SOUND PORT ON THE C1P \$4.00

HOW TO DO HIGH SPEED GRAPHICS IN BASIC \$4.00

HOW TO READ A LINE OF MICROSOFT \$1.00

JOYSTICK INSTRUCTIONS AND PLANS FOR C1P \$3.00

SAVING DATA ON TAPE \$4.00

THE AARDVARK JOURNAL

A tutorial bimonthly journal of how to articles \$9.00

Our \$1.00 catalog contains a free program listing, programming hints, lists of PEEK and POKE locations and other stuff that OSI forgot to mention and lots more programs like Modem Drivers, Terminal Programs, and Business Stuff.

Aardvark Technical Services 1690 Bolton, Walled Lake, MI 48088 (313) 669-3110

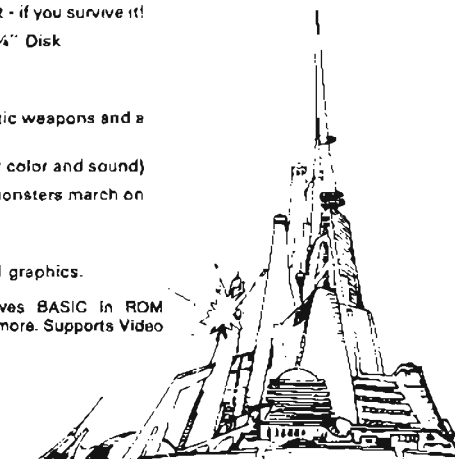

# OUR UNIQUE DESIGN PHILOSOPHY

## **MORE** is **MORE**

### WE PACK MORE FEATURES ON EVERY BOARD

This multi-purpose expansion board provides memory expansion of up to 48K and includes an EPROM programmer, two versatile Interface adapters, and a prototyping area. DRAM PLUS is fully compatible with AIM, SYM, KIM (ASK) microcomputers.

#### FEATURES

16 or 32K new generation dynamic RAM with all refresh handled on the board and completely transparent to ASK microcomputers. Memory addressable in Independent 4K segments placed on 4K boundaries.

Provisions provided for four ROMs or EPROMs - up to 16K nonvolatile memory. EPROM Programmer for 2716/2516 2K EPROMs, and 2732/3532 4K EPROMs. EPROMs programmed under automatic voltage control.

2 Versatile interface adapters (VIAs) provide 40 I/O lines brought out to the edge connector, 4 timers, and 2 shift registers. Prototype area provides space and support for the addition of special circuits.

Requires only +5V at 1 amp and any voltage between +12 and +24 at 150 milliamps. -5V is generated on board.

#### —DRAM PLUS—

#### BENEFITS

ASK microcomputers can handle more complex software tasks and store significantly more data. Added memory may be contiguous with existing memory. Nonvolatile memory further expands the use and application of microcomputers.

DRAM PLUS provides users all the hardware and software required to produce EPROMs.

The VIAs enables users to interface keyboards, printers, and other devices to DRAM PLUS and/or the microcomputer.

The prototyping area enables users to add memory write protection, multiplex EPROM's, or control other application specific devices.

Your existing power supply is probably adequate to run DRAM PLUS.

DEALER AND OEM QUANTITY DISCOUNTS AVAILABLE

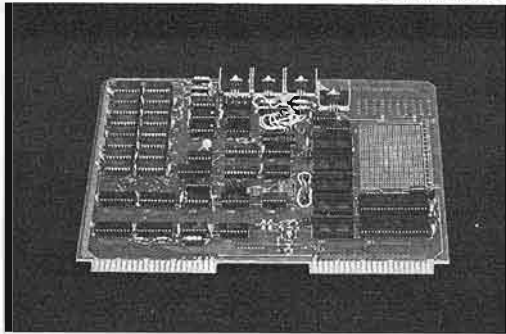

DRAM PLUS: 16K RAM-\$295, 32K RAM-\$395.

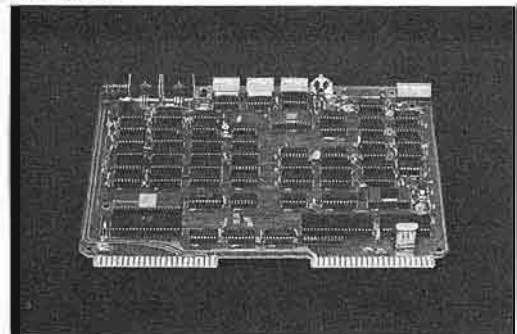

VIDEO PLUS II: Standard Board \$295, Options: 4K RAM-\$50, 6502 Stand-alone Processor-\$20, Communications Provision-\$35.

The most versatile and complete instant video expansion board for AIM, SYM, KIM (ASK) microcomputers. Includes many unique video features plus general purpose and communications interfaces, 2K EPROM and up to 7K RAM. With the 6502 microprocessor option, VIDEO PLUS II can function as a stand-alone terminal.

#### FEATURES

#### —VIDEO PLUS II—

#### BENEFITS

ASK VIDEO PLUS™ Software EPROM works with Monitors, BASIC, Editors and observes all standard programming conventions. Fast scrolling and flicker-free operation supports AIM keyboard, upper and lower case, or any ASCII keyboard. Software fully supports VIDEO PLUS II options.

EPROM character generators provide for 128 character set with 2716 EPROM, or 256 character set with user furnished 2532. Programmable Character Size. Selective character blank/unblank. Improved keyboard interface. Reverse Video.

Optional System Features are: 2K display RAM, 2K program character generator, 6502 stand-alone processor, ACIA communications provision.

Instant video display capability. Simple cable connection provides for easy installation and immediate use: simply "plug in and go". Standard options are available to meet user's requirements for future major system improvements.

Display requirements may be tailored to meet actual application requirements on an individual basis. User may specify character set, height, width and spacing in accordance with specific application display and man/machine requirements. 2000-4000 characters or limited, high resolution graphic screen displays.

VIDEO PLUS II supports major system enhancements which can significantly extend user's product life cycle. Any combination of options may be specified. Additional capability may be added to meet changing application requirements or planned product line improvements.

All prices shown are US and Canadian only, and are exclusive of shipping charges and applicable taxes. Other improved products now available include: MOTHER PLUS II, PROTO PLUS II, POWER A PLUS II, and AIM PLUS II. For more information, contact:

**THE COMPUTERIST®**  
34 Chelmsford St., Chelmsford, MA 01824  
617/256-3649

# OUR UNIQUE MARKETING PHILOSOPHY **MORE** for **LESS**

## WE PROVIDE PRODUCTS FOR COST-EFFECTIVE SOLUTIONS

A fully featured mother board with a standardized bus, full buffering, address decoding for adding up to 5 expansion boards to AIM, SYM, KIM (ASK) microcomputers. MOTHER PLUS II is also a microcomputer support board providing connections for power, TTY, audio cassettes, and cassette control relays.

### FEATURES

### —MOTHER PLUS II—

### BENEFITS

All address lines, data lines and control lines are buffered. Address control manager resolves host/peripheral address contention.

Address decoding and full buffering provides the necessary interface to easily add boards to increase microcomputer capabilities. No microcomputer hardware changes are required when boards are added via MOTHER PLUS II.

System I/O is supported with connectors for TTY and audio cassettes; relays to control two cassette recorders; Port A and Port B socket; LED audio input monitor, and more.

Simple switch settings prevent bus contention between the microcomputer and expansion boards.

Standard 44 pin edge connectors provide interconnection for 5 expansion boards.

The standard bus eliminates cables and permits more compact and efficient packaging.

Large terminal strip provides GND, +5V, +12V, 1 user defined voltage, and TTY I/O.

The terminal strip simplifies connections and supports special user requirements.

DEALER AND OEM QUANTITY DISCOUNTS AVAILABLE

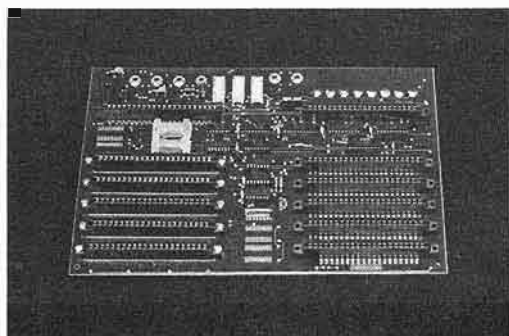

MOTHER PLUS II: \$100.

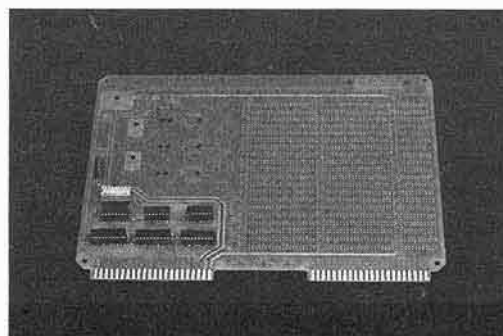

PROTO PLUS II: Unassembled-\$45, Assembled-\$60.

This expansion board product provides for the efficient design, development, checkout, and interface of digital design logic to AIM, SYM, KIM (ASK) microcomputers.

### FEATURES

### —PROTO PLUS II—

### BENEFITS

Full Size board with plated through holes and gold-plated fingers. Triple pad geometry permits solder connectors as well as wire wrap. Universal .1 grid pattern with GND and +5V conveniently bussed throughout the board. Additional patterns to permit quick insertion of a wide range of discrete components, voltage regulators, 25 pin "D" sub-miniature plug (RS 232), common transistors, switches, etcetera.

Product development times are improved.

Standard Interface has circuits for address buffers, bi-directional tri-state buffers, 8K bank address decoding, and control signal buffers.

The PROTO PLUS II board is designed to facilitate construction and assembly.

Engineers can now concentrate their efforts on new design work as standard interface circuitry and components are available as standard options. Time previously lost due to long and sometimes costly order and delivery cycles is avoided.

All prices shown are US and Canadian only, and are exclusive of shipping charges and applicable taxes. Other Improved products now available include: DRAM PLUS, VIDEO PLUS II, POWER A PLUS II, and AIM PLUS II. For more information, contact:

**THE**  
**COMPUTERIST**<sup>®</sup>  
34 Chelmsford St., Chelmsford, MA 01824  
617/256-3649

# OHIO SCIENTIFIC'S

In this month's issue of Ohio Scientific's Small Systems Journal, we are introducing a new word processing software system—WP-3. The description, though brief in comparison to the magnitude of the system, will hopefully convey some of WP-3's tremendous word processing power.

Two new Ohio Scientific game software releases—ZULU 9 and OSI INVADERS are also described in this issue.

We are pleased to include in this issue another contributed software feature—PINBALL 2001. Our thanks to Mr. Robert Wiebe for this contribution.

The final article this month is a piece originally scheduled for the October issue of MICRO. It is a BASIC routine for OS-65D V3.2 to increase file access efficiency by up to a factor of 20.

As always, comment on article content is welcome.  
Ohio Scientific, Inc.  
1333 South Chillicothe Road  
Aurora, Ohio 44202

## Introduction to WP-3

WP-3 is Ohio Scientific's latest word processing software system. Before describing some of WP-3's specific features, let's briefly review a few general word processing concepts.

Word processing is the automated manipulation of text. This includes initial entry of text into a word processing system, editing of previously entered text and formatted printing of text. The text itself can be a form letter, a technical manual or the chapters of a book. Or it could be any other textual material that you want to print without errors, or you will be printing a number of times with minor revisions from one printing to another.

There are three basic steps involved in using a word processing system.

1. *Entry of new text.*
2. *Editing or correcting previously entered text.*
3. *Output of previously entered text with formatting such as margin justification and page numbering.*

The entry of new text into a word processing system is roughly equivalent to typing a draft of the material. Then the new text is printed for review, proofread and edited. The automatic features of the Word Processing system provide for easily making changes and automatically compensate for these changes at each printing. For example, if you insert a new sentence or paragraph, all text after the insertion is moved down and page boundaries are readjusted appropriately. Since most word processing printers print 500 or more words per minute, each printout is produced quickly and also takes little operator assistance.

Another concept implied in a word processing software system is the ability to permanently store entered text in a machine readable form. Under WP-3 text may either be stored on floppy diskettes or on a hard disk (CD-23, CD-74, etc.).

Using WP-3 the actual storage and retrieval of text data is done via named files. This means that blocks of text may be conveniently referred to by common names which have a connection to their content. Some examples could be "CHAPT1", "CHAPT2", "AFORM", "LETTER", "RESUME", etc.

## Editing Features of WP-3

WP-3 has several features which greatly simplify entry and editing of text. For example, upon entry of text information, all typing may be done without concern for line length. The word processor automatically inserts all proper line terminations for easy readability on the CRT terminal.

The easiest way to demonstrate the fundamental features of WP-3 is by describing a simple session with the software.

Your first step is to initialize the text workspace. This is done with the "I" command followed by a "YES" response to "INIZ?". (This two-step procedure helps protect against unintentional initialization.)

After initialization, you type "NEW" and enter text by merely starting to type:

It was a dark and stormy night. The wind whipped mercilessly at the sails and the howling of the wolves on the tundra touched him to the marrow.

Upon exiting the text entry mode, you may return to the top of the text file with the AGAIN command. The text may then be reviewed simply by stepping through it by typing carriage returns (or down-arrows). As each line appears on the terminal, the cursor is positioned at the beginning of the line. At this time you may either edit the line or step onto the next line.

After reviewing the text, you will probably notice that it doesn't make much sense. "Howling wolves on the tundra" while at sea appears to be ridiculous. Either the "sails" or the "wolves on the tundra" have to go.

You have several options of how to change your text. The first might be simply to remove the phrase "of the wolves on the tundra" from the body of the text. This is accomplished by inserting "markers" into the text at the beginning and at the end of the offending phrase. These markers appear in the text file as blinking vertical lines. The command DELETE will remove all characters between the markers.

Another option is to enter the line in question, delete characters and insert new characters into the line. This is done by stepping to the line, "tabbing" to the character and then removing it. The word "sails" could be removed, for example, and the word "igloo" typed in.

As a final option, a block of text could simply be changed to other text by using the CHANGE command. You could simply type CHANGE "sails", "filmy cabin walls". This would replace the word "sails" with the phrase "filmy cabin walls".

There are several other editing commands that are extremely useful. Unfortunately, they don't lend themselves very well to our simple example, so a description will have to suffice.

# Small Systems Journal

LINE PRINTER	LIST XTRA OFF ADD SPACES BETWEEN WORDS TO RIGHT JUSTIFY	ZIGZAG XTRA OFF RAGGED EDGE TO LIMITED RIGHT MARGIN
	XTRA ON NOT ALLOWED	XTRA ON NOT ALLOWED
SERIAL WORD PROCESSING PRINTER	LIST XTRA OFF ADD SPACES BETWEEN WORDS TO RIGHT JUSTIFY	ZIGZAG XTRA OFF RAGGED EDGE TO LIMITED RIGHT MARGIN
	XTRA ON FINELY GRADUATED SPACING BETWEEN WORDS AND LETTERS TO RIGHT JUSTIFY	XTRA ON SAME AS XTRA OFF
PARALLEL WORD PROCESSING PRINTER	LIST XTRA OFF FINELY GRADUATED SPACING BETWEEN WORDS AND LETTERS TO RIGHT JUSTIFY	ZIGZAG XTRA OFF RAGGED EDGE TO LIMITED RIGHT MARGIN
	XTRA ON SAME AS XTRA OFF WITH ADDITIONAL PROPORTIONAL CHARACTER SPACING	XTRA ON SAME AS XTRA OFF WITH ADDITIONAL PROPORTIONAL CHARACTER SPACING

**Figure 1:**  
**WP-3 Output Format Table**

The FIND command will find the first occurrence of specified text. All remaining occurrences may be located by re-commanding FIND with no new text specification.

The MOVE and TRANSFER commands manipulate the location of blocks of text. A block of text may be moved by first defining its start and end with markers (described previously) and then locating where the text should be moved to with the cursor. That is, the marked text will be moved such that it will immediately follow the current cursor location. The TRANSFER command works the same way, but leaves a copy of the text at its original location.

### Output-Formatting Features of WP-3

After the entry of your text is complete, you will undoubtedly want some sort of permanent copy of your work. WP-3 supports three types of printed output:

- Lineprinter (Centronix-type interface)
- Serial Word Processing Printer
- Parallel Word Processing Printer

This is, of course, in addition to the standard CRT terminal output.

There are two basic output formatting commands. They are LIST and ZIGZAG. LIST outputs lines of uniform length while ZIGZAG outputs lines with "ragged" right margins. Each of these commands require a width parameter. LIST (width) defines the maximum line length. Parameters for page numbers, output device, etc., are optional.

Another pair of commands, XTRA ON and XTRA OFF controls the proportional spacing formatting of the output when used with a serial or parallel word processing printer.

The command HYPHENATE (count) allows automatic hyphenation of words at the end of lines after (count) characters in the word. HYPHENATE may be used with either LIST or ZIGZAG.

The chart in Figure 1 describes the various outputting options versus output device.

There are also several commands which allow control of the lines per page, spacing between lines, hold output at end of page, etc.

# OHIO SCIENTIFIC'S

A unique feature in the output formatting routine is the "embedded command" ACCEPT. When this command code has been "embedded" into your normal text and is found during a LIST or ZIGZAG output, the printing stops and waits for an input from the terminal. Upon completion of terminal input, whatever you have typed in is printed before continuation of the standard printed text.

A number of other commands may be "embedded" into your normal text to control WP-3's output formatting. These include command codes for indentation, tabination, pagination, skip specified lines, underline, etcetera. With all these commands, the action is taken without printing the "embedded" command code.

Of necessity, this has been a very brief description of a few of WP-3's many features. You should contact your nearest Ohio Scientific dealer for further details concerning WP-3 and the recommended system configuration to fully utilize this powerful word processing package.

## OSI Invaders and Zulu 9

OSI offers nearly one-hundred programs for its personal computer line. This range from battleship to tanks; including action games (like bomber and hectic), sports simulations (like bowling and golf), card games (spaces and hearts, for instance), strategy games (try Othello or chess) and arcade-type games. This month we will highlight two of the arcade-type games: Zulu and OSI Invaders.

Zulu 9, written in assembler, is a unique rendition of the interstellar pursuit theme made popular by the movie Star Wars. You are given the controls of a powerful star ship—your objective is to destroy as many invading alien ships as possible without running out of energy. On the disk version your controls consist of two joysticks to steer, accelerate, decelerate and fire your lasers. At the start of the game you have to choose your handicap (25 for beginners, 0 for experts), vertical retrace option (this selects optimum video display for color televisions) and whether or not collisions with invading space craft are allowed.

You will begin with 100% energy at speed 10. Speeds from 1-10 deplete your fuel and from 11-20 replenish the fuel supplies. The faster you go, the harder the incoming crafts are to destroy. The screen depicts your view of space from the cockpit of your star ship. The direction controls act like the control stick of an airplane. As you fly through the stars you will find that the alien's shields protect him from all hits except to the center of his ship—your shots have to be right "on target". Another interesting feature, your speed relative to the alien vessel, will determine whether he's getting closer or further away.

Zulu 9 is available on GD-8 with three other games for disk machines, black and white and color compatible with built-in DAC sound effects for \$35.00. The cassette version, which costs \$9.00, is a 4K black and white program and does not require joysticks.

OSI Invaders is a new release. Starting with three turrets, fire your laser cannon at the hoard of alien invaders as they relentlessly march across the screen

coming closer and closer, constantly dropping bombs on you and your shields. This popular game (written in assembler) offers 15 levels of play from slow to very, very fast. Each time you clear the screen you will get another turret (up to nine maximum) but it gets harder because the invaders come faster each time and the fewer you can see, the faster they go!

This is a one player game that is played from the keyboard. Current score, turret count, and high score are constantly displayed. Disk versions store the high score for each level (cassettes do not). The cassette costs \$19.00, runs in 8K on C1P's, C4P's and C8P's (program does not use color or sound). The disk is available for C1P's, C4P's and C8P's for \$29.00.

## Pinball 2001

Many users of Ohio Scientific's personal computers submit programs for our consideration. This one was authored by Mr. Robert Wiebe of Canada. The instructions are self-contained and complete. This is easily converted to BASIC-in-ROM machines by modifying lines 160, 161 and 2455. The POKES contained in those lines may be new to some readers: POKE 9770,0 disables the scroll and POKE 9770,64 restores it.

Some interesting visual effects can be produced by experimenting with these POKES. Try the following for starters:

```
10 FOR SC = 1 TO 30:?:NEXT:A = 9770
20 FOR I = 0 TO 255:POKE A,I:?:NEXT
30 POKE A,64
```

Remember to POKE 9770,64 when you are done experimenting with various STEP rates in line 20.

```
10 REM PINBALL 2001
20 INPUT "Do you want instructions (Y/N)";R$
25 IF LEFT$(R$,1)="" THEN 2300
30 FORX=1T038:PRINT:NEXT
40 FORX=0T043:POKEX=53514,155:POKEX=54986,154:NEXT
60 FORX=54010T054466STEP64:POKEX,156:POKEX+59,157:NEXT
70 FORX=53558T054013STEP65:POKEX,169:POKEX+1,96:NEXT
75 FORX=53513T053954STEP63:POKEX,170:POKEX+1,96:NEXT
80 FORX=54509T055030STEP63:POKEX,170:POKEX+1,96:NEXT
85 FORX=54648T054037STEP63:POKEX,169:POKEX+64,96:NEXT
90 FORX=54530T054985STEP65:POKEX,169:POKEX+1,96:NEXT
95 FORX=53508T053716STEP64:POKEX,233:POKEX+23,233:NEXT
100 FORX=53721T053049STEP64:POKEX,143:POKEX+1,136:POKEX+6,143
105 POKEX+7,136:POKEX+12,143:POKEX+13,136:NEXT
110 FORX=54599T054004STEP65:POKEX,190:POKEX+1,96:NEXT
115 FORX=54795T054797:POKEX,120:POKEX+39,129:NEXT
120 FORX=54674T054678:READA:POKEX,A:POKEX+23,A:NEXT
121 Q=125
125 A=54110:B=3:FORX=1T03:FORV=0T0B:POKER=V,Q:NEXTV:A=A+63
130 B=B+2:NEXTX:A=A-64
135 FORX=1T03:A=A+65,B=B-2:FORV=0T0B:POKER=A+V,Q:NEXTV,X
140 A=CHR$(13):PRINTSPC(63)A$,POKE55167,32
145 A=53961:FORX=0T07:POKEX=A,4:POKEX+A+30,4:NEXT
150 FORX=1T010:READA:READB:POKER=A+54154,B:POKER=54196,B
155 NEXT
160 POKE073,96:A=57000
161 POKE9770,0
165 B=6
200 B=B-1:PRINTAB(47)"BALLS:"B:IFB=0THEN2400
201 PRINTAB(22)"Hit (SPACE) for ball"
202 PRINTAB(9)"SCORE:"S
205 F=0:FORX=54992T05023:POKEX,154:NEXT
210 FORX=1T050:IFPEEK(57000)=16THEN220
211 POKEX,2:NEXT
215 PRINTSPC(60):PRINT
216 FORX=1T0200:NEXTX:GOTO201
220 PRINTSPC(60):PRINT
230 POKEX3611,32:C=53620:D=-1
240 FORX=1T031:C=C+D:POKEX,226:POKEX+1,32:NEXT
250 POKEX3611,233:FORX=1T0INT(RND(C)/19*1)
260 C=C+1:POKEX,226:POKEX-1,32:NEXT
270 D=65:POKER,1
300 P=PEEK(A):IFP(20RP)>7THEN400
301 IFF=1THEN400
302 FL=19:F=1
305 IFF=7THEN375
```

Call 1-800-6850 TOLL FREE

# Small Systems Journal

## OS-65D V3.0 'DISK GET' Subroutine

One of the many extensions to BASIC in OS-65D is the DISK GET command which is used in conjunction with random access data files. The effect of the command is this: one track of data is loaded into RAM and the memory I/O pointers are set to the beginning of the record which was requested. Unfortunately, if the record you request is already in RAM, the track will still be reread when the DISK GET is encountered. Hence, sequential or nearly-sequential access of random files can become very time consuming.

This subroutine allows for sequential access to random files at a speed comparable to strictly sequential files. The PEEKs and POKEs used, as well as the DISK GET command itself, are listed in the OS-65D User's Guide, page 8. The operation of the subroutine is as follows:

1. Open the file as usual—DISK OPEN,6,filename.
2. Set the record size as usual. (The record size will default to 128 bytes.)
3. Set the variable RN to the number of the record you wish to access.
4. GOSUB10000—Transfer control to the DISK GET subroutine.
5. Repeat 3-4 as desired.
6. Close the file as usual—DISK CLOSE,6.

The subroutine differs from the actual DISK GET command in the following respects:

1. No redundant disk reads are executed, that is, if records 5 and 7 are on the same track, that track will be read only once if both records are requested sequentially.
2. A DISK GET which requires another track to be read will involve a DISK PUT operation if any information currently in the buffer has been altered.

This subroutine is designed as an aid to home users of Ohio Scientific machines. Although this routine has been thoroughly tested, it is not suggested for use by the beginning computer enthusiast. It is strongly recommended that the user become familiar with standard data file techniques before moving on to this useful extension.

```
310 IFF=3THEN325
315 FORFF=35007T054992STEP-1:POKEFF,FL:GOSUB400:NEXT
320 FORFF=34992T053007:POKEFF,154:GOSUB400:NEXT:F=0:GOTO300
325 FORFF=35000T055023:POKEFF,FL:GOSUB400:NEXTFF
330 FORFF=35023T055000STEP-1:POKEFF,154:GOSUB400:NEXT
335 F=0:GOTO300
340 IFF=1THENRETURN
350 GOTO300
375 P1=03007:F2=F1+1:FORFF=0T013:POKEF1-FF,FL:POKEF2-FF,FL
380 GOSUB400:NEXT
390 FORFF=15T008STEP-1:POKEF1-FF,154:POKEF2-FF,154:GOSUB400:NEXT
395 F=0:GOTO300
400 C=C+D:IFPEEK(C)<>32THENP=PEEK(C):C=C-D:GOTO500

401 X=RND(2):IFX>.5THENX=64
402 IFX<.5THENX=-64
420 POKEC,226:POKEC-D,32
421 DC=DC+1:IFDC<>10THEN440
422 DC=0
425 IFPEEK(C+X)<>32THEN440
430 C=C+X:POKEC,226:POKEC-X,32
440 IFF=1THENRETURN
460 GOTO300
500 IFF=154THENPOKEC,32:GOTO200
501 IFF=120THENC=C-120:POKEC,226:POKEC+120,32:D=-D:GOTO400
507 IFF<>FLTHEN540
510 X=RND(A):IFX<.5THENX=1
515 IFX>.5THENX=-1
520 C=C+X:POKEC,226:POKEC-X,32
530 IFD=63THEND=-63:GOTO400
535 IFD=65THEND=-63:GOTO400
540 S=S+P:PRINTTAB(9)"SCORE:"S:IFF<1360RP=135THEN545
541 GOTO600
545 IFD=63THEND=-63:GOTO400
550 IFD=-63THEND=63:GOTO400
555 IFD=-63THEND=65:GOTO400
560 IFD=63THEND=-65:GOTO400
600 IFD=65THEND=63:GOTO400
605 IFD=-65THEND=-63:GOTO400
610 IFD=63THEND=65:GOTO400
615 IFD=-63THEND=-65:GOTO400
2000 DATA0,42,42,42,41
2010 DATA0,221,1,222,64,140,65,139,120,140,129,139,192,140,193
2020 DATA139,256,220,257,223
2400 B$="YOUR SCORE:"+STR$(S):BB=32-INT(LEN(B$)/2)
2401 PRINTSPC(60)
2402 PRINT
2410 PRINTTAB(80)B$
2415 PRINTTAB(19)"HIT <SPACE> TO PLAY AGAIN"
2420 FORX=1T01500:NEXT:PRINTSPC(60):FORX=1T0300:NEXT
2421 PRINT
2435 PRINTTAB(10)"HIT <RETURN> TO END THE GAME"
2440 FORX=1T01500:NEXT:PRINTSPC(60):FORX=1T0300:NEXT
2441 PRINT
2450 POKEA,255:BB=PEEK(A):IFBB=17THENCLEAR:RESTORE:GOTO40
2455 IFBB=9THENPOKE9770,64:RUN"BEKED"
2460 GOTO2415
2500 FORX=1T011:PRINT:NEXT:PRINTTAB(20)"PINBALL 2001"
2505 PRINT:PRINT:PRINT
3510 PRINT"It is a simple game of Pinball in which you control"
3520 PRINT"the flippers and the computer controls the ball."
3530 PRINT
3540 PRINT"To control the left hand paddle use the left <SHIFT>"
3550 PRINT"to control the right paddle use the right <SHIFT>"
3560 PRINT"to use both paddles at the same time use both <SHIFTS>"
3570 PRINT"at the same time (hold them both down)."
```

```
10000 DEF FNA(X)=10*INT(X/16)+X-16*INT(X/16)
10010 DEF FNB(X)=16*INT(X/10)+X-10*INT(X/10)
10020 TR=INT(RN/PEEK(12042))
10030 IF FNA(TR+FNB(PEEK(9002)))=PEEK(9004) THEN 10060
10040 IF PEEK(9005) THEN DISK PUT
10050 DISK GET,RN : RETURN
10060 RA=(RN-TR*PEEK(12042))*(2^PEEK(12076))+PEEK(3998)+PEEK(3999)*256
10070 AH=INT(RA/256) : AL=RA-AH*256
10080 POKE 9132,AL : POKE 9133,AH : POKE 9155,AL : POKE 9156,AH : RETURN
```



**American Data, Inc.**  
*The world's largest distributor of  
 Ohio Scientific, Inc. Microcomputer Systems*

**ANNOUNCES**

That OSI has appointed American Data as the exclusive distributor of Ohio Scientific products for Europe including the United Kingdom, Benelux, France, West Germany, Austria, Switzerland, Denmark, Italy, Spain, Portugal, Greece, Turkey, and Iceland.

Dealer inquiries invited. Contact Barbara Hall, 352-23-172, Luxembourg or David O'Brien, American Data (301) 840-9540 Telex 64405 (USA).

**ALL ABOUT  
 OSI  
 BASIC-IN-ROM**

**BASIC and MONITOR Reference Manual**

*Aardvark Journal:* "It is the book you were hoping was packed with your computer at the factory."  
*PEEK-65:* "... goes far enough... to hold the interest of advanced programmers..."

All statements and commands are explained. Loops. Arrays. Bugs. Tapes. BASIC, Auto-load and homemade.

USR(X). Floating Point. Variable tables. Binary Structure of Source Code. Maps of pages \$00, 01, 02, FE, FF. Location of routines end \$A0 — BF.

From your OSI dealer or software house or send check to me, \$8.95 postpaid. (COD \$1.10 extra)

E. H. Carlson  
 3872 Raleigh Drive  
 Okemos, MI 48864

**WP-6502**  
 a very fine word processor

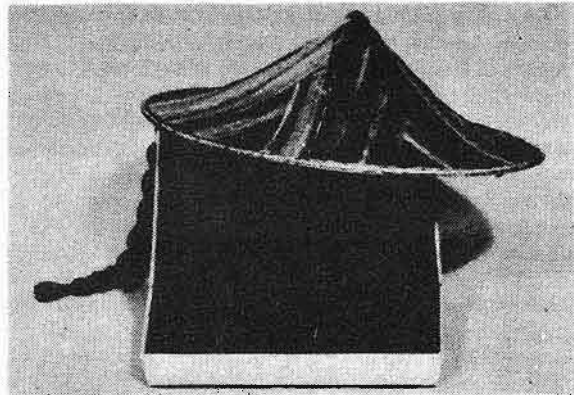

for **OHIO SCIENTIFIC**

- |                        |      |                    |             |
|------------------------|------|--------------------|-------------|
| Tape (C1,C2,C4) .....  | \$75 | 8" 65D & 65U ..... | \$125       |
| 5" Disk (C1,C2,C4) ... | \$75 | Descriptive        |             |
| 8" Disk for 65D .....  | \$75 | Brochure .....     | <b>FREE</b> |



**Dwo Quong Fok Lok Sow**  
 23 East 20th Street  
 New York City, New York 10003  
 (212) 685-2188





# A Versatile Hi-Res Function Plotter for the ATARI 400 and 800

The ATARI offers many possibilities with its color graphics. The discussion and program provide a starting point for understanding and utilizing these potentials.

David P. Allen  
19 Damon Road  
Scituate, MA 02066

In the September 1980 issue of MICRO (28:39) I presented a program for the APPLE II which plotted an infinity of trigonometric functions (and other functions as well) in the Hi-Res mode. Not long after I developed that program I obtained the new ATARI 400 computer. I was immediately impressed by the sophisticated graphics routines contained in ATARI BASIC and I decided to see how well some of my APPLE II graphics programs would translate into ATARI BASIC. The answer is ... very well, thank you!

While APPLE II has three screen modes (text, Lo-Res graphics, and Hi-Res graphics) the ATARI has *nine* screen modes and each has a greater number of permutations than does the APPLE II. This does not come completely unfettered by problems, for getting the graphic capability out of the ATARI machine is much more complicated than with the APPLE II. After telling it which of the two graphic modes you're interested in, APPLE asks only what color to plot and where to plot it. ATARI is interested in these things, and also the color of the

background, the color of the border outside the graphics window, and the luminance, or brightness, value of the plot, the background, and the border. And ATARI offers you not two grades of resolution, but *four!*

For comparison, see figure 1.

Since the ATARI 400 comes with only 8K of RAM it does not have enough available memory to support the GR.8 mode. So, my first translation from APPLE II Hi-Res graphics was to the substantially lower resolution of ATARI GR.7 mode. The conversion turned out to be quite easy and is contained in the listing. Lines 100 through 250 set the graphics parameters and, as set, will display the graph in orange (white, on black and white screens) on a black background. Change line 210 to Setcolor 2, 12, 4 and line 250 to Setcolor 4, 12, 4 and you will print the graph against a pleasant green background. Tough to do on an APPLE, easy to do on an ATARI.

I find the results of this lower resolution plot to be quite acceptable. Highly complex waveforms

can get badly muddled up at times, but changing line 50 to expand the muddled area can reveal the covered up detail. For example, if a 1- to 360-degree plot is inconclusive in the 45- to 60-degree range, then substitute 45 for 1 and 60 for 360 in line 50, and run the program again. This will cause the area in question to be expanded across the entire screen.

You can have greater resolution by stepping at rates of 1 or less in line 2100.

After this first translation I acquired an ATARI 800 computer with 48K of memory so I decided to see what would happen with a GR.8 version of this program. It comes off very well and, of course, has much higher resolution to offer than APPLE's Hi-Res mode. We are limited in the GR.8 mode to only two colors, namely white and something else for the background, but I do not find this to be particularly restricting. With more points to plot it takes more time, but much greater detail can be obtained, especially with the magnification techniques described above.

APPLE II		ATARI	
Mode	Resolution	Mode	Resolution
GR	40 × 48	GR.3	40 × 24
HGR	280 × 192	GR.4 (or 5)	80 × 48
		GR.6 (or 7)	160 × 96
		GR.8	320 × 192

Figure 1

Here are the program listings for the function plotting program in modes GR.7 and GR.8. The GR.8 version can be used with the ATARI 400 only if it is equipped with the accessory 8K memory, which makes the 400 a 16K machine.

So try these out on your ATARI machines. Eliminate the REM statements and save vast amounts of memory. Try fooling around with For... Next loops around line 2900 and get an integrated plot with variable changes. Lots of things are possible here. Have fun!

*David Allen's publications include Television System Design for the United States Air Force. As a contributing editor to Video Magazine, he writes both articles and a monthly production column.*

```

1 REM FUNCTION PLOTTER PROGRAM
2 REM BY DAVID P. ALLEN
3 REM ATARI FLOATING POINT BASIC
4 REM COPYRIGHT (C) 1980.
5 REM
6 REM THIS PROGRAM PLOTS A
7 REM CURVE FOR ANY EXPRESS-
8 REM ION AS A FUNCTION OF
9 REM INCREASING ANGLE FROM
10 REM 1 TO 360 DEGREES.
11 REM CHANGE LINE 2900
12 REM TO A FUNCTION YOU WISH
13 REM TO PLOT.
14 REM
15 REM
40 REM ESTABLISH GRAPH STARTING
41 REM AND ENDING POINTS.
42 REM
43 REM
50 R1=1:R2=360
88 REM
89 REM
90 REM SET GRAPHIC PARAMATERS
91 REM
92 REM
100 GRAPHICS 7
200 COLOR 1
210 SETCOLOR 2,0,0
250 SETCOLOR 4,0,0
268 REM
269 REM
270 REM PLOT GRAPH AXIS
271 REM
272 REM
300 PLOT 1,1:DRAWTO 1,80
400 PLOT 1,40:DRAWTO 157,40
500 FOR I=0 TO 80 STEP 10
600 PLOT 1,I:DRAWTO 3,1
700 NEXT I
800 FOR I=1 TO 158 STEP 39
900 PLOT 1,38:DRAWTO 1,42
1000 NEXT I
1100 REM
1110 REM
1120 REM SET FLAGS FOR FIRST PLOT
1130 REM AND SCALE.
1140 REM
1150 REM
2000 F=0:G=0
2010 REM
2020 REM
2030 REM START PLOTTING
2040 REM
2050 REM
2060 REM CHANGE STEP FOR MORE
2061 REM OR LESS RESOLUTION.
2062 REM IF R1>R2 THEN STEP
2063 REM MUST BE NEGATIVE
2064 REM (PRECEDED BY A MINUS
2065 REM SIGN).
2066 REM
2067 REM
2100 FOR I=R1 TO R2 STEP 3
2110 REM
2120 REM
2130 REM NEXT THREE STEPS ESTABLISH
2140 REM HORIZONTAL SCALE.
2150 REM
2160 REM
2200 IF ABS(R1)>=ABS(R2) THEN R=ABS(R1)
2300 IF ABS(R2)>=ABS(R1) THEN R=ABS(R2)
2400 IF G=0 THEN S=158/R:G=1
2500 X=I:Y=0
2550 REM
2551 REM
2552 REM CONVERT DEGREES TO
2553 REM RADIANS.
2554 REM
2555 REM
2600 X=X*3.14159/180
2650 REM
2651 REM
2652 REM PREVENTS CRASHING WHEN
2653 REM X = 0.
2654 REM
2655 REM
2800 IF X=0 THEN X=1.0E-05
2850 REM
2851 REM
2852 REM NEXT LINE DESCRIBES
2853 REM FUNCTION TO BE PLOTTED.
2854 REM

```

```

2855 REM
2900 Y1=SIN(X)*COS(X^2)
3000 Y=Y+Y1
3100 Y=Y*20
3150 REM
3151 REM
3152 REM SCALES X
3153 REM
3154 REM
3200 X=I*X
3250 REM
3251 REM
3252 REM RELATES PLOT TO X AXIS.
3253 REM
3254 REM
3300 Y=-Y+40
3350 REM
3351 REM
3352 REM SUBROUTINE PREVENTS
3353 REM OFF-SCALE CRASHING.
3354 REM
3355 REM
3400 GOSUB 5000
3450 REM
3451 REM
3452 REM PLOTS FIRST POINT.
3453 REM
3454 REM
3500 IF F=0 THEN PLOT X,Y:F=1
3600 DRAWTO X,Y
3700 NEXT I
3750 REM
3751 REM
3752 REM DISPLAYS EQUATION OF
3753 REM PLOTTED FUNCTION BENEATH
3754 REM GRAPHIC DISPLAY.
3755 REM
3756 REM
3800 LIST 2900
3900 END
5000 IF X<0 THEN X=0
5100 IF X>158 THEN X=158
5200 IF Y<0 THEN Y=0
5300 IF Y>80 THEN Y=80
5400 RETURN

1 REM FUNCTION PLOTTER PROGRAM
2 REM BY DAVID P. ALLEN
3 REM ATARI FLOATING POINT BASIC
4 REM COPYRIGHT (C) 1980.
5 REM
6 REM THIS PROGRAM PLOTS A
7 REM CURVE FOR ANY EXPRESS-
8 REM ION AS A FUNCTION OF

```

```

9 REM INCREASING ANGLE FROM
10 REM 1 TO 360 DEGREES.
11 REM CHANGE LINE 2900
12 REM TO A FUNCTION YOU WISH
13 REM TO PLOT.
14 REM
15 REM
40 REM ESTABLISH GRAPH STARTING
41 REM AND ENDING POINTS.
42 REM
43 REM
50 R1=1:R2=360
88 REM
89 REM
90 REM SET GRAPHIC PARAMATERS
91 REM
92 REM
100 GRAPHICS 8
200 COLOR 3
250 SETCOLOR 1,1,14
251 SETCOLOR 2,0,0
252 SETCOLOR 4,0,0
268 REM
269 REM
270 REM PLOT GRAPH AXIS
271 REM
272 REM
300 PLOT 1,1:DRAWTO 1,160
400 PLOT 1,80:DRAWTO 314,80
500 FOR I=0 TO 160 STEP 20
600 PLOT 1,I:DRAWTO 6,I
700 NEXT I
800 FOR I=0 TO 316 STEP 79
900 PLOT I,76:DRAWTO I,84
1000 NEXT I
1100 REM
1110 REM
1120 REM SET FLAGS FOR FIRST PLOT
1130 REM AND SCALE.
1140 REM
1150 REM
2000 F=0:G=0
2010 REM
2020 REM
2030 REM START PLOTTING
2040 REM
2050 REM
2060 REM CHANGE STEP FOR MORE
2061 REM OR LESS RESOLUTION.
2062 REM IF R1>R2 THEN STEP
2063 REM MUST BE NEGATIVE
2064 REM (PRECEDED BY A MINUS
2065 REM SIGN).
2066 REM

```

```

2067 REM
2100 FOR I=R1 TO R2 STEP 3
2110 REM
2120 REM
2130 REM NEXT THREE STEPS ESTABLISH
2140 REM HORIZONTAL SCALE.
2150 REM
2160 REM
2200 IF ABS(R1)>=ABS(R2) THEN R=ABS(R1)
2300 IF ABS(R2)>=ABS(R1) THEN R=ABS(R2)
2400 IF G=0 THEN S=316/R:G=1
2500 X=I:Y=0
2550 REM
2551 REM
2552 REM CONVERT DEGREES TO
2553 REM RADIANS.
2554 REM
2555 REM
2600 X=X*3.14159/180
2650 REM
2651 REM
2652 REM PREVENTS CRASHING WHEN
2653 REM X = 0.
2654 REM
2655 REM
2800 IF X=0 THEN X=1.0E-05
2850 REM
2851 REM
2852 REM NEXT LINE DESCRIBES
2853 REM FUNCTION TO BE PLOTTED.
2854 REM
2855 REM
2900 Y1=SIN(X)*COS(X^2)
3000 Y=Y+Y1
3100 Y=Y*20
3150 REM
3151 REM
3152 REM SCALES X
3153 REM
3154 REM
3200 X=X*S
3250 REM
3251 REM
3252 REM RELATES PLOT TO X AXIS.
3253 REM
3254 REM
3300 Y=-Y+80
3350 REM
3351 REM
3352 REM SUBROUTINE PREVENTS
3353 REM OFF-SCALE CRASHING.
3354 REM
3355 REM
3400 GOSUB 5000
3450 REM
3451 REM
3452 REM PLOTS FIRST POINT.
3453 REM
3454 REM
3500 IF F=0 THEN PLOT X,Y:F=1
3600 DRAWTO X,Y
3700 NEXT I
3750 REM
3751 REM
3752 REM DISPLAYS EQUATION OF
3753 REM PLOTTED FUNCTION BENEATH
3754 REM GRAPHIC DISPLAY.
3755 REM
3756 REM
3800 LIST 2900
3900 END
5000 IF X<0 THEN X=0
5100 IF X>316 THEN X=316
5200 IF Y<0 THEN Y=0
5300 IF Y>160 THEN Y=160
5400 RETURN

```

# OHIO SCIENTIFIC USERS

SOFTWARE - GAME AND UTILITY PROGRAMS FOR AS LOW AS \$1.00. ALL WITH LISTINGS AND COMPLETE DOCUMENTATION.

KITS - UPDATE YOUR COMPUTER TO PLAY MUSIC, INCREASE OPERATING SPEED, HIGH RESOLUTION GRAPHICS AND MUCH MORE. KITS INCLUDE PARTS AND COMPLETE ASSEMBLY INSTRUCTIONS. LOW AS \$3.00.

OUR \$1.00 CATALOG INCLUDES OSI PROGRAMMING TIPS PLUS DESCRIPTIONS OF AVAILABLE PROGRAMS AND KITS.



**MITTENDORF ENGINEERING 905 VILLA NUEVA DR. LITCHFIELD PARK, AZ 85340**

# Up From the Basements

by Jeff Beamsley

Though this column is being written in the heat of late summer, it will appear in late fall. For those of you who own department stores, late fall is just before that joyful time of uncontrolled consumption called Christmas. This will also be the first Christmas that the mass marketers will be involved in personal computers in a big way. In the thick of it, of course, is Ohio Scientific.

Large retailers have not had very pleasant experiences with home computers. Sears Roebuck and Co. made several tentative attempts to sell machines. Its latest liason was with Atari. At last report, Sears had pulled the Atari machines out of its stores because of the problems store personnel had selling and supporting the machines. Sears has since set up a special training program to educate its salespeople in the finer points of computer marketing. All of the retail computer stores had a chortle over that. But Sears and others did not get to be large multi-million dollar corporations by making silly mistakes. Where there is a dollar bill, there is a way.

Working under that philosophy, Ohio Scientific and Montgomery Ward & Co. have devised a solution to the problem. Their solution takes advantage of the "client store" philosophy used to justify the insurance booths, optical centers, restaurants, and specialty shops present in many department stores. These activities are not owned by the store. The operators rent the floor space for some percentage of the gross and provide the furniture and personnel. This same approach with staff and financing from local distributors and dealers will be producing Ohio Scientific computer shops in Ward's stores all over the country from now through Christmas.

Montgomery Ward is just the beginning, though. Every corporate president and his accountant read of the 650% growth enjoyed by Apple Computer Co. last year. They are all going to be eagerly watching this Christmas season, expecting to enjoy the same success. Digital Equipment Corporation (DEC) has already opened a number of retail stores around the country. Xerox Corporation is rumored to be taking the same path, as a result of a marketing agreement with Apple. Not to be outdone, Ohio Scientific is also represented among the biggies. CDC, that's spelled Control Data Corporation, is opening ten retail stores nationwide to market its PLATO systems and Ohio Scientific equipment. The CDC stores will also serve as regional repair depots for Ohio Scientific personal machines.

How do all of these fireworks affect you and me? Among other things, Ohio Scientific products will probably enjoy the biggest boost in credibility since Clark Kent discovered the phone booth. If the Montgomery Ward program is even marginally successful, there will be a very large number of new Ohio Scientific users coming into the marketplace. The average store must

produce twelve to fifteen users a month to break even. Multiply that by the hundred or so stores that are scheduled to be open by the Christmas season, and you get an idea of the potential of the market.

These new users will demand services from the marketplace in the form of software, additional documentation, and support. Ohio Scientific has already contracted with Howard W. Sams & Co., Inc. to rewrite its personal computer manuals in anticipation of this demand. Ohio Scientific has created a new machine, the C4P-DF, to better bridge the gap between the personal machine and its line of business computers. The company has also repackaged the C1P, added some features, and increased the retailer's margin. The new machine is called the C1P series II. CDC conveniently falls into place as the regional service center. CDC also has a very large library of excellent software created on its PLATO system. The company is rumored to be in the process of translating large portions of that library to run on Ohio Scientific systems — just in time to meet the anticipated demand.

We are already seeing a significant increase in independent vendors producing products for Ohio Scientific personal machines. I can't vouch for the quality of all of the software, or the advisability of some of the modifications that are advertised, but the fact that they are being advertised nationally implies that the market for such things is expanding. The influx of new users due this fall, combined with the pressure for quality documentation from Montgomery Ward and the high quality software and support due from CDC, should produce a whole new class of Ohio Scientific users. We will see the Ohio Scientific user who brags about his machine, the user who is impressed by the quality of the documentation as well as the hardware, and the user who buys the machine for the large library of software available.

Whether you like it or not, this is the user who will make up the phalanx of the personal computer invasion into the home. This is also the user that will determine the direction of the marketplace. The swelling numbers of this type of user will finally compel manufacturers to behave in a responsible way.

It is not a new age, but it is certainly a new face. If the mass market is as ripe for exploitation as the projections say, that face is sure to have a smile on it.

Please send all comments to:

Jeff Beamsley  
c/o The Software Federation  
44 University Drive  
Arlington Heights, IL 60004

**SIRIUS SOFTWARE** is proud to announce that **SYNERGISTIC SOFTWARE** is now a distributor for us and is carrying the following products in stock:

**E-Z DRAW.** It started as the best graphics editing package available for the APPLE and with our continuing support it is going to stay the best. Human engineered for ease of use and a tutorial intended to be used by computer novices. Still only \$34.95. E-Z DRAW requires a 48K APPLE with Applesoft in ROM or a Language System. Written by Jerry Jewell and Nasir/Gebelli.

**STAR CRUISER — The ULTIMATE ACTION game!** A real time hi-res action game with sound, action and suspense. Finally a game that requires fast reflexes, coordination and strategy. These critters actually chase you. A game for all ages and priced right at \$24.95. This game runs under 13 or 16 sector format with 32K RAM. Written by Nasir/Gebelli.

**BOTH BARRELS** Includes two games on the same diskette. **DUCK HUNT** is the traditional hunt from the blind, complete with dogs to retrieve the ducks and even an occasional dog fight to liven up the action. Hi-res, of course. **HIGH NOON** has you pitted against an entire town of BAD GUYS. They'll attack from doorways, windows, and even rooftops. Be quick or be dead. This has some of the most interesting graphics effects you'll see on the APPLE. Nine levels of play, one to match any age group. These games have great action, great graphics, and great sound effects. What else could you ask for? **BOTH BARRELS** requires 48K with Applesoft in ROM. Written by Nasir/Gebelli.

**SIRIUS SOFTWARE**  
1537 Howe Avenue #106  
Sacramento, CA 95825  
(916) 920-8981

**SYNERGISTIC SOFTWARE**  
5221 120th Avenue S.E.  
Bellevue, WA. 98006  
(206) 641-1917

APPLE, Applesoft and Language System are products of Apple Computer, Inc. E-Z DRAW and DUCK HUNT include character generation by Ron and Darrel Aldrich and fonts by Ted Cohn and Lawrence You.  
The products listed are all copyrighted © 1980 by SIRIUS SOFTWARE. ALL RIGHTS RESERVED.

## Computer House Div.

Programs for Commodore & Apple

"Legal Accounting" ..... \$1200.00  
"Political Party Mailing List" ..... 150.00

### ENGINEERING & MACHINE SHOP

"Machine Part Quoting" ..... \$280.00  
"Trig & Circle Tangent" ..... 70.00  
"Bolt Circle" ..... 25.00  
"Spur Gears" ..... 35.00  
"Beams; Stress & Deflection" ..... 145.00  
"Tank Thickness"  
For Filament Winding ..... 85.00

All 6 for only \$495.00

"SCRUNCH" — \$36.00

For Apple II or Apple II Plus. Compacts Basic Programs up to 20%.

Dealer inquiries invited

## COMPUTER HOUSE DIV.

1407 Clinton Road  
Jackson, Michigan 49202  
Phone: (517) 782-2132

## Computer House Div.

### Programs for Commodore Computers

- 1 - F.E.T.-Recover; File Editing Tools, Adds 11 commands to assist disk recovery ..... \$65.00
- 2 - SOF-BKUP; copy disks faster including random files. Displays error messages for bad blocks. .... \$40.00
- 3 - SUPER-RAM; checks every ram address against every other ram address, 2001 series ..... \$20.00
- 4 - VARI-PRINT; prints listing of all variables with every line number where each occurs ..... \$25.00
- 5 - DOCU-PRINT; prints CRT to printer, use in your own program, in basic ..... \$20.00
- 6 - SCREEN DUMP/REPEAT; similar to DOCU-PRINT except in machine language. Use with anyones program, REPEAT similar to Model 8032 ..... \$35.00
- 7 - TRACE-PRINT; prints listing of all line numbers in order of execution ..... \$25.00
- 8 - SCRUNCH-PLUS; packs a copy of program to save up to 25% of memory space. .... \$25.00
- 9 - SORTER; sorts a one dimensional array alphabetically (in machine language). .... \$35.00

PACKAGE PRICE \$170.00 FOR ALL 9 PROGRAMS  
SAVE \$120.00

Dealer inquiries invited

## COMPUTER HOUSE DIV.

1407 Clinton Road  
Jackson, Michigan 49202  
Phone: (517) 782-2132

# John Conway's Game of Life Using Display Devices with Automatic Scrolling

Life has been presented before for specific video displays. Here are the routines necessary to run Life on any general display device.

Theodore E. Bridge  
54 Williamsburg Drive  
Springfield, MA 01108

This is a much improved version of a previous article on the game of Life that was published in MICRO February 1979 (9:39). You can easily adapt this program for any 6502 computer by changing jump instructions between addresses 2096—20AF. You can use any display device, even a printer, if it will automatically roll the display upwards after the bottom line is printed.

The program is very fast. A carriage return occurs as soon as there are no more characters to be printed on a line. Moreover, two lines in the pond are printed as only one line on the display. Refer to the examples to see how this works.

Furthermore, you can change parameters in the program to adjust to the size of your display. Also, you can skip one or more generations between printings.

Martin Gardner published John Conway's game of Life in the October and November, 1970 issues of the *The Scientific American*. Our two examples were taken from his article.

We like to think of the game of Life as a computer simulation of a virus growing on a pond of DNA, using Conway's genetic rules, which are:

1. An empty cell having exactly 3 neighbors will give birth to a new cell.
2. A living cell having less than 2, or more than three neighbors will die.
3. All births and deaths occur at one time at the end of each generation; after all cells have been examined.

We kill all cells that touch the bank of the pond. This is necessary to prevent wrap-around. The pattern would be badly damaged if wrap-around growth were allowed to collide with the main organism. Because of our rather small pond, the display in our example 2 has already departed from the original pattern produced on an infinite pond.

The program occupies \$298 bytes of RAM. The pond immediately follows the program. The following space is needed for the pond:  $2*(CPL*(LIS + 1))$ .

After loading the program, start at address 2000 and depress "G". The computer will respond with "ENTER V,H?". This is your cue to start entering the verticle and horizontal coordinates for each living cell in the seed group that you want to start with. This is your way of planting the seed of the organism that you want to study.

These coordinates are displacements from an origin at the center of the screen. Positive directions are down and to the right. A coordinate may be any decimal digit less than "8", followed by a minus sign "-", if negative; or a space if positive. If you make a mistake, enter the letter "X" to erase the entry. (Any letter may be substituted for "X".)

ADDR	Parameter Name	Default Value	Description
2001	CPL	\$20	Insert the number of characters per line in your display.
2005	LIS	\$10	Insert the number of lines in your screen.
2009	GPB	\$00	Insert the number of generations to be skipped between printings.

After you have entered coordinates for all of the living cells in the arrangement you want to start with, depress slash "/", and you are off and running.

The following two examples were given in Gardner's article:

**Example 1: the famous traffic light.**  
It is plotted on a pond 16 x 16.

```
KIM
2000 AS 2001
2001 20 10.
2002 85 2005
2005 10 8.
2006 86 2000
2000 AS C
```

```
      ','
```

```
0002
```

```
      ';;'
```

```
0003
```

```
      ''''
      ''''
      '''
```

```
0004
```

```
      ';;'
      ';;'
```

```
0005
```

```
      ''''
      ''''
```

```
0006
```

```
      ';;'
      ';;'
      ';;'
```

```
0007
```

```
      ';;'
      ';;'
      ';;'
```

```
0008
```

```
      ''''
      ''''
      ''''
      ''''
```

```
0009
```

```
      ';;'
      ';;'
      ';;'
      ';;'
      ';;'
```

```
0010
```

```
      ''''
      ''''
      ''''
      ''''
      ''''
```

```
0011
```

```
      ';;'
      ';;'
      ';;'
      ';;'
```

```
0012
```

```
      ''''
      ''''
      ''''
      ''''
```

**Example 2: the R pentomino that was plotted to its death after 1103 generations at the Case Western Reserve University with a computer program by Gary Fillpski and Brad Morgan, with the results sent in by Ranan B. Banerji. It has produced 6 gliders before death. Here we plot every tenth generation on our ASR 33 TTY at 110 BAUD.**

```
2000 AS 2009
2009 04 9.
200A 85 2000
2000 AS C
```

```
      ','
```

```
0011
```

```
      ''''
      ''''
      ''''
```

```
0021
```

```
      ';;'
      ';;'
      ';;'
      ';;'
      ';;'
```

```
0031
```

```
      ''''
      ''''
      ''''
      ''''
```

```
0041
```

```
      ';;'
      ';;'
      ';;'
      ';;'
```

```
      ''''
      ''''
      ''''
```



```

0010: 2000      LIFE  ORG  $2000
0020: 2000      CPL   *  $0020  CHARACTERS PER LINE
0030: 2000      LIS   *  $0021  LINES IN SCREEN
0040: 2000      CENT  *  $0022  CENTER OF POND
0050: 2000      ADR   *  $0024  POINT TO PREV. LINE
0060: 2000      POINT *  $0026  POINT TO CURRENT LINE
0070: 2000      BEFORE * $0028  POINT TO LINE BEFORE POND
0080: 2000      POND  *  $002A  POINT TO START OF POND
0090: 2000      LAST  *  $002C  POINT TO LAST LINE IN POND
0100: 2000      BUFF  *  $002E  POINT TO BUFFER
0110: 2000      GC    *  $0030  GENERATION COUNT
0120: 2000      GBP   *  $0032  GENERATIONS BETWEEN PRINTS
0130: 2000      CNTG  *  $0033  COUNT OF GENERATIONS
0140: 2000      ACT   *  $0034  ACTIVITY
0150: 2000      OFFS  *  $0035  OFFSETS
0160: 2000      NN    *  $003D  NO. OF NEIGHBORS
0170: 2000      SAUV  *  $003E

0180: 2000 A9 20      LDAIM $20    SET 32
0190: 2002 85 20      STA  CPL      CHARS./LINE
0200: 2004 A2 18      LDXIM $10    SET 16
0210: 2006 86 21      STX  LIS      LINES IN SCREEN
0220: 2008 A9 00      LDAIM $00    SET ZERO
0230: 200A 85 32      STA  GBP      GENERATIONS BETWEEN PRINTS
0240: 200C A9 57      LDAIM END
0250: 200E 85 28      STA  BEFORE
0260: 2010 A9 22      LDAIM END /256
0270: 2012 85 29      STA  BEFORE +01
0280: 2014 1B          CLC
0290: 2016 A5 28      LDA  BEFORE
0300: 2017 85 20      ADC  CPL
0310: 2019 85 2A      STA  POND
0320: 201B 85 24      STA  ADR
0330: 201D A5 29      LDA  BEFORE +01
0340: 201F 69 00      ADCIM $00
0350: 2021 85 2B      STA  POND +01
0360: 2023 85 25      STA  ADR +01
0370:
0380:
0390:
0400: 2025 20 B0 20    JSR  MULTA
0410: 2028 A5 20      LDA  CPL
0420: 202A 4A          LSR#
0430: 202B 18          CLC
0440: 202C 65 24      ADC  ADR
0450: 202E 85 22      STA  CENT
0460: 2030 A5 25      LDA  ADR +01
0470: 2032 69 00      ADCIM $00
0480: 2034 85 23      STA  CENT +01
0490: 2036 A6 21      LDX  LIS
0500: 2038 20 B0 20    JSR  MULTA
0510: 203B 1B          CLC
0520: 203C A5 24      LDA  ADR
0530: 203E 85 2C      STA  LAST
0540: 2040 85 20      ADC  CPL
0550: 2042 85 2E      STA  BUFF
0560: 2044 A5 25      LDA  ADR +01
LIFE
0570: 2046 85 2D      STA  LAST +01
0580: 2048 69 00      ADCIM $00
0590: 204A 85 2F      STA  BUFF +01
0600:
0610:
0620:
0630: 204C A9 00      LDAIM $00
0640: 204E 85 35      STA  OFFS
0650: 2050 1B          CLC
0660: 2051 65 20      ADC  CPL
0670: 2053 85 36      STA  OFFS +01
0680: 2055 65 20      ADC  CPL
0690: 2057 85 37      STA  OFFS +02
0700: 2059 A9 01      LDAIM $01
0710: 205B 85 38      STA  OFFS +03
0720: 205D 65 20      ADC  CPL
0730: 205F 65 20      ADC  CPL
0740: 2061 85 39      STA  OFFS +04
0750: 2063 A9 02      LDAIM $02

```

0051

0061

0071

```

0760: 2065 05 3A          STA  OFFS  +05
0770: 2067 05 20          ADC  CPL
0780: 2069 05 30          STA  OFFS  +06
0790: 206B 05 20          ADC  CPL
0800: 206D 05 3C          STA  OFFS  +07
0810:
0820:                MAIN STRUCTURE
0830:
0840: 206F A0 00          LDYIM $00
0850: 2071 04 33          STY  CNTG
0860: 2073 04 30          STY  GC
0870: 2075 04 31          STY  GC  +01
0880: 2077 20 F2 20        JSR  CLEAR  FOND
0890: 207A 20 34 21        JSR  PLANT  SEED
0900: 207D 20 07 20  STAR JSR  INCG  INC. GEN. COUNT
0910: 2080 20 9E 21        JSR  SHOALL OF FOND
0920: 2083 A0 00          LDYIM $00
0930: 2085 04 34          STY  ACT
0940: 2087 20 01 22      JSR  POST   BIRTHS AND DEATHS
0950: 208A 20 5A 22      JSR  UPDATE FOND
0960: 208D A5 34          LDA  ACT   IF ACTIVITY IS
0970: 208F 00 CC          BNE  STAR  ZERO
0980: 2091 00            BRK
0990: 2092 00            BRK  HALT
1000: 2093 20 B0 20      JSR  STAR  +03 SHOW FOND
1010:
1020:                LINKAGL TO KIM ROUTINES
1030:
1040: 2096 4C 3B 1E  PRFBY JMP  $1E3B
1050: 2099 04 3C          GETCH STY  SAVY
1060: 209B 20 5A 1E        JSR  $1E5A
1070: 209E A4 3E          LDY  SAVY
1080: 20A0 00            RTS
1090: 20A1 A9 00          CRLF  LTRIM $00
1100: 20A3 20 AB 20        JSR  OUTTR
1110: 20A6 A9 00          LTRIM $0A
1120: 20A8 04 3E          OUTCH STY  SAVY
LIFE
1130: 20AA 20 A0 1E        TRP  $1EAO
1140: 20AD A9 3E          LDY  SAVY
1150: 20AF 00            RTS
1160:
1170:                ADD CPL TO ACT (X) TIMES
1180:
1190: 20B0 4A          MULTA DEX
1200: 20B1 30 FC          BMI  MULTA  -01
1210: 20B3 18          CLC
1220: 20B4 A5 24          LDA  ADR
1230: 20B6 05 20          ADC  CPL
1240: 20B8 05 24          STA  ADR
1250: 20BA A9 00          LDALM $00
1260: 20BC 05 25          ADC  ADR  +01
1270: 20BE 05 25          STA  ADR  +01
1280: 20C0 4C B0 20      JMP  MULTA
1290:
1300:                SUBTRACT CPL (X) TIMES FROM ADR
1310:
1320: 20C3 00          RTS
1330: 20C4 CA          SUBA  DEX
1340: 20C5 30 FC          BMI  SUBA  -01
1350: 20C7 38          SEC
1360: 20C8 A5 24          LDA  ADR
1370: 20CA E5 20          SBC  CPL
1380: 20CC 05 24          STA  ADR
1390: 20CE 05 25          LDA  ADR  +01
1400: 20D0 E9 00          SBCIM $00
1410: 20D2 05 25          STA  ADR  +01
1420: 20D4 4C C4 20      JMP  SUBA
1430:
1440:                INCREMENT AND DISPLAY GEN. COUNT
1450:
1460: 20D7 20 A1 20  INCG JSR  CRLF
1470: 20DA 18          CLC
1480: 20DB FB          SED
1490: 20DC A9 01          LDALM $01
1500: 20DE 05 30          ADC  GC

```

0081



0091







# Natural Organic Apple Software

Educational, intriguing and challenging...naturally!

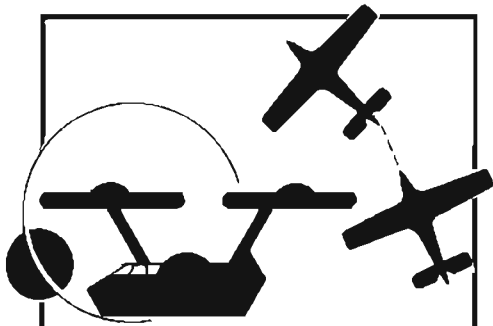

## Apple Fun

We've taken five of our most popular programs and combined them into one tremendous package full of fun and excitement. This disk-based package now offers you these great games:

**Mimic** — How good is your memory? Here's a chance to find out! Your Apple will display a sequence of figures on a 3x3 grid. You must respond with the exact same sequence, within the time limit.

There are five different, increasingly difficult versions of the game, including one that will keep going indefinitely. Mimic is exciting, fast paced and challenging — fun for all!

**Air Flight Simulation** — Your mission is to take off and land your aircraft without crashing. You're flying blind: on instruments only.

You start with a full tank of fuel, which gives you a maximum range of approximately 50 miles. The computer will constantly display updates of your air speed, compass heading and altitude. Your most important instrument is the Angle of Ascent/Bank Indicator. It will tell if the plane is climbing or descending and whether banking into a right or left turn.

After you've acquired a few hours flying time, you can try flying a course against a map or doing aerobatic maneuvers. Get a little more flight time under your belt and the sky's the limit!

**Colormaster** — Test your powers of deduction as you try to guess the secret color code in this Mastermind-type game. There are two levels of difficulty, and three options of play to vary your games. Not only can you guess the computer's color code, but it will guess yours! It will also serve as referee in a game between two human opponents. Can you make and break the color code...?

**Star Ship Attack** — Your mission is to protect our orbiting food station satellites from destruction by an enemy star ship. You must capture, destroy or drive off the attacking ship. If you fail, our planet is doomed.

**Trilogy** — This exciting contest of logic has its origins in the simple game of tic-tac-toe. The object of the game is to place three of your colors in a row into the delta-like, multi-level display. The rows may be horizontal, vertical, diagonal and wrapped around, through the "third dimension". Your Apple (or human opponent) will be trying to do the same, and there are many paths to victory. You can even have your Apple play against itself!

Minimum system requirements are an Apple II or Apple II Plus computer with 32K of memory and one minidisk drive. Mimic requires Applesoft in ROM, all others run in RAM or ROM Applesoft.

Order No. 0161AD \$19.95

## Paddle Fun

This new Apple disk package requires a steady eye and a quick hand at the game paddles! We've included four different games to challenge and amuse you. They include:

**Invaders** — You must destroy an invading fleet of 55 flying saucers while dodging the carpet of bombs they drop. Keep a wary eye for the mother ship directing the incursion. Your bomb shelters will help you — for a while. Our version of a well known arcade game! Requires Applesoft in ROM.

**Howitzer** — This is a one or two person game in which you must fire upon another howitzer position. This program is written in HIGH-RESOLUTION graphics using different terrain and wind conditions each round to make this a demanding game. The difficulty level can be altered to suit the ability of the players. Requires Applesoft in ROM.

**Space Wars** — This program has three parts: (1)

Two flying saucers meet in laser combat — for two players, (2) two saucers compete to see which can shoot out the most stars — for two players, and (3) one saucer shoots the stars in order to get a higher rank — for one player only. Requires Applesoft.

**Golf** — Whether you win or lose, you're bound to have fun on our 18 hole Apple golf course. Choose your club and your direction and hope to avoid the sandtraps. Losing too many strokes in the water hazards? You can always increase your handicap. Get off the tee and on to the green with Apple Golf. One of its nicest features is you'll never need to cancel a golf date due to rain. Requires Applesoft.

The minimum system requirement for this package is an Apple II or Apple II Plus computer with 32K of memory and one minidisk drive.

Order No. 0163AD \$19.95

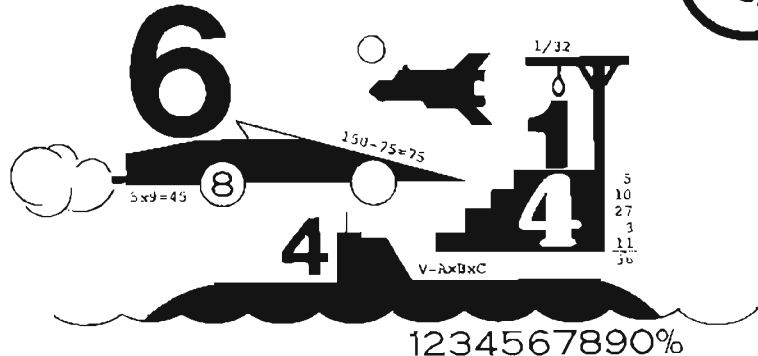

## Math Fun

Change an Apple computer into a mathematics tutor and change boredom into enthusiasm with the Math Fun package. Using the technique of immediate positive reinforcement, students can improve their math skills while playing a game with:

**Hanging** — A little man is walking up the steps to the hangman's noose. But YOU can save him by answering the problems posed by the computer. The program uses decimal math problems. Each correct answer will move the man down the steps and cheat the hangman.

**Spellbinder** — You are a magician competing against a computerized wizard. In order to cast death clouds, fireballs and other magic spells on him, you must correctly answer questions about using fractions.

**Whole Space** — Pilot your space craft to attack the enemy planet. Each time you give a correct answer to the whole number problems posed by the computer, you move your ship. But for

every wrong answer, the enemy gets a chance to fire at you.

**Car Jump** — Make your stunt car jump the ramps. Each correct answer will increase the number of buses your car must jump over. These problems involve calculating the areas of different geometric figures.

**Robot Duel** — Fire your laser cannon at the computer's robot. If you give the correct answer to problems on calculating volumes, your robot can shoot at his opponent. If you give the wrong answer, your shield power will be depleted and the computer's robot can shoot at yours.

**Sub Attack** — Practice using percentages as you maneuver your sub into the harbor. A correct answer lets you move your sub and fire at the enemy fleet.

All of these programs run in Applesoft BASIC, except Whole Space, which requires Integer BASIC.

Order No. 0160AD \$19.95

**TO ORDER:** Look for these programs at the dealer nearest you. If your store doesn't stock Instant Software send your order with payment to: Instant Software, Order Dept., Peterborough, N.H. 03458 (add \$1.00 for handling) or call toll-free 1-800-258-5473 (VISA, MC and AMEX accepted).

# Instant Software™

Prices subject to change without notice.  
PETERBOROUGH, N.H. 03458  
603-924-7296

# GALAXY SPACE WAR I

Galaxy Space War I (WAR1) is a game of strategy in which the player has complete control of his space fleet's tactical maneuvers. Each fleet battles its way toward the opponents galaxy in an attempt to destroy it and win the war. WAR1 simulates the actual environment encountered in a space war between two galaxies. Optimum use is made of Apple's high resolution graphics (HIRES) and colors in displaying the twinkling stars universe, the colored ships of each fleet, long range sensors colored illuminations, and the alternating blinking colors used in battles between ships. Complementing HIRES are the sounds of war produced by Apple's speaker.

WAR1 is played between Apple and a player or between two players. You may play with total knowledge of each others fleet or only ships sensor knowledge of the opponents fleet. Each player builds his starting fleet and adds to it during the game. This building process consists of creating the size and shape of each ship positioning it, and then allocating the total amount of energy for each ship.

During a player's turn he may dynamically allocate his ships total energy between his screen/detection and attack/move partitions. The percentage of the total energy allocated to each partition determines its characteristics. The screen/detection partition determines how much energy is in a ship's screens and the detection sector range of its short range sensors. The attack/move determines the amount of energy the ship can attack with, its attack sector range, and the number of sectors it can move in normal or hyperspace.

When an enemy ship is detected by short range sensors, it is displayed on the universe and a text enemy report appears. The report identifies the ship, its position, amount of energy in its screens, probable attack and total energy, a calculated detection/attack/move range, and size of the ship. Also shown is the number of days since you last knew these parameters about the ship. When a ship's long range sensor probes indicate the existence of an enemy presence at a sector in space, this sector is illuminated on the universe.

An enemy ship is attacked and destroyed with attack energy. If your attack energy breaks through his screens, then his attack energy is reduced by two units of energy for every unit you attack with. A text battle report is output after each attack. The program maintains your ship's data and the latest known data about each enemy ship. You may show either data in text reports or display the last known enemy positions on the universe. You can also get battle predictions between opposing ships. The text output calculates the amount of energy required to destroy each ship for different energy allocations.

APPLE® II, 48K, APPLESOFT ROM CARD, DISK II DOS 3.2  
**WAR1 DISK & MANUAL ...\$39.95**  
 (CA residents add 6% sales tax) Write or call for more information

 **GALAXY DEPT. M13 P.O. BOX 22072 SAN DIEGO, CA 92122 (714) 452-1072**

# Decision Systems

Decision Systems  
 P.O. Box 13006  
 Denton, TX 76203

## INDEXED FILES

\$60

**ISAM-DS** is an integrated set of routines for the creation and manipulation of indexed files. **ISAM-DS** provides capabilities comparable to those on large mainframes. You can rapidly retrieve records by key value or partial key value (retrieves any record in a 200 record file, 60 char/record, in less than 3 seconds compared to a maximum of 38 seconds for a **DOS** sequential file). Files never have to be reorganized. Duplicate key values may be used. Records may also be retrieved in sequence. **ISAM-DS** routines are easily integrated into Applesoft programs — they use less than **3K RAM** plus an index table.

Requires: Disk, Applesoft

## STRUCTURED BASIC

\$35

**PBASIC-DS** is a sophisticated preprocessor for structured **BASIC**. Now you can gain the power of **PASCAL**-like logic structures at a fraction of the cost. Use all regular **BASIC** statements plus 14 commands and 11 new statements/structures (**WHILE**, **UNTIL**, **CASE**, etc.). **PBASIC-DS** can be used to develop **INTEGER** or **APPLESOFT** programs. It is a great way to learn and use structured logic concepts.

Requires: Disk, Applesoft (48K ROM)

## DATA ENTRY

\$25

**FORM-DS** is a system of programs and routines that assist in the entry, editing and display of data. Describe screen formats by simply typing them on the screen. Automatic range tests for input data. Display edited numeric values with commas inserted, etc. Dump the screen contents to a printer. Routines are easily incorporated into Applesoft programs. Documentation included.

Requires: Disk, Applesoft (32K ROM)

(Texas residents add 5% tax)  
 (Add \$4.00 for Foreign Mail)

\*Apple II is a registered trademark of the Apple Computer Co.

Apple Owners!

# DEPRECIATION PROGRAM

- ★ 5 DEPRECIATION RATES
- ★ UP TO 99 YR TERM
- ★ RECORDS UP TO 600 ITEMS ON DISK
- ★ UP TO \$1 MILLION FOR EACH ITEM
- ★ REPORTS EACH MONTH, QUARTER, OR ANNUALLY
- ★ BONUS DEPR., INVESTMENT CREDIT
- ★ PRO-RATES DEPRECIATION
- ★ UPDATE RECORDS EACH YEAR
- ★ EQUIPMENT INVENTORY
- ★ FISCAL YEAR BASED
- ★ CONVERT METHODS ANY TIME
- ★ AN ACCOUNTANTS DREAM

APPLESOFT ..... 32K MIN. ~~\$25.00~~ \$150.00  
 HANDBOOK..... \$5.00

INTRODUCTORY OFFER

VISA & M/C USERS — CALL  
 509-943-9004

MONEYDISK  
 516 WELLSIAN WAY  
 RICHLAND, WA 99352



APPLE IS A REGISTERED TRADEMARK OF APPLE COMPUTER, INC. WA Residents, add 5% sales tax



DEALER INQUIRIES INVITED

# ASCII EXPRESS II

By Bill Blue

THE MOST COMPLETE COMMUNICATIONS PACKAGE FOR THE APPLE II AVAILABLE

This professional terminal system includes:

- Full upper/lower case support
- Upload/download files to ANY type of online computer
- Built-in line editor for files
- Keyboard macros for efficient operation

Recommended system requirements include a 48K APPLE II with disk, FP ROM or language card, and Micromodem or Comm. card.

\$59.95 plus 6% for Calif. residents

Available from your local computer store or:

**southwestern data systems**

P.O. BOX 582-M • SANTEE, CA 92071

(714) 562-3670

# Step and Trace for the APPLE II Plus

If you miss the Step and Trace of the original APPLE II on your new APPLE II Plus, here is all you need to restore it.

Craig Peterson  
1743 Centinela Avenue #102  
Santa Monica, CA 90404

Apple Computer's new APPLE II Plus is a pretty good machine. It has improved editing features over those of the standard APPLE II and a better cursor control and stop list feature. And it's really nice to fire up the machine and be right in BASIC or DOS, or better yet, to be in the middle of a turn-key type program.

Furthermore, Applesoft BASIC is a standard feature, and I'm partial to it over Integer BASIC. But all of these improvements didn't come for free. There's only so much room in the ROM monitor, and certain of its features had to be sacrificed to make room for the new additions. As a result, the machine language step-and-trace capabilities of the older APPLE II ended up on the cutting room floor.

A lot of people will probably never miss step and trace. Unless you are into assembly language programming, you probably don't need them. But if you do any assembly language programming, step and trace can be invaluable. They allow you to step through each machine language instruction, displaying all of the 6502 registers as you go along, so you can find any errors that might exist in the program, or even just see how the program works. Step does this one instruction at a time, and trace does it continuously, without stopping (unless a break instruction is encountered).

Well, fear not, APPLE II Plus owners, Step-n-Trace is here. The Step-n-Trace (S&T) program essentially just adds the step-and-trace

functions to the existing monitor of your APPLE II Plus. The operation and use of the monitor is identical to that of the original APPLE monitor. Type a hex address followed by one or more 'S's, to take steps through a program from that address. To trace, type a hex address followed by a 'T', to begin tracing from that address.

An improved feature of S&T over the original APPLE trace is that all you have to do is press any key (for example, the space bar) to stop the trace. To continue tracing, type a 'T', and trace will continue from where it stopped. Or you can type an 'S' to take only one step. The prompt character used for S&T is an inverse '\*' so you can distinguish it from the normal APPLE monitor. S&T also includes all of the normal monitor commands in addition to step and trace. In fact, it actually uses many parts of the existing monitor to do its work.

To use Step-n-Trace, first load it and then type 'CALL 768', or 'BRUN' it from your disk, if you have one. You will then have all of the monitor commands at your disposal, including step and trace. To get out of the program, just press 'RESET' on your APPLE II Plus, or use 'CTRL', 'C', or 'CTRL' 'B' and you will end up in BASIC.

Since the program resides in hex address \$300 to \$3E9, it loads over some of the DOS address pointers from \$3D0 to \$3E9. Generally, this doesn't cause any problems for me. However, this can be avoided by

moving it to some other area of memory; but the jump addresses in lines 590, 650, 730, 1100, 1580, and 1590 will have to be revised accordingly. The assembler listing for S&T makes use of most of the same labels as the APPLE monitor to make it easier to relate what's happening with the old monitor.

At this point, I should mention that the step-and-trace functions from the same problems as the original APPLE monitor. In that, under certain conditions, the stack register will be displayed with an incorrect value. When this happens, for example, after JSR or RTS, the display will be corrected after the next instruction. Also, if the program manipulates the stack with the use of TXS instructions, the actual operation will probably be incorrect. Lastly, with DOS in effect, when a program is traced through the changing of an I/O hook (usually \$36 or \$37) the program trace will lock up because the output will have a partially incorrect jump indirect address, and your trace will fall off the edge of the earth. The frailties mentioned above are not nearly as restrictive as they may seem. All in all, S&T is a useful utility.

For those of you who have read thus far, but don't really plan on doing any assembly language programming, here is how Applesoft works. First load Step-n-Trace and then enter the following BASIC program:

```
10 CALL 768: PRINT "HELLO"  
20 END
```

Next type 'RUN', and you will be rewarded with the sound of the bell and an inverse '\*' prompt character, telling you that you're in S&T. Next type 'FF58S'. From now on, each 'S' you type will step you through the operations of Applesoft. The first 'S' should display 'D823-4C D2 D7 JMP \$D7D2' on the screen, followed by the contents of the registers. This is the running return to Applesoft. As you 'S' step or 'T'race through the instructions, you will see the colon

(\$3A), the print command token (\$BA), the quotation (\$22), the characters of the word 'HELLO' (\$48,45,4C,4C,4F) and more pass through the A (accumulator) register, as Applesoft analyzes your program line.

With some study you'll begin to understand what Applesoft is doing. With some effort, you can actually find where the subroutines are located for the 'SIN', 'SQRT', or any

other function you're interested in. All of this is accomplished with the help of S&T.

So, if you're doing any assembly language work on an APPLE II Plus, S&T can be of great help. If you're just interested in seeing how things actually run inside your APPLE, Step-n-Trace can open a lot of interesting doors. Anyway, have fun, and if you find out anything interesting, write about it.

Table with columns for address, instruction, and assembly code. Includes instructions like STEP-N-TRACE, RETURN ADRES, and various register operations.



```

03C4 A52D 1390 RTNJ LDA *RTNH
03C6 48 1400 PHA
03C7 A52C 1410 LDA *RTNL
03C9 48 1420 PHA
03CA 4C17FA 1430 JMP REGD
03CD 18 1440 BRAN CLC
03CE A001 1450 LDY 01
03D0 B13A 1460 LDA (PCL),Y
03D2 2056F9 1470 JSR ADJ3
03D5 853A 1480 STA *PCL
03D7 98 1490 TYA
03D8 3B 1500 SEC
03D9 B0C5 1510 BCS PCN2
03DB 204AFF 1520 NBRN JSR SAVE
03DE 3B 1530 SEC
03DF B0C1 1540 BCS PCN3
03E1 EA 1550 INM1 NOP
03E2 EA 1560 INI1 NOP
03E3 EA 1570 NOP
03E4 4CDB03 1580 JMP NBRN
03E7 4CCD03 1590 JMP BRAN
1600 .EN

```

DISPLAY USR REG  
BRANCH TAKEN,  
AD LEN+2 TO PC

NORML RTN AFTR  
EXCING USER OP  
GO UPDATE PC

DUMMY FILL FOR  
REQ AREA

SYMBOL	TABLE	BELL	FF3A
RTNL	002C	RSTR	FF3F
RTNH	002D	SAVE	FF4A
LGTH	002F	GETN	FF47
FRMP	0033	TSUB	FFBE
YSAV	0034	TSB1	FFC5
PCL	003A	ZMOD	FFC7
PCH	003R	CHRT	FFCC
XGT	003C	STRT	0300
STAT	004B	CONT	0304
KBRD	0000	NXTI	030E
INSD	F882	TRYS	0313
DISA	F8D0	TRYT	0317
ADJ2	F954	ENT2	0322
ADJ3	F956	TRCR	032A
REGD	FAD7	MCMD	0337
RGDS	FADA	CHRS	0339
GETL	FD67	AGIN	0344
BL1	FE00	STPZ	0349
A1PC	FE75	STEP	034C

XQIN	0357
XQ1	03B1
XQ2	03B3
XBRK	03BF
XRTI	039B
XRTS	039C
PCN2	03A0
PCN3	03A2
XJSR	03AC
XJMP	03B7
XJAT	03B8
NEWP	03C0
RTNJ	03C4
BRAN	03CD
NBRN	03DB
INM1	03E1
INIT	03E2

μ

## NIKROM TECHNICAL PRODUCTS PRESENTS A DIAGNOSTIC PACKAGE FOR THE APPLE II AND APPLE II+ COMPUTER.

### "THE BRAIN SURGEON"

All major computer systems are checked for functional hardware analysis on a regular basis for logical as well as some practical reasons. Finding what is exactly wrong can account for most of the money consuming down-time.

Apple Computer Co. has provided you with the best equipment available to date. The Diagnostic's Package was designed to check every major area of your computer, detect errors, and report any malfunctions. *The Brain Surgeon* will put your system through exhaustive, thorough procedures, testing and reporting all findings.

The Tests include:

- MOTHERBOARD ROM TEST FOR BOTH APPLE II AND APPLE II+
- APPLESOFT I CARD TEST • INTEGER CARD TEST • MEMORY HAM TEST
- DISK DRIVE ANALYSIS • MONITOR ALIGNMENT
- DC HAYES MICRODODEM II TEST

System Diagnosis is an invaluable aid to your program library even if your system is working fine. Hours have been wasted trying to track down a "program bug" when actually hardware could be the blame!

*The Brain Surgeon* allows you to be confident of your system. This can be critical when file handling, sorts or backups are involved. You must depend on your computer during all these critical times. Running *The Brain Surgeon* prior to these important functions helps to insure that your system is operating at peak performance.

*The Brain Surgeon* is easy to use and supplied on diskette with complete documentation.

PRICE: \$39.95  
REQUIRES: 32 or 48K  
APPLESOFT: 1 Disk Drive

**Nikrom Technical Products**  
25 PROSPECT STREET • LEONMINSTER, MA 01450

APPLE is Registered  
Trademark of Apple Computer Co.  
MICRODODEM II is Registered  
Trademark of D.C. HAYES

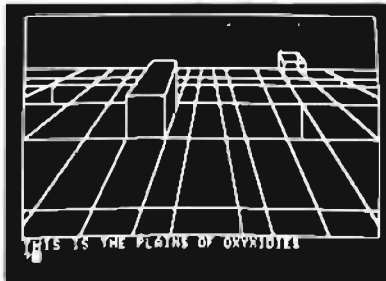
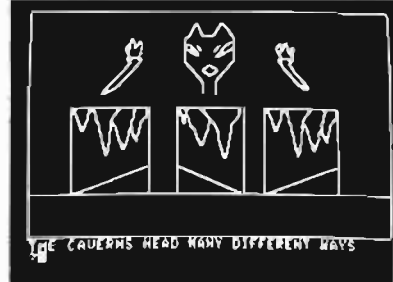

## Oldorf's Rebenge WIZARD I

WIZARD I is a well done and exciting Hi-Res game using over 100 Hi-Res pictures. WIZARD I requires 48K, Applesoft Rom, and Disk. As you explore the caverns and castles (each locale is done in Hi-Res) looking for treasure, you must battle the one-eyed, two-thumbed torkie; find the grezzertlips' sword; visit the snotgurgle's palace and get through the domain of the three-nosed ickyup plus more!

Wizard I on Disk.....\$19.95

SEE YOUR LOCAL DEALER  
OR SEND CHECKS TO

**HIGHLANDS COMPUTER SERVICES**  
14422 S.E. 132nd  
Renton, Washington 98055  
(206) 228-6691

Washington residents add 5.3% sales tax. Applesoft and Apple are registered trademarks of Apple Computers, Inc.

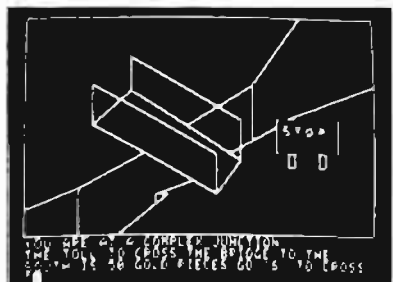
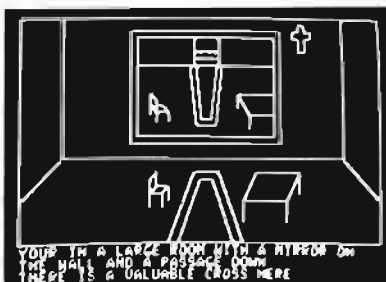
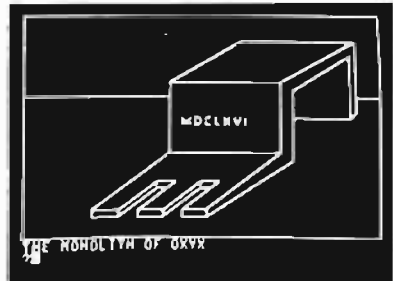

# PROGRESSIVE SOFTWARE

## Presents Software and Hardware for your APPLE

### ☆☆☆ ROSTER ☆☆☆

\*A complete package for Educators! Roster is a general purpose disk-based record-keeping program for teachers at all levels. It allows instructors to create and change class rosters label, enter and change test or assignment scores, sort the roster based on student number, student name, or rank in class, assign character or numeric grades based on any of five criteria (raw score, percent, rank, percentile rank or Z-score) and Lists scores, totals (or averages), and/or grades according to any of these options.

Roster on Disk (only) \$49.95 plus \$4.95 postage and handling.

Written by Douglas B. Eamon, Ph.D.

### ☆☆☆ FILES ☆☆☆

- \*Builds Serial Files
- \*Changes Serial Files to random access Files
- \*Adds to End of Serial Files
- \*Record insertion and deletion anywhere in Serial File
- \*Move Individual records or blocks of records within Serial Files. A file manipulator. \$49.95\*\*

### SUPER SORT & SEARCH

A free-form data-base pkg. which allows the User to define fields per record. As the data is loaded in it is automatically sorted. Can also merge together files or allow key sort entries. Will sort out a particular field, do a generic search and/or search for a specific piece of data. Will allow each particular record or records to be printed. \$69.95\*\*

#### \*\*\* VU #1 \*\*\*

- \* Accepts data from VISICALC\*
- \* Relocates data and names
- \* Corrects data and names
- \* Creates an out file that can be loaded into VISICALC\* \$49.95\*\*

#### \*\*\* VU #2 \*\*\*

Same as VU #1 except it will operate automatically to do repetitious functions, such as payroll. \$59.95\*\*

#### \*\*\* VU #3 \*\*\*

Includes VU #1 and VU #2. Will load data from any program's array statement and load it into VISICALC\*. (Will also do the reverse.) \$69.95\*\*

Written by MARC GOLDFARB

- \* VISICALC is a Trademark of Personal Software, Inc.
- \*\*ADD \$4.95 postage & handling for each of above (VU #1, VU #2, VU #3).

### HARDWARE

LIPSON LIGHT PEN - 15 programs on disk. Plugs directly into game I/O. 90 day guarantee on pen. Include \$3.00 postage & handling. \$29.95

**TOUCH TYPING TUTOR** — Teaches typing. Indicates speed and errors made. Finger Builders; General Typing; Basic Language and User Supplied. Diskette. (Applesoft or Integer).

Written by WM. MASSENA

\$19.95

**BOWLING** — Multi-player program. Various skill levels. Sound effects. Frame by frame results and total score displayed. Also, on same diskette, TIC-TAC-TOE — Col- or graphics. Announces winner.

Written by ED HOWERTON

\$19.95

**KNIGHTS** — Keyboard game. Using Chess Knight moves, change KNIGHTS to their matching half board. Also, on same diskette, SOLITAIRE — Old European peg game. Finish with last peg in center.

Written by CHARLES B. SMITH

\$19.95

### GAF UTILITY PAK I - 4 programs.

*File Compare* — compares 2 programs; reports differences to screen, printer, or disk file.

*Menu* — one keystroke program execution.

*Applesoft & Integer Sorts* — Super fast machine language sort for integer basic.

*Convert-to-Text* — Turns applesoft and integer programs into TEXT files.

Written by GARY A. FOOTE

\$19.95

### GAF UTILITY PAK II — 3 programs

*Multiple Disk Catalog* — Creates master catalog list; can be processed by APPLE'S FILE CABINET. (File cabinet report files incl. for producing lists by volume, name, type or size.)

*File Cabinet Fast Sort* — Improves File Cabinet Sort by factor of 10-20.

*File Copy* — Copies any type files from one disk to another.

Written by GARY A. FOOTE

\$19.95

**MATH DRILL I & II** — Decimal arithmetic problems and fraction problems (Add., Subtr., Multi., Div., or mixed). User selects type of operation and degree of difficulty. (Gr. 1-7)

Written by ED HOWERTON

\$19.95

**FOREIGN LANGUAGE DRILL (Spelling Drill I)** — Aids in spelling and word definition skills. User Input. Displays randomly selected word and waits for User to enter correct spelling. Contains review function.

Written by ED HOWERTON

\$19.95

## TO ORDER

Send Check or Money Order to:

**P.O. Box 273  
Plymouth Meeting, PA 19462**

PA residents add 6% sales tax.

### POSTAGE AND HANDLING

Please add \$1.50 for the first item and \$1.00 for each additional item.

U.S. and foreign dealer and distributor inquiries invited  
All programs require 16 K memory unless specified

# AIM 65 File Operations: Writing Text Files with BASIC

The value of BASIC is greatly enhanced with the capability of writing text files. The techniques and programs required are presented here.

Christopher J. Flynn  
2601 Claxton Drive  
Hemdon, VA 22070

In an article published in MICRO, July 1980 (26:61), I presented a subroutine which made AIM 65 text files accessible to BASIC. The capability to read text files with BASIC has satisfied many of our requirements. I also hope that the subroutine has been of help to other AIM 65 users as well.

There are, however, many applications which require the capability to write text files. Therefore, I have developed a second machine language subroutine to meet this need. This subroutine provides a means for creating AIM 65 text files directly from BASIC. Using this subroutine, you can store any kind of data on tape—character strings or numbers. With this subroutine you can also use BASIC to write other BASIC programs! In fact, our sample program will do just that.

As was the case with the earlier text file input subroutine, the text file output subroutine is both ROMable and completely position independent. Don't be surprised if you see sections of code from the input subroutine duplicated in the output subroutine. I have tried to emphasize ease of use above other factors.

The text file input and output subroutines handle all the file operations that will normally be required. However, I must point out one restriction at the start. A BASIC program cannot have an input file and an output file open at the same time. If a file must be updated, the

entire file must be read into memory, modified, and then written back to tape. Therefore, update processing is restricted to files which will fit entirely in memory. However, this restriction is not really too bad, since update processing must be done this way, if you only have one tape recorder connected to your AIM 65.

## Approach

The AIM 65 itself creates text files by first invoking the monitor routine WHEREO. WHEREO establishes the tape recorder as the active output device, obtains a file name, and obtains a tape drive number (1 or 2). Each time a character is to be written to tape, AIM 65 will invoke the monitor routine OUTALL. If BASIC is going to write text files these same functions must be performed.

I have designed a machine language subroutine which allows BASIC to create text files. The text file output subroutine follows the convention established by our text input subroutine. The BASIC program must place the text line (or record) in the character string variable A\$. Next, the BASIC program invokes theUSR function, the machine language subroutine locates A\$ in BASIC's memory and writes the contents of A\$ to tape. After A\$ has been written, control is given back to BASIC.

In this subroutine, I have used the capabilities of theUSR function to pass data both to and from the

machine language program. The argument of theUSR function, (which BASIC passes to the machine language program) contains the number of bytes of data to be written from A\$. In other words, you can set up A\$ as an 80 byte string and write the first 25 bytes one time, the first 50 bytes the next time, and so on. Conversely, the machine language program passes data the other way—to BASIC. The value returned by theUSR function indicates whether or not the write operation was successful.

AIM 65 users will note other similarities to our approach to reading text files. The AIM 65 will be put in the tape mode only for as long as it takes to write a record. Thus, the AIM 65 display is available as an output device between write operations. Data formatting considerations are simple: put what ever data you want into A\$ and write it.

## Loading the Subroutine

The hex dump of the machine code is shown in figure 1. In our system, the subroutine resides at location \$7CA4. Since the subroutine is position independent, you may relocate it anywhere in memory without having to change a single byte of code.

If you prefer entering the code in instruction format, the disassembly listing is included as figure 2. Just be careful of the absolute addresses which show up as operands of branch instructions.

Before testing out the subroutine, there is one address which your must check. It may vary from one version of the BASIC ROM to another. The machine language subroutine uses a BASIC subroutine to convert the USR argument from a floating point number to an integer. The address of this subroutine, not the subroutine itself, is contained in locations \$B006 and \$B007 of the BASIC ROM. Use the AIM 65 monitor to examine these locations. If they contain \$FE and \$BE respectively, then no changes are required. If they are different, however, you must modify the machine language subroutine. In this case, simply place the contents of location \$B006 into location \$7CF1, and place the contents of location \$B007 into location \$7CF2. All we are doing is telling the machine language subroutine where the BASIC floating point to integer conversion code is located.

Once your have loaded the subroutine and safely stored it on tape, you can initialize BASIC. Since the subroutine requires 148 bytes, you will have to account for this when responding the the MEMORY SIZE prompt. If you have a 4K system and you are only using the text file output subroutine, MEMORY SIZE would be 4096 minus 148 or 3948. If you are using both the text file input and output subroutines, MEMORY SIZE would be 4096 minus(148 + 164) or 3784.

#### Procedure

Now we're ready to go. The procedure for writing text files consists of the following four steps:

1. Open the file
2. Write a record
3. Test the return code
4. Close the file.

If you recall, our text file input subroutine closed the input file automatically. The text file output subroutine is different. It requires you to explicitly close the output file. This is necessary in order to make sure that the last block gets written to tape. We will illustrate these steps by going through a sample program. Our sample program will generate BASIC DATA statements. We will write these DATA statements to tape and then show how they can be appended to

a BASIC program. this is one approach to saving and reusing data.

#### Step 1: Open the File

An output file is opened by POKEing location \$F7 (247 decimal) to zero.

```
10 POKE 247,0
```

M>=7CA4	AD	13	A4	48
< > 7CA8	A5	75	85	F0
< > 7CAC	A5	76	85	F1
< > 7CB0	A5	77	C5	F0
< > 7CB4	D0	12	A5	78
< > 7CB8	C5	F1	D0	0C
< > 7CBC	A0	FF	A2	FF
< > 7CC0	68	8D	13	A4
< > 7CC4	8A	6C	08	B0
< > 7CC8	A0	00	B1	F0
< > 7CCC	C9	41	D0	07
< > 7CD0	C8	B1	F0	C9
< > 7CD4	80	F0	0D	18
< > 7CD8	A5	F0	69	07
< > 7CDC	85	F0	90	D0
< > 7CE0	E6	F1	D0	CC
< > 7CE4	A0	02	B1	F0
< > 7CE8	99	F0	00	C8
< > 7CEC	C0	05	D0	F6
< > 7CF0	20	FE	BE	A5
< > 7CF4	AC	D0	C5	A5
< > 7CF8	F7	D0	0A	20
< > 7CFC	71	E8	E6	F7
< > 7D00	AD	13	A4	85
< > 7D04	F8	A5	F8	8D
< > 7D08	13	A4	A5	F2
< > 7D0C	C5	AD	90	AC
< > 7D10	A5	AD	F0	17
< > 7D14	C9	51	B0	A4
< > 7D18	A0	00	B1	F3
< > 7D1C	20	BC	E9	C8
< > 7D20	C4	AD	D0	F6
< > 7D24	20	F0	E9	A2
< > 7D28	00	F0	95	20
< > 7D2C	F0	E9	20	F0
< > 7D30	E9	20	0A	E5
< > 7D34	A0	00	F0	EF
<				

Figure 1: Text File Output Subroutine — Hex Dump

This will cause the machine language subroutine to invoke the AIM 65 monitor WHEREO. As we have seen, WHEREO will ask for the output device, file name and tape drive number.

#### Step 2: Write the Record

```
20 LN = 50000
30 FOR I = 1 TO 5
40 A$ = STR$(LN) + "DATA"
  + STR$(I)
50 POKE 4,103
60 POKE 5,125
70 Z = USR(LEN(A$))
```

Lines 20 and 30 are part of our sample application. Since we are generating DATA statements, we need to place line numbers in front of each one. Our generated line numbers start with 50000. Five DATA statements will be output. The text line is formatted in line 40. BASIC's STR\$ function is used to convert numeric fields to character strings. The resultant line is placed in the character string A\$. A\$ is the output area. Each line of text to be written to tape must first be placed in A\$. No other variable will do. Text data cannot be written to tape from any other variable without first being moved to A\$.

Lines 50 and 60 tell BASIC where the machine language subroutine is located. The low order byte of the address (expressed in decimal) must be POKEd into location 4. Similarly, the high order byte of the address must be POKEd into location 5. In our example, the machine language subroutine is located at \$7CA4. Be sure you adjust this for your particular configuration.

The USR function in line 70 causes the machine language subroutine to write the data from A\$ to tape. Note that we've called the USR function with an argument. The argument tells the machine language subroutine how many bytes of A\$ to write. If the argument was set to, say, five, then only the first five bytes of A\$ would have been transferred to tape. By setting the argument to LEN(A\$), we insure that the entire string will be written.

NOTE: In accordance with AIM 65 text file format, the machine language subroutine will automatically append a carriage return to each line of text written. You should not try to do this with BASIC. If you do, there will be two successive carriage returns on the tape—the subroutine's and yours. As far as the AIM 65 is concerned, this represents an end-of-file mark. When you go to read the tape, you won't be able to read very much of it.

### Step 3: Test the Return Code

As line 70 shows, the USR function returns a value. This value is known appropriately as a return code. The return code can be assigned to any numeric variable (it doesn't have to be Z). The return code will tell you, from a software point of view, whether or not the write operation was successful. It won't tell you, for example, if your tape recorder is jammed or unplugged.

The return code can be interpreted as follows:

A: Return code is less than zero

If the return code has a value that is less than zero, then an error condition has been detected. There are four situations which will cause an error:

1. A\$ is not defined
2. A\$ is longer than 80 bytes
3. The USR argument is greater than 255
4. The USR argument is greater than LEN(A\$)

Please note the 80 byte limit on the length of a text line.

B. Return code is greater than or equal to zero

If the value of the return code is greater than or equal to zero, then the machine language subroutine has successfully located A\$ and has written its contents to tape. The return code will indicate the number of bytes written (exclusive of the carriage return).

Our sample program will test the return code like this:

```
80 IF Z    0 THEN STOP
90 LN = LN + 10
100 NEXT I
```

Figure 2: Text File Output-Subroutine—Instruction Format

Instruction	Comment
K> **7CA4	
/39	
7CA4 AD LDA A413	Save OUTFLG on the stack
7CA7 48 PHA	
7CA8 A5 LDA 75	Start of BASIC's symbol table
7CAA 85 STA F0	
7CAC A5 LDA 76	
7CAE 85 STA F1	
7CB0 A5 LDA 77	Is it the end of the symbol table?
7CB2 C5 CMP F0	
7CB4 D0 BNE 7CC8	No...
7CB6 A5 LDA 78	
7CB8 C5 CMP F1	
7CBA D0 BNE 7CC8	No...
7CBC A0 LDY #FF	Error exit. Set return code to -1
7CBE A2 LDX #FF	
7CC0 68 PLA	Normal exit. Restore OUTFLG
7CC1 8D STA A413	
7CC4 8A TXA	
7CC5 6C JMP (B008)	Back to BASIC
7CC8 A0 LDY #00	
7CCA B1 LDA (F0),Y	
7CCC C9 CMP #41	Is it A\$?
7CCE D0 BNE 7CD7	
7CD0 C8 INY	
7CD1 B1 LDA (F0),Y	
7CD3 C9 CMP #80	
7CD5 F0 BEQ 7CE4	
7CD7 18 CLC	Set up for next symbol table entry
7CD8 A5 LDA F0	
7CDA 69 ADC #07	
7CDC 85 STA F0	
7CDE 90 BCC 7CB0	
7CE0 E6 INC F1	
7CE2 D0 BNE 7CB0	
7CE4 A0 LDY #02	Get address and length of A\$
7CE6 B1 LDA (F0),Y	
7CE8 99 STA 00F0,Y	
7CEB C8 INY	
7CEC C0 CPY #05	
7CEE D0 BNE 7CE6	
7CF0 20 JSR BEFE	Convert USR argument to integer
7CF3 A5 LDA AC	Is it greater than 255?
7CF5 D0 BNE 7CBC	Yes, then error
7CF7 A5 LDA F7	First time through?
7CF9 D0 BNE 7D05	No...
7CFB 20 JSR E871	Yes, call WHEREO
7CFE E6 INC F7	
7D00 AD LDA A413	Pick up new OUTFLG and
7D03 85 STA F8	Save it in a temporary variable
7D05 A5 LDA F8	Restore OUTFLG from the temporary

Figure 2 (continued)

7D07	8D	STA	A413	
7D0A	A5	LDA	F2	
7D0C	C5	CMP	AD	
7D0E	90	BCC	7CBC	Error if USR arg greater than LEN(A\$)
7D10	A5	LDA	AD	
7D12	F0	BEQ	7D2B	Caller says it's time to close the file
7D14	C9	CMP	#51	
7D16	B0	BCS	7CBC	Error if USR arg greater than 80
7D18	A0	LDY	#00	
7D1A	B1	LDA	(F3),Y	Pick up a byte from A\$
7D1C	20	JSR	E9BC	Use OUTALL to write it
7D1F	C8	INY		
7D20	C4	CPY	AD	
7D22	D0	BNE	7D1A	
7D24	20	JSR	E9F0	CRLF marks the end of the line
7D27	A2	LDX	#00	
7D29	F0	BEQ	7CC0	Exit
7D2B	20	JSR	E9F0	Close the file. Two CRLFs
7D2E	20	JSR	E9F0	
7D31	20	JSR	E50A	DU11 writes the last block
7D34	A0	LDY	#00	Set return code to 0
7D36	F0	BEQ	7D27	Exit

were appended to our sample program. Please recognize that this is a sample program. We generated DATA statements only for the sake of simplicity. There is no reason why we couldn't have created and written to tape an entire BASIC program.

We have described a machine language subroutine which opens up the capability to create text files from BASIC. You can use this capability for any number of applications. Just keep in mind the restriction that was mentioned earlier in the article: an input file and an output file cannot be open at the same time in the same program.

### Subroutine Logic

Figure 4 contains the Warnier-Orr diagram of the machine language subroutine. With this diagram and the description that follows, you should be able to modify the subroutine to fit your particular needs. (To broadly review Warnier-Orr diagrams, the sequence of operations is determined by reading from the top of the diagram to the bottom. Hierarchy is indicated by reading from left to right).

A description of the zero page variable used in the subroutine is included as figure 5. If you are using our text file input subroutine, you will notice that many of the same zero page locations are used. There is no real conflict, however. Both the text file input and output subroutine initialize locations \$F0 through \$F4 each time they are called.

Upon entry to the text file output subroutine, the AIM 65 variable OUTFLG is saved on the stack. This allows us to preserve the AIM 65 active output device indicator between subroutine calls. In other words, assuming that the display/printer is the active output device, it will be disabled while the subroutine is using the tape recorder as the active output device. Next, one of two lower level routines is invoked, depending on whether or not A\$ has been defined by the BASIC program. When control is again received from one of these lower level routines, OUTFLG will be pulled from the stack. This restores the original active output device (for example the display/printer). Finally, the

So, if there is some kind of error, the program will terminate with a BREAK message.

Lines 90 and 100 set up the next DATA statement line number and finish up the loop.

### Step 4: Close the File

When we have finished writing all the records we want, we must "close" the output file. There are several actions that must be done in order to close a file. First of all, if we are writing a text file that contains BASIC source program statements, we must write a control-z at the end of the file. (Refer to the *Basic Reference Manual*, page G-3). In any case, the text file must be terminated with two carriage returns. Our machine language subroutine will take care of writing the two carriage returns. However, since the machine language subroutine has no idea of whether the text file that we are writing is a BASIC source program or not, we must write the control-z ourselves.

In our sample program, the code to close the output file is:

```
110 A$ = CHR$(26): REM
```

```
CONTROL Z
120 Z = USR(1)
130 Z = USR(0): REM CLOSE
FILE
END
```

Lines 110 and 120 write a control-z at the end of the text file.

Calling the machine language subroutine with the argument of the USR function set to zero, closes the text file. The machine language subroutine will output two consecutive carriage returns. Next, it will write the last block of data from the AIM 65 output buffer to tape. Lastly, it will turn both tape recorders (drives 1 and 2) on.

### Sample Program

Figure 3 shows a complete listing of the sample program and a test run. You should be able to duplicate the results exactly.

The sample program generates five DATA statements. These are written to a tape file. Next, the tape is read with the BASIC LOAD command (without first typing NEW). A LIST of the program reveals that not only was the tape write successful but also that the DATA statements

Figure 3: Sample Program

**STEP 1**

Key In and LIST the sample program. WARNING: The subroutine is located at \$7CA4 as specified by lines 50 and 60. You may need to change this for your system.

```
10 POKE 247,0
20 LN=50000
30 FOR I=1 TO 5
40 A$=STR$(LN)+"DATA"+STR$(I)
50 POKE 4,103
60 POKE 5,125
70 Z=USR(LEN(A$))
80 IF Z<0 THEN STOP
90 LN=LN+10
100 NEXT I
110 A$=CHR$(26):REM CONTROL-Z
120 Z=USR(1)
130 Z=USR(0):REM CLOSE FILE
140 END
```

**STEP 2**

RUN then program. It will write 1 block of data to tape TEST1.

```
RUN
OUT=T F=TEST1 T=2
00
```

**STEP 3**

LOAD tape TEST1 (do not type NEW). 1 block of data will be read. The data will be displayed as it is processed.

```
LOAD
IN=T F=TEST1 T=1
00 SRCH F=TEST1 BLK= 00 LOAD
50000DATA 1
50010DATA 2
50020DATA 3
50030DATA 4
50040DATA 5
```

**STEP 4**

LIST the program. The generated DATA have been appended to the original program.

```
10 POKE 247,0
20 LN=50000
30 FOR I=1 TO 5
40 A$=STR$(LN)+"DATA"+STR$(I)
50 POKE 4,103
60 POKE 5,125
70 Z=USR(LEN(A$))
80 IF Z<0 THEN STOP
90 LN=LN+10
100 NEXT I
110 A$=CHR$(26):REM CONTROL-Z
120 Z=USR(1)
130 Z=USR(0):REM CLOSE FILE
140 END
50000 DATA 1
50010 DATA 2
50020 DATA 3
50030 DATA 4
50040 DATA 5
```

machine language subroutine returns to BASIC. This is done by issuing a JMP indirect to location \$B008 in the BASIC ROM. \$B008 converts the 16-bit return code (stored in A and Y) to a floating point number.

If A\$ is defined, a call will be made to a subroutine in the BASIC ROM. This subroutine converts the argument of the USR function to a 16-bit integer. (Refer to page F-1 of the *BASIC Reference Manual*.) The value of the 16-bit integer is examined and one of two lower level routines is invoked as appropriate.

If A\$ is not defined, then no output record exists. This is probably an error. The machine language subroutine sets the return code to -1 to signal the error condition.

In the event that the argument of the USR function is 255 or less, the following steps will be carried out. First, if the machine language subroutine is being called for the first time, lower level initialization code will be invoked. In any case, OUTFLG is restored from the temporary variable located at \$F8. Normally, this will put the AIM 65 in the tape mode. Then, the USR argument (that is, the number of bytes to be written) is compared with the actual length of A\$.

Should the USR argument specify a value greater than 255, an error condition exists. Microsoft BASIC does not permit strings longer than 255 characters. Therefore, the machine language subroutine sets the return code to -1.

If the machine language subroutine is being called for the first time, WHEREO will be called. This AIM 65 monitor subroutine will prompt the user for the output device, file name, and tape drive number. WHEREO also sets OUTFLG with a new value. We store the new value in OUTFLG in the temporary variable at \$F8.

If the USR argument is less than or equal to the length of A\$, then processing can continue. We test the USR argument for three conditions:

- A. USR argument is 0
- B. USR argument is non-zero and less than or equal to 80

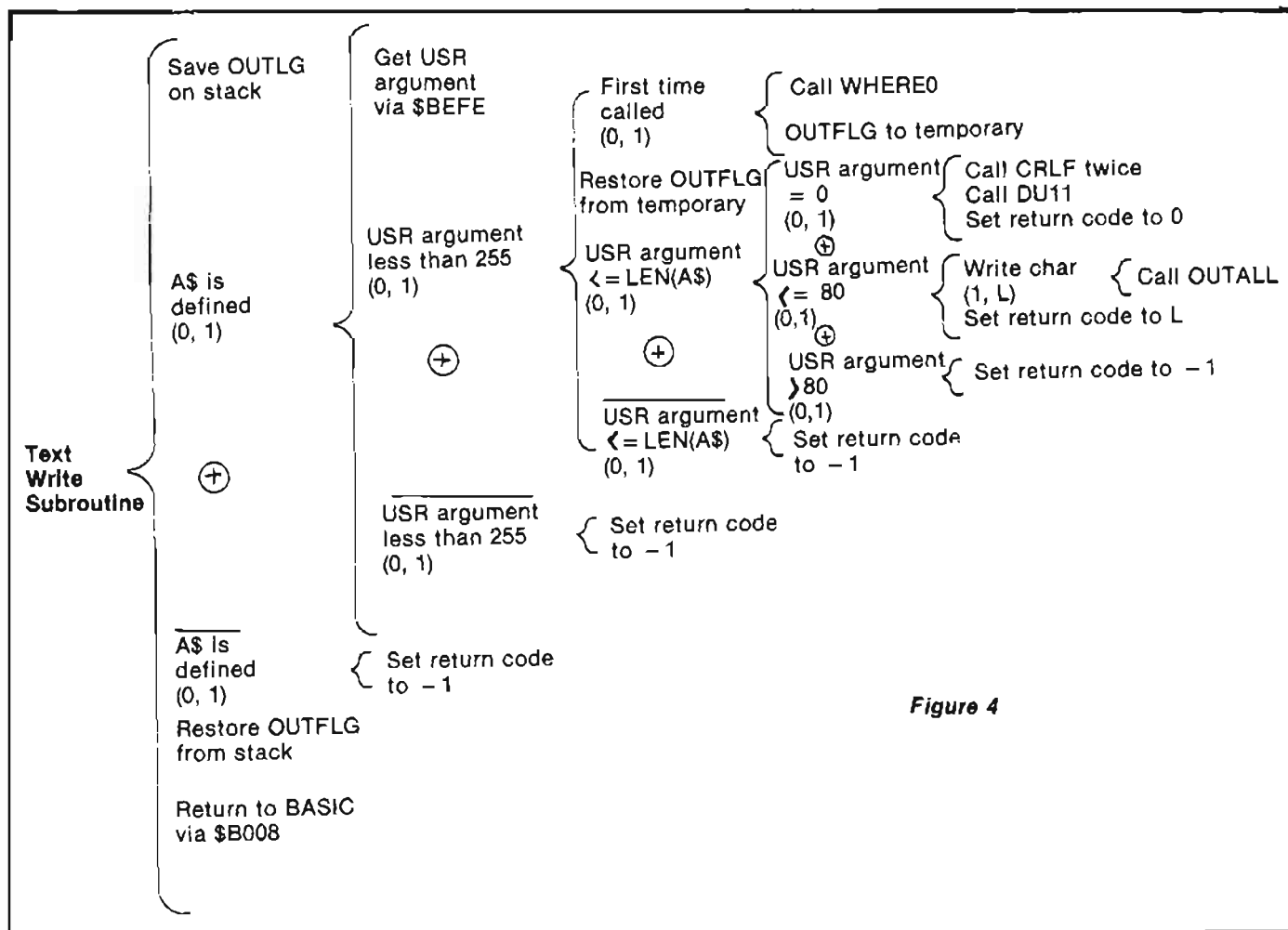

Figure 4

C. USR argument is greater than 80.

If, on the other hand, the USR argument is greater than the length of A\$, there is some inconsistency. The machine language subroutine is being asked to write more data than is actually present. So, in this case, an error condition is raised and the return code is set to -1.

80, we output the number of bytes specified by the USR argument. The AIM 65 subroutine OUTALL performs the output operation. The end of the text line is marked by calling CRLF. The return code is set to the number of bytes written (exclusive of the carriage return).

If the USR argument is greater than 80, the return code is set to -1 to indicate an error. This is because we have established a maximum record length of 80 bytes for our text file input and output operations. This limitation is easily relaxed, however.

μ

An output file is closed by setting the USR argument to zero (condition A above). The following actions take place. The AIM 65 monitor routine CRLF is called twice. This puts two successive carriage returns on the tape as an end-of-file mark. Next, the monitor routine DU11 is called. DU11 writes the last tape block and turns on both tape drives. Finally, we set the return code to zero and exit.

If the USR argument is greater than zero and less than or equal to

**Figure 5: Zero Page Variables**

SYMTAB	\$F0, \$F1	Pointer to BASIC's symbol table
LEN	\$F2	Length of A\$
APNT	\$F3, \$F4	Pointer of A\$ in BASIC's memory
TEMP2	\$F7	First time switch
TOTFLG	\$F8	OUTFLG hold area



# \$\$ WIN \$\$

## *Sirius Software announces* **TWO CONTESTS**



### **1. STAR CRUISER**

Does something unusual when you score over 9999. Be the first to describe what happens and win \$100 cash. Earliest postmarked correct entry wins. Send your entry with the face sheet from the package or other proof of purchase to Sirius Software.



### **2. E-Z DRAW**

We're looking for the most creative use of E-Z Draw. Judging will be done by members of the Apple Sac Club based on originality, artistic merit, and practicality. First prize will be \$100 cash and ten runners up will each receive their choice of either E-Z Draw, Starcruiser or both barrels.

Entries for both contests must be postmarked before 12/31/80. Star Cruiser entries need only send proof of purchase with a written description of what happened when they scored over 9999. E-Z Draw entries must be submitted on apple compatible diskette. Entries must include name, address & phone number. Diskettes will be returned to the contestants but we cannot guarantee safe return and we will not assume responsibility beyond the cost of a blank diskette for any work submitted. Winners of the contests will be contacted directly and the names of all winners will be announced in advertisements in this magazine after January 1, 1981. Contest void where prohibited by law. Employees or family of Sirius Software or their distributors are excluded from participation.

E-Z DRAW and DUCK HUNT include character generation by Ron and Darrel Aldrich

**SIRIUS SOFTWARE** is proud to announce that **SYNERGISTIC SOFTWARE** is now a distributor for these products. Contact your local dealer or call **SYNERGISTIC SOFTWARE** at (206) 641-1917.

**SIRIUS SOFTWARE**  
1537 Howe Avenue #106  
Sacramento, CA 95825  
(916) 920-8981

**SYNERGISTIC SOFTWARE**  
5221 120th Ave. S.E.  
Bellevue, WA 98006  
(206) 641-1917

# The MICRO Software Catalog: XXVI

## Software announcements for the 6502 based systems

**Mike Rowa**  
P. O. Box 6502  
Chelmsford, MA 01824

**Name:** Electric Bill  
**System:** ATARI OR PET  
**Memory:** 8K  
**Language:** BASIC  
**Hardware:** no extra  
**Description:** A household utility program designed to predict what your next month's electric bill is going to be BEFORE you use the electricity. By using this program weekly, you can watch your consumption rate, cutting excessive electrical use. Software package comes with BASIC program on cassette and six pages of documentation.  
**Price:** \$4.95 for PET version  
\$5.95 for ATARI version  
**Author:** Mitchell Kelly  
Advanced Data Services  
**Available:** Kinetic Designs  
401 Monument  
Rd.#123  
Jacksonville, FL 32211

**Name:** CRS/PDOS  
**System:** PET-Old or New Roms  
**Memory:** 16K, 24K, or 32K  
**Language:** Machine Language  
**Description:** A comprehensive disk operating system for the Microtech PEDISK — floppy disk system for PET. The system was designed to be easy to use, simple syntax, yet still provide powerful data file handling capabilities. It greatly facilitates the use of languages other than BASIC and a conditional assembler/editor is available. Its use does not interfere with any feature of the PET. All commands and keywords function as they do in a PET without

CRS/PDOS. Disk functions are provided by new commands added to PET BASIC for disk program and data file control. Can be modified.  
**Price:** \$75.00 (available with EXS 100 board)  
**Available:** CGRS Microtech, Inc.  
P.O. Box 102  
Langhorne, PA 19047

**Name:** GROCERY LIST  
**System:** APPLE II or APPLE II +  
**Memory:** 48K  
**Language:** ROM or RAM Applesoft  
**Hardware:** DISK II and PRINTER  
**Description:** An easy-to-use, self prompting program that lets the user scan a Master File of up to 500 grocery and related items. With a single key-stroke the shopper may select the quantity and item desired. Prints a shopping list organized by table number, section number, or department, such as "DARY", "DELI", or any other four letter code. The code is user defined. Over 150 items on a Master File are included. A Master File Editor is also included.  
**Price:** \$19.95 on disk  
**Includes:** Diskette and complete documentation  
**Author:** D.R. Jarvis  
**Available:** D. R. JARVIS COMPUTING  
1039 Cadiz Dr.  
Simi, CA 93065

**Name:** C1 Shorthand  
**System:** OS/ C1 (and Super-board) BASIC-in-ROM

**Memory:** Any size system  
**Language:** Basic and machine  
**Hardware:** None special  
**Description:** Shorthand is a BASIC program that POKES in a machine language routine that will allow you to use two keys to enter BASIC keywords and commands. Saves much time in typing in long programs. C2, C4, and C8 versions are about to be released. Write for availability.  
**Copies:** Just released  
**Price:** \$12 on cassette tape, ppd.  
**Author:** Mike Cohen  
**Available:** Orion Software Associates  
147 Main Street  
Ossining, N.Y. 10562

**Name:** Magic Boot  
**System:** Ohio Scientific  
**Hardware:** Disk  
**Software:** OS65D  
**Memory:** Uses 2K  
**Description:** Adds renumber, full cursor editing, memory pack, screen clear and color background to BASIC. All routines are superfast machine code and handle All cases. These are not USR (x) routines, but extensions to BASIC itself. All you do is boot and these commands are ready to use—in immediate mode or in your programs. Also includes new BEXEC\* and disk utilities. Write for more information or separate price list.  
**Price:** \$50.00  
**Available:** Universal Systems  
1647 E. Old Shakopee Rd.  
Minneapolis, MN 55420

# OHIO SCIENTIFIC

FREE  
ATV  
MICROVERTER  
with

## Challenger 1P

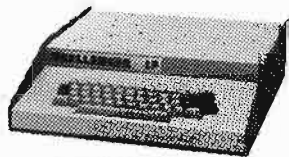

Superboard II  
also  
C2OEM-  
The Best Buy  
In 8" Disk Systems

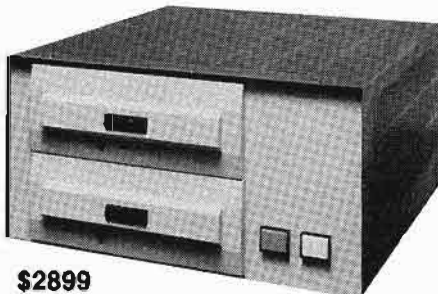

\$2899

The C2-OEM cabinet can be table top, rack mounted or incorporated in a matching desk which will accommodate a CRT terminal and printer. Industry standard parts provide very reliable operation and easy service. And best of all, the C2-OEM can make use of most of the business application software and accessories for the popular, premium performance Ohio Scientific Challenger III.

### COMPUTERSHOP

Boston 590 Comm. Ave. (across from B. U.) 247-0700	Union N.H. Rte 16B 603-473-2323	Cambridge 288 Norfolk St. (near M.I.T.) 661-2670
---	---------------------------------------	---

### PROGRESSIVE COMPUTER SOFTWARE

405 Corbin Rd., York, Pa. 17403  
(717) 845-4954

SOFTWARE — HARDWARE — SYSTEMS  
CUSTOM PROGRAMMING

APPLE & HDE  
\* \* \* \* \*

### TEMA II

The latest in a series of machine language program development tools for the APPLE. TEMA-2 is a machine language debugging aid designed to run exactly like the main-frame debug programs.

With TEMA-2 you can display or change the content of any register or memory location; display the last 4 stack locations; JSR to any subroutine without any interference to the user program flow. The direct mode also allows display format testing and finding ASCII or hex strings of up to 256 characters. A TEMA command editor checks all inputs.

Complete with TEMA-2 Trainer (in Applesoft or Integer) on disk, for \$49.95. HDE version coming soon.

Write for complete catalog

### MR. RAINBOW announces...

our all new 1980 catalog and prompts you to peek at the latest collection of software and hardware products for your APPLE II™



Write or call today for your free 1980 catalog.



Garden Plaza Shopping Center  
9719 Reseda Boulevard  
Northridge, California 91324 (213) 549-5560 Dept. 9M1

### MICRO-WARE DISTRIBUTING INC. PRESENTS

NEW—THE APPLE CARD — PLASTIC 8½x11 Reference Card for the APPLE \$3.98.

NEW DISK SOFTWARE FOR APPLE™: **UNCOPY**—A unique way to make APPLE disks uncopyable. Just load in the software that you want protected and init a disk with Uncopy. That's it (not for PASCAL or DOS 3.3 systems). . . . \$29.95

**GRAPH FIT**—A great hires graphing program that will make 3-d bar charts, pie charts, or line graphs. Just enter the data and the program will do the rest. (48K A-soft). . . . \$25.00

**ROAD RALLYE**—A stimulating hires auto race game with five spectacular full screen tracks. . . . \$14.95

**SUPER SEA WAR**—Hires graphics and unique sound add to this computer enhanced version of battleship. 3 levels of play incl. Super Salvo with missiles. . . \$13.65

**THE ULTIMATE TRANSFER**—Upload or download programs to distant areas over the phone (INTEGER, A-SOFT, MACH. LANG). Needs 48K and DC Hayes Assoc. Micromodem. . . . \$25.00

**INSTANT LIBRARY SPECIAL** — Buy any 4 of the above 5 and receive a 15% discount!

Z-80 Board for APPLE from Microsoft . . . \$275.00

PRINTERS! PRINTERS! PRINTERS!

**EPSON TX-80 w/GRAFTRAX**—Full upper & lower case 125 CPS printer that will dump either APPLE hires screen in 2 sizes plus inverse or normal mode. Complete with software for the hires screen dump. Only \$795. APPLE Type Parallels Interface, add \$88.00.

**EPSON MX-80**—Bi-directional, logic seeking, dot matrix printer with a 9x9 matrix character formation. Characters can be enlarged, condensed, emphasized or double struck and full software control of horizontal & vertical tabs as well as form feed comes standard. Only \$645., APPLE Type parallel interface add \$88.00.

**V300 DAISY WHEEL PRINTER**—Another fantastic value from Japan. A high quality daisy wheel that uses standard plastic daisies and standard Diablo type ribbon with 136 printable columns. Comes with a full 90 warranty and service available through 417 nationwide WESTERN UNION locations. Only \$1999.00, with APPLE Type Parallel Interface.

Call (201) 839-3478 or (201) 835-7080 for information

Or order from: MICRO-WARE DIST. INC.  
439A Route 23  
Pompton Plains, NJ  
07444

Dealer Pricing on Request!

## EXCERT, INCORPORATED AIM-65 SYSTEMS

EXCERT specializes in AIM-65 System Integration. In addition, we sell industrial quality power supplies from Condor, cases from the Enclosures Group, and expansion products from Seawell, MTU, The Computerist, Cubit, Optimal Technology and we integrate these items into the exact System *YOU* want! These Systems are completely *Assembled and Tested* (whenever possible and at no additional charge) and *Warranted* for six (6) months. All *YOU* have to do is plug in the line cord.

Here are several of the more popular configurations:

"BASIC" System	4K AIM w/BASIC	A65-4B	\$510
	Case & Power Supply	ENC4	100
	Assembly & Test	N/C TOTAL	610
"A/D" System	4K AIM	A65-4	\$420
	8 A/D In-2 D/A out, 500 conv/sec	ADC1	115
	Cable	CABLE	25
	Case & Power Supply	ENC5A	129
	Assembly & Test	N/C TOTAL	689
"32K" System	OK AIM	A65-0	\$360
	32K DRAM Plus <sup>™</sup> -EPROM-I/O	MEB4	395
	Cable	CABLE	15
	Case & Power Supply	ENC3A	119
	Assembly & Test	N/C TOTAL	889

For more information, call or write for our complete Product Sheet:

**EXCERT, INC**

P.O. Box 8600

White Bear Lake, MN 55110

(612) 426-4114

# 1,000,000 Bytes

## PET/BETA-1

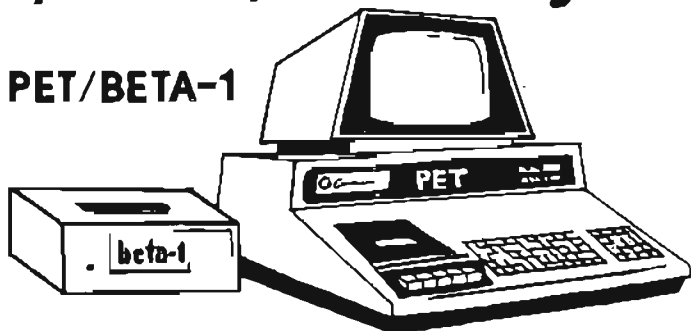

## THE FLOPPY DISK ALTERNATIVE

**FLEXIBLE DATA MANAGEMENT . . . MICRO-PROCESSOR CONTROLLED BETA-1 UNIVERSAL TAPE DRIVE BY MECA® . . . PERIPHERAL DEVICE WITH COMPLETE SOFTWARE SUPPORT**

The PET/BETA-1 digital tape system provides all the features of a disk, with powerful data handling capabilities. Your PET/CBM handles big jobs with a data capacity of one megabyte per drive, fast seek times, and 1k per second data transfer rates. Put your records on line with PET/BETA-1.

BETA-1 DRIVE, PET/BETA-1 OPERATING SYSTEM MANUAL  
 . . . . . \$700.00  
 MANUAL (applicable to purchase) . . . . . \$10.00

## PET/CBM Software

### Terminal

PETTERM I	All features above . . .	\$75.00
PETTERM II	All features of I, plus local text editor with downloading capability . . .	\$90.00
PETTERM III	All features of II, plus 80/122 column scrolling window for viewing formatted outputs wider than 40 columns . . .	\$100.00

Turn your PET into an intelligent terminal with one of our terminal packages. These are complete assembled hardware and software packages. All include line editing/ resend, repeat key, shift lock, output to CBM printer, and more . . . Delivered on PET cassette with manuals. Inquire for modem prices.

### Games

#### FORTH

Interactive high level compiler and operating system 5-10 times faster than PET BASIC. High level block structured language. A Big Forth. See August 1980 BYTE—featuring FORTH . . . \$60.00  
 With interactive assembler providing high level logic construction and macro capability . . . . . \$90.00

NUCLEAR WAR	Nuclear confrontation on a global scale. Many scenarios.	Each . . . . . \$15.00
GALAXY	Pillage a 3-D galaxy collecting loot from captive worlds.	
STOCK MARKET	Rage to riches game of buy and sell with computer stocks.	
ENCRYPT	Challenging puzzles, decipher coded messages.	
ALIEN	Protect the Federation. Real time 3-D navigation.	

**F S S**  
 software for small computers

... PET IS AN AUTHORIZED MECA, INC. DEALER  
 \*\*FEE AS RESIDENTS ADD IN SALES TAX  
 PET IS A REGISTERED TRADEMARK OF COMBOSARE, INC.

1983 Rio Grande  
 Austin, Texas  
 78785

1-512-477-2287

P.O. Box 8483  
 Austin, Texas  
 78712

# "NIBBLE<sup>®</sup> IS TERRIFIC" (For Your Apple)



**NIBBLE IS:** *The Reference for Apple computing!*

**NIBBLE IS:** One of the Fastest Growing new Magazines in the Personal Computing Field.

**NIBBLE IS:** Providing Comprehensive, Useful and Instructive Programs for the Home, Small Business, and Entertainment.

**NIBBLE IS:** A Reference to Graphics, Games, Systems Programming Tips, Product News and Reviews, Hardware Construction Projects, and a host of other features.

**NIBBLE IS:** A magazine suitable for both the Beginner and the Advanced Programmer.

Each issue of NIBBLE features significant new Programs of Commercial Quality. Here's what some of our Readers say:

- "Certainly the best magazine on the Apple II"
- "Programs remarkably easy to enter"
- "Stimulating and Informative; So much so that this is the first computer magazine I've subscribed to!"
- "Impressed with the quality and content."
- "NIBBLE IS TERRIFIC!"

*In coming issues, look for:*

- Numeric Keypad Construction Lab
- Assembly Language Programming Column
- Pascal Programming Column
- Data Base Programs for Home and Business
- Personal Investment Analysis
- Electronic Secretary for Time Management
- The GIZMO Business Simulation Game

And many many more!

NIBBLE is focused completely on the Apple Computer systems.

Buy NIBBLE through your local Apple Dealer or subscribe now with the coupon below.

**Try a NIBBLE!**

**nibble**
No. 4

Box 325, Lincoln, MA. 01773 (617) 259-9710

**I'll try nibble!**

**Enclosed is my \$15 (for one year).**

check     money order

(Please allow 4 to 6 weeks for delivery of 1st issue)  
BACK ISSUES of NIBBLE are available for \$2.00 + .50 postage and handling.

Name \_\_\_\_\_

Address \_\_\_\_\_

City \_\_\_\_\_

State \_\_\_\_\_ Zip \_\_\_\_\_

**NOTE:**

First Class or Air Mail is required for all APO, FPO and all foreign addresses with the following additional amounts:

- USA, Canada, Mexico, APO, FPO \$7.50
- Central and South America \$9.00
- Europe \$12.00
- Asia and elsewhere \$15.00

# 6502 Bibliography: Part XXVI

Dr. William R. Dial  
438 Roslyn Avenue  
Akron, OH 44320

## 721. Washington Apple Pi 2, No. 1 (Jan. 1980)

Mitchell, Howie, "Master Catalog Program," pg. 7.  
A catalog program which works well for finding diskettes containing specific programs.

## 722. The Harvest 1 No. 8 (January 1980)

Pfeiffer, Jim, "How Applesoft Stores String Arrays and a Tip on How to Clear String Array Space," pgs. 1-7.  
A tutorial for the APPLE.

Anon., "APPLE Configuration," pg. 6.  
This program figures out which cards your APPLE has in which peripheral slot.

Neiburger, Skip, "Label Maker," pg. 9.  
Print labels with a maximum of 4 lines and 28 characters in length.

## 723. The Paper 3 Issues 2/3 (March/April 1980)

Busdlecker, Roy, "The End," pgs. 19-21.  
A fast routine to find the end of whatever BASIC program that happens to be in your PET.

Barroll, Ken C., "A Simple Mail Label Program," pg. 23.  
Short Basic program for your printer.

Sparks, Paul W., "A Screen Print Machine Language Program," pgs. 24-33.  
A cookbook tutorial including assembly language programming.

## 724. APPLE Cookbook 1, No. 1 (January 1980)

Matsumoto, Tom, "Pascal Turtle Graphics," pgs. 2-3.  
How to control the Turtle head on the APPLE/Pascal system.

## 725. APPLE Cookbook 1, No. 1 (January 1980)

Wigginton, R. "Saving Character Strings on Cassette Tape," pg. 8.  
If you need to save strings to tape, this program will do very well on your Apple.

Golding, Val and Aldrich, Darrell, "Two Short Utilities," pg. 11.  
"Disk Space" and "C for Catalog" are listed for the APPLE.

## 726. APPLE Peel 2, No. 2 (February 1980)

Brown, Tom, "A New Dimension in Applesoft Programming," pgs. 8-10.  
Redimension your Applesoft array to a larger or smaller size.

## 727. The Harvest 1, No. 9 (February 1980)

Sander-Cederlof, Bob, "S-C Assembler Auto Line Number," pgs. 4-6.  
Add Auto-Number to your S-C Assembler II.

## 728. Washington APPLE Pi 2, No. 2 (February 1980)

Field, Bruce F., "Remote Temperature Measurement with the APPLE," pgs. 16-17.  
Hook up a thermistor sensor to your APPLE.

## 729. APPLE Cookbook 1, No. 2 (March/April 1980)

Matsumoto, Tom, "Pascal Tutor," pgs. 2-4.  
The second in this tutorial series on Pascal for the APPLE.

## 730. Rainbow 2, Issues 3/4 (March/April 1980)

Lee, Montgomery, "Printing Text on Page 2," pgs. 6-7.  
Hints for the APPLE.

Frazer, Fred, "The Search Goes On," pgs. 34-35.  
A faster version of a program to search for Pythagorean Triplets, on the APPLE.

## 731. The Harvest 1, No A (March 1980)

Russ, John C., "Simulation with the APPLE, or some thoughts on RND (NUMBERS)," pgs. 1-4.  
Several examples of the use of random numbers in listings.

## 732. APPLE Peel 2, No. 3 (March 1980)

Little, Gary, "EDIT + : Who needs Autostart ROM?" pg. 3.  
A program to provide editing features such as those offered on the Autostart ROM of the APPLE.

## 733. From the Core (April 1980)

Anderson, Chip, "The Processor," pg. 11.  
A utility program for the APPLE.

## 734. Stems from APPLE 3, No. 4 (April 1980)

Ward, Dennis, "Applesoft Debugger," pg. 7.  
Routine to print error codes in debugging APPLE programs.

Jochumson, Chris, "APPLE HI-RES Graphics," pgs. 8-11.  
A tutorial for Hires on the APPLE.

Reed, Ron, "APPLE Language System Pascal Patch," pgs. 16-17.  
How to live with the unruly cursor. Eliminates the flashing upper case.

## 735. The Harvest 1, No. B (April 1980)

Hobson, Blake, "DEF FN Defined," pgs. 6-7.

A program is given in which the DEF FN statement is changed with each input, thus results in a program which modifies itself.

#### 736. O.S.I. Users Independent Newsletter 3 (May 1980)

Curley, Charles, "OS-65D Addresses," pg. 2.  
A list of useful addresses for the OS-65D with comments and observations.

#### 737. Kilobaud Microcomputing No 41 (May 1980)

Baker, Robert W., "PET-Pourri," pgs. 7-8.  
Comments on Tape drive with a counter, programming tips, software and workbooks.

Garrett, Robert D., "Machine Language Routine for Challenger II," pg. 18.  
How to move a machine language program.

Williams, John D., "Software for the AIM 65," pgs. 96-98.  
Discussion of some of the mysteries of the AIM 65 monitor subroutines.

Hoyt, Bruce, "Keeping Real Time with OSI's Superboard II," pgs. 202-203.  
A real-time clock, with alarm and timer, for the 6502.

#### 738. Washington Apple PI 2, No. 4 (April 1980)

Pilloff, Hersch, "An Error in DOS 3.2.1," pg. 7.  
Under certain conditions the APPEND function will overwrite the previous sectors in the text file. Here is a fix.

Crossman, Craig, "APPLE Tricks," pg. 11.  
Learn how to INIT a disk in half the time, type 'unaccessible' characters, make your program unlistable, etc. in this article on the APPLE.

#### 739. Cider Press (April 1980)

Yee, David R., "Stop the Blinking Cursor," pg. 8.  
Routine to alter the cursor on the Apple.

Slater, Michael, "Apple Pascal Compiler," pg. 9.  
How to eliminate a bug in the compiler.

Anon., "APPEND FIX, DOS 3.2.1," pg. 10.  
Using this method, one never worries about APPEND overwriting the start of a file on the Apple Disk.

Uhley, John, "Integer Basic Super-Lock," pg. 11.  
A Machine Language program which alters an Integer Basic program using a code word which the user enters.

#### 740. Creative Computing 6, No. 5 (May, 1980)

Gelger, Rick, "Apple Strings," pg. 118-122.  
Discussion of the use of strings on the Apple.

Carpenter, Chuck, "Apple-Cart," pg. 158-165.  
Comparison of Apple II vs. Apple II Plus, Converting Integer Basic to Applesoft, Assembly Language, Monitor Commands, OpCodes, Address Modes, etc.

#### 741. Byte 5, No. 5 (May, 1980)

Helmers, Carl, "Computer-Controlled Viewing of the 1980 Eclipse," pg. 6.  
Use of an Apple II Pascal system controlling the photographing of the eclipse.

Swank, Joel, "KIMDOS," pg. 44-50.  
Using your KIM-1 with a Percom Floppy-Disk Drive.

Ezard, Lawrence A., "Formatted Program Output for the KIM-1," Pg. 190-194.  
Here is a short KIM-1 program to find bugs, print out and document programs, etc.

#### 742. Interface Age 5, Issue 6 (June, 1980)

Mallon, Marvin, "Teach Your PET to Read 'Marked Cards',"

pg. 56-61.

With your PET and a card reader you can enter data with the IBM cards.

Fox, Tom, "Looking at Micro-Based Business Systems," pg. 70-78.

6502 Based Micros are discussed in this article.

Wetzel, Ken, "A Break Service Routine for a KIM-1 with a Teletype," pg. 132-135.

The use of software Interrupts, or breakpoints, are recognized debugging aids. This listing for the KIM lists the contents of the registers on the interrupt.

#### 743. MICRO Issue 24 (May, 1980)

DePriest, Dale, "Plotting with Special Character Graphics," pg. 11-13.

A primer on generating plot mode type graphics with special characters, with special listings for PET and Challenger.

Wells, George, "SYM-1 Basic 'GET' Command," pg. 15-17.

The use of the 'GET' function is discussed and several examples for the SYM-1 are provided.

DeJong, Marvin L., "A Simple Temperature Measurement Program and Interface," pg. 19-23.

Using a micro for temperature measurement demonstrates problems involved in interfacing the real world.

Wevers, Henk J., "Shorthand Commands for Superboard II and Challenger CIP Basics," pg. 25-27.

How to intercept the BASIC's input routine and how to implement a shorthand notation.

Wilson, W.E., "A Formatted Dump Routine for the AIM 65," pg. 29-30.

Control the formatting of the dump to conform with the user's printer capabilities with this routine.

Tulloch, Michael, "New and Better PET User Port Printer Routines," pg. 33-37.

A series of programs are presented which drive any TTL, parallel, or ASCII printer from the PET's user port.

Taylor, William L., "Graphics and the Challenger CIP, Part 5," pg. 41-43.

The final installment in the series discusses plotting techniques and moving characters.

Orton, Ralph R., "SYM-1 Sends Morse Code," pg. 49-51.

Use your SYM as a Morse Code teaching tool, automatic ID'er or 'canned' message sender.

Reynolds, Lee, "An EDIT Mask Routine in Applesoft BASIC," pg. 53-57.

These routines permit you to produce professional looking output on your Apple.

Tenny, Ralph, "Expand KIM-1 Versatility in Systems Applications," pg. 63-64.

Techniques and programs permitting the simple addition of six sense switches or an ASCII keyboard to the KIM.

#### 744. Recreational Computing 8, No. 6, Issue 45 (May/June 1980)

Gollux, Ernest, "Programming the 6502 in Machine Language," pgs. 12-15.

A tutorial on machine language for 6502 micros.

Trenholme, John, "Pronounceable Names," pg. 21.  
A name generator for the PET.

Trenholme, John, "PET Input without Breaks," pg. 21.  
Useful routine for the PET.

Opedal, Donald R., "Editing Softape Prefix Programs," pg. 36.

How to manipulate those Softape programs.

**The MAGIC WAND™ is ready for APPLE™  
and OHIO SCIENTIFIC**

This powerful word processor is in stock, and we will deliver at the introductory price of \$300. (CP/M and 80 column board required).

Our fully interactive MAIL MAGIC™ mail management software, with 14 user defined fields and full merge capability is also available for \$149.

We stock hardware, software, printers for APPLE, PET, Ohio Scientific... call or write for our special prices on your specific needs.

Microsoft Z-80 Softcard	\$295.
Videx 80 column board	\$295.
NEC 12" green screen monitor	\$265.

**COMPUTER CITY**  
P.O. BOX 60284  
HOUSTON, TX 77205  
(713) 821-2702

mc/visa

**POWER TO YOUR AIM**

*Treat your AIM to a quality power supply:*

1. Designed to Rockwell's specifications for the AIM-65 (5 volts at 2 amps, regulated; 24 volts, .5 amps avg., 2.5 amps peak, unregulated).
2. *Overvoltage protection* to protect the expensive circuits in your AIM (5 volt output).
3. Handsome all metal case (two tone blue).
4. Fuse (externally accessible), switch, pilot light, line cord, cable from power supply to AIM — all included.
5. Conservative thermal design for long life.

\$64.95 plus shipping (5 lbs.)

CA residents add 6 % sales tax.  
VISA/MC, cashier's or registered check.  
Personal check (allow 2 weeks to clear).

**CompuTech**  
Box 20054  
Riverside, CA 92516

*What?  
You own  
a PET and you  
haven't received this  
brand new catalogue?*



*Software.  
Peripherals. Books.  
Over 60 items. From  
\$1.00 to \$1,250. 24 Pages.  
Write to Skyles today for  
your FREE catalogue.*



**Skyles Electric Works**

231 E South Whisman Road  
Mountain View, CA 94041

**GRAPPLE** T.M.

The Original inexpensive paper GRAPHICS PAD for the APPLE II and BELL & HOWELL MICROCOMPUTERS\*

**TEXT / LO-RES PAD**  
Formats either the TEXT or LO-RES screen. Features AUTOMATIC TEXT CENTERING.

**HI-RES PAD**  
HI-RES screens without expensive Graphics Tablet includes most-used Graphics commands.

TRUE screen proportions... NOT just graph paper. EXCELLENT for precision applications.

**EASY TO USE**  
Effective even at the elementary school level.

Simple HPLLOT statements made these pictures...



**GRAPPLE PADS:**  
\$3.00 per 50 sheet pad

**DEALER INQUIRIES INVITED**

Available at your local dealer... Ask to see the Demonstration Software

**ANOTHER CREATION FROM**

**Distributed by:**  
**SOLUTIONS, INC.**

3740 Coldry Drive  
San Antonio, Texas 78230  
(512) 690-1017

\*APPLE II is a registered TRADEMARK of Apple Computer Co.  
\*BELL & HOWELL MICROCOMPUTER is a registered TRADEMARK of BELL & HOWELL, INC.  
\*GRAPPLE is a TRADEMARK of SOLUTIONS, INC.



## HAS YOUR APPLE READ ANY GOOD PROGRAMS LATELY?

### APPLE II DISK SOFTWARE

#### DATA BASE MANAGER IFO PROGRAM

The IFO (INFORMATION FILE ORGANIZER) can be used for many applications such as sales activity, check registers, balance sheets, client/patient records, laboratory data reduction, perscription information, grade records, mailing lists, A/R, job costing and much more. This can be accomplished easily and quickly without prior programming knowledge.

Up to 1000 records with a maximum of 20 headers (categories) and 10 report formats (user defined) can be stored on a single diskette, information can be sorted on any header, both ascending and descending in alpha/numeric field. Mathematical functions can be performed on any 2 fields to manipulate the information. Information can be searched on any header using >, <, = >, = <, =, and first letter. Mailing list format provided. Fast assembly language sort, search and read routines. Many error protection devices provided. Put your application program together in minutes instead of hours.

PROGRAM DISKETTE and instruction manual...\$100.00

**MAILING LIST PROGRAM** and instruction manual...\$40.00

#### INVENTORY PROGRAM

2 disk drives, menu-driven program. Inventory categories include: STOCK#, DESCRIPTION, VENDOR ID, CLASS, LOCATION, REORDER PT., REORDER QTY, QTY ON HAND. All records can be entered, changed, updated, deleted, or viewed. Reports can be sorted in ascending/descending order by any category. There are 7 search reports (3 automatic). Calculates \$ VALUE of inventory and YTD, MTD, and period items sold, Accumulates inventory over a 13-month period. Plus much more. Requires a 132-column, serial/parallel printer, Complete turnkey operation with bootstrap diskette.

Program diskette and instruction manual...\$140.00

#### PAYROLL PACKAGE

2 disk drives, menu-driven program. Employee history include: NAME, ADDRESS #, ADDRESS #2 CITY, STATE, ZIP, FED EX, STATE EX., SOCIAL SEC.#, DATE EMPLOYED, DEPT #, CODE, EMPLOYEE #, STATUS, MARITAL STATUS, PAY RATE, OT RATE, VAC RATE, # VAC HRS, and PENSION PLAN. Program can generate weekly or biweekly payroll. Prints W-2, QTR REPORT, PAY CHECKS, MASTER AND CURRENT files. FEDERAL and STATE withholding taxes are built into program. Maintains a CASH DISBURSEMENT journal, Accumulates payroll for a 53 week period. Generates numerous type of payroll reports. Allows data to be searched, sorted and edited. Prints DEDUCTION register and more. Maintain up to 125 EMPLOYEES/EXPENSES for quick and easy PAYROLL. Numerous error protection devices provided.

PROGRAM diskette and instruction manual...\$240.00

\*PLEASE SPECIFY STATE WHEN ORDERING

#### APARTMENT MANAGER

2 disk drive, menu driven program written in assembly language and APPLESOFT II. All you will ever need to manage your apartment. Handles up to 6 BUILDINGS with a maximum of 120 units each. Complete turnkey operation. Data categories include APT #, TYPE, TENANT NAME, PETS, CHILDREN, SECURITY DEP., PET DEPOSIT, POOL DEP, MISC DEP, RENT ALLOWANCES, DATE MOVED IN, VACANCY DATE, REFERRAL, CONDITION OF APT, DAMAGE AMT and COMMENT LINE. Search, sort, enter, edit and vacate tenants. Maintains a MTD and YTD rent receipts as well as complete utility reports, rent lost by vacancies. Maintains expenses, vacated tenants report and much more.

PROGRAM DISKETTE and INSTRUCTION MANUAL...\$325.00

#### PROFESSIONAL TIME AND BILLING

2 disk drive program written in assembly language and APPLESOFT II. Completely menu-driven. Maintain all billing of clients and personnel. Generates and invoices. Numerous reports based on all types of criteria. Easy data entry for RATES, CLIENTS, and MATTERS. Has SEARCH, SORT, CHANGE (on screen editing), VIEW and BALANCE FORWARD. If you are a JOB CONTRACTOR, ATTORNEY, ACCOUNTANT, GENERAL CONSULTANT, or anyone that needs to charge for time, this program is a must. Complete turnkey operation. Numerous REPORTS are produced to aid in the TIME ANALYSIS PROCESS. All this and much more.

PROGRAM DISKETTE and INSTRUCTION MANUAL...\$325.00

#### SPEED READING

PROGRAM DISKETTE AND INSTRUCTION MANUAL...\$200.00

ALL PROGRAMS REQUIRE 48K and APPLESOFT II ON ROM OR AND APPLE II PLUS. ALL SOFTWARE IS COMPATABLE WITH PASCAL SYSTEMS. PROGRAMS RUN FROM ANY PORT OF THE COMPUTER WITH SERIAL/PARALLEL PRINTERS. REQUIRES 1 DISK DRIVE UNLESS OTHERWISE NOTED.

SEND CHECK/MONEY ORDER or C.O.D. To:

**SOFTWARE TECHNOLOGY for COMPUTERS**

P.O BOX 428

BELMONT, MA 02178

OR AVAILABLE FROM YOUR LOCAL DEALER.

## Advertisers' Index

Aardvark	39
Abacus Software	25
American Data Systems	46
Beta Computer Devices	31
R. J. Brachman Assoc.	25
Call A.P.P.L.E.	26
Carlson	46
Classified Ads	23,24
CompuTech	78
Computer City	78
Computer House Division	52
The Computerist, Inc.	40, 41
Computer Shop	71
Computer Shop Cambridge	73
Computers-R-Us	10
Creative Computing	16
Dakin5	35
Decision Systems	60
Dwo Quong Fok Lok Sow	46
Eastern House Software	32
Excert, Inc.	74
F.S.S.	74
Galaxy	60
Hepburn MCA	25
Highlands Computer Services	63
Instant Software	59
Lazer Systems	2
LemData Products	32
Malibu Microcomputing	1
MCC Engineering	6
MicroWare Dist. Inc.	73
Mittendorf Engineering	50
Money Disk	60
Nestar Systems, Inc	28
Nibble	75
Nikrom	63
Orion Software Associates	39
Ohio Scientific	BC
OS Small Systems Journal	42-45
Peelings II	35
Perry Peripherals	58
Prism Software	32
Programma	IFC
Prog. Comp. Software	73
Progressive Software	64
Rainbow	73
Sirius Software	52,71
Skyles Electric Works	15,78, IBC
Small Business Computer Sys.	35
Software Tech. for Comp.	79
Solutions, Inc.	78
Southeastern Software	80
Southwestern Data Systems	60
Versa Computing	4
Voicetek	32
Wyman Associates	6



Southeastern Software 'NEWSLETTER' for APPLE II Owners  
NOW IN THE THIRD YEAR OF PUBLICATION

10 Issues per year for \$10.00

Back Issues available at \$1.00 each

**EXAMPLE:**

Send \$10.00 and receive next 10 Issues

Send \$30.00 and receive 30 Issues beginning with #2

## DATA CAPTURE 3.0 - \$29.95

Is DATA CAPTURE 3.0 just another Smart Terminal program? NO! It is a GENIUS Terminal program for use with the Micromodem II<sup>™</sup>. It will 'capture' ANYTHING that appears on the screen of your CRT. ANY program or data. If you are using the Source you can even 'capture' CHAT. There is no need to create files in your file space on the other system to transfer data to your Apple. If you can list it you can capture it.

- \* You can then SAVE the data to disk, dump it to your printer or even do simple editing with DATA CAPTURE 3.0.
- \* You can use DATA CAPTURE 3.0 to compose text off line for later transmission to another computer. Think of the timeshare charges this will save you!
- \* Use DATA CAPTURE 3.0 with the Dan Paymar Lower Case Adapter and you can enter UPPER or lower case from the keyboard for transmission to another system. You can also capture UPPER/lower case data from another system.
- \* A program is also included to convert your programs to text files for transmission using DATA CAPTURE 3.0.
- \* DATA CAPTURE 3.0 will save you money if you are using any timesharing system.

Requires DISK II<sup>™</sup>, Applesoft II<sup>™</sup>.

Add \$64.95 to order the Dan Paymar Lower Case Adapter

## BAD BUY DISKETTE - \$9.99

Of course it's a bad buy. If you have issues #2 thru #11 of the NEWSLETTER you can type these programs in yourself. Includes a couple of bonus programs.

Requires DISK II<sup>™</sup>, Applesoft II<sup>™</sup>.

We ship within 3 working days of receipt of order and welcome your personal check. We also accept Visa and Master Charge.

## LCMOD for PASCAL - \$30.00

Finally! DIRECT entry of UPPER/lower case into the Pascal Editor. Why pay hundreds of dollars for a terminal just to set lower case entry with Pascal? If you have the Paymar Lower Case Adapter you can use this program.

- \* Left and right curly brackets for comment delimiters.
- \* An underline for VARs, program names and file names.
- \* The ESCape key does the shifting and Control Q is used for ESCape. Have you ever typed in a page or two of text and lost it by hitting ESC accidentally? This won't happen with LCMOD.

Requires Language System and Paymar LCA

Add \$64.95 to order the Dan Paymar Lower Case Adapter.

## MAG FILES - \$18.00

Finding it difficult to keep track of all those magazine articles you are reading? This program will help you do it. MAG FILES is Menu driven with separate modules for creating, editing, displaying and searching for your data. If you are using one drive a program is provided for transferring data to another diskette for backup. A sample data base of over 60 articles is included. The screen formatting and user orientation are what you have come to expect of Southeastern Software.

Requires DISK II<sup>™</sup>, Applesoft II<sup>™</sup>.

## MAILER - \$15.00

Don't let the low cost fool you. This is a single drive version of the program we use to maintain the NEWSLETTER subscriber list. Can be easily converted to 2.3 or 4 drives. Binary search and linear searches for finding any name in file. Sort on names and zip codes. Selective print by zip code or key. The separate modules are menu driven and will run on 32K system. There are 13 separate modules on the diskette for maintaining a mailing list. Sample data file included.

Requires DISK II<sup>™</sup>, Applesoft II<sup>™</sup>.

\* Apple, Apple II Plus, Disk II and APPLESOFT II are trademarks of Apple Computer Company.

\* Micromodem II is a trademark of D.C. Hayes Associates, Inc.

# TRENDCOM 200

## High-Speed Intelligent Printer

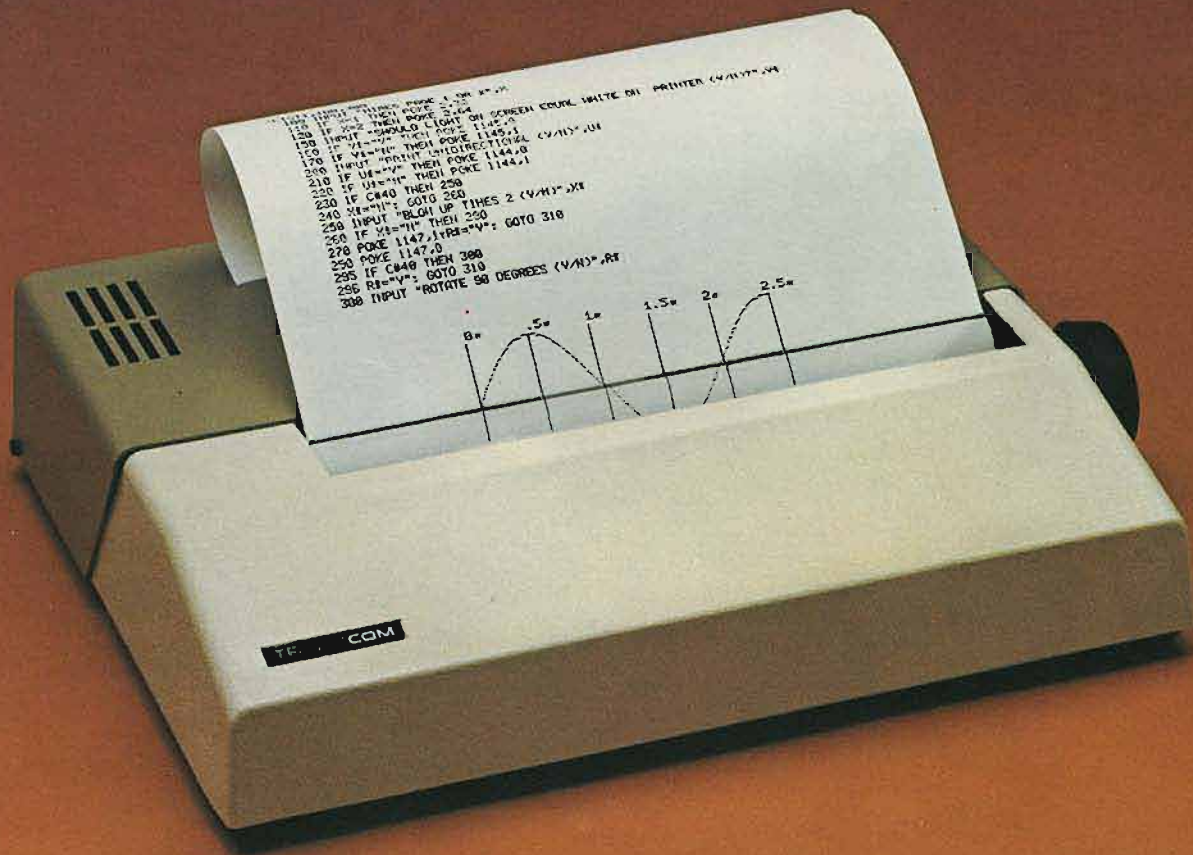

40 characters-per-second

80 characters per line

Upper and lower case

Continuous graphics at 60 dots per inch

Microprocessor controlled

Bidirectional look-ahead printing

Automatic "wrap-around"

Quiet operation

The Trendcom 200 is a high speed thermal printer offering the combination of text printing at 80 characters per line and continuous graphics at 60 dots per inch. In the text mode, upper and lower case data are printed at 40 characters per second. The 5 x 7 characters provide clear readable copy on white paper; no hard to find, hard to read aluminumized paper.

In the graphics mode, seven bits of each byte correspond to the seven dots in each of the 480 print positions per line. Since the computer driving the printer has full control over every print position, it can print graphs, bar charts, line drawings, even special and foreign language symbols. Despite its low cost, the Trendcom 200 is a true in-

telligent printer with full line buffering and bidirectional look-ahead printing. After one line has been printed left to right, the internal microprocessor examines the next line to choose the shortest print direction. The microprocessor also provides a built-in self-test mode for easy verification of proper operation.

High reliability is designed in: The thick film thermal print head has a life expectancy of 100,000,000 characters. Two DC stepping motors provide positive control of the print head and the paper drive, the printer's only driven parts. The absence of gears and solenoids also makes the printer extremely quiet; the only noise is the rustling of the paper advancing.

— Skyles PAL-80 printer(s) complete with 2½ foot interface cable to attach to my PET at \$675.00 each.\* (Plus \$10.00 shipping and handling.) I also will receive a test and graphics demonstration tape at no additional charge and over 150 feet of 8½ inch wide black on white thermal paper.

— rolls of 8½ inch wide by 85 ft. long thermal paper (black ink) at \$5.00 each; or cartons at 10@ \$45.00.

Visa, Mastercharge orders call (800) 538-3083

California orders please call (408) 257-9140



### Skyles Electric Works

231E South Whisman Road Mountain View, CA 94041 (415) 965-1735

# The home computer you thought was years away is here.



## C8P DF

Ohio Scientific's top of the line personal computer, the C8P DF. This system incorporates the most advanced technology now available in standard configurations and add-on options. The C8P DF has full capabilities as a personal computer, a small business computer, a home monitoring security system and an advanced process controller.

### Personal Computer Features

The C8P DF features ultra-fast program execution. The standard model is twice as fast as other personal computers such as the Apple II and PET. The computer system is available with a GT option which nearly doubles the speed again, making it comparable to high end mini-computer systems. High speed execution makes elaborate video animation possible as well as other I/O functions which until now, have not been possible. The C8P DF features Ohio Scientific's 32 x 64 character display with graphics and gaming elements for an effective resolution of 256 x 512 points and up to 16 colors. Other features for personal use include a programmable tone generator from 200 to 20KHz and an 8 bit companding digital to analog converter for music and voice output, 2-8 axis joystick interfaces, and 2-10 key pad interfaces. Hundreds of personal applications, games and educational software packages are currently available for use with the C8P DF.

### Business Applications

The C8P DF utilizes full size 8" floppy disks and is compatible with Ohio Scientific's advanced small business operating system,

OS-65U and two types of information management systems, OS-MDMS and OS-DMS. The computer system comes standard with a high-speed printer interface and a modem interface. It features a full 53-key ASCII keyboard as well as 2048 character display with upper and lower case for business and word processing applications.

### Home Control

The C8P DF has the most advanced home monitoring and control capabilities ever offered in a computer system. It incorporates a real time clock and a unique FOREGROUND/BACKGROUND operating system which allows the computer to function with normal BASIC programs at the same time it is monitoring external devices. The C8P DF comes standard with an AC remote control interface which allows it to control a wide range of AC appliances and lights remotely without wiring and an interface for home security systems which monitors fire, intrusion, car theft, water levels and freezer temperature, all without messy wiring. In addition, the C8P DF can accept Ohio Scientific's Votrax voice I/O board and/or Ohio Scientific's new universal telephone interface (UTI). The telephone interface connects the computer to any touch-tone or rotary dial telephone line. The computer system is able to answer calls, initiate calls and communicate via touch-tone signals, voice output or 300 baud modem signals. It can accept and decode touch-tone signals, 300 baud modem signals and record incoming voice messages.

These features collectively give the C8P DF capabilities to monitor and control home functions with almost human-like capabilities.

### Process Controller

The C8P DF incorporates a real time clock, FOREGROUND/BACKGROUND operation and 16 parallel I/O lines. Additionally a universal accessory BUS connector is accessible at the back of the computer to plug in additional 48 lines of parallel I/O and/or a complete analog signal I/O board with A/D and D/A and multiplexers.

Clearly, the C8P DF beats all existing small computers in conventional specifications plus it has capabilities far beyond any other computer system on the market today.

C8P DF is an 8-slot mainframe class computer with 32K static RAM, dual 8" floppies, and several open slots for expansion.

**Prices start at under \$3,000.**

Computers come with keyboards and floppies where specified. Other equipment shown is optional.

**For literature and the name of your local dealer, CALL 1-800-321-6850 TOLL FREE.**

**OHIO SCIENTIFIC**  
1333 SOUTH CHILLICOTHE ROAD  
AURORA, OH 44202 • (216) 831-5600