

**COMPLETE
WALKTHROUGH!**



King's Field™
The Ancient City™



Steve Honeywell

primagames.com

FROM SOFTWARE™



<http://kingsfield.agetec.com>

King's Field

The Ancient City

King's Field: The Ancient City

Prima's Official Strategy Guide

STEVE HONEYWELL

Prima Games

A Division of Random House, Inc.

3000 Lava Ridge Court

Roseville, CA 95661

(800) 733-3000

www.primagames.com



The Prima Games logo is a registered trademark of Random House, Inc., registered in the United States and other countries. Primagames.com is a registered trademark of Random House, Inc., registered in the United States.

©2002-2004 by Prima Games. All rights reserved. No part of this book may be reproduced or transmitted in any form or by any means, electronic or mechanical, including photocopying, recording, or by any information storage or retrieval system without written permission from Prima Games. Prima Games is a division of Random House, Inc.

Product Manager: Sara E. Wilson

Project Editor: Terri M. Stewart

©1994-2002 FromSoftware, Inc. FromSoftware and the FromSoftware logo are trademarks of FromSoftware, Inc. All rights reserved. King's Field and the King's Field logo, The Ancient City and The Ancient City logo, Agetec and the Agetec logo are trademarks of Agetec, Inc.

All products and characters mentioned in this book are trademarks of their respective companies.

Please be advised that the ESRB rating icons, "EC", "K-A", "E", "T", "M", "AO" and "RP" are copyrighted works and certification marks owned by the Entertainment Digital Software Association and the Entertainment Software Rating Board and may only be used with their permission and authority. Under no circumstances may the rating icons be self-applied or used in connection with any product that has not been rated by the ESRB. For information regarding whether a product has been rated by the ESRB, please call the ESRB at 1-800-771-3772 or visit www.esrb.org. For information regarding licensing issues, please call the ESA at (212) 223-8936. Please note that ESRB ratings only apply to the content of the game itself and does NOT apply to the content of this book.

Important:

Prima Games has made every effort to determine that the information contained in this book is accurate. However, the publisher makes no warranty, either expressed or implied, as to the accuracy, effectiveness, or completeness of the material in this book; nor does the publisher assume liability for damages, either incidental or consequential, that may result from using the information in this book. The publisher cannot provide information regarding game play, hints and strategies, or problems with hardware or software. Questions should be directed to the support numbers provided by the game and device manufacturers in their documentation. Some game tricks require precise timing and may require repeated attempts before the desired result is achieved.

ISBN: 0-7615-3796-1

Library of Congress Catalog Card Number: 2002101399

Contents

The Story of King's Field	2
Bestiary	4
Items	13
Weapons	13
Armor	16
Jewelry	21
Other Items	23
Magic	26
Combat Spells	26
Non-combat Spells	28
Strategy	29
Combat	29
Using Items	30
General Strategies	31
Maps	33
The Walkthrough	49
Starting Out	49
The Huge Spider	56
The Stone Guardians	59
The Forest Golem and	63
the Priest's Key	
The Fire Genie	68
Big Battles	73
The Ocean Fort	79
Against the Widdas	85
Eggs and Keys	89
Final Preparations	95
The Final Battles	101
Item Stats	103
Creature Stats	109

The Story of King's Field

The Ancient City

There was once a land called the Holy Land. A place of beauty, it was home to the Forest Folk. One day, a great darkness came over the land as a shroud of never-ending clouds rolled in and blackened the sky. The Forest Folk retreated, building a magnificent underground city. From that time forward, the Holy Land became known as the Land of Disaster.

In the nearby kingdom of Heladin, King Lucien IV received the gift of a small idol representing peace and harmony. He decreed that the idol should have a place of honor in his throne room. But, as soon as he had the idol in his possession, Lucien's kingdom began to crumble around him. He asked the sages to find out the cause of this decay.

The sages debated and studied, and after a time determined that the idol was the Idol of Sorrow, a mysterious relic of the Forest Folk said to have been the cause of their downfall. A group of Heladin soldiers led by Septien, the Sword Master, set out to return the Idol of Sorrow to its place in the Land of Disaster but they were never heard from again.

Not long after, a strange, cloaked figure visited Prince Devian of Heladin. The figure handed him the Idol of Sorrow, telling him to return it to the Land of Disaster so that other lands would not suffer Heladin's fate.

Now, armed with nothing more than his courage and resolve, Prince Devian must journey to a decayed land crawling with deadly creatures and deadlier traps. On his shoulders rests the fate of his land and the hopes of his people.

How to Use This Book

The following guide gives you one possible path through *King's Field*. Inside, you can find all of the important items and spells and equip yourself for your final battle. There are other paths through, of course. Many of the places visited in the walkthrough portion of this book aren't necessarily required to complete the game. However, these side paths provide you with many additional items that can help you find gold to buy more items, and gain the experience you need to be powerful enough to survive.

This guide works well with any style of play. Whether you prefer the added defense of a shield, coupled with quick-hitting weapons like rapiers and carvers, or causing as much damage as possible, forgoing a shield and using slow but deadly two-handed weapons, this guide will be of just as much value to you.

In short, the actual playing style you choose in *King's Field* is your own. This guide is here to show you the path, point out the highlights, tell you where the traps are, and help you defeat the many monsters you encounter. While suggestions are made for dealing with the many monsters, ultimately how to fight, what to use, and what armor to wear is yours to decide.





Helpful Characters



David Bunch

David runs the small shop below the ruined village. Though his selection is limited, his shop is an excellent source of herbs, antidote, and mushrooms early in your quest. He also has a Wind crystal for sale.



Chad Breshears

Chad Breshears is a successful thief. You encounter him frequently in your travels. Early on, trade him a Rock of Life for a crystal vial. Later, buy and sell items with him. Chad carries a lot of unusual items, and you can count on decent prices.



Ramirez Martin

Ramirez is one of the few soldiers who avoided an evil transformation in the Ancient City. He carries mushrooms and healing items, and is one of the few shopkeepers who supplies you with arrows.



JaMarc Neeley

Though JaMarc lost his way, he still opens his peddler's sack if you need something. His prices are high, but he's handy in a pinch. You find him near the Giant Beetle.



Oagh Burleigh

Oagh is unusual. Captured and forced into service of the Widdas, he desperately fears turning into a Widda himself. After you find him, you can trade with him, but he only accept scales, claws, and bones as payment for his wares.



Harmurah Forgefist

Harmurah is a Dwarven smith who proves indispensable to you. You encounter him first in the Forge, where he is frozen in a block of ice. After he's thawed, he returns to his home in the Earth Folks' Village, where he repairs your weapons and armor, and improves them if you have Earth stones.

Bestiary



ACID CRAWLER

Reptilian creatures with a dangerous acid attack, Acid Crawlers are rare but are a problem when you face them. They rush forward, striking with their heads and biting, then breathing a nasty acid gas. Acid Crawlers have a lot of hit points and can take a lot of damage, but they aren't resistant to anything. Use your favorite weapon and your favorite spell to do them in.



ANCIENT KING

You face the Ancient King as you near the end of your quest. A huge skeleton, the Ancient King is more powerful than any other undead creature you encounter. He has a lightning attack. However, he spends most of his energy summoning High Skeletons to fight for him. The Ancient King can take a lot of damage. He's resistant to all magic except for Light spells, and weapons normally affect him. Getting to him through the crowd of walking dead makes killing him difficult.



AQUA LIZARD

These huge lizards don't look tough. They have no arms to strike with, and their huge size makes them look ponderous. Nothing could be further from the truth. They strike from a great distance with their huge tongues, and they're difficult to attack from behind because they slap with their tails. Worse, when their tongue attack hits, it drags you toward them. They breathe a powerful water attack at long range. Attack them from a distance, moving in to strike with Fire-based weapons for the final killing stroke.



BEETLE

You see many of these creatures as you follow your quest. Beetles are everywhere, running around underfoot, jumping at you, and furiously biting. Beetles attack in a straight line, so slide to the side when they jump, then turn and slash at them as they line up for another pass.



BEETLE, GIANT

This massive brute lives in a tunnel near the Ancient City. It has the same basic attacks as a normal Beetle, but its huge size makes these attacks more deadly. It is immune to Earth spells and power but is vulnerable to blunt weapons. Its stone attack, which causes rocks to fall from the ceiling, is dangerous. Move in close, hack with something big and heavy, and have a lot of healing spells and items ready.



BLOOD BAT

Tiny flying creatures, these are an annoyance. A good swing with any weapon drops them. They are tough to hit because of their size and maneuverability, but swinging into a cloud of them brings down two or three at a time.



CRITTER

Giant roly-poly bodies and big, hands make Critters ungraceful, and their shuffling waddle makes them appear clumsy. Don't be fooled. Critters jump a good distance and attack with a vicious bite that strips your health. Use a slashing weapon and hack at them when they jump past.



CROW

Look in the trees around the cemetery behind the church early in your quest to spot Crows. These birds rest in trees and are harmless. If you don't bother them, they won't bother you. When you first see them, you don't have a spell or missile weapon with which to attack them. They're not worth much experience-wise, and you can kill them with anything. The benefit to killing them is that they drop up to 100 gold.



DARK ARCHER

These female warriors defend themselves both at a distance and at close range. They shoot arrows from long range, and they imbue their arrows with Dark magic for extra damage. Up close, Dark Archers kick either with one leg or, by dropping down and using an arm for support, with both. They are vulnerable to Light magic and aren't physically powerful. A Light spell knocks them off balance. Follow that with a good weapon strike to get rid of them.



DARK BIRD

Nasty birds with human faces on their chests, Dark Birds are problems. They hurl Fireball and Wind Cutter in combat and fly out of your weapon's reach. Run past them when you see them.



DARK FLOWER

These horrible plants are dangerous only if you get too close. When approached, they launch a putrid seed bomb that causes lethargy, slowing you down and making it difficult to see. Attack them from long range with spells. They drop a lot of gold and provide you with a forest root.



DARK KNIGHT

The terrible Dark Knight, who defeated Lord Myu, is the deadliest creature you face in the old jail near the ancient battlefield. He is swift and accurate with his powerful spear, which he imbues with Dark powers. He waits for you to approach, then throws a powerful Eclipse spell that drains your hit points while you strike him. When he charges, it's impossible to get out of his way. Use Light spells on him until he charges, then take the hit and retaliate with the Moonlight Sword.



DARK PUPPET

Dark Puppets guard the entrance to the Dark Sorcerer's lair. You have to fight two of them, and they aren't difficult. Dark Puppets look like feminine floating mummies. They attack with a greenish cloud of Dark magic and their wicked claws. Get rid of them with a combination of your favorite weapon and Light spells.

Hit them with the spells to knock them back, and charge in, slashing away. Bob around to avoid their Dark spell.



DARK SOLDIER

Dark Soldiers leap into combat, coming down in front of you with their claws bared. They are fast when they run because their loping motion covers a lot of ground. When they strike, they lunge forward, catching you while you retreat. For their power and hit points, Dark Soldiers are resistant to nothing, so use any spell and hit them with your favorite weapon. Weaken them before they get close and you're forced to defend yourself.



DARK SORCERER

The Dark Sorcerer is a nasty customer. He uses his Dark Protrusion spell to keep your magic energy low. He also calls forth spear traps from the walls of his chamber, as well as a ring of powerful homing arrows. He causes the floor to rise and fall, sending you to the ceiling only to crash to the floor. Hit him with Light spells early on, then charge. Use healing items when you need them and stay on him, moving in a circle to avoid his staff and his ring of arrows.



DARK SUCCUBUS

Except for your final enemy, the Dark Succubus is more powerful and has more hit points than anything else you encounter. She guards the entrance to the Altar of Dark, where you rid yourself of the Icon of Sorrow. She attacks with lightning, hitting for massive damage before she moves in to finish you with her giant scythe. She's deadly because she is accompanied by six Dark Archers. Use your most powerful Light spells, especially Judgment, and ignore the Dark Archers. Keep moving to avoid her lightning (and the arrows), and slash at her when she passes. Your spells turn the tide of battle against her.



DRAGON FLY

These huge nasty characters fly in and slice at you. Their speed makes them tough to hit, as does their ability to fly out of range. Ignore them, but if you are forced into combat with them, use a weapon with a wide sweep like a long sword or bastard sword.



EARTH KING

Armed with a cross-shaped ax that creates terrible wounds, the Earth King has magical attacks. Smashing his ax to the ground causes a massive shock wave, and he doesn't hesitate to use his ice breath as you near him. Use a Fire-based weapon and spell against him. Keep moving to avoid the shock wave, and back away when he breathes or swings.



ELEMENTAL, EARTH

Earth Elementals are bestial creatures who combine speed and attacks into one difficult package. Up close, they strike with a bite or with their razor-sharp claws.

They have an impulse attack that causes wounds in a small radius around them. From long range, they attack with Dark breath, which makes it difficult to see. Use quick strikes against them. Use Wind Cutter because it damages them and quickly charges. Because Elementals jump to avoid your attacks, use the Wind Carver.



ELEMENTAL, FIRE

Fire Elementals are like their other elemental siblings. They are fast and hard to track, which makes using a quick weapon like the

Water Carver a great choice for slaying them. Their defense against Fire magic is good, and they are resistant to Wind magic and weapons, but Water magic quickly kills them. Fire Elementals hurl Fireballs before charging and scratch with their powerful claws up close. You don't have offensive Water spells when you encounter them, so use the Water Carver to defeat Fire Elementals.



ELEMENTAL, WATER

Water Elementals are the nastiest Elementals. They hurl Water Balls, which they throw two at a time in a

spreading pattern that assures one will find its target. They are resistant to Fire magic, but they have a vulnerability to Earth. They share the speed and maneuverability of the other Elementals, which makes the Earth Carver the best choice for killing them.



ELEMENTAL, WIND

The weakest of the Elementals, Wind Elementals are nonetheless dangerous. They aren't swift, moving in short, hopping steps. They attack with claws, and from a distance hit with a Tornado attack. Slag them with Fire spells, Earth attacks, and weapons. Two good hits with a powerful weapon do them in.



EXPEDITION ARCHER

Like many enemies with missile weapons, Expedition Archers are dangers. They snipe at you while you fight other creatures, whittling away your hit points. Get too close, and they swing their bows at you. Handle them with spells. A single Fireball knocks one out.



EXPEDITION SOLDIER

The remains of the Heladin soldiers sent to investigate the ruined palace, these creatures have lost their humanity. They swing a powerful mace, using either a horizontal slash or a massive overhead crushing attack. To take them down, wait for a swing, then move in and hack at them. They aren't tough one at a time, but in groups, they are dangerous.



FADIN

Fadins are huge stone faces mounted on walls. They launch fire arrows at anything that approaches them. If you can get next to them, you can destroy them with any weapon, but they come back and fire moments after you kill them. Use blunt weapons against them.

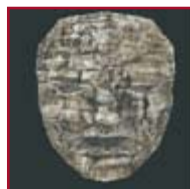

FADIN, MASTER

The Master Fadin is the same as a regular Fadin, but it controls the others. When you destroy the Master, you also destroy the others. It has a few more hit points than a normal Fadin, and it shares the Fadins' vulnerability to blunt weapons, as well as their strength against Fire.



FIRE GENIE

You encounter the bloated Fire Genie beyond the Forge. He has several attacks, all of them problematic. If you approach him, he swings with his burning arms, knocking you backward. He also has a deadly Fire breath that strips away your health. If you keep your distance, he hurls handfuls of lava that cause a lot of damage and, when they land on the ground, turn into Larva. Wear Fire-resistant items and attack with a Water-based weapon. Use your Endure Fire spell.



FIRE LORD

This powerful creature is unique—you only face him once. He has a number of deadly attacks, not the least of which is his ability to conjure balls of fire that attack. Up close, he strikes with punches and kicks. He also moves at an untrackable pace, making him tough to hit with a weapon. Use Water-based items against him, and the Endure Fire spell. Use Fire protection when you battle him.



GENEAN

Geneans look like slime in a human form. They are slow but stretch when they attack. They have no immunities. Geneans have a lot of hit points, so they take awhile to kill. They do not have a magical attack, though, so you can avoid anything they throw at you.



GIANT

There are two varieties of Giant: those who wield clubs and those who don't attack with poison. Every attack these giants have—a huge fist, claw, or their breath—poisons or kills you. Club-wielding Giants lack poison but can smash you with their clubs, which they swing behind or in front. These Giants also have a shock wave attack that emanates from their feet when they stomp. Giants are equally affected by magic and weaponry. Use your favorite spells and weapons against them.



GIANT LEADER

The huge Giant Leader lives in the basement of the Mansion of Howling Winds. He's accompanied by a pair of club-wielding Giants, which makes him tougher to fight. His main attack is with his massive hammer, which he brings down with thunderous force. When enraged, the Giant Leader spins, hitting with a trio of blasts that kill all but the staunchest of warriors. Use Light spells against the Giant Leader. All weapons work equally against him.



GOLDEN STATUE

The two Golden Statues stand guard over the Widda Queen's staff in the Widda fortress. These massive constructs are vulnerable to all normal attacks and have no defense against magic, but they have so many hit points that they are difficult to kill. Up close, they swing a huge fist that causes fatal damage, while their plasma attack tracks around corners. Bob and weave around them, moving in to strike and backing away to avoid being crushed.

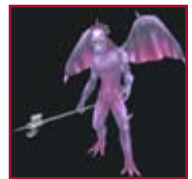

GREATER DEMON

Of all the creatures you fight multiple times, none are worse than Greater Demons. Their freeze breath, which they use infrequently, is easily avoided, but their Dark Matter spell, which is the same as yours, is dangerous. When attacked with spells, Greater Demons raise a protective shield that prevents magical damage. It doesn't stop you from rushing in and hacking away with a sword, however. All weapons are good against them, as are Light spells. To kill them, get them on the defensive by shooting a Light spell their direction, then run in and shred them with your favorite weapon.



ICE GOLEM

Ice Golems appear in the Forge before you defeat the Fire Genie. They rise out of the ground ready to attack in an instant. Up close, they attack with punches and kicks. If you stay too far away, they hurl shards of ice at you. Use Fire magic and a Fire-based weapon to slice them up. Hit them with a Fireball, then slice with the Fire Carver before they can react.



LARVA

Created by the Fire Genie when he hurls lava bombs, Larva are short-lived and have few hit points. They throw balls of fire to cause damage. They are a nuisance when you are fighting the Fire Genie because they not only damage you, but they also get in the way of your spells and make it difficult to maneuver out of the way of the Fire Genie's attacks. Slash at them when you have to; otherwise ignore them. Larva die and disappear after 30 seconds.



LAVA BIRD

Lava Birds are the complement to Onyxes in the second part of the Dark Reality at the end of your journey. Huge dragon-like monsters, Lava Birds attack with a fire bomb strike, similar to your Flame Strike or Meteor Cascade spell. Keep moving to avoid their bombs. Light spells are effective against them, as are weapons should they fly low enough for you to strike. Avoid them when possible.



LAVA FACE

There's nothing too serious about Lava Faces. Wall decorations, they drain a river of lava, filling hallways and floors, making them impassable. Destroy them with any blunt weapon; they can't attack, but they are immune to magic, stabbing weapons, and slashing damage. Don't step in their lava stream and you'll be fine.



LAVA LIZARD

Lava Lizards have three attacks against which you must guard. From long range, they try to scald you with a flaming breath attack, but you can avoid it. Lava Lizards charge into combat, ending their run with a vicious head butt that takes off a large number of hit points. They also strike with their claws. Use Water-based spells and weapons against them, and be prepared for a long combat. Lava Lizards are tough to kill.



LEE MAYNOR

Lee Maynor is an Expedition Soldier who has avoided being changed into a creature of the dark. If you have to fight Lee, he's a simple opponent. His mace swings are dangerous, but he's wounded and awkward, so his attacks are slow. Use Fire against him. He's vulnerable to anything you throw at him.



LIVING ARMOR

Magically animated suits of armor, these creatures are a melee specialist's worst nightmare. Living Armor is impervious to normal attacks; slay it with spells. When struck with anything, Living Armor collapses. You can't damage it in this state, but it still strikes with a magically animated glove. Hit Living Armor with spells, using the highest-level spell you have.



LIVING DEAD

Animated corpses of slain miners, Living Dead are slow until they swing their large pickaxes. They shamble along, their heads cocked back at awkward angles until they strike with deadly accuracy and great strength. Living Dead vomit a poison spittle that lands at their feet, making sparring with them riskier. Fire-based weapons are excellent against them, but you can take them down with anything. Wait for them to swing, then catch them before they can react.



LIVING STATUE

Stone sculptures come to life, Living Statues have an interesting blend of strengths and weaknesses. Don't cast spells on them, because they easily avoid magical damage. They are deadly up close, swinging massive axes. At long range, they strike with an ice attack. Attack them at close range with blunt weapons; the Hammer of Woe works well against them.



MAKARA

A hideous combination of man and fish, Makaras are dangerous because of their power and speed. They preface an attack with their mist ability, which makes it hard to see when they leap forward and slash away your hit points. Ignore the mist and charge. Swing away with a Fire-based weapon and use Fireball to keep them off balance. You cannot use Fire Wall in the watery habitat in which you normally find Makaras.



MALICE

Malices look more deadly than they are. Ghostly creatures wielding huge axes, Malices rush forward and slam into you before swinging down their axes to cut you in half. They breathe a deadly Dark breath that strips hit points and makes it difficult to see. Destroy Malices with a couple of good weapon slashes and Light spells. In groups, they are dangerous, surrounding you and breathing in unison, following up with their weapons.



MANEATER

The first enemy you face is the Maneater, a mutated Venus flytrap that moves, stretching forward to deliver a powerful bite. They go down with a couple of swift hits with any weapon. They're a danger when you first start, but you don't see them again outside of the area where you begin your quest. They're good for practice and early experience points.



MINION

Minions look like black-and-red, two-headed Dobermans. They are swift and run around, making them difficult to hit from long range and hard to find up close. They run around you, striking at your flanks before you can turn and swing at them. Minions also breathe Fireballs, and because they have two heads, they spit a pair of Fireballs at a time. Hit them with spells from a distance to slow them down and use a slashing weapon as they run around you. Minions have a high resistance to Fire, but Water spells and weapons kill them.



MUMMY

Mummies are the remains of humans preserved after death and reanimated by Dark magic. Impossibly tall, Mummies have a long reach, which makes dealing with them an exercise in retreating and looking for the right opening. Their attacks do a lot of damage when they strike, but because they are undead, Mummies are slower paced than most creatures. Holycrest is effective against Mummies, as are Fire-based weapons and spells. Let them swing, then charge in for some shots before you back out. Their slow speed means you can get in a few strikes if they turn their backs on you.



MUMMY, ADEPT

Even though they are weaker than Mummies, Adept Mummies are more dangerous and harder to kill. They can attack with their staves but usually attack with spells, poisoning you and darkening your vision. Get rid of them at close range with Holycrest.



MUTANT CEILING

You see Mutant Ceilings in the first part of the Dark Reality at the end of your quest. Of the mutant creatures, these are the easiest to eliminate because they can't move from their spots like Mutant Floors and stretch out to strike like Mutant Walls. They breathe a poisonous muck; do not get into close-range combat with them. Hit them with Light spells when you spot them.

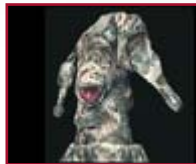

MUTANT FLOOR

Mutant Floors are the second of the creatures you face in the Dark Reality. Unlike the other mutant creatures, Mutant Floors are mobile. Spot them before they strike by looking for their holes in the floor. Mutant Floors are physically powerful and hard to kill because they have so many hit points. They are relatively slow, though, so a fast, powerful weapon like the Moonlight Sword is an excellent choice for getting rid of them.

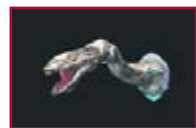

MUTANT WALL

Mutant Walls are the third of the mutant creatures. They aren't mobile, but can strike out from their wall a good distance. They love to jump, catching you with their teeth before they breathe a deadly poison. Because they can only move so far, destroy them while staying out of range with Light spells. You can spot them before they strike by looking for their faces on the walls.

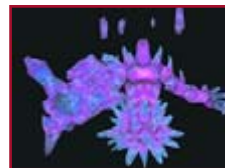

ONYX

Huge Onyxes are your main opponents as you go through the Dark Reality to your final battle. They emit a Dark cloud from one hand, and use their other to smash and grab you. Onyxes are resistant to Dark spells and to blunt and stabbing weapons. Use slashing weapons and Light spells against them. Lead with Light spells and charge in with the Moonlight Sword to keep them at bay.



PHAGOS

A Phagos is a small insect that appears in the Ancient City and the old jail. They infest human bodies and use their skills to host and possess the dead into life. When the host is destroyed they quickly flee. Phagos don't attack and have only one hit point, but they earn you a good amount of experience because they are so difficult to kill. Use spells to kill them.



REAPER

Reapers are mutated trees that act with a nefarious intelligence. Up close, they swing their branches, catching you with sharp thorns. At long range, Reapers cause their roots to jut out of the ground, similar to your Upheaval spell. They use this attack when you run behind them. Dodge in and out, swinging with any weapon. They aren't a big threat.



SALAMANDER

Flying lizards made from fire, Salamanders fly out of range of your weapons, meaning that you must plan weapon strikes.

They attack with a trio of Fireballs or with a concentrated stream of fire. Use a Water-based weapon. If you don't have one, knock them out of the sky with a non-Fire-based spell.



SCORPION

Large versions of the small desert pests, Scorpions scuttle around, swinging their massive tails at anything nearby. They slowly move side to side, quickly striking with their tails. Use blunt weapons against them. Use a rapier or Tsunami to hit them before they can strike with their tails.



SEA FANG

Sea Fangs are piranhas. They rush forward and bite, leaving big holes in your hit points when they connect. A good swing with a weapon kills one, particularly a Fire-based weapon like Black Scar. Sea Fangs appear in schools, and while you are killing one or two with a stroke, another eight or nine are biting you to death. Avoid them.



SENTINEL

Huge Sentinels guard the way to the King's room behind his throne. They have four arms, each of which swings a huge sword with accuracy and speed. At long range, Sentinels use a blade-like Shock Wave attack that cuts through your armor like a knife. Up close, they swing their swords in succession, causing a series of hits. There are only three Sentinels to worry about. Slashing weapons and Light spells are ineffective against them, but anything else scores a decent amount of damage.



SKELETON

There are four varieties of normal Skeleton: unarmed, armed with a sword and round shield, armed with a sword and square shield, and armed with an ax. Unarmed Skeletons are the easiest to deal with because their attacks have a shorter range. Handle Skeletons with blunt weapons. Stabbing weapons are worthless against all except those armed with square shields. The armor these creatures wear makes them easier to hit with that type of weapon. Because Skeletons are undead, use Holycrest against them.



SKELETON ARCHER

The two types of Skeleton Archer are indistinguishable from each other. Both attack with arrows from long range, shooting with accuracy and speed. The more dangerous Skeleton Archers can punch up close. As with most Skeletons, use blunt weapons, not stabbing weapons. All spells affect them. Skeleton Archers go down easily with a good hit. Pop out from cover and hit from a distance.



SKELETON, HIGH

High Skeletons are stronger and faster than normal Skeletons. There are two basic varieties. The first swings a two-handed sword over their heads, catching you both on the downswing and the upstroke. These Skeletons are vulnerable to Light spells and blunt weapons. Brownish High Skeletons who carry a sword and shield aren't vulnerable to Light spells but you can slay them with Fire and Earth magic. In both cases, let them finish their swing (including the upstroke with those holding two-handed swords) and knock them down with your best weapon.



SKULL

Disembodied, dead heads that float inside a globe of purplish darkness, Skulls are more dangerous than they appear. They ram into you, affecting you with their Dark powers. Skulls follow this attack by breathing a toxic fume that strips away your health. Normal weapons and all spells affect them, but Light spells affect them the most. Attack them from long range.



SOL

Sols live under the waves in the ruined city of the Dark Folk. Their bulbous bodies look harmless, but Sols pack a punch. Their bubble attack forces you to run for your forest roots and dried amphibia, while in combat, they strike with one or both arms. Sols get in your way, forcing you to fight while your air drains. Use Earth weapons against them.



SLASHER

Little demonic creatures, Slashers are more deadly than they look. They jump away from your attacks, only to rush in and smack you with a claw. This claw attack paralyzes you, leaving you open to more attacks. Handle Slashers with a combination of spells and weapons, hitting them with a spell, then rushing in to kill with a final blow. You can also use a carver and swing as the Slasher runs next to you.



SPIDER

Spiders inject deadly poison when they strike. They also jump a great distance when they attack. Back away when they jump, then move in and crush them when they land. Use any weapon—they aren't tough.



SLIME, GREEN

Pools of filth and muck, Green Slimes are nuisances. You need to be close to them to strike accurately. This leaves you open for an attack. Use your longest weapon to strike at them. In addition, Green Slime can absorb poison. If you are poisoned, stand on a Green Slime to abolish it.



SPIDER, GIANT

This huge creature stands on the ceiling of its lair, striking with webs to slow you and blind you from long range, and hitting with its massive front legs if you stray too close. It has good defenses against spells, but you can still use magic to kill it. Fireball works well.

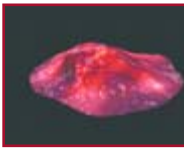

SLIME, POISON

More of a threat than Green Slimes, you can easily identify Poison Slimes because of their sickly red color. Their behavior is similar to that of Green Slimes, but when they hit, Poison Slimes inject a virulent poison. As with Green Slimes, use a long weapon and strike them from far away. One good, heavy swing will do in a Poison Slime.



STONE GUARDIAN

These magically animated defenders are tough on defense and offense. A strike from their massive granite fists strips hundreds of hit points. However, they patrol limited areas, which means that they can't pursue you beyond a certain point. They have two weaknesses. First, their heads are vulnerable. Second, piercing weapons damage them. Use a bow from a distance and aim for their heads.



SNAKE

Snakes are poisonous serpents. They are easy to kill with any weapon you have. They have a poisonous bite, but Snakes are more of a nuisance than a real threat. Don't waste spells on them.



STOOL

Mutated mushrooms, Stools send out a cloud of yellow spores when an enemy approaches. They fall with a single strike from any weapon. Wait for the spore cloud to disperse, then run in and hack away with any weapon. One slows down your progress, but in large groups, they are problems.

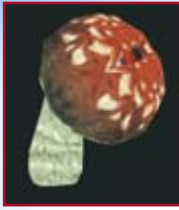

STOOL, PARA

When a Para Stool strikes, it paralyzes you for a few seconds. You can then use items and cast non-combat spells for 10 seconds. By themselves, Para Stools are easy to kill, if you advance and strike after the paralysis wears off. When other creatures are around, Para Stools become troublesome because the paralysis leaves you open for other enemies to move in.



WATCHERS

Watchers are pedestals placed in your way to strip your magical power. When you cross the Watcher's path, it opens its eye and drains your magical energy. Attack Watchers from behind. They are not a physical threat and drop with a couple of hits.



WIDDA

Widdas are snake-human crossbreeds that combine the worst features of both. They are aggressive and deadly, striking with speed and accuracy. Their scaly hides protect them from your attacks, and they can retaliate with nasty sword stabs. Light spells and weapons work well against them. Widdas jump back to avoid your strikes, so also use carvers.



WIDDA ARCHER

Less powerful than their melee-oriented cousins, Widda Archers are a larger problem. They load and fire their bows with speed and accuracy, meaning you'll take a couple of hits as you come into striking range. Their arrows paralyze you, which makes fighting them tougher. Light spells work against them, as do strong weapons swung hard. Attack from long range and close fast when you have to.



WIDDA QUEEN

The huge Widda Queen is one of the major bosses you have to fight. Able to poison you with a punch or her breath, the Widda Queen also strikes with a massive head butt. From long range, she strikes with lightning, as well. Use your favorite weapon from close range to avoid some of her deadlier attacks. Spells, except for Dark spells, are less effective against her than normal weapons.



WIDDACONA

The giant Widdaconas guard the Widda Queen. Massive snakes that combine a powerful bite with poisonous breath, Widdaconas also swing their massive heads, knocking you into the wall. Fight them at close range, swinging the Crystalline Blade. Wind magic also affects the two Widdaconas.



ZOMBIE

Towering undead creatures in the ocean fort, Zombies are quick and tough to kill. They have a massive stack of hit points. They attack with a quick slash or an overhead strike that takes time to develop but causes huge damage when it connects. Use Fire and Light weapons and spells against them, and keep out of the range of their swords.



Items

Weapons Swords



SHORT SWORD

The short sword is moderately good at slashing and stabbing, making it a decent choice against living enemies. It's less effective against Skeletons.



FIERY SWORD

This is essentially the same as a regular short sword, but with additional powers against creatures vulnerable to Fire damage.

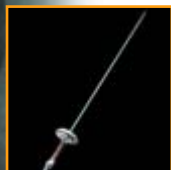

RAPIER

Not much use for bashing or slashing, the rapier is a very sharp, flexible sword designed for quick, piercing attacks.

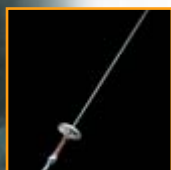

LETHAL RAPIER

A deadlier version of the rapier, this weapon is less effective at slashing and bashing, but fatal as a thrusting weapon.



LONG SWORD

The long sword is a well-rounded weapon. It offers decent reach and good damage against all opponents.



EARTHBINDER

Essentially a long sword, this weapon also causes extra damage against enemies vulnerable to Earth.

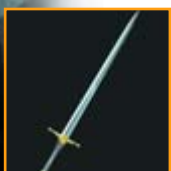

KNIGHT SWORD

Similar to a long sword, the knight sword is longer, heavier, and more effective.

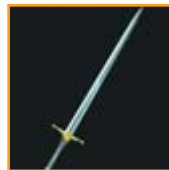

HOLYCREST

Another version of the long sword, Holycrest wards off undead creatures. It is otherwise similar to a knight sword.



FROSTBITE

This variation of the knight sword offers additional damage to creatures vulnerable to Water.



FOREST CARVER

A long knife, the Forest Carver is similar to a long sword. It is much shorter, however, and less effective in bashing attacks.



FIRE CARVER

This weapon is similar to the Forest Carver and causes considerable damage to creatures vulnerable to Fire.



EARTH CARVER

Another variation of the Forest Carver, this weapon is capable of tremendous damage against creatures vulnerable to Earth.

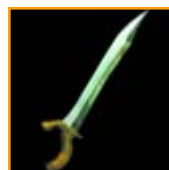

WIND CARVER

The Wind Carver creates tremendous damage against enemies vulnerable to Wind.

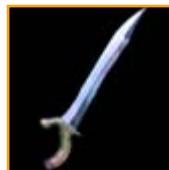

WATER CARVER

The Water Carver is excellent against creatures vulnerable to Water.

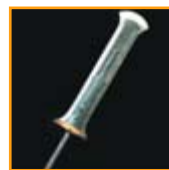

BROAD SWORD

This wide-bladed sword is an excellent slashing weapon, but it's ineffective against enemies vulnerable only to stabbing damage.



VENOMBLADE

Similar to a broad sword, this weapon is imbued with poison, adding additional damage to anything it strikes.



BASTARD SWORD

A large, two-handed weapon, the bastard sword is effective against all enemies.



BATTLE SWORD

Similar to the bastard sword, this weapon becomes stronger with each swing, making it deadly in combat.



DWARVEN SWORD

A variation of the bastard sword, this weapon does the same damage, but weighs only half as much as a normal bastard sword.



GREAT SWORD

A massive weapon, this long and extremely heavy sword causes terrible wounds to anything it hits.



WAR SWORD

This weapon causes more damage than the great sword, but is also significantly heavier.

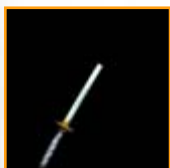

BROKEN SWORD

This weapon has been broken in half, so its blade is ineffective. It is almost worthless as a weapon.



WINDSLAYER

This two-handed katana is excellent for slashing attacks and has Wind attributes as well.



WAVECRASHER

Another katana, this weapon is effective at causing slashing, hitting, and stabbing damage. It also has both Wind and Light powers.



SCORPION

A cursed weapon that poisons both the victim and the wielder, Scorpion is powerful but better left alone.

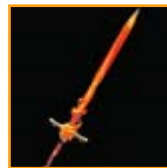

BLACK SCAR

Black Scar is the elemental power of the black beast that lived thousands of years ago, dominating the skys causing mayhem and bloodshed. Living flame gives this two-handed sword its power. It is similar in effect to a bastard sword.

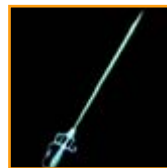

TSUNAMI

Tsunami is the elemental power of the sea and the raw fury of the tidal wave. A deadly magical rapier, Tsunami is excellent for stabbing and effective against foes vulnerable to Water.



CRYSTALLINE BLADE

The Crystalline Blade is the elemental power of winter's rage. An elegant blade made from crystals that forever shine, this magical weapon is effective against most opponents and has Wind attributes, as well.

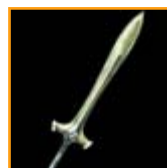

ANCIENT SWORD

This tremendous sword has powers of all elements, as well as Dark attributes. It also has the ability to cause slashing, hitting, and stabbing wounds.

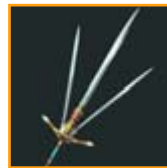

TRIPLE FANG

Both the elemental spirit and origin of Triple Fang is unknown. This sword has been spoken of in many legends and has been wielded by famous people such as the Holy King Alfred. Split into three deadly blades, this sword has significant Light attributes, as well.



LAWFUL BLADE

A powerful sword given to the Sword Master by the king, this weapon has some Light attributes.



MOONLIGHT SWORD

This holy sword with the true elemental spirit of light has conquered the darkness that plagued the land of Verdite. Only those with the purest heart may lay eyes on the sword, and only those with the

purest of souls may wield it. Holding this sword is proof of regal lineage. It can dispel the dark with its reflecting Light attributes. It's a truly magnificent weapon in all respects.

Clubs



WOODEN CLUB

A basic bashing weapon, this is the first implement of destruction you find. It's better than your bare hands, but you should upgrade as soon as possible.



DARKWOOD CLUB

A little stronger than the basic wooden club, the darkwood club shrouds enemies in darkness, which makes it difficult for them to attack you.



EARTHQUAKE

The rare elemental power of earth is imbued into the massive hammer. This two-handed war hammer is great against opponents vulnerable to hitting damage and Earth power.

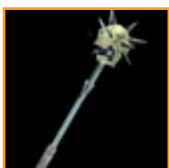

DARK DEFILER

The Dark Defiler is an elemental that was chosen by the gods to walk among the light, however tempted by the darkness, the elemental was soon banished by the gods to live among the dark. A petrified

demon's skull mounted on the end of this staff gives it both Dark attributes and the ability to cause terrible damage.

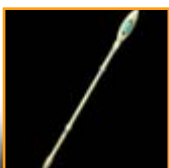

QUEEN'S STAFF

Although not much value as a weapon, the Queen's Staff increases the magical power of the wielder.



MORNING STAR

More effective than a basic club, the morning star is a long shaft with a spiked metal ball on the end. It causes both hitting and stabbing damage.



BATTLE HAMMER

Heavy and powerful, the battle hammer is used two-handed in combat.



WAR HAMMER

This is a heavier and more powerful version of the basic battle hammer.

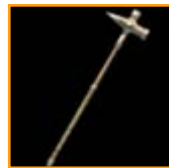

HAMMER OF WOE

Though slightly heavier and less powerful than the war hammer, the Hammer of Woe slows down anything it hits.

Axes

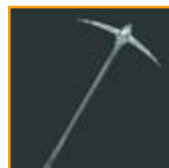

PICKAX

A mining tool, the pickax isn't very effective as a weapon.

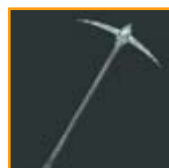

DWARVEN PICKAX

A more powerful version of the pickax, this is an effective weapon.

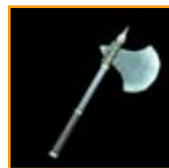

HAND AX

A basic weapon, this single-bladed ax is excellent for slashing and hitting.

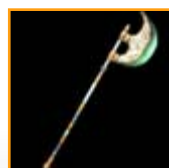

CRESCENT AX

A heavy weapon, this two-handed ax offers decent damage against all enemies.

Punch
Punching with your bare hands also has the ability to level up. Once punch becomes level 3, you can use sonic wave as with other weapons. The advantage with punch is no durability and the recover interval is quick. Punch is suggested only for the hard-core gamer.

Bows and Arrows



ARROW

Use the arrow with any normal bow or long bow. It is an excellent piercing weapon.



BOLT

Shorter than an arrow, use the bolt with the crossbow. Because it is fired at high velocity, the bolt is more effective than an arrow.



WIDDA ARROW

Usable only with a Widda's bow, this magical missile follows its target, ensuring a hit.



BOW

A standard bow used by Heladin archers.



LONG BOW

The long bow is more effective than the standard bow.



BLESSED BOW

This bow causes the same damage as a standard bow, but has significant Light attributes, as well.



CROSSBOW

The crossbow takes a long time to load, but it strikes with tremendous damage.

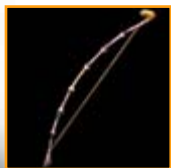

WIDDA'S BOW

This special bow requires unique arrows that track the target. Superior damage from range and Light attributes make it a weapon to fear.

Armor Shields



WOODEN SHIELD

This wooden shield is better than nothing.



FOREST SHIELD

Offering the same protection as a wooden shield, this also offers protection against all elements except Fire.



LEATHER SHIELD

This large shield of cured leather offers better protection than the wooden shield. One leather shield offers slight magical protection, as well.



BUCKLER

This small iron shield is light and easy to carry.



LIGHT BUCKLER

Similar to a standard buckler, this item offers the same protection at half the weight.



KNIGHT SHIELD

This large metal shield offers decent protection without adding too much weight.



EARTHEN SHIELD

This rust-colored shield offers better protection than a knight shield and has Earth attributes, as well.



CRUSADER SHIELD

Given to those worthy to carry it, the crusader shield defends well and protects against all elements.



KITE SHIELD

This shield offers better protection than the crusader shield but does not protect against magic.



TOWER SHIELD

Heavy and awkward, the tower shield offers superior protection in battle.



BLESSED SHIELD

This shield is excellent on defense and has Light attributes, as well.



CRYSTAL SHIELD

Created by the Earth Folk, the Crystal shield is excellent against stabbing attacks and offers Fire and Earth protection, as well.



FLAME SHIELD

As its name suggests, this shield is most effective against Fire attacks.

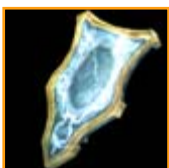

GUARDIAN SHIELD

Not as effective against normal attacks, the guardian shield is superior at defending against magic.



CHAOS SHIELD

This unholy shield causes the bearer to sacrifice might for its Dark attributes.



MAMMOTH SHIELD

Offering incredible protection against bashing attacks, the mammoth shield's weight makes it difficult to carry and use.

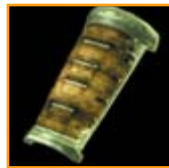

ANCIENT SHIELD

Heavy and emanating strange powers, this shield offers superior combat protection.



LORD MYU'S SHIELD

The best all-around shield, this offers less magical but more normal protection than the guardian shield.

Helm

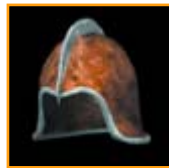

LEATHER HELM

This reinforced leather helm offers a little protection. It's better than going without.

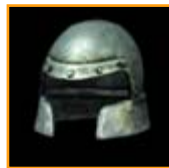

IRON HELM

This iron helm offers more protection than leather.



WAR HELM

Sturdier against slashing damage, the war helm is useless against stabbing attacks. A lighter version offers more slashing protection at the cost of less protection from blunt attacks.



PLATE HELM

This heavy helm offers marginal protection but a great deal of weight.



KNIGHT HELM

Lighter than the plate helm, the knight helm offers superior protection against normal attacks.



CRUSADER HELM

This helm is better than the knight helm against stabbing attacks, but less effective against blunt damage.



CAVALIER HELM

Offering well-rounded protection as well as Light attributes, this helm offers excellent defense.



GREAT HELM

This helm offers incredible protection from slashing and hitting, but it weighs a lot. Another version is weaker against slashes but excellent against stabbing.



CHAMPION HELM

Heavier than the great helm, this is excellent against all normal attacks.



BLESSED HELM

With its significant Light attributes and superior protection from normal attacks, the Blessed Helm makes for powerful defense.

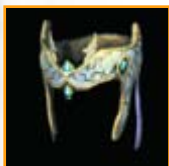

ANGELIC CROWN

Not a true helm, this headgear offers protection against attacks and provides Light attributes, as well.



SHADOW MASK

The defense and Dark attributes of this mask are superior, but the item is cursed. Wear at your own peril.

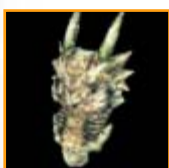

SACRIFICIAL MASK

This heavy mask offers decent protection. However, it is an unholy item that you should leave alone.



KING'S CROWN

This crown is weak on defense but improves magical abilities.



CRYSTAL HELM

Forged by the Earth Folk, this helm is excellent against normal attacks and offers minor Fire and Earth defense.



ANCIENT HELMET

This heavy helm radiates magical powers and provides protection against normal attacks.



LORD MYU'S HELMET

Forged by master craftsmen, this is the helm of legends. Its protection is unsurpassed, and it provides both Light and Dark attributes.

Body Armor



LEATHER VEST

The first armor you find, it provides minimal protection.



LEATHER ARMOR

Stronger than the leather vest, leather armor is also heavier. Some leather armor also provides decent magical defenses.



IRON BREASTPLATE

The iron breastplate's increased weight outweighs the minor improvement in protection over leather armor.



CHAIN MAIL

Great against slashing attacks and decent against hitting, chain mail is useless against stabbing attacks.



SCALE MAIL

Lighter than chain mail, scale mail is as good against slashing and much better against stabbing. One suit of scale mail has Water attributes, as well.



KNIGHT PLATE

This armor is well-balanced against all normal attacks, but it's heavy.



CRUSADER PLATE

This armor is better than knight plate, but heavier to wear.

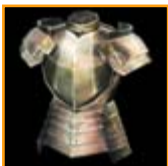

CAVALIER PLATE

This armor is as heavy as knight plate but offers less protection, mainly because it is badly damaged when you find it.

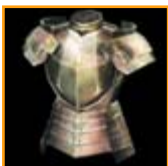

SACRED PLATE

This plate armor offers excellent protection against normal attacks and has Earth attributes.



BLESSED ARMOR

Good protection, Light attributes, and low weight are features of this excellent armor.



ENCHANTED ARMOR

Offering the same protection and Light attributes as Blessed Armor, Enchanted Armor is lighter to wear.



ICE ARMOR

Good protection from normal attacks, Ice armor also has Wind attributes, when wearing this armor, you cannot use Fire magic.

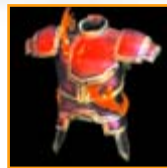

FIRE MAIL

Good protection, low weight, and Fire attributes make this armor difficult to beat.



DEMON ARMOR

Those wearing this cursed heavy plate armor get what they deserve. This armor has Dark attributes but is defenseless against blunt attacks.

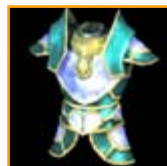

CRYSTAL ARMOR

Designed and crafted by the Earth Folk, Crystal Armor is heavy but offers great protection. It also has minor Fire and Earth attributes.



ANCIENT ARMOR

This old suit of armor is heavy but offers excellent defense. It also radiates strange magic.

Ancient King's Armor
Once you collect all of the King's armor (Shield, Helmet, Armor, Gloves, Greaves and Sword of Ancient series) and equip it, the weight of each piece of equipment becomes lighter.



LORD MYU'S ARMOR

Lightweight and unsurpassed in providing defense against normal attacks, this suit of plate armor is priceless.

Gauntlets and Gloves



LEATHER GLOVES

Basic protection for the hands and wrist, leather gloves are better than bare hands.



ARM GUARD

While these items leave the hands bare, they offer good protection to the wrists and forearms.



GAUNTLETS

Large metal gloves that cover the forearm well, these items offer an upgrade from arm guards or leather gloves.



BLESSED GLOVES

These enchanted bracers provide solid protection and offer Light attributes.



SACRED GLOVES

Offering less protection and the same Light attributes as Blessed Gloves, these bracers make your weapon lighter and easier to carry.



BONE HANDS

While these gloves offer great protection and have Dark attributes, they are cursed. Use with caution.



KNIGHT GLOVES

These are nonmagical gloves that offer well-rounded defense against normal attacks.



CRUSADER GLOVES

Similar to knight gloves, crusader gloves give protection from stabbing damage, but are vulnerable to slashes.



CAVALIER GLOVES

These golden gloves are similar to crusader gloves. They give more protection but weigh more.



BLESSED ARMS

Superior protection, Light attributes, and low weight make Blessed Arms a worthy addition to your defense.



SILVERY GLOVES

While these gloves offer modest protection, they increase the power of your attacks, making you deadlier in combat.



VENOM GLOVES

Venom gloves provide little protection, but they poison any enemy you strike.



CRYSTAL ARMS

Offering protection from normal attacks, and some Earth and Fire attributes, Crystal Arms are valuable.



ANCIENT GLOVES

The Ancient Gloves emanate strange magical powers. They are tremendous on defense; however, this power comes with incredible weight.



LORD MYU'S GLOVES

Lightweight, Lord Myu's Gloves are strong, and they have both Light and Dark attributes.

Boots and Greaves



WOODEN SHOES

These simple shoes provide little protection, but they're better than bare feet.



FOREST SHOES

Offering the same normal protection as wooden shoes, these also offer defense against all elements but Fire.



LEATHER BOOTS

These large, knee-length boots provide more protection than wooden shoes.



IRON BOOTS

The standard issue for Heladin soldiers, iron boots are heavy but offer better defense than leather. There is a pair of these comparable to plate boots.



PLATE BOOTS

These boots offer more stabbing protection than iron boots and weigh two-thirds as much.



LEG GUARDS

Leg guards are an upgrade over iron boots, offering more defense and less weight.



MYSTIC GUARDS

Mystic guards offer good protection, little weight, and solid magical defense, especially against Earth, Wind, and Water.



KNIGHT GREAVES

Knight greaves provide well-rounded defense against normal attacks.



CAVALIER GREAVES

Sturdier than knight greaves, cavalier greaves are also heavier.



CRUSADER GREAVES

Crusader greaves protect better than cavalier greaves at slashing and hitting, but they protect less against stabbing attacks.



BLESSED GREAVES

Great defense and Light attributes make the Blessed Greaves worth finding and using.



ABSORPTION BOOTS

These lightweight boots are great against slashing and stabbing attacks. They also have Wind attributes and lessen damage taken from long falls.



DEMON LEGS

High in defense and Dark attributes, the Demon Legs are cursed. Wearing them slows you down.



CRYSTAL GREAVES

These powerful greaves offer minor magical defense. They are also solid against normal attacks.



ANCIENT GREAVES

While these provide defense against normal attacks, their weight makes them difficult to use.



LORD MYU'S GREAVES

Low weight with unbeatable defense, both Light and Dark attributes make these greaves the stuff of legends.

Jewelry

Rings



RING OF SIGHT

This magical ring illuminates dark areas. It provides no additional defense.



RING OF WISDOM

This ring increases the wearer's magical power.

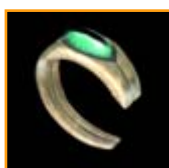

WIDDA'S RING

Wearing this ring increases hit points—excellent when entering battle against strong enemies.



RING OF FIRE

This magical ring provides decent defense against Fire attacks.



RING OF EARTH

This sturdy ring helps defend against Earth attacks and spells.



RING OF WIND

The wearer of the Ring of Wind takes less damage from Wind spells and attacks.



RING OF WATER

This ring helps protect against Water spells and attacks.

Bracelets

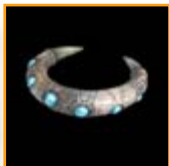

CLARITY BRACELET

Wearing this bracelet increases magic power, allowing for additional spells to be cast.

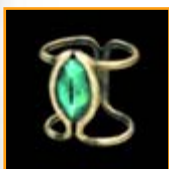

WIDDA'S BRACELET

When worn, this bracelet provides protection against paralysis at the cost of spell casting ability.



POWER BRACELET

This blue-green bracelet provides additional power in combat, amplifying the wearer's strength.

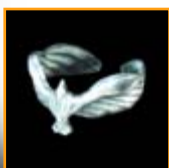

FEATHER BRACELET

Wearing this bracelet lowers body weight, letting you carry heavier items.



GUARDIAN BRACELET

The wearer of the Guardian Bracelet gains protection from all status anomalies.



SPIDER ARMBAND

Wearing the Spider Armband protects against poison from any source.



FORTUNE

This unique item has many strange and unusual powers. It is priceless.

Necklaces



LUCKY PENDANT

Wearing this necklace provides additional defense against normal attacks.



WIDDA'S NECKLACE

Similar to the Lucky Pendant, this necklace provides defense against magical attacks.



HEALING AMULET

This amulet slowly heals the wearer's wounds over time.



WATER TALISMAN

When worn, the Water Talisman aids in breathing, allowing the wearer to spend a significant amount of time underwater without drowning.



PURITY AMULET

This amulet repairs status anomalies by cleansing the body.



THIEVES NECKLACE

In addition to minor Wind and Water defense, the Thieves Necklace makes the wearer harder to detect.



MYU'S NECKLACE

This powerful necklace contains strange and unusual powers that aid in exploration.

Other Items



Maps

There are several maps to find in your journey. All provide you with important guidance in getting from place to place.

Keys



NORMAL KEYS

A normal key operates certain locks. As long as the key is in your possession, you can open these doors or chests when you encounter them.

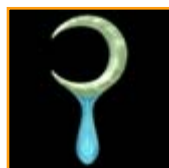

ITEM KEYS

Similar to normal keys, you must select these from your inventory. Once you use them, however, these keys stay where you placed them.

Health and Magic Items



HERB

When used, herbs restore a small portion of lost hit points. These are handy to have in battle.



HERBAL LIQUID

Herbal liquid is a concentrated form of normal herb. When used, this bottle of red liquid restores a greater amount of lost hit points.



FOREST FRUIT

A rare fruit, this has the ability to restore a tremendous amount of lost health. Use only when desperate because these are valuable.



ANTIDOTE

When eaten, antidote cures all currently active poisons. This is a necessity for battle against many creatures.



FOREST ROOT

This strange root cures most status anomalies—curse, paralysis, lethargy, and silence. It does not cure poison.



DRIED AMPHIBIA

This dried, two-headed creature cures all status anomalies, including poison.



MUSHROOM

When eaten, a mushroom restores magical power to cast spells.



DRAGON FLOWER

The ultimate healing item, dragon flower restores lost health and magic points, and cures all status anomalies. It's rare and valuable.

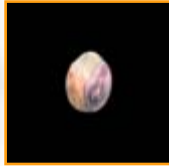

POWER SEED

A power seed temporarily raises physical energy when used. It is handy for a quick burst of energy.



WIDDA NEEDLE

Widda needles temporarily increase magic energy when used. Excellent for battles where magic is more important than might.

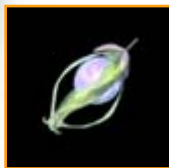

WISE MAN'S FRUIT

When a wise man's fruit is eaten, it permanently increases magic power by a point. Eat this as soon as you find it.



FOOL'S FRUIT

When eaten, this strange fruit permanently increases physical energy by one point. Like wise man's fruit, eat these as soon as you find them.



MAGIC CRYSTAL

When used, this crystal not only restores magic energy but also raises magic power.

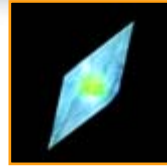

SPELL CRYSTALS

These crystals come in two shapes and six colors. When you use one, you gain the ability to cast a new spell.

Note

Spell crystals are colored according to the type of spell they teach. Red crystals contain Fire spells, orange crystals hold Earth spells, green crystals have Wind spells, blue crystals teach Water spells, yellow crystals contain Light spells, and purple crystals have Dark spells.

Special Items



CRYSTAL VIAL

This is a fine vessel, useful for carrying small amounts of liquid.



BONE

These jawbones fall from destroyed Skeletons. Save them to exchange with a merchant.

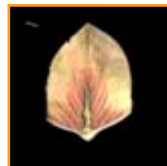

SCALE

Scales fall from reptilian creatures. Like bones, you can exchange them with a merchant.



CLAW

Another monster drop, save the claws to exchange with a merchant.



EARTH STONE

A master craftsman can use an Earth Stone to upgrade a weapon's power.



ICONS

You find four icons during your quest. Each is keyed to a particular power and provides something that has been lost from the cursed land.



ROCK OF LIFE

This rock has the power to cure any disease. It's rare and valuable.



FOREST DEW

Forest Dew is used by Forest Golems as food. It is found in the Heart of the Forest.



STRANGE EGG

The Widdas collect these unusual reddish-orange eggs for an unknown reason.



BLACK EYE

These mystical eye-like gemstones contain the power to open passages that have been closed.

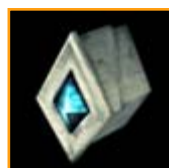

GUIDE STONES

Place each mystical, glowing Guide Stone in a Marker. Then when you later stand in a Symbol of Passage, use a wand of the same

color as the Guide Stone to transport back to that Marker.



WANDS

When used on a Symbol of Passage, the power of the wand transports the user to the location of the Guide Stone of the same color as the wand.



Note

There are five Guide Stone/wand colors: red, green, blue, yellow, and violet.



IDOL OF SORROW

You possess this cursed item when you begin your journey. It brings suffering and tragedy to whomever holds it.

Requirements to Level Weapons

LEVELING WEAPONS

Successfully land 180 hits to an enemy to obtain level 2

Successfully land 300 hits to an enemy to obtain level 3



Magic

Combat Spells

Fire Spells



FIREBALL

This spell creates a ball of flame that launches from your hand and travels in a straight line. Anything caught in the path of the Fireball takes damage when hit. At higher levels, the Fireball burns after it strikes, causing additional damage.



FIRE WALL

Fire Wall is a shorter-range version of the Fireball spell. What it lacks in range it makes up for in width and damage potential. The Fire Wall burns across the ground, moving away from you and striking multiple creatures before burning out. At higher levels, the ground burns after the Fire Wall passes. You cannot use this spell when standing in water.



FLAME BREATH

When cast, Flame Breath launches a huge blast of fire from your mouth, scalding any enemy standing in front of you. This is excellent for damaging creatures with which you are in close combat. At higher levels, the spell's range increases. Also, unlike other spells, you can cast this continually by holding down the button until you run out of magic power.

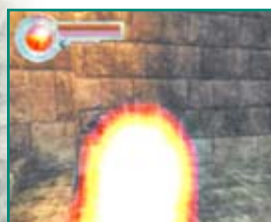

IMMOLATE

Immolate is similar to the Fireball spell. However, when cast, the ball of fire tracks its target and, if in a large, open area, swings around for multiple hits. At higher levels, a second ball of fire is added to this spell.



FLAME STRIKE

This spell creates a single ball of fire over the head of the enemy. This bursts, showering the target with flaming debris. This is a great spell for causing damage to closely packed targets or one large enemy.

Earth Spells



UPHEAVAL

When cast, the Upheaval spell creates spikes of Earth that track their target. When they reach the enemy, these spines jut out of the ground, piercing the target. At higher levels, Upheaval adds a single blow that causes massive damage.



EARTH LEECH

This spell creates a small patch of poisonous ground that infects anything crossing it, including you. It casts at short range and is good for weakening an approaching enemy. At higher levels, the size of the poison pool increases.



VOLCANNON

This is an Earth-based version of the Fireball spell. It sends chunks of burning earth at the enemy, causing both burning and impact damage. At higher levels, the flaming stone causes a minor volcano to erupt where it hits, causing more damage to the target.



METEOR CASCADE

Meteor Cascade calls down a shower of deadly burning rocks to pepper the target into submission. At higher levels, the shower lasts longer and causes more damage.



Wind Spells



WIND CUTTER

This spell creates a single, whirling blade of Wind energy. This blade is cast at the target, traveling in a straight line until it hits or reaches the end of its range. At higher levels, the Wind Cutter passes through targets, while at the highest level, a second blade is added and range increases.



ICE CLAD

This spell creates a large chunk of frozen air to strike the target. This ice ball has a curved trajectory, making it slower to hit than a spell like Wind Cutter. At higher levels, the ice ball creates a cold mist on impact.

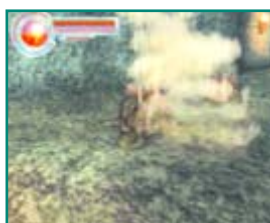

TORNADO

A whirling mass of air spins forth from this spell, knocking back and damaging whatever it hits. Back up when you cast this to avoid being trapped in the raging winds. At higher levels, a second Tornado is added, causing more mayhem.



FREEZE

This spell creates a freezing wind that encases the enemy in ice. This ice bursts, causing damage to the enemy. At higher levels, this effect is stronger and deadlier.

Water Spells



VORTEX

The Vortex spell creates pillars of water that shoot from the ground, engulfing the enemy. Against stationary foes, the Vortex hits several times before fading. At higher levels, a Shock Wave effect is added.



HYDROSPHERE

This spell creates a ball of water that floats in front of the target. This ball shoots small jets that damage anything they strike, including you. After casting this spell, keep your distance until it runs its course. At

higher levels, this spell creates a huge number of jets.

Light Spells



FLASH

The Flash spell creates a ball of brilliant light that shoots forth and damages whatever it strikes. Because many creatures are vulnerable to Light magic, it's a spell you'll use a lot. At higher levels, the light ball splits when it strikes, damaging other enemies caught in the spray.



RETRIBUTION

This short-ranged spell creates spears of light that appear in midair, stabbing the target from all sides at once. Retribution is a hard spell to target effectively because of its range, but when it strikes, it does a terrific amount of damage. At higher levels, a single, large spear is added at the end of the spell for additional damage.



VOKE LIGHTNING

When you cast Invoke Lightning, you create a single ball of energy that launches upward. A few seconds later, this ball releases a tremendous stroke of lightning straight down. Move away after you cast this spell so you aren't caught in the blast. At higher levels, this bolt of lightning becomes a lightning storm.



JUDGMENT

The Judgment spell is similar to the Immolate spell from the Fire domain. This spell creates a series of light balls that launch and chase the target until they strike. Additional orbs are created at higher levels.

Dark Spells



ECLIPSE

This spell summons a sphere of Dark magic that drains the life from all creatures who walk within it. This includes you, so retreat when you cast this spell. Use it against nearby foes. At higher levels, multiple spheres are created.



DRIFTING DEATH

The Drifting Death spell causes a cloud of darkness that damages foes and makes it difficult for them to see. You can get caught in this spell, so be careful when you cast it. A larger mist that spreads wider is created at higher levels.



DARK MATTER

When cast, the Dark Matter spell creates a huge ball of negative energy. This splits into four balls that release a powerful lightning attack. At higher levels, the main sphere splits into five or six smaller spheres.

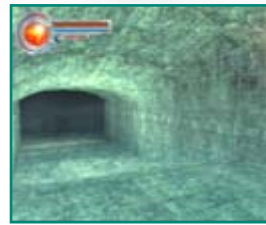

ENDURE FIRE

This spell improves your resistance to Fire spells and attacks. It protects you slightly against lava pools. This spell imbues your weapon with Water power at higher levels.



REMEDY

Use the Remedy spell after a tough combat. When cast, you recover your hit points without the need of restoratives like herbs.

Additionally, Remedy cures anomalies like poison and lethargy. At higher levels, this spell restores damage and status anomalies, and grants protection against status anomalies.

Non-combat Spells

Earth Spells



EARTH HEAL

This spell restores hit points lost from combat. It's a great spell between fights, especially when you are low on herbs and herbal liquids. At higher levels, Earth power is imbued into weapons, slowing enemies with a successful hit.



DIVINE LIGHT

The Divine Light spell creates a small area of magical light that helps you see in dark and dimly lit areas. At higher levels, this spell imbues your weapon with Light attributes

and nullifies enemy magical attacks.

Wind Spells

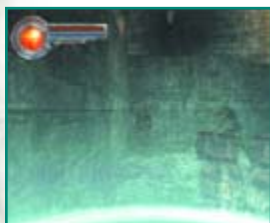

LIFE SHIELD

The Life Shield disrupts the flow of air around you, making it easier to avoid enemy arrows and missile weapons. It's a necessity against Dark Archers, Skeleton Archers, and Widda Archers. This protection increases at higher levels.

Dark Spells



SHADOW SKIN

Shadow Skin causes darkness to gather around you, making it difficult for your enemies to spot you. It also makes it more difficult for you to see. At higher levels, Dark magic is imbued in your weapon.

Water Spells



PURITY

The Purity spell acts like antidote, curing you of poison when you cast it. Its benefit is that it takes no magic power to use and, unlike antidote, it's free. At higher levels,

poison ability is temporarily granted to your weapon.



RECKLESS STRENGTH

A great combat spell if you aren't planning on doing a lot of spell casting, Reckless Strength increases your physical power. As a consequence, your magical abilities drop to

nothing, and your magic power recharges at a slow rate. This spell imbues your weapon with Dark magic at higher levels, which slows enemies on a successful strike.

Magic continued...

Requirements to Level Magic

LEVELING MAGIC

Level 2 – 50 Experience Points needed

Level 3 – 150 Experience Points needed

OFFENSIVE MAGIC

Each time an offensive spell successfully hits an enemy, one experience point is earned.

DEFENSIVE MAGIC

Each time a defensive magic is used, three experience points is earned.

NOTE: Earth Heal and Remedy only count as one experience point. Also, Earth Heal and Remedy must heal at least 1 HP in order for the experience point to be earned.

NOTE: Leveling magic experience points has nothing to do with in game experience points.

Strategy Combat

Bobbing and Weaving

The basic combat strategy you should employ is a bobbing motion, forward and back. Most of the monsters (but not all) warn you before they strike: Living Dead angle their pickaxes, Spiders pause before they pounce. Get close enough to a creature to cause it to attack, and back away before the strike hits you. While the creature recovers from its missed attack, hit without fear of retaliation.



With creatures like Stools, you can easily plan your attack. Wait for the spores to disperse, then swing away.

For creatures with a long-range attack like Archers, utilize a side-to-side movement. Get them to launch an arrow or cast a spell at you. Move away so the attack goes to the side of you. While they get another attack ready, charge in.



Monsters with long-range attacks are more trouble. Move from side-to-side to avoid their attacks as you approach.

Fast and Weak vs. Slow and Powerful

You have a choice in how you want to enter combat. You can go with faster weapons like Carvers and rapiers, or you can opt for bigger weapons. Each has its advantages.

With faster weapons, your attacks are more frequent. You don't have to wait as long to recover from a strike, which means you can hack away without having to back off. With a fast weapon, you can attack again before the enemy recovers from your first strike. Even better, you can usually get in your attack before the enemy strikes, often stopping its attack. However, fast weapons do less damage, which means you must hit more frequently as well.



Fast weapons don't do as much damage as heavier ones, but you can attack more rapidly, often stopping an enemy strike before it happens.

Tip

The other advantage to lighter weapons is that you can carry a shield while using them. The added defense can mean the difference between life and death.

Heavier weapons take longer between swings but do more damage when they hit. Where a rapier leaves a small hole, a massive two-handed bastard sword leaves a terrible gash. Using one of these weapons means fewer strikes are necessary to down your foe. The down side is that your attacks are slower, which means that fast opponents often hit you while you are swinging.



Heavier weapons do increased damage at the cost of speed.

Tip

To counteract the problem of heavier weapons, swing while you approach the enemy. Your attack finishes as you get close, scoring a hit and leaving you vulnerable for a shorter period of time.

The choice between fast and weak or slow and strong is yours. Both can be successful.

Spells in Combat

Offensive spells are invaluable in your battles. Use them to stun enemies, knock them back, wound them, and open them up for additional attacks.

The best way to use a spell, other than killing a creature, is preventing it from attacking. Hit the enemy with a spell while charging. While the enemy reacts to the damage from the spell, get in a good strike with your weapon. This is often enough to kill a foe, leaving you unscathed.



Hit first with a spell, then move in with the weapon. You hit your enemy twice before it can attack once.

Your non-combat spells can be used in combat, but they're tougher to work with. Have your combat spells working for you. Use spells like Earth Heal and Purity between fights so your magic power is usable for Fireballs and Meteor Cascades during battle.

Using Items

Restoratives

Restoratives return lost hit points, restore magic points, get rid of status anomalies, or some combination of the three. Use and buy them often.

Use health restoratives like herbs and herbal liquids as you need them in combat. Eating or drinking one affects you instantly, so you regain your health while you fight. After you learn the Earth Heal spell, use this between battles to restore your health.



Use health restoratives in combat.

Mushrooms restore your magic power; use them as you need them. If you run out of magic points while fighting, use a mushroom. Like all items, its effects are instant.

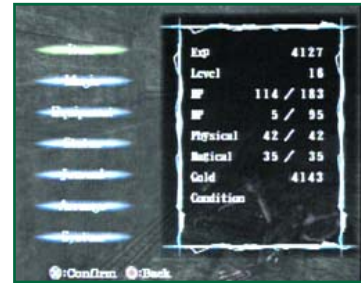

When you don't have enough magic points to cast the spell you wish, use a mushroom.

Use items like forest roots and dried amphibia, which get rid of status anomalies like poison and lethargy, when you need them. Be smart, though. If you're fighting a large group of creatures that can poison you, wait until the end of combat to use an antidote, or you can expect to use a lot of antidote before the combat is over. Heal yourself to get your hit points back.

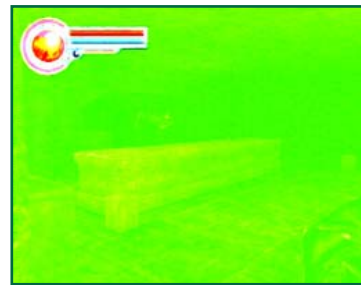

Finish the combat before using a forest root, dried amphibia, or antidote, then cure yourself afterward.

Equipping Yourself

You can swap out your equipment, including armor items and weapons, instantly—even change them in the middle of combat. Go into battle holding the best items in your repertoire. If you're carrying a rapier and run into a Skeleton, switch it for your morning star. The Skeleton won't get any free shots at you, and you'll be better

equipped to handle the combat. If you run into something that uses Fire magic, like Salamanders, equip yourself with items that protect against Fire damage.



Don't be caught in combat with the wrong weapon or spell.

Because of the importance of gaining experience, never avoid combat. If there are monsters in your way, take them down. Get their money, items, and experience for killing them. You don't need to go out of your way to find creatures to kill, but don't pass up monsters either. Run from combat when you are out of healing items, out of magic-restoring items, and are low on hit points. Otherwise, take out everything you encounter. The higher your level, the easier the fights are, the better your spells are, and the easier it is to successfully finish.

General Strategies Combat Experience

Combat is a major part of your quest in *King's Field: The Ancient City*. Everywhere you go, there are creatures trying to stop you from finishing your task.

In addition to clearing the way for your continued exploration, combat does three things for you. First, many of the creatures you fight drop items. Bosses, especially, drop spell crystals and other items you need to continue. Second, monsters drop gold, which allows you to buy items that you need to protect yourself, heal, and better continue your journey. Third, combat generates experience.

Experience is what turns you into a one-man wrecking crew capable of defeating any foe. Each time you go up a level, you become able to use heavier, more powerful items, your magic abilities increase, and you become harder to kill because of additional hit points. Attacks that would flatten you outright at the beginning of your quest can be shrugged off later on.

Exp		Attack		Defend	
Exp	132120	Slash	106	Hit	144
Level	53	Hit	72	Stab	148
MP	858 / 858	Fire	0	Earth	25
MP	535 / 535	Earth	0	Wind	25
Physical	111 / 111	Wind	0	Water	25
Mutical	194 / 194	Water	0	Light	100
Gold	5085	Light	100	Dark	65
Condition		Dark	0		

It takes a lot of combat to gain this many levels, but you must do it to survive.

Going Up Levels

There are a few different types of levels with which you should be concerned. The basic type is an experience level, which improves your hit points, magic points, and ability to carry items.

You can also raise levels in weapons and spells. Using a weapon or spell many times teaches you something about that weapon or spell. Eventually, you can improve your skills with it. At higher levels, you become faster, more accurate, and more dangerous with your weapons, and your spells gain strength and new abilities. Stick with a few weapons you really like to gain additional strength with them over time. As for spells, get several to second or third level. The maximum level for a spell or weapon is three.



Wounds caused by monsters, which are serious early on, are minor when you become stronger.

Weapon		Attack		Defend	
Attack	Level 2	Slash	0	Hit	41
Slash		Hit	45	Stab	45
Stab		Fire	0	Earth	0
Fire		Earth	0	Wind	0
Wind		Wind	0	Water	0
Light		Water	0	Light	0
Light		Light	0	Dark	0
Dark		Dark	0		
Weight	5.5 LB				
Length	2.2 FT				
Mora	83 / 100				

Norming Star

The additional level makes this weapon deadlier in combat. Pick a few weapons to specialize in.

Note

Weapon levels refer to specific weapons. If you gain a weapon level with the Fire Carver, you don't gain a level with any of the other carver weapons. Gaining a level with one morning star doesn't translate over to a different morning star.



Get rid of items you no longer need, and use the money to buy things you want.

Backing Out

When you look through the next section, there are mentions of going to a specific shop or using a save position. It isn't necessary to follow the walkthrough perfectly in terms of shopping and saving. At any time, you can back out of an area, return to someplace you've been, and buy items you need or save your game. You can use save positions as many times as you like, so run back and save your position after a tough combat, even if the walkthrough doesn't specifically mention it.



If you are low on health and items, back out even if the walkthrough doesn't mention it. You can come back.

Buy whatever you think you can use. The only item you need to buy is the Wind crystal early in the game. Everything else you can buy as you need it. Sell anything you aren't going to use, especially armor and weapons. Keep special items like crystal vials, keys, maps, and the like—you'll find uses for them all, often long after you discover them. With weapons and armor, when you have something better in your arsenal, get rid of things you no longer plan to use. There's no reason to hang on to your old wooden club when you have a morning star that quickly does more damage. Sell the club and get the money for it.

Tip

The only exception to this rule is the Lawful Blade. Don't sell this back. You need it at the end of the game.

Guide Stones and Wands

Throughout your travels, you find five Guide Stones and wands. Use these in conjunction with the Symbol of Passage to quickly move from one place to another. When you use a wand while standing in a Symbol, you go to the Guide Stone of the same color, as long as the Guide Stone is placed in a Marker.



Use Guide Stones, Markers, wands, and Symbols of Passage as shortcuts from place to place.

The walkthrough has some suggestions for using the Guide Stones and wands, but feel free to use them as you desire. They are there to shorten your travel time between locations. While the walkthrough makes some recommendations at certain places, use these items as you see fit.

Maps

While you can easily follow the written walkthrough to get from place to place, you can use these maps in conjunction with the walkthrough to help you find items and navigate how each area connects to the next. Throughout the Walkthrough (starting on page 49), look for the **64** icon, which appears in screen corners. The number on the icon references the maps in this chapter.

1 PALACE OF OATH EXTERIOR

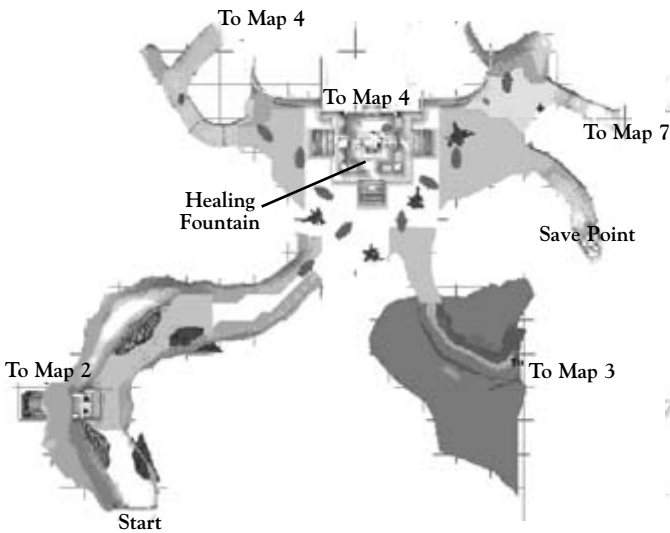

2 VILLAGE RUINS

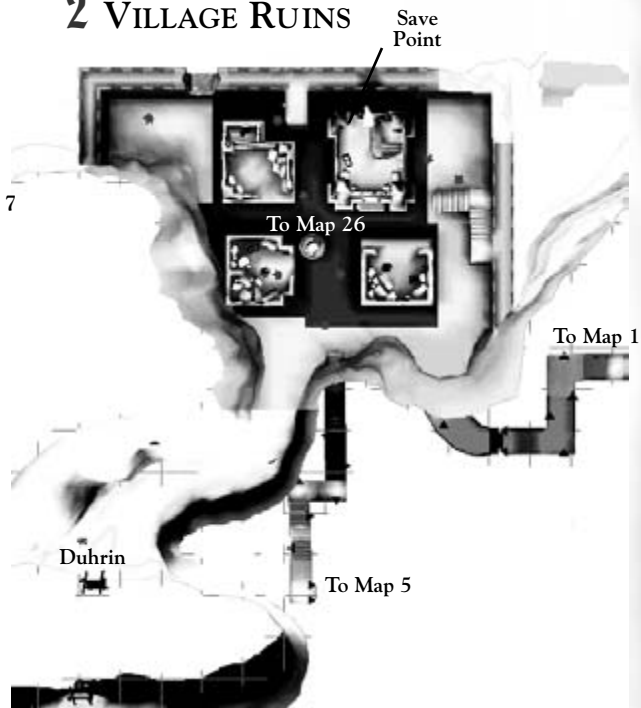

3 EAST VALLEY

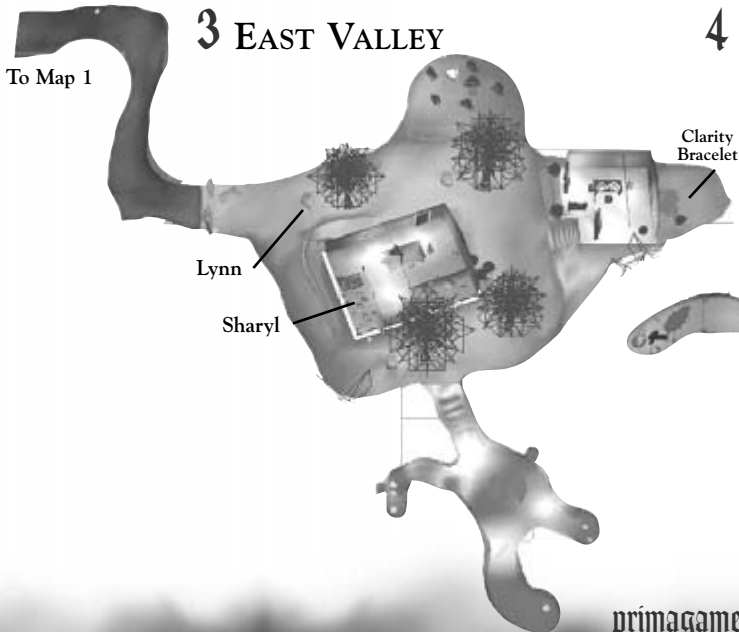

4 PALACE OF OATH INTERIOR

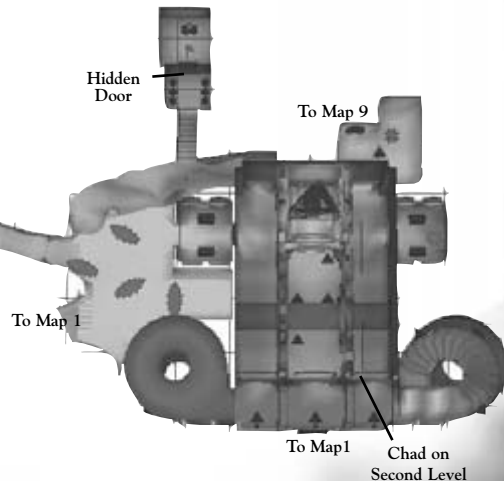

5 THE SHOP

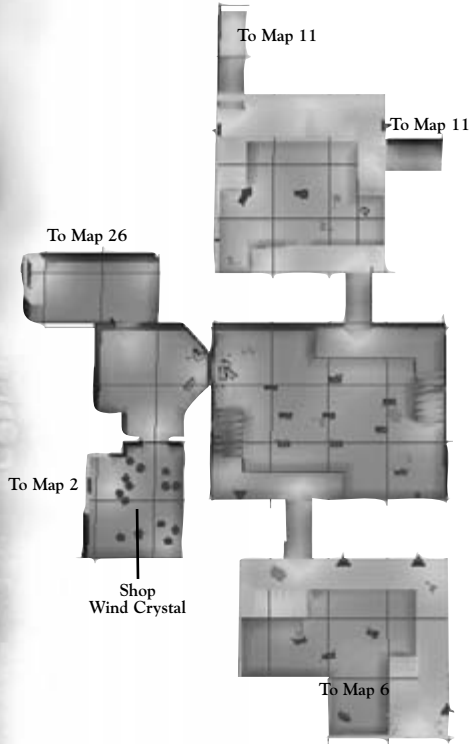

6 MINER'S CEMETERY

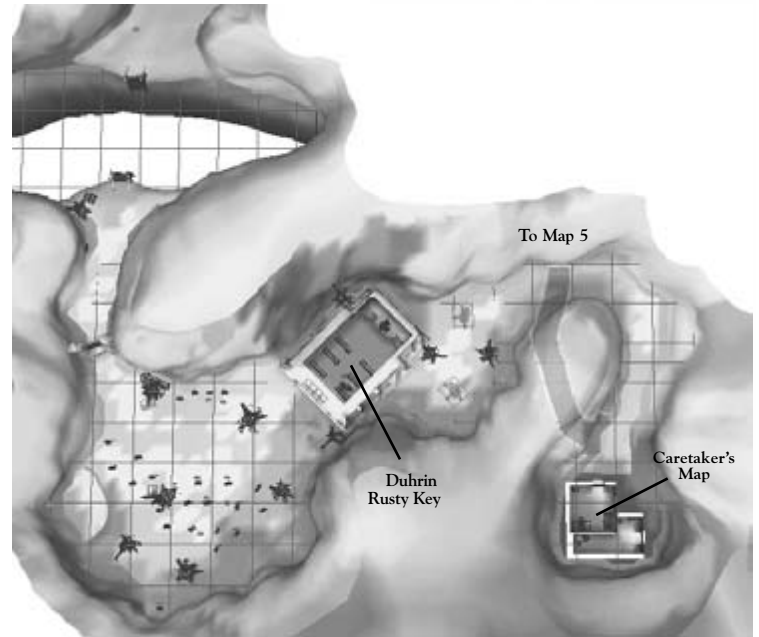

7 UPPER MINES

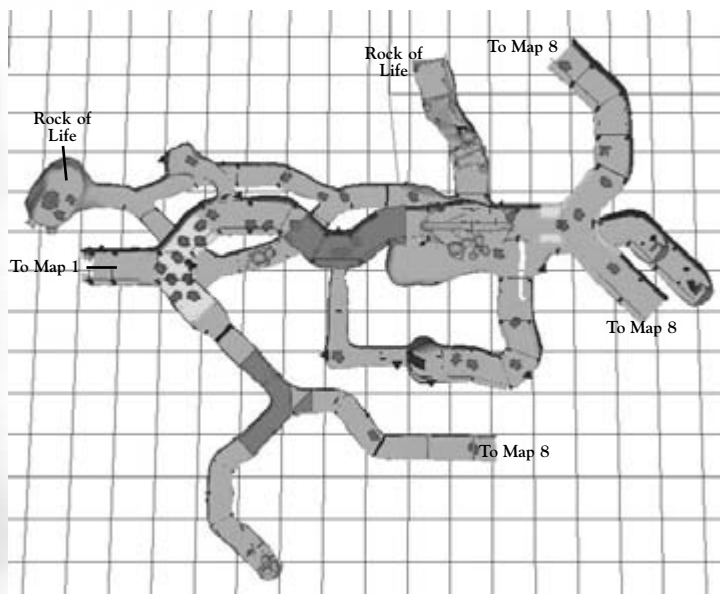

8 LOWER MINES

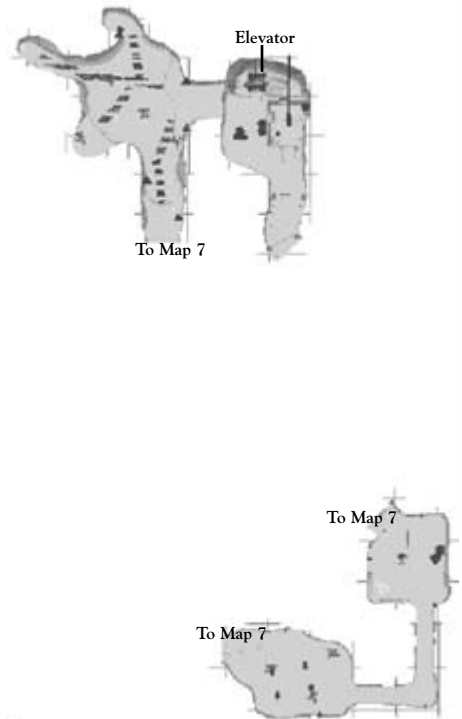

9 CATACOMBS (OR GIANT SPIDER'S LAIR) 10 UPPER UNDERGROUND GRAVEYARD

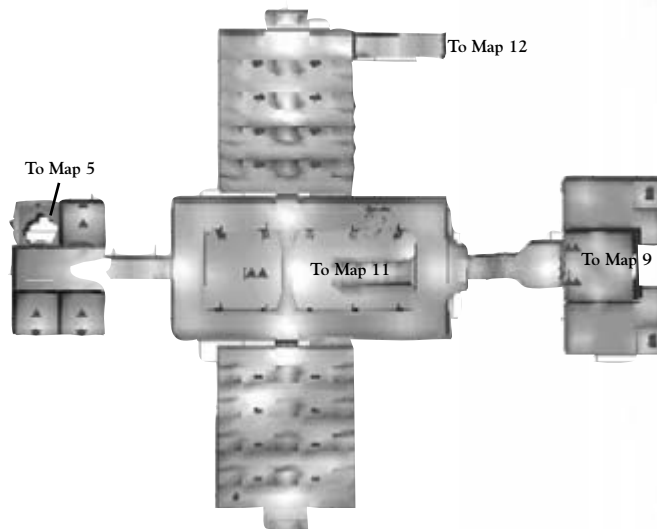
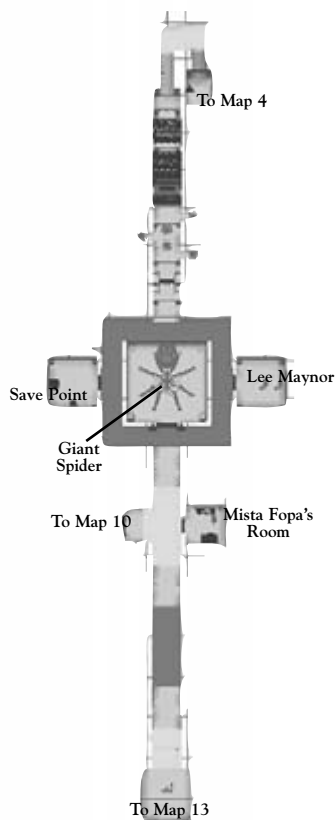

11 LOWER UNDERGROUND GRAVEYARD

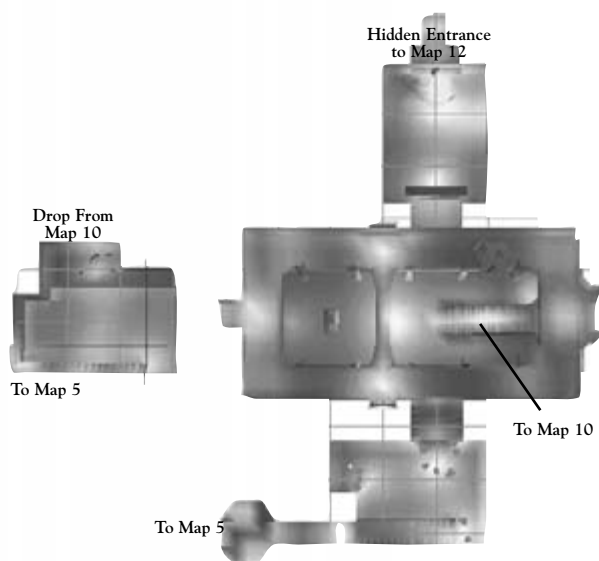

12 ICON OF HEALING

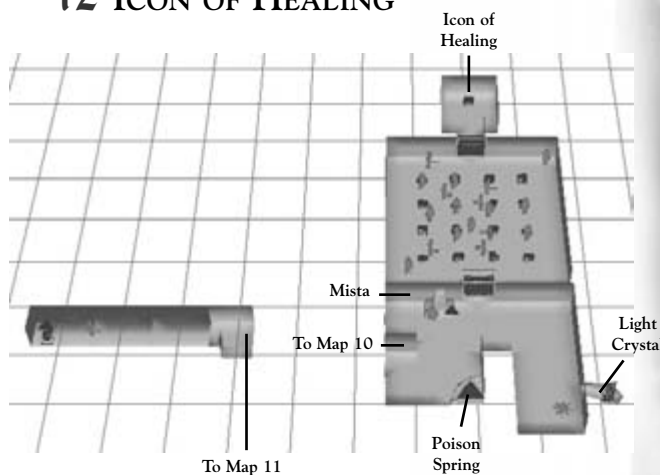

13 THE ANCIENT CITY EXTERIOR

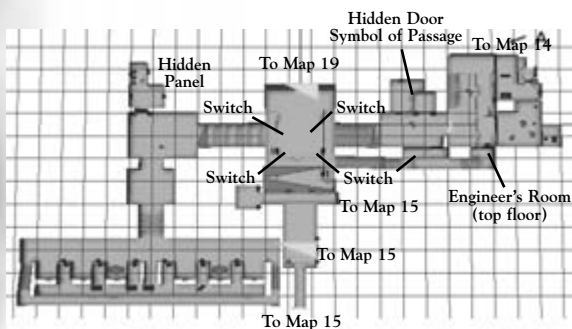

14 THE ARMORY

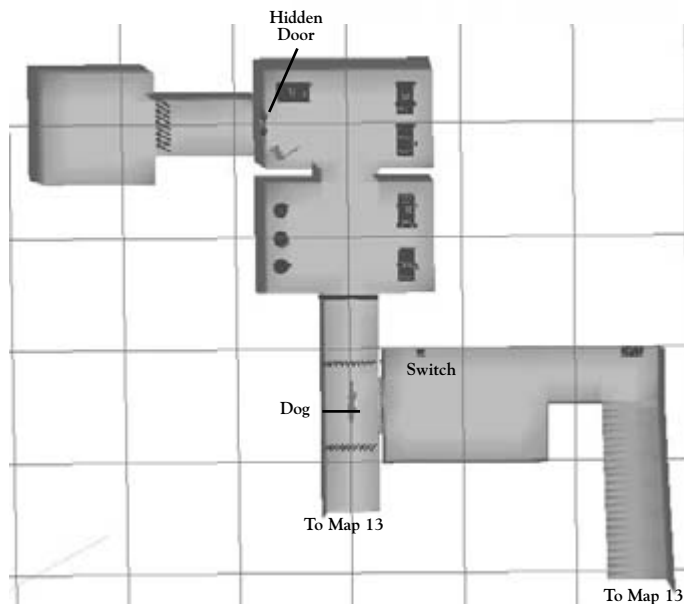

15 THE ANCIENT CITY LEVEL 3, WEST

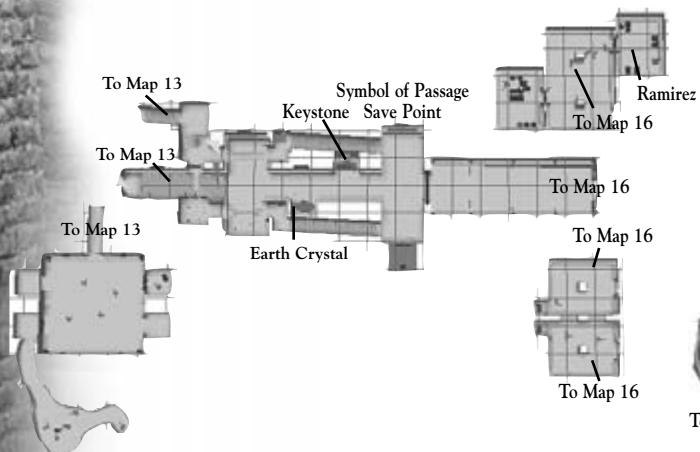

16 THE ANCIENT CITY LEVEL 3, CENTRAL TOWER

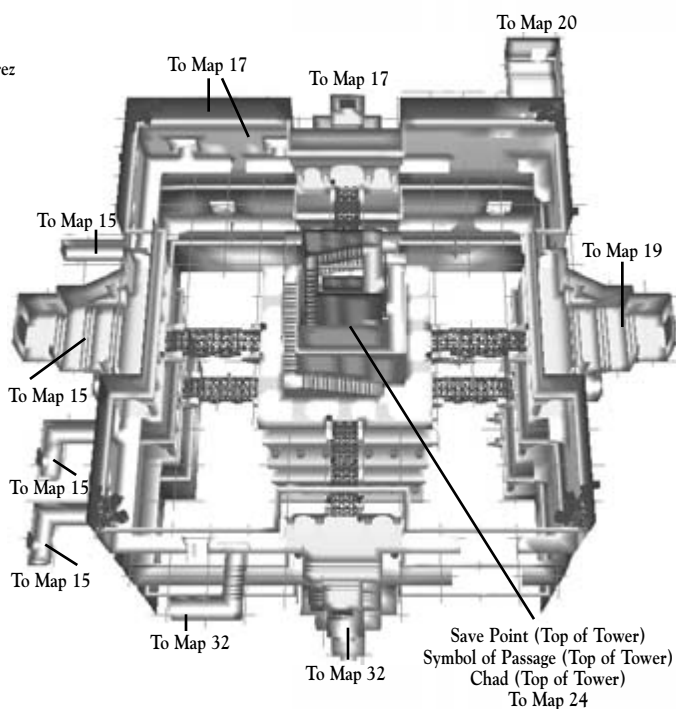



17 THE ANCIENT CITY, LEVEL 3, NORTH

18 NORTH CLIFFS

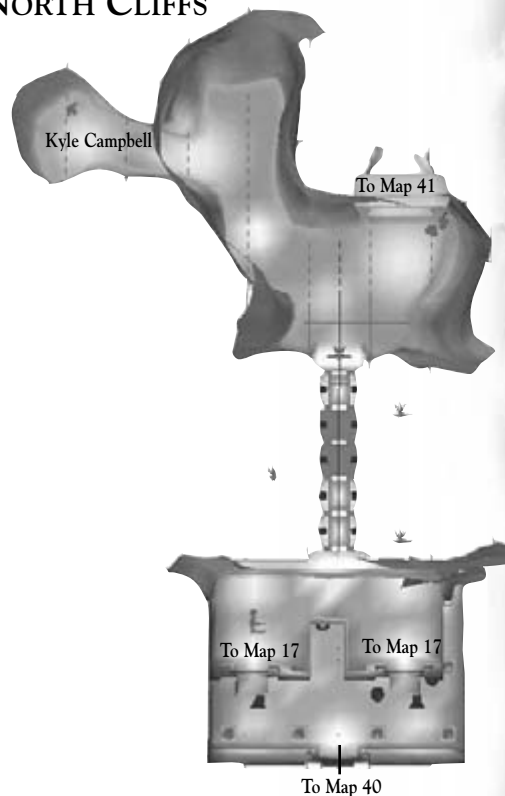
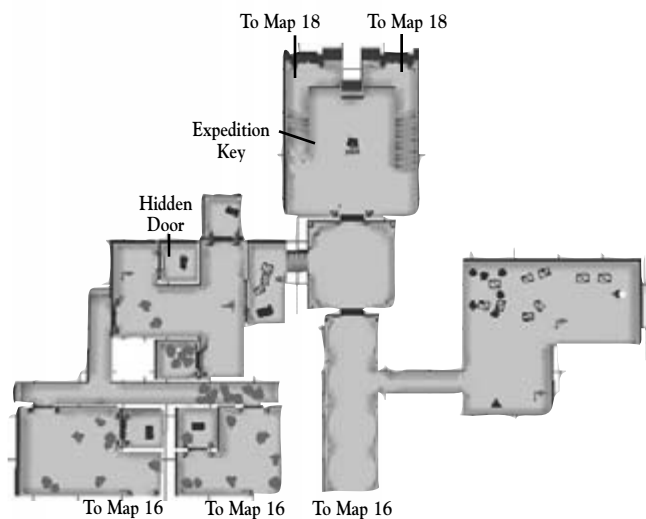

19 THE ANCIENT CITY, LEVEL 3, EAST

20 THE ANCIENT CITY, LEVEL 3, EAST CATACOMBS

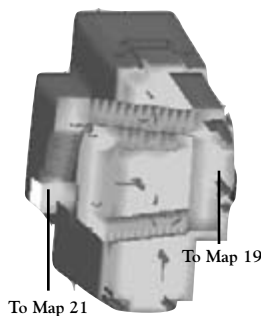
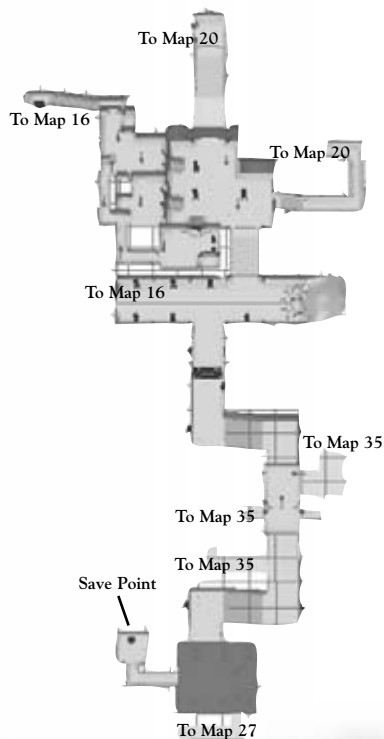

21 THE HOLY FOREST

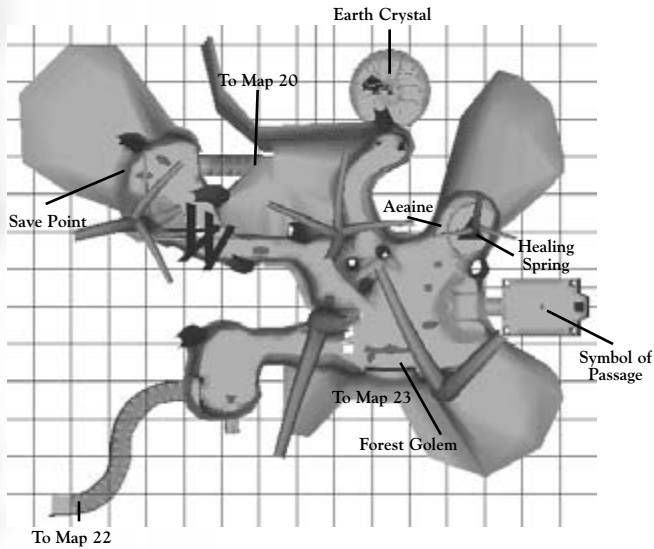

22 THE HEART OF THE FOREST

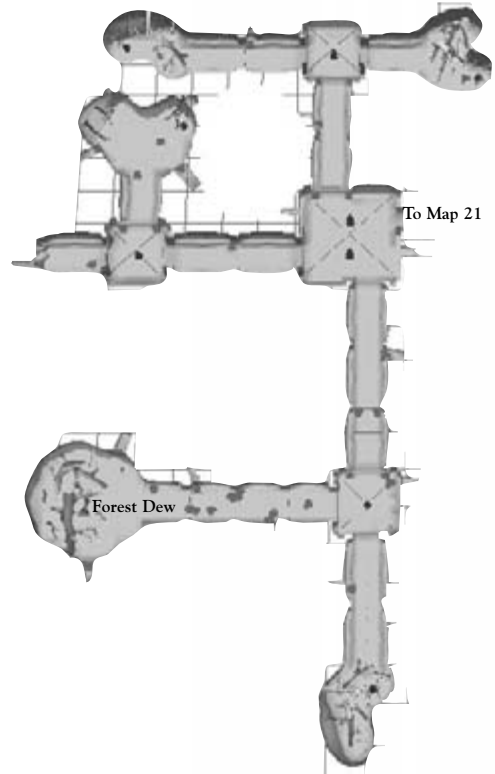

23 THE KING'S THRONE, UPPER

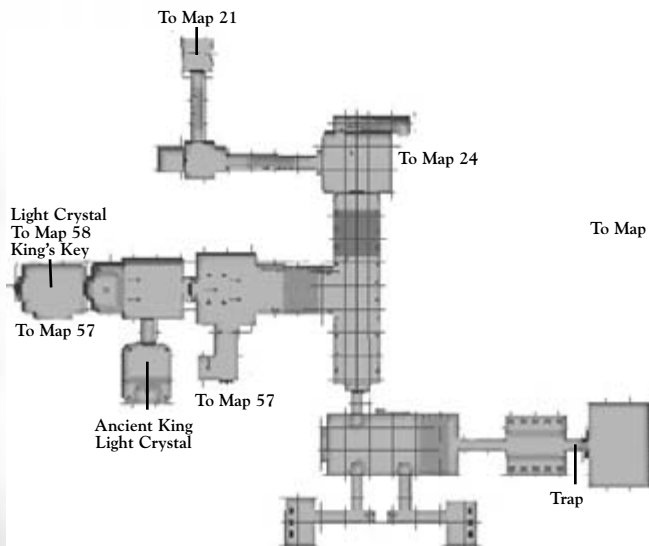

24 THE KING'S THRONE, LOWER

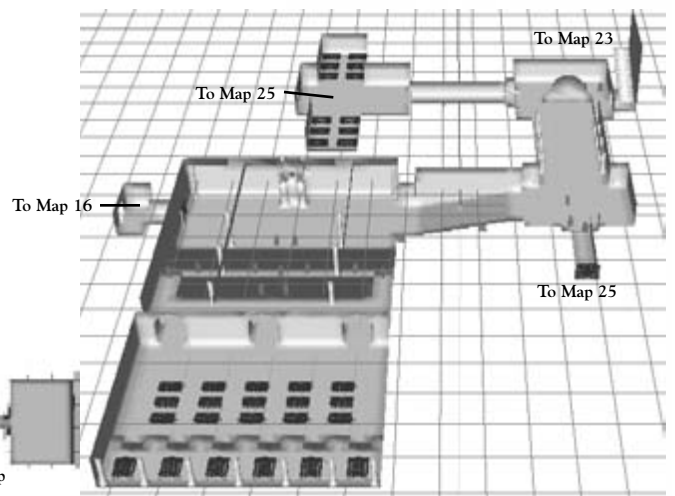



25 THE KING'S THRONE, ALCOVES

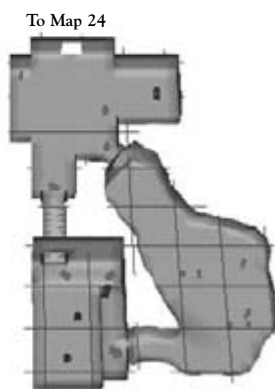
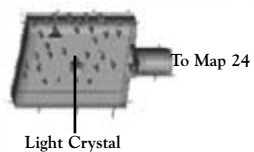

26 THE UNDERGROUND CANAL

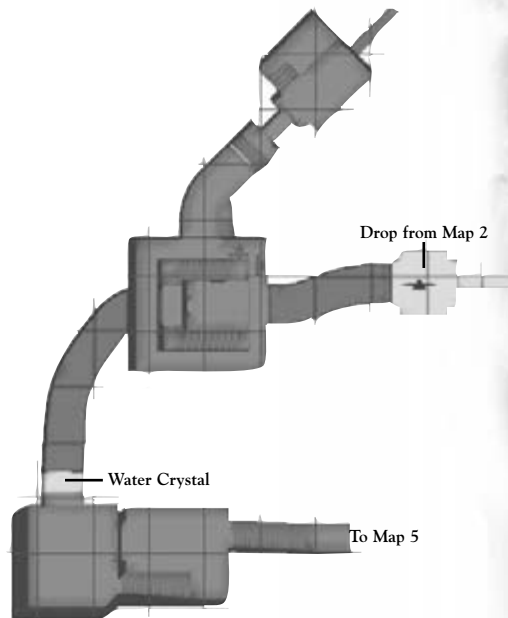

27 SOUTH CLIFFS

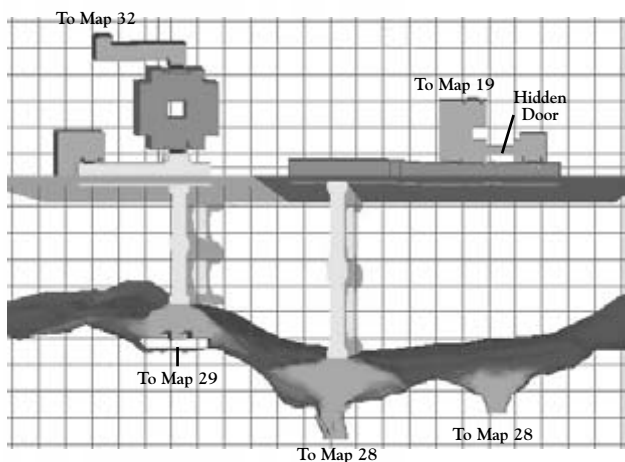

28 THE EARTH FOLKS' VILLAGE

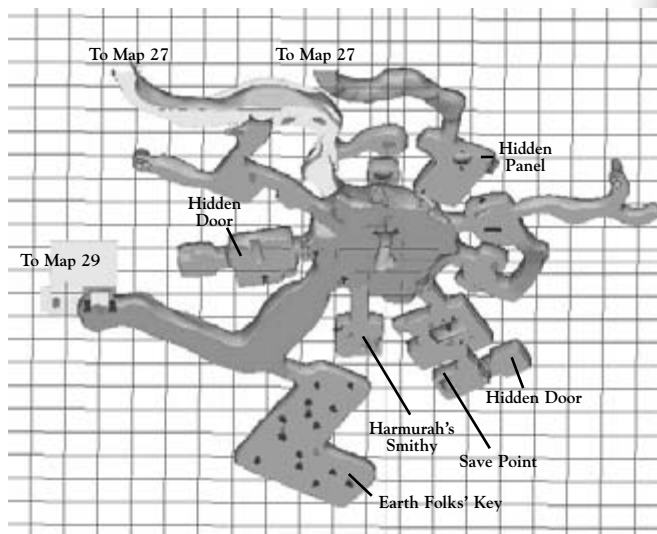

29 THE FORGE

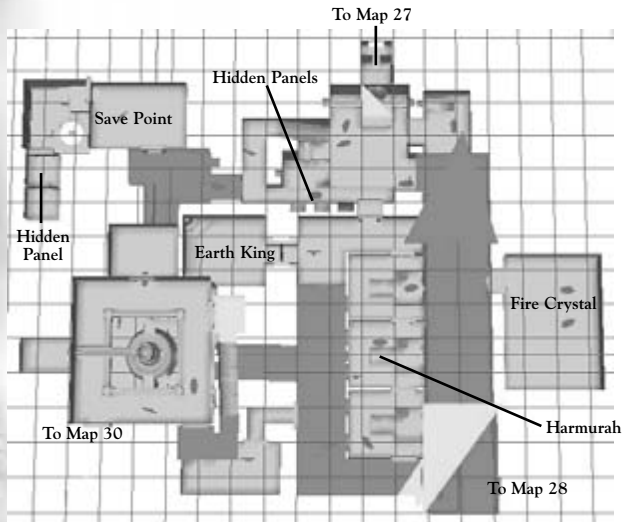

30 THE CAVERN OF LAVA

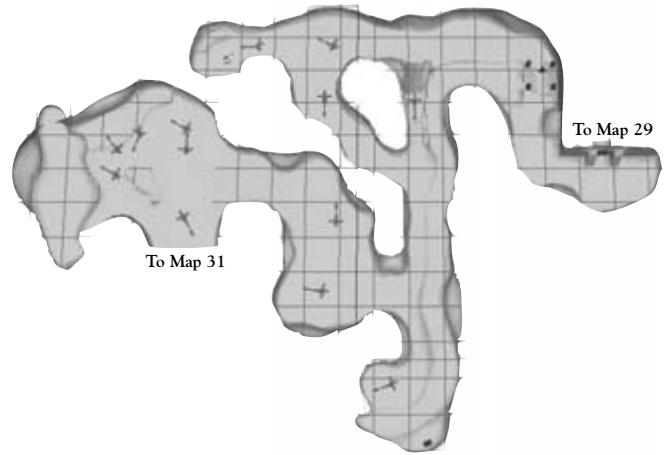

31 THE FIRE LORD'S DOMAIN



32 THE ANCIENT CITY, LEVEL 3, SOUTH

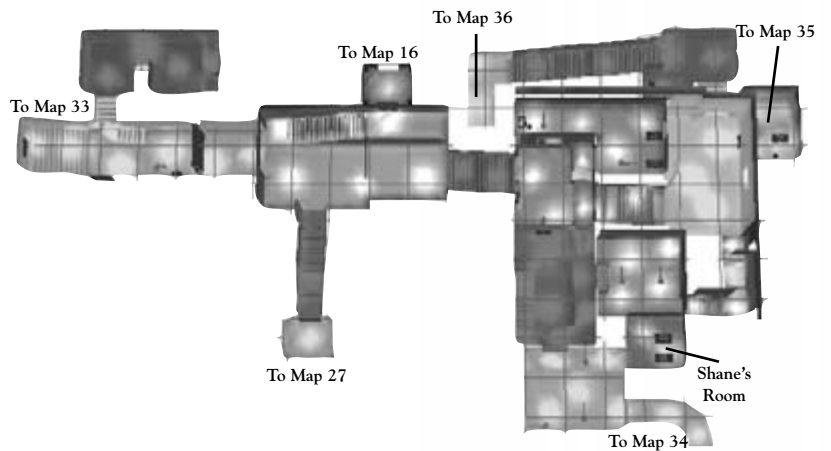



33 THE ANCIENT CITY, LEVEL 3, SOUTH, WIDDA AREA 2

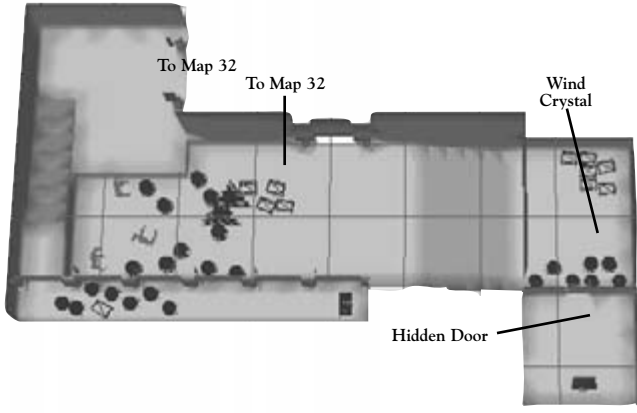

34 THE ANCIENT CITY, LEVEL 3, SOUTH, WIDDA AREA

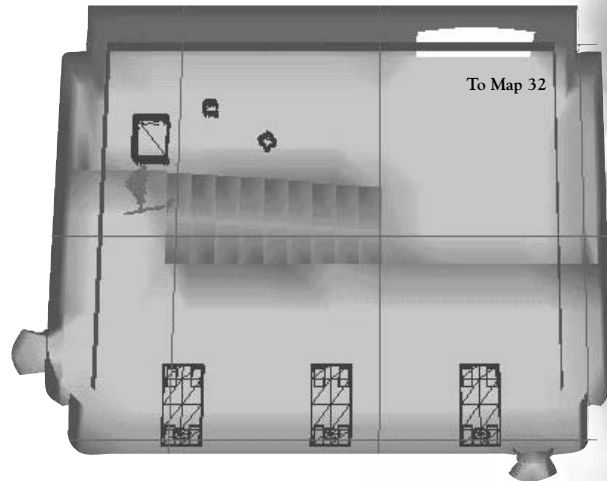

35 THE ANCIENT CITY, LEVEL 3, SOUTH, CRAFTSMAN'S ROOM

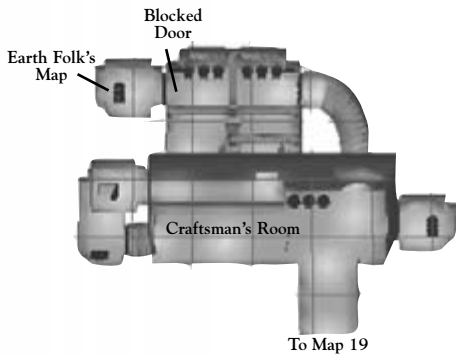

36 THE ANCIENT CITY, LEVEL 2, SOUTH

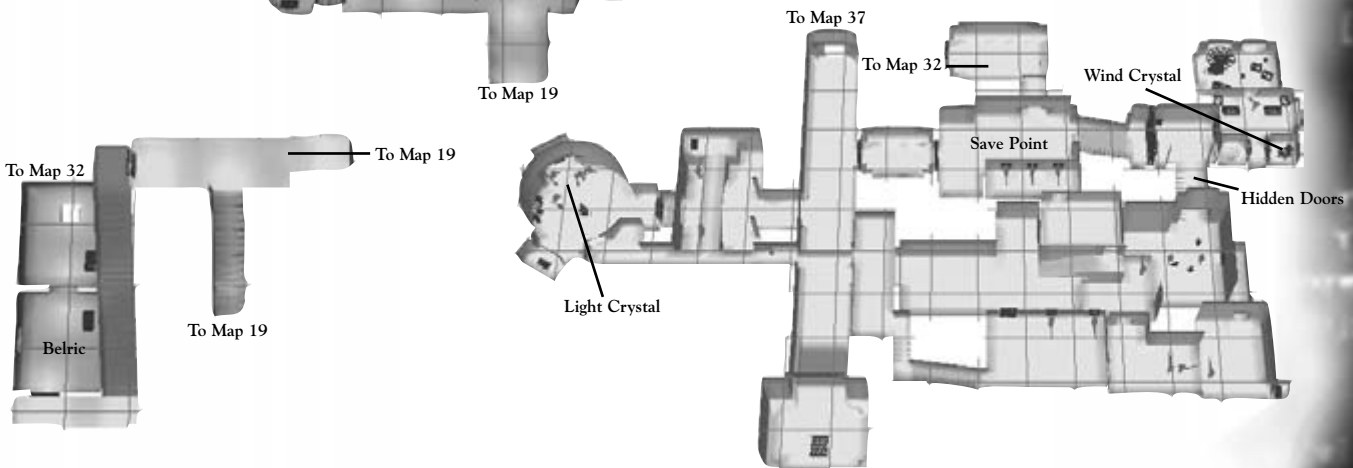

37 THE ANCIENT CITY, LEVEL 2, CENTRAL TOWER

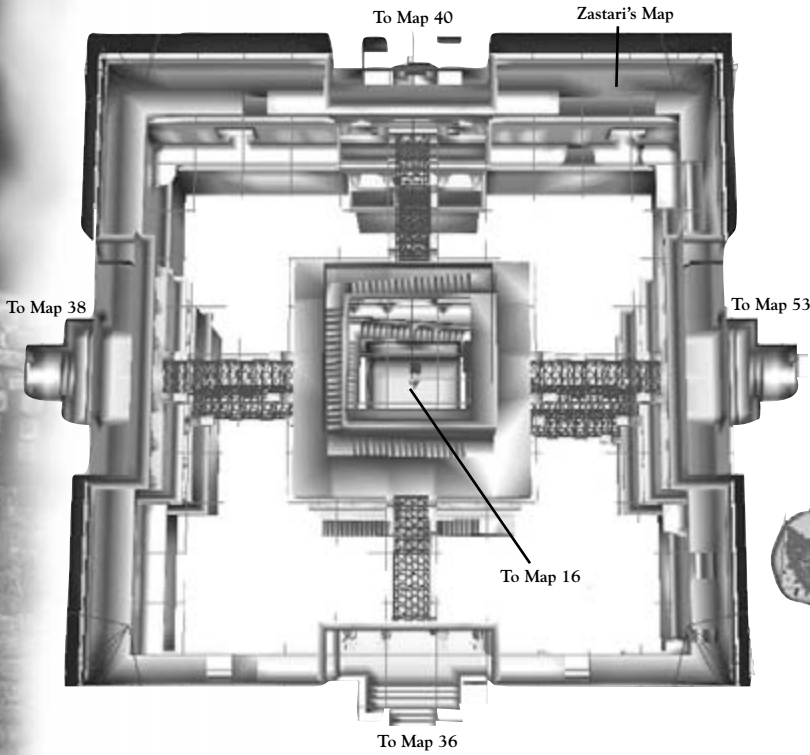

38 THE ANCIENT CITY, LEVEL 2, WEST

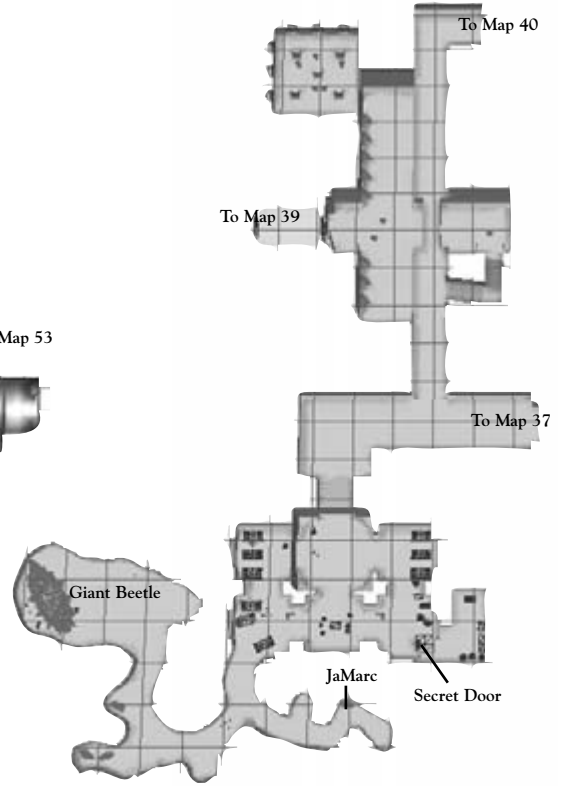

39 THE ANCIENT CITY, LEVEL 2, WEST, SORCERER'S AREA

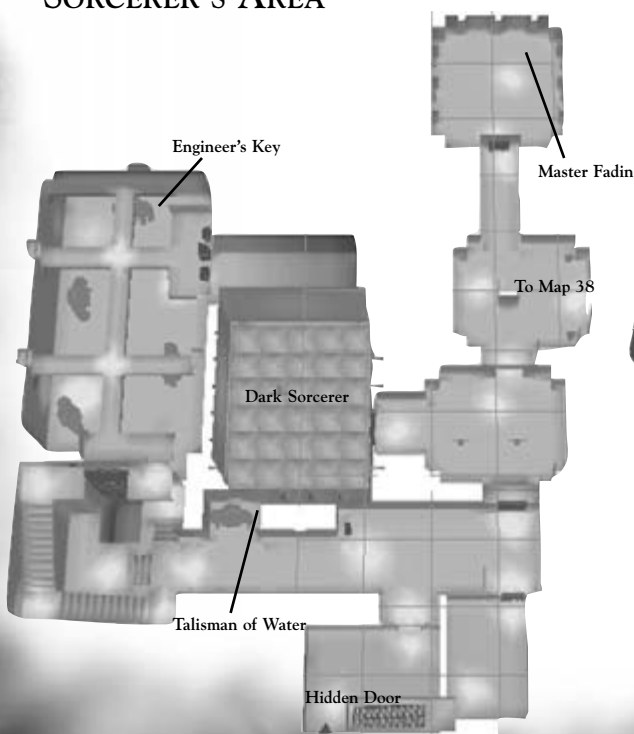

40 THE ANCIENT CITY, LEVEL 2, NORTH

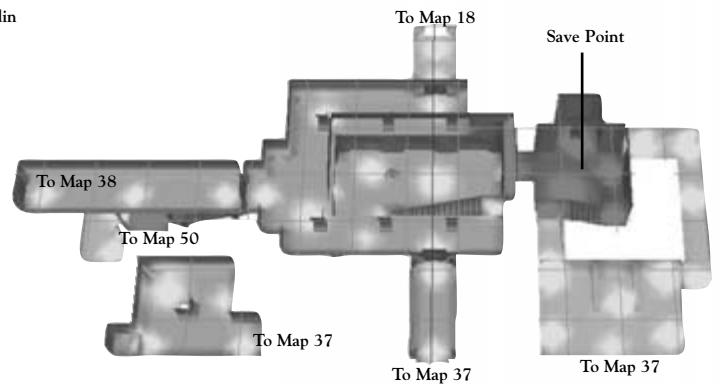

41 CLIFF PASSAGE

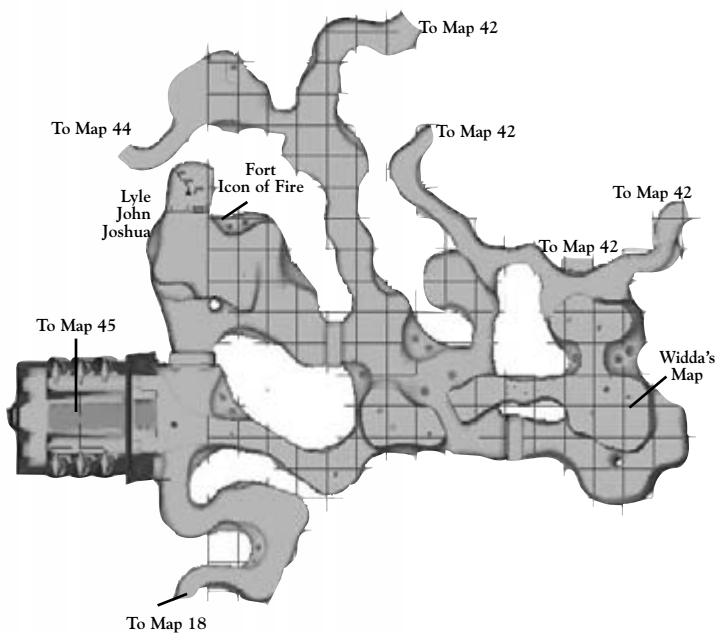

42 OCEAN SHORE

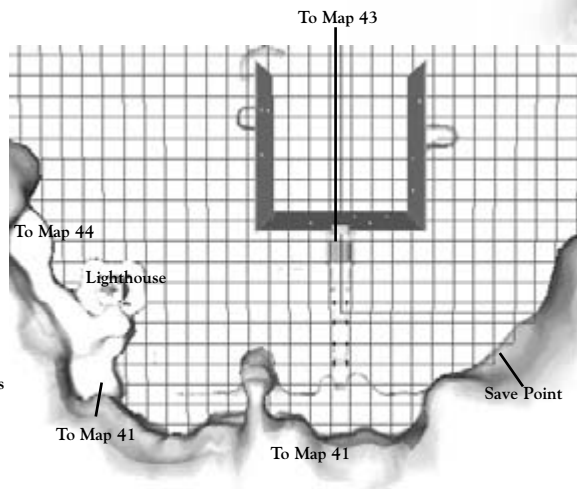

43 THE OCEAN FORTRESS

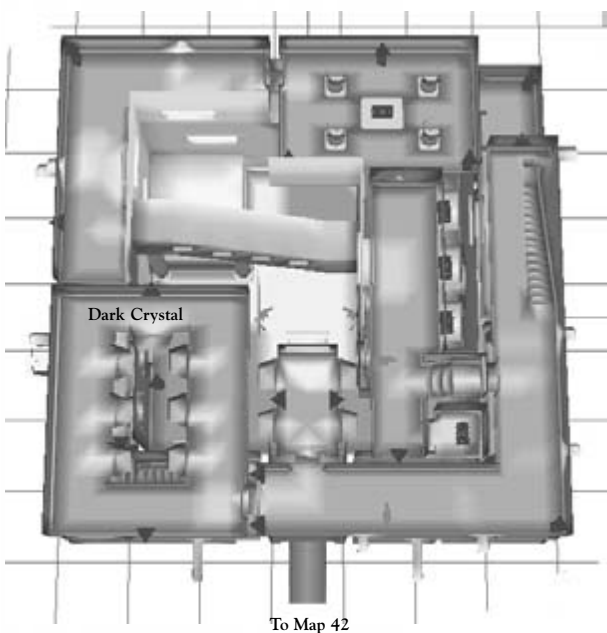

44 SEABED CAVE

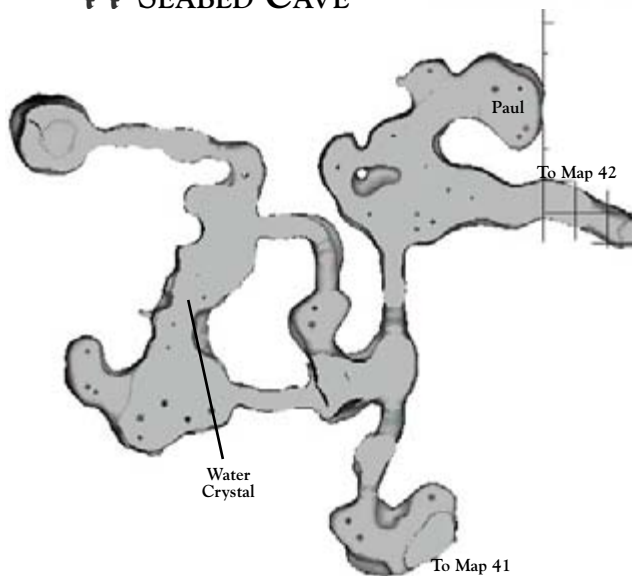

45 THE QUEEN'S PALACE

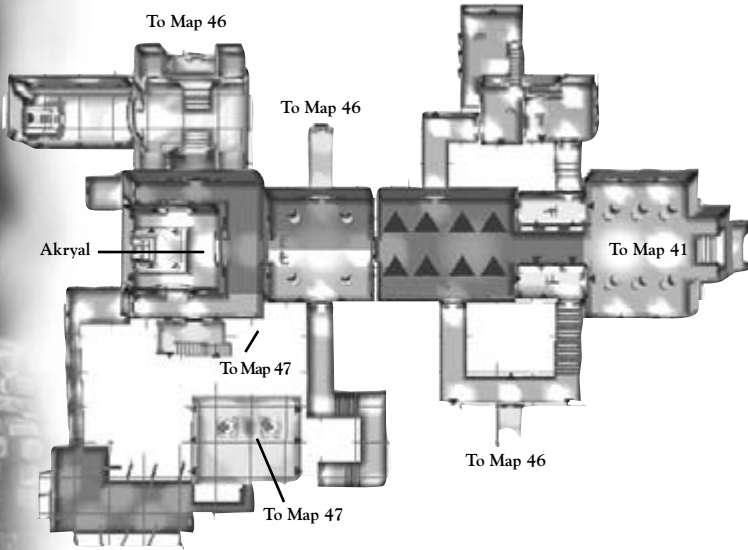

46 THE QUEEN'S PALACE, CATACOMBS

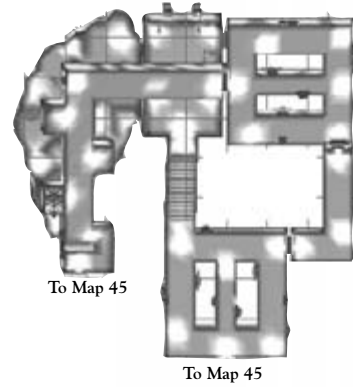

47 THE WIDDA QUEEN'S LAIR

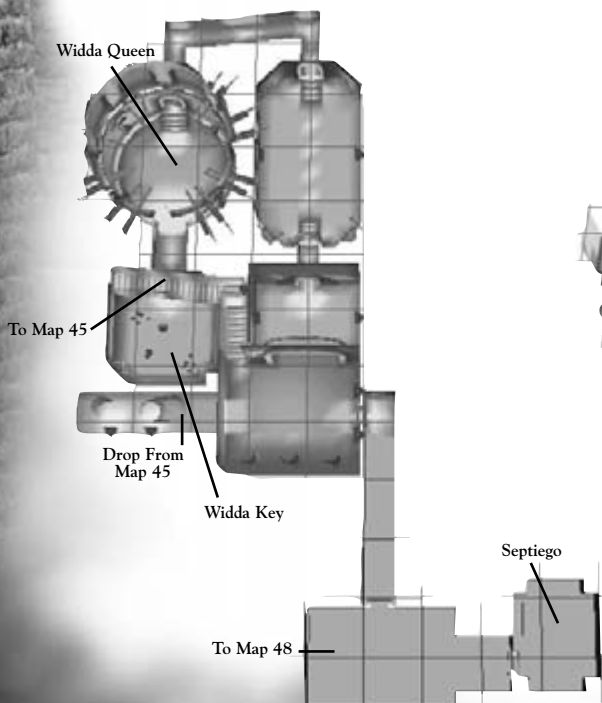

48 THE EGG MINES

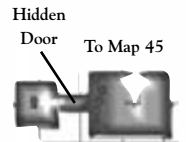
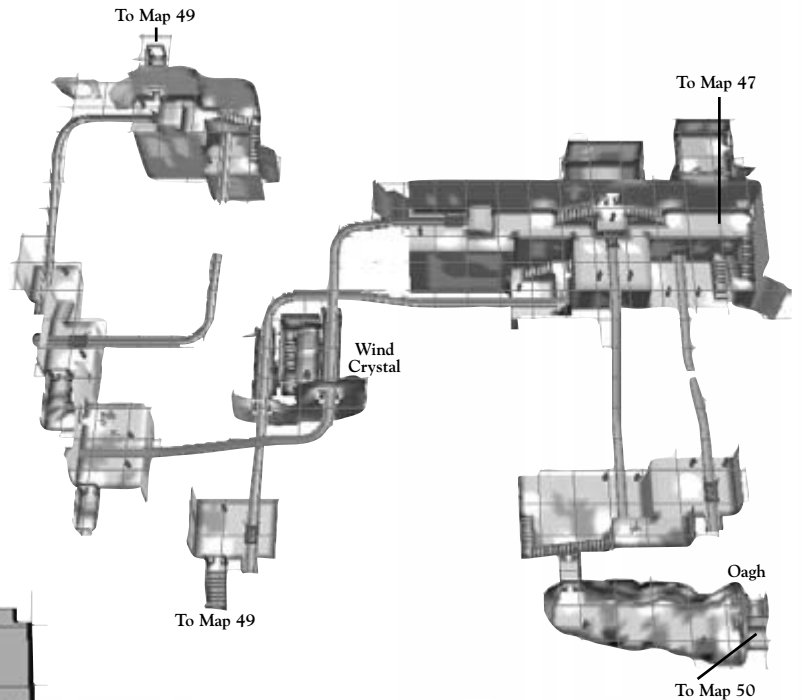

49 THE SNAKE DENS

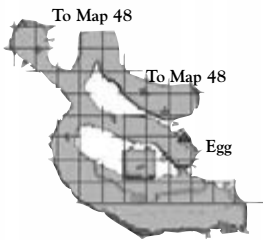
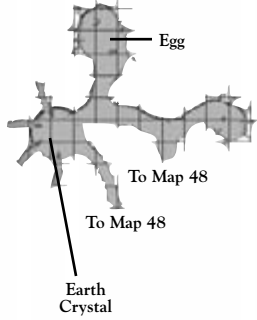

50 THE ANCIENT CITY, LEVEL 1, WEST

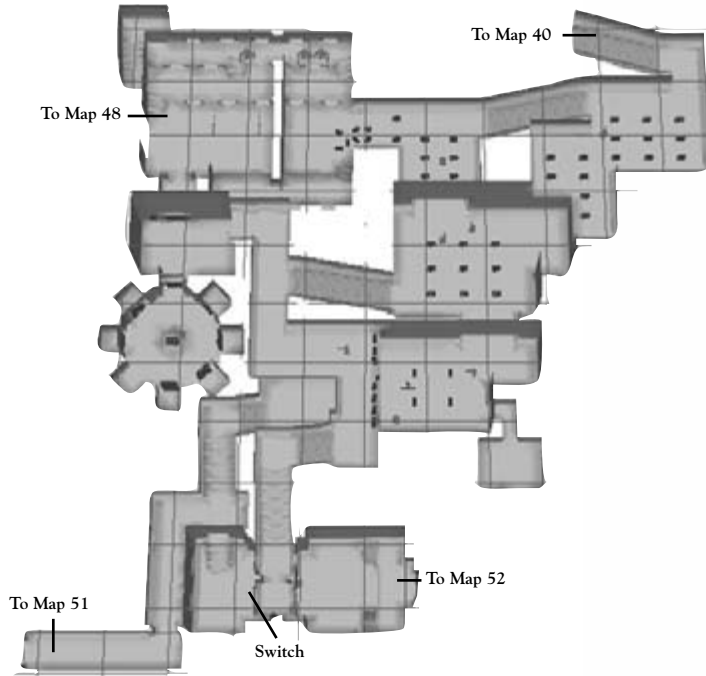

51 THE RUINS OF THE DARK FOLK

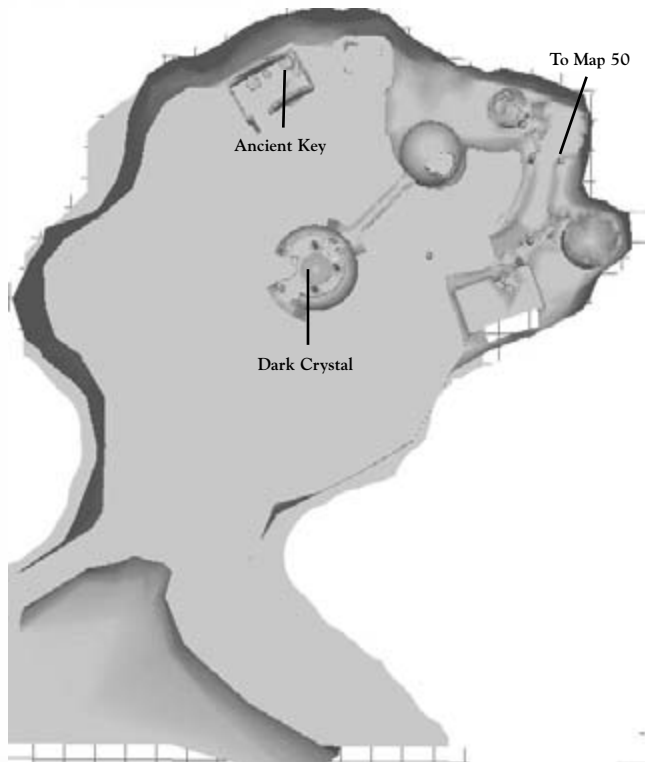

52 THE ANCIENT CITY, LEVEL 1, CENTRAL TOWER

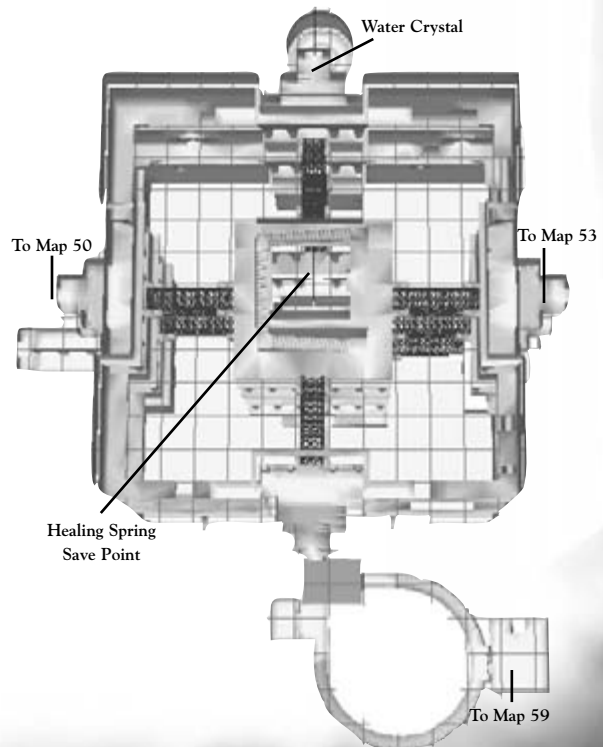

53 THE ANCIENT CITY, LEVEL 1 AND 2, EAST

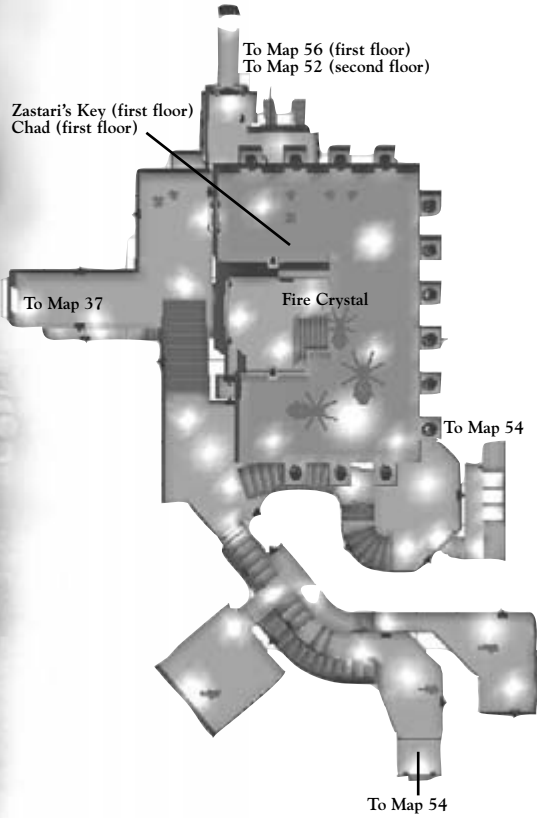

54 THE MANSION OF HOWLING WINDS, EXTERIOR

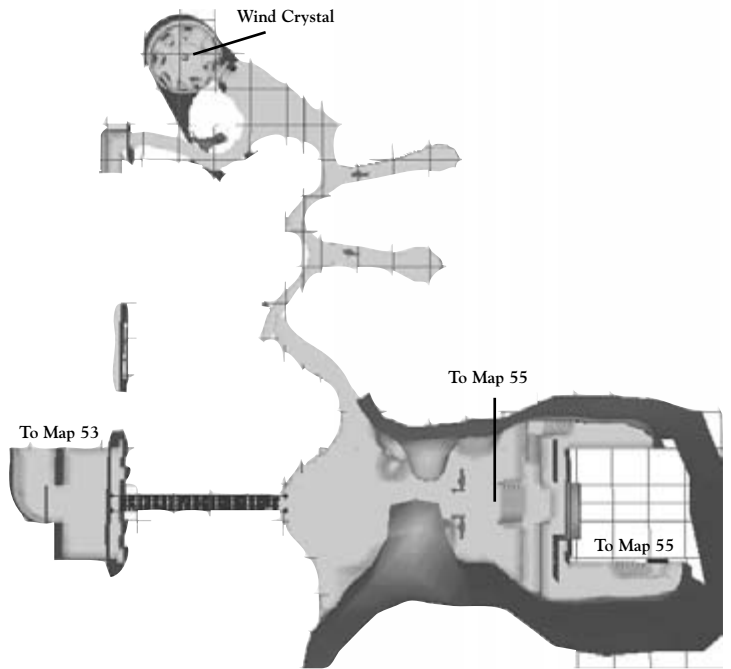

56 THE TREASURY

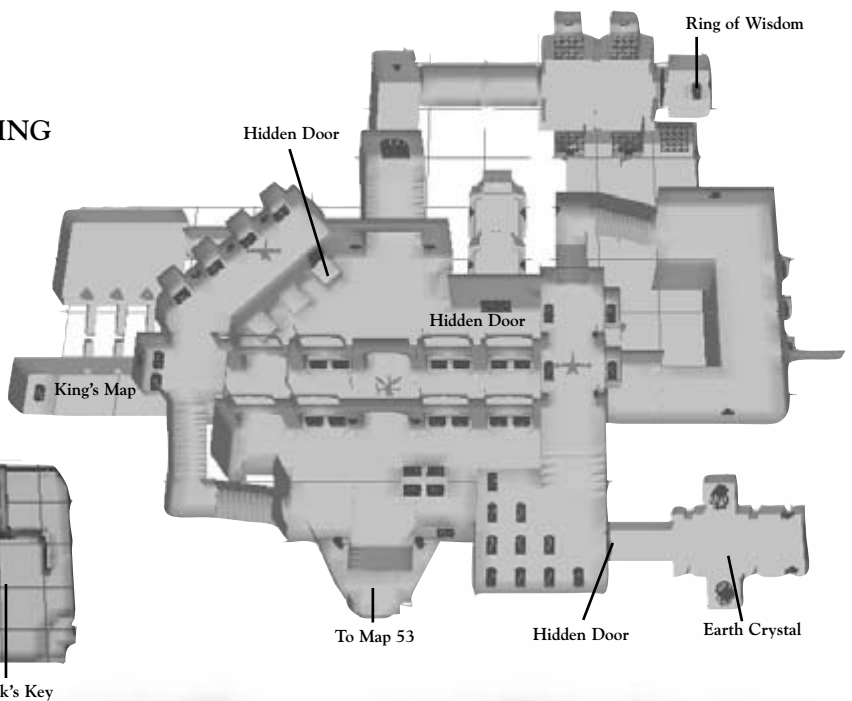

55 THE MANSION OF HOWLING WINDS, INTERIOR

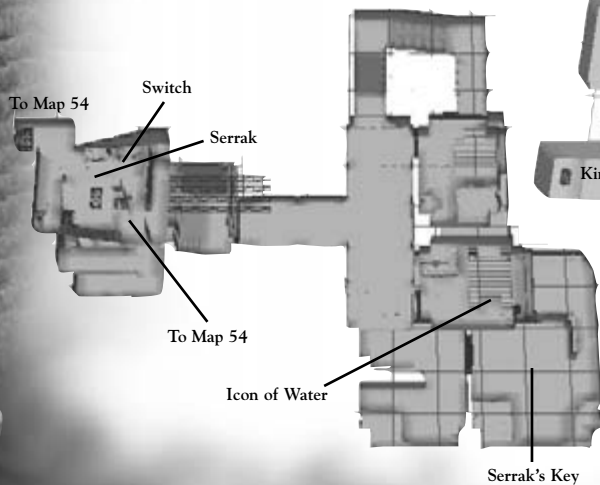

57 THE PASSAGE OF LIGHT

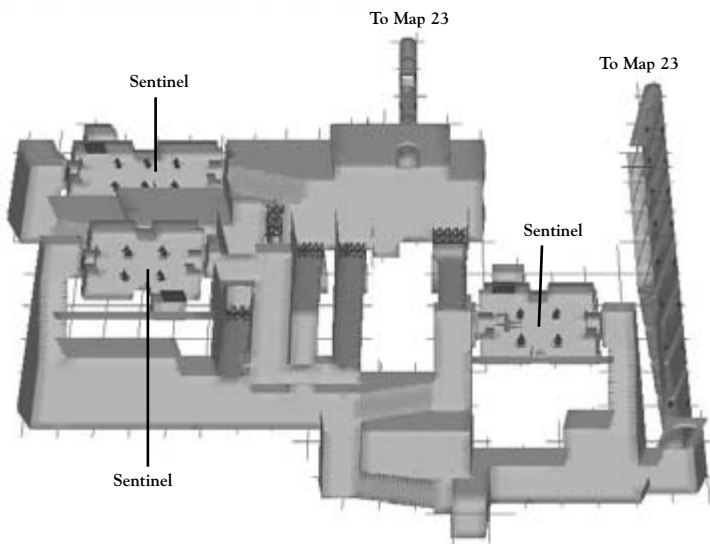

58 THE SANCTUARY OF LIGHT

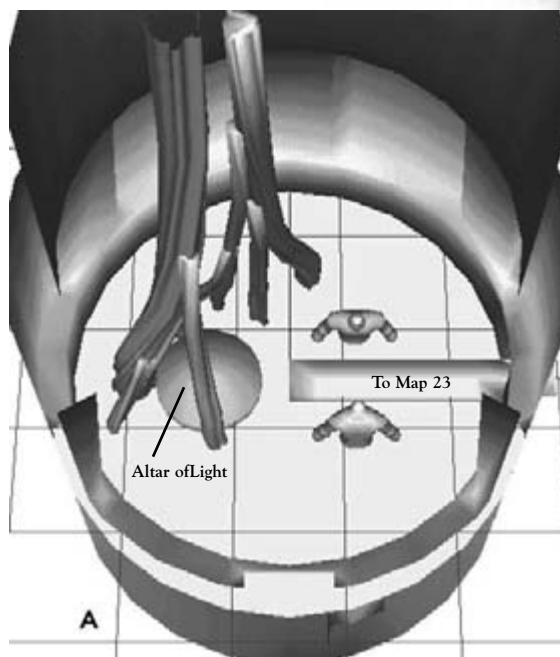

59 THE GUARDIAN'S ROOM

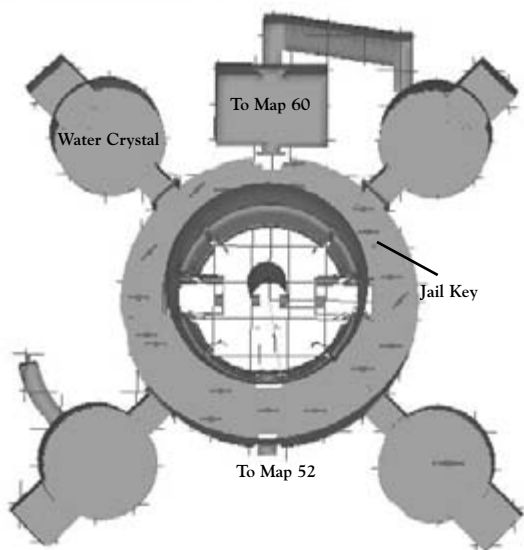

60 THE OLD BATTLEFIELD

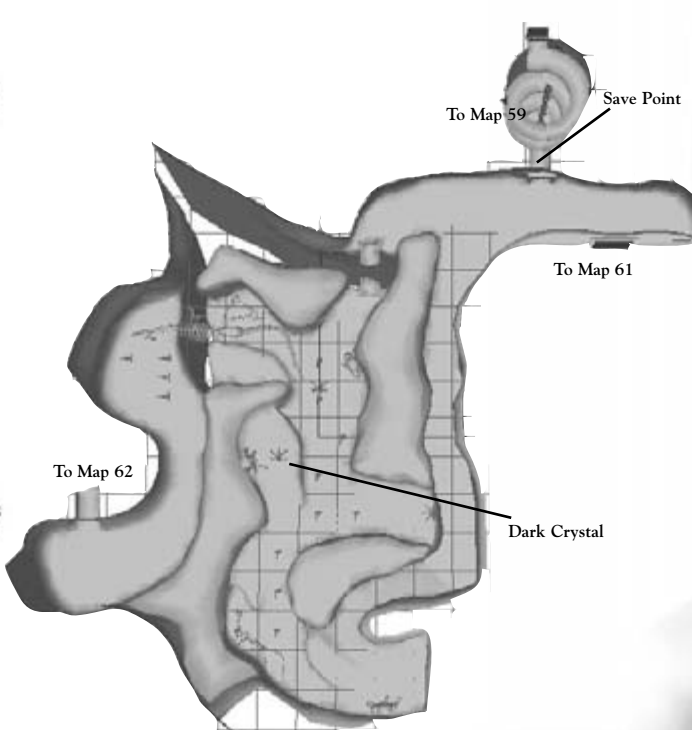

61 THE UNDERGROUND JAIL

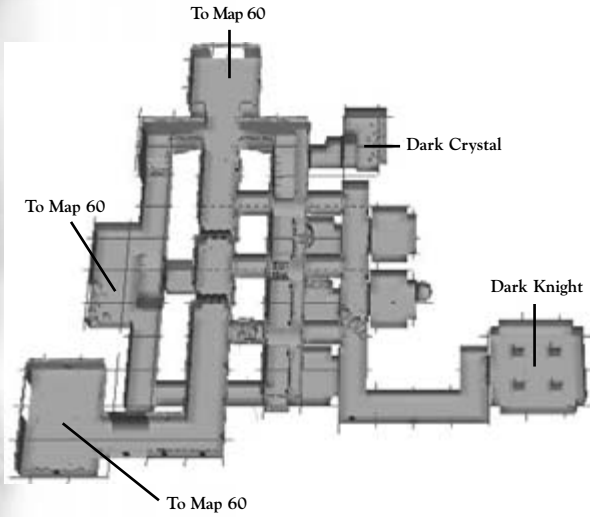

62 THE DARK SANCTUARY

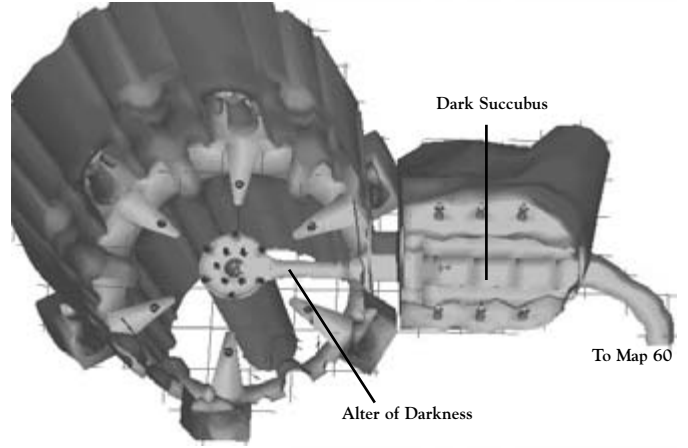

63 THE DARK REALITY, ENTRANCE

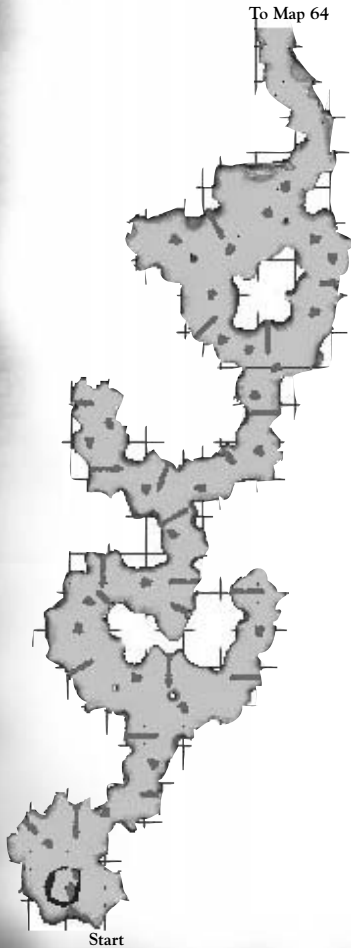

64 THE DARK REALITY, CONCLUSION

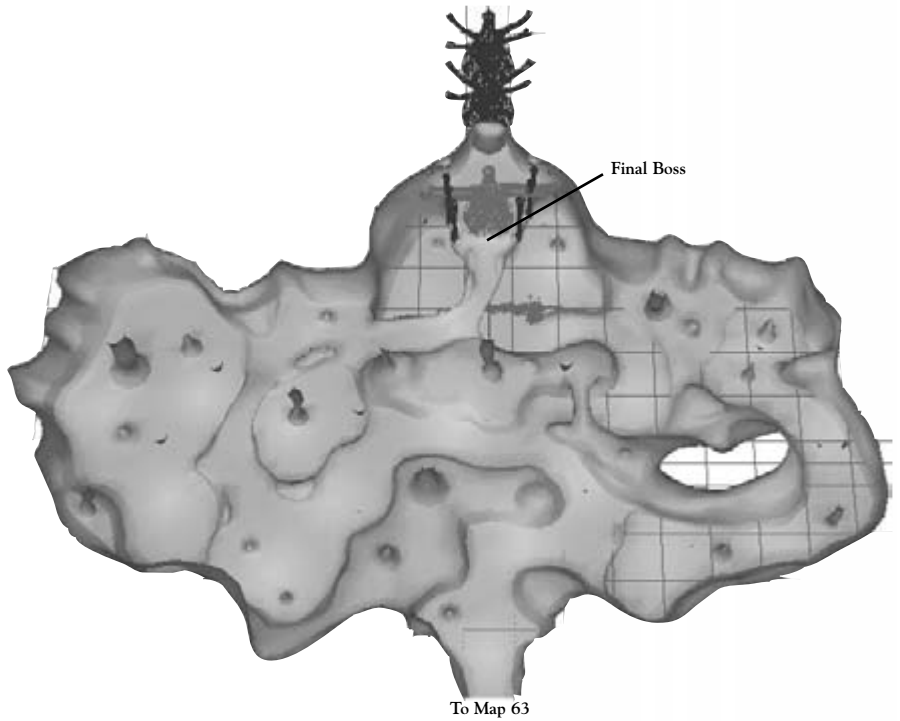



The Walkthrough

Starting Out

The **64** icons on the screens in this chapter refer, by number, to the Maps starting on page 33.

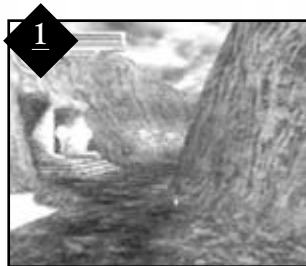

Walk forward from your starting position. Grab the herb resting on the ground in front of you.

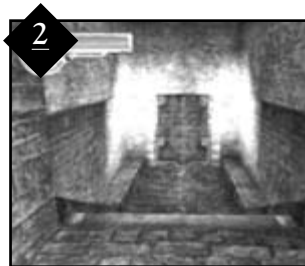
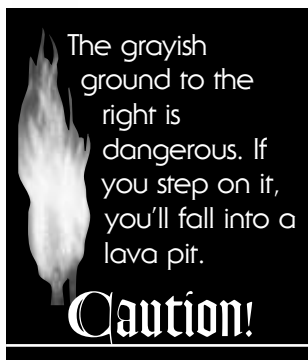

Walk through the doors on your left. Follow the stairs and hallway to the next door. Go through it.



On the other side of the second door, you see a man sitting. Talk to him. This is Cecile Yeala.



When you are done talking with Cecile, grab the club next to him. It's a low level weapon, but it's a start.



Walk into the main area. Go to the doorway across from you and head through it. Avoid the Maneaters for now.



In the chest in front of you, you find some leather gloves. Equip them. Like the club, they're not the best, but they're a start.



Go back out the door and head left. Go up the stairs in front of you. At the top of the stairs, go left along the battlements.



There's a wooden plank to your left. Walk across it and open the chest on the other side. You find an herbal liquid.



Go back up the plank and head left again. When you see a helm on the wall ahead of you, step carefully.



As you step toward the helm, the wall collapses. If you're quick, you can run back and avoid taking damage in the fall.



Kings Field

Prima's Official Strategy Guide

The Ancient City



Return along the battlements to the ground. Follow the wall on the right to find the helm that fell off the wall. Grab it and equip it.



With the equipment you have now, you can take on the Maneaters. Start killing them off and collecting the gold.



When you are done with the Maneaters, follow the path next to the entrance to this building.



At the end of the path is an old man named Duhrin. Talk to him and grab the herb on the ground near the broken bridge.



As you return to the ruined village, finish off the rest of the Maneaters. You should go up a level in experience.

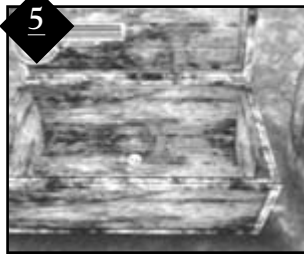

Enter the building and follow the stairs down to the door at the bottom. Beyond the door is a shop. There are 80 gold pieces in the chest in the back corner.



Most of the shopkeeper's items are too expensive for you right now. If you're having trouble in combat, buy some extra herbs.

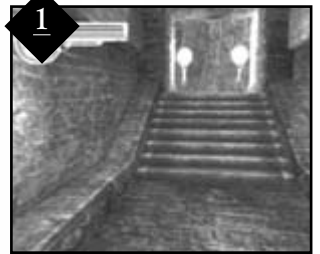

Walk out of the store and back past Cecile. Return to your starting position and go left.



As you walk forward, you see Beetles in the distance. You can easily handle them.



As you enter the open area ahead of you, take the first right and follow it to the end. Grab the antidote as you follow the path.



At the end of the path, you find a small homestead. Talk to Lynn, the girl standing outside.



When you are done with Lynn, go inside the house and talk to her mother, Sharyl.



There's a wooden shield on a stool. Take and equip it.

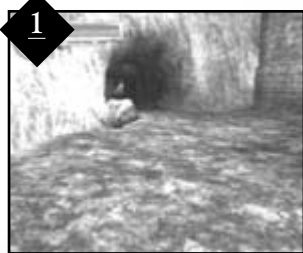

Return down the path and finish off the Beetles.

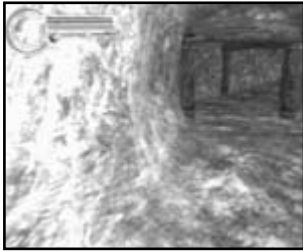

Go through the tunnel directly across from you. Don't be surprised if there are more Beetles inside.

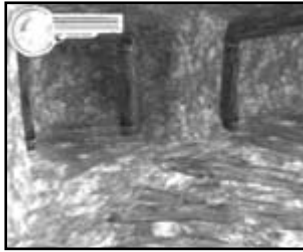

At the fork, bear to the right.

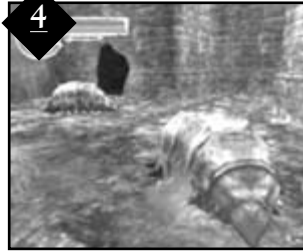

When the tunnel opens, there are plenty more Beetles to fight.



After the Beetles are dead, check out the rightmost exit. There are two chests inside. You find a short sword in one and 100 gold in the other.



Down the left tunnel, you find a skeleton and a leather vest. Get the vest and put it on.



Go back down the tunnel to the palace entrance, where you first fought the Beetles. Don't be surprised if there are more of them.



Open the doors and enter the palace. Walk toward the misty pedestal in front of you.

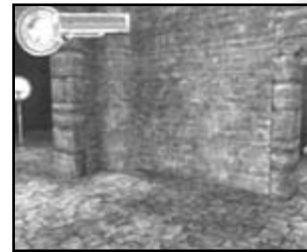

There are two doorways on your right. Go to the rightmost door.



Inside, there is a Green Slime and two chests. You find wooden shoes and a mushroom inside the chests.



Head back toward the entrance, but go left at the door to the spiral staircase. Take it to the top.



At the top of the stairs, you find Chad. Talk to him. Like Sharyl, he wants a Rock of Life.



Return to where you started your quest. You must get back to the shop near the ruined village.



Talk to the shopkeeper. He tells you that he sold his map to an old man, Duhrin.



Duhrin left out the back exit. Equip your club and get ready for battle. Leave through the passage near the shopkeeper.

Starting Out

King's Field

Prima's Official Strategy Guide

The Ancient City



Through the hole in the wall, you see Skeletons and Green Slime.



One of the two short staircases has a locked gate at the top. Take the other one and continue forward.



The next chamber contains a Green Slime and a Skeleton. Kill both and keep moving forward.



When the tunnel ends, you emerge near a house. Kill the Maneater and continue up the path.



The path ends near a church. There are a couple of Reapers out front for you to fight.



Go into the church. You see Duhrin sitting in one of the pews. Talk to him, and he asks for help dealing with the creatures out back.



Open the doors behind Duhrin to reveal a graveyard filled with Skeletons.



After you've killed the first group of Skeletons, walk around the graveyard. You attract some more.

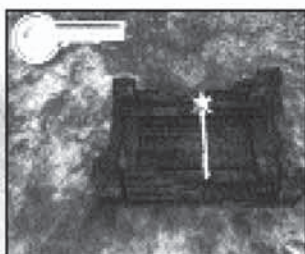

Walk through the gate at the back of the area. Destroy the wooden box to get a morning star, which is more effective against the Skeletons.



When all the Skeletons are dead, return to the church. There's a last Skeleton standing over the body of Duhrin.



Kill the Skeleton, then get the key from the ground near Duhrin's body.



Return to the house you passed earlier and use the key to open the door.



Inside, you find the Caretaker's map and an herbal liquid.



Walk behind the house and into the back room. Smash the barrels. Behind them, you find leather armor.



Return down the long tunnel and head back toward the shopkeeper. On the way, destroy a few of these barrels to get to the chest. You find an iron helmet.

Tip
The morning star is excellent for destroying the barrels. There's an herb in one of the barrels as well.



Return to the shopkeeper. Sell the leather helm, leather vest, and wooden club. If you found a forest shield (Reapers often drop one), sell back your other shield as well.



Return to the area with the sick woman, Sharyl. Behind the house, there is a cleft in the rocks. Descend and kill the Beetles.

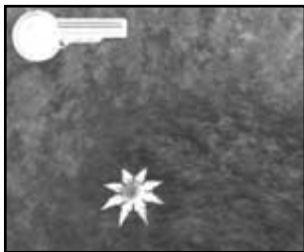

You find a lot of antidote here. Get all of it because you need it where you're going.



Go back outside and check around the house. Smash the barrels, then return to the palace.

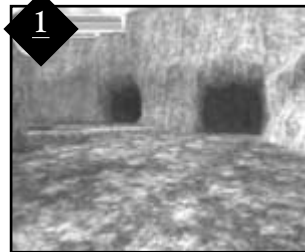

Go right when you enter the open area within the palace. There are two tunnels to the right. The rightmost tunnel has a save position at the end.



Go down the left passage when you are ready. You're entering the mine area, which is filled with Poison Slimes.

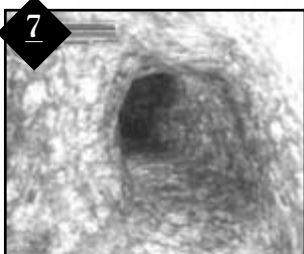

After the Slimes are dead, take the left passage. Go left again when you have the chance.

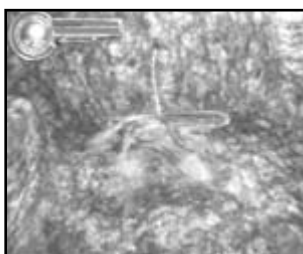

This passage dead-ends a few feet down. A Green Slime is here, as well as a healing pool. Stand in the pool and use the action button to regain some health.



Go back to the main passage and proceed left. Skip the tunnel to the right for now. You come to a log suspended over a chasm. Cross it.



On the far side of the log, there is a sign. Go right here and get your weapon ready.

Note
You may be attacked by a Blood Bat on the log. Don't worry—they don't hit too hard.



There are two Living Dead in this passage. Kill both and get the pickax from one of them. Smash the barrels in the room.

Starting Out



Continue down the passage ahead of you. It opens into a cave with a few more Living Dead.



The sign on the other side of the room says "Do Not Enter." Knock the sign down and keep going. When you get to the barrier, knock it down as well.

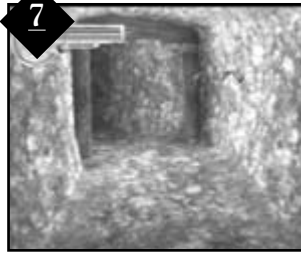

On the other side of the barrier are some Blood Bats. Fight your way through them.



Go left at the fork. Past the next group of Blood Bats, you find more antidote and some arm guards.

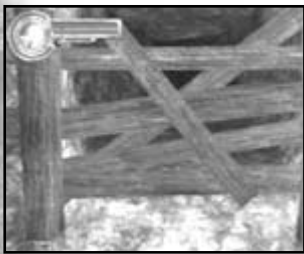

Go back and head left to the next barricade. Smash through it. Don't go left again, or you return to the entrance to the mines.



Instead, go right and walk past the healing pool again. Go back across the log, and this time, go left at the sign.



Past the Poison Slimes, you find an elevator. Flip the switch to call the elevator to your level.

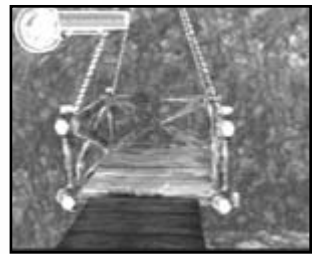

While you are waiting, smash the barrels. When the elevator arrives, stand on it to drop to the lower level.



On the floor below, you see some Living Dead walking around in a poison pool. If you are patient, a few come out to attack.

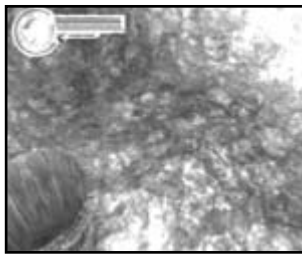

Planks lead to four areas here. Start with the rightmost plank. Run across to the small alcove. There is an Earth Stone in the bucket.

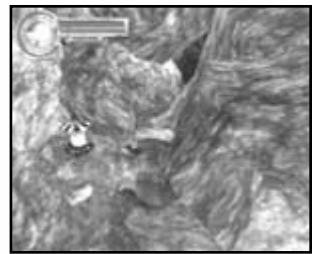
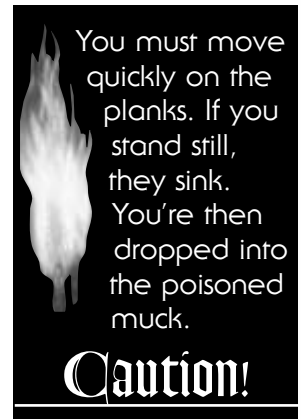

Go to the leftmost plank next. You find the body of a miner, the father of the girl you spoke with earlier. There is a Rock of Life next to him.

Tip If you can get to the second alcove from the left, there is another Earth Stone. However, it is usually guarded by a Living Dead who won't leave, which makes it too tough to grab.



Walk up the plank to the right until you're above the corpse. Drop to the ground below.



Go forward. To the right, growing on the body of a fallen miner, is a Stool. Kill it and get the mushrooms.



There are three corridors to examine here. The one on the left from where you entered has a miner at the end. Get the Earth Stone from the ground next to him.

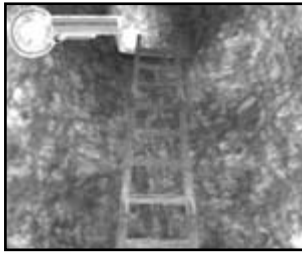

The central passage contains a ladder back to the top level of the mine. If you are low on antidote, climb up.



At the top of the ladder, walk forward and go left when the tunnel splits. The first fork to the right leads to the healing pool; the second right leads back outside.

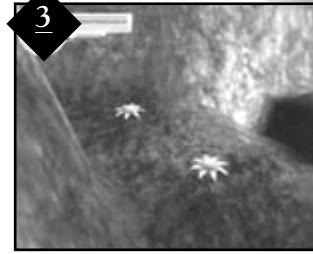

Return to Sharyl's house. Go back to the area behind the house with the red Beetles. The Beetles have returned, and many of the antidote plants have grown back.



While you are here, return to the interior of the house and give the Rock of Life to Sharyl.



Go back outside and talk to the girl. She rewards you by giving you a Fire crystal. Use it to gain your first spell.



Go to the boarded-up house and smash your way in. In the chest inside, you find a mushroom. Break through the other boarded-up door and smash the barrels here.



Go through the non-boarded door in the house to the backyard. There is a Reaper here. Kill it and receive the Clarity Bracelet.



Return to the mines and go back to the ladder. To get there, go left inside, past the healing pool, then take the first right. Out in the large area below, go left.

Tip
If you feel you still need more antidote, return to the shop and buy it before you head back to the mines.



Smash through the barricade and pick your way through the Poison Slimes. You get repeatedly poisoned here because the actual area is poisonous, so be ready with the antidote.

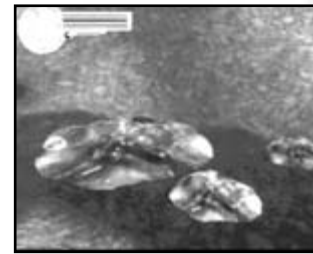

Go down the right fork, then go right again. There is a huge Slime here. Kill it to get another Rock of Life.



Go back to the ladder and return to the area outside the mines.



Head back into the palace, which is right in front of you. Go up the stairs and trade the second Rock of Life to Chad for the crystal vial.

Starting Out

The Huge Spider

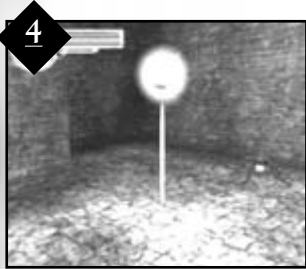

Leave Chad and return to the ground. Walk toward the misty altar, but bear right and walk straight ahead into the small room with the Spider.



Kill the Spider, then use your new Fireball spell to burn the webs off the door.

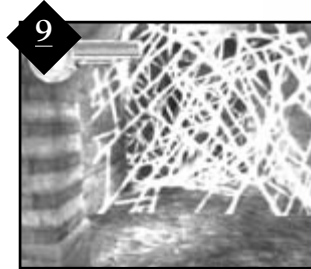

Go through the door and down the stairs. At the bottom, you see more webs.



Advance using Fireball to burn through the webs. There are plenty of Spiders to smash along the way.

One last Spider drops from the ceiling as you near the end of this passage.

Caution!



Once you are through the Spiders, open the door at the end of the corridor.



You are in a large square chamber with a smaller square room at its center. Go right to the door to find a save position.



Across from the save position, you find another door. Go in and talk to the soldier here.



The soldier is Lee. He tells you a terrible story when you talk to him.



Leave Lee and go to the door into the central room. It is locked.



Return to the room with Lee. He is standing and attacks you.



When Lee falls, he drops the key to the central room. Get it, but don't use it yet.

Tip

If you check the door before you see Lee, he'll give you the key without you having to fight him.



Walk down the corridor from the door to the central room. Go through the door on the right.

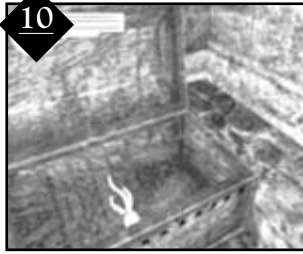

Check out the two side chambers inside. Each has a chest. In one you find a forest root, in the other you find a mushroom.



Open the gate ahead of you and walk down the stairs into the large area.



At the far end of this chamber, there is a Skeleton Archer. Move up carefully and destroy it.

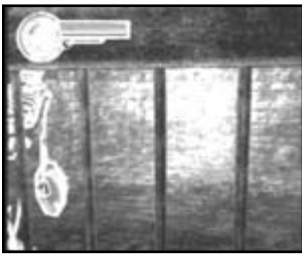

There are cells in the room beyond the Archer. There's a Skeleton in one of them and a gaping hole in another.

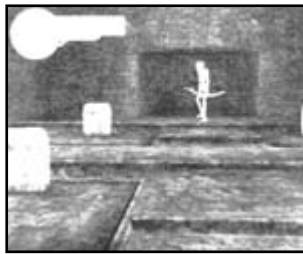

Leave the area with the cells and go to the door on the right. There is a Skeleton Archer at the back of the room.



Examine the pile of bones in the corner to find an herb. When you do, two Skeletons appear and attack.

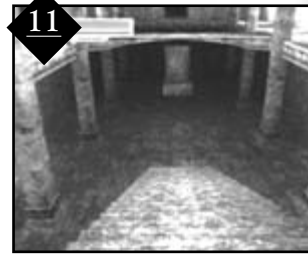

Go back outside and take the staircase down. In one alcove behind the stairs, you find an herbal liquid. In the other, there is a Skeleton.



Enter the room with the Stools and fight your way through them to the stairs at the back.

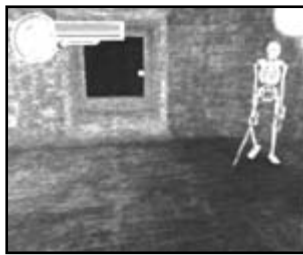

Bash the Skeleton at the top of the stairs and continue down the corridor.

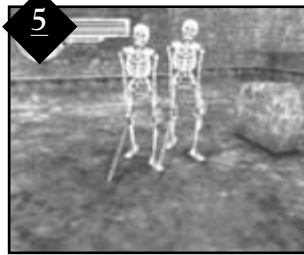

Go down the stairs all the way to the bottom in the next area. Fight the Skeletons.



At the top of the short staircase, there is a pile of bones and a release rock. Get this rock.

Tip
If you open the gate and go right, you'll be back at the shopkeeper's. If you need items, this is a great time to get them.

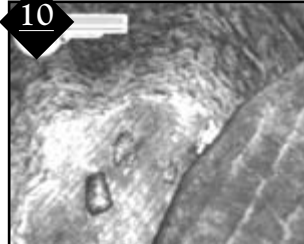

Return to the cells above you. Open the door to the cell with the gaping hole. Drop through to the shelf below.

The House Spider

Kings Field

Prima's Official Strategy Guide

The Ancient City



5 There is a Skeleton Archer here. Kill it.



6 Open the chest for some iron boots.

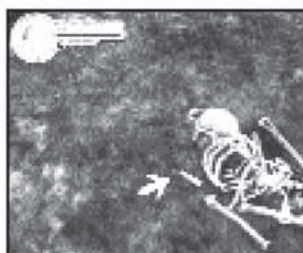

7 Drop to the ground below and get the second release rock from the pile of bones.



8 Take the stairs and follow the path all the way back through where you killed the Stools. Go straight across into the room on the opposite side and get the buckler from the bones.



9 Leave and go up the long staircase. Walk around to the door on the right. As you approach, a Skeleton attacks.



10 Go through the door and fight through the Skeletons inside.

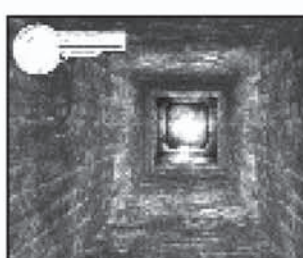

11 When the Skeletons are dead, go through the door at the back of the room. Continue down the short corridor to the next door.



12 In the next room, you find Mista. Talk to him, then go around the corner and kill the Spider.



13 Go to the large door. Fit the two release rocks into the spaces and open the door.



14 There is an astounding number of Skeletons inside. First, stand in the doorway and use a Fireball to thin them out.



15 When you have a little room, run in and fight them. Don't be afraid to retreat if you need to.



16 When all the Skeletons are dead, go back and talk to Mista again. He gives you a release rock for the door inside.



17 Go back and use the release rock on the inside door. Don't be surprised if a few more Skeletons show up to stop you.



18 Go into the room and get the Icon of Healing from the floor.

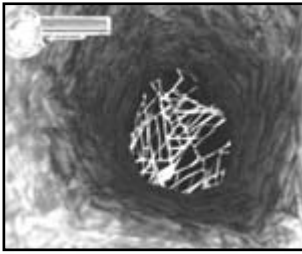

Return to Mista and find the hole in the wall near where you killed the Spider. Cast a Fireball through the hole to destroy the webs and drop the crystal to the ground below.

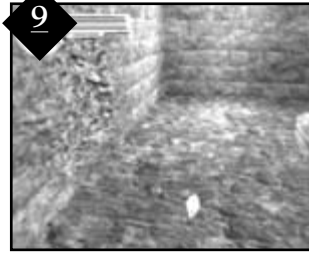

Leave this area. Go back to where you fought with Lee. The crystal you released from the webs is on the floor. Use it to learn the Divine Light spell.

Tip
The crystal is just outside the door to the last save position you used. Save your game.



Now it's time to use the key you got from Lee. Return to the door near where you fought him, and use the key.

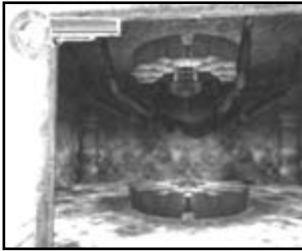

Inside, hanging from the ceiling, is a massive Spider. It attacks with webs, which hurt a little, slow you down, and make it tough to see.



Use Fireball spells. If you get close enough to strike the Spider, it will rip you apart with its claws.



When the Spider dies, it drops a Water crystal. Grab it to learn the Purity spell, which neutralizes poison.

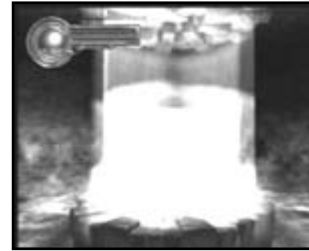

Place the Icon of Healing on the shrine where the Spider was.

The Stone Guardians

The Stone Guardians



From the Spider's lair, walk straight until you see a door on your left. Go inside. Mista warns you about the Ancient City.



Continue down the hallway. Kill a Spider and an Expedition Soldier, and proceed to the door beyond.



The door opens into a huge room. Walk in and go left.

Don't go straight. Four arrow traps slaughter you if you head for door.
Caution!

Kings Field

Prima's Official Strategy Guide

The Ancient City



There's an Expedition Soldier in the hallway. Kill him. Walk to the left of the door on the left and open the secret door.



Inside the secret room is a rapier in the chest and antidote in one of the barrels.



Go out and turn left. There is an Expedition Soldier on the ground and an Expedition Archer launching arrows from above.



Behind a barred door is a dog and an item you need. Remember this location.



Check out the two doors under the Archer above you. The left room is empty, but the right room holds Spiders and arrows.



Go out and up the stairs. Kill the Archer, but be careful approaching him.



The door on the right is locked. Check out the room on the left.



Smash the barrels and go down the stairs. In the room below is the dog. Flip the lever to free the dog.



Return to where the dog was trapped and get the Red Guide Stone. Go to the door beyond and open it.



The Skeleton in the next room guards a few chests. There's an herbal liquid in one and more iron boots in the other.



Walk out and go straight. Open the door next to the room where you found the arrows.



Walk up the stairs and drop off the end of the platform. Flip the switch to disable the arrow trap. Check where the arrows were coming from to find a plate helm.

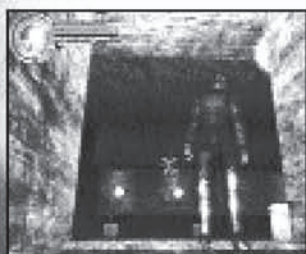

Walk up the stairs next to you. At the top, fight the Expedition Soldier, then cross the bridge and kill a second one.



Flip all of the switches to disable the arrow traps.

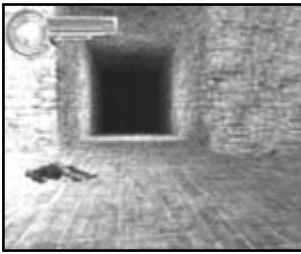

Go down the stairs and out the door. Turn left and walk forward. You're in the large room where you started in this area.



Go straight. When you find the door on your right at the far end, go in. The first two barrels in this room contain herbs, while the third holds a Skeleton.

Tip
Check the wall across from the Skeleton barrel. There is a pair of knight greaves in a small alcove.



Walk out of the room and fight the Expedition Soldier in front of you. Destroy him and get the arrows off the floor as you walk forward.



Head forward to the wall, then go left. Look left to find the Binding Crown on one of the pedestals.



Quickly grab the Binding Crown. This awakens the Stone Guardian in the nearby alcove.



Turn and run. You must get out of this room before the Stone Guardian blocks your path. Run to the large central room.



Go to the door that was guarded by the arrow traps. On the other side, kill an Expedition Archer.

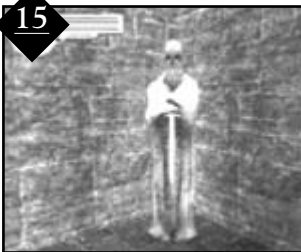

15
Kill the four Skeletons in the next room. In the front-right corner, get the knight sword from the statue.



Of the four side rooms here, only the one in the back right is important. Follow the tunnel from this room. Kill the Skeletons and get the iron breastplate and the herbs.



In the room across from the area containing the breastplate, there are gauntlets. The room next to this one holds two more Skeletons.

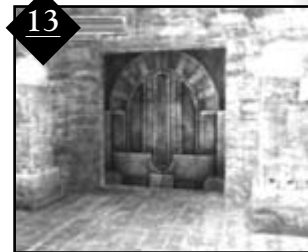

13
When you are done, go to the door between the two torches in the previous area.



15
When you open the door, an Expedition Archer fires at you from the balcony above. Run down the stairs and to the right.



Place the Binding Crown on the pedestal. This sends the Stone Guardian to its resting place.

The Stone Guardians



Follow the hall where the Stone Guardian walked. Go left and head up the stairs.

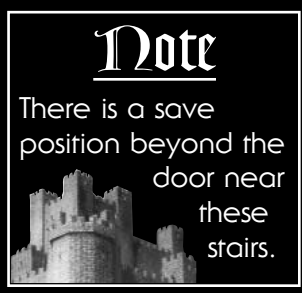

Note

There is a save position beyond the door near these stairs.



Cross the bridge at the top of the stairs and look left in the next small room. The Archer who attacked you earlier is here. Kill him. In the box near him is a suit of chain mail.



From where the Archer was, cross the bridge and go up the short staircase. Open the door and follow the ledge to the room at the end. The Forest Carver is in the chest.



Return to the last save position past the Stone Guardians. Go through the large double door.



Follow the next hall to the door at the end and walk through. Go left.



Take the first passage left and open the door at the end. Four Expedition Soldiers wait inside for you.



Go into the previous room and through the door on the left. Inside, talk to Ramirez. He gives you a bow. You can also buy and sell items here.



Go back to where you placed the Binding Crown. Get it to release the Stone Guardian, then proceed up to the stairs. The Stone Guardian can't follow you here.



Tip

Make sure you have at least 20 arrows before you leave Ramirez.

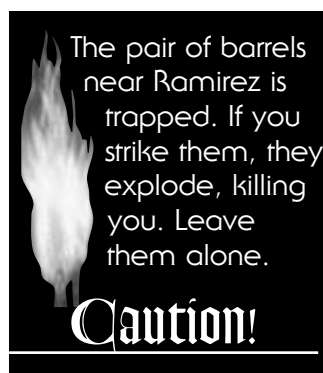

The pair of barrels near Ramirez is trapped. If you strike them, they explode, killing you. Leave them alone.

Caution!



Equip the bow and launch arrows into the Stone Guardian. Aim for its head and fire until it drops.



Get the Binding Crown from the other side and deal with the second Stone Guardian the same way. Check out the alcoves where the Stone Guardians were to find an Earth crystal and the Keystone.



The Forest Golem and the Priest's Key



15

Go to Ramirez. Stock up on anything you need. Mushrooms, herbs, and herbal liquids should top your list.



Leave Ramirez and go right. Pass the entrance to this area and take the second passage on the right. Go through the door at the end to the room containing two Expedition Archers.



The flying creatures in the huge room are Dark Birds. They launch fireballs at you.

Caution!



When the Archers are dead, collect the arrows from the floor and the herbal liquid from the chest. Through the windows, you can see an Expedition Soldier in the next room.

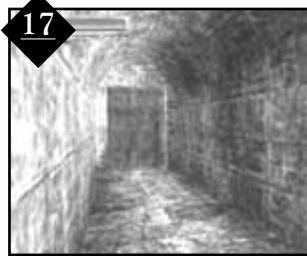

17

Leave this room and head back to the open area. Go left and take the next passage to reach the room with the Expedition Soldier, then go left past Ramirez to the next passage.

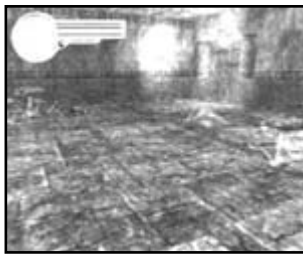

The next room is filled with Stools and Green Slime. Hack your way through to the door at the far end.

Note

The other door here leads to a small room with a box. Inside the box is antidote.



The hallway beyond is filled with Stools at the far end. Take the left passage to the door and go through.



There is an Expedition Archer to your left as you enter. Take care of him, then handle the Slimes and Soldier.

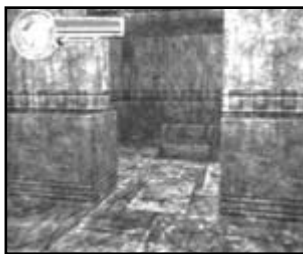

In the area where the Archer was, check the right wall for a secret door. Inside is a chest with scale mail.



In the other half of the room, the door to your left has an empty chest behind it. The door to your right has more Stools. Kill them and get the magic crystal they are guarding.



Return to the hallway containing the Stools and hack your way through to the door at the back.

The Forest Golem and the Priest's Key

Kings Field

Prima's Official Strategy Guide

The Ancient City



The room beyond has Slimes, Stools, and an Expedition Soldier. Kill them all.



Round the corner to the right and open the door. Kill the Stool behind it and get a pair of iron boots from the box.



Go to the other door in the main room. This leads to the open area outside. Go left and through the doorway on the left.



Go forward through the next door. Walk down the short staircase to the left in the next room and break the boxes for a few items.



Go up the stairs and left through the next door. This is your first encounter with a Widda. Be careful, Widdas are quick and cause damage.



When the Widda is dead, go up the stairs on the right side of the room and out the door at the top. There is another Widda outside.



Walk around the ledge to the door on the opposite side. This leads into the room with the first Widda. Check the body here to find the Expedition Key.



Retrace your steps through the two sets of double doors. Before wandering into the large open area, veer left down the passage to the large room containing crates and Expedition Soldiers.



Demolish everything. There are several arrows, forest roots, a wise man's fruit, and in the chest (which opens with the key you found), is a new sword. Watch out for the broken statue.



Walk to the open area and go to the drawbridge. Place the Keystone in the lock to lower the drawbridge.



Cross the bridge and go left to the next bridge. Cross it and go through the door at the top of the stairs.



In this area, the paths to the right and straight ahead are blocked. Go up the staircase to the left.

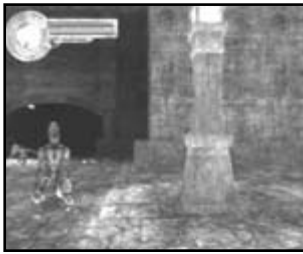

At the top of the stairs are four Earth Elementals. These are tough, but you must get through them.



You now have a bunch of possible paths. Take the stairs down to the right of where you entered to explore the catacombs.

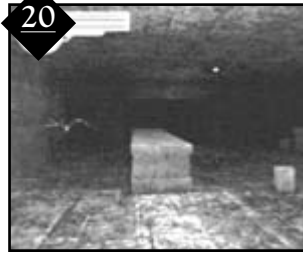

The catacombs are filled with Blood Bats, Spiders, and Earth Elementals.

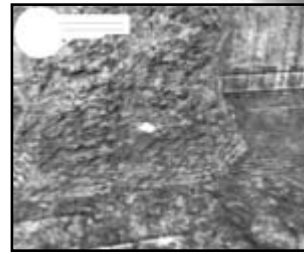

There are interesting things in the four catacomb rooms. Check everywhere and destroy all the boxes to find a war helm, forest root, the Wind Carver, and a Dark crystal.

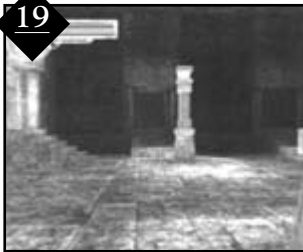

Walk up the stairs to the room above. The short staircase to your left is blocked. Take the middle stairs of this group of three.



While this room should be empty, there are many Earth Elementals around. Cautiously move into the hallway and bear left.



This corridor ends in the room with the blocked stairs. Collect the herbs from the planter on the right and get the Keystone from the chest.



Go to the hallway and follow it to the end. Kill any remaining Earth Elementals in this room, then go through the door across from where you entered.

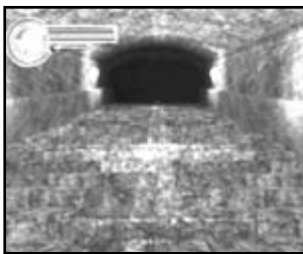

This door leads into the large, open room. Go up the huge staircase to your left. There is a door on your left.

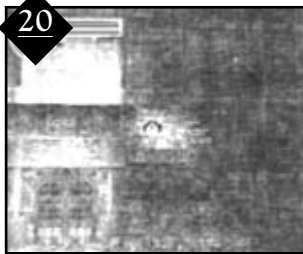

Kill the Earth Elemental on the other side of the door. Follow the long staircase to the top, through the clouds of Blood Bats.

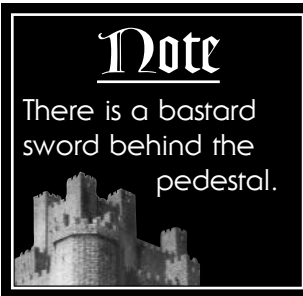

Go up the stairs until you come to a door. Go through and to the door on the other side of the pillar-lined hallway. Keep going until you reach the forest.

Tip
Use the save platform here.



Follow the path to the left until you reach the giant Forest Golem.

The Forest Golem and the Priest's Key

Kings Field

Prima's Official Strategy Guide

The Ancient City



Go left until you see the woman by the fountain. This is Aeaine Vigil. Talk to her to learn about the area and the Golem.

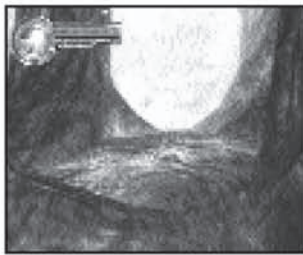

When you are done speaking with Aeaine, walk up the path next to her, collecting the herbs on the way.

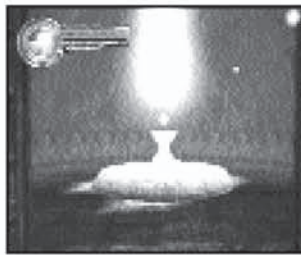

At the end of the path, enter the small shrine and collect the Earth crystal. This teaches you the spell Upheaval.



Return to the Forest Golem and go right. In the small area near the cave, you encounter your first Critter.



Enter the cave and walk down the tunnel. At the bottom, go right.



When you have a choice of going right or left, go left and destroy the Critter. Behind the Pedestal of Dew, is a knight helm.



Down the other branch of this area, are more Critters and the Fire Carver.



Walk back to the central room and go right. Walk to the back. You find more Critters and some herbs. One of these Critters drops Blessed Gloves.



The side passage here contains a half-dozen Critters. You also get an herbal liquid and the cavalier plate.



Return to the central chamber. The only passage you haven't explored is the one on your right.



Follow this path to the blue floor. There is nothing of value straight ahead, so take the passage to the right.



On the pedestal at the end, get the Forest Dew. Return to the Forest Golem.



Use the Forest Dew on the Golem. He comes to life and opens the doors for you. Talk to Aeaine again before you go through the doors.

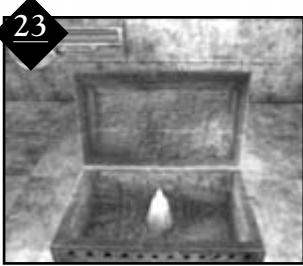

Follow the hall inside until you see a door on your right. Inside is a chest with a crystal vial. Grab it, then follow the halls and stairs until you come to a large, open room.



The room has a large passage to the right and a doorway to the left. Take the doorway and the stairs to the bottom. In the next room are two Living Statues.

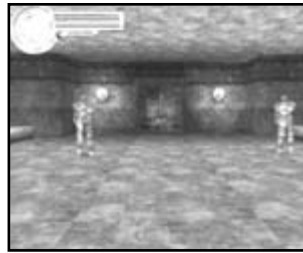

Go through the door past the Living Statues, then through the next door. There are two more Living Statues in this room. You also find forest root, herbal liquid, and a crusader shield.

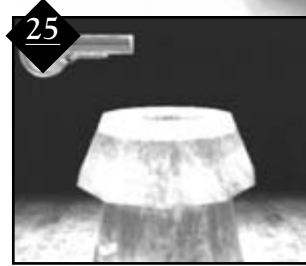

Walk through the door opposite from where you entered. Go through the short hall to the next door and walk to the middle of the dark room. Use Fireball on the pedestal for some light.

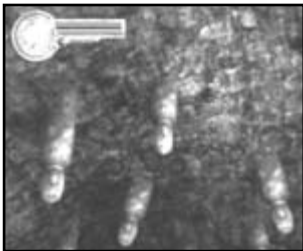

One of the statues on the ceiling holds a Light crystal. Hit it with an arrow or a Fireball to release it. This crystal teaches you a new offensive spell, Flash.

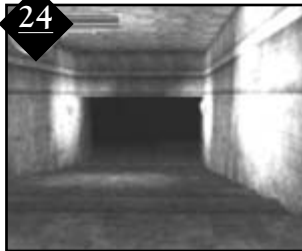

Leave this room the way you entered, and go to where you fought the first Living Statues. Go right to find a door and take the stairs leading down.



You are in a large room. Charge up the stairs to your left and look on the ledge to find Holycrest, a sword that's excellent against undead. Run into the room at the top of the stairs.

Tip
Use your bow to shoot and ring the bell to quickly destroy all the skeletons.



Go to the back in this room and open the coffins. Equip Holycrest because High Skeletons attack you.



In one coffin is the Priest's Key. In another is the Earth Carver.



Outside, you can either fight the Archers or run through them. You must get to the door across from where you first entered.

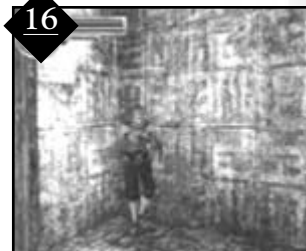

Beyond the next door is Chad, to whom you traded the Rock of Life. Talk to him. You can buy and sell items here.

The Forest Golem and the Priest's Key



Note

Among the items Chad has for sale are the Water Carver and the Hammer of Woe.



Descend the stairs next to Chad. At the bottom are a save position and a Marker. Use the Red Guide Stone with the Marker.

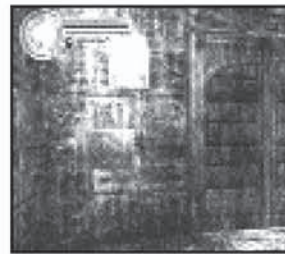

Walk to the door. Press the symbol on the left side to release the door. This leads to the top of the central tower, near where you found Ramirez.

The Fire Genie

25

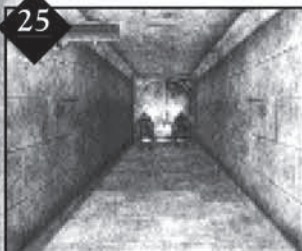

Go up the stairs past Chad and through the room that contained the Skeleton Archers. At the top of the stairs, go through the door on the right to find a pair of Slashers.



The next room contains a large group of Slashers. Destroy them all and get the arrows.



On the far side of the room is a doorway and a huge hole in the wall. Drop through the hole and battle more Slashers.

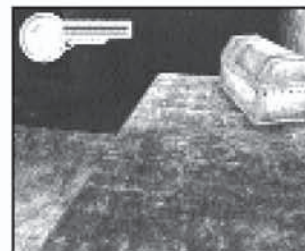

Walk up the ramp at the back of the room and kill the Poison Slime. On the ledge outside, there is a chest containing scale mail that offers magic protection.

The blue floor below you is acid. If you touch it, it hurts you and damages everything you have equipped. The dragon flower in the middle of the acid isn't worth it.

Caution!



Kill the Poison Slime below you and drop to the solid ground where you can get another suit of armor.

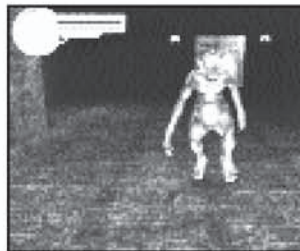

Climb the stairs. There is another Poison Slime, and two of the Slashers are back.



Walk through the doors ahead of you and down the pillar-lined corridor. Take the doorway on the right and climb the stairs. At the top is a row of statues.



Note
There is an herbal liquid behind one of the Living Statues.



Three of these statues are Living Statues. If you bought a Hammer of Woe, use it.

Ignore the stairs on the right for now. At the end of the hall, are two Living Statues guarding a door.

On the other side of the door are Earth Elementals. Be ready.



Tip
The correct eye is the third one on the right as you walk through the room.

Walk left up the stairs beyond the Elementals, and get the herbal liquid from the ledge as you go. Enter the door at the top of the stairs.

The next room holds eight pedestals with eyes in them. If you walk through, the pressure plate at the end of the room causes the ceiling in the room beyond to drop.

To stop the ceiling from dropping, find the eye that doesn't follow you as you walk past, and press it. This closes all of the eyes.

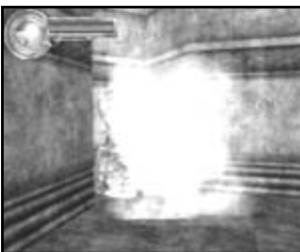

Note
The Living Statues don't become active until you open a chest.

More traps are in the next room. The statues in the corners belch flame as you near them. To get a wand, trigger the flame and wait until it dies off. When it does, run in, get the wand, and dash out.

Leave this area. Go to where you fought the last Earth Elementals, and check out the two doors on the left. There is a Living Statue behind each one.

These two areas also have trapped chests. Open them and run backward to avoid the poison gas. You find a knight sword and antidote.



You have a long walk ahead of you now. You need to return to the ruined village where you started your quest. When you pass the entrance to the palace, you see the restored pool. Use it to heal.

The Fire Genie

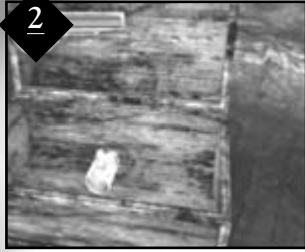

In the village, there is a chest you can now open. Inside is the Spider Armband, which protects against poison.



Drop through the well in the middle of town. The landing hurts, so heal yourself.

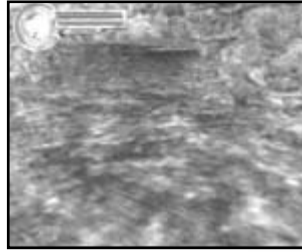

Walk forward through the sewer. Go past the Dragon Flies and walk down the steps into the water.

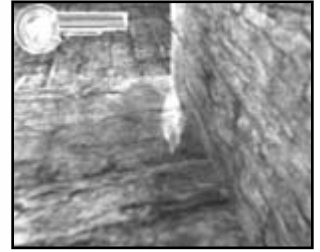

Run forward until you see the Water Crystal, which contains Endure Fire. Grab it, then go straight. Drop off the ledge and run to the stairs ahead of you.

Tip
Heal yourself while underwater to avoid drowning.

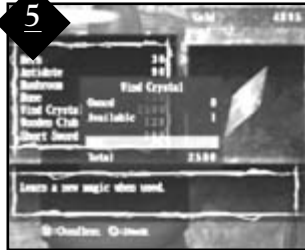

Walk out the door and go straight to return to the shop. Buy the Wind crystal to learn Wind Cutter.

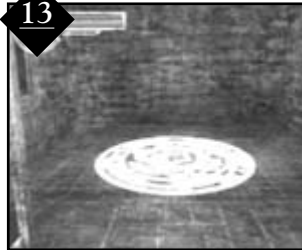

From here, return to Mista's room in the palace. Continue down the hall by Mista's room and into the area containing the arrow traps. Go left and open the first door on your left.

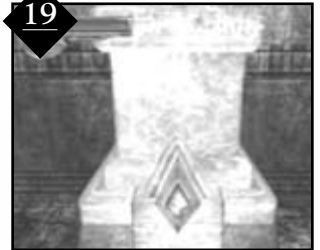

The white symbol on the floor is the Symbol of Passage. Stand on it and use the green wand. You're transported to a new location.



Leave the room. At the end of the corridor, you face a couple of Fire Elementals.



There is a large passage to your left and a small doorway to the right. Take the doorway and follow the corridor to the end. In the next room is a Fire Elemental and a number of barrels.

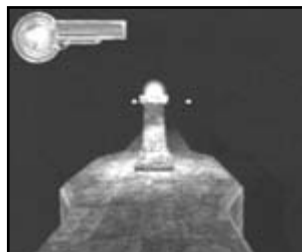

Go through the door opposite where you entered. You're in a huge, open area. Go up the stairs and cross the bridge to the far side.

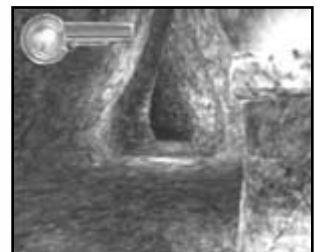

On the other side of the bridge, grab the mushrooms, then enter the fissure in the rock wall.



Follow the tunnel to the end, killing the Beetles as you go. Check the side passage for an Earth Stone. This tunnel opens into a round area filled with more tunnels.



Check the next passage to the right for an Earth Stone. Go left and battle the Fire Elementals in the next area. Look for an Earth Stone and forest fruit in this room.



Tip

The forest fruit is in a secret panel in the wall next to the table.

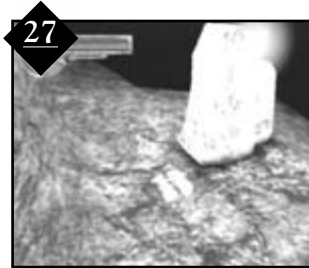

Continue to the end of this chamber to find a Slasher and a pair of knight gloves.



Go to the center, then left to the next passage. Inside, take the left fork past the Fire Elemental and check out the area in the back. Look for more Earth Stones.



Check out the side passage that was to the right when you entered this tunnel. There's a Slasher at the top.



This tunnel ends at the central room on a high ledge. Drop to the lower ledge on the left. Drop to the middle again. Pass the ramp and go to the next passage.



Check the back-right corner for a secret door. Inside the chest is a knight plate.

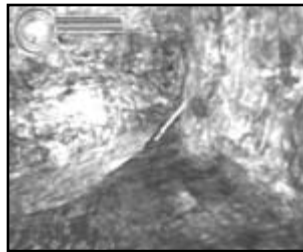

Go to the middle and turn left. Fight the Beetles at the top. Check the passages for Earth Stones and get the war hammer. Drop down by the war hammer to return to the passage you took to this area. Walk to the middle.



Across from you is a passage you skipped that is lined with torches. Go toward it, then up the ramp to the left. In this room is a Symbol of Passage and the sword Frostbite.



Go up the torch-lined tunnel. There are a few Slashers to handle.



At the end of the tunnel, go left into the Earth Folk graveyard. There are many more Slashers here, so battle them.

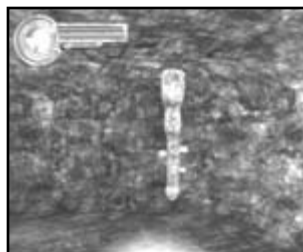

When the Slashers are dead, check the candles on the gravestones. You find several items. The most important one is the Earth Folk key, on the gravestone farthest from the entrance.

Note

In addition to the key, there are two Earth Stones and a forest fruit here.



Walk to the central area and go through the round opening across and to the right of where you are.



Take the slope to the right and go inside. Drop off the left ledge to the tunnel below.

Kings Field

Prima's Official Strategy Guide

The Ancient City

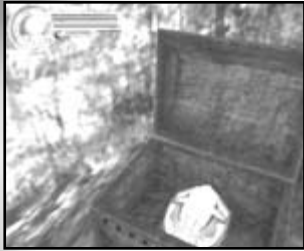

Use the key to open the chest and get the Earthen shield. In the back of the room is a save position.

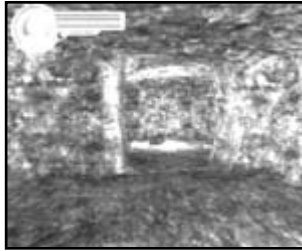

Across from the save position is a piece of wall that looks different from the rest of the wall. Fire a spell into it and explore the secret area for several good items, including the Earth Ring.

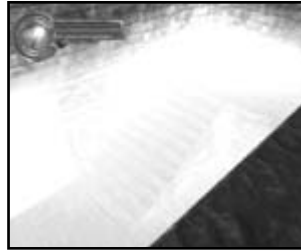

Return to the torch-lined tunnel and go right at the end. Go through the doorway to enter the Forge.

The Forge is frozen, and the mist makes it difficult to see.

Move carefully because it's easy to get lost. Also, the Beetles in this area have an icy breath attack.

Caution!



Walk down the stairs and go to the door. Beyond this door, go down the long staircase and walk forward, fighting through the Beetles. Ignore the door on the right.



Go left past the door and ignore the short staircase down. Walk forward, bearing right, and take the long staircase up past the next set of Beetles.



At the top of the stairs is an Ice Golem. Defeat him, then walk through the arch on the right past him. Go up the short stairs to a save position.

Tip

There is a Symbol of Passage in this room. If you are short on supplies, use the red wand to return to Chad and buy some items. Use the green wand to return to the Earth Folk area and the Forge.



Go through the arch and head straight through another Ice Golem. Take the door on the right. Look left when the door opens, and go through the door you see.



Follow the ledges in the next rooms to the far side. In the middle room is a dwarf frozen in a block of ice.



On the far side is a door to your left. Push it. This turns into a bridge that leads to where you entered the Forge.



Turn around and walk forward to the wall, then go right. Pass the door on your left and bear left to the stairs. Climb these to the top. Turn left as you go through the doorway. Walk across the ice bridge to the next door.



Follow the path to the next set of stairs. When you leave the stairs, go left through a Beetle. Continue to the door and kill the Ice Golem guarding it.

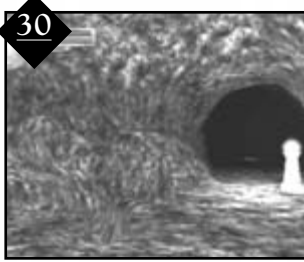

You are out of the Forge. Follow the cave tunnel to the right across the bridge. Climb the short staircase and kill the Lava Lizard.

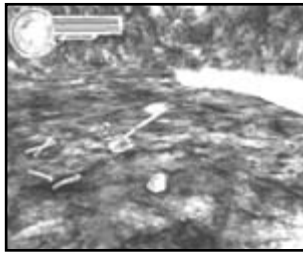

Go forward and take the tunnel to the right. Follow it to the end, slaying the Lava Lizards as you go. At the end is a crescent ax.

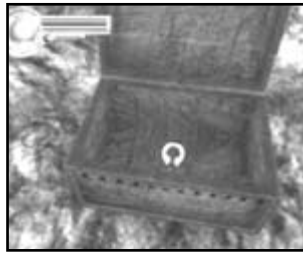

Retrace your steps to the stairs. Go right. At the end is a chest on a small plateau. Inside is the Fire Ring. Grab it and wear it.



Turn around and walk toward the entrance. Take the first left and battle the Lava Lizards here. Continue through the cavern, fighting all enemies.

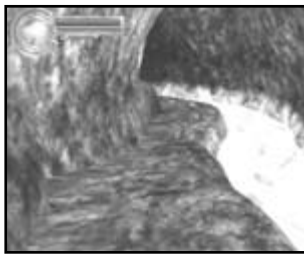

Follow the cave to the left. Don't cross the bridge. Instead, hug the left wall and follow the catwalk to the end.

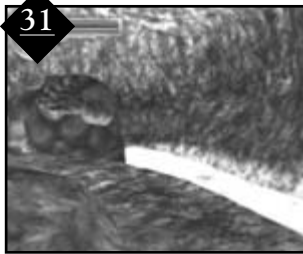

Here is the Fire Genie. He's big, so use spells to whittle him down and use a good Water-based weapon to kill him.

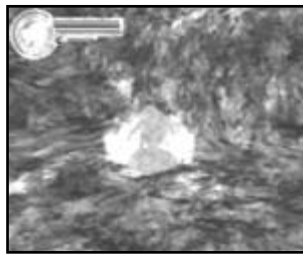

The Larva that the Fire Genie produces are an additional danger. Don't go out of your way to kill them, but if they are in front of you, take them down.



After the Fire Genie is dead, the lava flows past him to the Forge. This melts the ice that was there.

Big Battles



Your battle with the Fire Genie was a tough one, and you've got two more coming up. Retrace your steps, but cross the bridge to your left.



At the top of the steps is the Altar of ice. Use the Symbol of Passage and the Red wand. Buy some items from Chad. Use the Green wand and retrace your path to the Forge.

Note

You aren't far from Ramirez. His price on mushrooms is better than Chad's.



The first thing you notice as you re-enter the Forge is that visibility is better now. Return to where you re-entered the Forge, and cross the long bridge to the other side.

Big Battles



Kings Field

Prima's Official Strategy Guide

The Ancient City



Walk forward through the Beetles. Cross the short bridge to the chest to find the lethal rapier.



Check out the doorway next to the stairs across from the lethal rapier. In the back of the room is a secret panel revealing a chest containing knight plates.



Return to the door across from the bridge and go through. Follow the path to the dwarf, who is unfrozen. This is Harmurah Forgefist. Talk to him, then keep going.

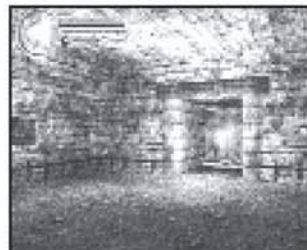

Go through the door past Harmurah and go left. Ignore the door to your right and continue to the door ahead of you.



Beyond this door is the Earth King. Stay out of his way, running in to slash at him. He's vulnerable to normal weapons and Fire magic.



Dodge around him, moving from side to side to avoid his Shock Wave attack and Ice Breath. Hit him with Fireball, then strike while he reacts to the magic.



When the Earth King falls, get the Icon of Wind from the floor.

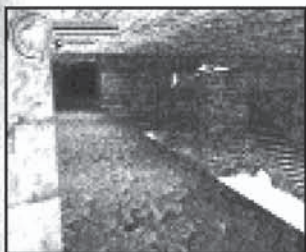

Leave the Earth King's room. In the hallway, take the door on the left. Follow the catwalk left past the Salamanders. Go straight through the arch to the save position and use it.



Leave and go down the stairs. Go right. Fight through the Beetles and climb the stairs. Follow the same path you did earlier to return to where you fought the Fire Genie.

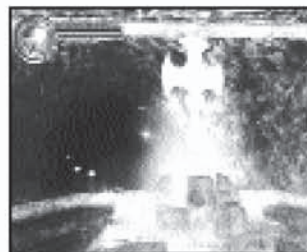

Cross the bridge near where you fought the Fire Genie and return to the Altar of ice. Place the Icon of Wind here to lower the lava level.



28

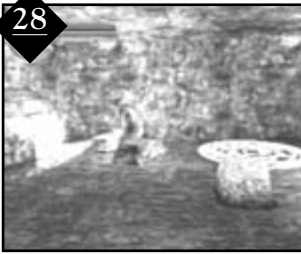

Move to the Symbol of Passage and use the Red wand. Take the Red Guide Stone and use the Green wand at the Symbol of Passage. Return to the Earth Folk village. Harmurah is in the room where you found Frostbite.



Talk to Harmurah. He gives you the Craftsman's Key.



He repairs your weapons and armor. Give him an Earth Stone, and he'll improve your weapons.

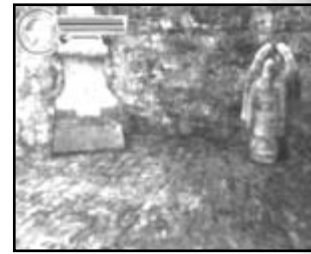

While you wait for your repairs and upgrades, return to the save position in this area. Place the Red Guide Stone on the Marker. Now you can easily return here for repairs.

29



When Harmurah is done with your repairs, return to the Forge. The lava level is down, so you can explore everything. Don't cross the bridge; go down the stairs.



Take the door on the right. Past the Beetles, there is a Fire crystal. This teaches you the Fire Wall spell.



Follow the path you took the first time through this area (when it was frozen) to the save position. There's a new door you can go through now that the ice is gone.

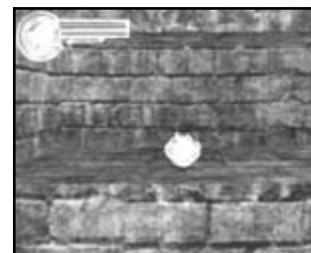

Go down the stairs and to the door in the next room. Ahead of the door is a secret panel. Open it to get the Flame Shield. Equip this.



Go to the previous room. There is a sword surrounded by lava. There's no way to get it right now.



Leave this area. Follow the river of lava to where you got the kite shield. You're heading back to the Altar of ice now.

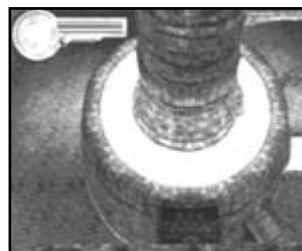

When you get to the door that exits the Forge area, stop and look down in the gap at the center of the room. Drop to the platform next to the chest. This hurts.



Drop to the chest now and open it. Inside is the Sacred plate, which is an excellent suit of armor.

Big Battles

Kings Field

Prima's Official Strategy Guide

The Ancient City

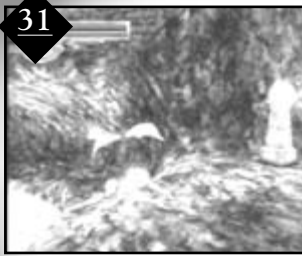

Head toward the Altar of ice. Cross the bridge to it, but follow the path that runs beneath it.

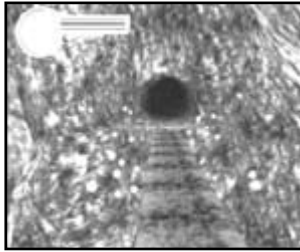

There is only one path to follow here. When you get to this bridge, run across it because the stones drop behind you.

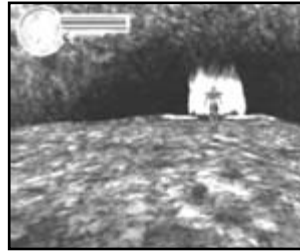

Keep going forward until you encounter the Fire Lord.

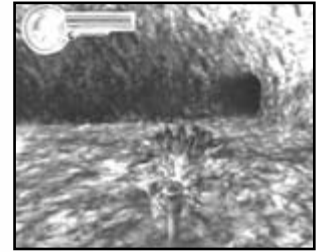

This guy is difficult to beat. Keep moving. Use a quick-hitting spell like Wind Cutter to jab at him, and a good Water-based weapon like the Water Carver or Frostbite to knock him back.



When the Fire Lord drops, you collect the Fire Mail. This is an outstanding suit of armor.

Tip
Check out the Fire Lord's altar when he his dead. You'll gain a Fire crystal and the spell Flame Breath.

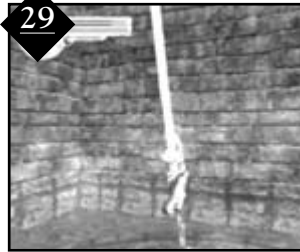

Run to the Forge and save your game. You've got more Fire protection now, so try for the Black Scar sword in the room beyond the save position.



If you need items, use the Blue wand next to Harmurah. This returns you to where you talked to Aeaine. From here, you can get to Chad.



Use the Red wand to return to Harmurah's area. Go to the Forge. Walk down the stairs and to the corner, then go left.



Take the first right and cross the short bridge. There's a mushroom to the left outside in the open area.

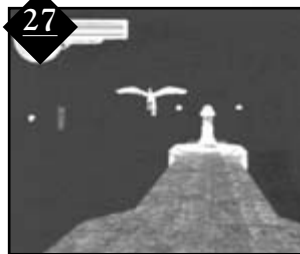

Cross the long bridge ahead of you. It's similar to the one you crossed to get to the Forge, but it leads to a different area.

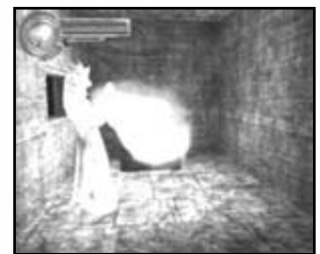

There are two doors on the opposite side of the bridge. Check out the left door. In the chest protected by the statue are cavalier graves.



Check the other door. Follow the path forward, to a new part of the Ancient City.



Walk down the stairs. As you enter the next area, a Widda Archer to your left closes the silver gate. Go up the stairs in front of you and follow the path to the outside.

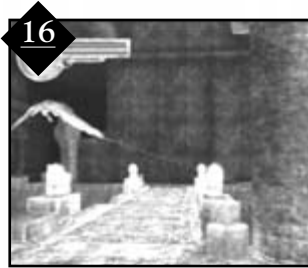

16
If you have a Keystone, use it on the bridge in front of you. Go left to the stairs and follow them up to the door.

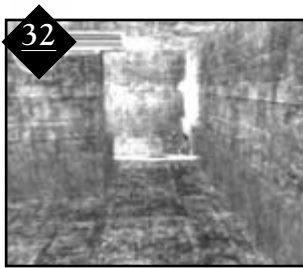

32
After you drop off the ledge inside, you can't go backward. Fight the Widda here and move forward.



At the bottom of the next set of stairs, you find the Widda Archer who closed the gate on you. Kill him and open the silver gate.



33
You have a couple of options. Start with the door at the bottom of the stairs. Inside are a number of barrels and boxes, a Widda, and two Widda Archers.

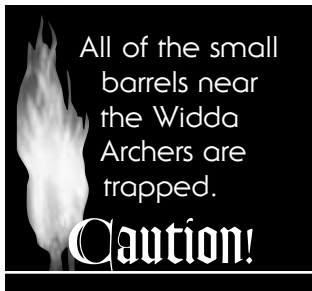

All of the small barrels near the Widda Archers are trapped.

Caution!



In one of the barrels are a Skeleton and a Wind crystal. The crystal teaches you the Life Shield spell, useful against Widda Archers.



Tip
When you leave this room, go up the stairs to your left. Follow the carwalk to the chest. It contains the Ring of Wind.



32
Leave this room and go to the right under the silver gate. Head down the stairs under the wide arch. At the bottom are a couple of Wind Elementals.



Open the door near the Wind Elementals. Beyond are several more paths to choose, but you must kill the Elementals first.



Take the stairs up and go to the door. Behind it is Shane, a researcher. Talk to him. There is a release rock on his bed.



Follow the ledge by Shane's room over the crack. In the next room are two High Skeletons and an herbal liquid.

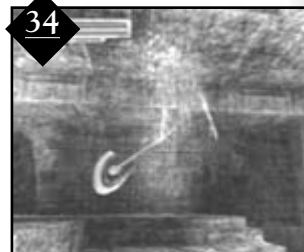

34
Go back down the stairs by Shane's room and under the arch. Follow the curving hallway to the room at the end. The creature here is a Malice, who drops with a couple of Flash spells.

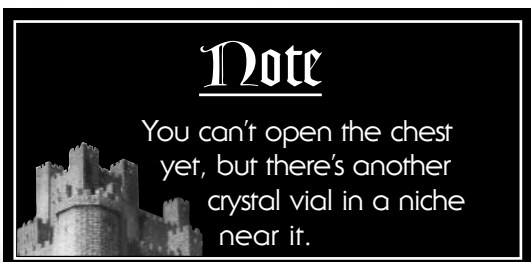

Note

You can't open the chest yet, but there's another crystal vial in a niche near it.



32
Go down the curved hall and through the door. Take the stairs on the right to the next area.

Big Battles





Go right and up the stairs, killing a Wind Elemental. Open the small doors to release a horde of Beetles. When they are dead, get the cavalier helm.

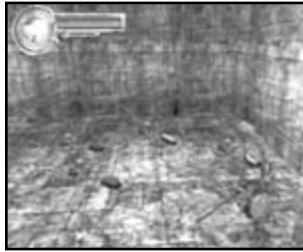

Head down the stairs and go straight. Fight the group of High Skeletons at the bottom of the short staircase. In the back corner, get the Dwarven Sword.

Tip
There is an herbal liquid on the table beyond the door to the right, before the High Skeletons. Don't go up the ladder yet.



Descend the stairs to the save position. Go through the door. Beyond the next door is a huge area containing several hallways.



Take the first hall to the left and climb the stairs. Fight the Wind Elementals and grab the herbal liquid from the chest.

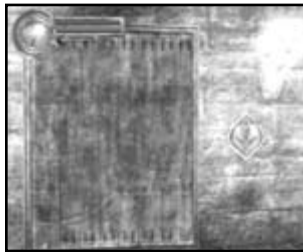

Go down the stairs to the door on your left. Use the release rock to open it, and fight the Wind Elementals on the other side.



Avoid the barrel because it is trapped. Head up the stairs through a few more Elementals. Follow the catwalks at the top of the stairs. There's a side path that leads to a chest holding crusader greaves.



At the end of the catwalks, the wall is broken. Edge forward and look down into the room.



Drop into the room. You're attacked by a horde of Malices. Use Flash, and hack at them with Holycrest.

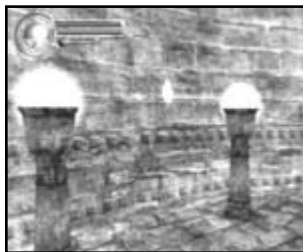

Open one of the two chests in the room to find a Keystone. Get the Light crystal to learn the spell Retribution.



Knock down the barricade on the door and leave. Return to the room you accessed with the release rock and drop off the ledge near the door.



Walk through the doorway and get the herbal liquid. Drop to the next ledge and kill the Elementals. There is a new kite shield in the chest.



Avoid the small barrels and walk to the door. Kill the Skeletons on the other side. Go up the stairs to the next door.



This room contains a couple of Malices. In the alcove to the right is the secret door. Sitting on the flaming statue is a Wind crystal that teaches you Ice Clad.



Note

Opposite this secret door is another. Behind it is a chest containing the Yellow Guide Stone.



In the other section of the room is an ice pedestal. Hit it with a spell, then kill the Malice that appears. The skeleton in the ice holds the Crystalline Blade.

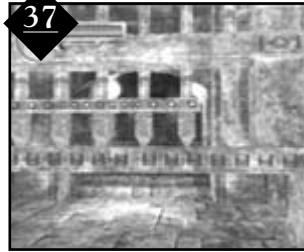

Leave the room and open the silver gate. This leads to the last save position. Walk forward through the doors and go right. This takes you to the central tower of the Ancient City.

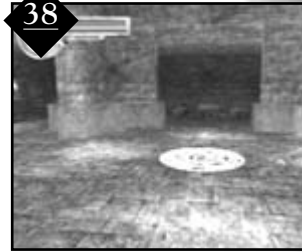

Go left at the tower to the next door. Walk in and ignore the path to the right for now. Follow the hall to the barracks area.



Explore the barracks area, making sure you get the release rock from the ledge. There are a couple of Skeletons here; battle them.



In the back left, behind the barrels, check the floor. There is a secret panel that reveals a ladder. Climb down and search the area for the Power Bracelet.



In the back-right corner is a tunnel. Go in and take the left fork to find JaMarc Neely, another merchant.

Tip
JaMarc has the Yellow wand. Because you have the Guide Stone, buy the Yellow wand.



Take the other fork through a couple of Beetles. At the end is the largest Beetle you've seen yet.



The Beetle is tough, but it's vulnerable to blunt weapons. Wear the Earth Ring to protect yourself from the falling stones, and attack the Beetle. When it dies, you gain an Earth crystal and the spell Earth Leech.

The Ocean Fort



Leave this area and return to where you entered. Take the side path toward the fire arrows being launched. Run through the volley and down the stairs to the Living Armor.



In the next hallway is a number of stone faces launching the fire arrows. These are Fadins. Kill one, and it comes back. Sneak to the door on the right.

The Ocean Fort



Tip

You can stand between the Fadins without being hit. Hack away at them. You get 50 experience points each time you kill one, and they keep coming back. You can raise yourself a couple of levels and increase your physical strength.



The room contains five suits of Living Armor. Kill them, then investigate the drawers around the room. Two contain traps, but the others hold useful items.

Note

Going from left to right, the first and fifth drawers contain traps. The fourth contains a release rock, which you need.



39

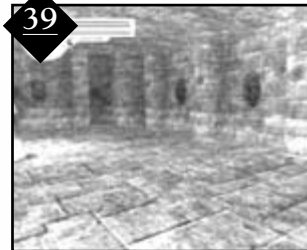

Go past the Fadins to the corridor and go to the right to the door. Past the next door, go right. The next room holds more Fadins.

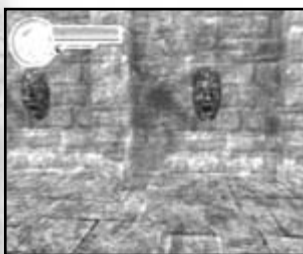

Run into the room to the Fadin on the right against the back wall. This is the Master Fadin. Kill it, and all of the Fadins here and outside die.



Leave and go around the pillar in the center of the room outside. Beyond the next door are two Dark Puppets.



Open the door. Inside is the Dark Sorcerer.



The Dark Sorcerer prevents you from casting spells by draining your magic power. He also attacks with spears, which shoot from the walls, and arrows. He shoots you into the air, and drops you from the ceiling.



After the Dark Sorcerer is dead, leave the room. The door that was protected by a spell is now accessible.

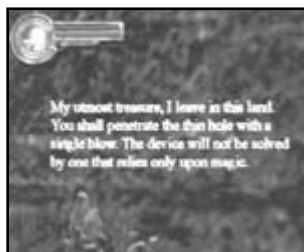

Walk through the short corridor to the next door. Beyond it, go into the room across from you. Follow the wall clockwise and read the graffiti. The next room over holds a Symbol of Passage.



Go to the hallway and get the Binding Crown. This releases the Stone Guardian here, but he can't walk past the Binding Pedestal. Shoot him with arrows or bolts until he drops.



The shelf behind the spot where the Stone Guardian was standing holds the Water Talisman.



Keep going until you see the hole in the floor. Use one of your release rocks here, then go up the stairs.



Use your other release rock at the top of the stairs. When the bridge forms in front of you, cross and walk to the door.



Below you are Stone Guardians. Use two of your Binding Crowns on the Binding Pedestals to make them leave. While they go, get the mammoth shield and a Widda needle.



Go downstairs into the Stone Guardians' room. Get the Engineer's Key from the back chest. The Stone Guardians won't attack.

Tip
Go to where you fought the Giant Beetle to find an Engineer's Chest in the barracks. It contains a Keystone.



Go to where the Fadins were launching fire arrows onto the catwalk. Go to the end of the catwalk and out the door at the end.



Go down the long corridor to the next door. Fight the Widda on the other side. You've got four doors here, three of which you can explore.

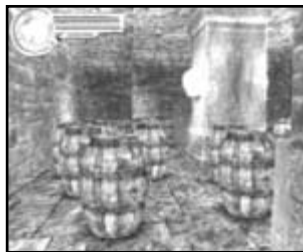

The upper door on the right leads back to the central tower. Go to the right outside to the next door. Inside are a number of barrels. They're all empty, but there's a power seed in the chest in the back.

Note
There is an Earth Stone in the back-right corner.



Return to the last room and go down the stairs. The door ahead of you leads to a dead end, but the door behind you leads to a save position.



Go up the stairs by the save position and through the next door. This room has a chest you can't open and two doors. Check the door on the right first. It leads to a small ledge near the central tower.



Look left. Run over the short gap here. Next to the skeleton on the ground is Zastari's Map. Get it and run over the gap.

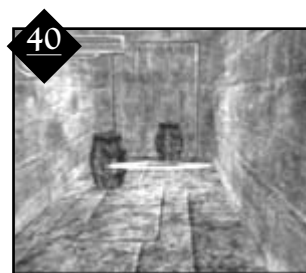

Take the door ahead and to the right. It ends in a door protected by exploding barrels. Hit them with a spell. The barrel near the door holds fool's fruit. Return the way you came past the save position.

The door is a trap. If you walk through, you will fall, taking damage.

Caution!



18

Go up the stairs to the door on the other side. Beyond the next door is a new area.

Tip
Break all of the pots here. They contain useful items.

The Ocean Fort

King's Field

Prima's Official Strategy Guide

The Ancient City



Cross the bridge and bear left. Pick up the Widda arrows and bolts, and talk to the soldier at the end of the path. Return to the bridge and go through the large door near it.

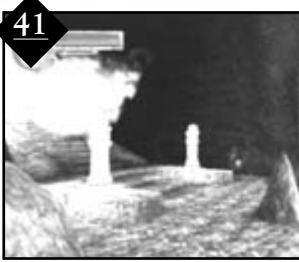

Follow the tunnel. It widens into an area containing a couple of Widdas and a huge staircase guarded by flame.



Walk down the watery tunnel first. Fight the Aqua Lizard and get the Ring of Water from the skeleton. Go to the flaming staircase.

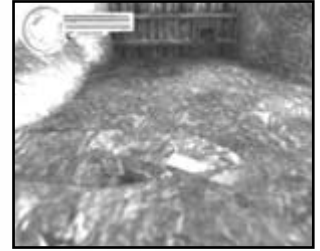

Take the tunnel on your right. Walk forward until a small fort appears in front of you. Drop and get the tower shield from the corpse, then go to the fort and enter it.



Talk to all three soldiers inside. The rightmost gives you the Icon of Fire.

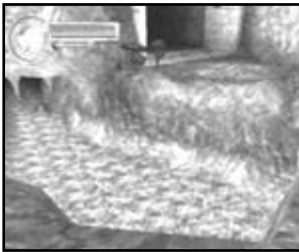

Leave the fort and go left into the tunnel. There is a branch to the left that you can avoid for now. To fight the Aqua Lizards, wade through the water. Otherwise, cross the bridge.



When the ledge you are on ends, you see two Widdas. Kill them. One is carrying the Widda Map.



Go toward the fort and follow the Stool-lined tunnel. There are Water Elementals at the end.



Take the left fork and drop into the water. Get the great helm and put it on.

Tip
Make sure you are wearing the Water Talisman when you do this.



Take the other fork to the lighthouse. Climb the stairs inside to the top.

Note
The Thieves Necklace is on the ground outside the back of the lighthouse.



Place the Icon of Fire in the slot at the top of the lighthouse to light the beach area.

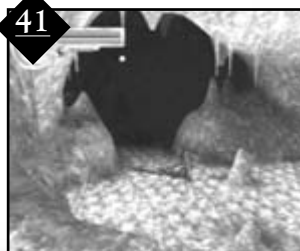

Go to where you got the Widda Map. Drop to the water and run past the Aqua Lizards to the beach outside.



The Ocean Fort



Go to the right to the next save position. Save the game here.

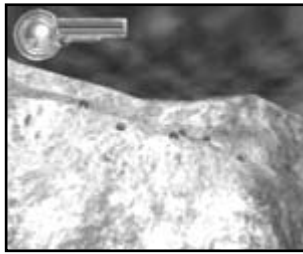

Follow the tunnel near the save position; it comes out near the lighthouse. There are mushrooms on the cliff face. Shoot them with arrows and they drop.



Go toward the lighthouse, following the beach, to find a cave filled with Aqua Lizards. At the back is the sword Tsunami.



The Icon of Fire in the lighthouse reveals the bridge to the ocean fort. Run across the bridge. There are Sea Fangs in the water.



Inside is a large room containing Aqua Lizards. There are three doors on this level: right, left, and straight ahead. Go left.



Climb the stairs and go to the chest. It contains the Enchanted Armor. Equip this.



Return to the central room. Go to the door that was straight ahead when you first entered. It's to your left now. Go to the right inside and get the Blessed Bow from the shelf.

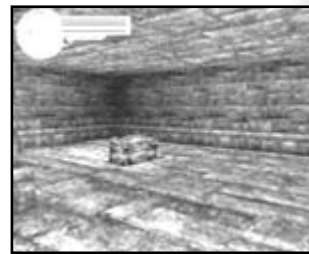

Turn around and head the other way. When you see the chest, stop. The floor here is trapped. Run to the chest. The chest holds the Widda Ring.

If you are too slow, you drop into the water and are surrounded by Sea Fangs. Follow the tunnel out to return to the ocean fort's entrance.

Caution!

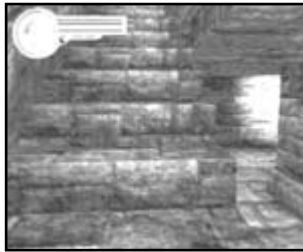

Run to the middle room. The last door you haven't gone through is the one on your left. Go up the stairs. The corridor next to the stairs leads to a room containing an Aqua Lizard and nothing else.

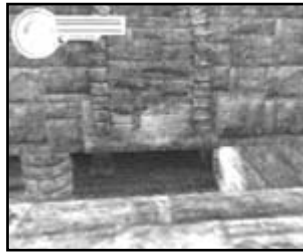

Fight the Zombie at the top of the stairs. From his room, you can spot the Stools across from you out the window. Hit them with a spell, then leave the room and go left.

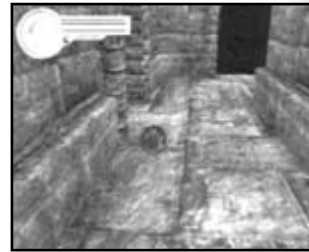

When you come around the corner, a Para Stool hits you. There's nothing else in the area. Kill it.



When you turn the corner, there's another Zombie to fight.



Walk to the end of the hall. There are arrows being fired down the hall. Use your Life Shield spell and run toward the arrows. Hug the right wall to avoid them.



Let the Zombie come to you. He gets damaged by the arrows. Kill the Stools with a spell as well.



Don't advance too far because there is another Para Stool around the corner.

Caution!

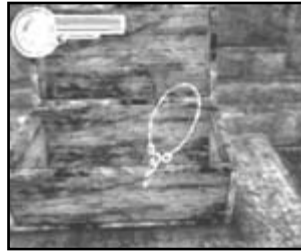

Follow the corridor past the arrows to the chest at the end. Inside is the Widda Necklace.



Go past the arrows and down the next corridor. Look for a staircase leading up to your right. There's a Zombie at the top.



Walk to the next door. Inside is a chest with the Widda Bracelet. Get it to trigger a trap. You take damage from a poison gas.



Destroy the piece of broken wall across from the chest and drop into the next corridor. Kill the Zombie here.

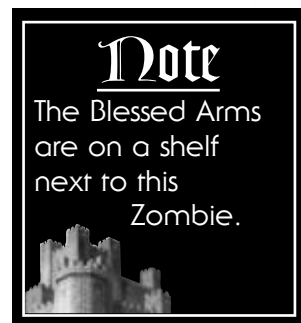

Note
The Blessed Arms are on a shelf next to this Zombie.



Go up the short staircase and take a right in the next corridor. Go to the end. There is a room containing a number of chests.



Open the chests, going counterclockwise. After the third chest, run around the corner. The floor here is trapped and deposits you at the entrance.

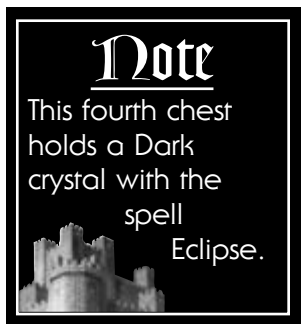

Note
This fourth chest holds a Dark crystal with the spell Eclipse.



Run around the next corner because this floor is trapped. Open the three chests on this side of the room.

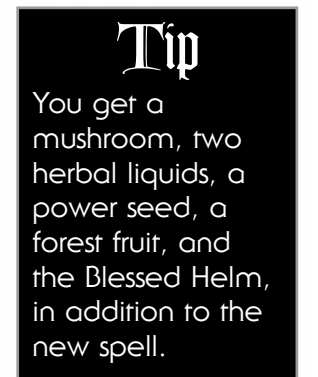

Tip
You get a mushroom, two herbal liquids, a power seed, a forest fruit, and the Blessed Helm, in addition to the new spell.



Leave, taking the long staircase down. This leads to the arrow trap. Return to the fort's entrance and leave. Save your game here.





Against The Widdas

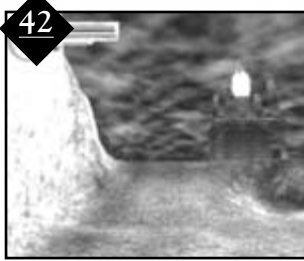

From the ocean fort, walk up the beach. Go through the first tunnel to where you found the mushrooms on the cliff.

Tip
If you don't have the Water Talisman on, equip it now. You spend a lot of time underwater in the next area.

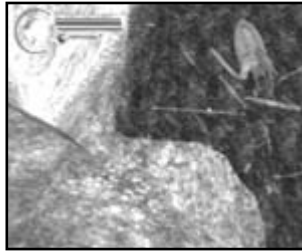

Walk to the far end of this area and look down. Drop to the ledge below you. This hurts.

If you miss the ledge, you sink below the waves and die.
Caution!

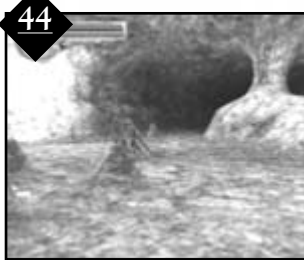

Walk up the tunnel behind you and into the cave. The creatures here are Makaras. Fight them, then go to the right.



Paul Hutchison is standing in the back part of this cave. Talk to him. He's looking for some poison to protect his fish from the Makaras.

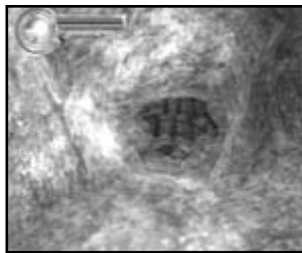

Turn around and walk away from Paul to the tunnel containing the floating barrels. Destroy these to proceed.



The underwater tunnel branches to the right and straight ahead. Go to the right under the floating barrels. Walk to the back of this cave to find the Lucky Pendant.



Examine the carved statues. Behind one is a Makara and a Water crystal containing the spell Vortex.



Go the way you came. Take the stairs to the right underwater and fight the Makara here. Drop into the pool below—this is where you found the great helm.

Tip
Destroy the three floating barrels; one of them drops the Sacrificial Mask.

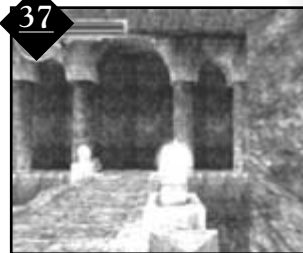

You now have a lot of backtracking to do. The closest Symbol of Passage is in the Ancient City. Use a Keystone to get to the central tower.

Against The Widdas

Kings Field

Prima's Official Strategy Guide

The Ancient City

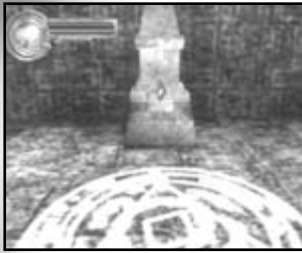

Enter the central tower and place the Yellow Guide Stone in the Marker. Climb the stairs and unlock the door, then go down and use the Green wand.

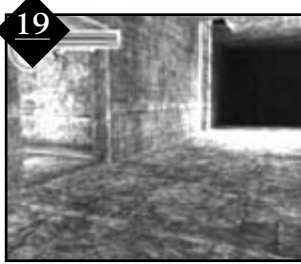

Take the Green Guide Stone. Go out of this room and left down the stairs. Take the narrow staircase up before the lava river.

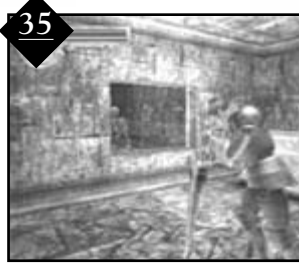

Go left at the top of the stairs and down the long staircase ahead of you. At the end of this path, talk to Belric Psytar and get the herbal liquid from the table.

Tip
Use spells to kill the Skeletons in the room next to Belric. Enter this room later, and the Skeletons stop you from climbing the ladder into the room.

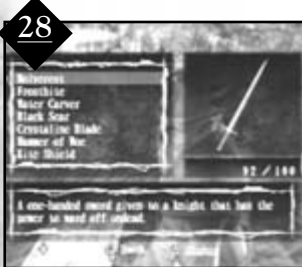

Go to the Earth Folk area and talk to Harmurah. This is a great opportunity to get your weapons and items repaired. Use the Blue wand on the Symbol of Passage.



You are by the Forest Golem. Walk to the entrance by the save position and continue down to the small doors. Take the one on the right.



Inside, go right and up the stairs to the Priest's door. Open it and get Earth-binder from the chest.

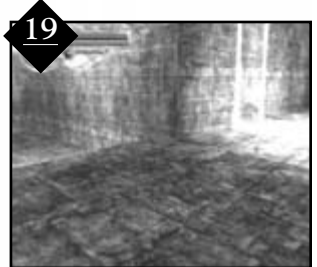

Go down the stairs in the main room. The silver gate is now open. Kill the Fire Elemental and continue down the stairs. You pass the lava river, but on the other side.



Go up the curved staircase at the bottom and enter the Craftsman's room. Destroy the barrels, then go out the door left of where you entered.



Follow the ledge and climb down the ladder. You take damage from the flaming statue here, but it isn't much. Open the chest to find the Ice armor.

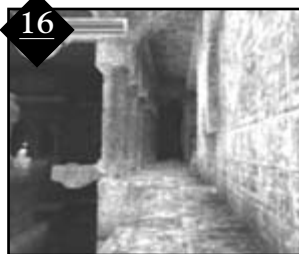

Go the way you came, past the silver gate and out the door on the left. Walk around the central tower to the opposite side. Stop and talk to Ramirez.

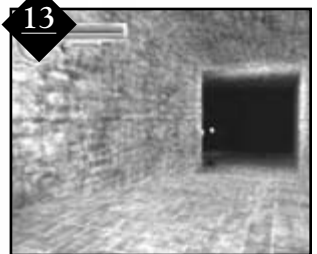

Continue past the spot where you fought the Stone Guardians. Go to the right past the stairs and right again past the arrow traps' location.



Climb the stairs at the end and use the Engineer's Key on the last door at the top. In the chest are the Silvery Gloves.

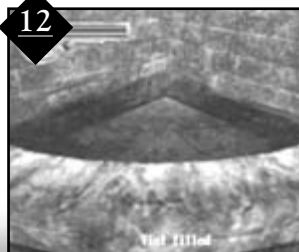

Go to Mista's room, but go left across from his door. Walk to where you talked to him. Use a crystal vial on the water in this fountain. It's poisonous; gather it for Paul.

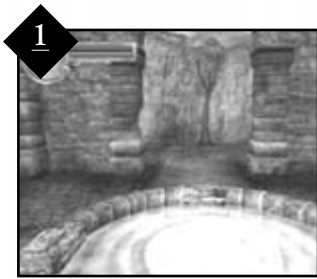

Go to where you first entered this area, the entrance to the palace. Use your other crystal vials here and fill them with healing liquid. On your way, put the Green Guide Stone in the Marker near the Giant Spider's lair.

Tip
While you are here, talk to the shopkeeper. Buy any herbal liquids, mushrooms, and forest roots he has.

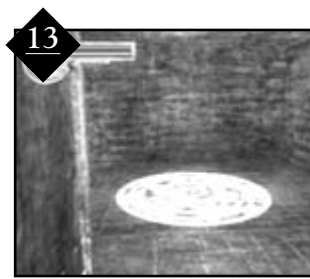

The closest Symbol of Passage is near the Engineer's room. Use the Red wand to reclaim your items from Harmurah, then use the Yellow wand.



Talk to Paul. When you give him the poison, he gives you the Fortune Bracelet.



Return to the area with the flaming staircase. Wear all three pieces of the Widda jewelry, and the flames disappear.



Watchers guard the interior of the fortress. Sneak up behind them and slash them so you don't lose your magic power.



Go down the corridor ahead of you and fight the Widdas at the end. There are two Widda Archers on ledges above you. Get in a corner.

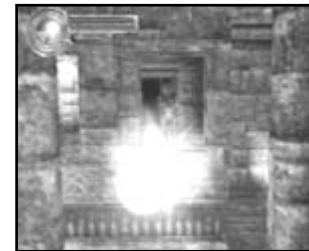

There are three exits from this area. Go left first, ignoring the door to the right by the Watcher for now. Go up the stairs and kill the Widda Archer and the Watcher. Snipe at the Widda Archer across from you.



Go down the stairs and through the door you ignored. There's a Widda and some pots here. Kill the Widda and smash the pots to find the champion helm.



There is a secret door behind the pots. The right and center pots inside contain Snakes, while the left pot holds the Absorption Boots.



Return to the pillared room and run across to the door opposite you. Past another Widda are two staircases. Take the left one, kill the Widda at the top, and claim the three herbal liquids.



Go up the other staircase. If you haven't killed this Widda Archer, kill him now. He drops an herbal liquid. There are two forest roots and another herbal liquid outside his room.

Against The Widdas

King's Field

Prima's Official Strategy Guide

The Ancient City



Return to the central room and go through the right-hand door. There are two Widdas in this room, and you have three choices for where to go next.



The door to your left leads to a Symbol of Passage. Ignore it. Take the door on the right. You enter a catacomb. As you walk in, Mummies come through the walls.



Go through the door on the right. Mummies coming through the walls attack you. Kill them and go through the door on the left.

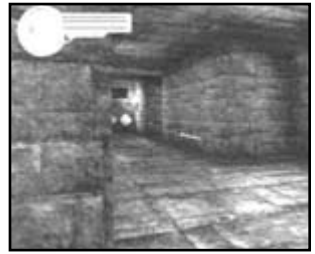

There are arrows being fired at the end of the next corridor. Put on your Spider Armband and move from alcove to alcove. In the third alcove, be ready for a surprise.



The floor in the third alcove is a trap, which drops you on a nest of Scorpions. Fight your way through them and get the items here, particularly the Blessed Shield.



The room beyond holds three Adept Mummies. Battle through them and go up the stairs.



Return to the hallway containing the arrows. Go to the end, avoiding the third alcove. Go through the door here to the Widda's area.

Tip
Collect the war sword in the Adept Mummy room. It's on one of the ledges.



In the alcove to the right are two Golden Statues. Destroy them and claim the Queen's Staff from the chest. Examine the chests outside for some nice items.

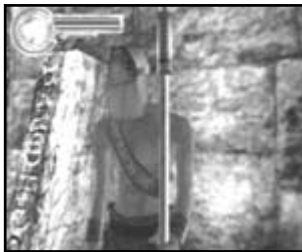

Open the locked gate and talk to the guard on the dais. He tells you to leave because the Queen is off limits.



The gate to the left of the guard is locked, but the door isn't. Take the door and walk down the long, narrow staircase to the bottom.



In the next room, Snakes pour out of the walls. Move to the corridor.

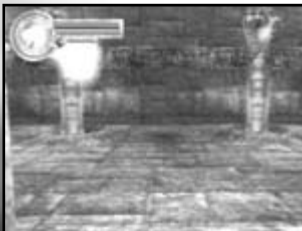

You have reached the lair of the Widdaconas. You must kill them.



When the Widdaconas are dead, drop down the right one's hole. You take less damage from the fall, and you can get a forest fruit.

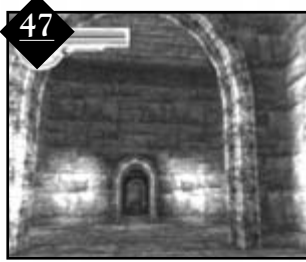

Go through the series of arches. When you get to the stairs, run. Four Adept Mummies break through the walls here. Avoid them by running through the room.



At the bottom of the ramp is the Widda Queen's lair. She's pleased to see you.



Run in and start hacking at the Widda Queen. Move to one of her sides where she can't strike easily, and lay into her with your best weapon.

Tip
Don't worry about the Snakes she summons. When you kill the Queen, they all die.



When the Queen dies, she'll drop a Fire crystal that teaches Immolate. Go to the chest in the alcove she was guarding to get the Widda Key.

Eggs and Keys



Leave the Queen's area. Pass the Adept Mummies' area through the arches and take the door on the left. Follow this corridor to the end. Use the Widda key to open the door at the end of this path.

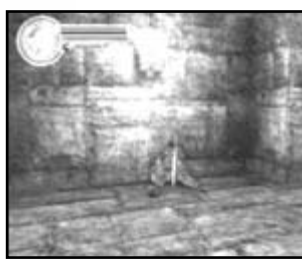

The body of Septiego the Sword Master lies in the back of this room. Get his weapon, the Lawful Blade, then leave this room.

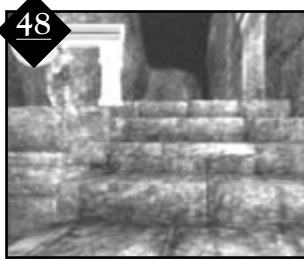

When you leave the room with Septiego's corpse, you find a door across from you. Go through the door and charge the Widda Archer on the stairs ahead of you.

Tip
If your major battles in the Widda area have left your supplies low, use the Green Guide Stone inside the room to the right. Use the Symbol of Passage to return to a shop, then use the Green wand with a Symbol of Passage to return here.



Drop onto the mine cart and let it carry you to the next area.



Jump off when the cart stops and go through the doorway. Continue forward to the cave.

Eggs and Keys



There's a Widda Archer guarding a couple of mushrooms in the back. The door here is barred, so find another way in.



Open the small window to the left of the door and talk to the man here. He won't open the door because you aren't a Widda. Talk to him until you discover what he really wants: a Widda egg.

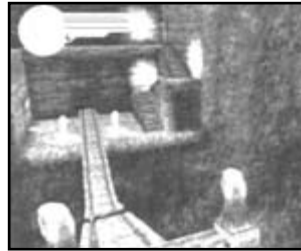

Leave the cave and climb the stairs. Kill the Widda Archer here and get on the mine cart. Don't worry, it can cross the gap easily.



Move through the doorway and kill the Widda Archer. Drop down and take the mine cart. You may have to wait for it to return.



Get off the cart when it stops. When it moves away, go up the track to the small building and get off the track to the right. Take the stairs and smash the pot at the top to receive a Wind crystal with the spell Tornado.

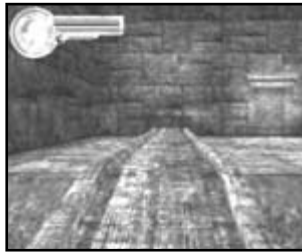

Return to the track. Wait for the cart to pass from left to right, then follow the track left. Go through the door at the end.



There are a couple of Dark Flowers in the cave. Deal with them and follow the path ahead of you.



It isn't long before you see some Widdas. Kill them and move forward. Take the right path ahead of you.



When you round the corner, you see a group of Widda Archers on a ledge. Handle them with spells.



There's also a Widda who charges as you approach the stairs.

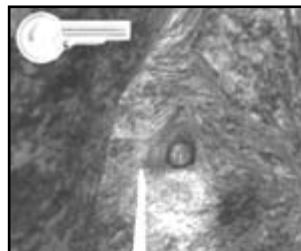

Climb the stairs to the Archer ledge and go right. Look through the oval-shaped gap in the wall. Shoot an arrow into the space across from you to drop a strange egg to the ground.



Walk around and get the egg. Go right to the nearest door. This leads to a Scorpion-infested area of the mine cart tracks.

Tip

On the ground below is a fool's fruit in one of the stone tubes. In the poisonous water, locate Venomblade.

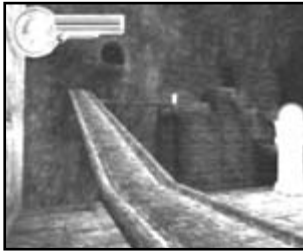

Walk to the end of this area and up the mine cart track at the end. When you are partway across, the mine cart at the other end starts moving. It hurts, but if you keep walking, it shouldn't knock you off the track.



Walk around the track and kill the Widda Archer below you. Get the forest fruit here, then climb the stairs and go through the door.



Go left in the cave, then right. Kill the Widdas and get the second strange egg from the stone tube.

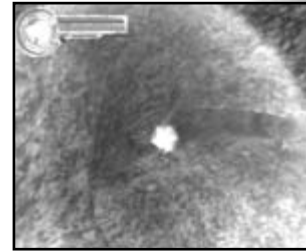

Walk back and go right. Through the gap in the floor, you can see four Acid Crawlers guarding an Earth crystal. Hit them with spells, then drop down and get the crystal.



Note

This crystal teaches the spell Volcannon.

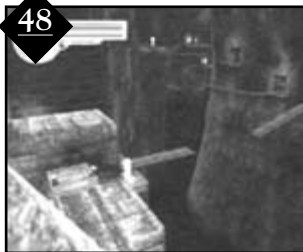

Walk out the tunnel and drop off the end onto the track below. Run right and follow the path to where you fought the Scorpions.



Enter the door and go left to the next door in the cave. Wait for the mine cart outside. It takes you back to where you first entered the mine cart area.

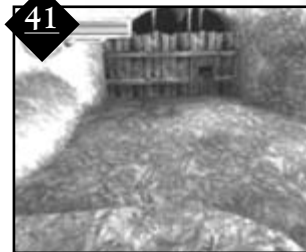

Return to the Widda Queen's area. Go up the stairs and unlock the gate. Go all the way back to the small fort where you got the Icon of Fire.

Tip

Don't forget to put on the Widda jewelry before you leave the fortress.



Give one of your strange eggs to Lyle behind the door. This prevents his transformation into a Widda. He gives you a crystal vial.



Go back to the mine carts. Return to the man guarding the door and give him the second egg. He opens the gate for you so you can proceed.

Tip

Collect the Green Guide Stone before you continue. Also, use the Widda key at the door next to the guard in the Queen's area. You find the venom gloves inside.



Go inside and kill the Widdas and Snakes. Go up the stairs and check the wall in the back corner.



You find a path to the man you gave the egg to and a pot. Smash the pot to find Lord Myu's Necklace.

Eggs and Keys



Talk to the man here. You can buy wise man's fruit, fool's fruit, and Widda arrows from him, but you have to pay in scales, claws, and bones.

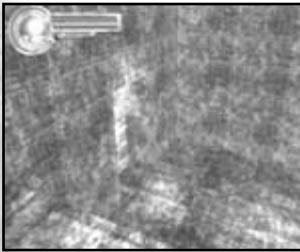

Drop off the ledge to the floor below. You take some damage, but not too much. Go left and use the Widda key to open the door.

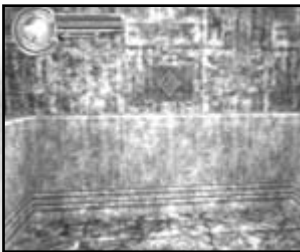

Fight the Skeleton and the Skulls. Check the last gravestone for the Demon Legs, then continue down the stairs. At the end of the hall, press the button on the back wall, then go back to the graveyard.

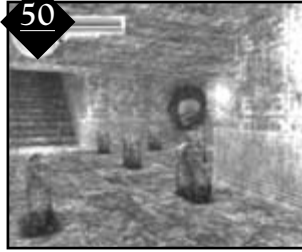

Leave this area and go to the graveyard. Deal with a Skull floating over the graves.

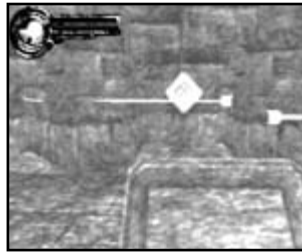

The chest at the center of the room holds a Widda's bow, but when you open it, slots on the walls open and start firing arrows. Get the bow and leave quickly.



Go through the graveyard and down the stairs at the end. Go right when you have a choice, and take the door at the end of the corridor.

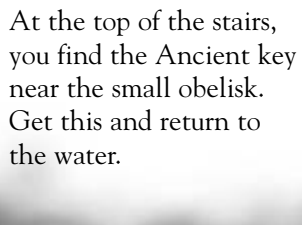

At the top of the stairs, you find the Ancient key near the small obelisk. Get this and return to the water.

Tip

Go up the stairs here, and come to a gate. Open the gate and continue up to reach the save position in the Ancient City near the Widda fortress.

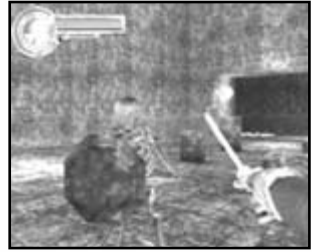

Walk through the cemetery to the stairs, fighting the Skeletons on the way. At the top of the stairs, go right.

Tip

On the back wall to the right, there is a secret panel. Behind it is a chest with the Dwarven pickax. You can't open this panel until you have opened the chest with the Widda bow.



Push the button to open the gate outside. This takes you back to the exit from the egg mines. Return to the graveyard and go back to the stairs. Go left this time.



The corridor leads to the ruins of the Dark Folk. Get the forest fruit on the stairs in front of you and to the left. Find the staircase on the left and walk down it into the water.



Fight the Sol and climb the stairs on the left.



Go straight through the doorway in front of you. Fight another Sol and climb the stairs. There is a catwalk in front of you. Take it to the small ruined structure.



Take the stairs to the right. Run past the Sols because you don't have a lot of time. On the other side of the sunken room, climb the stairs to the top and get the Dark crystal. It teaches the spell Reckless Strength.

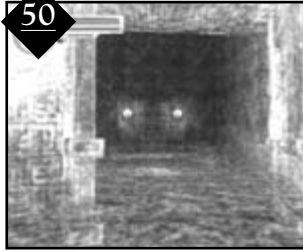

Retrace your steps out of the Dark Folk ruins. Go right in the corridor when you can and into the shallow water. Go through the open gates to the large door.

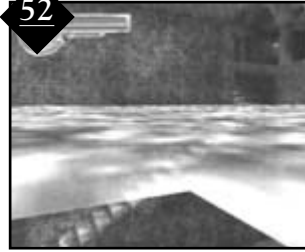

This takes you back to the central tower of the Ancient City, this time at the bottom. Drop into the water and climb the stairs.



Walk around the tower until you find the side on the far wall that has no door. Jump into the water and walk forward down the tunnel. Claim the Water crystal.

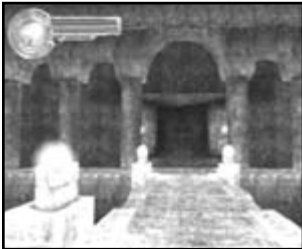

Turn around and go back through the tunnel. Go right, up the stairs. Walk around to the bridge opposite the door to the interior of the tower and cross it.

Tip
Go in the tower to find a healing pool, a Marker, a save position, and a Symbol of Passage.

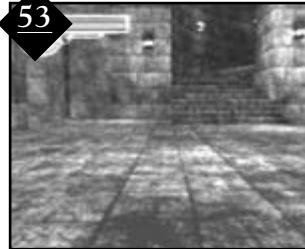

Climb the stairs inside. There is a Dark Archer on the stairs across from you. Kill her quickly.



At the top of the stairs, you are attacked by a Dark Soldier. Kill him and head up the next flight of stairs. The door across from the stairs leads to a save position.



There are two more Dark Archers at the top of this flight of stairs. Kill them and go up the wide staircase on your right.



Kill the Spider and enter the room on the right. Remember the Giant Spider you fought at the beginning of the game? Here's your chance to see three of them.

Tip
When the Giant Spiders are dead, find the dragon flowers on two of the statues. Check the wall near the central opening in the floor to find a secret area. Climb down the ladder and open the chest to find the Guardian Bracelet. The middle torch around the opening in the floor holds a Fire crystal.



Go back down the staircase and straight across to the opposite stairs. Fight the Giant at the top.



Skip the stairs for now. Go through the door past the Giant to reach the swinging bridge. Cross it to the far side.

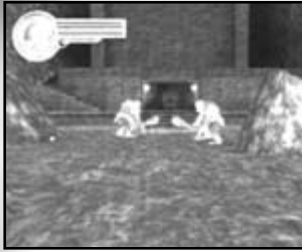

There are three club-wielding Giants on the far side of the bridge. Drop them all and walk toward the large door. Don't go through it, though. Take the stairs on the left instead.

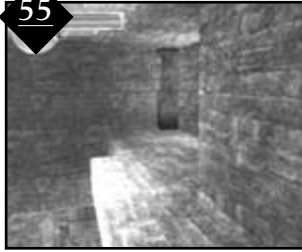

Go through the door at the top of the stairs. Find the switch on the wooden beam and flip it to open the gate. Go back to the large door outside and head through it.

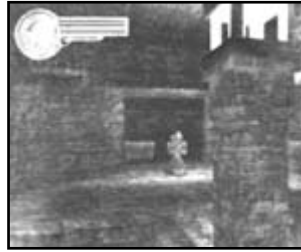

Take the stairs on the right. Climb all the way to the top to Serrak's room.



Check around the room for dragon flowers. In the chest, you find the Ancient Shield. Talk to Serrak, then go back down the stairs.



Go through the gate. There are two more club-swinging Giants here. You can't get through the door on the right yet, so go left.

Tip
In the first door on the right, you can find another dragon flower in a poison water pool. It's worth getting poisoned to get this item.

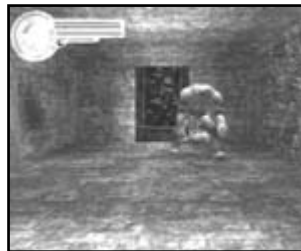

At the bottom of the stairs you run into another Giant. Kill him and open the door at the end. Fight the two Giants here from the doorway.



When you go through the door, the Giant Leader smashes through the wall in front of you. He's a dangerous foe. Use spells and keep your distance.



When the Giant Leader dies, get Serrak's key. Go up the stairs.



Go to the end of the hallway and use Serrak's key on the door. You receive the Icon of Water.



Walk toward the front of this house. You can now open the door on your right. There are tons of items in the back of this room.



Leave the house and head back toward the bridge. When you get to the bridge, go right and get the dragon flower. Look down. There's a ledge below you. Drop to it.

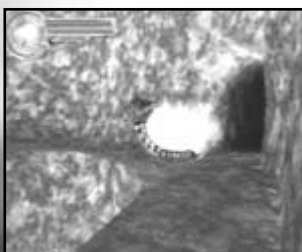

This area is inhabited by large Acid Crawlers. Kill them and check their caves for items.



In the third cave, you find a Wind crystal that teaches the spell Freeze. You now have all of your Wind spells.



Continue to the end of the path. Run over the gaps in the floor to claim the guardian shield. Drop through one of the holes in the floor, and you're back to the save position near the Dark Archers.

Final Preparations



Return to the stairs below and take the door on your right. You come to a square room containing a skeleton slumped against a pillar. Watch out for the spear traps and get Zastari's key from the bones.

Tip
There's a secret door on the wall on the other side of the skeleton. Push the switch here to shut off the spear traps.



Around the corner, is your old friend Chad. He looted the treasure room and has a number of unique items for sale. When you are done with Chad, go through the door next to him.



In the room are a Greater Demon and a pair of Dark Soldiers. Kill the Demon without alerting the Soldiers.

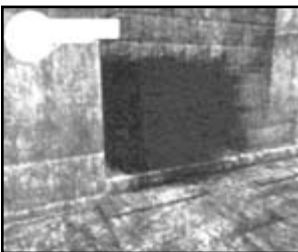

Tip
When you open a chest, back away. This allows you to avoid traps.

Open the chests carefully; many are trapped. When you find gold, you find 10,000 at a time.



Go up the narrow stairs left of where you entered and open the chests here. None of these are trapped.

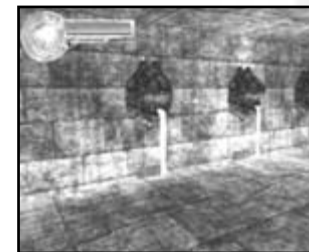

Look at the pillars below you. Drop onto the leftmost one and destroy the wall next to it. Follow this corridor to the end and destroy the Lava Faces.

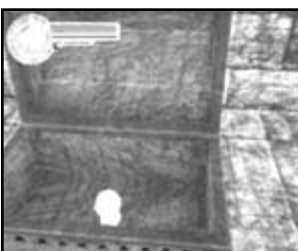

Go to the main room and through the door on the right. The chest at the end holds the King's Map.

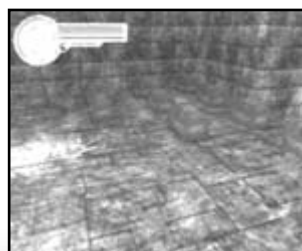

Return to the ground floor and go to the door across from you. Walk around the pit to the top. There are many chests here Chad didn't inspect.

Tip

You pass three small doorways. There's a chest behind each, but when you open the doors, you are pushed toward a pit of acid. Move quickly to open the chests and get the items before you are pushed away.



One of these chests reveals a switch that opens a secret panel when you press it. Go in and get the Earth crystal from the statue on the right. You learn Meteor Cascade from this crystal.



Read the sign on the back wall. It's a code you'll need soon.

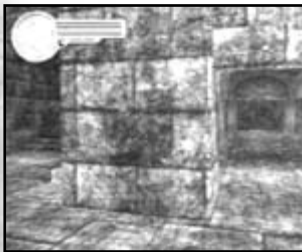

Return to the ground floor and walk along the right wall. Check it for a secret door that leads to the sword Triple Fang.



Go through the large door and up the stairs. There is a room containing four panels representing the four basic elements. Press them in the order they are on the sign you read to open a secret panel.

Tip

The order is: Earth (front right), Water (back left), Fire (front left), Wind (back right).

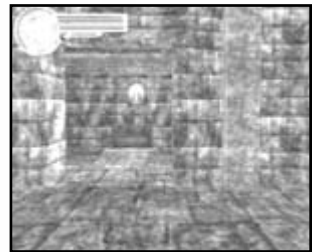

In the chest behind the secret door, is the Ring of Wisdom.

Tip

If you press the buttons in the wrong order, you'll be dropped into an acid pit containing a few High Skeletons. There's a Symbol of Passage on the ceiling; use it to get out.

21

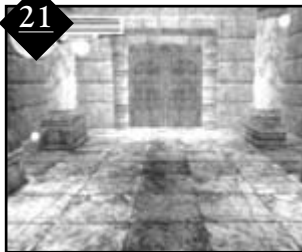

Leave the treasure room and go to the central tower of the Ancient City. Use the Blue wand on the Symbol of Passage to go to the Holy Forest.

Tip

Place a Guide Stone in the Marker here to make your return easier.

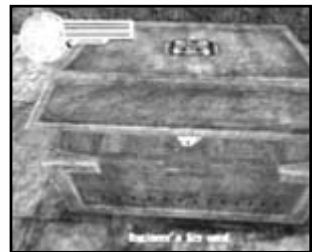

Open the four chests and get the Black Eyes from inside. You have all of the necessary keys to do this.

23



Walk down the stairs next to the Forest Golem. Turn right when you see the statues and right again up the stairs past the statues.



Open the door ahead of you at the top of the stairs. This leads to the Ancient King's throne room.



Go to the door across from the save position. Wear the Ring of Wisdom to open this door. The Ancient King is sitting on his throne.



The Ancient King summons hordes of High Skeletons to defend him. Use your best weapon and fight your way through them, hitting the King when you can.

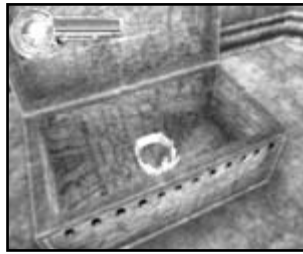

When the Ancient King dies, he drops a Light crystal. Open the chest next to him to get the Ancient Crown.



Leave the throne room. You can't open the door behind the throne yet, so leave through the other door. Go through the first door on your right outside.



Walk up the narrow staircase and loop around to the right at the top. Climb the next set of stairs to the door on your left.



Inside this room is a Sentinel. Hit him with spells, and avoid the glowing balls of light. When they flare up, you take damage.



When the Sentinel is dead, cross the room. In the small alcove to your right is the Ancient Helm. Leave this room and return to the outside.



Go left down the stairs. At the bottom, turn right and run to the wall. Turn right again and climb these stairs, taking the door on the right at the top.



Inside is another Sentinel in a room like the last Sentinel's. Kill him the same way and claim the Ancient Gloves from the alcove before leaving.



Drop off the ledge to the left outside and walk left to the next staircase up. Go through the door at the top.



It's another Sentinel room, but this one is different. Turn left and wait for the Sentinel to appear. Fight him at close range. Get the Ancient Greaves before you leave.

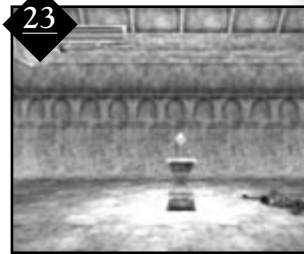

Go down the stairs on the other side of the room. Take a left and run down the narrow stairs. On the other side of the door at the bottom is a Light crystal.



Walk to the door on the left. Place the four Black Eyes here to open this portal. Walk through to the Altar of Light.



Don't slip off the path. Walk ahead until you can go no farther.

King's Field

Prima's Official Strategy Guide

The Ancient City



Place the Lawful Blade on the altar. A flash of light changes it into the Moonlight Sword, an incredible weapon.



Leave the Altar of Light. In the room below, you receive a message from beyond the grave through the skeleton on the floor. Get the King's Key from his body and open the door in front of you.



You must now return to the cemetery outside the Widda temple. The closest Symbol of Passage is in the room where you got the four Black Eyes.

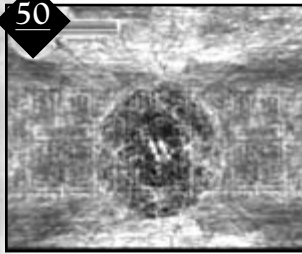

In the small chamber next to the Symbol of Passage, is a pair of gloves surrounded by magic. Use the Moonlight Sword to slice through the magic and you gain Lord Myu's Gloves.



Return to the central tower and go to the treasure room area. Go to the top of the stairs. Fight the Dark Archers and Giant, and get Lord Myu's Greaves using the Moonlight Sword.

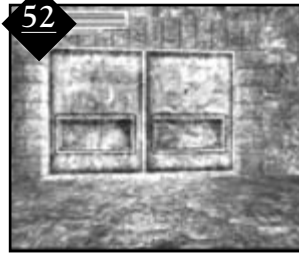

Walk toward the central tower, but don't cross the bridge. Walk right and drop off the ledge into the water.



Walk forward toward the corner. On the right wall, before the corner, is a secret door. Open it and go inside. Don't worry about the High Skeletons.

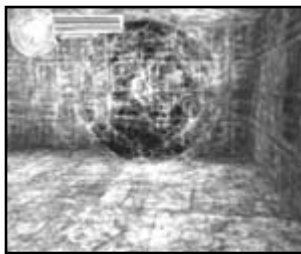

Destroy the shell around Lord Myu's Helmet with the Moonlight Sword and claim the Helmet. Turn around and walk out.

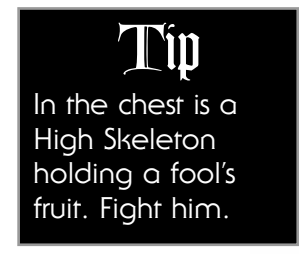

Tip
In the chest is a High Skeleton holding a fool's fruit. Fight him.

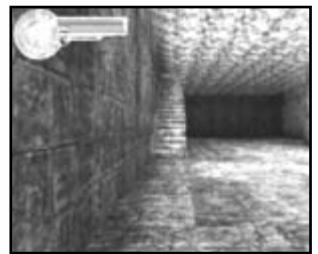

Go straight from the secret door, turning left as you round the tower. Climb up the stairs.



Go to the central tower. Go left down the short flight of stairs and cross the bridge to the next door.



Take the door on your left and follow the stairs down. At the bottom of the stairs, use Serrak's key on the door to your left. Open the chest to find the Ancient Armor.

Note

If you left the Yellow Guide Stone in the Marker on the second level of the central tower in the Ancient City, it's no problem to get back. Go here and walk past the place where you killed the Fadins. If you unlocked the barred gate from the graveyard, drop down the stairs and you're there.





Continue to the end of the hallway. When you open the door, Geneans appear. Cross the poisoned water.

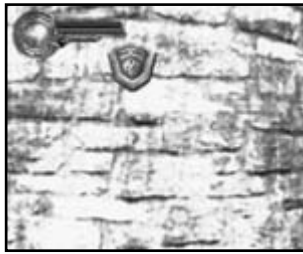

Use the Icon of Water in the hole on the central pillar. This cleans the water outside.

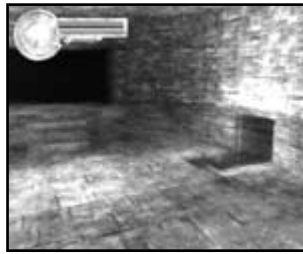

Walk into the water and go right. Explore the first alcove to your left. As you enter, there is an underwater passage. Swim through it and collect the Healing Bracelet.



Walk out and go clockwise. In the next alcove is the largest Genean you've seen. Kill him, and he drops a Water crystal.



Go out and continue clockwise. Skip the next door. In front of the next alcove, get the Jail key from the water.

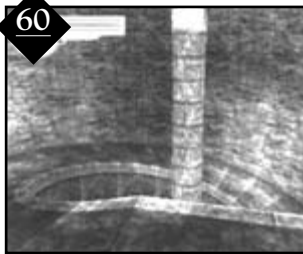

Walk to the door you skipped and go through it. Follow the stairs to the door below. There is a huge ramp leading down.

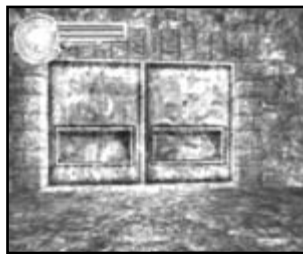

Walk through the door. To your left is another door. Open it with the Jail key and walk inside.



There are Minions inside. Kill the ones you see, and take the left corridor down the short staircase.



The jail cell you pass is gnarled and broken. The next cell is open and contains High Skeletons. Kill them and claim the Chaos Shield.

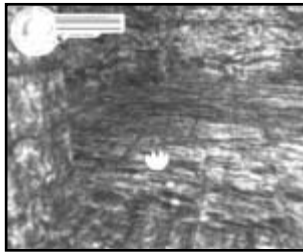

Go to the hallway and go left. Open the next cell and kill the High Skeleton. He drops a dragon flower.



Leave this cell and continue forward. Around the next corner, there's a break in the outside wall.

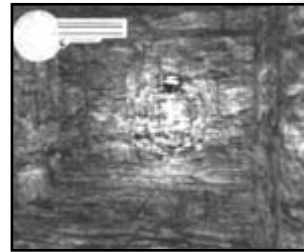

Walk through the doors here and turn right inside to find Lord Myu's Shield. Get it using the Moonlight Sword.



Return to the entrance of the jail. From the door, take the second left and run across the bridge.



Walk on the ledge. There's a secret door in the corner.

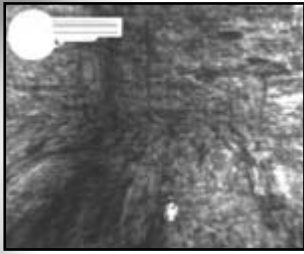

Open the grate beyond the secret door. A horde of Phagos scatters away—catch as many as you can. Claim the Dark crystal on the floor, then return to the ledge.

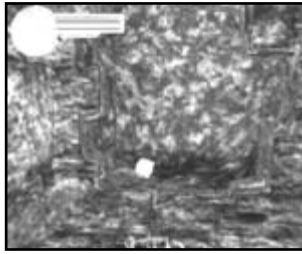

Walk left on the ledge and left through the opening into a new corridor. The High Skeleton in the first cell holds a forest fruit. In the second cell, knock down the back wall to find the Violet Guide Stone.



Leave the cell and walk through the opening on your right. Don't cross the bridge. Instead, follow the ledge past the barricade to the next bridge.



Don't cross this bridge. Go left through the opening and follow the corridor to the door at the end.

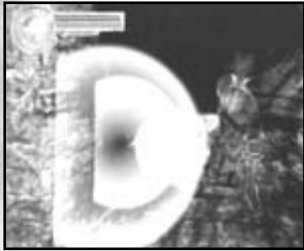

Open the door. Behind it is the Dark Knight; he's a tough customer. Use Light spells to knock him back, and attack with the Moonlight Sword to keep him off balance.



When the Dark Knight dies, he drops the Violet wand. Flip the switch on the back wall and return to the entrance of the jail.

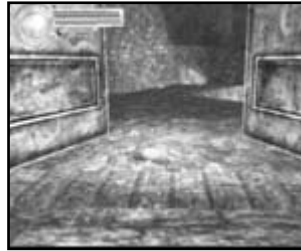

The switch dropped the barriers in front of you. Walk down the corridor to the door at the end. Ahead of you is the Old Battlefield.

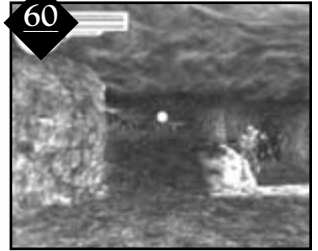

Go forward, fighting the Skeletons as you go. On the hill ahead of you is a Greater Demon.



Kill the Demon. When he dies, he drops a Dark crystal containing the last spell, Dark Matter.



Go down the hill. There's another Greater Demon to fight here.



Walk up the spine of the giant skeleton on the ground in front of you.

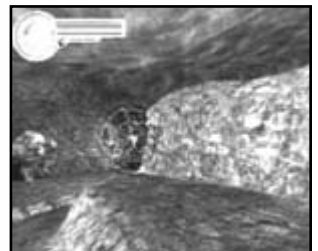

Halfway up, turn left and run onto the small plateau. Use the Moonlight Sword to claim Lord Myu's Armor.



If you wish to go forward, you may. If you'd like to stock up on supplies before your final battle, go through the jail to the Symbol of Passage outside the entrance.

Tip You should have the Green Guide Stone in the central tower on the lowest level, close to the long ramp that leads to the jail and not far from Chad. Visit Harmurah one last time and have him repair your weapons and armor before the final push.



The Final Battles



Continue forward from the giant skeleton through the graveyard. Enter the dark tunnel and move forward.

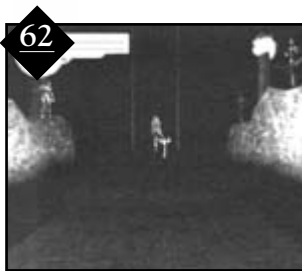

When the tunnel opens, the Dark Succubus and six Dark Archers face you.



Avoid the shots of the Dark Archers. Hit the Succubus, and don't fire at the Archers.

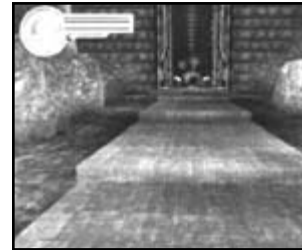

When the Dark Succubus dies, the Dark Archers disappear and the huge doors at the end of this area open.



Walk forward to the Altar of Dark.

Note
After you perform the next step, there's no turning back.



Place the Idol of Sorrow on the Altar of Dark. A spell is invoked, and the Idol is destroyed. This creates a change in the world. You have entered the Dark Reality.

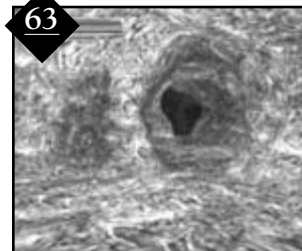

You arrive in a strange cave. The walls and floor are moving as if they were alive.



Walk down the tunnel. Watch out for the Mutant Walls, Floors, and Ceilings that live here.



Go left. The right tunnel is a dead end.



At the next fork, go right. The left fork is another dead end.



The third and final time the path splits, go in either direction. Both lead to the same place, but the right path is shorter.



Leave the cave. Walk forward down the path and keep your eyes open for Lava Birds and Onyxes.

Tip
Kill the Onyxes and Lava Birds when you have to, but don't spend too much time on them. They come back after you kill them.



Continue forward, avoiding the attacks from the Lava Birds.



Cross the bridge and continue forward along the right.



At the end of the path is the Dark One. Now begins the final test.



While you attack the Dark One, the Lava Birds assault you. Don't stand still.



Equip the Moonlight Sword. When you strike the Dark One, you're dropped to a low cavern filled with enemies.



Follow the path out. It leads to where you entered this area.



Spells are useless against the Dark One. Kill him with the Moonlight Sword.



After you strike him a second time and return, move in close for the final blow.

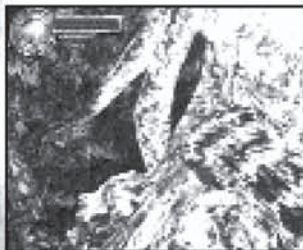

The final strike of the Moonlight Sword ends the reign of the Dark One.



The destruction of both the Dark One and the Idol of Sorrow lifts the curse from the land.



In the Holy Forest, the Forest Golems feel a returning strength.



With the power of the Dark One gone, the land heals.



The damage is great, but the recovery has begun. Things improve across the land.



The power of the forest seals off the Cursed Land.



Your legacy is assured. You will go down in history as the savior of your people and your land.





Item Stats

Weapons

WEAPON	WEIGH	LENGTH	SLASH	HIT	STAB	FIRE	EARTH	WIND	WATER	LIGHT	DARK	NOTES
WOODEN CLUB	4.4	1.9	0	51	0	0	0	0	0	0	0	—
DARKWOOD CLUB	6.6	1.9	0	80	0	0	0	0	0	0	0	darkness enemies
PICKAX	4.4	4.2	0	0	20	0	0	0	0	0	0	—
DWARVEN PICKAX	6.6	4.2	0	50	110	0	0	0	0	0	0	—
SHORT SWORD	2.6	2.6	40	10	30	0	0	0	0	0	0	—
SHORT SWORD	2.6	2.6	41	10	30	0	0	0	0	0	0	—
FIERY SWORD	2.6	2.6	40	9	31	45	0	0	0	0	0	—
RAPIER	2.6	4.5	10	5	68	0	0	0	0	0	0	—
RAPIER	2.6	4.5	10	6	69	0	0	0	0	0	0	—
LETHAL RAPIER	2.6	4.5	6	6	138	0	0	0	0	0	0	—
LONG SWORD	6.1	4.2	60	40	45	0	0	0	0	0	0	—
LONG SWORD	6.1	4.2	61	38	44	0	0	0	0	0	0	—
EARTHBINDER	6.1	4.2	60	40	42	0	30	0	0	0	0	—
KNIGHT SWORD	6.3	4.4	45	24	36	0	0	0	0	0	0	—
KNIGHT SWORD	6.3	4.4	75	38	61	0	0	0	0	0	0	—
KNIGHT SWORD	6.3	4.4	76	40	59	0	0	0	0	0	0	—
HOLYCREST	6.3	4.4	76	39	62	0	0	0	0	0	0	has power to ward off undead/double damage against undead
FROSTBITE	6.3	4.4	76	38	60	0	0	0	40	0	0	HP recover
FOREST CARVER	2.6	1.6	60	21	40	0	0	0	0	0	0	—
FIRE CARVER	2.6	1.6	55	20	41	60	0	0	0	0	0	—
EARTH CARVER	2.6	1.6	55	20	41	0	60	0	0	0	0	—
WIND CARVER	2.6	1.6	55	21	40	0	0	60	0	0	0	—
WATER CARVER	2.6	1.6	55	20	40	0	0	0	60	0	0	—
BROAD SWORD	7.7	4.2	155	80	4	0	0	0	0	0	0	—
BROAD SWORD	7.7	4.2	155	79	4	0	0	0	0	0	0	—
VENOMBLADE	7.7	4.2	154	77	10	0	0	0	0	0	0	poisons enemies
BASTARD SWORD	8.8	5.2	75	55	40	0	0	0	0	0	0	two-handed
BASTARD SWORD	8.8	5.2	75	54	42	0	0	0	0	0	0	two-handed
BATTLE SWORD	8.8	5.2	76	48	42	0	0	0	0	0	0	two-handed, becomes stronger with each swing
DWARVEN SWORD	4.4	5.2	75	56	39	0	0	0	0	0	0	two-handed
GREAT SWORD	9.9	5.4	101	80	32	0	0	0	0	0	0	two-handed
WAR SWORD	16	5.4	121	95	31	0	0	0	0	0	0	two-handed
BROKEN SWORD	1.7	1.9	10	0	0	0	0	0	0	0	0	two-handed
WINDSLAYER	2.8	4.5	135	0	0	0	0	80	0	0	0	two-handed
WAVECRASHER	3	4.5	135	40	72	0	0	50	0	50	0	two-handed



WEAPON	WEIGH	LENGTH	SLASH	HIT	STAB	FIRE	EARTH	WIND	WATER	LIGHT	DARK	NOTES
SCORPION	6.1	5.4	150	42	71	0	0	0	0	0	0	two-handed, poisons victim and user
BLACK SCAR	4.4	4.2	75	53	55	40	0	0	0	0	0	two-handed
TSUNAMI	3.9	4.5	10	20	131	0	0	0	80	0	0	two-handed
CRYSTALLINE BLADE	6.6	4.4	79	58	51	0	0	40	0	0	0	two-handed
EARTHQUAKE	13.4	4.9	0	118	0	0	65	0	0	0	0	two-handed
DARK DEFILER	6.6	3.2	0	92	99	0	0	0	0	0	70	—
QUEEN'S STAFF	1.5	3.9	0	9	0	0	0	0	0	0	0	MP Recover
ANCIENT SWORD	23.1	4.4	75	79	61	12	10	12	11	0	70	—
TRIPLE FANG	3.5	4.9	98	35	76	0	0	0	0	95	0	—
LAWFUL BLADE	2.6	4.5	71	65	66	0	0	0	0	59	0	—
MOONLIGHT SWORD	3	5	105	72	73	0	0	0	0	100	0	HP recover
HAND AX	5.2	2.2	50	60	0	0	0	0	0	0	0	—
HAND AX	5.2	2.2	53	59	0	0	0	0	0	0	0	—
MORNING STAR	5.5	2.2	0	45	48	0	0	0	0	0	0	—
MORNING STAR	5.5	2.2	0	46	47	0	0	0	0	0	0	—
MORNING STAR	5.5	2.2	0	45	46	0	0	0	0	0	0	—
BATTLE HAMMER	9.7	4.2	0	118	0	0	0	0	0	0	0	two-handed
WAR HAMMER	10.1	4.2	0	125	0	0	0	0	0	0	0	two-handed
HAMMER OF WOE	10.3	4.2	0	120	10	0	0	0	0	0	0	two-handed, slows enemy
CRESCENT AX	17.8	6.8	79	76	41	0	0	0	0	0	0	two-handed
CRESCENT AX	17.8	6.8	69	77	40	0	0	0	0	0	0	two-handed
BOW	4.4	3.6	0	0	80	0	0	0	0	0	0	two-handed
LONG BOW	4.4	3.6	0	0	81	0	0	0	0	0	0	two-handed
BLESSED BOW	4.4	3.6	0	0	80	0	0	0	0	70	0	two-handed
CROSSBOW	3.3	1.9	0	0	101	0	0	0	0	0	0	two-handed
CROSSBOW	3.3	1.9	0	0	100	0	0	0	0	0	0	two-handed
WIDDA'S BOW	3.3	3.9	0	0	150	0	0	0	0	30	0	two-handed, uses special arrows

Shields

SHIELD	WEIGH	SLASH	HIT	STAB	FIRE	EARTH	WIND	WATER	LIGHT	DARK	NOTES
WOODEN SHIELD	1.9	2	4	2	0	0	0	0	0	0	—
FOREST SHIELD	2.2	2	4	2	0	10	10	10	10	10	—
LEATHER SHIELD	2.8	8	8	3	0	0	0	0	0	0	—
LEATHER SHIELD	2.8	5	10	5	0	0	0	0	0	0	—
LEATHER SHIELD	3	8	7	3	2	2	2	2	2	2	—
BUCKLER	3.3	6	9	8	0	0	0	0	0	0	—
BUCKLER	4.4	6	6	12	0	0	0	0	0	0	—
BUCKLER	2.2	10	9	4	0	0	0	0	0	0	—
KNIGHT SHIELD	5	11	9	7	0	0	0	0	0	0	—



SHIELD	WEIGH	SLASH	HIT	STAB	FIRE	EARTH	WIND	WATER	LIGHT	DARK	NOTES
KNIGHT SHIELD	5	11	7	10	0	0	0	0	0	0	—
EARTHEN SHIELD	5.9	12	10	15	0	30	0	0	0	0	—
CRUSADER SHIELD	5	8	7	11	5	5	5	5	5	5	—
KITE SHIELD	6.1	12	13	17	0	0	0	0	0	0	—
KITE SHIELD	7	14	17	10	0	0	0	0	0	0	—
KITE SHIELD	6.6	12	16	18	0	0	0	0	0	0	—
TOWER SHIELD	7.7	13	14	19	0	0	0	0	0	0	—
TOWER SHIELD	8.1	10	16	25	0	0	0	0	0	0	—
TOWER SHIELD	7.2	13	14	18	0	0	0	0	0	0	—
BLESSED SHIELD	7	14	18	28	0	0	0	0	28	0	—
CRYSTAL SHIELD	14.9	15	21	33	5	5	0	0	0	0	—
FLAME SHIELD	12.3	12	13	11	20	0	0	0	0	0	—
GUARDIAN SHIELD	8.8	10	12	9	40	40	40	40	40	40	—
CHAOS SHIELD	13.2	20	24	16	0	0	0	0	0	50	—
MAMMOTH SHIELD	55.3	16	62	29	0	0	0	0	0	0	—
ANCIENT SHIELD	27.5	15	25	33	0	0	0	0	0	0	—
LORD MYU'S SHIELD	5.7	16	25	35	25	25	25	25	25	25	—

Headgear

HELM	WEIGH	SLASH	HIT	STAB	FIRE	EARTH	WIND	WATER	LIGHT	DARK	NOTES
LEATHER HELM	2.8	7	2	1	0	0	0	0	0	0	—
LEATHER HELM	3	7	0	5	0	0	0	0	0	0	—
IRON HELMET	5.5	7	5	2	0	0	0	0	0	0	—
IRON HELMET	5.5	6	5	1	0	0	0	0	0	0	—
WAR HELM	5.7	11	5	1	0	0	0	0	0	0	—
WAR HELM	3.7	13	1	2	0	0	0	0	0	0	—
PLATE HELM	5.9	9	4	2	0	0	0	0	0	0	—
PLATE HELM	5.5	9	5	2	0	0	0	0	0	0	—
KNIGHT HELM	4.8	14	10	4	0	0	0	0	0	0	—
KNIGHT HELM	5	14	11	4	0	0	0	0	0	0	—
CRUSADER HELM	5.9	15	7	8	0	0	0	0	0	0	—
CRUSADER HELM	5.9	16	8	7	0	0	0	0	0	0	—
CAVALIER HELM	5.9	16	10	5	0	0	0	0	3	0	—
GREAT HELM	6.3	22	15	5	0	0	0	0	0	0	—
GREAT HELM	6.3	18	15	12	0	0	0	0	0	0	—
CHAMPION HELM	6.6	20	17	11	0	0	0	0	0	0	—
BLESSED HELM	6.1	23	20	18	0	0	0	0	20	0	—
ANGELIC CROWN	3	5	2	2	0	0	0	0	12	0	MP increase
SHADOW MASK	7.4	26	20	23	0	0	0	0	0	30	darkness player
SACRIFICIAL MASK	11	16	13	11	0	0	0	0	0	0	napalm is cast at random
KING'S CROWN	3.3	10	4	4	0	0	0	0	0	0	increases magic power, HP recover
CRYSTAL HELM	7.9	27	24	22	1	1	0	0	0	0	—
ANCIENT HELMET	16.5	30	26	22	0	0	0	0	0	0	—
LORD MYU'S HELMET	3.3	32	26	26	0	0	0	0	20	20	—

Armor

ARMOR	WEIGH	SLASH	HIT	STAB	FIRE	EARTH	WIND	WATER	LIGHT	DARK	NOTES
LEATHER VEST	8.8	4	1	6	0	0	0	0	0	0	—
LEATHER VEST	8.8	7	2	4	0	0	0	0	0	0	—
LEATHER ARMOR	11.4	8	4	8	0	0	0	0	0	0	—
LEATHER ARMOR	12.1	9	3	8	15	15	15	15	5	5	—
IRON BREASTPLATE	15.8	10	6	4	0	0	0	0	0	0	—
IRON BREASTPLATE	17.1	12	6	2	0	0	0	0	0	0	—
CHAIN MAIL	18	15	7	1	0	0	0	0	0	0	—
SCALE MAIL	17.4	14	7	10	0	0	0	0	0	0	—
SCALE MAIL	13.6	9	4	6	0	0	0	0	0	0	—
SCALE MAIL	18	12	15	7	0	0	0	50	0	0	—
KNIGHT PLATE	20.2	17	15	10	0	0	0	0	0	0	—
KNIGHT PLATE	20.5	17	9	17	0	0	0	0	0	0	—
CRUSADER PLATE	22.2	18	15	13	0	0	0	0	0	0	—
CAVALIER PLATE	20.5	10	8	8	0	0	0	0	0	0	—
SCARED PLATE	20.2	23	16	19	0	32	0	0	0	0	—
BLESSED ARMOR	19.8	26	18	21	0	0	0	0	12	0	—
ENCHANTED ARMOR	17.6	25	20	21	0	0	0	0	12	0	—
ICE ARMOR	19.1	28	23	23	0	0	30	0	0	0	forbids use of fire magic
FIRE MAIL	18.7	24	11	22	30	0	0	0	0	0	—
DEMON ARMOR	25.3	39	1	29	0	0	0	0	0	50	stats recover slower
CRYSTAL ARMOR	21.6	35	28	31	2	2	0	0	0	0	—
ANCIENT ARMOR	39	35	30	33	0	0	0	0	0	0	—
LORD MYU'S ARMOR	13.6	38	31	35	0	0	0	0	0	0	stats recover faster

Gauntlets and Gloves

GLOVES	WEIGH	SLASH	HIT	STAB	FIRE	EARTH	WIND	WATER	LIGHT	DARK	NOTES
LEATHER GLOVES	2.4	3	3	1	0	0	0	0	0	0	—
LEATHER GLOVES	2.2	4	2	1	0	0	0	0	0	0	—
LEATHER GLOVES	2.6	2	2	5	0	0	0	0	0	0	—
ARM GUARD	3.3	6	5	3	0	0	0	0	0	0	—
ARM GUARD	3	5	6	3	0	0	0	0	0	0	—
ARM GUARD	3.5	6	4	6	0	0	0	0	0	0	—
GAUNTLETS	6.1	7	6	8	0	0	0	0	0	0	—
GAUNTLETS	6.3	7	7	5	0	0	0	0	0	0	—
GAUNTLETS	5.9	6	9	9	0	0	0	0	0	0	—
GAUNTLETS	3.3	8	9	9	0	0	0	0	0	0	—
BLESSED GLOVES	5.7	8	15	6	0	0	0	0	10	0	—
BLESSED GLOVES	5.9	10	13	6	0	0	0	0	10	0	lowers weapon's weight
SACRED GLOVES	6.1	9	15	6	0	0	0	0	10	0	—
BONE HANDS	4.4	25	12	12	0	0	0	0	0	20	increases weapon's weight, HP decrease, HP increase



GLOVES	WEIGH	SLASH	HIT	STAB	FIRE	EARTH	WIND	WATER	LIGHT	DARK	NOTES
KNIGHT GLOVES	7	15	18	16	0	0	0	0	0	0	—
CRUSADER GLOVES	7	10	19	22	0	0	0	0	0	0	—
CAVALIER GLOVES	7.9	14	22	19	0	0	0	0	0	0	—
BLESSED ARMS	6.3	18	26	20	0	0	0	0	10	0	—
SILVERY GLOVES	5.9	8	10	10	0	0	0	0	0	0	attack power increase
VENOM GLOVES	1.7	4	3	6	0	0	0	0	0	0	add poison attack to weapon
CRYSTAL ARMS	8.3	20	34	25	1	2	0	0	0	0	—
ANCIENT GLOVES	15.2	23	34	26	0	0	0	0	0	0	—
LORD MYU'S GLOVES	4.6	28	35	26	0	0	0	0	10	10	lowers weapon's weight

Boots and Greaves

BOOTS	WEIGH	SLASH	HIT	STAB	FIRE	EARTH	WIND	WATER	LIGHT	DARK	NOTES
WOODEN SHOES	1.7	1	4	1	0	0	0	0	0	0	lowers Fire defensive
FOREST SHOES	1.9	1	4	1	0	5	5	5	5	5	lowers Fire defensive
LEATHER BOOTS	2.6	2	2	5	0	0	0	0	0	0	—
LEATHER BOOTS	2.8	2	1	6	0	0	0	0	0	0	—
LEATHER BOOTS	2.8	3	2	5	0	0	0	0	0	0	—
IRON BOOTS	6.8	7	4	5	0	0	0	0	0	0	—
IRON BOOTS	6.8	7	5	6	0	0	0	0	0	0	—
IRON BOOTS	6.6	8	7	3	0	0	0	0	0	0	—
PLATE BOOTS	4.4	8	7	7	0	0	0	0	0	0	—
IRON BOOTS	4.6	8	8	7	0	0	0	0	0	0	—
LEG GUARDS	5.5	11	5	12	0	0	0	0	0	0	—
LEG GUARDS	5.2	12	6	13	0	0	0	0	0	0	—
MYSTIC GUARDS	5.5	12	5	10	1	10	10	10	2	2	—
KNIGHT GREAVES	6.1	15	10	11	0	0	0	0	0	0	—
KNIGHT GREAVES	6.1	15	10	13	0	0	0	0	0	0	—
KNIGHT GREAVES	6.1	11	8	6	0	0	0	0	0	0	—
CAVALIER GREAVES	7	17	14	15	0	0	0	0	0	0	—
CRUSADER GREAVES	7.4	20	16	10	0	0	0	0	0	0	—
BLESSED GREAVES	6.6	22	16	17	0	0	0	0	10	0	—
ABSORPTION BOOTS	4.4	20	4	17	0	0	10	0	0	0	lessens falling damage; increases recover time from falling
DEMON LEGS	11.4	25	25	10	0	0	0	0	0	30	lowers speed; decreases movement
CRYSTAL GREAVES	9.2	25	18	24	1	2	0	0	0	0	—
ANCIENT GREAVES	17.1	28	19	24	0	0	0	0	0	0	—
LORD MYU'S GREAVES	8.8	29	21	24	0	0	0	0	10	10	—

Rings

RING	WEIGH	SLASH	HIT	STAB	FIRE	EARTH	WIND	WATER	LIGHT	DARK	NOTES
RING OF SIGHT	0.2	0	0	0	0	0	0	0	0	0	illuminates dark areas
RING OF WISDOM	0.4	0	0	0	0	0	0	0	0	0	increases magic power



RING	WEIGH	SLASH	HIT	STAB	FIRE	EARTH	WIND	WATER	LIGHT	DARK	NOTES
WIDDA'S RING	0.4	0	0	0	0	0	0	0	0	0	increases hit points
RING OF FIRE	0.2	0	0	0	20	0	0	0	0	0	increase Fire attribute
RING OF EARTH	0.2	0	0	0	0	20	0	0	0	0	increase Earth attribute
RING OF WIND	0.2	0	0	0	0	0	20	0	0	0	increase Wind attribute
RING OF WATER	0.2	0	0	0	0	0	0	20	0	0	increase Water attribute

Bracelets

BRACELET	WEIGH	SLASH	HIT	STAB	FIRE	EARTH	WIND	WATER	LIGHT	DARK	NOTES
CLARITY BRACELET	0.4	0	0	0	0	0	0	0	0	0	increases magic power
WIDDA'S BRACELET	0.4	0	0	0	0	0	0	0	0	0	defense against paralysis, decreases magic power
POWER BRACELET	1.1	0	0	0	0	0	0	0	0	0	increases attack power
FEATHER BRACELET	0.2	0	0	0	0	0	0	0	0	0	lowers weapon's weight, power gauge recovery increase
GUARDIAN BRACELET	0.6	0	0	0	0	0	0	0	0	0	helps maintain normal status
SPIDER ARMBAND	0.2	0	0	0	0	0	0	0	0	0	protection against poison
FORTUNE	0.4	0	0	0	0	0	0	0	0	0	doubles all experience earned

Necklaces

NECKLACE	WEIGH	SLASH	HIT	STAB	FIRE	EARTH	WIND	WATER	LIGHT	DARK	NOTES
LUCKY PENDANT	0.2	5	5	5	0	0	0	0	0	0	increases melee defense
WIDDA'S NECKLACE	0.2	0	0	0	4	4	4	4	6	6	protection against all elements
HEALING AMULET	0.2	0	0	0	0	0	0	0	0	0	heals injuries over time
WATER TALISMAN	0.2	0	0	0	0	0	0	0	0	0	aids in breathing underwater
PURITY AMULET	0.4	0	0	0	0	0	0	0	0	0	increases resistance to poison, etc.
THIEVES NECKLACE	0.2	0	0	0	0	0	3	3	0	0	makes wearer less detectable
MYU'S NECKLACE	0.4	0	0	0	0	0	0	0	0	0	reveals all hidden and secret doors



Creature Stats

CREATURE	HIT POINTS	EXPERIENCE	VULNERABLE TO	STRONG AGAINST	SPECIAL ATTACKS	DROPS
ACID CRAWLER (SMALL)	1,200	150	None	None	Acid	Gold
ACID CRAWLER (LARGE)	2,000	300	None	None	Acid	Gold
ANCIENT KING	10,000	2,000	None	All Elements but Light	Lightning Bolt, Thunder Bolt	—
AQUA LIZARD	1,500	200	None	None	Water Shot	Gold
BEETLE (SMALL)	105	10	None	None	Jump Attack	Gold, 5% Herb
BEETLE (MEDIUM-SIZED)	250	10	Hit	None	Jump Attack	Gold
BEETLE (WHITE)	500	20	Hit, Fire	Slash, Stab, Immune to Wind	Ice Breath, Jump Attack,	Gold
BEETLE (LARGE)	510	10	None	Hit	Jump Attack	Gold
BEETLE (VERY LARGE)	600	25	Hit	Slash, Stab	Jump Attack	Gold
BEETLE (GIANT)	6,000	400	Hit	All but Hit, Immune to Earth	Stone Attack	Gold
BLOOD BAT	54	5	None	None	None	Gold
CRITTER	750	40	None	None	Jump Attack, Dash Attack	Gold, 5% Blessed Gloves
CROW	20	1	None	None	None	Gold
DARK ARCHER	3,000	800	Light	Dark	Arrow	—
DARK BIRD	600	200	None	Dark	Fireball, Wind Cutter	Gold, 50% Kite Shield
DARK FLOWER	500	150	None	None	Seed Bomb	50% Forest Root
DARK KNIGHT	15,000	2,000	Light	All but Light and Hit	Wind Slash, Shock Wave, Eclipse	Violet Guide Stone
DARK PUPPET	1,200	80	Light	All Elements but Light	Dark Aura	Gold
DARK SOLDIER	3,800	400	None	None	None	Gold, 15% Claw, 10% Herbal Liquid
DARK SORCERER	8,000	800	None	All Elements but Light	Shock Wave, Spear Trap, Dark Protrusion, Homing Arrow	—
DARK SUCCUBUS	11,000	200	None	All Elements but Light	Lightning	—
DRAGON FLY	550	20	None	None	None	Gold
EARTH KING	4,500	700	None	All Elements but Fire	Ice Breath, Shock Wave	Icon of Ice
ELEMENTAL, EARTH	900	60	Wind	Earth, Water	Dark Breath, Impulse	Gold, 30% Claw
ELEMENTAL, FIRE	900	65	Water	Fire, Wind	Dark Breath, Fireball	Gold, 30% Claw

CREATURE	HIT POINTS	EXPERIENCE	VULNERABLE TO	STRONG AGAINST	SPECIAL ATTACKS	DROPS
ELEMENTAL, WATER	1,500	75	Earth	Fire, Water	Bubble, Water Shot	Gold, 30% Claw, 30% Herbal Liquid
ELEMENTAL, WIND	700	60	Fire	Earth, Wind	Tornado	Gold, 30% Claw
EXPEDITION ARCHER	200	35	None	None	Arrow	Gold, 40% Arrow
EXPEDITION SOLDIER	540	35	None	None	None	Gold
FADIN	500	50	Hit	Fire	Fire Arrow	—
FADIN, MASTER	600	500	Hit	Fire	Fire Arrow	—
FIRE GENIE	4,000	700	None	All Elements but Water (Immune to Fire)	Throw Lava	—
FIRE LORD	6,000	1,000	None	Fire (Immune), Earth, Wind, Light, Dark	Flame Ball	Fire Mail
GENEAN	2,400	40	Slash	None	None	—
GIANT (WITH CLUB)	3,000	800	None	None	Shock Wave	Gold, 15% Darkwood Club
GIANT (WITHOUT CLUB)	3,000	500	None	None	Poison	Gold
GIANT LEADER	8,000	2,000	None	All Elements but Light	Shock Wave	Serrak's Key
GOLDEN STATUE	3,000	200	None	None	Plasma	Gold
GREATER DEMON	5,500	100	None	All Elements but Light	Darkness Bomb, Freeze Breath	50% Claw
HIGH SKELETON (SMALL)	800	70	Hit, Light	Stab	None	Gold, 30% Bone
HIGH SKELETON (LARGE)	1,200	100	Hit, Light	Stab	None	Gold
HIGH SKELETON (WITH SHIELD)	800	190	Hit, Fire, Earth	Stab	None	Gold, 35% Bone
ICE GOLEM	1,600	63	Fire, Hit	Slash, Stab, Immune to Wind	None	Gold
LARVA	205	5	Water, Light	Immune to Fire	Fireball	—
LAVA BIRD	3,200	500	Light	Fire, Dark	Death Bomb	—
LAVA FACE	200	500	Hit	Immune to All but Hit	None	—
LAVA LIZARD	3,000	68	Water	Fire (Immune)	Flame Breath	Gold
LEE MAYNOR	330	30	Fire	None	None	Gold
LIVING ARMOR	1,800	65	All Elements	Hit, Immune to Slash and Stab	Shock Wave	Gold, 25% Knight Gloves
LIVING DEAD	210	15	Fire	None	Poison Puke	Gold
LIVING STATUE	1,100	100	Hit	All Elements	Ice Attack	—
MAKARA	1,400	250	None	Water	Mist	—
MALICE	1,300	100	Light	Dark	Dark Breath, Fireball	Gold
MANEATER	91	9	None	None	None	Gold, 20% Herb
MINION	1,800	500	Water	Fire	Jump Attack, Flame Breath	Gold
MUMMY	4,000	250	Fire, Light	None	None	Gold
MUMMY, ANCIENT	1,800	300	Fire, Light	None	Curse, Energy Bolt	Gold
MUTANT CEILING	2,500	400	Light	Dark	Breath	—
MUTANT FLOOR	5,000	200	Light	None	None	—
MUTANT WALL	2,000	400	Light	Dark	Breath	—
ONYX	4,500	500	Light	Hit, Stab, Dark	Dark Breath	—



CREATURE	HIT POINTS	EXPERIENCE	VULNERABLE TO	STRONG AGAINST	SPECIAL ATTACKS	DROPS
PHAGOS	1	100	None	None	Dash	Gold
REAPER	300	20	None	Dark	Root Attack	Gold, 30% Forest Shoes, 80% Forest Shield
SALAMANDER	550	70	Water	Fire	Fire Breath, Fire Ball	Gold
SCORPION	1,000	70	Hir, Strab	None	Poison	Gold
SEA FANG	600	30	None	None	None	Gold
SENTINEL	4,500	1,000	—	Slash, Light	Shock Wave	Gold
SKELETON (UNARMED)	110	12	Hir	Strab	None	Gold
SKELETON (SWORD AND ROUND SHIELD)	250	19	Hir	Strab	None	Gold, 20% Bone, 5% Buckler
SKELETON (SWORD AND SQUARE SHIELD)	340	19	Hir	Strab	None	Gold, 20% Bone
SKELETON (AXE AND SHIELD)	250	19	Hir	Strab	None	Gold, 20% Bone
SKELETON ARCHER (SMALL)	150	19	Hir	Strab	Arrow	Gold, 20% Bone
SKELETON ARCHER (LARGE)	310	1	Hir	Strab	Arrow	5% Bone
SKULL	4,000	700	Light	None	Body Check, Dark Breath	1% Dark Defiler
SLASHER	550	63	None	None	None	Gold
SLIME, GREEN	60	4	None	Slash	Abolish Poison	Gold
SLIME, POISON	60	6	None	Slash	Poison	Gold
SNAKE	200	10	None	None	None	—
SPIDER (SMALL)	100	15	Fire	None	Jump Attack	Gold
SPIDER (BLUE)	2,500	350	None	None	Web	Gold
SPIDER BOSS	700	200	None	Earth, Wind, Water, Light, Dark	Web	Water Crystal
STONE GUARDIAN	2,000	10	None	All but Strab	None	—
STOOL	140	12	None	None	Poison	Gold
STOOL, PARA	200	20	None	None	Paralyze	—
SOL	1,200	100	Earth	Water	Bubble	Gold
WATCHER	1,000	10	Hir	None	Magic Drain	—
WIDDA	1,000	90	None	None	None	Gold, 30% Scale, 30% Leather Boots
WIDDA (LARGE)	1,600	350	Light	None	None	Gold, 35% Scale
WIDDA ARCHER (LARGE)	1,200	300	Light	None	Arrow	Gold, 40% Scale, 50% Widda Arrow
WIDDA ARCHER (SMALL)	900	90	None	None	Arrow	Gold, 50% Scale, 40% Widda Arrow
WIDDA QUEEN	7,000	1,500	None	All Elements but Dark	Poison, Lightning Ball	—
WIDDAONA	3,000	1,000	None	Fire, Earth, Water, Light, Dark	Poison	—
ZOMBIE	4,000	250	Fire, Light	None	None	Gold, 30% Gauntlet, 40% Dried Amphibia

