

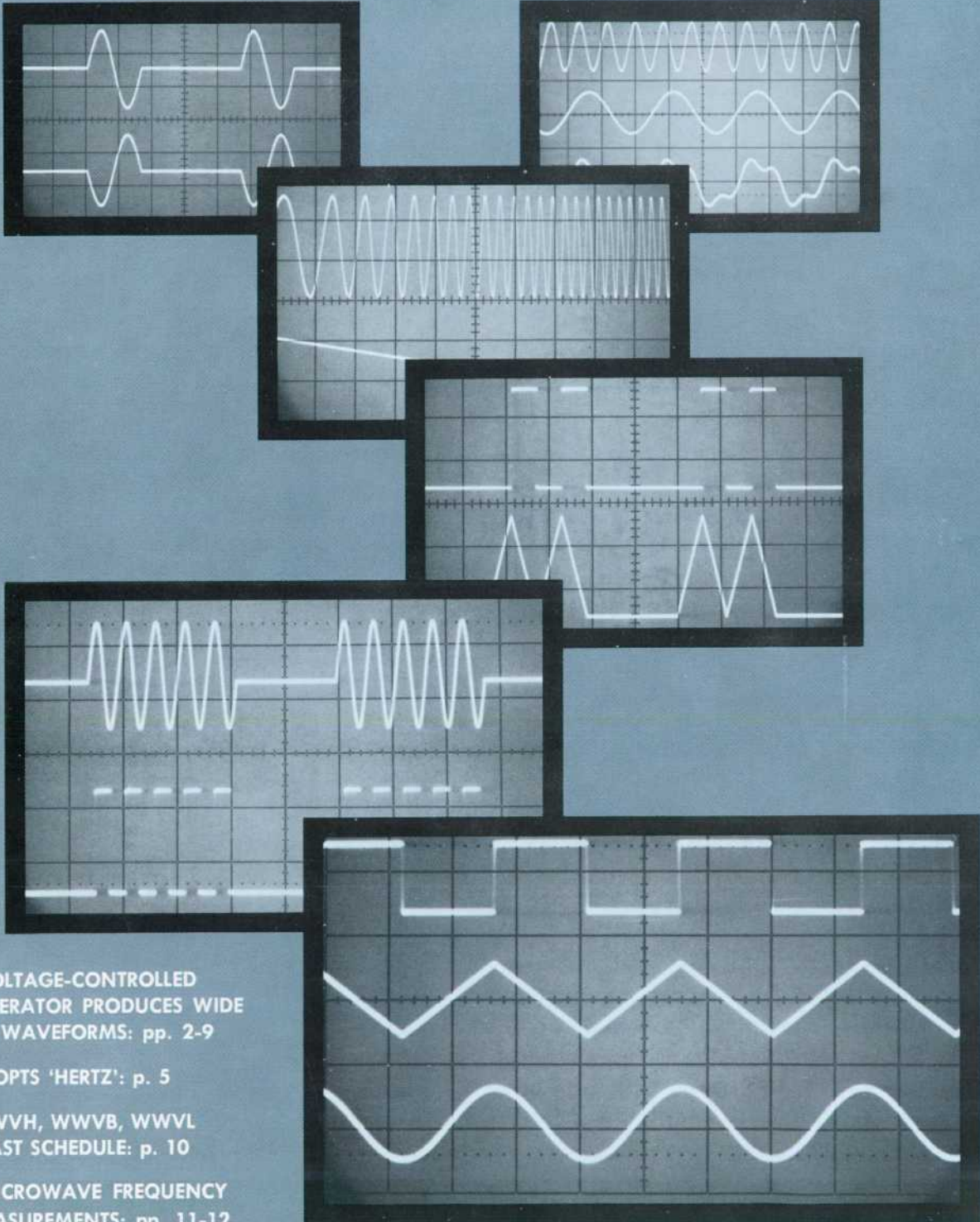

# HEWLETT-PACKARD JOURNAL

TECHNICAL INFORMATION FROM THE -hp- LABORATORIES

CORPORATE OFFICES • 1501 PAGE MILL ROAD • PALO ALTO, CALIFORNIA 94304 • VOL. 17, NO. 3 NOVEMBER, 1965



COVER: VOLTAGE-CONTROLLED  
FUNCTION GENERATOR PRODUCES WIDE  
VARIETY OF WAVEFORMS: pp. 2-9

IEEE ADOPTS 'HERTZ': p. 5

WWV, WWVH, WWVB, WWVL  
BROADCAST SCHEDULE: p. 10

PRECISION MICROWAVE FREQUENCY  
STABILITY MEASUREMENTS: pp. 11-12

# A VOLTAGE-PROGRAMMABLE LOW-FREQUENCY FUNCTION GENERATOR WITH PLUG-IN VERSATILITY

A new generator produces sine, square, and triangular signals as low as 0.01 hertz either unmodulated or with various modulations.

SOME fifteen years ago, engineers at Hewlett-Packard designed a Low Frequency Function Generator which overcame bothersome characteristics that had troubled previous low-frequency generators, i.e., frequency drift, and long-term amplitude instability following a change in frequency. By means of a circuit approach that differed considerably from established oscillator designs, this generator (*-hp-* Model 202A) was able to have a frequency range that extended to as low as 0.008 Hz (c/s), and it had excellent stability and was capable of rapid changes in frequency.<sup>1</sup> This instrument has found wide use as a real-time stimulus for process control systems, in the simulation of mechanical phenomena, and in medical, geophysical, and servo instrumentation testing.

Over the years, however, there have been many requests for special versions of this instrument. These requests included provisions for programmability, automatic frequency sweep, output gat-

<sup>1</sup> R. H. Brunner, "A New Generator of Frequencies Down to 0.01 CPS," *Hewlett-Packard Journal*, Vol. 2, No. 10, July, 1951.

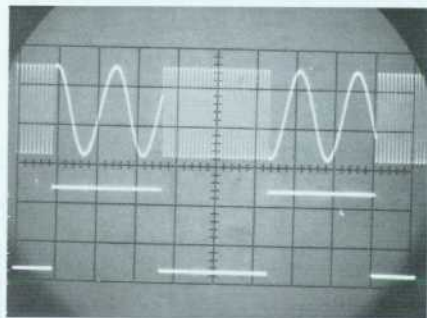

Fig. 2. Response of frequency-control circuits to changes in control voltage is shown by oscillogram displaying output of Function Generator on 'X10K' range changing frequency over more than 10-to-1 range (upper trace) as Frequency Control input is driven by 10-volt square wave having 0.2  $\mu$ s risetime (lower trace). At each transition in square wave, Function Generator changes frequency without requiring settling-down period.

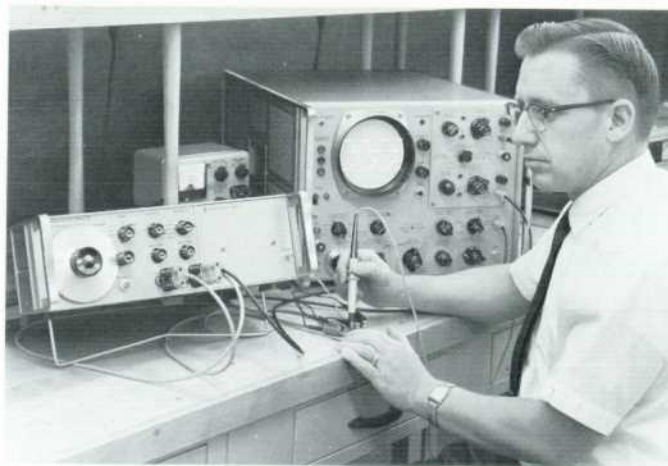

Fig. 1. New *-hp-* Model 3300A Function Generator has two independent outputs, each of which supplies any of three waveforms, sine, square, or triangular, throughout 0.01 Hz to 100 kHz frequency range. Plug-in capability enables Generator to be adapted for a wide variety of special applications (see text). Generator serves here as low-frequency trigger generator for breadboarded sawtooth generator.

ting, and ability to be phase-locked with another source of low frequency waveforms. In addition, there were requests for modifications that would permit the instrument to supply but one cycle of a waveform, starting from an arbitrarily selected part of the cycle and finishing at the same point.

## THE PLUG-IN FUNCTION GENERATOR

Now, a new Function Generator has been designed in the *-hp-* Loveland Laboratories with plug-in capability that enables it to be adapted for special applications. The basic instrument supplies sine, square, and triangular waves throughout a frequency range of 0.01 Hz to 100 kHz in seven decade ranges. With the Trigger/Phase-Lock plug-in, described on pages 6 through 9, the new Function Generator (*-hp-* Model 3300A) can also function as a tone-burst generator, as a low-frequency pulse generator with or without pulse-width modulation, as a frequency multiplier, and as a phase-locked oscil-

lator with variable phase control, as well as having many other special capabilities.

Additional flexibility of operation is made possible by the provision for electronic frequency control in the new generator. The frequency may be controlled throughout any of the decade frequency ranges by an externally-supplied voltage applied through a rear-panel connector. The output frequency may thus be programmed, when used in automatic systems, or it may be swept or frequency-modulated by remote control. The voltage-to-frequency transfer function is linear within 1% and the transient response of the frequency control circuits is exceptionally good (see Fig. 2).

Among other useful features, the instrument has two output stages supplying two separate waveforms for use in analog computers or other multiple waveform systems. Either output supplies any one of the three waveforms (sine, square, or triangular) independ-

ently of the other output and with amplitudes up to 35 volts peak-to-peak into an open circuit or 15 volts into 600 ohms. Both outputs are short-circuit proof and may be terminated in any impedance with very little deterioration in the output signal (nominal output impedance is 600 ohms).

Each output is de-coupled and has a separate, individually adjustable, 40-dB attenuator. In addition, one output may be switched to supply an inverted version of the waveform appearing at the other output, enabling the instrument to supply push-pull signals balanced to ground on any of the waveforms at any frequency. Loading of one output has no effect on the other.

**BASIC OPERATION**

A block diagram of the new Function Generator is shown in Fig. 4. The heart of the generator is the Triangle Integrator which generates a triangular waveform as the Integrator capacitance is alternately charged and discharged through constant current sources.

In tracing the sequence of events that sustain oscillations, assume that the Integrator output has just passed the peak of the triangular waveform. The Integrator output is then a negative-going voltage ramp, a result of the charging current  $i$  supplied to capacitor  $C$  by the Upper Current Source. At the same time, however, the Upper Current Source also supplies an equal current to the Lower Current Source.

The ramp continues linearly until it arrives at a fixed voltage level that trig-

gers the Voltage Comparator Multivibrator, which in turn shuts off the Upper Current Source. The Lower Current Source continues to draw a current  $i$ , but this current is now supplied by the discharge of capacitor  $C$ . The Integrator output thus becomes a positive-going ramp, which continues until reaching a voltage level that resets the Voltage Comparator. The Upper Current Source thus is turned on once more. Oscillations are therefore self-sustaining at a frequency determined by the ramp slope and by the voltage difference between the two triggering levels.

The upper and lower triggering levels remain fixed so that a change in frequency, by a change of ramp slope, does not affect waveform amplitude. The ramp slope is determined by the size of capacitance  $C$  and by the amount of current flow. The voltage at the input to the Current Control,

supplied either by a potentiometer attached to the FREQUENCY dial or by an external source, determines the current flow and hence the frequency of oscillation within a decade range. Range-changing is accomplished by switching the value of capacitor  $C$ .

The Current Control circuit establishes the current flow through both the Upper and Lower Current Sources such that the current through the Upper Source is always twice that through the Lower Source. The current flow into the Integrator during one half of the waveform cycle is thus equal to the current flow out of the Integrator during the other half of the cycle, assuring waveform symmetry. Switching only one current control device requires less circuitry and also avoids the transients that would result if both were switched simultaneously.

The frequency is controlled throughout a decade frequency range by a volt-



Fig. 3. New -hp- Model 3300A Low Frequency Function Generator, shown here with Trigger/Phase-Lock Plug-in, is voltage-programmable through rear panel connector. Separate outputs supply any two of available waveforms (sine, square, triangle) or may be used together in balanced push-pull configuration.

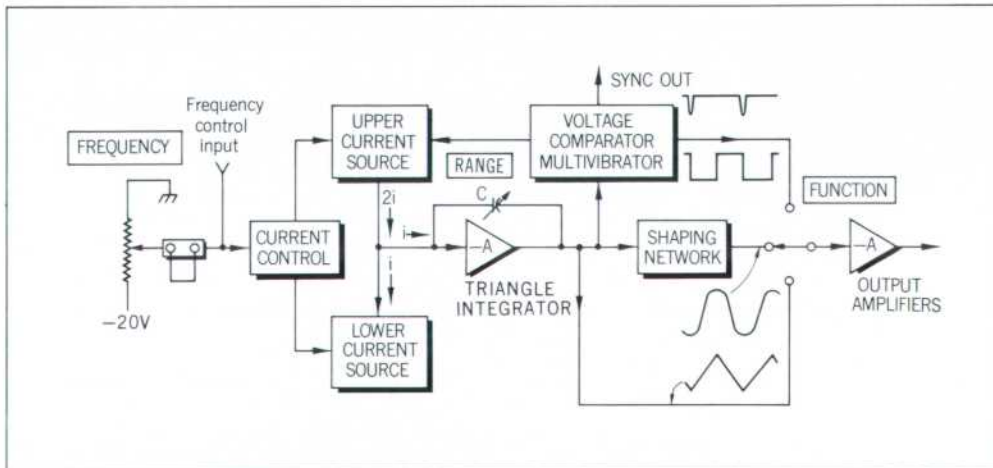

Fig. 4. Basic circuitry of Model 3300A Function Generator. Shorting bar on rear panel is removed to disconnect FREQUENCY dial and allow use of external frequency control voltage.

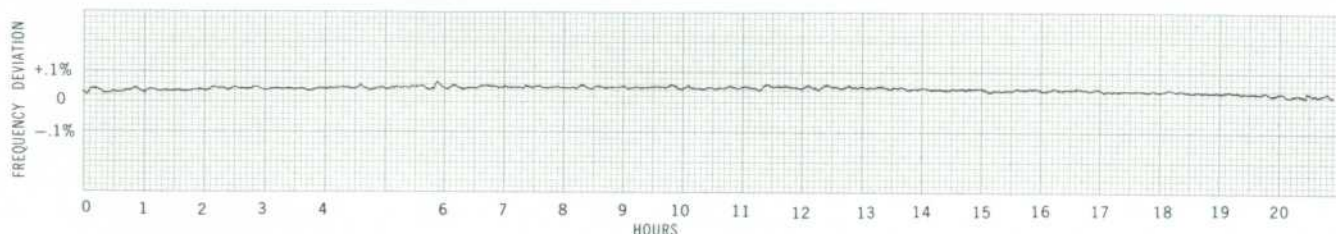

Fig. 5. Long-term frequency stability is shown by 20-hour recording of Function Generator operating at 1 kHz at low end of 'X1K' range.

age ranging from 0 to  $-10$  volts. The voltage-to-frequency transfer function is linear within 1%, enabling programming accuracy, lower FM envelope distortion, and linear frequency sweeps. When the output frequency is under control of the front-panel FREQUENCY dial, the accuracy of setting is within  $\pm 1\%$  (of maximum dial setting) to 10 kHz (2% to 100 kHz).

Because of the susceptibility of transistor performance to changes in temperature, the current control circuitry is mounted in an oven maintained at a constant temperature. Long-term frequency stability of better than 0.1% is thus obtained (see Fig. 5).

#### SINE-WAVE GENERATION

The basic circuit provides both square and triangular waves. Sine waves are synthesized from the triangular waves by the shaping network, a non-linear diode-resistance network that changes impedance as the wave-

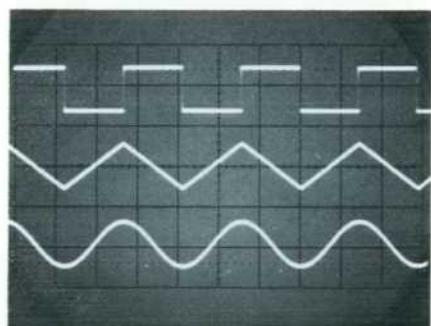

Fig. 6. Multiple exposure oscillogram shows high quality of waveforms produced by new Function Generator. Sine wave distortion is less than 1% from 0.01 Hz to 10 kHz and no more than 3% up to 100 kHz. Square wave rise and fall times are better than  $0.25 \mu\text{s}$  with less than 5% overshoot and 1% sag. Triangular waveform is linear within 1% from 0.01 Hz to 50 kHz and within 2% to 100 kHz. Any two waveforms are available simultaneously. Sync pulse, coincident with triangular and sine wave crests, is available from rear-panel connector.

form voltage level changes (see Fig. 7). The non-linear network progressively reduces the slope of the triangular waveform, achieving a sine wave with less than 1% distortion.

The heavy use of feedback in the amplifiers and in the power supplies insures a constancy of waveform amplitude, the sine wave frequency response being within 1% up to 10 kHz, and within  $\pm 2\%$  up to 100 kHz. The dc component in the output waveform is less than 0.5% of the peak-to-peak waveform voltage and dc drift is considerably less than 0.5% per day.

#### GROUNDING SYSTEM

The new instrument has a flexible grounding system which allows it to be used with dc voltage offsets while the cabinet remains at ground potential. An isolated connection is also provided for internal shielding that allows the generator to be used with guarded and floating systems. To permit these grounding arrangements, the new Low Frequency Function Generator has four independent electrical grounds.

These are:

1. Circuit ground.
2. Output ground, connected to the ground terminal of all output connectors, which are insulated from both the cabinet and circuit grounds.
3. Shield ground, which is connected to an isolated internal enclosure that contains the circuitry.
4. Power line ground, connected to the outer cabinet and the grounding lead in the power cord.

Normally, all the grounds are connected together on a rear panel connector strip. A dc offset voltage is applied to the output waveform, without floating the cabinet or output connectors, by connecting a power supply between circuit ground and the other grounds. The generator may be used in a guarded system by connecting the shield ground alone to the guard circuit. Other grounding arrangements may be used as required.

#### PLUG-INS

Connections to the Current Control, to both the Upper and Lower Current

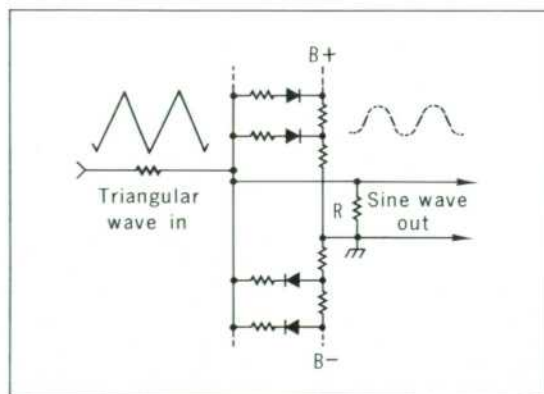

Fig. 7. Sine-wave shaping network uses diodes to switch in additional resistors in shunt with resistor R as triangular waveform swings towards peak value. Waveform is progressively flattened towards peaks, achieving very good approximation to sine wave. Actual circuit uses 12 diodes for minimum distortion.

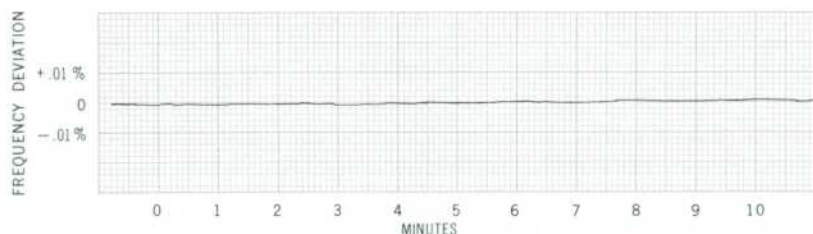

Fig. 8. Typical short term frequency stability of new Function Generator operating at 100 kHz.

Sources, and to the Integrator capacitor are completed through the plug-in. Any of these functions may therefore be controlled by circuits in the plug-ins to achieve special operating characteristics.

The *-hp-* Model 3301A Auxiliary plug-in simply completes these circuits to permit operation of the basic Function Generator in the manner just described. The *-hp-* Model 3302A Trigger/Phase-Lock plug-in broadens the capabilities of the Function Generator

to a significant degree, as described on pages 6 through 9.

#### ACKNOWLEDGMENT

The design of the 3300A Function Generator and plug-ins was accomplished through the efforts of James L. Crooks, Virgil G. Leenerts and the undersigned. The author also wishes to convey appreciation for the assistance provided by William Beierwaltes, a student summer employee, on the Model 3302A plug-in. The many valuable

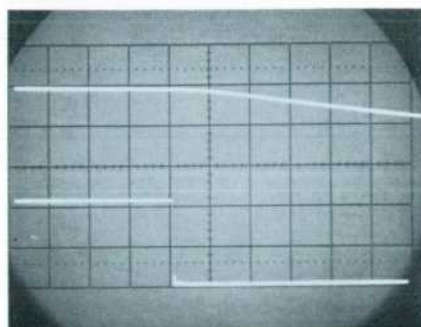

Fig. 9. Oscilloscope shows that output waveform (upper trace) responds to change in frequency control voltage (lower trace) within 0.5  $\mu$ s. Sweep speed here is 1 cm/0.5  $\mu$ sec. Upper waveform is sine wave output of Function Generator, changing from 10 kHz to 100 kHz.

ideas and suggestions of John Boatwright and Marco Negrete are most appreciated.

—Robert L. Dudley

#### SPECIFICATIONS

##### *-hp-* MODEL 3300A FUNCTION GENERATOR

(with Model 3301A Auxiliary Plug-in)

**OUTPUT WAVEFORMS:** Sinusoidal, square, and triangular selected by panel switch. (Any two outputs available simultaneously.)

**FREQUENCY RANGE:** 0.01 Hz to 100 kHz in seven decade ranges.

**FREQUENCY RESPONSE:**  $\pm 1\%$ , 0.01 Hz to 10 kHz;  $\pm 3\%$ , 10 kHz to 100 kHz.

**DIAL ACCURACY:**  $\pm 1\%$  of maximum dial setting (1 minor dial division), 0.01 Hz to 10 kHz;  $\pm 2\%$  of maximum dial setting (2 minor divisions), 10 kHz to 100 kHz. T.C.: 0.1% / °C.

**MAXIMUM OUTPUT PER CHANNEL:** > 35 volts p-p open circuit; > 15 volts p-p into 600 ohms; > 2 volts p-p into 50 ohms.

**OUTPUT ATTENUATOR:** Continuously variable, > 40 dB range.

**OUTPUT IMPEDANCE:** 600 ohms nominal (both channels).

**SINE WAVE DISTORTION:** < 1%, 0.01 Hz to 10 kHz; < 3%, 10 kHz to 100 kHz.

**SQUARE WAVE RESPONSE:** < 250 ns rise and fall time on all ranges; < 1% sag, < 5% overshoot, < 1% symmetry error.

**TRIANGLE LINEARITY:** < 1%, 0.01 Hz to 50 kHz; 2%, 50 kHz to 100 kHz; < 1% symmetry error.

**SYNC PULSE OUTPUT:** > -10 volts peak, open circuit, < 5  $\mu$ s duration. Sync pulse occurs at crest of sine and triangular wave output.

**DC STABILITY:** Drift  $\leq \pm 0.5\%$  of peak-to-peak amplitude.

**REMOTE FREQUENCY CONTROL:** 0 to -10 volts changes frequency linearly greater than 1 decade within a single range. Frequency resetability with respect to voltage:  $\pm 1\%$  of maximum frequency on range selected.

**POWER:** 115 or 230 volts,  $\pm 10\%$ , 50 to 1000 Hz. Approximately 50 watts.

**SIZE:** Nominally 5 in. high, 16 in. wide, 11 in. deep (127 x 406 x 279 mm.).

**WEIGHT:** Net 20 lbs. (9 kg). Shipping: 24 lbs. (10.8 kg).

**PRICE:** *-hp-* 3300A Function Generator: \$570.00

*-hp-* 3301A Auxiliary Plug-In: \$20.00

Prices f.o.b. factory.

Data subject to change without notice.

#### DESIGN LEADER



Robert L. Dudley

Bob Dudley joined the *-hp-* Microwave Division in 1959 as a development engineer assigned to a P-I-N diode attenuator project. He subsequently worked on the *-hp-* Models 489A-495A TWT Amplifiers and was Project Leader on the *-hp-* Model 690 series Microwave Sweep Oscillators.\* Bob transferred to the *-hp-* Loveland Division in 1963 where he has been Project Leader on the *-hp-* Model 3300A Function Generator and is presently a Group Leader.

Bob obtained a Bachelor of Science Engineering degree in Electrical Engineering from Brigham Young University and earned a MSEE from Stanford University in the *-hp-* Honors Cooperative Program. His work experience also includes two summers with an Aircraft Nuclear Propulsion project and 5 years in military service (1st Lt.) primarily as a Radar Observer on flying status with additional duty as Assistant Electronics Officer.

\* Robert L. Dudley, "A New Series of Microwave Sweep Oscillators with Flexible Modulation and Leveling," *Hewlett-Packard Journal*, Vol. 15, No. 4, Dec., 1963.

#### 'HERTZ' ADOPTED BY IEEE

On October 14, the IEEE Standards Coordinating Committee 14 on Quantities and Units adopted the name 'hertz' for the unit of frequency. This name had earlier been adopted by the National Bureau of Standards and before that by the International Committee on Weights and Measures and by the International Electrotechnical Commission. IEEE Committee adoption of 'hertz' applies to the publication of technical and scientific data.

In adopting 'hertz' the IEEE Committee observed that 'hertz' is preferred because of the widespread use of 'cycle' alone as a unit of frequency. 'Cycle per second' is, of course, technically correct, but the use of 'cycle' in place of 'cycle per second' is declared incorrect.

IEEE adoption of 'hertz' came about as part of the Committee 14 adoption of the International System (SI) of units for the IEEE. These units were earlier adopted by the International Committee on Weights and Measures and were printed in the March, 1964, issue of the 'Hewlett-Packard Journal.'

Another aspect of the recommended practice adopted by the IEEE Committee is that the use of British-American units is deprecated. The recommendation states that the 'number of British-American units in use should be reduced as rapidly as possible.' The SI System incorporates the metric system.

In the June, 1965, issue, the 'Hewlett-Packard Journal' indicated that it would increasingly adopt 'hertz.' That term is used in this issue and will be generally used in the future.

Readers may be interested in referring to the list of SI units<sup>1</sup> and of SI multiples and submultiples<sup>2</sup> printed previously herein.

<sup>1</sup> "International System of Units," *Hewlett-Packard Journal*, Vol. 15, No. 6, Mar., 1964.

<sup>2</sup> "New Submultiple Prefixes," *Hewlett-Packard Journal*, Vol. 14, No. 7-8, Mar.-Apr., 1963.

## THE TRIGGER/PHASE-LOCK PLUG-IN

A plug-in for the low-frequency function generator results in a variety of signals in the 0.01 to 100,000 hertz range.

**T**HE *hp*-Model 3302A Trigger/Phase Lock Plug-in enables the Model 3300A Function Generator to produce either a single cycle or a burst of cycles of any of the output waveforms in response to an input trigger. In conjunction with electronic frequency control, the waveform bursts may also be frequency modulated. In addition, the plug-in can phase-lock the output frequency to an external signal or to a harmonic of an external signal.

The plug-in employs two basic operating principles. In the 'Trigger' mode, it suppresses waveform generation in the main frame circuits, thus restricting the generator output to a single waveform cycle or burst of cycles. In the 'Phase Lock' mode, it contributes a correction voltage to the Function Generator frequency control circuits, phase-locking the output frequency to an external frequency source.

When the MODE switch is set to 'Free Run' the plug-in circuits are disabled and the Function Generator operates in its basic manner. With the MODE switch set to either 'Single' or 'Multiple' (see Fig. 1), the plug-in circuits stop the generation of waveforms by clamping the output of the Triangle Integrator to its input. The waveform generating circuits are released by pressing the MANUAL TRIGGER button on

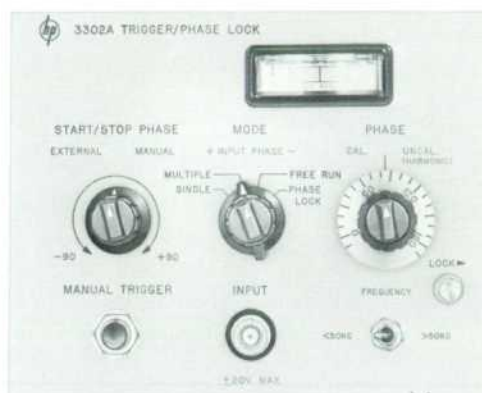

Fig. 1. Trigger/Phase-Lock Plug-in increases range of capabilities of *hp*-Model 3300A Function Generator. Plug-in enables generation of single cycles of output waveform or bursts of cycles, or it phase-locks Function Generator to external signal.

the plug-in or by applying a trigger pulse to the plug-in input (either positive or negative inputs may be used).

With the MODE switch set to 'Single', the circuits complete one full cycle of the waveform before being clamped again. The point in the waveform at which waveform generation starts and stops is determined by the START/STOP PHASE control, which can be adjusted over a range of  $-90^\circ$  to  $+90^\circ$  of the waveform. Use of the inverted waveform extends the range from  $+90^\circ$  to  $+270^\circ$ .

With the MODE switch set to 'Multiple', waveform generation continues as

long as the MANUAL TRIGGER button is held down or as long as the input gating waveform lasts. On release of the MANUAL TRIGGER button, or termination of the gating pulse, waveform generation continues until arriving at the phase at which it started. An integral number of waveform cycles therefore always results from use of the 'Multiple' mode.

When the MODE switch is set to 'Phase Lock', the plug-in circuits supply a correction voltage to the main frame frequency control circuits to adjust the output frequency such that phase-lock is maintained with respect to the input

### MULTIPLE CYCLE BURSTS

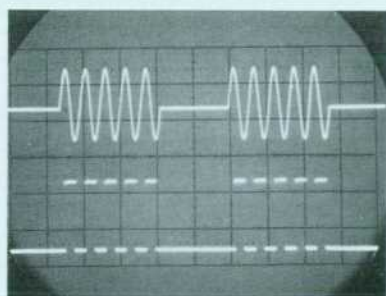

The oscillogram here shows one of the many outputs obtainable with the plug-in MODE switch set to 'Multiple.' Among other applications, the 'Multiple' mode is useful for tone-burst generation in peak-power frequency response and distortion measurements or in acoustic measurements where it may be desirable to separate the test tone from the effects of echoes. Unlike methods of generating pulse bursts by gating the output, the method used here actually stops oscillations between bursts, obtaining a theoretically infinite 'on-off' ratio.

One feature of both the 'Single' and 'Multiple' modes of operation worthy of special mention is that the dc level of the Function Generator output between bursts remains at the waveform level at which oscillations stop. The dc level can be varied over the peak-to-peak voltage range of the waveform by adjustment of the START/STOP PHASE control, a useful technique for measuring the dc response of a system over the same amplitude range that the ac response is measured.

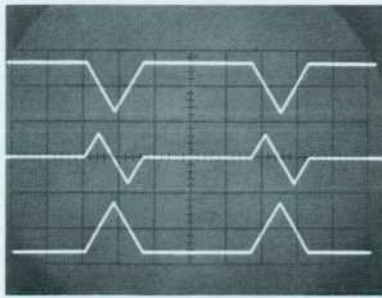

A

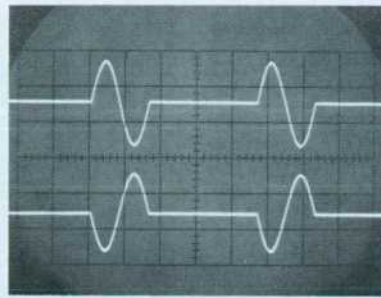

B

### SINGLE CYCLE BURSTS

The photographs here show some of the variations possible with the Trigger/Phase Lock Plug-in operating in the 'Single' mode. In A, the waveform at top is a single cycle triangle with the START/STOP PHASE control set to  $+90^\circ$ . The middle trace shows the output with the PHASE control set to  $0^\circ$  and the bottom trace is with the PHASE control at  $-90^\circ$ .

Photo B is a dual-trace oscillogram of both outputs of the Function Generator with channel A set to "Sine" and channel B set to "-A," showing that a balanced output can be provided. Photo C was made with output channel A set for square waves and channel B set for triangles while the PHASE control was set at  $-90^\circ$ . This shows how the 3300A/3302A combination can be used as a low-frequency pulse generator, with the

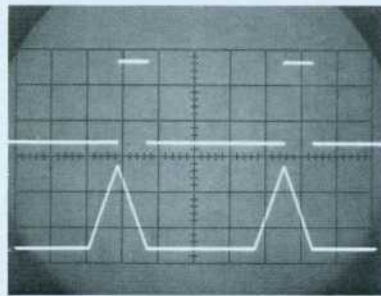

C

pulse repetition rate determined by the externally-supplied trigger rate and pulse width determined by the Function Generator frequency controls.

signal. A front panel meter indicates when phase lock is achieved. The phase relationship between the input and output signals can be adjusted by the front panel PHASE control over a range of  $0$  to  $180^\circ$  ( $180^\circ$  to  $360^\circ$  by using the inverted output or by reversing the input polarity switch).

The 'Phase Lock' mode functions with input waveforms of any shape at frequencies throughout a range of  $10$  Hz to  $100$  kHz. The phase control circuits can track variations in the input frequency over a range of  $10\%$  of the maximum dial frequency of the selected range. The Function Generator

can be programmed under remote control, of course, to follow and remain phase-locked to a signal that varies over a decade range of frequencies.

The plug-in circuits will also lock the output frequency to a harmonic of the input signal. Furthermore, phase-lock can be achieved between a har-

Oscilloscope A shows the sinewave output of the Function Generator (lower trace) locked to a  $5$ -kHz external signal (upper trace). The PHASE dial here was set to  $+90^\circ$ , locking the Function Generator output  $90^\circ$  ahead of the input waveform. Oscilloscope B shows the Function Generator (upper trace) phase-locked to the 3rd harmonic of the input signal (middle trace). Harmonic phase-locking has been found useful for synthesizing complex waves by adding the input and output waveforms together (lower trace). Phase locking to harmonics is also useful for frequency multiplication. Phase-locking to greater than the 1200th harmonic of low frequency waveforms has been achieved with this instrument.

### PHASE LOCK

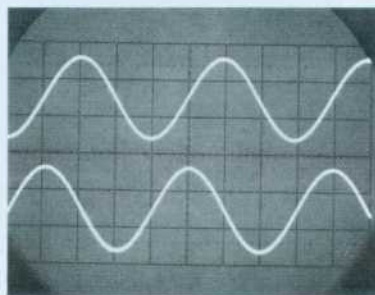

A

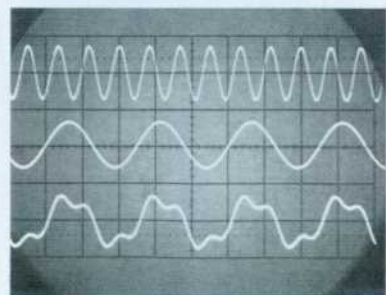

B

## FM PULSES

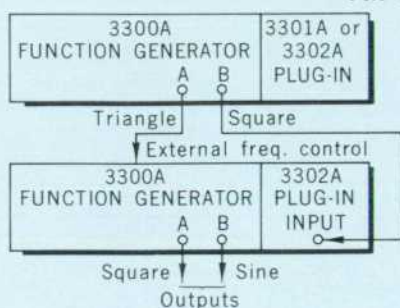

In the diagram here, the lower Function Generator is gated by the square-wave output of the upper Function Generator and its frequency is simultaneously modulated by the triangle output of the upper Generator. The result is an FM burst, much like a low-frequency ver-

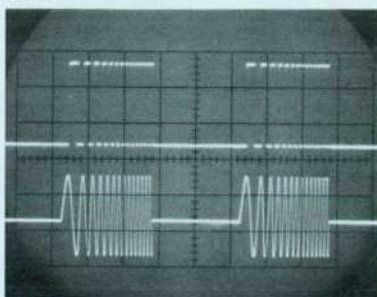

sion of the FM pulses of 'chirp' radar. This provides a swept-frequency signal with retrace blanking. This type of signal may also be used as a test signal for pulse decoding circuits, with a small amount of FM introduced to simulate noise.

monic of the input signal and a harmonic of the output. The Function Generator may thus be used to supply a variety of stable frequencies while locked on to a single stable frequency standard. Conversely, one can phase lock to a relatively unstable signal and translate the input frequency characteristics to a variety of other frequencies.

The instrument can be synchronized with frequencies below 10 Hz by using the plug-in in the 'Single' mode. The phase of the output with respect to the input is then determined by the setting of the START/STOP PHASE control.

## CIRCUIT OPERATION

A block diagram of the Trigger/Phase-Lock Plug-in operating in the 'Trigger' mode is shown in Fig. 2. In the absence of an input trigger, the Gating Amplifier suppresses oscillations in the Function Generator main frame circuits by closing a negative feedback path around the Triangle Integrator.

The main frame circuits are permitted to oscillate in response to a trigger pulse derived from either the front panel push-button or from an external source. The trigger pulse 'sets' the Phase Multivibrator and the re-

sulting positive voltage step is coupled through diode CR1 and the Gating Amplifier to diode CR2, back-biasing diode CR2. This opens the negative feedback loop allowing the main frame circuits to oscillate.

When the plug-in is in the 'Single' mode, the Phase Multivibrator is reset by the positive transition of the square wave from the main frame, as shown on the diagram. In the multiple mode, the main frame square wave is gated off by a gating signal from the input circuits (not shown in diagram) and the Phase Multivibrator is not reset until the next-occurring square-wave positive transition following termination of the input gating signal.

The Phase Multivibrator is reset in coincidence with the positive peak of the triangular waveform, but the waveform holds CR2 back-biased until it falls to the voltage level at which it started. Diode CR2 then becomes forward-biased, the negative feedback loop closes, and oscillations stop. The point in the triangular waveform at which oscillations start and stop can be selected by adjustment of the Gating Amplifier dc level with the START/STOP PHASE control.

The phase-lock circuits are diagrammed in Fig. 3. Here, the Phase Multivibrator functions as a phase detector that is set by the input signal and reset by the main frame square

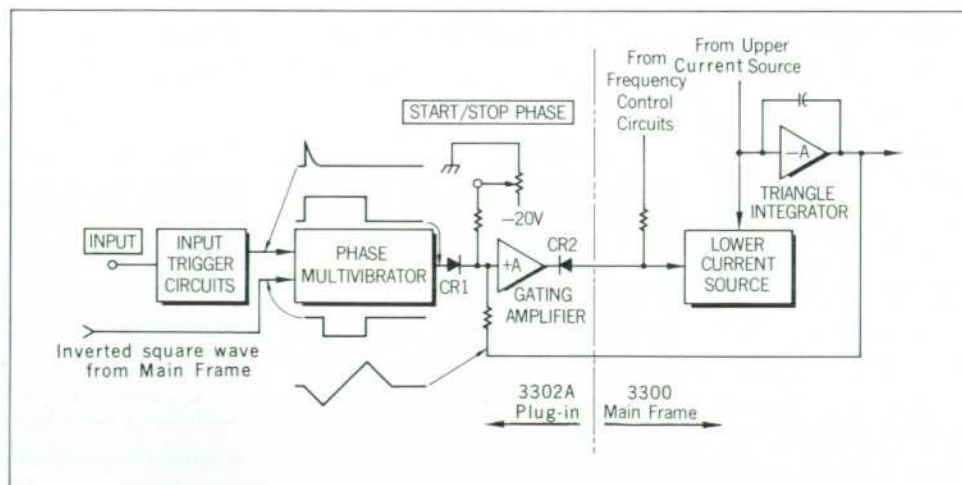
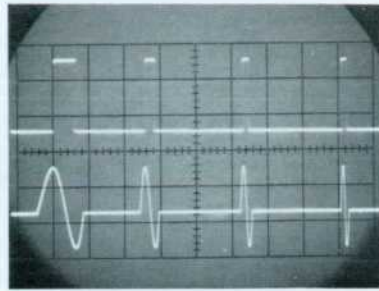

Fig. 2. Block diagram of Trigger/Phase-Lock Plug-in in 'Single' or 'Multiple' modes of operation. (Note: triangular waveform shown here is inverted by output amplifiers before arriving at output terminals.)



## MODULATED PULSES

The photo here shows one of the variations possible with simultaneous single cycle triggering and electronic frequency control. The plug-in is triggered repetitively from an external source while the frequency of the Function Generator is modulated by another source. Thus, a pulse-width modulated signal can be obtained for checking out a low-frequency PWM system.



wave. The width of the resulting pulses thus corresponds to the phase difference between the input and main frame signals.

The pulses are filtered to derive a dc control voltage, proportional to pulse width, that is added to the frequency control voltage supplied to the Current Control circuit in the main frame. Any tendency on the part of the main frame and input signals to drift in frequency with respect to each other results in a change in control level that adjusts the main frame frequency to maintain phase lock with the input.

The meter monitors the control voltage at the output of the phase detector filter. When the Function Generator is tuned exactly with respect to the input signal, the meter pointer is centered. The pulse duty cycle, and hence the signal phase difference that brings the pointer to the center position can be adjusted by the PHASE control. This control may thus be used to establish the phase difference between the input and output signals and is calibrated

throughout a range of 0 to 180° phase difference.

The Phase Multivibrator is set only by the input signal and, following reset, is unaffected by additional reset triggers until it is set once more. Thus, a useful phase lock control voltage is derived when the main frame square wave oscillates at some frequency multiple of the input. A front panel switch (CAL.-UNCAL) increases the range of the PHASE control, when in the UNCAL position, to compensate for the reduction in pulse duty cycle during harmonic phase-lock operation.

If the main frame and input frequencies are related by an integral frequency ratio (e.g. 2/3, 3/4, etc.) then the output of the phase multivibrator consists of a train of pulses of unequal widths, but with a regularly-recurring pattern of pulse widths. Such a train likewise develops a dc voltage that can lock the main frame frequency to the input, even though the two frequencies may not be in a direct harmonic relationship. It is thus possible to

## SIGNAL MULTIPLICATION

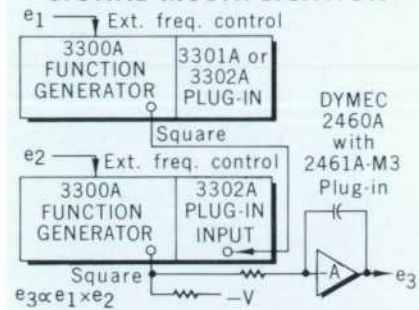

A combination of pulse-width modulation and pulse-repetition-rate modulation creates an electronic multiplier. As shown in the diagram, one signal ( $e_1$ ) modulates the frequency of the first Function Generator which in turn triggers the plug-in of the second Function Generator operating in the 'Single' mode. The other signal ( $e_2$ ) controls the frequency, and hence the pulse width, of the second Function Generator. The result is a pulse train modulated both in pulse width and in repetition rate. The pulse train is filtered in an active low-pass filter to obtain a dc voltage ( $e_3$ ) that is proportional to the product  $e_1 \times e_2$ .

phase-lock the Function Generator to a frequency that does not have an integral relationship to the output.

—Robert L. Dudley

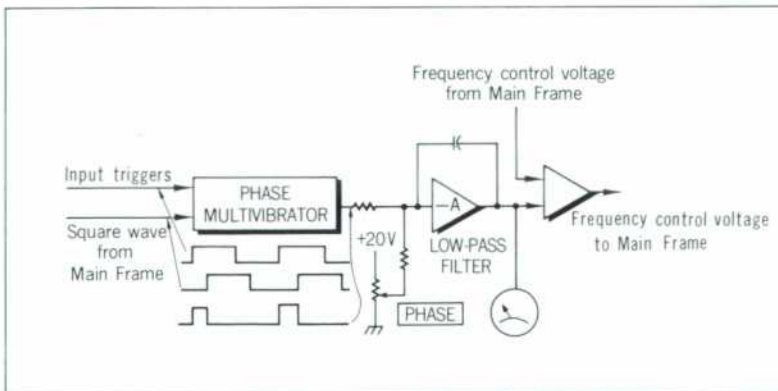

Fig. 3. Block diagram of Trigger/Phase Lock Plug-in 'Phase Lock' mode.

## SPECIFICATIONS

-hp- MODEL 3302A

TRIGGER/PHASE-LOCK PLUG-IN

### MODES OF OPERATION:

- Single cycle
- Multiple cycle
- Phase lock
- Free run

### TRIGGER REQUIREMENTS:

**SINGLE CYCLE:** Manual or external. DC coupled. Requires at least 0.5 volt to trigger externally. May be triggered with positive or negative input voltage ( $\pm 20$  V p-p max.).

**MULTIPLE CYCLE:** Manual or external start/stop. DC coupled. Requires at least 0.5 volt to start, 0 volts to stop. May be triggered with either positive or negative input voltage ( $\pm 20$  V p-p max.).

**PHASE LOCK (10 Hz to 100 kHz):** DC coupled. Requires at least 0.5 volt peak-to-peak to lock, 10 volts peak-to-peak for specified accuracy with sine wave input. Locks on fundamental or harmonic of input signal.

**PHASE ACCURACY:**  $\pm 10^\circ$  from 10 Hz to 10 kHz,  $\pm 20^\circ$  from 10 kHz to 100 kHz. (Fundamental only.)

**INTRODUCED DISTORTION:**  $< 1\%$  10 Hz to 10 kHz,  $< 3\%$  10 kHz to 100 kHz. (Fundamental only.)

**WEIGHT:** Net: 3 lbs. (1.4 kg). Shipping: 5 lbs. (2.5 kg).

**DIMENSIONS:** 4 3/4 in. high, 6 1/2 in. wide, 10 1/4 in. deep (120,7 x 153,9 x 260,4 mm).

**PRICE:** -hp- 3302A Trigger/Phase Lock Plug-In: \$190.00

Prices f.o.b. factory.  
Data subject to change without notice.

# NBS STANDARD FREQUENCY AND TIME BROADCAST SCHEDULES

The diagrams presented here, with explanatory notes, summarize the standard frequency and time services provided by the National Bureau of Standards radio stations WWV, WWVH, WWVB, and WWVL.

## HOURLY SCHEDULES OF WWVB AND WWVL

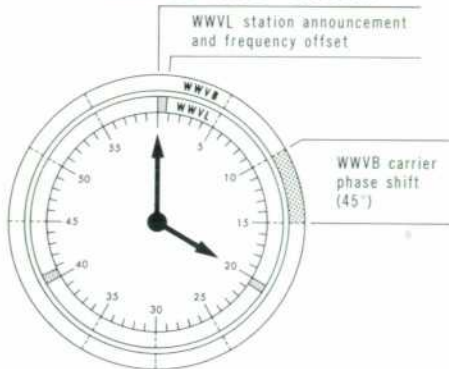

**WWVB (Carrier: 60 kHz):** Station is identified by 45° advance in carrier phase starting at 10 minutes after each hour and returning to normal at 15 minutes after each hour. Time is disseminated continuously by amplitude modulation of carrier level with once-per-second pulses. Modulation consists of 10-dB drop in carrier level during a pulse. Width of pulses carries time information in special "WWVB" format. Each time frame, which includes UT2 corrections, lasts 1 minute. Note: WWVB carrier frequency is now maintained without offset with respect to United States Frequency Standard.

**WWVL (Carrier: 20 kHz):** Program is experimental and subject to change. At present, WWVL broadcasts continuously and is identified in Morse code on 1st, 21st, and 41st minute of each hour by station call letters, repeated 3 times, followed by frequency offset. Code is produced by "on-off" carrier keying. WWVL carrier has -150 parts in  $10^6$  offset with respect to United States Frequency Standard.

## TIME PULSE ADJUSTMENTS

The National Bureau of Standards has announced that the clock which controls the 1-second time pulses from standard broadcast station WWVB (60 kHz) was retarded by 200 millisecon on Oct. 1, 1965. This change is in keeping with the previously-announced policy of maintaining the WWVB time pulses within 100 ms of the UT2 time scale (the period between the WWVB time pulses is 150 parts in  $10^6$  shorter than the period between UT2 seconds, a difference of 0.0013 second/day). The WWVB time pulses have already been retarded 200 msec on each of three occasions during 1965, on Jan. 1, April 1, and July 1.

There were no changes in the phases of time pulses of NBS high-frequency stations WWV and WWVH on Oct. 1, 1965. Retardations of 100 ms each were made on Jan. 1, Mar. 1, Jul. 1, and Sept. 1, 1965.

## HOURLY BROADCAST SCHEDULES OF WWV AND WWVH

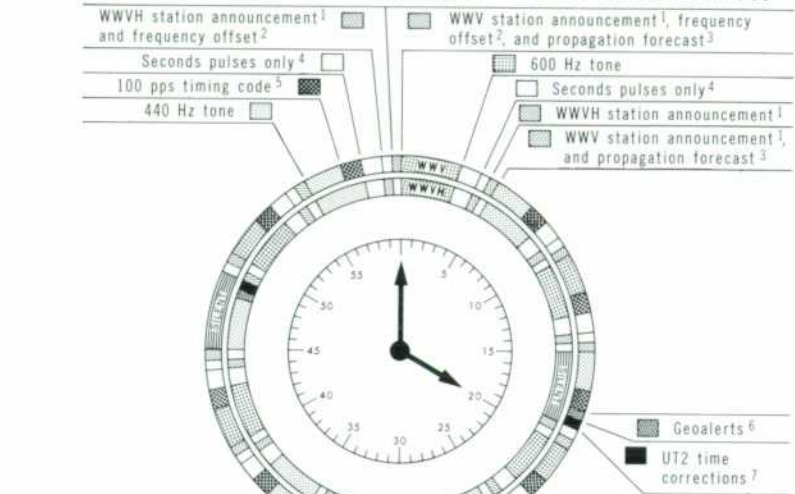

	Carrier Frequencies (MHz)					
WWV	2.5	5	10	15	20	25
WWVH	2.5	5	10	15	--	--

- Call letters and Universal time in Morse code; call letters and Eastern Standard time (WWV) or Hawaiian Standard time (WWVH) by voice.
- Frequency offset: amount in parts in  $10^6$  by which transmitted frequencies are offset from U. S. Frequency Standard; broadcast in fast Morse code immediately following voice announcement on the hour only. Symbols now transmitted are M150, meaning minus 150 parts in  $10^6$ .
- Propagation forecast (WWV only): condition of ionosphere in North Atlantic area, at time of last issue, and radio quality expected in subsequent 6-hour period (forecasts issued at 0500, 1200—1100 in summer—1700 and 2300 UT). Letter portion identifies radio quality at time of forecast and numbered portion is forecast of expected quality on typical North Atlantic path during 6-hour period following forecast, according to following scale:

Disturbed grades (W)	Unsettled grade (U)	Normal grades (N)
1. useless	5. fair	6. fair-to-good
2. very poor		7. good
3. poor		8. very good
4. poor-to-fair		9. excellent

- Seconds pulses are transmitted continuously except for 59th second of each minute and during silent periods. Each minute starts with two pulses spaced by 0.1 second.

- 100 pps timing code: binary-coded 1000-Hz tone gives Universal Time in seconds, minutes, hours, and day of year for use as unambiguous time base during data recording in scientific experiments. Format used is NASA 36-bit Time Code with 2-ms pulse for "0" and 6 ms pulse for "1." Each frame lasts 1 second, repeated once per second during 1-minute broadcast interval.

- Geolerts: slow Morse code to identify days on which outstanding solar or geophysical events are expected or have occurred during previous 24 hours. Geolert is identified by letters "GEO" followed by one of following letters repeated five times:

M — Magnetic storm	C — Cosmic ray event
N — Magnetic quiet	W — Stratospheric
S — Solar activity	warming
Q — Solar quiet	E — No geolert issued

- UT2 time corrections: corrections to be applied to time signals for obtaining actual UT2 time within  $\pm 3$  ms. Corrections, in Morse code, begin with "UT2" followed by either "AD" (for add) or "SU" (for subtract) in turn followed by number of milliseconds to be added or subtracted from time as broadcast.

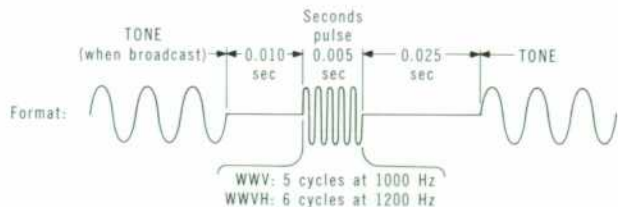

# A TECHNIQUE FOR MAKING ULTRA-PRECISE MEASUREMENTS OF MICROWAVE FREQUENCY STABILITY

Standard laboratory instruments are interconnected to provide a system that measures the short-term frequency stability of microwave sources to a precision of better than 1 part in  $10^{11}$ .

**S**TABILITY measurements of highly stable microwave frequency sources have been difficult because of the lack of suitable microwave frequency standards. This situation was greatly improved by the development of the -hp- Model 5100/5110A Frequency Synthesizer,<sup>1</sup> from which microwave frequencies can be derived by frequency multiplication. The 5 billion discrete frequencies available in this instrument, from 0 to 50 MHz in 0.01 Hz steps, allow the generation of microwave frequencies with the small offset from the measured source that is useful for stability measurements. The Synthesizer was designed to provide an output of high spectral purity especially for frequency multiplication purposes.

When stability measurements are to be made on sources which themselves have a stability comparable to that of the Synthesizer, then the small phase instabilities introduced by high order frequency multiplication become significant. To reduce the effects of phase noise introduced by high orders of frequency multiplication, a measurement technique using frequency reduction was developed in the -hp- Measurements Standards Lab. In this technique, the microwave frequency under test is first converted to a lower frequency by use of the phase-locked transfer oscillator in the -hp- Model 2590A Microwave Frequency Converter.<sup>2</sup> It is then heterodyned with the Synthesizer output to obtain a 1-kHz beat note for the stability measurement. Translation of the microwave frequency to 1-kHz increases the ratio of frequency instability to base frequency by a large factor for higher precision in the measurement.

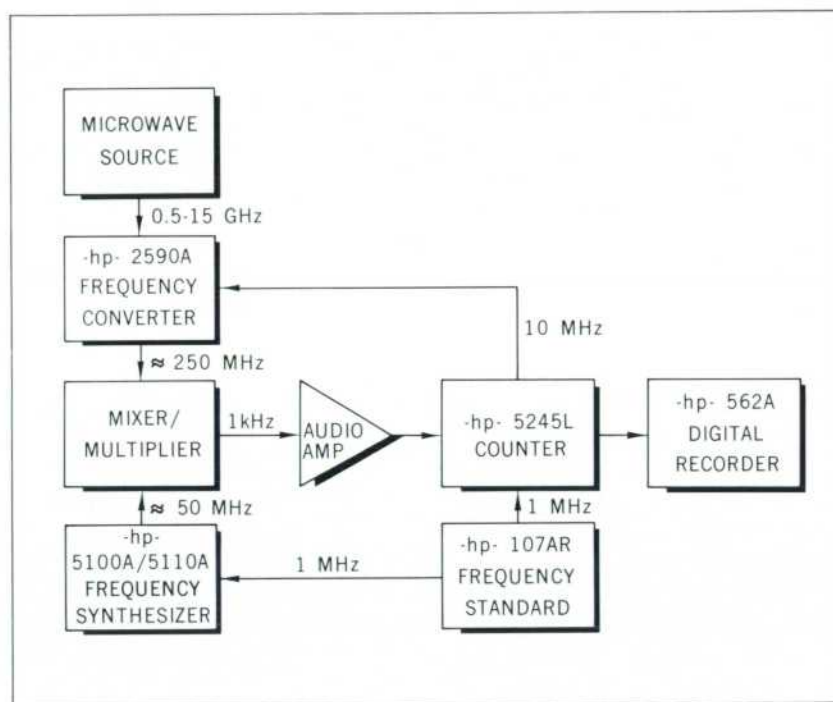

Fig. 1. Instrumentation for frequency stability measurements on microwave frequency sources.

The technique has enabled short term stability measurements on microwave sources with a precision approaching 5 parts in  $10^{12}$  rms (for 1 second averages). Although precisions one or two orders of magnitude better can be achieved with highly-specialized equipment, the method described here is performed with off-the-shelf equipment that is readily available.

## MEASUREMENT SET-UP

A block diagram of the measurement setup is shown in Fig. 1. The Frequency Converter changes the microwave input frequency to a related frequency near 250 MHz. This frequency is mixed with another, derived from the Synthesizer, that is offset from the Frequency Converter output by 1-kHz (the derived frequency is obtained by multi-

plication of the Synthesizer frequency by a factor of only 5). The period of the 1-kHz beat-note generated in the mixer is measured and averaged over a selected period of time, usually 1 second, by the electronic counter. The counter reads the average period with a precision of 8 decimal places, thus obtaining a resolution of  $0.0001 \mu\text{s}$  that permits the measurement of very small instabilities in the source.

The measurement is repeated many times to obtain a statistically significant number of samples, usually 100. The rms frequency stability of the microwave source is then found by the following procedure.

The average of the beat-note periods ( $P_1$ ) is calculated and the deviation ( $\Delta P_1$ ) of each measurement is found.

<sup>1</sup> Victor E. Van Duzer, "A 0-50 Mc Frequency Synthesizer with Excellent Stability, Fast Switching, and Fine Resolution," *Hewlett-Packard Journal*, Vol. 15, No. 9, May, 1964.

<sup>2</sup> Rudolph F. Pasos, "A New Instrument for Measuring Microwave Frequencies with Counter Accuracy," *Hewlett-Packard Journal*, Vol. 15, No. 8, April, 1964.



James A. Marshall

Jim Marshall joined -hp- in 1952 on a part-time basis as an assembler while attending San Jose State College. After obtaining his BSEE degree in 1954, Jim transferred to the production test department on a full-time basis but was called into military service a year later. He spent the next two years as an instructor in microwave communications in the Signal Corps.

Jim rejoined -hp- as a product development engineer in 1957 and worked on the design of the -hp- Model 434A Calorimetric Power Meter. A year later, he transferred to the -hp- Standards Lab where he has been concerned with the development of instrumentation for precision RF and microwave measurements including, among other devices, the -hp- 11049 series of Thermal Converters. At present, he is head of the Radio Frequency Section in the -hp- Standards Lab. He is also treasurer of the Precision Measurements Society.

Jim has done further graduate work both at Stanford and at San Jose State.

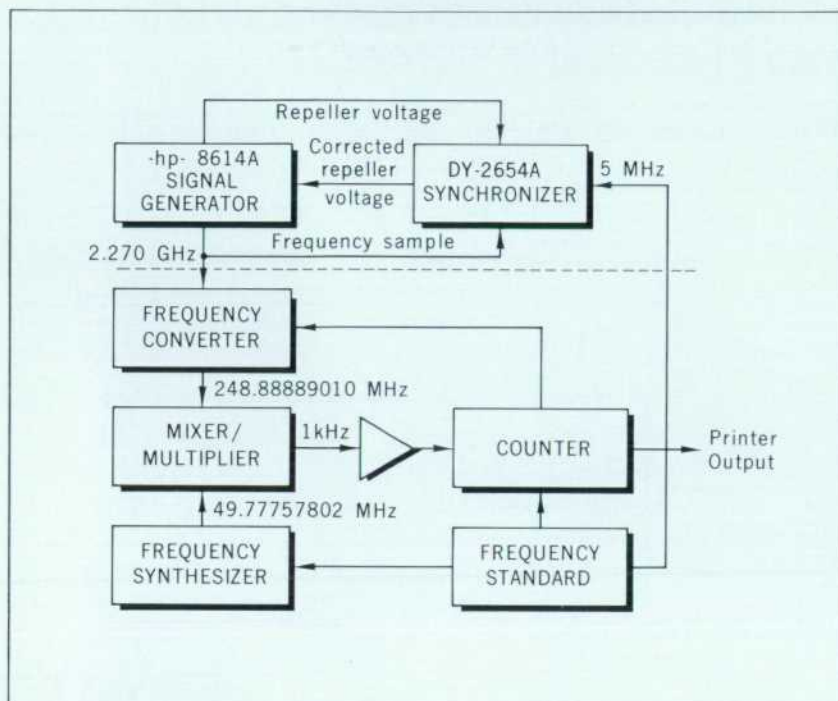

Fig. 2. Instruments above dotted line comprise highly stable microwave source for evaluating stability measurement system shown below dotted line.

The rms deviation ( $\Delta P_{rms}$ ) is:

$$\Delta P_{rms} = \sqrt{\frac{\Delta P_1^2 + \Delta P_2^2 + \dots + \Delta P_n^2}{n - 1}}$$

Where n is the number of samples.

Let f = frequency being checked, and

F = beat frequency

Since  $F = \frac{1}{P} \Delta F$ ,  $\Delta F$  can be approximated

by differentiation:  $\Delta F = -\frac{\Delta P}{P^2}$

Also, by mixer action:  $\Delta f = \Delta F$

Thus, the rms fractional frequency deviation ( $\Delta f/f$ ) or phase noise is expressed as:

$$\frac{\Delta f}{f} = -\frac{\Delta P_{rms}}{P^2 f}$$

#### POSSIBLE ERRORS

In examining the possible sources of error in this system, one is naturally led to consider first the performance of the transfer oscillator in the Microwave Frequency Converter. The solid-state push-pull oscillator was designed for highest stability, even in the absence of phase-lock control, and the

converter phase-locks the oscillator to the input signal. Since a phase-lock system is inherently a second-order servo system, the transfer oscillator exhibits essentially no frequency error with respect to the input frequency in the steady state (the Frequency Converter closely tracks frequency deviations at rates up to 50 kHz). There is a fixed phase error, however, and the question thus concerns how much phase noise the transfer oscillator adds to the measurement.

To investigate this, and also the performance of the entire system, the test set-up shown in Fig. 2 was used. The signal generator supplying the test microwave signal was phase-locked with a Dymec Model 2654A Synchronizer to the same Frequency Standard that drives the Synthesizer and Counter. Any phase noise in the Frequency Standard therefore does not enter into the test since it is common to both the source and measurement channels. The Synchronizer, of course, is also a possible source of phase noise but it is a source independent of the Frequency Converter.

The test frequency f was  $2.270 \times 10^9$ , the beat period P was 0.001 s (1 kHz) and  $\Delta P_{rms}$  was found to be 0.0118  $\mu$ s or  $11.8 \times 10^{-9}$  second. From this, the system noise is:

$$\left| \frac{\Delta f}{f} \right| = \frac{11.8 \times 10^{-9}}{(10^{-3})^2 2.27 \times 10^9} = 5.2 \times 10^{-12} \text{ for one-second averaging.}$$

This is comparable to the rms fractional deviation of the Frequency Standard used as the basic reference in the set-up of Fig. 1, the -hp- Model 107AR Quartz Oscillator, which has a specified rms fractional frequency deviation of less than  $1.5 \times 10^{-13}$  for one-second averaging and which represents the state-of-the-art in short-term frequency stability. The test results show that the system of Fig. 1 is capable of measuring the stabilities of microwave systems with a precision comparable to the oscillator used as the basic reference.

-James A. Marshall