

MAY 1985 / \$2.50

ANNUAL
ANTENNA
ISSUE

ham radio

magazine

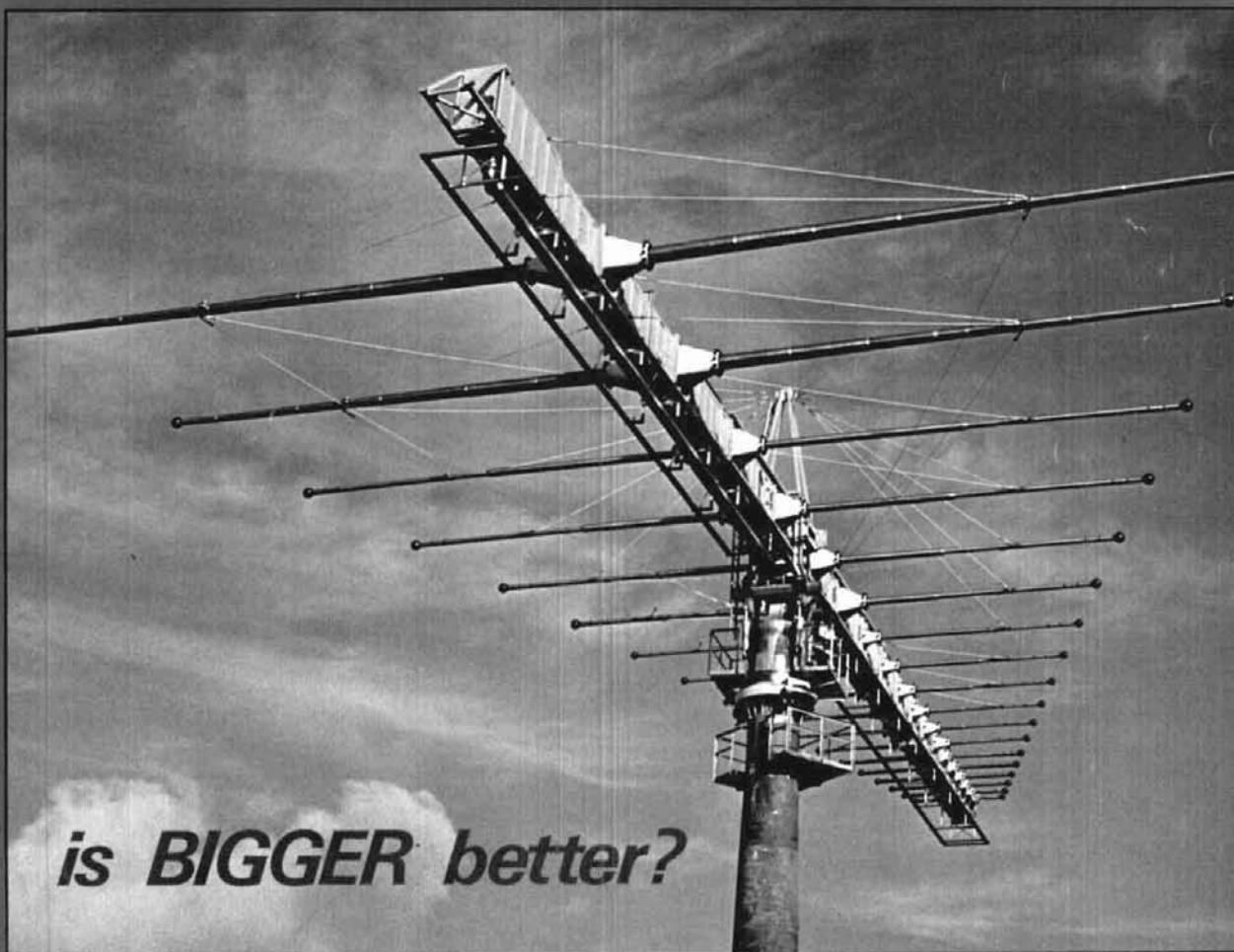

is BIGGER better?

hr
focus
on
communications
technology

*in this issue: stacking Yagis properly • 0.5-30 MHz active antenna
• vary your take-off angle • switchable vertical wire array • alternative
method of feeding phased arrays • multiband sloping vee beam
• 160-meter transmission line antenna • RF transmission cable for
microwave applications • baluns • convert your fixed tower to a
tilt-over • plus W1JR, W6SAI, K0RYW, and the Guerri report*

ICOM UHF Transceiver

IC-471H



For Maximum UHF Base Station Performance

Whether your interest is simplex, repeater operation, or satellite work, the IC-471H 430-450MHz base station transceiver will give you maximum UHF operation.

75 Watts. The IC-471H provides 10 to 75 watts of adjustable power in all modes. This enables adjusting the drive level to a linear amplifier for higher power uses such as moonbounce. For a portable UHF station, the optional IC-PS35 internal power supply is available.

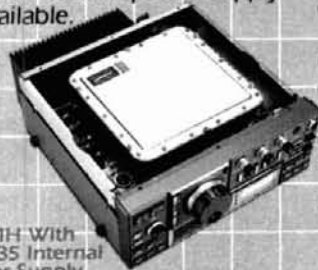

IC-471H With IC-PS35 Internal Power Supply Installed

Compare these exceptional Standard Features:

- 430 - 450MHz
- Variable tuning steps, FM 5KHz and 1 KHz; SSB 10Hz, 50Hz and 1KHz
- 32 full-function Memories with lithium battery backup
- 75 Watts, fully adjustable on all modes
- 32 built-in Subaudible Tones
- High visibility display
- Scanning systems... Memories, Modes or Programmable Band
- RIT/XIT with separate readout
- S-Meter and Center Meter
- IC-HM12 Microphone with Up/Down Scan
- 11 1/4" W x 4 3/8" H x 12 3/8" D

Optional Features. AG-35 switchable mast-mounted GaAsFET preamp, UT-155 CTCSS encoder/decoder (encoder is standard), IC-EX310



AG-35 Mast Mounted GaAsFET Preamplifier

voice synthesizer, IC-SM8 two-cable desk mic and IC-SM6 desk mic. PLUS a variety of power supplies...the IC-PS35 internal power supply, the IC-PS30 system power supply or the IC-PS15 external power supply.

The IC-471A. The 25 watt IC-471A is also available and has the same outstanding fea-

tures as the IC-471H, plus an optional IC-PS25 internal power supply for portable operation.

To complete your VHF/UHF base station, the IC-471's 2-meter companions, the 100 watt IC-271H and the 25 watt IC-271A are also available.



IC-PS30 Power Supply

See the IC-471H and other ICOM equipment at your local authorized ICOM dealer.



ICOM

First in Communications

ICOM America, Inc., 2380-116th Ave NE, Bellevue, WA 98004 / 3331 Towerwood Drive, Suite 307, Dallas, TX 75234

All stated specifications are approximate and subject to change without notice or obligation. All ICOM radios significantly exceed FCC regulations limiting spurious emissions. 471H108-

What To Look For In A Phone Patch

The best way to decide what patch is right for you is to first decide what a patch should do. A patch should:

- Give complete control to the mobile, allowing full break in operation.
- Not interfere with the normal operation of your base station. It should not require you to connect and disconnect cables (or flip switches!) every time you wish to use your radio as a normal base station.
- Not depend on volume or squelch settings of your radio. It should work the same regardless of what you do with these controls.
- You should be able to hear your base station speaker with the patch installed. Remember, you have a base station because there are mobiles. **ONE OF THEM MIGHT NEED HELP.**
- The patch should have standard features at no extra cost. These should include programmable toll restrict (dip switches), tone or rotary dialing, programmable patch and activity timers, and front panel indicators of channel and patch status.

ONLY SMART PATCH HAS ALL OF THE ABOVE.

Now Mobile Operators Can Enjoy An Affordable Personal Phone Patch. . .

- Without an expensive repeater.
- Using any FM transceiver as a base station.
- The secret is a **SIMPLEX** autopatch, The **SMART PATCH**.

SMART PATCH Is Easy To Install

To install **SMART PATCH**, connect the multicolored computer style ribbon cable to mic audio, receiver discriminator, PTT, and power. A modular phone cord is provided for connection to your phone system. Sound simple? . . . IT IS!

With SMART PATCH You are in CONTROL

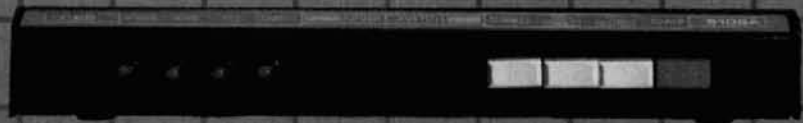

With **CES 510SA Simplex Autopatch**, there's no waiting for **VOX** circuits to drop. Simply key your transmitter to take control.

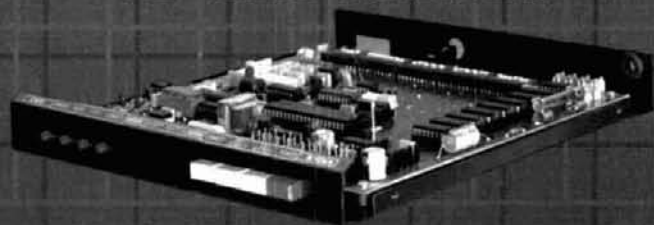

SMART PATCH is all you need to turn your base station into a personal autopatch. **SMART PATCH** uses the only operating system that gives the mobile complete control. Full break-in capability allows the mobile user to actually interrupt the telephone party. **SMART PATCH** does not interfere with the normal use of your base station. **SMART PATCH** works well with any FM transceiver and provides switch selectable tone or rotary dialing, toll restrict, programmable control codes, CW ID and much more.

To Take CONTROL with Smart Patch – Call 800-327-9956 Ext. 101 today.

How To Use SMART PATCH

Placing a call is simple. Send your access code from your mobile (example: *73). This brings up the Patch and you will hear dial tone transmitted from your base station. Since **SMART PATCH** is checking about once per second to see if you want to dial, all you have to do is key your transmitter, then dial the phone number. You will now hear the phone ring and someone answer. Since the enhanced control system of **SMART PATCH** is constantly checking to see if you wish to talk, you need to simply key your transmitter and then talk. That's right, you simply key your transmitter to interrupt the phone line. The base station automatically stops transmitting after you key your mic. **SMART PATCH** does not require any special tone equipment to control your base station. It samples very high frequency noise present at your receivers discriminator to determine if a mobile is present. No words or syllables are ever lost.

SMART PATCH Is All You Need To Automatically Patch Your Base Station To Your Phone Line.

Use **SMART PATCH** for:

- Mobile (or remote base) to phone line via Simplex base. (see fig. 1.)
- Mobile to Mobile via interconnected base stations for extended range. (see fig. 2.)
- Telephone line to mobile (or remote base).
- **SMART PATCH** uses **SIMPLEX BASE STATION EQUIPMENT**. Use your ordinary base station. **SMART PATCH** does this without interfering with the normal use of your radio.

WARRANTY?

YES, 180 days of warranty protection. You simply can't go wrong. An FCC type accepted coupler is available for **SMART PATCH**.

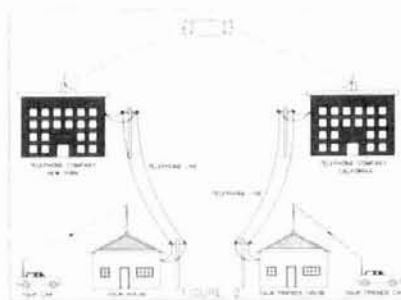
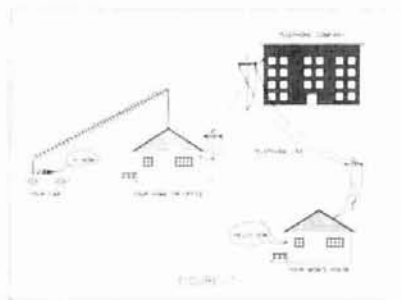

Communications Electronics Specialties, Inc.

P.O. Box 2930, Winter Park, Florida 32790

Telephone: (305) 645-0474 Or call toll-free (800)327-9956

KENWOOD

...pacesetter in Amateur radio

NOW
220 MHz!

The Smallest HT!

TH-21AT/31AT/41AT

Kenwood's advanced technology brings you a new standard in pocket/handheld transceivers!

- High or low power. Choose 1 watt high—enough to "hit" most local repeaters; or a battery-saving 150 mW low.
- Pocket portability! Kenwood's TH-series HTs pack convenient, reliable performance in a package so small, it slips into your shirt pocket! It measures only 57 (2.24) W x 120 (4.72) H x 28 (1.1) D mm (inch) and weighs 260 g (.57 lb) **with batteries!**
- Expanded frequency coverage (TH-21AT/A). Covers 141,000-150,995 MHz in 5 kHz steps, includes certain MARS and CAP frequencies.
TH-31AT/A: 220,000-224,995 MHz in 5 kHz steps.
TH-41AT/A: 440,000-449,995 MHz in 5 kHz steps.



- Repeater offset switch.
TH-21AT/A: ± 600 kHz, simplex.
TH-31AT/A: -1.6 MHz, reverse, simplex.
TH-41AT/A: ± 5 MHz, simplex.
- Standard accessories: Rubber flex antenna, earphone, wall charger, 180 mAh NiCd battery pack, wrist strap.

- Quick change, locking battery case. The rechargeable battery case snaps securely into place. Optional battery cases and adapters are available.
- Rugged, high impact molded case. The high impact case is scuff resistant, to retain its attractive styling, even with hard use.

See your authorized Kenwood dealer and take home a pocketful of performance today!



Optional accessories:

- HMC-1 headset with VOX
- SMC-30 speaker microphone
- PB-21 NiCd 180 mAh battery
- DC-21 DC-DC converter for mobile use
- BT-2 manganese/alkaline battery case
- EB-2 external C manganese/alkaline battery case
- SC-8 soft case for TH-21A/31A/41A
- SC-8T soft case for TH-21AT/31AT/41AT
- TU-6 programmable sub-tone unit
- AJ-3 thread-loc to BNC female adapter
- Service manual

More information on the TH-series HTs is available from authorized Kenwood dealers.

KENWOOD

TRIO-KENWOOD COMMUNICATIONS
1111 West Walnut Street
Compton, California 90220



- Easy-to-operate, functional design. Three digit thumbwheel frequency selection and handy top-mounted controls increase operating ease.

Note: Specifications guaranteed for the 144,000-148,000 MHz Amateur band only. TH-21AT shown. Standard versions TH-21A/31A/41A without DTMF pad also available. Specifications and prices are subject to change without notice or obligation.



MAY 1985

volume 18, number 5

T. H. Tenney, Jr., W1NLB
publisher

Rich Rosen, K2RR
editor-in-chief
and associate publisher

Dorothy Rosa, KA1LBO
assistant editor

Joseph J. Schroeder, W9JUV
Alfred Wilson, W6NIF
associate editors
Susan Shorrock
editorial production

editorial review board

Peter Bertini, K1ZJH
Forrest Gehrke, K2BT
Michael Gruchalla, P. E.
Bob Lewis, W2EBS
Mason Logan, K4MT
Ed Wetherhold, W3NQN

publishing staff

J. Craig Clark, Jr., N1ACH
assistant publisher

Rally Dennis, KA1JWF
director of advertising sales

Dorothy Sargent, KA1ZK
advertising production manager

Susan Shorrock
circulation manager
Therese Bourgault
circulation

ham radio magazine is published monthly by
Communications Technology, Inc.
Greenville, New Hampshire 03048-0498
Telephone: 603 878 1441

subscription rates

United States:
one year, \$19.95; two years, \$32.95; three years, \$44.95
Canada and other countries (via surface mail):
one year, \$22.95; two years, \$41.00; three years, \$58.00
Europe, Japan, Africa (via Air Forwarding Service): one year, \$28.00
All subscription orders payable in U.S. funds, via international
postal money order or check drawn on U.S. bank

international subscription agents: page 140

Microfilm copies are available from
University Microfilms, International
Ann Arbor, Michigan 48106
Order publication number 3076

Cassette tapes of selected articles from *ham radio*
are available to the blind and physically handicapped
from Recorded Periodicals,
919 Walnut Street, Philadelphia, Pennsylvania 19107

Copyright 1985 by Communications Technology, Inc.
Title registered at U.S. Patent Office

Second class postage paid
at Greenville, New Hampshire 03048-0498
and at additional mailing offices
ISSN 0148-5989

Send change of address to *ham radio*
Greenville, New Hampshire 03048-0498



ham radio

magazine

contents

18 stacking Yagis is a science
Steve Powlisken, K1FO

37 active antenna covers 0.5-30 MHz
Peter Bertini, K1ZJH

**46 control your take-off angle:
the JR vari-lobe antenna**
R.R. Schellenbach, W1JF

**53 the end-fed 8JK:
a switchable vertical array**
R.R. Schellenbach, W1JF

**58 feeding phased arrays:
an alternative method**
Al Christman, KB8I

66 ham radio techniques
Bill Orr, W6SAI

71 a sloping terminated vee beam
Robert Ross

87 160-meter transmission line antenna
Ted S. Rappaport, N9NB

**95 VHF/UHF world: stacking antennas,
part 2**
Joe Reisert, W1JR

**106 RF transmission cable
for microwave applications**
Howard Weinstein, K3HW

113 balun chop suey
John J. Nagle, K4KJ

**125 tilt-over conversion
of a fixed antenna tower**
Dick Rollema, PA0SE

165 the Guerri report
Ernie Guerri, W6MGI

166 advertisers index **157 new products**
and reader service **11 presstop**

79 DX forecaster **4 reflections**

140 flea market **121 short circuits**

144 ham mart

REFLECTIONS REFLECTIONS

the readers speak . . .

We asked — and you answered our call for solutions to the problems facing our hobby today (see "Reflections," February, 1985, page 5. Each and every one of your letters was read, and we're proud to act as a clearinghouse for your many ideas and suggestions.

Foremost you recognized that Amateur Radio has changed, and that hams have to accept that fact before any effective improvements can be made.

Here are some of your comments on the problems, followed by some suggested solutions:

"The challenge is gone. Want to hear China? Just turn on the TV."

"Equipment is just too expensive and complex for us to do our own repairs."

"Our kids are into computers, not radio."

"Hams are boring and don't know how to communicate any more."

"Consumer electronics and RFI — what a nightmare!"

"Enforcement, what a joke — the FCC's a paper tiger."

Can we expect the general public to help? I doubt it. Many of them see us as "the ham down the block with the ugly tower and wires all over." Don't expect too much sympathy from the neighbors — especially if their brand-new VCR is carrying our conversations as well as their programming. So what do we do?

SCHOOLS. Talk to your local school board. Could some space and time — say an hour a week — be set aside for a Novice course taught by local hams? What about high school science teachers? Would they be interested in having guest speakers address classes on Amateur Radio subjects? Radio clubs, how about sponsoring radio-related science fairs, with prizes or scholarships awarded for the best projects? How about donating software — morse code tutors and technical Q&A's, for example — to school libraries? Besides the school environment, summer camps and community centers would also be logical places for reaching and teaching prospective hams.

PUBLICITY. We need more of it — the good kind, that is. Make a personal effort to contact and provide details of Amateur Radio events to your local newspaper and radio or TV stations. Every little bit helps. There's a move afoot to produce and distribute a brochure describing the "fun" aspects of our hobby. When it becomes available, get some and hand them out to the neighborhood kids. Do any of you work in the media or public relations? How about using your skills to help improve our image?

PARTICIPATION. This means all of us. No contribution is too small. Participate by helping out at the club, helping newcomers to the hobby even *after* they're licensed. (This in itself might help reverse the "dropout" rate.) How about being an Elmer and forming a "ground wave net" to bring together new hams in a local net designed to help them overcome their initial shyness? I'm sure we can all remember how we felt during those first few weeks on the air.

Dear Senior Citizens, you have the time, the knowledge, and the political clout. Your active leadership and participation are essential.

What would happen if, for the good of Amateur Radio, we set aside our individual concerns and pooled our talents in a single "umbrella" organization dedicated solely to protecting and preserving our hobby? Perhaps then it would be more difficult for commercial interests to nibble away at our spectrum. We have to lobby from a position of unity and strength.

PERSONAL GROWTH. Hams used to be interesting people to talk to. We could converse on diversified subjects at length. Now too many of us appear to be overly involved in contesting and card-collecting — i.e., doing the same old thing all the time, when we should be advancing our knowledge, experimenting with different modes, and searching for new frontiers.

Perhaps we can act on some of the advice offered by our readers and help improve the hobby.

Rich Rosen, K2RR
Editor-in-Chief

MFJ ACCESSORIES

300 WATT ANTENNA TUNER HAS SWR/WATTMETER, ANTENNA SWITCH, BALUN. MATCHES VIRTUALLY EVERYTHING FROM 1.8 TO 30 MHz.



\$99.95 MFJ-941D

NEW FEATURES

MFJ's fastest selling tuner packs in plenty of new features!

- **New Styling!** Brushed aluminum front. All metal cabinet.
- **New SWR/Wattmeter!** More accurate. Switch selectable 300/30 watt ranges. Read forward/reflected power.
- **New Antenna Switch!** Front panel mounted. Select 2 coax lines, direct or through tuner, random wire/balanced line or tuner bypass for dummy load.
- **New airwound inductor!** Larger more efficient 12 position airwound inductor gives lower losses and more watts out. Run up to 300 watts RF power output. Matches everything from 1.8 to 30 MHz: dipoles, inverted vee, random wires, verticals, mobile whips, beams, balanced and coax lines. Built-in 4:1 balun for balanced lines. 1000V capacitor spacing. Black. 11x3x7 inches. Works with all solid state or tube rigs. Easy to use, anywhere.

RTTY/ASCII/CW COMPUTER INTERFACE

MFJ-1224
\$99.95



Free MFJ RTTY/ASCII/CW software on tape and cable for VIC-20 or C-64. Send and receive computerized RTTY/ASCII/CW with nearly any personal computer (VIC-20, Apple, TRS-80C, Atari, TI-99, Commodore 64, etc.). Use Kantronics or most other RTTY/CW software. Copies both mark and space, any shift (including 170, 425, 850 Hz) and any speed (5-100 WPM RTTY/CW, 300 baud ASCII). Sharp 8 pole active filter for CW and 170 Hz shift. Sends 170, 850 Hz shift. Normal/reverse switch eliminates retuning. Automatic noise limiter. Kantronics compatible socket plus exclusive general purpose socket. 8x1 1/4x6 in. 12-15 VDC or 110 VAC with adapter, MFJ-1312, \$9.95.

RX NOISE BRIDGE

Maximize your antenna performance!



\$59.95 MFJ-202B

Tells whether to shorten or lengthen antenna for minimum SWR. Measure resonant frequency, radiation resistance and reactance.

New Features: individually calibrated resistance scale, expanded capacitance range (± 150 pf). Built-in range extender for measurements beyond scale readings, 1-100 MHz. Comprehensive manual. Use 9 V battery. 2x4x4 in.

INDOOR TUNED ACTIVE

NEW! IMPROVED! ANTENNA with higher gain "World Grabber" rivals or exceeds reception

of outside long wires! Unique tuned Active Antenna minimizes intermode, improves selectivity, reduces noise outside tuned band, even functions as preselector with external antennas. Covers 0.3-30 MHz. Tele scoping antenna. Tune, Band, Gain, On-off bypass controls. 6x2x6 in. Uses 9V battery, 9-18 VDC or 110 VAC with adapter, MFJ-1312, \$9.95.



MFJ-1020A \$79.95

POLICE/FIRE/WEATHER 2 M HANDHELD CONVERTER

Turn your synthesized scanning 2 meter handheld into a hot Police/Fire/Weather band scanner!

\$39.95 MFJ-313

144-148 MHz handhelds receive Police/Fire on 154-158 MHz with direct frequency readout. Hear NOAA maritime coastal plus more on 160-164 MHz. Converter mounts between handheld and rubber ducky. Feedthru allows simultaneous scanning of both 2 meters and Police/Fire bands. No missed calls. Crystal controlled. Bypass/Off switch allows transmitting (up to 5 watts). Use AAA battery. 2 1/4x1 1/2x1 1/2 in. BNC connectors.



MFJ/BENCHER KEYSER COMBO

MFJ-422
\$109.95

The best of all CW worlds—a deluxe MFJ Keyer in a compact configuration that fits right on the Bencher iambic paddle! MFJ Keyer - small in size, big in features. Curtis 8044-B IC, adjustable weight and tone, front panel volume and speed controls (8-50 WPM). Built-in dot-dash memories. Speaker, sidetone, and push button selection of semi-automatic/tune or automatic modes. Solid state keying. Bencher paddle is fully adjustable; heavy steel base with non-skid feet. Uses 9 V battery or 110 VAC with optional adapter, MFJ-1305, \$9.95.



VHF SWR/WATTMETER

Low cost VHF SWR/Wattmeter! Read SWR (14 to 170 MHz) and forward/reflected power at 2 meters. Has 30 and 300 watts scales. Also read relative field strength. 4x2x3 in.

MFJ-812 \$29.95



1 KW DUMMY LOAD

MFJ-250 **\$39.95**

Tune up fast, extend life of finals, reduce QRM! Rated 1KW CW or 2KW PEP for 10 minutes. Half rating for 20 minutes, continuous at 200 W CW, 400 W PEP. VSWR under 1.2 to 30 MHz, 1.5 to 300 MHz. Oil contains no PCB. 50 ohm non-inductive resistor. Safety vent. Carrying handle. 7 1/2x6 1/4 in.



24/12 HOUR CLOCK/ID TIMER

MFJ-106
\$19.95 NEW

Switch to 24 hour UTC or 12 hour format!

Battery backup maintains time during power outage. ID timer alerts every 9 minutes after reset. Red LED .6 inch digits. Synchronizable with WWV. Alarm with snooze function. Minute set, hour set switches. Time set switch prevents mis-setting. Power out, alarm on indicators. Gray and black cabinet. 5x2x3 inches. 110 VAC, 60 Hz.

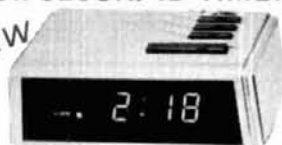

DUAL TUNABLE SSB/CW/RTTY FILTER

MFJ-752B **\$99.95**



Dual filters give unmatched performance! The primary filter lets you peak notch low pass or high pass with extra steep skirts. Auxiliary filter gives 70 db notch. 40 Hz peak. Both filters tune from 300 to 3000 Hz with variable bandwidth from 40 Hz to nearly flat. Constant output as bandwidth is varied. Linear frequency control. Switchable noise limiter for impulse noise. Simulated stereo sound for CW lets ears and mind reject QRM. Outputs for 2 rigs. Plugs into phone jack. Two watts for speaker. Off bypasses filter. 9-18 VDC or 110 VAC with optional adapter, MFJ-1312, \$9.95.

ORDER ANY PRODUCT FROM MFJ AND TRY IT-NO OBLIGATION. IF NOT DELIGHTED, RETURN WITHIN 30 DAYS FOR PROMPT REFUND (LESS SHIPPING).

- One year unconditional guarantee • Made in USA.
- Add \$4.00 each shipping/handling • Call or write for free catalog, over 100 products.

MFJ

MFJ ENTERPRISES, INC.
Box 494, Mississippi State, MS 39762

TO ORDER OR FOR YOUR NEAREST DEALER, CALL TOLL-FREE
800-647-1800. Call 601-323-5869 in Miss. and outside continental USA
Telex 53-4590 MFJ STKV



HAM RADIO OUTLET

YOUR VERY BEST SOURCE

FOR ANY AND ALL AMATEUR RADIO ITEMS

- 6 STORE BUYING POWER ASSURES TOP VALUE
- BIG, COMPLETE STOCKS. GET WHAT YOU WANT WHEN YOU WANT IT.
- MORE SAVINGS BY FREE DELIVERY MOST ITEMS

KENWOOD

TS-930S



PAY REGULAR PRICE OF
\$1599
RECEIVE FREE

AT-930 and MC-60A
ANT. TUNER MICROPHONE
Reg. \$199.95 Reg. \$79.95
PLUS FREE UPS

ICOM



IC-37A

YOUR BEST 220MHz
EQUIPMENT BUY!

REGULAR \$449

SALE! \$299.95

**SPECIAL BUY...
LIMITED QUANTITIES**

YAESU



FT-209RH



FT-757GX



FT-2700RH

NEW!
2M/70CM
TRANSCEIVER

CALL FOR GREAT PRICES

KENWOOD

TW-4000A



PAY REGULAR
PRICE OF **\$599.95**

RECEIVE FREE

ALL THE FOLLOWING

- 1) VS-1 VOICE SYNTHESIZER
\$39.95 VALUE
 - 2) TU4-C SUB-AUDIBLE \$39.95 VALUE
 - 3) MA-4000 DUO-BAND MOBILE ANT
\$44.95 VALUE
- PLUS FREE UPS**

ICOM



R-71A

SUPERIOR GRADE
GENERAL COVERAGE
RECEIVER

Regular \$799

SALE! \$629.95

MIRAGE



AMPLIFIER
SALE

MODEL	BAND	PRE AMP	INPUT	OUTPUT	DC PWR	SALE PRICE
A1015	6M	Yes	10W	150W	20A	\$249
B23S	2M	No	2W	30W	5A	\$79
B215	2M	Yes	2W	150W	22A	\$259
B108	2M	Yes	10W	80W	10A	\$159
B1016	2M	Yes	10W	160W	20A	\$249
B3016	2M	Yes	30W	160W	17A	\$199
C22A	220	Yes	2W	20W	5A	\$89
C106	220	Yes	10W	60W	10A	\$179
C1012	220	Yes	10W	120W	20A	\$259
D24	440	No	2W	40W	8A	\$179
D1010N	440	No	10W	100W	20A	\$289

RC-1 Remote Control for MIRAGE Amplifiers, \$24
MP1 and MP2 Peak Reading Wattmeters, each \$99
Limited quantity at this price.



SALE!

W-51 SALE \$899
LM-354 SALE \$1599

IMMEDIATE DELIVERY

BIRD



MODEL
43

THE LONG
TIME STANDARD
FOR ACCURACY

SLUGS



MOST ITEMS IN STOCK

US TOWER CORPORATION

Formerly Tristao Tower Co.

MA-40 40' tubular
Regular \$745
SALE! \$549

MA-550 55' tubular
Will handle 12 sq. ft. antennas
at 50 MPH winds.

Regular \$1245
SALE! \$899

**IN STOCK FOR
IMMEDIATE DELIVERY**

CALL FOR INFORMATION
ON ALL OTHER MODELS



TUBE SALE!

IN STOCK...
NO WAIT

3-500Z
\$99.95



8877
\$589.95



FREE SHIPMENT

UPS SURFACE (Continental U.S.) (MOST ITEMS)

Prices, specifications, descriptions subject to change without notice. Calif. and Arizona residents please add sales tax.

Store addresses/Phone numbers
are given on opposite page.

6 STORE BUYING POWER

ICOM R-71A



**SUPERIOR GRADE
GENERAL
COVERAGE
RECEIVER**

REGULAR \$799
SALE! \$629.95
PLUS FREE UPS

ICOM



IC-37A

220 MHz's BEST BUY!
REGULAR \$449
SALE! \$299.95
PLUS FREE UPS

ICOM IC-735

A BRAND NEW HF TRANSCEIVER



**WITH ALL THE
FEATURES
THAT MAKE IT
A TRULY
OUTSTANDING
BUY!**

CALL FOR PRICE AND INFORMATION

ICOM IC-751



**TODAY'S MOST ADVANCED
TRANSCEIVER**

REGULAR \$1399
SALE! CALL FOR SPECIAL PRICE

ICOM **HAND-HELDS**

AT GREAT LOW SUMMER PRICES

IC-02AT
IC-04AT



IC-2AT
IC-4AT



IC-3AT



CALL
NOW!

LATEST **ICOM** EDITION
IC-3200A DUAL BANDER
COVERS BOTH 2 METERS and 70CM



NEW!
CALL FOR PRICE
AND INFORMATION

**PERSONALIZED
SERVICE**



BOB FERRERO, W6RJ
President

JIM RAFFERTY, N6RJ
VP, So. Calif. Div., Anaheim
Managers

GEORGE, WB6DSV, Burlingame
DON, N6IPE, Oakland

BOB, K7RDH, Phoenix
GLENN, K6NA, San Diego

AL, K6YRA, Van Nuys
and other active amateurs to serve you.

FREE SHIPMENT
UPS SURFACE (Continental U.S.) (MOST ITEMS)

TOLL-FREE PHONE
INCLUDING ALASKA AND HAWAII

800-854-6046

CALIF. AND ARIZONA CUSTOMERS CALL OR VISIT NEAREST STORE

PHONE HOURS: 9:30 AM to 5:30 PM PACIFIC TIME.
STORE HOURS: 10 AM to 5:30 PM Mon. through Sat.

**HAM
RADIO
OUTLET™**

ANAHEIM, CA 92801

2620 W. La Palma,
(714) 761-3033, (213) 860-2040,
Between Disneyland & Knotts Berry Farm.

BURLINGAME, CA 94010

999 Howard Ave.
(415) 342-5757,
5 miles south on 101 from San Francisco Airport.

OAKLAND, CA 94609

2811 Telegraph Ave.,
(415) 451-5757,
Highway 24 Downtown. Left 27th off-ramp.

PHOENIX, AZ 85015

1702 W. Camelback Road,
(602) 242-3515,
East of Highway 17.

SAN DIEGO, CA 92123

5375 Kearny Villa Road,
(619) 560-4900,
Highway 163 and Clairemont Mesa Boulevard.

VAN NUYS, CA 91401

6265 Sepulveda Blvd.
(818) 988-2212
San Diego Freeway at Victory Boulevard



ICOM, IC-02AT, IC-04AT, IC-2AT, IC-4AT, IC-3AT, IC-735, IC-751, IC-3200A, R-71A, IC-37A, and other active amateurs to serve you. Prices, specifications, descriptions subject to change without notice. Calif. and Arizona residents please add sales tax.

THE ULTIMATE CONTACT . . .
MAKE IT WITH **ROBOT**TM COLOR SSTV

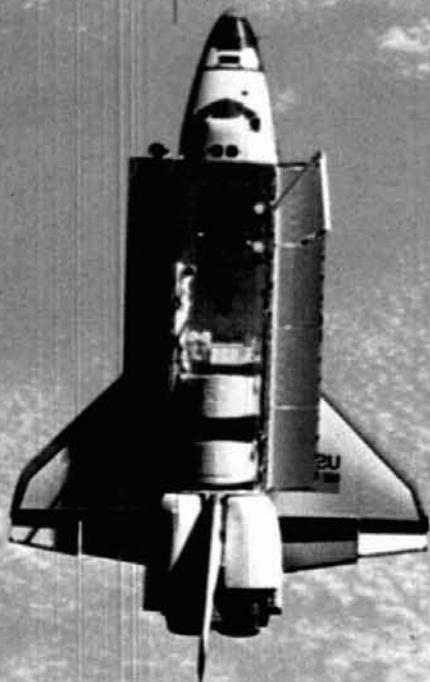

ROBOT

ROBOT RESEARCH, INC.
7591 Convoy Court
San Diego, California 92111
Phone (619) 279-9430

Step aboard the Shuttle from your shack with the world's most advanced slow scan video system!

YES! Tell me about how I can participate in SSTV aboard the Space Shuttle.

NAME

CALL

ADDRESS

CITY/STATE

ZIP

ELECTRO-SCAN 85

The most
trouble free
Dish Positioner on
the market today.

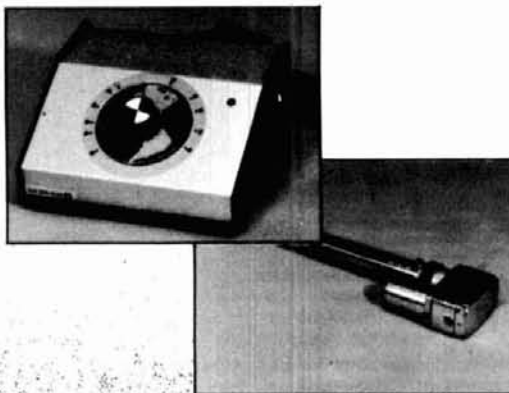

Features

- Economical
- Lock and Key
- 36 volt DC motor
- Precise positioning
- Analog Micro Systems
- 1 year limited warranty
- State-of-the-art circuitry
- LED to indicate dish movement
- Available in 18" or 24" ball actuators
- Modern, attractively styled control box
- Dial control always showing dish location
- Dial channels same as in program listings

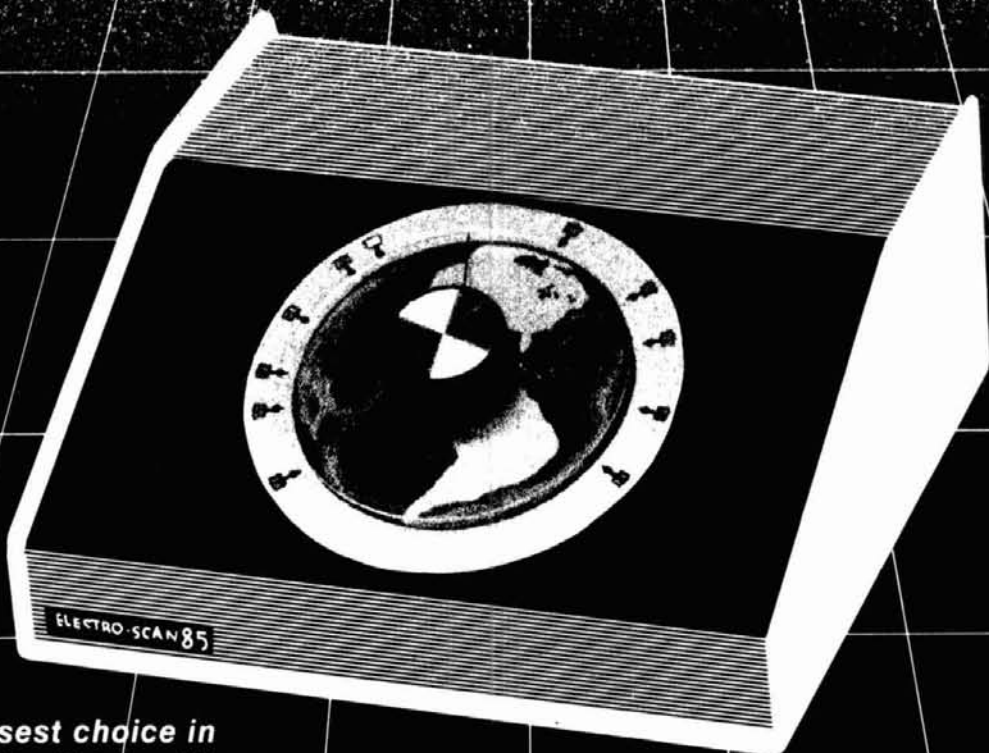

*Your wisest choice in
automatic dish positioners.
To learn more about the finest
in low cost, high performance -
dish positioners, contact...*

ELECTRO-COM
DIST. SALES

8459 North Main Street • Suite 112 • Dayton, Ohio 45415 • Phone (513) 454-0232

— For the Best —

**HF, VHF, UHF, SSB,
FM, RTTY, PACKET,
CW, ASCII & AMTOR**



IC-37A 220 MHZ COMPACT MOBILE

25 Watts, 32 PL Frequencies Standard Built-in, 9 Memories with Offset and PL Storage, 10 KHz/5 KHz Dial Steps, Memory Scan, Band Scan, and Priority Scan, Dual VFO's and Standard HM-23 Touchtone.



IC-27A COMPACT MOBILE

A breakthrough in 2-meter mobile communications! Most compact on the market (5½"W × 1½"H × 7"D), contains internal speaker for easy mounting, 25 watts, 32 PL frequencies, scanning and touchtone microphone.



**4' LIGHTWEIGHT FLEXIBLE
ANTENNA ADAPTOR
CABLE**

IC-02AT HANDHELD

The IC-02AT 2-meter LCD readout handheld features 10 memories, 32 PL tones, scanning keyboard frequency entry, dial lock, 3W standard, 5W optional, DTMF.

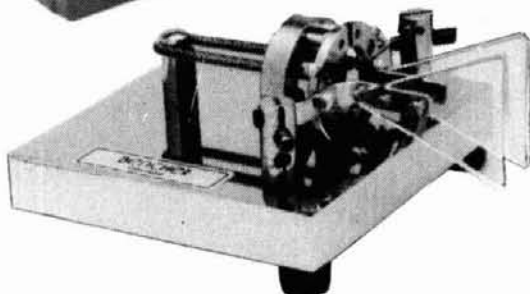

Bencher PADDLE

This is the paddle that provides the perfect interface between the CW operator and his rig. Smooth, instantly responsive and fully adjustable to suit your own touch. From the gold plated solid silver contacts to the heavy leaded steel base, it truly is the ultimate.



**THE R3 NO RADIAL VERTICAL
FOR 10-15-20 METERS**



C & A ROBERTS INC.

18511 HAWTHORNE BOULEVARD
TORRANCE, CALIFORNIA 90504
(213) 370-7451 (Calif.) • (800) 421-2258

REMEMBER WE SHIP
(UPS Brown - Cont. U.S.A.)

8/84

STORE HOURS: 10:00 a.m. - 5:30 p.m. MONDAY THRU SATURDAY

THE 2-METER CHANNEL SPACING ISSUE MAY RESULT IN A CONFRONTATION that could leave Amateur Radio with some bad long-term wounds. Repeater operators from the mid-Atlantic and New England states met March 2 to strongly endorse 15 kHz spacing not only for 146-148 MHz, but even possibly for 144.5-145.5 MHz as well, thus picking up another six channels. In a similar action southern California's 2-Meter Area Spectrum Management Association met March 23 to also endorse 15 kHz spacing across the whole band, despite serious interest in northern California in shifting to 20 kHz as their neighbors in Oregon and Washington have done. By their action the southern California group's decision puts them in direct conflict with Mexican Amateurs, whose government has mandated 20 kHz on the 2-meter band. It's believed that Mexican representatives who attended that meeting may even ask their government to lodge a formal objection with the U.S. State Department.

20 kHz Proponents Seem Equally Determined In Their Choice, with Texas the latest in a number of western states to endorse the change. Michigan was the first state east of the Mississippi to adopt 20 kHz, and it's under heavy pressure to reconsider. Alabama is reported to have voted to implement 20 kHz by July 1, but Missouri opted to stay at 15 kHz at a February meeting. Midwestern repeater representatives plan to meet at Dayton for further discussions.

Despite The FCC's Strong Desire For A National Coordinator, formalized in PR Docket 85-22, the escalating 15 vs 20 kHz conflict seems to offer little hope for simple or early resolution of the increasing number of repeater conflicts that led to that NPRM. Indeed, the FCC may even be asked to endorse 15 kHz through a Petition for Rule Making. Such a move was considered by the East Coast group at its recent meeting in support of 15 kHz. However, it is hard to see how such a petition would find any support at all within the Commission, which is trying very hard to get away from regulating details of Amateur operations. Furthermore, in this case such an FCC mandate would put it in direct conflict with the Mexican government and thus risk diplomatic repercussions.

AMATEUR RADIO PROBABLY WON'T FLY ON THIS SUMMER'S SPACE SHUTTLE, according to late word from NASA. The official reason is problems of integrating the exotic Amateur equipment that Tony England, W00RE, was to use on Flight 51F with shuttle equipment. Though strong last-ditch efforts are being made to salvage the Amateur operation, at presstime it looks very much like there won't be an Amateur operating from space this year.

AMATEUR RADIO VS CABLE TV IS YET ANOTHER CONFRONTATION that seems to be escalating. In late February the FCC proposed in Mass Media Docket 85-38 that cable TV radiation limits be relaxed by another 8 dB, to 50 microvolts per meter, and that various other restrictions including the requirement for annual system inspections be dropped. In view of the number of Amateurs who've had problems with cable leakage interfering with their 144 or 220 MHz operations, this proposal presents a real threat to Amateur Radio. Comments were due in late March. Amateurs have a strong ally against the proposal in the broadcast industry.

Amateurs Have Been Shut Down Due To Cable Interference in two recent unrelated cases. In the first, WB20TK/4 was ordered off the air by the Engineer-In-Charge of the FCC Atlanta Field Office for interference with the Greenville, S.C., cable system. FCC Amateur rule 97.73(d) on interference to other stations was cited, despite checks that showed the cable system was so badly maintained that a 150 mW hand-held's signal caused problems for viewers. The FCC inspected WB20TK's station but did not even contact the cable operator in an apparent violation of the FCC's own rules requiring a cable system to take responsibility for resolving interference problems. In the other case, WB4NMA was shut down, again by the Atlanta Field Office, for interfering with cable viewers in Gainesville, Georgia.

2-Meter Privileges Were Restored To Both Operators following the intervention of the ARRL through its General Counsel Chris Imlay, N3AKD. However, the Commission's proposed cable rules relaxation combined with the kind of FCC Field Office attitude that led to these two cases could spell serious trouble for future Amateur Radio VHF/UHF operation.

BASH EDUCATIONAL SERVICES IS OUT OF BUSINESS. Writing to subscribers to his FCC Rules Part 97 update service, Dick Bash, KL7THP, stated that his FCC exam study materials business had subsidized the rules updating service but, under the volunteer exam program, there was no longer a unique niche in training for him to fill. Bash was very controversial for his publishing of word-for-word correct answers to all FCC-administered Amateur exams.

A SUGGESTION THAT ARRL ASSUME CALLSIGN ASSIGNMENT RESPONSIBILITY is receiving some interest in Washington, as the FCC looks at tighter budgets. It's likely, however, that callsign responsibility would be delegated only as part of a total program that would include the entire licensing function now done by FCC's Gettysburg facility.

THE ANTENNAS VS LOCAL RESTRICTIONS ISSUE seems to be heading toward an FCC Notice of Proposed Rule Making, which will probably consider it from the private satellite dish viewpoint. Just what this means for PRB-1 and Amateur Radio remains to be seen.

NEW WARC BAND AVAILABILITY HAS BEEN DELAYED by at least three months. An extension of the Reply Comment period, requested by the Personal Radio Steering Group, bumped expected action on the 10, 24, and 902 MHz bands off the FCC's first quarter agenda. The PRSG is believed to be pushing for allocation of part of 902-928 MHz to a Personal Radio Service.

A NATIONAL VEC NET IS OPERATING on 20 meters Sundays, starting at 1700Z. The 40-meter mid-western VEC net has moved to 1800Z, still on 7280 kHz. DeVry is now officially a national VEC.

Get those
demons
downing
your
electronic
gear!



Nothing matches the MACC in voltage surge protection and component-by-component on-off control

- compact, attractive desk-top console
- eight clean AC power outlets
- individual and master on-off control
- superior three-stage auto-restore circuit with manual reset circuit breaker
- individually lighted rocker switches

Lightning striking miles away, electric motors running on the same power line, fluorescent lighting and even wind-driven snow static buildup can cause problems with delicate circuits and miniature electronic chips. But the MACC, within nanoseconds, can recognize the current disturbance, then clip it off and dissipate it, while maintaining clean current flow to your system's equipment. The MACC protects all semi-conductor, solid-state circuitry. The MACC is designed with three 2000-amp surge discharge protection circuits — one between each of the AC input's hot, neutral and ground lines. Other surge devices may use a single 100-amp surge protector between the hot and neutral lines only. Its resettable circuit breaker adds further protection.

MACC gives you control convenience, too. It provides 8 plug-in "U" ground outlets for your components — including one "hot" outlet for a continuously powered application such as your clock. Seven "on/off" rocker switches let you control individual components. And you can turn your entire system on or off with a single master rocker switch.

ALPHA DELTA'S MASTER AC CONTROL CONSOLE PROTECTS AGAINST ALL THESE DAMAGING SURGE PROBLEMS

Problems caused in circuitry by surging and transient voltages:

- Melting of "hot spots" within semi-conductor devices
- Thermal runaway of transistors
- Welding, pitting and metal transfer on switch contacts
- Switch contact corrosion
- Insulation breakdown causing arcing of components
- Shortening of component life

The MACC is tested to IEEE pulse standards and rated at 15A, 125V-AC, 60 Hz, 1875 watts continuous

duty total for the console. A label on the unit describes the surge protection limitations.

MACC Specs

Alpha Delta Master AC Control Console

Amperage 15
Volt (AC) 125
Hertz 60

Total
Wattage 1875

Size
MACC 11" x 2-3/4" x 2-3/4"
MACC-4 5-1/2" x 2-3/4" x 2-3/4"

Shipping
Weight 4-1/2 lbs. approximately

Alpha Delta Model MACC Systems are designed to reduce the hazards of lightning-induced surges. These devices, however, will not prevent fire or damage caused by a direct stroke to an AC line or a structure. Specifications, availability and price are subject to change without notice.

Warranted against defects in materials or workmanship.

ALPHA DELTA COMMUNICATIONS, INC.

P.O. Box 571, Centerville, Ohio 45459 • (513) 435-4772



current solutions to current problems

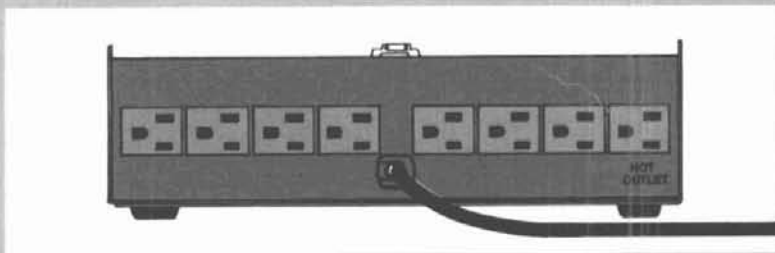
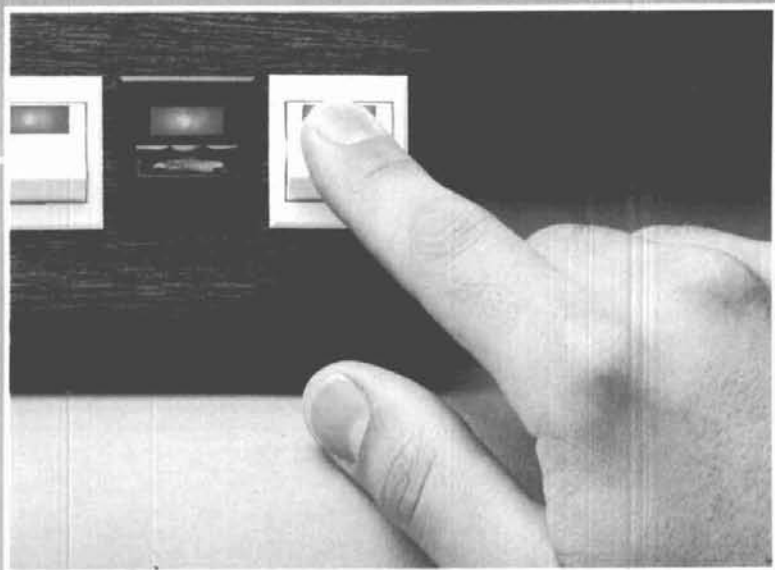
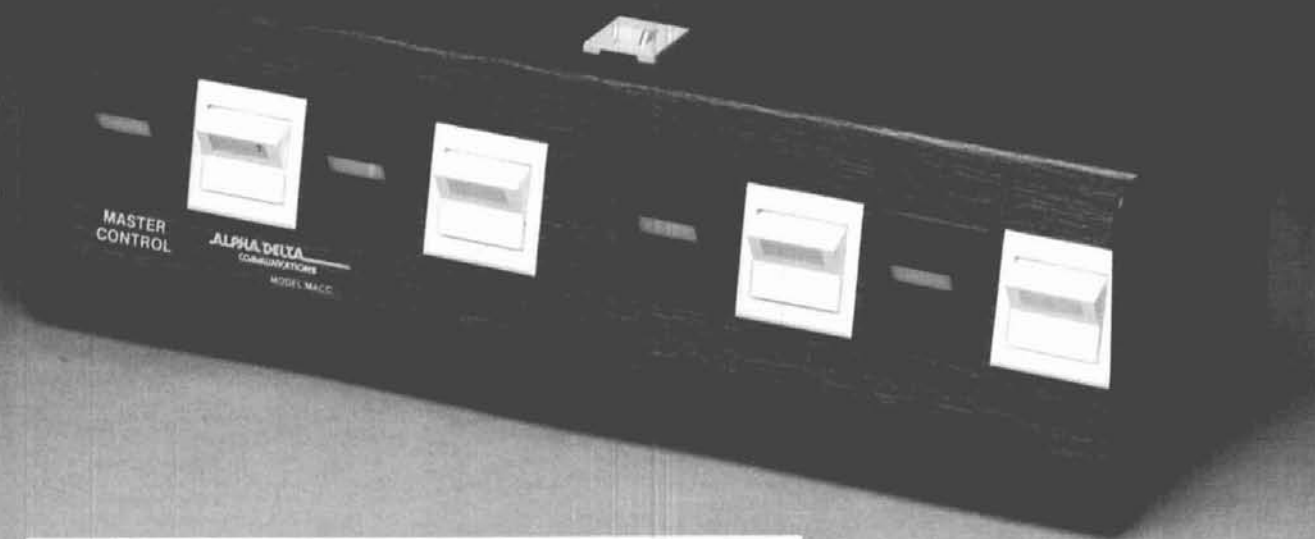

The MACC is unique in voltage surge/transient suppression and convenient, desk-top individual component control. Nothing matches the MACC in value and performance. Put one on duty on your AC line.

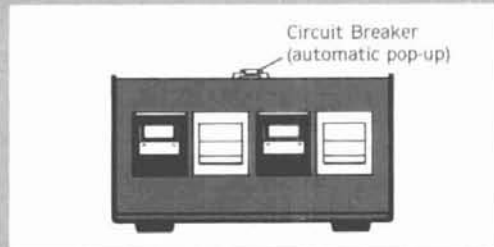

MACC only \$79.95
MACC-4 only \$59.95



At your Alpha Delta dealer. Or in U.S., order direct, adding \$4 for postage/handling to check or money order. (Approx. shipping wt.: 4-1/2 lbs. each) MasterCard and VISA accepted. Ohio residents add Sales Tax. Sorry no C.O.D.'s

The MACC-4 is a four clean-line output version of the MACC with all the same features. It gives you a cost- and space-saving solution for your application, without sacrificing performance. Rated a full 1875 total wattage. Includes master rocker switch, three independently switchable lines, one "hot" line and resettable circuit breaker.

RAG

ELECTRONICS, INC.

New and Used Electronic Test Equipment
Sales • Service • Rental • Leasing

■ Polaroid DS-34

Now you can get an instant picture in black & white or color from any oscilloscope screen. Includes CRT hood.
*Large hoods also available to fit computer terminals and CAD/CAM screens.

\$369.00



LEADER

Audio Sine/Square Wave Generator

- Distortion from <0.03%
- 10 Hz to 1 MHz

\$259.00



LAG-120B



BK PRECISION

FUNCTION GENERATOR

\$189.00

MODEL 3010

- Sine, square and triangle output
- Variable and fixed TTL outputs
- 0.1 Hz to 1 MHz in six ranges
- Typical distortion under 0.5% from 1 Hz to 100 KHz
- Variable DC offset
- VCO input for sweep tests

POWER SUPPLIES

GLOBAL SPECIALTIES TRIPLE OUTPUT POWER SUPPLY



MODEL 1301

\$198.00

- Fully regulated triple output
- Fixed 5VDC, 1A
- V1 + 5 VDC to 18 VDC .5A
- V2 - 5 VDC to 18 VDC .5A
- Fully automatic current limiting

BK PRECISION

TRIPLE OUTPUT POWER SUPPLY



MODEL 1650

\$319.00

- Functions as three separate supplies
- Exclusive tracking circuit
- Fixed output 5 VDC, 5A
- Two 0 to 25 VDC outputs at 0.5A
- Fully automatic, current-limited overload protection
- + and - terminals of each output are fully isolated, in all modes
- All three outputs may be connected in series or parallel for higher voltage or current

ELECTRO INDUSTRIES INC. Precision Test Instruments

DC POWER SUPPLY



\$125.00

MODEL 3002A/0-30 VDC/0-2A

VIZ

MULTI-FUNCTION COUNTER



MODEL WD-755

- 5 Hz to 125 MHz
- 8 Digit LED Display
- Period Measurement 5 Hz to 2 MHz
- Totalizes to 99,999,999 Plus Overflow
- Frequency Ratio Mode
- Time Interval Mode
- Switchable Attenuator & Low Pass Filter

\$259.00

PROBE MASTER

Oscilloscope Probes

MODEL	ATTENUATION	BAND WIDTH (MHZ)	PRICE
2904	10X	100	\$35.00
2901	10X/1X	100/5	\$39.00
2205	10X	250	\$59.00
2960	10X	60	\$30.00

STACO

VARIABLE TRANSFORMER

\$145.00



MODEL 3PN1010V

RAG CARRIES THE COMPLETE STACO VARIABLE TRANSFORMER LINE
CALL US WITH YOUR REQUIREMENTS.

DIGITAL CAPACITANCE METER



- Battery operated
- 3 1/2 digit LCD display
- Range 1 PF to 2,000 UF
- 0.2% basic accuracy

GLOBAL
MODEL 3000
\$139.00

CALL US TOLL FREE
1-800-732-3457
IN CALIFORNIA TOLL FREE
1-800-272-4225

- Master Charge
- VISA ■ COD
- Money Order
- Check



COD's extra (required 25% deposit) over \$1000.00 \$15.00

ADD FOR SHIPPING AND INSURANCE
\$0 to \$250.00 \$4.50
\$251.00 to \$600.00 \$6.50
\$601.00 to \$750.00 \$8.50
\$751.00 to \$1000.00 \$12.50
over \$1000.00 \$15.00

RAG ELECTRONICS, INC. / 21418 Parthenia Street / Canoga Park, CA 91304 / 1-818-998-6500

SCOPE SPECTACULAR



PORTABLE OSCILLOSCOPES

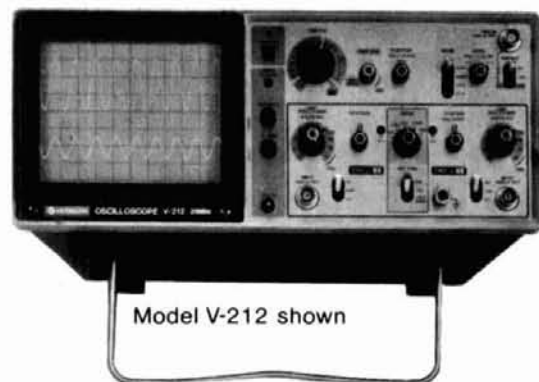

Model V-212 shown

MODEL V-212 \$461.00
DC to 20 MHz, 1 mV/div, Dual Trace
Features 6" Rectangular CRT
Full 2 year parts and labor warranty (w/two X10 probes).

MODEL V-222 \$536.00
DC to 20 MHz, 1 mV/div, Dual Trace, D.C. offset for DMM Output, Verticle Mode Trigger
6" CRT (w/two X1/X10 probes).

MODEL V-422 \$694.00
DC to 40 MHz,
other features same as V-222 (w/two X1/X10 probes)



Model V-1050F shown

MODEL V-1050F \$1276.00
DC to 100 MHz, .5 mV/div, Quad Trace, Delayed Sweep, Full T.V. Triggering, alternate time base (w/two X10 probes)

MODEL V-650 \$956.00
DC to 60 MHz, 1 mV/div, tripple trace, delayed sweep, Full T.V. Triggering, variable trigger hold-off (w/two X10 probes)



PORTABLE OSCILLOSCOPES



MODEL SS-5702 \$535.00
DC - 20MHz, 5 mV/div
Dual trace
6 inch rectangular internal graticule CRT.
Includes 2 each X1/X10 probes and full factory warranty; 2 years on parts, labor and CRT.

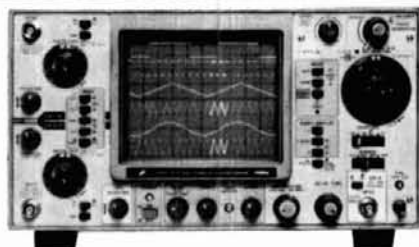

MODEL SS-5705 \$899.00
DC to 40MHz
Vertical and horizontal deflection accurate within $\pm 2\%$. CRT acceleration voltage 12KV. 3 channels, 6 traces. High precision calibrator ($\pm 1\%$). Fastest sweep rate: 10 ns.

- High sensitivity 1 mV/div
- CH1 signal output
- Beam finder
- Delayed sweep
- Alternate time base
- 2 ea. X1/X10 Probes

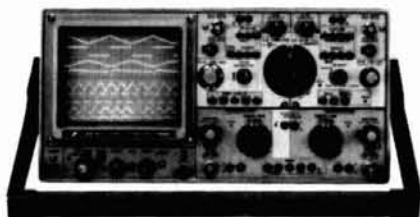

MODEL 5711 \$1695.00
DC to 100MHz (typically over 120 MHz), 5 mV/div, True 4 channel input, eight trace, Delayed sweep, alternate time base, CRT acceleration voltage 20 KV, (w/saddle bag, front cover, 2 ea. X10 probes).

MODEL 5711 D \$2495.00
'5711 with counter and DMM).

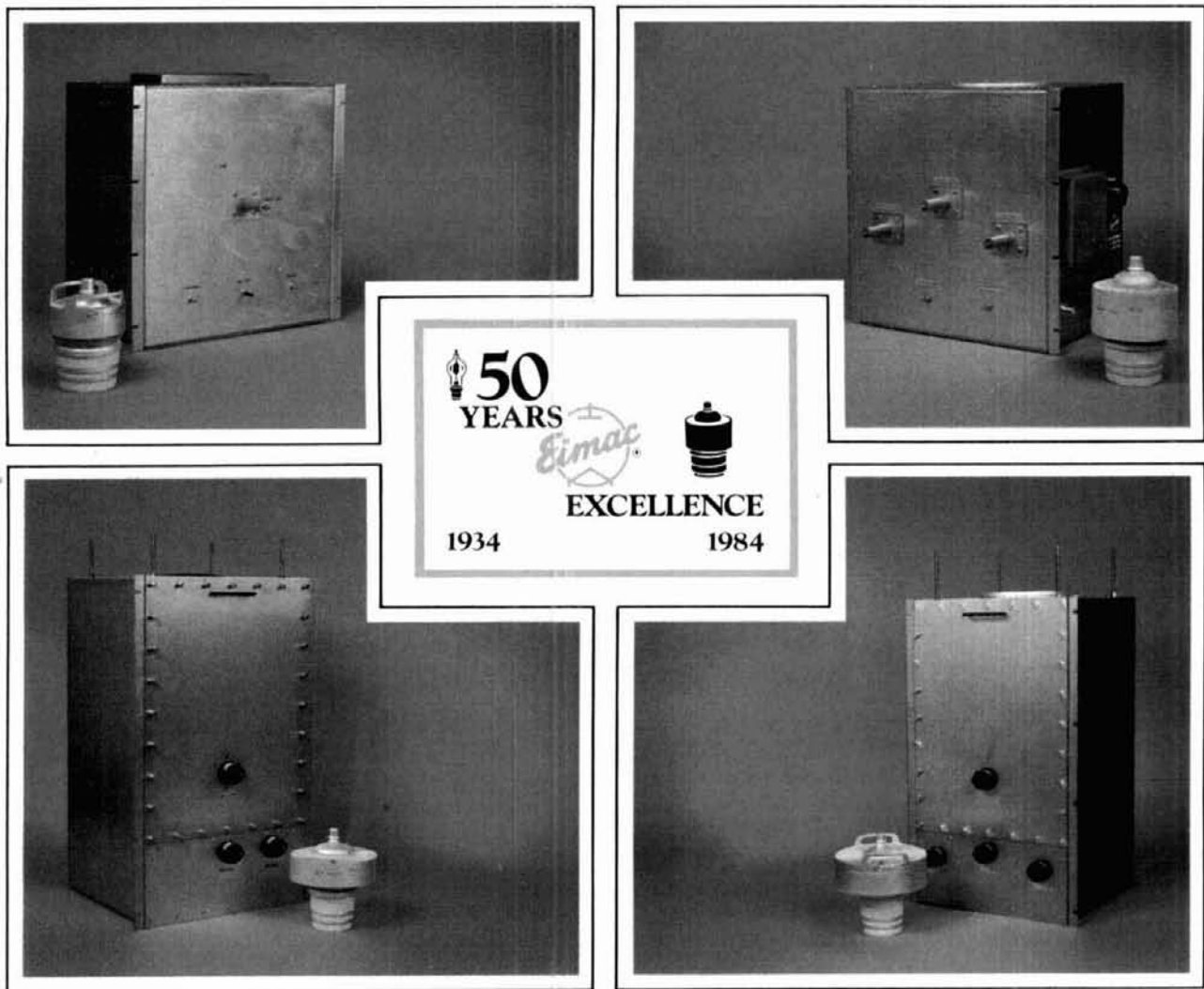

EIMAC celebrates its 50th Anniversary with an extensive line of FM Broadcast Cavity Amplifiers.

Varian EIMAC celebrates 50 years of service to the broadcast industry with a spectrum of FM from a powerful 60 kW to a mini power 150 W solid state IPA.

The cost-effective path to a modern FM transmitter.

No one knows more about broadcast tubes and cavities than EIMAC. Our strong cavity development capability reduces RF engineering problems. EIMAC cavities are inexpensive and simple to use.

For more information call or write Varian EIMAC or contact any Varian Electron Device Group sales office worldwide.

EIMAC FM BROADCAST CAVITY PRODUCT LINE

POWER	CAVITY	EIMAC TUBE
60 kW	CV-2230	4CX30,000G
30 kW	CV-2202	4CX20,000C
25 kW	CV-2200	4CX20,000A
15 kW	CV-2210	4CX12,000A
10 kW	CV-2228	4CX7500A
5 kW	CV-2225	4CX3500A
1.5 kW	CV-2220	3CX1500A7
150 W	AM-2215A	Solid State

Varian EIMAC
301 Industrial Way
San Carlos, California 94070
Telephone: 415-592-1221

Varian AG
Steinhauserstrasse
CH-6300 Zug, Switzerland
Telephone: 042-23 25 75



When we set out to make the best amateur radio equipment in the world, we had some pretty tough standards to live up to ...



... yours

... and ours.

So we designed the **RC-850 Repeater Controller**, the industry's top of the line repeater control system. Now in it's "third wave" of innovation, thanks to its designed for the future architecture and new software releases. The '850 defines the industry standard in repeater control systems.

- Fully remotely programmable with Touch-Tone commands or computer terminal
- Front panel LED display, or terminal based display
- Over 300 word customized male and female speech synthesis vocabulary
- Time/day of week Scheduler with 10 set-up states, 30 changeovers and events, over 100 scheduled items for hands off operation and automatic reminders.
- Full or half duplex autopatch, autodial (200 numbers), emergency autodial, reverse autopatch, antidiater, toll restrict including telephone exchange tables, supports remote and multiple phone lines
- Informative remotely programmable ID's (17), tail messages (13), bulletin boards (5)
- 16 channel voice response analog metering, automatic storage of min/max values on each channel, values may be read back on command or may be included in any programmable messages
- Supports synthesized remote base transceivers and full duplex links
- Individual user access codes to selectable features
- Mailbox for user-to-user, and system-to-user messages
- Paging - two-tone, 5/6 tone, DTMF, CTCSS, HSC display, GSC digital display, user commandable and may be included in programmable messages (i.e. alarms)
- Logical to physical I/O mapping and internal "toolbox" for easy customizing of the controller to meet your needs and minimize external wiring
- Easy hookup to any repeater

Our new **Digital Voice Recorder** lets you remotely record ID's, tail messages, and various other response messages for automatic playback through your repeater. Audio is stored digitally with no-compromise reproduction quality in up to eight megabits of memory. The DVR can support up to three independent repeaters for a low per-channel cost. Its Touch-Tone activated voice mailbox lets your users easily record messages for other users when they aren't around.

QST: Attention All Hams

If you own a shack, you should know about ShackMaster™

ShackMaster lets you carry your home station with you in the palm of your hand. It acts as your gateway to the world, linking your handheld transceiver to your high performance HF station. Now, instead of your valuable home equipment being available to you 1% of the time, it's available 99% of the time! Whether around the house, in the yard, or across town, ShackMaster let's you take it with you.

But that's just part of ShackMaster's story. It lets you communicate with the family by handling third party traffic - its electronic mailbox and intercom let you keep in touch. And a simplex patch lets you place important calls directly through your home phone.

- Crossband linking - VHF/UHF to HF
- Telephone access to your home station
- BSR Home Control interface
- Electronic Mailbox
- ShackPatch™ intercom into the shack
- PersonalPatch™ simplex autopatch

If your repeater budget can't afford the '850, we offer the **RC-85 Repeater Controller**, which we like to call the "second best repeater controller in the world". It's a scaled down, simplified version of our '850, but overall, it offers more capability and higher quality than anyone else's control equipment at any price.

- Remotely programmable with Touch-Tone commands
- Over 175 word customized male speech synthesis vocabulary
- Selectable "Macro sets" for easy control operator selection
- Autopatch, autodial (200) numbers, emergency autodial, reverse patch
- Remotely programmable informative ID's (7), tail messages (3), bulletin board (2)
- Supports synthesized remote base transceiver, control receiver, alarm
- Selectable, informative courtesy tones
- Talking S-meter, Two-tone paging
- Easy hookup to any repeater

For those who like to "roll their own", we can get you off to a rolling start with our **ITC-32 Intelligent Touch-Tone Control Board**. Much more than just a decoder, it's a mini-control system of its own, with the basic repeater and remote base functions built-in. And it can be tailored by you with its Personality Prom.

- 28 remotely controllable latched or pulsed logic outputs
- 4 alarm or remote sensed logic inputs
- Response messages to confirm command entry
- Repeater functions including COR, IDer, timers, courtesy tone, etc.
- Remote base functions including control of synthesized transceiver

- Remotely recordable, variable length audio tracks, accessed from controller messages
- Top quality, no compromise audio reproduction
- Supports up to three repeaters for cost effective installation
- Expandable to roughly 6 minutes of speech in 8 megabits of memory
- Easy interface to RC-850, RC-85 controllers, or to any stand-alone repeater

All our products are designed and manufactured with industrial grade reliability. Little things that many people don't notice, like machine contact IC sockets for all ICs, gold on gold signal connectors, high performance CMOS for minimum power drain, and transient suppression. And the products are documented with high quality, easy to read manuals. Our goal is to advance the state of the repeater art. But most of all, our products put the FUN back into the FUN MODE!



To order one of these advanced control products, call 408-749-8330 and speak with Tim or Catherine. Visa and Mastercard accepted. Technical manuals are available for purchase and the amount paid is applied as a deposit on the equipment. For specifications and a copy of our ACC Notes newsletter, just write or send in your QSL card to:

acc advanced computer controls, inc.

10816 Northridge Square • Cupertino, CA 95014

(408) 749-8330

stacking Yagis is a science

Determining E/H plane patterns results in optimized performance

Several years ago I began a project designed to develop a means of determining gain of a particular 144 MHz Yagi. Knowing that number, I would be able to calculate the aperture. Once the aperture was known, I would know the correct stacking distance and would then be able to build the perfect 144-MHz array.

As one might expect, things didn't quite work out as planned. But eleven years and seven EME arrays later, I believe I have found an improved method of determining the optimum stacking distances for multiple Yagi VHF and UHF arrays.

what is optimum stacking?

"Best array performance" is a matter of opinion, and depends on how the antenna is used; an array can be optimally stacked, for example, to deliver maximum gain, or for a controlled azimuthal pattern that produces a deep null in the direction of interference. This

table 1. Typical temperatures of "objects" at 144 MHz and 432 MHz.

object	144 MHz degrees K	432 MHz degrees K
cold sky	175	10
hot sky	3,200	190
earth	290	290
arcing power line	100,000	6,000

article primarily addresses Yagi stacking for use in EME (Earth Moon Earth or moonbounce) communications. However, this technique is also appropriate for other space communications applications such as satellite communications and radio astronomy. It could also be used for land-based communication requiring high gain such as tropospheric scatter.

For EME and other weak-signal VHF/UHF work, optimum stacking distance can be defined as that distance which yields the greatest array gain versus lowest array temperature. Used by professional space communications engineers, this definition refers to maximizing the G/T ratio. With Yagis, the best G/T usually never occurs at the distance which yields maximum stacking gain. It normally occurs at significantly closer spacing. In simpler terms, optimum stacking distance is that stacking distance which yields the greatest array gain increase while simultaneously keeping all sidelobes at an acceptable level.

the effect of antenna temperature

Several good sources of information are available for those unfamiliar with the concept of antenna temperature.^{1,2} To review, antenna temperature is the temperature of the object at which the main lobe of the antenna is pointed — i.e. the Earth, Moon, Sun, hot sky, or cold sky. However, if the array has sidelobes of significant area and amplitude, unwanted noise can be picked up from noise sources in the direction in which the sidelobes are pointed. This unwanted noise reception will increase the net antenna temperature. (Table 1 lists typical temperatures of several "objects" at 144 MHz and 432 MHz.) A 432-MHz array with large sidelobes pointed at the Earth will suffer a significant receive signal-to-noise loss because of the reception of Earth noise; likewise, a 144-MHz array with sidelobes directed toward a hot sky or a leaky power line will experience a similar degradation in receive performance.

By Steve Powlishen, K1FO, 816 Summer Hill Road, Madison, Connecticut 06443

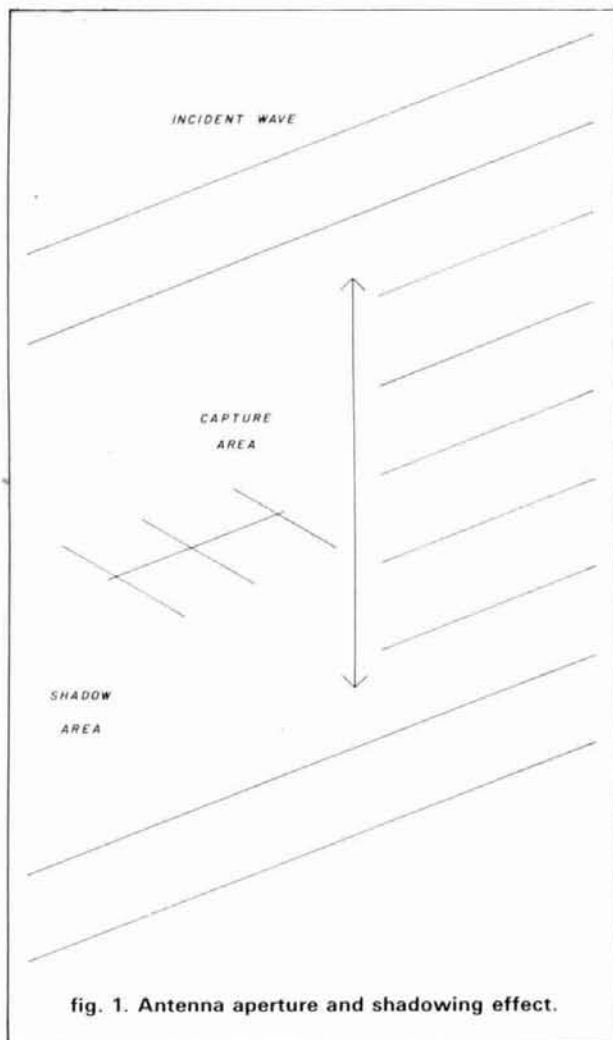

fig. 1. Antenna aperture and shadowing effect.

As a point of reference, commercial satellite Earth station antennas that use parabolic dish antennas with Cassegrain or Gregorian subreflector systems have antenna temperatures as low as 18 degrees K. In comparison, an Amateur dish using a simple dipole or horn feed at 432 or 1296 MHz has a typical antenna temperature of 65 degrees K, while a 16-Yagi 432-MHz array with the Yagis spaced for maximum gain may have an array temperature over 170 degrees K (or even worse if low-loss phasing lines are not used). Conversely, stacked 432-MHz EME Yagi arrays incorporating optimized stacking distances have been built to provide array temperatures lower than 85 degrees K — including phasing line losses. These antenna temperatures were measured by pointing the antenna at the Earth and then at the cold sky and comparing the noise ratios. The noise contribution due to the receiver can then be factored out if the receiver system noise temperature is accurately known. The significance of the lower array temperature cannot be overstated. If we assume a high performance receiver with a 0.45

dB system noise figure, lowering a 432 MHz array temperature from 170 degrees K to 85 degrees K results in a receive signal-to-noise improvement of about 2.3 dB or almost the equivalent of doubling the array size! These results have been obtained using standard Yagi designs such as the NBS Yagis and the K2RIW 19-element Yagi. I expect further improvements can be obtained when Yagis designed with best G/T in mind are available to Amateurs.

methods of determining optimum stacking distances

There are three methods of determining optimum stacking distances. The first method to be examined briefly, is based on classic antenna theory. The second, which will be emphasized, is experimental. Computer analysis, currently used by the professional community is the third, and will not be discussed here. With programs for Yagi analysis now readily available to the Amateur, it is hoped that the more mathematically inclined and computer-knowledgeable Amateurs will carry on where this article leaves off and extend computer modeling to include optimum stacking.

The concept of antenna directivity, (fig. 1), put forth by Kraus³ and introduced to Amateurs by Orr and Johnson,⁴ holds that all antennas have an effective capture area, or area around the antenna that "captures" or extracts the electromagnetic energy from space. The higher the gain of the antenna, the

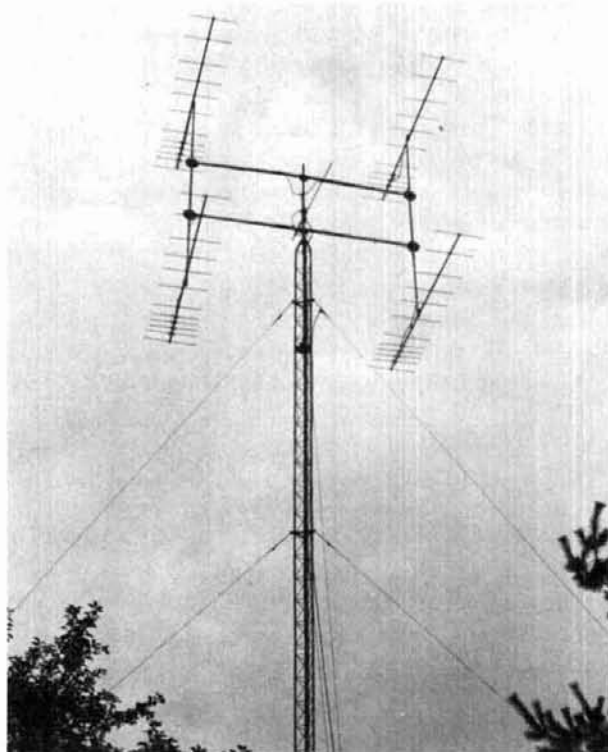

Four 12-element LPYs stacked on a telescoping H-frame.

larger the area from which energy will be extracted. Behind the antenna there will be a shadow area, or space where the field strength of the incident wave is reduced in magnitude. (This concept is analogous to putting an object in front of a light source and creating a shadow behind it.) In mathematical terms the capture area is directly proportional to gain and is defined in eq. 1.

$$A_{em} = 0.13 \cdot 10^{dBd/10} \quad (1)$$

Where A_{em} is the effective capture area in wavelengths squared and dBd is the gain of the antenna in decibels over a half wave dipole. For antennas such as Yagis, which have an elliptically shaped aperture, the size of the effective aperture will be slightly different between the E and H planes. The aperture dimensions in wavelengths squared can be calculated by using eqs. 2 and 3.

$$A_H = 2 \sqrt{\frac{A_{em} \cdot \theta_E}{\pi \cdot \theta_H}} \quad (2)$$

$$A_E = 2 \sqrt{\frac{A_{em} \cdot \theta_H}{\pi \cdot \theta_E}} \quad (3)$$

Where A_E is the E-plane aperture dimension, A_H is the H-plane aperture dimension, θ_E is the E-plane half power beamwidth, and θ_H is the H-plane half power beamwidth.

There are two problems with using these formulas to calculate stacking distances. First, an antenna's aperture is not an ellipse with a clearly defined boundary, with radio waves being extracted on one side of the boundary and nothing happening on the other side. Instead, an antenna progressively extracts less and less energy from space continuously. In addition, the half power beamwidths of an antenna are merely a point on the field strength gradient of the antenna. Therefore, proper stacking distance becomes a question of determining where two *unclearly* defined volumes separate. It is not a solid boundary like a brick wall.

The second problem, largely self-inflicted by Amateurs eager to believe they could defy the laws of physics and discover something that antenna engineers could not, is that of believing inflated gain figures produced by both Amateurs and some manufacturers of Amateur antennas. (In defense of Amateur equipment manufacturers, their claims are restrained in comparison to their CB and home TV counterparts). Using these optimistic gain claims, which in some cases are typically 3-dB high, leads to arrays which have grossly oversized stacking dimensions. The gain figures shown in the recommended stacking distance

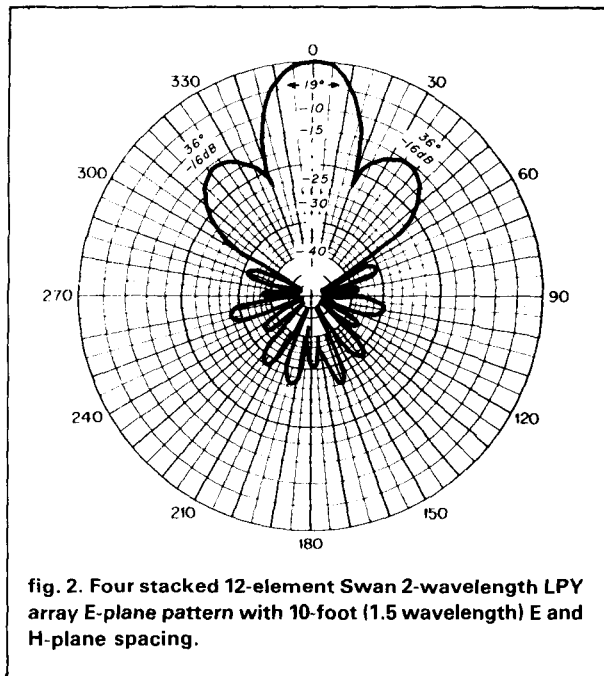

fig. 2. Four stacked 12-element Swan 2-wavelength LPY array E-plane pattern with 10-foot (1.5 wavelength) E and H-plane spacing.

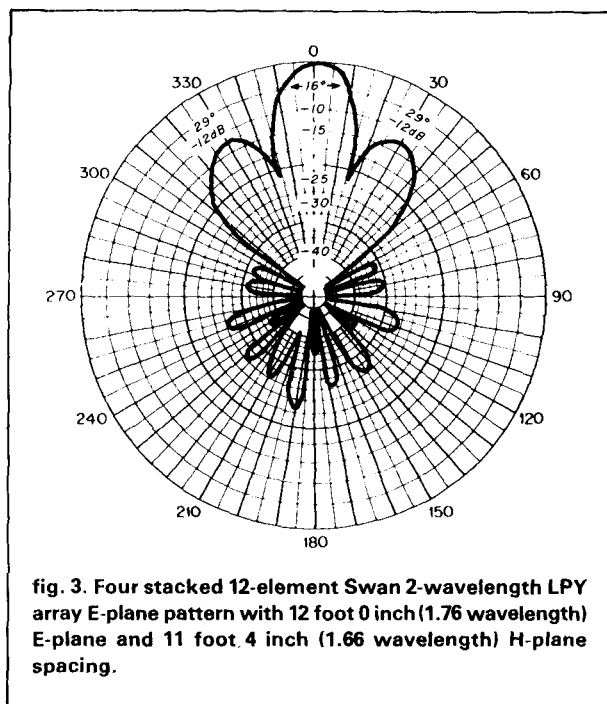

fig. 3. Four stacked 12-element Swan 2-wavelength LPY array E-plane pattern with 12 foot 0 inch (1.76 wavelength) E-plane and 11 foot 4 inch (1.66 wavelength) H-plane spacing.

table (table 2) represent hundreds of hours of antenna measurements I have performed, the compilation of data from ten years of antenna gain contests, and finally, computer analysis of almost all the antennas listed in the table. The result is a listing of gain figures closer to reality, I believe, than anything previously available. (For further discussion of how much gain can be expected from a given boomlength Yagi, reading DL6WU's article is suggested.)⁵

measuring antenna gain

As part of my experiments to measure antenna gain and determine proper stacking distances, a telescoping H frame was constructed on my 60-foot (18.3 meters) tower to measure the 144-MHz antenna. This arrangement allowed for rapid placement of Yagis along with a simple method of adjusting the spacing to any separation of up to 16 feet (4.9 meters). A smaller frame (6 feet/1.9 meters) was used to measure the 432-MHz Yagis.

The next step was to figure out a relatively accurate means of making pattern measurements. Over the years I tried a variety of measurement techniques, including use of strip chart recorders, spectrum analyzers, and RF voltmeters. Out of all this came a relatively simple and reasonably accurate method that is within the reach of most serious VHF/UHF experimenters.

The basic requirements for pattern measurement are:

- an accurate direction indicator;
- a receiver with a calibrated signal strength indicator; and
- a signal source located so as to minimize reflection problems.

Satisfying each requirement was surprisingly simple. The direction indicator I used was a selsyn readout* with close to 1 degree accuracy. Alternatively, the digital readout system using 10 turn pots and popularized by many EMERs⁶ could be used. The availability of signal generators such as the Hewlett-Packard 608 series (or their military counterparts, the TS-510 series)* solves the receiver calibration problem. My method of measurement consisted of connecting a digital voltmeter (DVM) to the AGC (automatic gain control line) of the station receiver (an R-4C and TR-7). Care must be taken to keep signal strengths high enough above the noise (floor) to eliminate signal-to-noise plus noise ratio correction problems. The signal level must not be so high that it causes gain compression problems. The quick way to get a pattern was to run the antenna through 360 degrees while recording the AGC voltage readings on the DVM. The antenna was then replaced with the signal generator and the AGC readings were converted to a dB scale. (A 10 dB attenuator was placed between the converter and antenna or signal generator to eliminate impedance problems.) This "calibration" of the receiver

was done after every measurement to eliminate receiver gain drift errors.

The signal source presented the trickiest problem, but again a simple solution was found. A number of signal sources were tried including locating signal sources in my back yard, in the woods about 1000 feet (305 meters) away, and at a local ham's QTH about 2 miles (1.3 km) away. All of these solutions gave marginally repeatable results. That is, an antenna would look different from day to day and from source to source. Because I believed the problem to be reflections from various objects, I decided to try a signal source located above the clutter. My location at that time was 105 feet (32 meters) above sea level. The antennas were located at 65 feet (20 meters), well above the nearby trees. My location was surrounded by hills up to 1200 feet (366 meters) high, 10 to 12 miles (16 to 19.2 km) away. The ground between my location and the hills dropped in elevation, which made the tops of the hills a completely clear shot at about a 0.5 degree elevation angle. A fellow ham located on one of the hills was called upon; by using high gain source antennas (stacked 3.2 wavelength NBS Yagis on 144 MHz and RIW19s on 432 MHz), repeatable pattern measurements became a reality. After performing many measurements I was able to "calibrate" my range such that I could see how different antennas gave the same false lobes or left to right unbalance. The patterns shown in this article have been cleaned up to eliminate known range errors. Various NBS antennas were constructed and their patterns measured. My measured patterns correlated very well with the NBS published patterns and offered proof of the method's validity.

It was also found that accurate relative gain measurements were possible. Gain measurement calibration was made by putting two identical antennas on the frame and measuring the relative signal level between them. The antennas were then switched in position and the measurement repeated. In this manner any differences in signal strength could be factored out before a test antenna was measured. Results were found to be repeatable to within 0.2 dB over the two-year period the gain tests were made. A similar method was used to measure the gain increases to be had from stacking antennas.

the effects of antenna spacing

To get an indication of what happens when the spacing of Yagi arrays is changed, an array of four 12-element LPY (log periodic Yagis, as introduced by Oliver Swan and later produced by KLM) was set up on the telescoping H-frame. Pattern measurements were made at one foot (0.3 meter) spacing increments from 10 feet (3.0 meters) up to 16 feet (4.9 meters) (1.4 to 2.3 wavelengths). The resultant patterns are

*Available from Fair Radio Sales, P.O. Box 1105, Lima, Ohio 45802

typical of all two-wide Yagi arrays. As the spacing between Yagis is increased, the main lobe beamwidth narrows, the sidelobes increase in amplitude and the nulls get much deeper. The E-plane pattern at 10 feet

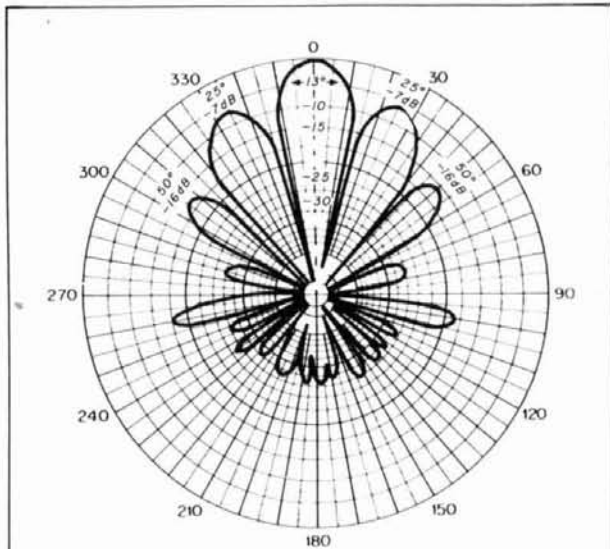

fig. 4. Four stacked 12-element Swan 2 wavelength, 144-MHz LPY array E-plane pattern with 14 foot 4 inch (2.1 wavelength) E and H-plane spacing.

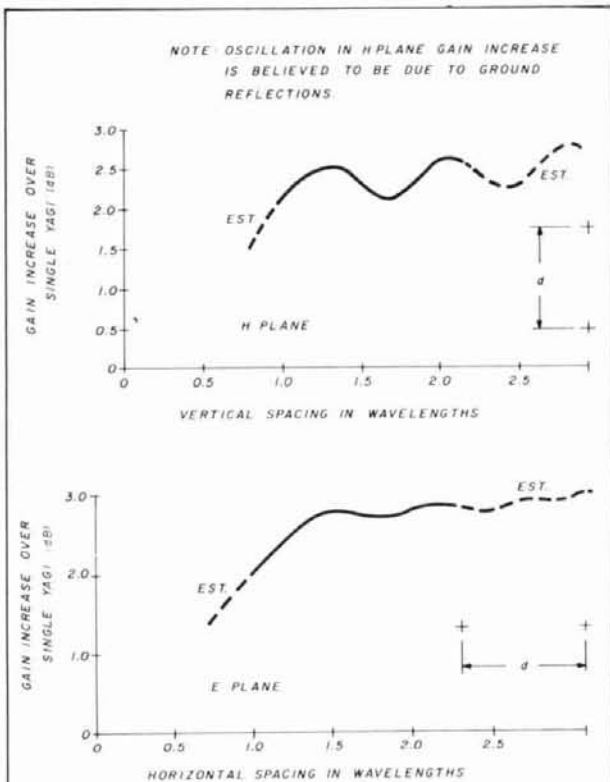
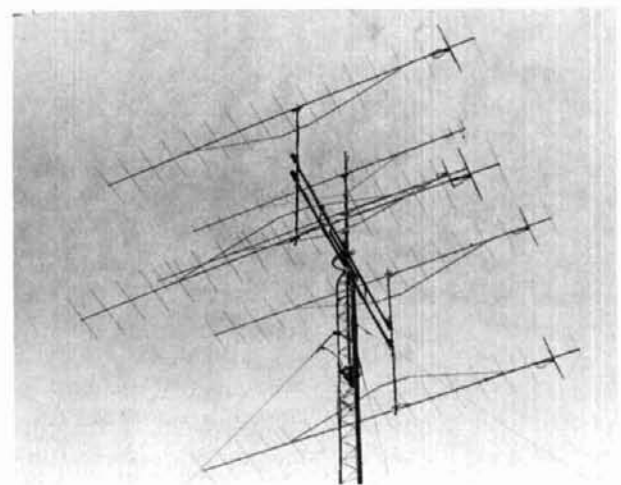

fig. 5. Array gain versus spacing using Swan 12-element, 2 wavelength 144-MHz LPYs.

(3.0 meters), 12 feet (3.7 meters) and 14 feet 4 inches (4.4 meters) spacings is illustrated in **figs. 2, 3, and 4**. Looking at the sample patterns, it can be seen that the beamwidth of the first sidelobes is close to that of the main lobe for each spacing and that its amplitude increases rapidly at larger separations. Other minor lobes start to have significant amplitudes at the greater separations.

The question of which distance is the proper one still remained to be answered. Gain and individual pattern measurements on the 12-element LPY indicated an actual gain of about 11.2 dB over a half-wave dipole (dBd). By using **eq. 1, 2, and 3** (single antenna pattern of 36 degrees E-plane by 40 degrees H-plane), stacking distances of 10 feet 8 inches E-plane (3.3 meters) 9 feet 7 inches (2.9 meters) H-plane were calculated. The 10 foot 8 inch (3.3 meter) E-plane spacing gave a pattern similar to **fig. 2**, but with first sidelobes down 14 dB. Next relative gain measurements were attempted between one and two antennas. Resultant gain curves showing stacking gain versus spacing are shown in **fig. 5**. The general shape of the curves are similar to those given in the now-famous NBS Technical Note 688,⁷ (**fig. 6**) except I did not see any gain decrease as the spacing was increased to large distances, only a flattening of the gain curve. I also saw an apparent larger gain increase in the E rather than the H-plane. This is again indicated in NBS Note 688. As illustrated in **fig. 5**, the knee in the gain increase occurs at about 2.7 to 2.8 dB in the E-plane and at 2.5 to 2.6 dB in the H-plane. (When phasing line losses are factored out.)

Next, I attempted to relate first sidelobe levels to position on the gain increase curve and found that the gain increase started to flatten out when the first sidelobes were -12 to -13 dB down. It should be pointed out that at the time these measurements were made,



Four 17-element, 3.2 wavelength NBS Yagis stacked on an H-frame.

WITH PRIVATE PATCH II YOU SPEND YOUR TIME COMMUNICATING . . . NOT WAITING TO TAKE CONTROL

PRIVATE PATCH II allows communications to proceed back and forth as rapidly as on a telephone. There is *no waiting for sampling circuits to acquire each time the mobile transmits.*

The **PRIVATE PATCH II VOX** system offers a **substantial improvement over sampling autopatches in time spent waiting for control!**

EXAMPLE: Suppose you made 10 phone calls — 9 completed, 1 busy — assume the completed calls average 20 talk exchanges each, 180 total.

You would spend 360 seconds (6 minutes!) *waiting for control* if you were using a sampling patch that samples every two seconds (180 waits × 2 seconds = 360 seconds). **It is a severe inconvenience to have to press the button for a seeming eternity before you can be heard on each and every mobile reply.**

With **PRIVATE PATCH II** there is **no lost time waiting for control on all 9 completed calls.** However, the busy call would cause a 15 second wait for the control interrupt timer to return control to the mobile.

SUMMARY

	CONTROL WAITS	TIME WAITED
Private Patch II	1	15 seconds
Sampling	180	6 minutes

If the sampling patch has a circuit that *"slows the sample rate when telephone audio is present,"* the speed of acquisition is made even slower. The wait time increases, and the phone party can say perhaps 25 or more words before they can be cut off.

WHY LAND MOBILE PROFESSIONALS AVOID SAMPLING PATCHES . . .

The majority of radios on the market (especially synthesized and relay switched types) **do not T/R quickly enough to give acceptable results.** Often engineering level modifications are required to improve T/R response time.

The slower the T/R response time, the longer the sample must last. And of course no telephone audio is heard during the sample. **Just noise.** The result is **lost words and syllables** which are proportional to T/R response.

Acquiring and maintaining control (in order to communicate) becomes erratic when the mobile is less than full quieting. This causes a **severe loss of range.**

The base station radio can not be equipped with a linear amplifier, and operation through repeaters (that have hangtime) is not possible with a noise sampled patch.

VOX autopatches overcome each of these shortcomings. In fact, nearly all simplex patches sold in commercial service are the VOX type.

Could these be some of the reasons that the competition refers to their VOX patch as **"our favorite commercial simplex patch"?**

FORGET AMATEUR GRADE SAMPLING AND STEP UP TO A COMMERCIAL GRADE PATCH. PRIVATE PATCH II!

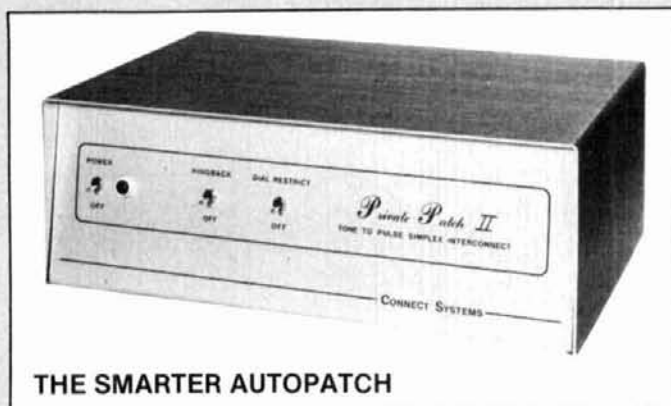

THE SMARTER AUTOPATCH

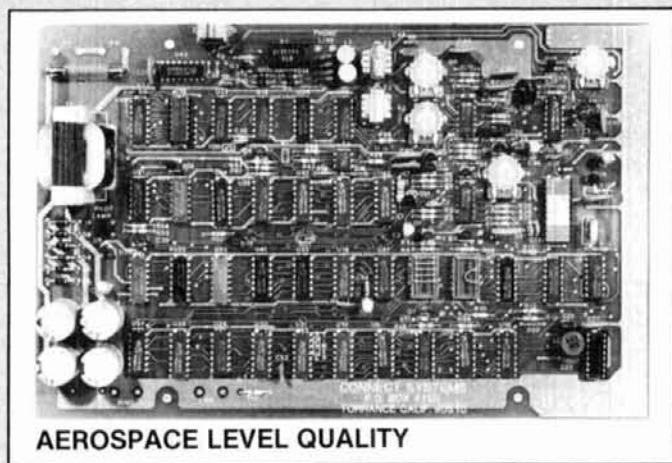

AEROSPACE LEVEL QUALITY

FEATURES

- CW ID (free ID chip) • Selectable tone or pulse dialing • User programmable toll restrict • Five digit access code • Ringback (reverse patch) • Busy channel ringback inhibit (will not transmit on top of someone) • Three/six minute "time-out" timer is resettable from the mobile • Modular phone jack and seven foot cord • Available in 12 VDC or 115 VAC version

ALSO

- ✓ 14 day return privilege — when ordered factory direct.
- ✓ One year warranty — compare to their six months.

CONTACT A LOCAL DEALER TODAY

AMATEUR ELECTRONIC SUPPLY
Milwaukee WI, Wickliffe OH,
Orlando FL, Clearwater FL,
Las Vegas NV

C&A ROBERTS INC.
Torrance CA

COLES COMMUNICATIONS
San Antonio TX

ERICKSON COMMUNICATIONS
Chicago IL

HAM RADIO OUTLET
Anaheim CA, Burlingame CA,
Oakland CA, Phoenix AZ,
San Diego CA, Van Nuys CA

HENRY RADIO
Los Angeles CA, Anaheim CA,
Butler MO

JUNS ELECTRONICS
Culver City CA, Reno NV

MIAMI RADIO CENTER CORP.
Miami FL

MIKES ELECTRONICS
Fl. Lauderdale, Miami FL

N&G DISTRIBUTING CORP.
Miami FL

PACE ENGINEERING
Tucson AZ

THE HAM SHACK
Evansville IN

CANADA:
DOLLARD ELECTRONICS
Vancouver, BC



23731 MADISON ST., TORRANCE, CA 90505
PHONE: (213) 373-6803

very wide spacing was very popular and many Amateurs, including myself, thought the NBS report with its relatively close spacings was in error. The correlation between my measurements to the NBS curves

was truly amazing, especially considering that I was intent on proving NBS *wrong*.

The additional rule of thumb used by Amateurs was to stack Yagis so that the first sidelobes were 13 dB down. This seemed to correspond to where the gain increase curves flattened out; however, when the sidelobes were -13 dB, the main lobe was less than one half that of a single antenna. When I attempted to find out where the -13 dB rule of thumb came from, the only explanation I could find was that two sidelobes at -13 dB were, in total, -10 dB from the main lobe and anything 10 dB down (or 1/10 amplitude) was insignificant. This seemed plausible except that the H-plane should have a pattern similar to the E-plane — and if it also had two sidelobes 13 dB down (with similar beamwidth to the main lobe), the sum of just those four lobes would be -7 dB relative to the main lobe or 20 percent of the amplitude of the main lobe. Thus if all four sidelobes were looking at noise sources 10 times stronger (in reality, it is not very likely all the sidelobes would be facing similar noise sources) than the background noise the main lobe was looking at, the array would suffer a 6 dB signal-to-noise loss on receive.

improving a 144-MHz EME array

With this information in mind, I began to look at the 144-MHz EME array I was using at that time. It consisted of 4 Cushcraft A32-19, 19-element 3.2-wavelength 22 foot (6.7 meter) long Yagis patterned after the NBS 17-element Yagi, with a tri-reflector added. The gain of a single A32-19 is about 13.2 dBd with -3 dB beamwidths in the E and H-plane of approximately 28 by 33 degrees. By using the previously defined aperture calculation method, spacings of 2.1 by 1.75 wavelength or 14 feet (4.3 meters) E-plane by 12 feet (3.7 meters) H-plane were calculated. The manufacturer of the antenna was recommending the same spacings, so it seemed reasonable to use them when constructing the array.

The performance of the array seemed acceptable. I usually received good signal reports, but on receive, signals always were poorer than expected. I easily dismissed the lack of hearing on a noisy urban environment. Looking at the NBS stacking curves, NBS was recommending 2.0 by 1.6 wavelength spacing for the 15-element 4.2 wavelength Yagi, an antenna with about 0.8 dB more gain than the A32-19. I then made some sidelobe measurements and found that the first E-plane sidelobes were down about 12 dB and the H-plane sidelobes were down only 10 dB. A quick decision was made to move the antenna spacing in to 1.9 by 1.6 wavelengths or 13 by 11 feet (4.0 by 3.4 meters) E by H-plane, respectively. The results were startling. During the first two months of operation at the closer spacing, about 20 new stations were worked on EME,

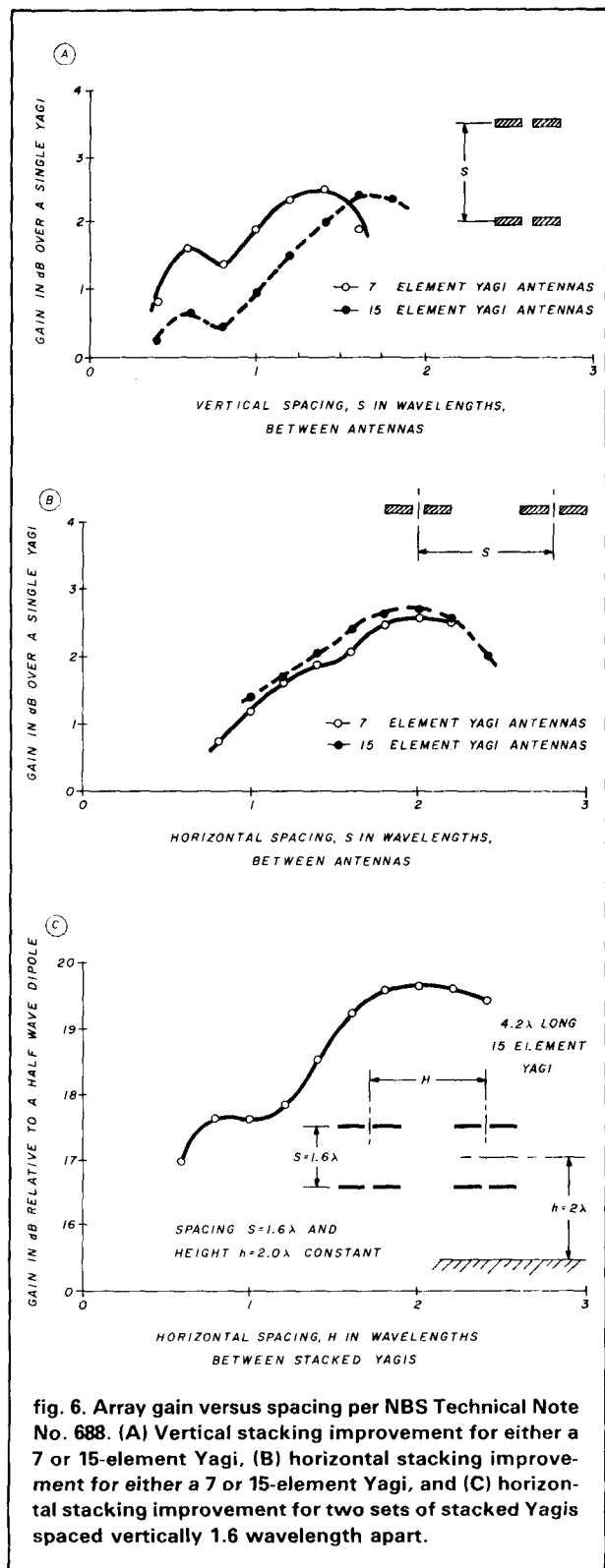
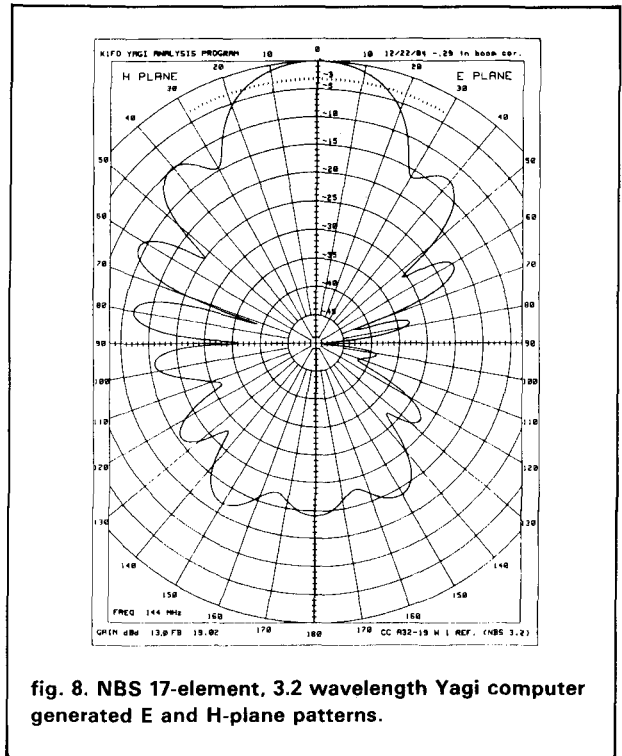
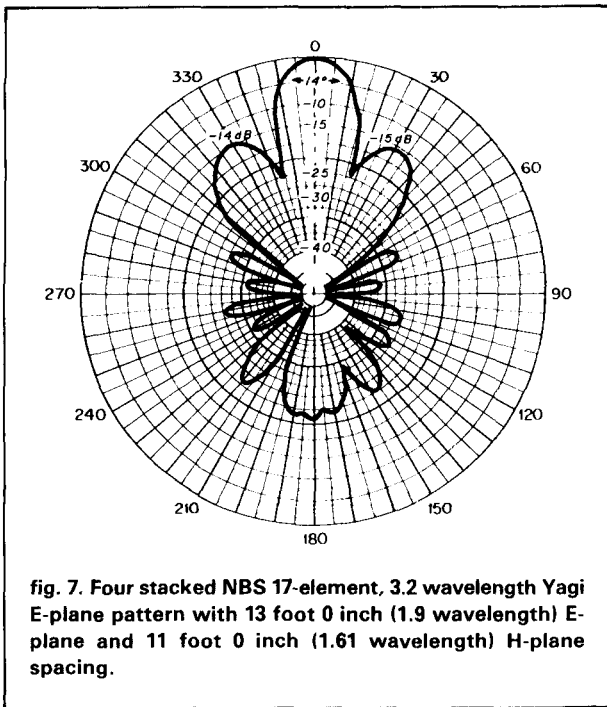
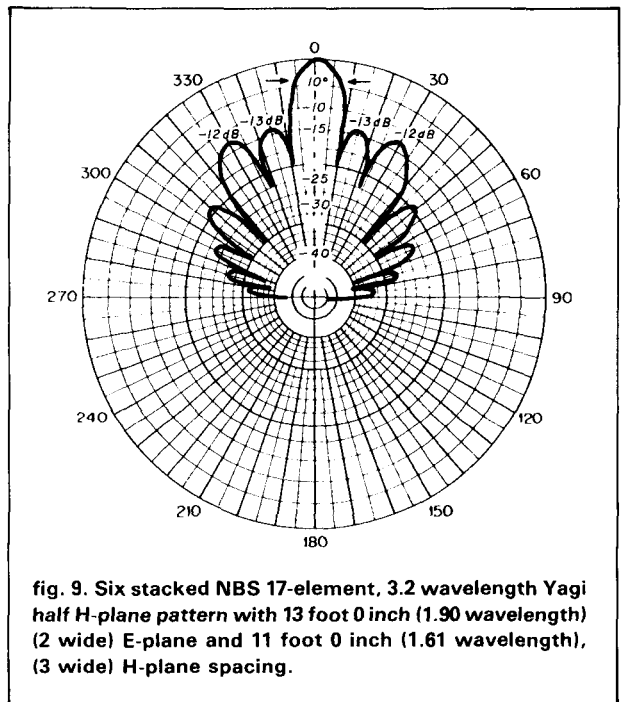

fig. 6. Array gain versus spacing per NBS Technical Note No. 688. (A) Vertical stacking improvement for either a 7 or 15-element Yagi, (B) horizontal stacking improvement for either a 7 or 15-element Yagi, and (C) horizontal stacking improvement for two sets of stacked Yagis spaced vertically 1.6 wavelength apart.



many of them stations I had tried to work in the past without success.

After that I obtained four more A32-19 Yagis. I modified them to standard NBS dimensions and removed the tri-reflectors. I then set them up on the telescoping H-frame and set out to find what was going on. The E-plane pattern of the 17-element 3.2λ NBS array spaced at 13 feet (4.0 meters) E-plane is shown in **fig. 7**. The pattern looks very good, with first sidelobes down 14 to 15 dB and all other lobes down 25 to 30 dB. H-plane patterns are usually more difficult to measure. Reflections from objects such as trees and utility poles, which are essentially vertically polarized, complicate the problem. Tilting the array back causes changes in ground reflections, which can induce errors if that method is used. Because of that I did not make a complete H-plane pattern measurement, but I did check the first H-plane sidelobes and found them to be only 12 dB down at the 11 foot (3.4 meter) spacing. The aperture calculations indicated that the spacing was already too close — however, NBS had indicated that 1.6-wavelength or 11-foot (3.4 meter) spacing was correct for the higher gain 15-element Yagi. To explain this wide discrepancy between calculated spacings and measured patterns, the patterns of the individual Yagis were examined. **Figure 8** is a computer-generated plot of the E and H-plane patterns of the 3.2 wavelength NBS Yagi. The H-plane pattern is noticeably less directive than the E-plane with larger sidelobes over the entire pattern. The array pattern of a number of Yagis is the resulting interference pattern of the individual Yagi patterns interacting with each



other. It follows that the resulting array pattern of multiple Yagis will have larger sidelobes in the H-plane.

While measuring the four 3.2-wavelength NBS Yagi array, it was decided to attempt to relate array main lobe beamwidth to sidelobe level and array gain increase. The 3.2 wavelength NBS Yagis reacted similarly to the 12-element LPY antennas previously meas-

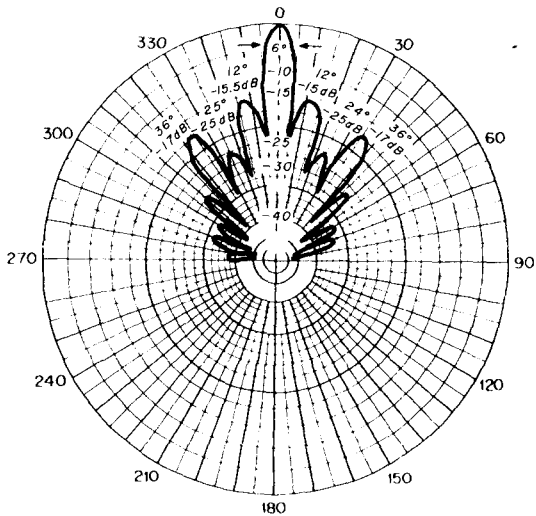

fig. 10. Sixteen stacked Cushcraft 424B Yagi E-plane pattern with 60 inch (2.2 wavelength) E-plane and 58 inch (2.1 wavelength) H-plane spacing.

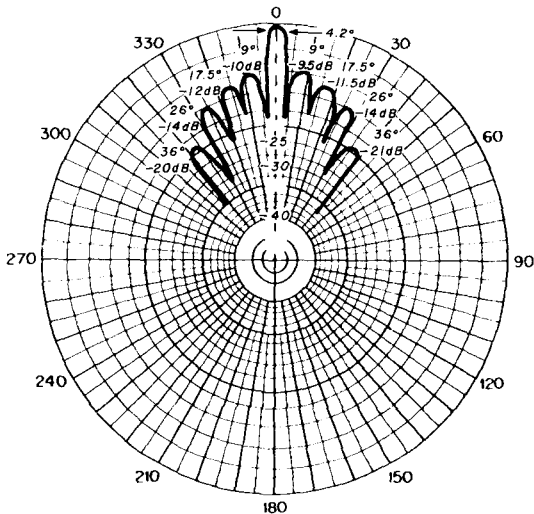

fig. 11. Sixteen stacked Cushcraft 424B Yagi H-plane pattern with 60 inch (2.2 wavelength) E-plane and 58 inch (2.1 wavelength) H-plane spacing.

ured. When the first sidelobes were -13 dB, the main lobe was narrower than one half that of a single Yagi. Likewise, the main lobe was approximately one half the beamwidth of a single Yagi when the first sidelobes were -14 to -15 dB. *This relationship of first sidelobes at -14 to -15 dB when the main lobe beamwidth is half that of a single Yagi has held up in all subsequent arrays I have measured.* This also includes arrays that are three and four Yagis wide where the array -3 dB beamwidth is approximately equal to the

beamwidth of a single Yagi divided by the number of Yagis in that plane. As an example, my 144-MHz array was expanded to six 3.2 wavelength Yagis. The vertical spacing was kept at 11 feet (3.4 meters). The array's H-plane pattern is shown in fig. 9. The number of major sidelobes in an array is equal to the number of elements in a plane minus 1. Thus the six-Yagi array will have two major H-plane sidelobes. In this case, the first sidelobe is -13 dB down and the second is -12 dB down. As expected, the main lobe is narrower than one third that of a single Yagi at 10 degrees. Note that as the number of elements in an array are increased (and consequently the number of major sidelobes increase) it becomes much more important to keep the sidelobe amplitudes under control. A look at a 16 Yagi 432-MHz EME array will expand on this point.

more dramatic results at 432 MHz

Frank Potts, WA1RWU, had erected a 432 MHz EME array consisting of 16 Cushcraft 424B 24-element 7.6 wavelength Yagis. The instruction sheet for the 424B recommended 66-inch E-plane by 60-inch H-plane spacing. This was considerably closer than the spacings determined from calculating the aperture. Based on actual antenna gain of 15.8 dBd and a pattern of 20 degrees by 22 degrees (E by H), the spacings were calculated to be 72 inches (1.8 meters) by 65 inches (1.7 meters) E-plane by H-plane. When Dave Olean, K1WHS, of Cushcraft was contacted, he recommended the use of even closer spacings for an EME array — as close as 60 inches (1.5 meters) by 54 inches (1.4 meters). Because of mechanical considerations, the array was assembled using 60-inch (1.7 meter) horizontal (E-plane) by 58-inch (1.5 meter) vertical (H-plane) spacing. Phasing lines consisted of 1/2-inch and 7/8-inch hardline and were cut on a return loss bridge known to be accurate. The performance of the array had a familiar ring to it; Frank would receive excellent signal reports, but on receive, signals were far poorer than expected. Checking into the 432-MHz EME activity, Frank found that there had been a considerable number of other hams who had erected 16-Yagi EME arrays for 432 MHz that never worked well, and as a result, their stations had disappeared from the EME ranks.

At this point I began helping Frank to improve the array. The first priority, I decided, was to obtain a pattern measurement. The height of the array, 20 feet (6.1 meters) above ground, made the likelihood of taking accurate measurements remote. However, with the amount of array gain available (close to 26 dBd) I decided it should be possible to make adequate measurements by using Sun noise.^{8,9} The E-plane pattern looked excellent, with the three major sidelobes down over 15, 25, and 17 dB, respectively

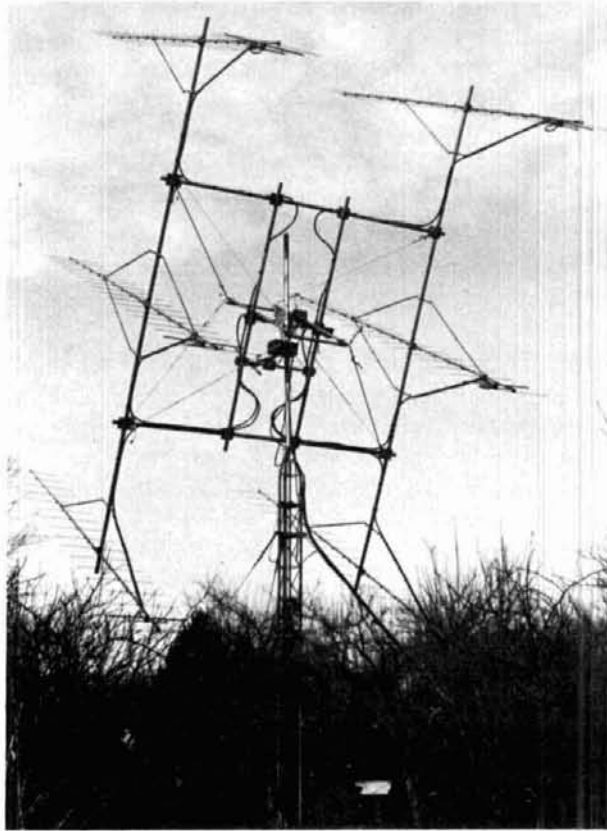

Six stacked NBS 17-element, 3.2 wavelength Yagi 144-MHz EME array.

(fig. 10). The main lobe beamwidth was close to 6 degrees or greater than one quarter that of a single antenna. The H-plane was a shock with the -3 dB beamwidth of 4 degrees or much narrower than the expected 5.5 degrees. The major sidelobes were very large, at only 9.5, 11.5, and 14 dB below the main lobe (fig. 11). No EME signals had ever been copied when the array elevation was below 18 degrees. The fact that this angle was the same as the second sidelobe direction was no coincidence.

Some tests with a pair of K2RIW 19-element Yagis were run to measure changes in H-plane sidelobe levels. It was found that the first sidelobes changed at about 1 dB for every 2 inches of spacing change. Since the gain of the RIW19 (15.1 dBd) is close to the 424B it was felt that the results would be similar with the 424B. The vertical spacing was moved in by 6 inches (15 cm) to 52 inches (1.3 meters). The first sidelobes were expected to drop down to -12.5 dB. The results of that spacing change were amazing. The major sidelobes were now -12.3 , -20.7 , and -14.4 dB (fig. 12). Sun noise was up over 2 dB.* The on-the-air performance improvement was even more spectacular, with 41 QSOs made with 34 different stations during the first ten days of operation at the new spacing. Fewer than 20 QSOs were made in over

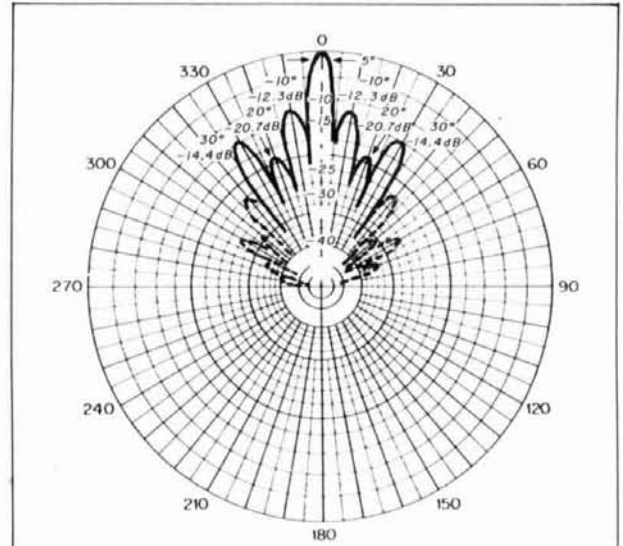

fig. 12. Sixteen stacked Cushcraft 424B Yagi H-plane pattern with 60 inch (2.2 wavelength) E-plane and 52 inch (1.9 wavelength) H-plane spacing.

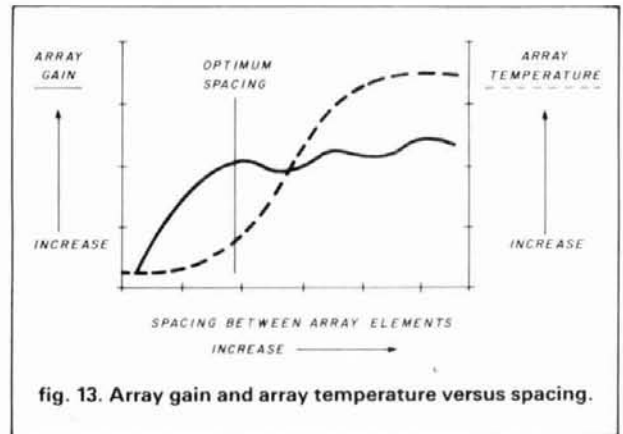

fig. 13. Array gain and array temperature versus spacing.

two months of operation at the wider spacing. Most of the contacts were on random operation (as opposed to pre-arranged schedules) and included several 8 Yagi and one 4 Yagi stations. EME signals, including echoes, were now consistently copied down to 2 degrees elevation (the elevation angle where the main lobe would be clearing the earth). The main lobe beamwidth was still narrower than one quarter that of a single 424B at 5 degrees. This again supports previous measurements which indicated that a $1/4$ beamwidth (5.5 degrees) would not occur until the first sidelobes are down 14 to 15 dB. The pattern indicates that the array has not yet been optimized. It is estimated that the best performance would occur at 62

*Sun noise is measured by pointing the array at cold sky, noting the noise level, and then pointing the array at the sun and measuring the noise increase. Sun noise is a combination measurement of overall receiver temperature and array gain.

inches (1.6 meters) E-plane by 50 inches (1.27 meters) H-plane spacing.

The reason for this dramatic improvement can be explained by looking at the approximate Earth noise pickup from the major sidelobes when the array was operated at low elevation angles. The main lobe at 432

MHz may typically see a sky temperature less than 20 degrees K. The sum of the first three sidelobes at -9.5 , -11.5 , and -14 dB would be equivalent to a single lobe 6.5 dB below the main lobe. Pointed at Earth (290 degrees K), those lobes would contribute about 65 degrees K of noise or cause a 5.1 dB degradation in signal-to-noise ratio. With the reduced sidelobes at the closer spacing, the sum of the three major sidelobes is about -9.8 dB and would cause about a 1.8 dB signal-to-noise degradation. This represents a 3.3 dB receive improvement, which is quite significant on EME. The actual array noise is much more complicated; to calculate it would require summing all the sidelobes and accounting for the strength of the noise sources toward which they pointed. The over-2 dB Sun noise improvement nonetheless confirms the performance improvement.

An alternative method for checking system temperature without taking array gain into account is to measure Earth noise. This is done by pointing the array at cold sky and then at the Earth and then comparing the noise levels. A well-performing 432-MHz EME system should see over a 4 dB ratio. Since this measurement does not take array gain into account it should not be used for array optimization because doing so could result in significant gain loss. Figure 13 is a graph of typical array temperature versus stacking gain increase. The temperatures are not "real world" because they are quite different for the various Amateur frequencies.

easier method for measuring array beamwidths

Measuring the -3 dB beamwidths on high gain arrays with very sharp beamwidths can be a difficult task. WA1RWU's 16-Yagi 432-MHz array uses a prop-pitch motor for an azimuth rotator and has a 360-degree rotation time of over 3 minutes. The elevation leadscrew drive takes over 2 minutes to run 90 degrees. Even with such a rotating system, attempting to measure a 5 degree beamwidth can be a taxing experience. With a conventional commercial rotator it appears to be impossible to get an accurate measurement. It was discovered very early on that the half-power beamwidth was always equal to slightly less than 1/2 the spacing of the first nulls on either side of the main lobe. Interestingly, DL6WU has said that the beamwidth of a single Yagi is equal to 0.485 times the first null spacing. The measurement of the first nulls provides a much easier and most likely more accurate means of determining antenna half-power beamwidths.

The H-plane pattern measurements on the RIW19 Yagi provided yet another surprise. A pair of RIW19s had first H-plane sidelobes down 13 dB at a spacing of 54 inches (1.37 meters). The 424Bs had first H-plane

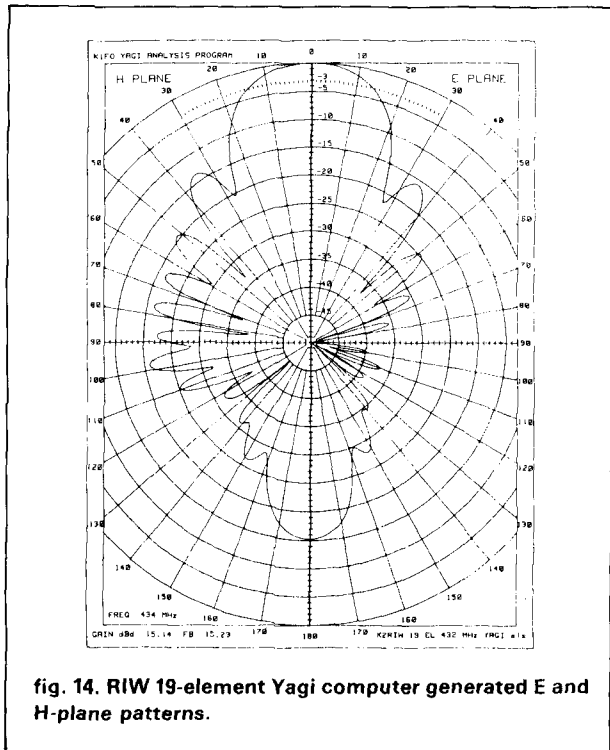

fig. 14. RIW 19-element Yagi computer generated E and H-plane patterns.

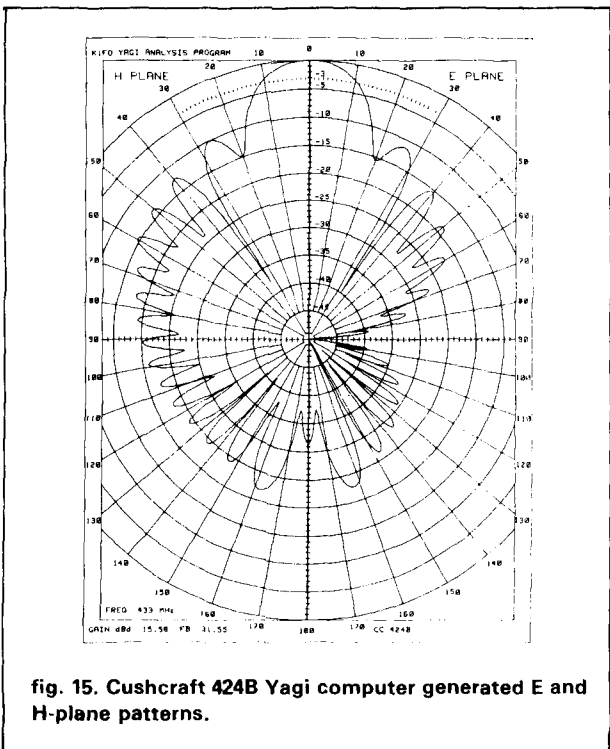

fig. 15. Cushcraft 424B Yagi computer generated E and H-plane patterns.

CALL US LAST!

We just might beat that "unbeatable" deal



Rudy
N9CC

Talk with everyone else. Then call us. We're hams with over 50 years of combined experience. We know communications and equipment. We also listen to what you want. And at what price. Then we work with you to put it all together.

We specialize in a total systems approach to communications. It's a concept that takes you to the top in operating performance.

Call us. We don't mind being your last chance to save.

We carry all the top names in amateur equipment.

Hours: Tuesday-Saturday, 10 am-6 pm.
Closed Mondays.

800/845-6183

803/366-7157 Inside SC

Service Department
803/366-7158



Ken
N4FYO



Morgan
KB4GFJ



Marji
KA4LPW

**THE
NEW!**



GISMO

1039 Latham Drive
Rock Hill, SC 29730



C.O.D.



✓ 116

THE MOST AFFORDABLE REPEATER

ALSO HAS THE MOST IMPRESSIVE PERFORMANCE FEATURES

(AND GIVES THEM TO YOU AS STANDARD EQUIPMENT!)

Band	Kit	Wired
10M,6M, 2M,220	\$680	\$880
440	\$780	\$980

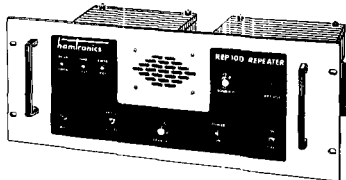

FEATURES:

- SENSITIVITY SECOND TO NONE; 0.15 uV (VHF), 0.2 uV (UHF) TYP.
- SELECTIVITY THAT CAN'T BE BEAT! BOTH 8 POLE XTAL FILTER & CERAMIC FILTER FOR > 100 dB AT ± 12 KHZ. HELICAL RESONATOR FRONT ENDS TO FIGHT DESENSE & INTERMOD.
- OTHER GREAT RECEIVER FEATURES: FLUTTER-PROOF SQUELCH, AFC TO COMPENSATE FOR OFF-FREQ TRANSMITTERS, SEPARATE LOCAL SPEAKER AMPLIFIER & CONTROL.
- CLEAN, EASY TUNE TRANSMITTER; UP TO 20 WATTS OUT (UP TO 50W WITH OPTIONAL PA).

HIGH QUALITY XMTR & RCVR MODULES FOR REPEATERS, LINKS, TELEMTRY, ETC.

- **R144/R220 FM RCVRs** for 2M or 220 MHz. 0.15uV sens., 8 pole xtal filter & ceramic filter in i-f, helical resonator front end for exceptional selectivity, > 100dB at ± 12 kHz, best available today. Flutter-proof squelch. AFC tracks drifting xmtrs. Xtal oven avail. Kit only \$138.
- **R451 FM RCVR** Same but for uhf. Tuned line front end, 0.3 uV sens. Kit only \$138.
- **R76 FM RCVR** for 10M, 6M, 2M, or 220. As above, but w/o AFC or hel. res. Kits only \$118. Also avail w/4 pole filter, only \$98/kit.
- **R110 VHF AM RECEIVER** kit for VHF aircraft or ham bands or Space Shuttle. Only \$98.
- **T51 VHF FM EXCITER** for 10M, 6M, 2M, or 220 MHz. 2 Watts continuous, up to 3W intermittent. \$68/kit.
- **T451 UHF FM EXCITER** 2 to 3 Watts. Kit only \$78. Xtal oven avail.
- **VHF & UHF LINEAR AMPLIFIERS.** For either FM or SSB. Power levels from 10 to 45 Watts to go with excitors & xmtrg converters. Several models. Kits from \$78.

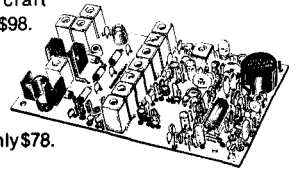
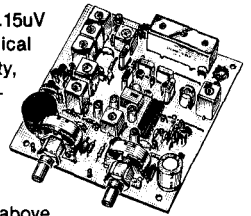

NOW—FCC TYPE-ACCEPTED TRANSMITTERS & RECEIVERS AVAILABLE FOR HIGH-BAND & UHF. CALL FOR DETAILS.

RECEIVING CONVERTERS

Models to cover every practical rf & lf range to listen to SSB, FM, ATV, etc. NF = 2dB or less.

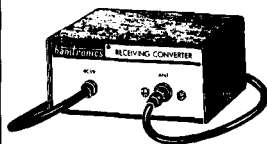

Antenna Input Range	Receiver Output
28-32	144-148
50-52	28-30
50-54	144-148
144-146	28-30
145-147	28-30
144-144.4	27-27.4
146-148	28-30
144-148	50-54
220-222	28-30
220-224	144-148
222-226	144-148
220-224	50-54
222-224	28-30

VHF MODELS

Kit with Case	\$49
Less Case	\$39
Wired	\$69

UHF MODELS

Kit with Case	\$59	432-434	28-30
Less Case	\$49	435-437	28-30
Wired	\$75	432-436	144-148
		439.25	50-54
			61.25

SCANNER CONVERTERS Copy 806 MHz band on any scanner. Wired/tested ONLY \$88.

TRANSMIT CONVERTERS

For SSB, CW, ATV, FM, etc. Why pay big bucks for a multi mode rig for each band? Can be linked with receive converters for transceive. 2 Watts output vhf, 1 Watt uhf.

For VHF,
Model XV2
Kit \$79
Wired \$149
(Specify band)

Exciter Input Range	Antenna Output
28-30	144-146
28-29	145-146
28-30	50-52
27-27.4	144-144.4
28-30	220-222*
50-54	220-224
144-146	50-52
50-54	144-148
144-146	28-30

For UHF,
Model XV4
Kit \$99
Wired \$169

28-30	432-434
28-30	435-437
50-54	432-436
61.25	439.25
144-148	432-436*

*Add \$20 for 2M input

VHF & UHF LINEAR AMPLIFIERS. Use with above. Power levels from 10 to 45 Watts. Several models, kits from \$78.

LOW-NOISE PREAMPS

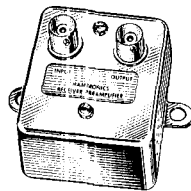

Hamtronics Breaks the Price Barrier!

*
No Need to Pay \$80 to \$125 for a GaAs FET Preamp.

FEATURES:

- Very Low Noise: 0.7 dB VHF, 0.8 dB UHF
- High Gain: 18 to 28 dB, Depending on Freq.
- Wide Dynamic Range for Overload Resistance
- Latest Dual-gate GaAs FET, Very Stable

MODEL	TUNES RANGE	PRICE
LNG-28	26-30 MHz	\$49
LNG-50	46-56 MHz	\$49
LNG-144	137-150 MHz	\$49
LNG-160	150-172 MHz	\$49
LNG-220	210-230 MHz	\$49
LNG-432	400-470 MHz	\$49
LNG-800	800-960 MHz	\$49

HELICAL RESONATOR PREAMPS

Low-noise preamps with helical resonators reduce intermod and cross-band interference in critical applications. 12 dB gain.

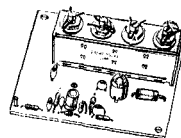

Model	Tuning Range	Price
HRA-144	143-150 MHz	\$49
HRA-220	213-233 MHz	\$49
HRA-432	420-450 MHz	\$59
HRA-()	150-174 MHz	\$54
HRA-()	450-470 MHz	\$64

ACCESSORIES

- **MO-202 FSK DATA MODULATOR.** Run up to 1200 baud digital or packet radio signals through any FM transmitter. Automatically keys transmitter and provides handshakes. 1200/2200 Hz tones. Kit only \$45.
- **DE-202 FSK DATA DEMODULATOR.** Use with any FM receiver to detect packet radio or other digital data in "202" modem format. Provides audio conditioning and handshakes. Kit only \$38.
- **COR-2 KIT** With audio mixer, local speaker amplifier, tail & time-out timers. Only \$38.
- **COR-3 KIT** as above, but with "courtesy beep". Only \$58.
- **CWID KITS** 158 bits, easily field programmable, clean audio. Kit only \$68.
- **A16 RF TIGHT BOX** Deep drawn alum. case with tight cover and no seams. 7 x 8 x 2 inches. Designed especially for repeaters. \$20.
- **DTMF DECODER/CONTROLLER KITS.** Control 2 separate on/off functions with touchtones®, e.g., repeater and autopatch. Use with main or aux. receiver or with Autopatch. Only \$90
- **AUTOPATCH KITS.** Provide repeater autopatch, reverse patch, phone line remote control of repeater, secondary control via repeater receiver. Many other features. Only \$90. Requires DTMF Module.
- **SIMPLEX AUTOPATCH.** Use with your FM transceiver. System includes DTMF & Autopatch modules above and new Timing module to provide simplex autopatch and reverse autopatch. Complete patch system only \$200/kit. Call or write for details.

- Call or Write for FREE CATALOG (Send \$2.00 or 4 IRC's for overseas mailing)
- Order by phone or mail • Add \$3 S & H per order (Electronic answering service evenings & weekends)
- Use VISA, MASTERCARD, Check, or UPS COD.

hamtronics, inc.

65-E MOUL ROAD • HILTON NY 14468

Phone: 716-392-9430

Hamtronics® is a registered trademark

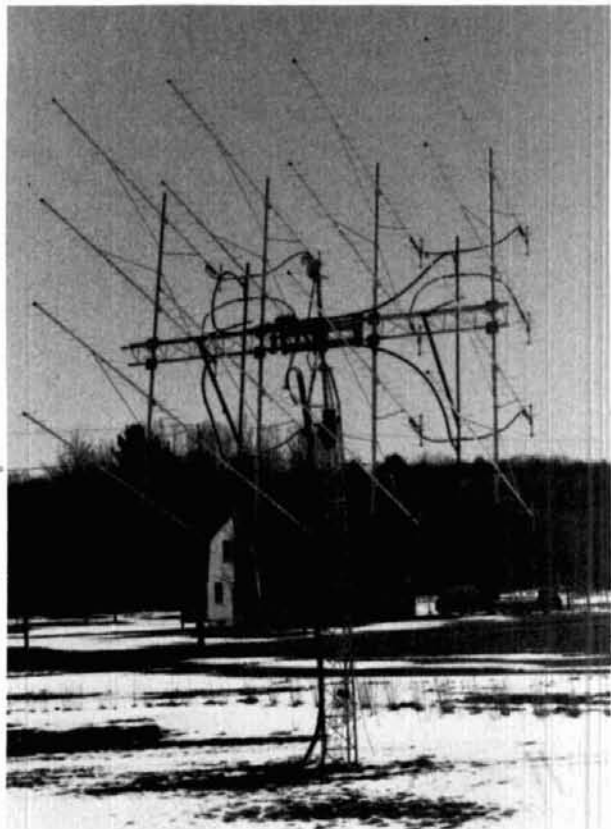

Sixteen stacked Cushcraft 424B Yagis in a 432-MHz EME array.

sidelobes down 12.3 dB at a spacing of 52 inches (1.32 meters). Considering that the 424B has an appreciably narrower H-plane beamwidth (22 inches versus 26 inches) and that it has more gain (15.8 dBd versus 15.1 dBd), just the opposite might be expected. The explanation again lies in the patterns of the individual antennas. **Figures 14** and **15** are computer-generated patterns for the RIW19 and the 424B. The RIW19 has, in general, sidelobes significantly lower than the 424B which would explain the different spacings for best array sidelobe levels. This effect has been noted in other Yagis also, and unfortunately makes most of the methods of calculating stacking distances (such as the aperture equations, or any of the various beamwidth formulas) of little use when array temperature is of concern. I spent a considerable amount of time trying to come up with a clever little formula for calculating stacking distances, but every one I tried had more Yagis disobey its numbers than ones that would.

This causes the optimum stacking distances to be different for different Yagis *even if they have the same gain*. Likewise a Yagi with a very clean pattern may have an optimum stacking distance greater than another with more gain but a poorer pattern. Keep in mind that "optimum" has, in this case, been defined as the highest G/T ratio.

mounting different frequency antennas on the same tower

The effect of having antennas for different bands located in close proximity has not received much attention. The interaction between antennas can be understood by looking again at **fig. 1**. If another antenna is located in the shadow of the first, it will not be able to extract as much energy as the first simply because the field strength is reduced behind the first antenna. To quantify the effect of having different antennas located nearby can be complicated. To evaluate the effect of a 144-MHz antenna on a nearby 432-MHz antenna, the aperture of the 144-MHz antenna at 432 MHz would have to be calculated in order to see how much of the capture areas overlapped. Next it would have to be determined who had "first dibs" on the signal or which antenna was in the other's shadow.

The only conclusive measurement I have been able to make has been to measure the Sun noise of a given array by itself and then add the other antennas and again measure Sun noise. I have found a consistent degradation in Sun noise by having arrays interlaced. Surprisingly, in most cases it is the lower frequency array that suffers. A side effect also appears to be the occurrence of stray sidelobes. The explanation of that phenomenon is that the unused antenna is re-radiating signals it had captured. Although not conclusive, terminating the unused antennas in a 50-ohm load appears to minimize the effect.

To be on the safe side, antennas should be located such that their apertures do not overlap. This can sometimes lead to very large spacings. As a practical matter the casual VHF/UHF operator may never see the performance degradation. The EME operator or enthusiastic weak signal worker who is looking for the last bit of performance is advised to either not mix arrays or to maintain sufficient spacing between them.

alternate stacking arrangements

This article has addressed only arrays with the Yagis arranged in uniform rows and columns. It may be possible to obtain additional stacking gain while controlling sidelobes by using other arrangements such as circle or diamond configurations. This would be due to the lower amount of aperture overlap required for sidelobe level control. I have not examined these alternative arrangements because of the difficulty in adapting them to an array with elevation control.

conclusions

Since most readers are likely to be more interested in a guide to how far apart to stack various antennas than in duplicating my work, **table 2** is provided. It covers a number of popular 144 MHz and 432 MHz antennas and their recommended stacking distances.

table 2. Measured performance of 144 and 432 MHz antennas.

144 MHz ANTENNAS								
ANTENNA TYPE	GAIN dBd	PATTERN E x H	BOOMLENGTH feet		SIDELOBES E x H -dB		STACKING feet E x H	
6 el NBS	10.2 a	40 x 42	1.2	8.2	17	9	9.6 x	7.5
9 el F9FT	10.6	38 x 46	1.6	10.8	18	14	9.9 x	7.0
11 el Swan/KLM	10.8	40 x 44	1.8	12.3	13	10	9.6 x	7.5
11 el Cushcraft	10.8 b	40 x 46	1.7	11.8	19	13	10.0 x	7.5
12 el Swan/KLM	11.2	36 x 40	2.0	14.1	14	10	10.6 x	8.6
14 el Swan/KLM	11.8	34 x 37	2.5	17.4	15	10	11.0 x	9.5
20 el CC Colin	11.9	45 x 26	--	--	--	--	9.8 x	13.2
14 el Hy-Gain	11.9	35 x 35	2.3	15.5	--	--	11.0 x	9.9
12 el NBS	12.0 a	34 x 36	2.2	15.0	15	11	11.2 x	9.6
14 el Cushcraft	12.1	34 x 36	2.2	15.0	15	12	11.2 x	9.6
16 el KLM	12.2	29 x 31	3.0	20.7	12	9	11.4 x	9.6
11 el KLM 11X	12.2 u	34 x 38	2.3	15.3	19	14	11.5 x	9.9
16 el F9FT	12.5	32 x 34	3.0	20.8	17	13	12.2 x	10.2
11 el LUNAR	12.6 c,g	32 x 35	2.6	17.4	16	12	12.4 x	10.2
13 el KLM LBA	13.0	31 x 32	3.1	21.5	14	10	12.7 x	10.6
15 el Cue Dee	13.1	30 x 32	3.1	21.3	--	--	12.8 x	10.7
17 el NBS	13.1	28 x 33	3.2	22.0	13	10	13.0 x	10.4
19 el Cushcraft	13.2	28 x 33	3.2	22.0	14	11	13.0 x	10.5
13 el W2NLY	13.4 d	27 x 29	3.5	23.5	12	9	13.3 x	11.2
15 el Telrex	13.5	26 x 28	4.1	27.8	12	9	13.3 x	11.3
14 el K1FO	13.7 g	29 x 31	3.6	24.3	15	13	13.7 x	11.2
15 el NBS	13.9 a	26 x 29	4.2	28.7	14	11	13.7 x	11.4
16 el KLM LBX	14.3 u	28 x 30	4.1	28.1	17	14	13.8 x	11.6
18 el Cushcraft	14.5	27 x 28	4.2	28.7	15	12	14.0 x	11.8

432 MHz ANTENNAS								
TYPE	GAIN dBd	PATTERN E x H	BOOMLENGTH feet		SIDELOBES E x H -dB		STACKING inches	
11 el Tilton	11.8 f,g	34 x 36	2.6	6.0	17	13	46 x	40
13 el W6QKI	13.3	27 x 29	3.4	7.8	12	9	53 x	44
13 el K2RIW	13.5	27 x 29	3.4	7.8	13	10	54 x	45
15 el NBS	13.9 a	26 x 29	4.2	9.6	14	11	55 x	46
16 el KLM LB	14.4	24 x 25	5.3	12.0	11	9	56 x	48
19 el K2RIW	15.1	24 x 26	5.6	12.8	16	14	60 x	54
21 el F9FT	15.2 h	24 x 26	6.6	15.0	14	12	58 x	52
26 el DL9KR	15.5 u,i	24 x 25	6.1	13.8	17	15	62 x	58
24 el Cushcraft	15.8	20 x 21	7.5	17.1	12	10	62 x	50
22 el DL6WU	15.8 u,l	23 x 24	6.9	15.6	15	14	64 x	58
24 el K1FO	16.6 k	22 x 23	7.5	17.2	16	15	66 x	60
28 el W1JR/DL6WU	17.0 u	20 x 21	9.3	21.1	14	13	70 x	64
30 el KLM LBX	17.3 u	19 x 20	9.6	21.9	15	13	72 x	66
31 el W1JR/DL6WU	17.5 u	19 x 20	10.4	23.7	14	13	74 x	68

- a These NBS yagis have gain peaks 2 percent high in frequency.
- b Gain peak is 11.1 dBd at 146 MHz, 38 x 44 degree pattern.
- c Has incorrect balun length. With stock balun gain is 12.4 dBd.
- d Figures are for 0.125 inch taper version with 20 in. reflector spacing
- f Is tuned to 440 MHz. Retuned to 432 MHz gain would be 12.6 dBd.
- g Design based on Greenblum / Tilton information.
- h Is designed for 435 MHz. Gain peak is 15.5 dBd at 436 MHz.
- i Uses 8 element screen reflector.
- k Is a modified 424B using a single reflector and 22 directors.
- l Is designed for 435 MHz. Gain peak is 16.0 dBd at 436 MHz.
- u Design based on DL6WU information.

Although a few tenths of a dB additional gain may be obtainable at larger spacings, the added size, weight, and windload would most likely not justify the wider

spacing even if EME or satellite communications are not anticipated.

It should be emphasized that gain alone does not

tell the whole story. A Yagi with a cleaner pattern may be a better choice for an EME array than one with higher gain and a "messy" pattern. The highest gain Yagi in the world is of little use if it splits into 5 pieces the first time a storm passes by.

Finally, the following summary should serve as a guideline in building multiple Yagi arrays:

- Optimum stacking distance is a compromise between gain increase and sidelobe level (G/T).
- Array - 3 dB beamwidth will be equal to single element beamwidth divided by the number of elements in a plane when the first sidelobes are -14 to -15 dB. This usually represents optimum stacking or best G/T.
- The H-plane's inherently less directive pattern requires substantially closer spacing than the E-plane to achieve optimum sidelobe levels.
- Negating phasing line losses, doubling the number of elements in an array at optimum spacing will give approximately 2.7 to 2.8 dB gain increase in the E-plane and 2.5 to 2.6 dB in the H-plane.
- The greater the number of elements in an array, the more critical it is to have that array optimally spaced.
- The higher the frequency of operation, the more critical it is to have an array with small sidelobes (i.e. optimally stacked).
- The cleaner the pattern of an individual Yagi, the greater the optimum stacking distance will be - hence the greater the array gain.
- Although spacings closer than the maximum gain distance can cause the loss of a few tenths of a dB in array gain, the closer spacing can result in several dB of signal-to-noise ratio improvement on receive.
- If you are going to make a mistake, put your antennas "too close together" rather than "too far apart."
- Placing different band antennas in close proximity can degrade performance.

references

1. Jim Kennedy, K6MIO, "The Real Meaning of Noise Figure," *ham radio*, March, 1969, page 26.
2. "Reference Data for Radio Engineers," Howard W. Sams & Co., Inc., New York, Sixth Edition, 1975, pages 29-1 to 29-6.
3. John D. Kraus, "Antennas," McGraw-Hill Book Company, New York, NY, 1950, pages 41-56.
4. William I. Orr, W6SAI, and H.G. Johnson, W6QKI, *VHF Handbook*, Radio Publications, Inc., Wilton, Connecticut, 1956, pages 91 to 96.
5. Gunter Hoch, DL6WU, "More Gain With Yagi Antennas," *VHF Communications*, April, 1977, pages 204 to 206.
6. Jerry Haigwood, KY4Z, "A Digital Readout Antenna Position Indicator," *The Lunar Letter*, March, 1983, pages 11 and 12.
7. Peter Vierzicke, W0NXB, "Yagi Antenna Design," *NBS Technical Note 688*, U.S. Department of Commerce, Washington, D.C., December, 1976, pages 6 and 11.
8. William L. Smith, W3GKP, "On Decibels and Noise," *QST*, January, 1968, pages 34 to 36.
9. D.W. Bray, K2LMG, and P.H. Kirchner, W2YBP, "Antenna Patterns from the Sun," *QST*, July, 1960, page 11.

ham radio

Two great ways to get Q5 copy

Ask:

G4HUW	KB5DN	WA4FNP	WD5DMP
KJ2E	K61MV	WD4BKY	WD8QHD
K4XG	K8MKH	WD4CCI	WB9NOV
KA4CFF	KB0TM	WD4CCZ	WD9DYR
KA5DXY	W4YPL	W5GA1	

444D SSB/FM

Base-Station Microphone

Shure's most widely used base-station microphone is a ham favorite because it really helps you get through... with switch-selectable dual impedance low and high for compatibility with any rig! VOX/NORMAL switch and continuous-on capability make the 444D easy to use even under tough conditions. If you're after more Q5's, you should check it out.



526T Series II SUPER PUNCH® Microphone

Truly a microphone and a half! Variable output that lets you adjust the level to match the system. The perfect match for virtually any transceiver made, regardless of impedance. Turns mobile-NBFM unit into an indoor base station! Super for SSB operation, too. These and many other features make the 526T Series II a must-try unit.

FREE! Amateur Radio Microphone Selector Folder. Write for AL645.



SHURE®

THE SOUND OF THE PROFESSIONALS®...WORLDWIDE

Shure Brothers Inc., 222 Hartrey Ave., Evanston, IL 60204

B. G. MICRO

P. O. Box 280298 Dallas, Texas 75228
(214) 271-5546



74LS

LS00	.20	LS163	.45
LS01	.20	LS164	.65
LS02	.20	LS165	.90
LS03	.20	LS166	.99
LS04	.20	LS169	1.25
LS05	.20	LS174	.45
LS08	.20	LS175	.40
LS09	.20	LS181	1.50
LS10	.20	LS191	.90
LS11	.20	LS192	.80
LS12	.35	LS193	.80
LS13	.40	LS194	.65
LS14	.40	LS195	.60
LS15	.32	LS196	.70
LS20	.20	LS197	.85
LS21	.25	LS221	.65
LS27	.28	LS240	1.00
LS30	.20	LS241	.80
LS32	.25	LS242	1.00
LS33	.40	LS243	1.00
LS37	.33	LS244	1.00
LS38	.30	LS245	1.00
LS42	.40	LS251	.50
LS51	.24	LS253	.50
LS54	.25	LS257	.50
LS55	.24	LS258	.55
LS73	.35	LS259	2.00
LS74	.30	LS260	.50
LS85	.60	LS266	.40
LS86	.25	LS273	1.00
LS90	.50	LS279	.40
LS93	.55	LS280	1.00
LS107	.37	LS283	.50
LS109	.25	LS290	.85
LS112	.30	LS293	.85
LS122	.45	LS298	.75
LS123	.55	LS299	1.60
LS124	2.75	LS323	2.60
LS125	.40	LS348	.75
LS126	.49	LS364	1.10
LS132	.50	LS366	.45
LS133	.35	LS367	.50
LS138	.45	LS368	.40
LS139	.40	LS373	1.00
LS151	.45	LS374	1.00
LS153	.50	LS375	.50
LS154	1.20	LS377	1.00
LS155	.50	LS378	.85
LS156	.50	LS390	1.00
LS157	.40	LS393	1.00
LS158	.50	LS399	1.25
LS160	.65	LS670	1.50
LS161	.50	25LS2569	3.00
LS162	.65		

EPROM

2708 1KX8 450 n.s.	2.20
2758 1KX8 +5V 450 n.s.	2.00
2716 2KX8 450 n.s.	3.20
2716-1 2KX8 350 n.s.	4.95
2732 4KX8 450 n.s.	4.00
2732A	5.50
2732A-35	4.75
2532 4KX8 450 n.s.	3.00
2764-25	5.00
2764-45	3.75
27128-25	10.00
27128-3	9.00
27128-45	7.50

EPROM SPECIAL

We bought a large quantity of 2708s from a computer manufacturer who redesigned their boards. We removed them from sockets, erased and verified them, and now we offer the savings to you. Complete satisfaction guaranteed.

2708
\$1.49 or 10/\$12.00

STATIC RAM

2016-2KX8 200 n.s.	8/20.00
2101-1 - 256X4 500 n.s.	.75
21L02-1 350 n.s.	.65
2102AL-4 L.P. 450 n.s.	.49
2111-1 256X4 500 n.s.	2.00
2114L-3 1KX4 300 n.s.	1.50
	8/10.00
2125A-2 1KX1 70 n.s.	2.20
2142-3 1KX4 300 n.s.	1.50
2147 4KX1	3.95
TMS4044 (MCM6641 C-25)	
4KX1 250 n.s.	8/6.00
6116P-4-2KX8	
200 n.s. CMOS	8/20.00

4K STATIC RAMS

LESS THAN 50¢ EACH
MK4104J-4 - 250 N.S. 18 Pin
Ceramic Computer Mfg.
Surplus. PRIME. Fully Static.
Easy to Use. Has Same Pin Out
as TMS4044, but slightly
different timing. With Specs.
(Mostek)

8 for 5.00 32 for 15.95
VERY LOW POWER!

DYNAMIC RAM

2108-4 8KX1	1.50
2118-4 16KX1-5Volt	1.50
4027-4KX1-250 n.s.	.80
4116-16KX1-250 n.s.	8/6.00
4116-16KX1-200 n.s.	8/7.00
4116 16KX1-150 n.s.	8/10.00
4164- +5v 64K 200 n.s.	8/16.00
4164 150 n.s.	8/18.00
TMS4416-16KX4-150 n.s.	3.95
MK4516-15 16KX1-5Volt	1.50
5280N-5 (2107B-4 • TMS4060)	
4KX1	8/3.95
41256 150 n.s.	8/68.00

SPECIAL

AY3-8910
W/60 Page Manual
New Price — \$7.00

58321 Clock-Calendar 2.95

8000

Z8002	20.00	8085	4.75
8035	4.50	8086-2	24.95
8039	4.50	8087-3	149.00
8080A	1.25	8088	15.00

8200

8202A	10.00	8255-5	5.00
D8203-1	29.95	8257	6.00
8212	1.50	8259A	3.50
8214	2.00	8259C-5	5.00
8216	1.75	8275	14.95
8228	3.25	8279-5	5.75
8237-5	7.50	8284	3.20
8250B	9.95	8287	5.75
8251	4.20	8288	7.50
8253-5	6.75		

Z80

Z80 2.5 MHZ CPU	1.25
Z80CTC	1.25
Z80DMA-DMA	7.50
Z80PIO	1.49
Z80SIO/O	3.99
Z80A-4MHZ CPU	1.99
Z80A-CTC	1.99
Z80A DART	7.50
Z80A-DMA	9.00
Z80A-PIO	1.99
Z80A SIO/O	5.99
Z80B 6 MHZ CPU	7.95

F.D. CONTROLLERS

1771 Single Density	12.95
1791 Double Density	20.00
1793 Special	12.50
1797	17.50
2793	22.00
2797	20.00

CONTROLLER SET

THREE CHIP SET

1797 or 1793. 2143-03. 1691

by W.D. Compare at up to 86.85.

B.G. SPECIAL

All 3 for only \$22.95

UART

TR1602B (COM 2017)	1.75
IM6402-(1863)+5v High speed	
AYS-1013 pin out	2.95
INS 8250B	9.95

6800

6800	2.50	6840	10.00
6802	3.50	6845P	7.50
6803	5.00	6845S	7.50
6809EP	3.99	6850	2.60
6810	2.00	68A09EP	4.99
6820	3.25	68A21	3.00
6821	2.00	68B45	10.00

6500

6502	2.60	6545	5.00
6522	6.95	6551	5.00

SPECIALS

9216	4.95
TM599532	19.95
BR1941L	5.95
LF353	.60
LF356	.60
TL494	2.50
LM555	.30
9401	5.00
DS8835	1.50
MC4024P	2.50
NE592	1.00
MCT350	1.00
LM2917	1.00
LM339	.50

SOCKETS

Low Profile SOLDER TAIL

6 Pin	14/1.00
8 Pin	13/1.00
14 Pin	10/1.00
16 Pin	8/1.00
18 Pin	8/1.00
20 Pin	7/1.00
22 Pin	7/1.00
24 Pin	6/1.00
28 Pin	6/1.00
40 Pin	5/1.00

BUY \$10

GET \$1.00 - FREE CHOICE

2114 SPECIAL!

COMPUTER
MANUFACTURERS
EXCESS INVENTORY
SALE!

PRIME! 2114-300 n.s.
INCREDIBLE PRICE!

YOU SAVE!
8/\$8.00

GUARANTEED

CRYSTALS

32.768 KHz SPECIAL	.65
262.144	.75
300.000	.75
1.5432 Mhz	.75
1.8432	2.49
2.000000	2.49
2.560	1.49
3.000	1.15
3.120	1.20
3.2	1.49
3.4560	1.49
3.579545	.75
4.000	1.75
4.194304	1.50
4.433618	.75
4444.000	1.25
4.9152	2.49
4.916 Bd. Rate	1.25
5.000000	1.50
5.0688	2.50
5.616	1.59
6.000	2.49
6.176	1.49
7.164112	1.00
7.3728	1.49
8.000	1.49
9.000	1.49
9.90000	1.25
10.69425	2.50
10.8864	1.49
10.920	1.49
11.088	1.59
12.000	2.75
13.440	1.00
14.31818	1.00
15.2	1.10
16.00000	1.50
16.5888	1.49
17.430	2.49
18.000	1.49
18.2259	1.00
18.4320	1.49
20.000	1.50
21.87108	1.00
22.092	1.00
32.000	2.49
40.000	2.00
87.3333	1.00
91.000	1.00
104.8	1.00

TERMS: (Unless specified elsewhere) Add \$1.50 postage, we pay balance. Orders over \$50.00 add 85¢ for insurance. No C.O.D. Texas Res. add 6-1/8% Tax. 90 Day Money Back Guarantee on all items. All items subject to prior sale. Prices subject to change without notice. Foreign order - US funds only. We cannot ship to Mexico. Countries other than Canada, add \$3.50 shipping and handling.



Big Computer Manufacturer Does It Again!!! DISK DRIVE BONANZA — DOUBLE SIDED 5 1/4" DOUBLE DENSITY FACTORY NEW DISK DRIVES

ORIGINAL
OEM COST
\$132.00

MANUFACTURED IN JAPAN BY CANON.
THESE ARE PROBABLY THE MOST BEAUTIFUL
5 1/4" DISK DRIVES WE HAVE EVER SEEN
ON THE SURPLUS MARKET!!

40
TRACK

BRAND NEW: UNUSED!

\$49⁹⁵ EA.

2 FOR \$85⁰⁰

ADD \$1.50 EACH FOR POSTAGE

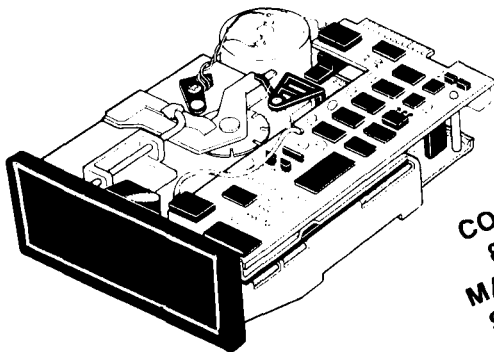

COMPLETE
80 PAGE
MANUAL AND
SCHEMATIC
\$12.50

SPECS: DOUBLE SIDED — 40 TRACK
SINGLE OR DOUBLE DENSITY
TWO THIRDS HEIGHT (SPACE SAVER!!)
INDUSTRY STANDARD PIN OUT
DIRECT DRIVE — NO BELT TO BREAK!
FAST ACCESS — 6MS
LATEST HEAD & DRIVE TECHNOLOGY

The same poor purchasing agent who nearly got lynched for over buying so many D.C. switchers has gotten carried away again. The Big Boss found another hiding place crammed with a truckload of the brand new precision manufactured 5 1/4" disk drives. Fortunately for us, the Big Boss remembered us from the switchers deal and he gave us an opportunity to make the "Second Best" surplus buy of the decade. Even though we bought a huge quantity, please order early to avoid disappointment. Please do not confuse these sleek, 2/3 height, high quality Japanese disk drives with the flimsy domestic units sold by others.

SERIAL ASCII KEYBOARD

\$14⁹⁵
Each



4
for
\$49⁹⁵

This is no misprint!

Maxi Switch 67 Key (includes 10 function keys) QWERTY serial keyboard. Number KYBD2185010 keyboard which uses a CMOS 8048 single chip microprocessor for super low power consumption. Very high quality with an exceptionally smooth feel. Originally designed for use in a portable computer. Simple serial interface — complete documentation included — Size: 12" x 5 1/2"

These won't last long at this price!!!!

ATARI HEX KEYBOARD

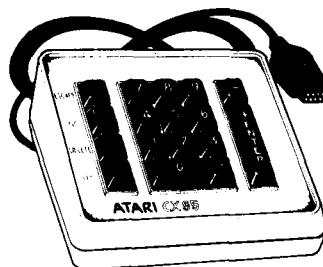

\$7⁹⁵

3 for \$20⁰⁰

Originally designed for use with an Atari Home Computer. Brand new in box. Encoded using the popular National Semi 74C923. Full schematic included. Originally sold for many times our price. Many applications besides computer use.

✓ 119

TERMS: (Unless specified elsewhere) Add \$1.50 postage, we pay balance. Orders over \$50.00 add 85¢ for insurance. No C.O.D. Texas Res. add 6-1/8% Tax. 90 Day Money Back Guarantee on all items. All items subject to prior sale. Prices subject to change without notice. Foreign order - US funds only. We cannot ship to Mexico. Countries other than Canada, add \$3.50 shipping and handling.

WE HAVE QUALITY PARTS. DISCOUNT PRICES AND FAST SHIPPING!

TRANSFORMERS



120 volt primaries

5.6 VOLTS @ 750 MA	\$3.00
6 VOLTS @ 150 MA	\$1.25
12 VCT @ 200 MA	\$2.00
18 V @ 650 MA	\$3.50
18 VOLTS @ 1 AMP	\$4.50
24 VOLTS @ 250 MA	\$2.50
24 VCT @ 1 AMP	\$4.50

LINE CORDS



TWO WIRE
6' 18ga TWO WIRE
3 FOR \$1.00

THREE WIRE
8 FOOT 18ga THREE WIRE
\$2.00 EACH

MIKE CONNECTOR



5 CONDUCTOR IN-LINE PLUG AND CHASSIS MOUNT JACK. TWIST LOCK STYLE. SAME AS SWITCHCRAFT 12CL5M \$2.50 PER SET

7 CONDUCTOR RIBBON CABLE



SPECTRA STRIP RED MARKER STRIP 28 GA STRANDED WIRE \$5.00 PER ROLL (100 FT.)

REVERBERATION UNIT



\$7.50 EACH

ACCUTRONICS COIL SPRING TYPE UNITS. USED IN ELECTRONIC ORGANS TO PROVIDE ACOUSTIC DELAY SOUND EFFECTS. INPUT IMPEDANCE 8 OHMS, OUTPUT IMPEDANCE 2250 OHMS. 4 1/2" x 16 1/4" x 1 1/2"

WALL TRANSFORMER



ALL ARE 115 VAC PLUG IN

4 VDC @ 70 MA	\$2.00
9 VAC @ 1 AMP	\$3.00
12.5 VAC @ 265 MA	\$2.50
17 VAC @ 500 MA	\$4.00
24 VAC @ 250 MA	\$3.00

MULTI-SWITCHES

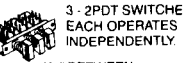

3 STATION NON-INTERLOCKING
3 - 2PDT SWITCHES EACH OPERATES INDEPENDENTLY.
1 3/4" BETWEEN MOUNTING CENTERS.
\$1.75 EACH

METER

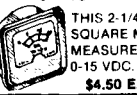

0 - 15 V.D.C.
THIS 2-1/4" SQUARE METEF MEASURES 0-15 VDC.
\$4.50 EACH

2K 10 TURN



MULTI-TURN POT SPECTROL #MOD 534-7161
\$5.00 EACH

SOUND AND VIDEO MODULATOR FOR T.I. COMPUTER



T.I. # UM1381-1. DESIGNED FOR USE WITH T.I. COMPUTERS. CAN BE USED WITH VIDEO SOURCES. BUILT-IN A/B SWITCH CHANNEL 3 OR 4 SELECTION SWITCH OPERATES ON 12 VDC. HOOK UP DIAGRAM INCLUDED.
\$10.00 EACH

SPRING LEVER TERMINALS



TWO COLOR CODED TERMINALS ON A STURDY 2 3/4" x 3 3/4" BAKELITE PLATE. GREAT FOR SPEAKER ENCLOSURES OR POWER SUPPLIES.
\$1.00 EACH 10 FOR \$9.00

5 STATION INTERLOCKING



MADE BY ALPS
3 - 2PDT AND 2 - 6PDT SWITCHES ON FULLY INTERLOCKING ASSEMBLY
3 1/4" BETWEEN MOUNTING CENTERS
\$2.50 EACH

SUB-MINIATURE D TYPE CONNECTOR



SOLDER TYPE SUB-MINIATURE CONNECTORS USED FOR COMPUTER HOOK UPS

DB-15 PLUG	\$2.75
DB-15 SOCKET	\$4.00
DB-15 HOOD	\$1.50
DB-25 PLUG	\$2.75
DB-25 SOCKET	\$3.50
DB-25 HOOD	\$1.25

ROTARY SWITCH



1 POLE 6 POSITION
1 1/4" DIA x 1 1/2" HIGH
75¢ EACH
10 FOR \$6.00

48 KEY ASSEMBLY FOR T.I. COMPUTER



NEW TEXAS INSTRUMENTS KEYBOARD. UNENCODED. 48 S.P.S.T. MECHANICAL SWITCHES. TERMINATES TO 15 PIN CONNECTOR. SOLID METAL FRAME 4" X 9"
\$6.50 EACH 2 FOR \$11.00

TI SWITCHING POWER SUPPLY



T1 # 1053214-2
COMPACT, WELL-REGULATED SWITCHING POWER SUPPLY DESIGNED TO POWER TEXAS INSTRUMENTS COMPUTER EQUIPMENT.
INPUT: 14VAC-25 VAC AT 1A
OUTPUT: +12VDC AT 350MA
 +5VDC AT 1.2A
 -5VDC AT 200MA
SIZE: 4 1/2" x 4 1/2" x 1 1/2" \$5.00 EACH

"PARALLEL" PRINTER CONNECTOR



SOLDER STYLE 16 PIN MALE USED ON "PARALLEL" DATA CABLES.
\$5.50 EACH

PUSHBUTTON POWER SWITCH

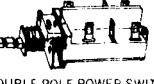

DOUBLE POLE POWER SWITCH PUSH ON, PUSH-OFF.
\$1.00 EACH

EDGE CONNECTORS



ALL ARE 156" SPACING

10 PIN EDGE CONNECTOR
TRW #50-10-A-20 \$2.00 EACH

120V INDICATOR

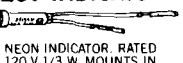

NEON INDICATOR. RATED 120 V 1/3 W. MOUNTS IN 5/16" HOLE... RED LENS.
75¢ EACH
10 FOR \$7.00
100 FOR \$65.00

SWITCHES MINI-PUSH BUTTON



S.P.S.T. MOMENTARY NORMALLY OPEN 1/4" BUSHING

35¢ EACH
10 FOR \$3.25
100 FOR \$30.00

SPECIFY COLOR:
RED, BLACK, WHITE, YELLOW

22/44 TIN

PC. STYLE. NO MOUNTING EARS
\$1.50 EACH 10 FOR \$14.00

22/44 GOLD

PC. STYLE \$2.00 EACH
10 FOR \$18.00

28/56 GOLD

28/56 GOLD PLATED CONTACTS 156 CONTACT SPACING.
\$2.50 EACH 10 FOR \$22.00

GEL CELL BATTERY

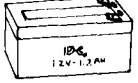

12V 1.3AH
12 VDC @ 1.2 AMP HOUR
4" X 1 13/16" X 2 1/8"
\$15.00 EACH

FREE! SEND FOR NEW 1985 48 PAGE CATALOG FREE!

13.8 VOLT REGULATED POWER SUPPLY

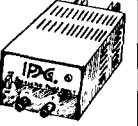

THESE ARE SOLID STATE FULLY REGULATED 13.8 VDC POWER SUPPLIES. ALL FEATURE 100% SOLID STATE CONSTRUCTION, FUSE PROTECTION, L.E.D. POWER INDICATOR.
2 AMP CONSTANT, 4 AMP SURGE.
UL LISTED \$18.00 EACH

RELAYS SOLID STATE RELAY



HEINEMANN ELECTRIC #101-5A-140-5 AMP CONTROL: 3-32VDC LOAD: 140VAC 5 AMPS SIZE: 2" X 1" X 3/4" HIGH
\$5.00 EACH 10 FOR \$45.00

COMPUTER GRADE CAPACITORS



2,000 mfd. 200 VDC 13/8" DIA. x 5" HIGH	\$2.00
3,600 mfd. 40 VDC 13/8" DIA. x 3 3/4" HIGH	\$1.00
6,400 mfd. 60 VDC 13/8" DIA. x 4 1/4" HIGH	\$2.50
31,000 mfd. 15 VDC 13/4" DIA. x 4" HIGH	\$2.50
72,000 mfd. 15 VDC 2" DIA. x 4 3/8" HIGH	\$3.50
185,000 mfd. 6 VDC 2 1/2" DIA. x 4 1/2" HIGH	\$1.50

CLAMPS TO FIT CAPACITORS 500 cc.

SLIDE POTS



100K linear tape 2" LONG	75¢ EACH
500K linear taper 2 7/8" LONG	75¢ EACH
DUAL 100K audio taper 3 1/2" LONG	\$1.50 EACH
2 1/2" TRAVEL	\$1.50 EACH

L.E.D.'S STANDARD JUMBO DIFFUSED

RED	10 FOR \$1.50
GREEN	10 FOR \$2.00
YELLOW	10 FOR \$2.00

FLASHER LED 5 VOLT OPERATION RED JUMBO SIZE \$1.00 EACH

BI POLAR LED 2 FOR \$1.70

DC CONVERTER

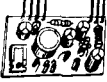

DESIGNED TO PROVIDE A STEADY =5 VDC @ 240 MA FROM A BATTERY SUPPLY OF 3.5 TO 6.25 V.
2 1/16" X 1 1/16" X 1 1/16" HIGH.
\$1.50 EACH

IN4148 SPECIAL



45" SPACING P.C. LEADS
1000 FOR \$10.00
10,000 FOR \$85.00

MINIATURE 6 VDC RELAY



SUPER SMALL SPDT RELAY. GOLD COBALT CONTACTS
RATED 1 AMP AT 30 VDC. HIGHLY SENSITIVE. TTL DIRECT DRIVE POSSIBLE. OPERATES FROM 4.3 TO 6 V. COIL RES. 220 OHM.
1 3/16" x 13/32" x 7/16" AROMAT # RSD-6V
\$1.50 EACH 10 FOR \$13.50

CRYSTALS



CASE STYLE HC33/U
COLORBURST 3579.545 KC
2 MHZ \$3.50 EACH \$1.00 EACH

METAL OXIDE VARISTOR



G.E. # V822A12
50 VOLTS. NOMINAL D.C. VOLTAGE 5/8" DIAMETER
2 FOR \$1.50

LED HOLDERS



TWO PIECE HOLDER FOR JUMBO LED
10 FOR 85¢ 200 FOR \$10.00

CLEAR CLIPLITE HOLDER
MAKE LED A FANCY INDICATOR. CLEAR 4 FOR \$1.00

TRANSISTORS

2N705	4 FOR \$1.00
2N2222A	3 FOR \$1.00
PN2222	4 FOR \$1.00
2N2904	3 FOR \$1.00
2N2905	3 FOR \$1.00
2N2907	3 FOR \$1.00

KEY ASSEMBLY 5 KEY



CONTAINS 5 SINGLE-POLE NORMALLY OPEN SWITCHES MEASURES 3 3/4" LONG
\$1.00 EACH

5 KEY
CONTAINS 6 SINGLE-POLE NORMALLY OPEN SWITCHES MEASURES 4 1/4" LONG.
\$1.25 EACH

13 VDC RELAY



CONTACT S.P.N.C. 10 AMP @ 120 VAC ENERGIZE COIL TO OPEN CONTACT...
COIL: 13 VDC 650 OHMS
SPECIAL PRICE \$1.00 EACH

MINIATURE TOGGLE SWITCHES



ALL ARE RATED 5 AMPS @ 125 VAC

S.P.D.T. (on-on) P.C. STYLE. NON-THREADED BUSHING 75¢ EACH 10 FOR \$7.00	S.P.D.T. (on-on) SOLDER LUG TERMINALS \$1.00 EACH 10 FOR \$9.00 100 FOR \$80.00	S.P.D.T. (on-off-on) SOLDER LUG TERMINALS \$1.00 EACH 10 FOR \$9.00 100 FOR \$80.00
--------------------------------------------------------------------------	---------------------------------------------------------------------------------	-------------------------------------------------------------------------------------

3 1/2" SPEAKER



8 OHM IMPEDANCE. FULL RANGE SPEAKER. 8 OZ MAGNET. 4" DIAGONAL MOUNTING CENTERS.
\$2.50 EACH
10 FOR \$20.00

POWER SUPPLY W/PRE-AMP

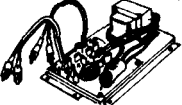

THIS SUPPLY WAS USED TO POWER AN 8 TRACK/CASSETTE UNIT IT WILL SUPPLY APPROX. 18 VDC AND INCLUDES A SMALL PRE-AMP TO BOOST SIGNAL LEVEL.
RCA PLUGS FOR LINE IN/OUT
\$4.50 EACH

4 PDT RELAY



14 pin style
3 amp contacts
24 volt d.c. or 120 volt a.c. coil
Used but fully tested
\$1.70 EACH
specify coil voltage
LARGE QUANTITIES AVAILABLE
SOCKETS FOR RELAY 50¢ each

S.P.D.T. (on-off-on)



P.C. STYLE. NON-THREADED BUSHING. P.C. STYLE 75¢ EACH 10 FOR \$7.00

S.P.D.T. (on-on)



P.C. LUGS. THREADED BUSHING. \$1.00 EACH 10 FOR \$9.00 100 FOR \$80.00

SOLID STATE BUZZER



STAR #SMB-06L. 6 VDC. TTL COMPATIBLE.
\$1.00 EACH
10 FOR \$9.00

ALL ELECTRONICS CORP.

TOLL FREE ORDERS ONLY 1-800-826-5432 (ORDER ONLY) (IN CALIFORNIA: 1-800-258-6666) ALASKA, HAWAII, OR INFORMATION (213) 380-8000

QUANTITIES LIMITED MINIMUM ORDER \$10.00 USA \$3.00 SHIPPING FOREIGN ORDERS INCLUDE SUFFICIENT SHIPPING CALIF RES. ADD 6.12% NO COD

3905 S. VERMONT AVE. P.O. BOX 20406 LOS ANGELES, CA 90006

6228 SEPULVEDA BLVD. VAN NUYS, CA 91411

SECOND LOCATION!

active antenna covers 0.5-30 MHz

Double duty allows
2-meter operation as well

Active antennas have been available commercially for several years, but relatively little practical information about them has appeared in the Amateur journals.^{1,2} This article illustrates how to build a simple one covering from 500 kHz to at least 30 MHz using commonly available components. As an added bonus, the antenna works as an omnidirectional 2-meter antenna when not in use for HF reception. It will also meet the needs of SWL's for casual monitoring on the HF bands.

First, some clarification is in order. True active antennas (sometimes referred to as voltage probe antennas) use circuitry somewhat more sophisticated than what is presented here.³ Antenna probe lengths of 2 inches have been used in some commercial models intended for military markets. Their circuitry does not match impedances in the usual sense, as does the simple approach used here.^{3,4} Instead, their reactive components are made small in comparison to the extremely high source-follower FET input impedance, effectively swamping out the reactive component. A short probe antenna, at the lower HF frequencies, may have a capacitive reactance in the millions of ohms, while its effective radiation resistance is only a very small fraction of an ohm.² Despite its lack of eloquence the antenna presented here works well, and can be built in a weekend for very little cost.

general coverage antenna needed

Amateur Radio manufacturers have caught on to the market for general-coverage reception — today many transceivers will receive from the lower LF ranges continuously up to 30 MHz and beyond. While the benefits of general-coverage receivers are obvious, some problems await those seeking a single antenna capable of spanning several octaves.

The simple link-coupled LC preselector circuits used in vintage tube-type receivers were capable of matching to a wide variety of loads, and an "antenna" tuning control served in tweaking the most out of any antenna. But the situation is somewhat different today. Modern receivers are carefully designed for proper gain distribution. The tracking preselectors and high-gain front ends are gone; in their place are mod-

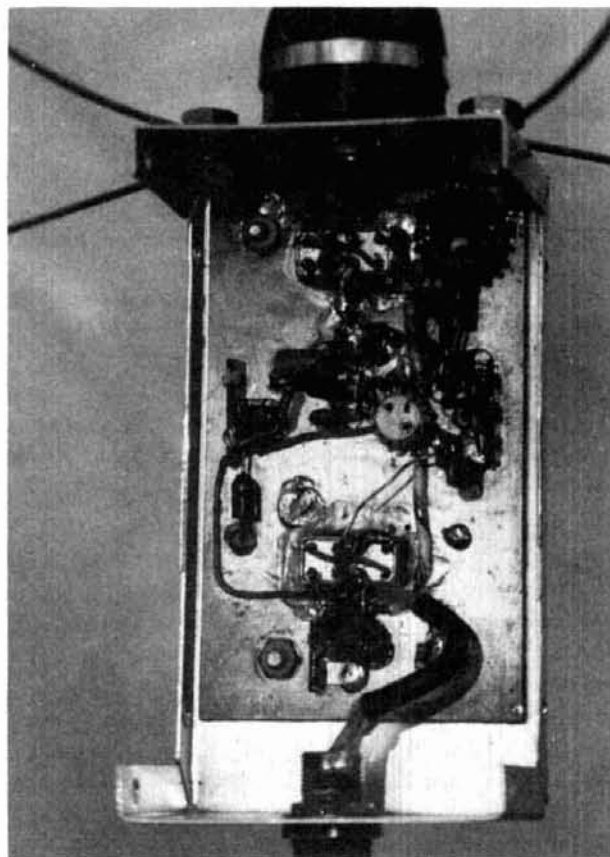

Internal view of unit shows the construction details of the active antenna. The ASP-677 commercial antenna was used. Because of the softness of the minibox aluminum, the 3/8-inch snap-mount washer was removed and installed on the inside wall of the minibox. This washer is part of the ASP snap-mount assembly.

By Peter J. Bertini, K1ZJH, 20 Patsun Road,
Somers, Connecticut 06071

Item	description
ANT-1	antenna probe, 20-50 inch length. Stainless steel antenna whip, aluminum tubing, or collapsible whip. Radio Shack No. 15-232 (38 inches) or No. 270-1401, 270-1402, 270-1403, or 270-1405.
F1	1 amp, fast-blow fuse
J1	RF connector, SO-239
RFC-1	20 turns No. 26 wire on Amidon FT50-61 core material (see text)
RL1	reed relay, SPST, 12 VDC coil
S1	SPST switch, 125 VAC rating. Radio Shack 275-612 or equivalent
T1	9 billiar turns, No. 26 wire on Amidon T68-8 core material. Wire 4-6 twists per inch (see text)
T2	power transformer, 117 VAC to 12.6 VAC at 100 mA minimum. Radio Shack No. 273-1385 or equivalent

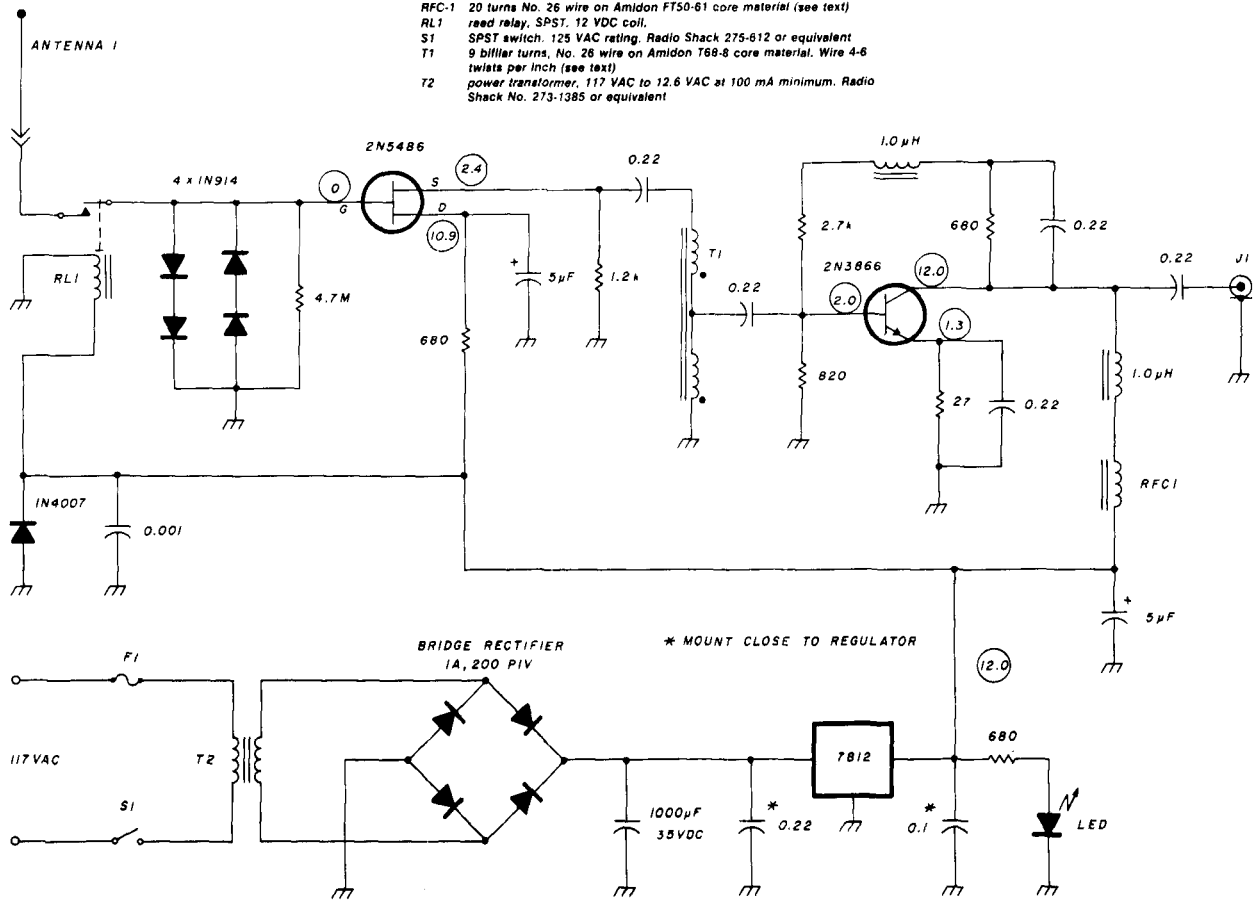

fig. 1. The schematic for the indoor antenna. This version has no provisions for 2-meter operation. DC voltage measurements are provided to assist in troubleshooting. Voltages are indicated by circled values.

ern electronically-switched broadband filters. But these filters are not tolerant. If the load is not 50 ohms, their performance is no longer predictable and losses can become excessive. Consider the use of an 80-meter antenna for shortwave reception in the 40-meter region. An 80-meter dipole at 40 meters is virtually unusable because as the feedpoint impedance soars to a very high value the shunt capacity of the coax greatly attenuates incoming signals.

impedance transformation needed

Did you ever wonder how an automobile's AM antenna could work effectively on FM and yet be so short? The answer lies in the special high-impedance coax and special front-end design used in these receivers. (If you've ever tried to replace this coax with a length of RG-58 you've quickly learned a lesson in capacitive losses.)

If a short antenna will work at 550 kHz, it will work elsewhere as well. All that's needed is an impedance transformation network to change the extremely high termination impedance of our short "probe" antenna into a usable 50-ohm impedance for our receiver, across a range of several octaves. The size of an antenna has little bearing on its performance — full-size antennas do offer 50-ohm feedpoint impedances and low enough resistance losses to allow efficient RF radiation.⁵ For receiving applications, many Amateurs have found that antennas such as the Beverage, ferrite-loop, and active antenna often out-perform full-size transmitting antenna arrays because of their lower susceptibility to noise pickup — and in some cases, their excellent directivity in the lower HF regions.

A JFET source-follower stage provides the desired high-to-low impedance transformation. (While a 2N5486 was used here, an MPF102 will also work.)

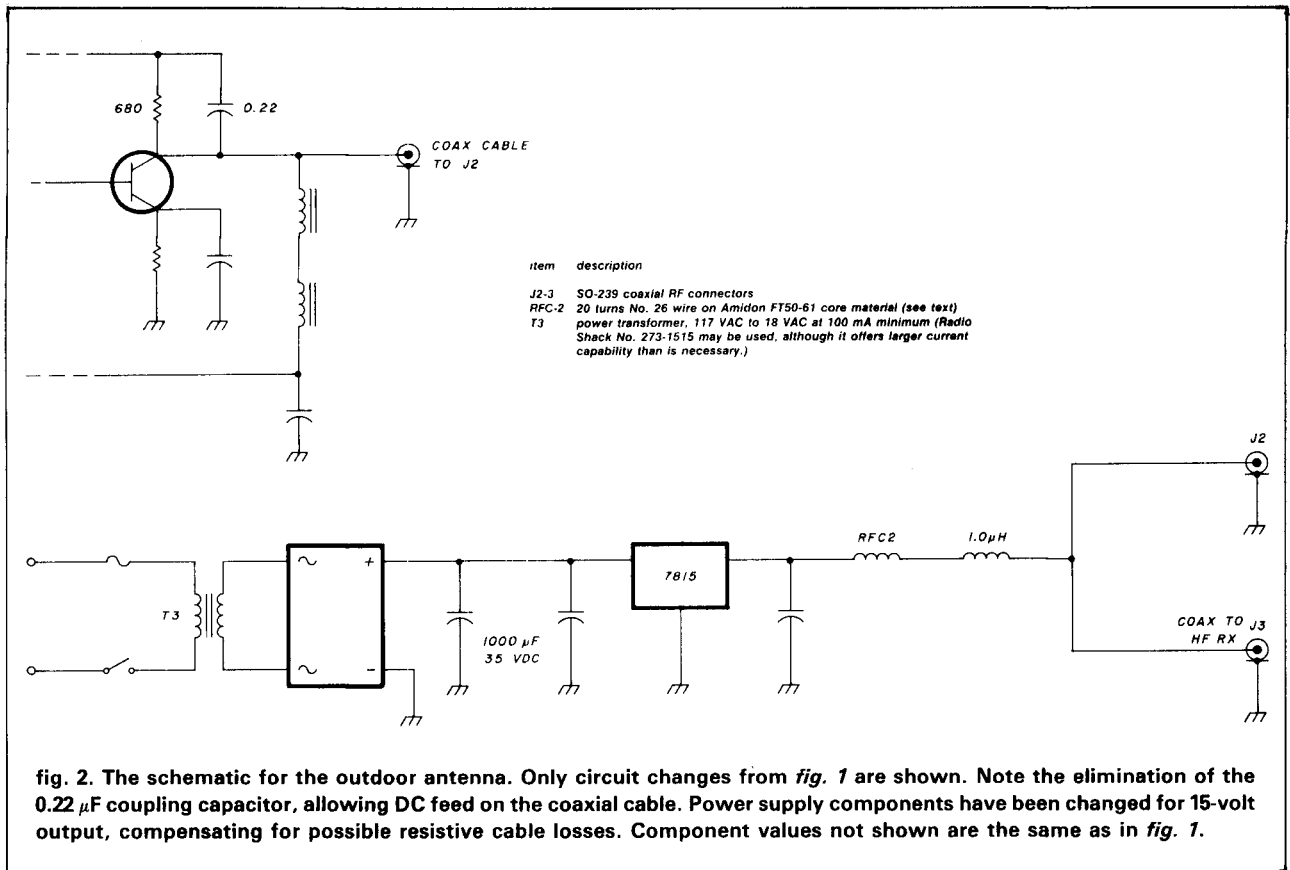

The antenna is a length of wire, about 48 inches (1.22 meters) long. A length of stainless-steel wire salvaged from an old VHF whip or automobile antenna or even a section of aluminum tubing may be used for the antenna probe.

Two versions of this antenna were built and tested; one was designed for indoor use and the other for outdoor mounting. The indoor unit was built in a small enclosure. The exact dimensions are not critical, providing all components can be comfortably mounted inside. The only difference between the indoor and outdoor models is in the packaging — the outdoor model uses a remote weather-proof housing for the preamp and antenna probe. Everything is self-contained in the indoor version.

Referring to fig. 1, for the schematic for the indoor model, note the back-to-back diode protection from the JFET gate to ground. I found that the static discharge generated from shuffling across the shack floor was responsible for the untimely demise of several 2N5486 devices before I realized what was going on. These diodes do not guarantee total protection — the best safeguard is to avoid touching the antenna probe. To prevent generation of an insidious form of TVI in the outdoor antenna caused by diode rectification of RF radiated from nearby HF or VHF transmitters, a small reed relay is used to disconnect the an-

tenna probe from the preamp stages when the antenna is not in use. This also offers some protection to the JFET during electrical storms, when static charges might build up on the antenna. The reed relay should be used in the indoor model as well for protection against static discharges. The reed relay is used only in the HF model — for 2-meter operation a more involved switching scheme using DPDT relays is needed. (This will be addressed in greater detail below).

The schematic shown in fig. 2 serves as the basis for the outdoor HF active antenna. The only difference is in the power feed arrangement. In the outdoor model, power for the preamp head is fed through the coax from the indoor power supply.

additional gain needed

Following the JFET device, which does not provide voltage gain, is a class-A bipolar stage using a 2N3866 transistor. (A 2N5109 could be used here instead.) "Hotter" transistors such as the TRW LT1001 might offer some improvement, especially at higher frequencies, but they might also require some circuit revisions to prevent self-oscillation. This stage does provide gain, building up the very small signals captured by the short antenna. The transistor must be heatsunk; the stage draws about 25 mA resulting in considerable



**“I LEFT PLACES WITHOUT POWER
FOR MAN TO CREATE”**

And the people at Photocomm are creating this needed power. Their solution is being the best in Photovoltaic engineering and design to service all your remote electrical energy needs from design to installation in a multitude of areas:

- Telecommunications
- Navigational Aids
- Water Pumping
- Railroad Signalling
- Cathodic Protection

Photocomm has the total service and professionalism that those of higher authority demand.



**PHOTOCOMM INC.
PHOTOVOLTAIC SYSTEMS**

7735 E. Redfield Rd.
Scottsdale, AZ 85260
(602) 948-8003
TELEX 6835043



SOLAVOLT
INTERNATIONAL

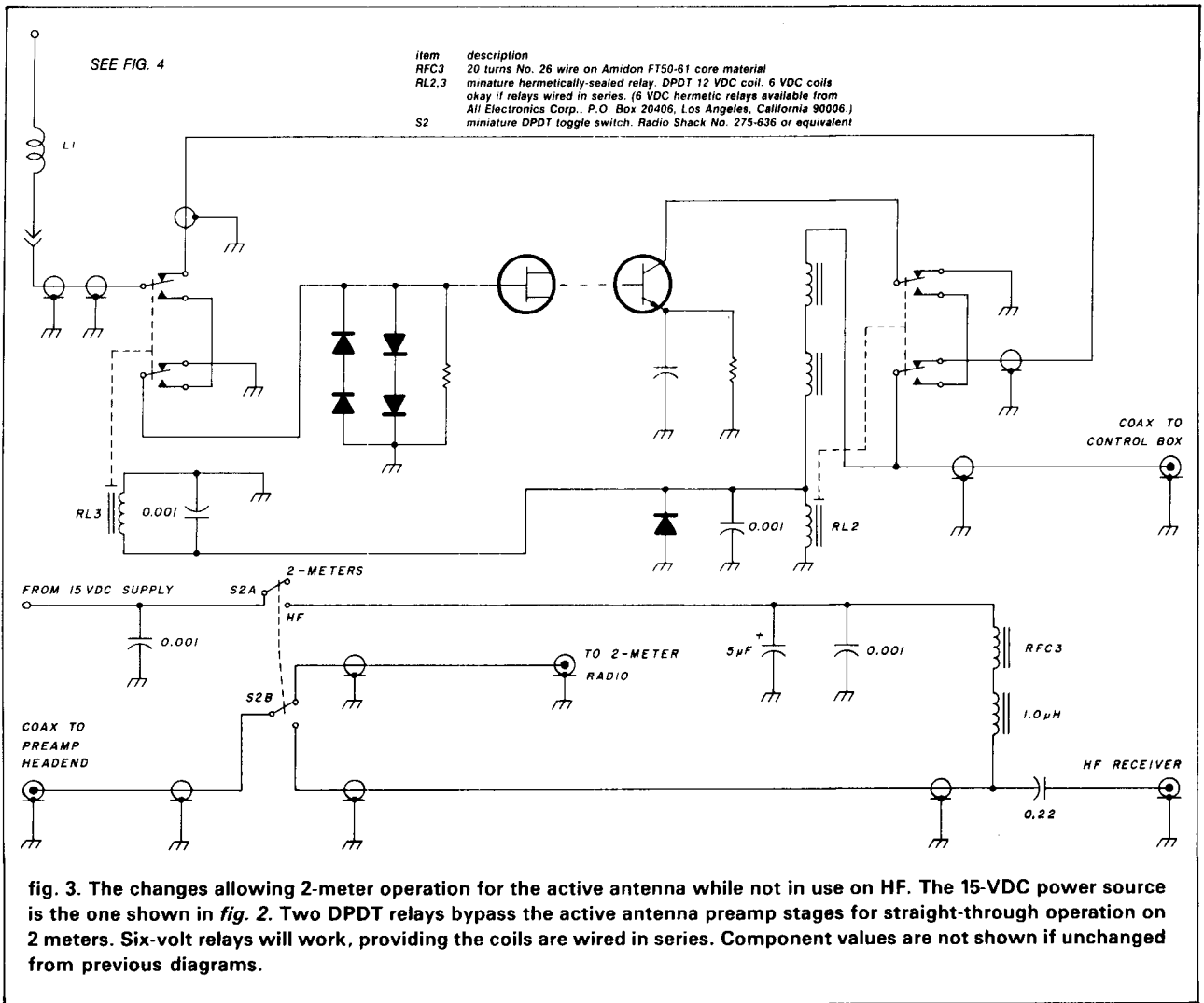

fig. 3. The changes allowing 2-meter operation for the active antenna while not in use on HF. The 15-VDC power source is the one shown in fig. 2. Two DPDT relays bypass the active antenna preamp stages for straight-through operation on 2 meters. Six-volt relays will work, providing the coils are wired in series. Component values are not shown if unchanged from previous diagrams.

device dissipation. Shunt feedback sets the stage gain and insures stable operation. A series choke in the feedback network allows greater gain at higher frequencies, this is necessary because the f_T (the gain-bandwidth product, or the frequency at which the current gain reduces to unity) of the 2N3866 is only 500 MHz. A broadband interstage matching transformer is used between the source follower and bipolar amplifier. Using 20 bifilar turns allows enough inductive reactance for operation through the AM broadcast band. If AM broadcast band coverage is not desired, the windings may be reduced to nine bifilar turns. This will cause gain to start rolling off below 1800 kHz, while yielding a slight improvement above 30 MHz.

All models were constructed and tested using point-to-point wiring techniques on double-sided PC board material. Phenolic soldering strips provide the mechanical support needed for components and wiring. While the results are not overly photogenic, the circuit works as intended. Etched printed-circuit construction is not needed here.

The outdoor model works best.¹ Mounted high and in the clear, it is not subjected to the man-made noises carried and radiated on the home's wiring. Many common home appliances will generate copious amounts of broadband hash across the HF spectrum: vacuum cleaners, television horizontal-sweep circuits, fluorescent lights, light dimmers, computers, and numerous other devices will cause grief for the serious HF operator. While the antenna can be side-mounted to an existing tower leg, it is best to mount it away from nearby metal objects. If at all possible the antenna should be top-mounted on the tower masting. Lead-in coax can be either RG-59 or RG-58 type cable. RG-8 coaxial cable can be used with the outdoor combination 2-meter/HF model to limit the VHF losses.

use for 2 meters as well

Since the antenna probe is 48 inches long, we have the basic foundation for a 5/8-wavelength vertically polarized antenna for 2 meters. All that's required is a matching transformer (fig. 4) to match the

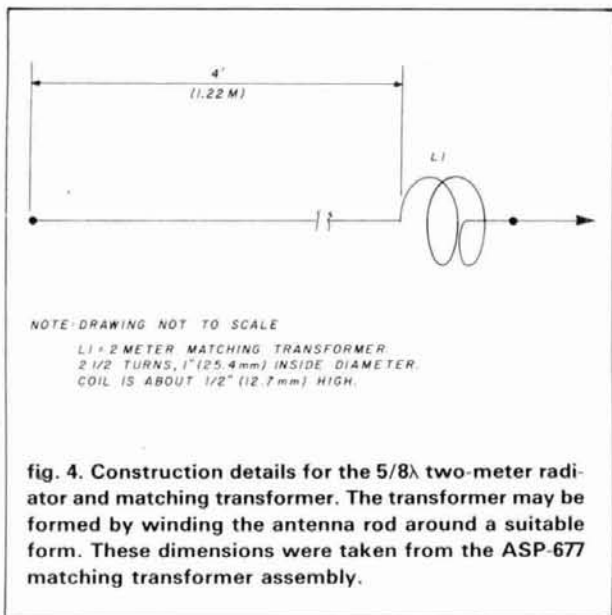

5/8-wavelength radiator to 50 ohms. Given a length of stainless steel antenna rod, it is possible to make the coil and whip one continuous piece. A commercial 5/8-wavelength antenna, such as the Antenna Specialists model ASP-677, could serve here as well, and was my choice for my outdoor HF/VHF combination antenna. Note that the ASP whip is cut for about 46 inches (1.17 meters); this is because of the added length introduced by the spring assembly. *Half-wave or 5/8-wavelength antenna designs using grounded, tapped matching transformers will not work.* The extremely small inductances will short circuit HF signals.

Three or four ground radials are needed for the 2-meter/HF combination active antenna. These should be a little longer than a quarter-wavelength, 20-inch lengths of stainless steel antenna whip wire or aluminum tubing will serve here. SWR is adjusted by trimming the radiator length; 48 inches will be about optimum for the upper 2 MHz of the band. If trimming the antenna does not yield an SWR under 1.5 to 1, compressing or expanding the transformer coil should provide a good match. The radials must make good electrical contact to the metal enclosure housing the antenna. A Radio Shack catalog No. 270-238 mini-box houses my unit. Its 5-1/4 × 3 × 2-1/8 inch (13.34 × 7.62 × 5.52 cm) size is roomy enough to comfortably mount the preamp components. The PC board used for mounting the active antenna components must also make a good low-impedance RF ground connection to the enclosure. This provides the needed RF ground path for the 2-meter antenna. If the ASP antenna is used, a short length of RG-58 coax should be used between the 3/8-inch snap-mount and preamp changeover relay. Use short coax lead connections to the relay and ground.

Figure 3 outlines the electrical details for the dual-purpose antenna. Two miniature hermetically sealed relays are used to bypass the preamp stages, allowing straight-through operation for 2 meters when the power is removed from the antenna. Metal-can 6 VDC hermetic relays can be used, providing the coils are connected in series. Six-volt relays are often more easily available, and cheaper, than their 12-volt counterparts. A 1N4007 silicon power diode protects the amplifier from reversed supply voltages; and from the counter-EMF generated by the relay coils as power is removed. Depending on the length of coax used, the power supply voltage may have to be increased to compensate for voltage drops in the coax cable. The 2-meter version draws over 100 mA; at least 12 volts should be available at the antenna preamp.

Short leads are mandatory for good VHF operation. The straight-through 2-meter operation uses a short piece of coax cable between the relays. RG-174 is okay for this, but extremely short ground and center wire connections must be made at the relays. The shack-mounted power supply unit should be as carefully constructed, to keep the losses at a minimum. Note the use of the DPDT switch; it does "double-duty" in switching the power to the antenna preamp and also changing the feedline between the HF receiver and

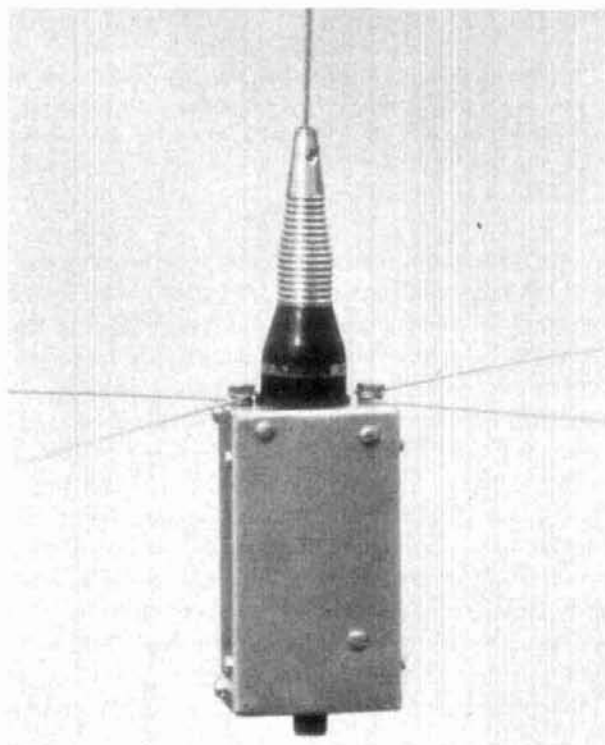

The finished dual-purpose active antenna. Note the installation of the 1/4-wave 2-meter radials. (See W6SAI's November, 1984, column in *ham radio* for a timely discussion on improving radial performance for 5/8-wave 2-meter antennas used in this fashion.)

2-meter FM rig. Very short leads are used for the coax connections at the switch terminals, avoiding severe impedance bumps at 146 MHz. Use care in soldering; overheating the center insulation may result in a short to the coax braid. The outdoor antenna enclosure should be weatherproofed. (Silicone bathroom caulk will do well for this purpose.) Be sure to allow for condensation; a small drain hole on the bottom of the enclosure is needed. Also spray the PC board and components with clear acrylic spray to prevent corrosion. Anti-moisture and fungicidal varnish, carried by some electronic suppliers, is what I used, and it is also ideal for sealing the coax connections after they have been taped.

what to expect

Although performance of either model is adequate for casual monitoring, it is difficult to evaluate these antennas unless an antenna test range equipped with full-size antennas for all of the frequencies involved is available. S-meter comparisons alone can be deceptive. A higher S-meter reading may be obtained with an active antenna with excessive internal gain, while the signal-to-noise ratio may be best on the comparison antenna. This lesson was demonstrated some years ago when I tried using an old RME preselector ahead of a 51J3 Collins receiver. Above 15 MHz the S-meter was very "busy". Switching off the preselector often dropped S-9 signals to an S-1 or less, even though the readability increased dramatically.

With the active antenna connected to your HF receiver and turned on, a slight increase in receiver noise should be heard. Disconnecting the whip antenna from the preamp should cause a noticeable reduction in receiver noise. This is a good indication that everything is working as it should. The gain of this active antenna is not as great as some commercial units I've used in the past. Do not expect signals to produce the same S-meter readings as a full-size antenna.

Some variations of the design are possible. SWL's with a need for coverage in the LF ranges below 550 kHz might consider eliminating the interstage matching transformer. However, without the matching transformer, 60-cycle cross-modulation from strong nearby AC powerline fields will be an annoying problem. This can be especially troublesome in the indoor model where the probe and preamplifier stages are near to the power transformer. The limiting factor for LF performance is the choke values used to isolate the DC supply voltages. They will have to be increased to allow operation below 500 kHz. There is no magic in the antenna probe length — antennas as short as 20 inches might prove adequate. The 48-inch length was selected to allow 5/8-wave 2-meter operation. An 18-inch (45.7 mm) probe could serve as a 1/4-wave

2-meter radiator and eliminate the need for the 2-meter matching transformer.

A few words of caution: the 2-meter antenna will handle about 25 watts. More than this invites damage to the 1- μ H chokes. When using the antenna on an HF transceiver, never transmit into the antenna. Always disconnect the mike and key and set the drive and mike controls at minimum *before* connecting to the active antenna!

There you have it, all in one package: an all-band HF antenna for SWL'ing on your transceiver and a 2-meter antenna for your FM rig. Considering the obstacles facing many Amateurs — lot size, restrictive zoning regulations, and unsympathetic landlords — this antenna will offer a lot of performance in a small, inexpensive and inconspicuous design.

references

1. Henry S. Keen, W5TRS, "Selective Receiving Antennas: A Progress Report," *ham radio*, May, 1978, page 20.
2. Douglas Blakeslee, N1RM "A Very Short Receiving Antenna," *Ham Radio Horizons*, June, 1979, page 24.
3. James R. Fisk, W1DTY, "Voltage-Probe Receiving Antenna," *ham radio*, October, 1970, page 20.
4. Robert Fischer, "Voltage Probe Antenna," *Kollmorgen Corporation Report ER848.1*, January 29, 1968, Kollmorgen Corporation, Northampton, Massachusetts 01060.
5. James Kennedy, K6MIO, "Antennas and Capture Area," *ham radio*, November, 1969, page 42.

ham radio

GLB PACKET RADIO CONTROLLER

Now you can get in on the fun in packet radio!

- * Ready to operate - wired and tested - Low Cost
- * Operates with Voice Transceivers
- * Easy to learn, easy to operate
- * Built in Packet Modem and CW Identification
- * Use with a computer, terminal or Teletype Machine
- * Terminal Code is ASCII or BAUDOT
- * Terminal Speeds from 45 to 9600 Baud
- * Radio Link Speeds of 300, 600 or 1200 Baud
- * Automatically selects AX.25 or VADC protocol
- * Remote Command Lockout for repeater control
- * Full 8 digipeater operation in AX.25
- * Over 90 Commands
- * Stores received messages for delayed reading
- * Able to display other calls while connected
- * "Block" and "Transparent" modes for data files
- * Operates as an unattended digipeater
- * "Beacon" mode
- * Signals available for Teletype Motor Control
- * Standard memory is 4K, expandable to 16K
- * 56K RAM available on special order
- * Can be customized for LAN's
- * Squelch input for sharing of voice channels

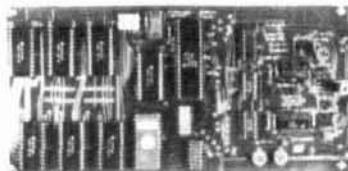

MODEL PK1
(Shown with 16K RAM and 8K ROM)

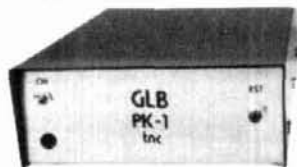

Dimensions: 4.5 X 9.5 X 1.5 (inches)
Power Requirement: 12 volts DC at 200 ma

PK1	Subassembly board (wired and tested, less case)	\$164.95
M2K	2K Additional memory, installed and tested	\$ 10.00/2k
PKDOC	Documentation only, refundable on first PK1 purchase	\$ 9.95
PKCBL	Set of 4-ft cables (DB-25 to 10 pin, uncommitted to 10 pin)	\$ 19.95
PKCNT	10 pin edge connector only (2 required)	\$ 2.95
PKPWR	Power supply (115V input)	\$ 9.95
PKCAB	Cabinet kit	\$ 34.95
PKTTY	Teletype adapter (Teletype machine as terminal)	\$ 17.95
PKWD1	WATCHDOG assembly (for unattended repeater use)	\$ 17.95
PKLAI	RS232 Level Converter (converts PK1 RS232 to -5 to +5 Voltages)	\$ 21.95
PKCPK	CPK Program (specify disc size, format, and computer)	\$ 34.95
PKS24	Each addl. socket installed for memory expansion - 24 pin	\$ 2.00
PKS28	Each addl. 28 pin socket	\$ 2.25

Please specify Call Sign, SSID Number, and Node Number when ordering.

Contact GLB for additional info and available options
We offer a complete line of transmitters and receivers, strips, preselector preamps, CWID ers & synthesizers for amateur & commercial use.
Request our FREE catalog. MC & Visa welcome.

122

GLB ELECTRONICS, INC.

Dept H, 151 Commerce Pkwy., Buffalo, NY 14224
716-675-6740 9 to 4

SEE YOU AT DAYTON

State
of the art



by
K.V.G.

9 MHz CRYSTAL FILTERS

MODEL	Applica-tion	Band-width	Poles	Price
XF-9A	SSB	2.4 kHz	5	\$53.15
XF-9B	SSB	2.4 kHz	8	72.05
XF-9B-01	LSB	2.4 kHz	8	95.90
XF-9B-02	USB	2.4 kHz	8	95.90
XF-9B-10	SSB	2.4 kHz	10	125.65
XF-9C	AM	3.75 kHz	8	77.40
XF-9D	AM	5.0 kHz	8	77.40
XF-9E	FM	12.0 kHz	8	77.40
XF-9M	CW	500 Hz	4	54.10
XF-9NB	CW	500 Hz	8	95.90
XF-9P	CW	250 Hz	8	131.20
XF910	IF noise	15 kHz	2	17.15

10.7 MHz CRYSTAL FILTERS

XF107-A	NBFM	12 kHz	8	\$67.30
XF107-B	NBFM	15 kHz	8	67.30
XF107-C	WBFM	30 kHz	8	67.30
XF107-D	WBFM	36 kHz	8	67.30
XF107-E	Pix/Data	40 kHz	8	67.30
XM107-S04	FM	14 kHz	4	30.15

Export Inquiries Invited.

Shipping \$3.75

MICROWAVE MODULES VHF & UHF EQUIPMENTS

Use your existing HF or 2M rig on other VHF or UHF bands.

LOW NOISE RECEIVE CONVERTERS

1691 MHz	MMk1691-137	\$249.95
1296 MHz GaAsFET	MMk1296-144G	149.95
432/435	MMc432-28(S)	74.95
439-ATV	MMc439-Ch x	84.95
220 MHz	MMc220-28	69.95
144 MHz	MMc144-28	54.95

Options: Low NF (2.0 dB max., 1.25 dB max.), other bands & IF's available

LINEAR TRANSVERTERS

1296 MHz	1.8 W output, 2M in	MM11296-144-G	\$299.95
432/435	10 W output, 10M in	MM1432-28(S)	259.95
144 MHz	10 W output, 10M in	MM1144-28	169.95

Other bands & IFs available.

LINEAR POWER AMPLIFIERS

1296 MHz	20 W output	UP1296-20-L	439.95
432/435	100 W output	MML432-100	369.95
	50 W output	MML432-50	199.95
	30 W output	MML432-30-LS	209.95
144 MHz	200 W output	MML144-200-S	374.95
	100 W output	MML144-100-LS	239.95
	50 W output	MML144-50-S	149.95
	30 W output	MML144-30-LS	109.95

All models include VOX T/R switching.
"L" models 1 or 3W drive, others 10W drive.
Shipping: FOB Concord, Mass.

ANTENNAS

420-450 MHz MULTIBEAMS			
28 Element	70/MBM28 12 dBd	\$49.95	\$39.95
48 Element	70/MBM48 15.7 dBd	75.75	59.95
88 Element	70/MBM88 18.5 dBd	105.50	89.95

144-148 MHz J-SLOTS

8 over 8 Hor. pol	D8/2M	12.3 dBd	\$63.40
8 by 8 Vert. pol	D8/2M-vert	12.3 dBd	79.95
10 + 10 Twist	10XY/2M	11.3 dBd	69.95

UHF LOOP YAGIS

1250-1350 MHz 29 loops	1296-LY 20 dBi	47.95
1650-1750 MHz 29 loops	1691-LY 20 dBi	57.95

Order Loop-Yagi connector extra:

Type N \$14.95, SMA \$5.95

Send 40¢ (2 stamps) for full details of all your VHF & UHF equipment and KVG crystal product requirements.



si

(617) 263-2145
SPECTRUM
INTERNATIONAL, INC.
Post Office Box 1084
Concord, MA 01742, U.S.A.

WOW! AT LAST!! A VERY AFFORDABLE COMPUTER
AT A VERY AFFORDABLE PRICE

SEE YOU AT
DAYTON

POWERFUL FULLY PROGRAMMABLE WITH 2K OF MEMORY—PORTABLE—6-7/8" x 1-3/8" INCH MODULE SINGLE KEY ENTRY COMMANDS—DURABLE 40 KEY MEMBRANE TYPE KEYBOARD—280A BASED FOUR CHIP DESIGN—EDUCATIONAL—UNIQUE SYNTAX CHECK, REPORT CODES FOR ERROR IDENTITY—GRAPH DRAWING AND ANIMATED DISPLAY—ACCURATE TO 9-10 DECIMAL PLACES FOR FULL RANGE MATH AND SCIENTIFIC FUNCTIONS—AT AN AFFORDABLE PRICE

WE CANNOT TELL YOU THE MAKE OF THE COMPUTER BUT IT WAS MADE BY A FAMOUS WATCH COMPANY THEY USED TO SELL FOR \$99.95

WE BOUGHT OUT WHAT THE FACTORY HAD LEFT IN STOCK AND HAD TO REMOVE THE LABELS, THESE UNITS ARE UNPACKAGED LESS THE 9V WALL ADAPTER AND MANUAL BECAUSE THIS IS A DISCONTINUED ITEM THERE IS NO WARRANTY

LIMITED SUPPLY

BUY 1st UNIT FOR \$19.95
BUY THE 3rd UNIT (NON OPERATING FOR PARTS) \$10.95

BUY 2nd FOR \$16.95
BUY 3rd FOR \$10.95

9V DC WALL ADAPTOR \$4.95
MANUAL (OVER 150 PAGES) \$2.95

See September 1984 issue of 73 for TIMEX/RTTY article

CHIP BONANZA (AT THESE PRICES THEY ARE A STEAL)

2708 8K EPROMS (REG. \$4.95)	\$1.50 EA OR 10 FOR \$12.50
2716 16K EPROMS (REG. \$5.95)	\$3.00 EA OR 10 FOR \$25.00
2732 32K EPROMS	\$4.95 EA OR 10 FOR \$45.00
2764 64K EPROMS (REG. \$6.95)	\$5.50 EA OR 10 FOR \$50.00
27128 128K EPROMS	\$18.95 EA OR 10 FOR \$189.00
6502	\$4.95 EA OR 10 FOR \$45.00
9810 (REG. \$3.95)	\$1.95 EA OR 10 FOR \$19.00
68A09 (REG. \$19.95)	\$5.95 EA OR 10 FOR \$50.00
68A21 (REG. \$9.95)	\$2.95 EA OR 10 FOR \$25.00
4116 AMD 9016PC 200 ns	\$1.25 EA OR 8 FOR \$ 8.00
TMS 9900NL MICRO-P 64 PIN 8 BIT DBI + 16 BIT CPU	\$ 4.95
TMS 9901NL MICRO-P PSU	\$ 2.95
74M 9904NL MICRO-P CLOCK GEN. AND DRIVER	\$ 5.95
TMS 9918NL MICRO-P COLOR GRAPHICS AND DISPLAY	\$ 9.95
KEYBOARD 9904 48 KEYS MEASURE 4" x 10" (HITEX)	\$ 8.95

APPLE II and APPLE II+ COMPUTER (HOT ITEM) IF YOU'RE TRYING TO BUILD THE CABLE DECODER AS FEATURED IN THE FEB. ISSUE OF RADIO ELECTRONICS, WE HAVE THE HARD TO GET COILS AND MOST OF THE PARTS

Unit as described above, fully assembled & tested. \$300 plus shipping

*Type in February Ad price should be \$150.00

FSK DEMODULATOR/TONE DECODER KR-211 (SPECIAL) \$2.95 LIMITED QUANTITY—5 PER CUSTOMER

16K RAM MODULES	NEW \$29.95
GAME CASSETTES	CALL OR 4 CORDS AVAILABLE WRITE

SWITCHING POWER SUPPLY

MODEL 44-PS-394: 3 DC OUTPUT VOLTAGES
12 V AT 40 AMPS
5 V AT 1.1 AMP
HIGHLY FILTERED
REQUIRES 24 V AT 40 WATT TRANSFORMER
AS USED IN THE 73-95
SUGGESTED LIST OF \$39.95

HAL TRONIX PRICE \$12.95
OR 2 FOR \$20.00
LIMITED SUPPLY

HAL-TRONIX, INC.

P.O. BOX 1101 - DEPT. HR
SOUTHGATE, MICH. 48195
PHONE (313) 285-1782

"HAL" HAROLD C. NOWLAND
W8ZXH

15th ANNUAL
INDIANAPOLIS HAMFEST™
And INDIANA STATE ARRL CONVENTION

Marion County Fairgrounds

July 13-14, 1985

FREE:

- Parking
- Kids Prize Drawings
- Camping
- Womens Prize Drawings

2 Full Days of:

- Commercial Exhibitors
- Large Flea Market
- Hourly Prize Drawings
- Forums

Indiana's Largest Electronic Flea Market and Amateur Radio Display

INDIANAPOLIS HAMFEST, P. O. Box 11776, Indianapolis, IN 46201
OR CALL: (317) 894-8522

RAMSEY

THE FIRST NAME IN ELECTRONIC TEST GEAR

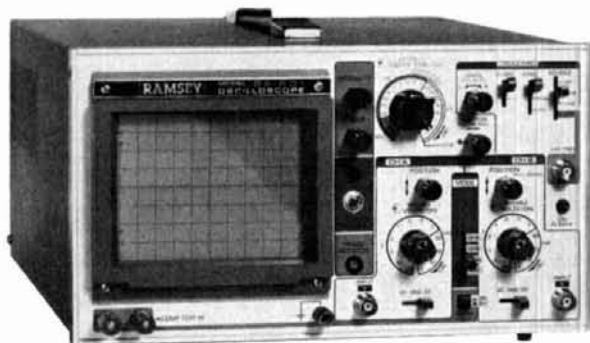

20 MHz DUAL TRACE OSCILLOSCOPE

Unsurpassed quality at an unbeatable price, the Ramsey oscilloscope compares to others costing hundreds more. Features include a component testing circuit for resistor, capacitor, digital circuit and diode testing • TV video sync filter • wide bandwidth & high sensitivity • internal graticule • front panel trace rotator • Z axis • high sensitivity x-y mode • regulated power supply • built-in calibrator • rock solid triggering. *USA — add \$10.00 per unit for postage, overseas orders add 15% of total order for insured surface mail.

\$399⁹⁵*

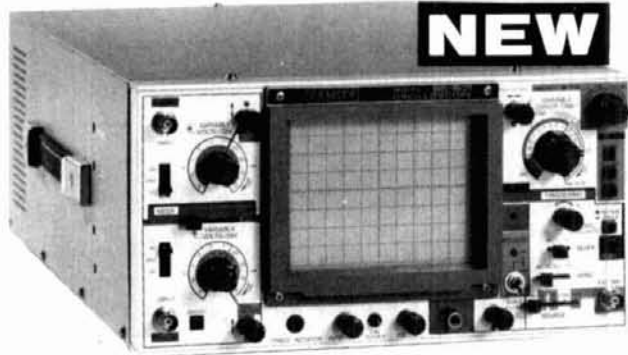

45 MHz DUAL SWEEP OSCILLOSCOPE

The Ramsey 625 is a dual time base, delayed sweep unit that includes a built-in signal delay line to permit clear viewing during very short rise times of high frequency waveforms. Other features include: variable trigger holdoff • 20 calibrated sweep time ranges from 0.5 μ div. to 0.2 μ div. • fully adjustable sweep time • X5 sweep magnification • five trigger sources, CH1, CH2, LINE, EXTERNAL and INTERNAL (V model) • front panel x-y operation, Z axis input • sum difference of CH1 and CH2 waveforms displayed as single trace • sweep gate and sweep output • auto focus • single sweep. *USA — add \$10.00 per unit for postage, overseas orders add 15% of total order for insured surface mail.

\$799⁹⁵*



RAMSEY D-1100 VOM MULTITESTER

Compact and reliable, designed to service a wide variety of equipment. Features include • mirror back scale • double-jeweled precision moving coil • double overload protection • an ideal low cost unit for the beginner or as a spare back-up unit.

\$19⁹⁵ test leads and battery included



NEW RAMSEY 1200 VOM MULTITESTER

Check transistors, diodes and LEDs with this professional quality meter. Other features include: decibel scale • 20K volt metering system • 3 1/2" mirrored scale • polarity switch • 20 measuring ranges • safety probes • high impact plastic case.

\$24⁹⁵ test leads and battery included

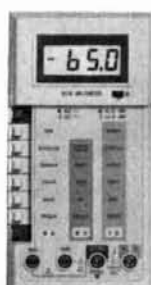

RAMSEY D-3100 DIGITAL MULTIMETER

Reliable, accurate digital measurements at an amazingly low cost • in-line color coded push buttons, speeds range selection • abs plastic tilt stand • recessed input jacks • overload protection on all ranges • 3 1/2 digit LCD display with auto zero, auto polarity & low BAT. indicator.

\$49⁹⁵ test leads and battery included



CT-70 7 DIGIT 525 MHz COUNTER

Lab quality at a breakthrough price. Features • 3 frequency ranges each with pre amp • dual selectable gate times • gate activity indicator • 50mV @ 150 MHz typical sensitivity • wide frequency range • 1 ppm accuracy.

\$11^{99⁵} wired includes AC adapter

CT-70 kit \$99.95
BP-4 nicad pack 8.95



CT-90 9 DIGIT 600 MHz COUNTER

The most versatile for less than \$300. Features 3 selectable gate times • 9 digits • gate indicator • display hold • 25mV @ 150 MHz typical sensitivity • 10 MHz timebase for WWV calibration • 1 ppm accuracy.

\$14^{99⁵} wired includes AC adapter

CT-90 kit \$129.95
OV-1 0.1 PPM oven timebase \$9.95
BP-4 nicad pack 8.95



CT-125 9 DIGIT 1.2 GHz COUNTER

A 9 digit counter that will outperform units costing hundreds more. • gate indicator • 24mV @ 150 MHz typical sensitivity • 9 digit display • 1 ppm accuracy • display hold • dual inputs with preamps.

\$16^{99⁵} wired includes AC adapter

BP-4 nicad pack 8.95



CT-50 8 DIGIT 600 MHz COUNTER

A versatile lab bench counter with optional receive frequency adapter, which turns the CT-50 into a digital readout for most any receiver • 25 mV @ 150 MHz typical sensitivity • 8 digit display • 1 ppm accuracy.

\$16^{99⁵} wired

CT-50 kit \$139.95
RA-1 receiver adapter kit 14.95



DM-700 DIGITAL MULTIMETER

Professional quality at a hobbyist price. Features include 26 different ranges and 5 functions • 3 1/2 digit, 1/2 inch LED display • automatic decimal placement • automatic polarity.

\$11^{99⁵} wired includes AC adapter

DM-700 kit \$99.95
MP-1 probe set 4.95



PS-2 AUDIO MULTIPLIER

The PS-2 is handy for high resolution audio resolution measurements, multiplies UP in frequency • great for PL tone measurements • multiplies by 10 or 100 • 0.01 Hz resolution & built-in signal preamp/conditioner.

\$4^{99⁵} wired

PS-2 kit \$39.95



PR-2 COUNTER PREAMP

The PR-2 is ideal for measuring weak signals from 10 to 1,000 MHz • flat 25 db gain • BNC connectors • great for shifting RF • ideal receiver/TV preamp.

\$4^{99⁵} wired includes AC adapter

PR-2 kit \$34.95



PS-1B 600 MHz PRESCALER

Extends the range of your present counter to 600 MHz • 2 stage preamp • divide by 10 circuitry • sensitivity, 25mV @ 150 MHz • BNC connectors • drives any counter.

\$5^{99⁵} wired includes AC adapter

PS-1B kit \$49.95

ACCESSORIES FOR RAMSEY COUNTERS

- Telescopic whip antenna—BNC plug \$ 8.95
- High impedance probe, light loading 16.95
- Low pass probe, audio use 16.95
- Direct probe, general purpose use 13.95
- Tilt ball, for CT-70, 90, 125 3.95



PHONE ORDERS CALL
716-586-3950

TELEX 466735 RAMSEY CI

TERMS: • satisfaction guaranteed • examine for 10 days; if not pleased, return in original form for refund • add 6% for shipping and insurance to a maximum of \$10.00 • overseas add 15% for surface mail • CDD add \$2.50 (CDD in USA only) • orders under \$15.00 add \$1.50 • NY residents add 7% sales tax • 90 day parts warranty on all kits • 1 year parts & labor warranty on all wired units.

RAMSEY

RAMSEY ELECTRONICS, INC.
2575 Baird Rd.
Penfield, N.Y. 14626

control your take-off angle: the JR vari-lobe antenna

Dial in your skip distance
and maximize your signals

The *ham radio* staff was saddened to learn of the recent death of Dick Schellenbach, W1JF. In memory of this exemplary Radio Amateur we are proud to present the following two articles.

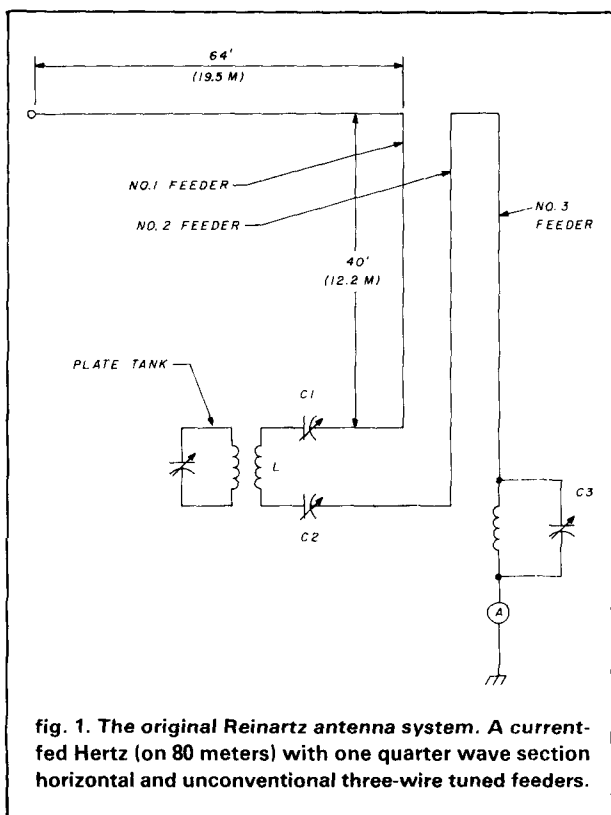

fig. 1. The original Reinartz antenna system. A current-fed Hertz (on 80 meters) with one quarter wave section horizontal and unconventional three-wire tuned feeders.

Most Radio Amateurs, I'm sure, are quite familiar with the directional properties of simple halfwave antennas. In these antennas, the majority of radiation is broadside to the radiating element, in the case of a horizontal type antenna. Some Amateurs may be familiar with, or may have experienced, the effect of raising or lowering an antenna and have seen how its launch angle, as well as its impedance, was significantly affected by the change in height. In this respect, a lower angle of vertical radiation usually produces a stronger signal further out in distance than one that has an extremely high angle of radiation when the communication path is governed by sky waves. This path distance versus launch angle phenomenon is very noticeable on the lower frequency Amateur bands of 160, 80, and 40 meters, where both high and low angles of radiation are useful in radio communications.

Given the fact that a half-wave antenna generally radiates most of its signal broadside to the antenna, what would you think of a simple modification that would permit controlled selection of its radiation angle? This would allow the Amateur station to take advantage of the prevailing ionospheric conditions, night or day, and therefore enhance signals to and from a particular distant location. Such an antenna system is feasible.

The basic idea for the variable lobe system was developed fifty years ago by the legendary John L. Reinartz, W1QP.¹

In developing this new concept and publishing the results of his experiments Reinartz discovered he truly had a multiband antenna system as well as one providing versatile radiation angle control allowing him to maximize signal strengths at different locations. Reinartz also found out he could compensate for time-varying propagation conditions, especially when the

By R.R. Schellenbach, W1JF, 12 Whitehall Lane, Reading, Massachusetts 01867

reflective layer was in the process of changing heights, thereby requiring a different radiation angle while he was communicating.

The ability to alter an antenna's vertical lobe characteristics is one solution to the thought-provoking question, why does it often seem that signal reports appear to differ drastically between individual stations, even when the stations are located only a few miles apart in the same general direction?

The causes for inconsistencies between signal reports include a myriad of possibilities such as polarization differences, vagaries of the ionospheric reflective layers, multi-hop propagation, launch radiation, and receiving station antenna angle differences, to name a few. Because of the large number of variables affecting sky-wave propagation, the solutions to these problems are complex. However, if a radio station possesses the capability to adjust to any potential condition, the inconsistencies are not at all important — only the corrective measure capability matters.

Reinartz recognized the same perplexing propagation differences between the station he worked and proposed that if he were to vary the vertical angle pattern of his antenna, he should maintain a maximum signal strength at both ends of the communication path. In his model, Reinartz developed an antenna system which is basically a simple current-fed Hertz type antenna with one quarter-wave horizontal section and another sixth-wave feeder section, the latter consisting of two normal operating feeders and a third, vertical wire carried into his ham shack for tuning and compensation control. The original Reinartz version of the controlled radiation angle antenna is shown in **fig. 1**. The model as shown, operating on the 80-meter band, proved to be capable of operating under vertical angle of radiation control at twice or even four times its fundamental design frequency.

In spite of the antenna's multiband capability, it was used primarily on the 80-meter band, where daily and seasonal propagation effects were more pronounced and allowed Reinartz to do a lot of experimentation during variable band conditions.

how it works

Referring again to **fig. 1**, illustrating the original Reinartz antenna system, it should be mentioned that the variable capacitor C2 was found to be unnecessary in the 80-meter application and that all vertical angle lobe changing was affected by varying C1 while maintaining resonance of the parallel L/C network against ground for each particular operating frequency. Reinartz used an RF current reading ammeter to determine resonance in the third (vertical) feeder wire, but the meter is deemed unnecessary, as other means are available to determine proper resonance of the vertical wire section.

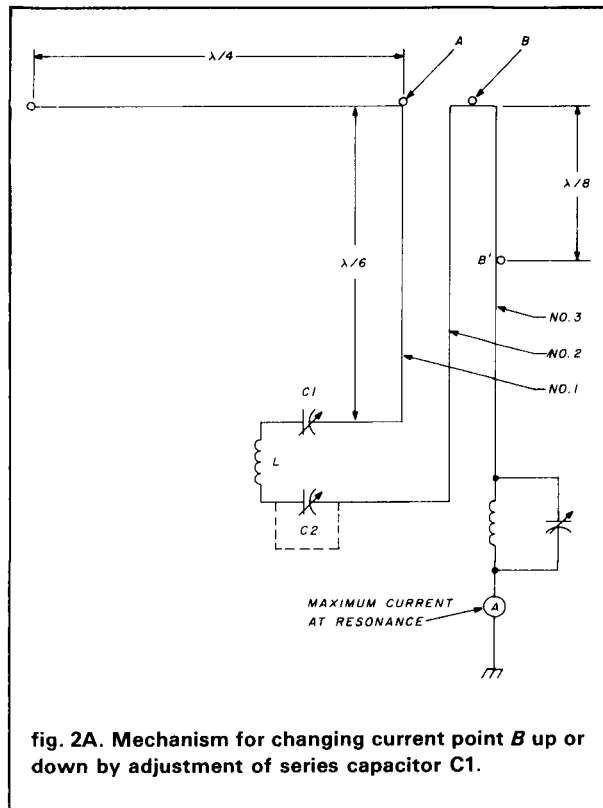
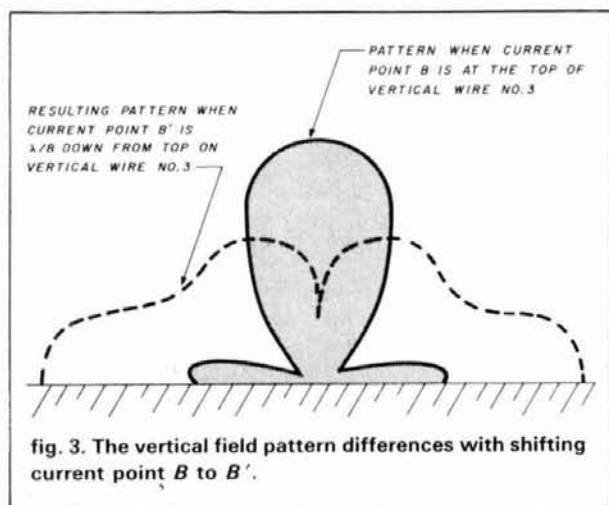
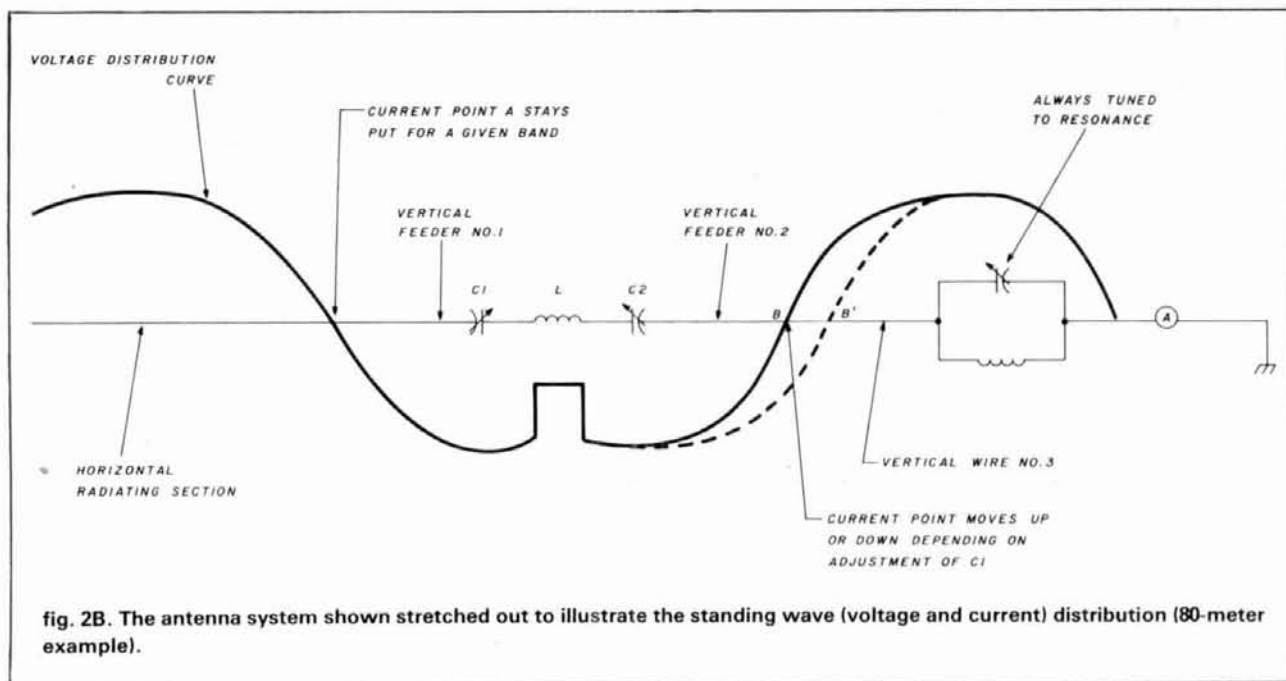

fig. 2A. Mechanism for changing current point **B** up or down by adjustment of series capacitor **C1**.

More details of the mechanism for changing the antenna's vertical field pattern is shown in **figs. 2A** and **2B**, where on the 80-meter band these figures indicate the voltage and current distributions on the model and the method employed to change the radiating current points on the system. The horizontal wire section of the antenna in **fig. 2A** is only one-sixth wavelength above the ground and hence, most of its radiation is directed upward — a real "cloud burner." During nighttime conditions, for example, this pattern would produce strong local signals because of the high angle and short distance skip zone; if we were to move the current point from the top of feeder number 3 downward, however, then the radiation characteristic would be reversed and the antenna's radiation would become predominately low angle — good for DX.

The change in vertical radiation pattern with relationship to the RF current maximum point on the third (vertical) wire section is illustrated in **fig. 3**. As one may surmise, the third vertical wire section of the antenna functions to provide the vertically polarized and low angle lobe control for the system. By controlling the current distribution by altering capacitor C1 in the series tuning circuit of **fig. 2**, the Vari-Lobe antenna changes from a high vertical angle radiator to a low vertical angle radiator quite simply. When capacitor C1 is slowly tuned, the antenna's vertical pattern may be finely adjusted anywhere between the two extremes depicted in **fig. 3**. This tuning control



effectively allows the operator to "tune in" the required skip distance to another station for maximum signal strength. Large departures in current control by changes in capacitor *C1* will require slight readjustment to the resonance of the parallel tuned circuit between the vertical section wire number 3 and ground.

According to tests by Reinartz in which he instrumented the vertical wire from top to bottom with small pilot lamps to indicate antenna current distributions, the further downward the current maximum was toward the one-eighth wavelength point, the greater the low angle effect and the further out the skip became.

It is interesting to note that Reinartz performed many of his early experiments and collected data on the shifting field strength patterns on the 10-meter

band. Later, actual on-the-air tests using a full-scale 3.5 MHz (80 meter) model was used to communicate with a number of Amateurs up and down the east coast of the United States.

Concluding remarks by Reinartz indicate that his repeated tests showed that compensation for the advance of time from early evening to past midnight must be made by a change in the location of the maximum current point on the vertical section in order to maintain maximum signal strength at the receiving station. During daytime operation, he noticed that although there was one generally satisfactory setting of *C1*, slight changes could be made in the lobe adjustment to provide a maximum signal at some particular receiving station. He noticed too, that some stations were always consistent in the antenna's lobe setting for obtaining a maximum signal strength.

a modern version of the JR antenna

By carrying Reinartz's ideas further and adding modern improvements, the JR Vari-Lobe antenna came into being. The new system offers more operating frequencies with ease of controlled radiation from either the ham shack or by remote control. The modern version is shown in **fig. 4** and its control section in **fig. 5**. I prefer the remote tuning method because it keeps the necessary radiating elements away from the surrounding objects such as houses, trees, telephone and power lines, etc. The JR Vari-Lobe antenna's performance could be adversely influenced by such local obstructions because the antenna is a relatively low height system and it utilizes low angle vertical polarization.

As an additional feature of modernization, I incorporated a 15-meter "high gain" capability by using the "JF Array"² principally on the horizontal section. When used, the JF Array mode is automatically invoked when the system is tuned up on the 15-meter band. On this frequency, the antenna acts as a two-element, wide-spaced collinear array producing a good 3-dB gain broadside to the horizontal sections. Vertical angle selectivity is not used on this higher frequency band because the system is operated in its "Zepp" mode, in which feeders A and B are used and B and C are tied together as shown in **figs. 4 and 5**.

The reader will notice that there are small differences between the original Reinartz antenna and the modern version. Most of the recent changes were brought about by the addition of the JF Array feature and a more compatible feeder length to handle multiband applications. In a departure from the original antenna system, we have taken advantage of using a multiband tuning network to implement the third wire to ground resonance of the system. This expedient is in keeping with modernization of the compensation tuning, since in practice, only one adjustment needs to be made for each operating band segment, and one that holds for a bandwidth of 40 to 60 kHz on the 80-meter band and greater than 60 kHz on the 40-meter band.

The coaxial transmission line to the radio station equipment may be provided by either a 50 or 75-ohm coaxial cable through a 1:1 balun transformer connected across a few turns at mid-point on inductor L of **fig. 5**. As discussed previously, capacitor C1 of **fig. 5** is the vertical lobe angle control, where decreasing its effective capacity corresponds to raising the current maximum point on the vertical wire number 3 corresponding to a high lobe angle for the antenna. Conversely, an increase in capacitance by C1 results in lowering the current maximum point on the vertical wire number 3 corresponding to a low angle of radiation for the antenna. Each extreme capacitance change of C1 must be followed by an adjustment of the parallel tuned resonance circuit, especially if the operating frequency has also been changed beyond the bandwidth restrictions previously mentioned.

performance

Because the JR Vari-Lobe antenna system is intended to be used primarily on the 80 and 40-meter bands with infrequent excursions to 15 meters, it is important to have a good ground in order for the system to work well. Ground radials should be employed beneath the horizontal section of the antenna and extend outward in a fan shape from the third (vertical) wire section. A good ground system will not only enhance the lobe selectivity feature, but will also significantly diminish ground losses surrounding the

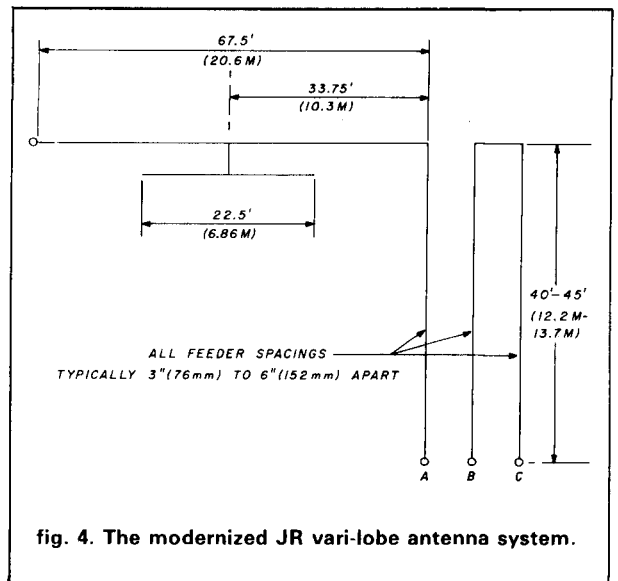

fig. 4. The modernized JR vari-lobe antenna system.

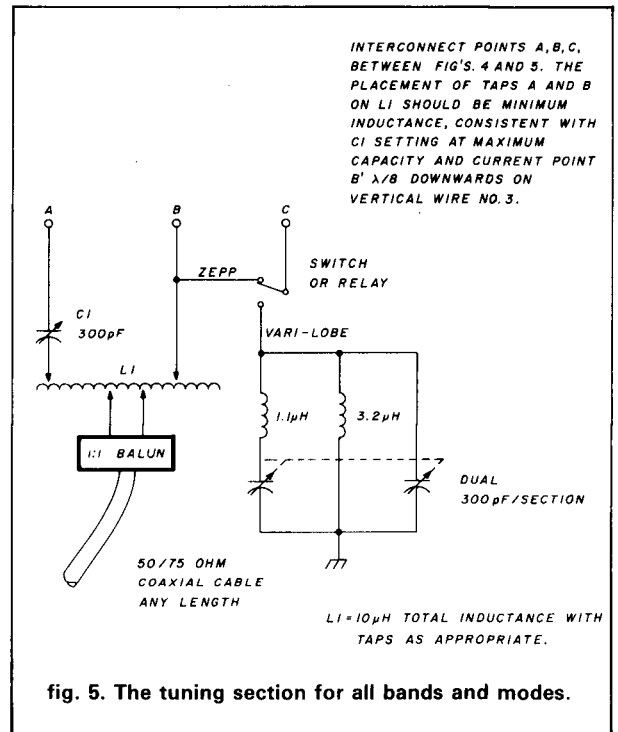

fig. 5. The tuning section for all bands and modes.

radiating system, especially on the lower frequency bands.

On-the-air tests were conducted on the 80, 40, and 15-meter bands over a period of three months. Based on these tests, it may be stated that the JR Vari-Lobe radiation characteristics on the 80 and 40-meter bands successfully proved to correspond to Reinartz's theory. The variable angle selectivity feature has enabled maximum signal strength adjustment over different path distances both during night and daytime conditions. While operation on the 15-meter band does not include variable angle control, it has proven to be an effective

AMATEUR TELEVISION

NEW 70 CM ATV TRANCEIVER

ALL YOU NEED IN ONE BOX



\$299 delivered
TC70-1

- **FULL COLOR, SOUND, & LIVE ACTION** just like broadcast TV. Get on this exciting amateur video mode at our affordable ready to go price.
- **WHAT IS REQUIRED FOR A COMPLETE OPERATING SYSTEM?** The TC70-1s downconverter outputs to any TV on ch 3 for receiving. Connect a good 70 cm antenna and low loss coax. Plug in any composite video source you want to transmit: Camera, VCR, computer, etc. Plug in any low Z dynamic mic or use color camera mic for Standard 4.5 MHz TV sound. Connect to 13.8 vdc for base, mobile, or portable. See chapt. 20 1985 ARRL Handbook. That's it!
- **WHAT CAN YOU DO WITH THE TC70-1 ATV TRANCEIVER?** Show the shack, projects, computer program listings, home video tapes, repeat Space Shuttle audio and video if you have a TVRO, repeat SSTV or RTTY, Weather Radar, do public service events such as parades, marathons, races, CAP searches and rescues... the list goes on. DX depends on antennas and terrain, typically 1 to 40 miles. We have video compensated RF linear amps for 20 (\$119) or 50 (\$189) watts pep for greater DX.
- **FEATURES:** Small 7x7x2.5". Push to Look (PTL) T/R switching. GaAsFet downconverter tunes whole 420-450 MHz band. Two switch selected video & audio inputs... RCA phone jacks and 10 pin color camera jack. Xmit video monitor output. Over 1 watt pep RF output on one or two (add \$15) selected crystal controlled frequencies. 439.25, 434.0, or 426.25 MHz.

CALL OR WRITE FOR OUR CATALOG for more info or who is on in your area. We stock antennas, modules, and everything you need on ATV.

TERMS: Visa, MC, or cash only UPS CODs by phone or mail. Checks must clear bank before shipment. Price includes UPS surface shipping in cont. USA, others add 3%. Transmitting equipment sold only to licensed Tech class or higher amateurs, verifiable in 1985 call book or copy of new license.

(818) 447-4565 m-f 8am-6pm pst.

P.C. ELECTRONICS
Tom W6ORG Maryann WB6YSS



2522 Paxson Lane
Arcadia CA 91006

✓ 126

YOU WANT IT? DAN'S GOT IT!

YAESU



FT-209

KENWOOD



TM-211

ALL OF THESE GOODIES AND MANY MORE
AT A SUPER SAVINGS!

CALL TODAY

1 (800) 241-2027

BRITT'S 2-WAY RADIO

Sales & Service

2508 Atlanta Street
SMYRNA, GA. 30080
(404) 432-8006

✓ 127

tive radiating system of modest size and relative simplicity. Although tests were not performed on the 10 and 20-meter bands, Reinartz has shown the antenna system will operate as a conventional Zepp on all bands and if desired, with variable angle control as well. Conventional Zepp configurations do not require the parallel tuning network to ground for the third (vertical) wire. Thus, the simple expedient of tying together feeders B and C of fig. 5 changes the antenna into a Zepp configuration. The Zepp mode may be used on all bands higher than 80 meters, providing a flexible multiband antenna system if you don't mind the coupling adjustments and tuning of two feeder wires. The system is a natural for the Amateur who has limited antenna space but would like something different and more versatile than other systems.

resonance tuning features

The original Reinartz antenna system used an RF ammeter in series with the ground connection to determine resonance of the antenna when excursions were made in lobe angle and frequency. A diode detector probe positioned near the top of the parallel tuning network will work as well and could be remoted quite easily if desired. However, it is also possible to tune the system "by ear." When the parallel tuned circuit is tuned to the correct resonant point, a noticeable increase in received signal strength or background noise is apparent, thereby dispensing with the requirement for remote meter reading.

The multiband tuner operates satisfactorily over all of the harmonically related Amateur Radio bands to maintain resonance of the system. Obviously, if only limited operation is contemplated on 80 or 40 meters, then the multiband tuning function may be eliminated and a single-band network would serve as well. In my installation, using remote controlled tuning proved to make the operation of the Vari-Lobe a joy to use. Small 24-VAC furnace valve control motors were coupled to the shafts of both tuning capacitors to provide remote tuning control from the shack. These small, economical motors rotate slow enough to allow sufficient tuning resolution and accuracy even though they are turning only in one direction. An alternative to these AC-type control motors are surplus stepping motors featuring bi-directional incremental DC pulse control with 3.65 degree/step resolution. These devices are available from a number of sources for a nominal price. Some even include additional gearing for slower response.

references

1. J.L. Reinartz, "A New Antenna System For Operating Control of Radiation," *QST*, February, 1935, page 9.
2. R.R. Schellenbach, W1JF, "The JF Array," *QST*, November, 1982, page 26.

ham radio

SAVE \$10.00* with home delivery!

*(One year newsstand cost \$30.00)

Here's my address label, enter my subscription. Payment enclosed

Bill me later

U. S. prices only

1 Year 12 issues \$19.95

2 Years 24 issues \$32.95

3 Years 36 issues \$44.95

Name _____ Zip _____

State _____

Address _____ (attach label)

City _____

Check here if this is your renewal (attach label)

Subscribe to **ham radio** magazine

Please allow 4-6 weeks for delivery of first issues.

Foreign rates: Europe, Japan and Africa, \$28.00 for one year by air forwarding service. All other countries \$22.95 for one year by surface mail.

Please
enter my
subscription



NO POSTAGE
NECESSARY
IF MAILED
IN THE
UNITED STATES

BUSINESS REPLY CARD

First Class Permit No. 1 Greenville, NH

Postage Will Be Paid By Addressee

**ham
radio**

Greenville, NH 03048



the end-fed 8JK: a switchable vertical array

30/40-meter antenna
radiates at low angles
and requires little space

This array was developed to provide maximum gain in a compact, convenient low-vertical angle antenna system. The 40-meter version requires only 1225 square feet of area, and the 30-meter version, less than half that amount.

The 30- and 40-meter bands were selected because of the increased activity on those bands — especially for DX — resulting from the diminishing MUF caused by declining solar activity. The selectable directivity and low radiation angle of this system should offer significant performance advantages as interference and competition on these bands increase. While the gain of this phased array is modest, the system will effectively double the RF radiated power of a single vertical in the preferred direction. The array also provides deep nulls spaced 90 degrees apart on each side of the main beam pattern, thus improving rejection of unwanted signals.

theory of operation

The 2 x 2 phased array is a pair of two parallel-element end-fire vertically polarized matched arrays, each of which is similar to W8JK's single section beam, with elements fed 180 degrees out of phase and spaced 1/8 wavelength apart. A composite simplified view of the array is shown in **fig. 1**. By folding the top and bottom 1/16-wavelength end sections of each element, a useful height reduction results without significantly effecting similar normal full-size array characteristics caused by element folding. Because each connecting wire at the base and the elevated end sections are only 1/16 wavelength long and carry very little current, little radiation and pattern distortion result from these folded sections

construction and implementation

Figure 2 depicts the 2 x 2 phased array configuration; **table 1** provides the element lengths and spacing as well as mast height requirements. **Figure 3** illustrates the matching 1/4-wavelength stub and

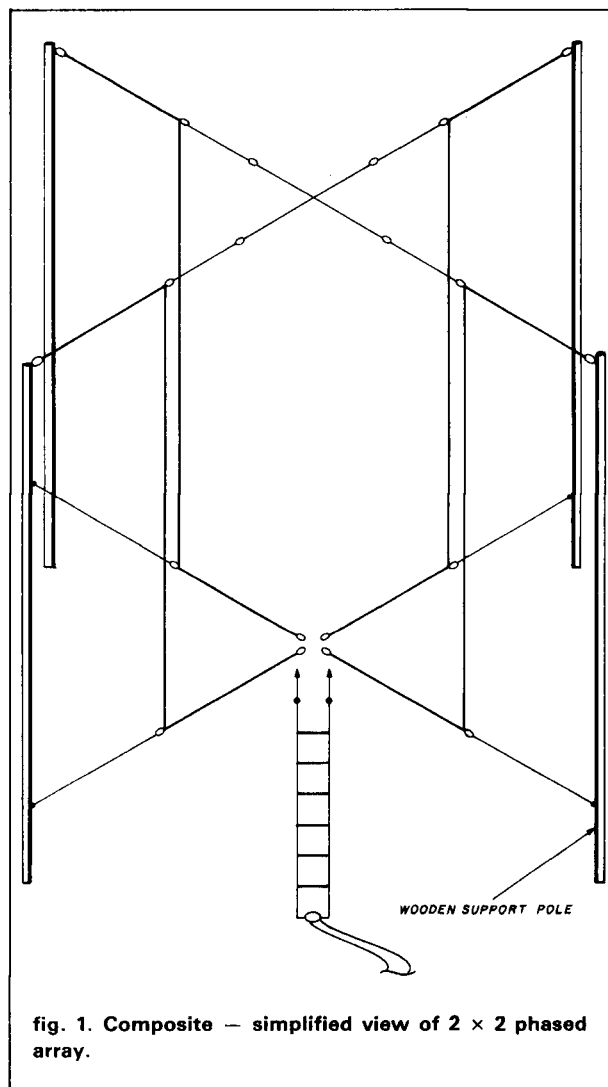

fig. 1. Composite — simplified view of 2 x 2 phased array.

By R.R. Schellenbach, W1JF, 12 Whitehall Lane, Reading, Massachusetts 01867

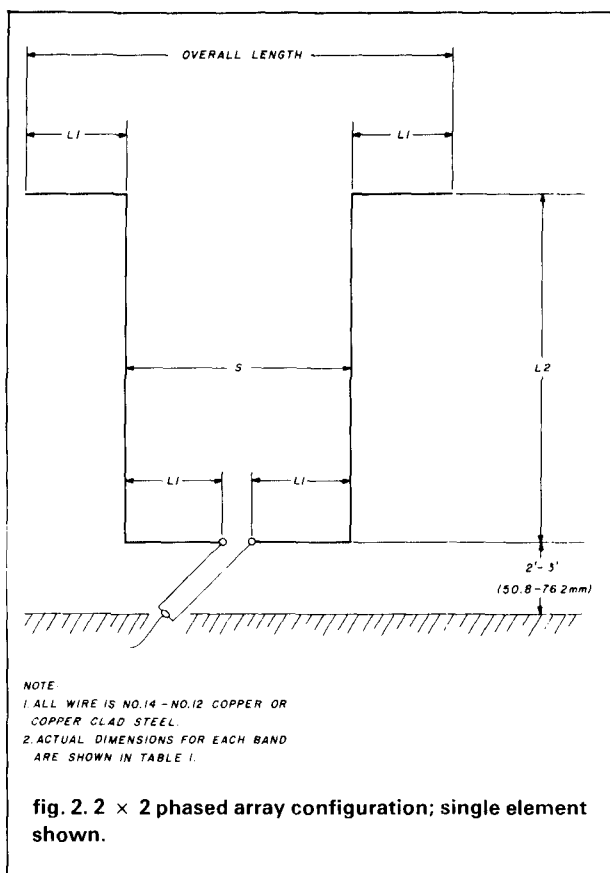

table 1. Physical dimensions for the 2 x 2 phased array on 40 or 30 meters.

	40-meter operation	30-meter operation
L1	8.75 feet	5.80 feet
L2	43.00 feet	29.00 feet
L3 (stub)	34.00 feet*	23.25 feet*
S	17.50 feet	11.60 feet
overall length	35.00 feet	23.25 feet
pole height (min.)	45.00 feet	31.00 feet

*May be laid horizontal as required.

tion will be a few inches higher toward the relay end than that of 50-ohm coaxial cable. More detail on proper matching is provided later, but the process is simple and provides wide bandwidth on either band of operation.

site and space requirements

Four poles, preferably wooden, are required to sup-

remote relay switching scheme including a balun for mating with coaxial cable. The length and physical positioning of the coaxial cable into the station are not critical.

Because the 2 x 2 phased array consists of two identical two-element arrays crossing at right angles to each other, a simple DPDT relay controls the selection of the array to be connected to the common 1/4-wavelength stub and hence through the balun transformer and coaxial cable into the station.

Once the 1:1 balun transformer tap position has been adjusted for a low VSWR at the desired operating frequency, no tuning or matching are required between the station and the system. The actual tap position depends on the stub line impedance and interwiring characteristics of the relay switching.

In order to reduce difficulties in array matching as much as possible, each element on an array — as well as the overall symmetry of the arrays — should be made as identical as possible to preserve balance and uniformity when changing directivity. Because a common 1/4-wavelength stub is used for matching into the antenna system, it is important that all wire connections to the DPDT relay be made equal in length. In placing the tap point for the balun transformer, you will find that with 75-ohm coaxial cable, the tap loca-

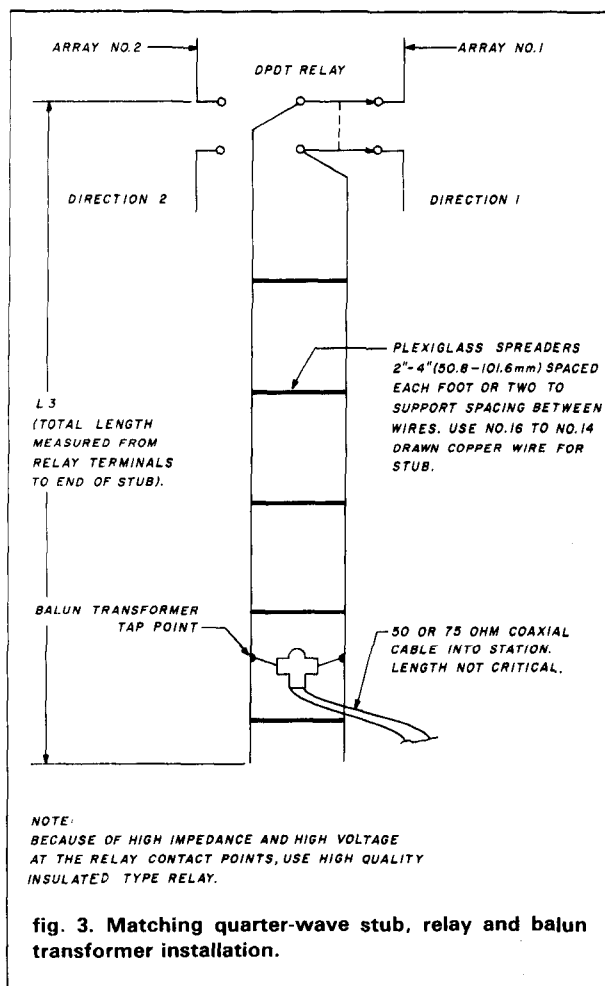

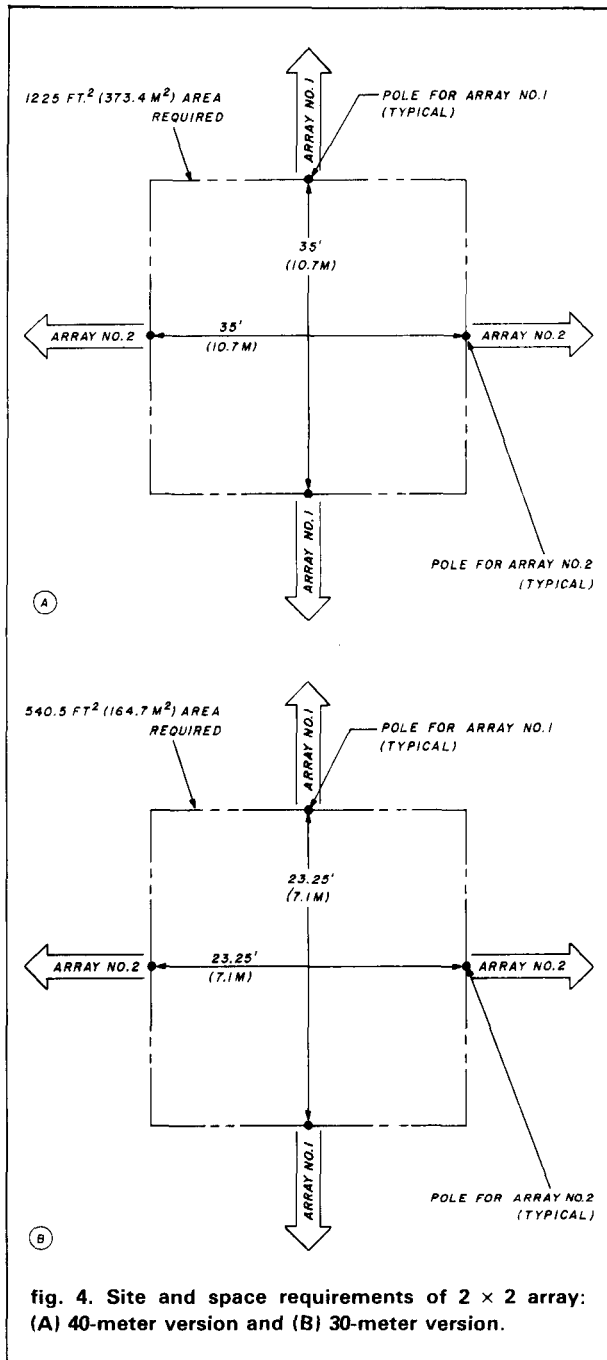

port the array. While they are oriented as shown in **fig. 4**, the distance between them can be increased to meet individual requirements. **Figure 4** also indicates the principal beam directions with respect to the DPDT relay position that is controlled from the station end. Using this directivity characteristic of the array, the individual beam patterns may be oriented in the most favorable compass directions.

To assure maximum low angle radiation and deep null beam pointing performance — and to eliminate

effects of pattern distortion and RF absorption — the array should be located in an area free of structures or power lines for at least 250 feet from its center on 40 meters and 190 feet on 30 meters.

technical performance

The 2 x 2 phased array provides approximately 4 dB gain over conventional 1/2-wavelength dipoles and 6 dB gain over 1/4-wavelength ground mounted single verticals. The azimuthal bi-directional beam pattern, although relatively broad, (approximately 80-degree half-power beamwidth) has quite deep nulls, better than 20 dB down from the main lobe maximum. The nulls are also bi-directional in either case and are located at right angles (90 degrees) to the two major beam lobes produced by each active array.

In operation, these nulls may be used to advantage to eliminate strong interference coming from an undesired direction. The major radiating point on each active element occurs at a point 42 percent up from the bottom end of each vertical. The distance between the bottom horizontal 1/16-wavelength interconnecting wires and earth ground should be no more than 2 to 3 feet for proper performance.

remote switching and balun tap alignment

The simple arrangement of a common 1/4-wavelength stub switching to activate either array provides controlled directivity for both transmitting and receiving. The length of the 1/4-wavelength stub for either band is given in **table 1** as a starting point for the balun tap position.

The tap should be made progressively upward from this overall dimension. Each time the tap location is changed a few inches at a time, the operator should observe an in-line measurement of SWR. The proper tap point will result in the lowest VSWR reading when matching into appropriate coaxial cable using a 1:1 ratio type balun transformer. The use of a balun in this array application is highly recommended to maintain a complete balance of the array system and to minimize beam pattern distortions as well as deterioration of noise pick-up immunity so characteristic of poorly matched or unbalanced feed systems.

The coaxial cable, whose length is not critical, may be buried and its outer shield grounded for further immunity from noise pick-up in severe cases.

Because of weather considerations for rain or snow, the DPDT relay should be mounted inside a waterproof enclosure. This may be combined with supporting the four bottom horizontal 1/16 wavelength wires if the enclosure is elevated by a post at the recommended 2 to 3 feet above the ground level.

ham radio

★ ★ ★ **VECTOR** ★ ★ ★

VT-3B and VT-4B
MOBILE HOME

NEW REMOTE CONTROLLED ANTENNA TUNERS

NEW COMPACT DESIGN WITH 10-segment LED tuning indicator

- ★ VT-4B INSTALLS DIRECTLY AT THE ANTENNA FEEDPOINT WHERE YOU CAN REALLY "TUNE" THE ANTENNA.
- ★ DESIGNED FOR HALF WAVE DIPOLES, INVERTED V's, AND QUARTER WAVE VERTICALS USING 50 OHM COAX FEED-LINES.
- ★ OPERATES WITH SINGLE BAND OR MULTIBAND ANTENNAS, TRAP TYPE OR PARALLEL ELEMENT TYPES.
- ★ WORKS ALL BANDS FROM 10 THROUGH 160 METERS.
- ★ FULL BAND COVERAGE WITH MAXIMUM EFFICIENCY AND VERY LOW VSWR, TYPICALLY LESS THAN 1.2 TO 1.
- ★ FINGER TIP CONTROL FROM THE HAM SHACK FOR EXACT RESONANCE AND IMPEDANCE MATCH.
- ★ FOR MOBILE OPERATORS THE VECTOR VT-3B INSTALLS IN THE TRUNK AND TUNES STANDARD TYPE MOBILE ANTENNAS FOR FULL BAND COVERAGE, (All of 75M phone band), WITH TYPICAL VSWR LESS THAN 1.2 TO 1.



VT-4B

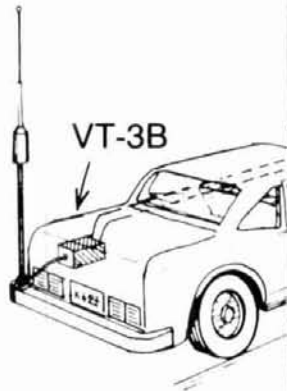

VT-3B

EITHER MODEL
\$169⁰⁰

WRITE FOR INFORMATION.

✓ 128

VECTOR RADIO CO., P.O. BOX 1166, CARDIFF, CA 92007

LISTEN TO THE WORLD



\$89.95

WITHOUT THE ANTENNA HASSLE!

Arcomm's AP4 active tuned antenna/preselector is ideal for those who want to listen but cannot put up outdoor antennas. Covers .540 to 32 MHz in 4 bands and incorporates a low noise, up to 18 dB gain preamp. Intermod is reduced by using Hi-Q toroidal inductors. Will switch four antennas and three receivers. Ideal for all general coverage receivers. 8-1/4" x 6-1/8" x 2", weight 4 lbs.

To order, send check or money order plus \$3 shipping. PA res. add 6% sales tax. Dealer inquires invited.

ARCOMM

24 Valley Street
Lewistown, PA 17044

✓ 130

AZOTIC INDUSTRIES

2026 W. BELMONT
CHICAGO, IL 60618
312-975-1290

ELECTRONIC COMPONENTS & SUPPLIES

- RF CONNECTORS
- UG CONNECTORS
- AUDIO CONNECTORS
- LINEAR IC'S
- DIGITAL IC'S
- TRANSFORMERS
- METERS
- COMPUTER CABLES
- DISKETTES
- IDC CONNECTORS
- D-SUBMINIATURE
- TEST EQUIP
- TRANSISTORS
- DIODES
- TRIM CAPS
- RELAYS
- SWITCHES
- TOOLS

WRITE FOR FREE CATALOG
VISIT OUR RETAIL STORE
HRS. MON-FRI 10-5 SAT 10-2
PHONE ORDERS WELCOMED
312-975-1290

✓ 131

FREE CATALOG!

Features Hard-to-Find Tools
and Test Equipment



Jensen's new catalog features hard-to-find precision tools, tool kits, tool cases and test equipment used by ham radio operators, hobbyists, scientists, engineers, laboratories and government agencies. Call or write for your free copy today.

JENSEN TOOLS INC.

7815 S. 46th Street
Phoenix, AZ 85040
(602) 968-6231

✓ 132

Iron Powder and Ferrite
TOROIDAL CORES

Shielding Beads, Shielded Coil Forms
Ferrite Rods, Pot Cores, Baluns, Etc.

Small Orders Welcome
Free 'Tech-Data' Flyer

AMIDON
Associates

Since 1963



12033 Otsego Street, North Hollywood, Calif. 91607

In Germany: Elektronikladen, Wilhelm — Mellies Str. 88, 4930 Detmold 18, West Germany
In Japan: Toyomura Electronics Company, Ltd., 7-9, 2-Chome Sota-Kanda, Chiyoda-Ku, Tokyo, Japan

✓ 129

Uncle Ben says...

**"I give you
much more than
just the lowest price..."**



"Uncle Ben" Snyder, W2SOH

the head man of
HARRISON

**"HAM HEADQUARTERS,
USA®" ...Since 1925!**

When you get that exciting new piece of equipment *from me*, you know you are going to be completely happy...

I see to it, personally! I also give you earliest delivery, greatest trade-in allowances, my friendly assistance in every possible way.

Just ask any of the many thousands of hams all over the world who have been enjoying my friendly good service for over a half a century.

73, Uncle Ben, W2SOH

• **CALL ME...**

(516) 293-7995

HARRISON

HAS THEM ALL!

KENWOOD

• **WRITE ME...**

For my prompt, personal reply.

• **SEE ME...**

At one of the world's largest Ham Supply Centers!



Kenwood TH-21A, TH-41A



Kenwood TL-922A



Kenwood TS-940S



Kenwood TS-430S



Kenwood TS-711A



Kenwood TR-2600, TR-3600



HARRISON

RADIO

...Since 1925!

CHARGE IT!

"HAM HEADQUARTERS, USA"

2263 Route 110 (at Smith St.)

E. Farmingdale, NY 11735

1-(516) 293-7995

feeding phased arrays: an alternative method

Carefully chosen
feeder lengths
provide
good match

This article describes a method of feeding a two-element phased-array antenna without using impedance-matching or phase-delay networks at each element. The method requires determining the length of the feedline from each antenna to the "common point" (the point at which the feedlines are combined) and installing a matchbox or antenna tuner at this location (or in the shack) in order to transform the paralleled impedance to 50 ohms.

network method of matching

As was clearly pointed out by Forrest Gehrke, K2BT, in his extensive series of articles on phased arrays, the insertion of a 90-degree delay line into a feeder will, in most cases, *not* guarantee a 90-degree phase shift in the feeder current.¹ If the actual driving-point impedance of each element is known (for a specified current amplitude and phase), then the voltage amplitude and phase at any point on that feeder can be calculated. The technique given by K2BT allows one to choose any convenient length for the antenna feeders and then design suitable networks to alter the feeder

voltages so that they are all transformed to the same value of voltage amplitude and phase. These terminals can then be safely and correctly joined together (at the "common point") since they are all at the same voltage. The impedance-matching and phase-delay networks are used to force all the voltages to be the same. Any convenient length of 50-ohm transmission line (the main feeder) can then be utilized to span the distance from the common point to the shack. The main feedline will be "flat" (the SWR will be low) because the networks at the ends of the antenna feeders are designed to present a combined impedance of $50 + j0$ ohms (pure resistance) when "looking" into the common point toward the antennas (see **fig. 1A**).

The method shown in this article calculates the voltages that must exist at various points along the antenna feeders. When a point is found on one antenna feeder where the voltage (both amplitude and phase) is identical to the voltage at some point on another antenna feeder, then those two points can be connected together without altering the relationship of the currents at the driving points of the two antennas. Rarely will the impedance seen looking toward the antennas from this common point be 50 ohms.* Thus, the main feedline running from this point into the shack will not be flat (the SWR will be high) and a matchbox or tuner will be needed at the operating position to present a well-matched load to the transmitter, (see **fig. 1B**). Note: the matchbox could be

By Al Christman, KB8I, Department of Electrical and Computer Engineering, Ohio University, Clip-pinger Lab, Athens, Ohio 45701-2979

placed into this circuit at the common point if desired. Then the main feeder into the shack would be "flat" as in fig. 1A. Of course, the matchbox would then be "dedicated" to the array and could not be used for other purposes unless removed.

calculations are simple

Only one formula, used repeatedly, is needed to calculate the voltages at all points along the antenna feedlines. It's best to utilize a personal computer or programmable calculator to reduce the drudgery of this task.

$$\bar{E}_{IN} = \bar{I}_{OUT} (A\bar{Z}_L + B) \quad (1)$$

where \bar{E}_{IN} = voltage at the input end of the antenna feeder

\bar{I}_{OUT} = current at the output or load end of the antenna feeder
 = current at the driving-point of the antenna

\bar{Z}_L = impedance at the output or load end of the feeder
 = driving-point impedance of the antenna

A = $\cos \theta$

B = $jZ_0 \sin \theta$

Z_0 = characteristic impedance of the antenna feeder

θ = electrical length of the antenna feeder, in degrees (360 degrees = λ)

Note that \bar{E}_{IN} , \bar{I}_{OUT} , and \bar{Z}_L are all complex numbers; that is, they have both magnitude and phase. The equation therefore requires the use of complex, or vector, arithmetic. A and B are two of the "ABCD" parameters discussed by K2BT in Part 5 of his series.² (In addition, both "A" and "B" can be complex numbers as well. "A" is complex if the cable attenuation is taken into account.)

The goal is to find a place on the antenna No. 1 feeder where the voltage is identical to the voltage somewhere on the antenna No. 2 feeder. To do this, make a list for each antenna, labeling one column for "feeder length in degrees" and the other "voltage at end of feeder." Then calculate and record the voltage on each feeder at 10 degree intervals. After finding 10 or 15 values for each feeder, stop calculating and compare the lists. It is better to record the voltages in polar form (amplitude and phase angle) for easier

*A 1:1 VSWR occurs only when the paralleled driving-point impedance of the elements equals the characteristic impedance of the line. Editor.

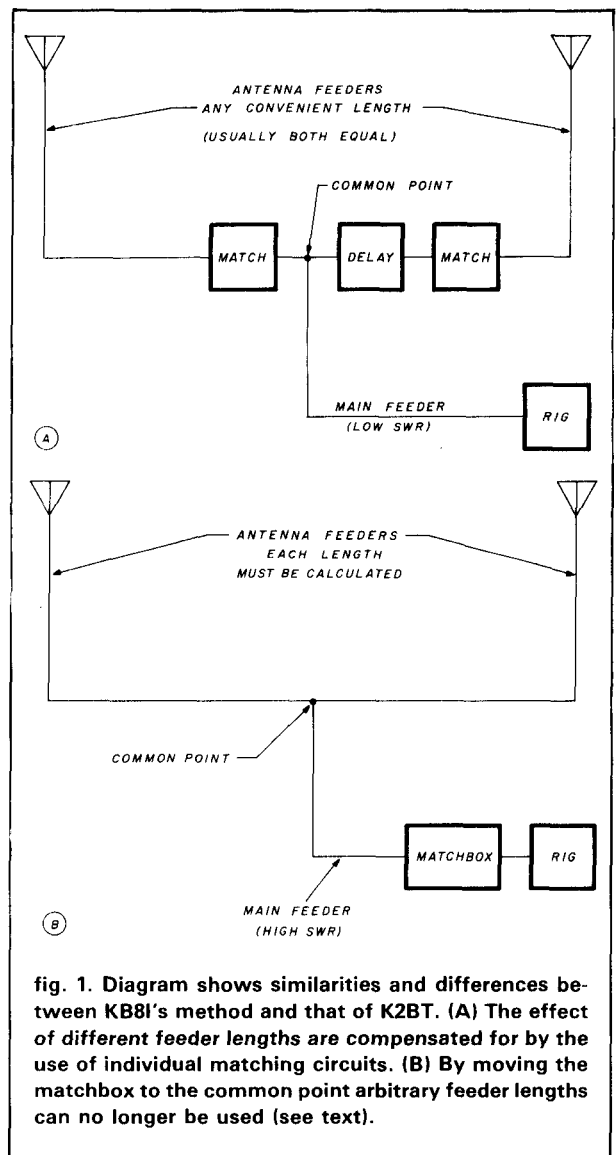

fig. 1. Diagram shows similarities and differences between KB8I's method and that of K2BT. (A) The effect of different feeder lengths are compensated for by the use of individual matching circuits. (B) By moving the matchbox to the common point arbitrary feeder lengths can no longer be used (see text).

comparison. Also, keep all the angles less than or equal to ± 180 degrees. (For example, an angle of -230 degrees is equivalent to $+130$ degrees. Always use the smaller number.) When two amplitude values are found that are close to each other, check the angles to see if they are similar. If both amplitude and phase are "in the ballpark," redo the calculation at 1 degree or 1/2 degree increments until two lengths are found where the voltages are identical, or nearly so. If none of the recorded values on one list are comparable to those on the other list, continue the calculations and add more data points to the lists — in other words, make the antenna feeders longer. It should be possible to find the required line lengths within a reasonable amount of time.

cutting the coax

After the required length of each antenna feeder has



IM Suppression Panels



R.F. Power Monitoring

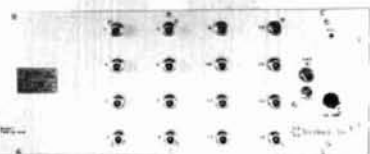

Receiver Multicoupling

The Problem Solvers



Duplexers & Preselectors

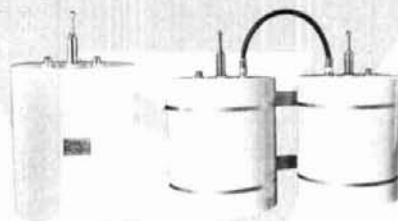

**Bandpass, Pass-Reject
and Notch Cavity Filters**

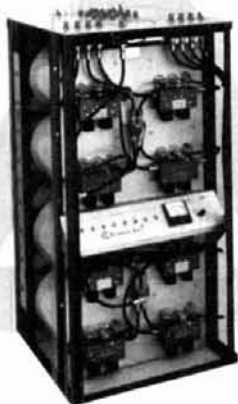

**Transmitter Combining
150 - 900 MHz**

COMPLETE SYSTEM ENGINEERING ASSISTANCE



TELEWAVE, INC.

1155 TERRA BELLA, MOUNTAIN VIEW, CA 94043
(415) 968-4400 • TWX 910-379-5055

been calculated, it's time to actually cut the coax, remembering to take the velocity factor of that particular cable into account. It's a good idea to actually measure the velocity factor of the cable, rather than relying upon the manufacturer's data. Since the electromagnetic fields travel more slowly inside the cable than they do in free space, the physical length of the cable will be shorter than the electrical length:

$$L = 2.734 (L_e) (V_F)/f \quad (2)$$

where L = physical length of antenna feeder, in feet (1 meter = 3.281 feet)

L_e = electrical length of antenna feeder, in degrees

V_F = velocity factor of the cable, as a decimal (i.e., 0.66)

f = operating frequency, in Megahertz

switching directions

For a two-element array, the pattern may be reversed by interchanging the antenna feeder cables at the antenna terminals. One way to do this, shown in **fig. 2**, is to cut the longer of the two antenna feeders into two pieces, one of which is the same length as the shorter antenna feeder. These two equal-length cables are then connected directly to the antenna feed-points and the remaining third piece of cable is switched back and forth from one antenna feeder to the other using a DPDT relay. For best results when building a switchable array, the lengths of the radiators and the ground systems under each antenna should be adjusted until both antennas have the same self-impedance.³

20-meter array

I became interested in phased arrays while accumulating the contacts necessary for WAS on 20 meters. A home-brew three-element wire beam suspended from trees at 18 feet (5.5 meters) seemed to be performing satisfactorily, and I was working new states at a good pace. However, a phone call revealed that I was also "quite strong" on my neighbor's (just to the west) color TV set. I wasn't too surprised because his portable TV — equipped only with rabbit ears for an antenna — was less than 50 feet (15.2 meters) from my wire beam, and I was running the legal limit. It became vitally important that I construct an antenna that would concentrate all the RF energy toward the east and place a big null right over my neighbor's living room — he is, after all, not only my neighbor, but my landlord.

My backyard was too small for a two-element array with 1/4 wavelength spacing, but the literature revealed that 75 degree spacing (0.208 wavelength)

table 1. Voltages at various points along the antenna feeders.

west antenna ($I = 1/0$ degrees)		
θ (degrees)	E_{IN} (volts)	
0	15.56	/ -45 degrees
10	11.04	/ -11.23 degrees
20	12.35	/33.2 degrees
30	18.17	/58.4 degrees
40	25.17	/70.4 degrees
50	32.02	/77.2 degrees
60	38.2	/81.7 degrees
70	43.4	/85 degrees
80	47.37	/87.7 degrees
90	50	/90 degrees
100	51.19	/92.1 degrees
110	50.89	/94.2 degrees
120	49.11	/96.4 degrees
130	45.92	/98.96 degrees
140	41.43	/101.7 degrees
150	35.82	/105.4 degrees
160	29.32	/110.6 degrees
170	22.32	/119 degrees
180	15.56	/135 degrees

east antenna ($I = 1 / -105$ degrees)		
θ (degrees)	E_{IN} (volts)	
0	49.68	/ -64.9 degrees
10	54.92	/ -57.95 degrees
20	59.16	/ -52.13 degrees
30	62.14	/ -46.98 degrees
40	63.69	/ -42.2 degrees
50	63.74	/ -37.53 degrees
60	62.27	/ -32.77 degrees
70	59.37	/ -27.65 degrees
80	55.19	/ -21.87 degrees
90	50	/ -15 degrees
100	44.18	/ -6.41 degrees
110	38.31	/4.83 degrees
120	33.26	/19.84 degrees
130	30.18	/39.02 degrees
140	30.09	/60.32 degrees
150	33.02	/79.71 degrees
160	37.99	/94.96 degrees
170	43.84	/106.39 degrees
180	49.68	/115.10 degrees

combined with 105-degree phasing would yield the desired cardioid end-fire pattern. Measurements showed that I could squeeze this array into the yard without the radials protruding onto the property of my neighbor to the east. Two tri-band trap verticals were

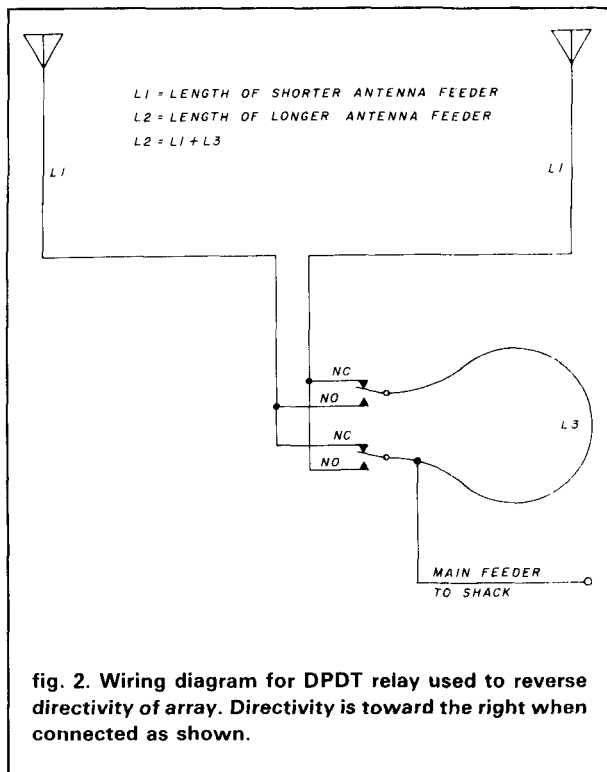

erected, each atop a 15-foot (4.6 meter) mast. They were spaced 75 degrees apart (14.4 feet or 4.4 meters at 14.25 MHz) on an east-west line, and each had twenty 1/4 wavelength radials. The feed system would be designed so that each antenna received the same current amplitude, but the east antenna would lag the west antenna by 105 degrees, placing the null directly on my landlord's living room.

After everything was built, I used an antenna noise bridge and calculator to analyze the system according to the procedure described by K2BT.³ I measured the self-impedance and driving-point impedance of each vertical at the end of a known length of coax, and then "rotated" each of these values to the antenna feedpoint. This may be done on a Smith chart or through the use of the following formula:

$$Z_L = \frac{D\bar{Z}_{IN} - B}{A - C\bar{Z}_{IN}} \quad (3)$$

where

Z_L = load impedance at the output end of the transmission line

Z_{IN} = impedance measured at the input end of the transmission line

$A = D = \cos \theta$

$B = jZ_0 \sin \theta$

$C = j \sin \theta / Z_0$

Z_0 = characteristic impedance of the transmission line

θ = electrical length of the line, in degrees

While it's better to measure all the impedances right at the antenna feedpoint, I didn't enjoy the prospect of standing on tiptoe perched 10 feet (3 meters) above the ground. I opted for the easier way, and the data obtained enabled me to calculate the mutual impedance between the two verticals. I used this figure to determine the actual driving-point impedance of each element when fed by the currents I had specified for the array. The product of the driving-point impedance and current gives the actual voltage at the feedpoint of each antenna:

west antenna:

$$I_1 = 1 / 0 \text{ degrees amperes}$$

$$Z_1 = 11 - j11 \text{ ohms}$$

$$= 15.56 / -45 \text{ degrees ohms}$$

$$E = I_1 Z_1 = 15.56 / -45 \text{ degrees volts}$$

east antenna:

$$I_2 = 1 / -105 \text{ degrees amperes}$$

$$Z_2 = 38 + j32 \text{ ohms}$$

$$= 49.7 / 40.1 \text{ degrees ohms}$$

$$E_2 = I_2 Z_2 = 49.7 / -64.9 \text{ degrees volts}$$

The antenna currents were assumed to have a magnitude of 1 ampere for ease of calculation. The actual current magnitudes will be determined by the amount of drive power. What is important is that the actual currents be equal in magnitude, and that the east antenna current lags the west antenna current by 105 degrees.

My lists of the voltages that will occur at various points along each antenna feedline are shown in **table 1**. Scanning the table, we can see that the voltage on the west antenna feeder at a point 50 degrees from the antenna is $32.02 / 77.2 \text{ degrees}$ volts, while the voltage on the east antenna feeder at a point 150 degrees from the antenna is $33.02 / 79.71 \text{ degrees}$ volts. These two values are close to each other, and we can now calculate more voltages, this time at 1 degree intervals centered around 50 degrees for the west feeder and 150 degrees for the east feeder. This information is shown in **table 2**. Comparing the voltages on the two feeders, we can see that the values are nearly identical for a 51-degree west feeder ($32.67 / 77.77 \text{ degrees}$ volts) and a 149-degree east feeder ($32.61 / 77.95 \text{ degrees}$ volts).

table 2. Voltages at 1 degree intervals along the antenna feeders.

west antenna ($I = 1 / 0$ degrees)

θ (degrees)	E_{IN} (volts)	
47	30.02	/75.53 degrees
48	30.69	/76.12 degrees
49	31.36	/76.7 degrees
50	32.02	/77.2 degrees
51	32.67	/77.77 degrees
52	33.32	/78.27 degrees

east antenna ($I = 1 / -105$ degrees)

θ (degrees)	E_{IN} (volts)	
147	31.87	/74.29 degrees
148	32.23	/76.14 degrees
149	32.61	/77.95 degrees
150	33.02	/79.7 degrees
151	33.45	/81.43 degrees
152	33.89	/83.11 degrees

table 3. Theoretical front-to-back ratio of the 2-element phased vertical array.

elevation angle, θ (degrees)	front-to-back ratio (dB)
0	∞
10	39.72
20	27.68
30	20.61
40	15.56
50	11.59
60	8.26
70	5.31
80	2.60

Notice that the driving-point currents are 105 degrees out of phase, yet the points on the feeders where the voltages are in phase are only (149 degrees - 51 degrees =) 98 degrees apart. Also notice that the east feeder, which has the lagging feed-point current, is longer than the west feeder, which one would expect.

Measurements on the RG8X cable used for the antenna feeders showed that its actual velocity factor was 0.725 rather than the advertised value of 0.81. Using eq. 2, the actual lengths of coax needed were 7.094 feet (2.162 meters) and 20.726 feet (6.317 meters). These two antenna feeders were cut to length and installed. A piece of RG-8 about 30 feet (9.1 meters) long extended from the Tee connector, where the antenna feeders were joined, to the matchbox in the shack.

The array performed as expected. State number 50

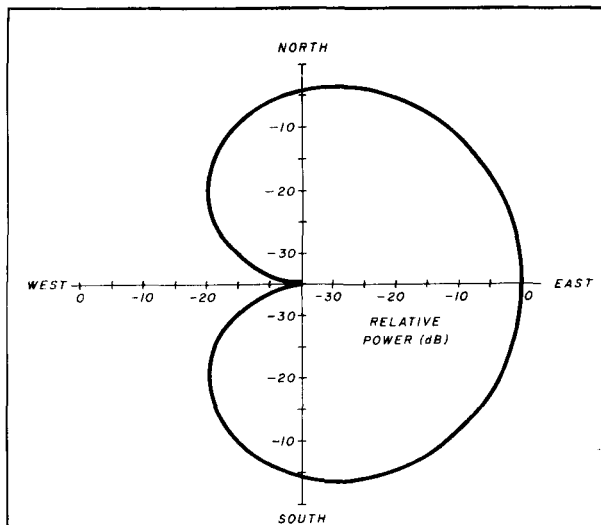

fig. 3. Azimuthal-plane power pattern for two 1/4 wavelength monopoles; spacing = 75 degrees, currents = 1/0 degree, 1/-105 degrees, perfect ground; 0 degree elevation angle.

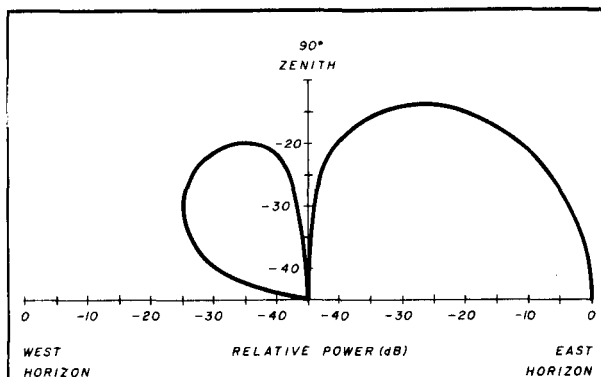

fig. 4. Elevation-plane power pattern for two 1/4 wavelength monopoles; spacing = 75 degrees, currents = 1/0 degree, 1/-105 degrees; perfect ground; east-west azimuth.

(Delaware) was worked shortly thereafter, along with contacts in Africa. There were almost no contacts to the west — but there also were no further TVI problems. The major azimuthal and elevation-plane radiation patterns are shown in **figs. 3 and 4**; the front-to-back ratio in the main elevation plane is provided in **table 3**. Notice that the front-to-back ratio is infinite only on the horizon (0 degree elevation angle) and deteriorates to just one or two S-units at high angles. There is actually a fairly large rear lobe whose maximum occurs at an elevation angle of about 60 degrees. Thus, there will be a fair amount of radiation and signal pickup off the back of the array if propagation favors this high angle.

STUMPED FOR A GIFT IDEA?

I.D. BADGES

No ham should be without an I.D. badge. It's just the thing for club meetings, conventions, and get-togethers, and you have a wide choice of colors. Have your name and call engraved in either standard or script type on one of these plastic laminated I.D. badges. Wear it with pride! Available in the following color combinations (badge/lettering): white/red, woodgrain/white, blue/white, white/black, yellow/blue, red/white, green/white, metallic gold/black, metallic silver/black.

UID Engraved I.D. Badge

\$2.50



HERE'S A GIFT IDEA!

How about an attractive **BASE-BALL** style cap that has name and call on it. It's the perfect way to keep eyes shaded during Field Day. It gives a jaunty air when worn at Hamfests and it is a great help for friends who have never met to spot names and calls for easy recognition. Great for birthdays, anniversaries, special

days, whatever occasion you want it to be. Hats come in the following colors: **GOLD, BLUE, RED, KELLY GREEN**. Please send call and name (maximum 6 letters per line).

UFBC-81

\$5.00



REGULAR PRICE HAT AND BADGE \$8.50 (\$7.50 + \$1.00 shipping)

SPECIAL

\$7.50

SAVE \$1.00

ham radio magazine

BOOKSTORE

GREENVILLE, NH 03048

603-878-1441

conclusion

A technique has been demonstrated for feeding two-element phased arrays based upon the premise that the feeders from individual radiating elements may be directly connected together if the voltages at the point of connection are identical in magnitude and phase. A method was shown for determining the voltage at any point on an antenna feeder when the impedance and current at the driving-point of the antenna are given. Using these ideas, an actual 2-element array can be built and operated successfully on the air.

acknowledgements

The author would like to thank Forrest Gehrke, K2BT, for his encouragement, especially during the early stages of this project in 1983. Appreciation is also expressed to Margaret Shields in the Department of Electrical and Computer Engineering at Ohio University for typing the manuscript.

references

1. Forrest Gehrke, K2BT, "Vertical Phased Arrays," *ham radio*, May, June, July, October, December, 1983, and May, 1984.
2. Forrest Gehrke, K2BT, "Vertical Phased Arrays, part 5," *ham radio*, December, 1983, page 59.
3. Forrest Gehrke, K2BT, "Vertical Phased Arrays, part 3," *ham radio*, July, 1983, page 26.

ham radio

NEW from BARKER & WILLIAMSON!

1.8 - 30 MHz. Continuous Coverage Antenna for Commercial and Amateur Service

Model AC 1.8 - 30

The AC 1.8 - 30 Antenna uses only 80 feet horizontally, and, when space is limited, can be shortened even further with only slight loss of radiation efficiency.

Patent Pending

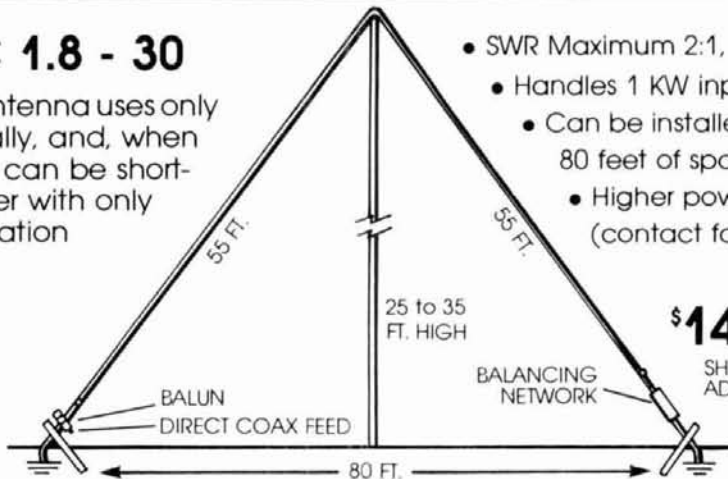

- SWR Maximum 2:1, 1.4:1 Average
- Handles 1 KW input ICAS
- Can be installed in approximately 80 feet of space
- Higher power models available (contact factory)

\$149.50

SHIPPING AND HANDLING ADD \$4.00



BARKER & WILLIAMSON

ALL OUR PRODUCTS MADE IN USA

Quality Communication Products Since 1932
At your Distributors write or call, 10 Canal Street, Bristol PA 19007
(215) 788-5581



Gunnplexers & accessories 10 & 24 GHz

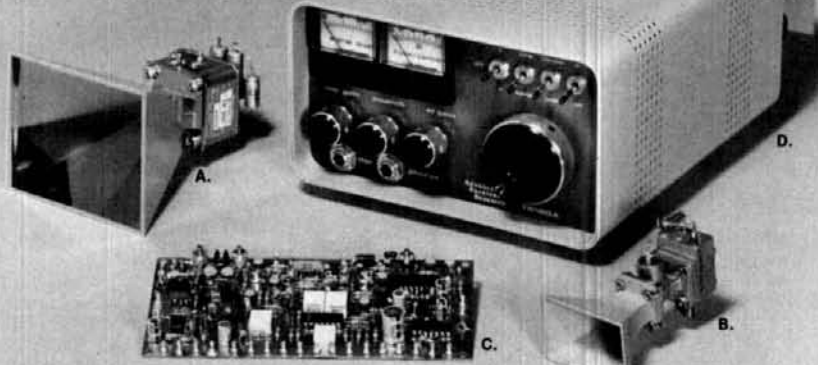

A. Microwave Associates 10 GHz Gunnplexer. Two of these transceivers can form the heart of a 10 GHz communication system for voice, mcw, video or data transmission, not to mention mountaintop DXing! MA87141-1 (pair of 10 mW transceivers) \$251.95. Higher power units (up to 200 mW) available. B. Microwave Associates 24 GHz Gunnplexer. Similar characteristics to 10 GHz unit. MA87820-4 (pair of 20 mW transceivers) \$739.20. C. This support module is designed for use with the MA87141 and MA87820 and provides all of the circuitry for a full duplex audio transceiver system. The board contains a low-noise, 30-MHz fm receiver, modulators for voice and mcw operation, Gunn diode regulator and varactor supply. Meter outputs are provided for monitoring received signal levels, discriminator output and varactor tuning voltage. RXMR30VD assembled and tested \$119.95. D. Complete, ready to use communication system for voice or mcw operation. Ideal for repeater linking. A power supply capable of delivering 13 volts dc at 250 mA (for a 10 mW version), microphone, and headphone and/or loudspeaker are the only additional items needed for operation. The Gunnplexer can be removed for remote mounting to a tower or 2 or 4 foot parabolic antennas. TR19GA (10 GHz, 10 mW) \$399.95. Higher power units available. TR24GA (24 GHz, 20 mW) \$839.95. Also available: horn, 2 and 4 foot parabolic antennas, Gunn, varactor and detector diodes, search and lock systems, oscillator modules, waveguide, flanges, etc. Call or write for additional information. Let ARR take you higher with quality 10 and 24 GHz equipment!

Advanced Receiver Research

Box 1242 • Burlington CT 06013 • 203 582-9409



RF TRANSISTORS

FRESH STOCK - NOT SURPLUS
TESTED — FULLY GUARANTEED

P/N	2-30MHz 12V (*=28V)		Match Pr
	Rating	Ea.	
MRF406	20W	\$14.50	\$32.00
MRF412	80W	18.00	40.00
MRF412A	80W	18.00	40.00
MRF421	100W	25.00	54.00
MRF421C	110W	27.00	58.00
MRF422*	150W	38.00	82.00
MRF426*	25W	17.00	40.00
MRF426A*	25W	17.00	40.00
MRF433	13W	14.50	32.00
MRF435*	150W	42.00	90.00
MRF449	30W	12.00	27.00
MRF449A	30W	11.00	25.00
MRF450	50W	12.00	27.00
MRF450A	50W	12.00	27.00
MRF453	60W	15.00	33.00
MRF453A	60W	15.00	33.00
MRF454	80W	16.00	35.00
MRF454A	80W	16.00	35.00
MRF455	60W	12.00	27.00
MRF455A	60W	12.00	27.00
MRF458	80W	18.00	40.00
MRF460	60W	16.50	36.00
MRF475	12W	3.00	9.00
MRF476	3W	2.50	8.00
MRF477	40W	13.00	29.00
MRF479	15W	10.00	23.00
MRF485*	15W	6.00	15.00
MRF492	90W	18.00	39.00
SFR2072	75W	15.00	33.00
CD2545	50W	24.00	55.00

Selected High Gain Matched Quads Available

VHF TRANSISTORS

Type	Rating	Ea.	Match/Pr
MRF221	15W	\$10.00	—
MRF222	12W	12.00	—
MRF224	40W	13.50	\$32.00
MRF231	3.5W	10.00	—
MRF234	25W	15.00	39.00
MRF237	1W	2.50	—
MRF238	30W	12.00	—
MRF239	30W	15.00	—
MRF240	40W	16.00	—
MRF245	80W	25.00	59.00
MRF247	80W	25.00	59.00
MRF260	5W	6.00	—
MRF264	30W	13.00	—
MRF492	70W	18.00	39.00
MRF607	1.8W	2.60	—
MRF627	0.5W	9.00	—
MRF641	15W	18.00	—
MRF644	25W	23.00	—
MRF646	40W	24.00	59.00
MRF648	60W	29.50	69.00
SD1416	80W	29.50	—
SD1477	125W	37.00	—
2N4427	1W	1.25	—
2N5945	4W	10.00	—
2N5946	10W	12.00	—
2N6080	4W	6.00	—
2N6081	15W	7.00	—
2N6082	25W	9.00	—
2N6083	30W	9.50	—
2N6084	40W	12.00	29.00

TMOS FET

MRF137	30W	\$22.50	—
MRF138	30W	35.00	—
MRF140	150W	92.00	—
MRF150	150W	80.00	—
MRF172	80W	65.00	—
MRF174	125W	88.00	—

Technical Assistance & cross-reference information on CD, PT, RF, SRF, SD P/Ns Call Engineering Dept. (619) 744-0728

RF Parts Catalog Available
OEM & Quantity Discounts ✓ 139

Minimum Order \$20 Add \$3.50 Shipping
WE SHIP SAME DAY C.O.D./VISA/MC

ORDERS ONLY: 800-854-1927



WESTCOM

1320 Grand Ave. San Marcos
California 92069 (619) 744-0728

VHF COMMUNICATIONS

915 North Main Street
Jamestown, New York 14701

Western New York's finest... amateur radio dealers!

PH. (716) 664-6345

The DX EDGE®: Now for your COMMODORE 64™

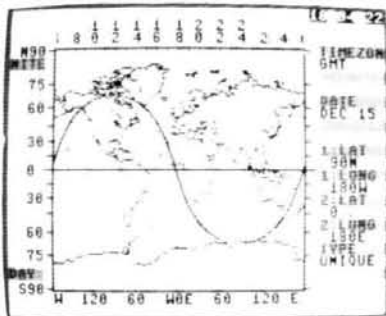

- Fabulous graphics for the great DX aid
- Long path/Gray Line/Sunrise/Sunset on a fine map
- Automatic Gray Line updating simulates earth's rotation
- Keyed to DXCC list and 40 Zones

It's fantastic! Daylight and darkness paths in real time on your computer. As simple as can be.
Price: \$34.95, on a disk, ppd. in U.S. and Canada. Add \$2.45 tax in N.Y.S. Add \$4.00 elsewhere, air mail. U.S. funds only. The original plastic DX EDGE, in large slide rule format, is still only \$16.95 (plus \$4.00 outside U.S. and Canada). Great Circle Slides are \$3.00 with DX EDGE, \$5.00 without. Specify your Latitude.

Please make check or M.O. payable to the DX EDGE and mail to:
The DX EDGE, P.O. Box 834, Madison Square Stn., New York, N.Y. 10159 ✓ 138

An information flyer is available free of charge. A product of Xantek, Inc. Xantek, Inc. 1985
Commodore 64 is a trademark of Commodore Electronics Ltd.

ham radio TECHNIQUES

Bill Orr
W6SAI

the first Radio Amateur

The world in 1900 was a far different place than the world we know. No one had heard of credit cards or ball point pens; time sharing meant togetherness, not computers. There were no fluorescent lights, instant coffee, antibiotics, Frisbees or frozen foods. There was no television, no radio — and no Amateur Radio.

Into this late Victorian era there stepped a Giant. In 1896 a young Italian arrived in England with some mysterious scientific apparatus in his luggage. The Customs officials, who had seen nothing like it before, examined it so thoroughly that the delicate apparatus was completely wrecked. This was the inauspicious beginning of a venture destined to remold the pattern of 20th-century living.

Guglielmo Marconi, at 26, had come to England to seek aid in developing his latest invention, a means of signalling at a distance without wires. The hub of a great Empire, Britain possessed the world's greatest mercantile fleet and the mightiest Navy — and it was in shipping that Marconi could see his dream come true. For once a ship left the sight of land it was isolated from the world. When disaster struck — as it often did — some form of communication between ship and shore was sorely needed.

Marconi demonstrated his equipment to the War Office and the British Post Office. The War Office was interested, but the idea of an alternative means of communication seemed to be unpleasant to the Post Office; it was unenthusiastic.

By 1898 Marconi had successfully demonstrated overland and ship-to-shore communication and had formed the Wireless Telegraph and Signal Company Limited. From time to time, communication across distances of up to 100 miles could be established. Yet therein lay an enigma. Hertz's early experiments showed that the invisible "wireless" waves obeyed the laws of light and travelled in straight lines. How, then, could Marconi communicate beyond the visible horizon?

The scientific community regarded Marconi's experiments with caution.

The Post Office monopoly on long distance telegraph communication and other restrictions made it impossible for Marconi to set up a revenue-earning inland wireless telegraph service. His company was rapidly going bankrupt. What to do?

the transatlantic gamble

Marconi had two ambitions: one, to prove his system offered dependable long-range capability and two, to compete directly with the Post Office, breaking its monopoly, and maintaining a profitable wireless telegraph ser-

vice. He conceived a bold stunt to draw attention to his plan: he would send a wireless signal across the Atlantic! Marconi proposed a station of breathtaking power, size, cost, and complexity. It was like proposing to build a cathedral in a world which had seen nothing more grandiose than a log hut. The directors of his company objected to taking such a risk. His grand idea was met with scorn and disdain.

But Marconi convinced his colleagues to go along with his plan. The station, to be built in Poldhu, Wales, was staggering in concept; a 25 kilowatt power plant would drive a two-stage spark transmitter (fig. 1) connected to a 400-wire antenna supported by 20 masts, each 200 feet high.

By early 1901 the station began to take shape. Preliminary tests indicated a range of at least 225 miles. Despite a myriad of troubles, the station could be heard as far away as Ireland. It had already proven that wireless waves followed the curvature of the globe; Marconi was certain that his signal could be extended to North America.

In March, 1901, Marconi sailed for America and chose the site for a second station: South Wellfleet, a small town on the eastern shore of Cape Cod, Massachusetts. Leaving his chief engineer there, Marconi returned to England.

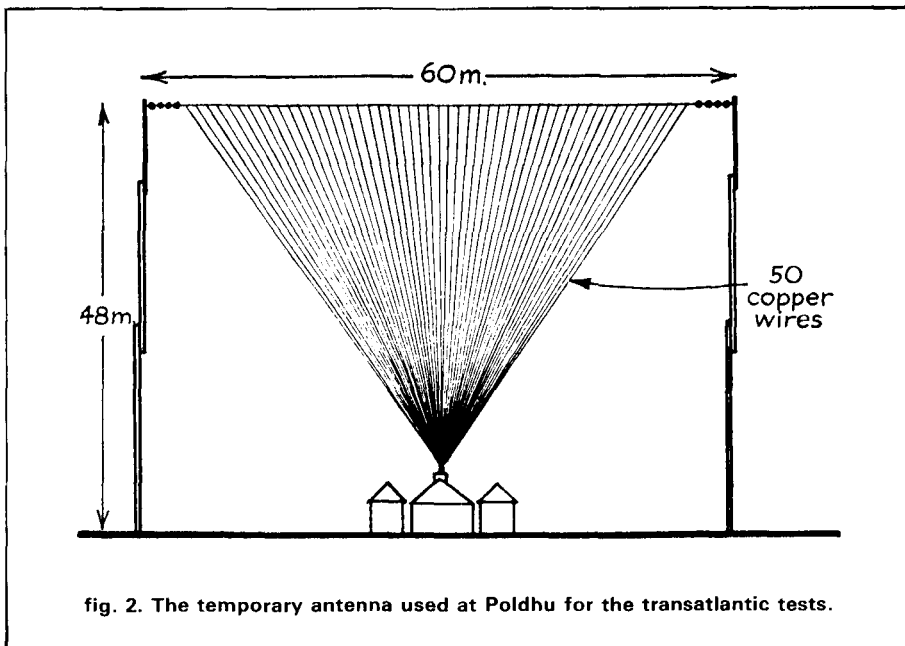
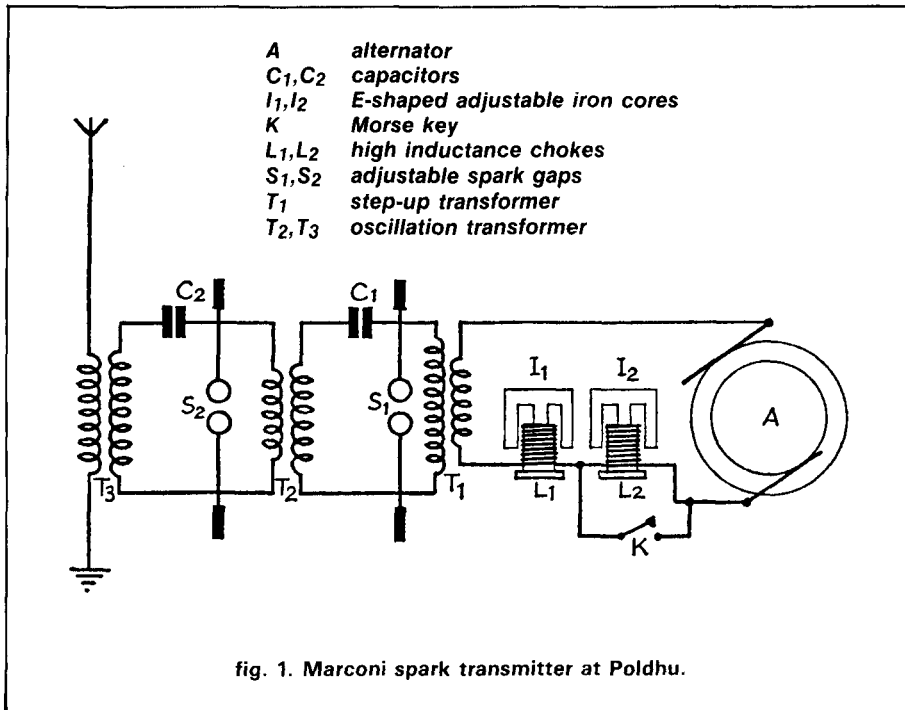

Catastrophe struck in September when a vicious gale hit the coast of Wales, breaking one of the many guy wires. All 20 masts collapsed into a shambles of broken timber and tangled wire. Just a month later a second storm destroyed the antenna system at South Wellfleet.

The directors of the Marconi Company were appalled. Over a quarter

million dollars had been spent with nothing to show for it but chaos. Marconi would not give up; he cleared away the wreckage, erected a temporary antenna (fig. 2) and had the station back on the air in 11 days.

Because of the diminished capacity of the makeshift station, Marconi decided to abandon the Wellfleet site and set up temporary receiving equip-

ment in Newfoundland, the point of landfall nearest to Wales. In great secrecy he set sail for St. John, with a small stock of kites and balloons to keep a single wire aloft in the stormy weather.

A site was chosen on Signal Hill, and on December 9 the apparatus was assembled in an abandoned military hospital. The balloon was prepared for inflation and ground plates were buried. A cable was sent to Poldhu requesting that the Morse letter "S" be transmitted continuously from 3 to 7 PM. Marconi chose his message wisely. He knew the fragile state of his equipment, and that the transmission of dashes, rather than dots, would have imposed too great a strain on the keyer and the transformers.

On December 10th the weather was fair. A balloon-supported kite antenna was sent aloft. The transmissions started at a power level of about 10 kilowatts and on a wavelength of about 366 meters (820 kHz). Since there was no means of measuring frequency, the actual wavelength remained a matter of speculation.

As the wind picked up, the balloon bobbed and weaved about in the sky above Signal Hill. Marconi adjusted his new "syntonizer" — a glass tube within which a globule of mercury was held between two iron or carbon rods, forming a crude semiconductor. Nothing which could be identified as the letter "S" could be heard amid the static. The wind picked up and the antenna crashed to earth as the balloon was swept away.

December 12, 1901

On the 12th the wind increased in intensity. A kite was launched bearing a 510-foot wire. The wind carried it away. A second kite was launched with a 500-foot wire attached. Because he had observed that the buffeting of the antenna by the wind made it impossible to keep the newer receiver in tune, Marconi sat listening intently at an older, untuned receiver (fig. 3). Time slipped by. Suddenly, at 12:30 PM, Newfoundland time, he handed the earphone to George Kemp, his

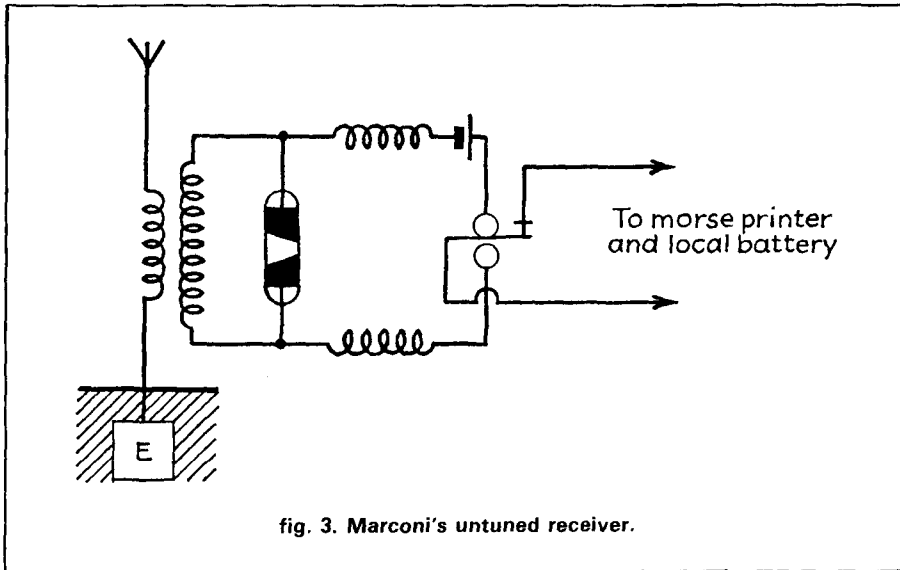

fig. 3. Marconi's untuned receiver.

assistant, and quietly asked, "Can you hear anything, Mr. Kemp?"

George Kemp took the headphone. Through the static crashes he could hear, faintly, the unmistakable rhythm of three clicks, followed by a pause, then three more and a pause, and so on, until — all too soon — the signals were lost once more in static. Marconi, a cool-headed man if there ever was one, wrote in his laboratory notebook: *Sigs at 12.20, 1.10 and 2.20.*

Marconi a fraud?

Marconi was in a quandry. What conclusive proof did he have? He and Kemp were not exactly unbiased. Should he make a public statement?

Finally on December 14th Marconi cabled his company the news. It was made public on December 16th, 1901.

The first reaction came from the lawyers of the Anglo-American Telegraph Company, whose cable line had carried the message to England two days previously. It was sharp and to the point. Marconi was told that the company had a monopoly on communication in Newfoundland and it forbade any future infringement of their rights under pain of legal action.

The public interest, however, was aroused and both the Canadian and American governments expressed interest in the experiment. The technical journals treated the incident with

a combination of skepticism and indignation. Marconi had no proof to substantiate his claim, which challenged the fundamental laws of physics and the proven knowledge of Newton, Maxwell, Hertz, and others. It was not until later, when the reception of signals across the Atlantic was demonstrated beyond any shadow of doubt, that Marconi's achievement was recognized.

Even today, it is difficult to believe that the 366-meter signals could actually have been heard. The receiving equipment after all, consisted of an inefficient antenna coupled to an untuned receiver which had no means of amplification whatsoever and was even less sensitive than crystal detectors, which evolved a few years later. If, in fact, the wavelength was 366 meters, the tests took place at the worst possible time of day because the entire path would have been in daylight. Today we know that radio signals can travel across the Atlantic and far beyond. But in 1901, anyone who believed that they could, and did, believed so as an act of faith based upon the integrity of one man — Marconi.

Marconi at the World's Fair

It was 1932. Marconi, an internationally acclaimed scientist, inventor, and businessman was in the United

States. He was scheduled to make an official visit to the Chicago World's Fair, a breathtaking exhibition of the modern world of technology. Fair officials were in a dither as Marconi arrived in the company of other important dignitaries. The Great Man toured the Fair, expressing great interest in the scientific exhibits. News photographers crowded around Marconi and he was followed by a large gathering, all craning their necks to see the Father of radio communication.

As he was about to leave, Marconi expressed a wish to visit the Amateur Radio station at the Fair. So, Marconi's big, black limousine, with colorful American and Italian flags flying from the fenders, drew up in front of a building on the edge of the fair-ground, followed by a horde of officials and newsmen. Marconi was escorted up the stairs to the World's Fair Amateur station, W9USA.

The young operators of W9USA appeared thunderstruck as the famous visitor strode into the station, introduced himself, and studied the homemade kilowatt transmitter and the superheterodyne receiver. He examined the station log book. The Fair officials were mystified by the incomprehensible collection of equipment that seemed to fascinate Marconi.

One of the operators apologized to Marconi, saying that the equipment had been built by mere Radio Amateurs. Marconi nodded and smiled, shaking the hand of the operator warmly. "Yes, yes," he said. "I understand — after all, I am a Radio Amateur myself."

radio silence

Marconi died in July, 1937. On the evening of the following day, at the state funeral in Italy, the Italian Radio Service observed an official period of radio silence. In England, and throughout the world, thousands of radio stations — broadcast, commercial, and Amateur — fell silent. The radio silence which Marconi had broken when he switched on his first transmitter came down in sorrow at his passing.

Shortly before he died, Marconi, in an address at St. Andrews University in Edinburgh, Scotland, stressed his original intention to make the high seas safe by giving ships a means of communication. Then, perhaps talking more to himself than to his audience, he added, "Have I done the world good — or have I added a menace?"

in retrospect

Much speculation has taken place during the decades following Marconi's famous transatlantic experiment. Ionospheric studies and a review of the sunspot cycle suggest that propagation across the Atlantic at that time of day, in that month and year, was highly unlikely on 820 kHz.

What, then, might Marconi and his assistant have heard? A few clues exist. Marconi's spark transmitter emitted a rough wave, high in harmonic content. He used a broadband (untuned) receiver. Perhaps Marconi was not hearing the fundamental transmitter signal, but instead a harmonic of the signal, in particular the fourth harmonic on about 3280 kHz. If that is so, then a few hundred watts of harmonic power would have easily made the transatlantic journey.

Of course, with a broadband receiver, Marconi could have heard many harmonics at the same time! So we shall never really be sure what transpired on that stormy day in Newfoundland. It is interesting, however, to think that if Marconi had elected to listen to his tuned receiver, used in the previous day's unsuccessful tests, he might have heard nothing at all!

acknowledgements

Thanks to the Official Historian of the Marconi Company (England) for the background information on Marconi's early experiments. The story of Marconi's visit to the Chicago World's Fair appeared in the November, 1932 issue of *QST*.

*Drawings adapted from *A History of the Marconi Company* by W.J. Baker, Methuen & Co., Ltd., London, 1970. (Distributed by the Marconi Co., Ltd.)

ham radio

ASK ANY HAM...
THEN ASK FOR HUSTLER.

AMATEUR ANTENNA PRODUCTS

STILL THE STANDARD OF PERFORMANCE

HUSTLER

3275 North Avenue B
Kissimmee, Florida 32758
(305) 933-0500

AN AMATEUR COMPANY

141

⊖-777 THE MOST ADVANCED COMPUTER INTERFACE EVER DESIGNED FOR COMMERCIAL AND AMATEUR USE.

RTTY, BIT INVERSION (RTTY), ASCII, AMTOR (MODE A (ARQ), MODE B (FEC AND SEL-FEC), MODE L), CW, ANY SPEED ANY SHIFT (ASCII AND BAUDOT)

NEW!

- **AUTO DECODING:** Automatically decodes signal and displays mode, speed and polarity on the CRT.
- **28 BAR-LED'S** and **LED'S** plus a Bar-Graph Tuning Indicator indicate function, mode, and status.
- The awesome power of the ⊖-777 is limited only by the imagination of the user and the terminal program of the computer.
- Use with Any computer that has RS232 or TTL I/O, IBM, Apple, Commodore, TRS80, etc.

Everything Built In - Including Software — Nothing Else To Buy!

- **SPEEDS:** CW 5-100 WPM (AUTOTRACK), 12-200 BAUD (ASCII AND BAUDOT), 12-600 BAUD TTL AND RS232 OR TTL LEVEL DATA CONNECTION - 100-2400 BAUD (ASCII) OR 45.5-200 BAUD (BAUDOT) • SELCAL • MEMORY: 15 CHANNELS • 768 CHARACTER INPUT BUFFER • AUTO PTT • CW ID • DIDDLE • ECHO • AUTO CR/LF • RUB-OUT • CW PRACTICE GENERATOR • VARIABLE CW WEIGHTS • TEST MESSAGE (RY AND QBF)
- FULL CRT FUNCTION DISPLAY • MARK - AND - BREAK (SPACE - AND - BREAK) SYSTEM • XTAL AFSK
- AUDIO MONITOR • POWER SUPPLY REQUIREMENTS: 13.8 V DC, 700MA • SIZE: 9W x 10D x 2 1/2 H •

AMATEUR-WHOLESALE ELECTRONICS TOLL FREE: 800-327-3102
8817 S.W. 129th Terrace, Miami, Florida 33176 Telephone (305) 233-3631 Telex 80-3356

VISA

140

**GO
WITH A
WINNER**

"I am very pleased with my Cayson Satellite TV System. I recommend it to anyone interested in Satellite TV."

Champion
Race Car Driver
BOBBY ALLISON



CAYSON
CENTURION ANTENNAS

Look to Cayson Electronics for durable and accurate satellite antennas. We are pioneers in the business and still growing. Here are two 10' antennas that you can be sure are winners.

The four-piece fiberglass features a highly reflective aluminum foil material for superior reception. The heavy duty polar mount utilizes a 3½ OD ground pole. This antenna has been around since 1979.

The 10' aluminum mesh antenna is becoming more popular for those who value attractive satellite equipment. The two-tone reflector features black mesh and aluminum ribs. The mount has declination adjustment and also uses a 3½ OD ground pole.



10 FT. MESH DATA

TYPE	EXPANDED MESH
WEIGHT	135 LBS. UPS
DIAMETER	127"
FOCAL DISTANCE	43½"
f/D	.35

CAYSON ELECTRONICS

Rt. 3 Box 160 • Fulton, MS 38843
2235 W. Mound • Decatur, IL 62526
Nation Wide 1-800-892-4916
1-800-382-1811
In MS 1-601-862-2132
In IL 1-217-877-7954

10 FT. FIBERGLASS DATA

TYPE	4-PIECE FIBERGLASS
WEIGHT (APPROX.)	200 LBS. SHIPPED
DIAMETER	122"
FOCAL DISTANCE	43"
f/D	.35

a sloping terminated vee beam

Low SWR across ham and SWL bands

This is the antenna that every ham has probably dreamed about: a beam antenna that works on every Amateur band and on all the spaces in between . . . an antenna that's cheap and requires just a single tree or pole for support . . . an antenna that doesn't require precision measurements, special tuning instruments, or almost anything else out of the ordinary. *Everything* needed can be purchased inexpensively or built at home, and the hardest part will be building a toroid transformer with about 25 turns of wire.

This is the same antenna used as a back-up by the Voice of America, so you know it works.

According to transmission line theory, a single conductor placed a few feet above and parallel to the ground can be used as an antenna. If the wire is raised more than a few feet above ground, the impedance approaches a value of 400 ohms according to the following formula:

$$Z_0 = 83.7 \log_{10} (4H/d) \quad (1)$$

where Z_0 = impedance of single wire above ground

H = height of the wire above ground in any units

d = diameter of the wire in the same units

The nonresonant "vee" antenna and a large family of

similar antennas such as rhombics are based on transmission line theory. When used as an antenna, however, the transmission line has spacing which is large compared with normal lines. As a result it is leaky and can be used as an antenna. The radiation field from a single wire transmission line may be calculated¹ and the two maximum gain lobes discovered by the equation:

$$E(a) = \frac{60 \sin a \cdot \sin \left[\frac{\pi L}{W} (1 - \cos a) \right]}{1 - \cos a} \quad (2)$$

where $E(a)$ = normalized field strength at angle a
 a = the angle from the axis of the wire
 π = 3.1416
 L = length of the wire in any units
 W = one full wavelength in the same units

If two terminated transmission lines are aligned so that the major lobes of each wire are additive, the lines then become a "vee" antenna. (Two vees placed end-to-end form a rhombic.) Because the line is terminated in a *matching impedance*, the wires are nonresonant — just like any correctly matched, well-behaved transmission line — and the antenna will accept power at any frequency.

Several good things happen with terminated transmission line antennas. One desirable result is broad-band operation; another is that the reverse lobes (toward the pointed side of the vee) are cancelled or greatly reduced. *The resulting antenna can be used to both transmit and receive at every frequency within its range, much like a log periodic antenna. But, it will*

**By Robert Ross, 17904 Muncaster Road,
Derwood, Maryland 20855**

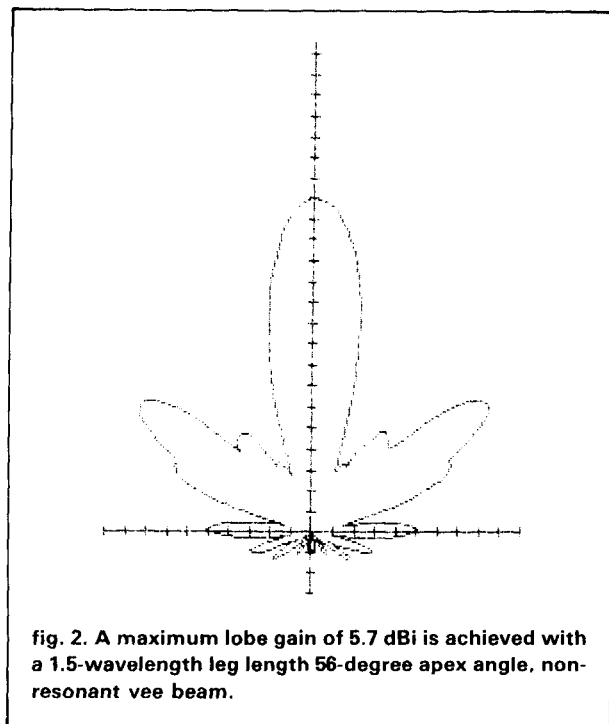
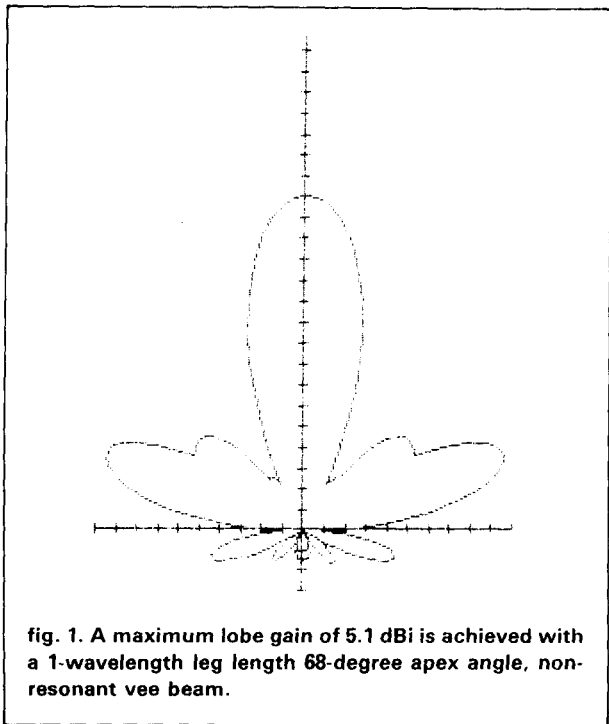
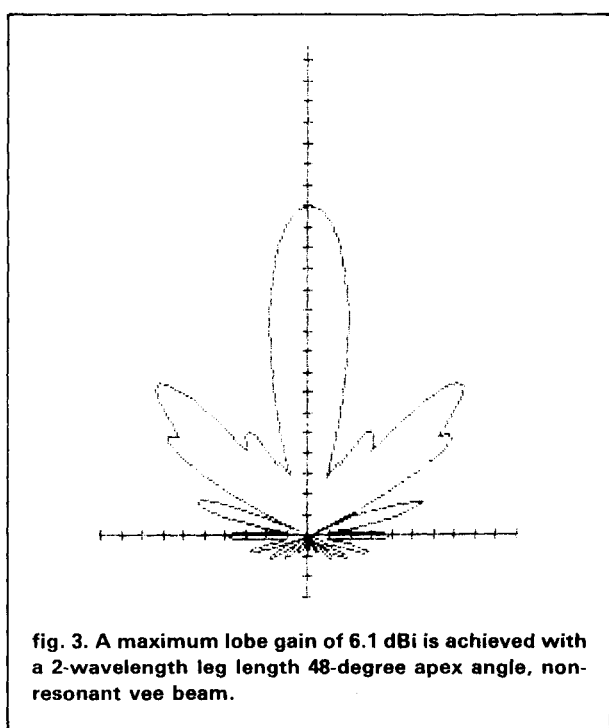

table 1. Relationship between vee beam leg lengths, apex angles, and gains.

vee leg length in half waves	apex angle in degrees	gain in dBi
2	68	5.1
3	56	5.7
4	48	6.1
5	44	6.4
10	32	7.4
20	22	8.4



produce its best gain only over a relatively narrow frequency range where the major lobes align for best gain. This frequency range depends on the angle of the apex of the vee and the length of the legs. For many purposes, +100 percent to -50 percent frequency excursion is reasonable, (see **table 1**). The worst thing that happens is that the beam splits and you find a null in the center with the gain lobes on either side.

In this case the vee has been optimized for the 14 to 15 MHz band — but it also works reasonably well from 40 to 10 and even radiates modestly on 160 and 80 meters. Optimization can be done for any band by calculating the major lobes and adjusting the apex angle for that band. Ordinarily, however, not much is gained by changing the apex angle of such a short vee. **Figures 1** through **6** illustrate the azimuthal pattern of vee beams with leg lengths from 1 to 10 wavelengths.

construction is easy

The vee is probably the simplest of all wide band beam antennas to build. A single support roughly 65 feet (20 meters) tall is required for the high end and two supports about 3 feet (1 meter) tall for the low ends. The only critical item is the pointing of the

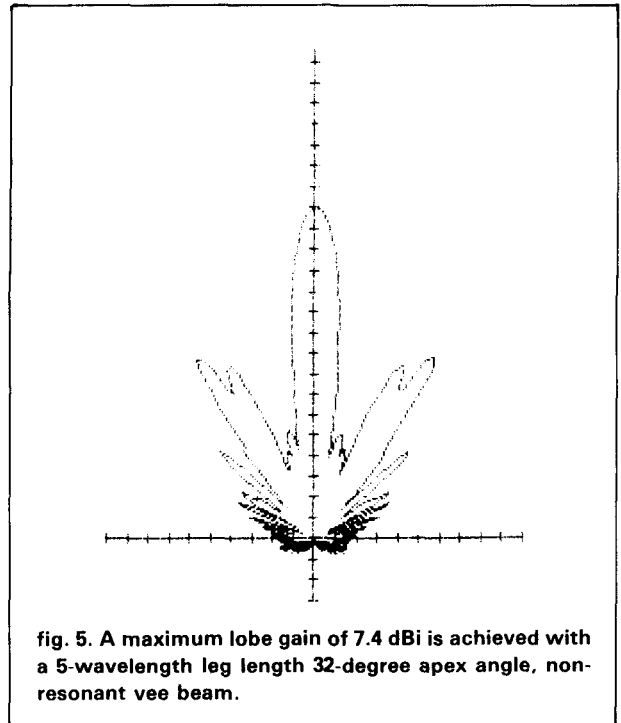
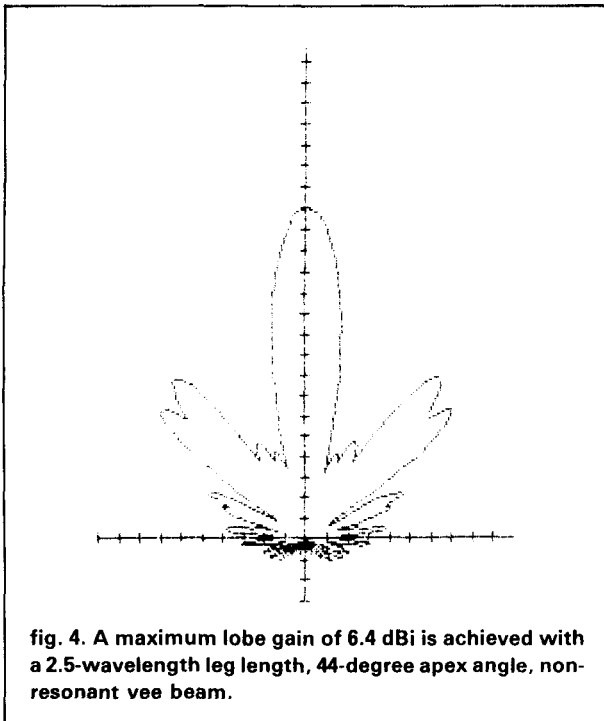

antenna. The position of the two low point anchor poles must be selected to direct the antenna at your target by using a compass bearing corrected for local magnetic variations. In Washington, D.C., the variation is 8 degrees west; thus 8 degrees must be added to the compass reading to get a true bearing. The legs must be located so that they are 22 degrees on either side of the great circle line of bearing to your target and to make the open end of the vee point toward the target. For example, on my globe London and Europe are 48 true (not magnetic) degrees from Washington, D.C.

materials are inexpensive

The wire and insulators can be of almost any kind. However, I prefer No. 14 AWG copperweld wire and No. 500 strain insulators (also known as guy wire insulators). Strain insulators are particularly good if you use a tree for your antenna pole because they won't break when the tree sways in the wind. I also advise soldering all antenna connections to avoid long-term problems from corrosion and the resulting bad connections.

The transformer can be purchased from at least one company for about \$150,² but building your own transformer is not difficult. Only a few turns of wire on a 2-inch diameter RF toroid core will do the job.³ Generally the largest RF toroid core which the manufacturer says will cover the desired frequency range will work reasonably well. On my transformer I used 20 turns of soft No. 12 AWG enameled copper wire for the sec-

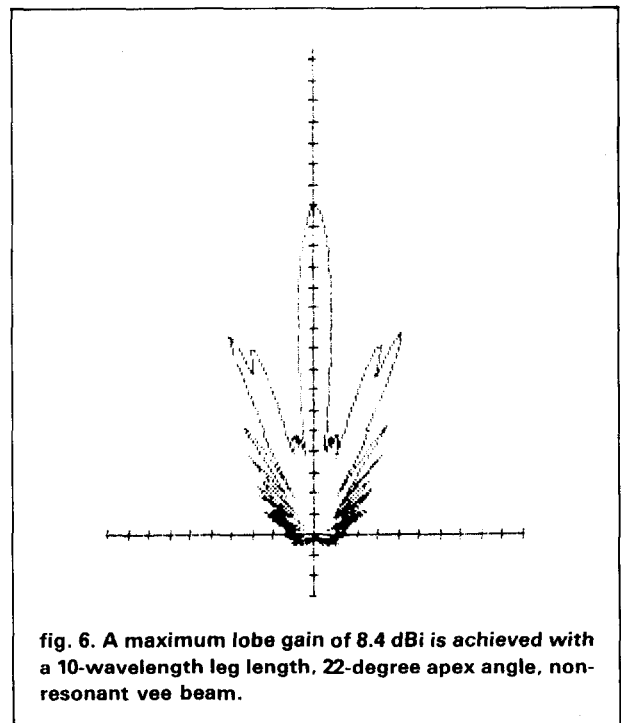

ondary, spacing it evenly around the core and making sure that there were at least a few millimeters between the two wire ends to prevent RF voltage flash-over. If you leave the ends of the secondary about two feet long you can also use them for antenna connections later. Anchoring the wire in place with silicone rubber is a messy but a very effective measure. Then slip

POCKET SIZE FAST CHARGER

Fast charge your hand held radio battery packs to full capacity in as little as 45 minutes. Example: Fully charge I-COM BP-3 in 30 to 45 minutes.

VERSATILE - Works on 115V. A.C. or 12V. to 24V. D.C. and turns itself off automatically when battery reaches full capacity. Use at home or in auto, airplane, boat, R.V. or anywhere there is house current or 12V. to 24V. D.C. available.

FEATURES -

1. New Hybrid thick film integrated circuit developed for this charger contains all measuring and control circuitry in a single chip. Laser trimmed precision resistors.
2. Small size - can be carried in your pocket.
3. High impact molded plastic case.
4. Reverse polarity protection built in.
5. Internally fused.
6. Full 1 year warranty.
7. Completely solid state circuit measures charge constantly and turns off automatically when cells reach full capacity.
8. Charges at optimum rate without any perceptible heating of cells.

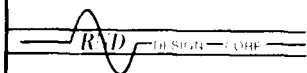

Price **\$65.00**
Dealer inquires invited

19780 Temescal Canyon
Corona, Calif. 91719
(714) 734-6179

Mail orders to:
P.O. Box 2679
Corona, Calif. 91718

✓ 143

some tube insulation over a second piece of the No. 12 AWG enameled wire and wrap five primary turns evenly over the outside of the first twenty turns. Getting even a semblance of a smooth wrap will be the hardest thing you'll have to do for this antenna. Again, use some silicone rubber to tack down the primary and give it at least twenty-four hours to harden. After stripping the enamel from the ends of toroid primary wire, solder on the coax connector of your choice. Resist the urge to use the hole through the middle of the toroid to hold up the high end of the antenna or attach the coax — powdered iron cores are brittle and are subject to breaking at the most inconvenient times.

The 390-ohm termination resistors, are noninductive resistors made specially for terminating antennas, and are available from electronic wholesalers,⁴ at ham fests (your best chance) or at surplus houses. On the other hand, you can also make a 200-watt terminating resistor out of one-hundred, 2-watt, 39 kilohm, carbon composition resistors. A simple way to do this is to lay out two tinned No. 12 AWG wires spaced the width of the resistor body and solder the 100 resistors to them.

Operating this antenna is pure joy. It loads my transmitter well from one end of the short wave bands to the other. My antenna also shows a maximum of about 1.5:1 SWR on 15 meters and about 1.2:1 maximum on all other bands. Adding or subtracting a turn or two on the transformer optimizes the SWR for any desired frequency.

At last I have an antenna that works smoothly from 160 to 10 meters and even works as an effective all-band antenna for my general coverage short-wave receiver. For cost and coverage, it's hard to beat this nearly foolproof sloping vee beam.

references

1. Landee, Davis & Albrecht, *Electronic Designers Handbook*, McGraw-Hill, New York, 1957, (see section 21).

2. The vee antenna feeding transformer, 1.8 to 30 MHz, is available from Apcom Inc., 625 Loffstrand Lane, Rockville, Maryland 20850, (301-294-9060). Note: this company and others will supply the complete antenna, mast, ground rods, earth anchors and everything else, optimized for your frequency and adjusted to fit various larger pieces of land. This is a good deal for commercial stations, but the cost is very high by ham standards.

3. Type F240-Q1 toroid core to cover 1.8 to 30 MHz is available from Amidon Associates, 12033 Otsego Street, North Hollywood, California 91607, or Palomar Engineers 1924-F W. Mission Road, Escondido, California 92025.

4. Carborundum Co., Graphite Products Division, Box 339, Niagara Falls, New York 14302. Please note that this is a manufacturer, not a retail outlet. If you can put together a large order, then request noninductive resistor type 888SP, 390 ohms (2 for each antenna). If more power is required, order type 891SP, 450 ohms (2 for each antenna).

ham radio

ORR BOOKS

BEAM ANTENNA HANDBOOK

by Bill Orr, W6SAI

Recommended reading. Commonly asked questions like: What is the best element spacing? Can different yagi antennas be stacked without losing performance? Do monoband beams outperform tribanders? These questions and more are fully answered. Lots of construction projects, diagrams, and photos. 198 pages. ©1983. 5th edition.

□RP-BA

Softbound \$7.95

SIMPLE LOW-COST WIRE ANTENNAS

by Bill Orr, W6SAI

Learn how to build simple, economical wire antennas. Apartment dwellers take note! Fool your landlord and your neighbors with some of the "invisible" antennas found here. Well diagrammed. 192 pages. ©1972. 2nd edition.

□RP-WA

Softbound \$7.95

THE RADIO AMATEUR ANTENNA HANDBOOK

by William I. Orr, W6SAI and Stuart Cowan, W2LX

Contains lots of well illustrated construction projects for vertical, long wire, and HF/VHF beam antennas. There is an honest judgment of antenna gain figures, information on the best and worst antenna locations and heights, a long look at the quad vs. the yagi antenna, information on baluns and how to use them, and new information on the popular Sloper and Delta Loop antennas. The text is based on proven data plus practical, on-the-air experience. 190 pages. ©1978. 1st edition.

□RP-AH

Softbound \$7.95

ALL ABOUT CUBICAL QUAD ANTENNAS

by Bill Orr, W6SAI — New 3rd Edition

Includes NEW data for WARC bands

The cubical quad antenna is considered by many to be the best DX antenna because of its simple, lightweight design and high performance. You'll find quad designs for everything from the single element to the multi-element monster quad. There's a wealth of data on construction, feeding, tuning, and mounting quad antennas. 112 pages. ©1982. 3rd edition.

□RP-CQ

Softbound \$6.95

Please add \$1.50 for one book, \$2.50 for two or more books to cover shipping and handling.

Ham Radio's Bookstore

Greenville, NH 03048

PACKET MADE

Easy



Suggested Retail \$389.95

Kantronics Packet Communicator™

Kantronics wants you to join one of the fastest growing segments of Amateur Radio today . . . Packet Radio. With the Kantronics Packet Communicator we've made getting on Packet as easy as getting on RTTY.

Ready to Use

The Kantronics Packet Communicator is a fully assembled and programmed terminal node controller ready for operation. Simply connect the Packet Communicator to the Serial TTL or RS232 port of your computer, and the microphone and external speaker jacks of your transceiver. The power supply, cables, and most connectors are included.

Compatibility Plus

The Kantronics Packet Communicator has both the AX.25 and Vancouver protocols, making it compatible with most existing Packet terminal node controllers. Added features include both Bell 103 and 202 tones, and the ability to use the unit as a 1200 baud radio modem without special protocols.

Easy to Operate

Because the Kantronics Packet Communicator uses internal microprocessors for protocol and signal processing, the operator simply follows procedures and commands outlined in the operators manual.

Any communications or terminal program, like those used with telephone modems, can be used to set up the computer to communicate with the Packet Communicator. Special Packet Terminal (Packet-Term™) programs for many popular personal computers will be available soon from Kantronics.

Error free data communication via computer makes Packet Radio technology exciting, and the Kantronics Packet Communicator lets you get in on the action.

For more information contact your local Kantronics dealer, or write Kantronics.

Kantronics

1201 E. 23rd Street • (913) 842-7745
Lawrence, Kansas 66046



DO YOU HAVE AN HEIRLOOM RADIO?

Well... they might not last forever. However, there are certainly many older model KDKs out there in 'Ham Radio-land' just chuggin away. Every day calls come from all over asking for information and advice on care and feeding of an FM-144sx or a '2015 and there are even a few older than that but some of them seem to be in disguise. That's a tribute to the folks who design and make the KDK. They care about building a radio to last longer because their name and their pride are on the front of each one. BUT... What we are really getting to is we would really like for all you folks who have known and loved your KDK's all these years to go and update yourselves by purchasing a newer KDK, one like, say, the FM-2033 or maybe an FM-7033 UHF. That way you can start your own collection of heirloom KDK radios. Right there in your own hometown. Take a look at the chart of available models and visit your nearest KDK dealer and check them out. We think you will drive home with one.

MAXPAC STACK

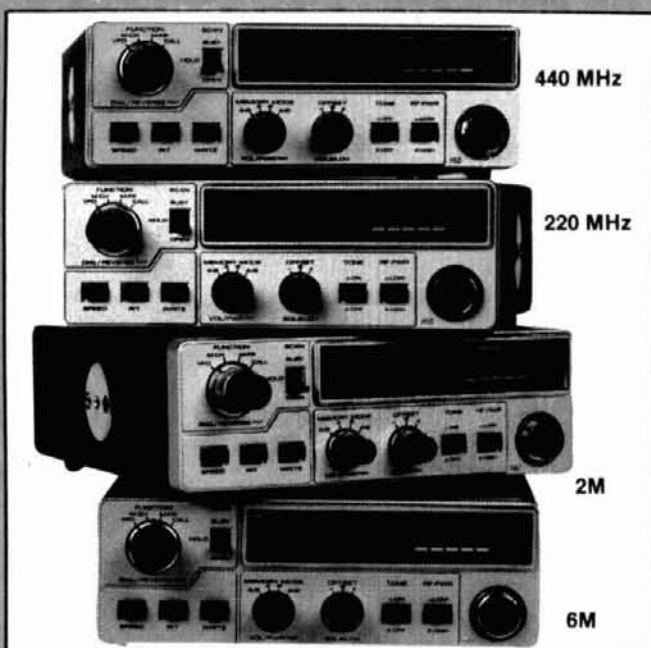

SPECIFICATION	FM-2033 144 MHZ	FM-4033 220 MHZ	FM-7033 440 MHZ	FM-6033 50 MHZ
NUMBER OF MEMORIES	10 Memories + CALL CHANNEL organized as two banks of 5 channels each. (CH 1-5, CH 6-10, CALL.)			
MEMORY SCANNING	Memories may be scanned A(1-5), B(6-10), A+B(1-10) or A x B(1-5)			
BAND SCANNING	Programmable band scan between values loaded into memories 5 and 10, step size set in INIT module.			
FREQUENCY RANGE	142.000-149.995 MHZ	220-224.995 MHZ	440-449.975 MHZ	50.00-53.995 MHZ
OUTPUT POWER HI/LO	25/2.5 Watts	25/2.5 Watts	10/2 Watts	10/2 Watts
REPEATER OFFSET	600 kHz UP or Down	1.6 MHZ UP or Down	5 MHZ UP or Down	600 kHz UP or Down
SUB AUDIBLE TONE	103.5 @ 500 Hz Dev	103.5 @ 500 Hz Dev	Dipswitch Select	103.5 @ 500 Hz
SENSITIVITY	0.2 uV @ 12dB SINAD	0.35 uV @ 12 dB SINAD	0.4 dB @ 12 dB SINAD	0.2 uV @ 12 dB SINAD
BANDWIDTH	± 5 kHz @ -6 dB	± 5 kHz @ -6 dB	± 5 kHz @ -6 dB	± 5 kHz @ -6 dB
SELECTIVITY	± 12.5 kHz @ -60 dB	± 12.5 kHz @ -60 dB	± 12.5 kHz @ -60 dB	± 12.5 kHz @ -60 dB



AMPLIFIERS • PREAMPS • COUPLERS

TEAM THL LINE-UP FOR '85 SEASON

TEAM THL brings competition class performance to everyday operation. Whether you're looking for a little more performance or a "super-charger" boost, TEAM THL products can get you out of the pits and back in the race better and faster almost every time. Three different power performance classes in either VHF or UHF band capability give the TEAM THL a broad spectrum of performance options. So remember the next time you get beat in the race, soup-up yourself with a product from TEAM THL.

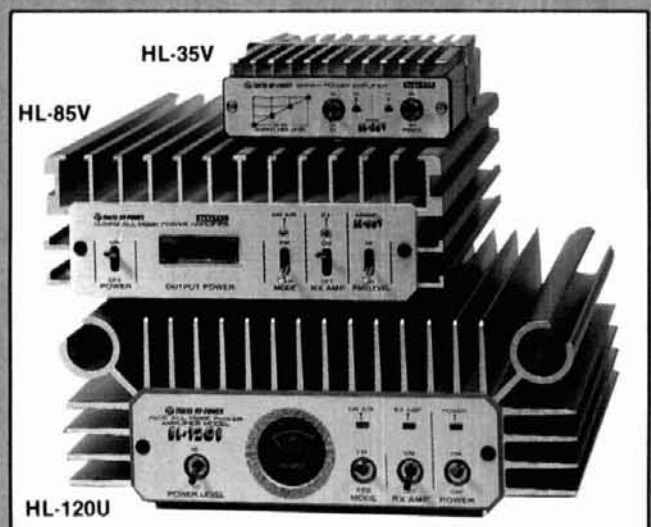

Specifications	HL-30V	HL-35V	HL-35VL	HL-85V	HL-110V	HL-160V	HL-160V25	HL-20U	HL-30U	HL-60U	HL-120U
Pre-Amp Type	N/A	Gaas-FET	Gaas-FET	Gaas-FET	Gaas-FET	MOS-FET	MOS-FET	N/A	Gaas-FET	Gaas-FET	Gaas-FET
Power Metering	N/A	LED	LED	Meter	Meter	Meter	Meter	N/A	LED	Meter	Meter
Input (Watts)	.25-5	.25-5	.25-5	10-14	3-14	3-14	20-30	.1-4	1-4	8-14	8-14
Output (Watts)	2.5-30	2.5-30	2.5-30	70-90	90-110	140-160	140-160	18-22	25-30	45-60	90-110
SSB Mode	NO	NO	YES	YES	YES	YES	YES	YES	NO	YES	YES
Sugg. Retail	\$69.95	\$79.95	\$89.95	\$169.95	\$239.95	\$349.95	\$299.95	\$114.95	\$129.95	\$229.95	\$379.95



2M ST-200ET 70CM ST-400ET

Priced at a level to make your budget smile, the ST-200ET and the ST-400ET are direct hardware replacements for the famous ICOM* series of thumbwheel switched hand held radios. Present accessories for the 2AT and the 4AT should work on the ST-200ET (VHF) and ST-400ET (UHF) with no modifications.** Same slip off battery pack style and the same mic and speaker jack arrangements provide as much compatibility as possible.

These units are made in Japan and sold by SANTEC and backed by the famous Encomm TWO YEAR EXTENDED SERVICE PLAN and Encomm service facilities located in Plano, Texas. Priced at \$199.95 for the ST-200ET (VHF) and \$249.95 for the ST-400ET (UHF). No it's not a misprint. Those are the Suggested retail prices. Now smile. Please see your favorite SANTEC dealer for his best price.



2M — \$199.95
70CM — \$249.95

SPECIFICATION	ST-200ET	ST-400ET
GENERAL		
Frequency Range	144-147.995	440-449.995
Battery Pack (V/mAhr)	8.4/250	8.4/250
Receive Squelched Norm	18 mA	22 mA
RX At Full Volume	130 mA	130 mA
Transmit (Low Power)	220 mA	300 mA
Transmit (High Power)	550 mA	700 mA
Dimensions mm	60 x 170 x 40	60 x 170 x 40
Weight (with Battery)	490 gms	490 gms
TRANSMITTER		
Output Pwr. (Hi, Lo)	1.5W, 0.15W	1.5W, 0.15W
Spurious Transmitted	< -60dBc	< -60dBc
Deviation Limit	5 kHz	5 kHz
Pickup Device	Condenser Mic	Condenser Mic
RECEIVER		
Receiving System	Dbl. Superhet.	Dbl. Superhet.
I.F. Frequencies	10.695 1st 455 kHz 2nd	21.6 1st 455 kHz 2nd
Receive Sensitivity	< 0.25 uV @ 12dB	< 0.35 uV @ 12 dB
I.F. Bandwidth	30 kHz @ -60dB	30 kHz @ -60 dB
Operating Temp	-10 + 60 C	-10 + 60 C
ACCESSORIES		
SKT-BA Battery Case	HSA-1/HBM-1 Headset/Mic	
SKT-PA DC/DC Conv.	STK-BP Battery Pack	
ST-MC Mobile Charger	STK-BC Battery Charger	
SKT-LC Leatherette Case		

NOTICE: These specifications are typical unless stated otherwise. They may be changed in the future without notice or obligation. Conditions of measurement may be obtained from Encomm, Inc.

* ICOM is a registered trademark of ICOM, INC of JAPAN.
** ST-200ET/400ET Batteries are not fully compatible with BC-30/35 drop in chargers.

WELZ CORP.

SUPERIOR ACCESSORIES

PEP • POWER • VSWR COMPACT STYLE

SP-122 HF PEP HOLD
SP-220 HF PEP MONITOR
SP-420 VHF/UHF PEP MONITOR

These new compact HF/VHF/UHF meters from WELZ provide multi-mode operation in auto or home station. Utilizing the WELZ toroidal core based wide-band sensor technology, these VSWR/POWER meters are the next generation of accuracy and reliability. Pictured here is the model SP-420 covering the VHF/UHF band from 140-525 MHz. In addition there is the SP-220 covering 1.8 to 200 MHz and the SP-122 covering 1.6-60 MHz with PEP peak hold mode. All three of these new models are ready for PEP output measurement with either the "PEP Monitor" function or the "Instantaneous PEP HOLD" function, back-lighted easy-to-read meters, high sensitivity and very attractive styling. Check your favorite dealer and check out the new WELZ COMPACT VSWR/POWER meters.



MODEL	SP-122	SP-220	SP-420	SP-230	SP-430
Freq. Range	1.6-60MHZ	1.8 - 200MHZ	140 - 525MHZ	6-1400MHZ	1.8 - 150MHZ
Sensor Mt.	FIXED	FIXED	FIXED	DETACHABLE	DETACHABLE
Pwr Ranges	20/200/2KW	2/20/200	2/20/200	15W/150W	5W/60W
No. Meters	1	1	1	1	1
Peak Mode?	YES + HOLD	YES	YES	NO	NO
Impedance	50 OHMS	50 OHMS	50 OHMS	50 OHMS	50 OHMS
Functions	PWR/VSWR PEP + HOLD	PWR/VSWR PEP	PWR/VSWR PEP	PWR/VSWR CAR VOLTS	PWR/VSWR CAR VOLTS
Accuracy	10% READING	10% READING	5% READING	5% F.S.	5% F.S.

Doctor QSO™

Is The Code Buster



Doctor QSO Relieves All Symptoms Of Morse Code Phobia!

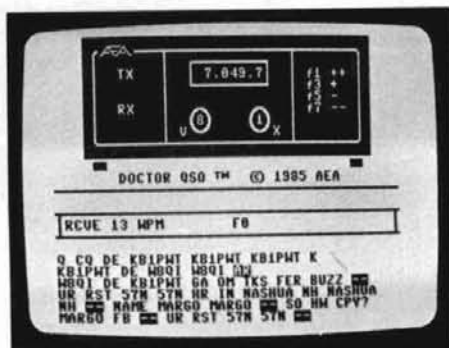

Doctor QSO™ is a plug-in cartridge for the Commodore 64 computer that provides a very realistic simulation of on-the-air two-way Morse Code ragchew contacts (QSOs). AEA, the undisputed leader in Morse training, has introduced Doctor QSO to amateur radio for the purpose of making Morse skill upgrading FUN and EASY. With Doctor QSO you can look forward to practicing your Morse Code skills in a non-confusing manner. Forget about all the drudgery you associated with Morse Code in the past; Doctor QSO ushers in a totally new era in Morse Code learning.

Doctor QSO is based on the same technology that has made the Doctor DX™ contest trainer so famous. The Doctor QSO simulator is so realistic that most skilled operators find it every bit as rewarding as the real thing. You can operate anytime you want; the only extra equipment you need is a Commodore 64 and a TV set.

Doctor QSO also removes the mystery of the CODE BEHIND THE CODE. Many people go so far as to learn the Morse Code characters, only to be frightened of getting on the air the first time because the QSO format is so confusing. With Doctor QSO, you will be a pro before you turn on your first transmitter. The Doctor QSO trainer/simulator is ideal for the aspiring Amateur Radio operator with little or no contact with helpful hams.

With Doctor QSO you will become familiar with all the U.S. call areas and associated call letter prefixes. The standard international QSO format is observed along with all the common amateur radio abbreviations which are explained thoroughly in the operator's manual. All Morse skill levels are addressed by Doctor QSO, from the person who has not yet learned the Code, to the person comfortable with sending and receiving at 40+ WPM.

Who says Morse Code can't be fun? You can even have fun with Doctor QSO before you have learned the Code. To begin with, the operator can view the messages being sent by the computer generated stations in real-time. The operator can also send Morse with the keyboard. In addition, the operator can select simulation of static interference (QRN) and adjacent CW interference (QRM). Normally, the beginner would operate in the novice band where stations will be sending as slow as 3 WPM. Later as the user becomes more skilled, he can move down the band to faster speeds, and he has the choice of using a key or keyer for sending.

If you have tried every other method known to learn the Morse Code and failed, then Doctor QSO has just the prescription for you. Now you can upgrade your Amateur Radio license in record time. Doctor QSO is more than the written word can describe. To fully appreciate all the merits of this trainer, see your dealer for a demonstration or contact AEA for more information.

*Prices and specifications subject to change
without notice or obligation.*

Advanced Electronic Applications, Inc.
P.O. BOX C-2160 • LYNNWOOD, WA 98036
(206) 775-7373 • TELEX: 152571 AEA INTL



**Brings you the
Breakthrough!**

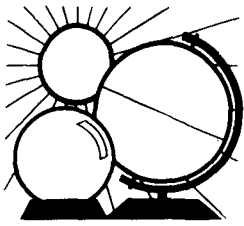

DX FORECASTER

Garth Stonehocker, KØRYW

what's this Sporadic E?

In these minimum years of the 10.7-year sunspot cycle when the 10-meter band is at best open only a few hours per day and only to the southern directions for long skip, it's still possible for propagation modes to exist on 6 meters and occasionally even the 2-meter band for short-skip openings. Signals appear suddenly, out of nowhere, and frequently rise to amazing strength. They may stay in for just a few minutes at a time — or the band may remain open for hours. Occasionally in June or July DX signals might be heard around the clock. Signals can be received from distances of 500 to 1200 miles and occasionally, due to multiple reflections, from distances as far away as 2500 miles.

How do you recognize such E_s openings? Say you're monitoring a beacon. The band is quiet. Suddenly you hear a buildup of "antenna noise." Almost instantly there are DX stations all over the band. Signal levels fluctuate rapidly as the session opens and as it declines. When the signal is there it usually pegs your S-meter, but it is also subject to rapid fades on the order of 60 dB or more that chop it into a garbled mess.

One way to recognize the probable opening of E_s on 6 meters was reported by George Jacobs, W3ASK, in the June, 1962, issue of *CQ*. Working a lower frequency band, say 15 or 10 meters, listen to the stations being worked. If the minimum skip distance is decreasing, the skywave geometry is such that the maximum usable frequency will be increasing by reflection from an E_s (more dense than F2 and lower height) cloud. W3ASK's rule of thumb states that when stations are heard less than 500 miles away on 10 meters, or less than 350 miles on 15 meters, the chances are good that 6

meters will open in that same direction. It's worth a try! (More on E_s DXing next month.)

last-minute forecast

DX conditions on the higher HF bands, 10 through 30 meters, are expected to be very good the first two weeks of the month and also again during the last week of this five-week month. The propagation at these times can be via long-skip if the radio flux is very high — above about 85 units. Sporadic E (E_s) short-skip is expected to occur occasionally, with the probability of occurrence increasing as the month goes by. The middle two weeks of the month will offer the best nighttime DXing. Geomagnetic disturbances are expected to occur around the 4th through the 8th and again on or about the 15th. Concurrently, the thunderstorm noise background level will also be higher on the lower bands.

Moonbounce DXers can take advantage of the lunar perigee (and full moon) that will occur on the 3rd and 4th of this month. An Aquarid meteor shower of interest to meteor-scatter and meteor-burst DXers peaks between May 4th and 6th with rates of 10 and 25 per hour for the Northern and Southern Hemisphere, respectively.

Two eclipse events are calculated to occur in May. The first is a total eclipse of the moon on May 4 from 1817 to 2135 UTC. The path of its shadow starts near New Zealand and travels west through Australia, Asia, Africa into the Atlantic Ocean. The width extends from the Antarctic to Europe. The second event, partial eclipse of the sun, (with 84 percent coverage) will occur on May 19 from 1925 to 2342 UTC. Its path begins at Greenland, travels across Canada and then moves on to Alaska and Japan. The second eclipse provides an opportunity to

evaluate propagation effects on the path between the United States and Europe. Schedule contacts for the day before the day of the eclipse and the day after. Compare signal strengths and quality on each band used (suggestion: try 40, 30, 20 and 15 meters). A club-coordinated effort is a good way to cover the bands needed.

band-by-band summary

Six meters may provide an occasional opening to South Africa and South America by short-skip E_s . These will occur around local noontime, toward the end of the month.

Ten and fifteen meters will provide a few short skip E_s openings and many long-skip openings, especially during high solar flux conditions, to most areas of the world during daylight. Some transequatorial (TE) openings, associated with a mildly disturbed geomagnetic field may occur in the evening hours. This is about the last month that affords many good TE openings until next fall.

Twenty, thirty, and forty meters will support DX propagation from most areas of the world during the daytime and into the evening hours almost every day. Forty meters has joined this daytime DX group because of lower signal absorption, lower LUF (lowest usable frequency) during these sunspot minimum years. During unusually high 27-day solar flux days 40 meters may not be usable and both 30 and 40 meters may not be usable in the pre-dawn hours after a high flux day. The DX on these bands may be either long-skip to 2500 miles (4000 km) or short-skip E_s to 1250 miles (2000 km) per hop. The length of daylight is approaching maximum, providing many hours of good DXing.

Thirty, forty, eighty, and one-sixty are all good for nighttime DX. Although the background thunderstorm noise is beginning to be noticeable these bands are still quiet enough to provide good DX working conditions. Sporadic-E propagation may be a contributing factor toward enhanced conditions at local sunset and will occur more often during the next three months.

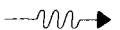

New From Butternut® HF2V DX The 80 & 40 Meter Bands

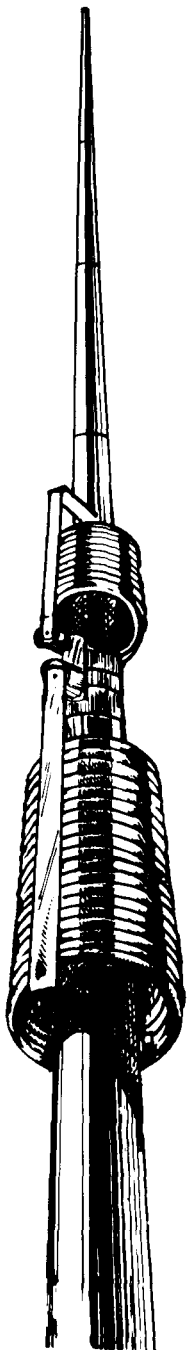

The HF2V is the perfect complement for the Ham who already has a beam antenna for 10-15-20 meters. Add 80 and 40 meters (160 meters with an optional resonator kit) with a trim-looking vertical that can be mounted almost anywhere.

With the decline in sunspot activity, the HF2V's low angle of radiation will get you DX on the low bands -- even when 10-15-20 meters are "dead."

Automatic bandswitching. No lossy traps. Double wall tubing on the bottom section. Stainless steel hardware. Full 1/4 wavelength on 40 meters.

Height: 32 ft. --Self supporting

Power rating: legal limit

VSWR: 2:1 or less

40 Meters: Full CW & Phone band

80 Meters: 90 kHz

Add-on resonator kits available for 160-30-20 meters.

Write for our FREE CATALOG.

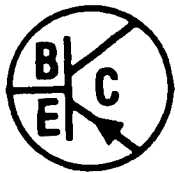

**BUTTERNUT
ELECTRONICS**

405 East Market Street
Lockhart, Texas 78644

(512) 398-9019

HAZER YOUR ROHN 25 G Tower

- Antenna and rotator mount on HAZER, complete system trams tower in verticle upright position.
- Safety lock system on HAZER operates while raising-lowering & normal position. Never can fall.
- Weight transferred directly to tower. Winch cable used only for raising & lowering. Easy to install and use.
- Will support most antenna arrays.
- High quality materials & workmanship.
- Safety - speed - convenience - smooth travel.
- Complete kit for 50' or less tower includes winch, cable, hardware and instructions.

Hazer 2-Heavy duty alum., 12sq.ft. load \$297.00 ppd.
Hazer 3-Standard alum., 8 sq.ft. load 213.00 ppd.
Hazer 4-Heavy galv. steel, 16 sq.ft. load 278.00 ppd.
Ball thrust bearing TB-25 for any of above 42.50 ppd.

As an alternative, purchase a Martin M-13 or M-18 aluminum tower engineered specifically for the HAZER system.



GLEN MARTIN ENGINEERING INC.
P.O. Box H 253 Boonville, Mo. 65233
816-882-2734



147

HANDI-HAM SYSTEM MANAGER

(Amateur Radio System)

Courage Center, an internationally recognized leader in providing innovative services to physically handicapped children and adults for more than 50 years, is searching for a middle level manager to direct the operation of the Courage HANDI-HAM System. This unique program, providing training, education and radio equipment, is made available to disabled amateur radio operators worldwide who join a total network membership exceeding 5,000. Position qualifications include a bachelor's degree, 2+ years administrative experience, strong verbal and written communication skills, and a general or higher level amateur radio operator license. Resumes received in confidence. Appointment will be made as soon as possible after June 1st, 1985. For more information contact Todd Johnson, Director of Human Resources.



COURAGE CENTER

3915 Golden Valley Road
Golden Valley, MN 55422

Equal Opportunity Employer

Omega Concepts, Inc.

Presents

"STATION MANAGER"

ADVANCED

**Professional Software
For The Radio Amateur**

Terence L. Jones (KB8OA)
Author

Stop At Our Booth At The
Hamvention, Dayton, Ohio, April 26



Omega Concepts, Inc.

P. O. Box 615 Troy, OH 45373

149

CADDELL COIL CORP.

35 Main Street
Poultney, VT 05764
802-287-4055

BALUNS

Get POWER to your antenna! Our Baluns are already wound and ready for installation in your transmatch or you may enclose them in a weatherproof box and connect them directly at the antenna. They are designed for 3-30 MHz operation. (See ARRL Handbook pages 19-9 or 6-20 for construction details.)

100 Watt (4:1, 6:1, 9:1, or 1:1 Impedance - select one)	\$ 8.50
Universal Transmatch 1 KW (4:1 Impedance)	12.50
Universal Transmatch 2 KW (4:1 Impedance)	15.00
Universal Transmatch 1 KW (6:1, 9:1 or 1:1-select one)	14.00
Universal Transmatch 2 KW (6:1, 9:1 or 1:1-select one)	16.50

Please send all reader inquiries directly.

2.3 GHz MICROWAVE EQUIPMENT

RMLA-I \$36.00

2.3 GHz LNA, 14 Db gain, 50 ohm (BNC). Input transisitor typical NF: 2.6 Db. Requires +12 VDC. 3.5" x 2" x 1.25", without enclosure.

RMMX-I \$20.00

2.3 GHz double balanced mixer, 50 ohm (BNC). 2.5" x 2.5" x 1", without enclosure.

RMVO-II \$35.00

2.3-2.45 GHz voltage controlled oscillator, 10 MW output. Requires +12 VDC bias and -1 to -12 VDC tuning. 2.25" x 1.25" x 1", may be FM modulated with 8 ohm speaker as microphone.

Also Antennas, Mast Mountable VCO/antennas, Detectors, Signal Generators, Attenuators, and Line Stretchers.

ROENSCH MICROWAVE

R.R. 1, Box 156B,
BROOKFIELD, MISSOURI 64628 146



GMT	PDT	WESTERN USA									
		N	NE	E	SE	S	SW	W	NW		
0000	5:00	20	20	15	15	20	10	15*	20		
0100	6:00	20	20	20	10	20	10	10	20		
0200	7:00	20	20	20	10	20	10	10	20		
0300	8:00	20	20	20	10	20	10	10	20		
0400	9:00	20	20	20	10	20	15	10	20		
0500	10:00	20	20	20	10	20	15	15	20		
0600	11:00	20	20	20	15	30	15	15	20		
0700	12:00	20	30	20	15	30	20	15	20		
0800	1:00	20	30	20	15	30	20	20	20		
0900	2:00	20	30	20	20	30	20	20	20		
1000	3:00	20	30	20	20	30	20	20	20		
1100	4:00	20	30	20	20	30	20	20	30		
1200	5:00	20	20	15	20	30	20	20	30		
1300	6:00	20	20	15	20	30	20	20	30		
1400	7:00	20	20	15	20	30	20	20	30		
1500	8:00	20	20	15	20	20	20	20	30		
1600	9:00	20	20	15	20	20	15	20	30		
1700	10:00	20	20	15	15	20	15	20	20		
1800	11:00	20	20	10	15	20	15	20	20		
1900	12:00	20	20	10	15	20	15	15	20		
2000	1:00	20	20	10	15	20	15	15	20		
2100	2:00	20	20	10	15	20	10	15	20		
2200	3:00	20	20	10	15	20	10	15	20		
2300	4:00	20	20	15	15	20	10	15	20		

GMT	MDT	MID USA									
		N	NE	E	SE	S	SW	W	NW		
0000	6:00	20	20	15	15	20	10	10	20		
0100	7:00	20	20	20	20	20	10	10	20		
0200	8:00	20	20	20	20	20	10	10	20		
0300	9:00	20	20	20	20	20	10	10	20		
0400	10:00	20	20	20	20	30	15	10	20		
0500	11:00	20	20	20	20	30	15	15	20		
0600	12:00	20	20	20	20	30	15	15	20		
0700	1:00	20	20	20	20	30	20	15	20		
0800	2:00	20	30	20	20	30	20	20	20		
0900	3:00	20	30	20	20	30	20	20	20		
1000	4:00	20	30	20	20	30	20	20	20		
1100	5:00	20	30	15	15	30	20	20	20		
1200	6:00	20	20	15	15	30	20	20	20		
1300	7:00	20	20	15	15	30	20	20	20		
1400	8:00	20	20	15	15	30	20	20	20		
1500	9:00	20	20	15	15	30	20	20	20		
1600	10:00	20	20	15	15	30	20	20	20		
1700	11:00	20	20	15	10	20	15	20	20		
1800	12:00	20	20	10	10	20	15	15	20		
1900	1:00	20	20	10	10	20	15	15	20		
2000	2:00	20	20	10	10	20	15	15	20		
2100	3:00	20	20	10	10	20	15	15	20		
2200	4:00	20	20	15	15	20	10	15	20		
2300	5:00	20	20	15	15	20	10	15	20		

GMT	EDT	EASTERN USA									
		N	NE	E	SE	S	SW	W	NW		
0000	8:00	20	20	15	15	20	10	15	20		
0100	9:00	20	20	20	20	20	10	10	20		
0200	10:00	20	20	20	20	20	10	10	20		
0300	11:00	20	20	20	20	20	10	10	20		
0400	12:00	20	20	20	20	30	15	10	20		
0500	1:00	20	20	20	20	30	15	15	20		
0600	2:00	20	20	20	20	30	15	15	20		
0700	3:00	20	30	20	20	30	15	15	20		
0800	4:00	20	30	20	20	30	20	15	20		
0900	5:00	20	30	20	20	30	20	20	20		
1000	6:00	20	30	20	20	30	20	20	20		
1100	7:00	20	30	15	15	30	20	20	20		
1200	8:00	20	20	15	15	30	20	20	20		
1300	9:00	20	20	15	15	30	20	20	20		
1400	10:00	20	20	15	15	30	20	20	20		
1500	11:00	20	20	15	15	30	20	20	20		
1600	12:00	20	20	15	15	20	15	20	20		
1700	1:00	20	20	15	10	20	15	20	20		
1800	2:00	20	20	10	10	20	15	15	20		
1900	3:00	20	20	10	10	20	15	15	20		
2000	4:00	20	20	10	10	20	10	15	20		
2100	5:00	20	20	15	15	20	10	15	20		
2200	6:00	20	20	15	15	20	10	15	20		
2300	7:00	20	20	15	15	20	10	15	20		

The italicized numbers signify the bands to try during the transition and early morning hours, while the standard type provides the MUF during "normal" hours.

*Look at next higher band for possible openings.

ham radio

Your Ham Tube Headquarters!

TUBES BOUGHT, SOLD AND TRADED
SAVE \$\$\$—HIGH \$\$\$ FOR YOUR TUBES

Call Toll Free 800-221-0860

Tubes

3-400Z.....\$85.00	7360.....\$10.00
3-500Z.....85.00	7735A.....27.50
4-400A.....80.00	8122.....110.00
4CX250B.....50.00	8156.....12.50
572B.....55.00	8643.....82.50
811A.....12.00	8844.....26.50
813.....30.00	8873.....175.00
6146B.....6.50	8874.....195.00
6360.....4.25	8877.....500.00
6883B.....6.75	8908.....12.50

MAJOR BRANDS ON RECEIVER TUBES 75% off list

Semiconductors

MRF 245/SD1416 ..\$30.00	SD108819.95
MRF 45414.95	2N3055.....75¢
MRF 45510.95	2N6084.....12.50

RF Connectors

PL259.....10/\$4.95	M358.....2.50 ea.
PL258.....10/8.95	M359.....1.75 ea.
UG 175/176.....10/1.60	Type "N" Twist on
UG255/u.....2.50 ea.	(RG8/u).....\$4.75 ea.
UG273/u.....2.25 ea.	Minimum Order \$25.00

Allow \$3.00 min. for UPS charges ✓ 150

CeCo

COMMUNICATIONS, Inc.

2115 Avenue X Brooklyn, NY 11235

SERVING THE INDUSTRY SINCE 1922

Phone (212) 646-6300

Call CECCO For Your CCTV Security And Color Production Requirements.

MICROWAVE TV ANTENNA SYSTEMS

Freq. 2.1 to 2.7 GHz . 34 db Gain +

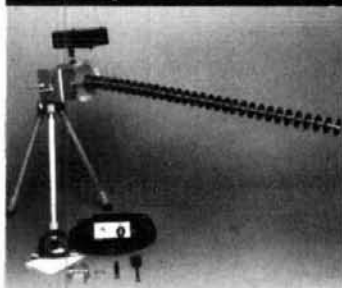

COMPLETE SYSTEMS:

(as Pictured)

Commercial 40"

Rod Style \$99.95

Parabolic 20"

Dish Style \$79.95

COMPONENTS

Down Converters

(either style) \$34.95

Power Supplies \$24.95

(12V to 16V. DC+)

Data Info (Plans) \$ 9.95

CALL OR WRITE FOR
KITS, PARTS, OR MORE
INFORMATION

Shipping & Handling Add \$5.00
We Repair Most Types Down
Converters & Power Supplies

Phillips-Tech Electronics

P.O. Box 34772

Phoenix, AZ 85087

(602) 947-7700

Special Quantity Pricing
Dealers Wanted



LIFETIME LIMITED WARRANTY
PARTS & LABOR

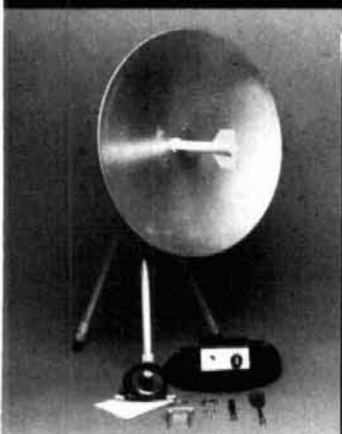

CTM

The monthly magazine with a natural blending of two popular hobbies — Ham Radio and Computers

- ★ Articles on Ham Radio & Most Personal Computers
- ★ Hardware & Software Reviews
- ★ Various Computer Languages
- ★ Construction Articles
- ★ Much Much More . . .

"...received my moneys worth with just one issue..."

—J. Trenbick

"...always stop to read CTM, even though most other magazines I receive (and write for) only get cursory examination..."

—Fred Blechman, K6UGT

U.S.A.....\$15.00 for 1 year

Mexico, Canada\$25.00

Foreign\$35.00(land) - \$55.00(air)

(U.S. funds only)

Permanent (U.S. Subscription)\$100.00

Sample Copy\$3.50

CTM

Circulation Manager

1704 Sam Drive

Birmingham, Alabama 35235

Phone 205/854-0271

Name _____

Call Sign _____

Address _____

City _____ State _____

Zip _____ Phone _____

Date _____

Signature _____

✓ 152

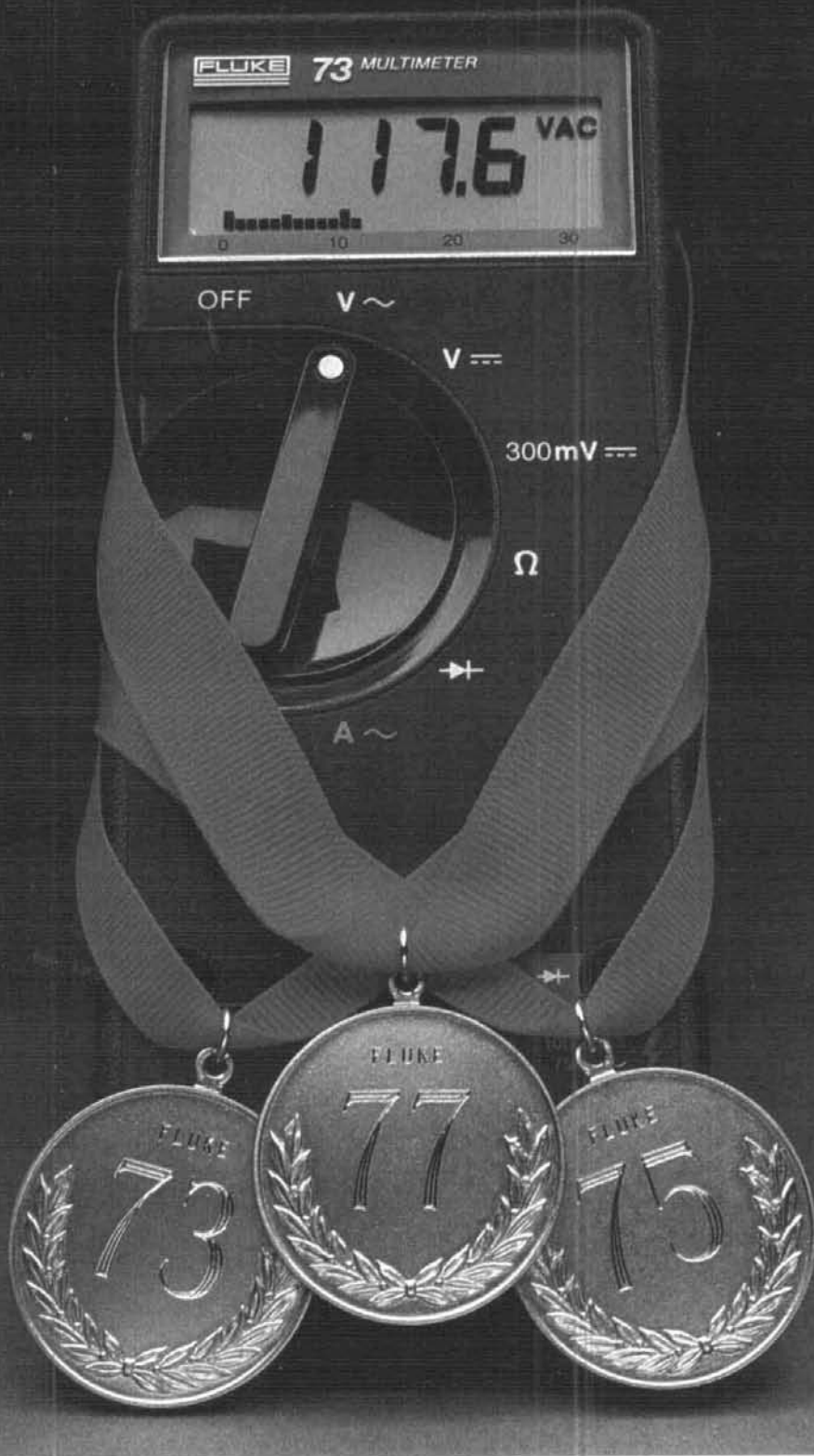

Take home a world champion.

\$85* gets you a technical knockout.
The Fluke 70 Series.
Winners of the digital vs. analog battle.

Since their debut, they've become the worldwide champions of the industry.

Never before have such tough, American-made meters offered so many professional features at such unbeatable prices.

Each comes with a 3-year warranty, 2,000+ hour battery life, and instant autoranging.

You also get the extra resolution of a 3200-count LCD display, plus a responsive analog bar graph for quick visual checks of continuity, peaking, nulling and trends.

Choose from the Fluke 73, the ultimate in simplicity. The feature-packed Fluke 75. Or the deluxe Fluke 77, with its own protective holster and unique "Touch Hold" function** that captures and holds readings, then beeps to alert you.

So don't settle for just a contender. Take home a world champion.

For your nearest distributor or a free brochure, call toll-free anytime

1-800-227-3800, Ext. 229. From outside the U.S., call 1-402-496-1350, Ext. 229.

**FROM THE WORLD LEADER
IN DIGITAL MULTIMETERS.**



FLUKE 73

\$85*
Analog/digital display
Volts, ohms, 10A, diode test
Audible continuity
Autorange
0.7% basic dc accuracy
2000+ hour battery life
3-year warranty

FLUKE 75

\$99*
Analog/digital display
Volts, ohms, 10A, mA, diode test
Audible continuity
Autorange/range hold
0.5% basic dc accuracy
2000+ hour battery life
3-year warranty

FLUKE 77

\$129*
Analog/digital display
Volts, ohms, 10A, mA, diode test
Audible continuity
"Touch Hold" function
Autorange/range hold
0.3% basic dc accuracy
2000+ hour battery life
3-year warranty
Multipurpose holster

* Suggested U.S. list price, effective July 1, 1984.

** Patent pending.

COMMUNICATIONS EQUIPMENT SALE!

ICOM



ICOM IC-751A LIST PRICE \$1399
CALL FOR SPECIAL SALE PRICE!



ICOM IC-745 LIST PRICE \$999
CALL FOR SPECIAL SALE PRICE!



IC-27A, IC-27H,
IC-37A, IC-47A
All Now Available
Call For Special Sale Prices!
Save \$\$\$!



IC-271A/H 2 mtrs
IC-471A 70 cm
Perfect Oscar Equipment
Call For Special Prices!



IC-02AT
New 2m HT

Call!
For Your
Special
Price!

KENWOOD



TS-930S LIST PRICE \$1799
CALL FOR SPECIAL SALE PRICE!



TS-430S LIST PRICE \$899.95
CALL FOR SPECIAL SALE PRICE!



TW-4000A
With FREE VSI Voice
Synthesizer and MA-4000
Dual-Band Antenna
Only \$599.95 Save \$85



TM-211A/411A
25 Watt FM Mobile
Call For Your Special Price



TR-2600
NEW!
High Tech
Compact 2 mtr HT
Now In Stock!
Call For Your Very
Special Price



FT-757GX LIST PRICE \$829
CALL FOR SPECIAL SALE PRICE!



FT-726R LIST PRICE \$829
CALL FOR SPECIAL SALE PRICE!



FT-209RH
NEW High Tech
2mtr HT
5 Watt Output
NOW IN STOCK
CALL FOR YOUR
SPECIAL PRICE

TEN-TEC SALE!



CORSAIR List \$1169
SALE PRICE \$999!

NEW 3KW Amplifier
Model 425 Titan
List \$2495
CALL FOR SPECIAL PRICE



TEN-TEC
New 2M HT
Full Featured!
List \$319
Sale \$279.95!
4229 2KW Tuner Kit \$189.95!

SANTEC



ST142 2m H.T.\$249
ST222 220 MHz H.T.\$279
ST442 440 MHz H.T.\$289
LS202 2m SSB/FM H.T.\$229

KDK FM2033
List \$339.95 Sale \$299.95



TOKYO HY-POWER AMPLIFIERS
HL30V 2m Amp 2-30 FM 59.95
HL32V 2m all-mode Amp 2-30 75.00
HL82V 2m Amp & Preamp 10-80 139.95
HL160V 2m Amp & Preamp 2/10-160 288.95
HL20U 440-450 MHz Amp 2-20 98.95
HL90U 430-440 MHz Amp 10-90 319.00

HAL SALE! NEW RTTY/CW COMPUTER INTERFACES



CRI-100 List \$249 SALE \$229.95!
CRI-200 List \$299 SALE \$269.95!



CWR6850
RTTY/CW
TERMINAL

List \$999 SALE \$749.95!

Other HAL Products On Sale

CWR6700	\$369.00	DS3100ASR	\$1899.00
CT2100 Upgrade Kit	95.00	MP3100	2189.00
CT2200K/02100	949.00	RS2100	289.00
DSK3100	999.00	S15000	219.00
FRQ1000	849.00	S16000	839.00

MIRAGE AMPLIFIER SALE!



B1016
\$249

Model	Band	Pre-amp	Input	Output	DC Pwr	Sale Price
A1015	6M	Yes	10W	150W	20A	\$249
B23	2M	No	2W	30W	5A	\$ 79
B215	2M	Yes	2W	150W	22A	\$259
B108	2M	Yes	10W	80W	10A	\$159
B1016	2M	Yes	10W	160W	20A	\$249
B3016	2M	Yes	30W	160W	17A	\$199
C22	220	No	2W	20W	5A	\$ 79
C106	220	Yes	10W	60W	10A	\$179
C1012	220	Yes	10W	120W	20A	\$259
D24	440	No	2W	40W	8A	\$179
D1010N	440	No	10W	100W	20A	\$289

RC-1 Remote Control for Mirage Amplifiers \$24
MP-1 and MP-2 Peak Reading Wattmeter \$99

ASTRON POWER SUPPLIES

Heavy Duty - High Quality - Rugged - Reliable
 • Input Voltage 105-125 VAC Output 13.8 VDC ± 0.5V
 • Fully Electronically Regulated - 5mV Maximum Ripple
 • Current Limiting & Crowbar Protection Circuits
 • M Series With Meter - A Series Without Meter

Model	Cont Amps	ICS Amps	Price
RS4A	3	4	\$ 39
RS7A	5	7	49
RS12A	9	12	69
RS20A	16	20	89
RS20M	16	20	109
RS35A	25	35	135
RS35M	25	35	149
RS50A	37	50	199
RS50M	37	50	229



MODEL RS-50A



CP-1 COMPUTER PATCH
List \$239.95 SALE \$189.95!
 CP1-20\$219 CP1-64\$219
 MP-20\$129 MP-64\$129
 VIC-20 MBA Text \$79 C-64 MBA Text...\$79

All AEA Keyers, Antennas & Accessories In Stock!



MFJ 1224 COMPUTER INTERFACE \$89.95

202B Noise Bridge\$59.95
 250 2KW Oil Load\$35.95
 422 Keyer/Paddle\$89.95
 901 300W Tuner\$59.95
 941C 300 W Tuner\$89.95
 989 Deluxe 2KW\$299.95

Kantronics

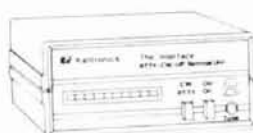

The Interface Reg. \$169.95 Sale \$129.95
 The Interface II Reg. \$269.95 Sale \$239.95

Apple Amior
 Soft/Hamtext...\$139 VIC-20 Hamsoft49
 VIC-20 Amior Soft..89 Hamtext VIC-2099
 Model 64 Hamtext Model-64..99
 Amior Soft.....89 Atari Hamsoft.....49
 Apple Hamsoft.....29 TRS-80C Hamsoft...59



TEXAS TOWERS

Div. of Texas RF Distributors Inc. 1108 Summit Ave., Suite 4 • Plano, Texas 75074

Monday-Friday 9 AM - 5 PM Saturday 9 AM - 1 PM

Telephone
(214) 422-7306

ANTENNA/TOWER SALE!

hy-gain CRANKUP SALE!

All Models Shipped Factory Direct—Freight Paid*!

Check these features:

- All steel construction
- Hot dip galvanized after fabrication
- Complete with base and rotor plate
- Totally self-supporting—no guys needed

Model	Height	Load	Sale Price
HG37SS	37 ft.	9 sq. ft.	\$749
HG52SS	52 ft.	9 sq. ft.	\$1099
HG54HD	54 ft.	16 sq. ft.	\$1699
HG70HD	70 ft.	16 sq. ft.	\$2699

Masts—Thrust Bearings—Other Accessories Available—Call! Prices Shown Are Your Total Delivered Price In Continental U.S.A.!

RG-213U \$.29/ft \$279/1000ft

Up to 600 ft via UPS

- RG-213/U—95% Bare Copper Shield
- Mil-Spec Non-contaminating Jacket for longer life than RG8 cables.
- Our RG-213/U uses virgin materials.
- Guaranteed Highest Quality!

RG-8X \$.19/ft \$179/1000ft

- RG8X—95% Bare Copper Shield • Low Loss
- Non-contaminating Vinyl Jacket • Foam Dielectric

Coaxial Cable Loss Characteristics (DB/100 ft)

Cable Type/Impedance	10MHz	30MHz	150MHz	450MHz
RG-213/U	5.0	6.9	2.3	5.2
RG8X	5.2	8.1	3.5	6.8
RG-58/U	5.2	1.4	1.9	6.0
1/2" Alum	5.0	3.5	1.2	2.2
1/2" Heliax	5.0	2.4	.9	1.6
1/4" Heliax	5.0	1.2	.5	.9

HARDLINE/HELIAX™

Lowest Loss for VHF/UHF!

1/2" Alum. w/poly Jacket	\$.79/ft
1/2" LDF4-50 Andrew Heliax™	\$1.69/ft
1/2" LDF5-50 Andrew Heliax™	\$3.99/ft

select connector below.

HARDLINE & HELIAX™ CONNECTORS

Cable Type	UHF FML	UHF MALE	N FML	N MALE
1/2" Alum	\$19	\$19	\$19	\$25
1/2" Heliax™	\$22	\$22	\$22	\$22
1/4" Heliax™	\$49	\$49	\$49	\$49

AMPHENOL CONNECTORS

Silver PL259	\$1.25	UG23D N Female	\$2.95
UG21B N Male	\$2.95		

ANTENNA WIRE & ACCESSORIES

14 Ga. Stranded Copperwire	\$.10/ft
450 Ohm H. D. Line	\$.16/ft
18 Ga. Copper coated steel wire 1/4 mile long	\$30
H. D. End Insulators	\$2/ea
Van Gorden 1:1 Balun	\$11
Van Gorden Center Insulator	\$6

HUSTLER

4B1V 40-10 mtr Vert	\$89	5BTV 80-10 mtr Vert	\$109
G6-144B 2-mtr Base	\$89	G7-144 2-mtr Base	\$119

Mobile Resonators	10m	15m	20m	40m	75m
400W Standard	\$16	\$17	\$19	\$22	\$26
2KW Super	\$20	\$22	\$25	\$29	\$39

Bumper Mounts - Springs - Folding Masts in Stock!

ROHN Self Supporting Towers On SALE!

FREIGHT PREPAID

- All Steel Construction—Rugged
- Galvanized Finish—Long Life
- Totally Free Standing—No Guy Wires
- America's Best Tower Buy—Compare Save \$
- Complete With Base and Rotor Plate
- In Stock Now—Fast Delivery

Model	Height	Ant. Load*	Weight	Delivered Price*
HBX40	40 ft	10 sq ft	164	\$329
HBX48	48 ft	10 sq ft	303	\$429
HBX56	56 ft	10 sq ft	385	\$499
HOBX40	40 ft	18 sq ft	281	\$399
HOBX48	48 ft	18 sq ft	363	\$489

*Your Total Delivered Price Anywhere in Continental 48 States. Antenna Load Based on 70 MPH Wind.

CUSHCRAFT MULTI-BAND HF ANTENNAS

A3 3-el Tribander	\$219	A4 4-el Tribander	\$289
R3 20/15/10mtr Vert	\$279	A73/A74 40mtr Kit	\$75

HF MONO-BAND ANTENNAS

10-3CD	\$ 95	10-4CD	\$109
15-3CD	\$119	15-4CD	\$129
20-3CD	\$199	20-4CD	\$279
40-2CD	\$289	DA0	\$149

VHF/UHF BEAMS

A50-5	\$ 79	617B	\$199
214B	\$ 79	3219	\$ 95
220B	\$ 95	424B	\$ 79

OSCAR/TWIST ANTENNAS

A144-10T	\$ 52	A144-20T	\$ 75
A147-20T	\$ 63	416TB	\$ 59
A147MB	\$ 29	PS4	\$ 69

VHF/UHF FM ANTENNAS

A147-4	\$ 29	A147-11	\$ 49
214FB	\$ 79	228FB	\$219
A449-6	\$ 29	ARX2B	\$ 39

HY-GAIN

Discoverer 2-el 40-mtr Beam	\$319
Discoverer 3-el Conversion Kit	\$199
EXPLORER-14 SUPER SPECIAL	\$309

OK170 30/40 mtr. Add-On-Kit	\$79
V2S 2-mtr Base Vertical	\$49
TH5MK2S Broad Band 5-el Triband Beam	\$389
TH7DXS 7-el Triband Beam	\$439
TH3JRS 3-el Triband Beam	\$189
TH2MK3S 2-el Triband Beam	\$179
205BAS 5-el 20-mtr Beam	\$349
155BAS 5-el 15-mtr Beam	\$199
105BAS 5-el 10-mtr Beam	\$129
64BAS 4-el 20-mtr Beam	\$259
64BS 4-el 6-mtr Beam	\$69
66BS 6-el 6-mtr Beam	\$139
18HTS 80-10 mtr Hy-Tower Vertical	\$439
LC-160 160-mtr Coil Kit for 18HTS	\$49
214BS 14-el 2-mtr Beam	\$49
28D0 80/40 mtr Trap Dipole	\$69
5BD0 80-10 mtr Trap Dipole	\$129
BN86 80-10 mtr KW Balun W/Coax Seal	\$22

MOSLEY

Pro37 7-el Triband Beam	\$469
CL-33 e-el Triband Beam	\$279
TA-33 3-el Triband Beam	\$249
TA-33JR 3-el Triband Beam	\$189
TA40KR 40 mtr Kit for TA33	\$119

Tri-Ex®

These rugged crankup towers now available from Texas Towers! All models available On Sale for tremendous savings to you!

To save on freight costs, all towers are shipped directly from the Tri-Ex factory to you!

Check these features:

- All steel construction
- Hot dip galvanized after fabrication
- Complete with base and rotor plate
- Totally self-supporting—no guys needed

Model	Height Up	Down	Wind Load	List	Sale
W36	36.0 ft	20.5 ft	9.0 sq ft	\$694	\$579
WT51	51.0 ft	20.5 ft	9.0 sq ft	\$1154	\$899
LM354	54.0 ft	21.0 ft	16 sq ft	\$2010	\$1599
LM4700	70.0 ft	22.0 ft	16 sq ft	\$4195	\$3199

(Motorized)
DX86 86.0 ft 23.0 ft 25 sq ft \$7200 Call
(Motorized)

MINI-PRODUCTS HQ-1

LIST \$182.50 SALE \$159

- Wing Span - 11 ft
- Wind Area - 1.5 sq ft
- Boom - 54 in. long
- 1200W P.E.P. Input

ALPHA DELTA COMMUNICATIONS

Transi-Trap™ Surge Protectors—In Stock Now!

Model LT 200W UHF Type	\$19
Model HT 2KW UHF Type	\$29
RT 200W Deluxe UHF Type	\$29
RT/N 200W Deluxe N Type	\$32
HV 2KW Deluxe UHF Type	\$32
HV/N 2KW Deluxe N Type	\$35

KLM

KT34A 4-el Broad Band Triband Beam	\$339
KT34XA 6-el Broad Band Triband Beam	\$489
40m-1 40-mtr Rotatable Dipole	\$179
40m-2 2-el 40-mtr Beam	\$309
40m-3 3-el 40-mtr Beam	\$459
40m-4 4-el 40-mtr Beam	\$649
2m-13LBA 13-el 2-mtr Beam	\$79
2m-14C 14-el 2-mtr Satellite Antenna	\$89
2m-16LBX NEW-16-el 2-mtr Beam	\$99
2m-22C NEW-22-el 2-mtr Satellite Antenna	\$119
432-30LBX NEW-30-el 432 MHz Antenna	\$99
432-18C 435 MHz Satellite Antenna W/CS-2	\$119
432-16LB 16-el 432 MHz Beam	\$69
435-40CX 435 MHz Satellite Antenna w/CS-2	\$159

ROTORS & CABLES

Alliance HD73 (10.7 sq ft rating)	\$109
Alliance U110 (3 sq ft rating)	\$49
Telex HAM 4 (15 sq ft rating)	\$219
Telex Tailtwister (20 sq ft rating)	\$269
Telex HDR300 Heavy Duty (25 sq ft rating)	\$519
Kenpro KR-500 Heavy duty elevation rotor	\$189
KLM EL-3000 Moon Tracker Elevation Rotator	\$369

Standard 8 cond cable \$.19/ft (vinyl jacket 2-#18 & 6-#22 ga)
Heavy Duty 8 Cond cable \$.36/ft (vinyl jacket 2-#16 & 6-#18 ga)

SOUTH RIVER ROOF TRIPODS

HDT-3 3 ft Tripod	\$19	HDT-5 5 ft Tripod	\$29
HDT-10 10 ft Tripod	\$49	HDT-15 15 ft Tripod	\$69

Heavy Duty Tripods include mtg hdw—UPS Shippable

BUTTERNUT ELECTRONICS CO.

HF6V \$129 Delivered (Cont. USA)

- Full Legal Power 80/10 Meters
- Optional Stub Tuned Radial Kit Model STR II \$29
- Optional Rook Mounting Kit Model RMK II \$49 (includes STR II)
- Optional 160 Meter Resonator Kit Model TBR 160HD \$49

New 80/40 Meter Vertical Antenna HF2V \$129 Delivered (Continental USA)

- Optional 160 Meter Resonator Kit Model TBR 160S \$49

Delivery Anywhere In The Continental USA At No Additional Cost. (Free Shipping On Butternut Accessories Also When Purchased With Antenna.)

ROHN GUYED TOWERS

10 ft Stack Sections

20G	\$39.50	25G	\$49.50
45G	\$112.50	55G	\$134.50

All 20G, 25G, 45G and 55G Accessories In Stock at Discount Prices - CALL!

Foldover Towers

Model	Height	Ant Load*	Price
FK2548	48 ft	15.4 sq ft	\$899
FK2558	58 ft	13.3 sq ft	\$948
FK2568	68 ft	11.7 sq ft	\$999
FK4544	44 ft	34.8 sq ft	\$1199
FK4554	54 ft	29.1 sq ft	\$1299
FK4564	64 ft	28.4 sq ft	\$1399

25G Foldover Double Guy Kit \$219
45G Foldover Double Guy Kit \$249
*Above antenna loads for 70 MPH winds and Guys at Hinge & Apex.

TOWER/GUY HARDWARE

3/16" EHS Guywire (3990 lb rating)	\$.15/ft
1/4" EHS Guywire (6000 lb rating)	\$.18/ft
5/32" 7 x 7 Aircraft Cable (2700 lb rating)	\$.15/ft
3/16" CCM Cable Clamp (3/16" or 5/32" Cable)	\$.45
1/4" CCM Cable Clamp (1/4" Cable)	\$.55
1/4" TH Thimble (fits all sizes)	\$.45
3/8EE (3/8" Eye & Eye Turnbuckle)	\$6.95
3/8" EJ (3/8" Eye & Jaw Turnbuckle)	\$7.95
1/2" EE (1/2" Eye & Eye Turnbuckle)	\$9.95
1/2" EJ (1/2" Eye & Jaw Turnbuckle)	\$10.95
3/16" Preformed Guy Grip	\$2.49
1/4" Preformed Guy Grip	\$2.99
6" Diam - 4 ft Long Earth Screw Anchor	\$14.95
5000 Guy Insulator (5/32" or 3/16" Cable)	\$1.69
502 Guy Insulator (1/4" Cable)	\$2.99
5/8" Diam - 8 ft Copper Clad Ground Rod	\$12.95

PHILLYSTRAN GUY CABLE

HPTG2100 Guy Cable (2100 lb rating)	\$.29/ft
HPTG4000 Guy Cable (4000 lb rating)	\$.49/ft
HPTG6700 Guy Cable (6700 lb rating)	\$.69/ft
9901LD Cable End (for 2100/4000 cable)	\$7.95
9902LD Cable End (for 6700 cable)	\$8.95
Socketfast Potting Compound	\$14.95

GALVANIZED STEEL MASTS

Heavy Duty Steel Masts 2 in OD - Galvanized Finish

Length	5 FT	10 FT	15 FT	20 FT
.12 in Wall	\$29	\$49	\$59	\$79
.18 in Wall	\$39	\$69	\$99	\$129
.25 in Wall	\$69	\$129	\$189	\$249

TEXAS TOWERS

Div. of Texas RF Distributors Inc.
1108 Summit Ave., Suite 4 • Plano, Texas 75074

Telephone (214) 422-7306

Store Hours: Mon-Fri: 9am - 5pm
Sat: 9am - 1pm
(Prices & Availability Subject To Change Without Notice)

DALBANI CORPORATION

PARTS COMPONENTS SYSTEMS

Dalbani Corporation offers the finest
in audio, video, computer and home electronics,
for the professional retailer or home specialist.

To obtain a copy of our 88 page
full-line 1985 catalog please call:

1-800-DALBANI*

DALBANI CORPORATION

785 E. 14th Street

Los Angeles, CA 90021

*Alaska, Hawaii and International please call:

1-(213) 747-6830

155



160-meter transmission line antenna

If height or space
is a problem, try this

If you're like me, you don't have adequate yard space to put up a half-wave dipole on the 160-meter band or a tower to load as a short vertical. In the past, I tried not to let this discourage me from getting on 160, but the RF burns and unanswered calls that resulted from loading up a 40-meter dipole forced me to come up with a better antenna!

Short transmission line antennas have been used at UHF and microwave frequencies for quite some time.¹ Small slots carved into the bodies of fast-moving vehicles (airplanes and rockets) have been used to effectively radiate RF energy using transmission line principles. In fact the folded dipole, commonly used with FM receivers, uses these same principles to receive RF signals. Other types of transmission line antennas include the "low-profile" type used on trains and emergency vehicles, where the antenna structure protrudes just fractions of a wavelength above the vehicle body. These antennas are advantageous when antenna size and height are extremely limited.

I live in an apartment complex. The tallest structures are a couple of 30-foot trees in my small backyard. I have also found that good grounding is a problem, making the use of an "RF-free" tuner difficult. After attempting to work the top band with my existing 20-meter and 40-meter dipoles (none too successfully), I decided to give these transmission line ideas a try. The results have been gratifying, to say the least. I now have a resonant 160-meter antenna that requires no tuner, is directly coax-fed, has given no trace of RF in the shack, and provides enhanced reception due to very low noise pick-up.

how it works

Many people associate the term "transmission line"

with the coaxial cable or ladder line that feeds their antenna — something that "carries power to the antenna," and not something that should, itself, radiate RF. Of course, it is undesirable to have our feedline radiate, but many successful antennas, such as the longwire, the rhombic, and the Beverage are indeed unbalanced (radiating) transmission line extensions of their feed systems. By configuring these lines properly, resulting current distributions along the wires enable these transmission line extensions to emit and receive far-field RF energy. By analyzing a familiar transmission line antenna, the half-wave folded dipole, we can get a feel for how and why a transmission line antenna works.

Consider a folded dipole made of twin-lead transmission line (fig. 1). This type of feedline typically has a 300-ohm characteristic impedance. We can think of this antenna as being driven by our transmitter, an unbalanced RF source voltage. A common and useful technique used to analyze transmission lines is the superposition principle, where the original source voltage is replaced by several different sources which, when combined, add to give the equivalent voltage of the original source. Superposition is used to reconfigure the folded dipole as shown in fig. 2. By breaking down the superposition model, it is possible to construct and identify distinctive modes that characterize the behavior of the antenna. Figure 3A shows "push-push" or even-mode feeding, in which both wires in the twin-lead transmission line are excited by the same voltage, and have currents traveling in phase. Figure 3C illustrates "push-pull," or odd-mode feeding, where the two wires of the twin-lead have currents traveling in opposite directions at any time. The impedances presented by the even and odd modes in terms of the excitation voltage and currents are easily found with the superposition model.

By Ted S. Rappaport, N9NB, Box 283, Electrical Engineering, Purdue University, West Lafayette, Indiana 47907

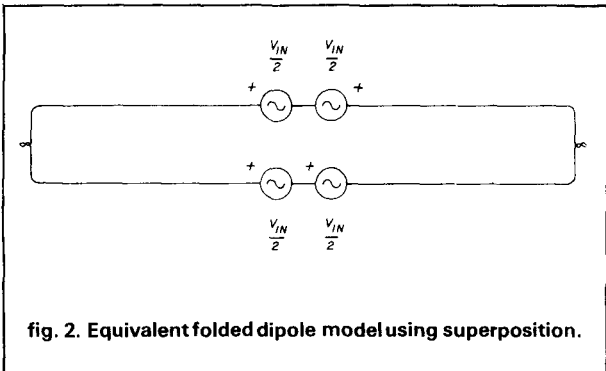
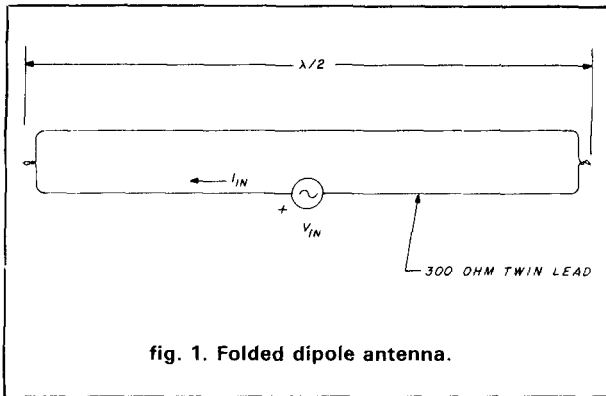

For the even mode case:

$$Z_{\text{even}} = \frac{\left[\frac{V}{2} \right]}{I_{\text{even}}} = \frac{V}{2I_{\text{even}}} \text{ (even mode)} \quad (1)$$

Since the pair of voltage sources in push-push are similar to just a single source voltage $V/2$ driving two parallel strands of wire (assuming the twin-lead spacing is much less than a wavelength), the even-mode impedance is that of a "wide" dipole ($Z_{\text{even}} = 50$ to 75 ohms). This simplification is shown in **fig. 3B**. Because the even (push-push) mode does the radiating, it is sometimes called the antenna mode. Note that the value of current in each of the transmission line wires is half of the total even-mode current.

For the push-pull case, the odd mode impedance is given by:

$$Z_{\text{odd}} = \frac{\left[\frac{V_{\text{in}}}{2} \right]}{I_{\text{odd}}} = \frac{V_{\text{in}}}{2I_{\text{odd}}} \text{ (odd-mode)} \quad (2)$$

Z_{odd} is the parallel combination of the impedances of each of the short-circuited ends of the folded dipole, reflected $1/4$ wavelength back to the center feedpoint. Recall that a short-circuited transmission-line offers a near infinite impedance when the source is placed one-quarter wavelength from the short. The odd mode (sometimes known as the transmission line mode) impedance is made very high in this manner. Instead of short circuits, resistors can be placed at various nodes to alter even and odd mode impedances, as well

as current distributions. This is sometimes done with rhombic antennas and vee beams. For our folded dipole example, we can observe that the antenna mode offers an impedance to RF on the order of a dipole antenna, whereas the transmission line mode offers extremely high resistances to RF.

Specifically, the input impedance to the antenna is easily computed (using superposition) as:

$$\begin{aligned} Z_{\text{in}} &= \left(\frac{V_{\text{in}}}{I_{\text{in}}} \right) = \frac{V_{\text{in}}}{\left[(I_{\text{even}}/2) + I_{\text{odd}} \right]} \\ &= \frac{V_{\text{in}}}{\left[\left(\frac{V_{\text{in}}}{4Z_{\text{even}}} \right) + \left(\frac{V_{\text{in}}}{2Z_{\text{odd}}} \right) \right]} \\ &= \frac{4Z_{\text{even}}Z_{\text{odd}}}{(2Z_{\text{even}} + Z_{\text{odd}})} \end{aligned} \quad (3)$$

Observe that for Z_{odd} very large (as is the case here):

$$Z_{\text{in}} = 4Z_{\text{even}} \cong 300 \text{ ohms}$$

We find that not only does this transmission-line antenna radiate, but it also has an input impedance of four times that of a conventional dipole. Conveniently, this structure can be fabricated out of 300-ohm twin-lead, and can also be fed with 300-ohm twin-lead, providing a good match to a 300-ohm receiver. In the case of Yagi antennas, where the mutual impedance effects drop the antenna feedpoint to below 20 ohms, a folded driven element can be used to increase feedpoint resistance by roughly a factor of four.²

using the ground as an image

By using the ground to electrically provide half of the antenna system, we can think in terms of a single wire above ground. **Figure 4** shows something that looks like a folded-dipole using an image. Note that the wire height must be much less than a wavelength for the transmission line principles to hold. Since horizontal image currents always travel in opposite directions as do the wire currents, the horizontal portion of this structure, unlike the original folded dipole, will tend to cancel out in the far-field (i.e., the even mode impedance for this antenna is extremely high). The vertical shorting segments, however, will provide a vertical radiation pattern, enabling this antenna to emit and receive RF energy.

Closer inspection reveals that the antenna of **fig. 4A** is identical to the odd-mode excitation of the original folded dipole. Recall that the odd-mode impedance was calculated by considering the parallel combination of the two transmission lines transferred back to the feedpoint. By this technique, it is easy to predict that the input impedance of the structure in **fig. 4A** will be very high, and the radiation will be due primarily to the short vertical segments at the ends of the structure.

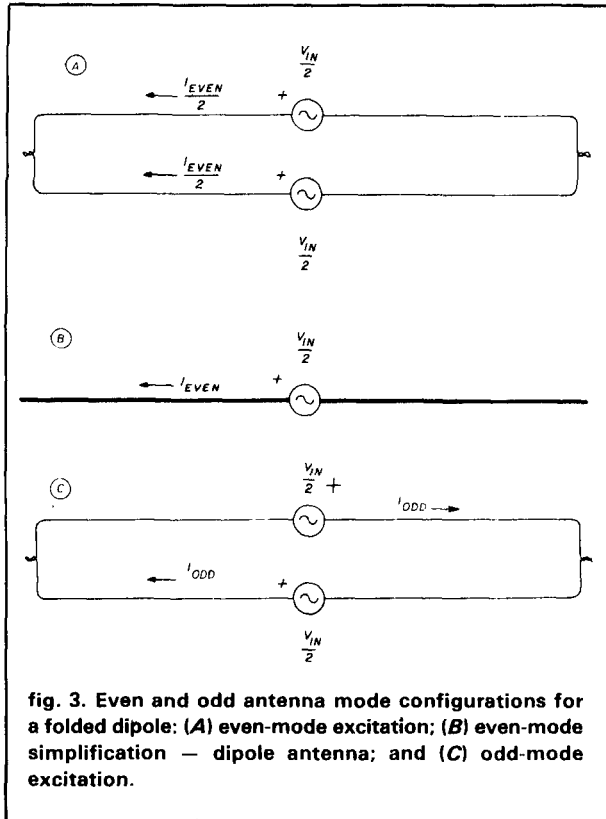

fig. 3. Even and odd antenna mode configurations for a folded dipole: (A) even-mode excitation; (B) even-mode simplification — dipole antenna; and (C) odd-mode excitation.

Now suppose instead of folding both sides of the antenna to ground, we open one of them and move the feedpoint to a "strategic" location **fig. 4B**). This type of antenna is known as a low-profile antenna, and has effectively been used at low frequency (LF) and medium frequency (MF) bands, as well as at microwave frequencies.³

low profile antenna

To calculate the input impedance of the low profile antenna at a particular feedpoint we need only deal with the odd mode, since, as was the case for the antenna in **fig. 4A**, the even mode offers an extremely high impedance because of image current cancellation.

Again, we must combine in parallel the impedances of the open and shorted (folded) sides of the structure. For any transmission line, input impedance values may be found by:

$$Z_{short}(x) = Z_0 \tanh(\gamma x) \text{ and } Z_{open}(y) = Z_0 \coth(\gamma y) \quad (4)$$

where $\tanh(\)$ and $\coth(\)$ are hyperbolic trigonometric functions, Z_0 is the characteristic impedance of the transmission line, x is the distance from the feedpoint to a short-circuit termination, y is the distance from the feedpoint to an open-circuit termination, and γ is the complex propagation constant of the transmission

line, made up of a real attenuation factor, α , and imaginary term, $j\beta$, representing the emission wavelength of the source ($\gamma = \alpha + j\beta$).

The characteristic impedance of the single wire (and its image) is dependent upon many factors. These include height above ground, ground conductivity, and moisture of the air, to cite just a few. At 1.8 MHz, an approximate value for the characteristic impedance of a wire 6 meters above ground is about 800 ohms. The value of Z_0 is really not important, though. The success of this antenna lies in the parameter γ .

Naturally occurring losses in the ground and in the wire cause some slight attenuation in electromagnetic waves as they propagate through the line. This attenuation, α , is expressed in units of relative voltage decrease per unit length (dB/m), and yields the real part of γ . It is instructive to compare a lossy and lossless model of the low-profile antenna to see exactly how it loads.

For lossless transmission lines, where $\gamma = j\beta$, the expressions for short-circuit and open-circuit transmission lines simplify to:

$$Z_{short}(x) = jZ_0 \tan(\beta x) \text{ and } Z_{open}(y) = -jZ_0 \cot(\beta y) \quad (5)$$

where $\tan(\)$ and $\cot(\)$ are trigonometric functions, and j is the imaginary operator, or a 90-degree phase shift. For this ideal case, the parallel combination of the open and short-circuited line yields an imaginary result for any value of x or y ! Since it is impossible to deliver power to a purely reactive load the SWR is infinity for the ideal case. However, when losses are considered, it is possible to solve for values of x and y which yield a purely real Z_{in} . This indicates that we are using the naturally occurring losses of a transmission line to provide a purely resistive RF load for our transmitter! The end result is an antenna that can be made to resonate at any real impedance, provided the correct lengths of open and short-circuited transmission line are used.

implementation

Solving for the lengths x and y is much too impractical because of the many variables that exist at an antenna site. Trial and error is the easiest way to "zero in" on the particular lengths needed for a desired impedance and a given configuration. For a 50-ohm antenna impedance, I wound up with the dimensions shown in **fig. 5**. Only four tries were required to get the SWR below 1.5:1 in the 1800 kHz to 1850 kHz band, pruning only the longer (open) length of wire. I also discovered that other configurations are possible, at the expense of some bandwidth (**fig. 5B**). Since different locations will use slightly different configurations, it is impossible to derive explicit formulas for the

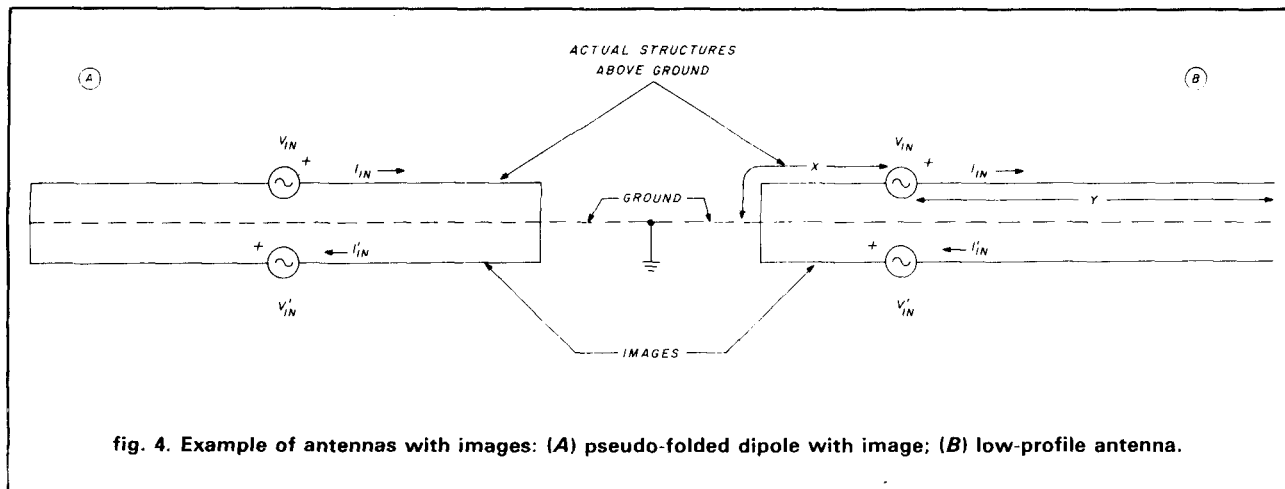

fig. 4. Example of antennas with images: (A) pseudo-folded dipole with image; (B) low-profile antenna.

wire lengths; however, it is safe to say that the open-circuit length will not exceed 40 meters (0.24λ), and the short-circuit length should not exceed 9 meters (0.05λ). To tune the antenna, start with these lengths and trim the longer wire (open-circuited transmission-line) by removing 0.5 meter lengths of wire until the SWR approaches 3:1 at the frequency of interest. Then, very finely prune both the open and short-circuit lines for best SWR. Small lengths of wire may have to be re-inserted after course pruning to optimize the match to the transmitter. It is important to be sure that all antenna SWR measurements are made with the antenna at its operating height, as the wire height above ground critically effects the tuning (in fact, this is another parameter that can be varied in the pruning process to provide the best match). It should be possible to achieve an SWR well below 1.5:1 if patience is exercised in trimming the antenna.

Wire heights from 2 to 8 meters make the transmission line approximation valid, although I would think that heights greater than this could also be made to resonate. The antenna feed system is simply a random length run of RG-58U coaxial cable. The open-circuit wire is connected to the coax center conductor, while the coax braid is soldered to the short-circuit wire, which is terminated at a ground stake (fig. 6).

antenna performance

I was able to obtain an SWR of less than 2.0:1 from 1800 kHz to 1900 kHz using the configuration shown in fig. 5A while obtaining the same SWR over a 70 kHz bandwidth for the set-up shown in fig. 5B.

My first evening on 160 meters with this antenna was most enjoyable, as I rag-chewed with stations from Delaware to California! Never before have I been able to call CQ and get an answer. It sure beat the RF burns and weak signals I had been used to!

I've worked over 30 states and several DX stations (including two Europeans) in the past month using

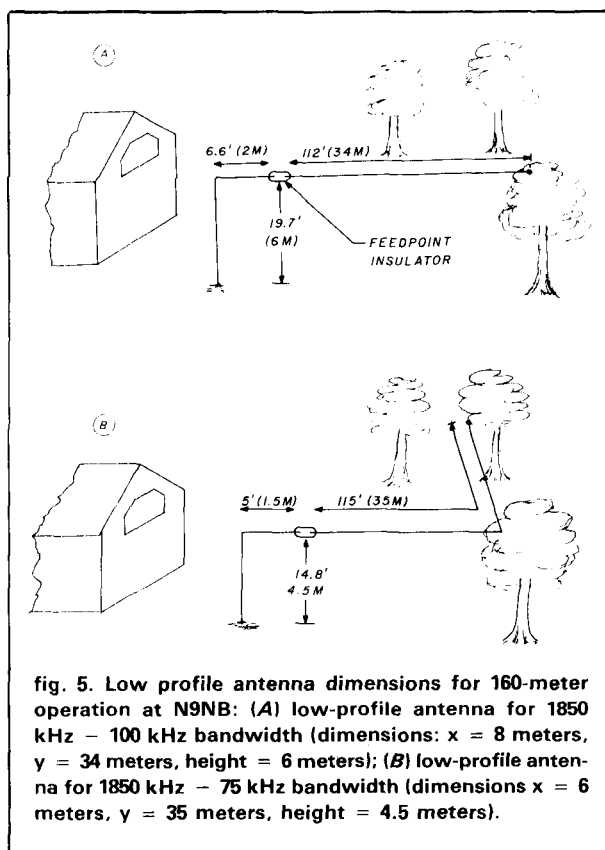
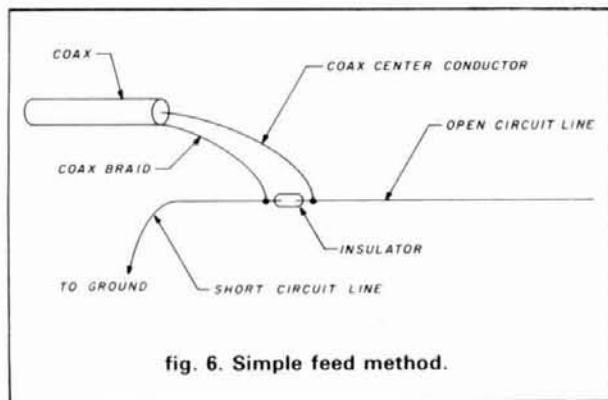

fig. 5. Low profile antenna dimensions for 160-meter operation at N9NB: (A) low-profile antenna for 1850 kHz - 100 kHz bandwidth (dimensions: $x = 8$ meters, $y = 34$ meters, height = 6 meters); (B) low-profile antenna for 1850 kHz - 75 kHz bandwidth (dimensions $x = 6$ meters, $y = 35$ meters, height = 4.5 meters).

only a 1-meter long ground pipe and 100 watts of transmitter power. Also incredible is the low receiver noise level. There have been many times when I could copy DX stations, while many other stateside operators could not. This antenna may be of interest to those who don't have room for Beverage antennas but want to get away from the received noise characteristics of verticals and dipoles.

The antenna seems to exhibit a moderately high angle of radiation and has a radiation pattern similar to that of a short dipole combined with a short verti-



cal. The short-circuit line provides a vertical pattern, making this structure similar to a short vertical antenna. The open circuit wire provides some horizontal radiation, and is effective in tuning the antenna to resonance. The efficiency of this antenna is determined primarily by the ground conductivity at the antenna site. Unfortunately, soil is a very imperfect conductor. Ground radials may be used to increase efficiency, although they are not essential. In fact, a poor ground may actually be beneficial as it would prohibit complete cancellation of the horizontal current components in the far-field.

KS9J and WA2JQW have reproduced this structure at their locations using wire heights as low as 6 feet (1.9 meters) and short-circuit wire lengths as short as 8 feet (2.6 meters). They have indicated that low SWR is obtainable using an arbitrary wire configuration, at an arbitrary height, as long as care is taken to prune the antenna patiently.

conclusion

After many frustrating attempts to work the 160-meter band without an adequate antenna, I have finally found something that keeps both me and my transmitter happy. The low SWR allows for operation without an antenna tuner, and the direct coax feedline minimizes RF in the shack. Most gratifying, though, are the many new friends I have made on 160 meters and the enjoyment that contacts on the "gentleman's band" can bring!

Those who are fortunate enough to have plenty of yard space, tall trees, or a tower might not want to use this type of antenna for 160-meter operation. But those of you who think you don't have the room to get on "top band," may want to give this tuner-less, trap-less transmission line antenna a try.

references

1. Walter L. Weeks, *Antenna Engineering*, McGraw-Hill, Inc. 1968.
2. Technical Correspondence, *QST*, January, 1984, page 48.
3. Rudolf J. Guertler, "Isotropic Transmission line Antenna and its Toroid-pattern Modification," *IEEE Transactions on Antennas and Propagation*, May, 1977, page 386.

ham radio

The HD-73 Rotator by Alliance

A precision instrument built to last.

The HD-73 combines Dual-Speed rotation and a single 5-position switch with the clear visibility of a backlit D'Arsonval meter. So you get precise control for fast and fine tuning.

And the advanced technology of HD-73 is backed by quality construction. Heavy duty aluminum casings and hardened steel drive gears. Lifetime factory lubrication that withstands -20°F. to 120°F. temperatures.

The superior design of the HD-73 mast support bracket, with optional no-slip positive drive, assures perfect in-tower centering with no special tools.

Automatic braking minimizes inertia stress. Easy to install, a pleasure to use. The HD-73 is on your wavelength. Write for performance details today.



I want to tune in on HD-73.

- Send complete details
 Give me the name of my nearest dealer.

NAME _____

ADDRESS _____

CITY _____ STATE _____ ZIP _____



The Alliance Manufacturing Company, Inc.,
Alliance, Ohio 44601

PICK A COMPUTER INTERFACE TO MATCH YOUR NEEDS

**COMPUTER PATCH™
MODEL CP-1**



MICROPATCH™ MODEL MP-1



COMPUTER PATCH MODEL CP-100

COMPUTER PATCH™ MODEL CP-1

The AEA Model CP-1 Computer Patch has earned a solid reputation for being the best overall interface value on the market today. We at AEA have now reaffirmed what our competitors already know; for the money, the CP-1 cannot be beat! That is why we have chosen to leave the popular CP-1 in our product line and to introduce new computer interface/terminal units with differing features and performance at different prices.

MICROPATCH™ MODEL MP-1

The new AEA model MP-1 Micropatch represents the best features and performance available for under \$140.00. Featuring true dual-channel filtering of Mark and Space tones with an AM detector and Automatic Threshold Correction (ATC) circuit, the MP-1 is in a totally different performance class than competitive units that often have only a single channel filter or no filtering at all.

The MP-1 also offers a high performance CW capability. With respect to the CP-1, overall performance is nearly as good; but the CP-1 offers a few more advanced features such as variable shift tuning, RS-232 option, and a more advanced tuning indicator.

COMPUTER PATCH MODEL CP-100

The new CP-100 Computer Patch offers all the following exciting features in addition to the CP-1 features:

- 170, 425, 850 Hz Calibrated Shifts for Transmit and Receive
- 75 to 1000 Hz Variable Receive Shift Range
- Normal and Reverse FSK Outputs
- Input AGC
- Direct Coupled Automatic Threshold Control
- Front Panel Squelch
- Discriminator Style Tuning Indicator
- Current Loop Option
- Built-in Monitor Speaker
- Baud Rate Switch
- Improved AM Detector



Henry Radio

2050 S. BUNDY DRIVE
LOS ANGELES, CA 90025
(213) 820-1234

TOLL FREE OUTSIDE CALIF. (800) 421-6631

931 N. Euclid, Anaheim, CA 92801 (714) 772-9200 • Butler, MO 64730 (816) 679-3127



**Brings you the
Breakthrough!**

ATU-1000™

Advanced Terminal Unit



More Hardware Features And Performance Than Any Other Morse, Baudot, ASCII, AMTOR, SITOR, or H.F. Packet Terminal Unit Anywhere At Any Price!

We recognize that there are few amateurs who can appreciate or afford the outstanding value of the ATU-1000, but those who can are in for some very pleasurable operating. The ATU-1000 is a commercial/military unit with all the performance and flexibility that is attainable from today's technology. Just check out the features below.

- 32 poles, active filtering
- Morse/Baudot/ASCII/AMTOR/SITOR/H.F. Packet
- Set receive filters to one Hz accuracy
- Set receive MARK & SPACE filters independently from 1000 to 3000 Hz
- All shifts, 170 Hz fixed or 0 to 2000 Hz adjustable
- Set AFSK output tones independently from 1000 to 3000 Hz to one Hz
- 5mV to 5V AGC
- Front-panel squelch control
- Built-in 4 digit counter
- CW filter adjustable 700 to 2500 Hz
- D.C. coupled automatic threshold correction
- Twin full-wave detectors
- Built-in TTL/RS-232/and loop keyer I/O
- Discriminator-type tuning indicator
- FSK, AFSK, and scope outputs
- 13 VDC operation, 110 VAC adaptor supplied
- TTL I/O logic inversion for use with virtually any software
- Optional 19 inch rack mount kit

Ask your favorite dealer for a demonstration of the world's finest RTTY/CW advanced terminal unit/computer interface—the AEA model ATU-1000. If you cannot see your dealer, send for our latest specification sheet.

*Prices & Specifications Subject To Change
Without Notice Or Obligation.*



Henry Radio

2050 S. BUNDY DRIVE
LOS ANGELES, CA 90025
(213) 820-1234

TOLL FREE OUTSIDE CALIF. (800) 421-6631

931 N. Euclid, Anaheim, CA 92801 (714) 772-9200 • Butler, MO 64730 (816) 679-3127



**Brings you the
Breakthrough!**

ICOM 144, 220 and 440MHz

MOBILES



The World's Most Compact Mobiles

ICOM's three ultra compact mobiles...the IC-27A 2-meter, the IC-37A 220MHz and the IC-47A 440MHz... are the smallest mobiles available.

Even in such a small package the 25 watt mobiles contain an internal speaker which makes them fully self-contained and easy to mount.

Size. The ICOM compacts measure only 5½"W x 1½"H x 7"D (IC-47A is 9" deep)... which allows them to be mounted in various "compact" locations. Yet the compacts have large operating knobs which are easy to use in the mobile environment.

More Features. Other IC-27A/37A/47A standard features include a mobile mount, IC-HM23 DTMF mic with up/down scan and memory scan, and internally adjustable transmit power. An optional IC-PS45 slim-line external power supply and IC-SP10 external speaker are also available.

Internal Speaker



32 PL Frequencies. The IC-27A/37A/47A come complete with 32 PL frequencies.

9 Memories. The compact mobiles have 9 memories which will store the receive frequency, transmit offset, offset direction and PL tone. All memories are backed up with a lithium battery.

Speech Synthesizer. To verbally announce the receive frequency, an optional UT-16 voice synthesizer is available.

Scanning. The ICOM compacts have four scanning systems...memory scan, band scan, program scan and priority scan. Priority may be a memory or a VFO channel...and the scanning speed is adjustable.

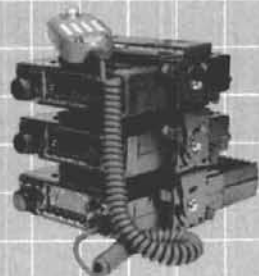

Stacking Mobile Mounts. The IC-27A/37A/47A can be stacked to provide a three band mobile station. Each band is full featured and will operate even when another band is in use.

The IC-27A/37A/47A provide superb performance in the mobile radio environment. See them at your local ICOM dealer.



ICOM

First in Communications

stacking antennas, part 2

Last month's column discussed the theoretical aspects of stacking antennas.¹ It was pointed out that the optimum stacking distance for two antennas occurs when the beamwidth in the stacking plane is reduced to approximately 50 percent of the original antenna beamwidth and grating lobes are about 13 dB below the main lobe. It was further stressed that the antenna to be stacked should be "clean" (low side-lobe) in order to achieve effective stacking since the 13 dB grating lobe level can't be obtained if the antenna to be stacked has 13 dB or poorer side-lobe levels to start with! Finally, it was shown that *if everything were done correctly*, a gain increase of 2.5 dB, instead of 3 dB, would be a realistic figure every time the number of antennas was doubled.

Several tables and graphs were also presented to enable you to determine the optimum stacking distance for any antenna. While all the electrical parameters are necessary, the practical feeding and physical aspects of stacking antennas are also important. Therefore, this month's column will try to tie the subject of stacking together so that you can choose the optimum configuration for your particular application.

While working on part 2 of this article I noticed that there is one caveat I neglected to point out in part 1. *All the information presented on stacking is based on having no ground reflections* (antennas in theoretical space). However, once an antenna is over 2 to

3 wavelengths above ground (a typical situation on 2 meters and above), the antenna is, for all practical purposes, in free space. At 6 meters there may be a problem since the lower antenna should be at least 40 feet (12 meters) above ground.

stacking configuration

There are literally dozens of ways that antennas can be stacked. However, only a few configurations are typically used by Amateurs.¹ Some of these are shown in **fig. 1**. (For clarity, the mechanical considerations have been omitted from the illustrations.) The simplest stacking configuration places two Yagis in either the horizontal (**fig. 1A**) or vertical (**fig. 1B**) plane. The optimum spacing between the Yagis was discussed in last month's column. I'm often asked the reference point for measuring the spacing: it is the distance between the current points — usually the boom on a Yagi. In the special case of the loop Yagi, it is the center-to-center spacing between the loops.

One of the most popular stacking configurations for higher antenna gain is the "quad" or "box" shown in **fig. 1C**. This is usually a simple mechanical arrangement and has almost identical beamwidth in both the vertical and horizontal planes.

An often-overlooked configuration is an array of six Yagis (**fig. 1D**), which yields a theoretical improvement of 1.75 dB and a typical increase of 1.5 dB over a four-Yagi array. This is only about 1 dB below an eight-Yagi array but with a 33 percent smaller area! This

configuration is only recommended using vertical stacking as shown and has a more complex mechanical structure. However, it is particularly recommended for those who can't double their arrays but could expand a four-bay array to six antennas with minimum cost and mechanical impact. Other common high-gain configurations especially popular with EME'ers are shown in **figs. 1E, 1F, and 1G**. These arrangements are usually the easiest to realize mechanically when very high gains are required.

vertical versus horizontal stacking

Last month's column discussed the problems associated with the side lobes in the H-plane (vertical) of a typical Yagi antenna and showed that they are normally 2 to 3 dB worse than in the E (horizontal) plane. Hence, Yagi antennas must often be stacked closer than desired in the vertical plane to control the vertical grating lobes. Consequently, vertical stacking may yield slightly less gain increase than horizontal stacking.

However, despite these negatives, there are reasons for stacking Yagis vertically. First, there is sometimes only one vertical mast available. Secondly, when very high gain is needed such as for EME, four or more antennas may be required and hence stacking some or all of the antennas vertically is often desirable. *Remember that the array beamwidth decreases only in the plane of the stacking.* Hence, if antennas are stacked verti-

cally, the horizontal beamwidth remains the same. This is particularly desirable when you don't want to "miss" stations that are slightly off the main beam such as when using tropospheric propagation. Likewise, vertical stacking is especially desirable when the signals may be up to 5 or 10 degrees off the great circle path such as in meteor scatter communications. Conversely, horizontal stacking is desirable for auroral propagation since the signal returning from the auroral curtain is usually elevated above the horizon. Horizontal stacking does not affect the vertical beamwidth of the antenna being stacked.

Finally, when high gain is required it is almost impossible to not stack in both planes as shown in **figs. 1C-1G**. If six or eight Yagis are used, you can still tailor the pattern by choosing which plane requires the greater beamwidth.

electrical considerations

After choosing the stacking con-

figuration, there are some important electrical considerations such as choice of feed line and the placement of the power splitter/combiner(s). As mentioned in part 1, losses in the feed harness can severely reduce the gain when stacking antennas. The total loss in antenna gain due to the phasing harness is the sum of the insertion losses from the input of the first power splitter/combiner to the final antenna feed point on the individual antennas (see **fig. 2**). Generally speaking the major losses are in the transmission lines in the phasing harness. Note that the overall antenna gain loss shown in **fig. 2** will only be 0.5 dB, not 2.0 dB as I sometimes hear! However, while 0.5 dB may sound low, remember that this loss reduces the stacking gain. Furthermore, a 0.5 dB phasing line loss can decrease the receiver signal-to-noise ratio by 2 or more dB when looking at a "cold" sky on 70 cm EME!

From the above discussion, you can see another reason why I get so upset when I see antennas stacked too far

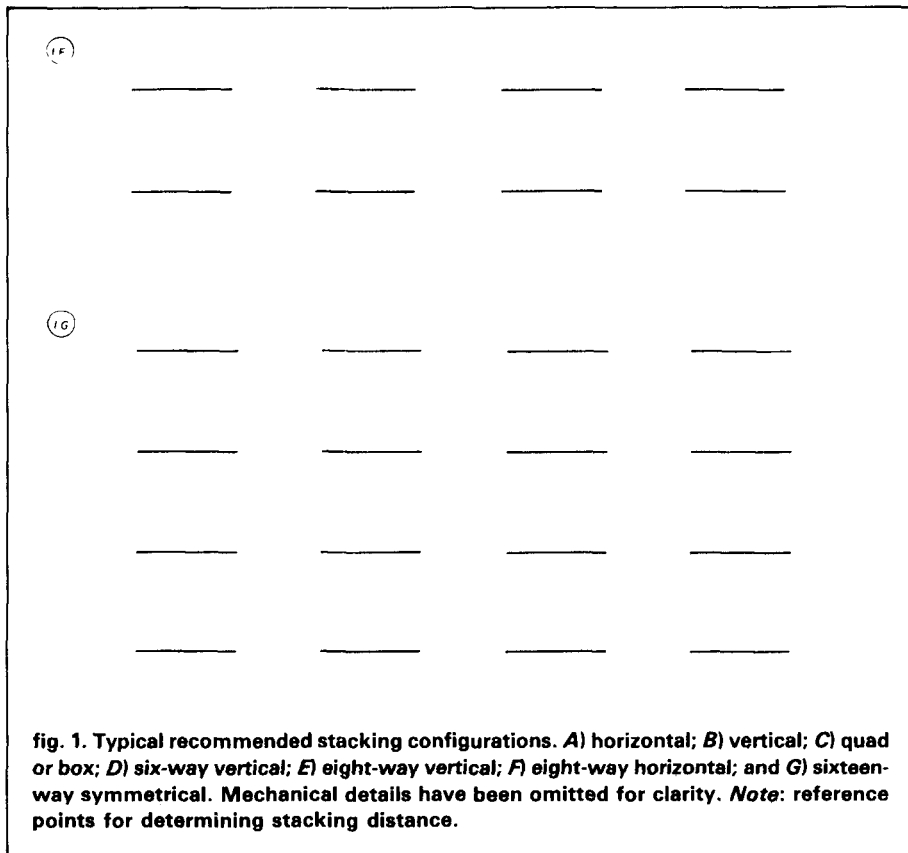
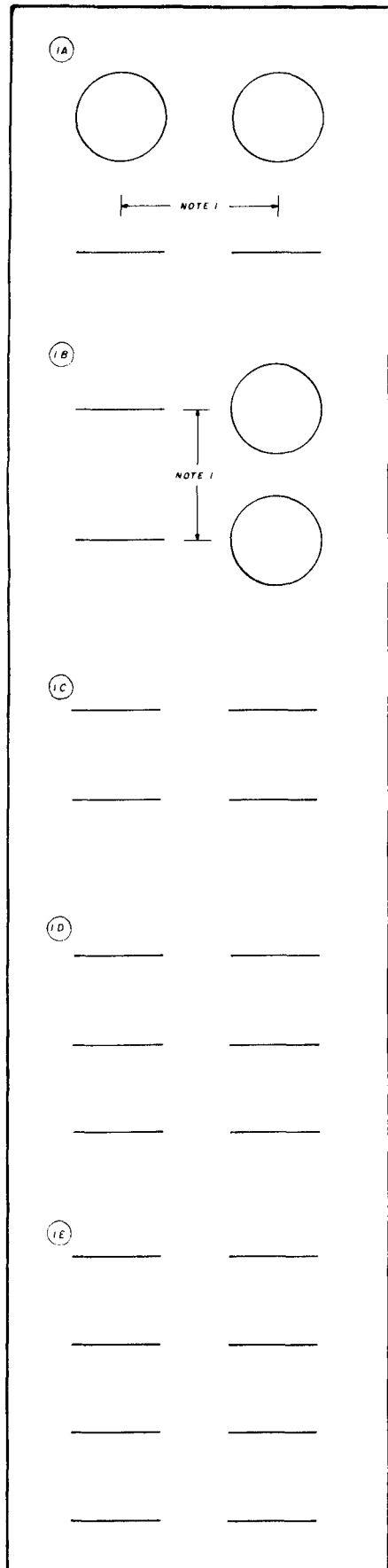

fig. 1. Typical recommended stacking configurations. **A)** horizontal; **B)** vertical; **C)** quad or box; **D)** six-way vertical; **E)** eight-way vertical; **F)** eight-way horizontal; and **G)** sixteen-way symmetrical. Mechanical details have been omitted for clarity. *Note:* reference points for determining stacking distance.

apart. The additional spacing not only increases the grating lobes and decreases the beamwidth unnecessarily but the hoped for gain increase of 0.1-0.2 dB by stacking wider than optimum may easily be offset by the extra phasing line loss. And that isn't all. The clincher against using unnecessarily greater spacing is the increased load that is placed on the rotator and structure.

feeding the array

When stacking antennas, it is common practice to have a separate phasing line on each antenna. This line is then connected to a common splitter/combiner for each 2, 4, or 6 antennas being stacked. Eight-way splitter/combiners are sometimes seen, but I personally feel that they are more difficult to use and can add additional phasing line losses. If coax phasing lines are used, each is usually run down the antenna boom to a common power splitter/combiner which is centrally located on the main mast or boom. This method is mechanically sound but often adds excessive feedline losses.

A more recent trend popular with EMEers is to use a "back plane" feed system. In this arrangement each phasing line is routed to the rear of the array rather than down the boom. The power splitter/combiner is then mounted behind the antennas, usually on a separate small boom extending from the main mast. This allows very short low loss phasing lines. The main feedline(s), which are fewer in number, can now be made from a more expensive but low-loss air or foam dielectric coax.

phasing line requirements

For best results all phasing lines should have the same overall electrical length within 22.5 degrees or 1/16 wavelength. This works out to be approximately 1.7 inches (4.3 cm) at 432 MHz. The longer the physical length of the phasing lines, the greater chance of having an unequal electrical length in these lines.

From my personal experience, I can

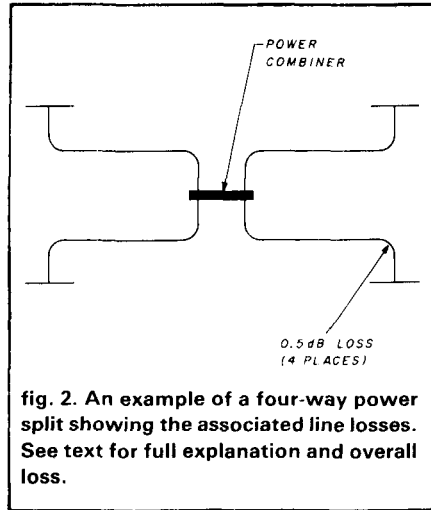

fig. 2. An example of a four-way power split showing the associated line losses. See text for full explanation and overall loss.

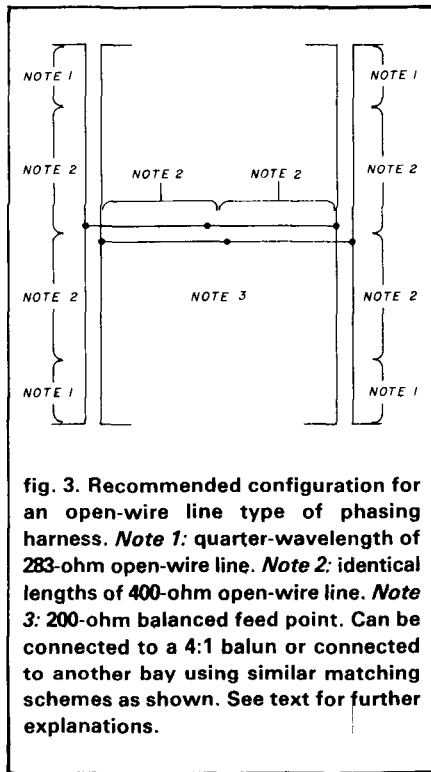

fig. 3. Recommended configuration for an open-wire line type of phasing harness. Note 1: quarter-wavelength of 283-ohm open-wire line. Note 2: identical lengths of 400-ohm open-wire line. Note 3: 200-ohm balanced feed point. Can be connected to a 4:1 balun or connected to another bay using similar matching schemes as shown. See text for further explanations.

offer the following suggestions. Always make all phasing lines from the same roll or piece of feedline. Stay away from small diameter (e.g., RG-58/U) and low-cost feedlines. If foam dielectric coax is used in a phasing harness, it should be treated carefully; it can "cold flow" when sharp bends are made and is more susceptible to variations with ambient temperature changes.

From practical phasing line measurements I have conducted at 70 cm

using a slotted line, I have found that a physical tolerance of 0.25 inch (6mm) on 20 feet (6.5 meters) of 50-ohm RG-213 type coax cable is more than adequate when using the same spool or length of coaxial feedline.

I offer another important observation. Always lay feedlines out in a straight line and measure them in a cool place such as a garage or cellar out of the direct rays of the sun. In some tests I conducted in my backyard, it was impossible to hold the null on a slotted line constant long enough to take an accurate reading since the sun kept changing the temperature of my coax line and hence varying the length!

open wire lines

I'm frequently asked, "Why not use open wire lines since they are low cost and low loss?" I will not argue with this statement but add the following caveat: open wire line is a fair weather feedline. Whenever deposits (water, snow, ice, or industrial wastes) build up on the spacers, the impedance and hence the VSWR changes.

If you decide to use open wire lines, try to keep a low VSWR on all the lines. The extended expanded collinear has a problem in this regard because the VSWR on the feedlines is very high.² An array of Yagis with a resistive (non-reactive) impedance is a good open wire candidate. However, use a "Q" or quarter-wave matching section at each point where the impedance changes. A recommended example using 200-ohm antennas and feed point is shown in fig. 3.

Low impedance (less than 250 ohms) open wire lines are not easy to realize since spacing is close and the conductors have a large diameter. Always use the fewest number of spacers possible and still maintain the mechanical integrity of the line. My experience with extended expanded collinears showed that the maximum power split for open wire lines should be two per junction since four ways can pose symmetry problems and congestion of lines which often leads to unequal splitting and lower gain.

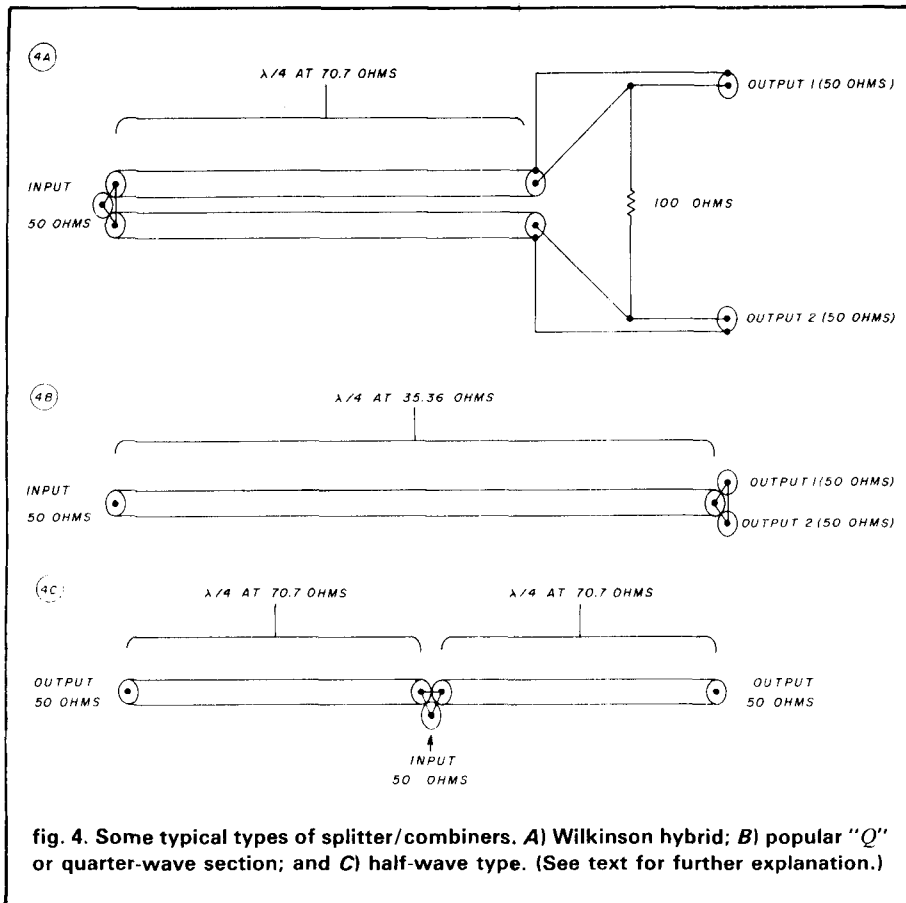

fig. 4. Some typical types of splitter/combiners. A) Wilkinson hybrid; B) popular "Q" or quarter-wave section; and C) half-wave type. (See text for further explanation.)

phasing line lengths

Finally, I am often asked, "Should the length of the phasing lines be a multiple of half-wavelengths?" This practice apparently started on 2 meters when two antennas were closely spaced and the feedlines were also acting as an impedance transformer.

Ideally speaking, the feedline length is unimportant if the antennas to be stacked have a reasonably low VSWR. However, when antennas are stacked, there is always some mutual impedance. It has been pointed out by Roy Lewallen, W7EL, that whenever any mutual impedance exists between antennas, the ideal phasing line length should be an odd multiple of quarter wavelengths which will enhance the proper distribution of power to each branch of the antenna.³ He further pointed out that this practice has been in use on TV antennas for many years.⁴ Although this may be difficult to realize in practice (especially on 70

cm), if possible cut your phasing lines to an odd multiple of quarter wavelengths.

power splitter/combiners

All the foregoing stacking information would be for naught if there weren't a convenient way to do splitting or combining at the antennas in the array. The methods shown in fig. 3 are fine for open-wire line. Coax, however, requires different handling.

There are two basic types of power splitter/combiner(s) that work well with coax. They are the isolated (hybrid) and the non-isolated quarter wavelength types.

The isolated type shown in fig. 4A is often referred to as the Wilkinson power divider.⁵ It uses quarter-wavelength lines between a floating resistor. The resistor doesn't consume power unless the loads are unequal or missing. This type of power splitter/combiner is not too popular with Amateurs since the resistors must be

able to dissipate high power (at least half the power entering the splitter/combiner) and isolated from ground. Lewallen also indicated that this type of splitter/combiner is not recommended for antenna phasing especially when mutual impedances are present.⁶ One of the most popular types of power splitter/combiners used by Amateurs with coax phasing lines is the quarter wave coaxial matching section shown in fig. 4B. Its impedance is the geometric mean between the input and output impedances and can be easily calculated using the following equation:

$$Z_{LINE} = \sqrt{Z_{IN} Z_{OUT}} \quad (1)$$

where Z_{IN} is usually 50 ohms and Z_{OUT} is the parallel impedance of the loads. This method can easily be used to split or combine two, three, or four ways. For instance, the impedance of the line should be 25 ohms for a four-way split in a 50-ohm system since the source is 50 ohms and the load is 12.5 ohms ($50/4$). Likewise a two-way split would require a 35.36 ohm impedance. Both of these impedances are easy to realize using standard square 1 inch (2.54 cm) tubing and hobby shop brass tubing.^{7,8,9}

An important attribute of well designed air dielectric splitter/combiners is that they have inherently low loss. There is no reason why they can't be extended internally as described in reference 9. Also, it is often forgotten that most quarter-wave type of power splitters are usable at the third harmonic. Therefore, a good 2-meter power splitter may be also usable at 70 cm and a 70 cm splitter at 23 cm.

Let us not forget to mention the so called half-wave power splitter/combiner. Actually it is still a quarter-wave type since it consists of two quarter-wave sections back to back as shown in fig. 4C. It has the added advantage that as a four-way splitter/combiner, the internal impedance is 50 ohms.

mechanical aspects of stacking

In general, try to use symmetrical

KENWOOD

...pacesetter in Amateur radio

“Digital DX-terity!”



TS-430S

Digital DX-terity—that outstanding attribute built into every Kenwood TS-430S lets you QSY from band to band, frequency to frequency and mode to mode with the speed and ease that will help you earn that dominant DX position from the shack or from the mobile!



- **Covers all Amateur bands** 160 through 10 meters, as well as the new 30, 17, and 12 meter WARC bands. High dynamic range, general coverage receiver tunes from 150 kHz to 30 MHz. Easily modified for HF MARS operation.
- **Superb interference reduction** Eliminate QRM with the IF shift and tuneable notch filter. A noise blanker suppresses ignition noise. Squelch, RF attenuator, and RIT are also provided. Optional IF filters may be added for optimum interference reduction.

- **Reliable, all solid state design.** Solid state design permits input power of 250 watts PEP on SSB, 200 watts DC on CW, 120 watts on FM (optional), or 60 watts on AM. Final amplifier protection circuits and a cooling fan are built-in.
- **Memory channels.** Eight memory channels store frequency, mode and band data. Channel 8 may be programmed for split-frequency operation. A front panel switch allows each memory channel to operate as an independent VFO or as a fixed frequency. A lithium battery backs up stored information.
- **Programmable, multi-function scan.**
- **Speech processor built-in.**
- **Dual digital VFOs.**
- **VOX circuit, plus semi break-in with sidetone.**

Optional accessories:

- PS-430 compact AC power supply
- SP-430 external speaker
- MB-430 mobile mounting bracket
- AT-130 compact antenna tuner covers 80-10 meters, incl. WARC bands
- AT-250 automatic antenna tuner covers 160-10 meters, incl. WARC bands
- AT-230 base station antenna tuner
- FM-430 FM unit
- YK-88C (500 Hz) or YK-88CN (270 Hz) CW filters
- YK-88SN (1.8 kHz) narrow SSB filter
- YK-88A (6 kHz) AM filter
- MC-42S UP/DOWN hand mic.
- MC-60A deluxe desk mic., with UP/DOWN switch
- SW-2000 SWR/power meter
- SW-100A SWR/power/volt meter
- PC-1A phone patch
- HS-4, HS-5, HS-6, HS-7 headphones



KENWOOD

TRIO-KENWOOD COMMUNICATIONS
1111 West Walnut Street
Compton, California 90220

Complete service manuals are available for all Trio-Kenwood transceivers and most accessories. Specifications and prices are subject to change without notice or obligation.

ENTER SOAR CORP.

MENU OF INSTRUMENTS

Featuring — Superb Performance, Great Accuracy, Rugged Construction, Meticulous Quality, Incomparable Prices

Resistance Substitution Box



- 1Ω to 11 MΩ in 1Ω steps.
- ±1% accuracy.
- 1 watt resistors.
- Size: 4" × 6" × 2".

MODEL RD-111
\$49.00

3½ Digit Multimeter



- 30 ranges, 8 functions, full overload protection.
- 10 Amperes AC and DC ranges.
- Super fast continuity beeper (<0.4 sec. response).
- Diode test plus transistor hFE.
- Large bold ½" LCD readout with low battery indicator.
- Complete with test leads, battery and spare fuse.
- Optional carrying case CC531, \$9.90; transistor test extension leads UP-11, \$4.50.

MODEL 8050
\$76.50

20k Ohm/V VOM

- Measures AC/DC volts, resistance, decibels, capacitance, battery test and continuity buzzer, also temperature scale with optional temperature probe TP-150 for \$19.50.
- 10 ampere DC range.
- Size: 3½" × 5½" × 1½".



MODEL SX-220
\$29.95

20 MHz Dual Trace Oscilloscope with Component Tester

- 5 mV to 20V on 12 ranges.
- 20 sweep ranges from 0.2 μs to 0.5 s/div plus ×5 mag.
- Built-in component tester. Ideal for trouble-shooting in cold circuits.
- Complete with 2 probes, spare fuse.



MODEL MS-6022
\$599.00

DC Power Supply



- Fully regulated 0 to 25V and 0 to 1.5A.
- LED 3 digit readout.
- Size: 6¼" × 4¾" × 13¾".
- Other units 0 to 36V at 0 to 3A.
- Duals, triples also available.

MODEL 7400
\$235.00

Auto-Ranging AC Clamp Tester



- Measures 0.1A to 1000A; 0.1 VAC to 1000 VAC; resistance, 0.1Ω to 2 kΩ.
- 3½ digit LCD readout.
- Has data hold switch, continuity beeper.
- Model 2210 with temp. meas. \$110.00.
- Model 2220 with temp. meas. and peak hold \$135.00.
- Complete with carrying case, probes and battery.

MODEL 2200
\$85.00

3½ Digit Bench Multimeter Auto/Manual Ranging

- Measures DC volts 0.1 mV to 1000V; ACV, 1 mV to 1000V; resistance, 0.1Ω to 20 MΩ; DCA, 0.1 μA to 10A; ACA, 0.1 μA to 10A; diode test, with continuity beeper.
- Supplied with batteries, test leads, spare fuse.
- AC adaptor Model MQ-62 available separately for \$12.00.
- Size: 2¼" × 7¼" × 7¼".

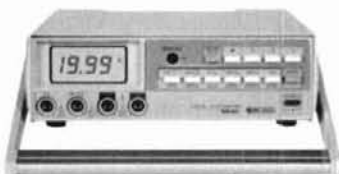

MODEL 5030
\$169.00

150 MHz Frequency Counter

- Measures 5 Hz to 150 MHz on 2 ranges; sensitivity, 30 mV.
- Crystal frequency 3.2768 MHz.
- Accuracy at 0.01 sec 100 PPM ± 1 dgt.
- Battery portable or AC optional.
- Size: 1¼" × 4" × 4¼".



MODEL FC-845
\$149.00

All prices shown are for 1 to 3 pieces of a type. Discounts are available for larger quantities. All models shown and over 70 other SOAR manufactured instruments are available from selected distributors in the USA.

**NORTH
AMERICAN**



1126 CORNELL AVENUE
CHERRY HILL, NJ 08002
PHONE (609) 488-1060

JAPAN
SOAR CORP.
Sakaki Machi, Nagano, Pref.
Phone (02688) 2-4191

EUROPE
SOAR EUROPA
Munich, W. Germany
Phone (089) 6097094

SINGAPORE
SOAR ELECTRONICS
Singapore Pte. Lt.
Phone 7796111

CANADA
WATERGLOW
Montreal, Quebec
Phone 514-389-8051

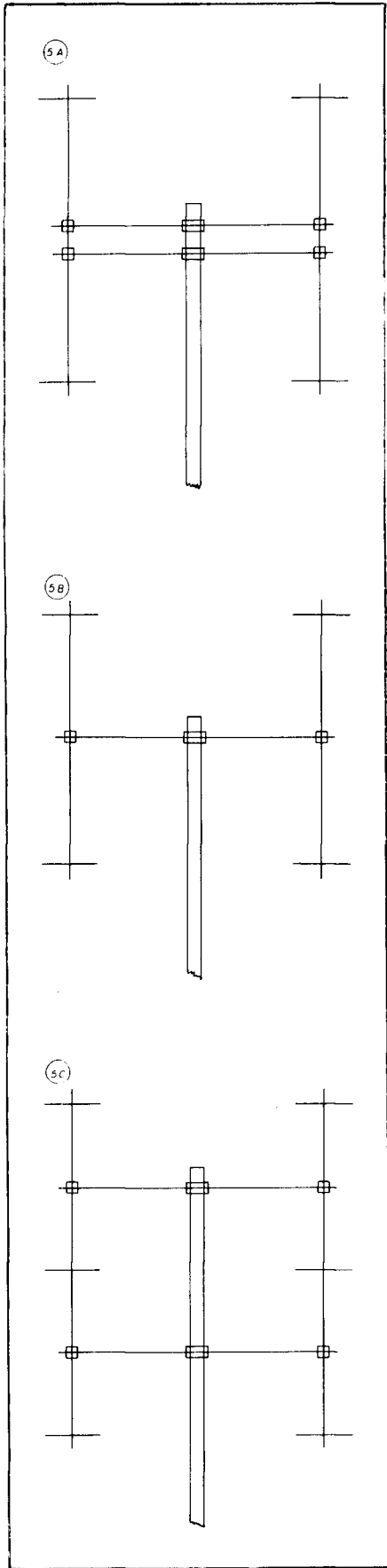

stacking configurations because they are less likely to be distorted by sagging resulting from wind or ice loading and are able to return to their intended shape after any external forces or loads are removed. Furthermore, in symmetrical configurations twisting moments are more likely to only cause a moderate decrease in performance if the mechanical structure

varies more than 1/16 wavelength or 22.5 electrical degrees (as discussed earlier). Several configurations are shown in **fig. 5**. Stacking frames should be strong mechanically. Excessive weight should be avoided at all cost because it can cause mechanical distortion. The materials used — as well as their diameter and weight — should be carefully examined. The

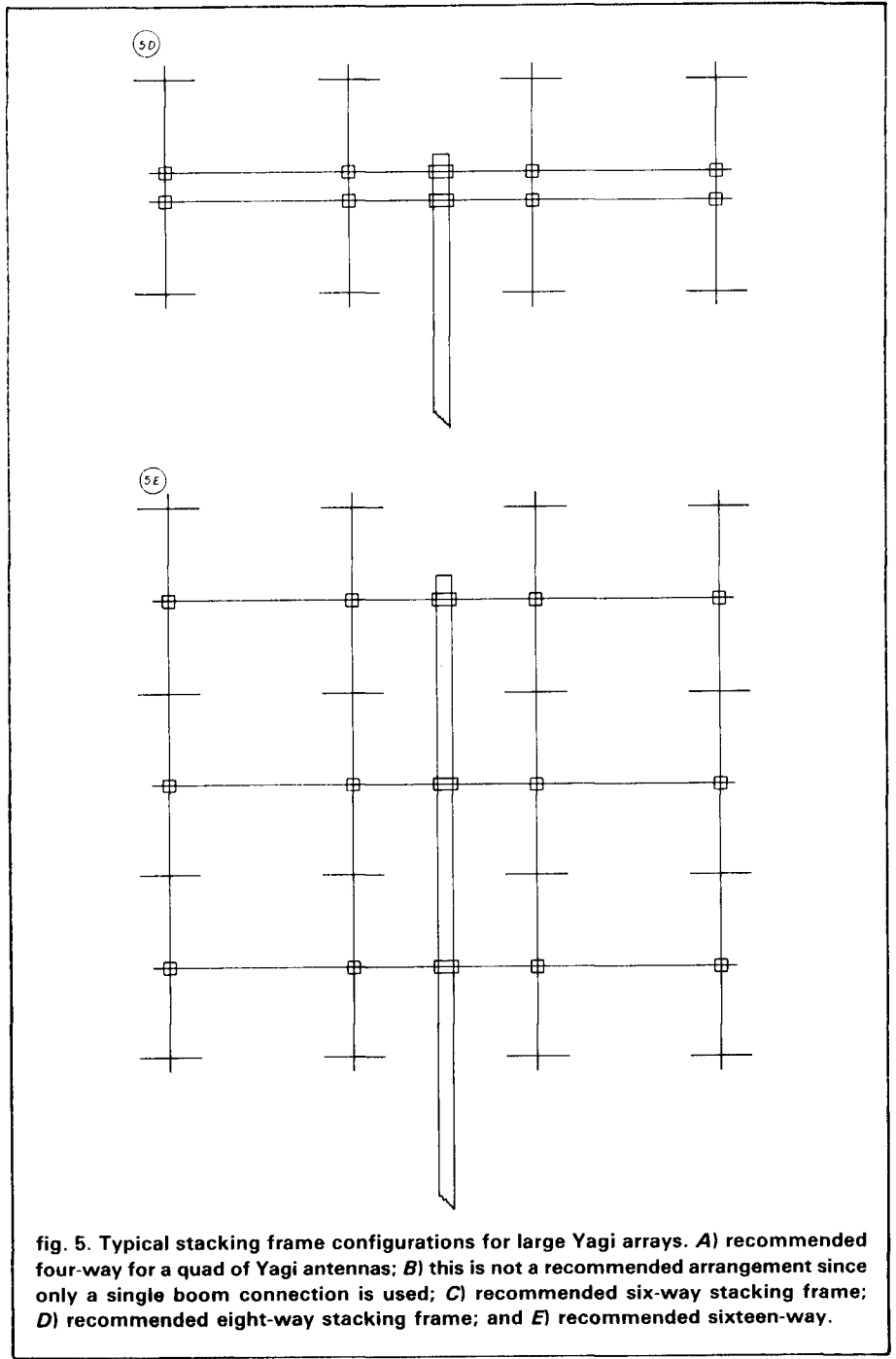

fig. 5. Typical stacking frame configurations for large Yagi arrays. **A)** recommended four-way for a quad of Yagi antennas; **B)** this is not a recommended arrangement since only a single boom connection is used; **C)** recommended six-way stacking frame; **D)** recommended eight-way stacking frame; and **E)** recommended sixteen-way.

TIME FOR AN BREAKTHROUGH

The high quality of AEA products is appreciated long after the price paid is forgotten.



No Antenna
No Radio
No TV!

THE FANTASTIC DOCTOR DX™ CW Band Simulation That Is So Real You Won't Believe It!

- Will improve the operating skills of ANY CW operator!
- More fun than ANY Morse Code trainer yet devised.
- Use with a C-64, TV set, and key (or keyer).
- Experience the thrill of a "DXpedition" to anywhere in the world.
- Operate anytime you want, ideal for travelers.
- Impressive award certificates available for verified performance.
- On-going contests: 8-hour sprint and 24-hour marathon.

\$179.95*

HOT ROD™

½ Wave Telescope Antenna \$24.95*

- Fewer telescopic sections than any ½ wave whips.
- Shorter and lighter than all ½ wave whips.
- Special matching network designed by Professor D.K. Reynolds (co-inventor of Iso-pole™ antenna) makes Hot Rod competitive-ly priced.



- Most gain attainable for length of antenna—3 dBd (0 dBd for JR models).
- Best decoupling of any commercial VHF base station antenna available.
- More gain than many antennas claiming up to 7 dB gain—don't be fooled by misleading claims!
- Zero degree angle of radiation.
- Factory-tuned matching network.
- Greater bandwidth than any competitive product.
- DC grounded for static discharge protection.
- Documented cases of wind survival in 140+ mph hurricanes.
- Easier than any competitive antenna to assemble.

Mast
Not
Included

ISO = 144 or 220—\$59.95*
ISO = 144 JR or 220 JR—\$49.95*
ISO = 440—\$84.95*

ANTENNA™

I
S
O
P
O
L
E



PKT-1 Packet Controller \$589.95

- First commercially available packet controller for Amateur Radio.
- Uses TAPR circuitry and firmware.
- Digital radio communications for computer to computer.
- Easy to use—five usual commands.
- Multiple conversations on simplex channel.
- EVERY PKT-1 is a digipeater.
- Send computer files error free.
- Operates from 9–15 VDC for portable or fixed operation.

ELECTRONIC KEYS



\$109.95*
BT-1 Basic Morse Trainer



\$149.95*
KT-2 Keyer/Trainer



\$199.95*
CK-2 Contest Keyer



\$229.95*
MM-2 MorseMatic™

- Teaches code at 20 wpm.
- Random practice mode.
- Variable monitor tone.
- Proficiency Trainer.
- 01–99 WPM.
- Full-feature keyer (no memory).
- 10 soft-partioned™ memories.
- Automatic serial number.
- Stepped variable speed.
- Two speed memories.
- Memory keyer.
- Auto serial number.
- Proficiency trainer.

All AEA Keyers operate from 9–15 VDC (power supply not included) and offer many more advanced features than can be listed here. It is no accident that AEA keyers are regarded as the best in the world.

TI-1
RTTY/AMTOR
Tuning Aid \$119.95



- Spectral display of RTTY tones.
- Instant indication of shift (THREE RANGES).
- Built-in speaker with switch for quiet monitoring.

MAP-64/2
\$239.95*



- Plug-in hardware and firmware for C-64 computer.
- Dual channel filters.
- Ext. 12 VDC reduces load on computer (power supply not included).
- Morse-Baudot-ASCII-AMTOR.
- Most advanced software available.



CP-1 \$239.95*
Computer Patch™ Interface

- Better performance than any competitive product
- Dual channel filtering with auto threshold correction
- Variable shift
- 117 VAC power supply included

AEA also offers Morse, Baudot, and ASCII software for the following computers: Apple II, II+, IIe; IBM-PC.

Unmatched Software For C-64
And VIC-20 Computers

MBA-TORT™—The most advanced software written for Morse-Baudot-ASCII-AMTOR including mail drop.

MARSTEXT™—A special Morse-Baudot-ASCII package written especially for MARS and other traffic operators.

SWLTEXT™—The most sophisticated software available for the shortwave listening enthusiast. Automatic data analysis; Morse, Baudot, ASCII, AMTOR, and SITOR.



VHF COMMUNICATIONS

915 N. Main St., Jamestown, New York 14701 (716) 664-6345

table 1. Calculated section moduli for various popular sizes of aluminum tubing using eq. 2 in text.

outside diameter		wall thickness		section modulus
inches	(mm)	inches	(mm)	
0.250	(6.35)	0.050	(1.27)	0.00134
0.375	(9.53)	0.050	(1.27)	0.00368
0.500	(12.70)	0.062	(1.57)	0.00839
0.750	(19.10)	0.050	(1.27)	0.01810
0.750	(19.10)	0.062	(1.57)	0.02140
1.000	(25.40)	0.062	(1.57)	0.04060
1.000	(25.40)	0.125	(3.18)	0.06710
1.250	(31.80)	0.062	(1.57)	0.06590
1.500	(38.10)	0.062	(1.57)	0.09740
2.000	(50.80)	0.062	(1.57)	0.17870
2.000	(50.80)	0.125	(3.18)	0.32500
2.500	(63.50)	0.062	(1.57)	0.28450
3.000	(76.20)	0.050	(1.27)	0.33610
3.000	(76.20)	0.062	(1.57)	0.41490
4.000	(101.60)	0.050	(1.27)	0.60510
4.000	(101.60)	0.062	(1.57)	0.74930

ARRL *Antenna Book* has an excellent table listing the weight per unit length of most popular aluminum tubing sizes.¹⁰ Furthermore, to prevent bending moments, it is often better to use a slightly thinner wall larger diameter tubing than vice-versa.

The "section modulus" is an excellent way to compare the relative bending moment of various tubing diameters with different wall thicknesses.

$$\text{section modulus} = 0.098 [(D^4 - d^4)/D] \quad (2)$$

where D is the outside and d is the inside diameter of the tubing. Typical values of section moduli on some popular tubing sizes are shown in table 1. Note, for example, that a 3 inch (7.6 cm) diameter tube with a 0.050 inch (1.27 mm) wall has a higher section modulus and is lighter weight than a 2 inch (5 mm) diameter tubing with a 0.125 inch (3.2 mm) wall thickness. Other values not listed on the table can be easily calculated using eq. 2.

Mechanical symmetry of the stacking frame also tends to keep all antenna pattern blockages equal. Likewise, wherever possible, the phasing and feedlines should be neatly and symmetrically dressed and secured to a boom. Stacking frames should have

several points of support. Sometimes tower sections are used for the main boom on large arrays! Judicious use of guy wires preferably at right angles to each other with adjustable turnbuckles is also recommended.

Finally, try to pass booms and masts at a mid-point between antennas rather than adjacent to them. If the material or boom used in the stacking frame passes through an antenna pattern, it will have little effect as long as it is at right angles to the plane of polarization and/or is less than 1/10 wavelength in diameter when passing through in the plane of polarization.

other configurations

So far I have been discussing the common arrays. There are many other possibilities. When really high gain is required, a large array of antennas may be constructed. Amateur arrays using 24 Yagis are already in use on 2 meters and 70 cm and a 32-Yagi 2-meter array is under construction! Basically, these arrays are configured using combinations already mentioned. For instance, a 24-bay array can be constructed by stacking three eight-Yagi bays per fig. 1E along a main boom. A single three-way splitter/combiner at the center of the array combines the three eight-bay sub-arrays.

Besides the monstrous mechanical

problems associated with very large arrays, feedline losses and phasing errors are probably the biggest source of performance degradation. Always try to use the largest and lowest loss phasing lines available. Finally, before constructing a large array, consider whether you are willing to accept all the mechanical risks — it will be large enough! Failure to do so may reduce performance to the point that you may have no more gain than with a smaller array!

final checkout

Whenever stacking is employed, each item should be checked in a methodical fashion. First off, the VSWR of each antenna in the array should be low, preferably 1.2:1 maximum. If coaxial lines are used, *each antenna should be VSWR tested after the antennas are mounted in the array.*

Next, connect the individual antennas into the associated power splitter/combiner in each grouping and test the VSWR again. Then, if applicable, test the entire array.

Be absolutely certain that all antennas are fed on the same side of the array so that 180-degree phase reversals do not occur. Preferably, mount all antennas the same way. If you decide to mount some upside down, make sure to reverse the feed attachment point. Recently, one major antenna manufacturer had a connector plate reversed on some of their antennas.¹¹ This did not affect performance until two antennas were stacked. Phase reversals of this type can cause radiation patterns to skew or even produce nulls where radiation would normally be present.

Finally, after final assembly and testing, measure antenna azimuthal and elevation patterns, if possible, using the methods described in reference 11. If the antenna pattern does not peak right on boresight (within 1 to 2 degrees) or if the anticipated beamwidth or level of the side lobes is not the value anticipated, as discussed earlier, recheck all electrical and mechanical parameters to find the problem.

FOR SALE

EPSILON RECORDS INTERNATIONAL: A small business ideally suited for Ham radio Operators OR established company desiring to expand present operations. Founded in 1957 by famed educator (late) Russ Farnsworth. Epsilon produces educational tapes and records, teaching a course in the international Morse Code by the patented "Word Method". Customers include Electronic dealers (wholesale) on an established basis and private individuals (retail) on a mail-order basis through advertising in trade magazines. Gross dollar in-take can be expanded in excess of \$125,000 with present equipment. Operations require small area (home or studio) in any geographical location. Firm price of \$45,000 includes all equipment, machinery, stock, inventory, master tapes, copy-rights, patents, customer accounts, files and all records. For additional information contact: Peter Shaun Rivage, Epsilon Records International, P.O. Box 71581, New Orleans, LA 70172 (504) 242-5922

MULTI-BAND TRAP ANTENNAS

Completely assembled & ready to use - Commercial quality, built to last - Lightweight, sealed, weatherproof traps - Automatic band switching - Low loss end insulators - Handles up to 2000 watts PEP - For all transmitters, receivers & transceivers - Tuner usually never required - Deluxe center insulator, with built in lightning arrestor, accepts PL-259 coax connector - May be used as inverted "V" - Excellent for all class amateurs - Instructions included - 10 day money back guarantee!

4-Band-40,20,15,10 meters (55') 2 traps #D42 \$55.95 PPD
5-Band-80,40,20,15,10 meters (105') 2 traps #D52 \$59.95 PPD

SHIPPED POSTPAID! READY TO USE!

90 ft. RG-58U, 52 ohm coax cable, with PL-259 connector on each end - Add \$12.00 to above price.

We accept VISA/MC-Give Card #, Exp. Date, Signature

SPI-RO DISTRIBUTORS

Room 103, P.O. Box 1538
Hendersonville, NC 28793



summary

In this two-part series, I have tried to cover the major electrical and mechanical considerations required for properly stacking antennas for increased gain. Stacked antennas should be used only when the gain required is beyond that attainable using a single antenna. Remember at the outset that you will be lucky to achieve 2.5 dB of gain increase for every doubling of the array size.

Before building an array that requires stacking, plan carefully. Review both parts of this article several times. Many alternative configurations have been discussed, with pros and cons. Stacking antennas is not a simple job and there are many pitfalls. Both electrical and mechanical decisions must be made. If properly executed, the results can be rewarding. Hopefully the material presented will be useful in building your new super-high-gain array!

acknowledgements

I would like to thank C.J. Beanland, G3BVU, for introducing me to the use of section modulus when comparing different tubing sizes.

references

1. Joe Reiser, W1JR, "VHF/UHF World, Stacking Antennas, Part 1," *ham radio*, April, 1985, page 129.
2. Joseph H. Reiser, Jr., W6FZJ/1, "VHF Antenna Arrays for High Performance," *QST*, December, 1974, page 38.
3. Roy W. Lewallen, W7EL, "Notes on Phased Verticals," *QST*, August, 1979, page 42.

4. Henry Jasik, *Antenna Engineering Handbook*, Chapter 2, page 11, and Chapter 24, page 8, McGraw Hill, 1961.
5. E.J. Wilkinson, "An N-Way Hybrid Power Divider," *IRE Transactions on Microwave Theory and Techniques*, Volume 8, #1, January, 1960, page 116.
6. Private Correspondence with Roy Lewallen, W7EL.
7. Don Hilliard, W0EYE, "50-Ohm Power Dividers," *QST*, October, 1973, page 97.
8. Jim Pruitt, KL7HIT, "Easy Matching Sections," *ham radio*, March, 1982, page 68.
9. George Chaney, W5JTL, "Extended/Expanded Power Dividers," *ham radio*, October, 1984, page 73.
10. *The ARRL Antenna Book*, American Radio Relay League, Newington, Connecticut, 14th Edition, Chapter 9, page 2.
11. Joe Reiser, W1JR, "VHF/UHF World, Determining VHF/UHF Antenna Performance," *ham radio*, May, 1984, page 110.

important VHF/UHF coming events

- May 1:** ARRL 70-cm Sprint Contest
May 3-5: West Coast VHF Conference, Sunnyvale, California, (Contact W6RXQ for information)
May 4: EME perigee
May 4: 1300 UTC, predicted peak of the Eta Aquarids meteor shower
May 9: ARRL 23-cm Sprint Contest
May 17-19: Eastern VHF/UHF Conference, Nashua, New Hampshire, (Contact W1EJ for information)
May 19: ARRL 6-Meter Spring Contest (tentative date)
June 1: EME perigee
June 5: 1930 UTC, predicted peak of Arietids meteor shower
June 8-9: ARRL VHF QSO Party
June 29-30: SMIRK 6-Meter Contest
June 15: 0400 UTC, predicted peak of June Lyrids meteor shower
June 21: Mean date of the two-month annual peak of sporadic-E propagation
June 29: EME perigee

ham radio

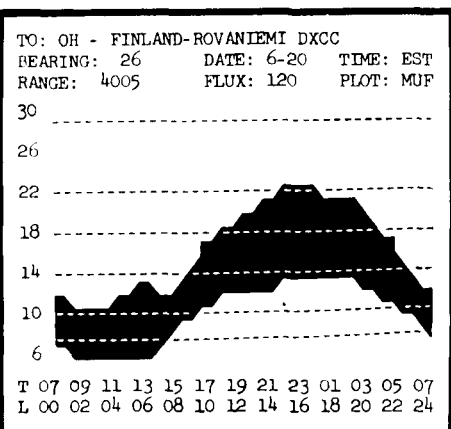

Propagation by Mufplot

MUFLOT is being used by amateurs from HONG KONG to BAGHDAD, SOUTH AFRICA to ALASKA, by sailors, commercial companies and people who know the need of propagation forecasting at its best.

MUFLOT will give you HPF, MUF, FOT with LUF plus distance and bearing (and time) to any target. You can select over 400 listed targets by DX or ARRL prefix, lat/long, or state. The database will let you enter target data by what ever you want to call it and you can change it anytime.

MUFLOT will keep track of the stations you have worked for WAS, DXCC or for any other award. MUFLOT gives you a video graph (and/or table) and printer display of band conditions. (A special DX function lets you see world conditions. You select the number of and locations you want). Band coverage for the C-64 is 6 to 30MHz video and less than 1 to more than 30MHz printer. The APPLE is 2 to 34MHz. You enter your QTH lat/long only once but you can change it anytime.

- () denotes for the (C-64) only.
C-64 MUFLOT V2 disk only \$32.95
APPLE MUFLOT disk only \$37.95
North American orders add \$2.00 for S/H all others \$5.00.
VISA, M.C., personal checks accepted.
APPLE is the trade mark of APPLE Computer Co.
C-64 is a trade mark of Commodore Co.
MUFLOT is a trade mark of BASE (2) SYSTEMS.

BASE (2) SYSTEMS

2534 Nebraska St.
Saginaw, MI 48601
Tel.517-777-5613

✓ 163

DRAKE R-4/T-4X OWNERS AVOID OBSOLESCENCE

PLUG-IN SOLID STATE TUBES!
Get state-of-the-art performance.
Most types available

INSTALL KITS TO UPGRADE PERFORMANCE!

- BASIC Improvement
- Audio Bandpass Filter
- Audio IC Amplifier

TUBES \$23 PPD KITS \$25 PPD

OVERSEAS AIR \$7

SARTORI ASSOCIATES, W5DA
BOX 832085
RICHARDSON, TX 75083
214-494-3093 ✓ 164

Need A Storage Scope?



The Model 601 Scope Memory converts your oscilloscope into a storage scope. With the Scope Memory you can capture & display transients, pulses and low frequency signals. Stores both analog & digital signals in a single sweep. Features a 1.4 MHz sample rate, 2K memory, pre and post trigger capabilities. Price \$515

Sibex, Inc.

2340 State Road 580 Suite 241
Clearwater, FL 33515
(813) 797-9589 ✓ 165

7 MILLION TUBES

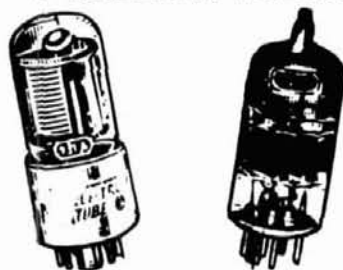

FREE CATALOG

Includes all Current, Obsolete, Antique, Hard-To-Find Receiving, Broadcast, Industrial, Radio/TV types. **LOWEST PRICES**, Major Brands, In Stock.

UNITY Electronics Dept. H
P.O. Box 213 ✓ 166

Elizabeth, NJ 07206

SHORT CUT



A quarter-wave antenna is great for range. But it's too tall for most VHF handheld applications. So Larsen® has cut the quarter-wave down to size, without taking any shortcuts in design or construction.

The Larsen HQ (helical-quarter-wave) Kùlduckie® antenna stands just slightly taller than a helical type, but measures up to almost full quarter-wave performance. The helical design below

gives it stability and keeps it short—nine to twelve inches. The flexible quarter-wave on top extends the range and allows it to bend 180°.

Larsen offers ten different VHF HQ series antennas in the 136 to 174 MHz range, to work with most popular handheld radios. So whether you're calling for help, or just shooting the breeze, you can be sure that Larsen Kùlduckie antennas will never run short on performance.



Larsen Antennas
The Amateur's Professional™

See your favorite amateur dealer or write for a free amateur catalog.

IN USA: Larsen Electronics, Inc.
11611 N.E. 50th Ave.
P.O. Box 1799
Vancouver, WA 98668
206-573-2722

IN CANADA: Canadian Larsen Electronics, Ltd.
149 West 6th Ave.
Vancouver, B.C. V5Y 1K3
604-872-8517

LARSEN® KÙLROD® AND KÙLDUCKIE® ARE REGISTERED TRADEMARKS OF LARSEN ELECTRONICS, INC.

RF transmission cable for microwave applications

Detailed discussion
examines all aspects
of the vital link between
radio and antenna

The correct selection of RF transmission cable requires proper analysis of the electrical and physical parameters of the system.

The amateur microwave enthusiast should be aware that even though materials and dimensions specified by manufacturers are usually accurate, changes in physical and environmental conditions as well as different types of manufacturing equipment or different manufacturing conditions can lead to cable with **substantially** different performance characteristics.

VSWR uniformity

The VSWR of a cable assembly is the summation of reflections due to the connectors, the connector termination technique and the cable. The VSWR of the cable is the summation of random and periodic reflections within the cable, most commonly caused by variations within the processing equipment. The VSWR **will** vary with frequency. A common occurrence is the VSWR "spike" which is illustrated in **fig. 1**.

characteristic impedance

The characteristic impedance of a coaxial cable is determined by the ratio of the inner diameter of the outer conductor to the outer diameter of the inner conductor and by the dielectric constant of the insulating material between the conductors. Select impedance to match your system requirements.

The most common values for coaxial cables are 50, 75, and 95 ohms. Other impedances from 35 to 185 ohms are available in coaxial configurations, but these are normally of interest only to the industry.

Note that the actual input impedance at a particular frequency may be quite different from the character-

istic, or surge impedance of the cable due to reflections in the line. The VSWR of a particular length of cable is an indicator of the difference between the actual input impedance of the cable and its average characteristic impedance.

The impedance **will** vary along the length of the cable. Variations of 5 percent are common and some mil spec cables are manufactured to 2 percent tolerance.

capacitance

Capacitance values for standard coax lines depend only on cable impedance and dielectric material.

nominal capacitance pF/foot	cable types
30.8	50 ohm solid polyethylene
25.4	50 ohm foam polyethylene
29.4	50 ohm solid PTFE (Teflon)
20.6	75 ohm solid polyethylene
16.9	75 ohm foam polyethylene
19.5	75 ohm PTFE
16.3	95 ohm solid polyethylene
13.5	95 ohm air space polyethylene RG62B
15.4	95 ohm solid PTFE
10.0	125 ohm air space polyethylene RG63B
6.5	185 ohm air space polyethylene RG114A

capacitance and impedance stability

The capacitance and impedance of long lengths of cable will exhibit very little change over their operating temperature ranges (less than 2 percent). Semi-flexible foam dielectric cables normally exhibit the least change in short cable lengths at frequencies over 1 GHz, although the VSWR can vary significantly if dielectric movement at the connector interface occurs.

average CW power rating

Coaxial cable power ratings must be derated by correction factors for the ambient temperature, altitude (admittedly not of much concern to the Radio Amateur) and VSWR encountered in a particular application. High ambient temperature and high altitude reduce the power rating of a cable by impeding the

By Howard Weinstein, K3HW, 15 Lakeside Drive, Marlton, New Jersey 08053

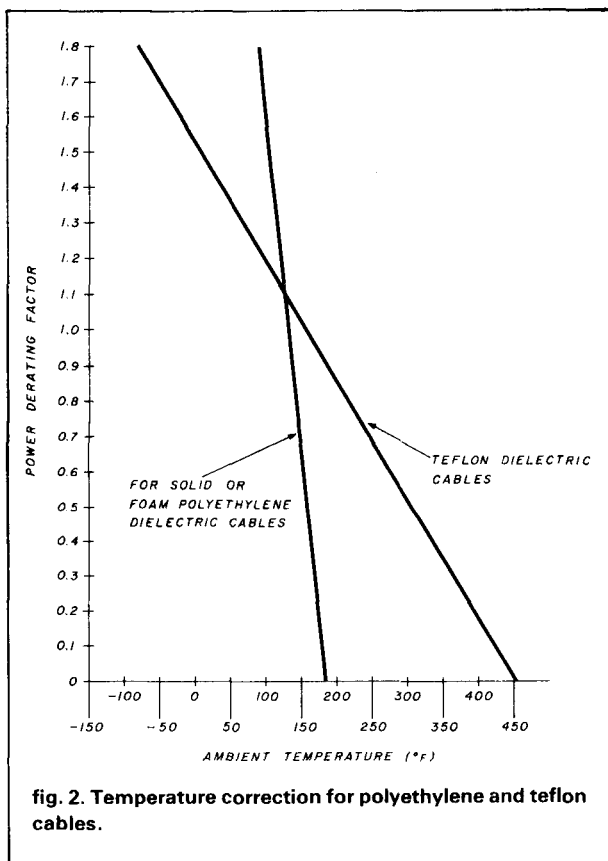
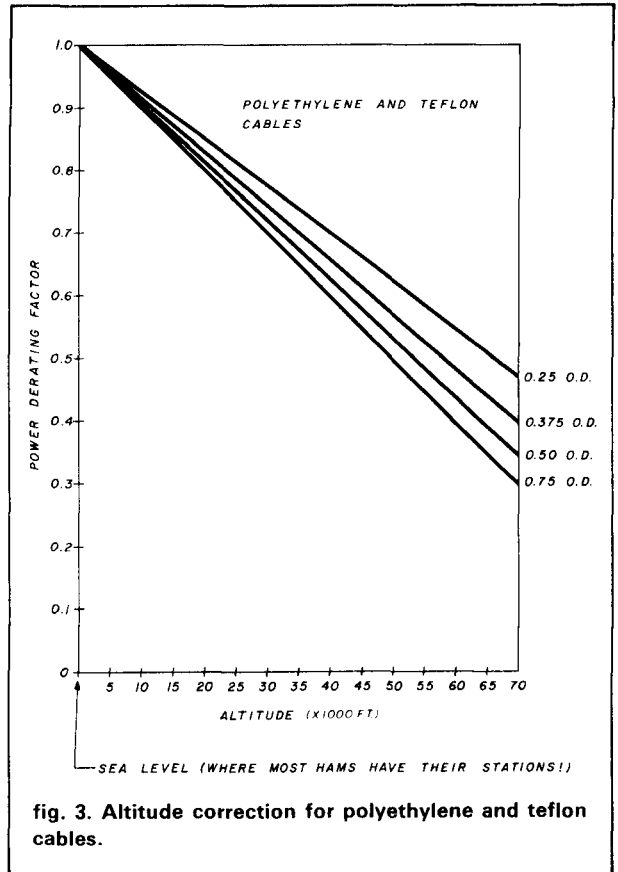
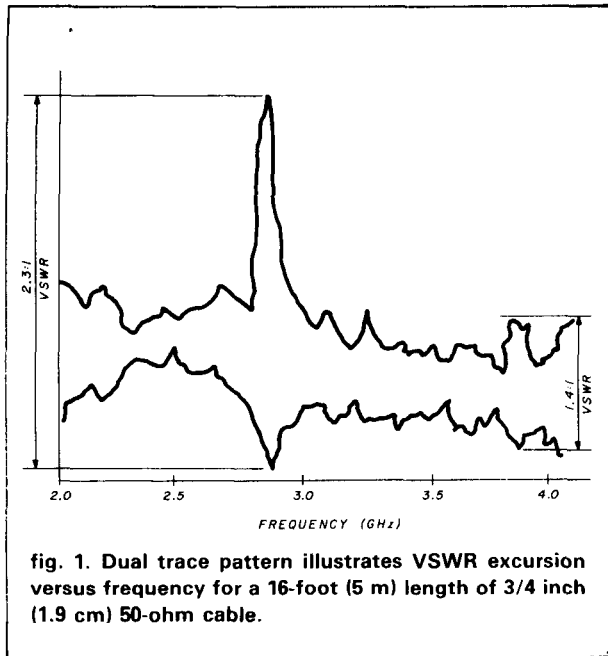

heat transfer out of the cable. VSWR reduces power ratings by causing hot spots.

To select the cable construction for a particular requirement, determine the average input power at the highest frequency from your station's requirements.

Then determine the effective average input power with the following formula:

$$\text{effective power} = \frac{\text{average power} \times (\text{VSWR correction})}{(\text{Temp. correction}) \times (\text{Alt correction})} \quad (1)$$

Temperature and altitude corrections are illustrated in **figs. 2 and 3.**

$$\text{VSWR correction factor} = \frac{1}{2}(\text{VSWR} + 1/\text{VSWR}) + \frac{1}{2}K' \cdot (\text{VSWR} - 1/\text{VSWR}) \quad (2)$$

(K' is shown in **fig. 4.**)

maximum AC operating voltage

A cable cannot operate continuously with corona because it causes noise generation, dielectric damage and eventual breakdown. The maximum operating voltage must be less than the corona level (extinction voltage) of the cable. This is not to be confused with the dielectric strength of the cable, which is the test voltage applied for one minute during manufacture.

Maximum operating AC (RMS) voltage levels or peak voltages are given for each type of cable in many manufacturer's catalogs. Usually the maximum permissible DC voltage level is 2.5 to 3 times the AC level.

To determine the actual RMS value, divide peak voltage by 1.4. To determine the peak voltage, multiply RMS by 1.4. Then determine the effective input voltage by multiplying the actual input voltage by the square root of VSWR.

The cable you select should have a maximum operating voltage specification greater than the effective RMS voltage.

attenuation

The attenuation of any cable may not change uniformly as the frequency changes. Random and periodic impedance variations give rise to different attenuation responses. Narrow band attenuation spikes can occur.

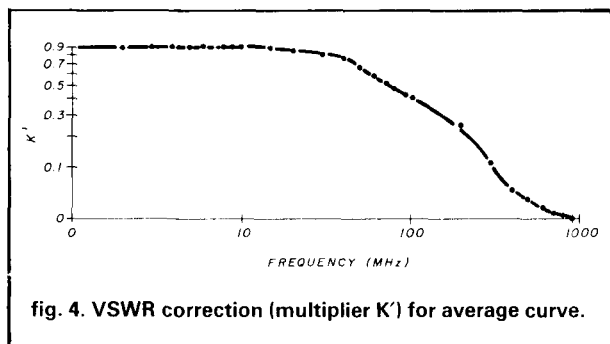

fig. 4. VSWR correction (multiplier K') for average curve.

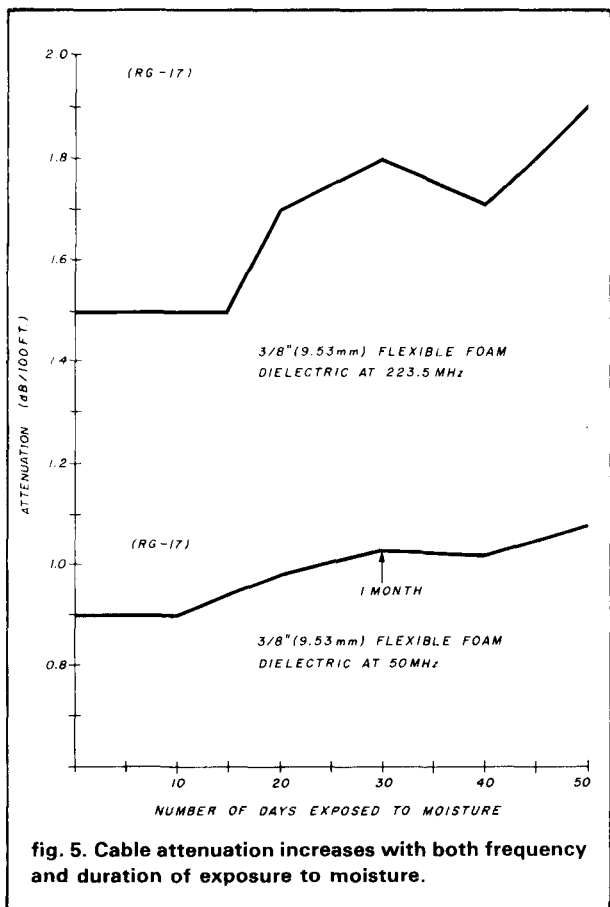

fig. 5. Cable attenuation increases with both frequency and duration of exposure to moisture.

The attenuation of braided cables can increase with time and flexure. The change with time can be caused by corrosion of the braided shield, by contamination of the primary insulation caused by chemicals in the cable jacket, and by moisture penetration through the jacket. Attenuation degradation is more pronounced at frequencies above 1 GHz. Cables having bare copper and tinned copper braids exhibit far greater attenuation degradation than do cables having silver plated copper braids. Refer to figs. 5, 6, and 7.

The following "rules of thumb" apply in Amateur service:

Tin-plated braids. Below 1 GHz, cables manufactured with tin-plated braids have at least 20 percent more attenuation than copper braids in the "as manufactured" condition, but are more stable than bare copper-braided cables.

Foam polyethylene. Flexible braided cables with foam polyethylene dielectrics have approximately 15 percent less attenuation than solid polyethylene cables of the same core size and impedance. However, as many of us have discovered, the attenuation of foam cables will increase if moisture is absorbed. In high humidity environments I suggest that foam cables not be used above 148 MHz. All of these problems can be eliminated by the use of semi-flexible cables; semi-

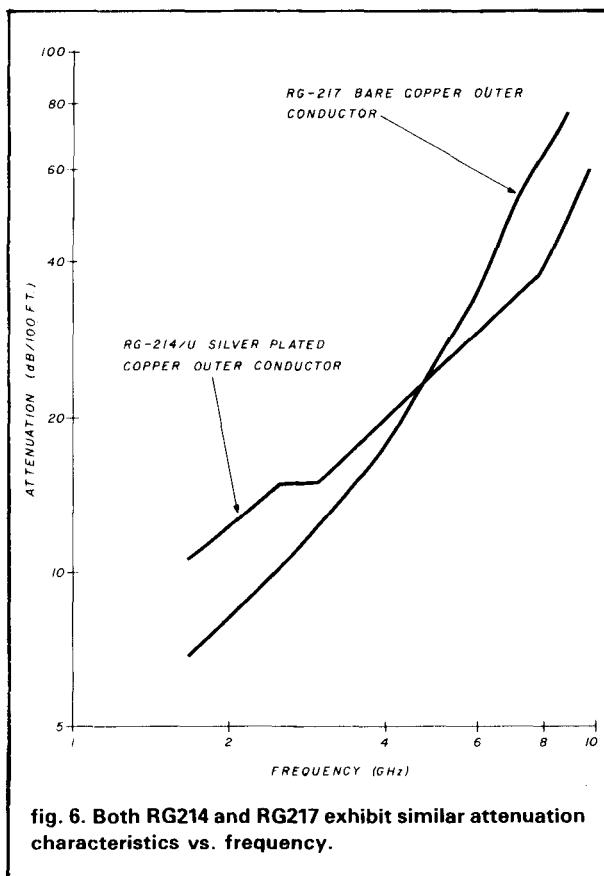

fig. 6. Both RG214 and RG217 exhibit similar attenuation characteristics vs. frequency.

table 1. Formulas common to all coax cable.

$$\text{Capacitance (C)} = \frac{7.36E}{\text{LOG}(D/d)} \text{ Picofarads/ft}$$

$$\text{Inductance (L)} = 0.140 \text{ LOG}(D/d) \text{ Microhenries/ft}$$

$$\text{Impedance (Z}_0) = \sqrt{\frac{L}{C}} = \frac{138}{\sqrt{E}} \text{ LOG}(D/d) \text{ ohms}$$

$$\text{Velocity of propagation as percentage of speed of light} = \frac{100}{\sqrt{E}}$$

$$\text{Time delay} = 1.016 \sqrt{E} \text{ nanoseconds/ft}$$

$$\text{Cutoff frequency} = \frac{7.50}{\sqrt{E} (D + d)} = F_{co} \text{ (GHz)}$$

$$\text{Reflection coefficient} = \Gamma$$

$$= \frac{Z_r - Z_0}{Z_r + Z_0} = \frac{\text{VSWR} - 1}{\text{VSWR} + 1}$$

$$\text{VSWR} = \frac{1 + \Gamma}{1 - \Gamma}$$

$$\text{Peak voltage} = \frac{1.15 S \cdot d (\text{LOG } D/d)}{K}$$

$$\alpha = \frac{0.435}{Z_0 (D)} \left[\frac{D}{d} \cdot K_1 + K_2 \right] \sqrt{F} + 2.78 \sqrt{E} \text{ (P.F.) (F)}$$

- where: α = attenuation in dB/100 ft
 d = the outside diameter of inner conductor in inches
 D = the inside diameter of outer conductor in inches
 S = the maximum voltage gradient of the cable insulation in volts per mil (thousandth of inch)
 E = the dielectric constant of the insulation of the cable
 LOG = logarithm to base 10
 K = safety factor
 K_1 = strand factor
 K_2 = braid factor
 F = frequency in MHz
 P.F. = power factor

property of insulating material (dielectric constant "E")

material	dielectric constant "E"
TFE	2.1
polyethylene	2.3
cellular polyethylene	1.4-2.1
polyvinylchloride	3.00-8.00
silicone rubber	2.08-3.50
ethylene propylene	2.24

flexible cable is generally not available to the average ham. Its price is also prohibitive, rising into the dollars-per-foot price range.

It is possible however, to use foam polyethylene cable up to 12 GHz. The only catch is that it must be protected from the environment by either running it

through a conduit with forced dry air pumped under pressure or sheathing it in a seamless metallic tube.

velocity of propagation

The velocity of propagation of cable is determined primarily by the dielectric constant of the insulating



HF Equipment Regular SALE
IC-740* 9-band 200w PEP xcvr w/mic 1099.00 **869⁹⁵**
***FREE PS-740 Internal Power Supply & \$50 Factory Rebate - until gone!**

- PS-740 Internal p/s (Special!) \$159.00 **99⁹⁵**
 - *EX-241 Marker unit..... 20.00
 - *EX-242 FM unit..... 39.00
 - *EX-243 Electronic keyer unit..... 50.00
 - *FL-45 500 Hz CW filter (1st IF)..... 59.50
 - *FL-54 270 Hz CW filter (1st IF)..... 47.50
 - *FL-52A 500 Hz CW filter (2nd IF)..... 96.50 **89⁹⁵**
 - *FL-53A 250 Hz CW filter (2nd IF)..... 96.50 **89⁹⁵**
 - *FL-44A SSB filter (2nd IF) 159.00 **144⁹⁵**
 - SM-5 8-pin electret desk microphone 39.00
 - HM-10 Scanning mobile microphone 39.50
 - MB-12 Mobile mount..... 19.50
- *Options also for IC-745 listed below**
- IC-730 8-band 200w PEP xcvr w/mic 829.00 **569⁹⁵**
 - FL-30 SSB filter (passband tuning) 59.50
 - FL-44A SSB filter (2nd IF)..... 159.00 **144⁹⁵**
 - FL-45 500 Hz CW filter..... 59.50
 - EX-195 Marker unit..... 39.00
 - EX-202 LDA interface; 730/2KL/AH-1 27.50
 - EX-203 150 Hz CW audio filter..... 39.00
 - EX-205 Transverter switching unit 29.00
 - SM-5 8-pin electret desk microphone 39.00
 - HM-10 Scanning mobile microphone 39.50
 - MB-5 Mobile mount..... 19.50
 - IC-720A 9-band xcvr/1-30 MHz rcvr 1349.00 **799⁹⁵**
 - FL-32 500 Hz CW filter..... 59.50
 - FL-34 5.2 kHz AM filter..... 49.50
 - SM-5 8-pin electret desk microphone 39.00
 - MB-5 Mobile mount..... 19.50
 - IC-745 9-band xcvr w/1-30 MHz rcvr 999.00 **779⁹⁵**
 - PS-35 Internal power supply..... 160.00 **144⁹⁵**
 - CFJ-455K5 2.8 kHz wide SSB filter 4.00
 - HM-12 Hand microphone..... 39.50
 - SM-6 Desk microphone..... 39.00

***See IC-740 list above for other options (*)**



- IC-751 9-band xcvr/1-30 MHz rcvr 1399.00 **1199**
 - PS-35 Internal power supply..... 160.00 **144⁹⁵**
 - FL-32 500 Hz CW filter (1st IF)..... 59.50
 - FL-63 250 Hz CW filter (1st IF)..... 48.50
 - FL-52A 500 Hz CW filter (2nd IF)..... 96.50 **89⁹⁵**
 - FL-53A 250 Hz CW filter (2nd IF)..... 96.50 **89⁹⁵**
 - FL-33 AM filter..... 31.50
 - FL-70 2.8 KHz wide SSB filter..... 46.50
 - HM-12 Hand microphone..... 39.50
 - SM-6 Desk microphone..... 39.00
 - CR-64 High stability reference xtal 56.00
 - RC-10 External frequency controller 35.00
 - MB-18 Mobile mount..... 19.50
- Options: 720/730/740/745/751 Regular SALE**
- PS-15 20A external power supply..... 149.00 **134⁹⁵**
 - EX-144 Adaptor for CF-1/PS-15..... 6.50



- Options - continued**
- CF-1 Cooling fan for PS-15..... 45.00
 - EX-310 Voice synth for 751, R-71A 39.95
 - SP-3 External base station speaker ... 49.50
 - Speaker/Phone patch - specify radio 139.00 **129⁹⁵**
 - BC-10A Memory back-up..... 8.50
 - EX-2 Relay box with marker..... 34.00
 - AT-100 100w 8-band automatic ant tuner 349.00 **314⁹⁵**
 - AT-500 500w 9-band automatic ant tuner 449.00 **399⁹⁵**
 - AH-1 5-band mobile antenna w/tuner 289.00 **259⁹⁵**
 - PS-30 Systems p/s w/cord, 6-pin plug 259.95 **234⁹⁵**
 - OPC Optional cord, specify 2 or 4-pin 5.50
 - GC-4 World clock..... (Closeout!) 99.95 **79⁹⁵**

- HF linear amplifier Regular SALE**
- IC-2KL w/ps 160-15m solid state amp 1795.00 **1299**
- VHF/UHF base multi-modes Regular SALE**
- IC-551D 80 Watt 6m transceiver..... 699.00 **599⁹⁵**
 - EX-106 FM option..... 125.00 **112⁹⁵**
 - BC-10A Memory back-up..... 8.50
 - SM-2 Electret desk microphone..... 39.00
 - IC-271A 25w 2m FM/SSB/CW xcvr..... 699.00 **619⁹⁵**
 - AG-20 Internal preamplifier*..... 56.95
 - IC-271H 100w 2m FM/SSB/CW xcvr 899.00 **759⁹⁵**
 - AG-25 Mast mounted preamplifier* 84.95
 - IC-471A 25w 430-450 SSB/CW/FM xcvr 799.00 **699⁹⁵**
 - AG-1 Mast mounted preamplifier* 89.00
 - IC-471H 75w 430-450 SSB/CW/FM xcvr 1099.00 **969⁹⁵**
 - AG-35 Mast mounted preamplifier* 84.95

For a Limited time!
With the purchase of IC-271A/H or IC-471A/H get the matching Preamp* for just \$1.00 extra.

- Common accessories for 271A/H and 471A/H**
- PS-25 Internal power supply for (A).... 99.00 **89⁹⁵**
 - PS-35 Internal power supply for (H) 160.00 **144⁹⁵**
 - PS-15 External power supply..... 149.00 **134⁹⁵**
 - CF-1 Cooling fan for PS-15..... 45.00
 - EX-144 Adaptor for PS-15/CF-1 6.50
 - SM-6 Desk microphone..... 39.00
 - EX-310 Voice synthesizer..... 39.95
 - TS-32 CommSpec encode/decoder ... 59.95
 - UT-15 Encoder/decoder interface..... 12.50
 - UT-15S UT-15S w/TS-32 installed 79.95
- VHF/UHF mobile multi-modes**
- IC-290H 25w 2m SSB/FM xcvr, TTP mic 549.00 **479⁹⁵**
 - IC-490A 10w 430-440 SSB/FM/CW xcvr 649.00 **579⁹⁵**
- VHF/UHF/1.2 GHz FM Regular SALE**
- IC-27A Compact 25w 2m FM w/TTP mic 369.00 **319⁹⁵**
 - IC-27H Compact 45w 2m FM w/TTP mic 409.00 **359⁹⁵**
 - IC-37A Compact 25w 220 FM, TTP mic 449.00 **299⁹⁵**
 - IC-47A Compact 25w 440 FM, TTP mic 469.00 **419⁹⁵**
 - UT-16/EX-388 Voice synthesizer ... 29.95
 - IC-3200A 25w 2m/440 MHz FM xcvr 549.00 **489⁹⁵**
 - IC-120 1w 1.2 GHz FM transceiver.... 499.00 **449⁹⁵**
 - ML-12 10w amplifier..... 339.00 **299⁹⁵**

- 6m portable Regular SALE**
- IC-505 3/10w 6m port. SSB/CW xcvr 449.00 **399⁹⁵**
 - BP-10 Internal Nicad battery pack 79.50
 - BP-15 AC charger..... 12.50
 - EX-248 FM unit..... 49.50
 - LC-10 Leather case..... 34.95
 - SP-4 Remote speaker..... 24.95



- Hand-held Transceivers**
- Deluxe models Regular SALE**
- IC-02AT for 2m..... 349.00 **289⁹⁵**
 - IC-04AT for 440 MHz 379.00 **319⁹⁵**
- Standard models Regular SALE**
- IC-2A for 2m..... 239.50 **189⁹⁵**
 - IC-2AT with TTP..... 269.50 **199⁹⁵**
 - IC-3AT 220 MHz, TTP 299.95 **239⁹⁵**
 - IC-4AT 440 MHz, TTP 299.95 **239⁹⁵**

- Accessories for Deluxe models Regular**
- BP-7 425mah/13.2V Nicad Pak - use BC-35 67.50
 - BP-8 800mah/8.4V Nicad Pak - use BC-35... 62.50
 - BC-35 Drop in desk charger for all batteries 69.00
 - BC-60 6-position gang charger, all batts **SALE 359.95**
 - BC-16U Wall charger for BP7/BP8 10.00
 - LC-11 Vinyl case..... 17.95
 - LC-14 Vinyl case for Dlx using BP-7/8..... 17.95
 - LC-02AT Leather case for Dlx models w/BP-7/8 39.95
- Accessories for both models Regular**
- BP-2 425mah/7.2V Nicad Pak - use BC35.... 39.50
 - BP-3 Extra Std. 250 mah/8.4V Nicad Pak.... 29.50
 - BP-4 Alkaline battery case..... 12.50
 - BP-5 425mah/10.8V Nicad Pak - use BC35 49.50
 - CA-2 Telescoping 2m antenna..... 10.00
 - CA-5 5/8-wave telescoping 2m antenna..... 18.95
 - FA-2 Extra 2m flexible antenna..... 10.00
 - CP-1 Cig. lighter plug/cord for BP3 or Dlx.... 9.50
 - DC-1 DC operation pak for standard models 17.50
 - LC-2AT Leather case for standard models.... 34.95
 - RB-1 Vinyl waterproof radio bag..... 30.00
 - HH-SS Handheld shoulder strap..... 14.95
 - HM-9 Speaker microphone..... 34.50
 - HS10 Boom microphone/headset..... 19.50
 - HS-10SA Vox unit for HS-10 & Deluxe only 19.50
 - HS-10SB PTT unit for HS-10..... 19.50
 - ML-1 2m 2.3w in/10w out amplifier..... **SALE 79.95**
 - SS-32M Commspec 32-tone encoder..... 29.95

- Shortwave receivers Regular SALE**
- R-71A 100 kHz-30 Mhz digital receiver \$799.00 **659⁹⁵**
 - FL-32 500 Hz CW filter..... 59.50
 - EX-310 Voice synthesizer..... 39.95
 - RC-11 Wireless remote controller.... 59.95
 - CR-64 High stability oscillator xtal 56.00
 - R-70 100 kHz-30 Mhz digital receiver 749.00 **569⁹⁵**
 - EX-257 FM unit..... 38.00
 - IC-7072 Transceive interface, 720A 112.50
 - FL-44A SSB filter (2nd IF)..... 159.00 **144⁹⁵**
 - FL-63 250 Hz CW filter (1st IF)..... 48.50
 - SP-3 External speaker..... 49.50
 - CK-70 (EX-299) 12V DC option..... 9.95
 - MB-12 Mobile mount..... 19.50



HOURS • Mon. thru Fri. 9-5:30; Sat. 9-3
 Milwaukee **WATS** line: 1-800-558-0411 answered evenings until 8:00 pm Monday thru Thursday.
Please use WATS lines for Ordering
 use Regular lines for other Info and Service dept.

Order Toll Free: 1-800-558-0411 In Wisconsin (outside Milwaukee Metro Area) 1-800-242-5195

AMATEUR ELECTRONIC SUPPLY[®] Inc.

4828 W. Fond du Lac Avenue; Milwaukee, WI 53216 - Phone (414) 442-4200

AES BRANCH STORES

WICKLIFFE, Ohio 44092
 28940 Euclid Avenue
 Phone (216) 585-7388
 Ohio WATS 1-800-362-0290
 Outside Ohio 1-800-321-3594

ORLANDO, Fla. 32803
 621 Commonwealth Ave.
 Phone (305) 894-3238
 Fla. WATS 1-800-432-9424
 Outside Florida 1-800-327-1917

CLEARWATER, Fla. 33575
 1898 Drew Street
 Phone (813) 461-4267
 No In-State WATS
 No Nationwide WATS

LAS VEGAS, Nev. 89106
 1072 N. Rancho Drive
 Phone (702) 647-3114
 No In-State WATS
 Outside Nevada 1-800-634-6227

Associate Store
CHICAGO, Illinois 60630
 ERICKSON COMMUNICATIONS
 5456 N. Milwaukee Avenue
 Phone (312) 631-5181
 Outside Illinois 1-800-621-5802

materials between the conductors. This property is expressed as a percentage of the velocity of light in free space.

cable dielectric	time delay nanosec/ft	velocity percentage
solid polyethylene	1.54	65.9
foam polyethylene	1.27	80.0
foam polystyrene	1.12	91.0
air space polyethylene	1.17	86.0
solid teflon	1.46	69.4
air space teflon	1.16	87.5

cable noise

An area often overlooked by Amateurs is self-generated cable noise, a phenomenon noted whenever a cable is flexed. Both acoustical and electrical noise are generated. This problem can be minimized by properly securing cable to rigid physical structures during antenna system installation.

Most prevalent in the "RG" series cables (RG-8, RG-213, RG-58, etc.) and should be carefully considered by hams who are concerned with feedline performance.

environmental resistance

The life of a coaxial cable depends on many factors other than the materials used in manufacture. The following factors all contribute to cable failure.

UV exposure. Polyethylene-jacketed cable has twice the life expectancy when exposed to direct sunlight as cable manufactured with PVC (Polyvinyl chloride) jackets.

Humidity. All cables experience vapor transmission through their plastic jackets. In Amateur applications it is advisable to install cable where it will not lie in or pass through an area where standing or running water is present.

Salt-water immersion. The electrical characteristics of cable will be rapidly affected if the conductors are exposed to salt water. If you live near a large body of salt water inspect your coax regularly for salt build-up. If your cable should become immersed, try to test the cable with a TDR (time-domain reflectometer) or find someone who can "sweep it" over the frequency range that your antenna system operates.

Underground burial and galvanic action. If you are going to install antenna cable underground, use armored/waterproof coaxial cable or regular "RG" cable installed in conduit or similar protective pipe or tubing.

selection guide

For the Amateur interested in communications through 50-MHz, RG-58 and RG-59 are prudent and inexpensive choices, though their power handling

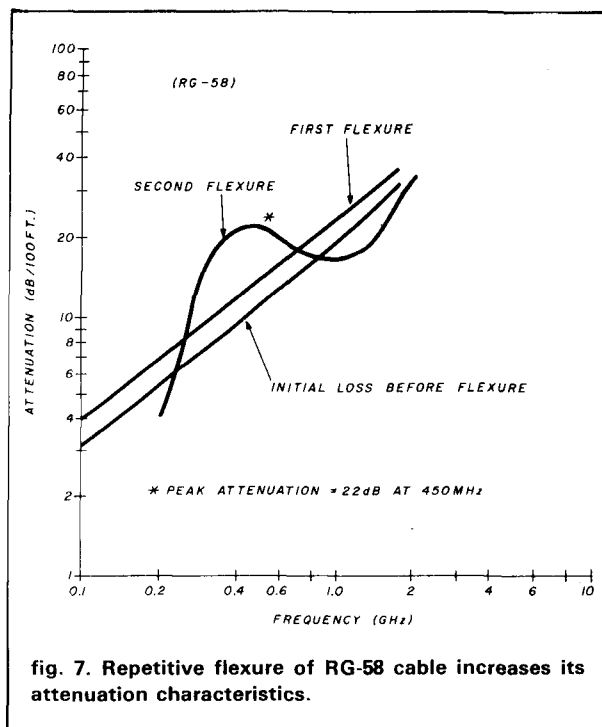

fig. 7. Repetitive flexure of RG-58 cable increases its attenuation characteristics.

capability is limited to 250 watts for RG-58 and 450 watts for RG-59.

A station designed to operate through 148 MHz should incorporate RG-8 or RG-213 coaxial cable. Unfortunately, the 3-dB roll-off point is just below 200 MHz. 220-MHz operation is possible, but 50 percent of transmitted power will be lost in a typical 100 foot run.

Many exotic transmission lines are available for 220 MHz and above. Flexible foam dielectric cable (FM-8 or FM-11, similar to RG-8 and RG-11) is useful up to 450 MHz but very susceptible to moisture penetration.

Flexible low loss cables are manufactured with braids of flat strips of silverplated copper. This helps to lower the VSWR and reduce attenuation above 1 GHz. Type SF-226, for example, is good through 10 GHz and its outside diameter is not much larger than that of RG-8.

For operation above 10 GHz I suggest using corrugated tubular aluminum with foam teflon dielectric, which is available in 3/8-inch OD for operation through 15 GHz. This cable is similar in appearance to the "BX" type of electrical conduit. The bend radius of this cable is 2.0 inches — an important fact to remember during installation.

The most popular coaxial cable among microwave enthusiasts is "hardline" or semi-flexible foam dielectric cable. It is available in various ODs, but for coverage through 22 GHz 1/4-inch OD is your best choice. Although this cable is quite expensive, CATV companies will occasionally discard it because of minor imperfections or oxidation on the outer jacket. This

AMATEUR TELEVISION

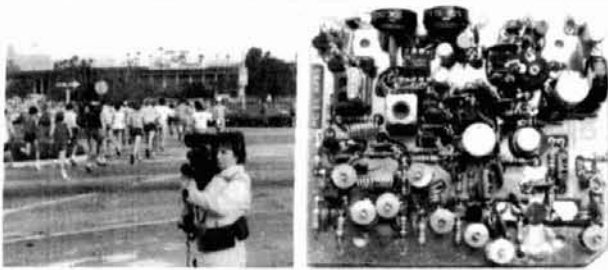

KPA5 1 WATT 70 CM ATV TRANSMITTER BOARD

- **APPLICATIONS:** Cordless portable TV camera for races & other public service events, remote VCR, etc. Remote control of R/C airplanes or robots. Show home video tapes, computer programs, repeat SSTV to local ATVs. DX depends on antennas and terrain typ. 1 to 40 miles.
- **FULL COLOR VIDEO & SOUND** on one small 3.25x4" board.
- **RUNS ON EXTERNAL 13.8 VDC** at 300 ma supply or battery.
- **TUNED WITH ONE CRYSTAL** on 426.25, 434.0, or 439.25 mHz.
- **2 AUDIO INPUTS** for a low Z dynamic and line level audio input found in most portable color cameras, VCRs, or home computers.
- **APPLICATION NOTES & schematic** supplied for typical external connections, packaging, and system operation.
- **PRICE ONLY \$159** delivered via UPS surface in the USA. Technician class amateur license or higher required for purchase and operation.

WHAT IS REQUIRED FOR A COMPLETE OPERATING SYSTEM? A TV set with a TVC-2 or TVC-4 420-450 mHz to channel 3 downconverter, 70 cm antenna, and coax cable to receive. Package up the KPA5, add 12 to 14 vdc, antenna, and any TV camera, VCR, or computer with a composite video output. Simple, eh?

CALL OR WRITE FOR OUR COMPLETE CATALOG & more info on atv downconverters, antennas, cameras, etc., or who is on in your area.

TERMS: Visa, Mastercard, or cash only UPS COD by telephone or mail. Telephone orders & postal MO usually shipped within 2 days, all other checks must clear before shipment. Transmitting equipment sold only to licensed amateurs verified in 1984 Callbook. Calif. include sales tax.

(818) 447-4565 m-f 8am-6pm pst.

P.C. ELECTRONICS

Tom W6ORG Maryann WB6YSS



2522 Paxson Lane
Arcadia CA 91006

discarded cable is suitable for Amateur service. The only real problem with its use and installation is the proper attachment of connectors; this task should be farmed out to your local Amateur microwave expert or to your local cable connector technician!

For use above 22 GHz, tubular copper teflon dielectric cable has *no* radiation loss except at the connector interface. An example is CL-50087T, which is good through 60 GHz. Difficult to work with and very expensive, this type of cable is used in military avionics.

conclusion

Considering the many electrical and physical characteristics that must be analyzed, selection of RF coaxial cable is really quite complicated. Knowing these parameters is important when attempting to design a communications system for optimum performance.

I am willing to provide additional information on cable, connectors, and installation procedures. Please send requests to my home address, which appears at the beginning of this article. (Please be sure to enclose a legal-size SASE with 3 first-class stamps or IRCs; only inquiries with SASEs can be answered.)

ham radio

✓ 168

**KENWOOD
SPECIAL
R-11
Receiver
\$79.95
Cash Price
& Shipping**

MA. ★

TEL-COM ★
Electronic Communications

Authorized Dealers For

KENWOOD & ICOM

Also displaying the popular accessories needed to complete a HAM STATION . . .

- ARRL PUBLICATIONS • AEA PRODUCTS • AMPHENOL
- ALPHA DELTA • ASTRON • AUSTIN ANTENNAS • AVANTI
- BELDEN • BENCHER • B & W • DAIWA • HAM-KEY
- HUSTLER • KLM • LARSEN • MIRAGE • ROHN
- TELEX/HY-GAIN • VIBROPLEX • WELZ • ETC.

OPEN SIX DAYS A WEEK

**SPECIAL
KENWOOD
TR 2600 A**

With extra PB-26
Battery

\$319.00

Shipping extra

Telephone 617/486-3400, 3040

675 Great Rd., (Rte. 119) Littleton, MA 01460

1 1/4 miles from Rte. 495 (Exit 31) toward Groton, Mass.

✓ 169

balun chop suey

A collection of
odds and ends
on 1:1 transmission-
line baluns

In San Francisco's famous Chinatown, I learned a secret: the words "chop suey" mean "odds and ends," which is apparently what that familiar Chinese dish is composed of. This article, a collection of odds and ends about 1:1 transmission-line baluns, is based on comments and questions I have been asked as a result of my previous balun articles. None of the individual comments is long enough to warrant separate articles — hence the peculiar title. These odds and ends also refer to balun articles presented by other writers. I hope this discussion will interest balun users and designers alike.

introduction

First, to establish a frame of reference, I plan to discuss transmission-line baluns with input-output impedance ratios of 1:1. The transmission line is wound into an inductance, usually on a ferrite form, either a rod or a toroid.

A balun serves two purposes: first, to provide equal and opposite voltages to a balanced load, and second, to provide isolation between the coax outer conductor and the half of the balanced antenna connected to the outer conductor. Because the second is the more difficult problem, I will limit my discussion to it.

The isolation requirement of a balun has been well defined qualitatively by Walter Maxwell, W2DU.¹

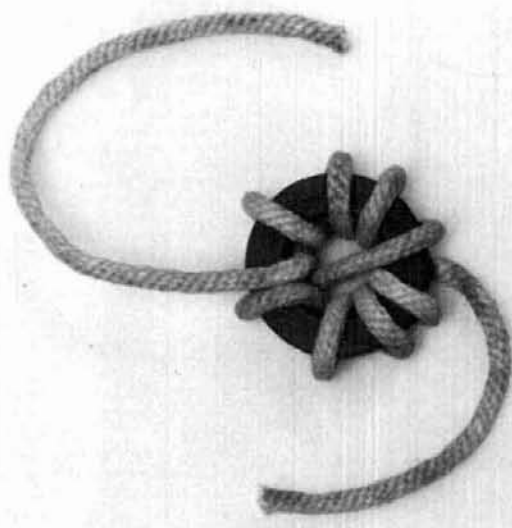

A toroidal core with a super-toroid winding. This core is wound with clothesline for photographic purposes.

Maxwell's article was the first to describe, in the Amateur literature, the concept of separate currents flowing on the inside and outside of the outer conductor, representing the signal current and unbalanced currents, respectively. I have found this concept helpful in describing the isolation function of a balun, both in a previous article² and in this one. I will expand on Maxwell's comments by giving some numbers to specify isolation quantitatively.

isolation

The isolation function of a balun is to provide a high impedance between the outside of the outer conductor, and that half of the dipole antenna connected to the outer conductor, without affecting the current flowing on the inside of the outer conductor to its half of the dipole. Very little appears to have been published, at least in the Amateur literature, either quantitatively or qualitatively, on the isolation property of a balun.



Briefly, isolation is necessary to ensure that the signal current flowing on the inside of the outer conductor flows into the antenna, not back down the outside of the outer conductor to ground. Lack of sufficient isolation is one reason antenna currents become unbalanced.

By John J. Nagle, K4KJ, 12330 Lawyers Road,
Herndon, Virginia 22071

SUPER ANTENNA SALE

CUSHCRAFT MULTI-BAND A3 \$215.00 A4 269.95 A743/A744 75.00 R3 Motor Tuned Vert. 279.00 A5 80-10M Vertical 99.00 VHF-UHF 215WB 2M Wide Band 79.00 230WB Stacked 215's 219.00 32-19 Boomer 19ELE 2M 95.00 A147-4 32.95 A449-6 34.00 A449-11 44.00 Ringo Rangers 2M, 6M, 220, 450 39.95 OSCAR TWIST A144-10T 54.00 A144-20T 75.00 A147-20T 75.00 416TB 64.00 AOP-1 Package 149.00	HY-GAIN TH7 DXS Tribander \$435.00 TH5 MK2S 5ELE 389.00 Explorer 14 3ELE 299.95 QK710 30/40Mtr Kit 79.00 205BAS 5ELE 20Mtr 349.00 204BAS 4ELE 20Mtr 259.00 66 BS 6ELE 6Mtr 135.00 18HTS 80-10M Vertical 439.00 18AVT/WBS 80-10M Vertical 104.95 14AVQ/WBS 40-10M Vertical 75.00 23BS 3ELE 2Mtr 28.00 25BS 5ELE 2Mtr 36.00 28BS 8ELE 2Mtr 49.00 V2S 2 Mtr Vertical 49.00 V3S 220 Vertical 55.00 V4S 440 Vertical 65.00 BN86 Balun 19.00 Telex Headsets in Stock—Call	KLM KT-34 \$335.00 KT-34XA 485.00 2M-14C 2Mtr Circular 85.00 435-18C 440 Circular 65.00 2M 16LBX 2 Mtr 105.00 2M 22C Circular 120.00 2Mx2C Stacking Frame 79.95 435-40CX Circular 149.95 Plus Much More	HUSTLER G7 144 2M Vertical \$119.95 G6 144 2M Vertical 85.95 G6 440 440 Vertical 109.95 6BTU 80-10M Vertical 129.95 MO-2 Mast 23.95 RM-80 400W PEP 19.95 RM-75 400W PEP 19.95 RM-40 400W PEP 18.95 RM-30 400W PEP 17.95 RM-20 400W PEP 16.95 RM-15/RM10 400W PEP ea 12.95 SF-2 2M Mobile 13.95 CG-144 2M Collinear 33.95 CGT-144 Collinear w/Trunk Mt. 53.95 Bumper Mounts—Springs in Stock
ROTORS Alliance HD73 99.95 Alliance U110 49.95 Telex CD-45 139.95 Telex Ham 4 219.00 Telex T2X 269.00 KenPro KR 500 185.00	TOWER Large Stock of Rohn 25G in Stock Call for Your Discount Price	BUTTERNUT HF6V 80-10M Vertical \$119.95 HF2V 80/40M Vertical 115.95 2MCV5 2 Mtr Vertical 55.00 TBR-160-S 160M Resonator 49.00 RMK-II Roof Mount Kit 49.00 STR-II Stub Tuned Radials 29.00	CABLE Standard 8 Cond 25/ft Heavy Duty 8 Cond 36/ft RG8U 97% 35/ft RG8X 97% 25/ft RG213U 35/ft
ANTENNA SPECIALISTS (Avanti) AP153 3G 2M on Glass \$34.00 AP200 3G 220 MHZ on Glass 38.00 AP450 3G 450 MHZ 34.00 AP450 5G 450 MHZ 38.00			

Large Stock At Discount Prices—For Orders & Quotes Call 1-800-523-7731



 & C.O.D.S Welcome—Freight, F.O.B. Evansville—Prices & Availability Subject to Change

PLUS RIGS RIGS RIGS

ICOM



New IC 735
Call for Your Special Price

ICOM	
751 Top of the Line	\$1179.00
745 Gen. Cov. Xcvr	769.00
R71A Gen. Cov. Rcvr	629.95
271A 2M All Mode	599.95
271H 2M 100W	749.95
471A 430-450MHZ 25W	699.95
471H 430-450MHZ 75W	949.75
27A 2M 25W Mobile	319.95
27H 2M 45W Mobile	355.00
37A 220MHZ Mobile	299.95
47A 440 MHZ Mobile	399.95
2AT 2Mtr H.T.	199.95
3AT/4AT 220/440 H.T.'s	ea. 229.95
NEW 3200 Dual-Bander	CALL
02AT 2Mtr H.T.	289.95
04AT 440MHZ H.T.	319.95
BC-35 Drop In Rapid Chgr	65.00
All Accessories in Stock	

AMERITRON	
AL84	\$ 399.95
AL80 3-500Z Tube	609.95
AL1200	1419.00
RCS-8 Remote Coax Switch	119.95

CALL FOR PRICES ON
EQUIPMENT FOR OSCAR 10

MON-FRI 9AM-6PM
SAT 9AM-3PM

TEN-TEC



Corsair List \$1169.00
Call for Discount Price

TEN-TEC	
260 P.S./Spkr	\$ 170.00
263 VFO	170.00
229 2KW Tuner	249.95
4229 Tuner Kit	189.00
525D Argosy	525.00
2510 Satellite Station	399.95
2591 2M H.T.	269.95
Titan—Ultimate Hog	2175.00
220, 288, 285, 282 Filters	ea 55.95
MIRAGE	
B23A 2-30W PreAmp	\$ 89.95
B108 10-80W PreAmp	159.95
B3016 30-160W PreAmp	204.95
B1016 10-160W PreAmp	249.95
D24N 2-40W 430-450	184.95
D1010N 30-100W 430-450	279.95

AEA	
CP-1 Computer Interface	\$189.95
CP-1/C-64 or Vic 20 Software	
Package	229.95
MP-20 or MP-64	149.95
MAP-64 w/AMTOR	199.95
MP-1—Micropatch	CALL
DR. DX	99.95
PKT-1 Packet Controller	459.95
Isopoles, Hotrods, Software in Stock	

BENCHER	
BY-1 Black Base	\$39.00
BY-2 Chrome Base	49.00
ZA-1A Balun	19.00

ENCOMM



KDK 2033
List 339.00—Sale 265.00

TOKYO HY-POWER	
HL30V 2M Amp 2-30FM	\$ 62.95
HL35V 2-30FM PreAmp	74.95
HL85V 2M, PreAmp 10-80	149.95
HL160V 2M, PreAmp 3/10-160	295.00
HL20U 440-450 2-20	105.00
HL90U 440-450 10-90	315.00
HRA-2 GasFet PreAmp	119.00
HRA-7 GasFet PreAmp	119.00

KANTRONICS	
Packet Communicator	\$349.95
U.T.U. Universal Terminal Unit	179.95
Interface II	229.00
The Challenger	89.95
All HamSoft, Hamtext, AMTOR Programs in Stock—Call for Discount Price	

MFJ	
1229 Interface/Free Software	\$159.95
1224 Interface/Free Software	85.00
1228 Interface/Free Software	62.95
989 3KW Roller Inductor Tuner	289.95
941D 300W Full Feature Tuner	89.95
422 Keyer/Bench Paddle	
Combo	99.95
313 H.T. Converter	36.00
106 24 Hr. Clock	19.95

B & W	
370-15 80-10M Folded Dipole	\$135.00
AT-110 5 Band Trap Dipole	76.00
AT-55 4 Band Trap Dipole	58.00
CS-3G Coax Switch 3 Pos.	27.25
CS-6B Coax Switch 6 Pos.	32.00
CSR-5G Coax Switch 5 Pos.	24.75
AC-1 Center Insulator	6.95

YAESU



FT757GX
Call for Special Price

YAESU	
FT980 Deluxe Xcvr	\$1425.00
FT757HD P.S. w/Fan	175.00
FC757AT Auto Tuner	235.00
MMB-20 Mounting Bracket	24.00
FT726R Tri-Band Xcvr	779.00
H.F. Module	205.00
6M Module	189.95
430 Module	249.95
FT209RH 2M H.T. 5W	299.95
FT203R/TT	229.95
Much Much More in Stock	

ASTRON POWER SUPPLIES	
RS7A 5-7 Amp	\$ 49.00
RS10A 7.5-10 Amp	59.00
RS12A 9-12 Amp	69.00
RS20A 16-20 Amp	89.00
RS20M 16-20 Amp w/meter	109.00
RS35A 25-35 Amp	135.00
RS35M 25-35 Amp w/meter	149.00
RS50A 37-50 Amp	199.00
RS50M 37-50 Amp w/meter	225.00
VS20M Dual Mtrs. Adj. Voltage	129.00
VS35M Dual Mtrs. Adj. Voltage	175.00
VS50M Dual Mtrs. Adj. Voltage	250.00

DAIWA	
CN520 1.8-60 MHZ	\$ 63.00
CN540 50-148 MHZ	72.00
CN550 144-250 MHZ	81.00
CN620B 1.8-150 MHZ	110.00
CN630 140-450 MHZ	130.00
CN720B 1.8-150 MHZ	129.00
CS201 2 Pos. Switch	23.00
CS-401 4 Pos. Switch	62.00

In its simplest terms, the situation can be considered as a circuit problem. To ensure that the transmission-line current flows into the antenna and not back down the outside of the outer conductor, the impedance provided by the path down the outside of the outer conductor should be many times that of one-half the dipole antenna. For example, if the impedance of the dipole antenna is assumed to be 70 ohms, the impedance of one-half the dipole will be 35 ohms. By making the impedance of the balun to these "outside" currents 10 times this impedance, or 350 ohms in this case, at least 90 percent of the transmission-line current will flow into the antenna and less than 10 percent back down the outside of the coax.

A balun impedance of five times the load impedance (as used above) is an arbitrary figure, although I feel it should be adequate for a general-purpose balun. For a precision balun, one might prefer an isolation of, say, 10 or more times the impedance presented by one-half the total load. In a transmission-line balun, the isolation is provided by the inductive reactance of the winding. The isolation actually provided by a given balun can be determined by measuring the inductive reactance as described in reference 2.

Assuming a linear inductor, as long as the operating frequency is well below the self-resonant frequency of the inductor, the inductive reactance will be directly proportional to frequency. Therefore, there will be a frequency below which the inductive reactance will not be sufficient to provide the required isolation between the antenna and the coax feedline. This determines the low frequency limit of the balun.

The maximum usable frequency of a balun is limited by the stray capacitance across the winding. As the operating frequency increases, a frequency will be reached where the stray capacitance across the balun resonates with the inductance of the winding so that the winding is in parallel resonance. At this frequency the impedance of the balun, and hence its isolation, is the maximum it will be, so that this is a desirable frequency at which to operate. As the operating frequency is further increased, the reactance of the balun becomes capacitive and decreases with frequency until the balun becomes series-resonant. At this frequency the balun impedance is very low and the balun provides virtually no isolation at all. The upper useful frequency limit of the balun is usually between the parallel and series resonant frequencies. The actual frequencies are a function of the construction techniques, the object being to maximize the inductance and minimize the stray capacitance across the winding. (This problem is a subject in itself.)

Fig. 1 shows the inductive reactance versus frequency of a typical transmission-line balun. From a graph such as this, the useful frequency range of the balun can be easily determined for any value of load

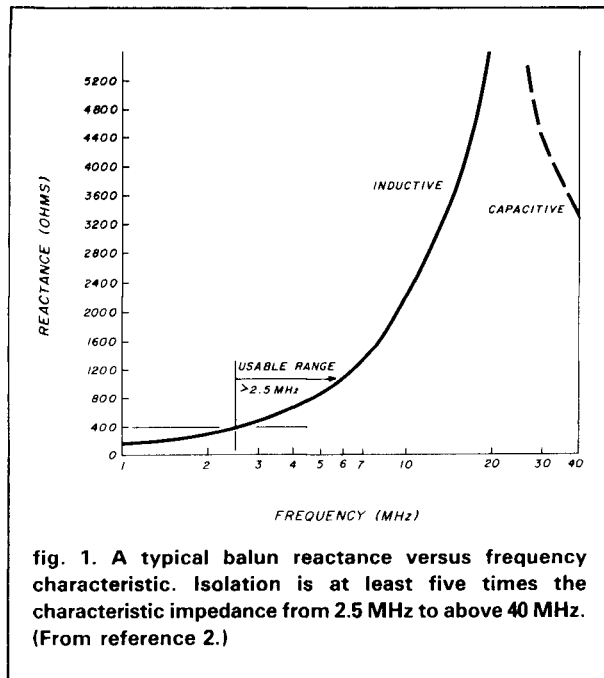

fig. 1. A typical balun reactance versus frequency characteristic. Isolation is at least five times the characteristic impedance from 2.5 MHz to above 40 MHz. (From reference 2.)

impedance. The assumed isolation impedance of five times the load impedance, based on VSWR considerations, has been arrived at by others.

To put the isolation property of a balun on a sound technical basis from the user's point of view, I believe balun manufacturers should specify the minimum ratio of the balun winding impedance to the characteristic impedance over the specified frequency range.

testing core saturation

The methods used for testing a balun for core saturation are simple; one method is to wrap a few turns of insulated wire around the balun, as shown in fig. 2, and then connect this winding to an oscilloscope to observe the waveform. Gradually increase the output power of the transmitter until a distorted waveform appears. Then back off the power until the waveform again becomes sinusoidal. This represents the maximum peak power a given balun can handle.

A more sensitive version of this method involves connecting the test winding to a spectrum analyzer, instead of an oscilloscope, and measuring the amplitude of the various harmonics. Care must be taken here, however, to make certain the harmonics measured are generated by the balun and not by the transmitter.

An even more sensitive test is to use the RF equivalent of the two-tone test used to measure intermodulation distortion on high-fidelity audio equipment or receiver front-ends. Here two transmitters operating on slightly different frequencies are connected to the balun (and a dummy load) through a diplexer. This test

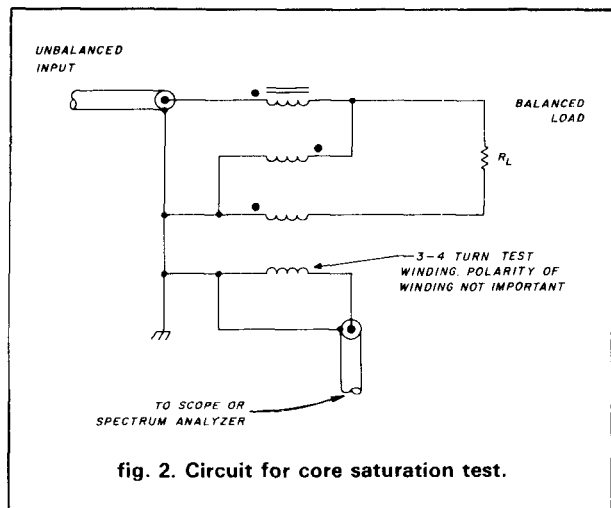

fig. 2. Circuit for core saturation test.

was proposed by Rich Rosen, K2RR, editor-in-chief of *ham radio*; I have not tried it myself.

If saturation is present, it can be corrected by increasing the number of turns, or by using a larger core (cross section), or both.

Increasing the number of turns will also have the effect of improving the performance of the balun at the low end of the frequency range. It will also lower the high-frequency end of the range by reducing the self-resonant frequency of the winding.

If the existing winding efficiently uses the available winding area, it will be necessary to increase the size of the core to accommodate the additional turns unless it is possible to use smaller wire. However, in a transmission-line balun the wire size may be dictated by the desired (or required) characteristic impedance of the winding; the wire diameter and spacing — being parameters — determine the characteristic impedance of the winding.

While the equipment needed and the procedures are relatively simple, the practical problems of testing baluns can be substantial. First, it takes a high-power transmitter and a high-power, preferably balanced, dummy load. Most Amateurs, however, will probably use an unbalanced load because this type is the most readily available. Care must be taken that the load case is well insulated from ground because the case will be at one-half the unbalanced line voltage when used as a balanced load.

The transmitter must be capable of providing the highest power level at which the balun is expected to operate. The balanced dummy load, of course, must be capable of dissipating this amount of power.

A more convenient load, at least if you are testing the balun for your own use, is to use the regular station antenna. (Choose a time when the band is dead!) The problem here is that the balun will be high in the air, requiring long test leads in a high-power antenna field,

because RF can be picked up by the line and result in inaccurate measurements.

transformers or inductors?

One of the principal sources of confusion in balun design, construction, and use seems to be the belief that all baluns are transformers. One well-respected writer recently stated "It is important to recognize that a 4:1 or a 1:1 balun . . . is essentially a broadband transformer." If he had stopped to think about it, I'm sure this writer would have known better. Strictly speaking, any device or collection of components which transforms a balanced line to an unbalanced line *can* be called a transformer; in electronics the expression "transformer" is usually reserved for one particular type of device where all, or part, of the energy passes from input to output by means of magnetic induction. The usual two-winding or three-winding 1:1 transmission-line balun, however, is not a transformer because none of the energy is transmitted from input to output by magnetic induction. This type of balun should not be designed, tested, or used as a transformer. A 1:1 transmission-line balun is an inductor wound with a transmission line and must be designed, tested, and used as an inductor wound with a transmission line. Failure to recognize this difference in design or application is almost certain to lead to disappointment in the use.

Further complicating the situation is the fact that a transmission-line balun can be constructed with impedance transformation ratios other than 1:1, although I have not seen this done in Amateur applications. The common 4:1 balun is really an auto-transformer and not a transmission line device.

A broadband transformer, on the other hand, must be designed in accordance with well-known transformer equations relating the number of turns, the peak voltage, and the allowable maximum magnetic flux density in the core.

A second means of distinguishing between transformer and transmission-line baluns is that with a transformer balun, the relationship between the load impedance and input impedance is the turns ratio squared. With a transmission-line balun, the load-to-input impedance ratio is calculated using the more complex transmission-line equation:

$$Z_{in} = \frac{Z_{ch} (Z_r \cos \theta + jZ_{ch} \sin \theta)}{(Z_{ch} \cos \theta + jZ_r \sin \theta)} \quad (1)$$

There are two problems in designing transmission-line baluns. The principal problem is designing a wide-band inductor, i.e., an inductor whose reactance is above a given value — usually five to ten times the load impedance — over the desired range of frequencies. The second problem is designing a suitable trans-

ham radio Reader Service

For literature or more information, locate the Reader Service number at the bottom of the ad, circle the appropriate number on this card, affix postage and send to us. We'll hustle your name and address to the companies you're interested in.

101 113 125 137 149 161 173 185 197 209 221 233 245 257 269 281 293 305 317 329 341
102 114 126 138 150 162 174 186 198 210 222 234 246 258 270 282 294 306 318 330 342
103 115 127 139 151 163 175 187 199 211 223 235 247 259 271 283 295 307 319 331 343
104 116 128 140 152 164 176 188 200 212 224 236 248 260 272 284 296 308 320 332 344
105 117 129 141 153 165 177 189 201 213 225 237 249 261 273 285 297 309 321 333 345
106 118 130 142 154 166 178 190 202 214 226 238 250 262 274 286 298 310 322 334 346
107 119 131 143 155 167 179 191 203 215 227 239 251 263 275 287 299 311 323 335 347
108 120 132 144 156 168 180 192 204 216 228 240 252 264 276 288 300 312 324 336 348
109 121 133 145 157 169 181 193 205 217 229 241 253 265 277 289 301 313 325 337 349
110 122 134 146 158 170 182 194 206 218 230 242 254 266 278 290 302 314 326 338 350
111 123 135 147 159 171 183 195 207 219 231 243 255 267 279 291 303 315 327 339
112 124 136 148 160 172 184 196 208 220 232 244 256 268 280 292 304 316 328 340

Limit 15 inquiries per request.

NAME _____ CALL _____
ADDRESS _____
CITY _____ STATE _____ ZIP _____

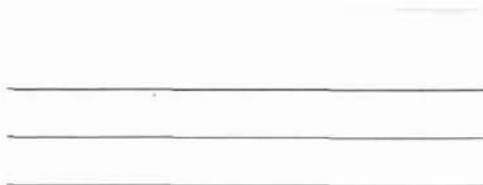

AFFIX POSTAGE
OR
POST OFFICE
WILL NOT
DELIVER

ham
radio
magazine

READER SERVICE CENTER
P.O. BOX 2558
WOBURN, MA 01888

ATTN: Reader Service Dept.

mission line, with the required characteristic impedance, capable of being wound on a ferrite core.

Briefly summarizing, because of the similarity in the appearance and circuit configuration of different types of baluns and transformers, both of which use magnetic cores, there is considerable confusion about their operating characteristics. This in turn leads to improper design and application of the devices. Before criticizing a device, one should make certain it has been properly designed and used.

the super-toroid

The super-toroid balun design was introduced to the Amateur community by Reisert in his article on the two-winding transmission-line balun.³ The concept of a super-toroid, however, was developed by Tom Gross in the early 1960's; Gross is a designer of precision magnetic components who specializes in devices operating at supersonic frequencies — 20 kHz to 500 kHz and up. The purpose of the super-toroid design is to reduce the sensitivity of the conventional toroidal coil to external magnetic fields.

Contrary to popular belief, a single-layer toroidal inductor is sensitive to external magnetic fields because of what is known as the one-turn effect. With a conventional, single-layer toroid, the winding is spirally wound around the core, as seen in **fig. 3**. Each turn is composed of two winding components: one component is aligned with the center of the toroid. The other component is at a right angle to the radial component and is known as the circumferential component. These two components are emphasized in **fig. 4**. The circumferential component provides the progression of the winding around the core. If there were no circumferential component, each turn would lie on top of the preceding turn.

The circumferential components constitute a single-turn loop antenna which, as is well known, has a response to extraneous signals originating in the plane of the toroid, as shown in **fig. 5**. This is known as the "one turn" effect of a toroidal winding. If the winding has more than one layer, the single-turn effect becomes an N-turns effect, where N is the number of layers.

The super-toroid design eliminates the one-turn effect by winding half the turns in one direction, then running the winding across the diameter of the core to the opposite side and winding the other half of the core in the opposite direction. The voltages induced in the circumferential components are therefore equal and opposite and therefore cancel. The photo shows a core wound in this manner. The winding in this case is clothesline rope to show up better in the photograph.

This technique assumes that the *external* magnetic field is uniform through the diameter of the core and

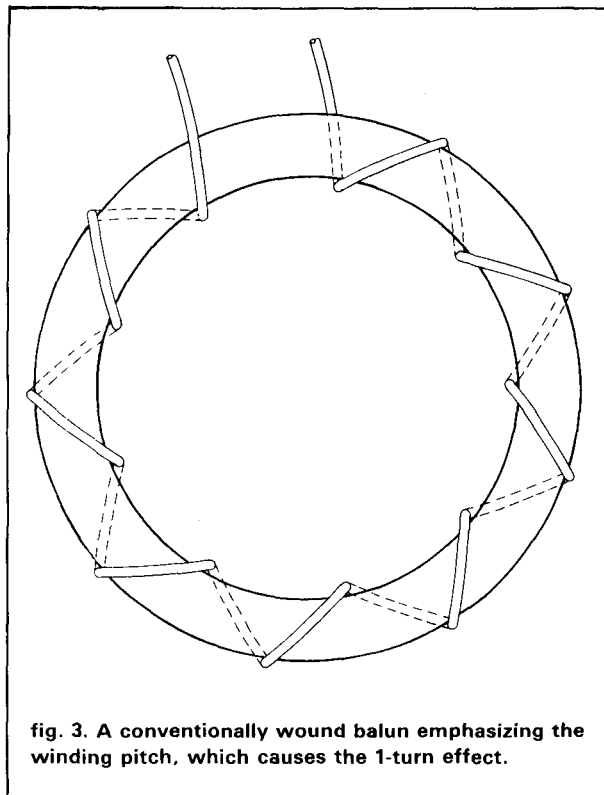

fig. 3. A conventionally wound balun emphasizing the winding pitch, which causes the 1-turn effect.

the core material is homogeneous. If both these conditions are not met, even more complex types of windings must be used to provide isolation from external magnetic fields.

A secondary advantage of the super-toroid design, and one that is much more important to balun designers, is the fact that the effective capacitance across the winding is reduced, which increases the usable bandwidth of the device.

Any inductor consists of stray capacitance as well as inductance. In the design of an inductance, the object, of course, is to maximize the inductance and minimize the capacitance. As seen in **fig. 6**, this capacitance consists of an infinitely large number of incremental capacitances such as the capacitance between adjacent turns, capacitance between turns that are not adjacent, and between the ends of coil. From an engineering standpoint, it is not practical to evaluate an infinite number of small capacitances. Therefore, the "effective capacitance" of an inductor is defined as that of a physical capacitor connected across the ends of the inductor, which stores the same amount of energy as that stored by the incremental capacitors.

The energy stored in a capacitor is proportional to the product of the physical capacitance and the voltage across the capacitor squared: $Energy = \frac{1}{2} CV^2$. If the two plates of a capacitor are at the same potential, the energy stored by the capacitor is zero

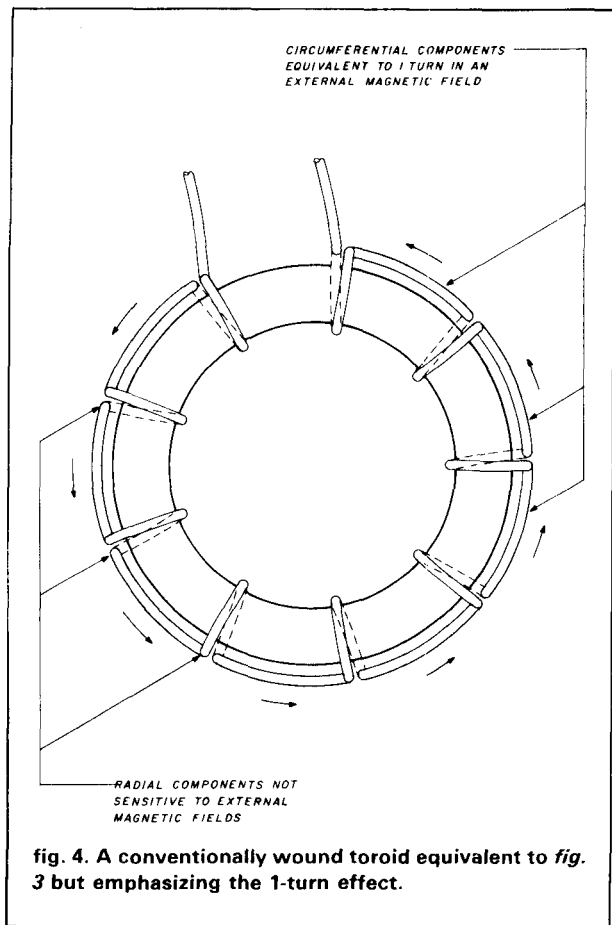

and the effectiveness of the capacitor is nil. It is, therefore, important that the portions of an inductance that are at the greatest potential difference have the lowest possible physical capacitance. The ends of the winding are at the greatest potential difference, hence they should have the greatest separation to minimize the physical capacitance.

A super-toroid has the ends of the windings at opposite ends of the core diameter, which is about as far apart as it is possible to place them. A conventionally wound balun, on the other hand, has the ends of the windings adjacent to each other, where they have the highest capacitance. It is, therefore, easy to see why the super-toroid winding would have a lower effective capacitance and hence a greater bandwidth. Then why not use the super-toroid winding exclusively?

For a two-winding balun, the super-toroid winding is preferable. For a three-winding balun, the situation is complicated by the tertiary interconnections between the opposite ends of the two main windings. With a continuously wound toroid, these interconnections can be short and can have a low impedance. With a super-toroid winding, the two leads of the tertiary winding come out on opposite sides of the core, so that both tertiary leads must cross the core. This

greatly increases the leakage reactance between the main winding and the tertiary winding and will prove detrimental to proper balun operation above 20 MHz.

Thus, even though the super-toroid winding inherently gives greater bandwidth, it should not be used for a three-winding balun. For three-winding baluns, it is necessary to use a continuous winding to ensure short, low impedance interconnections between the tertiary and main windings.

wide bandwidth?

Numerous *ham radio* readers have questioned the desirability, or necessity, of the wide bandwidths advertised for commercial baluns — typically 3.5 to 30 MHz, and more recently, 1.5 to 56 MHz. Are bandwidths this wide really necessary? Or desirable? The argument is that since few, if any, Amateurs use the same antenna for 80 through 10 meters, much less 160 through 6 meters, why insist that a balun cover a greater, wider bandwidth than the antenna?

My own opinion is that these wide bandwidths are unnecessary and may not be desirable. The antenna installation for a typical Amateur active in the HF region might be a dipole on 80/75 meters or 40 meters plus a triband beam for 20, 15; and 10 meters. If space permits, maybe a 6-meter beam, too. Therefore, a balun that gave high performance, say, from 3.5 to 10 MHz and a second balun optimized for 14 to 30 MHz could be designed to provide higher performance at the extreme edges of these bands than a single wideband balun covering the entire frequency range.

This has been substantiated by my own experience in building and measuring baluns. Wideband baluns — 80 through 10 meters — gave marginal but acceptable performance at the low end of 80 meters and at the high end of 10 meters. The isolation impedance was just barely equal to five times the characteristic impedance of the transmission line.

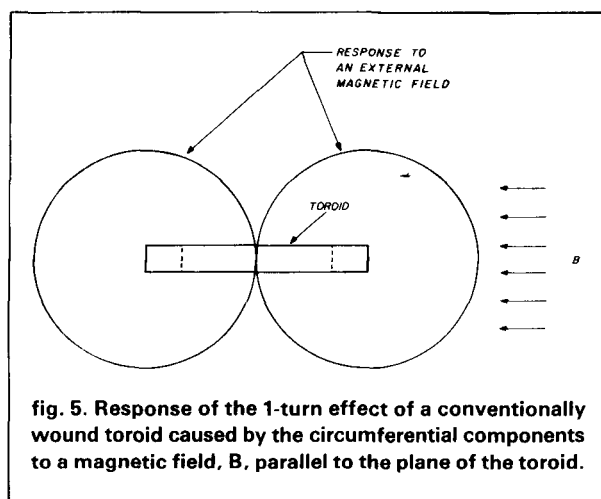

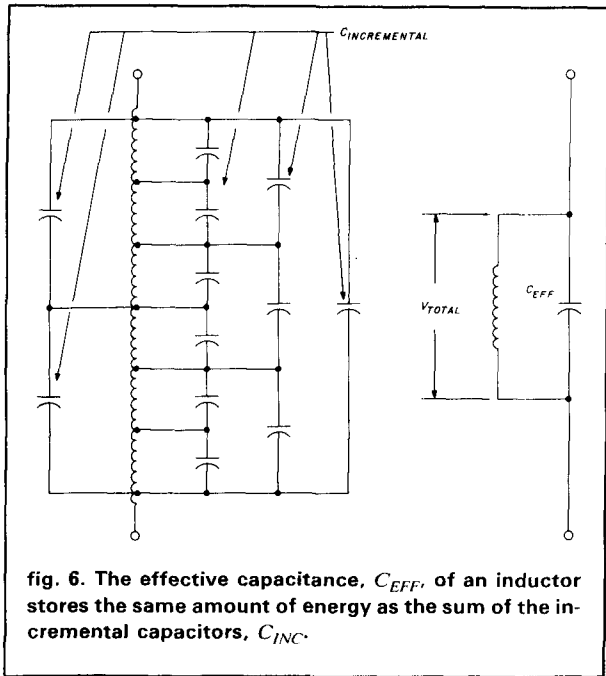

fig. 6. The effective capacitance, C_{EFF} , of an inductor stores the same amount of energy as the sum of the incremental capacitors, C_{INC} .

By adding one or two turns to the winding I could dramatically improve the performance at the low end of 80 meters, but the series resonant frequency occurred in the middle of the 10-meter band. Similarly, by removing a turn or two I could improve the isolation at 10 meters, but only at the expense of the 80-meter band.

In my opinion, the bandwidth performance of presently available baluns is limited by the following factors:

- State-of-the-art in presently available core materials — for example, higher permeabilities at the higher frequencies.
- The limitations imposed on the design by having to wind the core with a transmission line of a specified characteristic impedance rather than a single conductor as with the usual inductor.
- The need to handle an appreciable amount of power.

The reasons commercial baluns for Amateur applications are all wideband devices may include:

- Competition: no manufacturer can afford to offer a balun with less bandwidth than any other manufacturer.
- Lack of published specifications concerning isolation impedance, balance, and isolation make it impossible to tell how effective a given balun may be at the band edges.
- Economy: it is much less expensive for manufacturers and distributors alike to stock a single balun than several different "sizes."

For these reasons, I believe that if Amateurs want high-performance baluns optimized for particular bands, they will have to wind the balun themselves.

final comments

Physically, transmission-line baluns are very simple devices. This simplicity often causes some of the more subtle characteristics to be overlooked during design or use. Recognizing these subtleties may be the biggest problem in designing and using baluns.

reference

1. Walter Maxwell, W2DU, "Some Aspects of the Balun Problem," *QST*, March, 1983, page 38.
2. John J. Nagle, K4KJ, "Testing Baluns," *ham radio*, August, 1983, page 30.
3. Joe Reisert, "Simple and Efficient Broadband Balun," *ham radio*, September, 1978, page 12.

ham radio

short circuits

may 1985

digital HF radio

In "Digital HF Radio: A Sampling of Techniques" (April, 1985) the author's name was misspelled. "Dr. Ulrich L. Rhode," as it appears on page 18, should be corrected to read, "Dr. Ulrich L. Rohde." *ham radio* regrets the error.

may 1985

harmonic mixer

In fig. 2 of K1ZJH's "Harmonic Mixer for VHF Signal Generation" (March, 1985, page 40), T1 should be identified as a T37-6 toroid available from Amidon Associates, Inc., 12033 Otsego Street, North Hollywood, California 91607.

may 1985

low-voltage power supplies

In fig. 9 of the March article, "Designing Low-Voltage Power Supplies," Q1, Q2, and Q3 are shown incorrectly wired. The base leads of Q1 and Q2 should be connected to the collector of Q3, not its base.

SALE SAVE \$2.55

READY REFERENCE

by John Markus

Digital Circuits	MH-40457
Popular Circuits	MH-40458
Electronics Projects	MH-40459
Communications Circuits	MH-40460
Special Circuits	MH-40461

Each book is dedicated to one subject area and includes references from hundreds of hobby and professional publications. Originally appeared in *Modern Electronics Circuits Reference Manual* © 1980. We find the five separate volumes easier to use than the original. Of special interest to hams is *Communications Circuits*. 15 chapters include antennas, code, receiving and transmitting circuits as well as modulator, telephone, teleprinter and television circuits. © 1982, 2nd edition.

Softbound Reg. \$12.50 each

May Special Price

\$9.95 each

Please enclose \$3.50 shipping and handling

ham radio magazine **BOOKSTORE**

GREENVILLE, NH 03048



DoKay

COMPUTER
PRODUCTS,
Inc.

ORDER TOLL FREE

(800)
538-8800

(CALIFORNIA RESIDENTS)

(800)
848-8008



STATIC RAMS

2101	256 x 4 (450ns)	1.90
5101	256 x 4 (450ns) (cmos)	3.90
2102-1	1024 x 1 (450ns)	.79
2102L-4	1024 x 1 (450ns) (LP)	.89
2102L-2	1024 x 1 (250ns) (LP)	1.29
2111	256 x 4 (450ns)	2.29
2112	256 x 4 (450ns)	2.29
2114	1024 x 4 (450ns)	.99
2114-25	1024 x 4 (250ns)	1.10
2114L-4	1024 x 4 (450ns) (LP)	1.20
2114L-2	1024 x 4 (300ns) (LP)	1.30
2114L-2	1024 x 4 (200ns) (LP)	1.40
2147	4096 x 1 (55ns)	3.95
TMS4044-4	4096 x 1 (450ns)	2.95
TMS4044-3	4096 x 1 (300ns)	3.45
TMS4044-2	4096 x 1 (200ns)	3.95
MK4118	1024 x 8 (250ns)	8.95
TMM2016-20	2048 x 8 (200ns)	3.95
TMM2016-15	2048 x 8 (150ns)	4.45
TMM2016-10	2048 x 8 (100ns)	5.95
HMS1116-4	2048 x 4 (200ns) (cmos)	4.40
HMS1116-3	2048 x 4 (150ns) (cmos)	4.90
HMS1116-2	2048 x 4 (120ns) (cmos)	5.90
HMS1116LP-4	2048 x 4 (200ns) (cmos) (LP)	4.90
HMS1116LP-3	2048 x 4 (150ns) (cmos) (LP)	5.90
HMS1116LP-2	2048 x 4 (120ns) (cmos) (LP)	7.90
Z-6132	4096 x 8 (300ns) (Qstat)	29.95
HMS264P-15	8192 x 8 (150ns) (cmos)	19.95
HMS264LP-15	8192 x 8 (150ns) (cmos) (LP)	22.95
HMS264LP-12	8192 x 8 (120ns) (cmos) (LP)	24.95

LP = Low Power Qstat = Quasi-Static

DYNAMIC RAMS

TMS4027	4096 x 1 (250ns)	1.45
UPD411	4096 x 1 (300ns)	1.95
MMS280	4096 x 1 (300ns)	1.95
MK4108	8192 x 1 (200ns)	4.90
MMS298	8192 x 1 (250ns)	4.90
4116-20	16384 x 1 (200ns)	7.90
4116-15	16384 x 1 (150ns)	9.90
4116-12	16384 x 1 (120ns)	14.90
2118	16384 x 1 (150ns) (5v)	3.95
4184-25	85536 x 1 (250ns) (5v)	2.00
4184-20	85536 x 1 (200ns) (5v)	2.22
4184-15	85536 x 1 (150ns) (5v)	2.50
41256-20	262144 x 1 (200ns)	12.95
41256-15	262144 x 1 (150ns)	15.95

5V = Single 5 Volt Supply

EPROMS

1702	256 x 8 (1µs)	3.95
2708	1024 x 8 (450ns)	2.49
2758	1024 x 8 (450ns)	5.90
2716	2048 x 8 (450ns) (5v)	2.95
2716-1	2048 x 8 (350ns) (5v)	3.95
TMS2516	2048 x 8 (450ns) (5v)	3.95
TMS2716	2048 x 8 (450ns) (5v)	6.95
TMS2532	4096 x 8 (450ns) (5v)	3.95
2732	4096 x 8 (450ns) (5v)	3.95
2732 A-4	4096 x 8 (450ns) (21v)	3.95
2732 A-35	4096 x 8 (350ns) (21v)	3.95
2732 A	4096 x 8 (250ns) (21v)	5.95
2732 A-2	4096 x 8 (200ns) (21v)	8.95
2764	8192 x 8 (450ns) (5v)	4.95
2764-25	8192 x 8 (250ns) (5v)	5.95
2764-20	8192 x 8 (200ns) (5v)	9.95
TMS2564	8192 x 8 (450ns) (5v)	9.95
MCM68764	8192 x 8 (450ns) (5v) (24-pin)	17.95
MCM68766	8192 x 8 (350ns) (5v) (24-pin)	19.95
27128-45	16384 x 8 (250ns) (5v)	14.95
27128-30	16384 x 8 (300ns) (5v)	16.95
27128-25	16384 x 8 (250ns) (5v)	18.95
27256-25	32768 x 8 (250ns) (14v)	79.95

5v = Single 5 Volt Supply

74LS00

74LS00	23	74LS125	.48	74LS280	.58
74LS01	24	74LS126	.48	74LS286	.54
74LS02	24	74LS132	.58	74LS273	1.45
74LS03	24	74LS133	.58	74LS275	3.30
74LS04	23	74LS136	.38	74LS279	.48
74LS05	24	74LS137	.98	74LS280	1.95
74LS08	27	74LS138	.54	74LS283	.68
74LS09	28	74LS139	.54	74LS290	.88
74LS10	24	74LS145	1.15	74LS293	.88
74LS11	34	74LS147	2.45	74LS295	.98
74LS12	34	74LS148	1.30	74LS298	.88
74LS13	44	74LS151	.54	74LS299	1.70
74LS14	58	74LS153	.54	74LS323	3.45
74LS15	34	74LS154	1.85	74LS324	1.70
74LS20	24	74LS155	.88	74LS352	1.25
74LS21	28	74LS156	.88	74LS353	1.25
74LS22	24	74LS157	.54	74LS363	1.30
74LS26	28	74LS158	.58	74LS364	1.90
74LS27	28	74LS160	.88	74LS365	.48
74LS28	34	74LS161	.54	74LS366	.48
74LS30	24	74LS162	.88	74LS367	.44
74LS32	28	74LS163	.84	74LS368	.44
74LS33	54	74LS164	.88	74LS373	1.35
74LS37	34	74LS165	.94	74LS374	1.35
74LS38	34	74LS166	1.90	74LS377	1.35
74LS40	24	74LS168	1.70	74LS378	1.13
74LS42	48	74LS169	1.70	74LS378	1.30
74LS47	74	74LS170	1.45	74LS385	1.85
74LS48	74	74LS173	.68	74LS386	.44
74LS49	74	74LS174	.54	74LS390	1.15
74LS51	24	74LS175	.54	74LS393	1.15
74LS54	28	74LS181	2.10	74LS395	1.15
74LS55	28	74LS189	8.90	74LS399	1.45
74LS63	1.20	74LS190	.88	74LS424	2.90
74LS73	38	74LS191	.88	74LS447	.36
74LS74	34	74LS192	.78	74LS490	1.90
74LS75	38	74LS193	.78	74LS624	3.95
74LS76	38	74LS194	.68	74LS640	2.15
74LS78	48	74LS195	.68	74LS645	2.15
74LS83	58	74LS196	.78	74LS668	1.65
74LS85	68	74LS197	.78	74LS669	1.85
74LS86	38	74LS221	.88	74LS670	1.45
74LS90	54	74LS240	.94	74LS674	9.80
74LS91	88	74LS241	.98	74LS682	3.15
74LS92	54	74LS242	.98	74LS683	3.15
74LS93	54	74LS243	.98	74LS684	3.15
74LS95	74	74LS244	1.25	74LS685	3.15
74LS96	68	74LS245	1.45	74LS688	2.35
74LS107	38	74LS247	.74	74LS689	3.15
74LS109	38	74LS248	.98	74LS783	23.95
74LS112	38	74LS249	.98	81LS95	1.45
74LS113	38	74LS251	.58	81LS96	1.45
74LS114	38	74LS253	.58	81LS97	1.45
74LS122	44	74LS257	.58	81LS98	1.45
74LS123	78	74LS258	.58	25LS251	2.75
74LS124	2.85	74LS259	2.70	25LS259	4.20

CRT CONTROLLERS

6845	11.95	8275	28.95
68845	18.95	7220	38.95
HD46505sp	11.95	CRT5027	18.95
6847	10.95	CRT5037	28.95
MC1372	6.90	TMS9018A	36.95
68047	23.95	DP8350	48.95

DISC CONTROLLERS

1771	14.95	2797	54.95
1791	21.95	6843	33.95
1793	25.95	8272	18.95
1795	21.95	UPD765	18.95
1797	21.95	M88876	23.95
2791	49.95	M88877	25.95
2793	49.95	1691	6.95
2795	54.95	2143	6.95

UV ERASERS

QUV-T8/1 \$49.95
ECONOMY Model



- Erases 15 EPROMS in 20 minutes
- Plastic Enclosure

6500

1 MHz		2 MHz	
6502Z	4.90	6502A	5.90
6504	6.90	6520A	5.90
6505	8.90	6522A	9.90
6507	9.90	6532A	10.90
6520	4.90	6545A	12.90
6522	4.90	6551A	10.90
6532	9.90		
6545	9.90	3 MHz	
6551	9.90	6502B	7.90

6800

1 MHz		68800	
6800	2.90	2 MHz	
6802	7.90	68800	9.90
6803	17.90	68802	11.90
6808	12.90	68809	11.90
6809E	8.90	68809E	11.90
6809	8.90	68810	5.90
6810	2.90	68821	5.90
6820	4.30	68840	18.90
6821	2.90	68845	18.90
6828	13.90	68850	5.90
6840	11.90		
6843	33.90		
6844	24.90		
6845	11.90		
6847	10.90	68000-8	34.90
6850	2.90	68047	23.90
6852	5.90	68488	14.90
6860	7.90	68652	18.90
6862	10.90	68661	8.90
6875	6.90	68764	17.95
6880	1.90	68766	19.95
6883	21.90		

8000

8031	14.90	8253	6.90
8035	5.90	8253-5	7.90
8039	5.90	8255	4.45
INS-8060	16.90	8255-5	4.90
INS-8073	29.90	8257	7.90
8085	3.90	8257-5	8.90
8085A-2	11.90	8259-5	6.90
8086	24.90	8271	69.90
8087-3 (5 MHz)	159.90	8272	19.90
8087-2 (8 MHz)	279.90	8274	28.90
8088	19.90	8275	28.90
8089	59.90	8279-5	7.90
		8282	6.45
		8283	6.45
8131	2.90	8284	4.90
8155	6.90	8286	6.45
8155-2	7.90	8287	6.45
8156	6.90	8288	12.90
8185	28.90	8289	44.90
8185-2	38.90	8292	12.90

8100

8131	2.90	8284	4.90
8155	6.90	8286	6.45
8155-2	7.90	8287	6.45
8156	6.90	8288	12.90
8185	28.90	8289	44.90
8185-2	38.90	8292	12.90

8200

8202	23.90	8303	2.90
8203	38.90	8304	1.90
8205	2.90	8307	2.90
8212	1.75	8308	2.90
8214	3.75	8310	3.90
8216	1.75	8311	3.90
8224	2.20		
8226	1.75		
8228	3.45	8741	28.90
8237	12.90	8748	19.90
8237-5	14.90	8749	28.90
8238	4.45	8755	23.90
8243	4.45		
8250	9.90		
8251	3.90	80186-6	99.90
8251A	4.45	80188	99.90

2 MHz

Z80-CPU	1.95	Z80A-SIO/0	9.95
Z80-CTC	1.95	Z80A-SIO/1	9.95
Z80-DART	6.95	Z80A-SIO/2	9.95
Z80-DMA	7.95	Z80A-SIO/9	9.95
Z80-PIO	1.95		
Z80-SIO/0	8.95		
Z80-SIO/1	8.95	Z80B-CPU	7.95
Z80-SIO/2	8.95	Z80B-CTC	8.95
Z80-SIO/9	8.95	Z80B-PIO	8.95
		Z80B-DART	18.95
		Z80B-SIO/0	28.95
		Z80SIO/2	28.95

4 MHz

ROBOT KITS! PIPER-MOUSE



Controlled by sound sensor and 1-channel electronic circuit. Use the whistle in this kit and Piper-Mouse follows your commands, turning left or right, stopping and starting. Uses 2 AA and 1 9V battery (not included).

MV-915 \$44.95
RIBBON CABLE

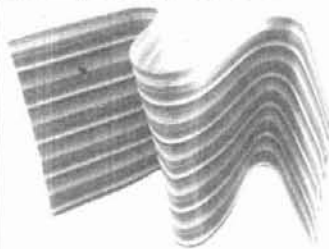

CONTACTS	SINGLE COLOR		COLOR CODED	
	1'	10'	1'	10''
10	.45	4.30	.78	7.20
16	.50	4.70	.95	8.70
20	.60	5.60	1.15	10.90
25	.70	6.50	1.22	11.50
26	.70	6.50	1.27	11.50
34	.93	8.50	1.55	14.40
40	1.27	11.50	1.82	16.70
50	1.28	12.00	2.40	21.90

RESISTORS

1/4 WATT 5% CARBON FILM
ALL STANDARD VALUES
FROM 1 OHM - 10 MEG OHM

50 PCS 1.25
100 PCS 2.00
1,000 PCS 15.00



**Checkmate
Technology,
Inc.**

**APPLE IIe Special
Extended 80-Col.
VIDEO CARD**

\$69.95

★ 64K to 128K ★
MULTIVIEW 80/160 249.00

80-160 columns with any monitor!

- Screens: 80x24, 80x32, 80x48, 96x24, 132x24, 132x30, 160x24
- On-screen **BOLD** and **Underline**
- Reverse scrolling
- Easy-to-read **Wide-angle** mode
- Apple II and IIe compatible
- Prompt lines
- Upper & lowercase letters



APPLE & IBM ACCESSORIES

80 Column Apple II+ ... 149.95
80 Column Apple IIe ... 119.95
Z80 Apple II+ 89.00
Z80 Apple IIe 89.00
16K Card 39.95
Cooling Fan 38.95
Power Supply 74.95
Joystick 29.95
RF Modulator 13.95
Disk Drive 169.95
Controller Card 59.95
Paddles 7.95

MICROMAX
INNOVATORS IN MICRO COMPUTER TECHNOLOGY

VIEWMAX-80 149.95
80-Column card for Apple II series

- Video Soft Switch
- Inverse Video
- VIDEK's Videoterm compatible



VIEWMAX-80e 119.95
80-Column extended video card for Apple IIe

- 64K RAM, expandable to 128K
- Double High-resolution circuit
- Compatible with Pascal & CP/M



PRINTMAX 59.95
Parallel printer card, Apple II series

- Centronics compatible
- Variable print widths
- Up to 5000 characters/second

**APPLE & IBM Compatible
DISK DRIVES**

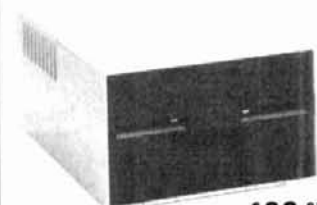

169.95

- Shugart mechanism, made in U.S.A.
- Directly replaces Apple Disk II
- Fully compatible with Apple Controller or other Apple compatible controllers.
- One Year Warranty

**FULL or 1/2-Height
16K RAM Card - Apple II+**
• 2-Year Warranty



Assembled & Tested **39.95**

APPLE or IBM JOYSTICK

\$29.95

Compatible for either:

**APPLE II and APPLE IIe
OR**

**IBM-PC, JR., & IBM-XT
MULTIFUNCTION CARD**



- 64K to 384K RAM
- Parallel Port
- Serial Port
- Clock Calendar
- Software Included
- 1-Year Warranty

\$249.95

MEMORY CARD



- Expandable to 512K
- Fully compatible with IBM software
- Fully compatible w/IBM diagnostic utilities
- Serial Port Available
- 1-Year Warranty

\$199.95

**MEMORY
EXPANSION KIT**



**4164 200ns
9 for \$19.98**

DISKETTES

5 1/4"

**ATHANA: (SOFT SECTOR
w/HUB RING)**
25 per package

SS/DD 29.75 or 1.19 ea.
DS/DD 34.75 or 1.39 ea.

**LIFETIME WARRANTY
ON ALL ATHANA DISKETTES**

**NO LABEL: (SOFT SECTOR
w/HUB RING)**
25 per package

SS/DD 24.75 or .99 ea.
DS/DD 29.75 or 1.19 ea.

**2-YEAR WARRANTY
ON ALL BULK DISKETTES**

ROBOT KITS! PEPPY



2-way sensor detects noise or solid objects in its path. When front sensor contacts an obstacle or hears a loud noise (hand-clap), Peppy automatically turns to the left.

Uses 2 AA and 1 9V battery (not included).

MV-916 \$24.95

**Reg. Power Supply
Model 4A/PS (99/4)**
3 DC Outputs:

12V @ .4A, +5V @ 1.1A
-5V @ .2A Highly Filtered

6.95



KEYBOARD (99/4)

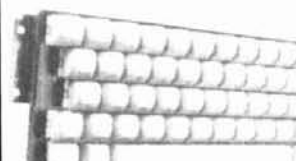

48 keys 4" x 10" **6.95**

TERMS: Minimum order \$10.00. For shipping and handling, include \$2.50 for UPS ground or \$3.50 for UPS Blue (air). For each additional air pound, add \$1 for UPS Blue shipping and handling. California residents must include 6% sales tax. Bay Area and LA residents include 6 1/2% sales tax. Prices are subject to change without notice. We are not responsible for typographical errors. We reserve the right to limit quantities and to substitute manufacturers. All merchandise subject to prior sale.

CALL for VOLUME Quotes

HOURS: Mon - Fri 7:30 to 5:00
Saturdays 10:00 to 3:00

VISIT OUR RETAIL STORE

2100 De La Cruz Blvd.
Santa Clara, CA 95050
(408) 988-0697

**ALL MERCHANDISE IS
100% GUARANTEED**

Telex: 756440

DoKay

QUICK WEATHER PROTECTION PRODUCTS & ANTENNA ACCESSORIES



SEE US AT THE DAYTON HAMVENTION
 Use covers with "Flo Thru" air vents for humidity control.



PRODUCT & DESCRIPTION		MODEL	
QIK-ON Polarotor, LNA, Wire Terminal and also Down Converter Weather Boots with "Flo Thru" air vents for humidity control. Pat. Pending		(White) LNA-S LNA-A LNA-DCB LNA-DCP LNA-DCI (intersat W/adapter) (Black) default \$1.00	
QIK-MOUNT (Universal) Down Converter Plate & Boot with "Flo Thru" air vents		Black	
QIK COVER Motor Boots with "Flo Thru" air vents Pat. Pending	Channel Master Saginaw Warner HYTEK Intersat MTI Gentek Basic S.	A UV resistant rubber cover that has the exclusive QIK PRO end that allows the boot to put on quickly and tightly seal on the drive unit. Rubber lips on bottom for wire exit. (Lock band included.)	(Black) MB MBO
QIK-PRO Actuator Boots with "Flo Thru" air vents Pat. Pending		A soft, pliable UV resistant expandable weather boot that covers the small end of the actuator protecting it from ice, rain, salt water, or dust. Withstands high heat and very low temperatures. (2 lock ties included.) For drives using limit switch designate "limit switch". (same price)	Regular 18 Drive 24 36 48 54 60 (Basic systems) 18 Small
QIK-LIMIT Universal Limit Switch		Universal limit switches mounted in an insulated bracket that clamps on all standard actuators quickly. (DC-AC wiring diagram included.)	Boxed
QIK-ALIGN Feed Horn Alignment Tool Pat. Pending		MOST ACCURATE FEEDHORN ALIGNMENT TOOL MADE!!! * Good instructions included. * Use on button hooks and mull-tool, etc. * One man alignment for maximum antenna signal. * Saves hours of set up, guess work and fawking. * Hooks flush on feedhorn to aim & align to exact center of dish. * 3 reinforced adjustable triangulating legs can be set at focal distance & point at center of dish in one easy setting.	Extends 25 to 47" Boxed
Terms: Cash, Certified check, Money order, Money transfer Freight: UPS, COD, FOB.			Prices effective 6-1-84 Paullin Industries, 1446 State Rtes. 60, Ashland, Ohio 44805

Designing and developing new products for growing industries.

GEM-QUAD FIBRE-GLASS ANTENNA FOR 10, 15, and 20 METERS

Two Elements \$235.00
 Extra Elements \$164.00

Price is F.O.B. Transcona
INCLUDES U.S. Customs Duty

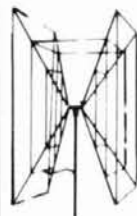

KIT COMPLETE WITH
 *SPIDER
 *ARMS
 *WIRE
 *BALUN KIT
 *BOOM WHERE NEEDED

WINNER OF MANITOBA DESIGN INSTITUTE AWARD OF EXCELLENCE

Buy two elements now — a third and fourth may be added later with little effort.

Enjoy up to 8 db forward gain on DX, with a 25 db back to front ratio and excellent side discrimination.

Ask for our new 2m Quad Kit when you order your Gem Quad. It's FREE for the asking!

Get maximum structural strength with low weight, using our "Tridetic" arms. Please inquire directly to:

GEM QUAD PRODUCTS LTD.

Box 53
 Transcona Manitoba
 Canada R2C 2Z5
 Tel. (204) 866-3338

UHF POWER AMP

AM-6155/GRT (ITT 3212) 225-400 Mhz RF amp, 50W output from 4-10W input using Eimac X651Z; silver-plated cavity in removable drawer. Requires 115/230 VAC & 20 VDC. 7x19 1/2 x 18", 75 lbs. sh. Used-not tested, excellent condition: **\$159.50**

AM-6154/GRT VHF POWER AMP, same as AM-6155 except covers 116-149.95 MHz range; used-not tested. **\$209.50**

CU-872 HF ANTENNA COUPLER for up to eight 2-32 MHz receivers; 70 ohm output, N connections, test meter, and 20/6922 tubes. 7x9x16.5, 40 lbs sh. Used, **\$49.50**

Prices F.O.B. Lima, O. • VISA, MASTERCARD Accepted.
 Allow for Shipping • Send for New FREE CATALOG '83
 Address Dept. HR • Phone: 419/227-6573

FAIR RADIO SALES
 1016 E. EUREKA • Box 1105 • LIMA, OHIO • 45802

✓ 172

PRICE REDUCTION

DX EDGE \$16.95
 GRAYLINE AND LONG PATH PREDICTOR

2nd Op \$2.95

Price Slashed on 2nd OP

JUST \$18.95 plus \$2.50 S+H

HAM RADIO'S BOOKSTORE
 GREENVILLE NH 03048

PREFIX CALLS TIME ZONES BEAM HEADINGS REGULAR \$19.90 PLUS SHIPPING

You can either buy one or buy both and save.

tilt-over conversion of a fixed antenna tower

Don't like climbing?
Try this.

Since 1973 I have been the proud owner of a self-supporting triangular steel lattice antenna tower. But because I'm afraid of heights, climbing this tower is out of the question. Changing antennas means engaging helpers, and even then it's not easy because the mast has an additional 10-foot (3 meter) long tube on top, making the rotator and antennas almost inaccessible.

It took a long time before I realized how I could convert my mast to a tilt-over. The 40-foot (12 meter) tower consists of two sections, each 20 feet (6 meters) long. (With the 10-foot, 3 meter tube on top, the total height comes to 50 feet, or 15 meters.) As shown in **fig. 1** the two sections are connected by three flanges with three bolts each; this division appeared to be the logical place for a hinge that would permit the upper section to pivot and be lowered to ground level.

The next problem to be solved was how to effect the tilt-over action by means of a winch and hoist line.

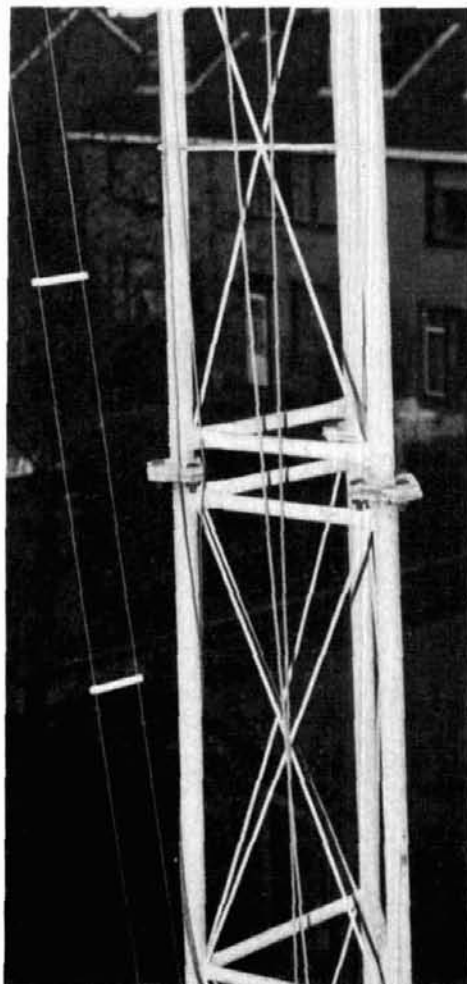

fig. 1. The tower before conversion. Hinge plates will be attached between the flanges connecting the upper and lower part of the tower.

Sketches of the parts constructed by PAØDON are available from the author. Send a large self-addressed envelope; enclose three IRCs.

By Dick Rollema, PAØSE, v.d. Marckstraat 5,
2352 RA Leiderdorp, Netherlands

SPACE/STTI TULSA SHOW '85!



**TULSA CONVENTION CENTER
TULSA, OKLAHOMA
JUNE 21-22-23, 1985**

**Join the Thousands of Others Here To See
the Fantastic World of Satellite TVRO!**



- 700 Booths Displaying Latest Equipment for '85!
- 300 Operating Satellite TV Antennas!
- Intensive Seminar Programming!
- Plus Fun for Everyone!

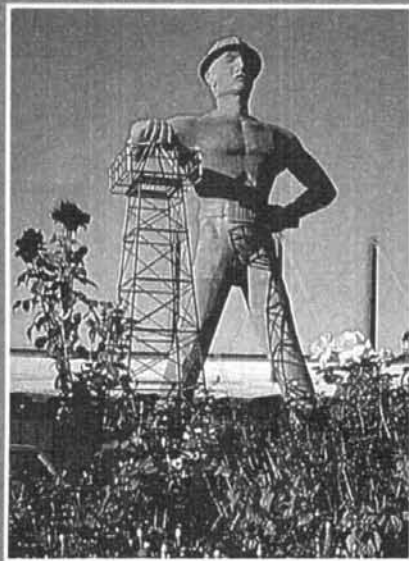

**FOR DETAILS: Call STTI at 1-800-654-9276 or (405) 396-2574
or Write STTI, P.O. Box G, Arcadia, OK 73007**

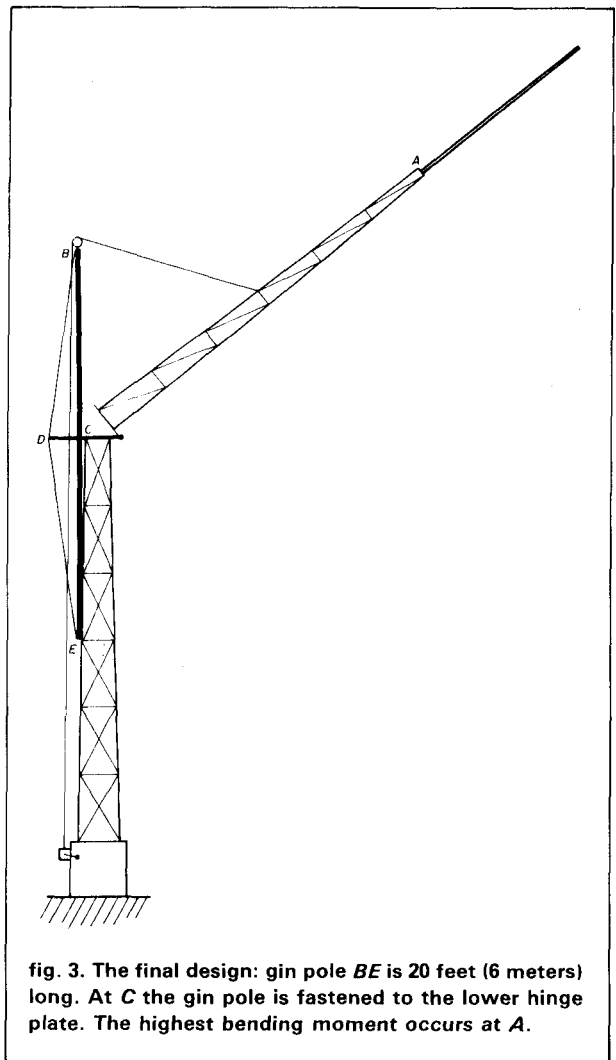
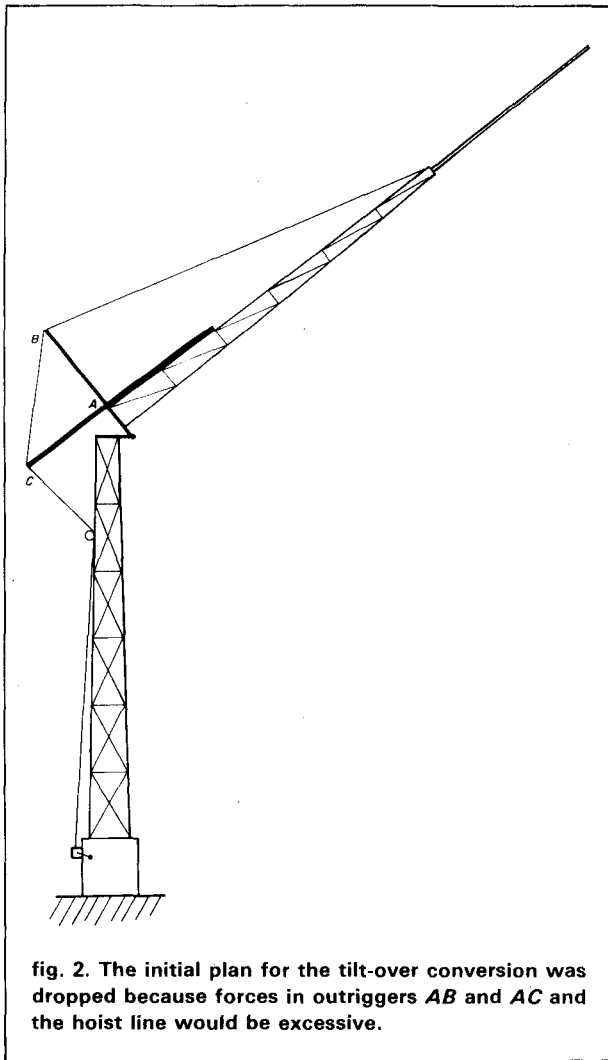

I first thought of using a method such as the one shown in **fig. 2**, similar to the cranes used by building contractors. But with the tower positioned immediately behind our house, outriggers *AB* and *AC* would have to be short enough to clear the structure. This would lead to high tension in the hoist line and cause too much stress on the overall system. So the idea was dropped.

The breakthrough occurred when I visited PAØWCW, who has a similar tower that had been converted into a tilt-over. PAØWCW used two adjacent gin poles permanently fixed to the tower. A pulley is mounted on top of each pole. Two hoist lines in parallel run from the winch over the pulleys to a point halfway up the upper section of the mast.

My final design is shown in **fig. 3**. Here a single gin pole (*BE*) is fixed to the tower at the lower end *E* and in the middle at *C*. A few calculations showed that bending moment at *C* is so large that no pipe of acceptable size could endure this stress, so two stays designed to bear most of the load were introduced.

These are fastened to the gin pole at both ends and pushed away from the middle of the pole by a triangular outrigger. **Figure 4** shows the finished system.

calculation is a must

Before working out a project such as this, it is absolutely essential to determine the forces exerted on the different parts. Calculating stresses in mechanical construction projects is definitely not part of my daily routine, but after consulting some textbooks — and with some professional advice from PAØTO — I managed to do the job. It was not very difficult after all. I quickly discovered that the most critical point is at *A* in **fig. 3** where the pipe top mast leaves the tower. The bending moment here should not exceed a certain maximum value set by the resistance moment and the tensile strength of the material.

My starting point is a pipe mast of 2-inch (50.8 mm) inner diameter with a resistance moment of 0.63 inches³ (10.25 cm³) that protrudes 10 feet (3 meters) out from the lattice mast. From a maximum admissible

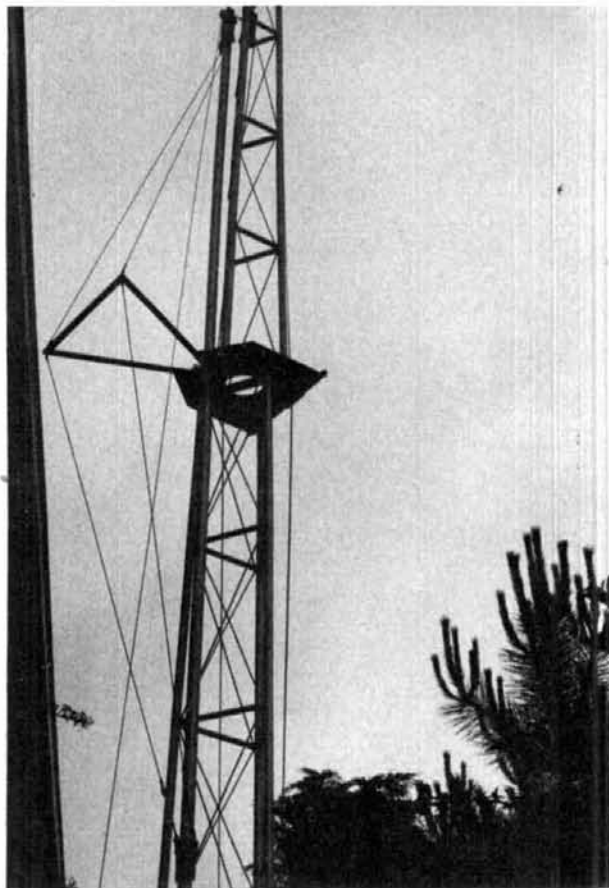

fig. 4. The completed structure.

stress of 23,205 pounds/inch² (160 N/mm²) it follows that the maximum admissible lateral force at the top of the pipe is 123 pounds (547 N). This is the maximum wind load on antenna plus rotator, if we neglect the wind load on the pipe itself for just a moment.

A second limitation occurs when the mast has been tilted to a horizontal position. Again at *A*, a bending moment occurs as the result of the gravitational force on the top mast, rotator, and antenna. Taking into account the mass of the top mast itself, we find a maximum admissible mass of about 99 pounds (45 kg) for the rotator plus antenna. With these numbers, the forces in the different parts of the system can be computed. Rather than bore you with the results, only the maximum force in the hoist line will be mentioned: almost 1,034 pounds (4,600 N), which represents the static load. During tilting of the tower, shocks can easily occur that considerably increase the force in the line.

construction

As already mentioned, a hinge has been installed at the 20-foot (6 meter) level where the lower and upper parts of the tower are joined by flanges. The flanges are bolted to steel plates that carry the hinge at one edge.

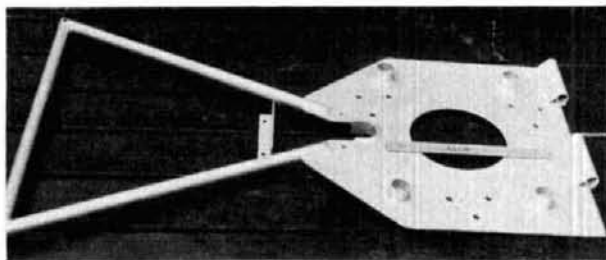

fig. 5. Lower hinge plate, made of 23/64-inch (9-mm) thick steel. The triangular outrigger is fabricated of 1-inch (25 mm) diameter steel tubing. The angle iron bracket secures the gin pole that is held in place in the half circular cutout. The central hole helps reduce the weight (64 pounds/29 kg).

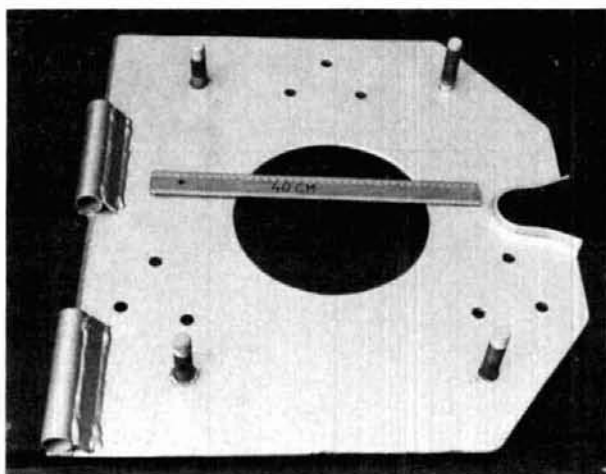

fig. 6. Upper hinge plate, made of 23/64-inch (9-mm) steel. The four bolts, welded on, keep the hinge plates together when the tower is upright. (Weight: 50 pounds/22.5 kg).

Figure 5 shows the lower plate and fig. 6 the upper. The hinge is fabricated from a piece of 2-inch (50.8 mm) steel tube sawed into four parts. These were welded, two by two, to both plates. Extra strength was provided by welding strips of steel to both pipe and plates, as can be seen in fig. 6. The hinge pivots around a 1-inch (25-mm) diameter shaft with bushings at both ends. One is permanently fixed to the shaft; the other is fitted after mounting and secured by a bolt and nut that traverse the shaft and bushing.

In the resting position, the two hinge plates are held together by four 25/32-inch (20-mm) bolts that have been welded to the upper plate and pass through oblong holes in the lower plate. Pieces of tubing are welded around these holes to keep the plates at the proper distance.

Before tilting the tower, the four nuts must be removed from the bolts on the bottom side of the lower plate.

In my original design one plate lay directly on top of the other without any distance in between. To pre-

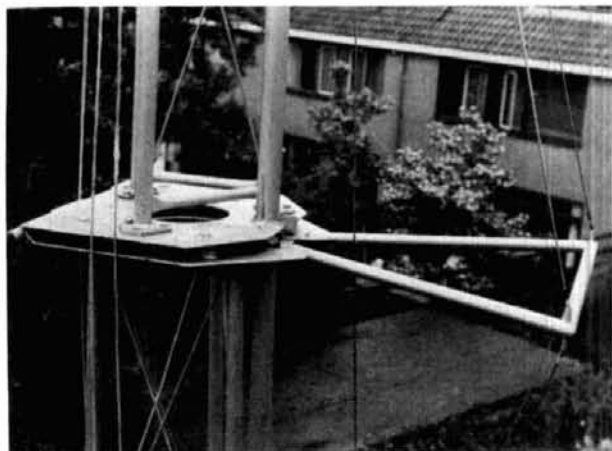

fig. 7. Tower in vertical position. The stainless-steel tubes that guide the stays through the outrigger can be seen at right.

vent the bolt heads in the upper and lower plates from interfering with each other, the upper part of the tower was rotated 60 degrees with respect to the lower part. This allowed the bolt heads of one plate to fall directly into holes drilled in the opposite plate. That 60-degree rotation has been maintained, though it is not necessary in the present construction. But while it presents neither advantage nor disadvantage, it does lead to an optical illusion: from whatever side the tower is viewed, it always seems that the center lines of the upper and lower part do not coincide.

The tower is hinged so that the top mast can be reached from the roof of the barn in the back of our garden, so it is easy to work on rotator or antenna. **Figure 7** shows the tower and hinge in its normal position. **Figure 8** shows it tilted over about 90 degrees.

The gin pole is a seamless steel tube 20 feet (6 meters) long and 2.5 inches (60.3 mm) outer diameter; its inner diameter is 2 inches (53 mm). The lower end is supported by the parts shown in the lower section of **fig. 9**. **Figure 10** shows the lower end in position on the tower.

The legs of the tower have a wall thickness of only 1/16 inch (1.5 mm). To spread the forces exerted by the U-bolts, my friend PAØDON fitted half-cylinder-shaped shells between the U-bolts and the tower legs. On the angle-iron bracket, a piece of tubing was welded over which the gin pole was placed. After mounting, a hole was drilled for a long bolt that pierces the gin pole and prevents turning.

On top of the gin pole a pulley was mounted by means of the method shown in **figs. 11** and **12**. As shown, precautions have been taken above and behind the pulley to prevent the hoist line from running off. The pulley, made of Novotex,TM has an outer diameter of 4.7 inches (120 mm). It rotates around a piece of steel tubing of 1.3 inches (32 mm) diameter. The steel strips that hold the pulley on top of the gin

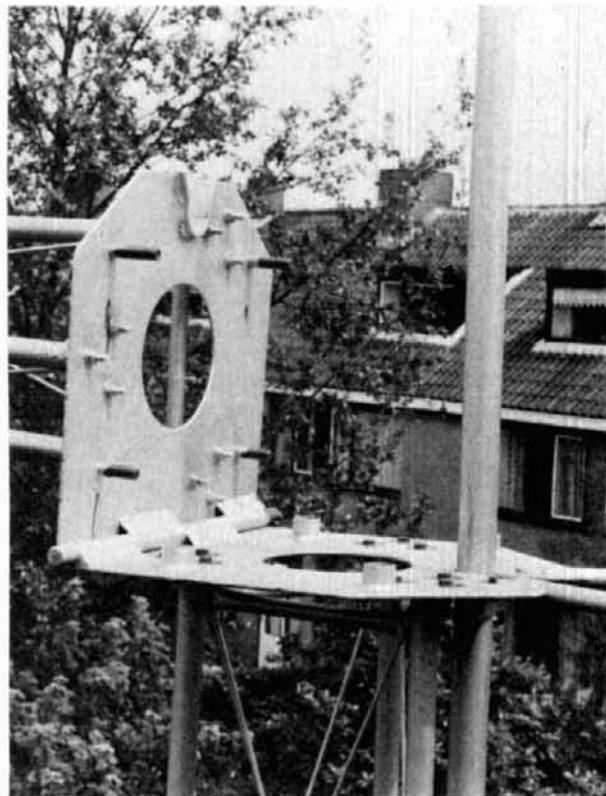

fig. 8. Tower tilted 90 degrees.

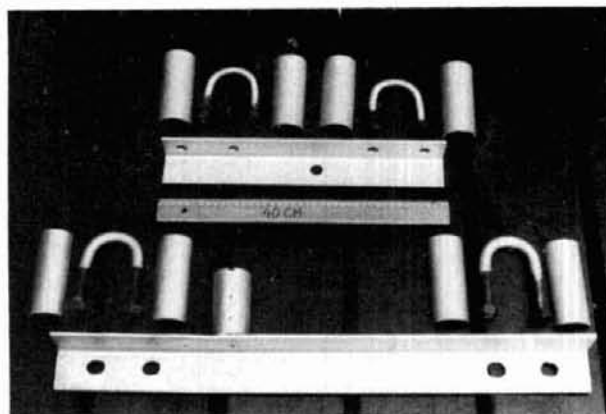

fig. 9. The parts that connect the hoist line to the upper tower section are shown above; the support for the gin pole is shown below.

pole also carry bolts for the stays. At the lower end the stays are connected with stainless steel turnbuckles with a breaking strength of 4,271 pounds (19,000 N). The lower hinge plate carries a triangular outrigger that keeps the stays at the proper distance from the middle of the gin pole (**fig. 7**). To prevent chafing, stainless steel tubes have been inserted in the outrigger that guides the stays. A nylon bushing inside the tubes provides extra protection.

Stays and hoist line consist of stranded stainless

NEMAL ELECTRONICS INTL., INC.

SEE US AT DAYTON BOOTH #104

your one stop coax supplier!



Exclusive

SATELLITE CONTROL CABLE

5 TYPES AVAILABLE!

NEW!!! Lowest Loss

AVAILABLE IN
250-500-1000
FT. ROLLS
OR BY
THE FOOT



TYPE 1 (General Purpose)	TYPE 2 (MTI)	TYPE 3 (Interstat)	TYPE 4	TYPE 5
1 - RG59/U 95% Copper Braid	1 - RG59/U 95% Copper Braid	2 - RG59/U 95% Copper Braid	1 - RG5/U 18 Gauge 95% Copper Shield	2 - RG5/U 18 Gauge 95% Copper Shield
2 @ 16 Gauge	2 @ 17 Gauge	2 @ 12 Gauge	2 @ 12 Gauge	2 @ 12 Gauge
5 @ 22 Gauge	3 @ 18 Gauge	6 @ 18 Gauge	3 @ 18 Gauge	3 @ 18 Gauge
3 @ 20 Gauge	3 @ 20 Gauge	3 @ 22 Gauge	1 @ 20 Gauge Shielded plus Tinned Copper	1 @ 20 Gauge Shielded plus Tinned Copper
Shielded plus Tinned Copper Drain Wire	Shielded plus Tinned Copper Drain Wire	Shielded plus Tinned Copper Drain Wire	Drain Wire	Drain Wire
3 @ 22 Gauge Shielded plus Tinned Copper Drain Wire	3 @ 22 Gauge Shielded plus Tinned Copper Drain Wire		1 @ 22 Gauge Shielded plus Tinned Copper Drain Wire	3 @ 22 Gauge Shielded plus Tinned Copper Drain Wire
55¢ FT	75¢ FT	95¢ FT	79¢ FT	89¢ FT

Designed for easy,
one-step installation,
providing the
required cables for
most earth station
equipment
all in a direct
burial jacket.

Only Nemal offers the quality construction RG59/U copper shielding made to mil spec JAN C-17,
12 gauge conductors, tinned copper drain wires, and a true direct burial polyethylene jacket

HARDLINE

Two styles, two sizes for all installation needs

- Aluminum Outer Conductor with Polyethylene Jacket
 - 1/2 inch loss 48 dB/100 ft @ 30 MHz
 - 3.68 dB/100 ft @ 1000 MHz \$1.25/ft.
 - 7/8 inch loss 28 dB/100 ft @ 30 MHz
 - 2.54 dB/100 ft @ 1000 MHz \$3.25/ft.

- Corrugated Copper Outer Conductor with Polyethylene Jacket
 - 1/2 inch loss 38 dB/100 ft @ 30 MHz
(FLC12-50J) 2.78 dB/100 ft @ 1000 MHz \$1.59/ft.
 - 7/8 inch loss 13 dB/100 ft @ 30 MHz
(FLC12-78J) 1.3 dB/100 ft @ 1000 MHz \$3.92/ft.

COMPARE RG 213 1.25 dB/100 @ 30 MHz
8.5 dB/100 @ 1000 MHz !

HARDLINE CONNECTORS

- 1/2 inch aluminum UHF M/F \$19.00 Type N M/F \$22.00
- 7/8 inch aluminum UHF M/F \$49.00 Type N M/F \$49.00
- 1/2 inch copper UHF M/F \$22.00 Type N M/F \$22.00
- 7/8 inch copper UHF M/F \$49.00 Type N M/F \$49.00

shipping
Cable — \$6.00 per 100 ft.
Connectors — \$3.00 per order.
Orders under \$20 add \$2 additional plus shipping.
Charge card — orders over \$30 only.
COD add \$2.00. Florida Residents add 5%.

FACTORY AUTHORIZED DISTRIBUTOR
AMPHENOL, CABLEWAVE, COLUMBIA, KINGS
BLONDER-TONGUE, TYTON, B&K

- COAXIAL CABLE
- MULTICONDUCTOR CABLE
- CONNECTORS-ADAPTERS
- HARDLINE
- CABLE TIES
- SMATV PRODUCTS
- COAX-SEAL
- COMPUTER CABLE
- CRIMP TOOLS
- FIELD STRENGTH METER

COAXIAL CABLE SALE POLYETHYLENE DIELECTRIC

- RG-8/U 96% shield Mil Spec. (\$29.00/100) or 31¢/ft
- RG11U 96% shield 75 ohm mil spec 25¢/ft
- RG-58/U double shield (RG-58 size) 50 ohm 45¢/ft
- RG58U mil spec 96% shield (\$10.00/100) or 11¢/ft
- RG62A/U 96% shield mil spec 93 ohm 12¢/ft
- RG174/U min. 50 Ω mil spec 10¢/ft
- RG213 noncontaminating 96% shield mil spec 36¢/ft
- RG214/U double silver shield 50 ohm \$1.65/ft
- RG214/U tinned copper 65¢/ft
- RG217/U double shield 50Ω 5/8" OD 85¢/ft.

LOW LOSS FOAM DIELECTRIC

- RG-8X (Mini 8) 95% shield (\$15.00/100) or 17¢/ft
- RG8U 80% shield (\$19.00/100) or 22¢/ft
- RG-8/U 97% shield 11 ga (eq Belden 8214) 31¢/ft
- RG58U 80% shield 07¢/ft
- RG58U 95% shield 10¢/ft
- RG59/U 100% foil shield TV type 10¢/ft
- RG59/U 70% copper shield 09¢/ft
- HEAVY DUTY ROTOR CABLE 2-16 ga 6-20 ga 36¢/ft
- Rotor cable 2-18 ga 6-22 ga Poly burial jkt 19¢/ft

Complete line of multiconductor cables available

CONNECTORS MADE IN USA

- Amphenol PL 259 89¢
- PL-259 and/or SO-239 65¢ ea or 10/\$5.99
- Double Male Connector \$1.79
- PL-258 Double Female Connector 98¢
- PL-259 Silver-Teflon Kings \$1.59 ea.
- Reducer UG-175 or 176 22¢ or 10/\$2.00
- UG-255 (PL-259 to BNC) \$2.95
- Elbow (M359) UHF Elbow \$1.79
- F59A (TV type) 24¢ or 10/\$2.00
- UG 21 D/U Type N Male for RG8, Amphenol \$3.00
- UG-88C/U BNC Male for RG-58, Amphenol \$1.25
- UG 273 BNC-PL259 Amphenol \$3.00
- 3/16 inch Mike Plug for Collins etc. (cutoff) \$1.25

shipping
Cable — \$3.00 per 100 ft.
Connectors — add 10%, \$3.00 minimum.
Orders under \$20 add \$2 additional plus shipping.
Charge card — orders over \$30 only.
COD add \$2.00. Florida Residents add 5%.

COVER NOTE: is BIGGER better?

Weighing in at 8 tons, covering 5.9-30 MHz, the Allgon (of Sweden) 128-foot long Model 601 log periodic handles 500,000 watts of RF while providing continuous azimuthal coverage and tilt capability for optimum takeoff angle control.

Speaking of BIG, this is the largest issue of *ham radio* ever published. Our thanks to our readers and advertisers for your continued support and encouragement. — Editor

HAM RADIO OUTLET, INC.

Is seeking a manager for two new retail stores: Nashua, New Hampshire and Atlanta, Georgia.

Please send resumes, in confidence, to Ham Radio Outlet, #1 Camino Sobrante — #14, Orinda, California, 94563.

Full benefits offered to the right applicant, salary reflected by experience.

Act now. Don't delay.

This publication is available in microform from University Microfilms International.



Please send information about these titles:

Name _____

Company/Institution _____

Address _____

City _____

State _____ Zip _____

Phone (____) _____

Call toll-free 800-521-3044. In Michigan, Alaska and Hawaii call collect 313-761-4700. Or mail inquiry to University Microfilms International, 300 North Zeeb Road, Ann Arbor, MI 48106.

SATELLITE HANDBOOKS

INTRODUCTION TO SATELLITE TV

by Chris Bowick, WD4C and
Tim Kearney, NZ4Q

Forty years ago, the most sophisticated piece of electronics in the average home was an AM radio. Today, many homes are set up with state-of-the-art receivers designed to pluck signals from satellites orbiting 23,000 miles in space. Instead of getting into a nuts and bolts approach to TVRO, this book gives you a broad overview of TVRO in general with emphasis on home use. Chapter 1 covers TVRO background and gives a generalized explanation of what TVRO is all about. Chapters 2-4 give you a broad overview of the equipment used to transmit and receive TVRO signals. Three appendixes also cover DBS, locating satellites and a glossary of TVRO terms. 1st edition. ©1983 142 pages.

21978 Softbound \$9.95

Foreign orders shipped FOB Greenville.

THE SATELLITE TV HANDBOOK

by Anthony T. Easton

Answers virtually any question you might have on satellite TV. This new book gives you a complete overview of the satellite service, how satellites work, what programming is available, who operates the various satellites, networks and stations, how to engineer and install a system, and the legal background of TVRO. For the "homebrewer", there is a section on building your own TV dish and receiver for around \$600. You also get a section about the non-television services from satellites — radio feeds, teletext, newswire and information on DXing international satellites. ©1983 439 pages. First edition

22055 Softbound \$16.95

Please enclose \$3.50 for shipping

HAM RADIO'S BOOKSTORE

Greenville, NH 03048

IN STOCK
— OVER 500 ITEMS —
COMPLETE LINES

✓ 174

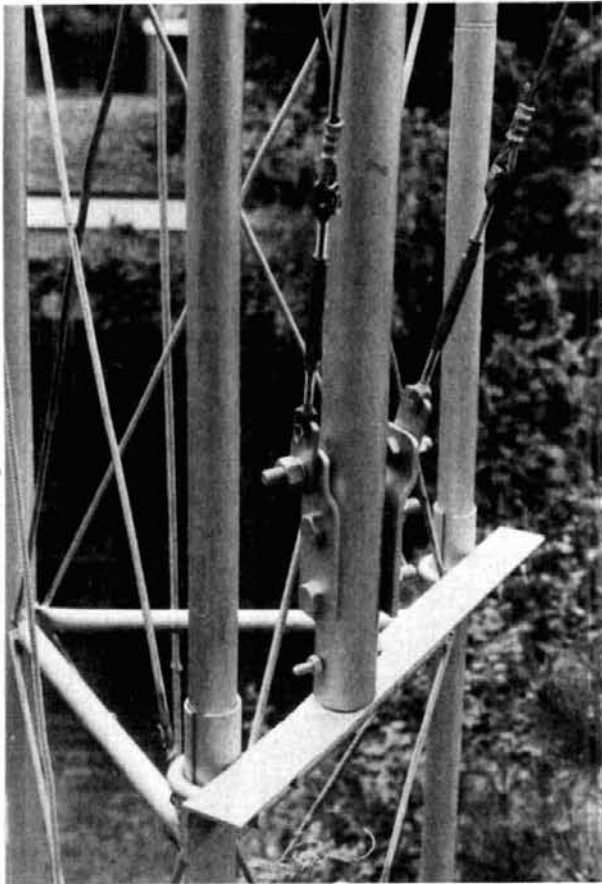

fig. 10. The lower end of gin pole, with stays.

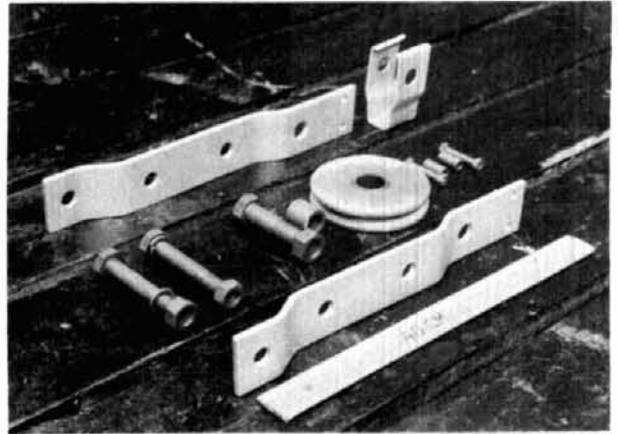

fig. 11. These parts support the pulley on top of the gin pole.

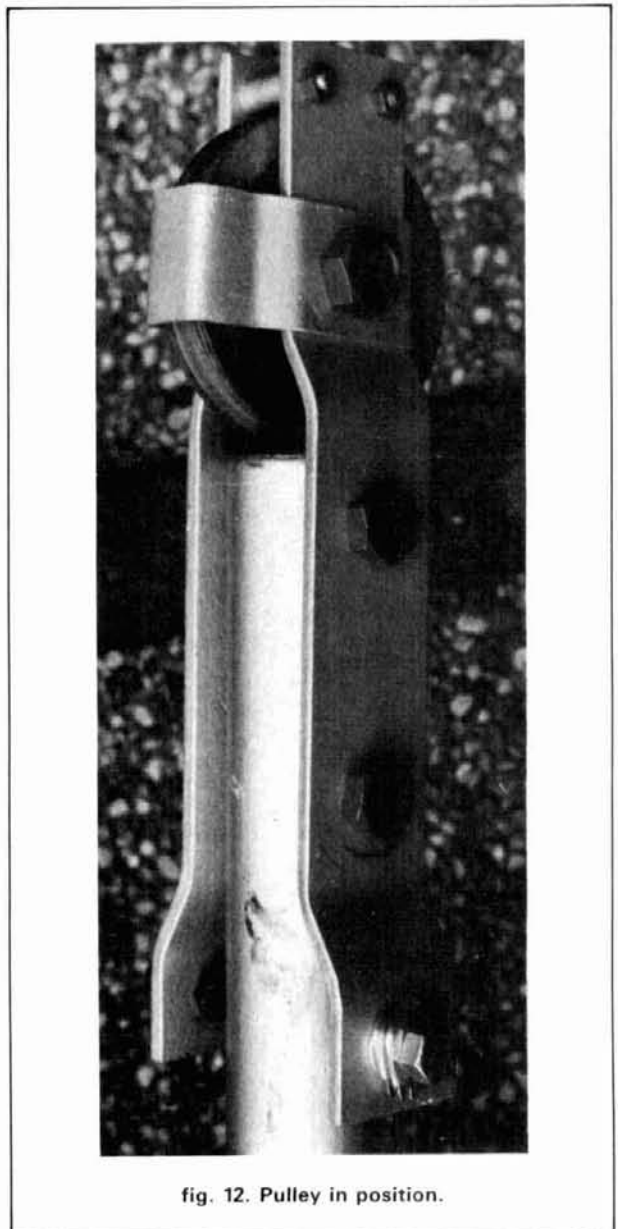

fig. 12. Pulley in position.

steel cable measuring 0.2 inch (5 mm) in diameter and having a breaking strength of 3,147 pounds (14,000 N). The hoist line ends in a winch with a capacity of 1,200 pounds (5,338 N) and a reduction of 4.1:1. (If I were to build this system again I would select a larger reduction). The tower rests on a concrete block, and the winch is fitted to this block by three "chemical" anchors measuring 0.31 inch (8 mm) (fig. 13). The upper end of the hoist line ends halfway up the top section of the tower. A bracket of angle iron is shown in the upper half of fig. 9. This bracket is mounted to the tower legs with U-bolts, and half-cylinder shells are installed to distribute the pressure more evenly. The hole in the bracket is for a 0.625-inch (16 mm) bolt. (The hoist line is fitted to this bolt with parts purchased at a marine shop; I am, unfortunately, unable to translate their names into English.)

The hinge plates and all parts visible in figs. 9 and 11 have been treated with zinc epoxy followed by two coats of aluminum paint. The gin pole, galvanized by the manufacturer, was given a coat of rust-preventive primer and two coats of aluminum paint. Although the tower was also galvanized, some traces of rust were visible at the upper end, so the whole thing was also treated with rust-preventer and aluminum paint.

NAMPA SATELLITE SYSTEMS, INC.

TWO LOCATIONS



MD9 - 9' Dish

312 12th Ave. So.
Nampa, Idaho 83651
(208) 466-6727

1-800-654-0795

For Service ONLY (208) 467-3204

6103 W. 34th St.
Houston, Texas 77092
(713) 957-5140

NEW LOW, LOW PRICES!

NATIONAL FINANCING AVAILABLE THROUGH NAMPA SATELLITE
FOR MORE INFORMATION CALL 208-466-6727

ALL SYSTEMS FREIGHT PRE-PAID FROM NAMPA, IDAHO OR HOUSTON, TEXAS

EACH OF THE FOLLOWING SYSTEMS CONSIST OF: Receiver, 100° LNA, LNB, or LNC, Wilson MD-9 Dish,
100 Ft. Cable Pack, LNA Cover, Polarmatic I Feedhorn, NSS Dish Drive, All Connectors and Instructions

Wilson YM1000 System 10% Down Payment-\$164.80 36 payments of \$54.00/mo.	\$1648	Uniden UST 3000 System 10% Down Payment-\$177.20 36 payments of \$57.00/mo.	\$1772
Wilson YM400 System 10% Down Payment-\$144.20 36 payments of \$46.00/mo.	\$1442	Uniden UST 1000 System 10% Down Payment-\$157.10 36 payments of \$52.00/mo.	\$1571
Little Wil LW5 10% Down Payment-\$109.90 36 payments of \$36.00/mo.	\$1099	Sigma Mark 2A 10% Down Payment-\$143.80 36 payments of \$46.00/mo.	\$1438
Little Wil RV5 10% Down Payment-\$139.90 36 payments of \$45.00/mo.	\$1399	Sigma Mark 3 BLOCK DC 10% Down Payment-\$166.20 36 payments of \$54.00/mo.	\$1662
Drake 240 A + APS24 10% Down Payment-\$199.50 36 payments of \$65.00/mo.	\$1995	Sigma Mark 5 BLOCK DC 10% Down Payment-\$204.90 36 payments of \$66.00/mo.	\$2049
Luxor Mark 2 System BLOCK DC 10% Down Payment-\$251.20 36 payments of \$75.00/mo.	\$2512	M/A Com HI BLOCK DC 10% Down Payment-\$228.20 36 payments of \$74.00/mo.	\$2282
Dexcel 1300-01 System 10% Down Payment-\$198.80 36 payments of \$63.00/mo.	\$1988	M/A Com TI BLOCK DC 10% Down Payment-\$218.20 36 payments of \$71.00/mo.	\$2182
Dexcel 1200-01 System 10% Down Payment-\$163.30 36 payments of \$54.00/mo.	\$1633	STS MBS-SR-AA 10% Down Payment-\$234.90 36 payments of \$76.00/mo.	\$2349

OPTIONS WITH SYSTEM

PM 9' Dish	\$ 60	NSS Memory Tracker.....	\$100
UM 10' Mesh Dish.....	\$180	MTI 2100.....	\$225
Prodelin 10' Dish.....	\$400	MTI 4100.....	\$345
Continental Mesh Dish 10'	\$400	Houston Tracker IV	\$325
85° LNA	\$ 80	Houston Tracker IV +	\$425

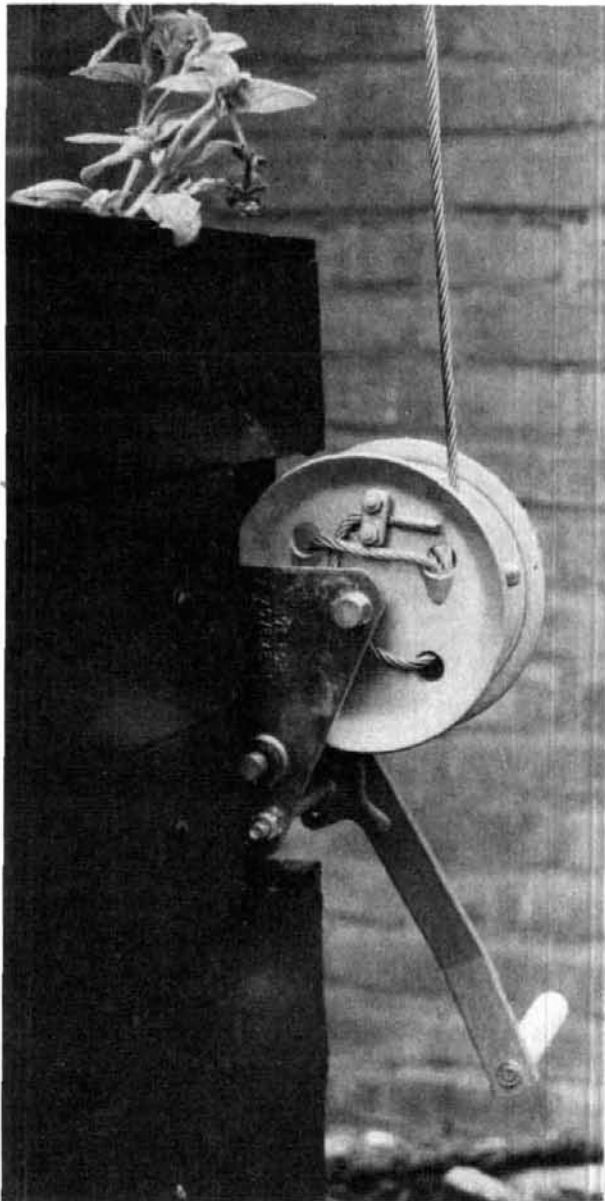

fig. 13. The winch is fastened to the concrete block that serves as base for the tower. Concrete block is concealed under a wooden cover for aesthetic purposes.

assembly

The first phase of the operation took place in early December, 1983, when the temperature was just below freezing. Our object was to take down the upper part of the tower, the top tube mast, the rotator, and the 2-meter beam. The gin pole was fitted temporarily to the tower. Because the hinge plates were not yet in place, the gin pole was tied to the upper end of the lower section with rope. The hoist line was also fitted. Using the winch, we gently lowered the upper part of the tower to ground. Now the holes in the flanges could be transferred to a template to be used later in drilling the holes in the hinge plates.



fig. 14. High level work: Jos (PA3ACJ) and SWLs Bert and Ed.

Final assembly and rigging of the tilt-over conversion occurred in mid-May, 1984, under more favorable weather conditions. Everything fit exactly, and it was a real pleasure to see the converted tower come together step by step (fig. 14).

acknowledgement

My sincere thanks to Ber van Dongeren, PA0DON, for his superb realization of my design. No operation like this can be performed without helpers: Piet de Bondt, PA3BGP; Jos Disselhorst, PA3ACJ; Ton Verberne, PA2ABV; Ben van Capel, PE1KCG; Gerrit van Zwam, PE1KAX, and SWLs Jo Chin-Chan-Sen, Bert Kraan and Ed Wassenburg helped disassemble the original tower and erect the new one.

ham radio

Invitation to Authors

ham radio welcomes manuscripts from authors all around the world. If you have an idea for an article you'd like to have considered for publication, send for a free copy of the *ham radio* Author's Guide. Address your request to *ham radio*, Greenville, New Hampshire 03048 (SASE appreciated).

J.I.L. SX-400

Uninterrupted
Frequency
Coverage
100 kHz to 1400 MHz
with Optional Converters

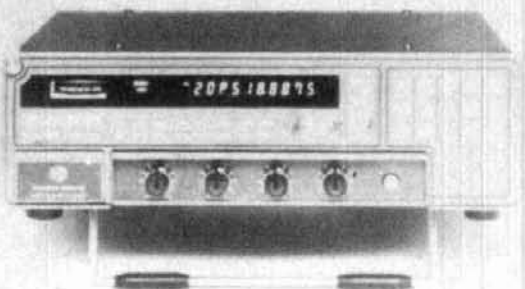

- A professionally created scanner for the serious listener
- Wide frequency coverage 26 to 520 MHz (with optional converters 100 kHz to 1400 MHz)
- Continuous coverage. You'll hear everything.
- Birdie-Free, no internal 'signals' to interfere with scanning
- 20 Channel memory, AM-FM Mode memory, Priority memory
- Carrier Operated Relay (COR) permits automatic start/stop of a recorder
- Four low-noise front end converters for optimum performance
- 12 Volt DC operation (120 Volt AC power supply optional)
- Check JIL's ad in this issue for further details

Sale Price \$549.95 List \$739.90
P-1A Power Supply \$34.95
Other options call

✓ 176



Electronic Equipment Bank

516 Mill Street
Vienna, Virginia 22180

800-368-3270
(703) 938-3350

Free Antenna Accessories Catalog



◀ Coaxial Antenna Relays

Remotely select up to 9 antennas from your transmitter, using only *one* coaxial cable. Environmentalized, high power and low loss.

W2AU and W2DU Baluns▶

Our baluns, center insulators and insulators have been preferred for 20 years by Hams, industry, and the armed forces. Protect against TVI and lightning 1.8-200 MHz.



◀ W2VS Antenna Traps

Add these traps to your dipole and get low SWR on 2 to 6 bands, depending on how many you add. Antenna wire and custom kits also available.

Send For Yours Today▶

Don't delay. Call or write today, and we will send you free literature which fully describes our Ham antenna accessory product line.

Dealer inquiries also welcome.



6743 Kinne St., East Syracuse, NY 13057
Toll Free 1-800-448-1666 TWX 710-541-0493
NY/IL/AK/Canada (Collect) 315-437-3953

✓ 177

**DO YOU
KNOW
WHERE
TO FIND
REAL
BARGAINS**



on **NEW** and **USED**
ELECTRONIC Equipment?

**You'll Find Them
in the Nation's No. 1
Electronic Shopper Magazine**

NUTS & VOLTS

Now in Our 5th Year

Nuts & Volts is published MONTHLY and features:

**NEW STATE-OF-THE-ART PRODUCTS •
SURPLUS EQUIPMENT • USED BARGAINS
• LOW COST AD RATES • PRIVATE AND
COMMERCIAL CLASSIFIEDS • NATIONAL
CIRCULATION • NEW PRODUCT NEWS
SECTION • AND A FREE CLASSIFIED AD
WITH YOUR SUBSCRIPTION**

SUBSCRIPTION RATES

- One Year - 3rd Class Mail \$10.00
- One Year - 1st Class Mail \$15.00
- One Year - Canada & Mexico (in U.S. Funds) .. \$18.00
- Lifetime - 3rd Class Mail (U.S. Only) \$35.00

ORDER NOW!

SEND: CHECK MONEY ORDER
 VISA MASTERCARD

TO: **NUTS & VOLTS MAGAZINE**
P.O. BOX 1111-H
PLACENTIA, CALIFORNIA 92670
(714) 632-7721

Name _____

Address _____

City _____

State _____ Zip _____

Card No. _____

Exp. Date _____

**IF YOU'RE INTO ELECTRONICS,
THIS MAGAZINE WILL SAVE YOU MONEY!**

Dealer Inquiries Invited

✓ 178

NCG Co. NEW-TECHNOLOGY HIGH-QUALITY

AFFORDABLE TRANSCEIVERS FOR ALL. WINNERS IN COMPARISON HANDS DOWN!

10/160 M HF TRANSCEIVER



40-15-6 M NEW TRI-BANDER



15 M 15 METER MOBILE



JUST SLIGHTLY AHEAD! WITH THE QUALITY YOU HAVE ALWAYS LOOKED FOR!

4 MEMORYS - 3 WAY AUTO SCAN, DUAL VFO, IF SHIFT, CW-W, 400 Hz. CW-N 200 Hz. ALL 9 BANDS PLUS MARS. BUILT IN AC/DC POWER, SSB, CW OR RTTY, I.F. TUNE 3-STEP TUNING SPEED, 200 WATT PEP, MICROPHONE IMPEDANCE 600-50K OHM HAND MIC. INCLUDED.

40, 15 AND 6 METERS ARE YOUR BASE STATION OR MOBILE WITH AC/DC BUILT IN POWER SUPPLY CW-N 200 Hz OR USB, 2 S0239 ANTENNA CONNECTORS, HAND MIC. BUILT IN TVI FILTER LITTLE TO NO TV INTERFERENCE, 20 WATTS PEP, MARS ON 40 AND 6 METERS.

A GREAT QRP RIG WITH THE BIG RIG SIGNAL, 2 WATTS OR 10 WATTS OUT, BUILT IN CW SIDE TONE, DIGITAL DISPLAY, HAND MIC. TOP MOUNTED SPEAKER, MOBILE BRACKET, RIT OR FINE TUNE TX&RX, ± 4 KHz, 21 TO 21.450 MHz SIGNAL TO NOISE MORE THAN 10dB DOWN.



SPECIAL

90 DAY WARRANTY ON ALL TRANSCEIVERS - DIRECT FROM NCG OR YOUR DEALER

WE HAVE 1.2 GHz BASE/REPEATER & MOBILE ANTENNAS

1275 N. Grove Street, Anaheim, CA 92806 (714) 630-4541

✓ 179

SPECIAL

SPECIAL

NOTE: PRICES AND SPECIFICATIONS SUBJECT TO CHANGE WITHOUT NOTICE OR OBLIGATION



July 27 thru Aug. 9, 1985

Our 26th year

TAKE A VACATION WITH
A PURPOSE THIS YEAR

Join students from around the world at
OAK HILL ACADEMY
AMATEUR RADIO SESSION
Instructors CERTIFIED VE's

Over 25 years of successful teaching experience means upgrading is as easy as 1-2-3.

Your vacation is spent in the beautiful Blue Ridge Mountains of Virginia with expert instructors in friendly surroundings and with excellent accommodations.

Oak Hill also has a ham lab set up for all to use.

Courses offered are:

Novice to General
General or Tech to Advanced
Advanced to Extra

Learn — don't just memorize the answers to the exam questions.

C. L. PETERS, K4DNJ, Director
Oak Hill Academy Amateur Radio Session
Box 43
Mouth of Wilson, VA 24363

Name _____ Call _____

Address _____

City/State/Zip _____

TOWERS

by ALUMA

HIGHEST QUALITY ALUMINUM

- TELESCOPING (CRANK-UP)
- GUYED (STACK-UP)
- TILT-OVER MODELS

Easy to install. Low Prices.
Crank-ups to 100 ft.

EXCELLENT FOR AMATEUR COMMUNICATIONS

Mobile Trailer Type

Mobile Truck Type

Fixed Base

Over 36 types aluminum and steel towers made—specials designed and made—write for details

SPECIAL Four Section 50 Ft. Van Mounted Crank-Up Aluma Tower

ALUMA TOWER CO.
BOX 2806HR
VERO BEACH, FLA. 32960-2806
(305) 567-3423 TELEX 80-3405

✓ 180

Crystal Filters

CW/SSB/AM For most
KENWOOD · YAESU · HEATHKIT

Also DRAKE R-4C/7 Line, COLLINS 755-3B/C, and ICOM (FL44A Type)

FOX TANGO filters with center frequencies to match your set range in bandwidths from 125Hz for needle-sharp CW to 6000Hz for hi-fi AM. Use them to fill your optional filter spots, to replace inferior ceramic or monolithic stock units, or to add more I-F filtering for super-selectivity. Most are drop-in or plug-in type; if patch-in, all needed parts and instructions are supplied. Get genuine FT matched-pair filter sets (2.1 SSB and/or 400 CW) for your RB20, TS830/930 or FT-980. Or a Filter Cascading kit for your TS430, TS520, TS 820; FT-101, 1012D, 107, 301, 901-2; or Heath SB-104A. Or super-size your R-4C with our GUF-1, 2 units. All kits include top-rated 8-pole discrete-crystal FOX TANGO filters. For complete details and prices send a business-size SASE marked with your rig's Make and Model Number. To save time, phone for information and order directly. We accept VISA/MC or ship C.O.D. in US.

FOX TANGO not only will meet or beat any currently advertised price for comparable units, but also offers quantity discounts. Order with confidence — our filters are guaranteed for ONE YEAR. Why not check us out over the air? You'll learn that FOX TANGO filters are best.

GO FOX TANGO — TO BE SURE!
FOX-TANGO Corp.
P.O. Box 15944, Dept. H
W. Palm Beach, FL 33416 ✓ 181
Telephone: (305) 683-9587

SATELLITE TELEVISION RECEIVER SEMIKIT

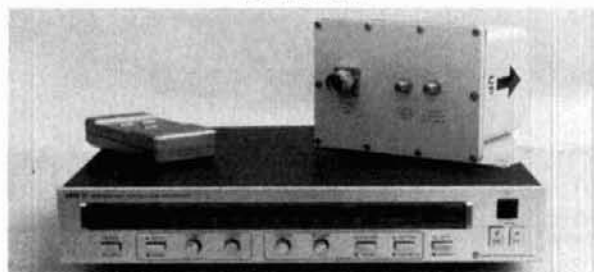

with dual conversion downconverter

FEATURES:

- Infrared remote control tuning
- AFC, SAW filter
- RF or video output
- Stereo output
- Polorator controls
- LED channel & tuning indicators

Install six factory assembled circuit boards to complete.

SEMIKIT	\$400.00
Completed downconverter add	100.00
Completed receiver and downconverter add	150.00

JAMES WALTER SATELLITE RECEIVER

2697 Nickel, San Pablo, CA 94806 ✓ 182 Tel. 415-724-0587

CB-10 FM SPECIAL



- Hy Gain 40-Channel Board
- 40-Channel Switch
- Volume & Squelch Control
- FM Detector Module
- Full Instructions Included

\$14.95 Add \$2.00 **BOARD ONLY**
shipping & handling \$6.95

QRP TRANSCEIVER SET - \$34.95

VHF CONVERTER SET - \$24.95

Add \$2.00 For Shipping & Handling - Send For FREE Brochure

SEND \$2.00 FOR FULL MANUAL WITH CIRCUIT DIAGRAMS

MANY OTHER MODULES AVAILABLE

MORNING DISTRIBUTING CO.

P.O. BOX 717, HIALEAH, FLA. 33011

(305) 884-8686

✓ 183

Join AMSAT...Today

Amateur Radio Satellite OSCAR 10 provides:

- A New Worldwide DX Ham Band open 10 hours a day.
- Rag Chew With Rare DX Stations in an uncrowded, gentlemanly fashion.
- Popular Modes In Use:
SSB, CW, RTTY, SSTV, Packet
- Full Operating Privileges open to Technician Class licensee or higher.

Other AMSAT Membership Benefits:

ORBIT Magazine Subscription:
Dependable technical articles, satellite news, orbital elements, product reviews, DX news, and more.

Satellite Tracking Software
Available for most popular PCs.

QSL Bureau, AMSAT Nets, Area Coordinator Support, Forum Talks

Construction of Future Satellites For Your Enjoyment!

AMSAT Membership is \$24 a year, \$26 outside North America. VISA and MC accepted.

AMSAT
P.O. Box 27
Washington, DC 20044

301 589-6062

✓ 184

John J. Meshna Jr., Inc.

P. O. Box 62 19 Allerton St. E. Lynn, Ma. 01904 Tel: (617) 595-2275

Dual 8" F. D. D. Case by SMS w/ POWER ONE Power Supply & Cooling Fans

We were very fortunate to find these beautifully designed & constructed rack mount disc drive cases in the surplus field. These cases were made for Scientific Micro Systems for their FT Series of equipment. They are manufactured from heavy gauge steel w/ a cast metal designer bezel. They were designed to house 2 8" floppy or hard drives. We offer you the case with the following components & features: hinged cover with restraining cable for simplified servicing of the interior components, 2 muffin fans for assured cool operation, studs for mounting the controller card listed below, and a heavy duty Power One power supply (their model no. CP 281A). The outputs of the power supply are as follows: +5 vdc 11 amps, +24 vdc 3.5 amps, +12 vdc .25 amps, -12 vdc .25 amps, & -5 vdc .25 amps. The input to the power supply is 115/230 vac 50/60 Hz. and is both filtered and fused. This assembly must have originally sold for well over \$300.00 each! Only 25 on hand, so order early or be left out on this super bargain! Shpg. wt. 38 lb. SPL-479-35 \$135.00 each

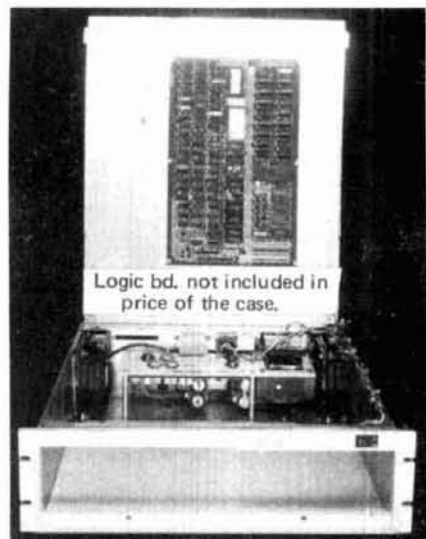

Scientific Micro Systems IBM 3740 Compatible 8" FDD Controller Card

The SMS FD 0502 8" floppy disc drive controller is a complete preprogrammed controller for single or double density recording on either single or dual headed disc drives. It performs control functions required to transfer data between 1 to 4 drives and a host system, performs all formatting functions required to read and write data and utilizes both IBM single and double density standards to achieve up to 630 Kilobytes of storage per disc surface. Some features are: programmable sector size, 128, 256, 512, or 1024 bytes, jumper selectable drive type, block transfer mode, sector buffer, overlapped head seek, on board General Purpose Host Interface with asynchronous 19 TTL signal lines for eight bit host system and input of only 5 vdc 6 amps. This board provides a direct interface to the following drives: Shugart 800-2/850, Pertec 511, Memorex 550/552, MFE 751B, Qume Data Trak and similar drives. These boards were removed from the above cabinets which were in service prior to our reception of them. The manufacturers price on these IBM compatible boards is currently \$900.00 each. These boards all appear to be in excellent condition. If more information is needed, please call us. Shpg. wt. 3 lb. SPL 480 \$150.00

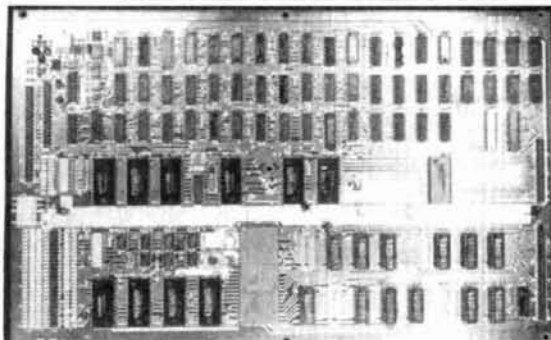

SEAGATE TECHNOLOGY ST 506 5 1/4" HARD DRIVES

The Seagate Technology ST 506 hard disc drive utilizes proven Winchester technology for reliable storage of up to 5 megabytes of formatted data. Some features of this very popular drive are: 5 megabit/second data transfer rate, simple floppy like interface, high speed band actuator & stepper head positioning, requires only +5 & +12 vdc, and same physical size and mounting parameters as a mini floppy drive. This Shugart compatible drive is the same as used on many home personal computers. Each drive is checked out prior to shipment. Comes with data. Only a few on hand, so order early. Shpg. wt. 8 lb. ST-506 \$225.00

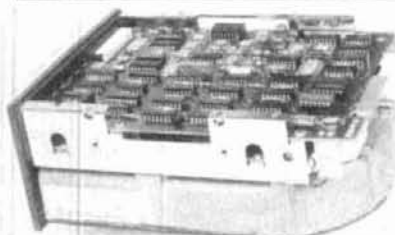

5 1/4" HARD DRIVE CONTROLLER CARD

Finally, affordable, intelligent disc drive controllers are available at low, low surplus prices. The OMTI 20C controller boards we offer are unused, late style, surplus from a now defunct system house. OMTI is a division of Scientific Micro Systems. These boards will handle up to (2) 5 1/4 inch Winchester type hard drives that utilize a standard 34 pin SASI interface. Perfect for using with the above Seagate ST 506 drive, or other hard drives from 5 megabytes of storage on up. The controllers have buffered slew/seek modes, overlapped seeks, auto seek & verify, extensive fault detection, auto head & cylinder switching, full sector buffering, 256/512 bytes/sector, 33 or 18 sectors/track (jumper selectable), programmable disc parameters and much more. The board runs on +5 vdc & +12 vdc. We supply users manual & pinout data. Guaranteed O. K.. Shpg. wt. 3 lb. OMTI 20 C \$150.00 each 2/\$275.00 Qty. pricing available.



5 VDC 25 AMP SWITCHING POWER SUPPLY

We just got in a small lot of ruggedly built, lightweight (4 lb.), compact (11" x 5" x 1 1/2"), fully enclosed (cover removed for pic.), regulated, switching, power supplies made by RO Industries. Input of 115/230 vac is attached thru convenient, clearly marked screw terminals. The hefty 5 vdc 25 amp output is via heavy duty, brass lugs with a Red LED status indicator. All appear to be unused and in excellent condition. Shpg. wt. 6 lb. PS-8 \$50.00

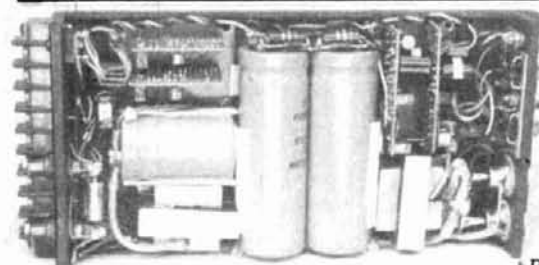

Free 72 page catalogue available or send \$1.00 for 1st class service to P. O. Box 62 E. Lynn, Ma. 01904.

Phone (617) 595-2275 to place your order by phone. MC, VISA or American Express charge cards accepted.

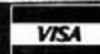



Use Your Wireless
Control
FROM ANY ROOM!!!

Works with most infrared
remote control receivers.



LIKE HAVING A SATELLITE RECEIVER, VCR,
CABLE TV, AND VIDEO DISC IN EVERY
ROOM!

- Remote-control Satellite Receiver, VCR, Cable TV, and Video Disc can now be used long distance
- Install on any TV to access all your remote control video components
- Makes non-remote TVs remote controllable with remote control VCR, Cable Selector, or Satellite Receiver
- No fancy wiring needed: uses existing coaxial wiring between TVs
- No extra controls to buy! Uses the hand-held remote controllers you already have
- No tools required. Easily installed in minutes

XTRA-LINK™

MODEL 170

XL



\$7995

Plus \$3.00
shipping & handling

608-493-2291

DEALER INQUIRIES WELCOME

MERRIMAC
SATELLITE

327 Palisade St. Merrimac WI 53561

SPACE



186

**WHAT'S REALLY HAPPENING
IN HOME SATELLITE TV?**

STV SATELLITE
TELEVISION
MAGAZINE

A monthly of 100-plus pages, has all you need to know about where to find equipment, how it performs, how to install it, legal viewpoint, & industry insights.

- \$24.95 per yr. (12 monthly issues)
- \$ 2.00 for Sample Issue

MONEY BACK GUARANTEE if not satisfied (subscription orders only). Keep first issue with our compliments.

If you already have a dish, then you need

OnSat™

—the best in satellite TV programming.

- ★ Weekly Updated Listings
- ★ All Scheduled Channels
- ★ Complete Movie Listing
- ★ All Sports Specials
- ★ Prime Time Highlights

- \$39.00 per yr. (52 weekly issues)
- \$ 1.00 for Sample Copy

Visa® MasterCard® accepted (subscription orders only). All prices in US funds only. Write for foreign rates.

Send this ad along with your order to:

STV™/OnSat™

P.O. Box 2384 - Dept. PS
Shelby, NC 28151-2384

Subscription calls only
Toll Free **1-800-438-2020**

187

HR





**ARRL TEXAS
STATE
CONVENTION**

MAY 31-JUNE 2, 1985

DALLAS NORTH PARK INN

Exhibitor Inquiries: (214) 521-9430



"TUNE IN" THE WORLD OF SPECIALIZED COMMUNICATIONS!

Thousands of "Ham Radio" operators across the country are enjoying "Specialized Communications" modes. Whether it's FSTV, SSTV, FAX, OSCAR, EME, RTTY, PACKET or COMPUTERS, today's Radio Amateur is a highly skilled Communications Specialist!

Providing full, in-depth coverage of these modes is our business and we've been doing it now for over 19 years! And now we're expanding!

Iowa Residents Must Add 4% Sales Tax.

4% Added To All Charge Card Orders.



Now published "monthly" 10 times per year, **SPEC-COM™** readers are kept up-to-date in a world of fast moving modern technology.

Why not give us a try? Back issue samples are available for just \$2.00 ppd. (Master Article Indexes add \$1.00).

Special Six Month Trial Subscription - \$10.00. U.S./Canada/Mexico Annual Subscription \$20.00. (Foreign Subscriptions slightly higher).

SPEC-COM™

Amateur Radio Specialized Communication Journal

P.O. Box H

Lowden, Iowa 52255

(319) 944-7669 (Membership Services)

✓ 188

1985 CALLBOOKS

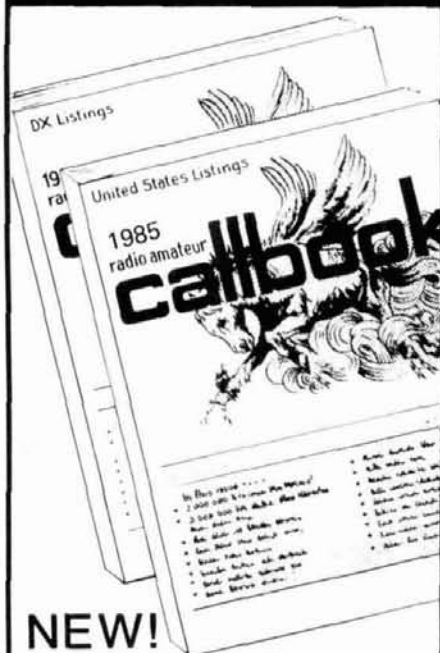

NEW! Special North American Edition

As an added bonus, the 1985 U.S. Callbook also lists the amateurs in Canada and Mexico! You get the complete and accurate U.S. listings (prepared by our own editorial staff), all the usual up-to-date Callbook charts and tables, PLUS Canada and Mexico. Now that's real value!

The best just got better!

Of course, Canadian and Mexican amateurs are also listed in the 1985 Foreign Callbook. Don't delay! The great new 1985 Callbooks were published December 1, 1984.

Order your copies now!

	Each	Shipping	Total
□ U.S. Callbook	\$21.95	\$3.05	\$25.00
□ Foreign Callbook	20.95	3.05	24.00

Order both books at the same time for \$45.00 including shipping within the USA.

Order from your dealer or directly from the publisher. Foreign residents add \$4.55 for shipping. Illinois residents add 6% sales tax.

Keep your 1985 Callbooks up to date.

The U.S. and Foreign Supplements contain all activity for the previous three months including new licenses. Available from the publisher in sets of three (March 1, June 1, and September 1) for only \$15.00 per set including shipping. Specify U.S. or Foreign Supplements when ordering. Illinois residents add 6% sales tax. Offer void after November 1, 1985.

RADIO AMATEUR **callbook** INC. ✓ 191



Dept. F
925 Sherwood Dr., Box 247
Lake Bluff, IL 60044, USA

Tel: (312) 234-6600



SEMICONDUCTORS:

MRF-208.....	12.00	MHW-252.....	53.00
MRF-240.....	18.40	MHW-710-1.....	61.00
MRF-247.....	34.80	MPSH-81.....	50
MRF-309.....	33.80	MV2205.....	58
MRF-422.....	41.40	78L08CP.....	50
MRF-454.....	20.00	2N4401.....	75
MRF-901.....	1.75	2N5190.....	1.50
SBL-1 Double-Balance Mixer.....	6.50		

P.C. BOARDS FOR MOTOROLA BULLETINS

AN-762.....	14.00	AN-791.....	10.00
EB-27A.....	14.00	EB-67.....	14.00
EB-63.....	14.00		
KEMET CHIP CAPACITORS: 56 pf, 82 pf, 100 pf, 390 pf, 470 pf.....50 ea. 680 pf, 1000 pf.....55 ea. 5600 pf, 6800 pf, .1 µf.....1.00 ea. .33 µf.....1.90 ea. 68 µf.....3.90 ea.			

CAMBION RF CHOKES: 15 µh, .22 µh, .33 µh, 4.7 µh, 10 µh.....1.20 ea.
BROADBAND TRANSFORMERS PER MOTOROLA BULLETINS: AN-762, EB-27A, EB-63
UNDERWOOD/SEMCO METAL-CLAD MICA CAPACITORS: 5pf, 10pf, 15pf, 25pf, 30pf,
40pf, 56pf, 60pf, 68pf, 80pf, 91pf, 100pf, 200pf, 250pf, 390pf, 470pf, 1000pf

We also carry a line of VHF, UHF amplifiers and ATV equipment.

Call or write for our free catalog.

✓ 189



CCI Communication Concepts Inc.



2648 North Aragon Ave. • Dayton, Ohio 45420 • (513) 296-1411

WHERE'S THE TURKEY?

★ Synthesized Voice Doppler Direction Finding

★ VHF and UHF Coverage

★ RS232C Computer Interface



★ No Receiver Mods

★ Mobile or Fixed

★ 12 VDC Operation

★ Digital and Circular Display

★ 90 Day Warranty

New Technology (patent pending) converts any VHF or UHF FM receiver into an advanced Doppler shift radio direction finder. Simply plug into receiver's antenna and external speaker jacks. Uses four omnidirectional antennas. Low noise, high sensitivity for weak signal detection. Call or write for full details and prices.

DOPLER SYSTEMS, INC. 5540 E. Charter Oak, (602) 998-1151
Scottsdale, AZ 85254

✓ 190

May 1985 **hr** 139

flea market



RATES Noncommercial ads 10¢ per word; commercial ads 60¢ per word **both payable in advance.** No cash discounts or agency commissions allowed.

HAMFESTS Sponsored by non-profit organizations receive one free Flea Market ad (subject to our editing) on a space available basis only. Repeat insertions of hamfest ads pay the non-commercial rate.

COPY No special layout or arrangements available. Material should be typewritten or clearly printed (**not** all capitals) and must include full name and address. We reserve the right to reject unsuitable copy. **Ham Radio** cannot check each advertiser and thus cannot be held responsible for claims made. Liability for correctness of material limited to corrected ad in next available issue.

DEADLINE 15th of second preceding month.

SEND MATERIAL TO: Flea Market, Ham Radio, Greenville, N. H. 03048.

FOR SALE: Ham station, Swan 350-C, power supply-speaker, Heath Watt-SWR meter, Heath electronic keyer, Ham-M meter and rotator, 40 ft. steel tower and 3 element beam. Best offer. Write Ms. Virginia Ingham, 2636 Forest Park Blvd., Ft. Worth, TX 76110.

CX7 REPAIRS. 414-549-9210.

LETTERING and text for QSL pasteup and label usage. Stamp brings circular. Labelcraft, PO Box 412, W. Sand Lake, NY 12196.

CABLE TV EQUIPMENT. Jerrold, Hamlin, Zenith, many others. Factory units/lowest dealer prices. Complete illustrated catalog \$2.00. Pacific Cable Co., Inc., 7325 1/2 Reseda Blvd., Dept. 1001, Reseda, CA 91335. (818) 346-5071.

ELECTRONIC CMOS keyer kit pcb & parts only \$9.95 plus \$1.50 shipping. WI res. add 5% tax. Send for free information. Bel-Tek, PO Box 125H, Beloit, WI 53511.

CUSTOM MADE embroidered patches. Any size, shape, colors. Five patch minimum. Free sample, prices and ordering information. Hein Specialties, Inc., Dept. 301, 4202 N. Drake, Chicago, IL 60618.

AWARDS DIRECTORY \$1.00 brings information. Refundable. Updated monthly. Computerized. Worldwide. List your awards free. Over 1000 now in files. KB0ZP, RR#1B, Cumming, IA 50061.

EQUIPMENT SALE. HAL DS2000 KSR RTTY/CW keyboard \$100. Panasonic 9" monitor \$80. Collins SM280 microphone \$60. Six good used 4-400A's \$20. each. TR3/AC3/MS4 \$120. 1.6 kHz S-Line filter \$40, 4-1000A and parts for amp. Mike Palmer, K5FZ, 16707 Creeksouth, Houston, Texas 77068. (713) 444-7737.

CUSTOM EMBROIDERED Emblems — Cloisonne' enameled pins, your design, low minimum, excellent quality, free booklet. A.T. Patch Co., Dept. 65, Littleton, NH 03561. (603) 444-3423.

TI 99/4A random, text, keyboard, send, receive code practice programs. Dr. Code "General" sends International Morse code and prints on screen; you choose: speed, tone, which characters to be send, spacing, and more! Dr. Code "Speech" same as "General" with speech; you choose how many characters before speech check. For cassette of both copyrighted programs and conditional copying privileges, send \$10.00 plus \$3.00 shipping and handling to N5ESF, Rt. 1, Box 1326, Lake Charles, LA 70601. Phone (318) 436-2048, no collect calls please. Satisfaction or money back.

QST Magazines. 271 of them about 200 lbs. 1930, 1933 through 1940 solid, 1952 through 1965 solid. Best offer for the whole works only. W2LJ.

FREE CATALOG of books for electronics professionals and hobbyists. Send SASE to Technical Advice, P.O. Box 4757, Englewood, Colorado 80155.

NEW low frequency products by K1RGO. L-101 VLF converter (2 kHz to 500 kHz), AM broadcast rejection 100 dB, i-f rejection 130 dB. L-201 VLF fixed tuned preamplifier (2 kHz to 500 kHz), 25 dB gain (adjustable). Free brochure. LF Engineering Co., 17 Jafry Rd., East Haven, CT 06512.

RUBBER STAMPS: 3 lines \$4.50 PPD. Send check or MO to G.L. Pierce, 5521 Birkdale Way, San Diego, CA 92117. SASE brings information.

CHASSIS and cabinet kits. SASE K3IWK.

IMRA, International Mission Radio Association, helps missionaries. Equipment loaned. Weekday net, 14,280 MHz, 2-3 PM Eastern. Eight hundred Amateurs in 40 countries. Brother Frey, 1 Pryer Manor Road, Larchmont, NY 10538.

WANTED: Old microphones, remote mixers other misc related items. All pre-1935. Box Paquette, 107 E. National Avenue, Milwaukee, WI 53204.

ELECTRON TUBES: Receiving, transmitting, microwave... all types available. Large stock. Next day delivery, most cases. Daily Electronics, PO Box 5029, Compton, CA 90224 (213) 774-1255.

RTTY-EXCLUSIVELY for the Amateur Teleprinter. One year \$7.00. Beginners RTTY Handbook \$8.00 includes journal index. P.O. Box RY, Cardiff, CA 92007.

TENNAEST — Antenna noise bridge — out-performs others, accurate, costs less, satisfaction guaranteed, \$41.00. Send stamp for details. W8UUR, 1025 Wildwood Road, Quincy, MI 49062.

ceived by April 19. Talk in on club repeater 146.34/.94. For information: Carl J. Denbow, KABJXG, Chairman, ACARA Hamfest Committee, 63 Morris Ave., Athens, Ohio 45701.

LOUISIANA: The Central Louisiana ARC (CLARC) will sponsor a Hamfest, Saturday and Sunday, June 8 and 9, Bolton Avenue Community Center, 315 Bolton Avenue, Alexandria. Free admission. Swap tables available. VEC exams. Talk in on 147.93/33 or 146.04/64. For more information: CLARC, PO Box 7772, Alexandria, LA 71306.

GEORGIA: The John Ross Amateur Radio Club's annual Hamfest, June 8 and 9. New location — Lakeview — Ft. Oglethorpe High School, Ft. Oglethorpe on Hwy. 2A. Air conditioned dealer spaces. Indoor/outdoor flea market. Tables available. FCC exams both days. Refreshments and plenty of free parking. Talk in on 145.35/down. For reservations and information: JRARC, PO Box 853, Rossville, GA 30741. (404) 861-5610.

MICHIGAN: The Chelsea Swap and Shop, Sunday, June 2, Chelsea Fairgrounds. Gates open for sellers at 5 AM. General public 8 AM to 2 PM. Donation \$2.50 advance or \$3.00 at gate. Children under 12 and non ham spouses admitted free. Talk in on 146.520 simplex and 147.255 Chelsea repeater. For information: William Allenberndt, 3132 Timberline, Jackson, MI 49201.

MINNESOTA: The North Area Repeater Association will sponsor the state's largest swapfest and exposition, Saturday, June 1, Minnesota State Fairgrounds in St. Paul. Free overnight parking for self-contained campers May 31. Exhibits, dealers, giant flea market. Amateur license exams given. Admission \$4 in advance, \$5 at Fair. Talk in on 25/85 or 16/76 repeaters. For tickets, information: Amateur Fair, PO Box 857, Hopkins, MN 55343. (612) 566-4000.

MARYLAND: The Maryland FM Association's annual Hamfest, Sunday, May 26. Howard County Fairgrounds, West Friendship, I-70, 30 miles west of Baltimore. Gate opens 8 AM to 4 PM. Inside tables by advance registration \$6.00. At the door \$10.00 if available. Donation \$3.00. Talk in on 146.16/76, 222.16/223.76, 449.1/444.1. For tables or information: Craig Rockenbauch, WA3TID, 429 Severnside Drive, Severna Park, MD 21146. (301) 987-6042 (6-10 PM).

GEORGIA: The Anderson, Hartwell and Toccoa Amateur Radio Clubs will hold the 6th annual Lake Hartwell Hamfest, May 18 and 19. Lake Hartwell Group Camp, Highway 29, Hartwell. Free admission, free camping, and free flea market space. Left footed CW contest, horseshoes, fishing, swimming and camping available on site. Campgrounds open 6 PM Friday. Talk in on 146.19/79, 147.93/33 and 146.895/295. For further information: Ray Pettit, WB4ZLG, Rt. #1, Dooley Drive, Toccoa, GA 30577.

MARYLAND: The Frederick Amateur Radio Club's 8th annual Hamfest, June 16, Frederick Fairgrounds. Admission \$3.00. YL's and children free. 8 AM to 4 PM. Tailgaters \$2.00 extra. Gates open for exhibitors 8 PM June 15. Overnight parking welcomed. Tables \$10.00 first, \$5.00 each extra. For information: Jim Kasunic, KA3LPC, 9419 Highlander Ct., Walkersville, MD 21793.

ILLINOIS: The Chicago Amateur Radio Club (C.A.R.C.) is sponsoring a Mini Hamfest, Wednesday, May 15, 6 to 10 PM, Edgebrook Golf Course Fieldhouse, 5900 N. Central Avenue, Chicago. (North of Elston Avenue, south of Devon Avenue). For more information: (312) 545-3622.

NEW HAMPSHIRE: The 11th annual Eastern VHF/UHF Conference, May 17-19, Rivier College, Nashua. Friday night hospitality room. Saturday tech talks by well-known VHFers. Pre-registration \$13.50 to David Knight, KA1DIT, 15 Oakdale Avenue, Nashua, NH 03062 before May 5. Registration at the door \$20.00. Saturday night banquet \$14.00 payable before May 5. Dormitory housing available, \$16.50 per night single, \$28.00 per night double, includes buffet breakfast. Include payment at time of pre-registration. Make checks payable to Eastern VHF/UHF Conference. There are also numerous hotels and motels nearby. For information: Lewis D. Collins, W1GXT, 10 Marshall Terrace, Wayland, MA 01778. (617) 358-2854 (6-10 PM).

OHIO: The 5th annual Columbus Hamfest sponsored by the Battelle Amateur Radio Club, Sunday, June 2, 8 AM to 3 PM. Ganyard Building on Franklin County Fairgrounds. Admission \$2 advance and \$3 at the door. Advance tables \$3; at the door \$4. Talk in on 146.37/97. For information Bill, W8LLU (614) 261-7053 or Kevin, WA8OHI (614) 766-5313. Advance sales SASE to Bill Welch, W8LLU, 396 Brevoort Rd., Columbus, Ohio 43214.

OHIO: The Sandusky-Ottawa Counties annual Hamfest, May 19, 8 AM to 3 PM. Ottawa County Fairgrounds, St. Rt. 163 east of Oak Harbor. Donation \$3.00 at gate; \$2.50 advance. Tables \$3.00. Gate opens 6 AM for dealers and 8 AM for

Foreign Subscription Agents for Ham Radio Magazine

<p>Ham Radio Austria Karin Ueber Postfach 2454 D-7850 Loerrach West Germany</p> <p>Ham Radio Belgium Sterehouse Brusselsesteenweg 416 B-9218 Gent Belgium</p> <p>Ham Radio Holland Postbus 413 NL-7800 Ar Emmen Holland</p> <p>Ham Radio Europe Box 2084 S-194 02 Upplands Vasby Sweden</p> <p>Ham Radio France SM Electronic 20 bis, Ave des Clarions F-89000 Auxerre France</p> <p>Ham Radio Germany Karin Ueber Postfach 2454 D-7850 Loerrach West Germany</p>	<p>Canada Send orders to Ham Radio Magazine Greenville, NH 03048 USA Prices in Canadian funds 1 yr. \$29.95, 2 yrs. \$53.30 3 yrs. \$75.40</p> <p>Ham Radio Italy Via Pordenone 17 I-20132 Milano Italy</p> <p>Ham Radio Switzerland Karin Ueber Postfach 2454 D-7850 Loerrach West Germany</p> <p>Ham Radio England c/o R.S.G.B. Alma House Cranborne Road Pottery Bar Herts EN6 3JW England</p> <p>Holland Radio 143 Greenway Greenside, Johannesburg Republic of South Africa</p>
-----------------------------------------------------------------------------------------------------------------------------------------------------------------------------------------------------------------------------------------------------------------------------------------------------------------------------------------------------------------------------------------------------------------------------------------------------------------------------------------------------------------------------------------------------------	------------------------------------------------------------------------------------------------------------------------------------------------------------------------------------------------------------------------------------------------------------------------------------------------------------------------------------------------------------------------------------------------------------------------------------------------------------------------------------------------------------------------------------------------------------------------------

Coming Events ACTIVITIES "Places to go..."

INDIANA: Hamfest and Computer Show, Sunday, June 9. Sponsored by the Muncie Area Amateur Radio Club. 8 AM to 3 PM. Rain or Shine. Delaware County Fairgrounds. Tickets \$2.00 advance, \$3.00 at door. Large Flea Market. Overnight camping on grounds. Hookups \$5.00. Talk in on 146.13/73. For tickets, table reservations or information: SASE to MAARC, PO Box 2102, Muncie, IN 47302.

OHIO: The Athens County Amateur Radio Association's sixth annual Hamfest and Computerfest. Sunday, May 19, City Recreation Center, East State Street, Athens. 8 AM to 3 PM. Admission \$3.00. Free paved outdoor tailgating or bring your own tables. Indoor space by advanced registration only. Contact Joe Follrod, NE8R, 15 Roy Avenue, The Plains, OH 45780. (614) 797-4874. This year there will be all level license exams. Mail completed FCC Form 610 and \$4.00 check payable to ARRL/VEC to John Cornwell, NCBV, exam coordinator, 101 Coventry Lane, Athens, OH 45701. Forms must be re-

general public. Trunk sale (donation 50¢), plenty of parking, food and refreshments. To reserve tables: Raymond Kruse, K8IDA, 18980 W. S.R. 51, Elmore, Ohio 43416. (419) 862-2619 (8 AM - 5 PM).

PENNSYLVANIA: The Warmister ARC Hamfest, May 19, Middletown Grange Fairgrounds, Penns Park Rd., Wrightstown (about 15 miles north of Phila.) Admission \$3.00. XYLs and children free. Indoor space with table and elec \$5.00. Tailgating space \$5.00. Gates open 7 AM. Talk in on 147.69/09 and 147.52. Computer hardware/software vendors welcome. For information: Bill Cusick, W3GJC, Apt. 706, Garner House, Hatboro, PA 19040. (215) 441-8048.

NEW YORK — Long Island: The Suffolk County Radio Club's Indoor/Outdoor Electronic Flea Market, Sunday, May 5, 8 AM to 3 PM, Republic Lodge No. 1987, 585 Broadhollow Road (Rt. 110) Melville. Refreshments and plenty of free parking. General admission \$2.00. Wives and children under 12 free. Indoor seller's tables \$7.00. Outdoor space \$5.00 includes one free admission. Talk in on 144.61/145.21 and 146.52. For information: Richard Tygar, AC2P. (516) 643-5956 evenings.

NEVADA: The 10th International Convention of the YLRL will be held June 20, 21, 22 and 23 at the Sahara Hotel, Las Vegas. Deluxe accommodations and RV parking available at reasonable rates. Activities include a Hoover Dam tour, Lake Mead cruise, desert tour, gala stage show, cocktail party, luncheon buffet and awards banquet plus a DX YL show, slide shows and business meetings. A convention station will operate on 14,288 kHz and other frequencies. Registration forms are to be found in recent issues of YLRL's "Harmonics". For information packet send business SASE with 2 oz. of postage to Jan Weaver, N7YL, 2195 East Camero Avenue, Las Vegas, NV 89123.

NEW JERSEY: The Tri-County Radio Association's Hamfest, Sunday, May 19, rain or shine, Passaic Valley Community Center off Valley Road, Stirling, 9 AM to 4 PM. Indoors, free parking, refreshments. Tables \$10. Registration \$2.50. Reserved tailgating only. All reservations to: Dick Franklin, W2EUF, PO Box 182, Westfield, NJ 07090. (210) 232-5955 or 270-3193.

SOUTH DAKOTA: The Black Hills Amateur Club is celebrating its 50th anniversary by sponsoring the 1985 ARRL Dakota Division Convention, July 5, 6, 7, Howard Johnson's (I-90, exit 59) Rapid City. Registration Friday from 4 to 7:30 PM followed by a social hour. Saturday exhibits, registration, indoor flea market (free tables while they last) ladies' activities and fun for the whole family. VE exams (limited walk-ins) 1 PM. Banquet at 7 PM. Sunday brunch at 8:30 followed by the ARRL forum. Exhibits will be open. Pre-registration & banquet \$18.00. Pre-registration only \$6.50. Must be made prior to 6/10/85. Additional banquet tickets \$12.50. Sunday brunch \$6.75, children 12 and under \$3.75. Registration after 6/10/85, \$7.50. Make check payable to Black Hills ARC, c/o Gene F. Bauer, KX0U, 713 Blaine Avenue, Rapid City, SD 57701. Confirmation by return mail.

WISCONSIN: The Central Wisconsin Radio Amateur's annual Swapfest/Family Picnic, June 16, Bukolt Park, Stevens Point. Swapfest will feature volunteer exams (by advanced registration only), dealers, food, refreshments and fellowship. Tables and tailgating \$2.00. Talk in on 146.07/67 and 385/985. For further information: Jim Benak, KA9ACE, 1775 Strongs Avenue, Stevens Point, WI 54481. To register for exams (by May 16): Gene Santoski, K9UTG, 1220 — 18th Street South, Wisconsin Rapids, WI 54494.

KENTUCKY: The Armored Force Amateur Radio Nationwide Emergency Team (A FAR NET) will hold an Eyeball Bivouac, June 7-9, at the Best Western Gold Vault Inn in Radcliff, just outside Fort Knox. Campers will use the Fort Knox campground at Camp Carlson. On Friday, June 7, there will be an informal picnic. Saturday, the group will take a guided bus tour of Fort Knox ending at the Patton Museum. Saturday evening's cocktail party is followed by dinner at 8 PM. There will be a farewell breakfast Sunday morning. For additional information contact Carl Quickmire, WB4UBS, 6341 Cloverdale Drive, Columbia, SC 29209. Any Amateur Radio operator who has ever served with or been assigned to an armored unit of the U.S. armed forces or its allies is eligible for membership in A FAR NET. Family members holding an Amateur license are eligible for associate memberships. Anyone interested in joining this unique organization can obtain information and an application from Harry B. Thomsen, W2PJH, 348 Jefferson Avenue, Apt. 15, Canandaigua, NY 11424. Please include business SASE.

PENNSYLVANIA: The 31st annual Breeze Shooters Hamfest, Sunday, June 2, 9 AM to 5 PM, White Swan Amusement Park, Rt. 60 near Greater Pittsburgh International Airport. Free admission and flea market. Family amusement park. Registration \$2.00, 3 for \$5.00 or 7 for \$10.00. Vendors tables by advance registration. Talk in on 146.28/88 or 29,000 MHz. For information: John Colbert, K3SDL, 1831 Highland Ave., Irwin, PA 15642. (412) 863-5167 evenings only.

COLORADO: The Longmont Amateur Radio Club's annual Boulder Spring Hamfest, Sunday, May 5, 9 AM to 2 PM rain or shine, Colorado National Guard Armory, 4750 North Broadway, Boulder. Donation \$3 per family. No sellers charge but bring own tables... Hamswap, plus tech demonstrations and seminars. Food and drink available. Talk in on 146.16/76 and 146.52. For information: William Currie, WD0EHJ, 1232 East Fourth Ave., Longmont, CO 80501. (303) 776-2829.

NEW YORK: Long Island Hamfair sponsored by LIMARC, Sunday, June 9, 9 AM to 4 PM, Electricians Hall, 41 Pinelawn Road, Melville, Long Island. General admission \$3.00 \$2.00 after 1 PM. Table space in advance from Hank Wener, WB2ALW, 53 Sherrard St., East Hills, NY 11577-1712. 4 x 6' table space \$10.00 or your own for \$6.00. Contact Hank at (516) 484-4322 evenings to 11:30 PM.

INDIANA: The 39th Annual Hamfest sponsored by the Wabash Valley ARA, Sunday, June 2, Vigo County Fairgrounds, Terre Haute. For information SASE to WVARA, PO Box 81, Terre Haute, IN 47808.

CONNECTICUT: Flea Market, sponsored by the Newington Amateur Radio League, June 9, Newington High School, 9 AM to 2 PM. Admission \$2.00. Tailgating \$5.00. Talk in on 146.52 or W1AW/R 145.450, 224.840.

NEW YORK: The Rome Radio Club's 33rd annual Ham Family Day, Sunday, June 2, Beck's Grove in Rome. Games, contests and large Flea Market. Good food and beverages available throughout the day. Educational and scientific presentations. The day will end with dinner and the presentation of "Ham of the Year Award". For further information: Rome Radio Club, PO Box 721, Rome, NY 13440.

NEW YORK: The 26th annual Southern Tier Amateur Radio club's Hamfest, Saturday, May 4, Treadway Inn, Owego. Flea market opens 8 AM. Vendor displays and sales. Dinner at 6:30 PM by advance tickets only. Talk in on 22/82, 16/76 and 146.52. For further information SASE to KF2X, RD #1, Box 144, Vestal, NY 13850.

NEW YORK: The Antique Radio Club of America will hold an international convention at Niagara Falls, June 5-8. The club has 1000 members who collect and restore antique wireless and radio equipment and who study and record the history of early radio. For information on the convention or membership in ARCA please write NFWA, PO Box 68, Central Park Station, Buffalo, NY 14215.

WASHINGTON: The Yakima Amateur Radio Club will hold the Central Washington State Hamfest, May 18 and 19, Hobby Building at Central Washington State Fairgrounds, Yakima. Saturday 9 to 5 with lunch available. Sunday 7 to 2 with breakfast and lunch available. Registration \$4.00 advance, \$5.00 at the door. Free swap and shop with plenty of tables. Talk in on 146.01/61 and 146.34/94. For pre-registration contact Tom Plaisance, PO Box 9211, Yakima, WA 98909.

OPERATING EVENTS

"Things to do..."

MAY 5 AND 5: The Mason County ARC will operate commemorative stations KB7MJ and W7KTI on SSB, KN7D RTTY and K7UAR on Packet to celebrate the Shelton, Washington, Centennial. Certificates will be exchanged for a QSL card and 9 x 12 SASE. Send to Loren Mercer, KA7GSV, 2213 Olympic Hwy. North, Shelton, WA 98584.

JUNE 2: SRRC Hamfest, Princeton, Illinois. Plans include FCC/VEC exams. Registrations \$2.50 before May 20. \$3.00 June 2. For advance registrations and/or complete information, furnish a long SASE to Starved Rock Radio Club, W9MKS, RFD #1, Box 171, Oglesby, Illinois 61348. (815) 667-4614.

JUNE 1 AND 2: The Southside Amateur Radio Club will operate station N0EWP in honor of President Harry Truman's 101st birthday. The station will operate near the old Truman farm home in Grandview, MO during the annual "Harry's Heydays" celebration. For a commemorative certificate send 9 x 12 SASE with 33¢ postage to Southside ARC, PO Box 412, Grandview, MO 64030.

MAY 4: The Sand Hills Amateur Radio Club will operate KZ0M during a DXpedition to Moscow, KS to commemorate May Day. For a special QSL SASE via Box 88, Moscow, KS 67952.

MAY 25: The Bay Area Amateur Radio Society, Pasadena, Maryland, will operate KM3I and KA3HKB to commemorate "Samuel F.B. Morse Day". For a special certificate send QSL and large SASE to B.A.A.R.S., PO Box 805, Pasadena, MD 21122-0805.

CG CONTEST: VHF'ers please note! The first annual CO World Wide VHF WPX Contest is July 20-22, 50 thru 1296

MHz. For details, logsheets, etc., write to SCORE, PO Box 1161, Denville, NJ 07834 or to CQ Magazine. We need your entry to make this a success.

MAY 18: ARRL/VEC License Exam at 9 AM, United Community Services Building (Red Cross), 39 North Park Street, Mansfield, Ohio. Send SASE, 610 and check for \$4 payable to ARRL/VEC to Peggy Boyle, KC8NH, 1464 Marion Avenue Road, Mansfield, Ohio 44906.

MAY 18 AND 19: The Amateurs of Lima and Allen County, Ohio will commemorate the discovery of oil in Lima. Stations participating will sign /OIL and operate in the Novice, Technician or General portions of the bands. For a certificate SASE to Northwest Ohio ARC, PO Box 211, Lima, Ohio 45801.

JUNE 1: The Wireless Institute of Northern Ohio (W.I.N.O.) will be operating a special event station from an actual winery in Madison, Ohio to commemorate Ohio Wine Month. Listen for KO8O Saturday evening 7 and 11 PM EDT and Sunday 11 AM to 3 PM EDT. A special 8 1/2 x 11 QSL certificate will be available from KO8O — WINO Weekend, 7126 Andover Drive, Mentor, Ohio 44060.

JUNE 8: Tri-City ARC will operate W7VPA from Ice Harbor Dam the highest lift navigable locks in the United States. Operation will be from 1700 to 2400Z. For a special QSL SASE to W7VPA, PO Box 73, Richland, WA 99352.

MAY 10: The Owensboro ARC will operate K4HY from 0000Z to 0530Z May 11 to celebrate their International BBQ Festival. Certificate for SASE via N4EKG, 1615 East 23rd Street, Owensboro, KY 42301.

COMING

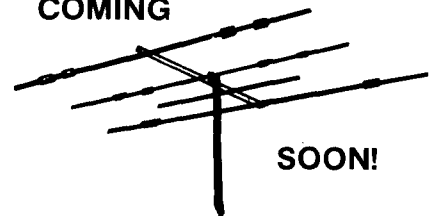

SOON!

THE ARRL ANTENNA COMPENDIUM

This new League publication will consist of over 20 antenna articles never published before. Availability will be in late May — just in time for your warm-weather antenna work! Watch QST for details.

Other books on antennas available from ARRL:

The ARRL Antenna Book 14th Edition, copyright 1982. 328 pages of comprehensive antenna, propagation and transmission line fundamentals. \$8.00 U.S., \$8.50 elsewhere. Cloth edition \$12.50

HF Antennas for All Locations, copyright 1982. From RSGB, 264 pages. \$12.00

Antenna Anthology The best hf antenna articles taken from QST. Copyright 1978, 148 pages. \$4.00 U.S., \$4.50 elsewhere.

THE AMERICAN RADIO RELAY LEAGUE
225 MAIN ST.
NEWINGTON, CT 06111

240

SAY YOU SAW IT
IN
HAM RADIO

THE VHF SHOP

ORDERS QUOTES **1-800-HAM-7373**

ASTRON	45.00	RS35M	138.95
RS7A	62.75	VS35M	156.95
RS20A	79.95	RS50A	179.85
RS20M	96.45	RS50M	203.25
VS20M	114.95	VS50M	223.95
RS35A	123.75	RM50A	206.95

MIRAGE

A1015 6Mtr 150w Amp/Pa	CALL FOR UPS BROWN ON MIRAGE
B23A 2 Mtr HT Amp/Pa	
B1016 2 Mtr 160w Amp/Pa	
B3016 2Mtr 30 In / 160 c-w	
C1012 1.3Mtr 120w Amp/Pa	QUOTE
D1010N 430-450MHz 100w N's	

KLM

KT34A 4el. Tribander	333.95
KT34XA 6el. Tribander	478.95
2M16LX/220-22L BX/432-30L BX	90.95
2M14C/2M-22C	85.50/113.95
435-18C	112.95

KENPRO

KR500 Elevation Rotor	169.95
FM2033 2Mtr 25w FM	279.95
FM6033/4033/7033	Call!

HENRY RADIO

2K-D Classic 2 KW Amp	965.00
2002/2004A KW's	1250.00/1350.00

MICROWAVE MODULES

MMT144-28 2Mtr X-verter	199.95
MMT220-28 220MHz X-verter	260.00
MMT432/435-28 10w X-verter	279.95
MMT1296-144G 2w X-verter	349.95
MMT144-28 2Mtr converter	59.00
MMC432/435-28 converter	69.00

Information & Pa. Residents
Call (717) 474-9399

16 S. Mountain Blvd. - Rt. 309
Mountaintop, Pa. 18707

FOR THE BEST DEAL IN TOWN
CALL THE BEST NUMBER AROUND **1-800-HAM-7373**
SPECIALS: Astron Power Supply Sale (see prices at left); Yaesu FT-980 \$1,330, FT-757GX \$745.95; Kenwood TS-430S - Call!, TS-711A - CALL!

YAESU

FT203R NEW 2Mtr HT	(FREE UPS BROWN ON YAESU)	CALL FOR OUR ROCK BOTTOM QUOTE
FT-209HR		
FT708R 440MHz HT		
FT77 Great Mobile Rig		
FT757GX HF XCVR - A Winner!		
FT960 CAT System Special		
FT72ER with 2Mtr Module		
432/435 Module - 72ER		
50 MHz Module - 72ER		
HF726 10 - 12 - 15Mtr Module		

SSB ELECTRONICS

High Performance - Low Noise DBM converters for 50MHz, 144MHz, or 432MHz	109.95
SSB1296-28/144 GaAsFet converter	149.95
SSB144-28 10w Transverter Kit with Double Balanced Mixer on Tx/Rx	199.95
SSB432/435-28 10w Transverter Kit with GaAsFet front-end, DBM's on Tx/Rx	Call!
LT23a 1296 MHz 10w X-verter, NF 1.8dB	
GaAsFet front-end, Dual Channel	650.00
Microline12 2.3GHz Linear X-verter	399.95
LSM24 OSCAR MODE L up-converter	279.95
DX144 GaAsFet Preamp NF 4dB	124.95
DX432 GaAsFet Preamp NF 5dB	124.95
DX1296 GaAsFet Preamp NF 8dB	124.95
SSB MAST-MOUNTED GaAsFet Preamps	
MV1445-01 NF 6dB 1Kw PEP Max.	275.95
MV4325-01 NF 7dB 1Kw PEP Max.	275.95

MUTEK LTD.

Low Noise - High dynamic range front-end boards with: Low loss relay, RF Amp, DBM, 6-pole Xtal filter, and IF Amplifier.	
ICOM IC211/251 Board	135.95
ICOM IC271A Board	149.95
GLNA432E mast mount GaAsFet preamp and sequencer	269.95
SLNA144s RF Switched Preamp, 100w max. Input, NF 1dB Gain 15dB typ	74.95
SLNA50s Same as above for 50MHz	74.95
SBLA144e Mast-Mounted RF Switched preamp, 250w, max input NF 1dB	159.95
GFBA144e Mast-Mounted GaAsFet preamp, 1 Kw PEP Max, includes Lin. amplifier sequencer, Interfaces to all rigs!	249.95
CUE DEE - The Swedish Boomer "SALE" 144-15AN 15el 144MHz Yagi w/N conn.	79.95

PARABOLIC - UHF UNITS - LABE

1296/28 dual conversion xverter	365.00
1269/1296 single tube amp (60w)	279.95
1269/1296 dual tube amp (120w)	369.95
1.2 meter dish kit	95.95
Dish feeds 1296 or 2304	85.95
2 way ant. combiners 144/432	51.95/49.95
4 way ant. combiners 144/432	59.95/56.95

TERMS: Prices do not include shipping except where indicated and are subject to change without notice. At our discretion some COD's may require a deposit. Returns are subject to a 15% restocking charge.
*Continental USA only

Bind 'em and Find 'em

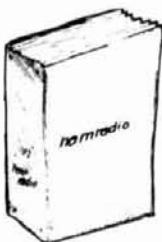

Keep those valuable issues of Ham Radio like new. Prevent smears, tears and dog ears. Bind 'em together and enjoy for years to come. You'll be happy you did!

HAM RADIO BINDERS

Beautiful buckram bound, rich brown material with gold embossing. These binders will really dress up your collection of Ham Radio. Year stickers included.

HR-BDL \$6.95 ea.
3 for \$17.95

Please add \$2.50 for shipping and handling, U.S. only.

HAM RADIO'S BOOKSTORE
GREENVILLE, NH 03048

10 METER F.M.

29.310-29.700 MHz in 10 kHz Steps. 100 kHz Repeater Split provided.
4W RF Out. 0.3 V for 12 dB Sinad. c/w Mic, mobile cradle etc.



VISA CARD MASTER CARD I.M.O. DRAFT **\$79** AIR POST PREPAID WORLDWIDE
S.M.C. Ltd., Totton, Southampton, SO4 4DP, U.K.

MULTI-BAND SLOPERS

ALSO DIPOLES & LIMITED-SPACE ANTENNAS

Outstanding performance of WINN antennas is well known. Now enjoy multi-band BIG-SIGNAL reports! Automatic bandswitching. Very low SWR. Coax feed. 3kw power. Compact - FULLY ASSEMBLED to your specified center frequency each band. Easy to install. Very low profile. Complete instructions. Your personal check accepted.

4 BAND SLOPER - 160, 80, 40, 30, or 20M	50 ft long	\$ 49 ppd
3 " " " " - 160, 80, 40M	50 ft "	\$ 43 "
2 " " " " - 80, 40M	40 ft "	\$ 35 "
3 " " NO-TRAP DIPOLE - 160, 80, 40M	113 ft long	\$ 71 "
2 " " " " - 40M	85 ft "	\$ 55 "
9 BAND SPACE-SAVING DIPOLE - 160 thru 10M*	45 ft long	\$ 85 ppd

* Requires wide-range tuner (80, 40, 20, 15M without tuner)

SEND SASE for complete details of these and other unique antennas

WINN ANTENNAS 312 394 3414
BOX 393-H MT. PROSPECT, IL 60056

NEW!



1985 WORLD RADIO TV HANDBOOK

39th Edition
Brand New. Just Released!
Get Your Copy Today.

This book has been called the SWL's bible and for good reason. It's chockfull of all the latest call signs, schedules, frequencies and other important information for broadcasters around the world. You also get equipment reviews and other special features that make the WRTV Handbook an invaluable reference guide.

©1985 39th edition 608 pages
 GL-WRTV85 (please add \$3.50 for shipping & handling) Softbound \$19.50

ham radio magazine **BOOKSTORE**
GREENVILLE, NH 03048 (603) 878-1441

MOVING? KEEP HAM RADIO COMING...

If possible let us know four to six weeks before you move and we will make sure your HAM RADIO Magazine arrives on schedule. Just remove the mailing label from this magazine and affix below. Then complete your new address (or any other corrections) in the space provided and we'll take care of the rest.

ham radio Magazine
Greenville, NH 03048
Allow 4-6 weeks for correction.

Thanks for helping us to serve you better.

Here's my new address:

Call _____

Name _____

Address _____

City _____ State _____ Zip _____

AFFIX LABEL HERE

Tell 'em you saw it in HAM RADIO!

MICROCOMPUTER REPEATER CONTROL



\$119

✓ 195

Introducing the MICRO REPEATER CONTROLLER RPT-2A, a new concept in LOW COST, EASY TO INTERFACE, microcomputer repeater control. Replace old logic boards with a state of the art microcomputer that adds NEW FEATURES, HIGH RELIABILITY, LOW POWER, SMALL SIZE, and FULL DOCUMENTATION to your system. Direct interface (drop in) with most repeaters. Detailed interface information included. Original MICRO REPEATER CONTROL article featured in QST Dec. 1983.

- Two CW ID Messages
- Time Out Timer
- Pre Timeout Warning MSG
- Post Timeout CW MSG
- Courtesy Beep
- Auxiliary Inputs
- Reconfigurable COR Input
- High Current PTT Interface
- Sine Wave Tone Generator
- Low Power 9.15 VDC @ 200 ma
- Size 3.5" x 3.5"
- All Connectors Included

RPT-2A Kit Only \$119 plus \$3.00 shipping

PROCESSOR CONCEPTS

P.O. BOX 185
FORT ATKINSON, WI 53538
(414) 563-4982 7pm-10pm evenings



CALL OR WRITE FOR FREE CATALOG AND SPECIFICATIONS



IT'S INCREDIBLE!

Master code or upgrade in a matter of days. Code Quick is a unique breakthrough which simplifies learning Morse Code. Instead of a confusing maze of dits and dahs, each letter will magically begin to call out its own name! Stop torturing yourself! Your amazing kit containing 5 power-packed cassettes, visual breakthrough cards and original manual is only **\$39.95!** Send check or money order today to WHEELER APPLIED RESEARCH LAB, P.O. Box 3261, City of Industry, CA 91744. Ask for Code Quick #103, California residents add 6% sales tax.

One User Comments:

"First new idea in code study and the darn thing works! So much fun you don't realize how much you're learning."

✓ 196 M.S. Grenada, Miss.

Hundreds of satisfied customers! You can't lose! Follow each simple step. You must succeed or return the kit for a total immediate refund!

ALL BAND TRAP VERTICAL

Great for DX

Completely assembled and ready to use!
-Commercial quality, built to last -Light weight, sealed, weatherproof trap(s)
-Low loss end insulator -Handles up to 2000 watts PEP - Automatic band switching -For all transmitters, receivers & transceivers -Tuner usually never required -Deluxe end feed connector, with built in lightning arrester, accepts PL-259 coax connector -Use as sloper or vertical
-Permanent or portable use - Easy to install -Can be used without radials - Attaches to almost any support -Excellent for all class amateurs - Instructions included -10 day money-back guarantee!

4-Band-40,20,15,10 meters (27') 1 trap #VS-41

\$39.95 plus \$4.00 shipping

5-Band-80,40,20,15,10 meters (52') 2 traps #VS-52

\$54.95 plus \$4.00 shipping

50 ft. RG-58U, 52 ohm coax cable with PL-259 connector on each end - add \$8.00 to above price.

We accept VISA/MC - give Card#, Exp. date, Signature ✓ 162

SPI-RO DISTRIBUTORS,

Room 103, P.O. Box 1538
Hendersonville, NC 28793



ROHN

brings the top to you

ROHN brings the top to you with its patented design. For the ultimate "on the ground" service and antenna installation, a ROHN "Fold-Over" Tower is your best buy. Your safety comes first with "Fold-Over." For complete details write:

ROHN

"FOLD-OVER" TOWERS

P.O. BOX 2000, PEORIA, IL 61656 U.S.A.
TWX: 910-652-0646 FAX: 309-697-5612

COAX RELAYS

CX-600N

Max Input Pwr. 600 W at 500 MHz
VSWR < 1.15 at 1500 MHz
Isolation > 40 db at 500 MHz
Impedance 50 ohm Type N connectors



MODEL CX-600N

1984-85
CATALOG
50¢



MODEL CX-120P

CX 120 P

Max Input Pwr 150 W at 500 MHz
VSWR < 1.12 at 2500 MHz
Isolation > 40 db at 500 MHz
Impedance 50 ohm PC Board Mounting
Similar type (CX 120A) available for direct connection to RG58/U



TOROID

F-568-1-H 2.4" OD μ 900
popular for broad band balun (Inc. 160 m) and RFI

RADIOKIT
Box 411H
Greenville, NH 03048
(603) 878-1033
telex 887697

✓ 198



GUS BROWNING, W4BPD's DX'ERS MAGAZINE

For over 17 years, Gus's DX'ERS MAGAZINE has brought thousands of DX'ERS worldwide, timely, pertinent information on when and where to find those elusive DX stations.

Gus's personable, chatty writing style and his years of DX operating experience makes the DX'ERS MAGAZINE a unique publication. One year \$14.00 USA, Canada & Mexico.

✓ 199

Gus also prints high quality QSLs and other related items.

Write today for a free sample of his QSLs and DX'ERS MAGAZINE.

Gus Browning, W4BPD • PO Drawer 405 • Cordova, SC 29039

HAM MART

Ham Radio's guide to help you find your local

California

C & A ROBERTS, INC.
18511 HAWTHORN BLVD.
TORRANCE, CA 90504
213-370-7451
24 Hour: 800-421-2258
Not The Biggest, But The Best —
Since 1962.

FONTANA ELECTRONICS
8628 SIERRA AVENUE
FONTANA, CA 92335
714-822-7710
714-822-7725
The Largest Electronics Dealer in San
Bernardino County.

JUN'S ELECTRONICS
3919 SEPULVEDA BLVD.
CULVER CITY, CA 90230
213-390-8003
800-882-1343 Trades
Habla Espanol

Connecticut

HATRY ELECTRONICS
500 LEDYARD ST. (SOUTH)
HARTFORD, CT 06114
203-527-1881
Call today. Friendly one-stop shopping
at prices you can afford.

Delaware

**AMATEUR & ADVANCED
COMMUNICATIONS**
3208 CONCORD PIKE
WILMINGTON, DE 19803
(302) 478-2757
Delaware's Friendliest Ham Store.

DELAWARE AMATEUR SUPPLY
71 MEADOW ROAD
NEW CASTLE, DE 19720
302-328-7728
800-441-7008
Icom, Ten-Tec, Microlog, Yaesu,
Kenwood, Santec, KDK, and more.
One mile off I-95, no sales tax.

Florida

AMATEUR ELECTRONIC SUPPLY
1898 DREW STREET
CLEARWATER, FL 33575
813-461-4267
Clearwater Branch
West Coast's only full service
Amateur Radio Store.
Hours M-F 9-5:30, Sat. 9-3

AMATEUR ELECTRONIC SUPPLY
621 COMMONWEALTH AVE.
ORLANDO, FL 32803
305-894-3238
Fla. Wats: 1 (800) 432-9424
Outside Fla: 1 (800) 327-1917
Hours M-F 9-5:30, Sat. 9-3

AMATEUR RADIO CENTER, INC.
2805 N. E. 2ND AVENUE
MIAMI, FL 33137
305-573-8383
The place for great dependable
names in Ham Radio.

Hawaii

HONOLULU ELECTRONICS
819 KEEAUMOKU STREET
HONOLULU, HI 96814
(808) 949-5564
Serving Hawaii & Pacific area for 51
years. Complete lines of Amateur equip-
ment, accessories and parts.

Illinois

ERICKSON COMMUNICATIONS, INC.
5456 N. MILWAUKEE AVE.
CHICAGO, IL 60630
312-631-5181
Hours: 9:30-5:30 Mon, Tu, Wed & Fri;
9:30-8:00 Thurs; 9:00-3:00 Sat.

Indiana

THE HAM STATION
808 NORTH MAIN STREET
EVANSVILLE, IN 47710
812-422-0231
Discount prices on Ten-Tec, Cubic,
Hy-Gain, MFJ, Azden, Kantronics,
Santec and others.

Massachusetts

James Millen Components by
ANTENNAS ETC.
16 HANSOM ROAD
ANDOVER, MA 01810
617-475-7831
Bezels, binding posts, capacitors, con-
densers, chokes, coils, ceramics, H.V.
connectors, plate caps, hardware
knobs, dials, scopes and grid dippers.
Inquire SASE or visit.

TEL-COM, INC.
675 GREAT ROAD, RTE. 119
LITTLETON, MA 01460
617-486-3400
617-486-3040
The Ham Store of New England
You Can Rely On.

Michigan

ENCON PHOTOVOLTAICS
Complete Photovoltaic Systems
27600 Schoolcraft Rd.
Livonia, Michigan 48150
313-523-1850
Amateur Radio, Repeaters, Satellite,
Computer applications.
Call Paul WD8AHO

Nevada

AMATEUR ELECTRONIC SUPPLY
1072 N. RANCHO DRIVE
LAS VEGAS, NV 89106
702-647-3114
Dale Porray "Squeak," AD7K
Outside Nev: 1 (800) 634-6227
Hours M-F 9-5:30, Sat. 9-3

JUN'S ELECTRONICS
460 E. PLUMB LANE — 107
RENO, NV 89502
702-827-5732
Outside Nev: 1 (800) 648-3962
Icom — Yaesu Dealer

NEW YORK

ADIRONDACK ELECTRONICS, INC.
1991 CENTRAL AVENUE
ALBANY, NY 12205
518-456-0203
Amateur Radio for the Northeast since
1943.

BARRY ELECTRONICS
512 BROADWAY
NEW YORK, NY 10012
212-925-7000
New York City's Largest Full Service
Ham and Commercial Radio Store.

VHF COMMUNICATIONS
915 NORTH MAIN STREET
JAMESTOWN, NY 14701
716-664-6345
Call after 7 PM and save! Supplying all
of your Amateur needs. Featuring ICOM
"The World System." Western New
York's finest Amateur dealer.

Dealers: *YOU SHOULD BE HERE TOO!*
Contact Ham Radio now for complete details.

RADIO WAREHOUSE

Division of HARDIN Electronics

**NO FRILLS—JUST LOW PRICES
CALL FOR SPECIAL PRICES ON—**

KENWOOD

YAESU

ICOM

TEN-TEC

**DAIWA METERS—KEYERS—AUDIO FILTERS
CUSHCRAFT LINE OF ANTENNAS**

CALL TOLL FREE

1-800-433-3203



IN TEXAS CALL 817-496-9000

5635 EAST ROSEDALE

FT. WORTH, TEXAS 76112

Amateur Radio Dealer

Ohio

AMATEUR ELECTRONIC SUPPLY
28940 EUCLID AVE.
WICKLIFFE, OH (CLEVELAND AREA)
44092
216-585-7388
Ohio Wats: 1 (800) 362-0290
Outside Ohio: 1 (800) 321-3594
Hours M-F 9-5:30, Sat. 9-3

UNIVERSAL AMATEUR RADIO, INC.
1280 AIDA DRIVE
REYNOLDSBURG (COLUMBUS), OH
43068
614-866-4267
Featuring Kenwood, Yaesu, Icom,
and other fine gear. Factory author-
ized sales and service. Shortwave
specialists. Near I-270 and airport.

Pennsylvania

**HAMTRONICS,
DIV. OF TREVISE ELECTRONICS**
4033 BROWNSVILLE ROAD
TREVISE, PA 19047
215-357-1400
Same Location for 30 Years.

LaRUE ELECTRONICS
1112 GRANDVIEW STREET
SCRANTON, PENNSYLVANIA 18509
717-343-2124
Icom, Bird, Cushcraft, Beckman,
Larsen, Hustler, Astron, Belden,
Antenna Specialists, W2AU/W2VS,
AEA, B&W, Amphenol, Saxton, J.W.
Miller/Daiwa, Vibroplex.

THE VHF SHOP
BOX 349 RD 4
MOUNTAINTOP, PA 18707
717-868-6565
Lunar, Microwave Modules, ARCOS,
Astron, KLM, Tama, Tonna-F9FT,
UHF Units/Parabolic, Santec, Tokyo
Hy-Power, Dention, Mirage,
Amphenol, Belden

Texas

MADISON ELECTRONICS SUPPLY
1508 MCKINNEY
HOUSTON, TX 77010
713-658-0268
Christmas?? Now??

Wisconsin

AMATEUR ELECTRONIC SUPPLY
4828 W. FOND DU LAC AVE.
MILWAUKEE, WI 53216
414-442-4200
Wisc. Wats: 1 (800) 242-5195
Outside Wisc: 1 (800) 558-0411
M-F 9-5:30
Sat 9-3

ALL BAND TRAP "SLOPER" ANTENNAS!



**FULL COVERAGE! ALL BANDS! AUTOMA-
TIC SELECTION with PROVEN Weatherproof
sealed Traps - 18 Ga. Copperweld Wire!
GROUND MOUNT SLOPERS - No Radials
needed! Ground up outside house. Max. install
Connect Top to Trees, Buildings, Poles, etc at
ANY angle from Straightup to 60 degrees for
-excellent "SLOPER" DX Antenna Gain or
- bend it anywhere you need to! 2000 Watt
PEP Input, max. Permanent or portable Use
Installs In 10 minutes. SMALL - NEAT -
ALMOST INVISIBLE - No one will know you
have a Hi-Power DX Antenna. Ideal For CONDO'S APART-
MENTS. RESTRICTED AREAS - Pre-tuned for 2-1 or less
SWR over ALL bands (except 80 - 400Kc) No adjust-
ments needed - EVER. COMPLETELY ASSEMBLED, with
50 ft RG-58U Coax feedline and PL259 connector - Built
in lightning arrester - ready to hookup! FULL INSTRU-
CTIONS!**

No. 1080S - 80-40-20-15-10 - 1 trap 49 ft. - \$49.95
No. 1040S - 40-20-15-10 - 1 trap 26 ft. - \$48.95
No. 1020S - 20-15-10 - 1 trap 13 ft. - \$47.95

SEND FULL PRICE FOR PP DEL IN USA (Canada is \$10.00
extra for postage etc) or order using VISA, MASCARD -
AMER EXP. Give Number Ex Date. Ph 1-308-236-5333
weekdays. We ship In 2-3 days (Per Cks 14 days) Guaranteed
1 yr - 10 day money back trial.

WESTERN ELECTRONICS 200
Dept. AR-5 Kearney, Nebraska 68847

**SAY
YOU SAW
IT IN
ham radio!**



**TUBES
and IC's
FAST DELIVERY
LOWEST PRICES**

call Toll Free (800) 221-5802

In-depth Inventory - Industrial & Receiving Tubes

Here are 2 dozen examples:

3-400Z	\$85.00	MRF455	\$19.95
3-500Z	85.00	M2057	15.00
4CX250B	60.00	872A	24.00
572B	53.00	4X150A	35.00
811A	12.00	6DJ8	2.75
813	35.00	6550A	7.50
6146B	7.75	8072	95.00
6360	5.75	8121	95.00
6883B	7.50	8874	215.00
7360	12.95	8877	520.00
8122	110.00	807	6.75
MRF454/A	19.95	8950	11.50

Major Manufacturers Factory Boxed and Full line of
sylvania ECG Replacement Semiconductors



Minimum order \$25.00

Allow \$3 UPS charge

TRANSELETRONIC INC.



Box H, 1365 39th ST., BROOKLYN, NY 11218
Tel. 718-633-2800/Watts Line 800-221-5802
FAX # (718) 633-4375

TUBES

TYPE	PRICE	TYPE	PRICE	TYPE	PRICE
2C39/7289	\$ 34.00	1182/4600A	\$500.00	ML7815AL	\$ 60.00
2E26	7.95	4600A	500.00	7843	107.00
2K28	200.00	4624	310.00	7854	130.00
3-500Z	102.00	4657	84.00	ML7855KAL	125.00
3-1000Z/8164	400.00	4662	100.00	7984	14.95
3B28/866A	9.50	4665	500.00	8072	84.00
3CX400U7/8961	255.00	4687	P.O.R.	8106	5.00
3CX1000A7/8283	526.00	5675	42.00	8117A	225.00
3CX3000F1/8239	567.00	5721	250.00	8121	110.00
3CW30000H7	1700.00	5768	125.00	8122	110.00
3X2500A3	473.00	5819	119.00	8134	470.00
3X3000F1	567.00	5836	232.50	8156	12.00
4-65A/8165	69.00	5837	232.50	8233	60.00
4-125A/4D21	79.00	5861	140.00	8236	35.00
4-250A/5D22	98.00	5867A	185.00	8295/PL172	500.00
4-400A/8438	98.00	5868/AX9902	270.00	8458	35.00
4-400B/7527	110.00	5876/A	42.00	8462	130.00
4-400C/6775	110.00	5881/6L6	8.00	8505A	95.00
4-1000A/8166	444.00	5893	60.00	8533W	136.00
4CX250B/7203	54.00	5894/A	54.00	8560/A	75.00
4CX250FG/8621	75.00	5894B/8737	54.00	8560AS	100.00
4CX250K/8245	125.00	5946	395.00	8608	38.00
4CX250R/7580W	90.00	6083/AZ9909	95.00	8624	100.00
4CX300A/8167	170.00	6146/6146A	8.50	8637	70.00
4CX350A/8321	110.00	6146B/8298	10.50	8643	83.00
4CX350F/8322	115.00	6146W/7212	17.95	8647	168.00
4CX350FJ/8904	140.00	6156	110.00	8683	95.00
4CX600J/8809	835.00	6159	13.85	8877	465.00
4CX1000A/8168	242.50*	6159B	23.50	8908	13.00
4CX1000A/8168	485.00	6161	325.00	8950	13.00
4CX1500B/8660	555.00	6280	42.50	8930	137.00
4CX5000A/8170	1100.00	6291	180.00	6L6 Metal	25.00
4CX100000/8171	1255.00	6293	24.00	6L6GC	5.03
4CX15000A/8281	1500.00	6326	P.O.R.	6CA7/EL34	5.38
4CW800F	710.00	6360/A	5.75	6CL6	3.50
4D32	240.00	6399	540.00	6DJ8	2.50
4E27A/5-125B	240.00	6550A	10.00	6DQ5	6.58
4PR60A	200.00	6883B/8032A/8552	10.00	6GF5	5.85
4PR60B	345.00	6897	160.00	6GJ5A	6.20
4PR65A/8187	175.00	6907	79.00	6GK6	6.00
4PR1000A/8189	590.00	6922/6DJ8	5.00	6HB5	6.00
4X150A/7034	60.00	6939	22.00	6HF5	8.73
4X150D/7609	95.00	7094	250.00	6JG6A	6.28
4X250B	45.00	7117	38.50	6JM6	6.00
4X250F	45.00	7203	P.O.R.	6JN6	6.00
4X500A	412.00	7211	100.00	6JS6C	7.25
5CX1500A	660.00	7213	300.00*	6KN6	5.05
KT88	27.50	7214	300.00*	6KD6	8.25
416B	45.00	7271	135.00	6LF6	7.00
416C	62.50	7289/2C39	34.00	6LQ6 G.E.	7.00
572B/T160L	49.95	7325	P.O.R.	6LQ6/6MJ6 Sylvania	9.00
592/3-200A3	211.00	7360	13.50	6ME6	8.90
807	8.50	7377	85.00	12AT7	3.50
811A	15.00	7408	2.50	12AX7	3.00
812A	29.00	7609	95.00	12BY7	5.00
813	50.00	7735	36.00	12JB6A	6.50

NOTE * = USED TUBE

NOTE P.O.R. = PRICE ON REQUEST

"ALL PARTS MAY BE NEW, USED, OR SURPLUS. PARTS MAY BE SUBSTITUTED WITH COMPARABLE PARTS IF WE ARE OUT OF STOCK OF AN ITEM.

NOTICE: ALL PRICES ARE SUBJECT TO CHANGE WITHOUT NOTICE.

For information call: 602-265-0731

Toll Free Number
800-528-0180
(For orders only)

"All parts may be new or surplus, and parts may be substituted with comparable parts if we are out of stock of an item."

MHz electronics

3802 North 27th Ave., Phoenix, AZ 85017

PRICES SUBJECT TO CHANGE WITHOUT NOTICE

"FILTERS"

COLLINS Mechanical Filter #526-9724-010 MODEL F455Z32F

455KHZ at 3.2KHz wide. May be other models but equivalent. May be used or new, \$15.99

ATLAS Crystal Filters

5.595-2.7/8/LSB, 5.595-2.7/LSB	8 pole 2.7KHz wide Upper sideband. Impedance 800ohms 15pf In/800ohms 0pf out.	19.99
5.595-2.7/8/U, 5.595-2.7/USB	8 pole 2.7KHz wide Upper sideband. Impedance 800ohms 15pf In/800ohms 0pf out.	19.99
5.595-.500/4, 5.595-.500/4/CW	4 pole 500 cycles wide CW. Impedance 800ohms 15pf In/800ohms 0pf out.	19.99
9.0USB/CW	6 pole 2.7KHz wide at 6dB. Impedance 680ohms 7pf In/300ohms 8pf out. CW-1599Hz	19.99

KOKUSAI ELECTRIC CO, Mechanical Filter #MF-455-ZL/ZU-21H

455KHz at Center Frequency of 453.5KC, Carrier Frequency of 455KHz 2.36KC Bandwidth.
 Upper sideband. (ZU) 19.99
 Lower sideband. (ZL) 19.99

CRYSTAL FILTERS

NIKKO	FX-07800C	7.8MHz	\$10.00
TEW	FEC-103-2	10.6935MHz	10.00
SDK	SCH-113A	11.2735MHz	10.00
TAMA	TF-31H250	CF 3179.3KHz	19.99
TYCO/CD	001019880	10.7MHz 2pole 15KHz bandwidth	5.00
MOTOROLA	4884863B01	11.7MHz 2pole 15KHz bandwidth	5.00
PTI	5350C	12MHz 2pole 15KHz bandwidth	5.00
PTI	5426C	21.4MHz 2pole 15KHz bandwidth	5.00
PTI	1479	10.7MHz 8pole bandwidth 7.5KHz at 3dB, 5KHz at 6dB	20.00
COMTECH	A10300	45MHz 2pole 15KHz bandwidth	6.00
FRC	ERXF-15700	20.6MHz 36KHz wide	10.00
FILTECH	2131	CF 7.825MHz	10.00

CERAMIC FILTERS

AXEL	4F449	12.6KC Bandpass Filter 3dB bandwidth 1.6KHz from 11.8-13.4KHz	10.00
CLEVITE	TO-01A	455KHz+-2KHz bandwidth 4-7% at 3dB	5.00
	TCF4-12D36A	455KHz+-1KHz bandwidth 6dB min 12KHz, 60dB max 36KHz	10.00
MURATA	BFB455B	455KHz	2.50
	BFB455L	455KHz	3.50
	CFM455E	455KHz +-5.5KHz at 3dB, +-8KHz at 6dB, +-16KHz at 50dB	6.65
	CFM455D	455KHz +-7KHz at 3dB, +-10KHz at 6dB, +-20KHz at 50dB	6.65
	CFR455E	455KHz +-5.5KHz at 3dB, +-8KHz at 6dB, +-16KHz at 60dB	8.00
	CFU455B	455KHz +-2KHz bandwidth +-15KHz at 6dB, +-30KHz at 40dB	2.90
	CFU455C	455KHz +-2KHz bandwidth +-12.5KHz at 6dB, +-24KHz at 40dB	2.90
	CFU455G	455KHz +-1KHz bandwidth +-4.5KHz at 6dB, +-10KHz at 40dB	2.90
	CFU455H	455KHz +-1KHz bandwidth +-3KHz at 6dB, +-9KHz at 40dB	2.90
	CFU455I	455KHz +-1KHz bandwidth +-2KHz at 6dB, +-6KHz at 40dB	2.90
	CFW455D	455KHz +-10KHz at 6dB, +-20KHz at 40dB	2.90
	CFW455H	455KHz +-3KHz at 6dB, +-9KHz at 40dB	2.90
	SFB455D	455KHz	2.50
	SFD455D	455KHz +-2KHz, 3dB bandwidth 4.5KHz +-1KHz	5.00
	SFE10.7MA	10.7MHz 280KHz +-50KHz at 3dB, 650KHz at 20dB	2.50
	SFE10.7MS	10.7MHz 230KHz +-50KHz at 3dB, 570KHz at 20dB	2.50
	SFG10.7MA	10.7MHz	10.00
NIPPON	LF-B4/CFU455I	455KHz +-1KHz	2.90
	LF-B6/CFU455H	455KHz +-1KHz	2.90
	LF-B8	455KHz	2.90
	LF-CL8	455KHz	10.00
TOKIN	CF455A/BFU455K	455KHz +-2KHz	5.00
MATSUSHIRA	EFC-1A55K	455KHz	7.00

SPECTRA PHYSICS INC, Model 088 HeNe LASER TUBES

POWER OUTPUT 1.6MW,	BEAM DIA. .75MM	BEAM DIR. 2.7MR	8KV STARTING VOLTAGE DC
68K OHM 1WATT BALLAST	1000VDC +-100VDC	At 3.7MA	\$59.99

ROTRON MUFFIN FANS Model MARK4/MU2A1

115 VAC	14WATTS	50/60CPS	IMPEDENCE PROTECTED-F	88CFM at 50CPS	\$ 7.99
105CFM at 60CPS	THESE ARE NEW				

MHz electronics

Toll Free Number
800-528-0180
(For orders only)

"All parts may be new or surplus, and parts may be substituted with comparable parts if we are out of stock of an item."

3802 North 27th Ave., Phoenix, AZ 85017

PRICES SUBJECT TO CHANGE WITHOUT NOTICE For information call: 602-265-0731

RF TRANSISTORS

TYPE	PRICE	TYPE	PRICE	TYPE	PRICE	TYPE	PRICE
2N1561	\$25.00	2N5920	\$ 70.00	40608 RCA	\$ 2.48	BFY90	\$ 1.50
2N1562	25.00	2N5921	80.00	40673 RCA	2.50	BLW60C5	15.00
2N1692	25.00	2N5922	10.00	40894 RCA	1.00	BLX67	12.25
2N2857	1.55	2N5923	25.00	60247 RCA	25.00	BLX67C3	12.25
2N2857JAN	4.10	2N5941	23.00	61206 RCA	100.00	BLX93C3	22.21
2N2857JANTX	4.50	2N5942	40.00	62800A RCA	60.00	BLY87A	7.50
2N2876	13.50	2N5944	10.35	62803 RCA	100.00	BLY88C3	13.08
2N2947	18.35	2N5945	10.00	430414/399ORCA	50.00	BLY89C	13.00
2N2948	13.00	2N5946	12.00	3457159 RCA	20.00	BLY90	45.00
2N2949	15.50	2N5947	9.20	3729685-2 RCA	75.00	BLY92	13.30
2N3118	5.00	2N6080	6.00	3729701-2 RCA	50.00	BLY94C	45.00
2N3119	4.00	2N6081	7.00	3753883 RCA	50.00	BLY351	10.00
2N3134	1.15	2N6082	9.00	615467-902	25.00	BLY568C/CF	30.00
2N3287	4.90	2N6083	9.50	615467-903	40.00	C2M70-28R	92.70
2N3288	4.40	2N6084	12.00	25C568	2.50	C25-28	57.00
2N3309	4.85	2N6094	11.00	25C703	36.00	C4005	2.50
2N3375	17.10	2N6095	12.00	25C756A	7.50	CD1659	20.00
2N3478	2.13	2N6096	16.10	25C781	2.80	CD1899	20.00
2N3553	1.55	2N6097	20.70	25C1018	1.00	CD1920	10.00
2N3553JAN	2.90	2N6105	21.00	25C1042	24.00	CD2188	18.00
2N3632	15.50	2N6136	21.85	25C1070	2.50	CD2545	24.00
2N3733	11.00	2N6166	40.24	25C1216	2.50	CD2664A	16.00
2N3818	5.00	2N6267	142.00	25C1239	2.50	CD3167	92.70
2N3866	1.30	2N6304	1.50	25C1251	24.00	CD3353	95.00
2N3866JAN	2.20	2N6368	30.00	25C1306	2.90	CD3435	26.30
2N3866JANTX	3.80	2N6439	55.31	25C1307	5.50	CD3900	152.95
2N3866JANTXV	4.70	2N6459	18.00	25C1424	2.80	CM25-12	20.00
2N3924	3.35	2N6567	10.06	25C1600	5.00	CM40-12	27.90
2N3926	16.10	2N6603	13.50	25C1678	2.00	CM40-28	56.90
2N3927	17.25	2N6604	13.50	25C1729	32.40	CME50-12	30.00
2N3948	1.75	2N6679	44.00	25C1760	1.50	CTC2001	42.00
2N3950	25.00	2N6680	80.00	25C1909	4.00	CTC2005	55.00
2N3959	3.85	021-1	15.00	25C1945	10.00	CTC3005	70.00
2N4012	11.00	01-80703T4	65.00	25C1946	40.00	CTC3460	20.00
2N4037	2.00	35C05	15.00	25C1947	10.00	DV2820S	25.00
2N4041	14.00	102-1	28.00	25C1970	2.50	DXL1003P70	22.00
2N4072	1.80	103-1	28.00	25C1974	4.00	DXL2001P70	19.00
2N4080	4.53	103-2	28.00	25C2166	5.50	DXL2002P70	14.00
2N4127	21.00	104P1	18.00	25C2237	32.00	DXL3501AP100F	47.00
2N4416	2.25	163P1	10.00	25C2695	47.00	EFJ4015	12.00
2N4427	1.25	181-3	15.00	A2X1698	POR	EFJ4017	24.00
2N4428	1.85	210-2	10.00	A3-12	14.45	EFJ4021	24.00
2N4430	11.80	269-1	18.00	A50-12	24.00	EFJ4026	35.00
2N4927	3.90	281-1	15.00	A209	10.00	EN15745	20.00
2N4957	3.45	282-1	30.00	A283	6.00	FJ9540	16.00
2N4959	2.30	482	7.50	A283B	6.00	FSX52WF	58.00
2N5016	18.40	564-1	25.00	A1610	19.00	G65739	25.00
2N5026	15.00	698-3	15.00	AF102	2.50	G65386	25.00
2N5070	18.40	703-1	15.00	AFY12	2.50	GMO290A	2.50
2N5090	13.80	704	4.00	AR7115	20.00	HEP76	4.95
2N5108	3.45	709-2	11.00	AT41435-5	6.35	HEPS3002	11.40
2N5109	1.70	711	4.00	B2-8Z	10.70	HEPS3003	30.00
2N5160	3.45	733-2	15.00	B3-12	10.85	HEPS3005	10.00
2N5177	21.62	798-2	25.00	B12-12	15.70	HEPS3006	19.90
2N5179	1.04	3421	28.00	HAL0204125	152.95	HEPS3007	25.00
2N5216	56.00	3683P1	15.00	BF25-35	56.25	HEPS3010	11.34
2N5470	75.00	3992	25.00	B40-12	19.25	HP8003	10.00
2N5583	3.45	4164P1	15.00	B70-12	55.00	HFET2204	112.00
2N5589	9.77	4243P1	28.00	BF272A	2.50	HP35821	38.00
2N5590	10.92	4340P3	18.00	BFQ85	2.50	HP35826B	32.00
2N5591	13.80	4387P1	27.50	BFR21	2.50	HP35826E	32.00
2N5596	99.00	7104-1	28.00	BFR90	1.00	HP35831E	30.00
2N5636	12.00	7249-2	10.50	BFR91	1.65	HP35832E	50.00
2N5637	15.50	7283-1	37.50	BFR99	2.50	HP35833E	50.00
2N5641	12.42	7536-1	30.00	BFT12	2.50	HP35859E	75.00
2N5642	14.03	7794-1	10.50	BFW16A	2.50	HP35866E	44.00
2N5643	25.50	7795	15.00	BFW17	2.50	HXTR2101	44.00
2N5645	13.80	7795-1	15.00	BFW92	1.50	HXTR3101	7.00
2N5646	20.70	7796-1	24.00	BFX44	2.50	HXTR5101	31.00
2N5651	11.05	7797-1	36.00	BFX48	2.50	HXTR6104	68.00
2N5691	18.00	40081 RCA	5.00	BFX65	2.50	HXTR6105	31.00
2N5764	27.00	40279 RCA	10.00	BFX84	2.50	HXTR6106	33.00
2N5836	3.45	40280 RCA	4.62	BFX85	2.50	J310	1.00
2N5842	8.45	40281 RCA	10.00	BFX86	2.50	JO2000	10.00
2N5847	19.90	40282 RCA	20.00	BFX89	1.00	JO2001	25.00
2N5849	20.00	40290 RCA	2.80	BFY11	2.50	JO4045	24.00
2N5913	3.25	40292 RCA	13.05	BFY18	2.50	KD5522	25.00
2N5916	36.00	40294 RCA	2.50	BFY19	2.50	KJ5522	25.00
		40341 RCA	21.00	BFY39	2.50	M1106	13.75

Toll Free Number
800-528-0180
(For orders only)

"All parts may be new or surplus, and parts may be substituted with comparable parts if we are out of stock of an item."

For information call: 602-265-0731

PRICES SUBJECT TO CHANGE WITHOUT NOTICE

MHz electronics

3802 North 27th Ave., Phoenix, AZ 85017

RF TRANSISTORS (CONTINUED)

M1107	\$16.75	MRF458	\$20.70	NEO2160ER	\$100.00	SD1009	\$15.00
M1131	5.15	MRF464	25.30	NEO21350	5.30	SD1009-2	15.00
M1132	7.25	MRF466	18.97	NE13783	61.00	SD1012	10.00
M1134	13.40	MRF472	1.50	NE21889	43.00	SD1012-3	10.00
M9116	29.10	MRF475	3.10	NE57835	5.70	SD1012-5	10.00
M9579	6.00	MRF476	3.16	NE64360ER-A	100.00	SD1013	10.00
M9580	7.95	MRF477	20.00	NE64480 (B)	94.00	SD1013-3	10.00
M9587	7.00	MRF479	8.05	NE73436	2.50	SD1013-7	10.00
M9588	5.20	MRF492	23.00	NE77362ER	100.00	SD1016	15.00
M9622	5.95	MRF502	1.04	NE98260ER	100.00	SD1016-5	15.00
M9623	7.95	MRF503	6.00	PRT8637	25.00	SD1018-4	13.00
M9624	9.95	MRF504	7.00	PT3127A	5.00	SD1018-6	13.00
M9625	15.95	MRF509	5.00	PT3127B	5.00	SD1018-7	13.00
M9630	14.00	MRF511	10.69	PT3127C	20.00	SD1018-15	13.00
M9740	27.90	MRF515	2.00	PT3127D	20.00	SD1020-5	10.00
M9741	27.90	MRF517	2.00	PT3127E	20.00	SD1028	15.00
M9755	16.00	MRF525	3.45	PT3190	20.00	SD1030	12.00
M9780	5.50	MRF559	1.76	PT3194	20.00	SD1030-2	12.00
M9827	11.00	MRF587	11.00	PT3195	20.00	SD1040	5.00
M9848	35.00	MRF605	20.00	PT3537	7.80	SD1040-2	20.00
M9850	13.50	MRF618	25.00	PT4166E	20.00	SD1040-4	10.00
M9851	20.00	MRF626	12.00	PT4176D	25.00	SD1040-6	5.00
M9860	8.25	MRF628	8.65	PT4186B	5.00	SD1043	12.00
M9887	2.80	MRF629	3.45	PT4209	25.00	SD1043-1	10.00
M9908	6.95	MRF641	25.30	PT4209C/5645	25.00	SD1045	3.75
M9965	12.00	MRF644	27.60	PT4556	24.60	SD1049-1	2.00
MM1500	25.00	MRF646	29.90	PT4570	7.50	SD1053	4.00
MM1550	10.00	MRF648	33.35	PT4577	20.00	SD1057	10.00
MM1552	50.00	MRF816	15.00	PT4590	5.00	SD1065	4.75
MM1553	50.00	MRF823	20.00	PT4612	20.00	SD1068	15.00
MM1607	8.45	MRF846	44.85	PT4628	20.00	SD1074-2	18.00
MM1614	10.00	MRF892	35.50	PT4640	20.00	SD1074-4	28.00
MM1810	15.00	MRF894	46.00	PT4642	20.00	SD1074-5	28.00
MM1810	15.00	MRF901 3 Lead	1.00	PT5632	4.70	SD1076	18.50
MM1943	1.80	MRF901 4 Lead	2.00	PT5749	25.00	SD1077	4.00
MM2608	5.00	MRF902/2N6603JAN	15.00	PT6612	25.00	SD1077-4	4.00
MM3375A	17.10	MRF902B	18.40	PT6619	20.00	SD1077-6	4.00
MM4429	10.00	MRF904	2.30	PT6708	25.00	SD1078-6	24.00
MM8000	1.15	MRF905	2.55	PT6709	25.00	SD1080-7	7.50
MM8006	2.30	MRF911	2.50	PT6720	25.00	SD1080-8	6.00
MM8011	25.00	MRF965	2.55	PT8510	15.00	SD1080-9	3.00
MPSU31	1.01	MRF966	3.55	PT8524	25.00	SD1084	8.00
MRA2023-1.5	42.50	MRF1000MA	32.77	PT8609	25.00	SD1087	15.00
MRF134	10.50	MRF1004M	31.05	PT8633	25.00	SD1088	22.00
MRF136	16.00	MRF2001	41.74	PT8639	25.00	SD1088-8	22.00
MRF171	35.00	MRF2005	54.97	PT8659	25.00	SD1089-5	15.00
MRF208	11.50	MRF5176	24.00	PT8679	25.00	SD1090	15.00
MRF212	16.10	MRF8004	2.10	PT8708	20.00	SD1094	15.00
MRF221	10.00	MSC1720-12	225.00	PT8709	20.00	SD1095	15.00
MRF223	13.00	MSC1821-3	125.00	PT8727	29.00	SD1098-1	30.00
MRF224	13.50	MSC1821-10	225.00	PT8731	25.00	SD1100	5.00
MRF227	3.45	MSC2001	30.00	PT8742	19.10	SD1109	18.00
MRF230	2.00	MSC2010	93.00	PT8787	25.00	SD1115-2	7.50
MRF231	10.00	MSC2223-10	245.00	PT8828	25.00	SD1115-3	7.50
MRF232	12.07	MSC2302	POR	PT9700	25.00	SD1115-7	2.10
MRF237	3.15	MSC3000	35.00	PT9702	25.00	SD1116	5.00
MRF238	13.80	MSC3001	38.00	PT9783	16.50	SD1118	22.00
MRF239	17.25	MSC72002	POR	PT9784	32.70	SD1119	5.00
MRF245	35.65	MSC73001	POR	PT9790	56.00	SD1124	50.00
MRF247	31.00	MSC80064	35.00	PT31083	20.00	SD1132-1	15.00
MRF304	36.00	MSC80091	10.00	PT31962	20.00	SD1132-4	12.00
MRF306	50.00	MSC80099	3.00	PTX6680	20.00	SD1133	9.50
MRF313	11.15	MSC80593	POR	RE3754	25.00	SD1133-1	10.00
MRF314	29.21	MSC80758	POR	RE3789	25.00	SD1134-1	2.50
MRF315	28.86	MSC82001	33.00	RF35	16.00	SD1134-4	12.00
MRF316	55.43	MSC82014	33.00	RF85	17.50	SD1134-17	12.00
MRF317	63.94	MSC82020M	130.00	RF110	21.00	SD1135	10.25
MRF412	18.00	MSC82030	33.00	S50-12	23.80	SD1135-3	12.00
MRF420	20.12	MSC83001	40.00	S3006	15.00	SD1136	12.50
MRF421	25.00	MSC83003	82.00	S3007	10.00	SD1136-2	12.50
MRF422	38.00	MSC83005	70.00	S3031	22.00	SD1143-1	10.00
MRF427	17.25	MSC83026	POR	SCA3522	5.00	SD1143-3	17.00
MRF428	63.00	MSC83303	POR	SCA3523	5.00	SD1144	4.00
MRF433	12.07	MSC84900	60.00	SD345	5.00	SD1145-5	15.00
MRF449/A	12.65	MT4150	14.40	SD445	5.00	SD1146	15.00
MRF450/A	14.37	MT5126	25.00	SD1004	15.00	SD1147	15.00
MRF452/A	17.00	MT5596 (2N)	99.00	SD1007	15.00	SD1188	10.00
MRF453/A	18.40	MT5768 (2N)	95.00	SD1007-2	15.00	SD1189	24.00
MRF454/A	20.12	MT8762	25.00	SD1007-4	15.00	SD1200	1.50
MRF455/A	16.00	NEO2136	2.00	SD1007-5	15.00	SD1201-2	15.00

Toll Free Number
800-528-0180
(For orders only)

"All parts may be new or surplus, and parts may be substituted with comparable parts if we are out of stock of an item."

For information call: 602-265-0731

MHz electronics

3802 North 27th Ave., Phoenix, AZ 85017

PRICES SUBJECT TO CHANGE WITHOUT NOTICE

E.F. JOHNSON ROLLER INDUCTORS

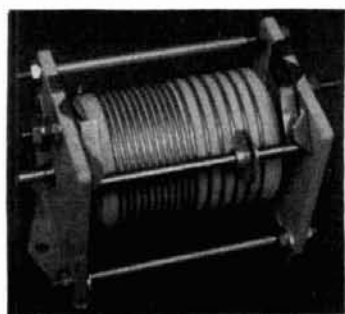

MODEL 229-0201-01
10UH at 3AMPS MAX. \$36.99

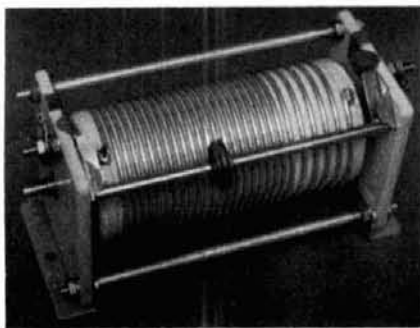

MODEL 229-0202-01
18UH at 5AMPS MAX. \$44.99

UNELCO, SEMCO, ARCO METAL CLAD MICA CAPACITORS

Standard Size				Micro Size		
3.9	14	33	62	175	5	25
4.7	15	34	68	180	6	27
5	18	36	75	200	7	33
5.1	20	38	80	220	8	36
6.8	22	39	82	240	9	51
7	24	40	100	250	12	62
8.2	25	43	110	300	15	
9.1	27	44	120	360	16	
10	27.5	47	123	470	18	
11	28	50	125	500	20	
12	30	51	140	820	22	
13	32	56	150	1000	24	

*****NOTE ALL VALUES LISTED IN PICO FARAD*****

PRICE INFORMATION

1 to 10 \$.90ea. 11 to 51 \$.80ea. 52 to 102 \$.70ea.
103 and up call

GOULD NI-CAD BATTERIES

AA size 1.25v at 500mahr new a \$ 1.99
D size 1.25v at 4 AMPHR new h 7.49

GENERAL ELECTRIC NI-CAD BATTERIES

AA size 1.25v at 500mahr new a 2.99
195194 3.75v at 100mahr new 1.99
AA size 3.75v at 100mahr new a 2.99
AA size pack of 10 12.5v at 450mahr used a 5.99
Sub C Pack of 10 12.5v at 2.5Amphr new c 9.99

UNION CARBIDE NI-CAD BATTERIES

193817 3.75v at 225mahr new a 2.99

GLOBE GEL-CELL BATTERIES

2v at 8AMPHR GC280 new g 5.99
12v at 20AMPHR GC12200 new g 49.99
12v at 23AMPHR GC12300 new g 54.99

EAGLE PICHER GEL-CELL BATTERIES

12v at 1.5AMPHR CF12V1.5 new d 11.99

GATES SEALED RECHARGEABLE LEAD ACID BATTERIES AND PACKS

2v at 2.5AMPHR D Cell new b 5.99
8v at 5AMPHR 4 X Cell used f 14.99
12v at 2.5AMPHR 6 D Cells new f 24.99
18v at 2.5AMPHR 9 D Cells new f 29.99

GENERAL ELECTRIC SEALED REACHARABLE LEAD ACID BATTERIES AND PACKS

6v at 2.5AMPHR 3 D Cells used e 10.00
12v at 2.5AMPHR 6 D Cells used e 19.99
12v at 5AMPHR 6 X Cells used e 24.99

Toll Free Number
800-528-0180
(For orders only)

"All parts may be new or surplus, and parts may be substituted with comparable parts if we are out of stock of an item."

For information call: 602-265-0731

MHz electronics

3802 North 27th Ave., Phoenix, AZ 85017

PRICES SUBJECT TO CHANGE WITHOUT NOTICE

NI-CAD BATTERY CHARGERS

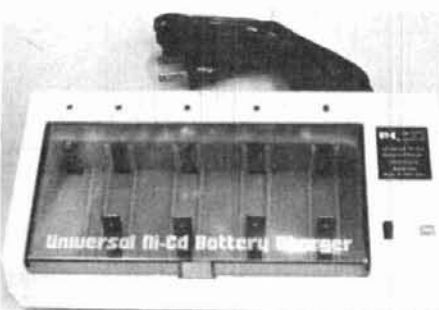

UNIVERSAL CHARGER \$19.99



MALLORY CHARGER \$23.99

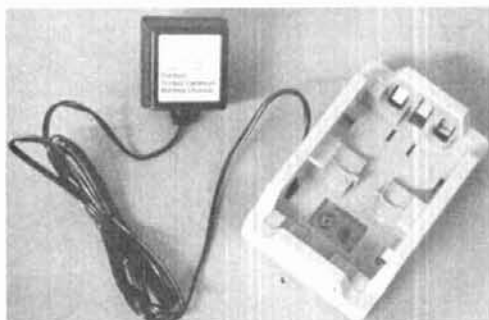

EVEREADY CHARGER \$9.99



RF Transistors (continued)

SD1202	\$10.00	SD1304-8	\$ 2.50	SD1451-2	\$15.00	SRF1427	\$50.00	SD1244H12	25.00	SD1410-8	21.00	SD1536-1	41.00	SRF2917	15.00
SD1212-8	4.95	SD1305	3.00	SD1452	20.00	SRF1431	40.00	SD1262	15.00	SD1413-1	18.00	SD1539H	100.00	SRF2918	15.00
SD1212-11	4.95	SD1307	3.00	SD1452-4	24.00	SRF1834	40.00	SD1263	15.00	SD1416	28.00	SD1542H1	170.00	SRF2919	15.00
SD1212-16	4.95	SD1308	3.00	SD1453H1	20.00	SRF2053-3	60.00	SD1263-1	15.00	SD1422-2	24.00	SD1544	26.00	SRF3071FP	50.00
SD1214-7	5.00	SD1311	1.00	SD1454-1	48.00	SRF2092	50.00	SD1272	10.95	SD1428	24.00	SD1345	33.00	SS4006	25.00
SD1214-11	5.00	SD1317	8.00	SD1477	35.00	SRF2147	22.00	SD1272-1	10.95	SD1428-6084	12.00	SD1546H1	55.00	SS4152	15.00
SD1216	12.00	SD1319	2.50	SD1478	21.00	SRF2225	15.00	SD1272-2	10.95	SD1429-2	15.00	SD1561	79.00	TA7686	15.00
SD1219-4	15.00	SD1345-6	5.00	SD1480	53.00	SRF2264	25.00	SD1272-4	10.95	SD1429-3	14.90	SD1576-1	6.95	TAR559	15.00
SD1219-5	15.00	SD1347-1	1.00	SD1484	1.50	SRF2265	100.00	SD1278	13.75	SD1429-5	15.00	SD1575	6.95	TAR561	15.00
SD1219-8	15.00	SD1365-1	2.50	SD1484-5	1.50	SRF2281	5.00	SD1278-1	13.75	SD1430	12.00	SRF4557	25.00	TAR562	15.00
SD1220-7	8.00	SD1365-5	2.50	SD1484-6	1.50	SRF2371	15.00	SD1278-5	13.75	SD1430-2	18.00	SK3048	5.00	TAR563	15.00
SD1220-1	9.50	SD1375	7.50	SD1484-7	1.50	SRF2381	50.00	SD1279-1	18.00	SD1434	28.00	SL501-59	15.00	TAR564	15.00
SD1220-9	8.00	SD1375-6	7.50	SD1488	22.85	SRF2356	38.00	SD1279-3	18.00	SD1434-5	28.00	SL501-173	15.00	TAR894	15.00
SD1222-8	16.00	SD1379	15.00	SD1488-1	28.00	SRF2372	16.00	SD1281-2	8.00	SD1434-9	28.00	SM7714	5.00	T13189	3.55
SD1222-11	7.50	SD1380-1	1.00	SD1488-7	27.00	SRF2572	25.00	SD1283	10.00	SD1438	26.00	SRF112	15.00	TF117	2.50
SD1224-10	18.00	SD1380-3	1.00	SD1488-8	28.00	SRF2584	40.00	SD1283-2	10.00	SD1441	56.00	SRF395	50.00	TF1014	5.00
SD1225	18.00	SD1380-7	1.00	SD1489-1	36.00	SRF2597	25.00	SD1283-3	10.00	SD1442	15.00	SRF750	36.00	TF1028	15.00
SD1225-1	15.00	SD1405	21.00	SD1511H3	75.00	SRF2741	40.00	SD1283-4	10.00	SD1444	3.25	SRF769H	20.00	TR3	5.00
SD1229-7	10.95	SD1408	25.00	SD1520-2	18.00	SRF2747	40.00	SD1289-1	15.00	SD1444-8	1.25	SRF887K3	2.50	TVXV2201/HP	450.00
SD1229-10	10.95	SD1409	18.00	SD1522-4	33.00	SRF2767H	40.00	SD1290-4	15.00	SD1444-9	3.25	SRF989E	15.00	V222-2	25.00
SD1232	4.00	SD1410	18.00	SD1528-1	24.00	SRF2821	25.00	SD1290-7	15.00	SD1446	4.03	SRF1005	50.00	V4101E	20.00
SD1240-8	15.00	SD1410-3	21.00	SD1528-3	34.00	SRF2822/286603	13.50	SD1300	1.25	SD1450-1	28.00	SRF1018	5.00	V415	5.00
SD1244-1	14.00	SD1410-6	21.00	SD1530-2	38.00	SRF2857	20.00	SD1301-7	3.00	SD1451	15.00	SRF1074	50.00		

Relays

BNC To Banana Plug Coax Cable RG-58 36 inch or BNC to N Coax Cable RG-58 36 inch.

\$7.99 or 2 For \$13.99 or 10 For \$50.00

\$8.99 or 2 For \$15.99 or 10 For \$60.00

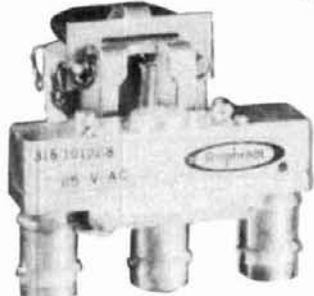

Amphenol
Part # 316-10102-8
115Vac Type BNC DC to 3 GHz.

\$29.99



COAXIAL RELAY SWITCHES SPDT

FXR
Part # 300-11182
120Vac Type BNC DC to 4 GHz.
FSN 5985-543-1225

\$39.99

FXR
Part # 300-11173
120Vac Type BNC Same
FSN 5985-543-1850

\$39.99

TERMS: DOMESTIC: Prepaid, C.O.D. or Credit Card
FOREIGN: Prepaid only, U.S. Funds, Money Order, or Cashier's Check Only

C.O.D.: Acceptable by telephone or mail. Payment from customer will be Cash, Money Order, or Cashier's Check. We are sorry but we cannot accept personal checks for C.O.D.'s. C.O.D.'s are shipped by air only and thru United Parcel Service.

CONFIRMING ORDERS: We would prefer that confirming orders not be sent after a telephone order has been placed. If company policy necessitates a confirming order, please mark "CONFIRMING" boldly on the order. If problems or duplicate shipments occur due to an order which is not properly marked, the customer will be held responsible for any charges incurred, plus a 15% restock charge on the returned parts.

CREDIT CARDS: We are now accepting MASTERCARD, VISA, AND AMERICAN EXPRESS

DATA SHEETS: When we have data sheets in stock on devices we will supply them with the order.

DEFECTIVE MATERIALS: All claims for defective materials must be made within 30 DAYS after receipt of the parcel. All claims must include the defective material (for testing purposes), a copy of our invoice, and a return authorization number which must be obtained prior to shipping the merchandise back to us. This can be obtained by calling (602) 242-8916 or sending us a postcard. Due to Manufacturer warranties we are unable to replace or issue credit on items which have been soldered to or have been altered in any way. All return items must be packed properly or it will void all warranties. We do not assume responsibility for shipping and handling charges incurred.

DELIVERY: Orders are usually shipped the same day they are placed or the next business day, unless we are out of stock on an item. The customer will be notified by post card if we are going to backorder the item. Our normal shipping method is UPS or U.S. Mail depending on size or the weight of the package. Test Equipment is shipped only by air and is freight collect, unless prior arrangements have been made and approved.

FOREIGN ORDERS: All foreign orders must be prepaid with a Cashier's Check, or Money Order made out in U.S. FUNDS ONLY. We are sorry but C.O.D. is not available to foreign countries and letters of credit are unacceptable as a form of payment. Further information is available on request.

HOURS: Monday thru Friday 8:30 a.m. to 5:00 p.m. Saturdays 8:30 a.m. to 4:00 p.m.

INSURANCE: Please include 25¢ for each additional \$100.00 over \$100.00 UPS ONLY. All insured packages are shipped thru UPS only. If you wish to have it shipped through the post office there is a \$5.00 fee which is additional to the shipping, handling and insurance.

OPEN ACCOUNTS: We regret that we do not issue open accounts.

ORDER FORMS: New order forms are included with each order for your convenience. Additional order forms are available on request.

PARTS: We reserve the right to substitute or replace any item with a part of equal or comparable specification.

POSTAGE: Minimum shipping and handling in the U.S., Canada, and Mexico is \$3.00 for ground shipments, all other countries is \$5.50. Air rates are available at the time of your order. All foreign orders please include 25% of the ordered amount for shipping and handling. C.O.D.'s are shipped AIR ONLY.

PREPAID ORDERS: Orders must be accompanied by a check.

PRICES: Prices are subject to change without notice.

PURCHASE ORDERS: We accept purchase orders only when they are accompanied by a check.

RESTOCK CHARGES: If parts are returned to MHZ ELECTRONICS, INC. due to customer error, the customer will be held responsible for all fees incurred and will be charged a 15% RESTOCK CHARGE with the remainder in CREDIT ONLY. The following must accompany any return; A copy of our invoice, return authorization number which must be obtained prior to shipping the merchandise back. Returns must be done within 10 DAYS of receipt of parcel. Return authorization numbers can be obtained by calling (602) 242-8916 or notifying us by post card. Return authorizations will not be given out on our 800 number.

SALES TAX: ARIZONA residents must add 6% sales tax, unless a signed ARIZONA resale tax card is currently on file with us. All orders placed by persons outside of ARIZONA, but delivered to persons in ARIZONA are subject to the 6% sales tax.

SHORTAGE OR DAMAGE: All claims for shortages or damages must be made within 5 DAYS of receipt of parcel. Claims must include a copy of our invoice, along with a return authorization number which can be obtained by contacting us at (602) 242-8916 or sending a post card. Authorizations cannot be on our 800 number. All items must be properly packed. If items are not properly packed make sure to contact the carrier so that they can come out and inspect the package before it is returned to us. Customers which do not notify us within this time period will be held responsible for the entire order as we will consider the order complete.

OUR 800 NUMBER IS STRICTLY FOR ORDERS ONLY (800) 528-0180. INFORMATION CALLS ARE TAKEN ON (602) 242-8916 or (602) 242-3037.



MHZ electronics

3802 North 27th Ave., Phoenix, AZ 85017

"All parts may be new or surplus, and parts may be substituted with comparable parts if we are out of stock of an item."

For information call: 602-265-0731

Toll Free Number
800-528-0180
(For orders only)

PRICES SUBJECT TO CHANGE WITHOUT NOTICE

ENGINEERING CONSULTING INTRODUCES

'REMOTE A PAD' MODEL RAP-1

2 FOUR DIGIT DTMF DECODERS, PLUS 16 DIGIT KEYPAD CONTROL

TUNE THE WORLD FROM YOUR HANDHELD VHF/UHF RADIO

- Audio tones from any source, are converted to solid state switches which control any 16 digit keypad of a radio or other device.
- Some examples you can control include the Pro Search® Receiver (Iratebeam remote), ICOM IC-701 or ICOM IC-211 when using the RM-2 controller (ICOM 7950 & 751), Arden PCS-4000, handhelds such as Yesu FT-208, FT-708, ICOM IC-02AT and many more.
- Anything you can do manually with your 16 digit keypad, the RAP-1 will do remotely using audio touch tones from any source.
- Two (four digit) programmable access codes are used to operate relays or other on-off functions.

Model RAP-1

- LED decoder status indicators and momentary plus steady state decoder outputs are provided.
- 22 gold pin card edge connector, 16 pin dip socket and ribbon cable are supplied.
- All CMOS low power drain (30ma) SSI 201 Decoder.
- Hook eight wires (4 rows and 4 columns) in parallel with the existing keypad of the radio you wish to control remotely. Connect audio from any source, 10 volts D.C. and you are in control.
- The dual 4 digit decoders will turn your links on and off using your programmable access code.
- Detailed interface diagrams and instructions included with purchase. Interface cable for Pro-Search® \$3.95 (plugs in acc. socket).

\$149.95

'Remote A Pad'

Remote control interface board and DTMF decoder.

ICOM IC-02AT USER'S "AUDIO BLASTER" MODULE

• Module installs inside the radio in 10 minutes

• Boosts audio to nearly 1 watt

• Low power drain (40ma stand by)

• Complete step by step instructions included

• Corrects the LOV audio problem

• Drive external speakers to full volume even signals with low deviation

Now Available for IC-2AT

Model AB-1

\$19.95

Price includes postage and handling, U.S.A. CA res. add 6%

Send check or money order to

ENGINEERING CONSULTING
583 CANDLEWOOD ST., BREA, CA 92621
(714) 671-2009

TOUCHTONE™ DECODER KIT

- MODEL TTK -

\$22.95

4 DIGIT SEQUENCE DECODER

- SSI 201 DTMF Receiver
- Receive all 16 DTMF digits
- No additional filtering
- Output BCD or hex format
- Low power (29ma @ 12V)
- Kit includes 3.58MHz crystal, 22 pin IC socket, resistor, capacitors, data sheet and schematics

3.5"

WIRED & TESTED - MODEL TSD -

\$59.95

- Completely wired & tested
- User programmable
- LED status indicator
- Open collector output
- Control relays, mute audio
- Control link on/off
- Custom IC insures high reliability & small size!
- Fits inside most rigs, runs on 12 VDC (35ma)
- Over 1500 different codes!

- Makes excellent private call on busy repeaters!
- Use it to turn on audio or sound an alarm
- Momentary and latching outputs

MasterCard and Visa accepted, or send check/M.O. Cal address add 6%, price includes shipping USA. Send to

ENGINEERING CONSULTING
583 CANDLEWOOD ST., BREA, CA 92621
TEL: 714-671-2009

ENGINEERING CONSULTING INTRODUCES

TOUCHTONE™ DTMF to RS-232-C 300 BAUD INTERFACE

107

TOUCHTONE RECEIVER DAP-1 SERIAL PORT RS-232-C COMPUTER

- Use your computer to decode DTMF touchtones.
- Receive all 16 digits as fast as they can be transmitted
- Easily program your computer in BASIC to decode multi-digit "strings", display digits, sound alarms, observe secret codes, control relays, remote base
- Simple to use, just provide +12 VDC and audio, hook two wires to the RS-232-C serial input on your computer, enter a simple BASIC program and begin to decode
- Sample BASIC program and instructions included
- L.E.D. Indicator

Model DAP-1

"Decode-A-Pad"

Wired and Tested **\$89.95**

Includes shipping USA. Cal. addresses add 6%. VISA and MasterCard accepted, or send check/M.O. to

ENGINEERING CONSULTING
583 CANDLEWOOD ST., BREA, CA 92621
714 / 671-2009

NEW!

THE RADIO AMATEUR'S LICENSE MANUAL

NOW INCLUDES ANSWERS TO FCC/VEC EXAM QUESTIONS

ARRL LICENSE MANUAL

Here's the latest up-to-date licensing guide from the ARRL. Plenty of theory and detailed explanations take most of the pain out of studying to upgrade your license.

© 1984 80th edition 216 pages

AR-LG

Softbound \$4.00

Please add \$2 shipping & handling

HAM RADIO'S BOOKSTORE
Greenville, NH 03048

AVAILABLE NOW

THE ARRL 1985 HANDBOOK FOR THE RADIO AMATEUR

THE 1985 ARRL HANDBOOK

\$15.00 (plus \$3.50 shipping)

1. It's BRAND NEW
2. It's BIGGER. Over 1024 pages.
3. It's EXPANDED. Covers everything from basic electronics to esoteric radio gear.
4. It's chockfull of NEW PROJECTS.
5. It's the MOST COMPLETE reference text available
6. Get your copy TODAY.

ORDER YOURS TODAY

ham radio BOOKSTORE

Greenville, NH 03048 Prices US funds only

SAM'S COOKBOOKS

MODERN DICTIONARY OF ELECTRONICS — 6th Edition by Rudolf Graf

This book should be in every ham's library. It has over 20,000 terms unique to electronics and other closely related fields. 3000 additions to the 5th edition and twice the size of the 1st edition! From A or angstrom to zoom lens, you'll find it in this updated dictionary. 6th edition, ©1984, 1152 pages.

22041 **Hardbound \$39.95**

CMOS COOKBOOK by Don Lancaster

CMOS is today's state-of-the-art! It's low cost, widely available and uses an absolute minimum of power. It's also fun to work with and very easy to use. The CMOS Cookbook is written to help you use CMOS and is chock-full of practical circuits and does not dwell on math or heavy theory. Projects include high-performance op-amps, TV type-writer, digital instruments, music synthesizers, video games and more. ©1977, 1st edition, 414 pages.

21398 **Softbound \$13.95**

IC OP AMP COOKBOOK by Walter Jung

This second edition is broadly updated in terms of device coverage. It includes the latest in state-of-the-art developments such as J Fet and MosFet in both single and multiple formats. This cookbook is edited into three basic parts. Part I introduces the IC op amp and discusses general considerations. Part II covers practical circuit applications. Part III is an appendix consisting of manufacturer's data sheets and other pertinent information. You'll find a wealth of information, as well as over 200 practical circuit applications.

©1980, 2nd edition, 480 pages.

21695 **Softbound \$15.95**

TTL COOKBOOK by Don Lancaster

Despite the advent of CMOS, there is still design work being done with TTL circuitry. This book gives you a broad overview of exactly what TTL is, how it works and is full of design ideas and practical circuits. Areas that receive attention include: flip-flops, clocked logic, counters, counting techniques, noise generators and much more. You also get a complete discussion of practical TTL applications including digital counter, events counter, stopwatch and voltmeter to name just a few. ©1974, 1st edition, 333 pages.

21035 **Softbound \$12.95**

Please enclose \$3.50 for shipping and handling.

Ham Radio's Bookstore
Greenville, NH 03048



ICOM

KENWOOD YAESU



Regular SALE
 IC-751 9-band Xcvt/1-30 MHz Rcvr \$1399.00 Call
 IC-745 9-band Xcvt/1-30 MHz Rcvr \$ 999.00 Call



IC-271H 100w 2m FM/SSB/CW Xcvt \$899 Call
 IC-271A 25w 2m FM/SSB/CW Xcvt \$699.00 Call
 IC-471A 10w 430-450 SSB/CW/FM Xcvt \$799.00 Call



IC-02AT Call
 IC-04AT Call
 IC-2AT Call
 IC-3AT Call
 IC-4AT Call

**IC-R71A
GENERAL
COVER RCVR**



Regular SALE
 TS-930S/AT \$1799.00 Call
 TS-930A \$1599.00 Call



TS-711A TS-811A Call



TR-2600A Call
 TH-21A Call
 TH-21AT Call
 TH-41A Call
 TH-41AT Call

**R-2000
GENERAL
COVER**



Regular SALE
 FT-980 \$1659.00 Call
 FT-09G Call



FT-726R \$ 899.00 Call



FT-209RH Call
 FT-709RH Call
 FT-203RH Call
 FT-103R Call
 FT-703R Call

**FRG-8800
GENERAL
COVER RCVR**



**SALE!!
NEW RTTY/CW
COMPUTER
INTERFACES**



BIRD



IC-471H

List \$1099

SALE \$899⁹⁵ CASH

HAL CWR-6850

List \$995

SALE \$699⁹⁹ CASH

LIMITED QUANTITY!

MIRAGE

**AMPLIFIER
SALE!**



AMERITRON

AL-80



JUN'S  **ELECTRONICS**

Calif. Call Collect for Order

800-882-1343

INCLUDES ALASKA HAWAII

204

- AMATEUR ● TWO WAY ● MARINE
- CELLULAR MOBILE PHONE ● SCANNER
- ★ Free U.P.S. Cash Order (Most Item, Most Place)
- ★ Shoppers, call us last, save \$\$
- ★ SE HABLA ESPANOL

(213)390-8003

3919 Sepulveda Blvd.
Culver City, CA 90230

ANTI-STATIC DUST COVERS

for New & Old Model Amateur Radios, Computers, Disk Drives, also Custom Made. Over 1 Million in use. Send for Brochure

Radio Covers Available:

- | | | | |
|---------|--------------|---------|-----------|
| Alpha | Halicrafters | ICOM | Panasonic |
| Bearcat | Heath | Kenwood | Robot |
| Collins | Henry | MJF | Swan |
| Dentron | | | Ten-Tec |
| Drake | | | Yaesu |



BIRCH HILL SALES, P.O. Box 129, Milford, NH 03055
 Tel. (603) 673-8907



**PROGRAM
DISK
NOW
AVAILABLE**



Please add \$3.50 for shipping

PACKET RADIO THRU SOFTWARE

AX.25 Protocol By Bob Richardson, W4UCH

You can get on Packet Radio two ways. One is with a sophisticated "black box". The other is by making your computer act like a "black box" by programming it in a high level machine language code. W4UCH has written a machine language program for the Radio Shack TRS 80 Models 1, 3 and 4 computer (Model 4 works with Model 3 disk while in Model 3 mode). This book has twelve chapters plus seven appendices that take you step by step through the process of setting your computer to first convert the digital information into a usable format and then to decode the information.

1984 3rd edition

- | | | |
|------------------------------------|-----------------------|----------|
| RE-AX | Softbound | \$21.95 |
| PROGRAM NOW AVAILABLE IN DISK FORM | | |
| RE-MI | Model 1 Disk | \$29.00 |
| RE-MIII | Model III & 4 Disk | \$29.00 |
| RE-BD | SPECIAL BOOK AND DISK | \$49.95 |
| (Specify disc, Mod. I or Mod. III) | | SAVE \$2 |

ham radio magazine
 GREENVILLE, NH 03048

BOOKSTORE

(603) 878-1441

MOSLEY...A BETTER ANTENNA...

Antennas For 40 Meters...

- *ALL STAINLESS HARDWARE
- *NO MEASURING
- *2 YEAR WARRANTY
- *5 KW P.E.P.
- *BROAD BAND WIDTH
- *BUILT TO LAST
- *NO BALUN NEEDED



S-401 M

Easy as... 1 - S-401 M. A 40 Meter Rotatable Dipole which gives you excellent bandwidth and performance. MOSLEY's S-401 M is the best 40 Meter Dipole ever built. All stainless hardware is standard. We have made it even stronger than before! We have added 2 extra insulator blocks and 2 feet more rectangle. The center of the elements are reinforced with an unbreakable non-conductive rod which makes it just about indestructible. Our link coupled feed system provides for an efficient match which enables you to direct feed the antenna with no need for a balun. This is why we give a 2 year warranty on parts, material, and workmanship.

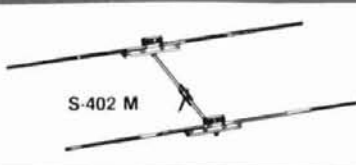

S-402 M

2 - Our S-402 M is now on a 24 foot boom and has all of the new improved structural changes. This antenna will give you years of outstanding mechanical and electrical performance in any climate. We feel this is the best performing, maintenance free, 2 element 40 Meter beam built anywhere in the world. Check it out! We believe you will agree. The elements are heavier constructed than other brands, and only reduces to 1 1/8 x .058 wall at their ends. Compare this to the other manufacturers. The S-402 M also comes with our 2 year warranty!

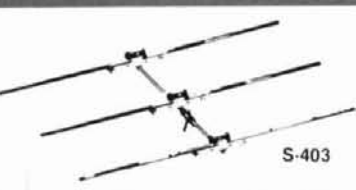

S-403

3 - The S-403 is the killer of the three models. This antenna gives you full size performance and is built to last. Our 36 foot boom is made out of 2" x .104 wall with a 24 foot sleeve of 1.785 x .125 wall. This gives you a wall thickness of .229 over 24 feet of the boom. The S-403 is spaced to give you the best front to back and forward gain. It will give you the whole 40 Meter band to chase DX or rag chew. Our S-403 also comes with our 2 year warranty.

If you are a new ham and are not familiar with MOSLEY, ask an older ham about us or call the PRESIDENT of MOSLEY. He will be glad to explain why MOSLEY is A BETTER ANTENNA.

These and other MOSLEY products are available through your favorite DEALER. Or write or call MOSLEY for the DEALER nearest you.

Mosley Electronics, Inc.

1344 BAUR BLVD. ST. LOUIS, MISSOURI 63132

1-314-994-7872

1-800-325-4016

VOLUNTEER EXAMINATION BOOKS & TAPES



- Novice Class Q&A Test Guide Package \$ 9.95
- Technician Class Q&A Test Guide 19.95
- Advanced Class Q&A Test Guide 19.95
- Extra Class Q&A Test Guide 19.95
- 5 wpm Novice QSO Test Preparation Tape 9.95
- 5-7 wpm Speed Builder 9.95
- 7-10 wpm Speed Builder 9.95
- 10 wpm Plateau Breaker QSOs 9.95
- 10-12 wpm Speed Builder 9.95
- 12-15 wpm Calls & Numbers Speed Builder 9.95
- 13-15 wpm Random Code Practice 9.95
- 13 wpm General Class QSO Test Prep Tape 9.95
- 13-15 wpm Speed Builder 9.95
- 15-17 wpm Speed Builder 9.95
- 17-19 wpm Speed Builder 9.95
- 20-22 wpm Random Code Practice 9.95
- 20 wpm Extra Class QSO Test Prep Tape 9.95
- Test Guides Updated to New '85 Questions and Answers
- Slow Code Tapes Use 13 wpm Character Speed
- We Ship First Class Mail, Same Day
- Add \$3.00 postage & handling for Test Guides. 50¢ P&H for each tape.
- 100% SATISFACTION OR MONEY BACK ✓ 205

GORDON WEST RADIO SCHOOL
2414 COLLEGE DR., COSTA MESA, CA 92626

Mon.-Fri. 10-4pm (714) 549-5000

NEW

ARRL TECH-GENERAL LICENSE MANUAL

Written in an easy to read and understand style, this is the guide you need for your Tech/General studying. FCC questions with complete answers ©1985. 1st edition.

AR-TG **Softbound \$5.00**

Please add \$2.50 for shipping and handling

ham radio BOOKSTORE
Greenville, NH 03048

MOSLEY...A Better Antenna... For New and Old

- *EASY ASSEMBLY
- *NO MEASURING
- *ALL STAINLESS HARDWARE
- *2 YEAR WARRANTY
- *LOW SWR
- *BUILT TO LAST



Whether you are just starting out or trying to complete the Honor Roll, Mosley offers a Full Line of Tri-Banders which will mechanically and electronically outperform the competition. For the new ham with limited space and pocket book, start with our TA-31 Jr. rotatable dipole. You can make our TA-31 Jr. into a 2 or 3 element as your needs increase.

If you start with the need to run higher power, then the TA-31 is for you. This also can be made into a 2 or 3 element beam as you expand your station.

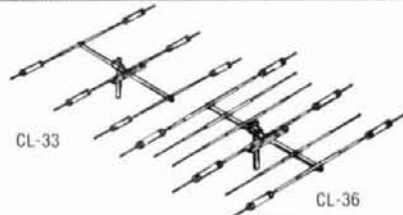

For the ham that wants a little more performance out of a Tri-Bander but is limited in room, then our CL-33 on a 18 foot boom is the way to go. For those that want MONO BAND performance out of a Tri-Bander, want to hear better, and be louder, the CL-36 is for you.

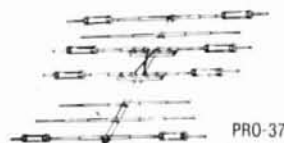

For the ham that wants to start right at the top, the PRO-37 is the antenna that will give you king of the hill performance. It is the broadest banded, highest power, best performing Tri-Bander in our line.

Compare ours before buying any other antenna. All stainless standard, all heavy telescoping aluminum elements which means better quality and no measurement. Ease of assembly gives you a quality antenna with consistent performance. Our elements are pre-drilled so you will get the same performance as we do. All of our Tri-Banders come with a 2 year warranty.

If you are a new ham and are not familiar with MOSLEY, ask an older ham about us or call the PRESIDENT of MOSLEY. He will be glad to explain why MOSLEY is A BETTER ANTENNA.

These and other MOSLEY products are available through your favorite DEALER. Or write or call MOSLEY for the DEALER nearest you.

Mosley Electronics, Inc.

1344 BAUR BLVD. ST. LOUIS, MISSOURI 63132

1-314-994-7872

1-800-325-4016

MISSOURI RADIO CENTER

KENWOOD



TS-430S Most Advanced, Compact HF Transceiver

- General Coverage Receiver
- USB/LSB/CW/AM/Optional FM • 10Hz Dual Step Digital VFO • Eight Memories w/Lithium Back-up • Memory and Band Scan

KENWOOD



TS-930S Top of the Line HF Transceiver

- General Coverage Receiver • Superior Dynamic Range • All Solid State—28 VDC Final • QSK CW • Optional Automatic Antenna Tuner • Dual VFO w/8 Memories • Dual Mode Noise Blanker

KENWOOD



TR-7950/7930

- Large LCD Readout • 21 Multi-Function Memory • Lithium Back-up • Automatic Offset • Built-in Encoder • Memory or Band Scan

KENWOOD



TR-2600

- 2.5W/300 mW (Switchable) 2 Meter Handheld Transceiver
- LCD Readout • Ten Memories w/Lithium Back-up • Band and Memory Scan • Built-in Sub-tone Encoder

YAESU



FT-757 GX

- Compact General-Coverage Receiver
- General Coverage Receiver
- USB/LSB/CW/AM/FM • Dual VFOs
- Memory/Band Scan • Speech Processor • CW Filter and CW Keyer included

YAESU

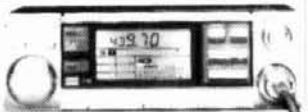

FT-2700RH

- Dual Bander
- VVHF FM
- 144/430 MHz
- 25 WATTS

YAESU



FT-209RH

- 5 Watts
- 10 Memories
- LCD
- Compact

YAESU



FT980

- CAT SYSTEM—Computer Aided Transceiver
- Wide Dynamic Range • General Coverage • Low Noise Front End • 10 Hz Digital Readout • All Mode Transceiver—CW/SSB/AM/FM/FSK!

ICOM

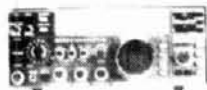

IC-745 HF Base

- All ham band HF transceiver. 16 memories. 100kHz to 30 MHz general coverage receiver and adjustable noise blanker and AGC.

ICOM



IC-27A Compact Mobile

- A breakthrough in 2-meter mobile communications! Most compact on the market (5 1/2" x 1 1/2" Hx7" D) contains internal speaker for easy mounting. 25 watts. 32 PL frequencies. 9 memories. scanning and touchtone mic.

ICOM



IC-02AT

- The IC-02AT 2-meter LCD readout handheld features 10 memories, 32 PL tones, scanning, keyboard frequency entry, dial lock, 3W std 5W opt. DTMF.

ICOM



IC-R71A General Coverage Receiver

- The IC-R71A 100kHz - 30 MHz superior grade general coverage receiver features keyboard frequency entry, 32 memories, SSB/AM/RTTY/CW, selectable AGC and noise blanker, and wireless remote controller (optional).

NEW

OUR ASSOCIATE
STORE IN THE
ST. LOUIS AREA

FLOYD ELECTRONICS
2213 VANDALIA COLLINSVILLE, ILL 62234
CALL 618-345-6448

✓ 207

CALL FOR SPECIAL SALE PRICES

- AEA
- ASTRON
- AVANTI
- AZDEN
- B & W
- BEARCAT
- BENCHER
- BUTTERNUT
- CENTURION
- CES
- COMM SPEC
- CUSHCRAFT
- DAIWA
- HUSTLER
- HYGAIN
- ICOM
- KANTRONICS
- KENWOOD
- KLM
- LARSEN
- MFJ
- MICROLOG
- MIRAGE
- SANTEC
- VANGORDON
- WELZ
- YAESU

CALL TOLL FREE 1-800-821-7323

MASTERCARD, VISA & C.O.D.'s WELCOME

2900 N.W. VIVION RD.
KANSAS CITY, MISSOURI 64150
816-741-8118

TOUCH-TONE DECODER SALE!

SSI-202P CMOS WE OVER PURCHASED

Our over supply can be your gain.

We've just got to try and get even so we are going to let our ham friends share in some of these great circuits, for a great price.

FEATURES

- Central office quality
- Band-splitting filters included on chip
- Single, low-tolerance, 5-volt supply
- Detects either 12 or 16 standard DTMF digits
- 18-pin DIP package
- Output in either 4-bit hexadecimal code or binary coded 2 of 8. Use 74159 decoder for 1 of 16 output
- Uses inexpensive 3.579545-MHz color-burst crystal for reference (Radio Shack P/N 272-1310 \$1.69)
- Excellent speech immunity

All you need is a color-burst XTAL from Radio Shack & 1 meg resistor to make a C.O. Quality Touch Tone decoder. SSI-202 is a 5V part and unlike the older 201 is TTL compatible and will directly interface to personal computers.

These won't last long and are limited to available supply, so HURRY!!



✓ 208

\$18 INCLUDING SPECS. & SCHEMATICS
In Wash. add 7.9% sales tax

R.M. FULLER CO.
902 Industry Dr., Seattle, WA 98188

1-800-626-6662

In Wash. Call **(206) 575-8640**



The Problem Solver...

The RF Wattmeter Model 81000-A from Coaxial Dynamics, Inc. does more than provide accurate rf measurements. Testing of transmission lines, antennas, connectors, filters and related components can reveal unknown problems and assure optimum equipment performance.

The 81000-AK Wattkit features this easy-to-read RF Wattmeter (pictured here), with its optional carrying case and



an array of elements and accessories. Coaxial Dynamics elements can be purchased separately for use in other manufacturer's Wattmeters. For more information on the 81000-A Wattmeter or any of the complete line of Coaxial Dynamics RF products and OEM components please contact Coaxial Dynamics, Inc.

SEE US AT
OUR BOOTH
IN DAYTON



**COAXIAL
DYNAMICS, INC.**

15210 Industrial Parkway, Cleveland, OH 44135 • (216) 267-2233
Outside Ohio, WATS: (800) Coaxial, Telex: 980-630



✓ 209



new IC-735 HF transceiver

ICOM has announced the IC-735 ultra compact all-ham band HF transceiver and general coverage receiver, said to be the most compact and advanced HF SSB unit on the market. Measuring only 3.7 inches high by 9.5 inches wide by 9 inches deep, the IC-735 is suited for mobile, marine, or base station operation.

To enhance receiver performance, the IC-735 has built-in receiver attenuator and preamp. It also has a 105-dB dynamic range and a new low-noise phase locked loop for rock-solid reception.

The IC-735 features a large LCD readout and conveniently located controls that allow simple operation, even in the mobile environment. VOX controls, mic gain, and other infrequently changed controls are kept out of sight behind a hatch cover on the front panel of the radio, but are immediately accessible.



Other standard features included at no additional cost are: built-in FM, a 500-Hz CW filter (FL-32), an electronic CW keyer, an HM-12 scanning mic, FM/CW/LSB/USB/AM (TX and RX). 12 tunable memories with lithium memory backup, and both program and memory scan. Adjustable AGC, automatic SSB selection by band, an RF speech processor, and 12 volt operation are also standard. Output power is continuously adjustable up to 100 watts.

A new line of accessories, including the AT-120 automatic programmable antenna tuner and the PS-55 power supply, will also be available. The IC-735 is also compatible with most of ICOM's existing line of HF accessories.

The IC-735 will be available in May, 1985, and pricing will be announced the end of April. The IC-735 will be displayed at the Dayton Hamfest.

For additional information, contact ICOM America, Inc., 2380-116th Avenue, N. E., Bellevue, Washington 98004.

Circle #301 on Reader Service Card.

PV voltage regulators

Photocomm, Inc., of Scottsdale, Arizona, has announced new design features on its Power Control Series voltage regulators for photovoltaic applications.

A removable printed circuit board has been incorporated to simplify servicing and repairs; spare boards can also be purchased separately. These regulators now have a 30-amp load handling capability that allows for up to 12 40-watt solar modules in parallel to be controlled simultaneously. This benefit helps to lower overall system cost by using fewer regulators.



Standard features include temperature compensation, low voltage disconnect, analog meter package, transient protection and adjustable voltage setpoints. The controller is housed in a NEMA 3R weather-proof enclosure. 12 and 24 volt units are available off the shelf; other voltage units (36, 48, and 120 volts) can be provided upon request. Special options include Array Power Diversion, Manual Array Switching and a Severe Environment Package.

For further information, contact Photocomm, Inc., 7735 E. Redfield Road, Scottsdale, Arizona 85260.

Circle #302 on Reader Service Card.

multi-mode tuning indicator

Get on frequency quickly and accurately with the new HAL SPT-1 "Spectra-Tune" multi-mode tuning indicator. The SPT-1 may be used in the following modes of operation: RTTY (high tones) and RTTY (low tones), Facsimile (FAX), Slow-Scan Television (SSTV) and Morse Code (CW).



The frequency spectra of the received signal is displayed on a calibrated linear 40-segment red LED bar graph. The front panel calibration control allows the selection of which 1000 Hz range

MADISON

Electronics Supply

1508 McKinney
Houston, Texas 77010

Call for Quotes
713-658-0268

EQUIPMENT

KENWOOD - We stock the KENWOOD line including the new products. The TS-711A 2 meter all mode, the TS-811A 70cm all mode and the TS-670 all mode for 40, 15, 10 and 6 meters. These new rigs match the TS-430S and make beautiful additions to any shack. We also have the new little hand-held rigs, the TH-21AT and TH41AT.

CALL FOR PRICES
KENWOOD SWL R-2000, R-1000, R-600 & R-11 CALL
KENWOOD TS-930S and TS-430S CALL
ICOM 02AT 299.95
YAESU FT203R CALL
MIRAGE AMPS less 12%
DENTRON GLT1000 1KW PEP tuner 174.95
ICOM R-71A 649.95
CES 510 SA SMART PATCH 349.95

SPECIAL

**KENWOOD TR-2600A
SPARE PB-26 BATTERY PACK
FREE with purchase**
HMC-1 HEADSET \$19.95 with TR-2600A purchase

ACCESSORIES

FLUKE 77 auto digital multimeter 114.95
BENCHER less 10%
VIBROPLEX less 10%
HEIL SOUND less 10%
DAIWA NEW METERS CALL
GORDON WEST code tapes (great!) 9.95
HI-MOUND Keyer paddles less 10%
ALPHA DELTA MACC-8 surge protector 71.95

AMPHENOL

831-T coax. fee 4.00
PL 259 831 SP 1.25
UG-176 reducer, RG8X/RG-59 30
4400 N male to SO-239 6.00
2900 BNC male to SO-239 4.00
8261 N male 3.00
83-10 RCA to SO 239 3.00
82-97 N female chassis 3.00

ANTENNAS

BARKER & WILLIAMSON Antennas less 10%
BUTTERNUT HF-2V 80 & 40 mtr 125.00
BUTTERNUT HF-6V 80 thru 10 125.00
BUTTERNUT accessories stock CALL
AEA ISPOLE 144 39.95
HYGAIN CALL
LARSEN CALL
HUSTLER 68TV VERTICAL 119.95
CUSHCRAFT A147-11 49.95
215WB NEW! 2 mtr beam 79.95
AOP-1 complete OSCAR Antenna 149.95
we have a large CUSHCRAFT inventory
HUSTLER CALL
ANTECO 2mtr 5/8 mag mount 24.95
KLM K734A 349.95
KLM is always in stock, large selection of HF, VHF, UHF,
& WORLD CLASS CALL

NEW

WM. NYE MB-V-A TUNER

3KW rating, back lit meters,
RMS reading to 3KW, better shielding,
higher voltage caps.
LIST \$585.00 SALE \$509.00

NEW! NEW! NEW!

**AEA CP-100 INTERFACE
IMPROVED FILTERING & FEATURES**
LIST \$369.95 SALE \$319.95
TRADE IN YOUR CP-1 call for details

USED AEA CP-1 125.00

POLICIES: MASTERCARD VISA COD

All prices FOB Houston, TX, except as noted. Prices subject to change without notice, subject to prior sale. Used gear sale price refunded if not satisfied. Texas residents subject to sales tax.

1-800-231-3057

COMPUTERIZE YOUR HAM SHACK THE EASY WAY

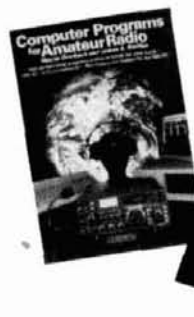

Computer Programs for Amateur Radio

by Wayne Overbeck, N6NB
and Jim Steffen, KC6A

Wouldn't you like to use one of the popular, inexpensive home computers to handle a variety of your Amateur Radio chores? N6NB and KC6A have come up with a host of valuable computer programs and background information which are just the ticket to help you computerize such duties as: logging, duping contest logs, awards record keeping, calculating Gray line and beam headings to name just a few examples. You can either enter the programs from the book by hand or you can buy the programs already loaded onto easy-to-use disks for the four most popular home computers: C-64, TRS-80, Apple II or the IBM-PC. In fact, the complete package of this 367 big, page book and program disk costs no more than many of the game programs that your kids are now using. Without a doubt, this is the real bargain in Amateur Radio software. See how much easier your home computer can make your hamming activities. ©1984 1st edition. 327 pages.

Program Listing

- | | |
|------------------------------------------------------------------------------------------------------------------------------------------------------|----------------------------------------------------------------------------------------------------------------------------------------|
| 1) <i>Demo</i>
MiniLogger | 4) <i>Contest and Duping</i>
Dupechecker (& Print)
General Contest Logger
Field Day Logger
Sweepstakes Logger
Log Print |
| 2) <i>Data Base Mgmt.</i>
Logbook
Radio Awards Data Base
Setup Program for Awards Data Base
Gridlocator | 5) <i>Antenna Programs</i>
Antenna Scaler
Antenna Matching Evaluator
Vertical Pattern Plotter |
| 3) <i>Latitude/Longitude Programs</i>
Data file
Beamheading chart
DX Display
Sunrise Chart
Grayline
Sunrise Anywhere
DX Checker | 6) <i>To the Moon and Beyond</i>
EME System Calculator
Sky locator
Moontracker |

Program disks available for: IBM PC-DOS, Apple II (DOS 3.3), TRS-80 Model I and III and Commodore C-64.

HA-0657 Softbound \$16.95
Program Disk Alone (No documentation included) \$19.95

HA-0657 with disk **SAVE \$6.95 — \$29.95**
(Please make sure you indicate which machine) (purchased separately \$36.95)



C-64 + DX Edge = Fun

USE THE INEXPENSIVE COMMODORE C-64

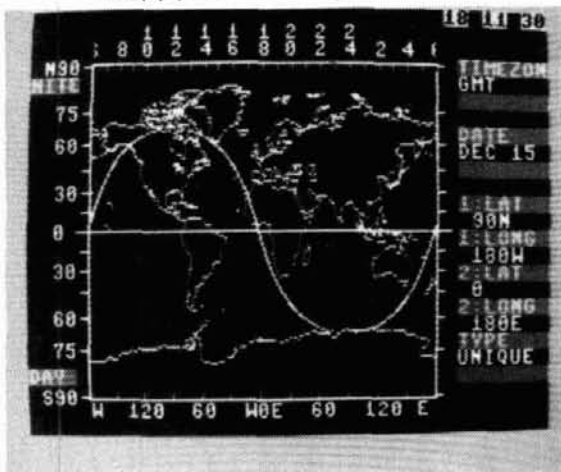

Now generate your own Grayline display.

Now that Commodore has reduced the price of the C-64 computer to \$150, there is little reason why you don't own one for your ham station. Xantek has adapted their best selling DX Edge to the computer world and it comes at a very reasonable price. Just \$34.95 brings into your ham shack the ability to know and predict when and where DX is going to appear. The DX Edge shows you the sun's path across the earth. When you are using the program, the computer will automatically update the information as the sun progresses across the face of the Earth. To make the computerized DX Edge even easier to use, the display is keyed to the DXCC list and the 40 CQ zones. Disk and documentation are just \$34.95. This is something you've GOT to have! ©1985.

XN-C64

\$34.95

Please enclose \$3.50 for shipping and handling. Prices U.S. Funds only.

**ham
radio** magazine
GREENVILLE, NH 03048

BOOKSTORE

(603) 878-1441



✓ 217



from 300 Hz to 3000 Hz is to be displayed. Best of all, hookup is very simple — and audio input line from the receiver/transceiver and a +12 VDC line are all that's required for operation. The SPT-1 comes with a one-year limited warranty.

The SPT-1 Spectra Tune is priced at \$169.00. For more information, contact HAL Communications Corporation, P.O. Box 365, Urbana, Illinois 61801.

Circle #303 on Reader Service Card.

KENPRO rotator products

The KENPRO brand line of rotators and accessories — including the KR-400 and KR-500 pair of rotators for satellite and space communications — are now available from Encomm, Inc. Also available are the KR-600RC medium-duty and the KR-2000RC heavy-duty units for use on the U.S.A. voltage system.

For further details, contact Encomm, Inc., Suite 800, 2000 Avenue 'G', Plano, Texas 75074. Circle #304 on Reader Service Card.

VHF and UHF transmitter and receiver modules

Hamtronics, Inc. recently announced commercial versions of its popular high-band and UHF FM transmitter and receiver modules, FCC Type Accepted under parts 15, 22, 74, and 90. The TA-51 VHF transmitter and the TA-451 UHF transmitter are each capable of operating at 2 watts continuous duty and up to 3 watts intermittent service. The companion R144 and R451 receivers feature high sensitivity and superior front-end and IF selectivity, automatic frequency control, and hysteresis squelch to lock onto drifting or fading signals.

The Hamtronics® transmitter and receiver modules are supplied as printed circuit board assemblies that can be housed in a variety of ways and adapted to many applications. The low-cost units are suitable for use in voice and data links to replace phone lines, for remote control, for wireless alarm systems, for telemetry, for monitor receivers, and for many other applications.

Other Hamtronics® products of interest include "202" type FSK modulators and demodulators to provide digital data operation with FM transmitters and receivers, low-noise receiver preamps, 806-MHz band scanner converters, VHF AM receivers, repeater CORs, CWIDs, simplex and duplex autopatches, DTMF control and many other products related to VHF and UHF transmission and reception.

For a copy of Hamtronics' new 40-page catalog, contact Hamtronics, Inc., 65-F Moul Road, Hilton, New York 14468-9535. (For overseas mailing, send \$2 or 4 IRCs.)

Circle #118 on Reader Service Card.

Barry Electronics Corp.

WORLD WIDE AMATEUR RADIO SINCE 1950
Your one source for all Radio Equipment!



KITTY SAYS: WE ARE NOW OPEN 7 DAYS A WEEK.
Saturday & Sunday 10 to 5 P.M.
Monday-Friday 9 to 6:30 PM Thurs. to 8 PM
Come to Barry's for the best buys in town.

For the best buys in town call:
212-925-7000
Los Precios Mas Bajos en
Nueva York



ONV Safety belts in stock
ICOM
IC-R71A, IC-751, IC-745, IC-27A/H, IC-37A, IC-47A, IC-271A/H, IC-3200A, IC-4714A/H, IC-735

MAY We Help You With the Best in Commercial and Amateur Radios? Jan KB2RV, Tom, Kitty WA2BAP, Mark K2CON
See You at the Spring County Hamfest May 30th

KENWOOD



R-600, R-1000, R-2000, TS-940/SIAT, TS-430S, TR-3600A, TR-7950, TW-4000A, Kenwood Service/Repair, TH2131/41AT, TM-211A, 411A & TS-711A/B1A

TELEX PRO-COM

ROCKWELL COLLINS KWM-380

VoCom/Mirage/Daiwa Large inventory of Tokyo Hy-Power Saxon Wire & Cable Amplifiers & 5/8 HT Gain Antennas IN STOCK



YAESU

FT-ONE, FT-980, FT-757GX, FRG-8000, FT-726R, FT-77, FT-270RH, FT-2700RH

YAESU ICOM Land Mobile HT Midland/Standard Wipac Maxon Yaesu FT-2203, FT-4703 Icom IC-M12 (Marine) M700 Tempo M-1



AMERITRON AMPLIFIER AUTHORIZED DEALER

Yaesu FTR-2410, Wilson ICOM IC-RP 3010 (440 MHz) ICOM IC-RP 1210 (1.2 GHz)

Computer Interfaces stocked: MFJ-1224 AEA CP-1, PKT-1, DR DX CP-100, ATU, Dr. QSO

ALPHA AMPLIFIERS

Complete Buttner Antenna Inventory in Stock!

DIGITAL FREQUENCY COUNTERS

Model TR 1000 0-1 GHz 12000Hz 0-500 MHz 0-1.3 GHz 12000Hz

BENCHER PADDLES, BALUNS, AUDIO FILTERS, IN STOCK

MIRAGE AMPLIFIERS ASTRON POWER SUPPLIES DENTRON IS BACK IN STOCK!



SMART PATCH

ETD Simple Autopatch 4-10.5A W/ Patch FM Transceiver, 50 Watt Telephone, Great For Telephone Lines From Mobile To Base, Simple To Use - 100%

CELLULAR PHONES



WELZ FLUKE 77 Multimeter

Nye MBV-A 3 Kilowatt Tuner



MURCH Model 2000 A, L.S. B in stock

HAM MasterTapes Beta or VHS Tapes IBC soldering iron in stock

HEIL EQUIPMENT IN STOCK



Tr Ex Towers Hi Gain Towers & Antennas, and Rotors will be shipped direct to you FREE at shipping cost

New TEN TEC 2591 HT, Corsairs, Argosy II, Century 22

MAIL ALL ORDERS TO BARRY ELECTRONICS CORP., 512 BROADWAY, NEW YORK CITY, NY 10012.

New York City's LARGEST STOCKING HAM DEALER COMPLETE REPAIR LAB ON PREMISES

"Aqui Se Habla Espanol!"
BARRY INTERNATIONAL TELEX 12-7670
MERCHANDISE TAKEN ON CONSIGNMENT FOR TOP PRICES
Monday-Friday 9 A.M. to 6:30 P.M. Thursday to 8 P.M.
Saturday & Sunday 10 A.M. to 5 P.M. Free Parking
AUTHORIZED DIST. MCKAY DYMEK FOR SHORTWAVE ANTENNAS & RECEIVERS
IRTXLEX - Spring St. Station
Subways: BMT - Prince St. Station
IND - F Train Bwy. Station
Bus: Broadway #6 to Spring St.
Path - 9th St. 4th Ave. Station

Commercial Equipment Stocked: ICOM, MAXON, Midland, Standard, Wipac, Yaesu. We serve municipalities, businesses, Civil Defense, etc. Portables, mobiles, bases, repeaters.
Local Ham Club Speeches Given

We Stock: AEA, ARRL, Alpha, Ameco, Antenna Specialists, Astatic, Astron, B & K, B & W, Bush, Bencher, Bird, Blumert, CDE, CES, Collins, Communications Spec. Connectors, Covercraft, Cushcraft, Daiwa, Dentron, Digimax, Drake, ETO (Alpha), Eimac, Encomm, Heil Sound, Henry, Hustler (Newtronics), Hy-Gain, Icom, KLM, Kantronics, Larsen, MCM (Daiwa), MFJ, J.W. Miller, Mini-Products, Mirage, Newtronics, Nye Viking, Palomar, RF Products, Radio Amateur Callbook, Robot, Rockwell Collins, Saxon, Shure, Telex, Tempo, Ten Tec, Tokyo Hi Power, Trionyx TUBES, W2AJ, Waber, Yaesu Ham and Commercial Radios, Vocom, Vibroplex, Curtis, Tri-Ex, Wacom Duplexers, Repeater, Phelps Dodge, Fanon Intercom, Scanners, Crystals, Radio Publications.

WE NOW STOCK COMMERCIAL COMMUNICATIONS SYSTEMS
DEALER INQUIRIES INVITED. PHONE IN YOUR ORDER & BE REIMBURSED
COMMERCIAL RADIOS stocked & serviced on premises.
Amateur Radio Courses Given On Our Premises, Call
Export Orders Shipped Immediately. TELEX 12-7670

VOICE OPERATED SQUELCH

- Fits inside most HF-SSB transceivers.
- Requires human voice to activate.
- Ignores static, noise and heterodynes.
- On/off switch only—no adjustments!
- Connects to audio leads and 9/12 VDC.
- Fully assembled and tested \$99.95.
- Complete with comprehensive manual.
- Used worldwide in commercial and military transceivers.

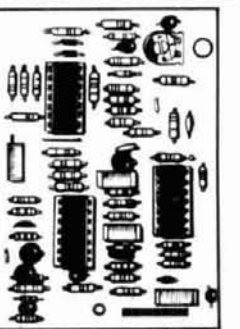

CMC COMMUNICATIONS, 5479 Jetport, Tampa, FL 33614 • (813) 885-3996

228

RF Porta-Tenna

VHF/UHF Telescopic 1/4 & 5/8 Wavelength Antennas for Hand-Held Transceivers & Test Equipment

1/4 WAVELENGTH

Model No.	Freq. MHz	Description	Price
196-200	144-148	5/16-32 stud w/spring	\$5.95
196-204	"	BNC connector w/spring	7.95
196-214	"	BNC connector	6.95
196-224	144-UP	BNC conn. adj. angle	7.95
196-814	220-225	BNC connector	6.95

5/8 WAVELENGTH

191-210	"	5/16-32 for old TEMPO	22.95
191-214	"	BNC connector	19.95
191-219	"	PL-259 w/M-359 adpt.	22.95
191-810	220-225	5/16-32 for old TEMPO	22.95
191-814	"	BNC connector	19.95
191-940	440-450	5/16-32 for HT-220	22.95
191-941	"	1/4-32 stud	22.95
191-944	"	BNC connector	19.95

Largest Selection of Telescopic Antennas. Write for info. Prices are postpaid via UPS to 48 States. For air delivery via UPS Blue add \$2.25. Florida add 5% sales tax. Payment by M.O. or Cashiers Check only.

✓ 212

RF PRODUCTS

P.O. Box 33, Rockledge, FL 32955, U.S.A.
(305) 631-0775

ATTENTION TECHNICIANS

Two-Way Radio Technician Wanted

Trio-Kenwood Communications is seeking an experienced technician to service state-of-the-art Amateur Radio Communications equipment, HF-UHF. A qualified candidate should be currently experienced with PLL synthesizers, micro processors, transistorized RF, and must be able to service to the component level.

We have a well-equipped service shop and parts department. Our service manuals are acknowledged as the best in the industry. We offer a competitive, comprehensive benefits package. If you would like to work with the industry's pace setter, contact:

Trio-Kenwood Communications

Attn: Service Department
1111 West Walnut Street
Compton, CA 90220

KENWOOD

pacesetter in Amateur radio

WARNING

SAVE YOUR LIFE OR AN INJURY

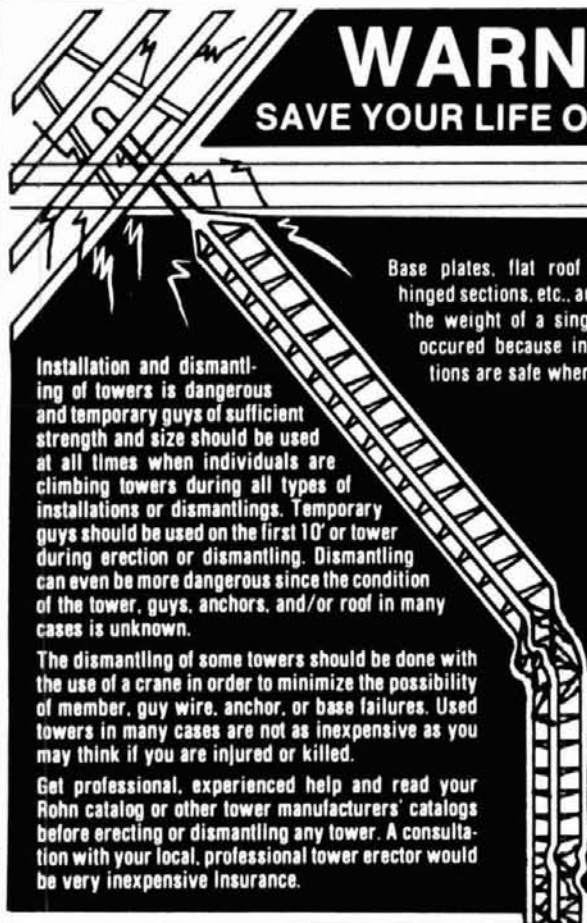

Base plates, flat roof mounts, hinged bases, hinged sections, etc., are not intended to support the weight of a single man. Accidents have occurred because individuals assume situations are safe when they are not.

Installation and dismantling of towers is dangerous and temporary guys of sufficient strength and size should be used at all times when individuals are climbing towers during all types of installations or dismantlings. Temporary guys should be used on the first 10' or tower during erection or dismantling. Dismantling can even be more dangerous since the condition of the tower, guys, anchors, and/or roof in many cases is unknown.

The dismantling of some towers should be done with the use of a crane in order to minimize the possibility of member, guy wire, anchor, or base failures. Used towers in many cases are not as inexpensive as you may think if you are injured or killed.

Get professional, experienced help and read your Rohn catalog or other tower manufacturers' catalogs before erecting or dismantling any tower. A consultation with your local, professional tower erector would be very inexpensive insurance.

Paid for
By the
Following:

ROHN

P.O. Box 2000
Peoria, IL 61656

COMMODORE

-USER WRITTEN SOFTWARE-
Supporting all COMMODORE computers
Written by users, for users
★ GAMES ★ UTILITIES ★ EDUCATIONAL ★

Our Latest Releases

C-64 Best Of Games	Vic 20 Best Of Games
C-64 Best Of Educational	Vic 20 Best Of Educational
C-64 Best Of Utilities	Vic 20 Best Of Utilities
C-64 84 Contest C-64 #1	Vic 20 Contest Vic #1
C-64 84 Contest C-64 #2	Vic 20 Contest Vic #2
C-64 84 Contest C-64 #3	Vic 20 Contest Vic #3

Specify Disk Or Tape \$10.00 each

COMAL STARTER PAK - 4 Disk Set - \$35.00
Bulletin Board Sys - On Best Of Utilities Collections

COMMODORE 64™ collections #1 thru 12
collections #1 thru 12 ✓ 229
Tape/Disk \$10.00 each per collection

SERIAL CABLES DINSET™: Reset Switch LOC-LITE™
PDI Program Manual \$10.00

Shipping and Handling Charges
US/Canadian Orders Add \$3.00
Foreign Orders Add \$5.00

CHECK, MONEY ORDER, VISA and MASTERCARD accepted. No COD's or P.O.'s
Write For A FREE Catalog

"PUBLIC DOMAIN", INC.
5025 S. Rangeline Rd., W. Milton, OH 45383
10:00 a.m. - 5:00 p.m. EST - Mon. thru Fri.
(513) 698-5638 or (513) 339-1725

VIC 20™, COM1 and Commodore 64™ are Trademarks of Commodore Electronics Ltd.
PDI™ is a Registered Trademark of Commodore Business Machines Inc.

SYNTHESIZED SIGNAL GENERATOR

MADE IN USA

MODEL SG-100F \$429.95 delivered

- Covers 100 MHz to 199.999 MHz in 1 kHz steps with thumbwheel dial
- Accuracy +/- 1 part per 10 million at all frequencies
- Internal FM adjustable from 0 to 100 kHz at a 1 kHz rate
- External FM input accepts tones or voice
- Spurs and noise at least 60 dB below carrier
- Output adjustable from 5-500 mV at 50 Ohms
- Operates on 12 Vdc @ 1/2 Amp
- Available for immediate delivery • \$429.95 delivered
- Add-on accessories available to extend freq range, add infinite resolution, AM, and a precision 120 dB attenuator
- Call or write for details • Phone in your order for fast COD shipment.

✓ 231

VANGUARD LABS

196-23 Jamaica Ave., Hollis, NY 11423
Phone: (718) 468-2720 Mon. thru Thu.

AITEOTIX
24 DB GAIN UHF/VHF/FM ANTENNA/LINE AMPLIFIER
AUV-724

75 Ohm in and out ✓ 220
\$19.50 EACH 3/\$17.50 EACH

AMNEC EPU 202
UHF VARACTOR TUNER
REC. CHANNELS: 14 - 83
ANTENNA INPUT: 75 Ohm
\$12.95 EACH
100 & OVER

P.O. BOX 486 HAWTHORNE, CA 90250
TELEPHONE (213) 324-1973
WE ACCEPT MONEY ORDER, VISA, MASTERCARD
PERSONAL CHECK ORDERS HELD 30 DAYS. NO COD
\$3.50 for Shipping & Handling, CA Residents ADD 6.5% TAX

Accessory Specialties
SHIPPED U.S.A.

Mosley.....

A BETTER ANTENNA

WHY SETTLE FOR LESS? LOOK WHAT THE MOSLEY TA-33 OFFERS

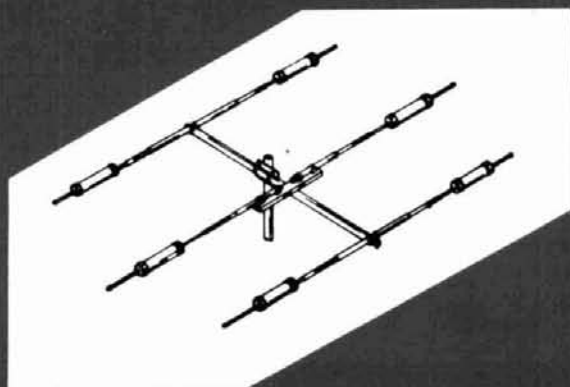

- 3 Element full power
- All stainless steel hardware
- Ease of assembly
- No balun required
- Now a 2 year limited warranty
- Now a standard 2" mast adapter
- Built to last

- Expandable to 30 or 40 meters
- Superb front to back ratio
- Excellent gain

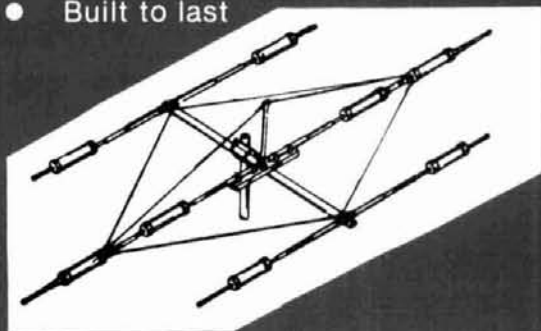

- Outstanding SWR

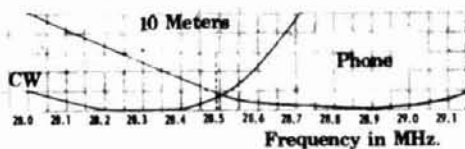
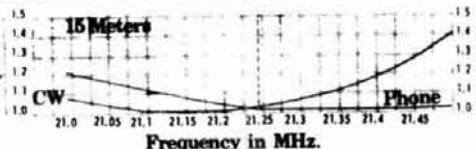
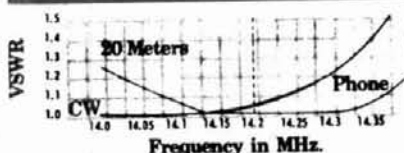

SPECIFICATIONS:

Forward gain	
Front-to-Back Ratio	
Power rating	CW 1KW
	SSB 2KW P.E.P.
Feedpoint Impedance	52 ohm
VSWR HT Resonance	1.5 to 1 or better
Matching System	Mosley
Number of Elements	3
Longest Element	28'
Boom Length	14'
Mast Size	1 1/2" or 2"
Turning Radius	15'6"
Wind surface area (in. sq. ft.)	5.7
Wind load (EIA standard 80 mph)	114 lbs.
Assembled Wt.	39 lbs.
Shipping Wt.	44 lbs.

- Used around the world
- Work CW or phone without tuning or adjusting antenna
- A great antenna for the new solid state rigs

ALL MOSLEY ANTENNAS
AND CATALOGS AVAILABLE
AT QUALITY DEALERS
OR CALL TOLL FREE

1-800-325-4016

This antenna is UPS shippable.

Prices and specifications
subject to change
without notice or
obligation.

REMEMBER WHETHER YOU USE TRAPS OR LINEAR LOADING, 8db GAIN IS 8db GAIN
YOUR RECEIVER CAN'T TELL THE DIFFERENCE... MOSLEY... TRAP MASTERS QUALITY STILL SETTING THE PACE...

Mosley Electronics, Inc.

1344 BAUR BOULEVARD ST. LOUIS, MO. 63132 1-314-994-7872

TNT RADIO SALES INC.

1-800-328-0250

1-612-535-5050

(IN MINNESOTA—COLLECT)

YOU GET MORE "BANG FOR YOUR BUCK" AT TNT RADIO SALES!

- | | | | |
|--------------|----------------|---------------|-------------|
| ■ Kenwood | ■ Mirage | ■ MFJ | ■ Welz |
| ■ Icom | ■ KLM | ■ Astron | ■ Azden |
| ■ Bencher | ■ Telex Hygain | ■ Alpha/Delta | ■ Santec |
| ■ AEA | ■ Nye Viking | ■ Bearcat | ■ KDK |
| ■ Kantronics | ■ Larsen | ■ Regency | ■ Ameritron |

SALES AND SERVICE AT PRICES YOU CAN AFFORD!
CALL OUR WATS LINE FOR LOW LOW PRICES!

SPECIAL OF THE MONTH: LARSEN MAG MOUNT 2M 1/8 PKG—\$36.95

VISA/MASTER CARD
FREE SHIPPING
ON MOST RIGS FOR CASH!



S.A.S.E. FOR OUR
"BENCH-TESTED"
USED EQUIPMENT LISTING

MON-FRI 9 AM - 6 PM CENTRAL TIME
SATURDAY 9 AM - 5 PM

4124 West Broadway, Robbinsdale, MN 55422 (Mpls./St. Paul)

✓ 221

here is the next generation Repeater

MARK 4CR

The **only** repeaters and controllers
with REAL SPEECH!

No other repeaters or controllers match Mark 4 in capability and features. That's why Mark 4 is the performance leader at amateur and commercial repeater sites around the world. Only Mark 4 gives you Message Master™ real speech • voice readout of received signal strength, deviation, and frequency error • 4-channel receiver voting • clock time announcements and function control • 7-helical filter receiver • extensive phone patch functions. Unlike others, Mark 4 even includes power supply and a handsome cabinet.

Call or write for specifications on the repeater, controller, and receiver winners.

SEE US AT DAYTON
BOOTHS 225, 226 & 227



MICRO CONTROL SPECIALTIES

Division of Kendecom Inc.

23 Elm Park, Groveland, MA 01834 (617) 372-3442

Create messages just by talking. Speak any phrases or words in any languages or dialect and *your own voice* is stored instantly in solid-state memory. Perfect for emergency warnings, club news bulletins, and DX alerts. Create unique ID and tail messages, and the ultimate in a real speech user mailbox — only with a Mark 4.



ACCURACY DIGIMAX PERFORMANCE



10 MHz Oven Oscillator 9 X 8 1/2 X 3 1/4
10 Hz to 1.2 GHz .1 PPM ACCURACY



50 Hz to 512 MHz 5 1/4 X 5 X 1 1/4
1 PPM ACCURACY
TCXO

ALL MODELS HAVE 1 YEAR WARRANTY

Optional factory installed rechargeable battery pack available



FOR DEALER LOCATIONS
OR PHONE ORDERS
800-854-1566
5625 Kearny Villa Road
San Diego, CA 92123
California Call 619-589-6582
Telex #697120-DATAMAX-103

DIGIMAX INSTRUMENTS CORP.

MODEL	PRICE	FREQUENCY RANGE	ACCURACY OVER TEMPERATURE	READ OUTS	SENSITIVITY TYP.		POWER REQ.
					50 Hz-25 MHz	25 MHz-450 MHz	
D500	\$149.95	50 Hz-512 MHz	1 PPM 17°-35°C TCXO TIME BASE	8	15 to 50 MV	20 to 50 MV to 450 MHz	8-15 VDC 300 MA
D510	\$179.95	50 Hz-1.0 GHz				50 to 100 MV to 1 GHz	AC-12 REQ. FOR 110 VAC
D612	\$259.95	50 Hz-1.2 GHz	0.1 PPM 20°-40°C PROPORTIONAL 10 MHz OVEN	9	15 to 50 MV	2 to 20 MV to 450 MHz	8-15 VDC 500 MA
D1200	\$299.95	10 Hz-1.2 GHz			15 to 50 MV	20 to 30 MV to 1 GHz	

AG-12 AC-ADAPTER \$8.95

T-1200 BNC-BASE 21" ANT. \$8.95

BAC12 \$34.95

BAC5 \$29.95

EXPORT AGENT: MAGNUS
3500 Devon Avenue
Chicago, IL 60659
312-679-6070
Telex #253503 MAGNUS CGO

223

THE DR10

**ONLY ONE ANTENNA
ROTATION SYSTEM IS
TRULY COMPLETE AND
SIMPLE TO INSTALL: THE
DR10**

The DR10 System offers a compact, single control unit with dual scale indicator; single, eight-wire control cable interconnect*; and will easily handle a 50 pound balanced antenna array and up to 8 sq. feet of wind load.

*One Rotor,
One Controller,
One Installation*

SEE US AT BOOTH 272/273 AT DAYTON

The DR10 Dual Axis Antenna Rotor System
A New Concept in Drive Systems

DYNETIC SYSTEMS

*not included

Call or Write for More Information.
Dealer Inquiries Invited

19128 Industrial Blvd.
Elk River, MN 55330 (USA)
612-441-4303 Telex 756135

224

May the Morse Be With You

LOOK FOR US AT ROCHESTER, NY



KENWOOD

HF TRANSCEIVERS



NEW TS-940S HF Transceiver CALL
With General Coverage Receiver

TS-930S HF Transceiver CALL
With General Coverage Receiver

TS-430S HF Transceiver SUPER SPECIAL
With General Coverage Receiver

TS-830S Transceiver CALL
160-10 Meter With Power Supply

TS-530SP 160-10 Meter XCVR CALL
With Power Supply & Notch Filter

RECEIVERS

R-2000, R-600, R-1000, R-11 CALL
General Coverage Receivers

VHF/UHF



TR-7950/7930 CALL
2-meter Mobile Units, 45 or 25 Watts

TR-9130 2m All-mode, 25 Watts CALL

TS-711A/TS-811A CALL
All-mode Transceivers
2m or 70cm mobile or base station

HANDHELDS

TR-2600A 2m FM Transceiver CALL
With Memories, LCD, scan

TH-21A, 21AT/TH-41A, 41AT CALL
2m/70cm Ultra-compact FM Transceiver

YAESU

HF TRANSCEIVERS

FT 980 CAT System 1439.00
AC Power Supply, Full Break-in CW,
SSB/AM/FM/FSK, Speech Processor

FT 77 with mic SPECIAL 510.95
Compact HF XCVR



FT 757 HF XCVR with mic 769.95
with General Coverage RCVR
includes CW keyer, AM/FM, CW filter

SWL RECEIVER

NEW FRG 8800 SWL Receiver 519.95
FRG 7700 Receiver Closeout 390.00

VHF Converters, Active Antennas available

HANDHELDS

FT 209RH 2m HT Intro Special 299.95
FT 203 2m HT with TTP, VOX 229.95
FT 203 2m HT with VOX 199.95

All accessories in stock

VHF/UHF
NEW FT 270RH 2m, 45-watt 379.95
Very small mobile rig

NEW FT 2700HF 25-watt 519.95
Dual-band 2m and 440

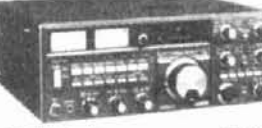

FT 726F For 2m 779.95
(Optional modules for 6m, 430, 440 MHz)
Great for Satellite Work

ICOM

HANDHELDS

IC 02AT 2m HT, 10 Memories CALL
IC 04AT 440 HT/Touchtone 309.95
IC 2AT 2m HT/Touchtone 199.95
IC 3AT 220 MHz HT/Touchtone 229.95
IC 4AT 440 MHz HT/Touchtone 229.95

ST 142 Handheld 249.95
STLC Leather Case with Strap 34.95
SM3 Speaker Mic 34.50

KDK
FM 2033 2m 25-watt 259.95

SWL RECEIVERS
R71 100KHz-30MHz 629.95
General Coverage Receiver

VHF/UHF
NEW IC 3200 2m/440 CALL
IC 271H 100-watt 2m XCVR 732.95
IC 27A 2m compact mobile 319.95
IC 290H 25-wt all-mode 2m XCVR 479.95



IC 271A 599.00
All-mode 2m Transceiver

HF TRANSCEIVERS



IC 745 759.95
HF XCVR/Gen Cov RCVR

IC 751 HF XCVR/Gen Cov RCVR 1179.00
With PS35 installed, 1,299.00

MARINE

M12 12-ch Programmable HT 219.95
M2 76-channel Synthesized HT 261.95
M80 25-watt all-channel Scanner 387.26
M80C Commercial M80 429.95
New M5 all-channel HT 325.95

IC 751 HF XCVR/Gen Cov RCVR 1179.00
With PS35 installed, 1,299.00

MARINE
M12 12-ch Programmable HT 219.95
M2 76-channel Synthesized HT 261.95
M80 25-watt all-channel Scanner 387.26
M80C Commercial M80 429.95
New M5 all-channel HT 325.95

SANTEC

ST 142 Handheld 249.95
STLC Leather Case with Strap 34.95
SM3 Speaker Mic 34.50

KDK
FM 2033 2m 25-watt 259.95

ST 142 Handheld 249.95
STLC Leather Case with Strap 34.95
SM3 Speaker Mic 34.50

KDK
FM 2033 2m 25-watt 259.95

ST 142 Handheld 249.95
STLC Leather Case with Strap 34.95
SM3 Speaker Mic 34.50

KDK
FM 2033 2m 25-watt 259.95

ST 142 Handheld 249.95
STLC Leather Case with Strap 34.95
SM3 Speaker Mic 34.50

KDK
FM 2033 2m 25-watt 259.95

ST 142 Handheld 249.95
STLC Leather Case with Strap 34.95
SM3 Speaker Mic 34.50

KDK
FM 2033 2m 25-watt 259.95

ST 142 Handheld 249.95
STLC Leather Case with Strap 34.95
SM3 Speaker Mic 34.50

KDK
FM 2033 2m 25-watt 259.95

ST 142 Handheld 249.95
STLC Leather Case with Strap 34.95
SM3 Speaker Mic 34.50

KDK
FM 2033 2m 25-watt 259.95

ST 142 Handheld 249.95
STLC Leather Case with Strap 34.95
SM3 Speaker Mic 34.50

KDK
FM 2033 2m 25-watt 259.95

ST 142 Handheld 249.95
STLC Leather Case with Strap 34.95
SM3 Speaker Mic 34.50

KDK
FM 2033 2m 25-watt 259.95

ST 142 Handheld 249.95
STLC Leather Case with Strap 34.95
SM3 Speaker Mic 34.50

KDK
FM 2033 2m 25-watt 259.95

ST 142 Handheld 249.95
STLC Leather Case with Strap 34.95
SM3 Speaker Mic 34.50

KDK
FM 2033 2m 25-watt 259.95

ST 142 Handheld 249.95
STLC Leather Case with Strap 34.95
SM3 Speaker Mic 34.50

KDK
FM 2033 2m 25-watt 259.95

ST 142 Handheld 249.95
STLC Leather Case with Strap 34.95
SM3 Speaker Mic 34.50

KDK
FM 2033 2m 25-watt 259.95

ST 142 Handheld 249.95
STLC Leather Case with Strap 34.95
SM3 Speaker Mic 34.50

KDK
FM 2033 2m 25-watt 259.95

ST 142 Handheld 249.95
STLC Leather Case with Strap 34.95
SM3 Speaker Mic 34.50

KDK
FM 2033 2m 25-watt 259.95

ST 142 Handheld 249.95
STLC Leather Case with Strap 34.95
SM3 Speaker Mic 34.50

KDK
FM 2033 2m 25-watt 259.95

ST 142 Handheld 249.95
STLC Leather Case with Strap 34.95
SM3 Speaker Mic 34.50

KDK
FM 2033 2m 25-watt 259.95

ST 142 Handheld 249.95
STLC Leather Case with Strap 34.95
SM3 Speaker Mic 34.50

KDK
FM 2033 2m 25-watt 259.95

ST 142 Handheld 249.95
STLC Leather Case with Strap 34.95
SM3 Speaker Mic 34.50

KDK
FM 2033 2m 25-watt 259.95

HAL

MPT 3100 Message Processor 2199.95
ST 6000 RTTY Demodulator 620.95
CT 2200 Communications Term 799.95
KB 2100 Keyboard for CT 2200 145.95
CWR 6850 Telereader 746.95
CRI 100 RTTY/CW Interface 214.95
CRI 200 RTTY/CW Interface 259.95

MPT 3100 Message Processor 2199.95
ST 6000 RTTY Demodulator 620.95
CT 2200 Communications Term 799.95
KB 2100 Keyboard for CT 2200 145.95
CWR 6850 Telereader 746.95
CRI 100 RTTY/CW Interface 214.95
CRI 200 RTTY/CW Interface 259.95

MPT 3100 Message Processor 2199.95
ST 6000 RTTY Demodulator 620.95
CT 2200 Communications Term 799.95
KB 2100 Keyboard for CT 2200 145.95
CWR 6850 Telereader 746.95
CRI 100 RTTY/CW Interface 214.95
CRI 200 RTTY/CW Interface 259.95

MPT 3100 Message Processor 2199.95
ST 6000 RTTY Demodulator 620.95
CT 2200 Communications Term 799.95
KB 2100 Keyboard for CT 2200 145.95
CWR 6850 Telereader 746.95
CRI 100 RTTY/CW Interface 214.95
CRI 200 RTTY/CW Interface 259.95

MPT 3100 Message Processor 2199.95
ST 6000 RTTY Demodulator 620.95
CT 2200 Communications Term 799.95
KB 2100 Keyboard for CT 2200 145.95
CWR 6850 Telereader 746.95
CRI 100 RTTY/CW Interface 214.95
CRI 200 RTTY/CW Interface 259.95

MPT 3100 Message Processor 2199.95
ST 6000 RTTY Demodulator 620.95
CT 2200 Communications Term 799.95
KB 2100 Keyboard for CT 2200 145.95
CWR 6850 Telereader 746.95
CRI 100 RTTY/CW Interface 214.95
CRI 200 RTTY/CW Interface 259.95

MPT 3100 Message Processor 2199.95
ST 6000 RTTY Demodulator 620.95
CT 2200 Communications Term 799.95
KB 2100 Keyboard for CT 2200 145.95
CWR 6850 Telereader 746.95
CRI 100 RTTY/CW Interface 214.95
CRI 200 RTTY/CW Interface 259.95

MPT 3100 Message Processor 2199.95
ST 6000 RTTY Demodulator 620.95
CT 2200 Communications Term 799.95
KB 2100 Keyboard for CT 2200 145.95
CWR 6850 Telereader 746.95
CRI 100 RTTY/CW Interface 214.95
CRI 200 RTTY/CW Interface 259.95

MPT 3100 Message Processor 2199.95
ST 6000 RTTY Demodulator 620.95
CT 2200 Communications Term 799.95
KB 2100 Keyboard for CT 2200 145.95
CWR 6850 Telereader 746.95
CRI 100 RTTY/CW Interface 214.95
CRI 200 RTTY/CW Interface 259.95

MPT 3100 Message Processor 2199.95
ST 6000 RTTY Demodulator 620.95
CT 2200 Communications Term 799.95
KB 2100 Keyboard for CT 2200 145.95
CWR 6850 Telereader 746.95
CRI 100 RTTY/CW Interface 214.95
CRI 200 RTTY/CW Interface 259.95

MPT 3100 Message Processor 2199.95
ST 6000 RTTY Demodulator 620.95
CT 2200 Communications Term 799.95
KB 2100 Keyboard for CT 2200 145.95
CWR 6850 Telereader 746.95
CRI 100 RTTY/CW Interface 214.95
CRI 200 RTTY/CW Interface 259.95

MPT 3100 Message Processor 2199.95
ST 6000 RTTY Demodulator 620.95
CT 2200 Communications Term 799.95
KB 2100 Keyboard for CT 2200 145.95
CWR 6850 Telereader 746.95
CRI 100 RTTY/CW Interface 214.95
CRI 200 RTTY/CW Interface 259.95

MPT 3100 Message Processor 2199.95
ST 6000 RTTY Demodulator 620.95
CT 2200 Communications Term 799.95
KB 2100 Keyboard for CT 2200 145.95
CWR 6850 Telereader 746.95
CRI 100 RTTY/CW Interface 214.95
CRI 200 RTTY/CW Interface 259.95

MPT 3100 Message Processor 2199.95
ST 6000 RTTY Demodulator 620.95
CT 2200 Communications Term 799.95
KB 2100 Keyboard for CT 2200 145.95
CWR 6850 Telereader 746.95
CRI 100 RTTY/CW Interface 214.95
CRI 200 RTTY/CW Interface 259.95

MPT 3100 Message Processor 2199.95
ST 6000 RTTY Demodulator 620.95
CT 2200 Communications Term 799.95
KB 2100 Keyboard for CT 2200 145.95
CWR 6850 Telereader 746.95
CRI 100 RTTY/CW Interface 214.95
CRI 200 RTTY/CW Interface 259.95

MPT 3100 Message Processor 2199.95
ST 6000 RTTY Demodulator 620.95
CT 2200 Communications Term 799.95
KB 2100 Keyboard for CT 2200 145.95
CWR 6850 Telereader 746.95
CRI 100 RTTY/CW Interface 214.95
CRI 200 RTTY/CW Interface 259.95

MPT 3100 Message Processor 2199.95
ST 6000 RTTY Demodulator 620.95
CT 2200 Communications Term 799.95
KB 2100 Keyboard for CT 2200 145.95
CWR 6850 Telereader 746.95
CRI 100 RTTY/CW Interface 214.95
CRI 200 RTTY/CW Interface 259.95

MPT 3100 Message Processor 2199.95
ST 6000 RTTY Demodulator 620.95
CT 2200 Communications Term 799.95
KB 2100 Keyboard for CT 2200 145.95
CWR 6850 Telereader 746.95
CRI 100 RTTY/CW Interface 214.95
CRI 200 RTTY/CW Interface 259.95

MPT 3100 Message Processor 2199.95
ST 6000 RTTY Demodulator 620.95
CT 2200 Communications Term 799.95
KB 2100 Keyboard for CT 2200 145.95
CWR 6850 Telereader 746.95
CRI 100 RTTY/CW Interface 214.95
CRI 200 RTTY/CW Interface 259.95

MPT 3100 Message Processor 2199.95
ST 6000 RTTY Demodulator 620.95
CT 2200 Communications Term 799.95
KB 2100 Keyboard for CT 2200 145.95
CWR 6850 Telereader 746.95
CRI 100 RTTY/CW Interface 214.95
CRI 200 RTTY/CW Interface 259.95

MPT 3100 Message Processor 2199.95
ST 6000 RTTY Demodulator 620.95
CT 2200 Communications Term 799.95
KB 2100 Keyboard for CT 2200 145.95
CWR 6850 Telereader 746.95
CRI 100 RTTY/CW Interface 214.95
CRI 200 RTTY/CW Interface 259.95

MPT 3100 Message Processor 2199.95
ST 6000 RTTY Demodulator 620.95
CT 2200 Communications Term 799.95
KB 2100 Keyboard for CT 2200 145.95
CWR 6850 Telereader 746.95
CRI 100 RTTY/CW Interface 214.95
CRI 200 RTTY/CW Interface 259.95

MPT 3100 Message Processor 2199.95
ST 6000 RTTY Demodulator 620.95
CT 2200 Communications Term 799.95
KB 2100 Keyboard for CT 2200 145.95
CWR 6850 Telereader 746.95
CRI 100 RTTY/CW Interface 214.95
CRI 200 RTTY/CW Interface 259.95

MPT 3100 Message Processor 2199.95
ST 6000 RTTY Demodulator 620.95
CT 2200 Communications Term 799.95
KB 2100 Keyboard for CT 2200 145.95
CWR 6850 Telereader 746.95
CRI 100 RTTY/CW Interface 214.95
CRI 200 RTTY/CW Interface 259.95

MPT 3100 Message Processor 2199.95
ST 6000 RTTY Demodulator 620.95
CT 2200 Communications Term 799.95
KB 2100 Keyboard for CT 2200 145.95
CWR 6850 Telereader 746.95
CRI 100 RTTY/CW Interface 214.95
CRI 200 RTTY/CW Interface 259.95

MPT 3100 Message Processor 2199.95
ST 6000 RTTY Demodulator 620.95
CT 2200 Communications Term 799.95
KB 2100 Keyboard for CT 2200 145.95
CWR 6850 Telereader 746.95
CRI 100 RTTY/CW Interface 214.95
CRI 200 RTTY/CW Interface 259.95

MPT 3100 Message Processor 2199.95
ST 6000 RTTY Demodulator 620.95
CT 2200 Communications Term 799.95
KB 2100 Keyboard for CT 2200 145.95
CWR 6850 Telereader 746.95
CRI 100 RTTY/CW Interface 214.95
CRI 200 RTTY/CW Interface 259.95

MPT 3100 Message Processor 2199.95
ST 6000 RTTY Demodulator 620.95
CT 2200 Communications Term 799.95
KB 2100 Keyboard for CT 2200 145.95
CWR 6850 Telereader 746.95
CRI 100 RTTY/CW Interface 214.95
CRI 200 RTTY/CW Interface 259.95

MPT 3100 Message Processor 2199.95
ST 6000 RTTY Demodulator 620.95
CT 2200 Communications Term 799.95
KB 2100 Keyboard for CT 2200 145.95
CWR 6850 Telereader 746.95
CRI 100 RTTY/CW Interface 214.95
CRI 200 RTTY/CW Interface 259.95

MPT 3100 Message Processor 2199.95
ST 6000 RTTY Demodulator 620.95
CT 2200 Communications Term 799.95
KB 2100 Keyboard for CT 2200 145.95
CWR 6850 Telereader 746.95
CRI 100 RTTY/CW Interface 214.95
CRI 200 RTTY/CW Interface 259.95

MPT 3100 Message Processor 2199.95
ST 6000 RTTY Demodulator 620.95
CT 2200 Communications Term 799.95
KB 2100 Keyboard for CT 2200 145.95
CWR 6850 Telereader 746.95
CRI 100 RTTY/CW Interface 214.95
CRI 200 RTTY/CW Interface 259.95

MPT 3100 Message Processor 2199.95
ST 6000 RTTY Demodulator 620.95
CT 2200 Communications Term 799.95
KB 2100 Keyboard for CT 2200 145.95
CWR 6850 Telereader 746.95
CRI 100 RTTY/CW Interface 214.95
CRI 200 RTTY/CW Interface 259.95

MPT 3100 Message Processor 2199.95
ST 6000 RTTY Demodulator 620.95
CT 2200 Communications Term 799.95
KB 2100 Keyboard for CT 2200 145.95
CWR 6850 Telereader 746.95
CRI 100 RTTY/CW Interface 214.95
CRI 200 RTTY/CW Interface 259.95

MPT 3100 Message Processor 2199.95
ST 6000 RTTY Demodulator 620.95
CT 2200 Communications Term 799.95
KB 2100 Keyboard for CT 2200 145.95
CWR 6850 Telereader 746.95
CRI 100 RTTY/CW Interface 214.95
CRI 200 RTTY/CW Interface 259.95

MPT 3100 Message Processor 2199.95
ST 6000 RTTY Demodulator 620.95
CT 2200 Communications Term 799.95
KB 2100 Keyboard for CT 2200 145.95
CWR 6850 Telereader 746.95
CRI 100 RTTY/CW Interface 214.95
CRI 200 RTTY/CW Interface 259.95

MPT 3100 Message Processor 2199.95
ST 6000 RTTY Demodulator 620.95
CT 2200 Communications Term 799.95
KB 2100 Keyboard for CT 2200 145.95
CWR 6850 Telereader 746.95
CRI 100 RTTY/CW Interface 214.95
CRI 200 RTTY/CW Interface 259.95

MPT 3100 Message Processor 2199.95
ST 6000 RTTY Demodulator 620.95
CT 2200 Communications Term 799.95
KB 2100 Keyboard for CT 2200 145.95
CWR 6850 Telereader 746.95
CRI 100 RTTY/CW Interface 214.95
CRI 200 RTTY/CW Interface 259.95

MPT 3100 Message Processor 2199.95
ST 6000 RTTY Demodulator 620.95
CT 22

THE GUERRI REPORT

Ernie *Guerré*
W6 MGI

a busy signal from space

For over twenty-five years various nations have been launching satellites of one type or another. Many of the early satellites were experimental in nature, primarily intended to develop and test space hardware. However, the past fifteen years have been devoted to the more utilitarian aspects of space. Because our only link to satellites has been through RF paths, the amount of the spectrum devoted to this purpose has grown dramatically.

The geosynchronous equatorial orbits are particularly popular. This is because satellites placed in this position appear to remain in one place all the time, and can illuminate a large portion of the earth's surface. Because of the desirability of this location, it has become imperative that there be global cooperation with respect to the placement of satellites in the general equatorial area. Current agreements allow satellites to be positioned every 2 degrees over the populous equatorial coverage areas.

The resulting proliferation in the number of equatorial satellites puts a significant burden on antenna designers. The 2-degree equatorial spacing requires that antennas have very narrow beams, in addition to low side-lobes, in order to prevent interference to transponders on adjacent satellites. The transmitters and receivers used in

these satellites are very sophisticated, and must utilize adaptive techniques in order to maintain predetermined signal-to-noise ratios without interference problems.

The RF spectrum assigned to satellites includes band segments from 400 MHz to over 30 GHz. The most densely used portions are in the region between 1.5 and 12.5 GHz. Because of the limited availability of electric power, satellite transmitters tend to be limited to about 50 to 100 watts, but antenna gains of 20 dB or more are not uncommon. Obviously, satellites intended to provide broad geographic coverage cannot employ highly directive antennas. Some key applications for modern satellites include the following:

Earth resources and position location. Most of us have seen some of the dramatic photographs taken from earth resources satellites showing crops, earthquake faults, volcanoes, and of course, daily weather patterns. These satellites rely on a wide variety of sensors employing optical, thermal, and radar techniques to form images of the earth's surface. In most cases the resolution is sufficient to reveal major highways, airports, and other key land-based features.

Most of these satellites operate in the 137 MHz and 1.6 GHz portions of the spectrum. Fairly simple receiving equipment will permit the home experimenter to receive exciting weather

photographs from the APT and GOES satellites.

An important additional function of this general class of satellites is mapping and position location. Virtually any satellite with high resolution sensors can function as an excellent mapping satellite since its orbit can be precisely determined and its position accurately known at any given time. Twenty continuous years of this process has resulted in highly accurate mapping of the earth's entire surface, permitting significant improvements in the efficiency and safety of commercial shipping and aviation. A series of Global Positioning Satellites (GPS) is being developed by the United States; when its 18 satellites are completed and in place a few years from now, the signals from these satellites will enable appropriately equipped vessels to determine their exact position on the earth's surface to within about 100 feet (30 meters).

Telecommunications. It is the telecommunications function performed by modern satellites with which most of us are familiar. Telephone communications, data transmission, video links, and broadcast television now unite the world in a massive satellite-linked network. Satellites designed for this purpose do not originate signals, but are simply repeaters in the sky. They typically consist of a number of channels, called "transponders," that repeat signals in a 24 or 36 MHz band.

—w—>

ADVERTISER'S INDEX AND READER SERVICE NUMBERS

Listed below are the page number and reader service number for each company advertising in this issue. To get more information on their advertised products, use the bind-in card found elsewhere in this issue, select the correct reader service number from either the ad or this listing, check off the numbers, fill in your name and address, affix a postage stamp and return to us. We will promptly forward your request to the advertiser and your requested information should arrive shortly. If the card is missing, send all the pertinent information on a separate sheet of paper to: *ham radio* magazine, Attn: Reader Service, Greenville, NH 03048.

READER SERVICE #	PAGE #
220 - Accessory Specialties.....	160
114 - Advanced Computer Controls.....	17
136 - Advanced Receiver Research.....	65
145 - AEA.....	78
120 - All Electronics.....	36
156 - Alliance Mfg. Co.....	91
111 - Alpha Delta Communications.....	12, 13
180 - Alumna Tower Co.....	135
* - Amateur Electronic Supply.....	110
140 - Amateur-Wholesale Electronics.....	69, 167
240 - American Radio Relay League.....	141
129 - Amidon Associates.....	56
130 - Arcomm.....	56
131 - Azotic Industries.....	56
* - Barker & Williamson.....	64
* - Barry Electronics.....	159
163 - Base 2 Systems.....	104
119 - B.G. Micro.....	34, 35
148 - Birch Hill Sales.....	153
127 - Britt's 2-Way Radio.....	50
173 - Buckmaster Publishing.....	124
* - Butternut Electronics.....	80
110 - C & A Roberts.....	10
* - Caddell Coil Corp.....	80
215 - Cayson Electronics.....	70
150 - CeCo.....	82
105 - CES.....	1
228 - CMC Communications.....	159
209 - Coaxial Dynamics, Inc.....	156
189 - Communications Concepts, Inc.....	139
213 - Communications Specialists.....	168
152 - Computer Trader Magazine.....	82
115 - Connect Systems.....	23
* - Courage Center.....	80
155 - Dalbani Corp.....	86
223 - Digimax Instrument Corp.....	163
190 - Doppler Systems.....	139
170 - Dokay Computer Products, Inc.....	122, 123
224 - Dynetic Systems.....	163
211 - EGE.....	164
109 - Electro-Com.....	9
176 - Electronic Equipment Bank.....	134
144 - Encomm, Inc.....	76, 77
* - Engineering Consulting.....	152
* - Epsilon.....	104
172 - Fair Radio Sales.....	124
207 - Floyd Electronics.....	155
153 - John Fluke Manufacturing Co., Inc.....	83
181 - Fox Tango Corp.....	135
208 - R.M. Fuller Co.....	156
* - Gem Quad Products.....	124
116 - G.I.S.M.O.....	29
122 - GLB Electronics.....	43
199 - Gus Browning's DX'ers Magazine.....	143
124 - Hal-Tronix.....	44
* - Ham-Com.....	138
217 - Ham Radio's Bookstore.....	74, 124, 130, 142, 145, 152, 153, 158
107 - Ham Radio Outlet.....	6, 7, 130
* - The Ham Station.....	114
118 - Hamtronics.....	30
133 - Harrison Radio.....	57
157 - Henry Radio.....	92, 93
141 - Hustler, Inc.....	69
104 - ICOM America, Inc.....	Cover II
158 - ICOM America, Inc.....	94
* - Indianapolis Hamfest.....	44
132 - Jensen Tools, Inc.....	56
204 - Jun's Electronics.....	153
142 - Kantronics.....	75
* - Trio-Kenwood Communications.....	2, 99, 160, Cover IV
167 - Larsen Electronics.....	105
106 - MFJ Enterprises.....	5

READER SERVICE #	PAGE #
202 - MHz Electronics.....	146-151
210 - Madison Electronic Supply.....	157
147 - Martin Engineering.....	80
186 - Merrimac Satellite.....	138
185 - John J. Meshna, Jr., Co., Inc.....	137
222 - Micro Control Specialties.....	162
177 - Microwave Filter, Inc.....	134
207 - Missouri Radio Center.....	155
183 - Morning Distributing.....	136
206 - Mosley Electronics, Inc.....	154, 161
175 - Nampa Satellite Systems.....	132
179 - NCG.....	135
174 - Nema Electronics.....	130
159 - North America Soar Corp.....	100
178 - Nuts & Volts.....	134
* - Oak Hill Academy ARS.....	135
149 - Omega Concepts.....	80
184 - Orbit Magazine.....	136
171 - Paulin Industries.....	124
126 - P.C. Electronics.....	50, 112
168 - P.C. Electronics.....	50, 112
151 - Phillips-Tech Electronics.....	82
121 - Photocomm, Inc.....	40
195 - Processor Concepts.....	143
229 - Public Domain.....	160
191 - Radio Amateur Callbook.....	139
198 - Radiokit.....	143
205 - Radio School.....	154
* - Radio Warehouse.....	145
112 - RAG Electronics, Inc.....	14, 15
125 - Ramsey Electronics.....	45
212 - RF Products.....	160
143 - RND Design Corp.....	74
108 - Robot Research, Inc.....	8
146 - Roensch Microwave.....	80
164 - Sartori Associates.....	105
187 - Satellite TV Magazine.....	138
117 - Shure Brothers, Inc.....	123
165 - SIBEX.....	105
193 - South Midlands Communications, Ltd.....	142
* - SPACE/STTI Tulsa Show.....	126
188 - Spec-Com.....	139
123 - Spectrum International.....	44
162 - Spi-Ro Distributing.....	104, 143
169 - Tel-Com.....	112
134 - Telewave, Inc.....	60
154 - Texas Towers.....	84, 85
221 - TNT Radio Sales.....	162
201 - Transleteronic, Inc.....	145
* - UNR-Rohn.....	143, 160
166 - Unity Electronics.....	105
* - University Microfilms International.....	130
231 - Vanguard Labs.....	160
113 - Varian/Eimac.....	16
128 - Vector Radio.....	56
137 - VHF Communications.....	65
160 - VHF Communications.....	102
192 - The VHF Shop.....	142
182 - James Walter Test Equipment.....	136
139 - Westcom Engineering.....	65
200 - Western Electronics.....	145
196 - Wheeler Applied Research Labs.....	143
194 - W9INN.....	142
* - Xantek, Inc./DXEdge.....	65
214 - Yaesu Electronics Corp.....	Cover III

PRODUCT REVIEW/NEW PRODUCT

304 - Encomm, Inc.....	159
303 - HAL Communications Corp.....	159
118 - Hamtronics, Inc.....	159
301 - ICOM America, Inc.....	157
302 - Photocomm, Inc.....	157

Each satellite can have as many as ten transponders. This means that a single satellite may handle as many as 50,000 phone calls simultaneously. The availability of these high quality RF links has dramatically improved intercontinental voice and data communications. These links can now reliably transmit a page of FAX data to another part of the world in just a few seconds. Satellites enable commercial broadcasters to bring us important events from virtually every corner of the earth as they occur; the societal ramifications of this news immediacy are still developing.

Defense. Not to be upstaged, the military establishments have also been busy in space. Since profitability, in the commercial sense, is not an issue for military users, some of the tasks which satellites are called upon to perform are indeed exotic. These include such things as very high-speed data links (1 Gbit/sec.) and very high resolution imagery for reconnaissance purposes. Charged coupled sensors, cooled with liquid helium to increase sensitivity and mounted at the focal plane of precision lenses, provide orbital images with stunning detail. The ability of radar to penetrate cloud coverage and provide high resolution images is particularly attractive to military users. In some cases, the orbital path of the satellite is used to synthesize an antenna of large aperture and provide a simulated very narrow beam. This technique, called "synthetic aperture radar" (SAR), is capable of revealing subtle details, not visible by any other means, hidden in the earth's surface. Techniques of this type are used by defense organizations to locate submarines concealed below the ocean's surface.

Next time you look at the evening sky, be sobered by the thought that at that very instant, there are probably more conversations being repeated through satellites than if all the world's Amateurs were on the air at the same time. The pros do it without QRM. Now *that's* what I call a band plan!

ham radio

*Please contact this advertiser directly.

Limit 15 inquiries per request.

Please use before June 30, 1985.

THE STANDARD OF EXCELLENCE

The world of CW, RTTY, and new DUAL AMTOR is as close as your fingertips with the new brilliantly innovative state-of-the-art microcomputer controlled EXL-5000E.*

Automatic Sender/Receiver: Due to the most up to date computer technology, just a console and keyboard can accomplish complete automatic send/receive of Morse Code (CW), Baudot Code (RTTY), ASCII Code (RTTY) and new ARQ/FEC (AMTOR).

Code: Morse (CW includes Kana), Baudot (RTTY), ASCII (RTTY), JIS (RTTY), ARQ/FEC (AMTOR).

Characters: Alphabet, Figures, Symbols, Special Characters, Kana.
Built-in-Monitor: 5" high resolution, delayed persistence green monitor — provides sharp clear image with no jiggle or jitter even under fluorescent lighting. Also has a provision for composite video signal output.

Time Clock: Displays Month, Date, Hour and Minute on the screen.

Time/Transmission/Receiving Feature: The built-in timer enables completely automatic TX/RX without operator's attendance.

Selcal (Selective Calling) System: With this feature, the unit only receives messages following a preset code. Built-in Demodulator for High Performance: Newly designed high speed RTTY demodulator has receiving capability of as fast as 300 Baud. Three-step shifts select either 170Hz, 425Hz or 850Hz shift with manual fine tune control of space channel for odd shifts. HIGH (Mark Frequency 2125Hz)/LOW (Mark Frequency 1275Hz) tone pair select. Mark only or Space only copy capability for selective fading. ARQ/FEC features incorporated.

Crystal Controlled AFSK Modulator: A transceiver without FSK function can transmit in RTTY mode by utilizing the high stability crystal-controlled modulator controlled by the computer.

Photocoupler CW, FSK Keyer built-in: Very high voltage, high current photocoupler keyer is provided for CW, FSK keying.

Convenient ASCII Key Arrangement: The keyboard layout is ASCII arrangement with function keys. Automatic insertion of LTR/FIG code makes operation a breeze.

Battery Back-up Memory: Data in the battery back-up memory, covering 72 characters x 7 channels and 24 characters x 8 channels, is retained even when the external power source is removed. Messages can be recalled from a keyboard instruction and some particular channels can be read out continuously. You can write messages into any channel while receiving.

Large Capacity Display Memory: Covers up to 1,280 characters. Screen Format contains 40 characters x 16 lines x 2 pages.

Screen Display Type-Ahead Buffer Memory: A 160-character buffer memory is displayed on the lower part of the screen. The characters move to the left erasing one by one as soon as they are transmitted. Messages can be written during the receiving state for transmission with battery back-up memory or SEND function.

Function Display System: Each function (mode, channel number, speed, etc.) is displayed on the screen.

Printer Interface: Centronics Para Compatible interface enables easy connection of a low-cost dot printer for hard copy.

Wide Range of Transmitting and Receiving: Morse Code transmitting speed can be set from the keyboard at any rate between 5-100 WPM (every word per minute). AUTOTRACK on receive. For communication in Baudot and ASCII Codes, rate is variable by a keyboard instruction between 12-300 Baud when using RTTY Modem and between 12-600 Baud when using TTL level. The variable speed feature makes the unit ideal for amateur, business and commercial use.

Pre-load Function: The buffer memory can store the messages written from the keyboard instead of sending them immediately. The stored messages can be sent with a keyboard command.

"RUB-OUT" Function: You can correct mistakes while writing messages in the buffer memory. Misspellings can also be erased while the information is still in the buffer memory.

Automatic CR/LF: While transmitting, CR/LF automatically sent every 64, 72 or 80 characters.

WORD MODE operation: Characters can be transmitted by word groupings, not every character, from the buffer memory with keyboard instruction.

LINE MODE operation: Characters can be transmitted by line groupings from the buffer memory.

WORD-WRAP-AROUND operation: In receive mode, WORD-WRAP-AROUND prevents the last word of the line from splitting in two and makes the screen easily read.

"ECHO" Function: With a keyboard instruction, received data can be read and sent out at the same time. This function enables a cassette tape recorder to be used as a back-up memory, and a system can be created just like telex which uses paper tape.

Cursor Control Function: Full cursor control (up/down, left/right) is available from the keyboard. Test Message Function: "RY" and "QBF" test messages can be repeated with this function.

MARK-AND-BREAK (SPACE-AND-BREAK) System: Either mark or space tone can be used to copy RTTY.

Variable CW weights: For CW transmission, weights (ratio of dot to dash) can be changed within the limits of 1:3-1:6.

Audio Monitor Circuit: A built-in audio monitor circuit with an automatic transmit/receive switch enables checking of the transmitting and receiving state. In receive mode, it is possible to check the output of the mark filter, the space filter and AGC amplifier prior to the filters.

CW Practice Function: The unit reads data from the hand key and displays the characters on the screen. CW keying output circuit works according to the key operation.

CW Random Generator: Output of CW random signal can be used as CW reading practice.

Bargraph LED Meter for Tuning: Tuning of CW and RTTY is very easy with the bargraph LED meter.

In addition, provision has been made for attachment of an oscilloscope to aid tuning.

Built-in AC/DC: Power supply is switchable as required; 100-120 VAC; 220-240 VAC/50/60Hz + 13.8VDC.

Color: Light grey with dark grey trim — matches most current transceivers.

Dimensions: 363(W) x 121(H) x 351(D) mm; Terminal Unit.

Warranty: One Year Limited
Specifications Subject to Change



Everything built in — nothing else to buy!

EXCLUSIVE DISTRIBUTOR: DEALER INQUIRIES INVITED
AMATEUR-WHOLESALE ELECTRONICS
8817 S.W. 129th Terrace, Miami, Florida 33176

FOR YOUR NEAREST DEALER OR TO ORDER:
TOLL FREE . . . 800-327-3102
Telephone (305) 233-3631 Telex: 80-3356



MANUFACTURER:

 **TONO CORPORATION**

98 Motosoja Machi, Maebashi-Shi, 371, Japan

*Dual Amtor: Commercial quality, the EXL-5000E incorporates two completely separate modems to fully support the amateur Amtor codes and all of the CCIR recommendations 476-2 for commercial requirements.



Eureka!

We just struck gold with a miniature, high quality and very reliable DTMF decoder at a rock bottom price of \$59.95. Our DTD-1 will decode 5040, 4 digit codes with the security of wrong digit reset. It contains a crystal controlled, single chip DTMF decoder that works great in bad signal to noise environments and provides latched and momentary outputs. Why carry that heavy gear when its size is only 1.25 x 2.0 x .4 inches and it comes with our etched in stone, legendary, one year warranty.

Instead of sifting through the field...searching, use our super quick one day delivery and cash in on a rare find.

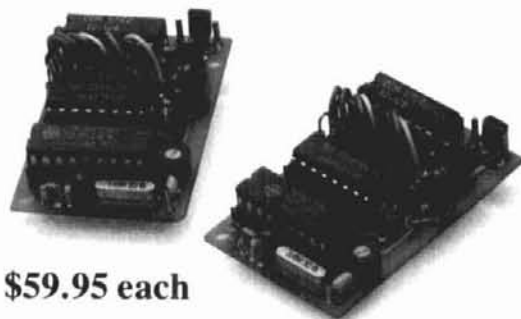

\$59.95 each

**COMMUNICATIONS
SPECIALISTS**

426 W. Taft Ave., Orange, CA 92665-4296
Local (714) 998-3021 • FAX (714) 974-3420
Entire U.S.A. 1-800-854-0547





Presenting two small cases for a lot of mobile power.

You won't find a 45-watt, 2-meter FM mobile rig that's built smaller than the Yaesu FT-270RH.

Nor will you find a dual-band FM mobile that offers the crossband full-duplex capability found in the 25-watt Yaesu FT-2700RH.

It shouldn't be surprising. We've been coming up with a lot of innovative concepts lately.

The FT-270RH measures just 2 x 6 x 7 inches. Conveniently fitting its high-power punch into many small spaces of your car. Places where other 45-watt mobiles just won't fit.

The FT-2700RH is small too. Smaller than other dual-banders. But with one big difference: a "DUP" button. Push it, and you're operating full duplex, 2 meters on one VFO, 440 MHz on the other. Each at 25 watts. So you can simultaneously

transmit and receive in true telephone style.

Once installed, you'll find the FT-270RH and the FT-2700RH equally simple to operate. Just turn the rig on, dial up a frequency, select offset or duplex split, and you're on the air.

Each rig gives you 10 memories for storing your favorite frequencies. Dual VFO capability. A clean, uncluttered LCD display for easy readout. Push-button jumps through the band in 1 MHz steps. Band scanning with programmable upper and lower limits. And priority channel operation.

You don't even have to take your eyes off the road to determine your operating frequency and memory channel. An optional voice synthesizer announces them both at the push of a button on the microphone. The FT-2700RH announces both your

2-meter and 440 MHz operating frequencies.

Also, tone encode and encode/decode capability is programmable from the front panel, using an optional plug-in board.

So when you need a lot of power in a compact mobile radio, discover Yaesu's FT-270RH and FT-2700RH. There's nothing else like them on the road.

YAESU

Yaesu Electronics Corporation
6851 Walthall Way, Paramount, CA 90723
(213) 633-4007

Yaesu Cincinnati Service Center
9070 Gold Park Drive, Hamilton, OH 45011
(513) 874-3100

Prices and specifications subject to change without notice.

214



KENWOOD

...pacesetter in Amateur radio

NEW!

“DX-cellence!”

TS-940S

The new TS-940S is a serious radio for the serious operator. Superb interference reduction circuits and high dynamic range receiver design to give you no-nonsense, no compromise performance that gets your signals through! The exclusive multi-function LCD sub display graphically illustrates VBT, SSB slope, and other features.

- 100% duty cycle transmitter. Super efficient cooling system using special air ducting works with the internal heavy-duty power supply to allow continuous transmission at full power output for periods exceeding one hour.
- Programmable scanning.
- Semi or full break-in (QSK) CW.

- Low distortion transmitter. Kenwood's unique transmitter design delivers top "quality Kenwood" sound.
- Keyboard entry frequency selection. Operating frequencies may be directly entered into the TS-940S without using the VFO knob.
- Graphic display of operating features. Exclusive multi-function LCD sub-display panel shows CW VBT, SSB slope tuning, as well as frequency, time, and AT-940 antenna tuner status.
- QRM-fighting features. Remove "rotten QRM" with the SSB slope tuning, CW VBT, notch filter, AF tune, and CW pitch controls.

Optional accessories:

- AT-940 full range (160-10 m) automatic antenna tuner
- SP-940S external speaker with audio filtering
- YG-455C-1 (500 Hz), YG-455CN-1 (250 Hz), YK-88C-1 (500 Hz) CW filters;
- YK-88A-1 (6 kHz) AM filter
- VS-1 voice synthesizer
- SO-1 temperature compensated crystal oscillator
- MC-42S UP/DOWN hand mic.
- MC-60A, MC-80, MC-85 deluxe base station mics.
- PC-1A phone patch
- TL-922A linear amplifier
- SM-220 station monitor
- BS-8 pan display
- SW-200A and SW-2000 SWR and power meters.

9.40
on 21:00 off 0:00

SLOPE 1

V-B 21.250.00 US
V-A 14.200.01 US

ANTENNA TUNER
AUTO TUNE READY



- Built-in FM, plus SSB, CW, AM, FSK.
- High stability, dual, digital VFOs. An optical encoder and the flywheel VFO knob give the TS-940S a positive tuning "feel".
- 40 memory channels. Mode and frequency may be stored in 4 groups of 10 channels each.
- General coverage receiver. Tunes from 150 kHz to 30 MHz.



More TS-940S information is available from authorized Kenwood dealers.

KENWOOD

TRIO-KENWOOD COMMUNICATIONS
1111 West Walnut Street
Compton, California 90220

Complete service manuals are available for all Trio-Kenwood transceivers and most accessories. Specifications and prices are subject to change without notice or obligation.