

NOVEMBER 1984 / \$2.50

# *ham radio* magazine

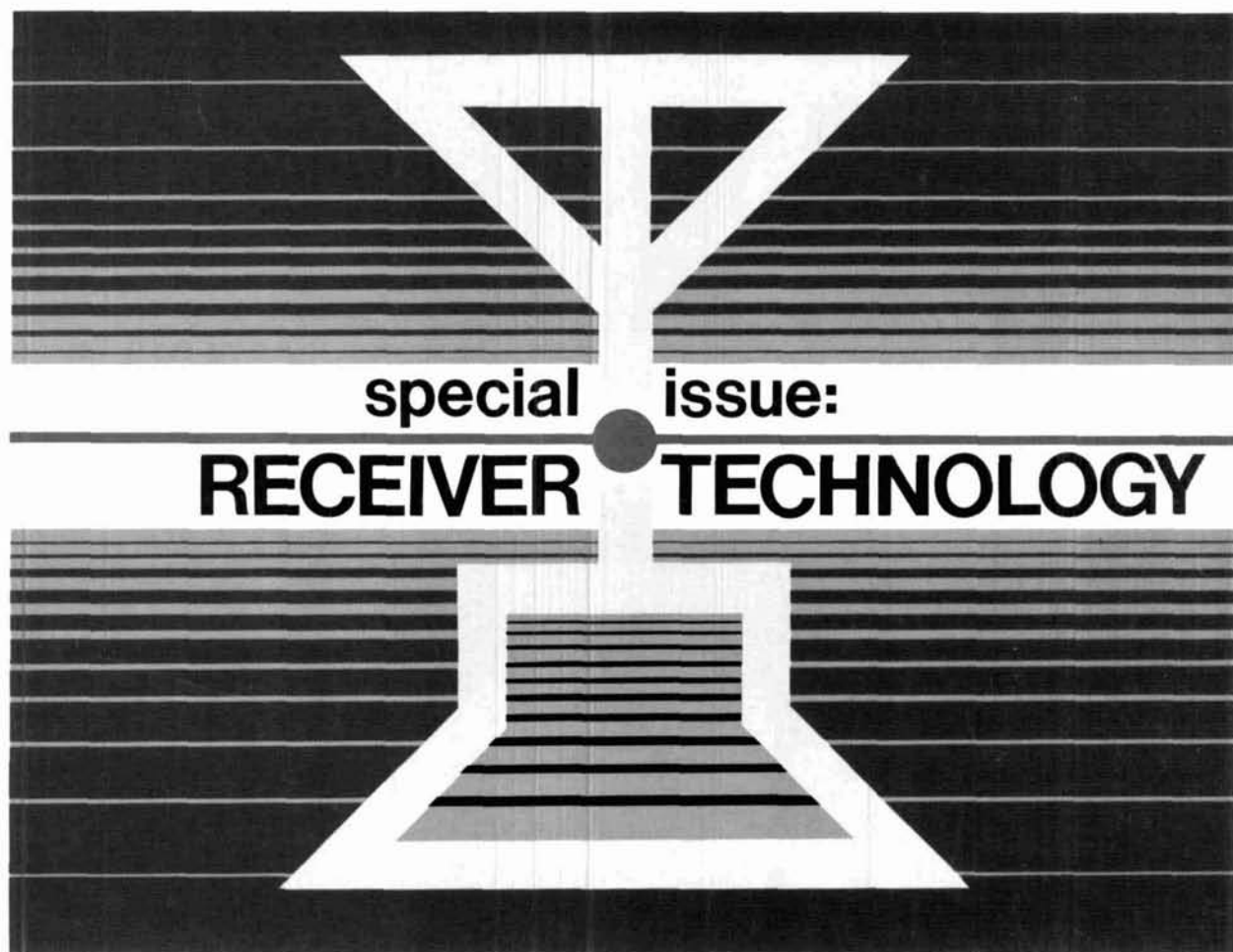

**hr**  
focus  
on  
communications  
technology

*understanding preamps • pulsewidth noise discriminator •  
predicting IMD • quieting the Russian Woodpecker •  
SW receiver modification • locating geostationary  
satellites • extended HF receiver • making PC boards •  
designing superhet coilsets • NEW: THE GUERRI REPORT*

# ICOM IC-751

## The New Standard of Comparison

IC-2KL  
Solid-state  
linear  
amplifier

IC-AT500  
Automatic  
Antenna Tuner

IC-SP3  
External  
Speaker



IC-SM6  
Desk Mic

The IC-751 is the most advanced amateur HF transceiver available on the market today... the new standard of comparison.

**Receiver.** ICOM's 100kHz — 30MHz general coverage receiver with a specially designed DFM (Direct Feed Mixer) utilizes FETs in the receiver front end which gives extremely low intermodulation distortion, -19dBm intercept point, and a high dynamic range, 105dB. With cascaded filters, the IC-751 is virtually immune

to intermod. The FL-44 8-pole crystal in the third IF is standard and provides exceptional receiver selectivity.

**Transmitter.** An extremely low-noise PLL and conservative transmitter design give extremely low distortion products (-38dBm, third order) for a crystal clear transmit signal. A microphone tone control is provided to personalize the set to your particular voice. The 9 band solid-state transmitter is also a full 100% duty cycle

(internal cooling fan standard) rated. For the CW operator, semi break-in or full QSK is possible.

**32 Memories.** An ultra versatile memory system allows storage of frequency and mode in each of the 32 memories. Data may be transferred from VFO to memory or from memory to VFO.

**Standard Features.** FM, FL-44A 455kHz high-grade SSB filter, SSB and FM squelch, built-in marker unit, convenient large controls, a new high-visibility fluorescent

display and HM-12 Hand Mic.

**Options and Accessories.** Voice synthesizer, high stability master reference crystal, a wide range of CW filters, an external IC-PS15 or PS30 power supply, an internal IC-PS35 power supply, CT-10 computer interface unit, RC-10 keyboard frequency controller, IC-2KL solid-state linear amplifier (160 — 15 meters), IC-AT500 automatic antenna tuner, IC-SP3 external speaker and IC-SM6 desk mic.



### IC-PS30 System Power Supply.

The IC-PS30 25 Amp Switching Power Supply consolidates your power requirements by supplying up to four pieces of ICOM equipment, eliminating the need for independent AC power supplies for each. The IC-PS30 is designed to match all of ICOM's amateur equipment.

✓ 168

**ICOM**  
The World System

ICOM America, Inc., 2112-116th Ave NE, Bellevue, WA 98004 / 3331 Towerwood Drive, Suite 307, Dallas, TX 75234

All stated specifications are approximate and subject to change without notice or obligation. All ICOM radios significantly exceed FCC regulations limiting spurious emission. 75148A

# With SMART PATCH You are in CONTROL

With CES 510SA Simplex Autopatch, there's no waiting for VOX circuits to drop. Simply key your transmitter to take control.

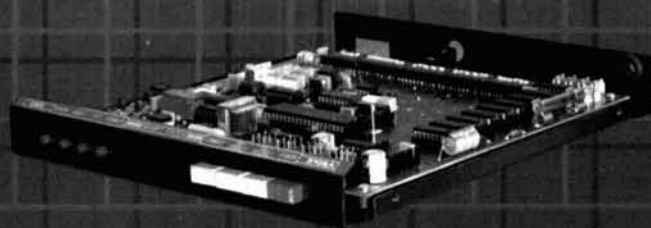

SMART PATCH is all you need to turn your base station into a personal autopatch. SMART PATCH uses the only operating system that gives the mobile complete control. Full break-in capability allows the mobile user to actually interrupt the telephone party. SMART PATCH does not interfere with the normal use of your base station. SMART PATCH works well with any FM transceiver and provides switch selectable tone or rotary dialing, toll restrict, programmable control codes, CW ID and much more.

**To Take CONTROL with Smart Patch  
— Call 800-327-9956 Ext. 101 today.**

## How To Use SMART PATCH

Placing a call is simple. Send your access code from your mobile (example: \*73). This brings up the Patch and you will hear dial tone transmitted from your base station. Since SMART PATCH is checking about once per second to see if you want to dial, all you have to do is key your transmitter, then dial the phone number. You will now hear the phone ring and someone answer. Since the enhanced control system of SMART PATCH is constantly checking to see if you wish to talk, you need to simply key your transmitter and then talk. That's right, you simply key your transmitter to interrupt the phone line. The base station automatically stops transmitting after you key your mic. SMART PATCH does not require any special tone equipment to control your base station. It samples very high frequency noise present at your receiver's discriminator to determine if a mobile is present. No words or syllables are ever lost.

## SMART PATCH Is All You Need To Automatically Patch Your Base Station To Your Phone Line.

Use SMART PATCH for:

- Mobile (or remote base) to phone line via Simplex base. (see fig 1.)
- Mobile to Mobile via interconnected base stations for extended range. (see fig. 2.)
- Telephone line to mobile (or remote base).
- SMART PATCH uses SIMPLEX BASE STATION EQUIPMENT. Use your ordinary base station. SMART PATCH does this without interfering with the normal use of your radio.

## WARRANTY?

YES, 180 days of warranty protection. You simply can't go wrong. An FCC type accepted coupler is available for SMART PATCH.

## What To Look For In A Phone Patch

The best way to decide what patch is right for you is to first decide what a patch should do. A patch should:

- Give complete control to the mobile, allowing full break in operation.
- Not interfere with the normal operation of your base station. It should not require you to connect and disconnect cables (or flip switches!) every time you wish to use your radio as a normal base station.
- Not depend on volume or squelch settings of your radio. It should work the same regardless of what you do with these controls.
- You should be able to hear your base station speaker with the patch installed. Remember, you have a base station because there are mobiles. ONE OF THEM MIGHT NEED HELP.
- The patch should have standard features at no extra cost. These should include programmable toll restrict (dip switches), tone or rotary dialing, programmable patch and activity timers, and front panel indicators of channel and patch status.

**ONLY SMART PATCH  
HAS ALL OF THE  
ABOVE.**

## Now Mobile Operators Can Enjoy An Affordable Personal Phone Patch. . .

- Without an expensive repeater.
- Using any FM transceiver as a base station.
- The secret is a SIMPLEX autopatch, The SMART PATCH.

## SMART PATCH Is Easy To Install

To install SMART PATCH, connect the multicolored computer style ribbon cable to mic audio, receiver discriminator, PTT, and power. A modular phone cord is provided for connection to your phone system. Sound simple? . . . IT IS!

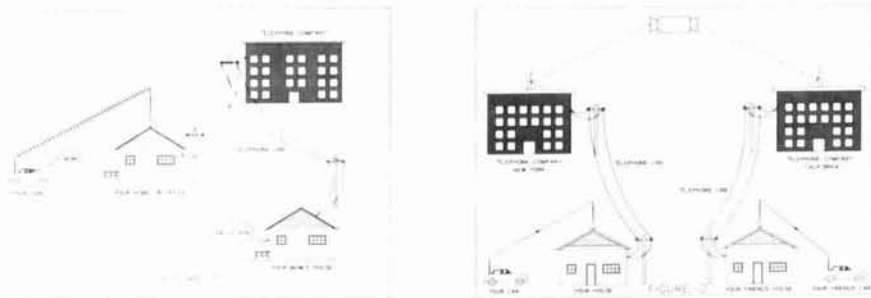

132



**Communications Electronics Specialties, Inc.**  
P.O. Box 2930, Winter Park, Florida 32790  
Telephone: (305) 645-0474 **Or call toll-free (800)327-9956**

# KENWOOD

...pacesetter in amateur radio

## TS-930S "DX-traordinary"

### TS-930S

We call it "DX-traordinary" because the TS-930S has now become the favorite rig of the serious contester! Its superior capability for full break-in split-frequency operation, the speed and convenience with which its eight memory channels can be accessed, its unsurpassed receiver dynamic range and its remarkable ability to select the desired signal during periods of heavy QRM, utilizing VBT, Slope tuning, IF Notch filtering, and tuneable audio filtering, have all combined to make this the rig that gives you the EXTRA EDGE!

The TS-930S is loaded with all the special features that you always wanted in an HF transceiver. Full coverage of the 160 through 10 meter bands, including the new WARC frequencies, (easily modified for HF MARS), plus a general coverage receiver that can tune any frequency from 150 kHz to 30 MHz. Operation in the SSB, CW, FSK, and AM modes, with selectable full or semi CW break-in. All solid-state, with 250 watts PEP input on SSB,

CW, FSK, and 80 watts input on AM. SWR/power meter. Triple final protection circuits plus two cooling fans built-in. 10-Hz step synthesized frequency control. Available with optional automatic antenna tuner built-in, another industry first! Dual digital VFO's. Eight memory channels that store both frequency and band information, with internal battery back-up, (batteries not supplied). Dual mode adjustable noise blankers, especially effective in eliminating "woodpecker" type interference. SSB IF slope tuning, for maximum rejection of interference. CW variable bandwidth, with pitch and side-tone control. IF notch filter. Tuneable audio peaking filter. Unique six digit white fluorescent tube digital display is easy-on-the-eyes during those long contests. RF speech processor, for higher average "talk-power." SSB monitor circuit. 4-step RF attenuator. VOX. 100-kHz marker. AC power supply built-in, 120, 220, or 240 VAC.



#### TS-930S Optional Accessories:

AT-930 automatic antenna tuner, SP-930 external speaker, with selectable audio filters, YG-455C-1 (500 Hz), YG-455CN-1 (250 Hz), YK-88C-1 (500 Hz) CW filter, YK-88A-1 (6 kHz) AM filter, all plug-in type. SO-1 commercial stability TCXO, MC-60A deluxe desk microphone, MC-80 and MC-85 communications microphones, MC-42S mobile hand microphone, TL-922A linear amplifier (not for CW QSK), SM-220 station monitor, PC-1A phone patch, SW-2000 SWR/power meter, 160 ~ 6 meter, SW100A SWR/power/volt meter 160-2m HS-4, HS-5, HS-6, and HS-7 headphones.

Isn't it about time you stepped into the winner's circle?

More information on the TS-930S is available from authorized dealers of Trio-Kenwood Communications, 1111 West Walnut Street, Compton, California 90220.



Specifications and prices are subject to change without notice or obligation.



# ham radio

magazine

NOVEMBER 1984

volume 17, number 11

**T. H. Tenney, Jr., W1NLB**  
publisher

**Rich Rosen, K2RR**  
editor-in-chief  
and associate publisher

**Dorothy Rosa, KA1LBO**  
assistant editor

Joseph J. Schroeder, W9JUV  
Alfred Wilson, W6NIF  
associate editors  
Susan Shorrock  
editorial production

#### editorial review board

Forrest Gehrke, K2BT  
Bob Lewis, W2EBS  
Mason Logan, K4MT  
Ed Wetherhold, W3NQN

#### publishing staff

**J. Craig Clark, Jr., N1ACH**  
assistant publisher

**Rally Dennis, KA1JWF**  
director of advertising sales

Dorothy Sargent, KA1ZK  
advertising production manager

Susan Shorrock  
circulation manager  
Therese Bourgault  
circulation

Wayne Pierce, K3SUK  
cover art

ham radio magazine is published by  
Communications Technology, Inc.  
Greenville, New Hampshire 03048-0498  
Telephone: 603-878-1441

#### subscription rates

United States:  
one year, \$19.95; two years, \$32.95; three years, \$44.95  
Canada and other countries (via surface mail):  
one year, \$22.95; two years, \$41.00; three years, \$58.00  
Europe, Japan, Africa (via Air Forwarding Service): one year, \$28.00  
All subscription orders payable in U.S. funds, via international  
postal money order or check drawn on U.S. bank

international subscription agents: page 154

Microfilm copies are available from  
University Microfilms, International  
Ann Arbor, Michigan 48106  
Order publication number 3076

Cassette tapes of selected articles from *ham radio*  
are available to the blind and physically handicapped  
from *Recorded Periodicals*,  
919 Walnut Street, Philadelphia, Pennsylvania 19107

Copyright 1984 by Communications Technology, Inc.  
Title registered at U.S. Patent Office

Second-class postage paid  
at Greenville, New Hampshire 03048-0498  
and at additional mailing offices  
ISSN 0148-5989

Postmaster send form 3579 to *ham radio*  
Greenville, New Hampshire 03048-0498



## contents

- 14 quiet! preamp at work**  
H. Paul Shuch, N6TX
- 23 a pulsewidth noise discriminator**  
Don E. Hildreth, W6NRW
- 28 IMD and intercept points  
of cascaded stages**  
William Richardson, W3IMG
- 37 the Russian Woodpecker:  
a continuing nuisance**  
Bradley Wells, KR7L
- 48 a double conversion  
portable SW receiver**  
Jack Perolo, PY2PEIC
- 54 NEW: THE GUERRI REPORT**  
Ernie Guerri, W6MGI
- 57 extending the modular 2-band receiver**  
James J. Forkin, WA3TFS
- 67 receiving signals from space**  
Dennis Mitchell, K8UR
- 75 ham radio techniques**  
Bill Orr, W6SAI
- 83 make your own PC boards  
using silk screen techniques**  
Keats A. Pullen, Jr., W3QOM
- 96 VHF/UHF world**  
Joe Reisert, W1JR
- 113 design superhet coilsets  
with a microcomputer**  
Frithjof A. S. Sterrenburg
- 124 receiver sweep alignment system**  
Cliff Klinert, WB6BIH
- 8 comments**
- 146 ham mart**
- 158 advertisers index**
- 108 ham notebook  
and reader service**
- 141 new products**
- 92 DX forecaster**
- 6 presstop**
- 154 flea market**
- 5 reflections**

# NEW FROM MFJ

**MFJ'S MOST ADVANCED RTTY/ASCII/AMTOR/CW COMPUTER INTERFACE HAS FM, AM MODES, LED "SCOPE" TUNING ARRAY, RS-232 INTERFACE, VARIABLE SHIFT TUNING, 170/850 Hz TRANSMIT, TRUE MARK-SPACE DETECTION.**



**MFJ-1229**  
\$ **179.95**

**FREE MFJ RTTY/ASCII/CW software for C-64/VIC-20. Complete package includes MFJ-1229, software on tape, cables for C-64/VIC-20.**

**Engineering, performance, value and features** sets MFJ's most advanced RTTY/ASCII/AMTOR/CW computer interface apart from others.

**FM (limiting) mode** gives easy, trouble-free operation. Best for general use, off-shift copy, drifting signals, and moderate signal and QRM levels.

**AM (non-limiting) mode** gives superior performance under weak signal conditions or when there are strong nearby stations.

**Crosshair mark-space LED tuning array** simulates scope ellipse for easy, accurate tuning even under poor signal-to-noise conditions. Mark and space outputs for true scope tuning.

**Transmits on both 170 Hz and 850 Hz shift.**

**Built-in RS-232 interface, no extra cost.**

**Variable shift tuning** lets you copy any shift between 100 and 1000 Hz and any speed (5-100 WPM RTTY/CW and up to 300 baud ASCII). Push button for 170 Hz shift.

**Sharp multi-pole mark and space filters** give true mark-space detection. Ganged pots give passband tuning with constant bandwidth. Factory adjusted trim pots for optimum filter performance.

**Multi-pole active filters** are used for pre-limiter, mark, space and post detection filtering. Has automatic threshold correction. This advanced design gives good copy under QRM, weak signals and selective fading.

**Has front panel sensitivity control.**

**Normal/Reverse switch** eliminates retuning while checking for inverted RTTY. Speaker jack. +250 VDC loop output.

**Exar 2206 sine wave generator** gives phase continuous AFSK tones. Standard 2125 Hz mark and 2295/2975 Hz space. Microphone lines: AFSK out, AFSK ground, PTT out and PTT ground.

**FSK keying for transceivers** with FSK input. **Has sharp 800 Hz CW filter**, plus and minus CW keying and external CW key jack.

**Kantronics software compatible socket.**

**Exclusive TTL/RS-232 general purpose socket** allows interfacing to nearly any personal computer with most appropriate software. Available TTL/RS-232 lines: RTTY demod out, CW demod out (TTL only), CW-ID in, RTTY in, PTT in, key in. All signal lines are buffered and can be inverted using an internal DIP switch.

**Metal cabinet.** Brushed aluminum front. 12½x2 2½x6 inches. 18 VDC or 110 VAC with optional AC adapter, MFJ-1312, \$9.95.

**Plugs between rig and C-64, VIC-20, Apple, TRS-80C, Atari, TI-99 and other personal computers.** Use MFJ, Kantronics, AEA and other RTTY/ASCII/AMTOR/CW software.

## 7-IN-1 RTTY OPERATING AID

MFJ-1221  
\$79.95



Indispensable. Improves any RTTY station.

**1. Crosshair LED "scope" Tuning Array.** Makes tuning quick and easy with dead-on accuracy. Tune for maximum vertical and horizontal display.

**2. Scope Adapter.** Mark/Space outputs for scope.

**3. Shift Indicator.** LEDs indicate 170, 425, 850 Hz shift. Especially useful for RTTY outside ham bands.

**4. Sharp Mark and Space Filters.** Greatly improves copy under crowded, fading and weak signal conditions. For 170, 425, 850 Hz shifts.

**5. Normal-Reverse Switch.** Check for inverted RTTY without changing sidebands and retuning.

**6. Output Level Control.** Adjust signal level into TU.

**7. Limiter.** Evens out signal variation for easier, smoother copy.

Plugs between receiver and TU. Mark is 2125 Hz and Space is 2295, 2550, or 2975 Hz. 10x2x6 inches. Uses floating 18 VDC or 110 VAC with AC adapter, MFJ-1312, \$9.95.

## 24/12 HOUR CLOCK/ID TIMER

**Switch to 24 hour UTC or 12 hour format!** Battery backup. ID timer alerts every 9 minutes after reset. Red .6 in. LEDs. Synchronizable to WWV. Alarm, Snooze function. Minute, hour set switches. PM, alarm on indicators. Gray/Black cabinet. 5x2x3 in. 110 VAC, 60 Hz.

MFJ-106 \$19.95



## MFJ ELECTRONIC KEYS

MFJ-407  
\$69.95



**MFJ-407 Deluxe Electronic Keyer** sends iambic, automatic, semi-auto or manual. Use squeeze, single lever or straight key. Plus/minus keying. 8 to 50 WPM. Speed, weight, tone, volume controls. On/Off, Tune, Semi-auto switches. Speaker. RF proof. 7x2x6 inches. Uses 9 V battery, 6-9 VDC or 110 VAC with AC adapter, MFJ-1305, \$9.95.

## MFJ PORTABLE ANTENNA

**MFJ's Portable Antenna** lets you operate 40, 30, 20, 15, 10 meters from apartments, motels, camp sites, vacation spots, nearly any electrically clear location where space for a full size antenna is a problem.

**A telescoping whip** (extends to 54 in.) is mounted on self-standing 6x3x6 inch aluminum case. Built-in antenna tuner, field strength meter, 50 feet RG-58 coax. Complete multi-band-portable antenna system that you can use nearly anywhere. Up to 300 watts PEP.

MFJ-1621  
\$79.95



## MFJ ANTENNA BRIDGE

MFJ-204  
\$79.95

**MFJ Antenna Bridge.** Trim your antenna for optimum performance quickly and easily. Read antenna resistance up to 500 ohms. Covers all ham bands below 30 MHz. Measure resonant frequency of antenna. Tells to lengthen or shorten antenna. Easy to use, connect antenna, set frequency, adjust bridge for meter null and read antenna resistance. Has frequency counter jack. Use as signal generator. Portable, self contained. 4x2x2 in. 9 V battery or 110 VAC with adapter, MFJ-1312, \$9.95.



## MICROPHONE EQUALIZER

MFJ-550  
\$49.95



**Greatly improves transmitted SSB speech** for maximum talk power. Evens out speech peaks and valleys due to voice, microphone and room characteristics that makes speech hard to understand. Produces cleaner, more intelligible speech on receiving end. Greatly improves mobile operation by reducing bassy peaks due to acoustic resonances. Plugs between mic and rig. 4 pin mic jack, shielded output cable. High, mid, low controls provide ±12 db boost or cut at 490, 1170, 2800 Hz. Mic gain, on/off/bypass switch. "On" LED. 7x2x6 inches. 9 V battery, 12 VDC or 110 VAC with adapter, MFJ-1312, \$9.95.

**ORDER ANY PRODUCT FROM MFJ AND TRY IT-NO OBLIGATION. IF NOT DELIGHTED, RETURN WITHIN 30 DAYS FOR PROMPT REFUND (LESS SHIPPING).**

- One year unconditional guarantee • Made in USA.
- Add \$4.00 each shipping/handling • Call or write for free catalog, over 100 products.

# MFJ

MFJ ENTERPRISES, INC.  
Box 494, Mississippi State, MS 39762

**TO ORDER OR FOR YOUR NEAREST DEALER, CALL TOLL-FREE**

**800-647-1800.** Call 601-323-5869 in Miss. and outside continental USA  
Telex 53-4590 MFJ STKV



# REFLECTIONS

## polish until it shines

**It was a lazy afternoon. The air was warm, the sky was blue, and a soft sea breeze wafted gently across the deck. The place was Martinique, and a young radio operator from the SS *Brasil* — me — had the afternoon free.** In those days my call sign was WMDT (all ships used four letters for identification), and I was at the halfway point in my fourth trip out to sea as a radio operator in the U.S. Merchant Marines.

Thinking back now, I recall the slow, undulating motion of the ship, the immense expanse of ocean, and the fresh smell of sea breeze created by the water splashing against the fantail. It was a wonderful experience for a lad of 19 to be able to visit many foreign ports, operate a high-power shipboard radio station (with four receivers), to receive room and board — and *be paid* — for the privilege!

On that lazy afternoon I decided to visit my counterparts (radio operators) aboard the SS *France* (FNRR). I suppose it was natural to want to see what equipment and antennas they had, what operating procedures they used, and in general, what their life was like aboard ship.

While the radio room on the *France* was larger than the *Brasil's*, they had about the same complement of transmitters and receivers as we had aboard our vessel, plus a high-resolution TV system used to pipe signals throughout the ship. Although our working conditions seemed similar, our feelings seemed to be quite different. The radio operators (there were about six, I believe) all appeared to be good, close friends, and they obviously enjoyed each other's company. I couldn't help but compare the atmosphere aboard my ship with that of the *France*. Though we were all friendly while on duty, we went our separate ways immediately after docking — I guess you could call our style "rugged individualism." I found myself preferring, however, the camaraderie shown by my new-found friends aboard this "foreign" liner.

What is a visit to France (or a French ship) without tasting the food? I was invited to lunch. In the cafeteria we enjoyed an excellent meal, several glasses of good wine, and amicable conversation. But suddenly my attention focused on one of the kitchen workers. I couldn't help noticing the considerable effort he was applying to the polishing of his equipment. Summoning up my best French, I went over to him and asked why he worked so hard. Were they that strict aboard the ship?

First he laughed. Then he became quite serious and said something that I'll probably never forget: "This is my job. I want to do the best I can at it. If I thought it were 'beneath me' to do this job, I'd get another."

I couldn't help thinking how many people I knew and had known who had what might be considered very good jobs, yet complained, for one reason or another, that they should have been doing something else. We have so much in this wonderful country of ours. We have resources and resourcefulness. Our children have the opportunity to acquire an excellent education, and we have the facilities to train them — and ourselves — for many different interesting jobs.

In Amateur Radio it's no different. We have the equipment, spectrum, technical resources, and obviously the time (just listen to some of our lengthy rag chews!) and yet I often come away from an evening on the air with the feeling that something's missing. We're all, it appears, "rugged individuals" diligently protective of our own frequencies and thoughts, content to do the same thing day after day. (For those who know my operating habits, perhaps I'm a fine one to talk . . . I *do* zero in on chasing quite a bit of DX.) I guess what I'm trying to say is that I'd be very happy to see what we have appreciated more and used more fully.

For my part I'm going to continue my experiments in antenna development and propagation studies, my two favorite technical subjects. But first I'm going to work on a more pressing problem — how to squeeze just two more hours into a 24-hour day. I don't think that's asking for too much.

**Rich Rosen, K2RR**  
Editor-in-Chief

REALLOCATION OF THE TOP HALF OF 160 METERS TO RADIOLOCATION could take place in the very near future. In a mid-September Notice of Proposed Rule Making, the Commission has proposed moving non-government radiolocation operations from their present slot between the top end of AM broadcast and the bottom of 160 up to 1900-2000 kHz. The shift is based on the WARC '79 upward expansion of AM broadcast, displacing present radiolocation operation.

Ironically, The Importance Of Medium Frequency Radiolocation is being questioned in a Petition for Initiation of Inquiry Procedure filed by the ARRL just the day before the FCC's NPRM was released. In it the League asks that the actual spectrum requirements of the individual radiolocation users be specified along with the actual number of such stations that might be active in any geographical area. Though the ARRL petition addressed the needs of all non-government radiolocation, it specifically asked the Commission to consider whether radiolocation's real needs are sufficient to justify taking over the 1900-2000 kHz slot.

The League Has Now Petitioned The FCC To Withhold Consideration of the reallocation docket until after it considers the League's Inquiry Procedure petition.

A BILL STRENGTHENING FEDERAL LAW ON MALICIOUS INTERFERENCE has been introduced in the U.S. Senate by Barry Goldwater, K7UGA. In his bill, S-2975, Sen. Goldwater would make any operator of equipment used to maliciously interfere with any form of radio communications (or radar) subject to Section 501 of the Communications Act if he continues after receipt of written notice to stop. Section 501 provides for fines up to \$10,000 and two years in prison; under present law the fine for malicious interference is only \$500. In addition, the equipment used to generate the malicious interference could also be seized.

RELIEF OF AMATEUR OPERATIONS FROM STATE AND LOCAL REGULATION is being sought by the ARRL. The League has asked the FCC to issue a "Declaratory Ruling of Limited Federal Preemption of State and Local Regulation of Amateur Radio Station Installation and Operation," to spell out just what limitations local and state authorities could place over federally-licensed Amateurs. A similar request regarding local regulation of TVRO satellite dishes was filed some time ago by United States Communications, Inc.

Comments From Concerned Amateurs, Particularly Those who've had problems with local regulators, are being sought by the Commission. An original and four copies should go to the Secretary, FCC, 1919 M St., NW, Washington, D.C. by November 9; refer to PRB-1. A copy of those Comments, along with any supporting documentation, would also be very helpful to the ARRL in its efforts. USCI's proposal on behalf of TVRO owners has generated strong opposition from a number of governmental organizations, and it's almost certain they'll resist the League's request with equal fervor.

THOUGH THERE'S BEEN NO REAL CHANGE IN THE 220 MHZ SITUATION since last month's Presstop, there have been some interesting developments. "220 Notes" Publisher K9XI has requested a Congressional investigation of the FCC's Office of Science and Technology, based on concerns that the OST may have been improperly involved in the STI petition that asked for reallocation of the 220-222 MHz slot to ACSB. "Westlink" reports Congress is getting plenty of mail on the subject, with Sen. Goldwater's office receiving about a thousand letters from concerned Amateurs and California Senator Pete Wilson almost 400.

WAZMCT's Petition To Permit Novices All-Mode 220 Privileges has been denied and dismissed by the FCC. In denying the petition Private Radio Bureau Chief Bob Foosaner noted that both the FCC and National Telecommunications Information Administration (NTIA) are conducting on-going studies of future 216-225 MHz uses, so it is "not appropriate to consider petitions which could have a major impact on the 220 MHz band..." at this time.

A SPREAD SPECTRUM FREQUENCY HOPPING 2-METER BEACON IS NOW ON THE AIR from Falls Church, Virginia. Start and stop frequencies are 144.5 and 147.7 MHz, on a 25-kHz spaced pseudo-random pattern. It's transmitting MCW on narrow band FM with a hop rate of 10 hops per second, sending a series of Vs followed by the station ID. Contact N4EZV for details.

EXTENSIVE CHANGES IN THE VEC PROGRAM HAVE BEEN PROPOSED by W6NLG on behalf of the Sunnyvale VEC Amateur Radio Club, the newly appointed California VEC. They'd like the prior notification requirement relaxed, and more leniency with respect to the exams Advanced class VE's can administer. They'd also limit any VEC to a maximum of 3 call areas, to provide for local control. An RM number has not been assigned at the present time.

It Appears The FCC May Let The VEC Program Run As Is for the time being, until both it and the participants have enough experience to know what (if any) real bugs it has. However, it may act favorably on RM-4835, which would shorten the delay period for retaking a failed exam from the present 30 days to 7, despite ARRL opposition.

ARIZONA IS ADOPTING 20 KHZ SPACING ON 2 METER'S TOP END, effective immediately. No more "odd digit" coordination for either new repeaters or for changes in existing machines will be permitted, and a statewide program to move all odd digit systems will begin soon.

AN NPRM TO IMPLEMENT VARIOUS WARC BANDS IS DUE for FCC release very soon, possibly before this sees print. It's expected to include 24 and 902 MHz as well as 10 MHz (still operating under temporary authorization), and probably other WARC changes as well.



“THE NEW KID”  
ON THE BLOCK

Kantronics

Challenger Terminal Unit

MARK SPACE POWER

## Kantronics Quality at a Knockout Price

# \$99.95

The new **Kantronics Challenger** makes you the winner with superior performance at a knockout price. The **Challenger** terminal unit is designed for RTTY/ASCII/AMTOR operation with any of the Kantronics software programs. Compare our specifications with the competition, then check the price.

**Challenger's** four pole switched capacitance filter gives sensitivity and selectivity found in units costing much more. And with only 5mvRMS of audio required to drive **Challenger**, you can really chase the weak signals. With features like Scope Outputs, Direct FSK or Crystal Controlled AFSK, and an Extruded Aluminum Case, you know this is Kantronics quality.

If you really want to work RTTY/ASCII/AMTOR without breaking the budget, get **Challenger** and a Kantronics software program. Kantronics currently offers programs for Apple, Atari, TRS-80C, VIC-20, TI-99, and Commodore 64 computers.

### Kantronics Software

**Hamssoft** — Send/Receive CW, RTTY, ASCII \* Split Screen Display \* Message Ports \* Type-Ahead Buffer \* Printer compatibility.

**Hamtext** — Includes all features of Hamssoft plus Text

Editing \* Receive Message Storage \* Variable Buffer sizes \* Diddle \* Word Wraparound \* Time and Text Transmission.

**Hamssoft/Amtor** — Includes all features of Hamssoft plus communication in all three modes of AMTOR.

**Amtorsoft** — Includes all the features of Hamtext but is for use with AMTOR ONLY. The Apple program is available only as a Hamtext/Amtorsoft combination.

**Supertap** — Receive Only CW, RTTY, ASCII, AMTOR \* Decode inverted, bit inverted, and unusual bit order \* Multiple line display \* "SCOPE" feature for baud rate measure.

## Specifications

**Input Filter** — Four pole Switched Capacitance Filter with 170Hz Shift RTTY bandwidth of 260Hz nominal. Copies any shift.

**Audio Input** — Minimum level 5mvRMS. Input impedance is 600 ohms unbalanced. Accepts baudot or ASCII code up to 300 baud. Max input level is 12VRMS.

**AFSK Output** — Crystal controlled. Mark-2125Hz; Space-2295Hz (170 shift). Level 100mvpp (35mvRMS) standard. Optional 500mvpp (175mvRMS). Output impedance 600 ohm unbalanced.

**FSK Output** — Open Collector +40 VDC Max. Polarity can be reversed.

**Scope Output** — 10K ohm output impedance.

**PTT Output** — Open Collector +40 VDC Max.

**Computer Connection** — TTL Compatible. Inputs also RS232 level compatible.

**Power Requirements** — 11 to 15 VDC (12VDC nominal) 75ma

**Construction** — Precision Extruded Aluminum Alloy Case

**Dimensions** — 1.9"H x 5.9"W x 7"D

**Weight** — 1¼ lbs.

**Kantronics**

1202 E. 23rd Street  
Lawrence, Kansas 66044

# RF TRANSISTORS

FRESH STOCK - NOT SURPLUS  
TESTED — FULLY GUARANTEED

| 2-30MHz 12V (* = 28V) |        |         |          |
|-----------------------|--------|---------|----------|
| P/N                   | Rating | Ea.     | Match Pr |
| MRF406                | 20W    | \$14.50 | \$32.00  |
| MRF412                | 80W    | 18.00   | 40.00    |
| MRF412A               | 80W    | 18.00   | 40.00    |
| MRF421                | 100W   | 25.00   | 54.00    |
| MRF421C               | 110W   | 27.00   | 58.00    |
| MRF422*               | 150W   | 38.00   | 82.00    |
| MRF426*               | 25W    | 17.00   | 40.00    |
| MRF426A*              | 25W    | 17.00   | 40.00    |
| MRF433                | 13W    | 14.50   | 32.00    |
| MRF435*               | 150W   | 42.00   | 90.00    |
| MRF449                | 30W    | 12.00   | 27.00    |
| MRF449A               | 30W    | 11.00   | 25.00    |
| MRF450                | 50W    | 12.00   | 27.00    |
| MRF450A               | 50W    | 12.00   | 27.00    |
| MRF453                | 60W    | 15.00   | 33.00    |
| MRF453A               | 60W    | 15.00   | 33.00    |
| MRF454                | 80W    | 16.00   | 35.00    |
| MRF454A               | 80W    | 16.00   | 35.00    |
| MRF455                | 60W    | 12.00   | 27.00    |
| MRF455A               | 60W    | 12.00   | 27.00    |
| MRF458                | 80W    | 18.00   | 40.00    |
| MRF460                | 60W    | 16.50   | 36.00    |
| MRF475                | 12W    | 3.00    | 9.00     |
| MRF476                | 3W     | 2.50    | 8.00     |
| MRF477                | 40W    | 13.00   | 29.00    |
| MRF479                | 15W    | 10.00   | 23.00    |
| MRF485*               | 15W    | 6.00    | 15.00    |
| MRF492                | 90W    | 18.00   | 39.00    |
| SRF2072               | 75W    | 15.00   | 33.00    |
| CD2545                | 50W    | 24.00   | 55.00    |

Selected High Gain Matched Quads Available

## VHF TRANSISTORS

| Type   | Rating | Ea.     | Match/Pr |
|--------|--------|---------|----------|
| MRF221 | 15W    | \$10.00 | —        |
| MRF222 | 12W    | 12.00   | —        |
| MRF224 | 40W    | 13.50   | \$32.00  |
| MRF231 | 3.5W   | 10.00   | —        |
| MRF234 | 25W    | 15.00   | 39.00    |
| MRF237 | 1W     | 2.50    | —        |
| MRF238 | 30W    | 12.00   | —        |
| MRF239 | 30W    | 15.00   | —        |
| MRF240 | 40W    | 16.00   | —        |
| MRF245 | 80W    | 25.00   | 59.00    |
| MRF247 | 80W    | 25.00   | 59.00    |
| MRF260 | 5W     | 6.00    | —        |
| MRF264 | 30W    | 13.00   | —        |
| MRF492 | 70W    | 18.00   | 39.00    |
| MRF607 | 1.8W   | 2.60    | —        |
| MRF627 | 0.5W   | 9.00    | —        |
| MRF641 | 15W    | 18.00   | —        |
| MRF644 | 25W    | 23.00   | —        |
| MRF646 | 40W    | 24.00   | 59.00    |
| MRF648 | 60W    | 29.50   | 69.00    |
| SD1416 | 80W    | 29.50   | —        |
| SD1477 | 125W   | 37.00   | —        |
| 2N4427 | 1W     | 1.25    | —        |
| 2N5945 | 4W     | 10.00   | —        |
| 2N5946 | 10W    | 12.00   | —        |
| 2N6080 | 4W     | 6.00    | —        |
| 2N6081 | 15W    | 7.00    | —        |
| 2N6082 | 25W    | 9.00    | —        |
| 2N6083 | 30W    | 9.50    | —        |
| 2N6084 | 40W    | 12.00   | 29.00    |

## TMOS FET

|        |      |         |   |
|--------|------|---------|---|
| MRF137 | 30W  | \$22.50 | — |
| MRF138 | 30W  | 35.00   | — |
| MRF140 | 150W | 92.00   | — |
| MRF150 | 150W | 80.00   | — |
| MRF172 | 80W  | 65.00   | — |
| MRF174 | 125W | 88.00   | — |

Technical Assistance & cross-reference information on CD, PT, RF, SRF, SD P/Ns  
Call Engineering Dept. (619) 744-0728

RF Parts Catalog Available  
OEM & Quantity Discounts ✓ 231

Minimum Order \$20 Add \$3.50 Shipping  
WE SHIP SAME DAY C.O.D./VISA/MC

ORDERS ONLY: 800-854-1927



**WESTCOM**  
1320 Grand Ave. San Marcos  
California 92069 (619) 744-0728

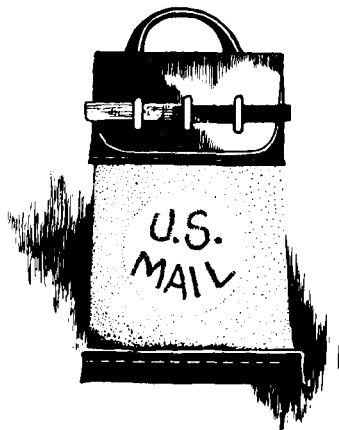

## comments

### wait for the mailman

Dear HR:

Thanks for bringing VHF and UHF out of the dark ages and into the daylight. As I sat here carefully cutting out W1JR's article on propagation, (July, 1984) it occurred to me that it's the best primer I've ever read. The article now has a home on my research book shelf right next to authorities such as *Natural Electromagnetic Phenomena*, *Electronic Density Profiles in the Ionosphere and Exosphere*, and other noteworthy journals and papers.

WB3BGU's series on VHF and UHF *Antenna Design* (May-October, 1984) helps clear the smoke screen on design that has snowed hams for years. I have built and put up some large arrays over the years; Stan's notes are the best guide ever written for hams.

Since Rich Rosen took over as Editor-in-Chief, *ham radio* has moved to the number 1 position on my wait-for-the-mailman list. Keep up the great work.

Sid Liberman, WA2FXB  
Woodbridge, New Jersey

### Model 28 printer

Dear HR:

I have a TRS80 Color Computer,™ Kantronic Software, and an MFJ TU-1224. I'd like to use my Model 28 as a printer. Can someone out there show me how?

John L. Gill  
6000 Duda Road  
House Springs, Missouri 63051

## cheers

Dear HR:

Regarding your July, 1984 editorial, "The Number 1 Question," thanks! Not exactly for spelling out how to write a magazine article, but for announcing the birth of the "Superduper Louden-Boomer Metal Noodle." We in this area are using the "new and improved" version with extraordinary results and will shortly — yesterday, I believe — come out with an even more versatile one — the DASH 2 — on which I would be glad NOT to write a technical paper.

Seriously, though, I enjoy *ham radio* very much. Keep up the good work!

Frank Brumett, WB4CIZ  
Lexington, Kentucky

### wideband VCO design

Dear HR:

Your July, 1984, issue came just in time. I was showing my students how to use the Smith chart for finding the length of a transmission line to act as an inductor and I wanted a circuit to build. Alan Victor's article on wideband VCO design was just what I needed.

The circuit was easy to build, and because the resonator is shielded, it was immune to handling by the students. I was able to vary the frequency of the Colpitts oscillator throughout the FM radio band for the students to hear. This circuit helped my students in applying theory to a practical application.

Joe Avampato, W8DKR  
Fort Mill, South Carolina

In the May, 1984, article, "Remote-controlled 40, 80, and 160-meter Vertical," reference was made to 4-inch O.D. irrigation pipe. Local inquiries produced the following information: 4-inch aluminum irrigation pipe with 0.050 inch wall is available in lengths up to 40 feet from Larchmont Engineering, P.O. Box 66, 11 Larchmont Lane, Lexington, Massachusetts 02173. The price is \$2.38 per foot; other sizes are available. (Check your local phone book for additional sources.)

For additional sources of Ledex, also specified in W7LR's article, send an SASE to *ham radio*, Greenville, New Hampshire 03048.

Editor



Cards and plaque courtesy W6TC

# EIMAC's new DX champion! The 3CX800A7.

Varian EIMAC continues to commit its development of reliable tubes for HAM radio.

The new, rugged 3CX800A7 power triode provides 2 kW PEP input for voice service or 1 kW cw rating up to 30 MHz. Two tubes will meet the new, higher power ratings authorized by the FCC.

Designed for today's low profile, compact linear amplifiers, the 3CX800A7 powerhouse is only

2½ inches (6.35 cm) high. Cooling requirements are modest and a matching socket, air chimney and anode clamp are available.

A data sheet and more information is available from Varian EIMAC. Or the nearest Electron Device Group sales office. Call or write today.

Varian EIMAC  
301 Industrial Way  
San Carlos, California 94270  
Telephone: 415-592-1221



# KENWOOD

...pacesetter in amateur radio

## TS-430S "Digital DX-terity!"

### TS-430S

Digital DX-terity... that outstanding attribute built into every KENWOOD TS-430S that lets you QSY from band to band, frequency to frequency, and from mode to mode with the speed and ease that will give you a dominant position in DX operations.

KENWOOD'S TS-430S, a revolutionary, ultra-compact, HF transceiver has already won the hearts of radio Amateurs the world over. It covers 160-10 meters, including the new WARC bands (easily modified for HF MARS). Its high dynamic range receiver tunes from 150 kHz-30 MHz. It utilizes an innovative UP conversion PLL circuit for superior frequency stability and accuracy. Two digital VFO's allow fast split-frequency operations. A choice of USB, LSB, CW, or AM, with FM optional, are at the operators fingertips. All Solid-state technology permits inputs of 250 watts PEP on SSB, 200 watts DC on CW, 120 watts on FM (optional), or 60 watts on AM. Final amplifier protection circuits and a cooling fan are built-in.

Eight memories store frequency, mode, and band data, with Lithium battery memory back-up. Memory scan and programmable automatic band scan help speed up operations. An IF shift circuit, a tuneable notch filter, and a Narrow-Wide switch for IF filter selection help eliminate QRM. It has a built-in speech processor. A fluorescent tube digital display makes tuning easy and fast. An all-mode squelch circuit, a noise blanker, and an RF attenuator control help clean up the signal. And there's a VOX circuit, plus semi-break-in, with side-tone. All-in-all, it just could be that the expression "Digital DX-terity" is a bit of an understatement.

#### TS-430S Optional Accessories:

In typical KENWOOD fashion, there are plenty of optional accessories for this great HF transceiver. There is a special power supply, the PS-430. An external speaker, the SP-430, is also available. And the MB-430 mounting bracket is available for mobile operation. The

AT-250 automatic antenna tuner was designed primarily with the TS-430S in mind, and for those who prefer to "roll their own," the AT-130 antenna tuner is available. The FM-430 FM unit is available for FM operations. The YK-88C (500 Hz) or YK-88CN (270 Hz) CW filters, the YK-88SN SSB filter, and the YK-88A AM filter may be easily installed for serious DX-ing. An MC-60A deluxe desk microphone, MC-80 and MC-85 communications microphones, an MC-42S mobile hand mic., and an MC-55 8-pin mobile microphone, are available, depending on your requirements. TL-922A linear amplifier (not for CW QSK), SM-220 station monitor, PC-1A phone patch, SW-2000 SWR/power meter 160 ~ 6 meter, SW100A SWR/power/volt meter 160-2m, HS-4, HS-5, HS-6, HS-7 headphones, are also available.

More information on the TS-430S is available from authorized dealers of Trio-Kenwood Communications, 1111 West Walnut Street, Compton, California 90220.



Specifications and prices are subject to change without notice or obligation.



# KENWOOD

pacesetter in amateur radio

## TS-711A

### TS-711A Multi-function all-mode 2 m transceiver.

The TS-711A 2 m all-mode transceiver is the perfect base station unit. It features Kenwood's innovative D.C.S. circuitry that allows you to respond only to signals that include a pre-selected digital code. The system recognizes 100,000 different 5-digit codes, making

it possible for each station to have its own "private call," "group call," or "common call" code. Built-in dual digital VFO's provide commercial-grade frequency stability through the use of a TCXO (Temperature Compensated Crystal Oscillator). The new fluorescent multi-function display shows frequency, RIT shift, VFO A/B, SPLIT, ALERT, repeater offset, digital code, call sign code, and memory channel. 40 multi-

function memories store frequency, mode, repeater offset and tone. It has programmable scan, memory scan, and mode scan. The Auto-mode function automatically selects the correct mode for the frequency being used. When a mode key is depressed, an audible "beeper" announces mode identification in International Morse Code.

The TS-711A has all-mode squelch, noise blanker, speech processor (SSB, FM), IF shift, RF power control, alert, and a

unique channel Quick-Step tuning that varies tuning characteristics from conventional VFO feel, to stepping action when CH.Q switch is depressed.

#### Optional accessories:

- CD-10 Call Sign Display
- TU-5 CTCSS Tone Unit
- VS-1 Voice Synthesizer
- MC-60A Deluxe Desk Mic
- MC-80 Desk Mic
- MC-85 Desk Mic
- SP-430 External Speakers
- MB-430 Mobile Mount
- PG-2J DC Cable



## TS-670

### TS-670 All-mode "Quad Bander"

The TS-670 "Quad Bander" is a unique all-mode transceiver that covers the 6 meter VHF band and the 10, 15 and 40 meter HF bands. FM operation may be added with the optional FM-430. Key features include dual digital VFO's, 80 memory channels, memory scan, and programmable band

scan. Direct keyboard frequency selection allows you to enter a frequency to either VFO or to a memory channel using the 10-button key-pad on the front panel. The 2-color fluorescent tube display indicates frequency to the nearest 100 Hz (10 Hz modifiable) and includes LED indicators that signal the specific functions in use. The optional GC-10 general coverage receiver unit allows continuous tuning from 500 kHz to 30 MHz. The VS-1

voice synthesizer unit is another popular option available. All this plus IF shift, all-mode squelch, CW semi-break-in with side tone, narrow-wide filter selection, noise blanker, and R.F. attenuator make the TS-670 "Quad Bander" the next transceiver you should own!

#### Optional accessories:

- GC-10 General Coverage Unit, 500 kHz to 30 MHz
- VS-1 Voice Synthesizer
- FM-430 FM Unit
- YK-88C 500 Hz CW

- Filter
- YK-88CN 270 Hz CW Filter
- YK-88A 6 kHz AM Filter
- PS-430 DC Power Supply
- KPS-7A DC Power Supply
- MC-60A Deluxe Desk Mic
- MC-80 Desk Mic
- MC-85 Multi-Function Desk Mic
- VOX-4 VOX Unit

More information on the TS-711A and TS-670 is available from authorized dealers of Trio-Kenwood Communications, 1111 West Walnut Street, Compton, CA 90220.

Specifications and prices are subject to change without notice or obligation.



# You touch.

# It holds.

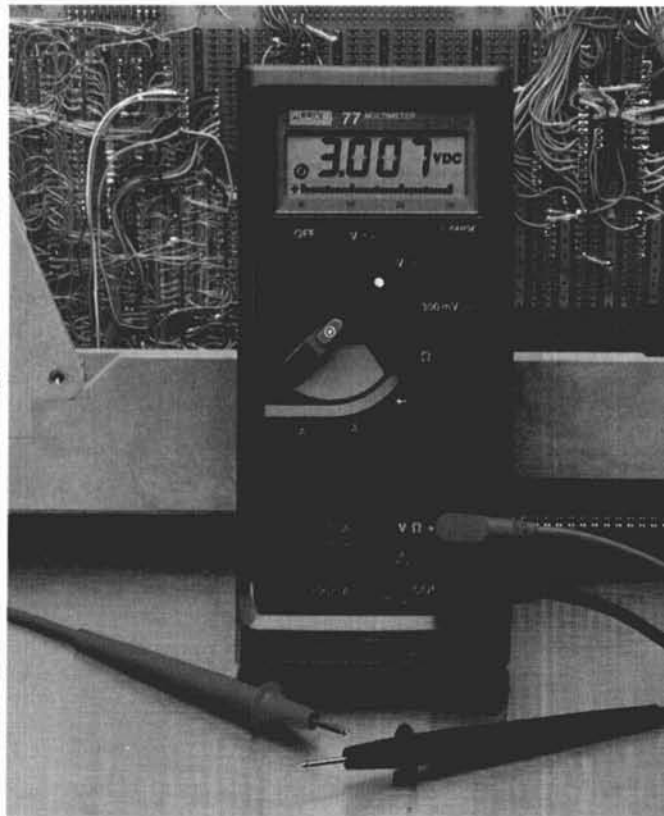

**\$129\*** gets you the world's first handheld digital/analog multimeter with "Touch Hold."

### The Fluke 77

Its unique "Touch Hold" function automatically senses and holds readings, leaving you free to concentrate on positioning test leads without having to watch the display.

Then, when you have a valid reading, it signals you with an audible beep.

The Fluke 77 is perfect for those test situations where accessibility is a problem, or when extra care is needed for critical measurements.

It's the top model in the world champion Fluke 70 Series line — the first industrial quality autoranging multimeters to combine digital and analog displays. These tough, American-made meters feature a three-year warranty and 2000+ hour battery life.

So call now for the complete story on the Fluke 77 with "Touch Hold." Because if you don't deserve the world's first, who in the world does?

For the name of your distributor or a free brochure, call our toll-free hotline anytime **1-800-227-3800, Ext. 229.**

From outside the U.S., call 1-402-496-1350, Ext. 229.

FROM THE WORLD LEADER  
IN DIGITAL MULTIMETERS.



### FLUKE 73

\$85\*  
Analog/digital display  
Volts, ohms, 10A, diode test  
Autorange  
0.7% basic dc accuracy  
2000+ hour battery life  
3-year warranty



### FLUKE 75

\$99\*  
Analog/digital display  
Volts, ohms, 10A, mA, diode test  
Audible continuity  
Autorange/range hold  
0.5% basic dc accuracy  
2000+ hour battery life  
3-year warranty



### FLUKE 77

\$129\*  
Analog/digital display  
Volts, ohms, 10A, mA, diode test  
Audible continuity  
"Touch Hold" function  
Autorange/range hold  
0.3% basic dc accuracy  
2000+ hour battery life  
3-year warranty  
Multipurpose holster

\* Suggested U.S. list price, effective July 1, 1984  
\*\* Patent pending



taking  
out  
the  
guess work...

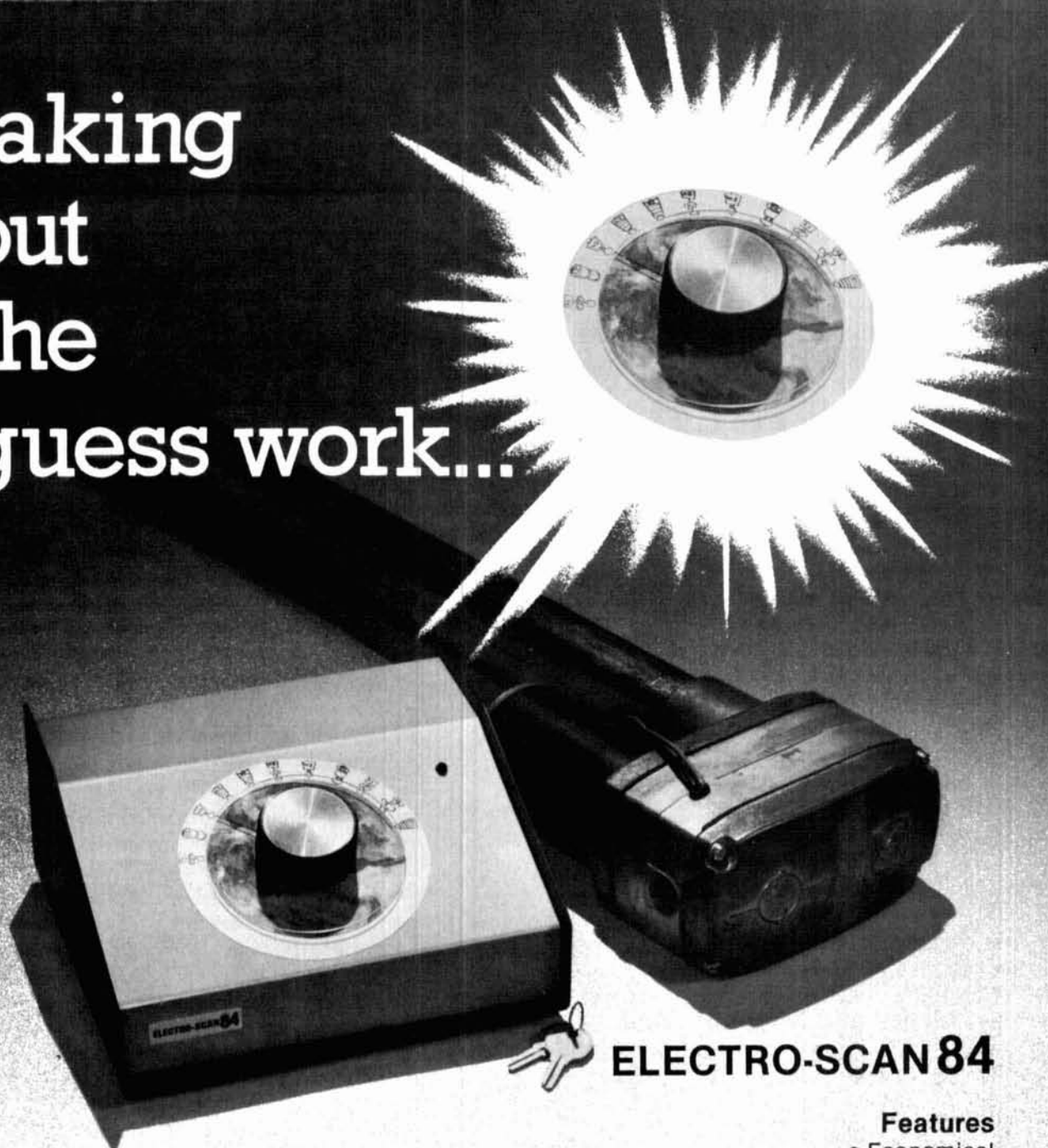

## ELECTRO-SCAN 84

### Features

- Economical
- Lock and Key
- On-Off Switch
- 36 volt DC motor
- Precise positioning
- 10 Turn potentiometer
- Analog Micro Systems
- 1 year limited warranty
- State-of-the-art circuitry
- 18" Saginaw Acme actuator
- LED to indicate dish movement
- Modern, attractively styled control box
- Dial control always showing dish location

**Your wisest choice in  
automatic dish positioners.**

To learn more about the finest  
in low cost, high performance  
dish positioners, contact. . .

**ELECTRO-COM**

5512 Savina Avenue • Dayton, Ohio 45415 • Phone (513) 832-2937

# quiet! preamp at work

Understanding preamplifiers  
means understanding  
all the important parameters  
of receiver performance

For years, the standard technique employed by Radio Amateurs to improve receiver sensitivity has been to precede their receivers with one or more stages of preamplification. Invariably a preamplifier that performs well on the bench will actually *degrade* the actual on-the-air system sensitivity. This article explores the relationship between gain, noise figure, bandwidth, distortion, and sensitivity in an attempt to answer the classic preamp question, "If a little is good, is a lot better?"

## sensitivity

Sensitivity is a measure of the weakest input signal that will produce a specified output signal-to-noise ratio. We can quantify receiver performance in terms of *minimum discernible signal* sensitivity, which is the input level producing an output signal-to-noise ratio of unity; *tangential signal sensitivity*, which generally refers to the input level needed to produce an output signal-plus-noise to noise ratio of 6 dB or the RF level required to produce a detected signal which is 8 dB above the RMS noise level; or *threshold*, which refers to the input amplitude required to produce a specified level of receiver quieting and is frequently employed in FM systems. All of these sensitiv-

ity measures are a function of the receiver circuitry's internally generated noise, bandwidth, and distortion.

Of these three parameters, the receive bandwidth can be considered fixed for a given application, and would ideally be wide enough to pass all the modulation sidebands of the desired signal, yet sufficiently narrow to exclude both background noise and any adjacent-channel signals. Because the response bandwidth of modern receivers is established primarily in the IF stages, it is relatively independent of the parameters of any preamplifier employed.

Both noise and distortion, on the other hand, are very much influenced by preamplifier performance. Most Radio Amateurs are now aware that preamplifier gain, by itself, does not necessarily assure an improvement in receiver sensitivity. Rather, to be beneficial in a system, the preamplifier must generate an internal noise level significantly lower than that generated by the receiver it precedes. The noise relationships in a cascade of stages are quantified by the now-familiar Friis Equation.<sup>2</sup> A well-known rule of thumb derived from the Friis Equation is that if a preamp's gain exceeds by at least 10 dB the noise figure of the receiver it precedes, the noise performance of the preamplifier will dominate the cascade.

Yet the above relationship serves merely to confuse the Amateur who measures a new preamp at a regional VHF Conference at, say, 3 dB noise figure for 15 dB gain, brings it home, installs it in front of a 10 dB noise-figure receiver, and finds its sensitivity actually degraded. What has been overlooked? Probably the effects of distortion.

## distortion

A linear amplifier is one whose output signal is an exact replica of the input signal, measured in either

By H. Paul Shuch, N6TX, 14908 Sandy Lane, San Jose, California 95124



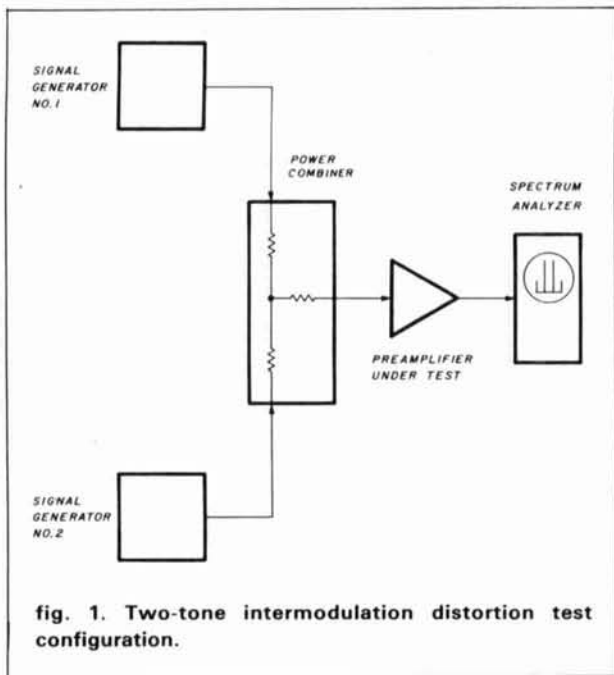

however, is the receiver to which only a single input signal is applied. In our crowded spectra, we can anticipate countless signals of varying amplitudes within the passbands of our preamplifiers, only one of which (at a time) can be said to constitute "signal." All potentially interfering waveforms must, from a communications standpoint, be classified as noise.

It is these multiple input signals that give rise to both intermodulation (mixing of in-band signals) and cross-modulation (mixing of signals from in-band with out-of-band) distortion. When the harmonics of one signal mix with the harmonics of another, the resulting distortion products can fall within the receiver passband, degrading sensitivity.

### dynamic range

Neglecting distortion effects, the weakest signal to which a receiver can respond is a function of its bandwidth and noise performance. If the multiple input signals applied to a receive system are all relatively low in amplitude, their distortion products may fall below this sensitivity limit, and be negligible. But if the input signals are of sufficient amplitude, their distortion products may appear strong enough to degrade reception of the desired signal. Thus, noise figure of a receiver generally determines the weakest signal to which it can respond. Maximum spurious free input signal, a function of a receiver's linearity, establishes an upper limit for the range of signal amplitudes to which the receiver can respond without generating perceptible distortion. The difference between sensitivity and maximum spur-free input levels is called spurious-free dynamic range, and represents a primary limitation in receiver performance.

Dynamic range is generally degraded by the addition of a preamplifier in front of a receiver. Although the low inherent circuit noise of a preamplifier may significantly improve minimum discernible signal sensitivity, degradation occurs because any additional gain in a system increases the amplitude of the desired signal, but increases the amplitude of the distortion products at an even greater rate, diminishing the maximum spurious-free input signal level. Thus, at least with respect to preamplifier gain, the old axiom, "If a little is good, a lot is better" can get us into trouble. Preamplifiers should be used only when actually necessary to improve weak-signal performance, and then only with as much gain as is actually necessary to establish the required system noise performance.

Even so, preamplifiers can result in a net degradation in system sensitivity. Some preamps are worse than others in this respect; as far as dynamic range is concerned, not all preamps are created equal. We need to measure and quantify their dynamic range, as well as their noise figure, in order to accurately predict their impact on system performance. —

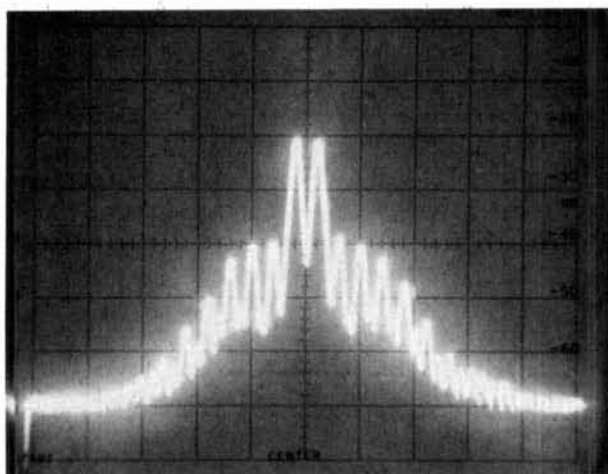

fig. 2. Typical intermodulation distortion spectrum display. Note the next pair of "signals" (IMD) are 20 dB down from the primary two-tone output.

the time or frequency domains, differing only in its increased amplitude. Try as we might, we cannot build truly linear amplifiers in the real world. Any non-linearity introduced by an amplifier will manifest itself as a deviation from sinusoidal response when viewed in the time domain, or as the generation of new frequencies when measured in the frequency domain.

In a receive preamplifier, as in any non-linear device, the distortion products generated are integer multiples (harmonics) of the input frequency, plus their various sums and differences. Normally these distortion products would not degrade receiver sensitivity, as they would fall outside of the receiver's passband. Rare,

```

10 -----> IMD.BAS <-----
20 / Rev. A, 24 May '84
30 / by N6TX
40 / COPYRIGHT (C) 1984 MICROCOMM
50 /
60 / Determines Spurious-Free Dynamic Range from
70 / Spectrum Analyzer Two-Tone IMD Measurements
80 /
90 /
100 CLR$ = CHR$(26) ' Defines Clear-Screen String
110 PRINT CLR$
120 PRINT "DO YOU WISH OUTPUT ROUTED TO:"
130 PRINT
140 PRINT "          PRINTER (P)"
150 INPUT "          or SCREEN (S)";PR$
160 IF PR$="P" OR PR$="p" OR PR$="S" OR PR$="s" GOTO 200
170 PRINT CLR$
180 PRINT "YOU MUST RESPOND WITH 'P' OR 'S'": PRINT
190 GOTO 120
200 -----
210 PRINT CLR$
220 PRINT "TONES -->      | | |"
230 PRINT "          | | |"
240 PRINT "          | | |"
250 PRINT "          | | |"
260 PRINT "IMD -->      | | | |"
270 PRINT "          | | | |"
280 PRINT
290 PRINT "FOR TWO-TONE OUTPUT SPECTRUM AS INDICATED ABOVE,"
300 PRINT
310 INPUT "ENTER Two-Tone Output Amplitude, in dBm",TONES
320 INPUT "ENTER Third-Order IMD Amplitude, in dBm",IMD
330 INPUT "ENTER System Gain, in dB",GAIN
340 INPUT "ENTER System Noise Figure, in dB",MDS
350 INPUT "ENTER System Bandwidth, in kHz",BW
360 I3=TONES + ((TONES - IMD) / 2)
370 MDS = NF - 144 + 10*(LOG(BW)/LOG(10))
380 INMAX = ((2/3)*(I3-GAIN))+MDS/3
390 RANGE = INMAX - MDS
400 -----
410 PRINT CLR$
420 PRINT "INTERMODULATION ANALYSIS BY MICROCOMM"
430 PRINT : PRINT
440 PRINT USING "###.# dBm -->      | | |",TONES
450 PRINT "          | | |"
460 PRINT "          | | |"
470 PRINT "          | | |"
480 PRINT USING "###.# dBm -->      | | | |",IMD
490 PRINT "          | | | |"
500 PRINT
510 PRINT : PRINT
520 PRINT USING "SYSTEM GAIN = ###.# dB",GAIN
530 PRINT USING "SYSTEM NOISE FIGURE = ###.# dB",MDS
540 PRINT USING "SYSTEM BANDWIDTH = ###.# kHz",BW
550 PRINT
560 PRINT USING "OUTPUT THIRD ORDER INTERCEPT POINT = ###.# dBm",I3
570 PRINT USING "MINIMUM DISCERNIBLE INPUT SIGNAL = ###.# dBm",MDS
580 PRINT USING "MAXIMUM SPURIOUS-FREE INPUT SIGNAL = ###.# dBm",INMAX
590 PRINT USING "SPURIOUS-FREE DYNAMIC RANGE = ###.# dB",RANGE
600 -----
610 IF PR$="S" OR PR$="s" THEN GOTO 800
620 PRINT "INTERMODULATION ANALYSIS BY MICROCOMM"
630 PRINT : LPRINT
640 LPRINT USING "###.# dBm -->      | | |",TONES
650 LPRINT "          | | |"
660 LPRINT "          | | |"
670 LPRINT "          | | |"
680 LPRINT USING "###.# dBm -->      | | | |",IMD
690 LPRINT "          | | | |"
700 LPRINT
710 LPRINT : LPRINT
720 LPRINT USING "SYSTEM GAIN = ###.# dB",GAIN
730 LPRINT USING "SYSTEM NOISE FIGURE = ###.# dB",MDS
740 LPRINT USING "SYSTEM BANDWIDTH = ###.# kHz",BW
750 LPRINT
760 LPRINT USING "OUTPUT THIRD ORDER INTERCEPT POINT = ###.# dBm",I3
770 LPRINT USING "MINIMUM DISCERNIBLE INPUT SIGNAL = ###.# dBm",MDS
780 LPRINT USING "MAXIMUM SPURIOUS-FREE INPUT SIGNAL = ###.# dBm",INMAX
790 LPRINT USING "SPURIOUS-FREE DYNAMIC RANGE = ###.# dB",RANGE
792 LPRINT
794 LPRINT
796 LPRINT
798 LPRINT
800 -----
810 PRINT : PRINT
820 INPUT "TYPE <return> TO CONTINUE, 'Q' TO QUIT",DS
830 IF DS = "Q" OR DS = "q" THEN GOTO 850
840 GOTO 100
850
860 -----
870 /
880 / EQUATIONS EXECUTED
890 /
900 / MINIMUM DISCERNIBLE SIGNAL = -174 dBm/Hz + NF (dB) + 10 * LOG BW (Hz)
910 /
920 / OUTPUT INTERCEPT POINT = P (tones) + [ P (tones) - P (i3d) ] / 2
930 /
940 / MAXIMUM INPUT SIGNAL LEVEL = (2/3) * (INTERCEPT - GAIN) + (M. D. S. /3)
950 /
960 / SPURIOUS FREE DYNAMIC RANGE = MAXIMUM INPUT - MINIMUM DISCERNIBLE SIGNAL
970 /
980 /
990 /
1000 END

```

fig. 3. CP/M BASIC language program listing to determine spurious-free dynamic range from spectrum analyzer two-tone IMD measurements.

## gain compression

Inferences about an amplifier's dynamic range can be drawn by applying to its input a single signal of varying amplitude and observing the amplitude present at the output. In its linear region, the amplifier will produce a 1-dB change in output signal amplitude for every 1-dB change in the applied signal. That is, the gain of the amplifier is independent of applied signal level. But as the upper limit of dynamic range is ap-

## INTERMODULATION ANALYSIS BY MICROCOMM

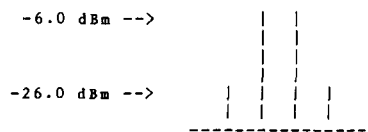

SYSTEM GAIN = -6.0 dB  
SYSTEM NOISE FIGURE = 7.0 dB  
SYSTEM BANDWIDTH = 2.4 kHz

OUTPUT THIRD ORDER INTERCEPT POINT = 4.0 dBm  
MINIMUM DISCERNIBLE INPUT SIGNAL = -133.2 dBm  
MAXIMUM SPURIOUS-FREE INPUT SIGNAL = -37.7 dBm  
SPURIOUS-FREE DYNAMIC RANGE = 95.5 dB

fig. 4. IMD analysis of a double-balanced mixer with a +7 dBm injected LO level.

proached, output signal changes will be unable to keep pace with the input. That is, the gain of the amplifier compresses at the upper end of its dynamic range. The output level at which the amplifier is exhibiting 1 dB less gain than it was under weak-signal conditions is referred to as its *output 1-dB compression point*, and is an indicator of the amplifier's immunity to intermodulation and cross-modulation distortion.

For a given noise figure, the preamplifier with the highest compression point will offer the greatest spurious-free dynamic range. But correlating the two parameters directly is difficult because the relationship between compression and distortion varies between active devices, and between circuit configurations.

Another indicator of dynamic range relates to the fact that if you continue to increase the drive level to an amplifier beyond the compression point, the gain further decreases. Eventually, the amplification of the desired signal is degraded to a point at which its amplitude at the output of the amplifier, and those of the intermodulation distortion products, would be the same. The output level at which this should occur is called the *output intercept point*.<sup>\*</sup> Intercept point is more readily correlated to dynamic range than is compression point, but is difficult to measure directly. To best quantify dynamic range limitations, it is necessary to test the preamplifier in its actual operating environment — that is, under multiple-signal conditions.

## two-tone testing

In the method of dynamic range testing prevalent in industry, two sinusoidal signals of equal amplitude are applied to the input of the device under test, and the resulting output spectrum monitored in the frequency domain. The two input signals, or tones, may be generated by summing the outputs of the two signal generators in a power combiner, or by applying a single RF source to the LO input of a balanced mix-

<sup>\*</sup>For many amplifier circuits, this is a *theoretical*, rather than an *attainable*, level, because the active device may burn out before this output level is reached.

# THE BEST JUST GOT BETTER

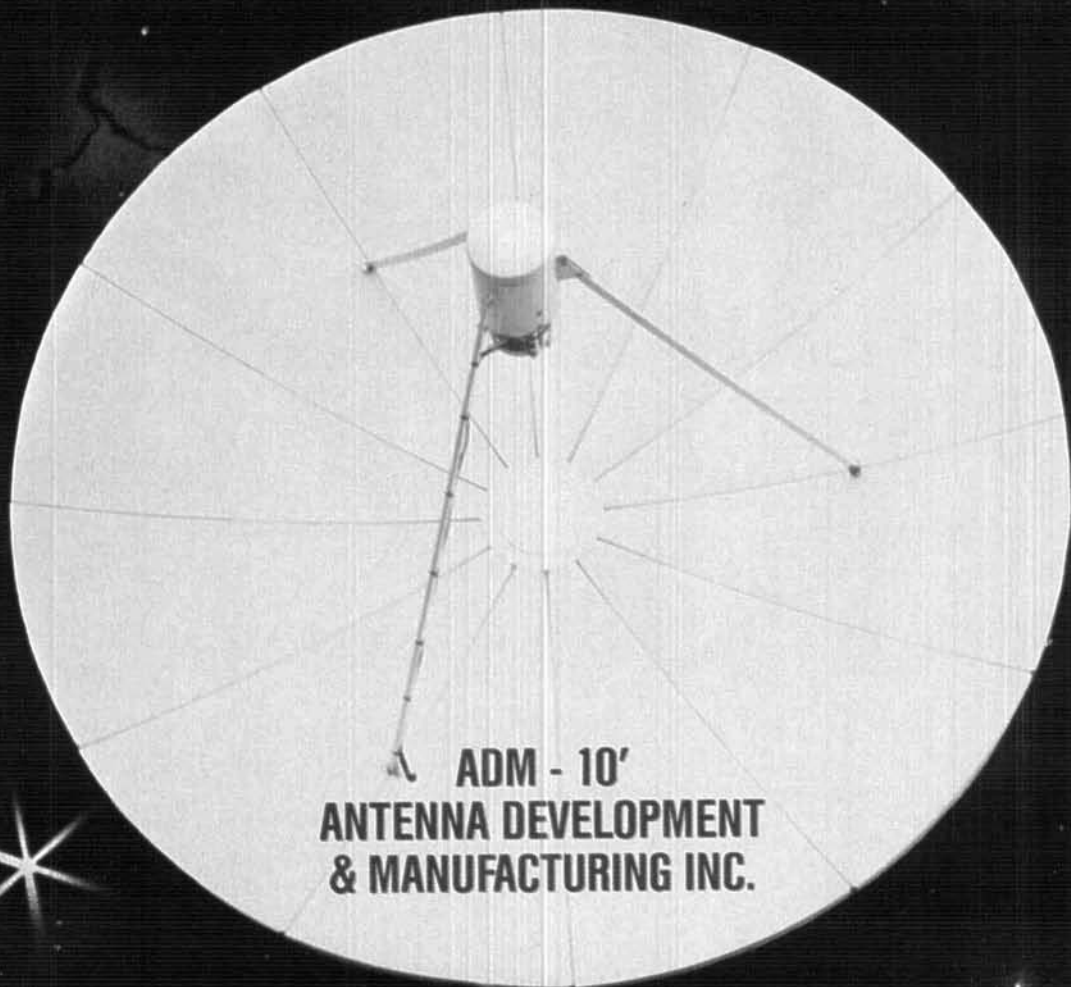

ADM - 10'  
ANTENNA DEVELOPMENT  
& MANUFACTURING INC.

A 10' aluminum sectional that is optimized for your feed system. The hub, petal and truss construction are the ultimate in durability. The best doesn't have to cost more.

Contact Antenna Development & Manufacturing 314-686-1484 or your nearest distributor.

Echosphere Corporation  
2250 South Rantan Bldg. A  
Englewood, CO 80110  
303-935-1909

Echosphere East  
10536 Lexington Drive  
Knoxville, TN 37922  
615-966-4114

Echosphere West  
5671 Warehouse Way  
Sacramento, CA 95826  
916-381-5084

Heifner Communications  
1805 Burlington  
Columbia, MO 65202  
314-474-6414

Hoosier Electronics  
P.O. Box 3300  
Terre Haute, IN 47803  
812-238-1456

Nat'l Satellite Communication  
21st Century Park  
Clifton Park, NY 12065  
518-383-2211

National Satellite  
10779 Satellite Blvd.  
Orlando, FL 32809  
305-851-4738

Avcom of Virginia, Inc.  
500 Southlake Blvd.  
Richmond, VA 23236  
804-794-2500

Video Specialties, Inc.  
417 Chambers Drive  
Booneville, MS 38829  
601-728-7700



# SOAR CORPORATION MODEL 8050 DMM . . .

## WINNER OF 5 BLUE RIBBONS



### **1st** AWARDED FOR STAYING ON THE JOB

With tens of thousands of 8050's presently in use in all types of service and environment, returns for any reason are well under a hundred units. **That's Staying Power!** Our built-in overload protection was designed to keep the 8050 on the job, not in the repair shop.

### **1st** AWARDED FOR STAYING ACCURATE

The accuracy of the 8050's shipped to date, far exceeds our published specifications. We took 5 units out of our stock at random and tested them using the latest NBS traceable DMM Calibrator\* Here are the Results . . .

| Calibrated Output DCV/<br>DMM Range Setting DCV | 190 mV/<br>200 mV | 1.90V/<br>2V   | 19.9V/<br>20V  | 199V/<br>200V  | 990V/<br>1000V |
|---|-------------------|----------------|----------------|----------------|----------------|
| Unit #1<br>Actual Reading<br>% Accuracy         | 190.6<br>0.316    | 1.904<br>0.211 | 19.94<br>0.201 | 199.2<br>0.101 | 993<br>0.303   |
| Unit #2<br>Actual Reading<br>% Accuracy         | 190.5<br>0.263    | 1.905<br>0.263 | 19.97<br>0.352 | 199.1<br>0.050 | 992<br>0.202   |
| Unit #3<br>Actual Reading<br>% Accuracy         | 190.3<br>0.158    | 1.901<br>0.053 | 19.92<br>0.101 | 199.3<br>0.151 | 992<br>0.202   |
| Unit #4<br>Actual Reading<br>% Accuracy         | 190.4<br>0.211    | 1.902<br>0.105 | 19.92<br>0.101 | 199.4<br>0.201 | 993<br>0.303   |
| Unit #5<br>Actual Reading<br>% Accuracy         | 190.4<br>0.211    | 1.901<br>0.053 | 19.89<br>0.050 | 198.7<br>0.151 | 989<br>0.101   |

And we guarantee accuracy for 1 full year.

### **1st** AWARDED FOR KEEPING UP WITH OUR ADVANCING TECHNOLOGY

The 8050 measures DC and AC voltage from 0.1 mV through 1000V DC, 750V AC; DC and AC current 0.1  $\mu$ A through 10 Amperes; Resistance from 0.1 ohm through 20M ohms, test diodes,

measures PNP and NPN transistor hFE, and has a super fast continuity beeper. This DMM was designed to respond to your testing needs now and in the future!

### **1st** AWARDED FOR EASE OF OPERATION, READABILITY AND SIZE

The single knob rotary switch is easy to set, yet provides full contact wiping action just like the time proven VOM's. The lens protected LCD readout with its bold 3-1/2 digit display makes it easy to read, even in dimly lit areas. The ideal size (6-1/4" x 3-1/3" x 1") it fits comfortably in one hand, and can be slipped into most shop coat pockets. Our optional Carrying Case (Model CC-0 \$9.90) was designed to allow in-case, no hands on meter use, and contains a separate probe storage compartment as well.

### **1st** AWARDED FOR PRICE/PERFORMANCE

The 8050 now costs less than ever before, just \$76.50 in quantities of 1-3, \$72.00 for 4-9 pieces and \$67.00 for 10 or more units, with no sacrifice in quality construction, accuracy and field maintainability.

**SOAR CORP.** is the **Prime Manufacturer** of all it sells. For more information on the 8050 or any of our other Digital Multimeters, VOM's, Oscilloscopes, DC Power Supplies, Digital Temperature Meters, Pulse Generators, Frequency Counters, AC Current Meters and Energy Monitors. Write or call:

#### NORTH AMERICAN SOAR CORP.

1126 Cornell Avenue  
Cherry Hill, New Jersey 08002  
(609) 488-1060

**NORTH  
AMERICAN**



\*Fluke Model 5101B, Accuracy DCV  $\pm 0.005\% +0.001 +5 \mu$ V

INTERMODULATION ANALYSIS BY MICROCOMM

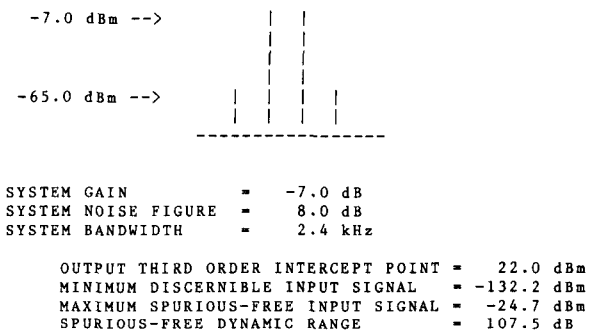

fig. 5. IMD analysis of a double-balanced mixer with a +17 dBm injected LO level.

er, a suitable audio signal generator to the mixer's IF input, and applying to the device under test the double-sideband (two-tone) signal appearing at the mixer's RF port. In either case, the two tones must be separated in frequency sufficiently to be individually resolved on the spectrum analyzer's display, yet sufficiently close in frequency to both fall within the response bandwidth of the device under test.

A typical interconnection of instruments for two-tone dynamic range analysis is shown in fig. 1, and a typical resulting spectrum is displayed in fig. 2. Note that the distortion products of greatest amplitude (in this case, the pair of signals immediately adjacent to the two applied tones) are roughly two divisions, or 20 dB, below the amplitude of the desired output tones. The intermodulation distortion level of this particular amplifier, measured at this particular signal level, is thus -20 dB.

If the vertical axis of the spectrum analyzer is calibrated in absolute amplitude (typically in dBm), the output power per tone, the PEP output power (6 dB above the level of each individual tone), and power of the individual distortion products can be readily determined. And from these values, with minimal number crunching, we can determine the dynamic range of the preamplifier.

### data analysis

The mathematical relationships applied next are, as is said in college texts, "beyond the scope of this course." However, I have included in fig. 3 a listing of a Micro-soft™ BASIC program that performs the complete analysis. Although written to run under the CP/M™ operating system, the program can likely be modified to run on any of the popular home computers using their version of BASIC. Figures 4 through 8 are sample executions of the IMD program for various receiver configurations. Comparing these printouts will enable us to draw some significant conclusions with regard to the utility of preamplifiers in VHF and UHF communications systems.

INTERMODULATION ANALYSIS BY MICROCOMM

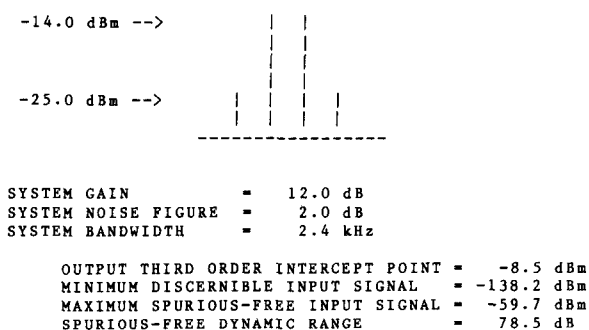

fig. 6. IMD analysis of a bipolar junction transistor preamplifier.

### mixer design considerations

As a rule, balanced mixers offer excellent dynamic range and intermodulation distortion performance, although their weak-signal sensitivity leaves something to be desired. Mixers are designed to operate at different levels of local oscillator injection, and generally, the higher the LO level employed, the higher will be the mixer's compression level. However, raising the LO injection above perhaps 5 milliwatts tends to degrade mixer conversion efficiency and noise figure. Nonetheless, as figs. 3 and 4 indicate, so-called high level mixers offer sufficiently improved dynamic range to override the considerations of slightly degraded sensitivity, in most applications.

Not shown in the computer runs, but worthy of consideration, are the so-called "starved LO" mixers. These devices use an extremely low LO injection level with external DC bias of their mixer diodes, and excel in low-noise performance. Their dynamic range, however, is severely degraded, typically 12 to 15 dB below that of even the "low-level" balanced mixer shown in fig. 3. Thus, except in those applications in which it is impractical to generate 5 milliwatts or more of LO injection, starved LO operation should be avoided.

The same is true for harmonic mixers. These devices are extremely popular in microwave TV receive converters, and employ LO injection at half the normal frequency, with the mixer diodes serving double duty as frequency multipliers. Obviously, the more frequencies we generate within a mixer, the more spurs will be available to bite us later. I recommend multiplying in a stage separate from that doing the heterodyne conversion.

### preamp design considerations

Most receive preamplifiers operate with their active devices drawing relatively low quiescent current. This is done because high device current generates high thermal activity, which degrades noise performance significantly. Unfortunately, biasing any active device

INTERMODULATION ANALYSIS BY MICROCOMM

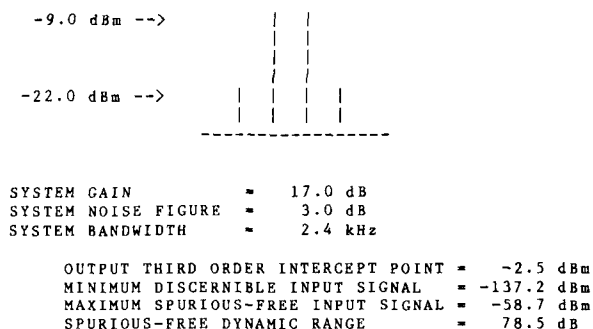

fig. 7. IMD analysis of a MOSFET preamplifier.

INTERMODULATION ANALYSIS BY MICROCOMM

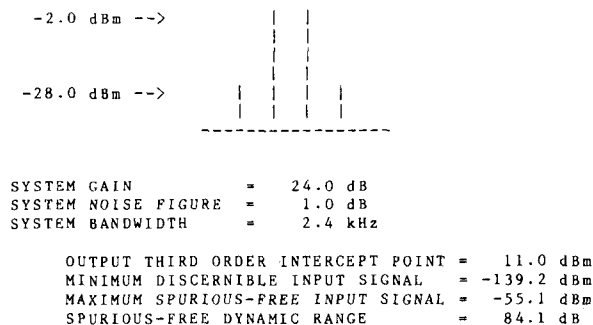

fig. 8. IMD analysis of a GaAs FET preamplifier.

near cutoff tends to limit its dynamic range, such that the "optimum" bias point from a noise figure standpoint often coincides with the "worst" bias point as far as dynamic range and actual system sensitivity are concerned. Remember, although we talk about desiring high "signal to noise ratio," what we really need for maximum sensitivity is a signal level that is high relative to the sum of noise and distortion. If we can considerably reduce IMD interference by giving up some slight amount of noise performance, the overall system sensitivity has to improve!

Joe Reisert, W1JR — probably the most prominent UHF DXer of our time — has long advocated designing bias circuits for preamplifiers so that device quiescent current can be readily and remotely varied.<sup>3</sup> This way the user can optimize noise figure when operating conditions call for it, and readily improve dynamic range, at a sacrifice in noise performance, should interference conditions dictate. Since all RF design is a series of compromises, Joe's approach seems to offer the best of all possible worlds.

There has long been controversy in Amateur circles over the relative merits of bipolar junction transistors and MOS field effect devices as VHF preamplifiers. Bipolar advocates boast the excellent low-noise performance of these devices, while those preferring the

NOTX TABLE 1  
RECEIVER DYNAMIC RANGE COMPARISON

|                       | STANDARD LEVEL DBM | HIGH LEVEL DBM | BIPOLAR JUNCTION TRANS | MOS FET FIELD EFFECT | GaAs FET FIELD EFFECT |
|-----------------------|--------------------|----------------|------------------------|----------------------|-----------------------|
| Conversion Gain (dB)  | -6                 | -7             | 12                     | 17                   | 24                    |
| Noise Figure (dB)     | 7                  | 8              | 2                      | 3                    | 1                     |
| IMD Intercept (dBm)   | +4                 | +22            | -8                     | -2                   | +11                   |
| SSB Sensitivity (dBm) | -133               | -132           | -138                   | -137                 | -139                  |
| Maximum Input (dBm)   | -38                | -25            | -60                    | -59                  | -55                   |
| Dynamic Range (dB)    | 95                 | 107            | 78                     | 78                   | 84                    |

NOTE: Measurements were performed at 144 MHz, with representative devices. Results at other frequencies will vary, but comparisons will be similar.

MOS devices cite their higher gain and stable operation, which eliminates the need for neutralization. Figures 6 and 7 seem to indicate that neither device holds a clear advantage as far as overall system performance is concerned. The two representative amplifiers I tested in preparing this manuscript exhibited identical dynamic range.

Gallium-Arsenide Field Effect Transistors, on the other hand, are the undisputed winner in all areas of VHF and UHF performance. As indicated in fig. 8, the GaAs FET offers exceptional high gain, low noise, and wide dynamic range performance. If only they weren't so expensive!

summary

In evaluating receiver performance, it is necessary to consider dynamic range limitations, as well as noise figure, to select the combination of devices and circuits that will yield the best overall sensitivity. Table 1 summarizes the results of testing various competing mixer and preamplifier technologies. Although the tests were performed at 2 meters, we can generalize the results to other VHF and UHF bands as well.

It appears that best receiver performance will be achieved by cascading a GaAs FET preamplifier with a high-level doubly-balanced mixer. Two-tone analysis confirms that such a combination has considerable immunity to intermodulation and cross-modulation interference, while maintaining an impressively low-noise figure.

references

1. H.W. Bode, *Network Analysis and Feedback Amplifier Design*, D. Van Nostrand Co., Inc., New York, New York, 1945.
2. H.T. Friis, "Noise Figures of Radio Receivers," *Proceedings of the IRE*, July, 1944, page 419.
3. Joe Reisert, W1JR, "Ultra Low-Noise 432 MHz Preamplifier," *ham radio*, March, 1975, page 8.

This article was adapted from a paper originally presented at the 18th Conference of the Central States VHF Society, held in Cedar Rapids, Iowa, on 28 July, 1984, and appeared in the Proceedings of that conference.

ham radio

# Advanced Computer Control

... for your repeater

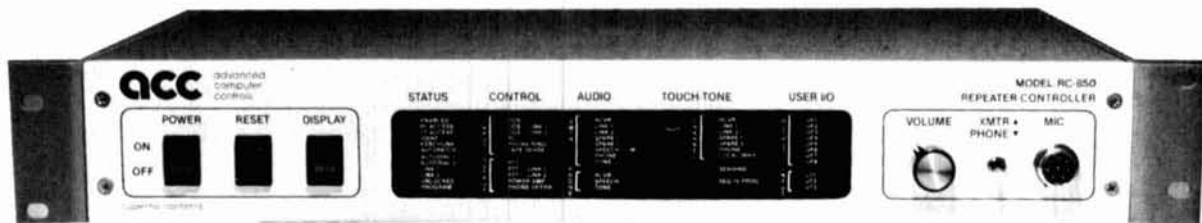

The RC-850 provides the most advanced technology available in repeater control. With "designed for the future" architecture that allows upgrade through software so that it will never be obsolete. Complete remote programmability with E<sup>2</sup>PROM via Touch-Tone™ or your personal computer. Offering unique features including the highest quality synthesized speech and fully automatic scheduled operation. Plus voice

response metering, synthesized remote base operation, paging, mailbox, and the most advanced autopatch available — anywhere! Designed for reliable, consistent, enjoyable operation in any system. Field proven in hundreds of commercial and amateur repeater installations. The RC-850 will **always** be the leader in high performance repeater control.

Available from \$1195\*\*

## The RC-85 Repeater Controller

The RC-850's "little brother"! Remotely programmable ID's, command codes, auto-dial numbers, timers, and more. The RC-85 controller includes many of the features pioneered by ACC such as synthesized speech, remote base, paging, and more. Now any repeater budget can afford the benefits of an ACC controller! All just \$895 (board) or \$995 (rack mount).\*



## The ITC-32 Intelligent Touch-Tone Control Board

Remote control at your fingertips with 28 commandable outputs, plus alarms, repeater and remote base control functions, response messages, and more. An ideal building block for your repeater.

An easy way to add a remote base to your system. Or even to remotely control your home.

Only \$389

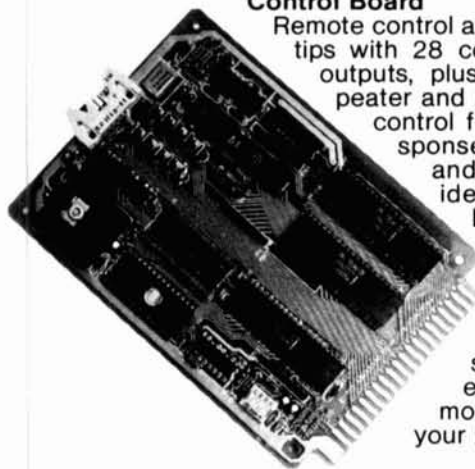

## NEW PRODUCTS

DVR 128 • Digital Voice Recorder — Solid state voice storage and playback for remote recording of ID's and announcements, voice mail, and user diagnostics.

IVS 6/12 • Intelligent Voting System — Six or twelve channel voting with DTMF remote control. In-band signal quality evaluation, audio equalization, and activity logging.

ShackMaster™ — Remotely control your home station using Touch-Tone commands over the air or over the telephone. Patch yourself through your home equipment onto the HF bands, and to VHF and UHF frequencies.

\*Includes a one year limited warranty

\*\*Includes a two year limited warranty

Call us for more information on our complete line of amateur and commercial repeater control products.

10816 Northridge Square, Cupertino, CA 95014 (408) 749-8330

**acc** advanced computer controls, inc.

## DIXIE ELECTRONICS

IS LOUISIANA'S ONE STOP ELECTRONICS STORE. THERE ARE NO TURKEY DEALS. JUST SUPER GOOD PRICES AND PROMPT DELIVERY. CALL ROBIN, WB5UXA, TODAY AND GET ALL THE DETAILS ON THE LINES IN STOCK.

AMATEUR RADIO EQUIPMENT

SATELLITE EQUIPMENT

**TEN-TEC**  
TEN-TEC

**MFJ**

**MIRAGE**

**HUSTLER**

**hy-gain**

**JPCA ZDEN**

**cushcraft**

full line of RF and other cables

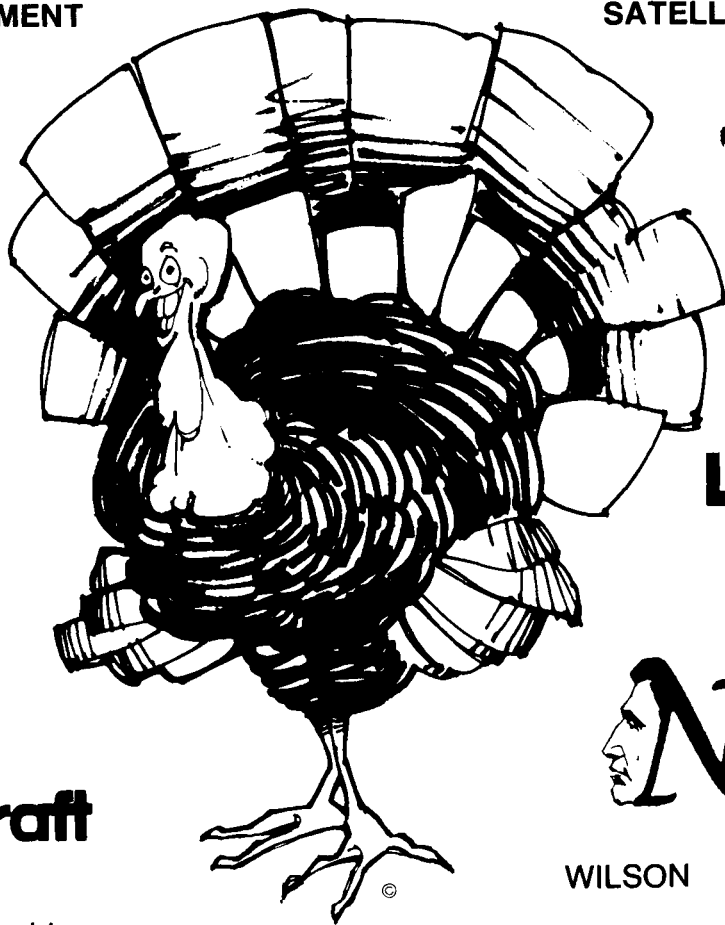

**ODOM**

**STS**

**LOWRANCE**

**PenTec**  
**MTI**  
Systems  
Produced  
in the U.S.A.

**Nampa**

WILSON

TRACKER

WE TALK TURKEY  
NO TURKEY DEALS

### HOLIDAY SPECIALS

Whistler Radar Detectors

|                 |       |
|-----------------|-------|
| Q 1200          | \$109 |
| Q 2000          | \$149 |
| Spectrum        | \$199 |
| Spectrum Remote | \$209 |

### Dixie Electronics

Robin Hudson, WB5UXA

LA WATS (800) 272-8293

Out of state WATS (800) 535-8134

2418 S. Philippe Avenue • Gonzales, LA 70737



# a pulsewidth noise discriminator

Impulse noise control works on time duration rather than amplitude

I think most hams would agree that the best impulse-noise squelch would be one that stopped each noise burst at its source. Unfortunately there are too many noise bursts arriving from too many directions to make such a thing possible. It's usually difficult to locate a local source; even if you do, the person responsible for the noise is often unwilling or unable to cooperate. Once launched, these disturbances seem determined to enter our receiving systems; when they do, they're repeatedly amplified, modified, and stretched as they race from antenna terminals to speaker. In short, once admitted, these unfriendly signals are actually made worse — often *much* worse — by your receiver's own circuits.

What happens at the output after a burst of noise arrives at your receiver's input is quite predictable. Some of the fast-changing wave front is absorbed by the first tuned circuit, then released in the form of ringing at this filter's natural resonant frequency. The resulting damped oscillation is then translated by a local oscillator, resulting in a rapid rise at the input of the IF filter, which absorbs some of the energy and then releases it in the form of ringing at *its* resonant frequency . . . and so on.

## basic noise control methods

Over the years a great many circuits have been tried in an effort to control impulse noise. Successful methods have been of two basic types: the noise blanker and the noise limiter. The well known Lamb filter (often called a hole-puncher, noise silencer, or noise blanker) takes a sample of each noise pulse from a receiver stage as near to the antenna as possible and, using fast circuits, forms a blanking pulse that momen-

tarily blocks the receiver's IF stage just before the ringing pulse of noise energy arrives. The blanking pulse is designed to embrace the ringing time caused by the filter characteristic. Some rise and fall time is usually added so the blanking function will not itself generate audible clicks at the receiver's output. This system has been around for a long time; properly designed, it works very well. But one problem with this technique is that it must be designed to go into action only on noise pulses that are significantly larger than desired signals in order to avoid the creation of excessive distortion.

Another form of impulse noise control is called the "peak limiter" system. Again, this method is restricted to noise signals whose peak amplitudes are above that of desired signals. When a noise burst is received, the desired signal is momentarily suppressed and the interference is limited in peak amplitude. Perhaps the best features of this noise control system are its simplicity and its ability to reduce possible damage to our ears caused by otherwise nearly unlimited sharp audio sound transients.

Neither method is effective in removing noise bursts of low to moderate amplitude, or of durations of greater than a few microseconds, which usually includes those "woodpecker" style noise disturbances. The majority of disturbances fall in the latter category, with high amplitude disturbances in the minority.

## pulsewidth noise discriminator

This article is about a third method that effectively handles a wide range of impulse noise amplitude levels and can be used either by itself or in conjunction with the more familiar methods described above. Furthermore it can be added at the *audio* output of any receiver. I have called this method the PND — Pulsewidth Noise Discriminator. Rather than working on peak amplitudes, this system makes use of time duration differences between the character of almost all desired signals and impulse noise. Impulse noise bursts at their origin exist for only a few nanoseconds to

By Don E. Hildreth, W6NRW, P.O. Box 60003, Sunnyvale, California 94088

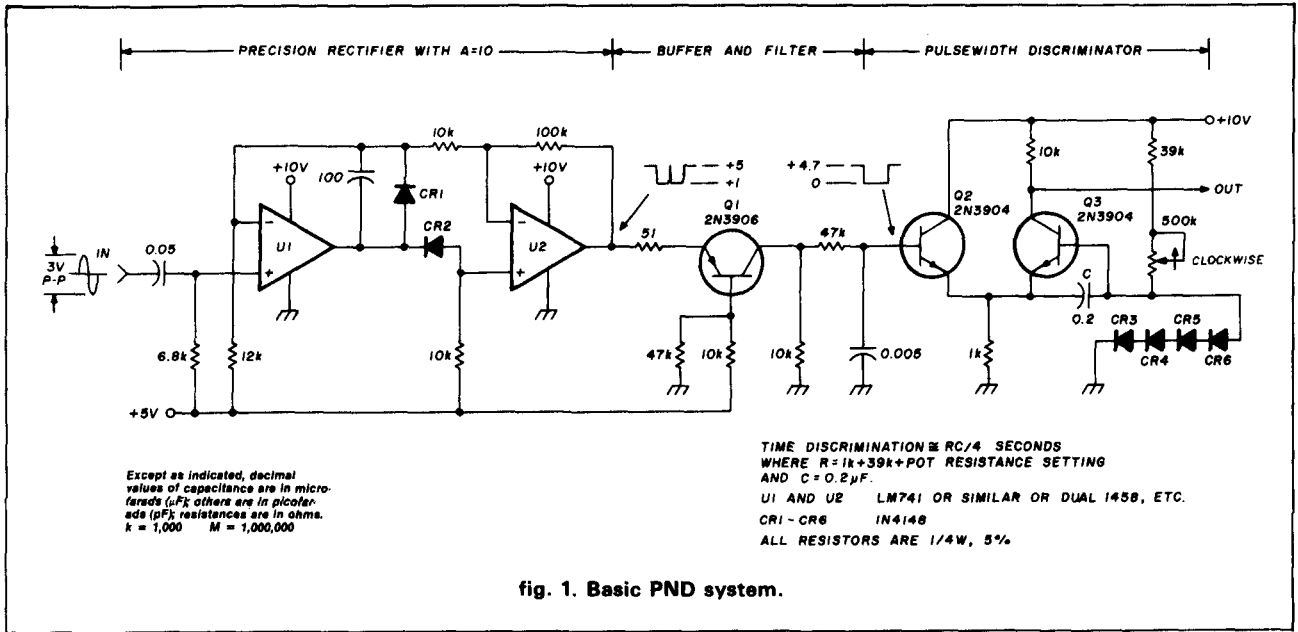

fig. 1. Basic PND system.

microseconds, but they are then transformed by receiver circuits into ringing bursts lasting from a little less than one millisecond up to as much as ten milliseconds, depending on the shape and bandwidth of the narrowest filter being used.<sup>1</sup> Concurrently, the vowel parts of desired SSB voice signals are fractions of a second long; even the shortest parts of CW are typically of 50 to 100 milliseconds duration for the "dit" and "space" lengths.

Using this data, a basic pulse width discriminator is designed to ignore any signal until it has existed for a selectable period of time — 10 milliseconds, for example — and will consequently block a noise pulse stretched by a typical 100 Hz bandwidth filter.

The circuit of fig. 1 is the basis of this system. When no signal is present, Q1 and Q2 are ON and Q3 is OFF. When a signal arrives, the precision rectifier formed by U1 and U2 develops a negative gate that turns off Q1 and Q2. However, Q3 remains off until the no-signal reverse charge of a nominal -2 volts on C, Q3's base to emitter capacitor, is bled off and reversed to the required level of approximately +0.7 volts by charging through R, which is made up of 1K + 39K + the 500K pot setting. When Q3 goes on, its collector voltage drops. It is this signal that is used to accept a desired signal or to reject those that are too short for completion of the timing cycle as determined by the effective value of R. A second and very desirable feature of the basic pulsewidth discriminator part of the circuit is that it resets very quickly, thereby avoiding the integration of noise pulses provided they are not too close together (equal to or less than the selected time discrimination period). This feature makes the full-wave rectification provided by U1 and U2 plus a small amount of filtering necessary to avoid a functional dropout between the cycles of a desired

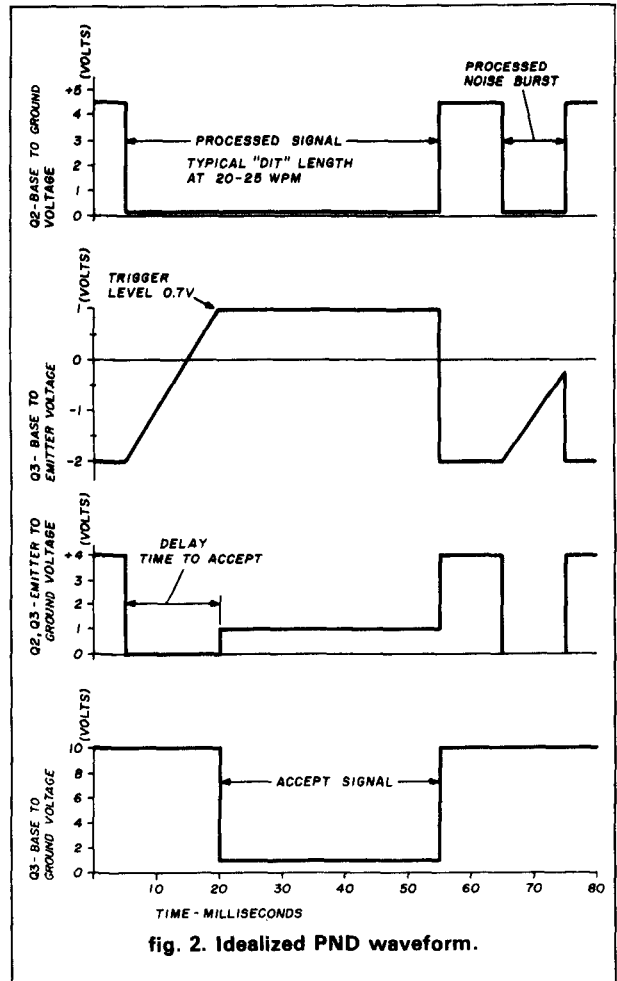

fig. 2. Idealized PND waveform.

signal. Using the specified circuit values, a minimum of 1 volt RMS is required for normal operation.

Fig. 2 shows what happens as a function of time. Since the pulsewidth discriminator circuit would ig-

nore a ringing or sinusoidal signal of any period, the incoming signal is transformed into a negative gate. An ideal gate pulse is shown for clarity. This use of an oscilloscope is convenient at the Q2 and Q3 emitter junction, to observe and measure the time discrimination performance.

### a PND application

Fig. 3 shows an application in which an audio filter feeds the pulse noise discriminator and the output of the discriminator is used to key an audio white-noise generator for listening to CW. (Of course you can have it key a tone oscillator if your prefer.) The mixer control is arranged to enable listening to CW directly through the filter, or to the noise generator, or to any mixture of the two. By connecting the control in this experimental way, you can test and experience how well this idea works: simply compare a non-noise discriminated 750 Hz CW output to the processed audio-noise CW output that is driven by the PND.

In operation, the +10 volt level at Q3's collector is used to squelch noise output from the dual op-amp

noise generator shown in fig. 3 or in the SSB output of fig. 4. When the PND system recognizes a signal, the Q3 collector level drops, opening the transistor switch Q2 of fig. 3 or Q1 of fig. 4. One undesirable feature of this noise control system relates to operating convenience: your receiver's output is normally OFF until a qualified signal appears. If you like to be aware of the noise floor, as I do, this can be a disadvantage, so I usually run the mixer control midway when looking for DX. Then, depending on conditions, I decide which way to twist this control. If I want to avoid the tinkling roar present when listening to a low-level signal through a narrow CW filter, I turn the control to admit only the keyed-noise signal with its silence between characters. But if I want to make use of the ear-brain filter capabilities (when there is more than one signal in the filter passband) then I turn the control to allow only the signal through the 750 Hz filter<sup>2</sup> to reach the power amplifier.

With the mixer control set toward keyed-noise operation, and with the delay control set at minimum, slowly increase the receiver gain at a no-signal spot

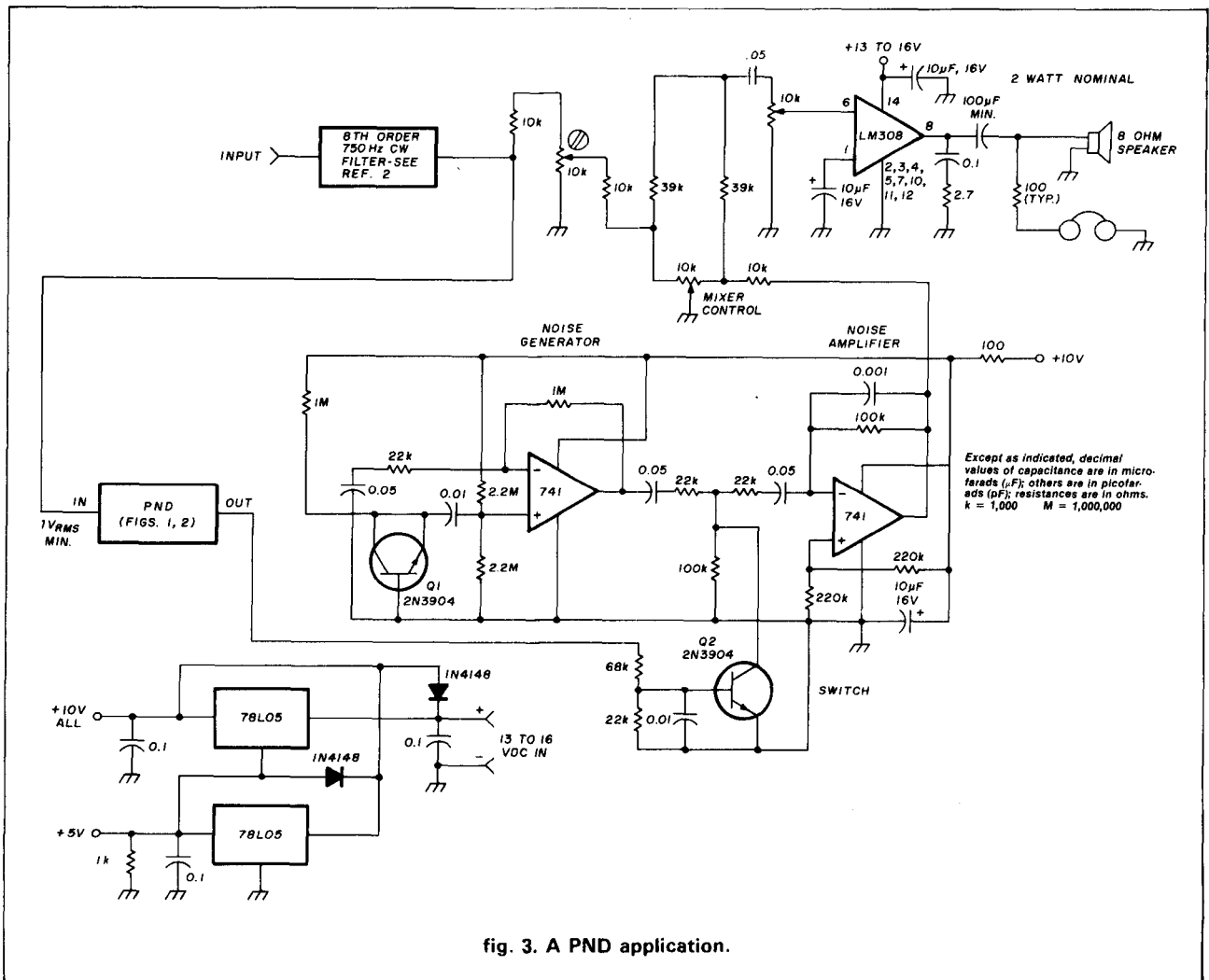
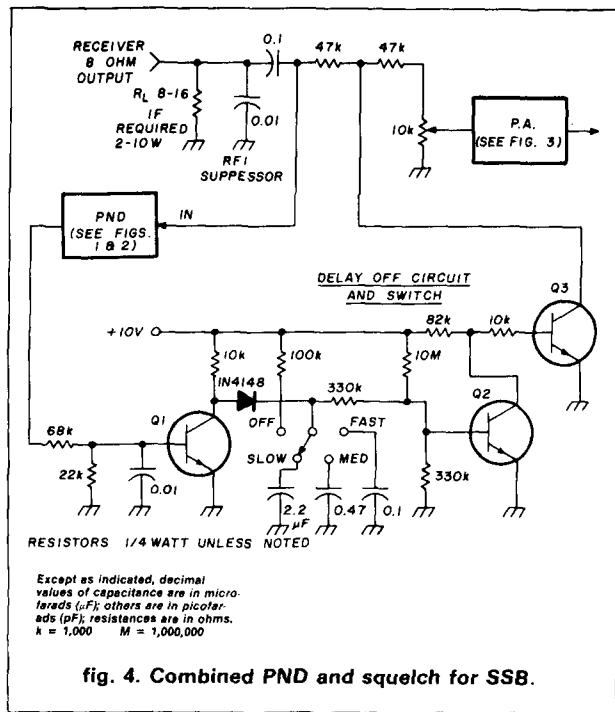

fig. 3. A PND application.



on the dial until the noise function starts to be heard sporadically. Increase the delay until the noise stops, then increase the delay just a bit more. This will match the delay to your filter bandwidth. If you are in a location that is too radio-quiet at the time, set the 500K pot at about mid-range for a nominal 12 millisecond delay. This will usually enable the rejection of noise pulses as they are stretched by a typical 100 Hz bandwidth filter. For best operation, the amplitude of a signal being received should be adjusted by your receiver's output level control to just a little above that required for reliable keying of the noise generator. Once this is done, the control at the output of the filter is set so that either the perceived level of keyed noise or the tone level are about the same when the mixer control is in any position. Adjust the volume control for the overall listening level desired. Once all of these settings are made, you will usually work with only your receiver's output control and the mixer control.

### single sideband

Although the electronic switch as driven by the PND system can follow code quite well, its use on SSB would result in choppy voice reception. To use PND on sideband it is best to insert a delay circuit between the PND circuitry and the electronic switch to keep the controlled audio stage ON for a short time after the PND has shut off. This technique was used with my laryngeal squelch<sup>3</sup> and that part of the circuit is included in **fig. 4**. If you use the voice-filter system,<sup>2</sup> you can either use PND to open both channels, or you can feed a sample of the vowel filter to PND and control the consonant filter with the delay/switch combi-

nation. If you use the vowel filter, the delay setting is about the same as that used for CW. However, if the normal 3 kHz voice bandwidth is used the delay may usually be reduced to its minimum. The PND system, in its basic form shown here, is not as effective for SSB as it is when used to key the noise generator for CW, for although noise is rejected between a voice signal's ON times, it can appear in addition to the desired signal during the ON periods. Circuit development to improve on this problem is being studied, but requirements are much more complex.

### general considerations

Although PND can handle most impulse noise problems unaided by the more prevalent noise silencers, it is still best to have a Lamb-type noise blanker in addition. Since the basic noise blanker blocks out noise bursts early in the receiver, it reduces the probability that strong pulses will drive one or several amplifier stages into heavy saturation, which can block a receiver for periods much longer than the offending noise-pulse length, and this is something that PND cannot help. Also, the front-end blanker system can suppress auto ignition pulses produced by an engine at moderately high RPMs, while PND is limited to rejecting auto ignition at idling RPMs when a 100 Hz bandwidth is used and at higher RPMs only when the bandwidth is increased. At the same time, PND can wipe out those woodpecker noise sources while their ON periods are too long for the Lamb blanker to handle. PND can be most effective when it is used in conjunction with either a blanker or a limiter, but use with a blanker is my first choice.

Because we are accustomed to using noise floor as a guide — and with PND you lose this reference — it's easy to run up your receiver gain much too high. Unfortunately, when the gain is too high, the noise-floor itself, even without an antenna, creates what amounts to a constant ringing level as it is stuffed through filters. Moreover, since the noise-floor in linear receivers is not limited, amplitude variations on this ringing can make a weird form of noise-floor-generated CW by the PND. When you hear this, just back off on the gain control a little to achieve silence.

### references

1. Don E. Hildreth, W6NRW, "Graphic Filter Design," *ham radio*, April, 1984, page 38.
2. Don E. Hildreth, W6NRW, "Communications Audio Processor for Reception," *ham radio*, January, 1980, page 71.
3. Don E. Hildreth, W6NRW, "Smart Squelch," *ham radio*, June, 1983, page 37.

### ham radio

A printed-circuit board (**fig. 3**) is available for \$9.95 postpaid; the PC board *plus parts* (no controls) is available for \$32.95 postpaid. Contact the author, Don Hildreth, W6NRW, P.O. Box 60003, Sunnyvale, California 94088.

## Join the New Industry Leader... Uniden®

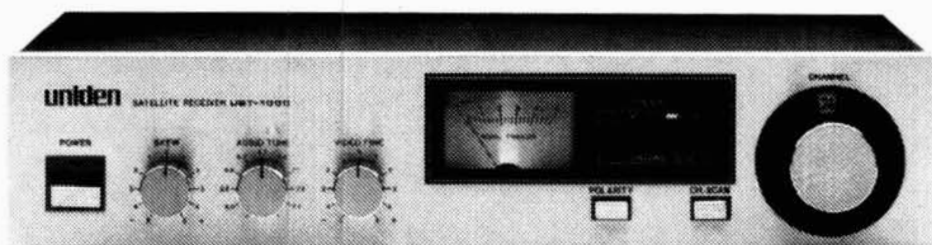

### UST 1000

Uniden's standard Satellite Receiver is a durable, low-cost, user-friendly satellite receiver that's a great value.

- Built-In Modulator
- Automatic Polarity Selector

- Video Fine Tuning
- Polarity Indicator Light
- Antenna Polarity Mode Switch
- Channel Scan
- Signal Strength Meter
- Weather-Sealed Down Converter



### UST 3000

Uniden's top-of-the-line unit gives you maximum performance capabilities along with the latest infrared circuitry.

It features:

- Digital LED Channel Indicator
- Built-In Modulator
- Automatic Polarity Selector
- Video Fine Tuning

- Both Fixed and Variable Audio Tuning
- Polarity Indicator Light
- Antenna Polarity Mode Switch
- TV/SAT Selector and Indicator
- Channel Scan
- Signal Strength Meter
- Optional Remote Control
- Weather-Sealed Down Converter
- Limited One Year Warranty

For low competitive prices on our Uniden receivers and our complete line of Uniden products, call Precision Satellite Systems at

**1-800-HOT-DISH**

**Dealers only please.**

Precision Satellite Systems, Inc.  
715 Grove Street  
Clearwater, FL 33515

## CALL 800-HOT-DISH

# IMD and intercept points of cascaded stages

Use this program  
to determine  
performance parameters

**Intercept point is a useful concept** in predicting the spurious intermodulation products generated by components, systems, or subsystems. Only the second-order and third-order products are significant. The intercept point is the power level at which the spurious response equals the fundamental response. The value may be referred to the input or output. Usually the output is referenced for amplifiers and mixers, and the

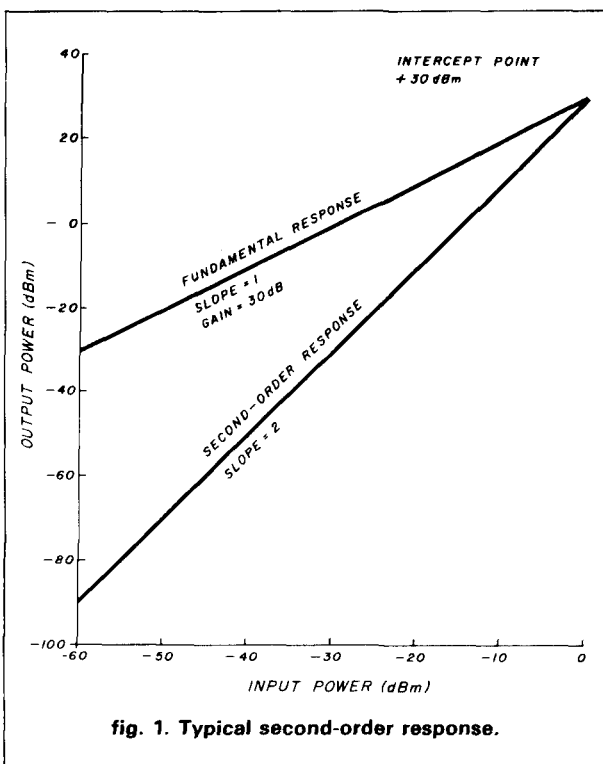

fig. 1. Typical second-order response.

input for receivers. The intercept points for the second-order and third-order products may be the same or different, depending on the circuit of the device. Typically the responses are plotted using log-log scales with the values in dBm as shown in **figs. 1 and 2**.

Assuming two signals at frequencies  $f_A$  and  $f_B$ , and  $f_A > f_B$ , the second-order products are:  $f_A + f_B$ ,  $f_A - f_B$ ,  $2f_A$ , and  $2f_B$ . The second harmonics are not strictly intermodulation products, but may be predicted in the same manner except that their amplitudes are 6 dB less than the sum and difference products. If the two fundamental frequencies are almost equal, the  $f_A - f_B$  term is near zero frequency and the remaining product is at about twice the fundamental frequencies. Half-octave filters can be used to attenuate the second-order products. Refer to **fig. 3** for the worst case with  $f_A$  and  $f_B$  at the band edges of a half-octave filter.

Third-order intermodulation products present the most serious problem for devices having bandwidths less than one-half octave. For two signals at frequencies  $f_A$  and  $f_B$ , the third-order products are:  $2f_A + f_B$ ,  $2f_A - f_B$ ,  $2f_B + f_A$ , and  $2f_B - f_A$ . For a narrow-band device centered at 20 MHz, two signals,  $f_A = 20.50$  MHz and  $f_B = 20.25$  MHz, will generate the third-order product  $2f_B - f_A$  at exactly 20 MHz. For three signals at frequencies  $f_A$ ,  $f_B$ , and  $f_C$ , the third-order products are:  $\pm f_A \pm f_B \pm f_C$ . Third-order products of three signals are seldom considered except for multi-frequency systems such as cable TV.

## measurement techniques

For single or cascaded components, intercept point is measured by driving the device with two equal amplitude signals and measuring the fundamental outputs and intermodulation products on a spectrum analyzer.

The concept of intercept point for a receiver is usually limited to the RF front end. It is meaningless for the IF passband because of the nonlinearities of detection

By William Richardson, W3IMG, 1003 Wagner Road, Baltimore, Maryland 21204

and gain control, as well as the high overall gain. Two equal level signals, outside the IF passband but within or as close as possible to the RF passband, are selected so that an intermodulation product is at the receiver center frequency. Their levels are simultaneously increased until an output (intermod) signal of about 10 dB signal-to-noise is observed. Record the level of the signals. Then the two signals are removed, and a single signal at the receiver center frequency is adjusted in level to produce the same output. Its level is also recorded. For third-order products the two signals are usually placed within the RF passband. However, for second-order products the signals fall out of the RF passband if the RF bandwidth is less than an octave. Refer to **fig. 3**. The most important second-order product in a receiver comes from a signal at one-half center frequency that doubles into the center frequency. This latter measurement is made by increasing the amplitude of a signal at one-half the receiver center frequency until an output signal of about 10 dB signal-to-noise is observed. Record the input level. This signal source must be well filtered so that its second harmonic is well below the second-order response. Next the input signal is tuned to the receiver center frequency and its level is adjusted to produce the same output, and this level is recorded.

When connecting two signals to the input, the insertion loss of the combiner must be subtracted from each generator output. A second precaution is to make all measurements at least 10 dB below the 1 dB compression point. Otherwise the device will be operating in its large signal area.

### second-order products

Refer to **fig. 1**. The slope of the second-order response is 2. As the fundamental output decreases by 1 dB, the second-order intermodulation products decrease by 2 dB. For two equal signals, the function may be expressed as:

$$IP = P + IMR \quad (1)$$

$IP$  is the second-order intercept point in dBm,  $P$  is the fundamental response in dBm, and  $IMR$  is the ratio between the fundamental and second-order responses in dB. In the case of a receiver,  $P$  is the level of the two signals or half-frequency input, and  $IMR$  is the ratio of  $P$  to the level of the signal at center frequency.

For example, if the fundamental outputs of an amplifier are  $-10$  dBm and the second-order intermodulation products are  $-45$  dBm, the second-order intercept point is:

$$IP = -10 + 35 = +25 \text{ dBm}$$

Knowing the intercept point, this equation will predict the second-order intermodulation products for known signal levels. For a single input signal, the same

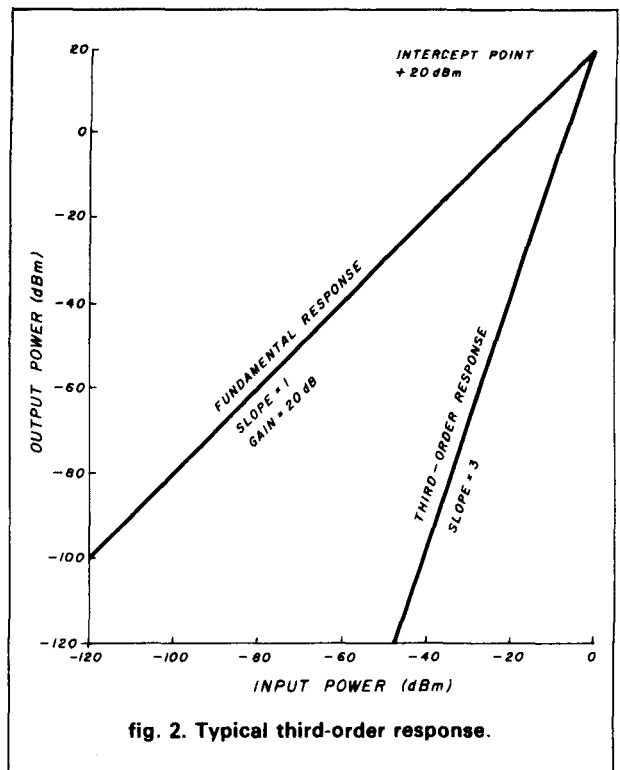

fig. 2. Typical third-order response.

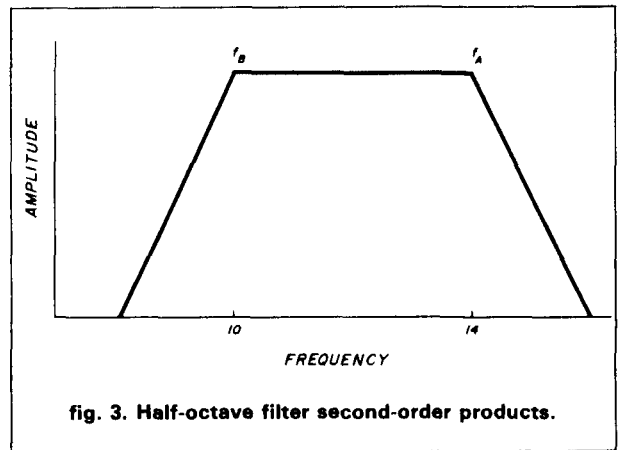

fig. 3. Half-octave filter second-order products.

methods can be used to calculate the intercept point if the second harmonic is measured, or to predict the second harmonic if the intercept point is known. However, the second-harmonic response is 6 dB less than a second-order intermodulation product.

The levels of the second-order intermodulation products are proportional to the product of the levels of the fundamental signals. For signals of unequal levels, the level of equal signals that produce the same intermodulation products can be calculated. If the levels are in dBm, add the two and divide by one-half. For two signals, one at  $-20$  dBm and the other at  $-26$  dBm, the equivalent equal amplitude signals are

**VECTOR POINTS UP A NEW ANTENNA ANGLE!**

# NOW 28<sup>FT</sup>, 75/80M ROTATABLE "SLOPER"

Remotely tunes to VSWR of less than 1.3:1 from 3.5 to 4MHz.

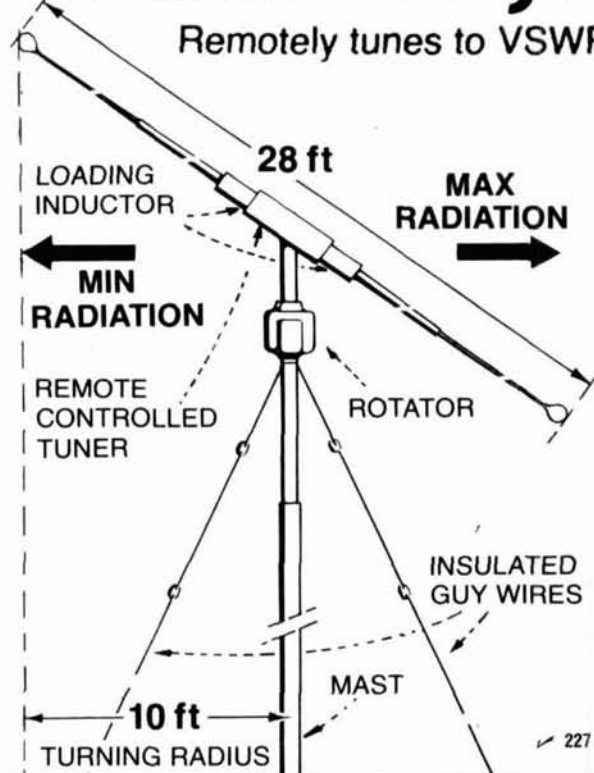

- Remote controlled, motor-driven tuning system optimizes "sloper" at any frequency in the 75-80M band!
- Sloping configuration can result in FB ratios up to 20dB depending upon ground conductivity and propagation angle.
- Low-angle forward lobe for DX plus high angle for short-haul skip.
- Requires no ground (except for lightning protection).
- 50 ohm coax feed plus 8 conductor control cable (not supplied).
- Outperforms some full size dipoles, inverted vee's and verticals.
- Light in weight (only 12 lbs). Complete system requires only supporting mast and TV-type rotator (8 sq. ft. rating).
- 40 meter model also available. Same characteristics.

**INTRODUCTORY  
PRICE**

**\$295**

**SHIPPED UPS PREPAID**

Calif. residents please add sales tax.



**VECTOR RADIO CO.**

P.O. Box 1166,  
Cardiff, CA 92007  
(619) 944-1063

## AMATEUR TELEVISION



### KPA5 1 WATT 70 CM ATV TRANSMITTER BOARD

- **APPLICATIONS:** Cordless portable TV camera for races & other public service events, remote VCR, etc. Remote control of R/C airplanes or robots. Show home video tapes, computer programs, repeat SSTV to local ATVers. DX depends on antennas and terrain typ. 1 to 40 miles.
- **FULL COLOR VIDEO & SOUND** on one small 3.25x4" board.
- **RUNS ON EXTERNAL 13.8 VDC** at 300 ma supply or battery.
- **TUNED WITH ONE CRYSTAL** on 426.25, 434.0, or 439.25 MHz.
- **2 AUDIO INPUTS** for a low Z dynamic and line level audio input found in most portable color cameras, VCRs, or home computers.
- **APPLICATION NOTES & schematic** supplied for typical external connections, packaging, and system operation.
- **PRICE ONLY \$159** delivered via UPS surface in the USA. Technician class amateur license or higher required for purchase and operation.

**WHAT IS REQUIRED FOR A COMPLETE OPERATING SYSTEM?** A TV set with a TVC-2 or TVC-4 420-450 MHz to channel 3 downconverter, 70 cm antenna, and coax cable to receive. Package up the KPA5, add 12 to 14 vdc, antenna, and any TV camera, VCR, or computer with a composite video output. Simple, eh?

**CALL OR WRITE FOR OUR COMPLETE CATALOG & more info** on atv downconverters, antennas, cameras, etc., or who is on in your area.

**TERMS:** Visa, Mastercard, or cash only UPS COD by telephone or mail. Telephone orders & postal MO usually shipped within 2 days. All other checks must clear before shipment. Transmitting equipment sold only to licensed amateurs verified in 1984 Callbook. Calif. include sales tax.

(818) 447-4565 m-f 8am-6pm pst.

**P.C. ELECTRONICS**  
Tom W6ORG Maryann WB6YSS



2522 Paxson Lane  
Arcadia CA 91006

## SATELLITE TELEVISION RECEIVER SEMIKIT

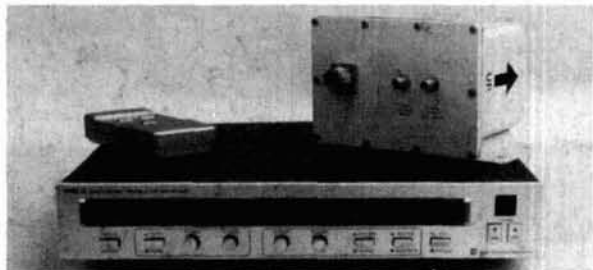

with dual conversion downconverter

### FEATURES:

- Infrared remote control tuning
- AFC, SAW filter
- RF or video output
- Stereo output
- Polarator controls
- LED channel & tuning indicators

Install six factory assembled circuit boards to complete.

|  |                 |
|--|-----------------|
| <b>SEMIKIT</b>                           | <b>\$400.00</b> |
| Completed downconverter add              | 100.00          |
| Completed receiver and downconverter add | 150.00          |

### JAMES WALTER SATELLITE RECEIVER

2697 Nickel, San Pablo, CA 94806 ✓ 230 Tel. 415-724-0587



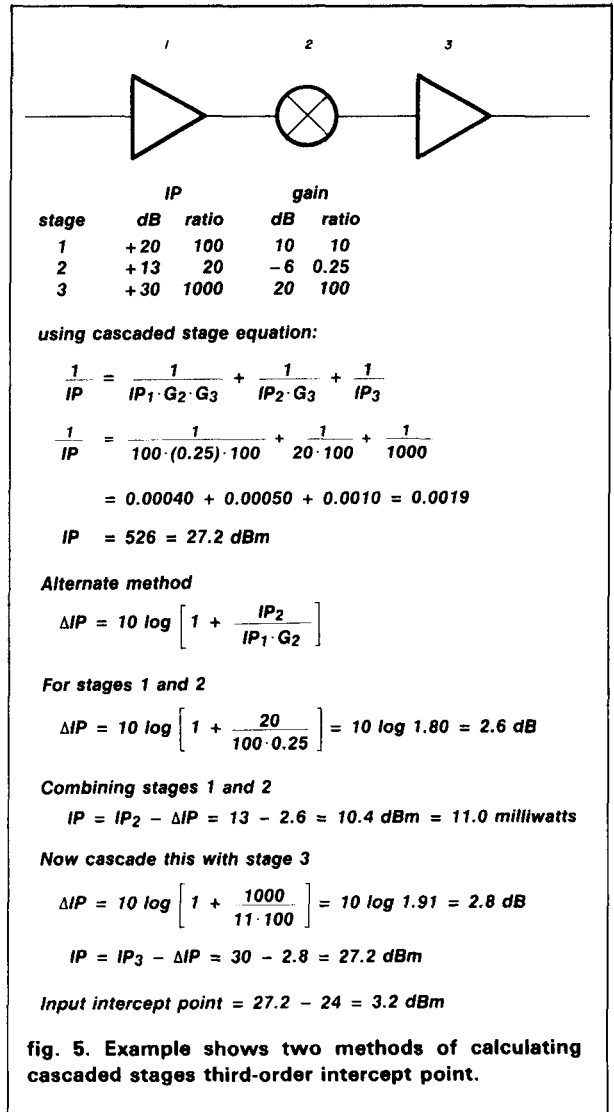
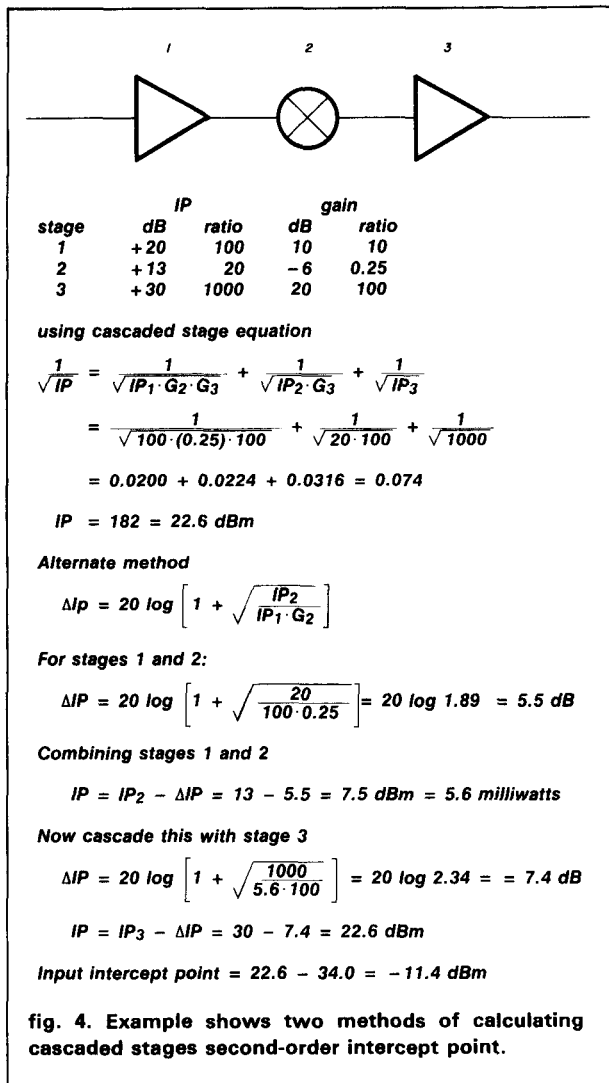

each at -23 dBm. If the levels are in milliwatts, the equivalent equal signal levels are each:

$$\sqrt{A_A \cdot A_B}$$

where  $A_A$  and  $A_B$  are individual signal levels.

If the second-order intercept point and gain of each stage are known, the overall intercept point of the cascaded stages may be found from the following formula:

$$\frac{1}{\sqrt{IP}} = \frac{1}{\sqrt{IP_1 \cdot G_2 \cdot G_3 \cdot G_4}} + \frac{1}{\sqrt{IP_2 \cdot G_3 \cdot G_4}} + \frac{1}{\sqrt{IP_3 \cdot G_4}} + \frac{1}{\sqrt{IP_4}} \quad (2)$$

Each term of the formula has the intercept point of the stage multiplied by the gain of all of the following stages. The terms are numerical ratios, not dB or dBm. A look at each term will indicate the contribution of each stage to the overall system intercept point.

Another method of calculating the overall intercept point of cascaded stages is to use the formula:

$$\Delta IP = 20 \log \left[ 1 + \sqrt{\frac{IP_2}{IP_1 \cdot G_2}} \right] \quad (3)$$

The  $\Delta IP$  is in dB and is subtracted from the second stage intercept point to give the overall intercept point of the two cascaded stages. For more than two stages, this formula is used for the first two stages, and that result is then used with the third stage and so forth.

Both formulas assume the worst case in which the intermodulation products within each stage add in phase. If a linear stage is part of the system, it must be included with its actual gain (or loss) and an infinite intercept point.

Refer to fig. 4 for sample calculations of the intercept point of three cascaded stages. The output intercept point is calculated. The input intercept point

# FOR THE BEST BUYS



## BURTON'S SATELLITE INC.

MEMBER OF  
**SPACE**

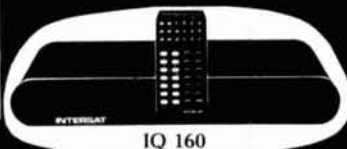
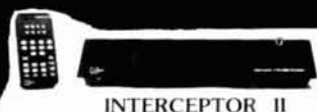

✓ 127



MICROWAVE  
SYSTEMS ENG.

PenTec  
**MTI**  
CHAPARRAL



INTERNET  
**STC**

DH SATELLITE

BRINGING  
THE  
FUTURE  
TO YOU  
TODAY

4995 HWY 35 BIGFORK, MT. 59911 (406) 837-5290 or 837-5416

## FULL BREAK-IN WITH ANY AMPLIFIER

IF YOU OWN A  
QSK TRANSCEIVER

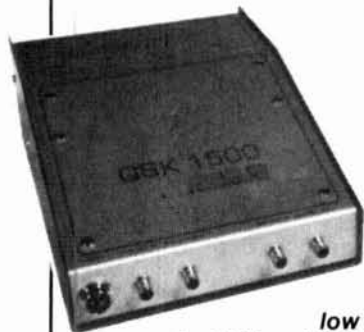

*Don't be limited to low power operation with your expensive full break-in transceiver. You can run high power QSK CW and high power AMTOR.*

The DEO QSK 1500 is designed using the latest in solid state switching technology and will give you full break-in operation with any one of the currently available commercial amplifiers, homebrew too! Pin diodes provide ultra high speed, noiseless switching. All you need to do is connect two RF cables and two control cables, turn it on and you are ready to go, up to 1500 watts at 1.5-1 VSWR. Fully automatic bandswitching, 1.8 - 30 MHz and mode selection, either CW or SSB, no cables to change. The QSK 1500 eliminates amplifier damage due to "hot switching" and gives you full receiver performance with an insertion loss less than .7 dB, typically .2 dB.

90 day limited warranty. ✓ 141 **For More Info Send QSL**

**\$299.00**

Please add \$6 for shipping and handling  
(US only Foreign FOB Groveport)



DESIGN ELECTRONICS OHIO  
4925 S. HAMILTON RD. GROVEPORT, OHIO 43125

## Free Antenna Accessories Catalog



### ◀ Coaxial Antenna Relays

Remotely select up to 9 antennas from your transmitter, using only *one* coaxial cable. Environmentalized, high power and low loss.

### W2AU and W2DU Baluns ▶

Our baluns, center insulators and insulators have been preferred for 20 years by Hams, industry, and the armed forces. Protect against TVI and lightning 1.8-200 MHz.



### ◀ W2VS Antenna Traps

Add these traps to your dipole and get low SWR on 2 to 6 bands, depending on how many you add. Antenna wire and custom kits also available.



### Send For Yours Today ▶

Don't delay. Call or write today, and we will send you free literature which fully describes our Ham antenna accessory product line.

Dealer inquiries also welcome.



6743 Kinne St., East Syracuse, NY 13057  
Toll Free 1-800-448-1666 TWX 710-541-0493  
NY/IL/AK/Canada (Collect) 315-437-3953

equals the output intercept point reduced by the total gain.

### third-order products

Refer to **fig. 2**. The slope of the third-order response is 3. As the fundamental output decreases by 1 dB, the third-order intermodulation products decrease by

3 dB. For equal signals, the curve may be expressed as:

$$IP = P + 1/2(IMR) \quad (4)$$

$IP$  is the third-order intercept point in dBm, and  $IMR$  is the ratio between the fundamental and third-order responses in dB. For the case of a receiver,  $P$  is the level of the two input signals and  $IMR$  is the ratio of  $P$  to the level of the signal at center frequency.

For example, if the fundamental outputs of an amplifier are  $-10$  dBm and the third-order intermodulation products are  $-50$  dBm, the third order intercept point is:

$$IP = -10 + 1/2(40) = +10 \text{ dBm}$$

Knowing the intercept point, the equation will predict the third-order intermodulation products for known signal levels.

The levels of the third-order intermodulation products are proportional to (1) the cube root of the product of three signals or (2) in the case of two signals, the cube root of the square of the higher level signal times the other. For signals of unequal levels, the equivalent equal level signals that produce the same intermodulation products can be calculated. If the levels are in dBm, for the two signals add 2/3 of the larger to 1/3 the smaller. If one signal is at  $-20$  dBm and the other at  $-32$  dBm, the equivalent equal level signals are at  $-24$  dBm. For three signals, add 1/3 of each level in dBm. If the levels are in milliwatts, the equivalent levels are

```

10 PRINT"INTERCEPT POINT OF CASCADED STAGES"
20 PRINT:PRINT
30 PRINT"2 SECOND-ORDER INTERMODULATION"
40 PRINT"3 THIRD-ORDER INTERMODULATION"
50 INPUT"SELECT 2 OR 3?"A$
60 INPUT"ENTER NUMBER OF STAGES":C
70 CLS
80 FOR N=1 TO C
90 PRINT"ENTER INTERCEPT POINT FOR STAGE":N;"IN DBM"
100 INPUT I(N)
110 PRINT"ENTER GAIN OF STAGE":N;"IN DB"
120 INPUT G(N)
130 NEXT N
140 CLS
150 PRINT"IP(DBM)","GAIN(DB)
160 PRINT
170 FOR N=1 TO C
180 PRINT I(N),G(N)
190 NEXT N
200 PRINT:INPUT"IS DATA OK Y/N?":B$
210 IF B$="N" THEN CLS
220 IF B$="Y" THEN GOTO 80
230 FOR N=1 TO C
240 I(N)=10*(I(N)/10)
250 G(N)=10*(G(N)/10)
260 NEXT N
270 E(C)=10*(C)-1/3*(C):IF A$="2" THEN D(C)=SDR(D(C))
280 FOR N=(C-1) TO 1 STEP -1
290 F(N)=G(N)+E(N+1)
300 D(N)=I(N)*E(N)
310 D(N)=1/D(N)
320 IF A$="2" THEN D(N)=SDR(D(N))
330 NEXT N
340 FOR N=1 TO C
350 IP(N)=D(N)+IP(N-1)
360 NEXT N
370 IP(C)=1/IP(C)
380 IP(C)=10*LOG(IP(C))/LOG(10):PRINT
390 IF A$="2" THEN IP(C)=2*IP(C)
400 IF A$="2" THEN PRINT "SECOND-ORDER INTERCEPT POINT IS ";IP(C);" DBM"
410 IF A$="3" THEN PRINT "THIRD-ORDER INTERCEPT POINT IS ";IP(C);" DBM"

```

**fig. 6. TRS-80 Model III program listing determines the intercept point of cascaded stages.**

```

INTERCEPT POINT OF CASCADED STAGES

2 SECOND-ORDER INTERMODULATION
3 THIRD-ORDER INTERMODULATION
SELECT 2 OR 3? 3
ENTER NUMBER OF STAGES? 3
ENTER INTERCEPT POINT FOR STAGE 1 IN DBM
? 20
ENTER GAIN OF STAGE 1 IN DB
? 10
ENTER INTERCEPT POINT FOR STAGE 2 IN DBM
? 13
ENTER GAIN OF STAGE 2 IN DB
? -6
ENTER INTERCEPT POINT FOR STAGE 3 IN DBM
? 30
ENTER GAIN OF STAGE 3 IN DB
? 20
IP(DBM)          GAIN(DB)

20                10
13                -6
30                20

IS DATA OK Y/N? Y

THIRD-ORDER INTERCEPT POINT IS 27.2141 DBM

```

**fig. 7. Three-stage device IMD intercept point calculation is simple with user-friendly program.**

$$\sqrt[3]{A_A \cdot A_B \cdot A_C} \text{ or } \sqrt[3]{A^2_A \cdot A_B}$$

where  $A_A$  is the highest level.

If the third-order intercept point and gain of each stage are known, the overall intercept point of cascaded stages may be found from the following formula:

$$\frac{1}{IP} = \frac{1}{IP_1 \cdot G_2 \cdot G_3 \cdot G_4} + \frac{1}{IP_2 \cdot G_3 \cdot G_4} + \frac{1}{IP_3 \cdot G_4} + \frac{1}{IP_4} \quad (4)$$

Each term of the formula has the intercept point of the stage multiplied by the gain of all the following stages. The terms are numerical ratios, not dB or dBm. A look at each term indicates the contribution of each stage to the overall system intercept point.

Another method of calculating the overall intercept point of cascaded stages is to use the formula:\*

$$\Delta IP = 10 \log \left[ 1 + \frac{IP_2}{IP_1 \cdot G_2} \right] \quad (5)$$

The  $\Delta IP$  is in dB and is subtracted from the second-

\*Note differences between eqs. 2 and 4 and 3 and 5. — Editor.

State  
of the art



by

K.V.G.

### 9 MHz CRYSTAL FILTERS

| MODEL    | Application | Bandwidth | Poles | Price   |
|----------|-------------|-----------|-------|---------|
| XF-9A    | SSB         | 2.4 kHz   | 5     | \$53.15 |
| XF-9B    | SSB         | 2.4 kHz   | 8     | 72.05   |
| XF-9B-01 | LSB         | 2.4 kHz   | 8     | 95.90   |
| XF-9B-02 | USB         | 2.4 kHz   | 8     | 95.90   |
| XF-9B-10 | SSB         | 2.4 kHz   | 10    | 125.65  |
| XF-9C    | AM          | 3.75 kHz  | 8     | 77.40   |
| XF-9D    | AM          | 5.0 kHz   | 8     | 77.40   |
| XF-9E    | FM          | 12.0 kHz  | 8     | 77.40   |
| XF-9M    | CW          | 500 Hz    | 4     | 54.10   |
| XF-9NB   | CW          | 500 Hz    | 8     | 95.90   |
| XF-9P    | CW          | 250 Hz    | 8     | 131.20  |
| XF910    | IF noise    | 15 kHz    | 2     | 17.15   |

### 10.7 MHz CRYSTAL FILTERS

|           |          |        |   |         |
|-----------|----------|--------|---|---------|
| XF107-A   | NBFM     | 12 kHz | 8 | \$67.30 |
| XF107-B   | NBFM     | 15 kHz | 8 | 67.30   |
| XF107-C   | WBFM     | 30 kHz | 8 | 67.30   |
| XF107-D   | WBFM     | 36 kHz | 8 | 67.30   |
| XF107-E   | Pix/Data | 40 kHz | 8 | 67.30   |
| XM107-SO4 | FM       | 14 kHz | 4 | 30.15   |

Export Inquiries Invited.

Shipping \$3.75

### MICROWAVE MODULES VHF & UHF EQUIPMENTS

Use your existing HF or 2M rig on other VHF or UHF bands.

### LOW NOISE RECEIVE CONVERTERS

|                  |  |              |          |
|------------------|--|--------------|----------|
| 1691 MHz         |  | MMk1691-137  | \$249.95 |
| 1296 MHz GaAsFET |  | MMk1296-144G | 149.95   |
| 432/435          |  | MMc432-28(S) | 74.95    |
| 439-ATV          |  | MMc439-Ch x  | 84.95    |
| 220 MHz          |  | MMc220-28    | 69.95    |
| 144 MHz          |  | MMc144-28    | 54.95    |

Options: Low NF (2.0 dB max., 1.25 dB max.), other bands & IF's available

### LINEAR TRANSVERTERS

|          |                     |               |          |
|----------|---------------------|---------------|----------|
| 1296 MHz | 1.8 W output, 2M in | MMt1296-144-G | \$299.95 |
| 432/435  | 10 W output, 10M in | MMt432-28(S)  | 259.95   |
| 144 MHz  | 10 W output, 10M in | MMt144-28     | 169.95   |

Other bands & IFs available.

### LINEAR POWER AMPLIFIERS

|          |              |               |        |
|----------|--------------|---------------|--------|
| 1296 MHz | 20 W output  | UP1296-20     | 439.95 |
| 432/435  | 100 W output | MML432-100    | 369.95 |
|          | 50 W output  | MML432-50     | 199.95 |
|          | 30 W output  | MML432-30-LS  | 209.95 |
| 144 MHz  | 100 W output | MML144-100-LS | 239.95 |
|          | 50 W output  | MML144-50-S   | 149.95 |
|          | 30 W output  | MML144-30-LS  | 109.95 |

All models include VOX T/R switching.  
"L" models 1 or 3W drive, others 10W drive.

Shipping: FOB Concord, Mass.

### ANTENNAS



#### 420-450 MHz MULTIBEAMS

|            |                   |                    |         |
|------------|-------------------|--------------------|---------|
| 48 Element | 70/MBM48 15.7 dBd | <del>\$75.75</del> | \$59.95 |
| 88 Element | 70/MBM88 18.5 dBd | <del>105.50</del>  | 89.95   |

#### 144-148 MHz J-SLOTS

|                   |            |          |         |
|-------------------|------------|----------|---------|
| 8 over 8 Hor. pol | DB/2M      | 12.3 dBd | \$63.40 |
| 8 by 8 Vert. pol  | DB/2M-vert | 12.3 dBd | 79.95   |
| 10 + 10 Twist     | 10XY/2M    | 11.3 dBd | 69.95   |

#### UHF LOOP YAGIS

|                        |                |       |
|------------------------|----------------|-------|
| 1250-1350 MHz 29 loops | 1296-LY 20 dbi | 47.95 |
| 1650-1750 MHz 29 loops | 1691-LY 20 dbi | 57.95 |

Order Loop-Yagi connector extra:

Type N \$14.95, SMA \$5.95

Send 40¢ (2 stamps) for full details of all your VHF & UHF equipment and KVG crystal product requirements.



si

(617) 263-2145  
SPECTRUM  
INTERNATIONAL, INC.  
Post Office Box 1084  
Concord, MA 01742, U.S.A.

stage intercept point to give the overall intercept point of the two cascaded stages. For more than two stages, this formula is used for the first two stages, and the result is then used with the third stage and so forth.

Both formulas assume the worst case in which the intermodulation products within each stage add in phase. If a linear stage is part of the system, it must be included with its actual gain (or loss) and an infinite intercept point.

Refer to **fig. 5** for a sample calculation of third-order intercept point for three cascaded stages. The output intercept point is calculated. The input intercept point equals the output intercept point reduced by the total gain.

### computer program aids calculation

**Figure 6** lists the steps of a typical BASIC language computer program for calculating the second-order and third-order intercept points of cascaded stages if the values for the individual stages are known.

**Figure 7** is a TRS-80 Model III™ printout showing a typical calculation of third-order IMD intercept point of a three-stage device.

ham radio

## AMATEUR TELEVISION

### ATV TRANSMITTER/CONVERTER

ALL YOU NEED IN ONE BOX



\$399 delivered  
TC-1 plus

- **OVER 10 WATTS PEP OUTPUT.** Crystal controlled continuous duty transmitter. Specify 439.25, 434.0, 426.25 standard or other 70 cm frequency. 2 freq. option add \$26.
- **BASE, MOBILE, or PORTABLE.** Use the builtin AC supply or external 13.8 vdc. Do parades, Marathons, CAP searches, etc.
- **TWO VIDEO AND AUDIO INPUTS** for camera, TVRO, VCR, or computer. Wide bandwidth for broadcast quality color video and computer graphics. Standard broadcast subcarrier sound which is heard thru the TV speaker.
- **RECEIVE ON YOUR STANDARD TV SET** tuned to channel 3 or 4. Sensitive varicap tuned TVC-2L downconverter covers simplex and repeater freq. over the whole 420-450 mHz 70 cm amateur band.
- **ATTRACTIVE 10.5 x 3 x 9 CABINET.**

CALL OR WRITE FOR OUR CATALOG or more information on ATV antennas, transmit modules, cameras, etc. or who is on in your area. See chapter 14 1984 ARRL Handbook.

TERMS: Visa, Mastercard, or cash only UPS CODs by telephone or mail. Postal money orders and telephone orders usually shipped within 2 days. All other checks must clear before shipment. Transmitting equipment sold only to licensed amateurs, verifiable in the 1984 call book.

(818) 447-4565 m-f 8am-6pm pst.

P.C. ELECTRONICS  
Tom W6ORG Maryann WB6YSS



2522 Paxson Lane  
Arcadia CA 91006

# HOME SATELLITE EARTH STATIONS!

## LEWIS ELECTRONICS STOCKS ITEMS FROM OVER 80 MANUFACTURERS

We invite you to compare our PRODUCTS, PRICES and SERVICE.

### COMPLETE SYSTEMS AS LOW AS \$869!

#### Receivers:

|            |            |            |         |        |
|------------|------------|------------|---------|--------|
| Arunta     | Drake      | Janeil     | Luxor   | S.T.S. |
| Astron     | El-Tech    | Keytronics | MA/Com  | Toki   |
| Auto-Tech. | Gen. Inst. | KLM        | Regency | Uniden |
| Boman      | Gillaspie  | Locom      | Sat-Tec | Wilson |

#### LNA's:

|             |           |        |        |          |
|-------------|-----------|--------|--------|----------|
| Avantek     | Gardiner  | Hytek  | Locom  | Regency  |
| Boman       | Gillaspie | M.S.E. | MA/Com | Winegard |
| Calif. Amp. |           |        |        |          |

#### Antennas:

|             |             |            |          |          |
|-------------|-------------|------------|----------|----------|
| Alpine      | Continental | Laux       | Prodelin | Wilson   |
| Cinci. Fib. | D. H.       | M & L      | Raydx    | Winegard |
| Conifer     | Janeil      | Paraclipse | Regency  |          |

#### Antenna Drives:

|            |                 |        |        |        |        |
|------------|-----------------|--------|--------|--------|--------|
| Pro-Sat    | Gillaspie       | Janeil | Luxor  | M.T.I. | T.D.F. |
| Gen. Inst. | Houston Tracker | Laux   | M.C.M. | S.T.S. | Vector |

#### Stereo Processors:

|        |       |        |         |  |
|--------|-------|--------|---------|--|
| Arunta | Drake | Janeil | Sat-Tec |  |
|--------|-------|--------|---------|--|

#### Antenna Feeds:

|       |           |        |               |  |
|-------|-----------|--------|---------------|--|
| Boman | Chaparral | MA/Com | International |  |
|-------|-----------|--------|---------------|--|

#### Accessories:

|                   |                |                   |            |
|-------------------|----------------|-------------------|------------|
| Aim               | Fuji           | Marshall Electric | Regency    |
| Amphenol          | General Inst.  | Mayes Brothers    | S.G.C.     |
| Arunta            | ITT            | Microwave Consul. | Saxton     |
| Avantek           | Ideal          | Microwave Filter  | Sharp      |
| Beldon            | Ikko           | Newton            | Stand-By   |
| Belmoor           | Intermagnetics | Nexus             | Swire Mag. |
| Blonder-Tongue    | International  | P.C.M.            | Tru-Spec   |
| Brown Electronics | Itera          | Panasonic         | Ultima     |
| Calif. Amplifier  | Lindsay        | Pfanstiehl        | Walden     |
| Com Scope         | M & M          | R.C.A.            | Winegard   |
| Drake             | MA/Com         | Radio Shack       | Xtra-Link  |

LEWIS ELECTRONICS COMPANY  
P.O. BOX 100 WEST ELM STREET  
HUMBOLDT, TENNESSEE 38343  
(901) 784-2191

# HIGH PERFORMANCE PRESELECTOR-PREAMP

The solution to most interference, intermod, and desense problems in **AMATEUR** and **COMMERCIAL** systems.



- 40 to 1000 Mhz - tuned to your frequency
- 5 large helical resonators
- Low noise - High overload resistance
- 8 dB gain - ultimate rejection > 80 dB
- 10 to 15 volts DC operation
- Size - 1.6 x 2.6 x 4.75" exc. connectors
- **FANTASTIC REJECTION!**

Typical rejection:

- ± 600 KHz@144 Mhz: -28dB
- ± 1.6 Mhz@220 Mhz: -40dB
- ± 5 Mhz@450 Mhz: -50dB

Price - **\$89.95** bipolar w/RCA jacks  
Connector options: BNC \$5, UHF \$6,  
N \$10

**SUPER HOT!** GaAs Fet option \$20

# AUTOMATIC IDENTIFIERS



ID-1



ID-2

- For transceivers and repeaters - **AMATEUR** and **COMMERCIAL**
- Automatic operation - adjustable speed and amplitude
- Small size - easy installation - 7 to 15 volts DC
- 8 selectable, reprogrammable messages - each up to 2 min. long
- Wired, tested, and programmed with your message(s)

Model ID-1 - \$49.95 Model ID-2 w/2 to 10 minute timer - \$69.95

We offer a complete line of transmitter and receiver strips and synthesizers for amateur and commercial use.

Request our free catalog. Allow \$2 for UPS shipping - Mastercard and VISA welcome

# GLB ELECTRONICS

1952 Clinton St. Buffalo, NY 14206  
716-824-7936, 9 to 4

✓ 158

**Use Your Wireless Control FROM ANY ROOM!!!**

Works with most infrared remote control receivers.

LIKE HAVING A SATELLITE RECEIVER, VCR, CABLE TV, AND VIDEO DISC IN EVERY ROOM!

- Remote-control Satellite Receiver, VCR, Cable TV, and Video Disc can now be used long distance
- Install on any TV to access all your remote control video components
- Makes non-remote TVs remote controllable with remote control VCR, Cable Selector, or Satellite Receiver.
- No fancy wiring needed: uses existing coaxial wiring between TVs
- No extra controls to buy! Uses the hand-held remote controllers you already have
- No tools required. Easily installed in minutes.



**\$79<sup>95</sup>**

Plus \$3.00 shipping & handling

**608-493-2291**

DEALER INQUIRIES WELCOME

**MERRIMAC**  
**SATELLITE**

327 Palisade St. Merrimac WI 53561

SPACE



✓ 181

**DO YOU KNOW WHERE TO FIND REAL BARGAINS**



on **NEW** and **USED** **ELECTRONIC** Equipment?

**You'll Find Them in the Nation's No. 1 Electronic Shopper Magazine**

# NUTS & VOLTS

**Now in Our 5th Year**

Nuts & Volts is published MONTHLY and features:

**NEW STATE-OF-THE-ART PRODUCTS • SURPLUS EQUIPMENT • USED BARGAINS • LOW COST AD RATES • PRIVATE AND COMMERCIAL CLASSIFIEDS • NATIONAL CIRCULATION • NEW PRODUCT NEWS SECTION • AND A FREE CLASSIFIED AD WITH YOUR SUBSCRIPTION**

## SUBSCRIPTION RATES

- One Year - 3rd Class Mail ..... \$10.00
- One Year - 1st Class Mail ..... \$15.00
- One Year - Canada & Mexico (in U.S. Funds) .. \$18.00
- Lifetime - 3rd Class Mail (U.S. Only) ..... \$35.00

## ORDER NOW!

SEND:  CHECK  MONEY ORDER  
 VISA  MASTERCARD

TO: **NUTS & VOLTS MAGAZINE**  
**P.O. BOX 1111-H**  
**PLACENTIA, CALIFORNIA 92670**  
**(714) 632-7721**

Name \_\_\_\_\_  
Address \_\_\_\_\_  
City \_\_\_\_\_  
State \_\_\_\_\_ Zip \_\_\_\_\_  
Card No. \_\_\_\_\_  
Exp. Date \_\_\_\_\_

**IF YOU'RE INTO ELECTRONICS, THIS MAGAZINE WILL SAVE YOU MONEY!**

Dealer Inquiries Invited

✓ 195

# the Russian Woodpecker: a continuing nuisance

## What it is and what can be done

**It never fails . . . you're working some choice DX** on 20 meters for your 300th country or you're in one of the Area traffic nets, trying to pass a message to another ham a thousand miles away. Suddenly, without warning, the band is shattered by something that sounds like a cross between a machine gun and a jackhammer. No, it's not the neighbor's power saw or the family microwave oven . . . it's the Russian Woodpecker in full operation. With the interference level running 10 to 20 dB over S9, your much-needed contact is buried under this avalanche of QRM and heard no more. The only solution is to turn off the rig and cool down with a tall, cold 807.

What is the Woodpecker? Why is it in operation? And why does the Soviet Union persist in creating this level of interference worldwide? What can we do about it? And what have other radio services and users of the spectrum done? This article will explore the aspects of this problem and suggest some possible solutions.

Basically, the Russian Woodpecker is an extremely powerful over-the-horizon radar system. It operates over most of the HF band, with effective radiated power levels of some 10 to 50 megawatts. To understand the nature of this problem, we need to have a basic understanding of how OTHB (Over-The-Horizon-Backscatter) radar operates, some sense of the history

of experimentation and operation in this field, and an educated awareness of Soviet diplomatic response to complaints about the interference their system is generating.

### basic radar operation

It has long been recognized that radar can be operated on any frequency. The earliest radar systems — built by the British and responsible for much of that nation's success during the Battle of Britain — were operated at a frequency around 30 MHz. This was due, in part, to 30 MHz being the highest frequency at which significant levels of power could be generated. Later radar systems were operated at much higher frequencies as technology developed tubes capable of generating multi-kilowatt levels of power at shorter and shorter wavelengths. Moving through the spectrum from VHF to UHF and finally into the microwave regions, radar engineers have traditionally sought the highest possible frequency of operation for several reasons. Shorter wavelengths bring increased target resolution and give the system, as a whole, increased immunity to interference, either natural or man-made. In addition, highly directional antennas become physically smaller, making possible the design of mobile radar units with greater target discrimination.

Unfortunately, all these radar systems suffer from a single common defect: they can operate only on line-of-sight. This means that at greater distances, the target must be at higher altitudes in order to be detected. Aircraft or cruise missiles flying at very low altitudes can escape radar detection

**By Bradley Wells, KR7L, 5053 37th Avenue,  
S.W., Seattle, Washington 98126**

until they are almost on top of the radar transmitter. Thus, several aircraft flying at tree-top level could approach and neutralize radar installations undetected, leaving a blind spot through which an enemy could pour aircraft or missiles. This scenario, dealing with the problem of low level detection, has left many a defense planner, both American and Soviet, in a cold sweat.

### lower frequencies provided new opportunities

It had been recognized by many that some form of high-frequency radar, utilizing backscatter techniques, could detect these low-level targets. Since the radar signal would be reflected off the ionosphere and illuminate the target from above, there would be no escape from this type of detection system. It was also recognized that there were several inherent problems in this approach. First, the ionosphere was thought to be in a state of continuous flux, unable to provide stable refraction characteristics for any length of time; second, there would be continuous interference both to and from other users of the HF spectrum; and, finally, the reception of backscattered signals would require extremely complex detection systems.

By the early 1970's, scientific inquiry and experiments brought new light to this gloomy picture. The widespread use of ionospheric sounders, both ground-based and satellite, had shown the ionosphere to be more stable than previously thought. It was discovered that the refractive characteristics of the ionosphere changed very little in the short term — that is, for periods of approximately 30 minutes, the ionosphere is remarkably homogeneous. During the course of a day, these characteristics change in response to shifts of solar flux and geomagnetic activity. This meant a radar system would have to be capable of operating over much of the HF band to provide coverage of selected areas. Simply put, the radar would have to be frequency-agile to follow these changes in the Maximum Usable Frequency (MUF).

The explosion of computer technology made possible the correlation and analysis of weak backscattered signals on a real-time basis. Using cross-correlation reception techniques coupled with the development of magnetic drums for data storage, high-speed computers were used to sort out interference in the system. These computers could not only discern a weak target signal from ground clutter but also selectively filter out other users of the HF spectrum.

### early OTHBs

In the 1950's, the United States Naval Research Laboratory and other groups began small-scale experiments with OTHB radar. These early experiments led to the solution of some of the major problems in de-

signing a functional HF radar. Among these problems were the following:

- The return from prospective targets would be 40 to 80 dB weaker than the ground return (i.e., ground clutter).
- It was not known whether sufficient angular resolution could be developed at HF wavelengths to permit accurate target identification.
- Extremely precise doppler techniques would have to be used to permit identification.

The magnitude of this doppler problem may be seen in the following equation:

$$fd = \frac{2 V_r f_o}{C}$$

$fd$  represents the doppler shift,  $f_o$  represents the radar carrier frequency,  $V_r$  is the target relative velocity, and  $C$  is the speed of light. For aircraft type targets, the doppler shift varies from tenths of a Hertz upward to 50 Hz. This is dependent upon the operating frequency. The development of technologies to deal with these and other problems have resulted in the operation of both American and Soviet OTHB radar systems.

Both the American CONUS OTH-B (Continental United States Over-The-Horizon Backscatter — see sidebar, page 43) and the Soviet Woodpecker share characteristics common to all HF radars. The interaction of these characteristics may be seen from an examination of the radar range equation:

$$R_{MAX} = \frac{P_{AV} G_T G_R \lambda^2 \sigma F_P T_C}{(4\pi)^3 N_o (S/N) L_S}$$

- where  $R_{MAX}$  = maximum range  
 $P_{AV}$  = average power  
 $G_T$  = gain of transmitting antenna  
 $G_R$  = gain of receiving antenna  
 $\lambda$  = wavelength  
 $\sigma$  = target cross section  
 $F_P$  = propagation effects factor  
 $T_C$  = coherent processing time  
 $N_o$  = noise power/unit bandwidth  
 $S/N$  = signal to noise ratio required for detection  
 $L_S$  = system losses

The major differences between HF and microwave radar systems are related to the following:

- Propagation effects — energy loss over ionospheric paths, polarization mismatch between transmitted and received signals, and gains or losses related to the dynamic nature of the transmission path.
- The amount of noise injected into the system by natural sources (i.e., distant thunderstorms) and, more importantly, by other users of the HF spectrum



(e.g., international broadcasting, Amateurs, Maritime mobile, etc.).

- Processing time (the number of hits integrated divided by the pulse-repetition frequency) — important since doppler radar requires a dwell time of  $T_C$  seconds to realize a frequency resolution of  $1/T_C$  Hertz.

The transmitted waveform for HF radar systems is similar to that of microwave systems. It can be CW, pulse, FM-CW, or some other coded mode of transmission. OTHB radar have different problems with detection at minimum ranges than do microwave radars. This is because of the existence of a skip zone — that region, familiar to all hams, from which no signal is received. This skip zone accounts for HF radar's inability to detect targets closer than 1000 km to the transmitter.

A long pulse is used in HF radar to increase the sensitivity of the system and may reduce to interference levels associated with pulse modulation. In addition, the pulse repetition frequency is normally low to avoid range ambiguities. A PRF of 50 Hz will yield an unambiguous range of some 3000 km. Individual pulse widths may range from tens of microseconds to several milliseconds depending upon the sensitivity desired and the desire to reduce interference to other services.

### antenna requirements are severe

OTHB radar places more demands upon the anten-

## the solar jammer

At frequencies in the high HF and low VHF range, natural extra-terrestrial sources of interference can play havoc with radar systems. During the height of the Battle of Britain, for example, British radars operating around 30 MHz were suddenly jammed by a strange, unknown signal. The interference became so severe that the British High Command felt sure it was some new and very effective form of German jamming. A group of engineers and astronomers, led by Stanley Hey, was detailed to locate the source and develop countermeasures. Together they determined that the interference appeared to originate in the area of the Sun. After photographs revealed a large sunspot group on the surface of the Sun, Hey concluded that the intensity of interference was related to the size and position of the sunspots on the solar surface. This discovery, confirmed by other investigators, led to the post-war development of solar radio astronomy.

na system than do other types of radar. The antenna must be physically large because of the low frequencies involved, be capable of handling very large amounts of power, exhibit gain and directivity over a wide range of frequencies, and be steerable in both elevation and azimuth. Typically the antenna consists of phased arrays of vertical bowtie driven elements in front of screen reflectors. The antenna lobes are steered in azimuth and elevation by shifting the phase relationships between individual active elements. Normally, separate antennas are used for transmitting and receiving. While this increases the problems of synchronizing the transmitter with the receiver, it is more than offset by the simplification of antenna construction. To place the first lobe as near horizontal as possible, an extended ground screen is placed in front of the array. This ground screen may extend up to 3000 meters in front of and be as wide as the antenna array.

Changes in the ionosphere bring about changes in the MUF. HF radar adapts to these changing conditions by shifting its operating frequency. The ionosphere is probed with a sounder and the profiles are updated constantly. This gives real-time information as to what the best operating frequency for coverage of a particular area of interest will be. The relationship between vertical profiles and transmission paths can be seen from **figs. 1 and 2**. As the transmission frequency approaches the MUF, the paths lengthen, providing the maximum distance in a single hop transmission. Operating at or near the MUF greatly reduces path losses. Since these radar systems are not limited to a few discrete bands of frequencies, as are other services (including hams), they can follow the MUF quite closely.

The reliability of HF radar is related to antenna size, radiated power, and the range of frequencies used. These factors can overcome shortcomings in the reliability of the ionospheric paths. The ionosphere places limits on operation in both summer and winter, but for different reasons. In summer, ionization extends well into the lower regions, which normally contain neutral particles. Thus strengthened, the D-layer causes increased path loss. During the winter, decreased solar radiation creates lower electron densities in the F-layer and results in lower frequencies being required for reliable transmission. Several other problems exist because of changes within the ionosphere. These problems include the following:

- Propagation velocity is frequency dependent which places lower limits on pulse length and range resolution.
- The refractive characteristics of the ionosphere allow specific areas to be covered only by a narrow range of frequencies at any given moment.

# RECEIVE WEATHER CHARTS IN YOUR HOME!



## You can DX and receive weather charts from around the world.

Tune in on free, worldwide government weather services. Some transmitting sites even send weather satellite cloud cover pictures!

## You've heard those curious facsimile sounds while tuning through the bands—now capture these signals on paper!

Assemble ALDEN's new radiofacsimile Weather Chart Recorder Kit, hook it up to a stable HF general-coverage receiver, and you're on your way to enjoying a new hobby activity with many practical applications. Amateurs, pilots, and educators can now receive the same graphic printouts of high-quality, detailed weather charts and oceanographic data used by commercial and government personnel.

## Easy to assemble—Backed by the ALDEN name.

For over 40 years, ALDEN has led the way in the design and manufacture of the finest weather facsimile recording systems delivered to customers worldwide. This recorder kit includes pre-assembled and tested circuit boards and mechanical assemblies. All fit together in a durable, attractive case that adds the finishing professional touch.

## Buy in kit form and save \$1,000!

You do the final assembly. You save \$1,000. Complete, easy-to-follow illustrated instructions for assembly, checkout, and operation. And ALDEN backs these kits with a one-year limited warranty on all parts.

## Easy to order.

Only \$995 for the complete ALDEN Weather Chart Recorder Kit.

To order, fill out and mail the coupon below. For cash orders enclose a check or money order for \$995. Add \$5 for shipping and handling in the U.S. and Canada, plus applicable sales tax for CA, CO, CT, IA, MA, NY, WI. (Export price is \$1250 F.O.B. Westborough, MA. Specify 50 or 60 Hz.) To use your MasterCard or Visa by phone, call (617) 366-8851.

## ALDEN ELECTRONICS

Washington Street, Westborough, MA 01581

|   |                         |  |  |  |  |  |  |  |  |  |  |  |  |
|---|-------------------------|--|--|--|--|--|--|--|--|--|--|--|--|
| NAME: _____   |                         |  |  |  |  |  |  |  |  |  |  |  |  |
| CALLSIGN: _____   |                         |  |  |  |  |  |  |  |  |  |  |  |  |
| ADDRESS: _____  |                         |  |  |  |  |  |  |  |  |  |  |  |  |
| CITY: _____   | STATE: _____ ZIP: _____ |  |  |  |  |  |  |  |  |  |  |  |  |
| <input type="checkbox"/> I've enclosed a check or money order for \$995.00 and \$5.00 for shipping and handling, plus applicable sales tax.   |                         |  |  |  |  |  |  |  |  |  |  |  |  |
| <input type="checkbox"/> Charge to: <input type="checkbox"/> MasterCard  <input type="checkbox"/> Visa    |                         |  |  |  |  |  |  |  |  |  |  |  |  |
| ACCOUNT # (ALL DIGITS)  |                         |  |  |  |  |  |  |  |  |  |  |  |  |
| <table border="1" style="width:100%; height:15px;"> <tr> <td style="width:10%;"></td> <td style="width:10%;"></td> <td style="width:10%;"></td> <td style="width:10%;"></td> <td style="width:10%;"></td> <td style="width:10%;"></td> <td style="width:10%;"></td> <td style="width:10%;"></td> <td style="width:10%;"></td> <td style="width:10%;"></td> <td style="width:10%;"></td> <td style="width:10%;"></td> </tr> </table> |                         |  |  |  |  |  |  |  |  |  |  |  |  |
|   |                         |  |  |  |  |  |  |  |  |  |  |  |  |
| EXPIRATION DATE   |                         |  |  |  |  |  |  |  |  |  |  |  |  |
| <table border="1" style="width:100%; height:20px;"> <tr> <td style="width:20%;"></td> <td style="width:5%;"></td> <td style="width:20%;"></td> <td style="width:5%;"></td> <td style="width:20%;"></td> <td style="width:5%;"></td> <td style="width:20%;"></td> </tr> </table>   |                         |  |  |  |  |  |  |  |  |  |  |  |  |
|   |                         |  |  |  |  |  |  |  |  |  |  |  |  |
| SIGNATURE REQUIRED IF USING CREDIT CARD _____   |                         |  |  |  |  |  |  |  |  |  |  |  |  |

**table 1. Current capabilities of United States and USSR OTHB radars.**

|                          |  |
|--------------------------|--|
| range coverage:          | 1000-4000 km, with longer ranges possible through multiple-hop transmissions.  |
| angle coverage:          | 360 degrees in azimuth possible, but less than 120 degrees typical.  |
| range resolution:        | As low as 2 km, with 20-40 km typical.   |
| absolute range accuracy: | 10-20 km, assuming accurate and timely assessments of the ionosphere and optimum operating frequency.  |
| angle resolution:        | Determined by beamwidth. It can be as low as 1 degree, which corresponds to 50 km at a range of 3000 km.   |
| Doppler resolution:      | Generally resolution of 1/10 Hz is possible. At an operating frequency of 20 MHz it corresponds to a target velocity of just under 2 MPH.  |
| level of interference:   | Dependent upon such factors as frequency of operation, antenna design, power level, type of modulation, area of illumination, and duration of operation at any particular frequency. |

- The propagation medium is filled with unwanted clutter from meteor and auroral ionization in addition to other areas of scattering that compete with target returns.

### present OTHBs

The current capabilities of OTHB radars, both American and Soviet, are shown in table 1.

### it all started with Ivan The Terrible

The initial evidence of Soviet OTHB radar capability surfaced in mid-1976. The first of these radar units, nicknamed "The Kiev Buzzsaw" or "Ivan The Terrible" was a 2-million watt transmitter operating near the city of Kiev, augmented by a smaller installation near the Black Sea town of Nikolayev. From these initial efforts, the Soviets have expanded their system into a fully functional early-warning high-frequency radar. Most of the early information concerning the Russian Woodpecker, as it is now known, came from the worldwide efforts of Amateur Radio operators. Even today, little hard information is available concerning the physical make-up of these radar installations. Western intelligence reports remain classified and, or course, the Russians appear reluctant to volunteer anything.

The Woodpecker is part of some 7000 surveillance radar systems deployed at over 1200 sites across the length and breadth of the USSR. While it was initially thought that the Woodpecker was designed for aircraft or ship detection, recent information indicates that it is actually a ballistic missile early warning system. There are currently three of these OTHB radars in operation. Two of them pointed at the United States and the other was directed at central China. These radar systems operate in conjunction with satellite detection systems to provide upwards of 30 minutes warning of an ICBM strike launched from sites within the United States or China. This HF radar launch detection system is not as accurate or reliable as a satellite system, but the two working together give 24 hour-a-day coverage of missile silos.

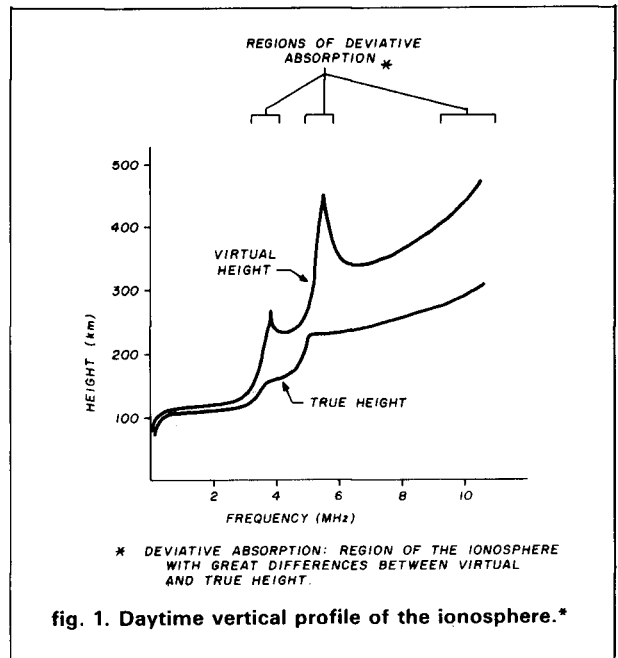

fig. 1. Daytime vertical profile of the ionosphere.\*

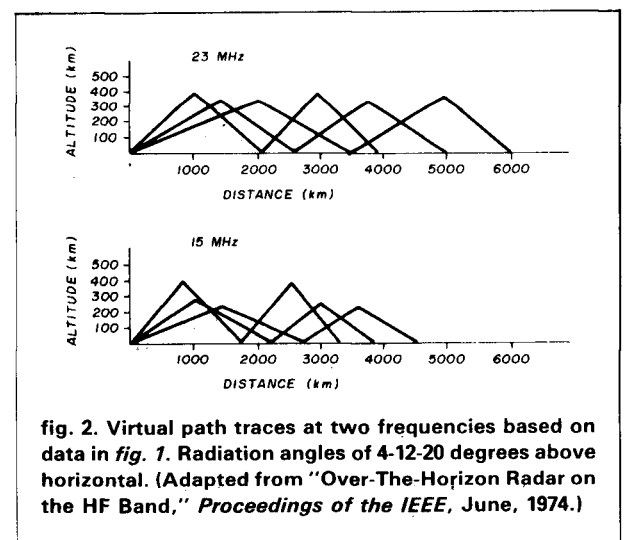

fig. 2. Virtual path traces at two frequencies based on data in fig. 1. Radiation angles of 4-12-20 degrees above horizontal. (Adapted from "Over-The-Horizon Radar on the HF Band," *Proceedings of the IEEE*, June, 1974.)

\*Adapted, with permission, from James M. Headrick's "Over-The-Horizon Radar on the HF Band," *Proceedings of the IEEE*, Volume 62, Nov. 6, June, 1974. ©1974, IEEE.

Since its beginning in 1976, the Soviet OTHB systems have increased their power and currently operate at the 20 to 50 megawatt level. Their system utilizes pulse modulation, in contrast to the American CONUS OTHB, which transmits FM-CW. The PRF (Pulse Repetition Frequency) is normally 10 per second, although additional analysis has suggested each pulse actually consists of a pulse train of up to twenty different square wave pulses with some less than two milliseconds long, giving an effective PRF of 800 pps. The modulation scheme employed by the Russians has undergone some evolutionary changes since the inception of this radar system. Currently, the modulation, though still a pulse system, causes the radar signal to be spread in frequency. This permits frequency compression on the receiving end and results in "processing gain" for the system as a whole. In addition, this spread-spectrum technique allows the detection system to more easily discriminate against other stations on frequency. Unfortunately, these wide-band signals have further increased the interference levels to other, legitimate users of the HF band.

Currently, the radar signals no longer sit on one frequency for extended periods of time, as they once did. This is due, in part, to the protests of other users of the HF spectrum, but also to the Soviets' efforts to utilize the optimum transmission frequency. At the present time, the signals move up and down the band in 100 kHz steps at intervals of 30 seconds to 10 minutes.

### why hams are most affected

It is also noteworthy that the Woodpecker chooses parts of the HF spectrum with low rates of RF occupancy. Certain portions of the band have few users per unit time and those users operate with low levels of radiated power. These areas of the spectrum are a natural for radar operation, placing less stringent requirements on the detection system. As can be seen in fig. 3, the Amateur bands fit nicely into this category. This helps to explain why hams have suffered the most. In addition, Amateurs tend to have limited political "pull" with their governments and, thus, are less able to bring pressure to bear to curb this interference than are other users of the spectrum. Other services, such as international broadcasting, can overcome the Woodpecker by raising their effective radiated power into the megawatt range and thereby swamping out the Russian radar.

Worldwide response to the Woodpecker arose almost immediately after its first transmission. In July, 1976, the Federal Communications Commission sent a telegram — prompted by complaints from ham operators about interference levels on the 20-meter

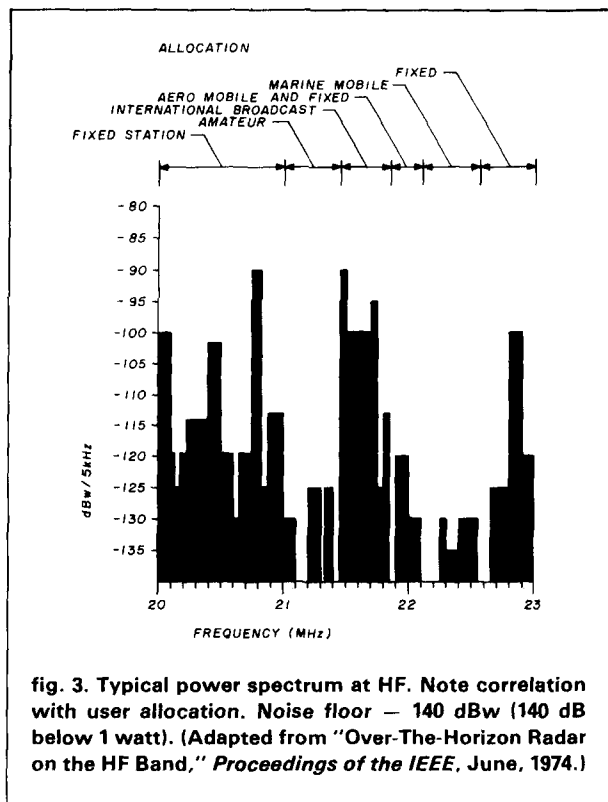

fig. 3. Typical power spectrum at HF. Note correlation with user allocation. Noise floor — 140 dBw (140 dB below 1 watt). (Adapted from "Over-The-Horizon Radar on the HF Band," *Proceedings of the IEEE*, June, 1974.)

band — to the Soviet Ministry of Post and Telecommunications. With no response from the USSR, the FCC sent three more cables. Still there was no response. In October, the FCC filed a formal complaint with the International Frequency Registration Board.

Additional complaints poured in from Amateur, Maritime, and aeronautical operators in other countries. In addition to the United States, and European nations, countries in the region of the Baltic Sea as well as Australia and New Zealand voiced strong protests. Early in 1977, the Soviet Union admitted that their experiments might cause some interference to other radio facilities for short periods of time. As worldwide pressure mounted, the USSR agreed to cut back on these radar transmissions. In reality, the *Woodpecker* remained on the air for the same amount of time, but its signals moved back and forth through the HF band rather than staying in one spot for extended periods of time.

In 1979, this issue surfaced, but was never pressed, at the World Administrative Radio Conference. In retrospect, this was probably for the best. This conference resulted in substantial gains for the Amateur community that might never have come about if the Conference had been disrupted over the Woodpecker issue.

### Soviets ignore treaty

The USSR is signatory to international telecom-

munications treaties that spell out, in detail, the allocations for broadcasting. However, the Soviets have made full use of an escape clause included in all of these treaties. Simply put, a nation may ignore the treaty if such action is deemed to be in the best interests of its national defense. In addition, telecommunications treaties are only as good as a nation's willingness to abide by them. There is no practical way to force compliance by other countries. Most nations observe these treaties rather closely, however, realizing that compliance is in the best interest of the world community.

The current position of the United States was recently stated by Dr. William Schneider, Under Secretary of State for Security Assistance, Science and Technology. In an interview, Schneider commented, "We are making every effort to encourage the USSR to comply with their treaty obligations. In this regard, I hope we will be more effective in the future than we have been in the past." In reality, this means that the Soviets will continue to use the Woodpecker as long as it suits their needs or until they develop a completely accurate and reliable satellite surveillance system for ICBM launch detection.

### what can we do?

So what can you do the next time the Woodpecker blows the 20-meter band apart? There's no point in complaining to the FCC or Department of State — they're not interested. They have literally *thousands*

## interference not inevitable

The USA's CONUS OTH-B radar has received widespread publicity in technical, professional, and Amateur publications. At the onset of operation, the project's organizers actually *solicited* interference reports from all users of the HF spectrum. A committee was set up to handle the expected deluge of complaints; after two years of operation, only eight reports had been received. Of these, seven were disallowed because the radar had not been in operation at the time the alleged interference occurred or because the radar was operating on a frequency far removed from the one specified in the complaint. The eighth report was not a complaint at all, but rather a report from an SWL looking for confirmation. This absence of interference to other services is due to the nature of the American radar and the care exercised in the selection of clear frequencies.

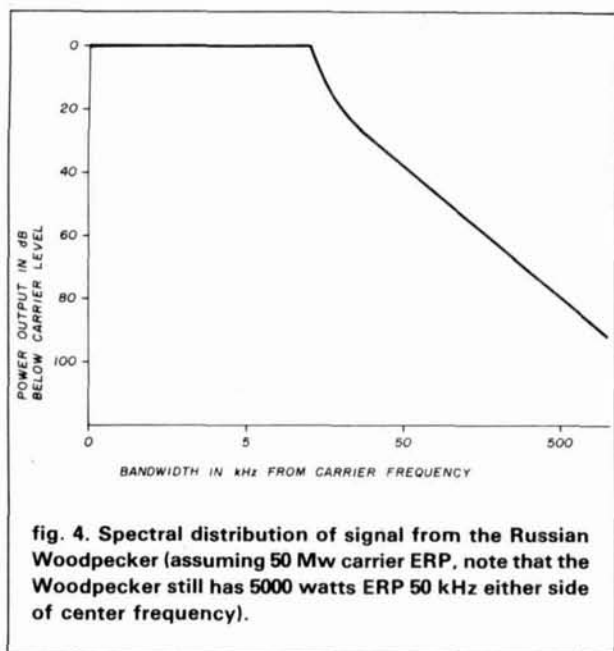

fig. 4. Spectral distribution of signal from the Russian Woodpecker (assuming 50 Mw carrier ERP, note that the Woodpecker still has 5000 watts ERP 50 kHz either side of center frequency).

of complaints on file and don't need any more. They are fully aware of the problem and realize how little they can do to change it. Cranking your keyer up to 99 WPM and shooting a string of pulses in the direction of the Soviet Union is equally futile. Because the radar is designed to ignore this type of interference, all this accomplishes is additional QRM for other hams.

Perhaps the best solution to Woodpecker interference lies in the field of electronics. The technology is available to eliminate this pest at the receiver. The newer transceivers, such as the Kenwood TS-930, the ICOM IC-751, and the Yaesu FT-1, among others, have dual noise blankers, one of which is designed to eliminate long pulse noise such as that from the Woodpecker. This trend is likely to continue until most new rigs have this capability.

All this doesn't help those of us who aren't quite ready to buy a new state-of-the-art transceiver. What can we do? We have two choices. The first is to build a custom noise blanker for our existing rigs. Circuits to eliminate the Woodpecker have been published in Amateur magazines and in the ARRL's *Radio Amateur's Handbook*. The second choice is the purchase of a "Moscow Muffler," a Woodpecker noise blanker manufactured by AEA (Advanced Electronics Applications) of Lynnwood, Washington. Installed between the transceiver and antenna, this unit effectively blanks out the Woodpecker by means of an RF sensing unit that automatically takes it out of the circuit when the transmitter is keyed. The blanking width and synchronization are both adjustable. The basic sync rate may be switched between 10 and 16 Hz to allow for blanking when both OTHB radars are in operation.

It does not appear that the Woodpecker will dis-

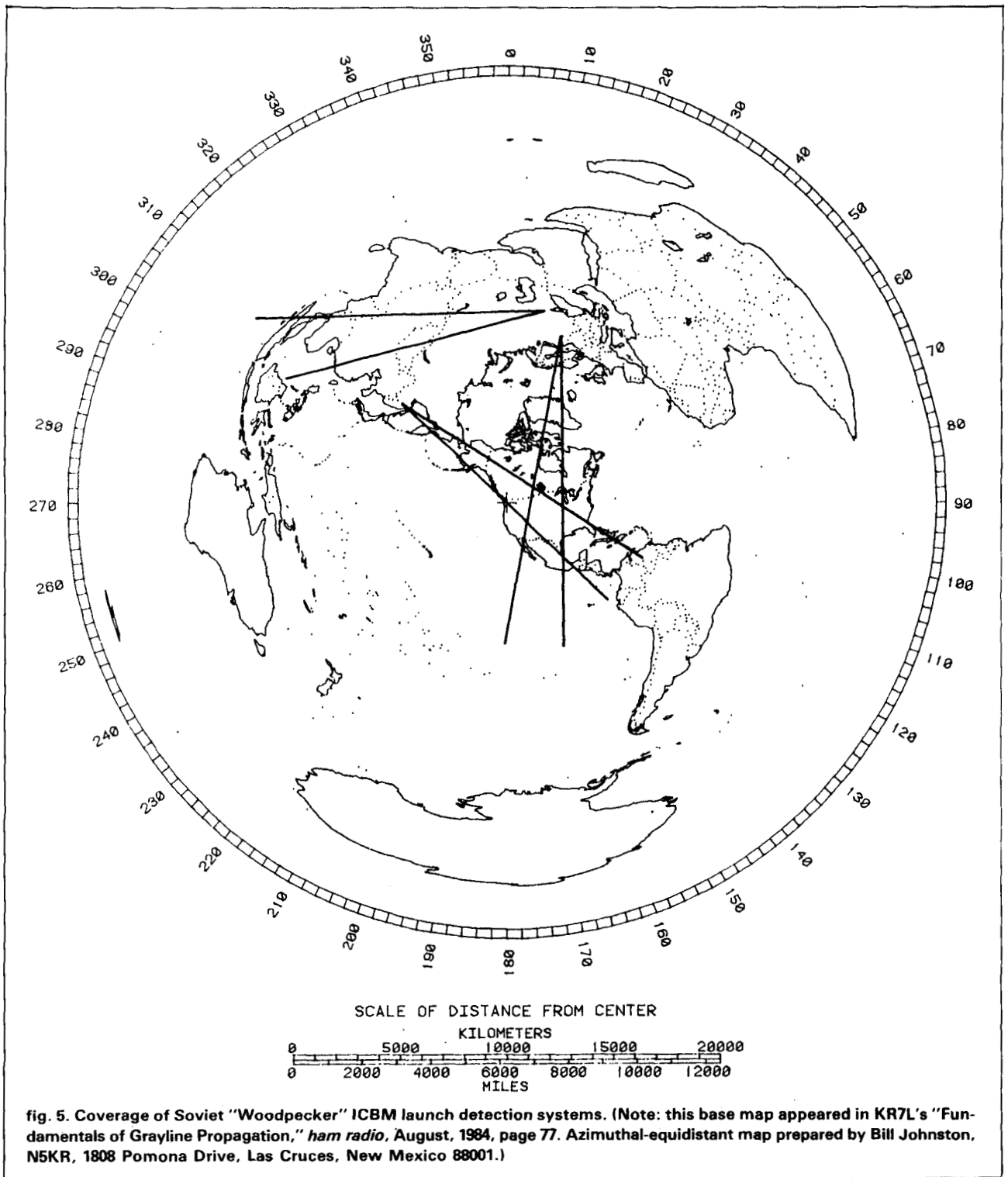

appear within the near future. The Soviet Union will continue operation despite world opinion, as long as it deems the practice necessary. The ultimate practical solution will be the inclusion into Amateur equipment of noise blankers capable of removing this interference. Advancing electronic technology will pro-

vide the solution to a worldwide problem that apparently cannot be resolved by diplomatic methods.

### reference

1. Theodore J. Cohen, "CQ Interviews . . . Dr. William Schneider, K2TT, Under Secretary of State for Security Assistance, Science and Technology Department of State, Washington, D. C.," *CQ*, February, 1983, pages 11-13.



fig. 6. The MOSCOW MUFFLER® by Advanced Electronics Applications, Inc. This transceiver accessory is capable of removing interference from the Woodpecker.

### bibliography

- Cohen, Theodore J., "Interference From Russian OTH Radar Intensifies," *CQ*, August, 1979, page 60.
- Cohen, Theodore J., "Questions Raised About Russian Treaty Violations," *CQ*, January, 1980, page 78.
- Cohen, Theodore J., "Russians Continue to Violate ITU Treaty," *CQ*, April, 1980, page 71.
- Cohen, Theodore J., "Opposition To The Woodpecker Grows," *CQ*, August, 1981, page 67.
- Hauser, Glenn, "The Soviet Pulser," *Popular Electronics*, March, 1977, page 102.
- Hauser, Glenn, "USAF Starts Radar on Shortwave Bands," *Popular Electronics*, September, 1980, page 117.
- Headrick, James M. and Skolnik, Merrill I., "Over-The-Horizon Radar in the HF Band," *Proceedings of the IEEE*, Volume 62, No. 6, June, 1974, pages 664-673.
- Ingram, Dave, "The Fine Art of DXing," *Secrets of Ham Radio DXing*, TAB Books, Blue Ridge, Pennsylvania, pages 45-46.
- Kell, R. E. and Ross, R. A., "Radar Cross Section of Targets," *Radar Handbook*, M. I. Skolnik, Editor, McGraw-Hill, New York, 1970, Chapter 27.
- Lyon, Ed, "Over-The-Horizon Radar," A seminar presented at the Northwest Regional ARRL Convention, Seaside, Oregon, June 2, 1984.
- Villard, Jr., O. G., "Over-The-Horizon or Ionospheric Radar," *QST*, April, 1980, pages 39-43.
- "Soviet Military Power 1983," United States Department of Defense, pages 27-28.
- "Soviet Military Power 1984," United States Department of Defense, pages 32-33.
- "CONUS OTH-B Over-The-Horizon Radar," *Ground Radar/USA*, *Jane's Weapons Systems 1983-1984*, Franklin Watts, Inc., New York, page 486.
- "Powerful Soviet Radio Signals Protested," *Aviation Week and Space Technology*, November 8, 1976, page 19.
- "Soviet OTH Radar," *Ground Radar/USSR*, *Jane's Weapons Systems 1979-1980*, Franklin Watts, Inc., New York, page 506.

ham radio

### SHORT CIRCUIT HOTLINE

Building a current *ham radio* project? Call the Short Circuit Hotline any time between 9 AM and Noon, or 1 to 3 PM — Eastern time — *before* you begin construction. We'll let you know of any changes or corrections that should be made to the article describing your project.

(See "Publisher's Log," April, 1984, page 6, for details.)

603-878-1441

THE  
BETTER  
MOUSE TRAP FOR  
AC WALL OUTLET  
AND LIGHTNING  
AND SURGE PROTECTION  
JUST \$29.95



The Alpha Delta ACTT AC Transi-Trap™ is a plug-in-the-wall surge protector that has two 120 volt grounded sockets, status light, circuit breaker and a unique 3 stage protection circuit.

The ACTT gives you both transverse and common mode protection with a high speed, self restoring, 6000 volt/2000 amp surge discharge circuit. This circuit goes from hot to neutral and ground and neutral to ground. Several competitive devices use only a single stage 100 amp protector. Plug a distribution box into the ACTT and everything downline is protected. The ACTT is UL listed and is available from either Alpha Delta dealers or Alpha Delta direct. Please add \$2.00 for shipping and handling.

The ACTT is designed to reduce the hazards of lightning and induced surge voltages. It is not for direct strike protection.

**ALPHA DELTA COMMUNICATIONS, INC.**

PO Box 571  
Centerville, OH 45459  
(513) 435-4772

✓ 107



## PORTABLE ANTENNA

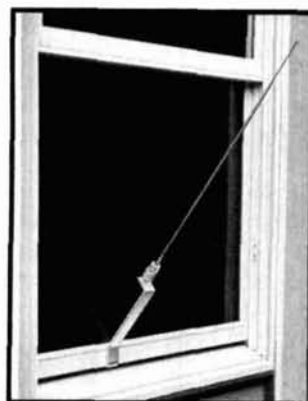

MODEL AP-10

Designed for  
APARTMENTS  
MOTELS  
VACATIONS

PRICE  
\$43.75

Add \$3.00  
Shipping and Handling

Quick Simple Installation. Operates on 2, 6, 10, 15, 20, 30 and 40 meters. All coils supplied. Only 22-1/2 inches long. Weighs less than 2 lbs. Supplied with 10 ft. RG 58 coax and counter poise. Whip extends to 57 inches. Handles up to 300 watts.

VSWR—1.1:1 when tuned

Write for more details and other B&W products

ALL OUR PRODUCTS MADE IN USA

**BW BARKER & WILLIAMSON**

Quality Communication Products Since 1932

At your Distributors. Write or Call.

10 Canal Street, Bristol PA 19007

(215) 788-5581



# THE MOST AFFORDABLE REPEATER

## ALSO HAS THE MOST IMPRESSIVE PERFORMANCE FEATURES

(AND GIVES THEM TO YOU AS STANDARD EQUIPMENT!)



### JUST LOOK AT THESE PRICES!

| Band          | Kit   | Wired/Tested |
|---------------|-------|--------------|
| 10M,6M,2M,220 | \$680 | \$880        |
| 440           | \$780 | \$980        |

Both kit and wired units are complete with all parts, modules, hardware, and crystals.

### CALL OR WRITE FOR COMPLETE DETAILS.

Also available for remote site linking, crossband, and remote base.

### FEATURES:

- SENSITIVITY SECOND TO NONE; TYPICALLY 0.15 uV ON VHF, 0.3 uV ON UHF.
- SELECTIVITY THAT CAN'T BE BEAT! BOTH 8 POLE CRYSTAL FILTER & CERAMIC FILTER FOR GREATER THAN 100 dB AT  $\pm 12$  KHZ. HELICAL RESONATOR FRONT ENDS. SEE R144, R220, AND R451 SPECS IN RECEIVER AD BELOW.
- OTHER GREAT RECEIVER FEATURES: FLUTTER-PROOF SQUELCH, AFC TO COMPENSATE FOR OFF-FREQ TRANSMITTERS, SEPARATE LOCAL SPEAKER AMPLIFIER & CONTROL.
- CLEAN, EASY TUNE TRANSMITTER; UP TO 20 WATTS OUT (UP TO 50W WITH OPTIONAL PA).

## HIGH QUALITY MODULES FOR REPEATERS, LINKS, TELEMETRY, ETC.

### HIGH-PERFORMANCE RECEIVER MODULES

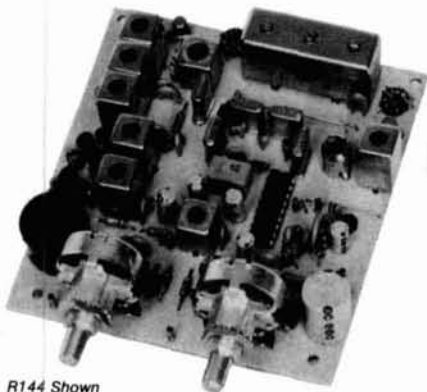

R144 Shown

- **R144/R220 FM RCVRs** for 2M or 220 MHz. 0.15uV sens.; 8 pole xtal filter & ceramic filter in i-f, helical resonator front end for exceptional selectivity, more than -100 dB at  $\pm 12$  kHz, best available today. Flutter-proof squelch. AFC tracks drifting xmtrs. Xtal oven avail. Kit only \$138.
- **R451 FM RCVR** Same but for uhf. Tuned line front end, 0.3 uV sens. Kit only \$138.
- **R76 FM RCVR** for 10M, 6M, 2M, 220, or commercial bands. As above, but w/o AFC or hel. res. Kits only \$118. Also avail w/4 pole filter, only \$98/kit.
- **R110 VHF AM RECEIVER** kit for VHF aircraft band or ham bands. Only \$98.
- **R110-259 SPACE SHUTTLE RECEIVER**, kit only \$98.

### TRANSMITTERS

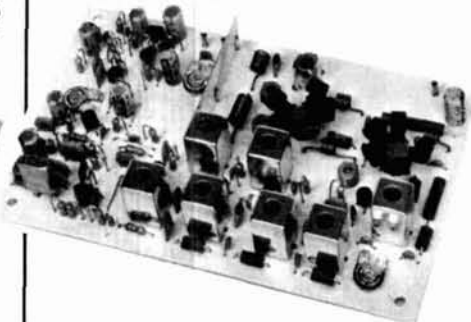

- **T51 VHF FM EXCITER** for 10M, 6M, 2M, 220 MHz or adjacent bands. 2 Watts continuous, up to 2 1/2 W intermittent. \$68/kit.



- **T451 UHF FM EXCITER** 2 to 3 Watts on 450 ham band or adjacent freq. Kit only \$78.
- **VHF & UHF LINEAR AMPLIFIERS.** Use on either FM or SSB. Power levels from 10 to 45 Watts to go with exciters & xmtg converters. Several models. Kits from \$78.
- **A16 RF TIGHT BOX** Deep drawn alum. case with tight cover and no seams. 7 x 8 x 2 inches. Designed especially for repeaters. \$20.

### ACCESSORIES



- **HELICAL RESONATOR FILTERS** available separately on pcb w/connectors.  
HRF-144 for 143-150 MHz \$38  
HRF-220 for 213-233 MHz \$38  
HRF-432 for 420-450 MHz \$48
- **COR-2 KIT** With audio mixer, local speaker amplifier, tail & time-out timers. Only \$38.
- **COR-3 KIT** as above, but with "courtesy beep". Only \$58.
- **CWID KITS** 158 bits, field programmable, clean audio, rugged TTL logic. Kit only \$68.
- **DTMF DECODER/CONTROLLER KITS.** Control 2 separate on/off functions with touchtones®, e.g., repeater and autopatch. Use with main or aux. receiver or with Autopatch. Only \$90
- **AUTOPATCH KITS.** Provide repeater autopatch, reverse patch, phone line remote control of repeater, secondary control via repeater receiver. Many other features. Only \$90. Requires DTMF Module.
- **NEW - SIMPLEX AUTOPATCH** Use with any transceiver. System includes DTMF & Autopatch modules above and new Timing module to provide simplex autopatch and reverse autopatch. Complete patch system only \$200/kit. Call or write for details.

# hamtronics®



# NEW LOW-NOISE PREAMPS RECEIVING CONVERTERS TRANSMIT CONVERTERS



**Hamtronics Breaks the Price Barrier!**



**No Need to Pay \$80 to \$125 for a GaAs FET Preamp.**

**FEATURES:**

- Very Low Noise: 0.7 dB VHF, 0.8 dB UHF
- High Gain: 18 to 28 dB, Depending on Freq.
- Wide Dynamic Range for Overload Resistance
- Latest Dual-gate GaAs FET, Stable Over Wide Range of Conditions
- Rugged, Diode-protected Transistors
- Easy to Tune
- Operates on Standard 12 to 14 Vdc Supply
- Can be Tower Mounted

| MODEL   | TUNES RANGE | PRICE |
|---------|-------------|-------|
| LNG-28  | 26-30 MHz   | \$49  |
| LNG-50  | 46-56 MHz   | \$49  |
| LNG-144 | 137-150 MHz | \$49  |
| LNG-220 | 210-230 MHz | \$49  |
| LNG-432 | 400-470 MHz | \$49  |
| LNG-40  | 30-46 MHz   | \$64  |
| LNG-160 | 150-172 MHz | \$64  |

## ECONOMY PREAMPS

Our traditional preamps, proven in years of service. Over 20,000 in use throughout the world. Tuneable over narrow range. Specify exact freq. band needed. Gain 16-20 dB. NF = 2 dB or less. VHF units available 27 to 300 MHz. UHF units available 300 to 650 MHz.

- P30K, VHF Kit less case \$18
- P30W, VHF Wired/Tested \$33
- P432K, UHF Kit less case \$21
- P432W, UHF Wired/Tested \$36

## HELICAL RESONATOR PREAMPS

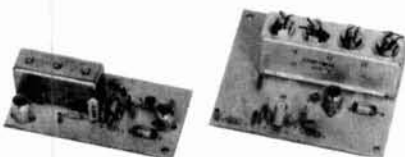

Our lab has developed a new line of low-noise receiver preamps with helical resonator filters built in. The combination of a low noise amplifier and the sharp selectivity of a 3 or 4 section helical resonator provides increased sensitivity while reducing intermod and cross-band interference in critical applications. See selectivity curves at right. Gain = approx. 12 dB.

| Model   | Tuning Range | Price |
|---------|--------------|-------|
| HRA-144 | 143-150 MHz  | \$49  |
| HRA-220 | 213-233 MHz  | \$49  |
| HRA-432 | 420-450 MHz  | \$59  |
| HRA-( ) | 150-174MHz   | \$69  |
| HRA-( ) | 450-470 MHz  | \$79  |



Models to cover every practical rf & if range to listen to SSB, FM, ATV, etc. NF = 2 dB or less.

|                    | Antenna Input Range | Receiver Output |
|--------------------|---------------------|-----------------|
| <b>VHF MODELS</b>  | 28-32               | 144-148         |
|                    | 50-52               | 28-30           |
| Kit with Case \$49 | 50-54               | 144-148         |
| Less Case \$39     | 144-146             | 28-30           |
| Wired \$69         | 145-147             | 28-30           |
|                    | 144-144.4           | 27-27.4         |
|                    | 146-148             | 28-30           |
|                    | 144-148             | 50-54           |
|                    | 220-222             | 28-30           |
|                    | 220-224             | 144-148         |
|                    | 222-226             | 144-148         |
|                    | 220-224             | 50-54           |
|                    | 222-224             | 28-30           |

|                    | Antenna Input Range | Receiver Output |
|--------------------|---------------------|-----------------|
| <b>UHF MODELS</b>  | 432-434             | 28-30           |
|                    | 435-437             | 28-30           |
| Kit with Case \$59 | 432-436             | 144-148         |
| Less Case \$49     | 432-436             | 50-54           |
| Wired \$75         | 439.25              | 61.25           |

**SCANNER CONVERTERS** Copy 72-76, 135-144, 240-270, 400-420, or 806-894 MHz bands on any scanner. Wired/tested Only \$88.

## SAVE A BUNDLE ON VHF FM TRANSCEIVERS!

**FM-5 PC Board Kit - ONLY \$178** complete with controls, heatsink, etc. 10 Watts, 5 Channels, for 2M or 220 MHz.



Cabinet Kit, complete with speaker, knobs, connectors, hardware. Only \$60.

**REPEAT OF A SELLOUT!**

While supply lasts, get \$60 cabinet kit free when you buy an FM-5 Transceiver kit. Where else can you get a complete transceiver for only \$178

For SSB, CW, ATV, FM, etc. Why pay big bucks for a multi mode rig for each band? Can be linked with receive converters for transceiver. 2 Watts output vhf, 1 Watt uhf.

|                             | Exciter Input Range | Antenna Output |
|-----------------------------|---------------------|----------------|
| For VHF, Model XV2 Kit \$79 | 28-30               | 144-146        |
|                             | 28-29               | 145-146        |
|                             | 28-30               | 50-52          |
|                             | 27-27.4             | 144-144.4      |
|                             | 28-30               | 220-222*       |
| Wired \$149 (Specify band)  | 28-30               | 220-224        |
|                             | 50-54               | 50-52          |
|                             | 144-146             | 50-52          |
|                             | 50-54               | 144-148        |
|                             | 144-146             | 28-30          |

|                             | Antenna Input Range | Receiver Output |
|-----------------------------|---------------------|-----------------|
| For UHF, Model XV4 Kit \$99 | 28-30               | 432-434         |
|                             | 28-30               | 435-437         |
|                             | 50-54               | 432-436         |
|                             | 61.25               | 439.25          |
| Wired \$169                 | 144-148             | 432-436*        |

\*Add \$20 for 2M input

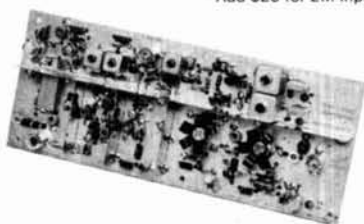

**VHF & UHF LINEAR AMPLIFIERS.** Use with above. Power levels from 10 to 45 Watts. Several models, kits from \$78.

## LOOK AT THESE ATTRACTIVE CURVES!

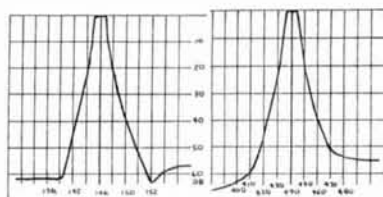

Typical Selectivity Curves of Receivers and Helical Resonators.

## IMPORTANT REASONS WHY YOU SHOULD BUY FROM THE VALUE LEADER:

1. Largest selection of vhf and uhf kits in the world.
2. Exceptional quality and low prices due to large volume.
3. Fast delivery; most kits shipped same day.
4. Complete, professional instruction manuals.
5. Prompt factory service available and free phone consultation.
6. In business 21 years.
7. Sell more repeater modules than all other mfrs. and have for years. Can give quality features for much lower cost.

- Call or Write for **FREE CATALOG**
- (Send \$1.00 or 4 IRC's for overseas mailing)
- Order by phone or mail • Add \$3 S & H per order (Electronic answering service evenings & weekends)
- Use VISA, MASTERCARD, Check, or UPS COD.

**hamtronics, inc.**

65-E MOUL RD. • HILTON NY 14468  
Phone: 716-392-9430

Hamtronics® is a registered trademark

# a double conversion portable SW receiver

Modify an earlier design  
for additional coverage,  
built-in frequency counter

In the April, 1984 issue of *ham radio*, Jack described the construction of a compact, portable, high performance shortwave receiver for the 46- through 100-meter bands.<sup>1</sup> This article provides a design for an extended coverage receiver based on that design, but offering front-end RF tuning and a built-in frequency counter and power supply. Helpful circuit hints applicable to other receiver designs are also described. The April article should be reviewed for schematics, component values and construction details. **Figures 1, 2, and 3** show several views of the new receiver from different angles, including component layout and shielding requirements — Editor.

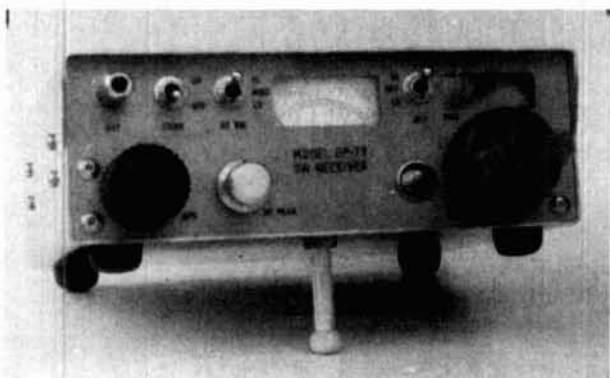

fig. 1. Top row of controls includes antenna input, on/off switch, RF bandswitching. Bottom row includes AF gain knob, RF tuning, main tuning.

**Good converter design** calls for an examination of all mixing by-products for each choice of local oscillator and desired input signal range and minimizes in-band spurious responses.<sup>2</sup> The frequency conversion scheme finally decided upon extends front-end coverage to include signals in the 9.3 to 10 MHz range. The incoming signal is downconverted to 3.3 to 4.0 MHz using a crystal oscillator and active mixer. The digital display is made to "track" by converting the "3" MHz readout to "9" MHz simply by switching the "F" LED segment, thereby eliminating the need for elaborate frequency readout conversion schemes. To accomplish this a 4-pole, 2-position C&K miniature switch performs the following functions:

- supplies +12 VDC to the converter board
- bandswitches the converter input
- bandswitches the converter output
- switches the "F" LED between "3" and "9"

The converter has been designed for a broadband response and the RF and MIX trimmers should be stagger-tuned for flattest front-end response. The converter schematics and the wiring of the CONV band-switch are detailed in **fig. 4**.

## construction details

In addition to the schematics and photos shown, the following information should be useful.

**Power transformer.** This should supply 14 volts at 120 mA. A 15-volt unit would probably be better to use because it would deliver (under load) a DC voltage closer to that of a car battery. Presently, power drain

By Jack Perolo, PY2PE1C, P.O. Box 2390, Sao Paulo, Brazil

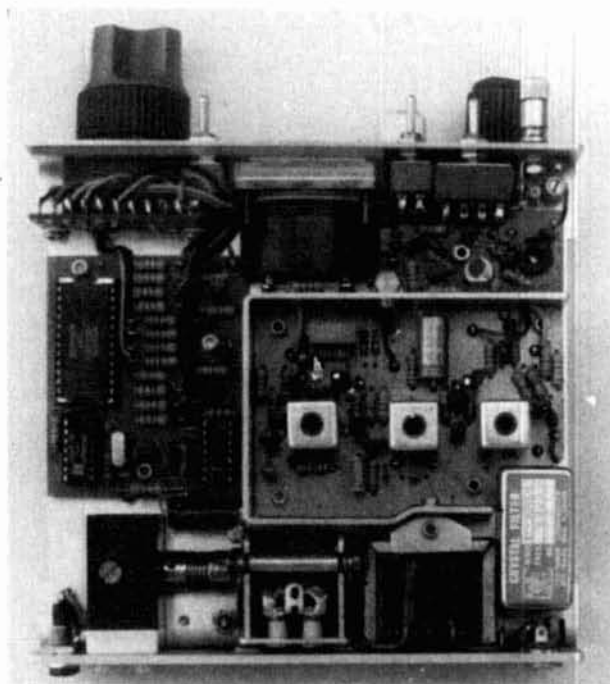

fig. 2. Top view. At top left is the 4-digit display, wired to the frequency counter below it. At top center is the S-meter, with C&K switches to its right. The input 9 MHz trap is at top right. The IF strip is below the S-meter, shielded with 1/16 inch aluminum sheet. At bottom left is the 60:1 ratio Muffett gear reducer connected with flexible coupling to the 104 pF variable capacitor. To the right of the variable capacitor is the power transformer, followed by the 9 MHz crystal filter. The back panel has provisions for two AF output jacks, DC power (12 volt) input jacks, and a 110 VAC connector (see fig. 3).

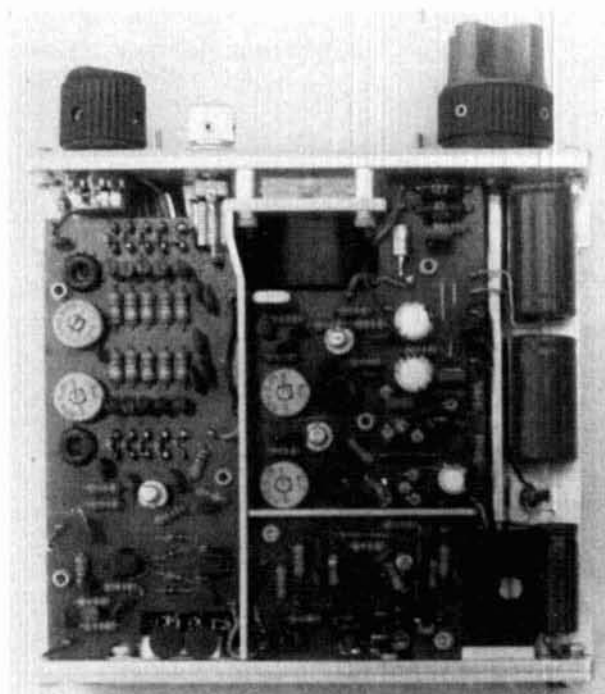

fig. 3. Bottom view. At top left are the audio frequency potentiometer and 5-24 pF Jackson RF trimmer. S-meter is at top center; below the S-meter is the PC board for power supply, AF strip and the front-end converter. The power supply electrolytic capacitors are at its right. At left is the RF/Mixer PC; notice shield between it and the front-end converter. The 110 VAC connector is at bottom. At bottom right is the VFO PC board, with electronic bandswitching circuitry, shielded from both the RF PC and front end converter PC; the VFO PC board ends near the gear reducer, seen at bottom right. All RF transistors are mounted in sockets to ease replacement in case of failure.

is 120-125 mA with the 9 MHz converter on, dropping to about 100-105 mA with the converter off. (Saw off the original brackets; use a bolted pillar and pressure holder to keep it in place.)

**Space-saving techniques.** In order to make room for the converter and power transformer, a new layout was developed. The audio strip PC board was redesigned and reduced in size, with all components vertically mounted. This reduced it from 1.57 x 2 inches (40 x 50 mm) to 1.18 x 1.57 inches (30 x 40 mm).

The PC board that houses the audio strip also includes the power supply, the zener diodes, and the front-end converter. The 1/16 inch thick epoxy board measures 2-3/8 x 3-1/2 inches (60 x 90 mm). Separate diodes were used in the supply to avoid confusion in case 110 VAC and external power were left on at the same time.

**Gear reducer.** Zero backlash, Muffett size 1 with gear ratio 60:1. Available in the U.K. for \$75.00.

**Cabinet.** 2 x 6 x 6 inches (50 x 150 x 150 mm) HWD.

## ham band options

The 80-meter band, covered in the earlier project, is included in the current version. The 40-meter band can be covered by the direct method or by the converter method. Using the direct method extends the coverage of the basic receiver to 7 MHz. (The MHz digit of the display must be read.) The converter option would employ a 4 MHz crystal; the digit problem appears to be easier to solve, but some spurious signals are likely to appear within the band. Coverage on 30 and 20 meters can be implemented by modifying the front-end conversion using a single set of coils and electronically bandswitching the parallel capacitors and the oscillator crystal. One can cover 7, 10, and 14 MHz with the same basic converter by increasing PC board size slightly.

The frequency counter can easily handle the fifth digit (tens of MHz) because the 7207 IC has provisions for it, but the power supply must be sized accordingly for the extra load. Care should also be taken in the layout and design of the front panel, which is presently

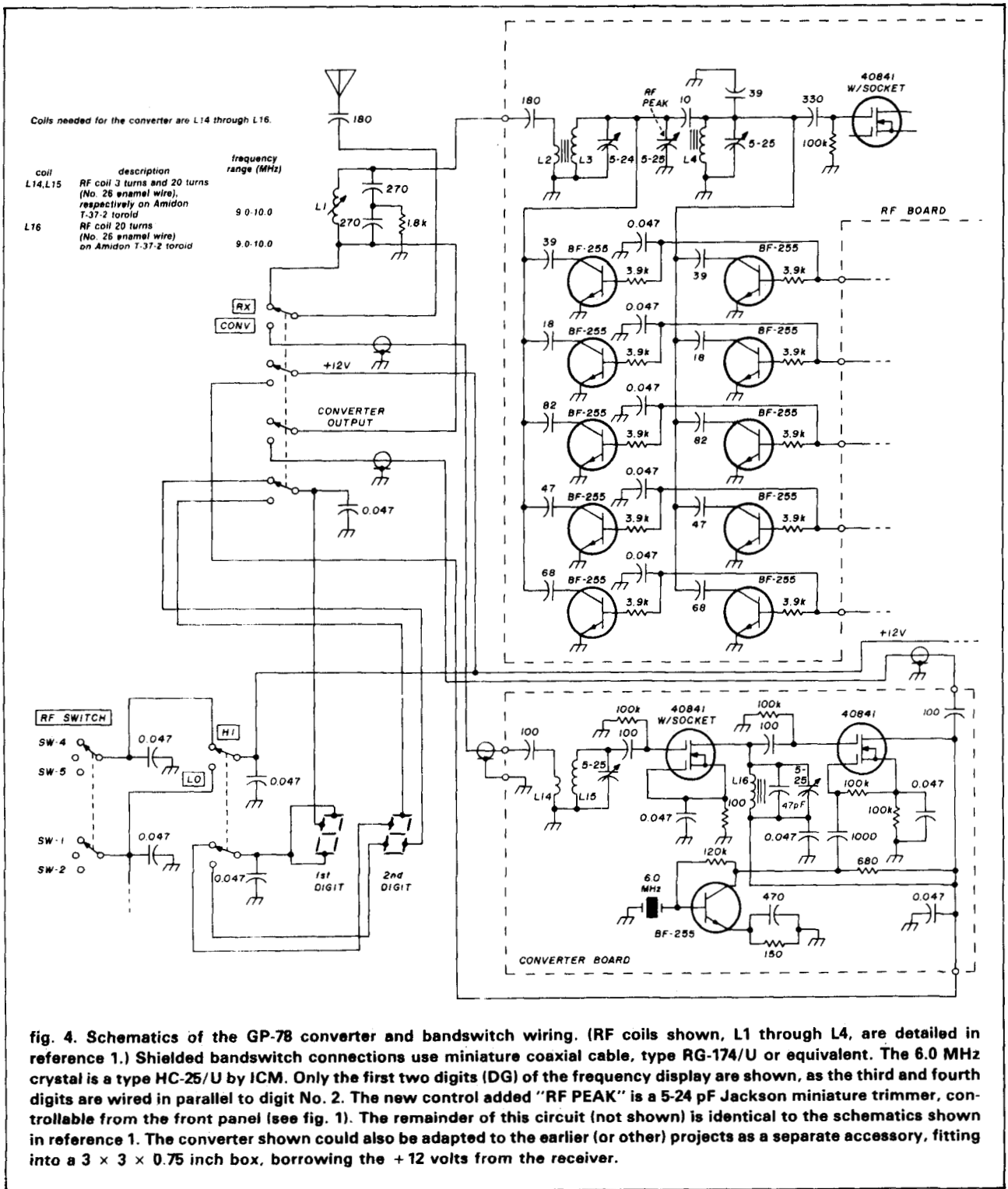

fig. 4. Schematics of the GP-78 converter and bandswitch wiring. (RF coils shown, L1 through L4, are detailed in reference 1.) Shielded bandswitch connections use miniature coaxial cable, type RG-174/U or equivalent. The 6.0 MHz crystal is a type HC-25/U by ICM. Only the first two digits (DG) of the frequency display are shown, as the third and fourth digits are wired in parallel to digit No. 2. The new control added "RF PEAK" is a 5-24 pF Jackson miniature trimmer, controllable from the front panel (see fig. 1). The remainder of this circuit (not shown) is identical to the schematics shown in reference 1. The converter shown could also be adapted to the earlier (or other) projects as a separate accessory, fitting into a 3 x 3 x 0.75 inch box, borrowing the +12 volts from the receiver.

very crowded; the addition of an extra digit would require widening the panel.

### acknowledgement

Thanks go to Fernando, PY2DQU, for his support and encouragement on this project.

### references

1. Jack Perolo, PY2PE1C, "Portable Shortwave Receiver," *ham radio*, April, 1984, page 67.
2. Jack Perolo, PY2PE1C, "The Analytical Approach to Mixer Spurious Evaluation," *CQ*, August, 1971, page 24.

ham radio

REG.  
\$19.95

Please enter my gift subscriptions  
to HAM RADIO Magazine as follows:

**EACH GIFT JUST \$14.95**

**SAVE 25%**

Prices U.S. only

**SAVE 25% \$AVE 25% \$AVE 25%**

**FIRST**

Name \_\_\_\_\_ Call \_\_\_\_\_  
Address \_\_\_\_\_  
City \_\_\_\_\_ State \_\_\_\_\_ Zip \_\_\_\_\_  
 new  renewal

**SECOND**

Name \_\_\_\_\_ Call \_\_\_\_\_  
Address \_\_\_\_\_  
City \_\_\_\_\_ State \_\_\_\_\_ Zip \_\_\_\_\_  
 new  renewal

**THIRD**

Name \_\_\_\_\_ Call \_\_\_\_\_  
Address \_\_\_\_\_  
City \_\_\_\_\_ State \_\_\_\_\_ Zip \_\_\_\_\_  
 new  renewal

Start or  Renew my own HR subscription  
 Enclosed is a check or money order for \$\_\_\_\_\_ for  
\_\_\_\_\_ subscriptions (use separate envelope)  
 VISA  MasterCard  Bill me later  
Acct # \_\_\_\_\_ Expires \_\_\_\_\_ MC Bank # \_\_\_\_\_  
My Name \_\_\_\_\_ Call \_\_\_\_\_  
Address \_\_\_\_\_  
City \_\_\_\_\_ State \_\_\_\_\_ Zip \_\_\_\_\_

Prices U.S. only

Please  
enter my  
subscription

**BUSINESS REPLY CARD**

First Class    Permit No. 1    Greenville, NH

Postage Will Be Paid By Addressee



NO POSTAGE  
NECESSARY  
IF MAILED  
IN THE  
UNITED STATES



**ham  
radio**

Greenville, NH 03048

# MONTH AFTER MONTH ...

Ham Radio gives you the very best in state-of-the-art Radio Technology. It's a super gift idea for that hard-to-buy-for ham friend or yourself.

It's simple and easy to do. And you save 25% on each subscription you order.

One year, 12 issues,  
Reg. \$19.95

**SPECIAL PRICE**  
**\$14.95**

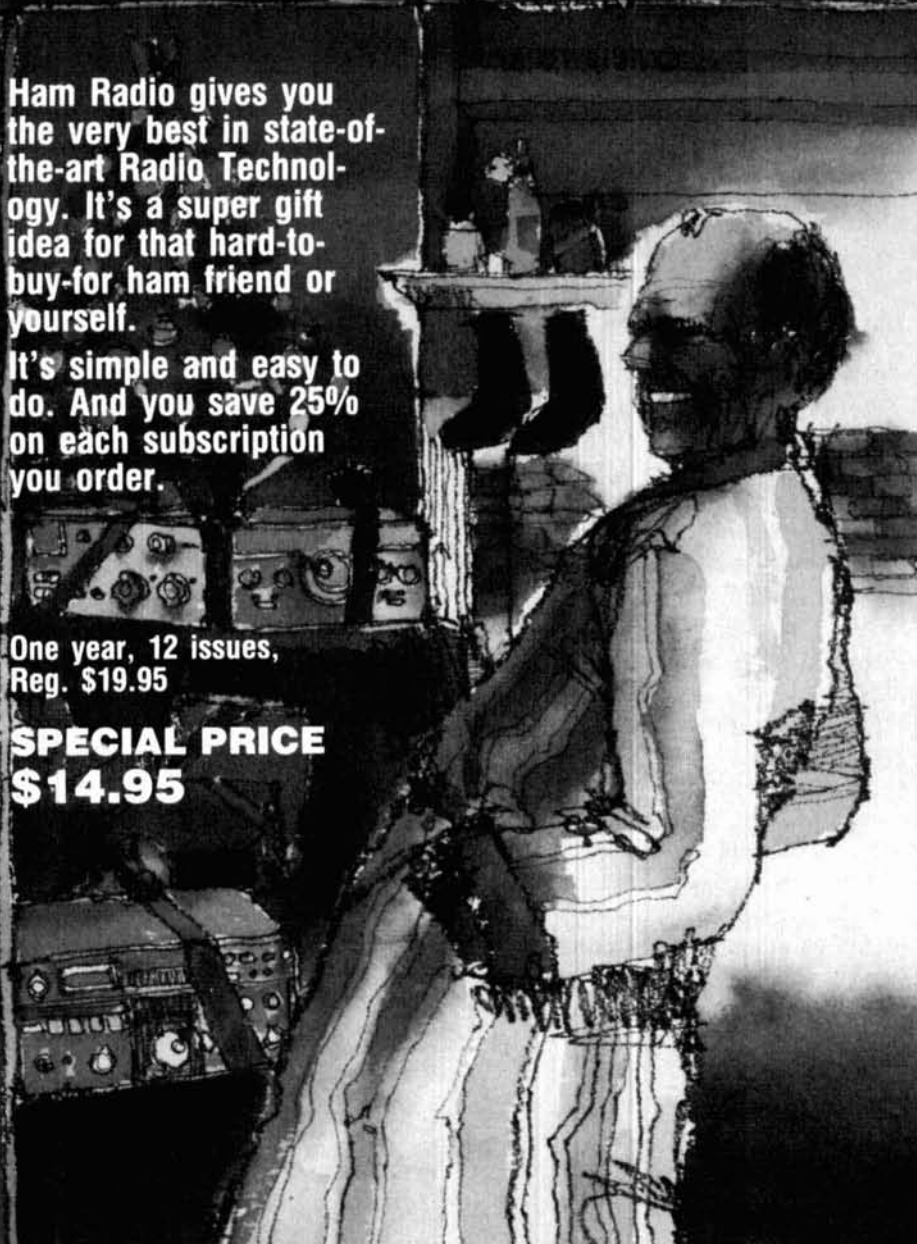

Please send my **hamradio** gift subscriptions as indicated. Also send a handsome gift acknowledgment card. (Gift card will be sent if your order is received before Dec. 16, 1984.)

From: \_\_\_\_\_

Name \_\_\_\_\_

Address \_\_\_\_\_

City \_\_\_\_\_ State \_\_\_\_\_ Zip \_\_\_\_\_

Sign me up, extend my subscription

Payment enclosed \$ \_\_\_\_\_ (check or money order)

Mastercard     VISA/BAC

Acct.# \_\_\_\_\_ Exp. \_\_\_\_\_ Bank# \_\_\_\_\_

Bill me after Jan. 1, 1985. (MC only)

**FILL OUT AND MAIL OR CALL YOUR ORDER IN TODAY**  
**HAM RADIO MAGAZINE**  
**Greenville, NH 03048**  
**(603) 878-1441**



**\$14.95**  
**Save 25%**

**\$14.95**  
**Save 25%**

**\$14.95**  
**Save 25%**

SEND TO:  
Name \_\_\_\_\_  
Address \_\_\_\_\_  
City \_\_\_\_\_ State \_\_\_\_\_ Zip \_\_\_\_\_  
 New Subscription     Subscription Renewal

SEND TO:  
Name \_\_\_\_\_  
Address \_\_\_\_\_  
City \_\_\_\_\_ State \_\_\_\_\_ Zip \_\_\_\_\_  
 New Subscription     Subscription Renewal

SEND TO:  
Name \_\_\_\_\_  
Address \_\_\_\_\_  
City \_\_\_\_\_ State \_\_\_\_\_ Zip \_\_\_\_\_  
 New Subscription     Subscription Renewal

PRICES U.S. only. CANADA \$22.95 per year. Foreign \$28.00  
Use Handy Bind-in Card or this Form.

# THE GUERRI REPORT

Ernie Gueri  
WB MGI

## computer technology: fast, fast, **FAST!**

Some of the most dramatic changes in computer technology are taking place in architecture — that is, in the way computer logic is organized. This is necessary because electronic speeds are now so fast that the physical distance between circuit elements has become a major limitation. To alleviate this problem, the Cray supercomputer features logic bays arranged in a circle so that all interconnects are not more than one circle diameter away.

NASA has developed a design called the Massively Parallel Computer — and massive it is: over 16,000 identical processors are arranged in parallel. This approach allows an image processing task that takes 8 hours on a conventional large mainframe to be reduced to only 17 minutes! Companies such as Cray, ETA, and Fujitsu are developing computers that will be 10,000 times faster than an IBM PC by 1987 or 1988. The implications of this kind of progress make exciting news for hams. Might it someday be possible to contain a basic HF receiver on a single chip? A complete SSB receiver could actually consist of 3000 individual receivers, each having 1 kHz bandwidth and tuned to a different part of the HF spectrum under computer control. Such a unit could represent the ultimate in interference avoidance and MUF agility!

## cooling high-speed circuits

Ever since the beginning of the electronic era, heat has been a problem. The absence of effective ways to remove it at the device level continues

to be a major limitation to present large-scale integration. Designers are now examining methods by which an IC substrate can be bonded to a porous metal carrier, with coolant circulated through the porous metal, then evaporated and recovered in a closed system. Using this method, thermal transfer can be improved to a rate 100 times better than with conduction alone, with each LSI circuit containing its own refrigeration system.

Also significant is the interest in running VLSI circuits at the temperature of liquid nitrogen (77 degrees K). At this temperature electron mobilities go up, speed increases, and thermal efficiency improves. With modern techniques, even the cryogenic problems aren't too difficult. Look for examples of this approach to appear in commercial products before too long.

Even more exotic are super-cold devices called Josephson junctions (JJ's). These are thin film devices that operate at 4 degrees K (the temperature of liquid hydrogen), exhibit picosecond (one millionth of a microsecond) speed, and consume nearly zero power because they operate at superconducting temperatures. After spending nearly twenty years developing JJ's for supercomputer applications, IBM recently threw in the towel because of the difficulty of manufacturing the device and its support system. Work continues in Japan, however, with Fujitsu pursuing research and the Ministry of International Trade and Industry (MITI) funding the development of a JJ analog-to-digital converter. With several GHz bandwidths, such a device could make possible digital storage scopes with several hundred MHz capability, or

low-noise digital VHF receivers with direct conversion to digital information at the front end. Although very low temperature devices have many attractive characteristics, they may be difficult to put to use — except in space, where the necessary low temperature is free. But the benefits are great enough to warrant a substantial continued effort around the world. We should see some exciting breakthroughs in the near future.

## faster antennas, too

Take a look at what's happening in telecommunications. More and more information is being sent over each circuit; system bandwidths are being increased, and most data is now digitized before transmission. All this wideband data eventually goes to an antenna that radiates the signal. This means that the antenna has to have some measure of frequency independence — that is, be broadband. As data rates and information density increase, the pulse response of the system also becomes a consideration.

It is now being observed that many antenna types don't exhibit adequate pulse response for present and contemplated data links. The problem is not an easy one to resolve. In order to radiate, antennas must depart from the distributed characteristics that give transmission lines their good pulse response. Much attention is now being given to measuring the pulse/transient response of various antennas, and the relevant journals abound with complex math as a result. Perhaps all this effort will lead to new antennas that will couple the desired energy into space without acting as if they had all kinds of L & C hung across them.

ham radio



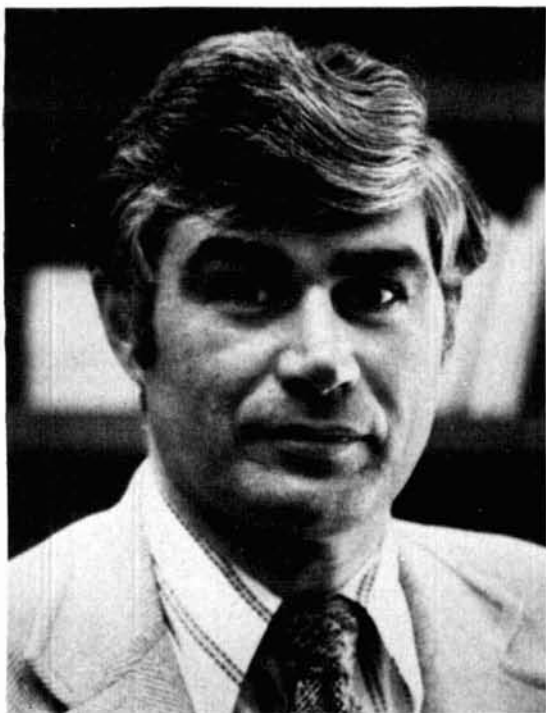

### meet Ernie Guerri, W6MGI

Ernie Guerri, W6MGI, comes to the pages of *ham radio* with a background that includes 32 years as a licensed Amateur, and 27 years in the development and management of advanced technology. He is a Senior Member of the IEEE and a life member of ARRL.

Ernie was educated in Physics at the University of Maine, Semiconductor Electronics at the University of California, and in Business at Stanford. He has held engineering and management positions at IBM, Raytheon, and General Dynamics. Each of these positions involved work at the leading edge of aerospace technology, telemetry, and deep space communications. Most recently he has been President and General Manager of the Advanced Technology Center of Gould Inc., one of America's large (\$1.5B) electronics companies. In October, 1983 he left Gould to form his own technology consulting firm, which he now operates from offices in Chicago.

Ernie will be commenting on technological developments that will shape the equipment of tomorrow. Some will have direct relationship to Amateur Radio; others will hopefully encourage implementation of new technologies in yet unexplored areas of our hobby.

# Two great ways to get Q5 copy

## Ask:

|        |       |        |        |
|--------|-------|--------|--------|
| G4HUW  | KB5DN | WA4FNP | WD5DMP |
| KJ2E   | K61MV | WD4BKY | WD8QHD |
| K4XG   | K8MKH | WD4CCI | WB9NOV |
| KA4CFF | KB0TM | WD4CCZ | WD9DYR |
| KA5DXY | W4YPL | W5GAI  |        |

### 444D SSB/FM

#### Base-Station Microphone

Shure's most widely used base-station microphone is a ham favorite because it really helps you get through... with switch-selectable dual impedance low and high for compatibility with any rig! VOX/NORMAL switch and continuous-on capability make the 444D easy to use even under tough conditions. If you're after more Q5's, you should check it out.



### 526T Series II SUPER PUNCH<sup>®</sup> Microphone

Truly a microphone and a half! Variable output that lets you adjust the level to match the system. The perfect match for virtually any transceiver made, regardless of impedance. Turns mobile-NBFM unit into an indoor base station! Super for SSB operation, too. These and many other features make the 526T Series II a must-try unit.

FREE! Amateur Radio Microphone Selector Folder. Write for AL645.

# SHURE<sup>®</sup>

THE SOUND OF THE PROFESSIONALS<sup>®</sup>...WORLDWIDE

Shure Brothers Inc., 222 Hartrey Ave., Evanston, IL 60204

# Ham MasterTapes™

THE N2NY HAM RADIO COURSE ON VIDEOTAPE

© 1983 N2NY Productions, Inc.

## PRESENTS:

# THE ONLY HAM RADIO COURSE ON VIDEOTAPE

Ham MasterTapes brings the best possible personalized Ham Radio license preparation right into your own living room. If you, a friend or family member wants the best help available to get past the FCC test hurdle, it's available now in Beta or VHS home video format.

Larry Horne, N2NY brings his 33 years of Ham Radio teaching experience right to your home. Each of the 26 video lessons has close-up details of components and systems along with superb graphic drawings. Each lesson has important points superimposed over the action and reviewed at the end of each section. This makes note-taking a snap! Miss something? Didn't get it the first time? Just back up the tape and run it again or freeze-frame it for detailed close-up study!

Larry's classroom is a real ham shack. Lee, a 13-year-old boy, and Virginia are led through the learning process. The questions that they ask are the ones Larry knows you would ask if you were there in person. You soon feel like you're part of an ideal small class.

The topics covered will not only get you through the Novice test—General class theory is covered also. By the time you get your Novice license, you will be able to upgrade to General or Technician!

Larry's technique of involving the viewer with the demonstrations makes

the most difficult topics easy to understand. Understanding—not mere memorization—is what makes Ham MasterTapes so effective. When you study the 700 possible FCC questions, the answers will be obvious.

Larry doesn't stop with just test-passing. All the proper techniques of operating practices and courtesy are demonstrated. The instruction manual for that new rig won't be a mystery! Larry becomes your own personal instructor to help you on that first set-up and contact!

The Ham MasterTapes series is produced in one of New York City's top commercial studios. Not only is the production crew made up of real professionals but many of them are also licensed amateurs. Everybody puts in obvious extra effort to make the production a classic.

The 6-hour course is available on three 2-hour Beta II or VHS-SP cartridges for \$199.95, for individual, home or nonprofit Ham Club use. (High schools or colleges must order our Scholastic licensed version, \$499.95 for Beta or VHS and \$750 for 3/4" U-matic.)

To order, call or write Larry Horne, N2NY at Ham MasterTapes, 136 East 31st Street, New York NY 10016. Phone 212-685-7844 or 673-0680 MasterCard and Visa accepted. New York state residents add appropriate sales tax.

SOME OF THE  
TOPICS  
COVERED INCLUDE

- AMPLITUDE MODULATION
- DOUBLE SIDEBAND
- SINGLE SIDEBAND
- FREQUENCY MODULATION
- PHASE MODULATION
- SIDEBANDS
- BANDWIDTH LIMITS
- ENVELOPE
- DEVIATION
- OVERMODULATION
- SCATTER
- FREQUENCY TRANSLATION
- ANTENNAS AND FEEDLINES
- YAGI ANTENNAS
- QUAD ANTENNAS
- POLARIZATION
- FEEDPOINT IMPEDANCE
- HALF-WAVE DIPOLE
- QUARTER-WAVE VERTICAL
- RADIATION PATTERNS
- DIRECTIVITY
- MAJOR LOBES
- CHARACTERISTIC IMPEDANCE
- STANDING WAVES
- ATTENUATION
- ANTENNA-FEEDING MISMATCH
- STATION ID
- CALL SIGNS
- LOGGING REQUIREMENTS
- POWER LIMITATION
- CONTROL OF REQUIREMENTS
- R-S-T REPORTING SYSTEM
- TELEGRAPHY SPEED
- ZERO-BEATING SIGNAL
- TRANSMITTER TUNE-UP
- TELEGRAPHY ABBREVIATIONS
- RADIO WAVE PROPAGATION
- SKY WAVE AND SKIP
- GROUND WAVE
- HARMONIC INTERFERENCE
- SWR READINGS
- SIGNALS AND EMISSIONS
- BACKWAVE
- KEY CLICKS-CHIRPS
- SUPERIMPOSED HUM
- SPURIOUS EMISSIONS
- COMPUTERS
- OSCAR
- ATV-SSTV
- OPERATING COURTESY
- RULES AND REGULATIONS
- OPERATING PROCEDURES
- RADIO WAVE PROPAGATION
- AMATEUR RADIO PRACTICE
- ELECTRICAL PRINCIPLES
- CIRCUIT COMPONENTS
- PRACTICAL CIRCUITS
- SIGNALS AND EMISSIONS
- RADIO WAVE PROPAGATION
- EMERGENCY COMMUNICATIONS
- TRANSMITTER POWER LIMITS
- STATION-ID REQUIREMENTS
- THIRD-PARTY PARTICIPATION
- FREQUENCY BANDS
- SELECTION OF FREQUENCIES
- R.C. MODELS
- PROHIBITED PRACTICES
- RADIOTELEPHONY
- RADIO TELEPRINTING
- REPEATERS
- VOX TRANSMITTER CONTROL
- BREAK-IN TELEGRAPHY
- ANTENNA ORIENTATION
- INTERNATIONAL COMMUNICATION
- EMERGENCY-PREP DRILLS
- IONOSPHERIC LAYERS D-E-F
- MAXIMUM USEABLE FREQUENCY
- IONOSPHERIC DISTURBANCES
- SUNSPOTS
- SCATTER, DUCTING
- LINE-OF-SIGHT
- TROPOSPHERIC BENDING
- SAFETY PRECAUTIONS
- TRANSMITTER PERFORMANCE
- TWO-TONE TEST
- NEUTRALIZING AMPLIFIERS
- POWER MEASUREMENT
- TEST EQUIPMENT
- OSCILLOSCOPES
- MULTIMETERS
- SIGNAL GENERATORS
- SIGNAL TRACERS
- AUDIO RECTIFICATION
- REFLECTOMETERS - SWR
- SPEECH PROCESSORS
- ANTENNA-TUNING UNITS
- S-METERS
- WATTMETERS
- IMPEDANCE
- RESISTANCE
- REACTANCE
- INDUCTANCE
- CAPACITANCE
- IMPEDANCE MATCHING
- OHM'S LAW
- AMPS AND VOLTS DIVIDERS
- POWER CALCULATIONS
- SERIES AND PARALLEL
- FILTERS

# Ham MasterTapes™

THE N2NY HAM RADIO COURSE ON VIDEOTAPE

© 1983 N2NY Productions, Inc.

136 East 31st Street  
New York, New York 10016  
(212) 685-7844 • 673-0680

✓ 161

# extending the modular 2-band receiver

Add two boards  
— and build yourself  
an HF transceiver  
for SSB and CW

In the July, 1983, issue of *ham radio* I presented a design for a practical, easy-to-use HF receiver with digital readout.<sup>1</sup> The simple addition of a converter to the front end extends the receiver's frequency coverage to VHF; the addition of just two more boards turns the unit into an SSB/CW transceiver as well, see fig. 1.

## design concept

Simply stated, an SSB transmitter amplifies voice, mixes it with a carrier frequency in such a way as to balance out the carrier, removes one sideband, and mixes the result up or down in frequency to the desired output frequency.

In this design, see fig. 2, the audio from the microphone is amplified by a two-stage speech amplifier and applied to a simple two-diode balanced modulator that removes the carrier, providing a signal that contains two sidebands and a suppressed carrier. The carrier source is the BFO. By selecting either USB or LSB, the operating mode for the transmit signal is also selected. To remove one of the sidebands, the signal is passed through the same crystal filter used for receive. Just as the unwanted sideband is removed on receive, the output from the crystal filter contains only one sideband. Because this sideband signal, however, is too low in level to allow the transmitting mixer to function properly, an IF amplifier must be used to increase the signal to an effective level. The output of this stage is injected into the MC1496 double-balanced mixer IC, where it again mixes with the VFO to produce outputs at 14 and 4 MHz ( $9 + 5 = 14$  and  $9 - 5 = 4$ ). The same filters as those used for receive are used here to remove the undesired output. The 20-meter filter removes the 80-meter signal and vice-versa.

The SSB signal present at the output of the band-pass filter is clean but at a very low level. A two-stage broadband amplifier has been designed for an output of about 10 watts (see fig. 3). The driver transistor is a 2N3866 which in turn drives a 2N5590 operating in class AB. The output at this power level is "clean" (low spurious/harmonic content) and requires no additional filtering. However, if you wish to drive a much higher output broadband amplifier, I would recommend adding low-pass filters for each band. Several articles on this subject have been published in this and other magazines.

## operation

The same mixing scheme used for SSB transmission can be used to generate CW. A twin-T oscillator serves the dual purpose of generating both a sine wave tone, used for monitoring, and the CW signal. When a clean tone of a single frequency is applied to an SSB transmitter, a single output frequency, separated from the removed carrier frequency by the frequency of the applied tone, is produced from the transmitter. For example, if a 1 kHz tone is injected into the SSB transmitter, a CW output offset by 1 kHz is generated. Conversely, if tuning in another station produces a 1 kHz CW tone on receive, your transmitter will be on the exact transmitting frequency of the other station when you answer. (A similar method was used to produce CW in the old Heathkit SB/HW series of transceivers.)

To send CW it's necessary to activate the transmitter by either manually switching to transmit or, more easily, using the included 555 timer circuit. This keeps the transmitter on between the dots and dashes. The twin-T oscillator and the timer circuit are keyed at the same time; only the 555 timer is keyed in SSB. This timer stage switches all stages into transmit for a period determined by the adjustable time constants. In addition, the AGC for the IF amplifier must be disabled while in the transmit mode by grounding the AGC control pin 5 on the MC1350, through a 4.7 kilohm resistor.

By James J. Forkin, WA3TFS, 3210 Shadyway Drive, Pittsburgh, Pennsylvania 15227

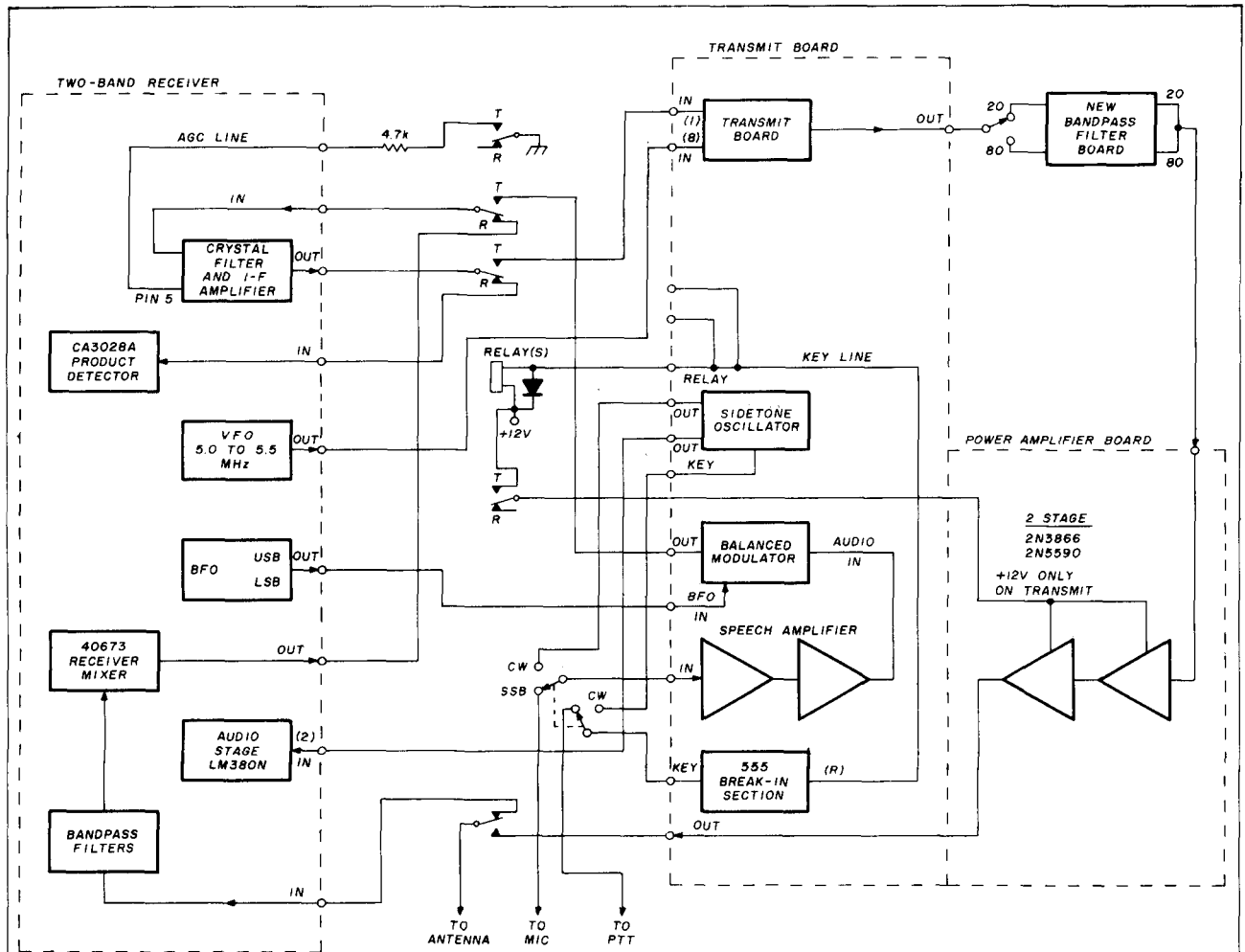

fig. 1. The interconnection diagram. Circuits within the dotted lines are on either the receive board on the left or the transmit board on the right. If more than one relay is used, wire the coil in parallel with the one shown. Use a protection diode as shown on each. Use shielded wiring on all audio circuits and 50-ohm coax on the transmit/receive relay wiring. The new bandpass filter board is identical to the board described in the July, 1983, *ham radio* receiver article.

## construction

The transmit modification is accomplished through the addition of two PC boards. One consists of the two-stage amplifier described above. (Component layout and printed circuit board artwork are detailed in **figs. 4**, and **5**, respectively.) The other board, however, is the actual transmit conversion. Shown on the board, (component layout and printed circuit board artwork are detailed in **figs. 6** and **7**), from left to right, is the 1 kHz sidetone oscillator coupled through a panel switch to the speech amplifier stage in the CW mode. Next is the 555 timer stage, which holds the rig in transmit for a period of time adjusted by the trimmer pot. To the right of the timer is the transistor, used to switch the relays used in the various stages of the receiver. Next in line is the two-stage speech amplifier; note that the two stages are coupled by a jumper wire to simplify the addition of audio compressors, proc-

essors, or other components later. The balanced modulator is next. Be careful to wind the toroid core exactly as shown, keeping all leads as short as possible. It is this stage that determines the ultimate level/amount of carrier suppression the transceiver will offer. The double-balanced mixer completes the board.

## switching

It is important to switch the crystal filter and IF amplifier stage when going from receive to transmit. A single-pole, double-throw miniature relay mounted close to the input and output of this stage does this. Use shielded wire to and from the transmit board. (RG-174 miniature coax works well.) The front end filters must also be modified by adding two relays or alternatively, replaced with new filters exactly like those used for receive for the transmitter, thus eliminating the need for relay switching here. The only

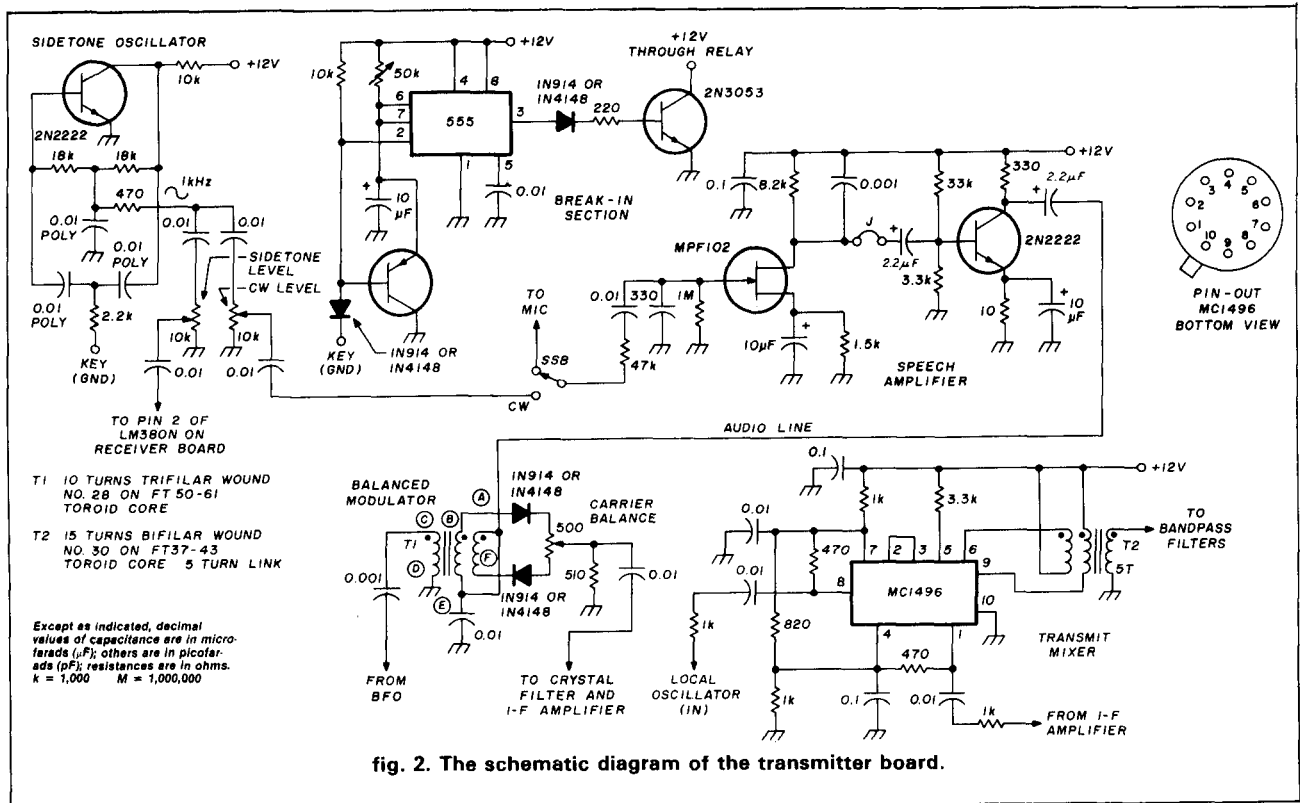

disadvantage to the latter approach is the need to allow for weight and additional space; despite these disadvantages, replacing the filters rather than adding relays does simplify the modification. Use coax for the filters — keep the RF where it belongs! And don't forget that to pull the AGC voltage below 5 volts for maximum gain, you'll have to use another relay or add an extra set of contacts to one of the other relays to ground pin 5 of the IF amplifier through a 4.7 kilohm resistor. Should you choose to use diode switching instead of relays, you may wish to consult several articles that have been published on the subject for help with the design.

For simplicity's sake, you may decide, as I did, to use relays. Several types of 5- and 12-volt DC relays are available on the surplus market. Use 12-volt relays if you can find them at a reasonable price, or wire three 5-volt relays in series; they'll key reliably on 12 volts. Mount your relays to the board with double-sided foam tape or glue. Place a diode across each relay coil to prevent voltage spikes.

### initial adjustments

After completing the modification, make sure that the receiver still works. Realign it and check the BFO frequencies. When you're convinced that the receiver is working as well as it did before the modification, connect a dummy load to the antenna terminal and key the transmitter in the CW position. Check that all

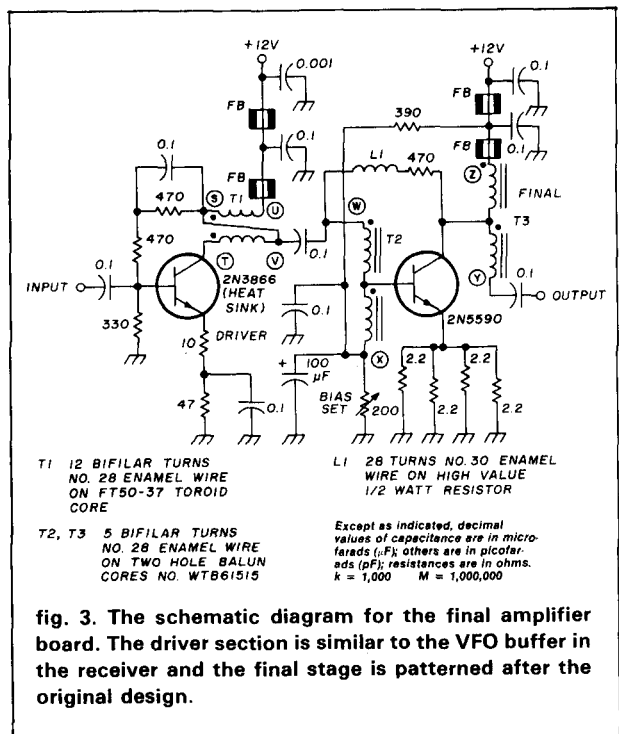

relays switch as they should and adjust the 555 for a hold-in time of about 1 second. Check that the AGC voltage at pin 5 of the MC1350 is in fact dropping below 5 volts on transmit. Put the rig into SSB and



# VHF COMMUNICATIONS

## NOW FEATURING STATE-OF-THE-ART MOSFET REPEATER AMPLIFIERS



4111: 2 METER Power Amplifier  
2W in—30W out  
20W in—100W out

4112: 220 MHz Power Amplifier  
2W in—25W out  
25W in—100W out

4114: 2 METER Power Amplifier  
2W input—100W OUTPUT

All above amplifiers designed  
for 13.8 VDC operation.

SEE US ALSO FOR  
YOUR MOBILE AMPLIFIER NEEDS



# FALCON

## COMMUNICATIONS

ALSO FEATURING: ICOM, AEA, LARSEN, VAN GORDEN, VIBROPLEX, NYE-VIKING, LEADING EDGE, ARRL PUBLICATIONS, KAGLO, HAMTRONICS, PROWRITER, ELEPHANT DISKS, DEBCO, TRIONYX.

915 N. Main St., Jamestown, New York 14701 (716) 664-6345

## DESIGN EVOLUTION IN RF P.A.'s



Now with  
**GaAs FET**  
Preamp

- Linear (all mode) RF power amp with automatic T/R switching (adjustable delay)
- Receive preamp option, featuring GaAs FETS (lowest noise figure, better IMD). Device NF typically .5 dB.
- Thermal shutdown protection incorporated
- Remote control available
- Rugged components and construction provide for superior product quality and performance
- Affordably priced offering the best performance per dollar
- Designed to ICAS ratings, meets FCC part 97 regulations
- 1 year transistors warranty
- Add \$5 for shipping and handling (Cont. U.S.). Calif. residents add applicable sales tax.
- Specifications/price subject to change

| MODEL 1 | FREQUENCY 2 | OUTPUT POWER | INPUT POWER | SUGG. PRICE<br>LESS TAX |
|---------|-------------|--------------|-------------|-------------------------|
|         | (MHz)       | (W)          | (W)         | \$                      |
| 1410    | 144         | 160          | 10          | 225                     |
| 1410G   | 144         | 160          | 30          | 265                     |
| 1412    | 144         | 160          | 30          | 199                     |
| 1412G   | 144         | 160          | 30          | 239                     |
| 2210    | 220         | 130          | 10          | 225                     |
| 2210G   | 220         | 130          | 10          | 265                     |
| 2212    | 220         | 130          | 30          | 199                     |
| 2212G   | 220         | 130          | 30          | 239                     |
| 4410    | 440         | 100          | 10          | 225                     |
| 4410G   | 440         | 100          | 10          | 265                     |
| 4412    | 440         | 100          | 30          | 199                     |
| 4412G   | 440         | 100          | 30          | 239                     |

1. Models with G suffix have GaAs FET preamps. Non-G suffix units have no preamp.
2. Covers full amateur band. Specify 10 MHz Bandwidth for 420-450 MHz Amplifier.

★SEND FOR FURTHER INFORMATION★

**TE**  
**SYSTEMS**

**TE SYSTEMS**  
P.O. Box 25845  
Los Angeles, CA 90025  
(213) 478-0591

## TOWERS

by ALUMA

HIGHEST QUALITY  
**ALUMINUM**

60 Ft. Alum.  
Crank-Up  
Model T-60-H

- TELESCOPING (CRANK-UP)
- GUYED (STACK-UP)
- TILT-OVER MODELS

Easy to install. Low Prices.  
Crank-ups to 100 ft.

EXCELLENT FOR  
AMATEUR COMMUNICATIONS



Mobile  
Truck  
Type

Over 36 types aluminum  
and steel towers made—  
specials designed and  
made—write for details



Fixed Base

**ALUMA TOWER CO.**

BOX 2806HR  
VERO BEACH, FLA. 32960-2806  
(305) 567-3423 TELEX 80-3405

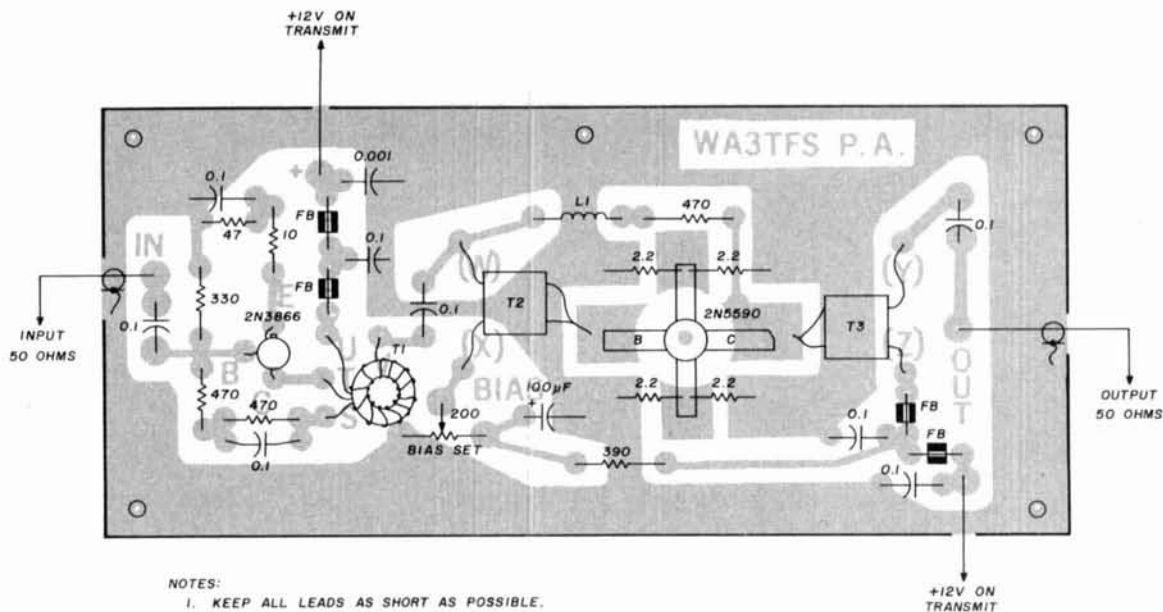

- NOTES:
1. KEEP ALL LEADS AS SHORT AS POSSIBLE.
  2. ALL COMPONENTS MOUNT ON FOIL SIDE OF BOARD.
  3. MOUNT 2N5590 FIRST TO HEATSINK AND THEN SPACE BOARD ABOVE HEATSINK WITH WASHERS SO THERE IS NO STRAIN ON TRANSISTOR.
  4. USE 50 OHM COAX FOR INPUT/OUTPUT.
  5. ADJUST BIAS FOR 75-80mA WITH NO SIGNAL ON 2N5590.

Except as indicated, decimal values of capacitance are in microfarads ( $\mu F$ ); others are in picofarads (pF); resistances are in ohms.  $k = 1,000$   $M = 1,000,000$



fig. 4. The parts layout for the RF amplifier board. Positive 12 volts is applied only on transmit. Set bias adjustment for an idle current in the final stage of 75 to 80 mA with no drive applied to the board.

adjust the output stage for a resting current of 80 mA. With the rig in SSB there will be no drive to the final stage. Put the switch back in CW. When keying, adjust the trim pot in the oscillator stage for sidetone

level. Increase the drive level with the other trim pot until no increases in output level from the transmitter are noted. Back off the adjustment slightly. CW tune-up is completed.

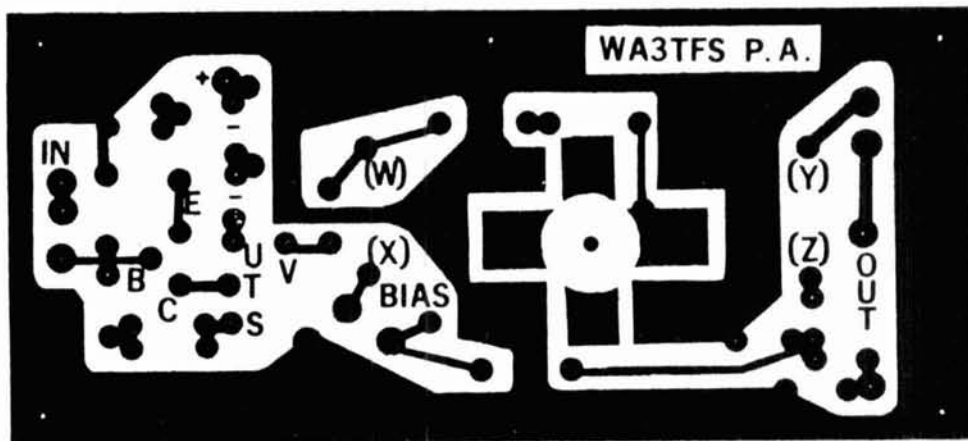

fig. 5. The foil side layout for the RF amplifier board. All parts on this board are mounted on the foil side.

# NEW! SPECIAL

## North American Edition

As an added bonus, the 1985 U.S. Callbook also lists the amateurs in Canada and Mexico! You get the complete and accurate U.S. listings, all the usual up-to-date Callbook charts and tables, PLUS Canada and Mexico.

### THE BEST JUST GOT BETTER!

Of course, Canada and Mexico are also included in the 1985 Foreign Callbook. And our editorial staff has checked and corrected all new information before use to bring you the most accurate listings possible. But that's just what you'd expect from the people who invented Callbooks.

Want to keep your 1985 Callbooks up-to-date throughout the year? Optional supplements are published March 1, June 1, and September 1; each contains all activity for the preceding 3 months. Thousands of new licenses, call changes, and address changes are included in each issue.

**COMPARE!  
WHY SETTLE FOR LESS THAN THE BEST?  
ORDER YOUR COPIES NOW.**

- 433,000 current U.S. Listings • 413,000 current Foreign Listings • Great Circle Bearings
- Then & Now call changes • Silent Keys • Census of Amateur Licenses in all countries
- Standard Time Charts • International Postal Information • World-wide QSL Bureaus
- Table of Amateur Prefix Allocations • Prefixes of the World • Plus many other features.

Publication: December 1, 1984

|   | Including shipment to U.S.A. points | Illinois residents, incl. tax & shipping | Including shipment to foreign countries |
|---|-------------------------------------|--|---|
| <input type="checkbox"/> Single 1985 U.S. Callbook  | \$25.00                             | \$26.35                                  | \$26.50                                 |
| <input type="checkbox"/> Single 1985 Foreign Callbook   | 24.00                               | 25.30                                    | 25.50                                   |
| <input type="checkbox"/> SPECIAL OFFER: Order both 1985 Callbooks at the same time for shipment to one address. | 45.00                               | 47.50                                    | 49.50                                   |
| <input type="checkbox"/> Set of 3, U.S. Supplements for 1985  | 15.00                               | 15.95                                    | 15.00                                   |
| <input type="checkbox"/> Set of 3, Foreign Supplements for 1985   | 15.00                               | 15.95                                    | 15.00                                   |

Name \_\_\_\_\_ Amount enclosed \_\_\_\_\_

Address \_\_\_\_\_

radio amateur  
**callbook**

925 Sherwood Dr., Box 247,  
Lake Bluff, IL 60044, USA

✓ 207

Tel: (312) 234-6600





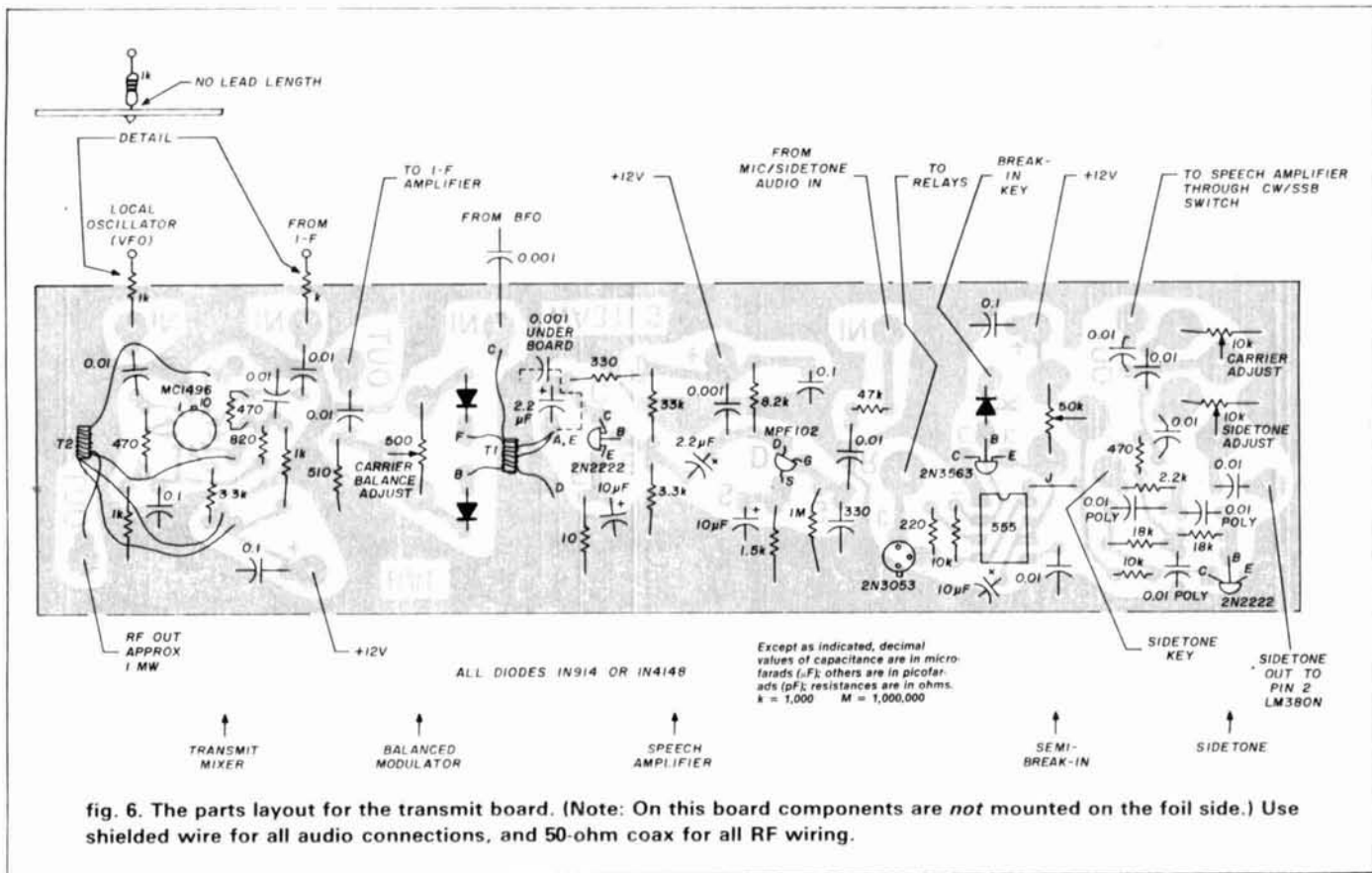

fig. 6. The parts layout for the transmit board. (Note: On this board components are *not* mounted on the foil side.) Use shielded wire for all audio connections, and 50-ohm coax for all RF wiring.

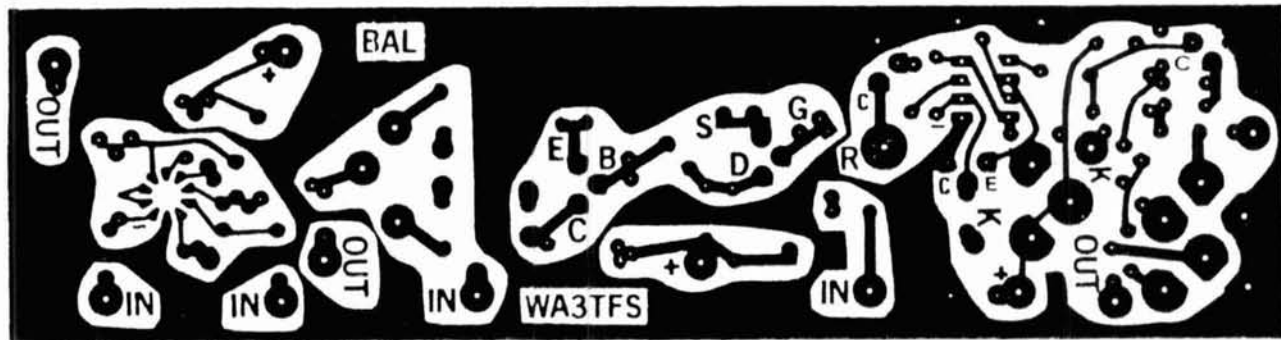

fig. 7. The foil side layout for the transmitter board.

Next attach a microphone to the input. (A CB replacement microphone will be sufficient.) If the CW/SSB switch has been wired correctly, the microphone will be connected to the input of the speech amplifier and the twin-T oscillator will be disconnected. When you press the PTT and whistle into the microphone, the RF output should increase. The level should be about the same as when transmitting CW, but may vary because of different output levels of various microphone elements.

Disconnect the microphone and while still in SSB,

key the transmitter with a jumper wire. While checking the output with a meter, or better still, an oscilloscope, adjust the trim pot in the balanced mixer for minimum output and, consequently, maximum carrier suppression. If you can't see any change in the meter reading as you make this adjustment, you'll know you've either wound the coil in the balanced modulator incorrectly or caused some stage to oscillate because of poor wiring layout or failure to ground something. Check your construction step by step. You should see a definite null in output power. If everything

# COMPUTER TRADER MAGAZINE

The monthly magazine with a natural blending of two popular hobbies — Ham Radio and Computers

- ★ Articles on Ham Radio & Most Personal Computers
- ★ Hardware & Software Reviews
- ★ Various Computer Languages
- ★ Construction Articles
- ★ Much Much More . . .

• FREE Classified Ads for subscribers, non-subscribers - 10¢ a word/number (used equipment only)

• Excellent display ad rates

Join the **CTM**<sup>®</sup> readership family by subscribing NOW, during our Baker's Dozen Special.

USA . . . . . \$12.00 for 13 issues  
 Mexico, Canada . . . . . \$25.00  
 Foreign . . . . . \$35.00(land) - \$55.00(air)  
 (U.S. funds only)  
 Permanent (U.S. Subscription) . . . . . \$100.00  
 Sample Copy . . . . . \$2.50

## CTM

Circulation Manager  
 1704 Sam Drive  
 Birmingham, Alabama 35235  
 Phone (205) 854-0271

Name \_\_\_\_\_

Call Sign \_\_\_\_\_

Address \_\_\_\_\_

City \_\_\_\_\_ State \_\_\_\_\_

Zip \_\_\_\_\_ Phone \_\_\_\_\_

Date \_\_\_\_\_

Signature \_\_\_\_\_

✓ 137

appears to be in order, go back and readjust everything until no further change occurs. Your new transceiver is now ready to be connected to the antenna.

### conclusion

This complete transceiver will operate reliably and efficiently as long as care is taken to attach a matched 50-ohm load. The output stage will not self-destruct if you have high SWR or forget to attach the antenna, but output power will be low. The rig should run about 8 to 10 watts out into a matched antenna. I have worked all states on 20-meter sideband and find I require no more power from the home station.

A kit is available from the author to make the modification described in this article. For details, please send an SASE to me at the address shown at the beginning of this article.

ham radio

## Your Ham Tube Headquarters!

TUBES BOUGHT, SOLD AND TRADED  
 SAVE \$\$\$—HIGH \$\$\$ FOR YOUR TUBES

Call Toll Free 800-221-0860

### Tubes

|                   |         |                 |         |
|-------------------|---------|-----------------|---------|
| 3-400Z . . . . .  | \$85.00 | 7360 . . . . .  | \$10.00 |
| 3-500Z . . . . .  | 85.00   | 7735A . . . . . | 27.50   |
| 4-400A . . . . .  | 80.00   | 8122 . . . . .  | 110.00  |
| 4CX250B . . . . . | 50.00   | 8156 . . . . .  | 12.50   |
| 572B . . . . .    | 55.00   | 8643 . . . . .  | 82.50   |
| 811A . . . . .    | 12.00   | 8844 . . . . .  | 26.50   |
| 813 . . . . .     | 30.00   | 8873 . . . . .  | 175.00  |
| 6146B . . . . .   | 6.50    | 8874 . . . . .  | 195.00  |
| 6360 . . . . .    | 4.25    | 8877 . . . . .  | 500.00  |
| 6883B . . . . .   | 6.75    | 8908 . . . . .  | 12.50   |

### MAJOR BRANDS ON RECEIVER TUBES

75% off list

#### Semiconductors

|                      |         |                  |       |
|----------------------|---------|------------------|-------|
| MRF 245/SD1416 . . . | \$30.00 | SD1088 . . . . . | 19.95 |
| MRF 454 . . . . .    | 14.95   | 2N3055 . . . . . | 75¢   |
| MRF 455 . . . . .    | 10.95   | 2N6084 . . . . . | 12.50 |

#### RF Connectors

|                      |           |                   |            |
|----------------------|-----------|-------------------|------------|
| PL259 . . . . .      | 10/\$4.95 | M358 . . . . .    | 2.50 ea.   |
| PL258 . . . . .      | 10/8.95   | M359 . . . . .    | 1.75 ea.   |
| UG 175/176 . . . . . | 10/1.60   | Type "N" Twist on |            |
| UG255/u . . . . .    | 2.50 ea.  | (RG8/u) . . . . . | \$4.75 ea. |
| UG273/u . . . . .    | 2.25 ea.  | Minimum Order     | \$25.00    |

Allow \$3.00 min. for UPS charges ✓ 131

## CeCo

COMMUNICATIONS, Inc.

2115 Avenue X Brooklyn, NY 11235

SERVING THE INDUSTRY SINCE 1922

Phone (212) 646-6300

Call CECO For Your CCTV Security And Color Production Requirements

SAY  
 YOU SAW **ham**  
 IT IN **radio** magazine

# ICOM IC-R71A

## The Best Just Got Better



IC-GC4  
World Clock

ICOM introduces the IC-R71A 100kHz to 30MHz superior-grade general coverage receiver with innovative features including keyboard frequency entry and wireless remote control (optional).

This easy-to-use and versatile receiver is ideal for anyone wanting to listen in to worldwide communications. Demanding no previous shortwave receiver experience, the IC-R71A will accommodate an SWL (shortwave listener), Ham (amateur radio operator), maritime operator or commercial operator.

With 32 programmable memory channels, SSB/AM/RIT/CW/FM (optional), dual VFO's, scanning, selectable AGC and noise blanker, the IC-R71A's versatility is unmatched by any other commercial grade unit in its price range.

**Superior Receiver Performance.** Utilizing ICOM's DFM (Direct Feed Mixer), the IC-R71A is virtually immune to interference from strong adjacent signals, and has a 100dB dynamic range.

Passband tuning, a deep IF notch filter, adjustable AGC (Automatic Gain Control) and noise blanker provide easy-to-adjust clear reception, even in the presence of strong interference or high noise levels. A preamplifier allows improved reception of weak signals.

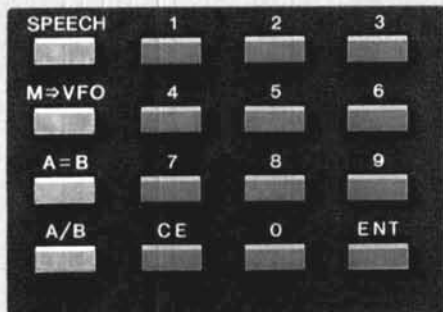

**Keyboard Entry.** ICOM introduces a unique feature to shortwave receivers... direct keyboard entry for simplified operation. Precise frequencies can be selected by

pushing the digit keys in sequence of frequency. The frequency will be automatically entered without changing the main tuning control. Memory channels may be called up by pressing the VFO/M (memory) switch, then keying in the memory channel number from 1 to 32.

**VFO's/Memories.** A quartz-locked rock solid synthesized tuning system provides superb stability. Three tuning rates are provided: 10Hz / 50Hz / 1KHz.

**32 Tunable Memories.** Thirty-two tunable memories, more than any other general coverage receiver on the market, offer instant recall of your favorite frequency. Each memory stores frequency, VFO and operating mode, and is backed by an internal lithium memory backup battery to maintain the memories for up to five years.

**Options.** FM, synthesized voice frequency readout (activated by SPEECH button), RC11 wireless remote controller, IC-CK70 DC adapter for 12 volt operation, MB12 mobile mounting bracket, two CW filters FL32 — 500Hz, and FL63 — 250Hz, and high-grade 455KHz crystal filter FL44A.

IC-RC11  
Infrared  
Remote  
Controller



**ICOM**  
The World System

# The Problem Solver...

The RF Wattmeter Model 81000-A from Coaxial Dynamics, Inc. does more than provide accurate rf measurements. Testing of transmission lines, antennas, connectors, filters and related components can reveal unknown problems and assure optimum equipment performance.

The 81000-AK Wattkit features this easy-to-read RF Wattmeter (pictured here), with its optional carrying case and an array of elements and accessories. Coaxial Dynamics elements can be purchased separately for use in other manufacturer's Wattmeters. For more information on the 81000-A Wattmeter or any of the complete line of Coaxial Dynamics RF products and OEM components please contact Coaxial Dynamics, Inc.

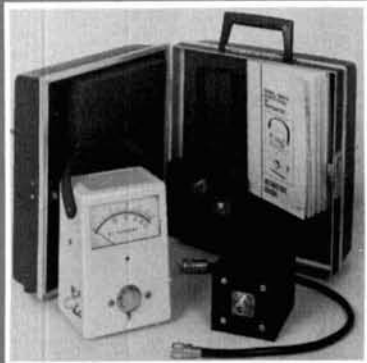

**COAXIAL DYNAMICS, INC.**

15210 Industrial Parkway, Cleveland, OH 44135 • (216) 267-2233  
Outside Ohio, WATS: (800) Coaxial, Telex: 980-630

134

## MICROWAVE TV ANTENNA SYSTEMS

Freq. 2.1 to 2.7 GHz . 34 db Gain +



COMPLETE SYSTEMS:  
(as Pictured)

Commercial 40"  
Rod Style \$99.95

Parabolic 20"  
Dish Style \$79.95

### COMPONENTS

Down Converters  
(either style) \$34.95

Power Supplies \$24.95  
(12V to 16V, DC+)

Data Info (Plans) \$ 9.95

CALL OR WRITE FOR  
KITS, PARTS, OR MORE  
INFORMATION

Shipping & Handling Add \$5.00  
We Repair Most Types Down  
Converters & Power Supplies

**Phillips-Tech  
Electronics**

P.O. Box 34772  
Phoenix, AZ 85067  
(602) 967-6972

Special Quantity Pricing  
Dealers Wanted



NORTH AMERICAN SOAR corporation

## PEN-STYLE DIGITAL MULTIMETER

MODEL 3100 **\$49.00**  
GREAT PRICE



Hand Held LCD Display - Fast One Hand Operation

### SPECIFICATIONS:

**Display:** LCD 3 1/2 digits maximum reading of 1999/continuity beeper built-in

**Range:** Auto ranging

**Polarity:** Automatic no indication for positive polarity, minus sign for negative polarity

**Overrange Indication:** MBS 1 or -1 indication

**Data Hold:** Data hold in all ranges with hold switch on

**Low Battery Indication:** "B" mark displayed when battery drops below operating voltage

**Sampling:** 2 Times/second

**Power Supply:** SR-44 battery (1.55V) X2 (Included)

**Power Consumption:** 5.5mW

**Size:** 6" x 1 1/2" LWH (less probe tips) includes 1/2" and 2" probes

Add \$2.50 For Shipping

STOCKING DISTRIBUTOR



**KCS ELECTRONICS  
CORPORATION**

SEMICONDUCTOR PARTS AND PRODUCTS

1043 N. STADEM DR.  
TEMPE, AZ 85281

**(602) 967-6945**

Call or Write for **FREE**  
Semiconductor Parts & Products Catalog

200

175

# receiving signals from space

## How to locate geostationary satellites from your QTH

With the price of TV-Receive Only (TVRO) terminals on its way down and the availability of channels expanding, interest in geostationary satellites is increasing. This article describes how to locate these satellites from any given latitude and longitude in terms of azimuth, elevation, and range.

Two programs are included — one in BASIC for the TRS-80™ (level II or similar) and the other for the Hewlett-Packard 67 or equivalent. While the mathematics are the same for each program, some minor changes have been made to accommodate the specific programming language used and the functions available on each machine. For example, (cos/sin) is substituted for (cot) because of the absence of the cotangent function on the HP-67 and in TRS-80 Level II BASIC.

### celestial mechanics

For a satellite to always appear stationary above a particular point on earth, it must have the same **period** as the Earth — that is, 23 hours, 56 minutes, 4.09 seconds or 86164.09 seconds. In order to have a period that matches that of the earth, the geostationary satellite must be a specific height above earth. This measurement can be found by using the Newtonian law stating that the square of the velocity of an object (satellite in this case) is equal to the universal gravitational constant times the mass attracting the

object (the Earth), divided by the distance of the object from the center of the mass (Earth).

$$V^2 = \frac{GM_E}{D} \quad (1)$$

where  $V$  = velocity of satellite  
 $G$  = universal gravitational constant

$$6.673 \times 10^{-11} \frac{\text{Newtons-meter}^2}{\text{kilogram}^2}$$

$M_E$  = Mass of Earth =  $5.975 \times 10^{24}$  kg

$D$  = distance from center of earth to satellite  
 =  $(R + H)$  = radius of earth + height of satellite above earth

$G$  and  $M_E$  are constants and can be combined:

$$G' = GM_E = 3.987 \times 10^{14} \text{ meters}^3/\text{sec}^2 \\ = 3.987 \times 10^5 \text{ km}^3/\text{sec}^2 \quad (2)$$

which results in

$$V^2 = \frac{G'}{R + H} = \frac{G'}{D} \quad (3)$$

$$\text{or } V_{SAT} = \sqrt{\frac{G'}{D}} \quad (4)$$

The period of one complete revolution of the satellite is equal to the distance it travels in orbit divided by its velocity or:

$$P_{SAT} = \frac{2\pi D}{V_{SAT}} = \frac{2\pi D}{\sqrt{\frac{G'}{D}}} = 2\pi \sqrt{D^3/G'} \quad (5)$$

But this is equal to 86,164 seconds (approximately 24 hours) for it to be a geostationary satellite as explained above.

By Dennis Mitchell, K8UR, 1 Cider Mill Lane, Upton, Massachusetts 01568

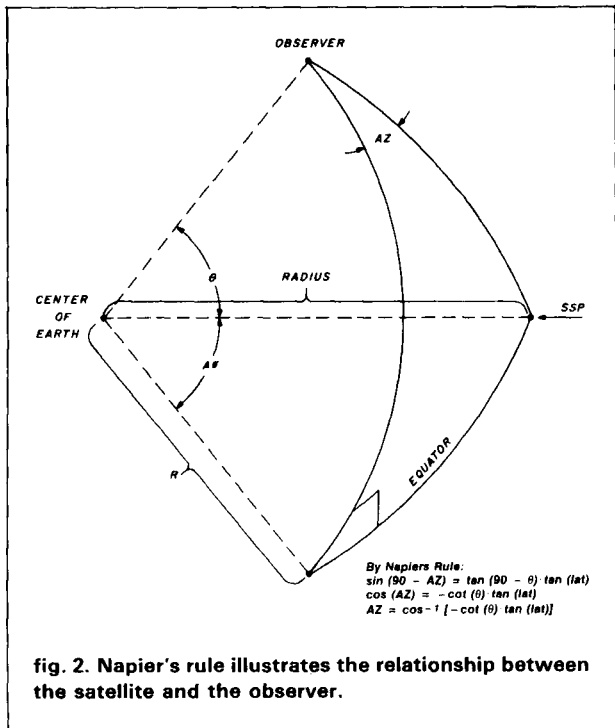
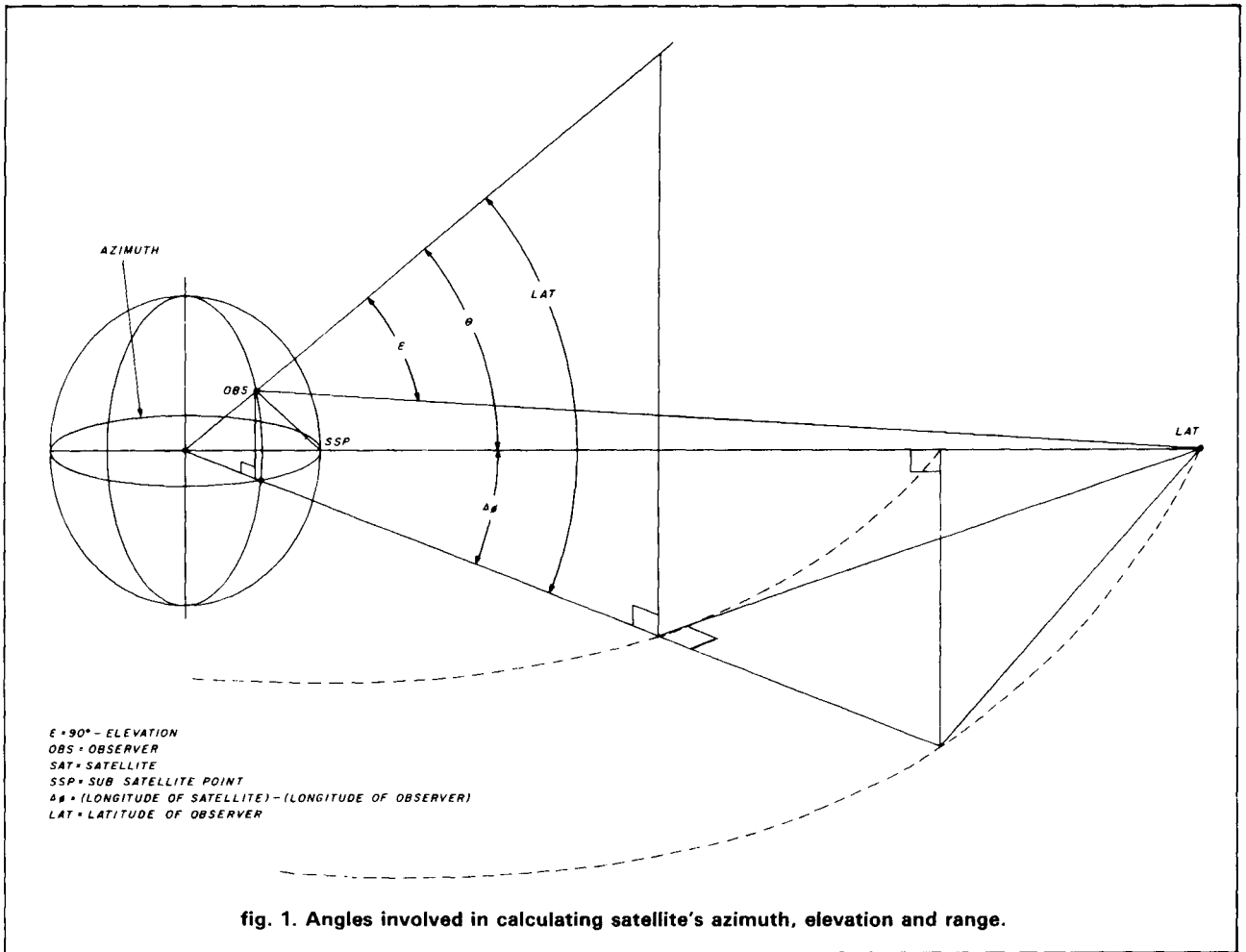

Rearranging terms and solving for D:

$$D = \sqrt[3]{\left(\frac{P_{SAT}}{2\pi}\right)^2 G'} \quad (6)$$

$$= 42,168 \text{ km}$$

$$\begin{aligned}
 H \text{ (height of satellite above earth)} &= 42,168 - 6378 \\
 &= 35,790 \text{ km} \\
 &= 22,239 \text{ miles}
 \end{aligned}$$

$$\begin{aligned}
 \text{and } V_{SAT} &= \sqrt{\frac{G'}{D}} = \frac{398,700}{42,168} = 3.075 \text{ km/sec} \\
 &= 3075 \text{ meters/sec.}
 \end{aligned}$$

### finding azimuth, elevation, and range

Fig. 1 shows the angles involved in finding the azimuth, elevation, and range of the satellite.

Fig. 2, an exploded view of a section of the Earth, shows how the locations of the Earth's center, an observer, the Equator, and latitude are related. The difference in longitude and the sub-satellite point are also shown.

By viewing figs. 1 and 2 and using Napier's rule with

**table 1. List of the current C-band (3.7-4.2 GHz) geosynchronous satellites and their longitude.**

| satellite name | degrees west |
|----------------|--------------|
| AURORA I       | 143          |
| ANIK B         | 109          |
| ANIK C2        | 105          |
| ANIK D         | 104.5        |
| ANIK III       | 114          |
| COMSTAR I      | 128          |
| COMSTAR II     | 95           |
| COMSTAR III    | 87           |
| COMSTAR IV     | 127          |
| GALAXY I       | 128          |
| GALAXY II      | 74           |
| SATCOM I-R     | 139          |
| SATCOM II-R    | 72           |
| SATCOM III-R   | 131          |
| SATCOM II      | 119          |
| SATCOM IV      | 83           |
| SBS I          | 100          |
| SBS II         | 97           |
| SBS III        | 95           |
| TELSTAR 301    | 96           |
| USAT I         | 85           |
| WESTAR I       | 99           |
| WESTAR II      | 79           |
| WESTAR III     | 91           |
| WESTAR IV      | 99           |
| WESTAR V       | 123          |

**table 2. Sample calculation of geosynchronous satellite azimuth, elevation, and range for an observer in Upton, Massachusetts.**

| satellite    | longitude | azimuth | elevation | range (km) |
|--------------|-----------|---------|-----------|------------|
| AURORA I     | 143       | 257     | 5         | 41128      |
| ANIK B       | 109       | 228     | 28        | 38763      |
| ANIK C2      | 105       | 224     | 30        | 38555      |
| ANIK D       | 104.5     | 223     | 30        | 38530      |
| ANIK III     | 114       | 233     | 25        | 39049      |
| COMSTAR I    | 128       | 245     | 15        | 39979      |
| COMSTAR II   | 95        | 212     | 35        | 38125      |
| COMSTAR III  | 87        | 202     | 38        | 37883      |
| COMSTAR IV   | 127       | 244     | 16        | 39907      |
| GALAXY I     | 128       | 245     | 15        | 39979      |
| GALAXY II    | 74        | 183     | 41        | 37700      |
| SATCOM I-R   | 139       | 254     | 7         | 40811      |
| SATCOM II-R  | 72        | 180     | 41        | 37695      |
| SATCOM III-R | 131       | 248     | 13        | 40199      |
| SATCOM IV    | 83        | 196     | 39        | 37799      |
| SBS I        | 100       | 218     | 33        | 38324      |
| SBS II       | 97        | 215     | 34        | 38201      |
| SBS III      | 95        | 212     | 35        | 38125      |
| TELSTAR 301  | 96        | 213     | 35        | 38162      |
| USAT I       | 85        | 199     | 39        | 37838      |
| WESTAR II    | 79        | 190     | 40        | 37739      |
| WESTAR III   | 91        | 207     | 37        | 37993      |
| WESTAR IV    | 99        | 217     | 33        | 38281      |
| WESTAR V     | 123       | 241     | 19        | 39627      |

```

10 CLEAR 100
20 REM*****
30 REM** THIS PROGRAM WILL COMPUTE THE AZIMUTH, ELEVATION **
40 REM** AND RANGE TO GEOSTATIONARY SATELLITES FOR TVRO ***
50 REM***** BY D.C. MITCHELL-KBUR/1 1/1/81 *****
52 REM***** UPDATED SATELLITE LIST 6/27/84 *****
55 REM***** 1 CIDER MILL LN, UPTON, MA, 01568 *****
60 REM*****
70 CLS
80 PRINTCHR$(23);PRINT"ENTER YOUR LATITUDE";GOSUB 100:LA=DD
90 CLS:PRINTCHR$(23);PRINT"ENTER YOUR LONGITUDE";GOSUB 100:LO=DD:GOTO 150
100 PRINT#60,"DEGREES-----";PRINT#324,"MINUTES-----";PRINT#188,"SECONDS-----"
110 PRINT#286,"";:INPUTDD:PRINT#324,"MINUTES-----";:INPUTMM:PRINT#188,"SECONDS-----";:INPUTSS
120 PI=3.14159
130 LAS=STR$(DD)+STR$(MM)+STR$(SS):DD=(MM*60+SS)/3600+DD:RETURN
140 REM
150 INPUT"ENTER YOUR CITY";CS:INPUT"ENTER YOUR STATE";TS:CS+CS+","*TS
160 CLS
170 LA=PI*LA/180:LO=PI*LO/180
180 PRINT" SATELLITE *** AZIMUTH / ELEVATION / RANGE *** LOCATOR"
190 PRINT" FOR "CS:PRINT""
200 PRINT"SATELLITE LONG AZIMUTH ELEVATION RANGE (KM)"
210 PRINTSTRING$(60,"")
220 READ SS,S
230 IF SS="END" THEN END
240 SS=PI/180
250 DEFN AC=ATN(X/SQR(-X*X+1))-1.5708
260 X=(COS(LA)*COS(S-LO))-TH*FNAC
270 X=(-TAN(LA)*COS(TH)/SIN(TH)):AZ=FNAC
280 IF SIN(S-LO)>0 THEN AZ=6.28-AZ
290 FI=ATN((COS(TH)-.151066)/SIN(TH))
300 R=SQR((1.81854E9-(7.37111E8*COS(TH)))
310 AZ=AZ-180/PI+FI+180/PI:SS=PI*180/PI
320 DATA"AURORA I",143,"ANIK B",109,"ANIK C2",105,"ANIK D",104.5
321 DATA"ANIK III",114,"COMSTAR I",128,"COMSTAR II",95,"COMSTAR III",87
322 DATA"COMSTAR IV",127,"GALAXY I",128,"GALAXY II",74,"SATCOM I-R",139
323 DATA"SATCOM II-R",72,"SATCOM III-R",131,"SATCOM IV",83,"SBS I",100
324 DATA"SBS II",97,"SBS III",95,"TELSTAR 301",96,"USAT I",85,"WESTAR IV",99
325 DATA"WESTAR I",79,"WESTAR II",79,"WESTAR III",91,"WESTAR V",123,"END",999
326 AZ=FI(AZ):FI=FI(AZ):RAC=FI(RA)
330 PRINTSS;TAB(13)S;TAB(24)AZ;TAB(39)FI;TAB(53)RA
340 GOTO 220

```

**fig. 3. BASIC language program listing used to determine geosynchronous satellite azimuth, elevation angle, and range from your QTH.**

spherical trigonometry and some trigonometric identities, the equations for azimuth, elevation, and range are:

$$\theta = \cos^{-1}[\cos(\text{lat}) \cdot \cos(\Delta \text{ long})] \quad (7)$$

$$Az = \cos^{-1}[-\tan(\text{lat}) \cos(\theta) / \sin(\theta)] \quad (8)$$

If  $\sin(\Delta \text{ long}) > 0$  then  $Az = 360 - Az$  and the

$$\text{elevation angle} = \tan^{-1}[\cos(\theta) - 0.151 / \sin(\theta)] \quad (9)$$

where:  $R / (R + H) = 6378 / 42168 = 0.151$

and:

$$\text{Range} = \sqrt{(R + H)^2 + R^2 - 2 \cdot (R + H) \cdot R \cos \theta}$$

### program hints

In the HP-67 program, the observer's latitude and longitude are replaced in decimal form. (Latitude is replaced in lines 3 through 7; longitude in lines 9 through 13.) Don't forget to use your own numbers — not mine — in these steps. The only other entry is the satellite longitude taken from **table 1**; after entry, hit key (A). Outputs are elevation, azimuth, and range in that order.

The BASIC program, which should need no explanation, prompts the user for all inputs. As shown in **table 2**, outputs provide satellite name, azimuth, elevation, and range in kilometers.

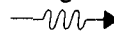
Locating the geostationary satellite you're looking for among the many orbiting the Earth in the crowded "satellite belt" is getting more difficult, but with a computer program such as this and some good microwave gear, they can be found. 

# Join AMSAT...Today

Amateur Radio Satellite OSCAR 10 provides:

- A New Worldwide DX Ham Band open 10 hours a day.
- Rag Chew With Rare DX Stations in an uncrowded, gentlemanly fashion.
- Popular Modes In Use: SSB, CW, RTTY, SSTV, Packet
- Full Operating Privileges open to Technician Class licensee or higher.

Other AMSAT Membership Benefits:

### ORBIT Magazine Subscription:

Dependable technical articles, satellite news, orbital elements, product reviews, DX news, and more.

Satellite Tracking Software  
Available for most popular PCs.

QSL Bureau, AMSAT Nets, Area Coordinator Support, Forum Talks

Construction of Future Satellites For Your Enjoyment!

AMSAT Membership is \$24 a year, \$26 outside North America. VISA and MC accepted.

**AMSAT**  
P.O. Box 27  
Washington, DC 20044  
301 589-6062

✓ 196

| STEP | KEY ENTRY | KEY CODE | COMMENTS  | STEP | KEY ENTRY | KEY CODE | COMMENTS |
|------|-----------|----------|-----------|------|-----------|----------|----------|
| 001  | F LBL A   | 21 25 12 |           |      | FX <> V   | 25 52    |          |
|      | STO A     | 33 11    |           |      |           | 51       |          |
|      | 4         | 04       | USERS OWN |      | STO C     | 33 13    |          |
|      | 2         | 02       |           |      |           | GTO B    | 22 12    |
|      |           | 83       | LATITUDE  |      | F LBL 1   | 31 25 01 |          |
|      | 4         | 04       |           |      |           |          | 01       |
|      | 8         | 08       | LATITUDE  |      |           | 83       |          |
|      | STO 0     | 33 02    |           |      |           | 8        | 08       |
|      | 7         | 07       | USERS OWN |      |           | 01       |          |
|      | 1         | 01       |           |      |           | 8        | 08       |
| 010  |           | 83       | LONGITUDE |      | EXX       | 43       |          |
|      | 2         | 02       |           |      |           | 9        | 09       |
|      | 2         | 02       | LONGITUDE |      | ENTER     | 41       |          |
|      | STO 1     | 33 01    |           |      |           | 5        | 05       |
|      | RCL 0     | 34 00    | LONGITUDE |      |           | 3        | 03       |
|      | RCL 1     | 34 01    |           |      |           | 7        | 07       |
|      |           | 51       | LONGITUDE |      |           | 83       |          |
|      | STO B     | 33 12    |           |      |           | 1        | 01       |
|      | F COS     | 31 63    |           |      | 4         | 04       |          |
| 020  | RCL 0     | 34 00    |           |      |           | 02       |          |
|      | F COS     | 31 63    |           |      | EXX       | 43       |          |
|      | X         | 71       |           |      |           | 06       |          |
|      | 9 COS-1   | 32 64    |           |      | RCL 2     | 34 02    |          |
|      | STO 2     | 33 02    |           |      | F COS     | 31 63    |          |
|      | F COS     | 31 63    |           |      | X         | 71       |          |
|      | RCL 0     | 34 00    |           |      | F TAN     | 31 64    |          |
|      | F TAN     | 31 64    |           |      | R/S       | 84       | RANGE    |
|      | X         | 71       |           |      |           |          |          |
| 030  | RCL 2     | 34 02    |           |      |           |          |          |
|      | F SIN     | 31 62    |           |      |           |          |          |
|      |           | 81       |           |      |           |          |          |
|      | 9 COS-1   | 32 63    |           |      |           |          |          |
|      | STO C     | 33 13    |           |      |           |          |          |
|      | F X > 0   | 31 81    | AZIMUTH   |      |           |          |          |
|      | GTO 0     | 22 00    |           |      |           |          |          |
|      | F LBL B   | 21 25 12 |           |      |           |          |          |
|      | RCL 2     | 34 02    |           |      |           |          |          |
|      | F COS     | 31 63    |           |      |           |          |          |
| 040  |           | 83       |           |      |           |          |          |
|      |           | 01       |           |      |           |          |          |
|      |           | 05       |           |      |           |          |          |
|      |           | 51       |           |      |           |          |          |
|      | RCL 2     | 34 02    |           |      |           |          |          |
|      | F SIN     | 31 62    |           |      |           |          |          |
|      |           | 81       |           |      |           |          |          |
|      | 9 TAN-2   | 32 64    |           |      |           |          |          |
|      | STO D     | 33 14    | ELEVATION |      |           |          |          |
|      | F ~ X ~   | 31 84    |           |      |           |          |          |
| 050  | RCL C     | 34 13    |           |      |           |          |          |
|      | F ~ X ~   | 31 84    |           |      |           |          |          |
|      | GTO 1     | 22 01    |           |      |           |          |          |
|      | F LBL D   | 31 25 00 |           |      |           |          |          |
|      |           | 02       |           |      |           |          |          |
|      | 6         | 06       |           |      |           |          |          |
|      | 0         | 00       |           |      |           |          |          |

| REGISTERS   |           |           |             |    |    |    |    |    |   |
|-------------|-----------|-----------|-------------|----|----|----|----|----|---|
| 0           | 1         | 2         | 3           | 4  | 5  | 6  | 7  | 8  | 9 |
| LAT         | LONG      | θ         |             |    |    |    |    |    |   |
| S1          | S2        | S3        | S4          | S5 | S6 | S7 | S8 | S9 |   |
| A SAT LONG. | B Δ LONG. | C AZIMUTH | D ELEVATION | E  |    |    |    |    |   |

fig. 4. HP-67 program listing for locating geosynchronous satellites.

ham radio

## ORR BOOKS

### BEAM ANTENNA HANDBOOK by Bill Orr, W6SAI

Recommended reading. Commonly asked questions like: What is the best element spacing? Can different yagi antennas be stacked without losing performance? Do monoband beams outperform tribanders? These questions and more are fully answered. Lots of construction projects, diagrams, and photos. 198 pages. ©1977. 5th edition.

□RP-BA

Softbound \$7.95

### SIMPLE LOW-COST WIRE ANTENNAS by Bill Orr, W6SAI

Learn how to build simple, economical wire antennas. Apartment dwellers take note! Fool your landlord and your neighbors with some of the "invisible" antennas found here. Well diagrammed. 192 pages. ©1972. 2nd edition.

□RP-WA

Softbound \$7.95

### THE RADIO AMATEUR ANTENNA HANDBOOK by William I. Orr, W6SAI and Stuart Cowan, W2LX

Contains lots of well illustrated construction projects for vertical, long wire, and HF/VHF beam antennas. There is an honest judgment of antenna gain figures, information on the best and worst antenna locations and heights, a long look at the quad vs. the yagi antenna, information on baluns and how to use them, and new information on the popular Sloper and Delta Loop antennas. The text is based on proven data plus practical, on-the-air experience. 190 pages. ©1978. 1st edition.

□RP-AH

Softbound \$7.95

### ALL ABOUT CUBICAL QUAD ANTENNAS by Bill Orr, W6SAI — New 3rd Edition Includes NEW data for WARC bands

The cubical quad antenna is considered by many to be the best DX antenna because of its simple, lightweight design and high performance. You'll find quad designs for everything from the single element to the multi-element monster quad. There's a wealth of data on construction, feeding, tuning, and mounting quad antennas. 112 pages. ©1982.

□RP-CQ

Softbound \$6.95

Please add \$1.50 for one book, \$2.50 for two or more books to cover shipping and handling.

Ham Radio's Bookstore

Greenville, NH 03048



# AMTOR RTTY

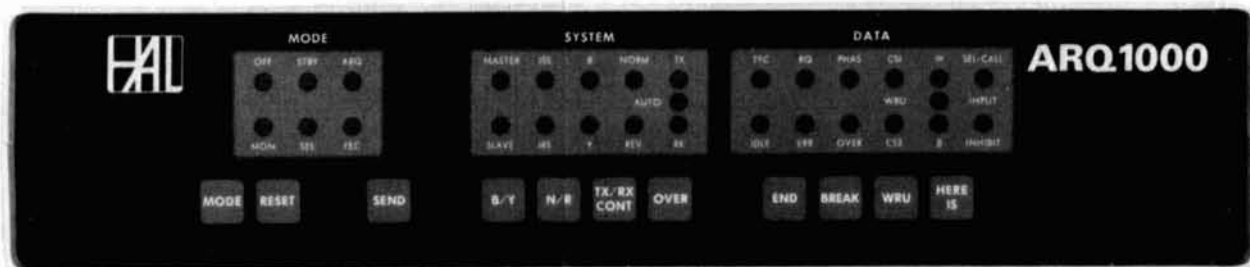

HAL is proud to announce the ARQ1000 code converter. This terminal not only supports the AMTOR amateur codes, but meets ALL of the commercial requirements of CCIR Recommendation 476-2. The ARQ1000 can be used with present and previous generation HAL RTTY products. In fact, any Baudot or ASCII full duplex terminal at data rates from 45 to 300 baud may be used with the ARQ1000. Some of the outstanding features of the ARQ1000 are:

- Send/receive error-free ARQ, FEC, and SEL-FEC modes
- Automatic listen mode for ARQ, FEC, and SEL-FEC
- Meets commercial requirements of CCIR 476-2
- By-pass mode for normal RTTY without changing cables
- Programmable ARQ access code, SEL-CAL code and WRU
- Programmable codes stored in non-volatile EEPROM
- Keyboard control of normal send/receive functions
- 30 Front panel indicators and 11 control switches
- Interfacing for loop, RS232, or TTL I/O
- "Handshaking" control for printer and keyboard or tape
- Self-contained with 120/240V, 50/60 Hz power supply
- Cabinet matches style and size of HAL CT2200
- Table or rack mounting
- Built-in M1700 modem option available
- Encryption option available for commercial users
- 3 1/2" x 17" x 10 1/2"

The ARQ1000 is commercial-quality equipment that will give you the outstanding performance you expect from a HAL product. Write for full details and specifications of the ARQ1000.

## BY POPULAR REQUEST



By popular request — the new CT2200. Our slogan is "When Our Customers Talk, We Listen" — and we have been listening. The CT2200 includes these often requested features:

- New AMTOR connections for use with ARQ1000
- Keyboard programming of all 8 "brag-tape" messages
- Programmable selective call code
- Expanded HERE IS storage for a total of 88 characters
- Non-volatile storage of HERE IS, "brag-tape," and SEL-CAL code
- 3 1/4" x 17" x 10 1/2"

All of the proven CT2100 features are retained. Some of these features are:

- Tuning scope outputs (a MUST for AMTOR)
- Built-in demodulator for high tones, low tones, "103", or "202" modem tones
- 36 or 72 character display lines
- 2 pages of 72 character lines or 4 pages of 36 character lines
- Split screen or full screen display
- Baudot or ASCII, 45 to 1200 baud
- Full or half duplex
- Morse code send/receive at 5 to 99 wpm
- Send/receive loop connection
- Automatic transmit/receive control (KOS)
- Audio, RS232C, or Loop I/O
- On-screen tuning and status indicators
- Clearly labeled front panel switches, not obscure keyboard key combinations
- Separate convenient lap-size keyboard
- Internal 120/240, 50/60 Hz power supply
- Attractive shielded metal cabinet

In addition, an update kit is available so that all CT2100 owners can update their CT2100's to include CT2200 features. The kit even includes a new CT2200 front panel! Rather than making a proven product obsolete, HAL put even more behind the buttons. Pick up a CT2200 at your favorite HAL dealer and join the RTTY fun. Write for our full RTTY catalog.



HAL COMMUNICATIONS CORP.

Box 365

Urbana, IL 61801 (217) 367-7373 TWX 910-245-0784

# YOUR VERY BEST SOURCE FOR



# HAM RADIO OUTLET

*without doubt!*

- 6 STORE BUYING POWER ASSURES TOP VALUES.
- BIG, COMPLETE STOCKS. GET WHAT YOU WANT WHEN YOU WANT IT.
- MORE SAVINGS BY FREE SHIPMENT., MOST ITEMS THAT CAN BE SHIPPED UPS SURFACE (Continental U.S.A.)
- TOLL-FREE PHONE (Except California and Arizona).

## PRICE REDUCTION



**IC-730**  
MOBILE  
TRANSCIVER

SMALL! only 3.7" high, 9.5" wide and 10" deep.  
Provides 10 to 80 meter coverage.

**BIG VALUE! CHECK IT OUT!**

## THE IDEAL PAIR FOR OSCAR



**IC-271A\***                      **IC-471A\***  
2M • 25 WATTS • ALL MODE    430-450MHz • ALL MODE  
RETAIL PRICE \$699.00        RETAIL PRICE \$799.00  
\* 100W MODEL AVAILABLE  
**CALL FOR YOUR SPECIAL PRICE**



**IC-751**

IC-751, ICOM's brilliant transceiver, sets a new high standard of comparison with high-tech advancements and the superior quality essential for competitive-grade performance.

# ◀ SALE ▶

**CALL NOW FOR  
YOUR LOW  
SALE PRICE**



**IC-745**

- 9 ham bands • General coverage receiver
- 16 memories • Scanning • Pass-band tuning
- Variable NB and AGC • Eight accessories and options are also available.



**NEW!! IC-27A**  
SUPER-COMPACT  
2 METER MOBILE

An important breakthrough in compact mobile equipment. Only 1½ × 5½" but full-featured including internal speaker. 25W of power, 10 full-function tunable memories, memory and band scan, priority scan. Includes mic. w/16 button Touchtone.

**ALSO \*IC-27H HIGH POWER VERSION  
AND IC-37A, 220MHz  
IC-47A, 70CM                      SAVE!**

## R-71A GENERAL COVERAGE RECEIVER



**CHECK  
DOWN-TO-EARTH  
PRICES.**

Superior grade receiver w/100kHz to 30MHz general coverage and features that include keyboard frequency entry.

## HAND HELD

PLUS COMPLETE  
LINE OF  
ACCESSORIES

IC-2AT  
IC-3AT  
IC-4AT



IC-02AT  
IC-04AT

**LOW  
PRICES!  
CALL!**

## 1.2 GHz EQUIPMENT



**IC-RP1210**  
UHF FM REPEATER



**IC-120**  
UHF FM MOBILE TRANSCIVER

**CALL FOR INFORMATION.  
LOW PRICES!**

**FREE SHIPMENT, ALL OF THE  
ABOVE ITEMS, UPS (Surface).**

Store addresses/Phone numbers  
are given on opposite page.

# 6 STORE BUYING POWER

**NEW!!**

TH-21AT/  
TH-41AT



TR-2600A



TM-211A/ TM-411A

HERE'S WHERE  
YOU GET THOSE  
LOW, LOW PRICES ON  
**KENWOOD**  
PLUS FREE SHIPMENT

MOST ITEMS UPS SURFACE (Continental U.S.A.)

CALL NOW OR  
DROP INTO ANY OF  
OUR SIX LOCATIONS

ESTABLISHED  
FAVORITES



TS-930S



TS-430S



TW-4000A



**ICOM**



R-71A  
GENERAL  
COVERAGE  
RECEIVER



IC-751

**SALE!**



IC-745  
SUPER SAVINGS!



IC-02AT  
IC-04AT

CALL!



MIRAGE

**SALE!**

B-3016 SALE \$199.95  
B-1016 SALE \$249.95  
B-108 SALE \$159.95  
B-23A SALE \$ 89.95  
D-1010 SALE \$289.95

**BIRD**

MODEL 43  
AND  
ELEMENTS



CALL FOR PRICES



**YAESU**

FT-726R



TOP CHOICE FOR OSCAR



FT-757GX



FT-203R

DON'T MISS  
THESE  
BARGAINS!

CALL!



FT-209RH

**TRISTAO SALE**

MA-40 SALE \$549

40' 2 SECT. TUBULAR TOWER

MA-550 SALE \$899

55' 3 SECT. TUBULAR TOWER

IN STOCK

**KLM SALE**

KT-34A SALE \$329

KT-34XA SALE \$469

40M-2 SALE \$309

CALL FOR LOW, LOW PRICES  
80 THRU 1 1/4M KLM ANTENNAS

**ALLIANCE**

ROTOR SALE

HD-73



U-110



\$99.95

\$54.95



W-51  
\$899

W-36  
\$549

**SALE**  
IN STOCK

LM-354  
\$1599

PERSONALIZED  
SERVICE

BOB FERRERO, W6RJ  
President

JIM RAFFERTY, N6RJ  
VP, So. Calif. Div. Anaheim

Managers:

GEORGE WB6DSV, Burlingame

GREG, N6PO Oakland

BOB, K7RDH Phoenix

GLENN, K6NA San Diego

AL, K6YRA Van Nuys

and other active amateurs

ANAHEIM, CA 92801

2620 W. La Palma,  
(714) 761-3033, (213) 860-2040,  
Between Disneyland & Knotts Berry Farm.

BURLINGAME, CA 94010

999 Howard Ave.,  
(415) 342-5757,  
5 miles south on 101 from S.F. Airport.

OAKLAND, CA 94609

2811 Telegraph Ave.,  
(415) 451-5757,  
Hwy 24 Downtown. Left 27th off-ramp.

PHOENIX, AZ 85015

1702 W. Camelback Rd.,  
(602) 242-3515,  
East of Highway 17.

SAN DIEGO, CA 92123

5375 Kearny Villa Rd.,  
(619) 560-4900,  
Hwy 163 & Clairemont Mesa Blvd.

VAN NUYS, CA 91401

6265 Sepulveda Blvd.,  
(818) 988-2212,  
San Diego Fwy at Victory Blvd

**HAM  
RADIO  
OUTLET**

FREE SHIPMENT  
UPS SURFACE (Continental U.S.) (MOST ITEMS)

TOLL-FREE PHONE  
INCLUDING ALASKA AND HAWAII

**800-854-6046**

(Calif. and Arizona customers please phone or visit listed stores)

PHONE HOURS: 9:30 AM to 5:30 PM PACIFIC TIME.

STORE HOURS: 10 AM to 5:30 PM Mon. through Sat.



AEA • ALLIANCE • ALPHA • AMECG • AMPHENDI • ANKTER  
MARK • ANTENNA SPECIALISTS • ARRL • ASTRON • BELDEN  
BENCHER • BIRD • BUTTERNUT • B & W • CALBOOK

COLLINS • CURTIS • CUSHCRAFT • DAIWA • DRAKE • DX EDGE  
EMAC • HUSTLER • HY-GAIN • ICOM • J.W. MILLER • KANTRONICS  
KENWOOD • KLM-LARSEN • LUNAR • METZ • MFJ • MICRO-LOG

MINI-PRODUCTS • MIRAGE • NYE • PALOMAR • ROBOT • ROHN  
SHURE • SIGNAL ONE • STONER • TEMPO • TEN-TEC • TRISTAO  
TRI-EX • VIEWSTAR • VOICOM • YAESU and many more!

Prices, specifications, descriptions subject to change without notice. Calif. and Arizona residents please add sales tax.

# WHAT THE COMPETITION CALLS "NO LOST WORDS OR SYLLABLES" WE CALL NOISE

**THE COMPETITION:** "HI HONEY I (NOISE BURST) M FIXING YOUR (NOISE BURST) VORITE SUPPE (NOISE BURST) BARBECUE HAMB (NOISE BURST) GERS. THEY WI (NOISE BURST) BE READY AT 6: (NOISE BURST) WILL YOU MA (NOISE BURST) IT IN TIME? (NOISE BURST)"

Samples (heard as bursts of noise) displace your phone party's audio for as long as it takes your transceiver to T/R. The above example assumes a transceiver T/R time of about 150 mS (typical)

**PRIVATE PATCH II:** " HI HONEY I AM FIXING YOUR FAVORITE SUPPER...BARBECUE HAMBURGERS. THEY WILL BE READY AT 6:30. WILL YOU MAKE IT IN TIME?"

Thousands of PRIVATE PATCH II owners are enjoying the commercial communications quality that only a VOX based, simplex autopatch can deliver.

## PRIVATE PATCH II IS PRICED AT LESS THAN HALF OF OUR COMPETITORS "FAVORITE COMMERCIAL SIMPLEX VOX PATCH"

### SAMPLING VS. PRIVATE PATCH II

The performance of a sampling patch is totally dependent on the T/R speed of your radio. Such is not the case with PRIVATE PATCH II. PRIVATE PATCH II will give excellent results with any radio. Synthesized and relay switched types included.

PRIVATE PATCH II requires only three connections to your radio (MIC, PTT and SPKR audio). If these connections are made inside your radio PRIVATE PATCH II does not interfere with the normal use of your radio. Otherwise for a quick and easy interface you may plug PRIVATE PATCH II into the MIC and SPKR jacks. A 10 minute job! Unlike sampling patches, connections are not required to the squelch, discriminator or power. And best of all, modifications are never required.

Controlling and talking through PRIVATE PATCH II is almost always quicker and easier than using a sampling patch. This is because you may talk or send control commands the instant you press the PTT button. The ability to break in or take control is assured by interrupt control logic. The interrupt controller creates a window (similar to sampling) but is seldom heard in normal quick back and forth communication. With a sampling patch you press the MIC button for one to five seconds before talking on each and every transmission. This is very frustrating for the mobile, and causes confusion for each party.

The sampling process reduces the effective range of your base radio. This is because if a sample, and a signal fade coincide, the sampling patch thinks the mobile is not transmitting. This causes a sampling patch to become erratic at ranges still very useable by PRIVATE PATCH II. PRIVATE PATCH II will not diminish the range of your system.

PRIVATE PATCH II has two more range extending tricks not available to a noise sampled autopatch.

1. You may use a linear amplifier with no loss of performance
2. You can operate through any repeater from your base station.



### FEATURES

- CW ID (free ID chip) • Selectable tone or pulse dialing • User programmable toll restrict • Five digit access code • Ringback (reverse patch) • Busy channel ringback inhibit (will not transmit on top of someone) • Three/six minute "time-out" timer is resettable from the mobile • 115 VAC power supply • Modular phone jack and seven foot cord...and many more.

#### ALSO

- ✓ 14 day return privilege — when ordered factory direct.
- ✓ One year warranty — compare to their six months.

### CONTACT A LOCAL DEALER TODAY

|   |  |   |
|---|--|---|
| <b>AMATEUR ELECTRONIC SUPPLY</b><br>Milwaukee WI, Wickliffe OH,<br>Orlando FL, Clearwater FL,<br>Las Vegas NV | <b>HENRY RADIO</b><br>Los Angeles CA, Anaheim CA,<br>Butler MO | <b>N&amp;G DISTRIBUTING CORP.</b><br>Miami FL                 |
| <b>COLES COMMUNICATIONS</b><br>San Antonio TX   | <b>JUNS ELECTRONICS</b><br>Culver City CA, Reno NV             | <b>PACE ENGINEERING</b><br>Tucson AZ                          |
| <b>ERICKSON COMMUNICATIONS</b><br>Chicago IL  | <b>MIAMI RADIO CENTER CORP.</b><br>Miami FL                    | <b>THE HAM SHACK</b><br>Evansville IN                         |
| <b>HAM RADIO OUTLET</b><br>Anaheim CA, Burlingame CA,<br>Oakland CA, San Diego CA,<br>Van Nuys CA, Phoenix AZ | <b>MIKES ELECTRONICS</b><br>Ft. Lauderdale                     | <b>CANADA:</b><br><b>DOLLARD ELECTRONICS</b><br>Vancouver, BC |

**CONNECT  
SYSTEMS  
INCORPORATED**

23731 MADISON ST., TORRANCE, CA 90505  
PHONE: (213) 373-6803



# ham radio TECHNIQUES

Bill W6SB1

## more about radials

**Antenna experimentation** is one field in which the enthusiast doesn't need an advanced degree in electronics and a room full of expensive test equipment. Sometimes a twenty-five cent "instrument" can provide meaningful results for the investigator.

A case in point: the experiments of Ralph, W8HXC, and Don, AF8B, which were designed to determine the effectiveness of quarter-wave radials on various 2-meter vertical antennas. The tests, conducted intermittently over a period of 5 years, pointed out some interesting aspects of radials that help to remove some of the mystery of VHF antennas.

The original investigation was designed to determine the best way to decouple the shield of a coaxial feedline from the field of the VHF antenna. The goal was to make the antenna do all the work, and to prevent the feedline from becoming part of the antenna. Only by making the feedline "inert" to the field of the antenna could the antenna do its job of laying down a low-angle signal.

To determine the degree of RF on the outer surface of the coaxial line, the simple "RF-sniffer" shown in fig. 1 was built. It was used to detect current loops on the antenna elements, the feedline, and supporting mast and structure. Made out of junk box parts, the simple device worked well with transmitter powers as low as 7 watts.

The "sniffer" consisted of a 144-

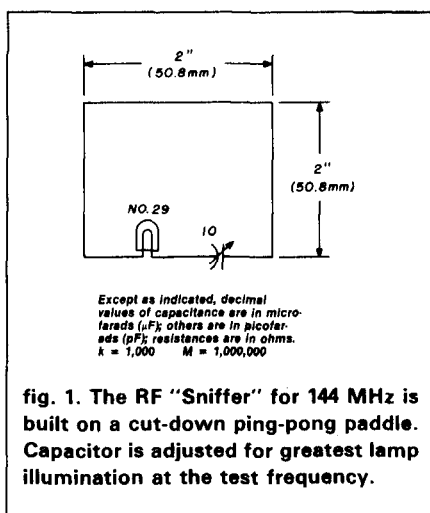

fig. 1. The RF "Sniffer" for 144 MHz is built on a cut-down ping-pong paddle. Capacitor is adjusted for greatest lamp illumination at the test frequency.

MHz resonant circuit with a pilot lamp indicator, all mounted on a wooden handle. The capacitor was adjusted for maximum glow of the lamp (resonance) when held near the RF source used in the experiments.

The first experiments conducted were on a homebrew 1/4-wave groundplane antenna. It was found that the outside of the coax line, which dropped down beneath the groundplane antenna, was "hot" and exhibited a standing wave of energy along it that could be detected with the "sniffer." Excellent feedline isolation was achieved by simply wrapping the RG-58/U feedline into a two-turn coil 1-1/2 inches in diameter directly below the antenna. This little RF choke decoupled the feedline so that it was isolated from the antenna.

The next experiment was with an extended half-wave vertical antenna. RF was found on the feedline, and adding the choke in the feedline accomplished little. The outside of the line was still coupled to the antenna. Four quarter-wave radial rods were added to the antenna immediately below the matching coil (fig. 2). It was necessary to readjust the antenna for best SWR; however, the feedline isolation was *not* improved, and the radials did not seem "hot" with RF energy.

The last experiment, which was more meaningful, used a 5/8-wave-length antenna (48-inch long radiator) and a two-turn base matching coil (fig. 3). The feedline was carried down inside the metal supporting mast and a set of four quarter-wave radials with a clamping arrangement that allowed the radials to be placed anywhere on the mast was added.

Initially, the radials were positioned at the base of the antenna loading coil and the coil feedpoint was adjusted for best SWR indication. When a near-perfect match was achieved, the RF "sniffer" was used to examine the feedline. Unhappily, the feedline and mast indicated pronounced current loops over the entire length! The feedline and support pipe had become part of the antenna in spite of the radials, which were supposed to isolate the antenna from the feedline. In addition it was discovered that there was very little RF in the radials, a

sure indication they were not doing their job.

Further experimentation proved that moving the radials down the mast, away from the antenna base, changed the SWR reading and required feed-point readjustment. By cut-and-try a combination of feedpoint adjustment and radial position yielded excellent SWR, radials "hot" with RF and no detectable current loops on either the feedline or the supporting mast below the radials. Measurement placed this optimum radial position  $3/8$ -wavelength below the base of the antenna. The radial angle was finally set at 45 degrees to the horizontal for best SWR.

Further tests with this antenna and with a car-mounted antenna of the same general type led to the interesting discovery that  $5/8$ -wavelength long radials attached at the base of the  $5/8$ -wavelength antenna provided the same excellent feedline isolation as did  $1/4$ -wavelength radials attached  $3/8$ -wavelength down the structure. A final experiment showed that radials could be attached to the mast at any point up to  $3/8$ -wavelength beneath the antenna base provided that the sum of radial length and distance from the antenna base totalled  $5/8$ -wavelength.

Don, AF8B, points out that the  $5/8$ -wavelength vertical antenna plus the  $5/8$ -wavelength long radial system is the same overall electrical length as an extended double-Zepp antenna.

The conclusion of the experiments is that radial length cannot be taken for granted and, in the case of an extended antenna, may not be  $1/4$ -wavelength long. The important dimension is the overall length of antenna plus radial. The test to determine radial length is to use a "Sniffer" to make sure the RF remains in the radials and not on the outside of the coaxial feedline. (Thanks to Don, AF8B, for supplying data on the W8HXC and AF8B experiments.)

## the Australian wideband dipole

Reader interest has been aroused by my description of the so-called

"Australian dipole" wideband antenna (January, 1983, page 67). It seems that there is a whole family of wideband HF antennas and other related products of this type manufactured by *Antenna Engineering Australia PTY. Ltd.*, Box 191, Croydon, Victoria 3136, Australia. Contact Ian R.H. Wade, Sales Manager, for further information. The correct name of the antenna described in my January column is *Model 632 Travelling Wave Dipole*.

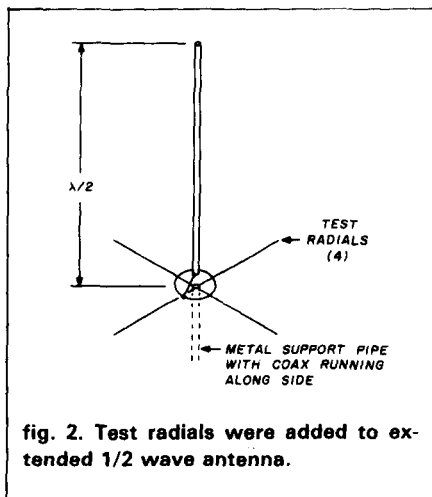

fig. 2. Test radials were added to extended  $1/2$  wave antenna.

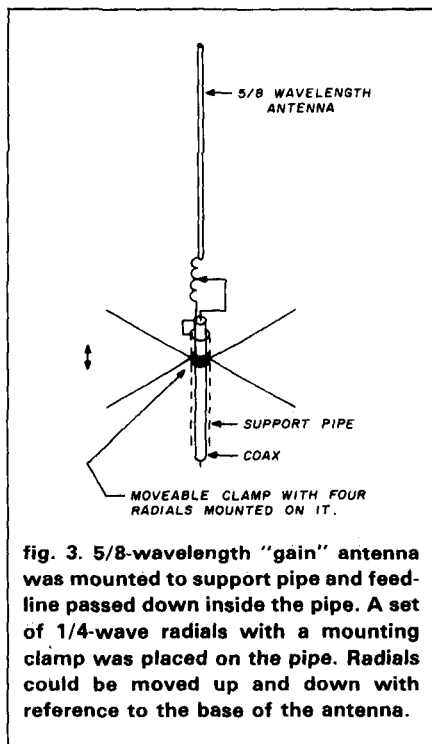

fig. 3.  $5/8$ -wavelength "gain" antenna was mounted to support pipe and feedline passed down inside the pipe. A set of  $1/4$ -wave radials with a mounting clamp was placed on the pipe. Radials could be moved up and down with reference to the base of the antenna.

## the K4EF "all-band" antenna

Several years ago Ev Brown, K4EF, described a wire antenna that would cover all HF Amateur bands between 80 and 10 meters (*ham radio*, May 1977, page 10). Since then he's done a lot of work on his design and has devised a new configuration that has several advantages over the old one. The new antenna covers the 160-meter band, uses four support points instead of five, and occupies less space. In addition, because the elements are arranged in a V-configuration, it provides some signal gain on the higher frequency bands.

A plan view of the new antenna design is shown in fig. 4. The array consists of five long wires arranged in a semicircle. The antenna is fed at points F-F with a 4-to-1 balun and a 50-ohm transmission line. In actual use, one of the two elements at the left of the illustration is used with one of the three wires at the right. The wires can be selected from the operating position with a remote switch. For example, if the 353-foot wire is added to the 313-foot wire, an element 666 feet long is produced. An odd number of half waves is required to produce approximately 200 ohms feedpoint impedance at or near the element center. The chart of table 1 shows the odd-halfwave resonances in this combination. As can be seen, the bandwidth coverage is enormous (see column 3), and when you consider that the 666-foot combination is merely one of six, the complete configuration provides wide spectrum coverage with very low SWR. A simple computer program could calculate all of the resonances and bandwidths for all elements. The results could then be combined to determine what frequency gaps (if any) exist in the complete array coverage.

As Ev says, ". . . it is difficult to convey to a ham who has never used an all-band, broadband antenna just how convenient it is. During contests, changing bands is accomplished by flipping the bandswitch. Checking band conditions is done in an instant.

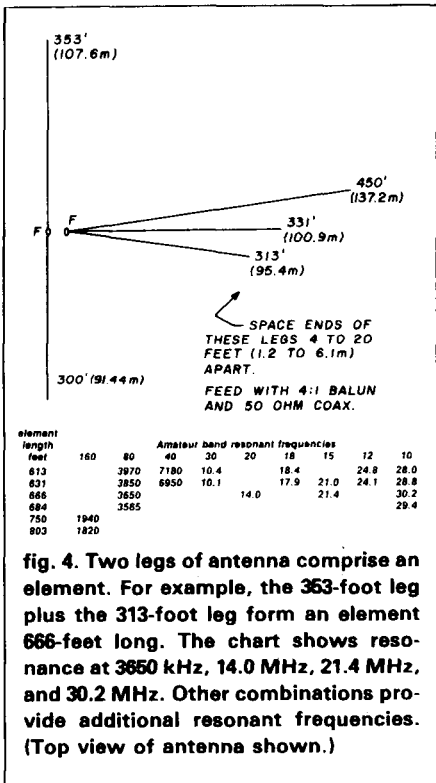

fig. 4. Two legs of antenna comprise an element. For example, the 353-foot leg plus the 313-foot leg form an element 666-foot long. The chart shows resonance at 3650 kHz, 14.0 MHz, 21.4 MHz, and 30.2 MHz. Other combinations provide additional resonant frequencies. (Top view of antenna shown.)

My FOC friends frequently ask to get credit for another band and find me waiting for them. Perhaps the most important aspect of the idea is that it encourages the operator to use the whole spectrum available."

### the W2TBZ quad-loop beam antenna

I had not seen Sid, W2TBZ, for over 15 years and our QSOs on the air were few and far between. "Keep in touch," I had said, and just recently I heard from him — with a new antenna idea that he was using with great success on 15 and 20 meters.

To stay in touch with his friends, Sid needed an inexpensive wire beam that could be easily erected and would provide a modest amount of gain and a low angle of radiation. Various antennas were tried, and the final version, a 2-loop Quad beam is shown in fig. 5. Estimated gain of this bidirectional array is about 4.5 dB over a dipole.

The antenna consists of two side-by-side Quad loops, horizontally polarized and driven in phase. The feed system consists of two equal lengths

of 300-ohm TV line and a 1-to-1 balun. The feedpoint impedance of a single loop in this configuration runs about 120 ohms, so parallel-connected loops provide a terminal impedance close to 60 ohms. This provides a good match to a 50-ohm transmission line system.

The 40-foot masts support the antenna. The figure-8 radiation pattern is at right angles to the plane of the array. The pattern is sharper than that of a dipole, being about 60 degrees between the half-power (-3 dB) points.

table 1. Odd halfwave resonances in 666 feet of wire.

| band meters | electrical length halfwaves | resonant frequency (MHz) | bandwidth to 2:1 SWR points |
|-------------|-----------------------------|--------------------------|-----------------------------|
| 80          | 3                           | 2.179                    | 2.142 to 2.216              |
|             | 5                           | 3.657                    | 3.597 to 3.717              |
|             | 7                           | 5.134                    | 5.057 to 5.211              |
|             | 9                           | 6.612                    | 6.512 to 6.712              |
|             | 11                          | 8.089                    | 7.969 to 8.209              |
|             | 13                          | 9.567                    | 9.427 to 9.707              |
|             | 15                          | 11.044                   | 10.879 to 11.184            |
|             | 17                          | 12.522                   | 12.342 to 12.702            |
| 20          | 19                          | 13.999                   | 13.789 to 14.209            |
|             | 21                          | 15.477                   | 15.244 to 15.709            |
|             | 23                          | 16.954                   | 16.999 to 17.208            |
|             | 25                          | 18.432                   | 18.155 to 18.709            |
|             | 27                          | 19.909                   | 19.610 to 20.207            |
| 15          | 29                          | 21.386                   | 21.065 to 21.706            |
|             | 31                          | 22.864                   | 22.521 to 23.206            |
|             | 33                          | 24.341                   | 23.975 to 24.706            |
|             | 35                          | 25.819                   | 25.431 to 26.206            |
|             | 37                          | 27.296                   | 26.886 to 27.705            |
| 10          | 39                          | 28.774                   | 28.342 to 29.205            |
|             | 41                          | 30.251                   | 29.797 to 30.704            |

Note: The 666-foot element (summarized above) is only one of six element combinations. Single element switch will provide enormous coverage of HF spectrum with low SWR.

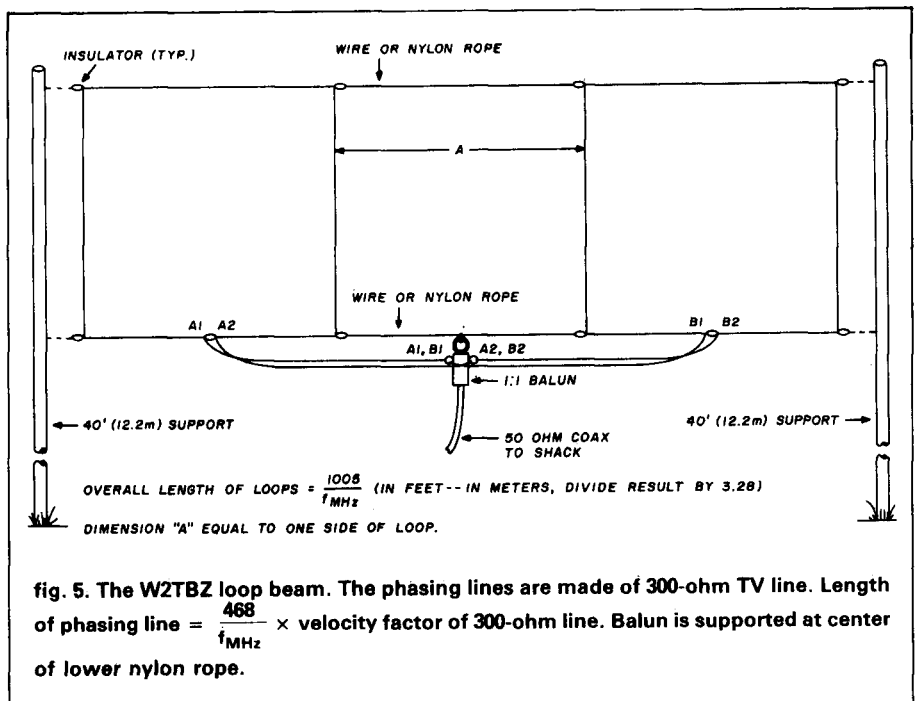

fig. 5. The W2TBZ loop beam. The phasing lines are made of 300-ohm TV line. Length of phasing line =  $\frac{468}{f_{MHz}} \times$  velocity factor of 300-ohm line. Balun is supported at center of lower nylon rope.



# Brings You The PACKET Breakthrough!

PACKET RADIO lets you share a simplex channel error-free with up to 20 simultaneous users at 1200 Baud.

AEA introduces the MODEL PKT-1 PACKET CONTROLLER. Through an arrangement with TAPR (Tuscon Packet Radio, Inc.), AEA brings you the proven performance of the TAPR kit board and software in a rugged metal package, fully wired and tested with a full year's warranty and with all the free applications assistance you can stand.



Using only your existing radio and RS232 terminal (or computer), you can join the rapidly expanding packet radio community. Operate on VHF, HF or satellite and talk to more than 1000 existing packet users. Store messages addressed to you automatically and read them from your printer or monitor later. Easy to hook-up!! Easy to use!!

Call today for the rest of the story: 206-775-7373!!

Better yet, see your favorite AEA dealer.

Advanced Electronic Applications  
P.O. Box C-2160  
Lynnwood, WA 98036

All right, AEA, send me info fast!

To: AEA, P.O. Box C-2160,  
Lynnwood, WA 98036

Name \_\_\_\_\_  
Address \_\_\_\_\_  
City, State, Zip \_\_\_\_\_  
Phone \_\_\_\_\_ Date \_\_\_\_\_

## TUBES, SEMICONDUCTORS, IC'S DIODES AT SUPER LOW PRICES IN DEPTH INVENTORY EIMAC, SYLVANIA, GE, CETRON

|                     |        |  |
|---------------------|--------|--|
| OA2.....            | \$2.75 |  |
| 3CX800A7.....       | 242.00 |  |
| 3-400Z.....         | 115.00 |  |
| 3-500Z.....         | 90.00  |  |
| 4CX250B/7203.....   | 58.00  |  |
| 4CX1000A/8168.....  | 430.00 |  |
| 4PR60C/8252W.....   | 295.00 |  |
| 4X150A/7034.....    | 45.00  |  |
| 5AR4.....           | 6.24   |  |
| 5C22.....           | 165.00 |  |
| 5R4GB.....          | 3.85   |  |
| 6AK5.....           | 4.91   |  |
| 6AL5.....           | 3.86   |  |
| 6AQ5.....           | 3.77   |  |
| 6CA7.....           | 7.41   |  |
| 6DJ8.....           | 2.75   |  |
| 6JG6A.....          | 7.53   |  |
| 6JS6C.....          | 8.00   |  |
| 6KD6.....           | 8.85   |  |
| 6KV6A.....          | 6.92   |  |
| 6L6GC.....          | 6.83   |  |
| 6LF6.....           | 8.85   |  |
| 6LQ6.....           | 8.85   |  |
| 6MJ6.....           | 8.99   |  |
| 12AT7.....          | 3.87   |  |
| 12AU7.....          | 3.47   |  |
| 12AX7A.....         | 3.48   |  |
| 572B/T160L.....     | 49.50  |  |
| 705A.....           | 10.00  |  |
| 811A.....           | 13.50  |  |
| 813.....            | 40.00  |  |
| 829B.....           | 40.00  |  |
| 832A.....           | 38.00  |  |
| 833A.....           | 145.00 |  |
| 866A.....           | 9.50   |  |
| 872A.....           | 24.00  |  |
| M-2057.....         | 15.00  |  |
| 5670.....           | 4.40   |  |
| 5684.....           | 33.00  |  |
| 5687.....           | 4.00   |  |
| 5751.....           | 4.00   |  |
| 5814A.....          | 3.70   |  |
| 5879.....           | 5.75   |  |
| 5894.....           | 65.00  |  |
| 6005.....           | 5.25   |  |
| 6146B.....          | 8.75   |  |
| 6360.....           | 6.50   |  |
| 6528A.....          | 75.00  |  |
| 6550A.....          | 7.50   |  |
| 6883B.....          | 10.00  |  |
| 7360.....           | 12.25  |  |
| 7558.....           | 7.00   |  |
| 7591A.....          | 6.20   |  |
| 7868.....           | 6.68   |  |
| 8072.....           | 95.00  |  |
| 8417.....           | 8.99   |  |
| 8874.....           | 210.00 |  |
| 8875.....           | 220.00 |  |
| 8877/3CX1500A7..... | 475.00 |  |
| 8908.....           | 12.95  |  |
| 8950.....           | 11.50  |  |
| MRF-453.....        | 19.95  |  |
| MRF-454/A.....      | 19.95  |  |
| MRF-455/A.....      | 19.95  |  |
| 2N6084.....         | 15.00  |  |

Full line of Sylvania ECG Replacement Semiconductors Always in Stock. All Major Manufacturers Factory Boxed, Hard To Get Receiving Tubes At Discount Prices.

Minimum Order \$25.00. Allow \$3.00 For UPS Charges. Out of Town, Please Call Toll Free: 800-221-5802 and Ask For "DAVID."



1365 39th STREET, BROOKLYN, N. Y. 11218H  
Tel. 212-633-2800/Wats Line 800-221-5802  
TWX 710-584-2460 ALPHA NYK.

### interesting reading!

From time to time I like to recommend interesting books or periodicals that provide information that otherwise may be unobtainable, and that are of general interest to Radio Amateurs.

This month's recommendation is *The Monitoring Times*, published monthly by Grove Enterprises, Inc., 140 Dog Branch Road, Brasstown, North Carolina 28902. The subscription rate is \$10.50 for one year.

*The Monitoring Times* is full of timely information about what's going on in the HF/VHF spectrum. The editor and publisher is Bob Grove, WA4PYQ. This newspaper covers items of interest not generally found in Amateur publications. I look forward with interest to each issue! The latest information on the mysterious "beacon" and "numbers" stations may be found in this publication, as well as up-to-date information and interesting stories of other aspects of radio communication.

Some of the columns in *Monitoring Times* are "High Seas Radio," "Signals from Space," "Utility Intrigue," "RTTY/FAX," and "Pirate Radio." There's also a good review of some of the new communications receivers in the present issue of this interesting publication.

Good luck, Bob — you have a winner!

ham radio

### DRAKE R-4/T-4X OWNERS AVOID OBSOLESCENCE

PLUG-IN SOLID STATE TUBES!  
Get state-of-the-art performance. Most types available

INSTALL KITS TO UPGRADE PERFORMANCE!

- BASIC Improvement
- Audio Bandpass Filter
- Audio IC Amplifier

TUBES \$23 PPD KITS \$25 PPD

OVERSEAS AIR \$7

SARTORI ASSOCIATES, W5DA  
BOX 832085  
RICHARDSON, TX 75083  
214-494-3093

✓ 210





# Look hear...

## Satellite TV and *stereo* sound.

Now you can enjoy the fullness of stereo sound via satellite. Stereo is standard on the **GLR-868**. . .and, so is top quality video.

### Features:

- Priority 6.8 mono audio plus narrow-band direct stereo and wide-band matrix stereo
- Automatic volume compensation for wide/narrow band signals
- Crystal synthesized tuning and built-in terrestrial filter
- Automatic polarity seeking control plus 100° or better LNF
- Wireless, infrared remote for changing channels
- Single cable convenience for all power and control wiring

The **GLR-868** connects with your stereo and your television set to turn your den into a theater. You get stereo sound separate from the video on selected subcarriers and with video on other subcarriers. Your choice. . .for your enjoyment. Take a look at the **GLR-868**, and hear the difference of stereo sound. At your local satellite TV dealer.

We make technology affordable.

# AUTOMATION TECHNIQUES, INC.

1550 North 105th East Avenue • Tulsa, OK 74116 (918) 836-2584





# NEW!

# OSCAR 10 Dual Axis Rotor

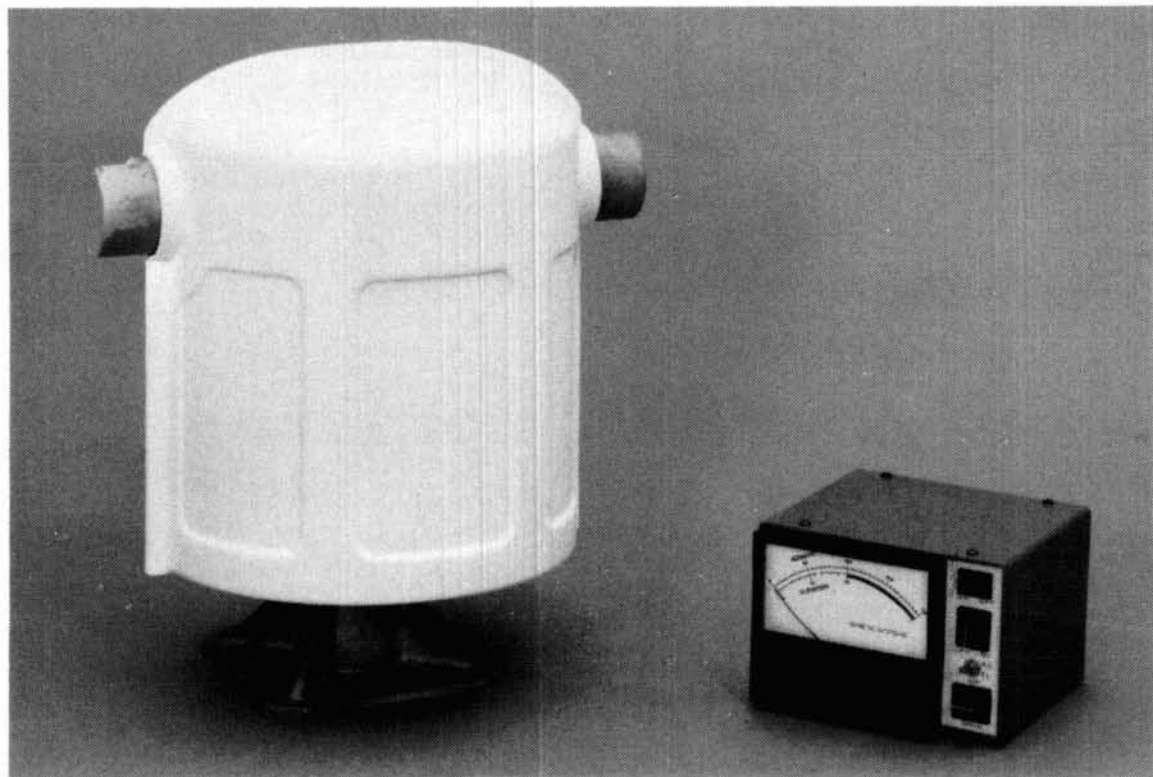

As a leading manufacturer of precision motor drive systems, we believe the newly developed DR10 is the finest dual drive system for satellite antennas. To provide you the highest level of performance and convenience, the DR10 Dual Axis Rotor features:

- **COMPACT CONTROL UNIT WITH SELF CONTAINED AC POWER SUPPLY**
- **SINGLE DUAL SCALE METER (AZIMUTH/ELEVATION)**
- **SINGLE 8 WIRE CONTROL CABLE (BELDEN TYPE)**
- **STANDARD TOWER TOP MOUNTING**
- **ACCEPTS 1½ INCH ANTENNA BOOM**
- **SERVICEABLE WITHOUT ANTENNA REMOVAL**
- **DYNETIC SYSTEMS' HIGH TORQUE, PRECISION GEARMOTORS**

**NOW AVAILABLE  
for immediate delivery**

✓ 147

Our DR10 will out-perform any combination of conventional rotors popularly used, and is supplied ready to mount, including the rotor, control unit, and all stainless steel mounting hardware. (less cable)

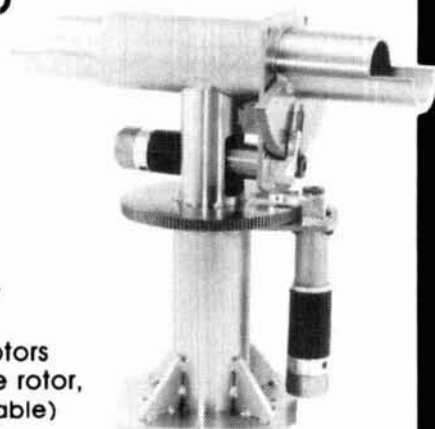

For immediate ordering information,  
individuals and dealers call or write

**612-441-4303**

**DYNETIC SYSTEMS**

19128 INDUSTRIAL BOULEVARD  
ELK RIVER, MN 55330

# make your own PC boards using silk screen techniques

A step-by-step guide to  
easy, inexpensive duplication  
of simple circuits

**At least two silk-screen approaches** to PC board duplication will work for reproducing relatively simple circuits. One is based on the use of printing film, and the other is based on the use of a photo-sensitizing material that can be applied directly to a silk screen or to a board. I have found both of these techniques to be quite satisfactory, and I consider them to be superior to the usual board photo-sensitizing approach for all but the most sophisticated circuit configurations. The screen-sensitization technique can be used with "LIFT-IT"™ patterns or by applying sensitizer directly on the board if one is certain replication will not be necessary. The printing-film approach is suitable for relatively simple circuits such as those used for RF voltmeter probes.

In order to produce a conductive pattern on a circuit board it is necessary to transfer a drawn pattern to the copper on a board. This requires the application of material that will protect the desired conductor area from an etchant. Of the various methods available, silk-screen techniques are probably the least expensive and most convenient solution to the typical multi-board problems encountered by hams. (Where only single boards are required, the photo-sensitizing method can be applied directly to the board.)

## board preparation

I buy my copper-clad material (copper one side) at hamfests, usually for less than one cent per square

inch, far less than the 20 cents or more charged for sensitized boards.

First I cut the board to size with a bandsaw. Metal shears or a pair of tinsnips can also be used. The board may also be scored with a linoleum knife and separated. After the boards have been cut to size, the edges and corners should be deburred to avoid cutting the silk in the process of inking. If the board is badly corroded the copper surface should be scoured with 600 grit emery, and finally with a cleaning powder such as "Old Dutch Cleanser," one that is free of chlorides and phosphates. An all-over clean copper lustre is required to assure efficient etching.

## mounting frame preparation

Two kinds of mounting frames can be used. Because the boards I use are seldom larger than 3 by 5 inches, I purchased some 3/4-inch square wood strips and cut them into 6- and 8-inch lengths. Using picture frame clamps, I assembled these pieces into frames having outer dimensions of about 7 by 9 inches, gluing the pieces of wood together with white glue and inserting 2-inch long wood screws through the joints and reinforcing the joints with flat L brackets measuring 1-1/2 inches on each side (see fig. 1). After assembly, the forms should be protected with shellac to improve their resistance to water. I use these frames for board applications having continuous use, such as power supply configurations.

It is difficult to get enough tension on the screen to minimize under-flow with this arrangement. I have found it convenient to attach 7-inch pieces of flat aluminum stock about 3/4 of an inch wide on the inside of the long sides. These can be used to stretch the screen tightly. Beware of sharp corners on the tensioning bars; any burrs or sharp edges or corners will cut the silk. I cut slots in the bars and use screws to hold them in place. Much less underflow results.

By Keats A. Pullen, Jr., W3QOM, 2807 Jerusalem Road, Kingsville, Maryland 21087

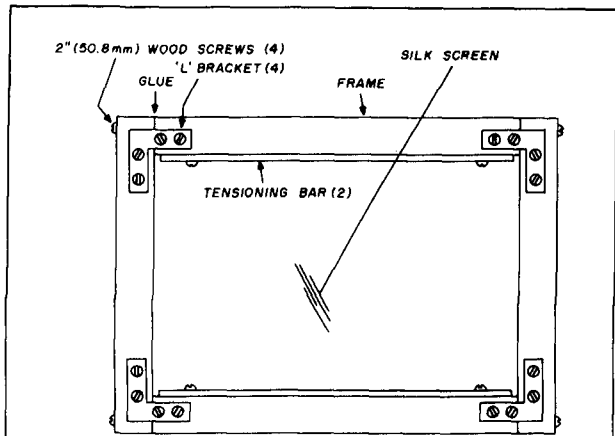

fig. 1. Wood silk-screen printing frame with pattern. The irregular outer edge of the wood frame is caused by the silk. I didn't use the cardboard reinforcement with this frame.

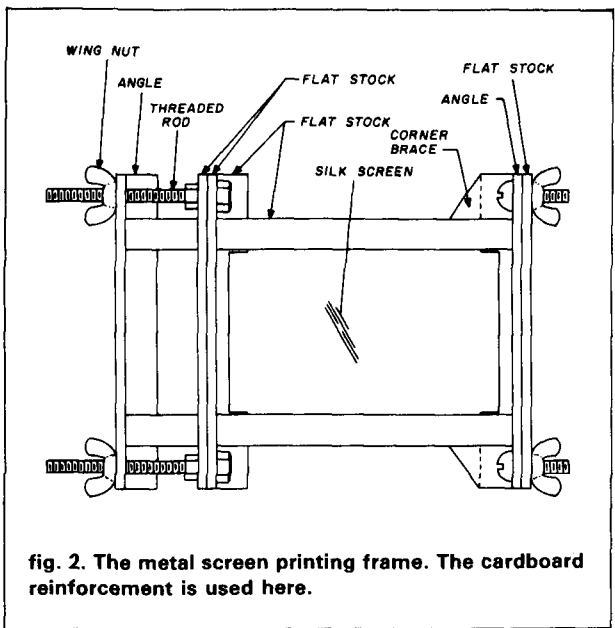

fig. 2. The metal screen printing frame. The cardboard reinforcement is used here.

The second kind of frame can be made from ordinary aluminum stock available in most hardware stores. I use 3/4-inch angle and 3/4-inch flat stock. One clamping surface for holding the screen is fixed; the other is moveable. There are two fixed elements, the second being used for application of the required tension. One of the fixed angle pieces is reinforced to the flat bars with corner braces for additional stiffness. The moveable angle is coupled to the second angle piece with 1/4 x 20 inch threaded rod; wing nuts are used for adjusting tension on the silk.

The one fixed angle element and the moveable one are arranged so that the two ends of the screen, supported by cardboard as explained in the next section,

can be clamped tightly to the two members. In this way, ample tension can be applied to the screen for use in printing (see fig. 2).

### screen preparation

The silk screen is prepared by washing, again with the cleanser, and thorough rinsing. A monofilament nylon screen material of the finest possible mesh is best and will give the finest resolution and minimum problem from etch-through resulting from blockage of ink penetration by the screen material itself. The screen must be stretched as tightly as possible when used, since only then can sufficient contact of the pattern and the copper be achieved, minimizing "run-under."

To protect twisting the thread pattern of the screen material, use cardboard bracing strips on each tension edge, leaving enough silk to wrap around the strip. The silk can then be stapled to the cardboard strip and the combination tacked on the frame or clamped as required. This way the stress can be distributed uniformly on the silk.

### using printing film

Since there are two possible ways the screen master can be used, each method is considered separately. I have found orange printing film to be useful and easy to prepare for simple circuits. In using it, one simply marks off and removes narrow ribbons of film to form conductors, lifting them from the backing material. The material removed represents a current path. Care should be taken to minimize the cutting of the backing, a plastic, nylon-type material, as the transfer of the film to the silk is most easily accomplished if the film has been cut through without scoring the backing.

I have made some simple tools for preparing the film. One type, for cutting conductor paths, consists of two halves of a double-edged razor blade mounted on opposite sides of a piece of used copper-clad (see fig. 3). This will cut both sides of a conductor path at one time, and help in making sure that the length of the cut is correct. These cuts can extend to about a hundredth of an inch into an adjacent pad or across an intersecting path to simplify the removal of the material. This ribbon is then picked up with an Xacto™ knife or a pin and removed. Pads can be cut with a tool made by taking a short length of 1/4-inch rod, center-drilling it on a lathe or drill press, and cutting down its outside diameter to the size of the pad required.

When the pattern has been prepared, it may be attached to the silk screen material by stretching the screen tightly over the pattern and patting the screen with a piece of cheesecloth wetted with lacquer thinner (use a gentle push, not a sliding motion). You will be able to see where the attachment is satisfactory.

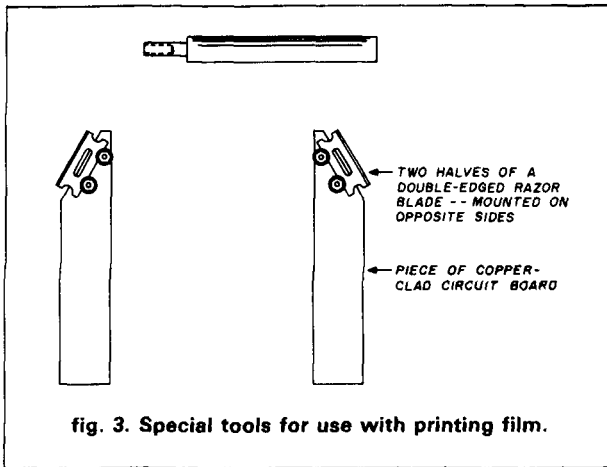

fig. 3. Special tools for use with printing film.

You will want to go back and redo any imperfectly imbedded areas. When the combination has dried completely, carefully peel off the backing, resticking if required.

### photo-sensitized silk screen

The silk can also have the required pattern applied to it by the use of a photographic sensitizing technique. The sensitizer I have used is the Hunt Manufacturing Company Printing Photo Emulsion Kit No. 4533. This contains two components which are mixed just prior to use. Instructions are provided with the package. A leaflet on screen printing is also available.

To prepare the photo screen, mount the screen material on the frame you have chosen and apply the mixed sensitizer in a thin, smooth layer on both sides of the screen. (You can expedite drying by blowing cool air from a hair dryer on to the screen.) After mixing, handle the coated screen in semi-darkness only. If the image to be transferred is closest to the back of your image master, you expose with that surface adjacent to the sensitive surface and expose through it. (Lift-it masters are exposed from the top, whereas drafted masters will be exposed from the bottom; see figs. 4 and 5). The master should be between the light and the sensitive layer, and the image as viewed from the top should be as required. A transparent cover should be placed on top of the master and weighted so as to assure close contact between the master and the screen. (I use a No. 2 photoflood in a reflector about 14 inches from the work, for about six minutes.) The exposed silk is then washed and rinsed immediately.

### inking

After the circuit board has been scoured and prepared for use, and the screen with the appropriate pattern is in tight contact with it, the inking can be begun. The ink must be reasonably thick, yet it must spread through the open areas of the screen. At the

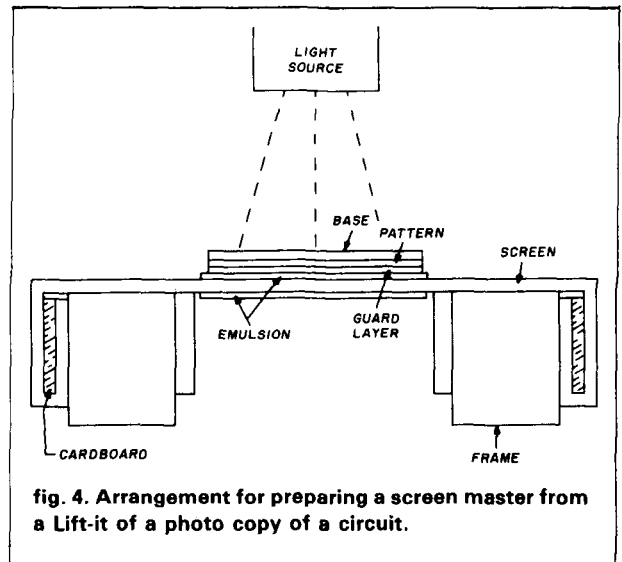

fig. 4. Arrangement for preparing a screen master from a Lift-it of a photo copy of a circuit.

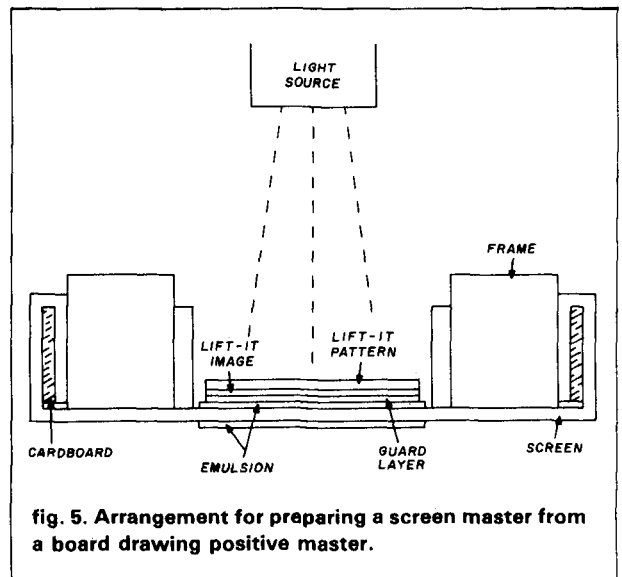

fig. 5. Arrangement for preparing a screen master from a board drawing positive master.

same time it must be able to be completely removed from the stencil screen without leaving residues or damaging the screen. It must dry "hard" — that is, it must, after drying, be resistant to the etchant.

A bead of ink is spread along the short length of the circuit to be printed, and then spread along the image of the circuit. I use a piece of Plexiglass™ or other transparent acrylic as a spreading tool. It should be an inch wide or wider, and can be wide enough to cover the entire width of small boards. (All burrs and sharp edges should be removed from the spreader prior to use. To re-use, simply peel off the dried ink.) Acrylic inks such as the Hunt Permanent Acrylic Screen Printing Ink or the Liquitex Permanent Acrylic Ink are suitable.

After the printed board is dry, the image can be touched up by using pin or a needle to repair breaks,

or an Xacto knife to scrape away any run-unders that may have occurred. I usually use a hair dryer *with heat* to speed the drying in this phase of production.

I print as many boards as I need in rapid succession and then wash out the screen master with a thorough spray of water. (Printing inks are soluble in water until they dry; after drying, they become impervious to water but can be peeled or scraped off.)

### initial artwork preparation

When the photographic screen method is used, it is necessary to work from some kind of master. These masters may be those printed in a magazine (either positive or negative) or some you have prepared from any of the various commercial materials. Each approach is discussed here.

A complex circuit or one available as a circuit pattern in an article can be made into a screen by combining a photocopy of the layout with the silk-screen process. The photocopy can provide increased contrast, if necessary, and eliminate the need to cut the magazine. If the original is positive, make a Lift-it from the photocopy and use it to expose the screen. If the original is a negative, make the Lift-it copy and then print it directly onto a piece of high-contrast 4 x 5 inch cut film. This will give a positive that can be used to sensitize the screen again. (With a negative, the print may be made directly from the Lift-it to the board using the Hunt preparation if you prefer. This works, particularly if the hardener is used as described later.)

I make some of my masters on tracing vellum using extremely thin transfer materials such as those made by Vector. Ruled India ink lines are suitable for conductors. Transfers used for pads and IC sockets finish the circuit layout. The result is a simple, direct step-by-step process.

### washing and etching

Washing must be done at several points in this process. The boards should be washed thoroughly and carefully after scouring. The screen material should be washed thoroughly from both sides to remove any sizing and acrylic ink. With the photo-sensitization process, it is spray-washed from both sides to remove the filler from the pattern.

With both the exposed photo-screen and the inked screen, I use a discarded spray bottle for washing, which must be done immediately after completion. A fine but fairly hard spray is best.

I generally use ferric chloride as an etchant. Either plastic or glass trays may be used with it; I use Pryex™ glass trays so I can heat the etchant and thereby speed the operation. My heater is an electric plate warmer with two switches added to the line cord, one with a diode connected across its points for the convenience of two heat levels.

After etching, the board should be washed thoroughly. You'll find the ink softened enough to peel off, leaving the copper with the dull appearance of cuprous oxide. If you wish to apply tinning solution, the copper must be made bright once again by the use of 600 grit paper used lightly as needed and scouring. Hardened ink can be dissolved in lacquer thinner.

### hardening

The photo-emulsion image on the screen can be hardened by treating it with Hunt's "Permanizer"™ No. 4529. The developed and dried image on the silk screen is painted with this material, and the combination dried with cool air. The use of a water spray wash with cold water once again opens the mesh where the pattern is.

### acknowledgement

I am deeply indebted to A. L. Spizzo of Hunt Manufacturing Company for his assistance in solving various technical problems I have encountered.

### bibliography

Kosloff, A., *Screen Printing Electronic Circuits*, printed by Signs of the Times Publishing Company.  
Filhaber, I.J., W2HCQ, "PC Boards for Penny Pinchers," 73, August, 1983, page 30.

ham radio

Hi we're **Hatry Electronics**

|  |   |  |
|--|---|--|
|                         |   |                             |
| AMPHENOL   | AMIDON Associates   | DAIWA  |
|                        | J. W. Miller  |                             |
|                         |   |                             |
|  THE ANTENNA COMPANY    | Bash Books  | MFJ ENTERPRISES, INCORPORATED  |
|  Division of UNR, Inc. |  | RADIO AMATEUR  callbook inc |
|                         | Used Equipment  |                             |
| <b>Hatry Electronics</b><br><i>The Elect in Electronics</i>  |   |  |
| 500 LEDYARD STREET<br>HARTFORD, CONN. 06114  |   |  |
|                         | Phone 203-527-1881 ✓ 165  |                             |



# JPC/AZDEN®

## 4000 SERIES FM TRANSCEIVERS

### 10 METERS & DOWN



PCS-4000  
2-m FM Transceiver

**COMMERCIAL-GRADE  
QUALITY AT AMATEUR PRICES**

**EXCLUSIVE 1 YEAR LIMITED WARRANTY! COMPARE!**

#### THE 4000 SERIES



PCS-4300 70-cm FM Transceiver



PCS-4500 6-m FM Transceiver



PCS-4800 10-m FM Transceiver

### SALE

**PLEASE CALL FOR  
SPECIAL PRICE**

PCS-300  
2m Handheld  
FM Transceiver  
142-149.995 MHz

✓ 111

- **WIDE FREQUENCY COVERAGE:** PCS-4000 covers 142,000-149,995 MHz in selectable steps of 5 or 10 kHz. PCS-4200 covers 220,000-224,995 MHz in selectable steps of 5 or 20 kHz. PCS-4300 covers 440,000-449,995 MHz in selectable steps of 5 or 25 kHz. PCS-4500 covers 50,000-53,995 MHz in selectable steps of 5 or 10 kHz. PCS-4800 covers 28,000-29,990 MHz in selectable steps of 10 or 20 kHz.
- **CAP/MARS BUILT IN:** PCS-4000 includes coverage of CAP and MARS frequencies.
- **TINY SIZE:** Only 2"H x 5.5"W x 6.8"D. COMPARE!
- **MICROCOMPUTER CONTROL:** At the forefront of technology!
- **UP TO 8 NONSTANDARD SPLITS:** Ultimate versatility. COMPARE!
- **16-CHANNEL MEMORY IN TWO 8-CHANNEL BANKS:** Retains frequency and standard simplex or plus/minus offsets. Standard offsets are 600 kHz for PCS-4000, 1.6 MHz for PCS-4200, 5 MHz for PCS-4300, 1 MHz for PCS-4500, and 100 kHz for PCS-4800.
- **DUAL MEMORY SCAN:** Scan memory banks either separately or together. COMPARE!
- **TWO RANGES OF PROGRAMMABLE BAND SCANNING:** Limits are quickly reset. Scan the two segments either separately or together. COMPARE!
- **FREE AND VACANT SCAN MODES:** Free scanning stops 5 seconds on a busy channel; auto-resume can be overridden if desired. Vacant scanning stops on unoccupied frequencies.
- **DISCRIMINATOR SCAN CENTERING (AZDEN EXCLUSIVE PATENT):** Always stops on frequency.
- **TWO PRIORITY MEMORIES:** Either may be instantly recalled at any time. COMPARE!
- **NICAD MEMORY BACKUP:** Never lose the programmed channels!
- **FREQUENCY REVERSE:** The touch of a single button inverts the transmit and receive frequencies,

no matter what the offset.

- **ILLUMINATED KEYBOARD WITH ACQUISITION TONE:** Unparalleled ease of operation.
- **BRIGHT GREEN LED FREQUENCY DISPLAY:** Easily visible, even in direct sunlight.
- **DIGITAL S/R F METER:** Shows incoming signal strength and relative power output.
- **BUSY-CHANNEL AND TRANSMIT INDICATORS:** Bright LEDs show when a channel is busy and when you are transmitting.
- **FULL 16-KEY TOUCHTONE® PAD:** Keyboard functions as autopatch when transmitting (except in PCS-4800).
- **PL TONE:** Optional PL tone unit allows access to private-line repeaters. Deviation and tone frequency are fully adjustable.
- **TRUE FM:** Not phase modulation. Unsurpassed intelligibility and audio fidelity.
- **HIGH/LOW POWER OUTPUT:** 25 or 5 watts selectable in PCS-4000; 10 or 1 watt selectable in PCS-4200, PCS-4300, PCS-4500, and PCS-4800. Transmitter power is fully adjustable.
- **SUPERIOR RECEIVER:** Sensitivity is 0.2 uV or better for 20-dB quieting. Circuits are designed and manufactured to rigorous specifications for exceptional performance, second to none. COMPARE!
- **REMOTE-CONTROL MICROPHONE:** Memory A-1 call, up/down manual scan, and memory address functions may be performed without touching the front panel! COMPARE!
- **OTHER FEATURES:** Dynamic microphone, rugged built-in speaker, mobile mounting bracket, remote speaker jack, and all cords, plugs, fuses, and hardware are included.
- **ACCESSORIES:** CS-7R 7-amp ac power supply, CS-4.5R 4.5-amp ac power supply, CS-AS remote speaker, and Communications Specialists SS-32 PL tone module.
- **ONE YEAR LIMITED WARRANTY!**

EXCLUSIVE DISTRIBUTOR:

DEALER INQUIRIES INVITED

**AMATEUR-WHOLESALE ELECTRONICS**

**TOLL FREE... 800-327-3102**

8817 S.W. 129th Terrace, Miami, Florida 33176

Telephone (305) 233-3631

Telex: 80-3356

MANUFACTURER:

**JPC/AZDEN**

**JAPAN PIEZO CO., LTD.**

1-12-17 Kamirenjaku, Mitaka, Tokyo, 181 Japan.

Telex: 781-2822452



# DOCTOR DX™ BY AEA

## Work The World With No Antenna



For the active CW operator, there is nothing more fun than operating with the "Doctor DX" CW DX simulator. For the person who has never liked CW, Doctor DX will show you what real fun is. Doctor DX has something for everyone from the aspiring Novice to the experienced Amateur Extra Class licensee. And you need no FCC license to operate Doctor DX!

With Doctor DX, all you need is a Commodore-64 computer, a key (or keyer), and a TV set. There is no need for an expensive transceiver, amplifier and antenna farm to enjoy the thrill of working "rare DX." No more TVI or dead bands! Doctor DX is more than the most sophisticated CW trainer ever developed, it is your DXpedition ticket to anywhere in the world at a very affordable price.

Doctor DX simulates real H.F. CW band conditions. All the stations you will work are generated by the computer. As you tune up and down the particular band you have selected, you will hear realistic sounding stations in contact with other stations (some within your skip zone). There is also the normal QRN and QRM one would expect to hear in the real world. All call letters heard are totally random (subject to the country's callsign assignment rules). The prefixes are weighted according to the Amateur Radio population density, with 304 possible countries represented. The speed of stations operating in the lower portion of the bands is much faster than those operating in the upper band segments. The "operators" are also more polished in the lower portion of the bands.

Radio propagation (programmed for each band) represents what you would expect to hear on a good propagation day at the peak of the sunspot cycle. The propagation follows the internal real-time clock that you set before beginning operation. All the simulated stations you hear (with proper prefixes) are at distances you would expect to hear for the time of day and band selected.

You can learn and enhance your CW operating skills with Doctor DX. Doctor DX will not reward bad habits. AEA even offers an awards program to owners of Doctor DX that work all zones, 100 countries, 5 band Dr DXCC, or Doctor DX Honor Roll.

The Doctor DX CW trainer is a totally new concept in Amateur Radio. See what all the excitement is about. Send for full details, and see your dealer for a demonstration.

### MIDWEST AMATEUR RADIO SUPPLY

3456 Fremont Avenue, North  
Minneapolis, MN 55412

Store Hours: Mon.-Fri. 9-6, Saturday 9-3

For service call: (612) 521-4662

For orders call: 1-800-328-6365



# Doctor DX™ Challenge

BY 

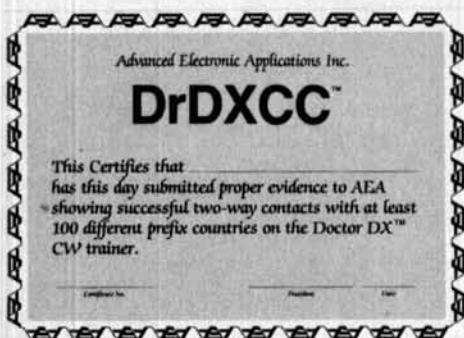

DOCTOR DX CONTEST BOX

| TOP SPRINT SCORES | TOP MARATHON SCORES |
|-------------------|---------------------|
| 1. _____          | 1. _____            |
| 2. _____          | 2. _____            |
| 3. _____          | 3. _____            |
| 4. _____          | 4. _____            |
| 5. _____          | 5. _____            |

WILL YOUR CALL APPEAR HERE?



For good clean, competitive fun, Doctor DX™ shows your score and QSO rate for continuous monitoring of your improved CW operating skills. The DDX-64 can be a vehicle for fairly settling those club rivalries by competing with your friends under identical operating conditions.

AEA also has two on-going CW contests that you can enter with Doctor DX as your own schedule permits. The AEA SPRINT CONTEST is a timed non-stop eight hour event and the AEA MARATHON CONTEST is a timed 24 hour non-stop event. The top 5 contest scores will be published in our future advertisements and upgraded periodically as new higher scores are achieved.

In addition to the two AEA contests, we are offering award certificates for achieving certain milestones. You will be automatically alerted when you have achieved these milestones by a display at the bottom of the monitor screen.

AEA DrDXCC is achieved when you have worked 100 different countries, regardless of the frequency band or the amount of time operated. DOCTOR DX WAZ can be earned by working all 40 CQWW zones of the world, without regard to the band or duration of operating time. The DOCTOR DX HONOR ROLL is reserved for top notch operators capable of working 250 countries without regard for band or operating time. Additional endorsement awards are available for each additional 10 countries worked up to 300 (out of 304 possible) countries. AEA 5 BAND Dr DXCC is a very difficult award to achieve. It requires working 100 countries on each of five different bands, without regard for the amount of operating time.

Each award can be obtained by filling out a photocopy of the award application form (supplied) along with the score information and qualifying check sum from your screen display. Please enclose \$3.00 to cover handling costs for each certificate (\$1.00 for Honor Roll endorsements). Awards will only be granted to owners having a Doctor DX warranty card on file.

There is no need to ever be bored with your hobby again just because the bands are dead or you are apartment bound. Try Amateur Radio's own version of Solitaire - DOCTOR DX.

## MIDWEST AMATEUR RADIO SUPPLY

3456 Fremont Avenue, North  
Minneapolis, MN 55412

Store Hours: Mon.-Fri. 9-6, Saturday 9-3

For service call: (612) 521-4662

For orders call: 1-800-328-6365



**Brings you the  
Breakthrough!**

**QUICK WEATHER PROTECTION PRODUCTS & ANTENNA ACCESSORIES**

**COVER BEFORE WINTER!**

Use covers with "Flo Thru" air vents for humidity control.



**PRODUCT & DESCRIPTION**

**MODEL**

|   |  |  |                |                |  |
|---|--|--|----------------|----------------|--|
| <p><b>QIK-ON</b><br/>Polarotor, LNA, Wire Terminal and also Down Converter Weather Boots</p> <p>with "Flo Thru" air vents for humidity control.</p> <p>Pat. Pending</p> | <p>LNA-S</p>   | <p>LNA-A</p>   | <p>LNA-DCB</p> | <p>LNA-DCI</p> | <p>(White)<br/>LNA-S<br/>LNA-A<br/>LNA-DCB<br/>LNA-DCP<br/>LNA-DCI</p> <p>(Interstat W/adapter)<br/>(Black)<br/>deduct \$1.00</p> <p>LNA-DCP</p> |
| <p><b>QIK-MOUNT (Universal) Down Converter Plate &amp; Boot</b></p> <p>with "Flo Thru" air vents</p>  |  | <ul style="list-style-type: none"> <li>• Accepts most Down Converters</li> <li>• Keeps D.C. and terminals dry</li> <li>• Prevents grounding</li> </ul> <p>The universal mounting plate is rubber covered perforated metal and a tight sealing rubber cover with wire exits</p> |                |                | <p>Black</p>   |
| <p><b>QIK-COVER Motor Boots</b></p> <p>with "Flo Thru" air vents</p> <p>Pat. Pending</p>  | <p>Channel Master<br/>Saginaw Burt<br/>Warner Hytek<br/>Interstat MTI<br/>Gentek Basic 5</p>   | <p>A UV resistant rubber cover that has the exclusive QIK-PRO end that allows the boot to put on quickly and tightly seal on the drive unit. Rubber lips on bottom for wire exit. (Lock band included.)</p>  |                |                | <p>(Black)<br/>MB<br/>MBO</p>  |
| <p><b>QIK-PRO Actuator Boots</b></p> <p>with "Flo Thru" air vents</p> <p>Pat. Pending</p>   | <p>Regular with "Limit Switch" Basic System 1-1/4" Actuators</p>   |  |                |                | <p>Regular<br/>18" Drive<br/>24"<br/>36"<br/>48"<br/>54"<br/>60"<br/>Basic Systems<br/>18" Small</p>   |
| <p><b>QIK-LIMIT Universal Limit Switch</b></p>  | <p>Universal limit switches mounted in an insulated bracket that clamps on all standard actuators quickly. (DC-AC wiring diagram included.)</p> <p><b>QUICK &amp; ACCURATE</b></p>   |  |                |                | <p>Boxed</p>   |
| <p><b>QIK-ALIGN Feed Horn Alignment Tool</b></p> <p>Pat. Pending</p>  | <p><b>MOST ACCURATE FEEDHORN ALIGNMENT TOOL MADE!!</b></p> <ul style="list-style-type: none"> <li>• Good instructions included</li> <li>• Use on butternuts and milkstool, etc.</li> <li>• One man alignment for maximum antenna signal</li> <li>• Saves hours of set up, guess work and tweaking</li> </ul> <p>• Hooks flush on feedhorn to aim &amp; align to exact center of dish</p> <p>• 3 reinforced adjustable triangulating legs can be set at focal distance &amp; point at center of dish in one easy setting.</p> |  |                |                | <p>Extends 25 to 47"</p> <p>Boxed</p>  |

Terms: Cash, Certified check, Money order, Money transfer Prices effective 6-1-84  
 Freight: UPS, COD, FOB Paullin Industries, 1446 State Rtes. 50, Ashland, Ohio 44805

Designing and developing new products for growing industries.

✓ 197

**SEMICONDUCTORS:**

|                                     |                     |
|-------------------------------------|---------------------|
| MRF-208.....12.00                   | MHW-252.....53.00   |
| MRF-240.....18.40                   | MHW-710-1.....61.00 |
| MRF-247.....34.80                   | MPSH-81.....50      |
| MRF-309.....33.80                   | MV2205.....58       |
| MRF-422.....41.40                   | 7BL08CP.....50      |
| MRF-454.....20.00                   | 2N4401.....75       |
| MRF-901.....1.75                    | 2N5190.....1.50     |
| SBL-1 Double-Balance Mixer.....6.50 |                     |

**P.C. BOARDS FOR MOTOROLA BULLETINS**

|                  |                  |
|------------------|------------------|
| AN-762.....14.00 | AN-791.....10.00 |
| EB-27A.....14.00 | EB-67.....14.00  |
| EB-63.....14.00  |                  |

KEMET CHIP CAPACITORS: 56 pf, 82 pf, 100 pf, 390 pf, 470 pf.....50 ea.  
 680 pf, 1000 pf.....55 ea.  
 5600 pf, 6800 pf, 1 µf.....1.00 ea.  
 33 µf.....1.90 ea. .68 µf.....3.90 ea.

CAMBION RF CHOKES: .15 µh, .22 µh, .33 µh, 4.7 µh, 10 µh.....1.20 ea.  
 BROADBAND TRANSFORMERS PER MOTOROLA BULLETINS: AN-762, EB-27A, EB-63  
 UNDERWOOD/SEMCO METAL-CLAD MICA CAPACITORS: 5pf, 10pf, 15pf, 25pf, 30pf,  
 40pf, 56pf, 60pf, 68pf, 80pf, 91pf, 100pf, 200pf, 250pf, 390pf, 470pf, 1000pf

We also carry a line of VHF, UHF amplifiers and ATV equipment.  
 Call or write for our free catalog.

✓ 135



**CCI Communication Concepts Inc.**



2648 North Aragon Ave. • Dayton, Ohio 45420 • (513) 296-1411



Life Time Warranty - 100% Certified

**\$180** ea. 5 1/4" SSDD **\$200**  
 QTY 10 5 1/4" DSDD ea. QTY 10

Packaged in polybags of 10 with labels, reinforced hubs and Tyvek envelopes.

MM-5 holds 50 5 1/4" disks.  
 MM-3 holds 30 3 1/4" 3 1/2" disks. Units have self locking covers with easy-carry handles, adjustable tab dividers and many other features.  
 Great buy!  
**MM-3 \$12.95 MM-5 \$13.95 MEDIA-MATE**



Free shipping in Continental US if order over \$25, else add \$2.50. COD add \$3.00. Visa and MasterCard. Personal checks take 10 days to clear. Florida residents add 5%.

**DISCOUNT DISCS**

P.O. Box 1231 Shalimar, FL 32579  
 (904) 651-4550 ✓ 144

IF YOU COMBINE 1.3 - 1296 and 249.95 WHAT DO YOU GET?  
 A COMBINATION THAT YOU CAN'T BEAT.



1.3 IS THE FREQUENCY  
 1296 IS THE BAND  
 \$249.95 IS THE PRICE

- Frequency Range 10Hz to 1.3Ghz
- Accuracy ± 1 ppm (.0001)
- 4" 8 Digit LED Display
- Reads 1296 Mhz Band
- Automatic decimal point
- Stability ± 1 ppm/hour
- 5 1/2" x 6" x 2" all metal case
- Stability ± 1ppm/Mo.
- Built in pre-scaler
- 115v operation
- 1 year warranty
- Temp ± 3ppm 20 to 50 C
- Input impedance 1M ohm/20 pf to 100 Mhz - 50 ohm above 100 Mhz

MASTER CARD OR VISA ACCEPTED  
 CALL 716-874-5848 or WRITE: 15 DAY - NO HASSLE RETURN GUARANTEE

**DIGITAL Instruments Inc.** 636 Sheridan Drive, Tonawanda, New York 14150 (716) 874-5848

✓ 143

**INCREDIBLE CODE!!**

Learn the International Morse Code by the patented "WORD METHOD"

**NO** BOOKS  
 CARDS  
 VISUAL AIDS  
 GIMMICKS

Just listen and learn! The "WORD METHOD" is based on the latest scientific and psychological techniques. You can zoom past 13 WPM in less than HALF THE USUAL TIME!!

The kit contains two cassette tapes, over TWO HOURS of unique instruction by internationally famed educator Russ Farnsworth. Complete satisfaction guaranteed.

Available at local Electronic Dealers, or send check or money order for \$18.50 plus \$1.50 for postage and handling to:

**EPSILON RECORDS**  
 P.O. Box 71581  
 New Orleans, LA 70172

✓ 153



Rob, WA3QLS



Katherine, KA31YO



Paul, WA3QPX

# Delaware Amateur Supply

71 Meadow Road, New Castle, Del. 19720 302-328-7728

*Factory Authorized Dealer! 9-5 Daily, 9-8 Friday, 9-3 Saturday*

**KENWOOD YAESU ICOM TENTECH  
MICROLOG KDK SANTECH KANTRONICS**

## 800-441-7008

*Order & Pricing  
New Equipment*

Large Inventory



Daily UPS Service



**All Other Calls  
302-328-7728**

**No Sales Tax  
in Delaware!  
One mile off I-95**

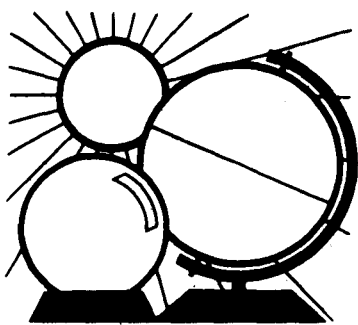

# DX FORECASTER

Garth Stonehocker, KØRYW

## winter DX

The winter DX season is here. One characteristic of winter is a steep rise in the daily MUF peak followed by an early decline to a deeper predawn minimum. This makes for shorter daytime DX operating time in the higher HF bands, but for more nighttime DX on the lower frequency bands. Signal strengths are higher because of lower absorption of energy and less propagated or local atmospheric noise (by this time of year, thunderstorms are fewer and more distant).

Absorption is a result of the loss of energy from the signal as it collides with ions on its path through the D region (about 100-120 miles, or 60-80 km, above the earth). How much energy is absorbed per transit of the D region depends on the location of the sun, and is a function of cosine X, the zenith angle to the sun. Maximum absorption occurs at the subsolar point (directly under the sun); absorption decreases as the signal transit moves away from the subsolar point in any direction. In our winter the subsolar point moves down to 23 degrees south latitude, resulting in less absorption. At the same time the earth is closer to the sun by 2 percent. The net result is still less absorption in winter. The degree of absorption is related to and follows the changes in the ultraviolet output of the sun. (It takes slightly over 8 minutes for a change on the sun to begin affecting our ionosphere.) A measure of this is the daily solar flux at 2800 MHz recorded in Ottawa, Canada, and broadcast at 18 minutes after the hour by radio station WWV. Another source of absorption, caused by increased particle influx during geomag-

netic storms, occurs on propagation paths through or along the auroral zone (60-80 degrees latitude). An indication of this cause is an increase in the geomagnetic K (greater than 4) and A (greater than 30) indices, also broadcast from WWV.

On any propagation path, absorption increases with the number of transits of the D region and also varies inversely with frequency. Therefore in working DX it pays to use the higher frequency bands to obtain more distance per hop (resulting in fewer transits) and less signal loss. This is why we generally think of 6, 10, or 15 meters for DXing. But in winter, we have the opportunity to work DX on the lower frequency bands with less QRN and lower signal loss than at any other time of the year.

Lower signal loss is something to look forward to, but you can't count on it. Sometimes in winter, signals are poor for several days at a time. This is caused by anomalous absorption, which will be discussed in next month's column.

## last-minute forecast

The low HF bands, 160 through 30 meters, are expected to be the favored bands of operation during the first two weeks of November, with higher bands providing the best DX during the last two weeks of the month. The solar radio flux should be about the same as last year's values, yet higher than it's been in the last month or two. Some possibility of recurrent geomagnetic storms still exists, with greatest probability of occurrence on November 4, 9, 14, 18, and 28. Remember: even though disturbances affect signal

strength and produce fading conditions for some paths, conditions on other paths may actually improve.

November is the month during which numerous meteor showers occur. Shower activity should begin on October 26 and last until November 22. A shower maximum of ten per hour is expected during the Taurids meteor shower from the 3rd through the 10th. Lunar perigee is on the 20th; full moon is the 8th.

A total eclipse of the sun will occur on November 22 and 23 in the south Pacific, starting at 2013 UT in the Philippines and New Zealand, traveling east to Antarctica, and ending at 0133 UT. You might want to schedule some contacts with ZL and KC4 land for some unusual DX.

## band-by-band summary

*Ten, fifteen, and twenty meters* will be open from morning to early evening almost every day, and to most areas of the world. The openings on the higher of these bands will be shorter and will occur closer to local noon. Transequatorial propagation on these bands will more likely occur toward evening during conditions of high solar flux and a disturbed geomagnetic field. Absorption effects are not too noticeable.

*Thirty and forty meters* will be useful almost 24 hours a day. Daytime conditions will resemble those on 20 meters. Skip distances and signal strength may decrease during midday on those days that coincide with high solar flux values. Nighttime DX will be good except after days of very high MUF conditions and the winter anomaly. The usable distance is expected to be somewhat greater than that achieved on 80 at night.

*Eighty and one-sixty meters* are the nighttime DXer's bands. The bands open just before sunset and last until the sun comes up on the path of interest. Except for daytime short-skip signal strengths, high solar flux values don't affect these bands much. The anomaly will affect day and night signal strength on some days.

ham radio

### WESTERN USA

| GMT  | PST   | Directional Indicators |     |     |    |    |     |    |    |
|------|-------|------------------------|-----|-----|----|----|-----|----|----|
|      |       | N                      | NE  | E   | SE | S  | SW  | W  | NW |
| 0000 | 4:00  | 20                     | 30  | 15  | 10 | 15 | 10  | 10 | 20 |
| 0100 | 5:00  | 20                     | 30  | 15  | 10 | 15 | 10  | 10 | 20 |
| 0200 | 6:00  | 20                     | 30  | 15  | 10 | 15 | 15  | 10 | 20 |
| 0300 | 7:00  | 20                     | 30  | 20  | 10 | 15 | 15  | 10 | 20 |
| 0400 | 8:00  | 20                     | 30  | 20  | 10 | 15 | 15  | 15 | 20 |
| 0500 | 9:00  | 20                     | 30  | 20  | 15 | 15 | 20* | 15 | 20 |
| 0600 | 10:00 | 20                     | 40* | 20  | 15 | 20 | 20  | 15 | 30 |
| 0700 | 11:00 | 30                     | 40  | 20  | 15 | 20 | 20  | 20 | 30 |
| 0800 | 12:00 | 30                     | 40  | 20  | 15 | 20 | 20  | 20 | 30 |
| 0900 | 1:00  | 30                     | 40  | 20  | 20 | 20 | 20  | 20 | 30 |
| 1000 | 2:00  | 30                     | 40  | 20  | 20 | 20 | 20  | 20 | 30 |
| 1100 | 3:00  | 30                     | 40  | 30* | 20 | 20 | 20  | 20 | 30 |
| 1200 | 4:00  | 30                     | 40  | 20  | 20 | 20 | 20  | 20 | 30 |
| 1300 | 5:00  | 30                     | 30  | 20  | 20 | 20 | 20  | 20 | 40 |
| 1400 | 6:00  | 40                     | 30  | 20  | 20 | 20 | 20  | 20 | 40 |
| 1500 | 7:00  | 40                     | 30  | 15  | 20 | 20 | 20  | 40 | 40 |
| 1600 | 8:00  | 40                     | 20  | 15  | 20 | 20 | 15  | 20 | 40 |
| 1700 | 9:00  | 40                     | 20  | 15  | 20 | 15 | 15  | 20 | 30 |
| 1800 | 10:00 | 40                     | 20  | 15  | 20 | 15 | 15  | 30 | 30 |
| 1900 | 11:00 | 40                     | 20  | 15  | 15 | 15 | 15  | 30 | 30 |
| 2000 | 12:00 | 40                     | 20  | 15  | 15 | 15 | 15  | 20 | 20 |
| 2100 | 1:00  | 30                     | 20  | 15  | 15 | 15 | 15  | 20 | 20 |
| 2200 | 2:00  | 30                     | 20  | 15  | 15 | 15 | 15  | 20 | 20 |
| 2300 | 3:00  | 30                     | 20  | 15  | 15 | 10 | 15  | 20 | 20 |

### NOVEMBER

### MID USA

| GMT  | MST   | Directional Indicators |    |     |    |    |    |    |    |
|------|-------|------------------------|----|-----|----|----|----|----|----|
|      |       | N                      | NE | E   | SE | S  | SW | W  | NW |
| 0000 | 5:00  | 30                     | 30 | 15  | 15 | 15 | 10 | 15 | 20 |
| 0100 | 6:00  | 30                     | 30 | 15  | 20 | 15 | 15 | 15 | 20 |
| 0200 | 7:00  | 40                     | 30 | 20  | 20 | 15 | 15 | 15 | 20 |
| 0300 | 8:00  | 40                     | 30 | 20  | 20 | 15 | 15 | 15 | 20 |
| 0400 | 9:00  | 40                     | 30 | 20  | 20 | 15 | 15 | 15 | 20 |
| 0500 | 10:00 | 40                     | 30 | 20  | 20 | 20 | 15 | 15 | 20 |
| 0600 | 11:00 | 40                     | 40 | 20  | 20 | 20 | 20 | 20 | 30 |
| 0700 | 12:00 | 40                     | 40 | 20  | 20 | 20 | 20 | 20 | 30 |
| 0800 | 1:00  | 40                     | 40 | 20  | 20 | 20 | 20 | 20 | 30 |
| 0900 | 2:00  | 30                     | 40 | 20  | 20 | 20 | 20 | 20 | 30 |
| 1000 | 3:00  | 30                     | 40 | 20  | 20 | 20 | 20 | 20 | 30 |
| 1100 | 4:00  | 30                     | 40 | 20  | 20 | 20 | 20 | 20 | 30 |
| 1200 | 5:00  | 20                     | 40 | 20  | 20 | 20 | 20 | 20 | 40 |
| 1300 | 6:00  | 20                     | 30 | 20  | 15 | 20 | 20 | 20 | 40 |
| 1400 | 7:00  | 20                     | 30 | 15  | 15 | 20 | 20 | 20 | 40 |
| 1500 | 8:00  | 20                     | 30 | 15  | 15 | 20 | 20 | 20 | 40 |
| 1600 | 9:00  | 20                     | 30 | 15  | 15 | 20 | 20 | 20 | 40 |
| 1700 | 10:00 | 20                     | 20 | 15  | 10 | 15 | 15 | 20 | 30 |
| 1800 | 11:00 | 30                     | 20 | 10  | 10 | 15 | 15 | 30 | 30 |
| 1900 | 12:00 | 30                     | 20 | 10  | 10 | 15 | 15 | 30 | 30 |
| 2000 | 1:00  | 30                     | 20 | 10  | 10 | 15 | 15 | 20 | 20 |
| 2100 | 2:00  | 30                     | 20 | 10  | 10 | 15 | 15 | 20 | 20 |
| 2200 | 3:00  | 30                     | 20 | 15* | 15 | 15 | 15 | 20 | 20 |
| 2300 | 4:00  | 30                     | 20 | 15  | 15 | 15 | 10 | 20 | 20 |

### EASTERN USA

| GMT  | EST   | Directional Indicators |     |     |    |    |    |     |    |
|------|-------|------------------------|-----|-----|----|----|----|-----|----|
|      |       | N                      | NE  | E   | SE | S  | SW | W   | NW |
| 0000 | 7:00  | 30                     | 30  | 15  | 15 | 15 | 15 | 15* | 20 |
| 0100 | 8:00  | 40                     | 30  | 15  | 20 | 15 | 15 | 15  | 20 |
| 0200 | 9:00  | 40                     | 30  | 20  | 20 | 15 | 15 | 15  | 20 |
| 0300 | 10:00 | 40                     | 30  | 20  | 20 | 15 | 15 | 15  | 20 |
| 0400 | 11:00 | 40                     | 30  | 20  | 20 | 20 | 20 | 15  | 30 |
| 0500 | 12:00 | 40                     | 40* | 20  | 20 | 20 | 20 | 20  | 30 |
| 0600 | 1:00  | 40                     | 40  | 20  | 20 | 20 | 20 | 20  | 30 |
| 0700 | 2:00  | 40                     | 40  | 20  | 20 | 20 | 20 | 20  | 30 |
| 0800 | 3:00  | 40                     | 40  | 20  | 20 | 20 | 20 | 20  | 30 |
| 0900 | 4:00  | 30                     | 40  | 20  | 20 | 20 | 20 | 20  | 30 |
| 1000 | 5:00  | 30                     | 40  | 20  | 20 | 20 | 20 | 20  | 30 |
| 1100 | 6:00  | 30                     | 40  | 20  | 20 | 20 | 20 | 20  | 40 |
| 1200 | 7:00  | 20                     | 30  | 20  | 15 | 20 | 20 | 20  | 40 |
| 1300 | 8:00  | 20                     | 30  | 15  | 15 | 20 | 20 | 30  | 40 |
| 1400 | 9:00  | 20                     | 30  | 15  | 15 | 20 | 20 | 40  | 40 |
| 1500 | 10:00 | 20                     | 20  | 15  | 15 | 20 | 20 | 40  | 40 |
| 1600 | 11:00 | 20                     | 20  | 15  | 15 | 20 | 20 | 40  | 40 |
| 1700 | 12:00 | 20                     | 20  | 15  | 10 | 15 | 15 | 30  | 30 |
| 1800 | 1:00  | 20                     | 20  | 15  | 10 | 15 | 15 | 30  | 30 |
| 1900 | 2:00  | 30                     | 20  | 15* | 10 | 15 | 15 | 30  | 30 |
| 2000 | 3:00  | 30                     | 20  | 10  | 10 | 15 | 15 | 20  | 20 |
| 2100 | 4:00  | 30                     | 20  | 10  | 10 | 15 | 15 | 20  | 20 |
| 2200 | 5:00  | 30                     | 20  | 15* | 15 | 15 | 15 | 20  | 20 |
| 2300 | 6:00  | 30                     | 20  | 15  | 15 | 15 | 10 | 20  | 20 |

The italicized numbers signify the bands to try during the transition and early morning hours, while the standard type provides the MUF during "normal" hours.  
 \*Look at next higher band for possible openings.

# RADIO WAREHOUSE

Division of HARDIN Electronics

NO FRILLS—JUST LOW PRICES  
CALL FOR SPECIAL PRICES ON—

KENWOOD

YAESU

ICOM

TEN-TEC

DAIWA METERS—KEYERS—AUDIO FILTERS  
CUSHCRAFT LINE OF ANTENNAS

CALL TOLL FREE

1-800-433-3203



IN TEXAS CALL 817-496-9000  
5635 EAST ROSEDALE  
FT. WORTH, TEXAS 76112

## DISTRIBUTORS

### UNITED STATES

#### A-TECH

Kansas 913-582-5819

#### BROOKS (Franchise)

201-583-2800

#### CAYSON ELECT.

Mississippi 601-862-2132

#### DULANEY's

Oklahoma 405-528-0511

#### ECHOSPHERE

Sacramento, Ca. 880-338-5477

Englewood, Co. 800-521-9282

Dallas, Tx. 800-521-9282

Knoxville, Tn. 880-223-1507

#### HOOSIER ELECTRONICS, INC.

Terre Haute, In. 800-457-3330

#### I.Z.C.C.

Arkansas 501-771-2800

#### KAUL-TRONICS

Wisconsin 608-647-8902

#### NAT'L MICRO DYNAMICS

Tennessee 615-892-3901

#### SATELLITE DATA

Florida 813-823-7669

#### SAT-VIEW DISTRIBUTORS

New York 315-822-6900

#### SATELLITE EARTH STATIONS

Louisiana 800-762-2110

Texas 512-385-0738

#### D.H. SATELLITE T.V. INC.

Prairie Du Chien, Wi.  
608-326-8406

#### S.R.C. INDUSTRIES

Ontario, Or. 503-889-7261

#### SATELLITE MARKETING

Douglasville, Ga. 800-438-2807

#### TENN-SAT

Tennessee 415-349-7180

#### M & M VIDEO

Carson City, Nv. 702-882-5786

### CANADA

#### STARSCAN

Kelowna, B.C. 604-763-4266

#### C.L. BLUE

Saskatoon, Sask. 306-242-5133

#### CANADIAN MICRO-TECH

Ontario

### WESTERN and EASTERN SATELLITE

✓ 233

VHF COMMUNICATIONS



ICOM

VHF COMMUNICATIONS



END OF SUMMER CLEARANCE

IC-745 HF Base

SUPER SAVINGS !!!

hamtronics®

HIGH QUALITY MODULES FOR  
REPEATERS, LINKS, TELEMETRY, ETC.

Contact us for all of your amateur radio needs.....  
FEATURING:

ICOM, AEA, LARSEN, VAN GORDEN, VIBROPLEX,  
NYE-VIKING, FALCON COMM., LEADING EDGE,  
ARRL PUBLICATIONS, KALGLO, HAMTRONICS,  
PROWRITER, ELEPHANT DISKS, RAMSEY ELECT.

915 North Main Street  
Jamestown, New York 14701 ✓ 229

Western New York's finest amateur radio dealer!

PH. (716)664-6345

### MICA COMMUNICATIONS CONSOLES

4 - 6' 8" Wide - 1' to 8' wide optional  
L & U & Circular set up 5 - with optional corner table  
Replaceable Front Panel - for station changes  
Precisely cut panel holes - by computerized wood cutter  
High station density - because no shelves are used!  
Hidden accessory shelf - for power supplies, dummy load  
Puppets of all your equipment - for easy station layout

#### OPTIONAL ITEMS:

Drawer/Bookshelf combination - hangs under desk  
1000 Mica's to select from - to match your decor  
Desk recessed for keyboard - optimum 26" typing height  
Desk top extensions into panel - for apple computer or storage  
Matching dolly for floor amp's - with concealed casters  
Shelf under desk, quick access - for headphones, key mic  
Exhaust cooling fan system - thermostatically controlled  
Wire duct, wire labels, etc...



4 console displayed

DEALER  
INQUIRIES  
ARE INVITED  
✓ 128

Break  
Communications  
Systems, Inc.

5817 S.W. 21st Street, Dept. HRM • Hollywood Florida 33023  
Phone (305) 989-2371



# MAXUM

007™

a good deal  
more  
for a good deal  
less

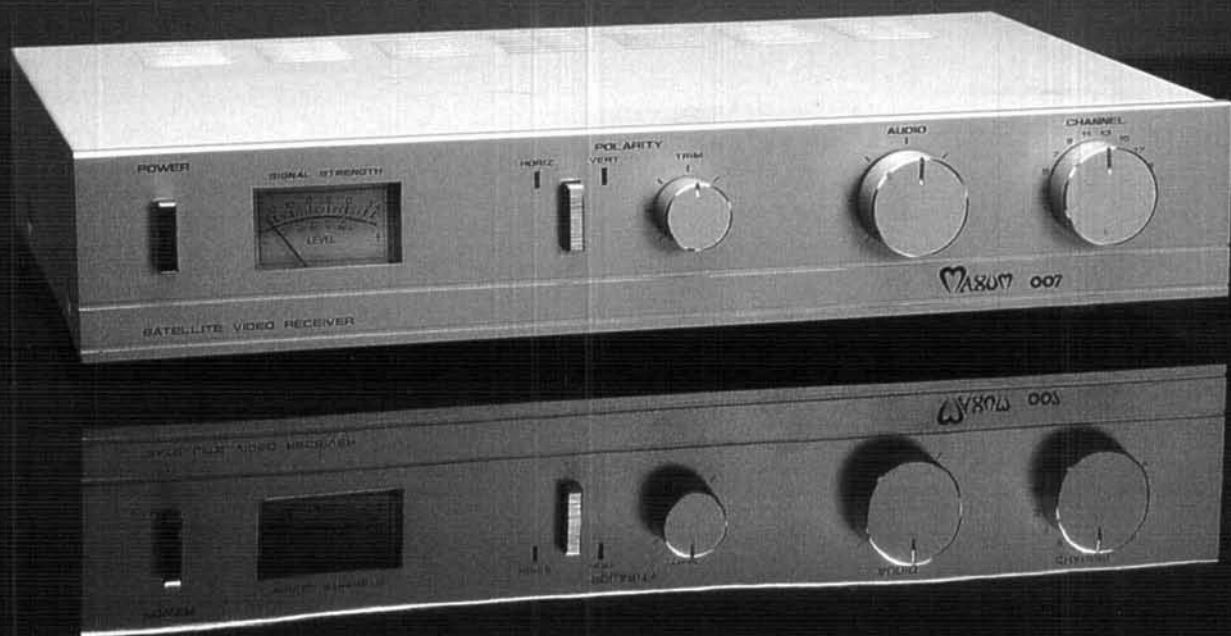

MANUFACTURED BY WESTERN & EASTERN SATELLITE

**WESTERN SATELLITE**

916-337-6202

Orders only — 800-243-3019

**EASTERN SATELLITE**

904-224-8965



# SANTEC presents the smarter handhelds

FOR 144 VHF, 220 VHF & 440 UHF

SANTEC Handhelds just got a little smarter, with new computer-control software designed by U.S. Hams who are also professional programmers. Now SANTEC Handhelds, which were the first to offer you varactor diode tuning in a handheld, first to offer you thick-film technology, first to provide 3.5W as a selectable handheld option and first to give you the time of day on a handheld read-out, have made another user-friendly leap forward in the logical progression of computer-controlled handhelds.

Now three SANTEC Handhelds can lock out selected memory channels from the memory scan, allowing you to check your favorite frequencies much faster, without interruption from less commonly used ones or from unprogrammed memory channels. SANTEC Handheld's new operating programs now allow you to store variable offset values in all 10 user-written memory channels; and, as always with SANTEC Handhelds, your stored offset automatically comes back when you select a channel through the memory mode, and the plus or minus indication shows on the LCD display.

Other new features are the provision in Memory 9 for split memory offset operation, for those really unusual offset situations, and the capacity for hardware storage of a special PL tone for each memory channel (requires an optional encoder, available December, 1983). The new SANTEC Handhelds will also accept the keyboard input of all frequencies as either short, fast 4-digit numbers or the familiar 6-digit versions: your SANTEC Handheld is smart enough to know what you want, either way.

The handhelds with the most now have more for you. Don't you dare settle for anything less: get your hands on a SANTEC Handheld today!

Shown above is just one of the three new smarter handhelds from SANTEC: the ST-142 VHF, the ST-442 UHF and the ST-222 VHF. Owners of earlier SANTEC models ST-144, ST-440 and ST-220, please write for information on how your SANTEC Handhelds can be upgraded to the new state of the art in handheld transceivers.



© 1983, Encomm, Inc.  
2000 Avenue G, Suite 800, Plano, Texas 75074  
Phone (214) 423-0024 • TLX 79-4783 ENCOMM DAL

Repairs, Parts & Services Available...

Export orders invited.

✓ 150

All stated specifications are subject to change without notice or obligation.

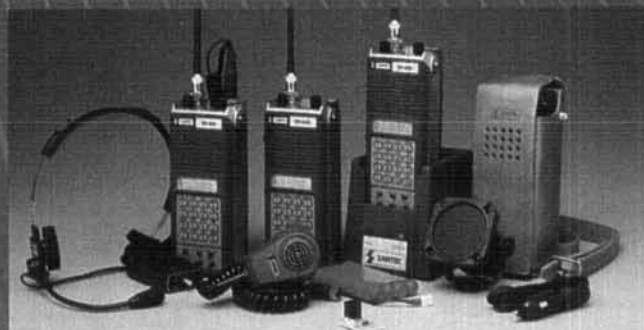

**The Smarter Handhelds**, clockwise from upper left: ST-142 VHF Transceiver; ST-442 UHF Transceiver; ST-222 VHF Transceiver, operating from the ST-4QC Quick-Charge Battery Charger & Power Supply; ST-LC Leather Case and Strap; ST-MC Mobile Charger; MS-505 Remote Speaker; ST-500B3 Rechargeable 500 mAh NiCd Battery Pack; ST-EC External Charge Adapter; SM-3 Speaker Mic; ST-HA-1/HBM-1 Head Set Boom Mic & Adapter.

# VHF/UHF WORLD

Joe Reiser  
W1JK

## high dynamic range receivers

Mention high dynamic range and you'll really get a discussion going. Everyone has a story and a solution. We'd all like to believe that our receivers or transmitters are always clean, and that any splatter or other obnoxious noise has to be coming from somebody else's poor receiver or dirty or overdriven linear amplifier. Because all aspects of the situation, both on the transmit and receive side, are seldom separated, the problem is rarely resolved.

A few years ago, after lots of arm-twisting by Jim Stitt, WA80NQ, I tackled this dilemma. The main goal was to improve Jim's 6-meter receiver sufficiently so he could be sure it wasn't the culprit in these situations. Then his station could be more competitive in the VHF contests and he'd be able to operate alongside the strong local transmitters — assuming *they* were also clean (more on this later).

The end product was a high dynamic range 6-meter receive converter with an extra transmitter LO (local oscillator) output. Since this month's *ham radio* emphasizes receivers, I decided to discuss this subject in some detail and examine some of the problems, limitations, and solutions for such a design. Typical recommended circuits for a 6-meter receive converter will then be shown.

## high dynamic range

What is high dynamic range? One answer is that it describes transmitter or receiver design that allows copying weak DX signals in close proximity to

strong signals. It sounds simple enough, but how strong is that local? Let's assume that a big 6-meter station is only 1 mile (1.6 km) distant and runs the legal limit of 1.5 kW PEP output through a feedline with a 1 dB loss to a 10 dB gain antenna pointed at your receiving antenna. If you're using a dipole receiving antenna broadside to this signal and have no feedline loss, the signal at the input to your receiver will be approximately 0 dBm or 1 milliwatt, about 130 dB above the noise floor in a typical VHF receiver! If you also have a 10 dB gain antenna, the signal received (when aimed at this source) will be +10 dBm (10 milliwatts) — more power than is used for the LO in most Amateur receivers! If the distance between stations is doubled, the signal will drop by 6 dB but still be quite respectable.

Recently I tested the dynamic range of a well-designed Amateur 6-meter converter that uses a single JFET preamplifier and a standard level (+7 dBm or 5 milliwatts) DBM (doubly-balanced mixer). When two equal signals of -20 dBm (23 millivolts or 10 microwatts) were present at the input to the converter, spurious signals or IMD (intermodulation distortion) were generated and only 30 dB below the desired outputs. This is hardly high dynamic range! These spurs or IMD products usually appear as sidebands or additional signals spaced equally above and below the normal signals by the difference between the input frequencies (see **fig. 1**). When the IMD gets worse, additional spurs appear alongside the first sidebands as is also seen in the photo in **fig. 1**.

All is not lost. The antennas can be part of the solution. If you use a directional antenna with a clean pattern, moving your antenna back and forth can place a null on a strong signal.<sup>1</sup> If overload is still present, one solution is to place an attenuator at your receiver input (more on this later); on VHF, especially on 6 meters, where the local ambient noise is usually high, the weak signal will still be good copy while the local (interfering signal) will have been "knocked" down.

## is the receiver at fault?

Before proceeding, it may be worth mentioning the transmitter. Typically speaking, it would be desirable for all Amateurs to transmit a clean signal. But what is a clean transmitted signal? Typical Amateur linears call for IMD products to be at least 30 dB below the desired signals. However, if the received signal is 130 dB above the noise, 30 dB IMD isn't going to be much help 3 kHz from the other station's frequency. You'll just have to QSY further away.

Therefore, before you accuse the other station of "hitting it too hard," perform one simple test. *First observe the splatter several kHz away on a relative basis or on your receiver "S" meter.* Next, place an appropriate attenuator (10 dB recommended, see **fig. 2**) at the input to your receiver or converter (or use the internal attenuator if one is an integral part of your receiver) and then recheck the splatter level. If the received level drops by approximately the insertion loss of the attenuator, the transmitter is the culprit and the transmitting station is

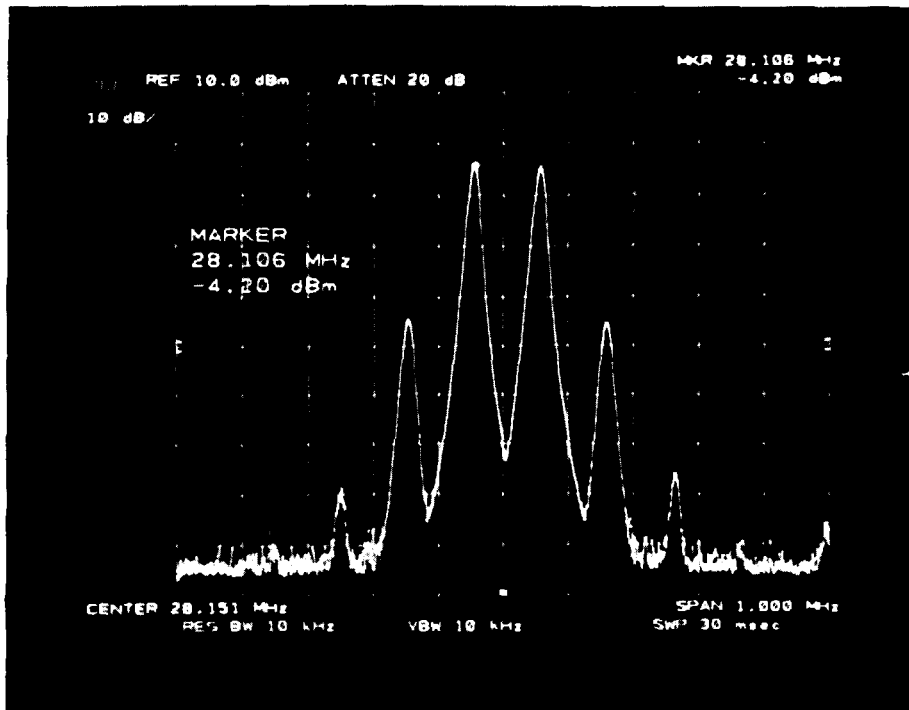

fig. 1. A spectrum analyzer shows the 28 MHz IF output of a typical 6-meter converter as described in the text. Input signals are approximately 50.1 and 50.2 MHz at -20 dBm each.

either overdriving its equipment or your frequency is just too close for comfort. However, if the splatter drops by more than the attenuator value (it could be up to 3 times less!), your receiver is surely part of the problem.

Assuming that the problem is the receiver (maybe in some future column we'll examine transmitter and power amplifier requirements in greater detail), there are design approaches that will enhance receiver performance.

### general receiver design requirements

The old saw "If you can't hear them, you can't work them" still applies to high dynamic range receivers. Low noise figure, sufficient RF selectivity to reject images and undesired out of band signals plus a clean local oscillator are still required.

In order to obtain low noise figure, a preamplifier is usually required ahead of the first mixer. Herein lies the problem. Any gain ahead of the mixer will decrease the dynamic range. Therefore, the preamplifier gain must be kept as low as possible, consistent

with obtaining the desired noise figure. The desired or total system noise figure can be determined from:

For example, a 3 dB noise figure preamplifier with 9-10 dB of gain feeding a mixer with a 10 dB noise figure will yield an overall system noise figure of less than 5 dB. Fortunately, we can live with lower sensitivity receivers, especially on 6 meters, where a noise figure less than 5 to 10 dB is usually wasted since the typical ambient noise is usually very high.\* At 2 meters the problem is more acute, but the level and number of signals are usually somewhat less of a problem. For the computer-minded Amateur, a computer program is available for eq. 1 so that you can quickly iterate various combinations of gain and noise figure to determine your own optimum case.<sup>2</sup> Before leaving the subject, remember that a preamplifier must have high output power capability in order not to distort the signals prior to the first mixer (more on this later).

For good performance you need adequate RF selectivity ahead of the mixer, which means additional losses that further increase the noise figure. Again, these losses can be handled (as we shall soon see) by the proper choice of RF filter characteristics and by optimizing the location of the filters in the receiver chain.

Let's not forget the choice of IF and its effect on selectivity, images and spurious responses. For 6 meters I personally favor a 28 MHz IF with a 22 MHz LO, rather than a 14 MHz IF with the 36 MHz LO used on some of the older converters. Spurious signal analysis reveals that a 28 MHz IF is slightly less susceptible to "birdies."<sup>3</sup> Also, a 28 MHz IF is far less likely to respond to IF breakthrough. The latter term refers to leakage at the IF frequency that permits normal signals in this spectrum to also be received. The 20-meter band is a good example since propagation yields signals of high intensity, especially during the days when 6 meters is hot. Although 10-meter IF breakthrough can be a

\*Everything's relative -- Joe, who also operates 160 meters, would probably agree that in contrast, 6 meter ambient noise is low -- Editor

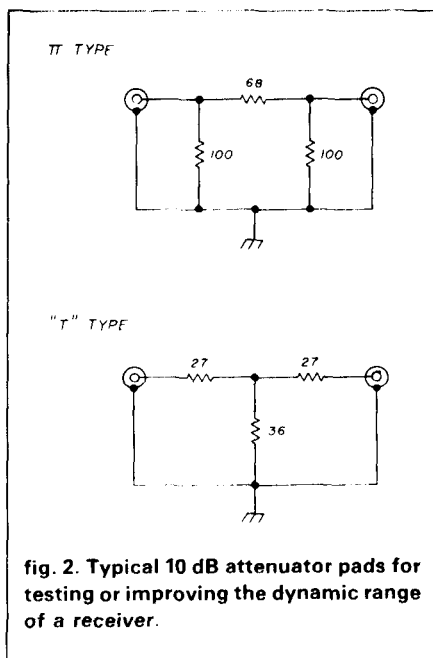

fig. 2. Typical 10 dB attenuator pads for testing or improving the dynamic range of a receiver.

with obtaining the desired noise figure. The desired or total system noise figure can be determined from:

$$NF (total) = NF1 + (NF2 - 1)/G1 + (NF3 - 1)/G1G2, \text{ etc.} \quad (1)$$

where G is gain and NF is noise fac-

problem, the number and strength of stations present is usually less, especially below 28.3 MHz.

High dynamic range mixers that require moderate LO power (10-100 milliwatts) are usually required. Also the LO must be very clean with low phase noise (more on this later) and should be followed by an amplifier to boost the level high enough to adequately drive the mixer.

Finally, if the overall system noise figure is to be realized, the mixer must usually be followed by a low noise figure postamplifier with a high dynamic range. The IF receiver should also have high dynamic range and a moderate (10 dB or so) noise figure.

### preamplifiers

Surely the preamplifier is one of the most important aspects of a good receiver. However, obtaining high dynamic range and low noise figure simultaneously and with a reasonable input and output VSWR is difficult. Devices (transistor, FET, etc.) with low inherent noise figure are common. However, increasing preamplifier dynamic range usually requires increased device current or a device with greater current-carrying capacity. This, in turn, usually increases the noise figure and the overall gain, the exact opposite of the desired effect!

Before discussing different preamplifiers in detail, it may be well to mention the subject of the linearity in an active device. Just because an amplifier is operated in class "A" doesn't mean it is free from distortion. *Every amplifier, regardless of its type and power, has a point beyond which the output signal will no longer be an exact replica of the input signal.* Hence distortion will occur.

Over the years various methods have been devised to measure distortion. The most frequently used test is for 1 dB compression. This is defined as the CW power level where the output signal increases 9 dB for an input power increase of 10 dB. Most class "A" amplifiers can only increase output power by 2-6 dB beyond this level, as shown in fig. 3. Amplifiers often are

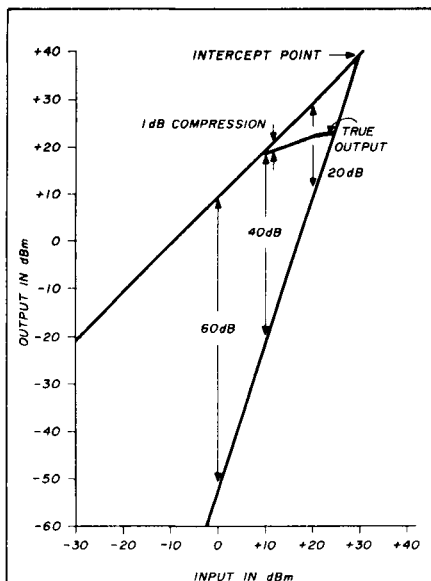

fig. 3. A high dynamic range preamplifier (fig. 6) input versus output level response with typical IMD levels and compression levels.

heavily distorting a signal 5-10 dB before it reaches compression levels; consequently, this is not a good point for referencing distortion. Furthermore, some devices are more non-linear than others, especially when approaching the compression point.

In 1967, McVay wrote his classic reference paper on the third-order intercept point, a new method of measuring dynamic range.<sup>4</sup> Basically, what this method does is to determine distortion based on a two-signal IMD test performed in a similar manner to that used to specify single sideband linear amplifiers. The third-order intercept point is then determined either mathematically or by use of nomograph (see fig. 3). The distortion can then be calculated or read off the nomograph for any power level on any device if the third-order intercept point is known. Suitable nomographs are available in reference 4 and from most commercial amplifier manufacturers.

In most of the work I have done on high dynamic range, I have used the intercept point test method. Several things are immediately apparent. The IMD products increase at three times the rate of the desired output signal

level change. Hence, the ratio between the output signal level and distortion will change on a 2 for 1 basis. For example, if the IMD products from two equal level signals are 60 dB below the desired output signal level and the signal level is increased by 1 dB, the IMD products will now be only 58 dB below the desired output level. A 10 dB input signal increase will decrease the IMD difference by 20 dB. This can be seen graphically in fig. 3. Therefore, once IMD becomes apparent, it will usually degrade very rapidly, perhaps even on a greater than 2-to-1 basis, with increased signal level! This is common on many active devices whenever the IMD is less than 60 dB below the output levels.

A search was launched for the ideal preamplifier. First a low-gain (12-13 dB) grounded-gate J310 JFET preamplifier was designed (after all, FETs are supposed to have such great dynamic range and low noise figures). The results were fair. On a typical circuit the output compression point was +14 dBm (250 milliwatts). The IMD was down 60 dB for -3.5 dBm (0.45 milliwatts) output per signal for an output third-order intercept point of +26.5 dBm (450 milliwatts). However, the noise figure was over 4 dB with no input matching. When input noise figure matching was added, the gain increased and the input impedance match degraded — both detrimental to the desired results. Also, the overall selectivity for this preamplifier was inadequate for the final converter.

Before proceeding with the next preamplifier design, some re-examination was in order. Previous experience with modular circuits led to the conclusion that in a high dynamic range receiver all circuits should have good input and output VSWR at a common impedance such as 50 ohms.<sup>5</sup> This would allow easy interchange between filters, amplifiers, mixers, and LOs, as well as facilitate any future improvements or changes, especially when new or improved devices became available.

With this in mind, the search for a low-noise high dynamic range pre-

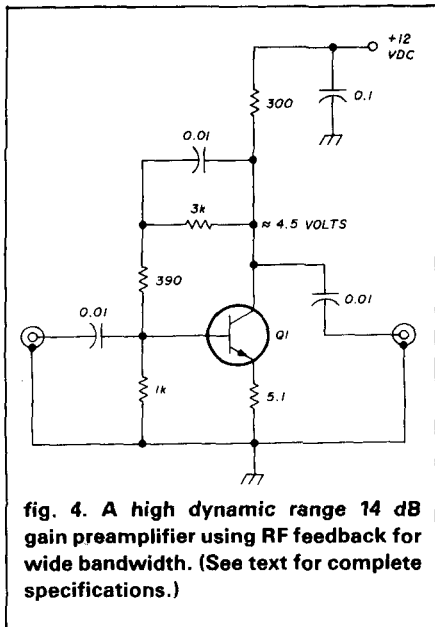

for  $-60$  dB IMD were  $-4$  dBm (0.4 milliwatts) for an output intercept point of  $+26$  dBm (400 milliwatts). Higher output power could be obtained with still higher  $I_c$ . Unfortunately, when high feedback and high  $I_c$  are used, the noise figure also increases. In this case the noise figure was already about 4 dB for an  $I_c$  of 25 mA. Adding more current or a 4:1 output transformer would have resulted in an undesirable increased noise figure and equally undesirable increased gain.

Not being totally content with this amplifier, I tried one of the less expensive (approximately \$8.25 each) broadband hybrid amplifiers, a Motorola MWA 130, which exhibits a  $+19$  dBm (95 milliwatts) compression point. For 60 dB IMD, the outputs were  $+4.77$

similar to the performance of the 2N5109 circuit just described, when its current was raised to the same level. Also, the gain — over 15 dB — was too high for this application.

I finally tested one of my favorite preamplifiers, a single transformer lossless feedback type using a common base circuit similar to the one designed by Norton.<sup>6</sup> Although it is more complex to construct, the results are well worth the effort. Using a medium gain (9 dB) configuration, the output power and IMD were outstanding, provided the emitter current was moderate (17 mA). Output compression was typically  $+20$  dBm (100 milliwatts). IMD was down 60 dB for  $+9$  dBm (8 milliwatts) output, for an output intercept point of  $+39$  dBm (8 watts)! The typical IMD versus input and output for this circuit is shown in fig. 3 and a typical two-tone spectrum display is shown in fig. 5. As a bonus, if the preamplifier is properly constructed, the bandwidth is greater than 1.8 to 200 MHz with a 2:1 maximum VSWR and 10-150 MHz for a 1.2:1 VSWR! Truly this was the circuit I was searching for (fig. 6).

A big key to the success of a high dynamic range preamplifier is the type of transistor chosen. Many RF devices will work well but not always have the same noise figure, bandwidth, or IMD. In the lossless feedback case, the noise figure was typically 1.5 to 2 dB maximum when using the NEC NE41632B transistor, but a 2N5109 had a noise figure of 2.5 to 3 dB in the same circuit. In addition, previous work showed that the most linear transistors were those which were specifically designed for CATV and class "A" linear operation with a very constant DC current gain ( $h_{fe}$ ) over a wide range of collector current. In the CATV business, which is particularly interested in IMD, these devices are frequently referred to as large area multiple emitter structures. The NE41632B and the 2N5109 are both included in this category. (For those who do not have easy access to the NE41632B transistor or the balun core shown in fig. 6B, I have made arrangements for PROTO-FAB,

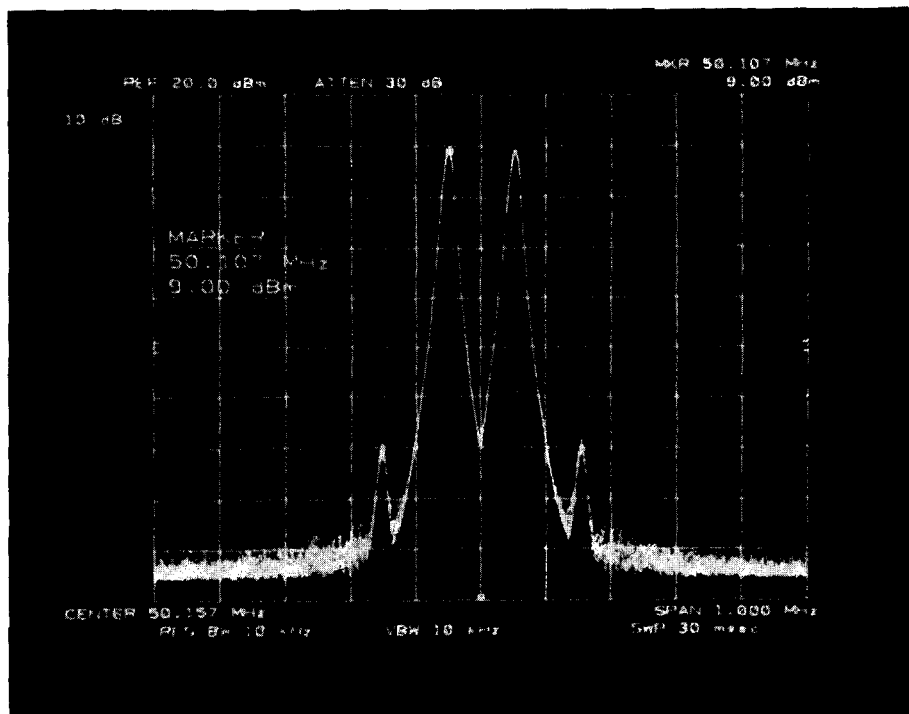

fig. 5. A spectrum analyzer photograph of the output of the high dynamic range amplifier (fig. 6.) with two equal level input signals at approximately 50.1 and 50.2 MHz at 0 dBm each.

amplifier with good input and output VSWR began. A preamplifier was designed around the 2N5109 transistor, a CATV favorite, using shunt and series feedback to obtain a matched input and output impedance (fig. 4). The VSWR was less than 1.5:1 from 1 to 70 MHz range while the IMD was

acceptable but only with high (25 mA)  $I_c$  (collector current). Typical outputs dBm (3 milliwatts) for an output intercept point of  $+34.8$  dBm (3 watts), a substantial improvement over the home-brew circuit. However, the current drain was 60 mA and the noise figure was about 6.5 dB at 50 MHz,

74 Wedgemere Drive, Lowell, Massachusetts 01852, to provide them at a nominal cost. Write them for price and delivery information.)

*Caution: This circuit has been modified and has a higher dynamic range than the original Norton circuit. However, his original circuit is patented (U.S. Patent No. 3,891,934, issued June 24, 1975, to David E. Norton and Allen F. Podell). Therefore, any attempt to duplicate this circuit for profit may violate the rights held by the Anzac Division of Adams Russell, Inc.*

## RF filtering

It goes without saying that high dynamic range cannot be obtained if spurious frequencies or high power out-of-band signals are present in the receiver. Hence RF filtering is very important. It was pointed out in a prior article that the type of input filtering chosen can lessen the chances of destruction from HF signals or lightning entering the first preamplifier of a receiver.<sup>5</sup>

In my August column I discussed the problems of multiple pole filtering such as VSWR distortion and increased losses. Hence it was decided to use a simple low-loss single pole bandpass filter with a pseudo-highpass response at the input to the receiver.<sup>7</sup> In this case a 5 MHz bandwidth was chosen because it would allow reception of 48 MHz European video carriers as well as 52 MHz VK/ZL DX with little degradation at either frequency, but still reject other services. This filter has a nominal insertion loss of 0.75 dB, less than a multi-section type. The schematic is shown in **fig. 7**, with its typical frequency response in **fig. 8**. The input filter chosen doesn't have sufficient out-of-band rejection by itself. Hence a post filter (**fig. 9**) with the same bandwidth (5 MHz) but higher insertion loss (2 dB typical) is required. Its frequency response is shown in **fig. 10**. The filter topography may be somewhat new; it was developed by this author and William K. Talley while at the Mitre Corporation in an effort to obtain a symmetrical attenuation versus frequency response.<sup>7</sup> This filter

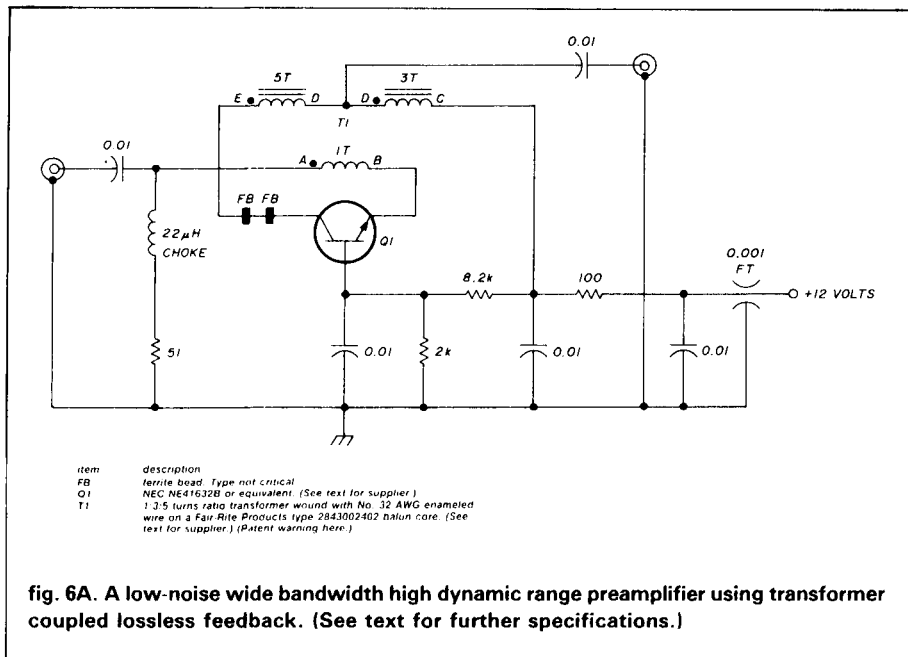

design is available in computer-aided design form in reference 2. Since this filter is placed after the preamplifier, the loss has a minimal impact on overall system noise figure. As a bonus, the extra insertion loss of the filter will improve the overall system dynamic range accordingly.

## mixers

In prior work I had experienced poor dynamic range with the more common Amateur type of mixers such as dual-gate MOSFETs and single-ended bipolar and JFET mixers. However, despite conversion loss, DBMs have always performed very well in my circuit designs.<sup>5,8,9</sup> Hence, when striving for high dynamic range, I decided from my prior experience that DBMs "are the only way to fly." They are easy to drive with a reasonable 50-ohm impedance match at all ports, a goal stated earlier. Also, because of their balanced structure, they tend to cancel any AM present on the local oscillator, a problem which is particularly prevalent if phase-locked LOs are used.

However, when striving for high dynamic range, DBMs must be treated properly. Attenuator pads on the RF and LO ports are a must to terminate undesired mixer generated products and the LO as well as to terminate any

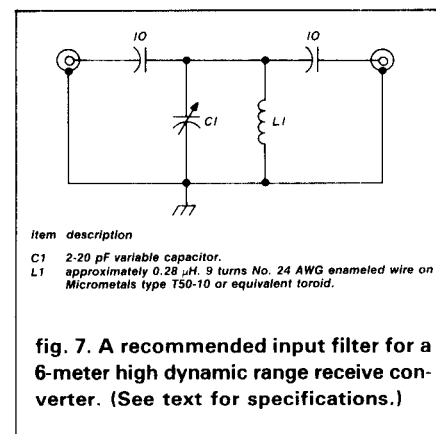
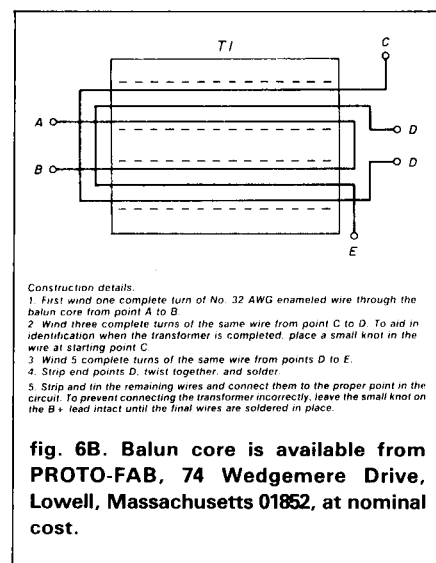

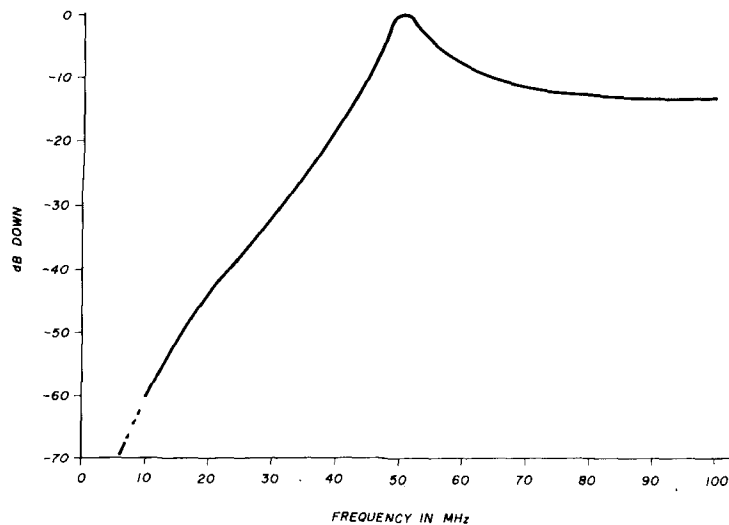

fig. 8. The attenuation-versus-frequency response of the bandpass filter shown in fig. 7.

in-line filters in their proper impedances.<sup>8</sup> Likewise, a diplexer should be added to the IF output port if low IMD is to be maintained.<sup>8,10</sup>

Many DBMs were tested, with the Mini-Circuits Labs TAK-1H selected as the best overall mixer on a cost-versus-performance basis. For comparison, some of the data taken on this and some other popular DBMs are summed up on **table 1**. The final circuit using the TAK-1H is shown in **fig. 11**. This mixer requires higher LO power (+17 dBm or 50 milliwatts) than the more common DBMs usually seen in Amateur equipment, but this is a definite need if high dynamic range is to be obtained. Due to the 3 dB pad on the LO port of the DBM, the LO power required by the overall circuit in **fig. 11** is +20 dBm (100 milliwatts). The RF and LO bandwidth are 2 to 500 MHz. Hence, this circuit has considerably more capability than meets the eye.

A few final remarks on DBMs are in order. Although the so-called high dynamic range mixers (those specified for use with +17 dBm or 50 milliwatts LO), are recommended, the typical DBMs specified with a +7 dBm (5 milliwatts) LO can be used, but with 5 to 10 dB lower LO and dynamic range. Sometimes DBMs are not readily available in single quantity. This can often be handled by getting a group of persons together to buy the minimum quantity. PROTO-FAB, as mentioned earlier, has also agreed to make the TAK-1H DBM available at a reasonable price. Finally, many DBMs are now showing up at flea markets at some pretty good prices, so shop around. You may not find the exact DBM desired but you may be willing to accept slightly lower performance as a compromise. If you adopt the modular approach suggested, it will be easy to upgrade performance at a later date.

### local oscillators

My favorite crystal oscillator is the overtone Colpitts.<sup>5,8</sup> The frequency of the LO is determined by the IF chosen, as discussed above. It has great stability and low phase noise, a requirement

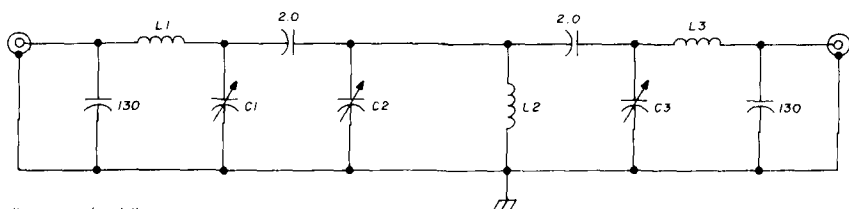

| item   | description  |
|--------|--|
| C1,2,3 | 2-20 pF trimmer capacitor.   |
| L1,2,3 | approximately 0.42 $\mu$ H inductor. 11 turns of No. 24 AWG enameled wire on Micrometals type T50-10 or equivalent toroid. |

fig. 9. A recommended three-section bandpass filter for a 6-meter receive converter. (See text for specifications.)

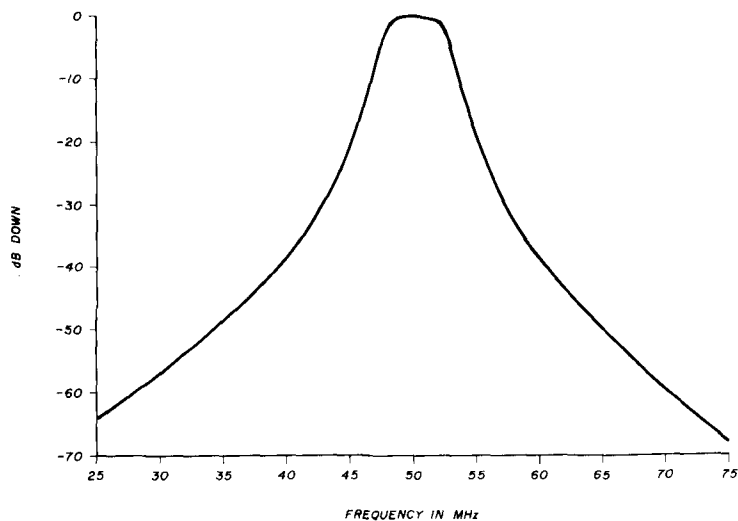

fig. 10. The attenuation-versus frequency response of the 6-meter bandpass filter shown in fig. 9.



table 1. Typical measured data on commonly used DBMs. Input signals are at 50, LO at 22, and IF at 28 MHz.

| type    | LO (dBm) | input compression (dBm) | output intercept (dBm) | approximate cost | quantity |
|---------|----------|-------------------------|------------------------|------------------|----------|
| SBL-1   | +7       | +2                      | +14                    | 4.50             | (10-49)  |
| MD-108  | +7       | +4                      | +16                    | 14.00            | (1-5)    |
| SRA-1   | +7       | +4                      | +16                    | 11.95            | (1-49)   |
| SRA-1H  | +17      | +12                     | +22.5                  | 17.95            | (5-24)   |
| MHP-106 | +17      | +13                     | +22.5                  | 45.00            | (1-5)    |
| TAK-1H  | +17      | +16                     | +28                    | 19.95            | (5-24)   |
| MD-139  | +20      | +17.5                   | +29                    | 115.00           | (1-5)    |
| RAY-3   | +23      | +16.5                   | +24                    | 34.95            | (4-9)    |
| SAY-1   | +23      | +20                     | +32.5                  | 54.95            | (1-9)    |
| VAY-1   | +27      | +24                     | +36.5                  | 74.95            | (1-9)    |

of any high-performance receiver. Phase noise, caused by poor design in the phase lock loops employed, is typically poor in many of the transceivers presently available. Phase noise generates noise on the LO, which, in turn, causes strong signals to be heard several kHz away.

As shown in reference 8, the output of this LO is only about +10 dBm (10 milliwatts). Therefore, an amplifier is required if a high level DBM is used. It was decided not to fight the class "C" type of amplifier, but to go class "A" because there would be improved linearity and less possibility of generating LO noise. Since design of the 2N5109 feedback amplifier had already been completed (fig. 4), the bias values were modified slightly for use as the LO amplifier. A simple 1/2 λ low-pass filter followed this amplifier to keep any harmonics from reaching the mixer circuitry.<sup>7</sup>

When the preliminary design was completed for WABONQ, it was decided to take the LO output through a two-way power splitter for use on both the receive and transmit mixer. This was more power than required by the transmit mixer, and also dropped the output power substantially on the receive side. So a unique connection was made at the output of the oscillator in conjunction with the attenuator usually used at this point.<sup>8</sup> The result is a secondary output sufficient to drive a standard level DBM (+7 dBm) in a transverter similar to those designs in reference 9. If this output is not needed, terminate it with 51 ohms for

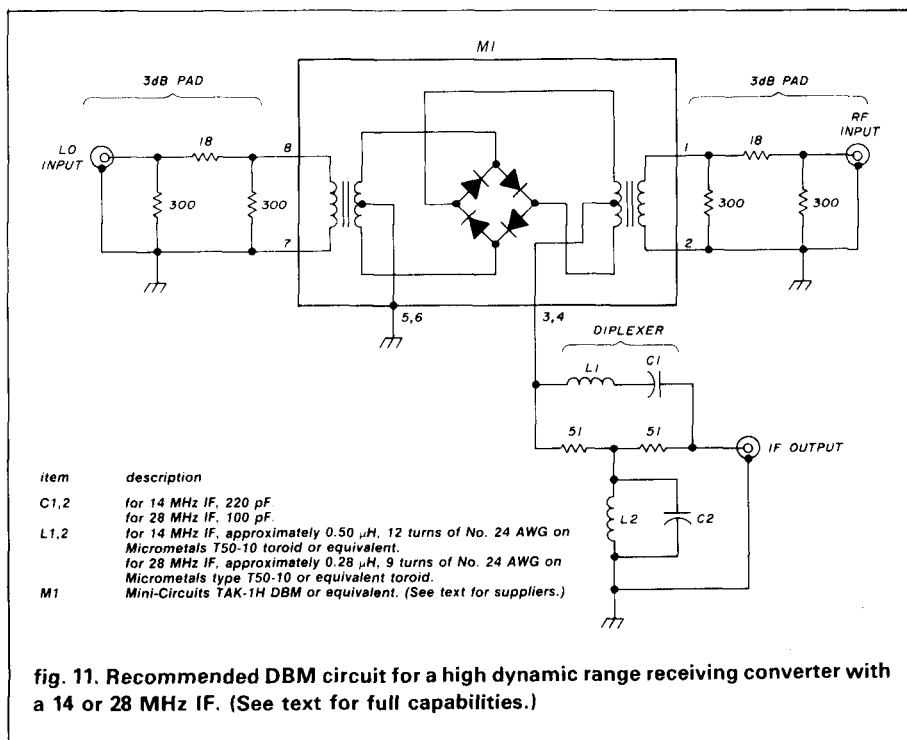

fig. 11. Recommended DBM circuit for a high dynamic range receiving converter with a 14 or 28 MHz IF. (See text for full capabilities.)

possible future use and to insure that the oscillator is seeing the proper match. The final LO schematic is shown in fig. 12 and delivers +20 dBm (100 milliwatts) at the output connector, the power required by the mixer circuit in fig. 11.

### postamplification

As already stated, the DBM type of mixer has conversion loss and, therefore, must be followed by a low-noise postamplifier if the system noise figure is to be preserved. The signal levels at this point are about equal to those present at the input to the preamplifier.

Therefore, the preamplifier already used is an excellent candidate for this amplifier since it has a good impedance match, low noise figure and high dynamic range. This is also a recommended circuit for HF, 10-meter OSCAR reception, interface with existing VHF/UHF converters, or other applications where moderate gain, low noise figure and high dynamic range are required over a broad bandwidth. In my shack, I have a DPDT coax switch which allows me to bypass the postamplifier when strong signals are present, thereby increasing dynamic range.

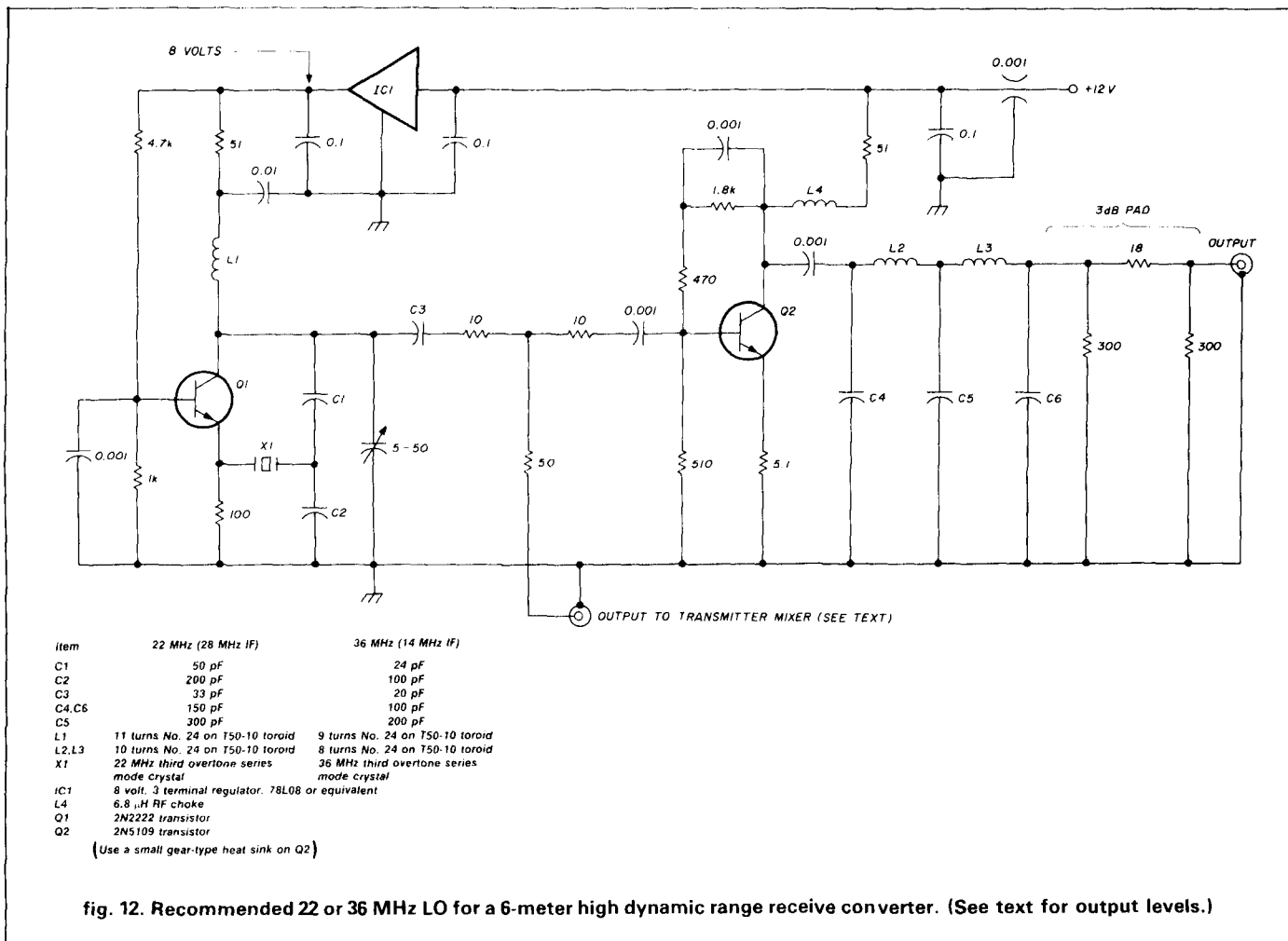

fig. 12. Recommended 22 or 36 MHz LO for a 6-meter high dynamic range receive converter. (See text for output levels.)

## IF requirements

At this point it must be obvious that the converter presented has to be followed by a high dynamic range IF receiver if the true capabilities are to be realized. Bypassing the postamplifier or inserting an adjustable attenuator after the receive converter can also help improve dynamic range, but the ultimate limits will probably be limited by the IF receiver. Fortunately, the commercial manufacturers are improving the HF gear that is now being marketed. Furthermore, a converter of the type just described, in conjunction with one of the more modern HF receivers, will definitely outperform any presently available equipment that is solely devoted to the VHF or UHF spectrum.

## construction

The 6-meter converter was designed

using a modular approach.<sup>5</sup> The final block diagram is shown in fig. 13. Each circuit was placed in a cast aluminum box such as the Pomona 2417, Bud CU 123/124 or equivalent with BNC type input/output connectors

and feedthrough-type capacitors on the power supply lines. Each box has a piece of double-clad PC board attached to the cover for point-to-point wiring and grounded, as previously discussed in reference 8. The final

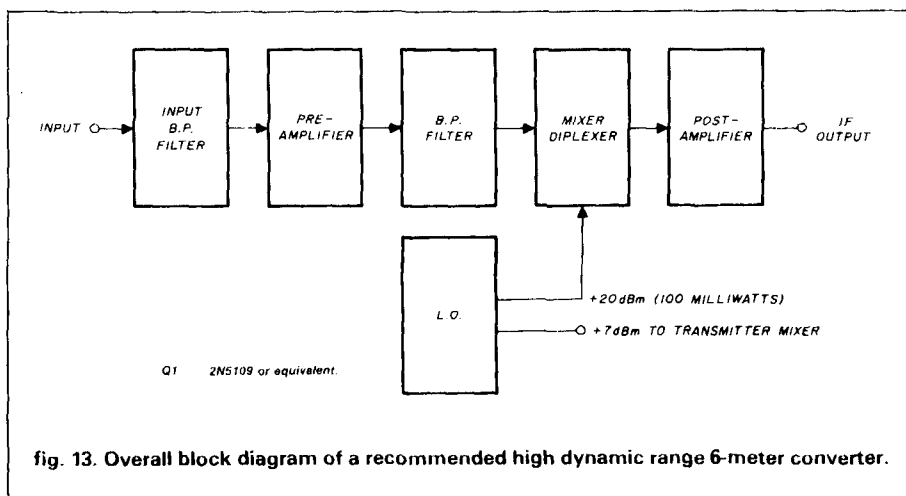

fig. 13. Overall block diagram of a recommended high dynamic range 6-meter converter.

result is a versatile unit with no apparent RF pickup or interaction between modules.

Construction of the circuits is quite straightforward. Leads should be kept short, especially on the filters. High-quality trimmers with low lead inductance such as the ceramic, mylar, or teflon types should be used. The transformer construction hints (fig. 6B) for the preamplifier should be followed carefully and the leads on the capacitors, especially on the base bypass, should be kept as short as possible. If a different DBM is used, check the pin designations as some manufacturers use different pin-outs.

### tune-up and performance

Very little tuning is required. The input filter can be easily aligned by tuning for maximum signal at 50.1 MHz. The second filter may require more effort. It is best tuned with a sweep setup. However, on the tests I conducted, it was very close to nominal if all capacitors are tuned for maximum signal at 50 MHz in a matched test setup and then inserted in the chain. All the LO requires is to be tuned for maximum output. Properly aligned, the converter described has typically a 5 MHz bandwidth, a gain of about 4 to 6 dB and a noise figure less than 6 dB.

### future designs

The state of the art is constantly improving. If a modular approach is used on this receive converter, new or improved circuits can be easily added or changed as prices decrease or parts become available. If you don't change the IF frequency, you'll probably never have to build another LO. If a lower LO power is required, just add an appropriate attenuator on the output. Higher dynamic range mixers are slowly decreasing in price while increasing in performance. **Table 1** can be used as a guide to selection of DBMs.

Finally, our IF receivers must be improved, especially on dynamic range and phase noise. Ultimately, I think that the best receiver will be one that uses a high dynamic range converter directly feeding a narrow bandwidth crystal filter. However, this will require

a variable LO and some additional design to prevent phase noise and birdies.

Again, I have rambled on and written a more lengthy column than I intended. However, I feel that the material presented is broad enough in scope and should be worthwhile regardless of frequency. As stated earlier, even using more conventional circuits such as standard level DBMs and JFETs, a substantial improvement can be made over most existing receive converters. After all, the principles discussed are usable at any frequency if time and money are no object!

I hope this material will encourage you and others to try to improve receiver dynamic range and thereby make life more enjoyable. The cost to build such a high dynamic range receive converter is really not that much more than that of a conventional converter. If the dynamic range of the receive circuits is improved, transmitters can be evaluated more effectively. Who knows, you too may find a way to improve these circuits! (Is there any interest in designs for higher bands?)

### acknowledgements

I would like to thank Dr. David Norton for his advice and reference material on the lossless feedback amplifier and Jim Reiser, AD1C, for his constructive comments and suggestions on this column. I'd also like to thank Jim Stitt, WA80NQ, for his encouragement and comments on the performance of the converter circuits as they evolved.

### references

1. Joe Reiser, W1JR, "VHF/UHF World: Determining VHF/UHF Antenna Performance," *ham radio*, May, 1984, page 110.
2. "RF Computer-Aided Design Package," Heath User's Group, 885-8020(-37)CP/M.
3. Jim Fisk, WA6BSO, "Choosing IF and Mixer Frequencies," 73, April, 1966, page 62.
4. Franz C. McVay, "Don't Guess the Spurious Level of an Amplifier," *Electronic Design*, February 1, 1967, page 70.
5. Joe Reiser, W1JAA, "What's Wrong with Amateur VHF/UHF Receivers — And What You Can Do to Improve Them," *ham radio*, March, 1976, page 8.
6. David E. Norton, "High Dynamic Range Transistor Amplifier Using Lossless Feedback," *Microwave Journal*, May, 1976, page 53.

7. Joe Reiser, W1JR, "VHF/UHF World: The VHF/UHF Primer — An Introduction to Filters," *ham radio*, August, 1984, page 112.
8. Joe Reiser, W1JR, "VHF/UHF World: VHF/UHF Receivers," *ham radio*, March, 1984, page 42.
9. Joe Reiser, W1JR, "VHF/UHF World: VHF/UHF Exciters," *ham radio*, April, 1984, page 84.
10. P. Will, "Reactive Loads — The Big Menace," *Microwaves*, Volume 10, No. 4, April, 1971, page 38.

#### important VHF/UHF events in November, 1984

- |              |   |
|--------------|---|
| November 2:  | 0330 UTC, predicted peak of Taurids meteor shower |
| November 16: | 2100 UTC, predicted peak of Leonids meteor shower |
| November 21: | EME perigee                                       |

ham radio



**The HAM SHACK**

808 N. Main Street • Evansville, IN 47711



**NEW IC-02A/T**



**ICOM's new IC-02A/T** represents the latest in state-of-the-art handheld radios. The **IC-02A/T** uses a microprocessor to control this radio. The **IC-02A/T** will scan, has 10 memories, stores offset frequency in memory, has keyboard selectable PL tones and an internal lithium battery memory back up.

Uses IC-2 series accessories. Standard 3 watts or 5 watts with optional high power battery pack.

Call Ham Shack today for more information and your price on this and the rest of the ICOM radio line.

 (812) 422-0231 

**SAY YOU SAW IT  
IN  
HAM RADIO**

# NAMPA SATELLITE SYSTEMS

312 12th Ave. So.  
Nampa, Idaho 83651  
(208) 466-6727  
1-800-654-0795

IN HOUSTON, TEXAS  
(713) 957-5140  
1-800-521-8300

## NSS PB3 MOTOR DRIVE

CONTROL  
CONSOLE ONLY  
**\$150.00**

CONTROL CONSOLE  
ONLY (in kit form)  
**\$99.00**

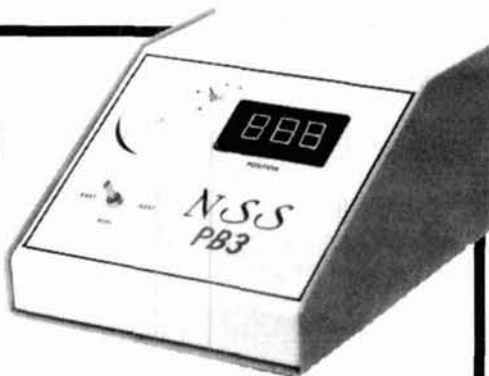

- PLUG-IN CONTROL BOARD
- 3 DIGIT LED READOUT
- MANUAL EAST-WEST CONTROL
- RESET TO -000
- 36 VOLT DC MOTOR
- 125' CONTROL CABLE
- ZINC PLATED FINISH

COMPLETE UNIT  
**\$250.00**

Control your dish from your  
living room . . . rain or shine.

✓ 191

# BRAND NEW



## RTTY TODAY

### MODERN GUIDE TO AMATEUR RADIOTELETYPE

by Dave Ingram, K4TWJ

This brand new book is the only RTTY handbook available that covers all facets of RTTY operation from the "green key" generation to personal computers. Author Dave Ingram, K4TWJ, noted RTTY enthusiast, writes in a personable, easy-to-understand style that will appeal to all levels of RTTY interest. **RTTY TODAY** is fully illustrated with photos, diagrams, RTTY station set ups and equipment to help ensure full understanding of the material. 11 chapters cover: an overview of RTTY operation, operating parameters, home computers, equipment you can build, dedicated systems and complete chapters on RTTY SWLing with frequencies, codes and other helpful hints and tips. Old time RTTY users and novices alike will find this book extremely useful. ©1984. 95 illustrations. 1st edition. 8 1/2" x 11."

Order yours today **\$895**  
plus \$1.75 shipping

### UNIVERSAL ELECTRONICS

4555 Groves Rd. • Suite 3 • Columbus, OH 43232  
(614) 866-4605

Dealer Inquiries Invited ✓ 224

## 10 METER F.M.

29.310-29.700 MHz in 10 kHz Steps. 100 kHz Repeater Split provided.  
4W RF Out. 0.3 µV for 12 dB S/N. c/w Mic, mobile cradle etc.



VISA CARD  
MASTER CARD  
I.M.O. DRAFT

**\$79**

AIR POST  
PREPAID  
WORLDWIDE

S.M.C. Ltd., Totton, Southampton, SO4 4DP, U.K. ✓ 215

## P.C. BOARDS AND ART SERVICES

FACE  
PLATES



ENCLOSURES  
WRITE OR CALL  
For Literature or Quotes

Let us quote you  
on any stage of  
your product from  
proto types to  
production.

FABTRON DIV.  
P.O. Box 925  
Columbia, TN 38401  
(615) 381-1143

✓ 154

## JRS Distributors

646 W. Market Street  
York, PA 17404  
(717) 854-8624

Friendly  
Personalized Service

Full Line of  
Amateur Radio Equipment.  
Factory Authorized  
Kenwood and ICOM dealer.  
Call us today

Jim, K3JFL Jean K3OAU

Dale, KA3KOL ✓ 173

## VIC 20 & C64 USERS A Powerful MSO!

Now you can own your own MSO! Your computer and any interface plus our menu driven, machine language Radio Bulletin Board Service software will give you and your MSO users a powerful mailbox with the following features:

- Read, write & delete messages
- List a directory of all messages
- Scan directory of messages
- User selectable baud rates
- Automatic date and time keeping
- Automatic time out feature
- Automatic ID of your call
- Automatic indication of memory used
- 3 modes - MSO, SYSOP & Direct RTTY
- Works with or without disk drive
- Specifically for VIC 20 (8 k min) or C64

Software package includes — manual, program diskette or cassette and interface cable

**\$49.95 plus \$1.90 postage**  
(Kantronics interfaces add \$5.00)  
Ph. (818) 957-7550

Vid-Com ✓ 228

Communication

3131 Foothill Blvd., #H • La Crescenta, CA 91214

## SANTEC handhelds

ST-142 **259<sup>00</sup>**  
For 2 Meters

Free \$9.95 Mob. Quick Charge Cable

ST-222 H/T (220 MHz) . . . \$279

ST-442 H/T (440 MHz) . . . \$285

LS-202 (2-M FM/SSB-H/T) \$229

**KDK** **KDK**

FM-2033 **265<sup>00</sup>**  
25 Watt 2-Meter FM

FM-4033 (220-mHz) . . . \$329

FM-6033 (6-Meters) . . . \$279

FM-7033 (440-mHz) . . . \$329

FREE UPS Brown Shipping-Add \$1.65 for COD  
N.C. Res. Add 4 1/2 % Sales Tax. Sorry No Cards.

The Nation's Largest Mail Order SanteC Dealer

**WILLIAMS RADIO SALES**

600 LAKE DALE ROAD, DEPT. H

COLFAX, N.C. 27235 ✓ 234

(919) 993-5881 Noon to 10 P.M. EST



TWO LOCATIONS TO SERVE YOU

In Idaho  
312 12th Ave. So.  
Nampa, Idaho 83651  
(208) 466-6727

In Texas  
6012 W. 34th St.  
Houston, Texas 77092  
(713) 957-5140

# Nampa

## Complete Satellite Television Systems



MD9 - 9' Dish

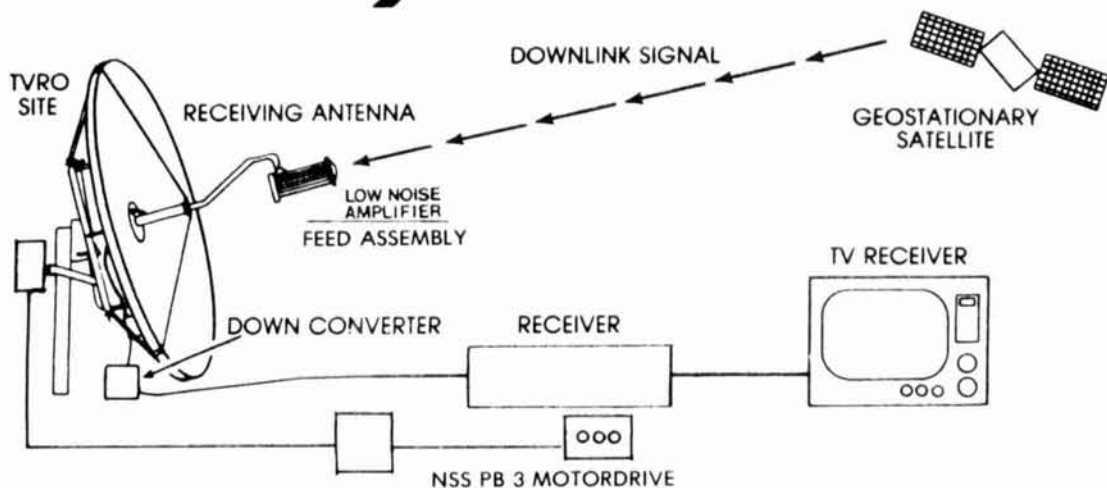

YM1000

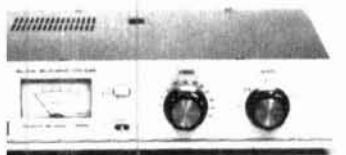

YM400,



NSS PB3 Motor Drive,

### WILSON YM1000 SYSTEM

Consists of:  
Wilson YM1000, 100° LNA, NSS Deluxe Feed, Wilson MD9 Dish, Feed Assembly, All Cables, Complete Hardware, NSS PB3 Motor Drive, and Instructions **Total \$1628**

#### OPTIONS WITH SYSTEM

9 ft. Wilson Mesh ADD ..... \$100  
NSS Memory Tracker ADD ..... \$100  
10 ft. Prodelin ADD \$400      11 ft. Radarmesh dish ADD \$250

### WILSON YM400 SYSTEM

Consists of:  
Wilson YM400, 100° LNA, NSS Deluxe Feed, Wilson MD9 Dish, Feed Assembly, All Cables, Complete Hardware, NSS PB3 Motor Drive, and Instructions **Total \$1393**

#### OPTIONS WITH SYSTEM

9 ft. Wilson Mesh ADD ..... \$100  
NSS Memory Tracker ADD ..... \$100  
10 ft. Prodelin ADD \$400      11 ft. Radarmesh dish ADD \$250

192

Call Toll Free

Nampa, Idaho  
1-800-654-0795

Houston, Texas  
1-800-521-8300

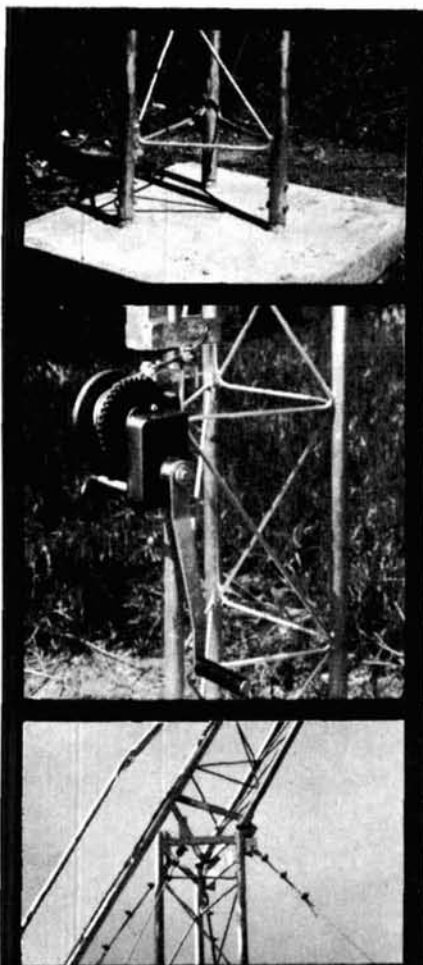

## ROHN<sup>®</sup> "FOLD-OVER" TOWERS

**EASE OF INSTALLATION**  
ROHN "Fold-Over" Towers are quickly and easily installed. The "Fold-Over" is safe and easy to service.

**ADAPTABILITY**  
ROHN has several sizes to fit your applications or you can purchase the "Fold-Over" components to convert your ROHN tower into a "Fold-Over".

**HOT DIP GALVANIZED**  
All ROHN towers are hot dip galvanized after fabrication.

**REPUTATION**  
ROHN is one of the leading tower manufacturers, with over 25 years of experience.

Write today for complete details.

QUALITY STEEL PRODUCTS BY

# ROHN

Box 2000 Peoria, Illinois 61656  
U.S.A.



## the half-wave transmission line in bridge measurements

With the increasing availability of inexpensive, accurate RF impedance bridges, Amateurs are discovering how useful such a bridge can be in building and understanding antenna systems. However, unless bridge measurements are taken directly at the antenna, which is generally impractical, the effect of line length has to be taken into consideration when making calculations to determine the actual antenna impedance. This can be accomplished rigorously (by exact mathematical solution)<sup>1</sup> or in this case, simplified as in eq. 1. The transmission line is considered lossless, which for short lines is a valid assumption.

$$Z_{ANT} = \frac{Z_{in} - jZ_o \tan \phi}{Z_o - jZ_{in} \tan \phi} \cdot Z_o \quad (1)$$

where  $Z_{ANT}$  = antenna impedance

$Z_{in}$  = transmission line impedance measured at bridge terminals

$Z_o$  = characteristic transmission line impedance

$\phi$  = electrical length of transmission line in degrees

Now as everyone knows, regardless of the antenna or transmission line impedance, measurements made in multiple half-wavelengths repeat — i.e. the same value is seen regardless of whether measurements are taken di-

rectly at the antenna terminals or at an electrical half-wavelength along a transmission line. This is where I got into trouble. I measured the antenna impedance through a transmission line that was exactly one-half wavelength (180 degrees) at 3.75 MHz. Then I performed the same measurement (of the antenna) at 4.0 MHz *without* changing the transmission line length. How much difference could that make?

First off, my 180 degree half wavelength line at 3.75 MHz is actually  $(4.0)(180)/3.75 = 192$  degrees electrical length at 4.0 MHz. And my measured impedance at the end of the line at 4 MHz was  $175 + j 100$  ohms impedance.

Substituting the values in eq. 1, I found:

$$Z_{ANT} = \frac{175 + j100 - (j)(50)(0.213)}{50 - (j)(175 + j100)(0.213)} \cdot (50)$$

$$Z_{ANT} = 70.8 + j 99.7 \text{ ohms impedance}$$

Well, my bridge had measured  $175 + j 100$  ohms, and my true calculated antenna impedance actually was  $70.8 + j 99.7$  ohms! That's really a large difference, and yet the electrical length of the line was only 12 degrees longer, or 6.7 percent longer.

So don't be fooled as I was into thinking that if you use an electrical half wavelength line at mid-band, your band end measurements will be close unless you actually correct for the few degrees as I first neglected to do.

Naturally, all antenna measurement calculations could have been done using a Smith chart, but to me the equation shows the impedance relationships involved more clearly.

Although the example was given for the 80-meter band, the same equation can be used for other bands, either for a band center half wavelength line, or as a general equation for use with any length of coax line, as long as you know the electrical length. And after I applied the technique just described, my previously measured data was much more meaningful.

### reference

1. F.E. Terman, *Radio Engineers Handbook*, McGraw-Hill, 1943, page 186.

William Vissers, K4KI

# ham radio Reader Service

For literature or more information, locate the Reader Service number at the bottom of the ad, circle the appropriate number on this card, affix postage and send to us. We'll hustle your name and address to the companies you're interested in.

101 113 125 137 149 161 173 185 197 209 221 233 245 257 269 281 293 305 317 329 341  
102 114 126 138 150 162 174 186 198 210 222 234 246 258 270 282 294 306 318 330 342  
103 115 127 139 151 163 175 187 199 211 223 235 247 259 271 283 295 307 319 331 343  
104 116 128 140 152 164 176 188 200 212 224 236 248 260 272 284 296 308 320 332 344  
105 117 129 141 153 165 177 189 201 213 225 237 249 261 273 285 297 309 321 333 345  
106 118 130 142 154 166 178 190 202 214 226 238 250 262 274 286 298 310 322 334 346  
107 119 131 143 155 167 179 191 203 215 227 239 251 263 275 287 299 311 323 335 347  
108 120 132 144 156 168 180 192 204 216 228 240 252 264 276 288 300 312 324 336 348  
109 121 133 145 157 169 181 193 205 217 229 241 253 265 277 289 301 313 325 337 349  
110 122 134 146 158 170 182 194 206 218 230 242 254 266 278 290 302 314 326 338 350  
111 123 135 147 159 171 183 195 207 219 231 243 255 267 279 291 303 315 327 339  
112 124 136 148 160 172 184 196 208 220 232 244 256 268 280 292 304 316 328 340

*Limit 15 inquiries per request.*

NAME \_\_\_\_\_ CALL \_\_\_\_\_

ADDRESS \_\_\_\_\_

CITY \_\_\_\_\_ STATE \_\_\_\_\_ ZIP \_\_\_\_\_

Please use before December 31, 1984

**November 1984**

\_\_\_\_\_  
\_\_\_\_\_  
\_\_\_\_\_

AFFIX POSTAGE  
OR  
POST OFFICE  
WILL NOT  
DELIVER

**ham  
radio**

*magazine*

READER SERVICE CENTER  
P.O. BOX 358  
ARLINGTON, MA 02174

ATTN: Reader Service Dept.





**HF Equipment** Regular SALE  
**IC-740\*** 9-band 200w PEP xcvr w/mic \$1099.00 899<sup>95</sup>  
**\*FREE PS-740 Internal Power Supply & \$50 Factory Rebate - until gone!**

- PS-740 Internal power supply..... 159.00 149<sup>95</sup>
- \*EX-241 Marker unit..... 20.00
- \*EX-242 FM unit..... 39.00
- \*EX-243 Electronic keyer unit..... 50.00
- \*FL-45 500 Hz CW filter (1st IF).... 59.50
- \*FL-54 270 Hz CW filter (1st IF).... 47.50
- \*FL-52A 500 Hz CW filter (2nd IF) 96.50 89<sup>95</sup>
- \*FL-53A 250 Hz CW filter (2nd IF) 96.50 89<sup>95</sup>
- \*FL-44A SSB filter (2nd IF)..... 159.00 144<sup>95</sup>
- SM-5 8-pin electret desk microphone 39.00
- HM-10 Scanning mobile microphone 39.50
- MB-12 Mobile mount..... 19.50

- \*Options also for IC-745 listed below**
- IC-730 8-band 200w PEP xcvr w/mic \$829.00 569<sup>95</sup>
  - FL-30 SSB filter (passband tuning) 59.50
  - FL-44A SSB filter (2nd IF)..... 159.00 144<sup>95</sup>
  - FL-45 500 Hz CW filter..... 59.50
  - EX-195 Marker unit..... 39.00
  - EX-202 LDA interface; 730/2KL/AH-1 27.50
  - EX-203 150 Hz CW audio filter..... 39.00
  - EX-205 Transverter switching unit 29.00
  - SM-5 8-pin electret desk microphone 39.00
  - HM-10 Scanning mobile microphone 39.50
  - MB-5 Mobile mount..... 19.50
  - IC-720A 9-band xcvr/.1-30 MHz rcvr \$1349.00 899<sup>95</sup>
  - FL-32 500 Hz CW filter..... 59.50
  - FL-34 5.2 kHz AM filter..... 49.50
  - SM-5 8-pin electret desk microphone 39.00
  - MB-5 Mobile mount..... 19.50
  - IC-745 9-band xcvr w/.1-30 MHz rcvr \$999.00 769<sup>95</sup>
  - PS-35 Internal power supply..... 160.00 144<sup>95</sup>
  - CFJ-455K5 2.8 kHz wide SSB filter 4.00
  - HM-12 Hand microphone..... 39.50
  - SM-6 Desk microphone..... 39.00

\*See IC-740 list above for other options (\*)



- IC-751 9-band xcvr/.1-30 MHz rcvr \$1399.00 1199<sup>95</sup>
  - PS-35 Internal power supply..... 160.00 144<sup>95</sup>
  - FL-32 500 Hz CW filter (1st IF).... 59.50
  - FL-63 250 Hz CW filter (1st IF).... 48.50
  - FL-52A 500 Hz CW filter (2nd IF).... 96.50 89<sup>95</sup>
  - FL-53A 250 Hz CW filter (2nd IF).... 96.50 89<sup>95</sup>
  - FL-33 AM filter..... 31.50
  - FL-70 2.8 Khz wide SSB filter..... 46.50
  - HM-12 Hand microphone..... 39.50
  - SM-6 Desk microphone..... 39.00
  - CR-64 High stability reference xtal 56.00
  - RC-10 External frequency controller 35.00
  - MB-18 Mobile mount..... 19.50
- Options: 720/730/740/745/751 Regular SALE**  
 PS-15 20A external power supply..... \$149.00 134<sup>95</sup>  
 EX-144 Adaptor for CF-1/PS-15..... 6.50



- Options - continued** Regular SALE
- CF-1 Cooling fan for PS-15..... 45.00
  - PS-20 20A switching ps w/speaker... 229.00 199<sup>95</sup>
  - CC-1 Adapt. cable; HF radio/PS-20 10.00
  - CF-1 Cooling fan for PS-20..... 45.00
  - EX-310 Voice synth for 751, R-71A 39.95
  - SP-3 External base station speaker... 49.50
  - Speaker/Phone patch - specify radio 139.00 129<sup>95</sup>
  - BC-10A Memory back-up..... 8.50
  - EX-2 Relay box with marker..... 34.00
  - AT-100 100w 8-band automatic ant tuner 349.00 314<sup>95</sup>
  - AT-500 500w 9-band automatic ant tuner 449.00 399<sup>95</sup>
  - MT-100 Manual antenna tuner..... 249.00 224<sup>95</sup>
  - AH-1 5-band mobile antenna w/tuner 289.00 259<sup>95</sup>
  - PS-30 Systems p/s w/cord, 6-pin plug 259.95 233<sup>95</sup>
  - GC-4 World clock..... 99.95 94<sup>95</sup>
- HF linear amplifier Regular SALE**  
 IC-2KL w/ps 160-15m solid state amp 1795.00 1299
- VHF/UHF base multi-modes Regular SALE**  
 IC-251A\* 2m FM/SSB/CW transceiver \$749.00 549<sup>95</sup>
- \*\$50 Factory Rebate - until gone!**

- IC-551D 80 Watt 6m transceiver..... \$699.00 599<sup>95</sup>
  - PS-20 20A switching ps w/speaker 229.00 199<sup>95</sup>
  - EX-106 FM option..... 125.00 112<sup>95</sup>
  - BC-10A Memory back-up..... 8.50
  - SM-2 Electret desk microphone.... 39.00
  - IC-271H 100w 2m FM/SSB/CW xcvr 899.00 799<sup>95</sup>
  - IC-471H 75w 430-450 SSB/CW/FM xcvr 1099.00 Call
  - PS-35 Internal power supply..... 160.00 144<sup>95</sup>
  - PS-15 20A power supply..... 149.00 134<sup>95</sup>
  - IC-271A 25w 2m FM/SSB/CW xcvr... 699.00 619<sup>95</sup>
  - AG-20/EX-338 2m preamplifier.... 56.95
  - IC-471A 25w 430-450 SSB/CW/FM xcvr 799.00 699<sup>95</sup>
  - PS-25 Internal power supply..... 99.00 89<sup>95</sup>
  - EX-310 Voice synthesizer..... 39.95
  - HM-12 Hand microphone..... 39.50
  - SM-6 Desk microphone..... 39.00
- VHF/UHF mobile multi-modes**  
 IC-290H 25w 2m SSB/FM xcvr, TTP mic 549.00 489<sup>95</sup>  
 IC-490A 10w 430-440 SSB/FM/CW xcvr 649.00 579<sup>95</sup>
- VHF/UHF/1.2 GHz FM Regular SALE**  
 IC-22U 10w 2m FM non-digital xcvr 299.00 249<sup>95</sup>  
 EX-199 Remote frequency selector 35.00



- Closeout item Regular NOW**
- IC-25H 45w, 2m FM w/up-dn TTP mic 389.00 299<sup>95</sup>
  - BU-1H Memory back-up..... 38.50 +10<sup>00</sup>
  - † BU-1H \$10 purchased with IC-25H, otherwise \$38.50
- IC-27A Compact 25w 2m FM w/TTP mic 369.00 329<sup>95</sup>
  - IC-27H Compact 45w 2m FM w/TTP mic 409.00 369<sup>95</sup>
  - IC-37A Compact 25w 220 FM, TTP mic 449.00 399<sup>95</sup>
  - IC-47A Compact 25w 440 FM, TTP mic 469.00 419<sup>95</sup>
  - UT-16/EX-388 Voice synthesizer... 29.95
  - IC-120 1w 1.2 GHz FM transceiver... 499.00 449<sup>95</sup>
- 6m portable Regular SALE**  
 IC-505 3/10w 6m port. SSB/CW xcvr \$449.00 399<sup>95</sup>
- BP-10 Internal Nicad battery pack 79.50
  - BP-15 AC charger..... 12.50
  - EX-248 FM unit..... 49.50
  - LC-10 Leather case..... 34.95



- Hand-held Transceivers**
- Deluxe models Regular SALE**  
 IC-02A for 2 meters \$ 319.00 289<sup>95</sup>  
 IC-02AT w/DTMF..... 349.00 299<sup>95</sup>  
 IC-04A for 440 MHz TBA  
 IC-04AT w/DTMF..... 379.00 339<sup>95</sup>
- Standard models Regular SALE**  
 IC-2A for 2 meters \$ 239.50 214<sup>95</sup>  
 IC-2AT with TTP..... 269.50 219<sup>95</sup>  
 IC-3A for 220 MHz... 269.95 234<sup>95</sup>  
 IC-3AT with TTP..... 299.95 239<sup>95</sup>  
 IC-4A for 440 MHz... 269.95 234<sup>95</sup>  
 IC-4AT with TTP..... 299.95 239<sup>95</sup>

- Accessories for Deluxe models Regular**
- BP-7 800mah/13.2V Nicad Pak - use BC-35 67.50
  - BP-8 800mah/8.4V Nicad Pak - use BC-35... 62.50
  - BC-35 Drop in desk charger - all batteries..... 69.00
  - BC-16A Wall charger - BP7/BP8..... 10.00
- Accessories for both models Regular**
- BP-2 425mah/7.2V Nicad Pak - use BC35... 39.50
  - BP-3 Extra Std. 250 mah/8.4V Nicad Pak.... 29.50
  - BP-4 Alkaline battery case..... 12.50
  - BP-5 425mah/10.8V Nicad Pak - use BC35 49.50
  - CP-1 Cig. lighter plug/cord - BP3 or Dlx..... 9.50
  - DC-1 DC operation pak for standard models 17.50
  - LC-2AT Leather case for standard models.... 34.95
  - LC-14 Soft case for Deluxe models..... 17.95
  - HM-9 Speaker microphone..... 34.50
  - HS10 Boom microphone/headset..... 19.50
  - HS-10SA Vox unit for HS-10 (dlx only).... 19.50
  - HS-10SB PTT unit for HS-10..... 19.50
  - ML-1 2m 2.3w in/10w out amplifier..... SALE 79.95
  - ML-25 2m 2.3w in 20w out amplifier.... SALE 179.95
  - 3A-TTN Optional TT Pad - 2A/3A/4A..... 39.50
  - SS-32M Commspec 32-tone encoder..... 29.95



- Shortwave receivers Regular SALE**
- R-71A 100 Khz-30 Mhz digital receiver \$799.00 689<sup>95</sup>
  - FL-32 500 Hz CW filter..... 59.50
  - EX-310 Voice synthesizer..... 39.95
  - RC-11 Wireless remote controller... 59.95
  - CR-64 High stability oscillator xtal 56.00
  - R-70 100 Khz-30 Mhz digital receiver 749.00 599<sup>95</sup>
  - EX-257 FM unit..... 38.00
  - IC-7072 Transceiver interface, 720A 112.50
  - FL-44A SSB filter (2nd IF)..... 159.00 144<sup>95</sup>
  - FL-63 250 Hz CW filter (1st IF).... 48.50
  - SP-3 External speaker..... 49.50
  - CK-70 (EX-299) 12v DC option..... 9.95
  - MB-12 Mobile mount..... 19.50



**HOURS: Mon. thru Fri. 9-5:30; Sat. 9-3**  
 Milwaukee WATS line 1-800-558-0411 answered evenings until 8:00 pm, Monday thru Thursday.  
**Please use WATS line for Placing Orders.**  
 For other information, etc. please use Regular line.

**Order Toll Free: 1-800-558-0411**

*In Wisconsin (outside Milwaukee Metro Area)*  
 1-800-242-5195

**AMATEUR ELECTRONIC SUPPLY<sup>®</sup> Inc.**

4828 W. Fond du Lac Avenue; Milwaukee, WI 53216 - Phone (414) 442-4200

**AES BRANCH STORES**

**WICKLIFFE, Ohio 44092**  
 28940 Euclid Avenue  
 Phone (216) 585-7388  
 Ohio WATS 1-800-362-0290  
 Outside Ohio 1-800-321-3594

**ORLANDO, Fla. 32803**  
 621 Commonwealth Ave.  
 Phone (305) 894-3238  
 Fla. WATS 1-800-432-9424  
 Outside Florida 1-800-327-1917

**CLEARWATER, Fla. 33575**  
 1898 Drew Street  
 Phone (813) 461-4267  
 No In-State WATS  
 No Nationwide WATS

**LAS VEGAS, Nev. 89106**  
 1072 N. Rancho Drive  
 Phone (702) 647-3114  
 No In-State WATS.  
 Outside Nevada 1-800-634-6227

**Associate Store**  
**CHICAGO, Illinois 60630**  
 ERICKSON COMMUNICATIONS  
 5456 N. Milwaukee Avenue  
 Phone (312) 631-5181  
**15 mln. from O'Hare!**

## ASTRON POWER SUPPLIES

• HEAVY DUTY • HIGH QUALITY • RUGGED • RELIABLE •

### RS and VS SERIES

#### SPECIAL FEATURES

- SOLID STATE ELECTRONICALLY REGULATED
- FOLD-BACK CURRENT LIMITING Protects Power Supply from excessive current & continuous shorted output.
- CROWBAR OVER VOLTAGE PROTECTION on all Models except RS-4A.
- MAINTAIN REGULATION & LOW RIPPLE at low line input Voltage.
- HEAVY DUTY HEAT SINK • CHASSIS MOUNT FUSE
- THREE CONDUCTOR POWER CORD
- ONE YEAR WARRANTY • MADE IN U.S.A.

#### PERFORMANCE SPECIFICATIONS

- INPUT VOLTAGE: 105 - 125 VAC
- OUTPUT VOLTAGE: 13.8 VDC  $\pm$  0.05 volts (Internally Adjustable: 11-15 VDC)
- RIPPLE: Less than 5mv peak to peak (full load & low line)

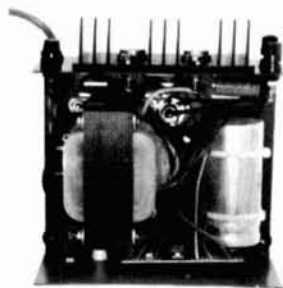

INSIDE VIEW - RS-12A



MODEL RS-50A



MODEL RS-50M



MODEL VS-50M

### RM-A Series



MODEL RM-35A

### 19" X 5 1/4" RACK MOUNT POWER SUPPLIES

| Model  | Continuous Duty (AMPS) | ICS* (AMPS) | Size (IN) H X W X D | Shipping Wt. (lbs.) |
|--------|------------------------|-------------|---------------------|---------------------|
| RM-35A | 25                     | 35          | 5 1/4 x 19 x 12 1/2 | 38                  |
| RM-50A | 37                     | 50          | 5 1/4 x 19 x 12 1/2 | 50                  |

### RS-A SERIES



MODEL RS-7A

| MODEL  | Continuous Duty (Amps) | ICS* (Amps) | Size (IN) H x W x D | Shipping Wt (lbs) |
|--------|------------------------|-------------|---------------------|-------------------|
| RS-4A  | 3                      | 4           | 3 3/4 x 6 1/2 x 9   | 5                 |
| RS-7A  | 5                      | 7           | 3 3/4 x 6 1/2 x 9   | 9                 |
| RS-7B  | 5                      | 7           | 4 x 7 1/2 x 10 3/4  | 10                |
| RS-10A | 7.5                    | 10          | 4 x 7 1/2 x 10 3/4  | 11                |
| RS-12A | 9                      | 12          | 4 1/2 x 8 x 9       | 13                |
| RS-20A | 16                     | 20          | 5 x 9 x 10 1/2      | 18                |
| RS-35A | 25                     | 35          | 5 x 11 x 11         | 27                |
| RS-50A | 37                     | 50          | 6 x 13 3/4 x 11     | 46                |

### RS-M SERIES



MODEL RS-35M

- Switchable volt and Amp meter

| MODEL   | Continuous Duty (Amps) | ICS* (Amps) | Size (IN) H x W x D | Shipping Wt (lbs) |
|---------|------------------------|-------------|---------------------|-------------------|
| -RS-12M | 9                      | 12          | 4 1/2 x 8 x 9       | 13                |
| RS-20M  | 16                     | 20          | 5 x 9 x 10 1/2      | 18                |
| RS-35M  | 25                     | 35          | 5 x 11 x 11         | 27                |
| RS-50M  | 37                     | 50          | 6 x 13 3/4 x 11     | 46                |

### VS-M SERIES



MODEL VS-20M

- Separate Volt and Amp Meters
- Output Voltage adjustable from 2-15 volts
- Current limit adjustable from 1.5 amps to Full Load

| MODEL  | Continuous Duty (Amps) @ 13.8VDC @ 10VDC @ 5VDC | ICS* (Amps) @ 13.8V | Size (IN) H x W x D | Shipping Wt (lbs) |
|--------|---|---------------------|---------------------|-------------------|
| VS-20M | 16 9 4  | 20                  | 5 x 9 x 10 1/2      | 20                |
| VS-35M | 25 15 7   | 35                  | 5 x 11 x 11         | 29                |
| VS-50M | 37 22 10  | 50                  | 6 x 13 3/4 x 11     | 46                |

### RS-S SERIES



MODEL RS-12S

- Built in speaker

| MODEL            | Continuous Duty (Amps) | ICS* Amps | Size (IN) H x W x D | Shipping Wt (lbs) |
|------------------|------------------------|-----------|---------------------|-------------------|
| RS-7S            | 5                      | 7         | 4 x 7 1/2 x 10 3/4  | 10                |
| RS-10S           | 7.5                    | 10        | 4 x 7 1/2 x 10 3/4  | 12                |
| RS-10L (For LTR) | 7.5                    | 10        | 4 x 9 x 13          | 13                |
| RS-12S           | 9                      | 12        | 4 1/2 x 8 x 9       | 13                |
| RS-20S           | 16                     | 20        | 5 x 9 x 10 1/2      | 18                |

# design superhet coilsets with a microcomputer

Improve tracking  
with a one-minute  
interactive program

**The design of superhet coilsets to ensure tracking** for correct simultaneous tuning of preselector and oscillator circuits has taken on an undeserved air of mystery. Some receiver designers have avoided the problem by resorting to pre-peaked narrow-band circuits (not exactly ideal) or separate tuning of the pre-selector circuits, a throwback to the 1920s.

The project that led to this article was a receiver for 150-1560 kHz and 2.5-20 MHz in 6 bands with an IF of 1650 kHz. All the parts, including a zero-temperature coefficient (Invar) three-section tuning capacitor, were available. The specifications for the coilset — involving 18 coils, 18 trimmers, and 6 padders — had to be calculated. But how?

## the one-minute solution

Years ago I found a set of formulae in the literature that seemed practical to use, although their derivation was not entirely clear to me. Using them, I wound and trimmed coilsets for my home-brew receivers. Because the receivers had worked well I hoped they would also track reasonably well. The problem was that calculating

a single set took a whole day using a slide-rule and even after the advent of the pocket calculators, several hours. Half the time was spent in making mistakes and a quarter of the time in wondering if I had discovered all of them. I decided to write a design program based on the existing formulae to produce faster and more reliable results. Written in BASIC, the program reduced the chore to less than a minute!

Thereafter I added a subprogram for plotting the actual tracking curve on the screen. Such a curve shows the difference between the sum of signal and intermediate frequency on the one hand and the oscillator frequency on the other, for an entire tuning range. Ideally, it should be a straight line of zero error value. Without the aid of a computer, this would have taken me many hours to do. With the computer, the task took only a few seconds. As I watched, aghast, the errors ran off the screen as the program kept crashing for all types of designs.

After much thought, I concluded that the algorithms (published in a reliable journal) did not include the effect of stray capacitances such as coil winding capacitances. Even a few pF caused substantial tracking errors, up to 200 kHz or more.

An exhaustive search of the international literature led me to believe that tracking equations are avoided like the plague. Perhaps the subject is thought to be too boring and too difficult for Amateurs. I did find, however, two articles that were *not* over my head, but neither one could pass the computer test! A third article used complex math such as Vieta's theorem and

By Frithjof A.S. Sterrenburg, Westerstraat 47,  
Sijbekarspel, The Netherlands

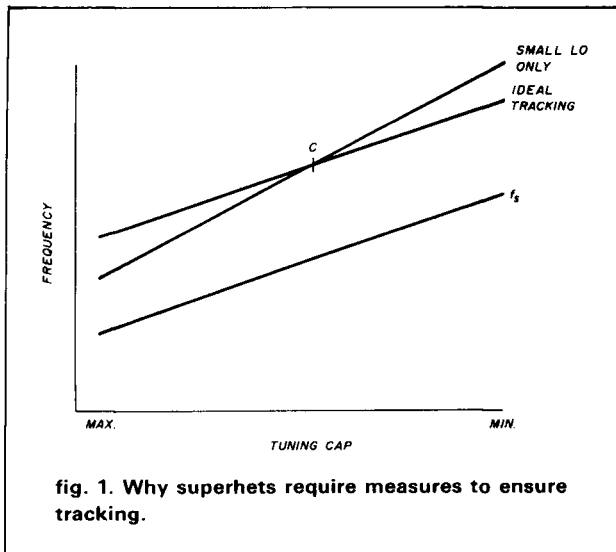

fig. 1. Why superhets require measures to ensure tracking.

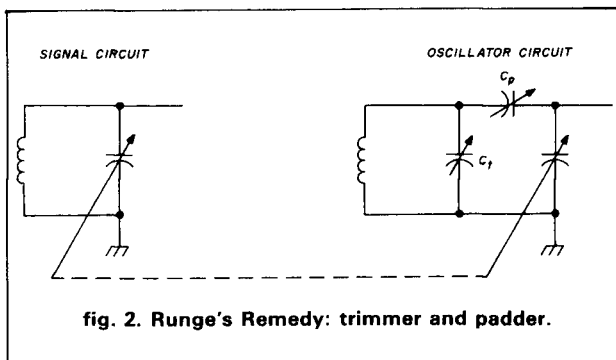

fig. 2. Runge's Remedy: trimmer and padder.

higher order polynomials, but the values given in the examples *did not check* with the formulae supplied! For instance, a trimmer of 46.36 pF in parallel with a tuning capacitor of 20-500 pF was said to give a tuning range of 1.5-5.0 MHz, whereas the actual value would be 1.5-4.3040 MHz. I almost gave up, but finally — in the absence of any information I could both understand and trust — I decided to try to work out the whole thing from the beginning. This is the result, but as you can imagine, I sometimes wonder how many published superhet designs really track.

### the principle

In a superhet all signals ( $f_s$ ) are mixed with a variable oscillator frequency ( $f_o$ ) to produce a fixed intermediate frequency ( $f_i$ ). The better solution is to choose an LO frequency higher than the incoming signals ( $f_o = f_s + f_i$ ) as this reduces spurious responses due to oscillator harmonics. We will consider this case only; the alternative ( $f_o < f_s$ ) is analogous with the proviso that the signal and oscillator coils are exchanged in the equations. The tuning capacitor will have identical sections; this is the reason tricks are

necessary — with different sections for the tuning capacitor good tracking can be obtained, but such components are not readily available. The general equation for resonance is:

$$f^2 = \frac{25330}{L \cdot C} \text{ (MHz, pF and } \mu\text{H)} \quad (1A)$$

and from this it is clear that tuning is not a linear function. If the oscillator coil (LO) were given less inductance than the signal coil  $L_s$  to obtain a high  $f_o$ , the rate of change of  $f_s$  and  $f_o$  would never yield a constant difference  $f_i$ . Fig. 1 shows the ideal tracking curve and the error resulting from using a smaller  $L_o$  only. If the receiver is made to track near the center of the tuning range (point C),  $f_o$  will be too high at the high end and too low at the low end. This could mean attenuation of the signal by 30 dB if you were using potted inductors in the 150-1600 kHz range.

A technique that solves this tracking problem, patented as far back as 1924 by W.T. Runge, is shown in fig. 2; a trimmer,  $C_t$  curtails the tuning capacitor and has the greatest effect at the high frequency end of the tuning range while the padder capacitor,  $C_p$ , does the same thing for the low end. This you know if you have ever aligned a receiver, but it is less widely known that adjustment of  $C_t$  and  $C_p$  only is not enough. Fig. 3 shows a situation in which perfect tracking is obtained at both ends of the tuning range with nevertheless a substantial error in the middle, in this case because  $L_o$  is too small. Tracking, therefore, requires the determination and adjustment of  $C_t$ ,  $L_o$ , and  $C_p$  at *three* frequencies and the curve will then approach a straight line with zero error at three points. Residual errors can be further reduced by shifting the outer two tracking points to the middle which will then result in a curve similar to that in fig. 4.

The circuits shown in fig. 2 represent an idealized case; fig. 5 represents the actual situation including stray capacitances. As indicated by the vertical lines, a clear distinction should be made between the left half (all circuit elements associated with the coils) and the right half (all capacitances associated with the tuning capacitors and the receiver — for example, input capacitance of the active elements).

### circuit elements

Both for practical and theoretical considerations all right half receiver sections must be identical. One important case to be considered is a Colpitts-type oscillator with capacitive divider, indicated by  $C_x$  and  $C_y$  in fig. 5. An equivalent capacitor,  $C_e$ , is therefore added to the signal sections, where

$$C_e = (C_x \cdot C_y) / (C_x + C_y) \quad (2)$$

The winding capacitance of the coils,  $C_w$ , is a problem because it is largely unpredictable (depending on

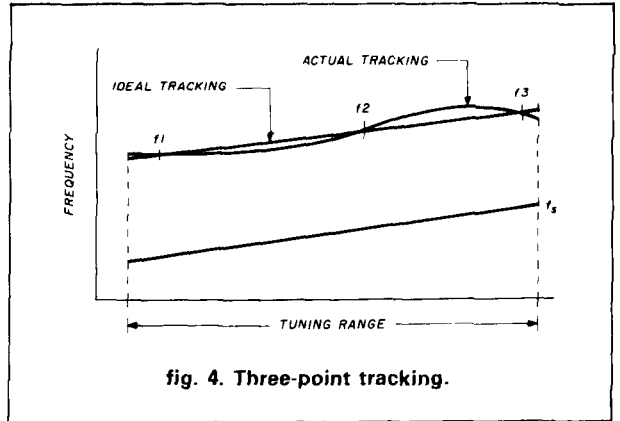
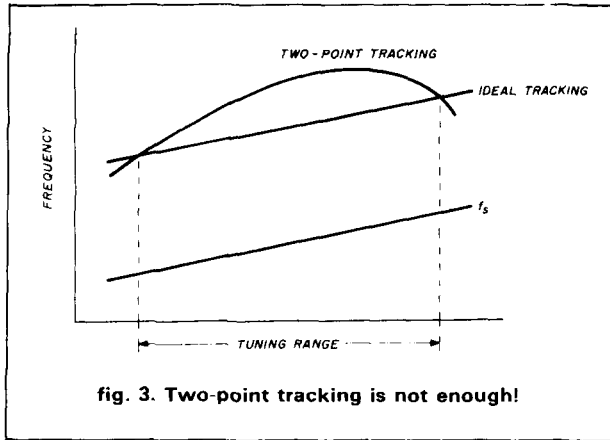

winding technique) and is different for  $L_s$  and  $L_o$ . I solved the problem by combining  $C_w$  with  $C_l$  to form "coil capacitances"  $C_{cs}$  and  $C_{co}$ . The computer will ask you whether that value seems realistic; you can find out by simply winding a trial coil that resonates at the desired frequency with the tuning capacitor used. Then find its self-resonant frequency (without the tuning capacitor) with a dipper and from this derive its  $C_w$ . The same applies to the minimum and maximum capacitance of the tuning capacitor,  $C_{min}$  and  $C_{max}$ , and the wiring stray capacitance  $C_s$ . These are the known and unknown values of the circuit elements we shall work with.

### calculating the values for the signal coils

These are easy to calculate. They are tuned by the combination on the right, which varies with tuning from a high to a low value:

$$C_H = C_{max} + C_s + C_e \quad (3)$$

$$C_L = C_{min} + C_s + C_e \quad (4)$$

Using the general resonance formula, it is seen that if a tuning range starts at  $f_L$  low frequency, an idealized coil without  $C_{cs}$  would tune to maximum frequency.

$$f_m = \sqrt{(C_H/C_L)} \cdot f_L \quad (5)$$

Let the desired top frequency by  $f_H$  and let  $R = f_H/f_L$  then:

$$R = \frac{25330/\sqrt{L_s \cdot (C_L + C_{cs})}}{25330/\sqrt{L_s \cdot (C_H + C_{cs})}} \quad (6A)$$

$$\text{Therefore: } R^2 = (C_H + C_{cs})/(C_L + C_{cs}) \quad (6B)$$

$$\text{or: } C_H + C_{cs} = R^2 \cdot (C_L + C_{cs}) \quad (6C)$$

and from this it follows that the maximum allowed total capacitance across the signal coil (trimmer plus winding capacitance) can be

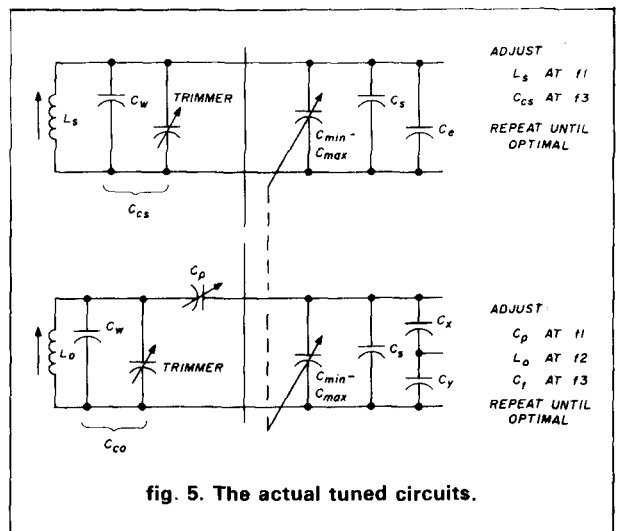

$$C_{cs} = (R^2 \cdot C_L - C_H)/(1-R^2) \quad (6D)$$

Allowing a reasonable value for the trimmer, you'll have to determine whether this leaves enough for the winding capacitance, by employing the procedure mentioned above — using a trial coil and dipper — if you're not sure.

### example

Design a coil set for the medium wave band that tunes from 520-1620 kHz and incorporates a non-Colpitts oscillator. The tuning capacitor to be used provides from 15-500 pF capacitance and the stray capacitance is 15 pF.  $C_{cs}$  when evaluated turns out to be 25.7 pF which is a low value for this range. The medium wave band, with a frequency ratio of over 1:3 requires an approximate 1:10 capacitance ratio and this leaves little leeway for strays.

The value of the signal coil is:

$$L_s = 25330/f_L^2 \cdot C_H \quad (1B)$$

and in this example  $L_s = 173.25 \mu H$

# WE HAVE QUALITY PARTS, DISCOUNT PRICES AND FAST SHIPPING!

## TRANSFORMERS

120 volt primaries



5.6 VOLTS @ 750 MA \$3.00  
 6 VOLTS @ 150 MA \$1.25  
 12 VCT @ 200 MA \$2.00  
 18 V. @ 650 MA \$3.50  
 18 VOLTS @ 1 AMP \$4.50  
 24 VOLTS @ 250 MA \$2.50  
 24 VCT @ 1 AMP \$4.50  
 42 VCT @ 1 AMP \$4.50

## WALL TRANSFORMER

ALL ARE 115 VAC PLUG IN



4 VDC @ 70 MA \$2.00  
 6 VDC @ 100 MA \$2.50  
 6 VDC @ 500 MA \$5.00  
 9 VAC @ 1 AMP \$3.00  
 15 VAC @ 300 MA \$3.00  
 16.5 VAC @ 10 VA \$3.50  
 17 VAC @ 500 MA \$4.00

## SPRING LEVER TERMINALS

TWO COLOR CODED TERMINALS (W/A STURDY 2 3/4" x 3 3/4" BAKELITE PLATE) GREAT FOR SPEAKER ENCLOSURES OR POWER SUPPLIES

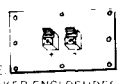

\$1.00 EACH 10 FOR \$9.00

## 2 CHANNEL LIGHT ORGAN

EASILY HOOKS INTO STEREO SPEAKERS AND ALLOWS 110 VAC LIGHTS TO DANCE WITH MUSIC. TWO SEPARATE 110 VAC OUTPUTS FOR HIGH AND LOW FREQUENCY AUDIO SIGNALS. USE TWO ORGANS FOR STEREO

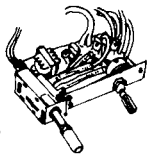

\$6.50 PER UNIT  
 COLOR LIGHT STRING AVAILABLE \$1.75 EA

## RS-232 EXTENSION

4 LINE CONNECTED LINES 1 THROUGH 8 & 20 DB25S MALE TO FEMALE 10 FEET SHIELDED



\$11.00 EACH

## MULTI-SWITCHES

3 STATION NON-INTERLOCKING  
 3 - 2PDT SWITCHES EACH OPERATES INDEPENDENTLY  
 1 1/4" BETWEEN MOUNTING CENTERS

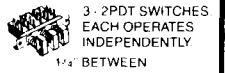

\$1.75 EACH

## 5 STATION INTERLOCKING

MADE BY ALPS  
 3 - 2PDT AND 2 - 6PDT SWITCHES ON FULLY INTERLOCKING ASSEMBLY  
 3 1/4" BETWEEN MOUNTING CENTERS



\$2.50 EACH

## 5 STATION NON-INTERLOCKING

SAME AS ABOVE EXCEPT EACH SWITCH OPERATES INDEPENDENTLY

\$2.50 EACH

## MIKE CONNECTOR

5 CONDUCTOR IN-LINE PLUG AND CHASSIS MOUNT JACK TWIST LOCK STYLE. SAME AS SWITCHCRAFT 12CL5M



\$2.50 PER SET

## METER

0 - 15 V.D.C.  
 THIS 2-1/4" SQUARE METER MEASURES 0-15 VDC

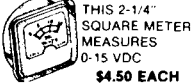

\$4.50 EACH

## SUB-MINIATURE D TYPE CONNECTOR

SOLDER TYPE SUB-MINIATURE CONNECTORS USED FOR COMPUTER HOOK UPS

DB-15 PLUG \$2.75  
 DB-15 SOCKET \$4.00  
 DB-15 HOOD \$2.75  
 DB-25 PLUG \$1.50  
 DB-25 SOCKET \$3.50  
 DB-25 HOOD \$1.25



## "PARALLEL" PRINTER CONNECTOR

SOLDER STYLE 36 PIN MALE USED ON PARALLEL DATA CABLES



\$5.50 EACH

## I.D.C. MALE

WILL PRESS FIT ON STANDARD RIBBON CABLE

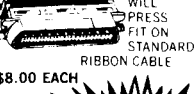

\$8.00 EACH

## 7 CONDUCTOR RIBBON CABLE

SPECTRA-STRIP RED MARKER STRIP 28 GA STRANDED WIRE \$5.00 PER ROLL (100 FT.)

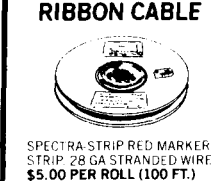

## COMMUNICATION MICROPHONE

NEW C.B. STYLE MIKE WITH PUSH S.P.D.T. SWITCH.



\$5.00 EACH

## PUSHBUTTON POWER SWITCH

DOUBLE POLE POWER SWITCH PUSH ON, PUSH OFF

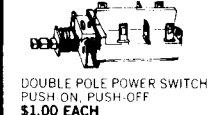

\$1.00 EACH

## SWITCHES MINI-PUSH BUTTON

S.P.S.T. MOMENTARY NORMALLY OPEN 1/4" BUSHING

35¢ EACH  
 10 FOR \$3.25  
 100 FOR \$30.00

SPECIFY COLOR  
 RED, BLACK, WHITE,  
 GREEN, YELLOW



## REVERBERATION UNIT

ACCUTRONICS COIL SPRING TYPE UNITS. USED IN ELECTRONIC ORGANS TO PROVIDE ACOUSTIC DELAY SOUND EFFECTS. INPUT IMPEDANCE 8 OHMS. OUTPUT IMPEDANCE 2250 OHMS. 4 1/2" x 16 1/2" x 1 1/2"

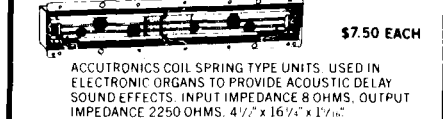

\$7.50 EACH

## SOUND AND VIDEO MODULATOR FOR T.I. COMPUTER

T.I. # UM1581-1. DESIGNED FOR USE WITH T.I. COMPUTERS. CAN BE USED WITH VIDEO SOURCES. BUILT-IN A/B SWITCH, CHANNEL 3 OR 4 SELECTION SWITCH. OPERATES ON 12 VDC. HOOK UP DIAGRAM INCLUDED.

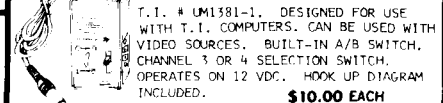

\$10.00 EACH

## 2K 10 TURN MULTI-TURN POT

SPECTROL #MOD 534-7161

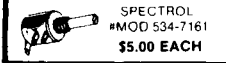

\$5.00 EACH

## PHOTO-FLASH CAPACITORS

170 MFD 330 VOLT  
 1 1/8" x 7/8"  
 2 FOR \$1.50 10 FOR \$7.00

750 MFD 330 VOLT  
 2" HIGH x 1 1/4" DIA.  
 \$1.25 EACH 10 FOR \$11.00

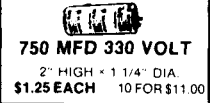

## EDGE CONNECTORS

ALL ARE .156" SPACING

10 PIN EDGE CONNECTOR  
 TRW #50-10-A-20 \$2.00 EACH

18/36 GOLD SOLDER EYELET \$2.00 EACH

22/44 TIN PC STYLE NO MOUNTING EARS \$1.50 EACH 10 FOR \$14.00

22/44 GOLD PC STYLE \$2.00 EACH 10 FOR \$18.00

28/56 GOLD 28/56 GOLD PLATED CONTACTS 156 CONTACT SPACING \$2.50 EACH 10 FOR \$22.00



## 120V INDICATOR

NEON INDICATOR. RATED 120 V 1/3 W. MOUNTS IN 5/16" HOLE 1/2" RED LENS

75¢ EACH  
 10 FOR \$7.00  
 100 FOR \$65.00

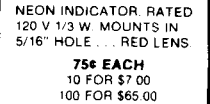

## SOLID STATE RELAY

HEINEMANN ELECTRIC #101 5A-140-5 AMP CONTROL: 3-32VDC LOAD 140VAC 5 AMPS SIZE: 2" X 1" X 3/4" HIGH

\$5.00 10 FOR \$45.00



# FREE! FREE! FREE! SEND FOR NEW LARGER! 48 PAGE CATALOG FREE! FREE! FREE!

## LINE CORDS

TWO WIRE  
 6 18ga TWO WIRE  
 3 FOR \$1.00

THREE WIRE  
 18 INCH 18ga THREE WIRE  
 2 for \$1.00

8 FOOT 18ga THREE WIRE  
 \$2.00 EACH

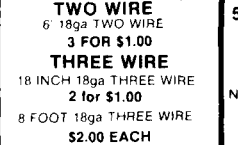

## SOLDERING IRON STAND

SPRING STEEL IRON HOLDER ON WEIGHTED BASE

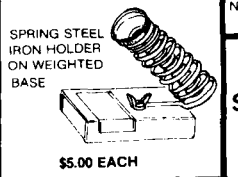

\$5.00 EACH

## TRANSISTORS

2N706 4 FOR \$1.00  
 2N2222A 3 FOR \$1.00  
 PN2222 4 FOR \$1.00  
 2N2904 3 FOR \$1.00  
 2N2905 3 FOR \$1.00  
 2N2907 3 FOR \$1.00

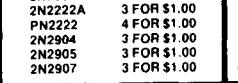

## KEY ASSEMBLY

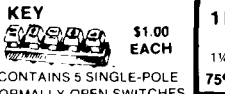
5 KEY  

 \$1.00 EACH

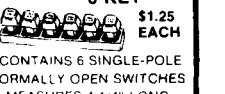
CONTAINS 5 SINGLE-POLE NORMALLY OPEN SWITCHES MEASURES 3 3/4" LONG

6 KEY  

 \$1.25 EACH

CONTAINS 6 SINGLE-POLE NORMALLY OPEN SWITCHES MEASURES 4 1/4" LONG

## BATTERY OPERATED SMOKE DETECTOR

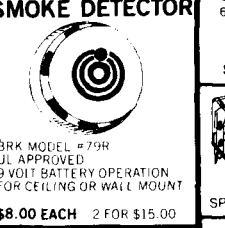
BRK MODEL #79H UL APPROVED 9 VOLT BATTERY OPERATION FOR CEILING OR WALL MOUNT



\$8.00 EACH 2 FOR \$15.00

## ROTARY SWITCH

1 POLE 6 POSITION  
 1 1/4" DIA x 1 1/2" HIGH  
 75¢ EACH 10 for \$6.00

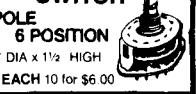

## RELAYS

MINIATURE 6 VDC RELAY  

 SUPER SMALL SPDT RELAY GOLD COBALT CONTACTS

RATED 1 AMP AT 30 VDC. HIGHLY SENSITIVE TTL DIRECT DRIVE POSSIBLE. OPERATES FROM 43 TO 6 V COIL RES 220 OHM

1 3/16" x 1 3/32" x 7/16" AROMAT # RSD-6V

\$1.50 EACH 10 FOR \$13.50

## 13 VDC RELAY

CONTACT SPNC 10 AMP @ 120 VAC ENERGIZE COIL TO OPEN CONTACT

COIL 13 VDC 650 OHMS

SPECIAL PRICE \$1.00 EACH

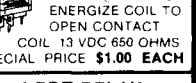

## 4 PDT RELAY

14 pin style  
 3 amp contacts  
 24 volt d.c. coil  
 120 volt a.c. coil  
 Used but fully tested

\$1.70 EACH  
 specify coil voltage  
 LARGE QUANTITIES AVAILABLE  
 SOCKETS FOR RELAY 50¢ each



## COMPUTER GRADE CAPACITORS

2,000 mfd. 200 VDC 1 3/4" DIA 5" HIGH \$2.00  
 3,600 mfd. 40 VDC 1 3/8" DIA 3 3/4" HIGH \$1.00  
 6,400 mfd. 60 VDC 1 3/8" DIA 4 1/4" HIGH \$2.50  
 22,000 mfd. 40 VDC 2" DIA 6" HIGH \$3.00  
 31,000 mfd. 15 VDC 1 3/4" DIA 4" HIGH \$2.50  
 72,000 mfd. 15 VDC 2" DIA 4 3/8" HIGH \$3.50  
 185,000 mfd. 6 VDC 2 1/2" DIA 4 1/2" HIGH \$1.50

CLAMPS TO FIT CAPACITORS 50¢ ea.

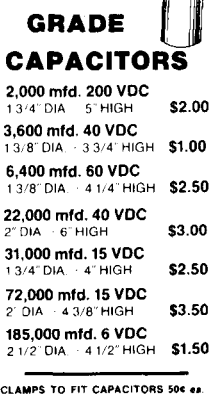

## MINIATURE TOGGLE SWITCHES

ALL ARE RATED 5 AMPS @ 125 VAC

S.P.D.T. (on-on)  

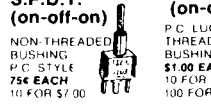
 P.C. STYLE NON-THREADED BUSHING 75¢ EACH 10 FOR \$7.00

S.P.D.T. (on-off-on)  

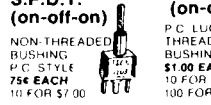
 P.C. LUGS THREADED BUSHING \$1.00 EACH 10 FOR \$9.00

S.P.D.T. (on-on)  

 SOLDER LUG TERMINALS \$1.00 EACH 10 FOR \$9.00

S.P.D.T. (on-off-on)  

 SOLDER LUG TERMINALS \$1.00 EACH 10 FOR \$9.00

## SLIDE POTS

100K linear tape  
 2" LONG  
 1 5/8" TRAVEL 75¢ EACH

500K linear taper  
 2 7/8" LONG  
 1 3/4" TRAVEL 75¢ EACH

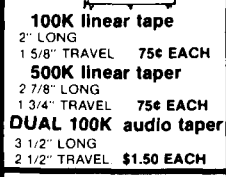
DUAL 100K audio taper  
 3 1/2" LONG  
 2 1/2" TRAVEL \$1.50 EACH



## CRYSTALS

CASE STYLE HC33/U  
 2 MHZ \$3.50 EACH  
 COLORBURST 3579.545 KC \$1.00 EACH

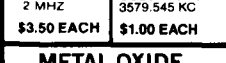

## METAL OXIDE VARISTOR

G.E. # V82A12  
 50 VOLTS NOMINAL D.C. VOLTAGE 5/8" DIAMETER

2 FOR \$1.50



## L.E.D.'S STANDARD JUMBO DIFFUSED

RED 10 FOR \$1.50  
 GREEN 10 FOR \$2.00  
 YELLOW 10 FOR \$2.00

FLASHER LED 5 VOLT OPERATION RED JUMBO SIZE \$1.00 EACH

BI POLAR LED 2 FOR \$1.70

LED HOLDERS  
 TWO PIECE HOLDER FOR JUMBO LED  
 10 FOR 65¢ 200 FOR \$10.00

CLEAR CLIPITE HOLDER MAKE LED A FANCY INDICATOR CLEAR 4 FOR \$1.00

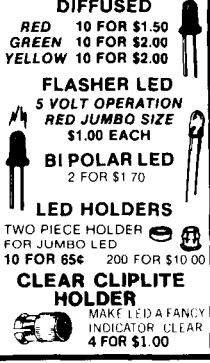

## 3 1/2" SPEAKER

8 OHM IMPEDANCE, FULL RANGE SPEAKER, 8 OZ MAGNET, 1/4" DIAGONAL MOUNTING CENTERS.

\$2.50 EACH  
 10 FOR \$20.00



## POWER SUPPLY W/ PRE-AMP

THIS SUPPLY WAS USED TO POWER AN 8 TRACK CASSETTE UNIT IT WILL SUPPLY APPROX 18 VDC AND INCLUDES A SMALL PRE-AMP TO BOOST SIGNAL LEVEL RCA PLUGS FOR LINE IN OUT

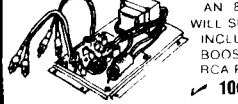

106 \$4.50 EACH

## SOLID STATE BUZZER

STAR #5MB 061  
 6 VDC  
 111 COMPATIBLE  
 \$1.00 EACH  
 10 FOR \$9.00

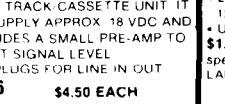



TOLL FREE ORDERS ONLY  
 1-800-826-5432 (ORDER ONLY)  
 (IN CALIFORNIA: 1-800-258-6666)  
 ALASKA, HAWAII, OR INFORMATION  
 (213) 380-8000

# ALL ELECTRONICS CORP.

905 S. VERMONT AVE. P.O. BOX 20406 LOS ANGELES, CA 90006

NEW LOCATION! 6228 SEPULVEDA BLVD. VAN NUYS, CA 91411

QUANTITIES LIMITED  
 MINIMUM ORDER \$10.00  
 USA: \$2.50 SHIPPING  
 FOREIGN ORDERS:  
 INCLUDE SUFFICIENT SHIPPING  
 CALIF. RES. ADD 6 1/2%  
 NO C.O.D.

The signal circuits are now completely defined; additional preselector circuits must be identical.

### determining the tracking points

One tracking point must be at the center of the range. This can be found by taking the geometric means of the two end frequencies:  $\sqrt{f_L \cdot f_H}$ . The outer tracking points must be shifted slightly toward the center. The amount will vary with the tuning range. Empirically, the following factor gives good results:

$$Q = 1 + (f_H/40 \cdot f_L) \quad (7)$$

You can easily change this factor in the program and observe the result on the display. The greatest deviation will occur at the high end, which is acceptable because the bandwidth of the signal coils is also a maximum there. The tracking (and trim-) points are:

$$f_1 = f_L \cdot Q \text{ (low end)} \quad (8)$$

$$f_2 = \sqrt{f_L \cdot f_H} \text{ (center)} \quad (9)$$

$$f_3 = f_H/Q \text{ (top end)} \quad (10)$$

which calculates to be 560, 918, and 1503 kHz, respectively in the example outlined earlier. As the operator tunes to these frequencies, he will set the tuning capacitor to values that can be calculated from the resonance formula after subtracting  $C_{cs}$ . These values (for the right half of the signal sections) are:

$$C1 = \frac{25330}{f_1^2 \cdot L_s} - C_{cs} \quad (11)$$

$$C2 = \frac{25330}{f_2^2 \cdot L_s} - C_{cs} \quad (12)$$

$$C3 = \frac{25330}{f_3^2 \cdot L_s} - C_{cs} \quad (13)$$

In the oscillator section, the total capacitance to the right will be the same as above ( $C_s$  and  $C_e$  are identical), so with the three capacitances  $C1$ ,  $C2$ , and  $C3$  the oscillator must tune to  $f_1 + f_i$ ,  $f_2 + f_i$  and  $f_3 + f_i$ .

### determining the oscillator circuit elements

Taking into account the total coil capacitance for the oscillator circuit and the padder, gives the following three equations:

$$f_1 + f_i = 25330 / \sqrt{C_{co} + \frac{C_p \cdot C_1}{C_p + C_1}} \cdot L_o \quad (14)$$

$$f_2 + f_i = 25330 / \sqrt{C_{co} + \frac{C_p \cdot C_2}{C_p + C_2}} \cdot L_o \quad (15)$$

$$f_3 + f_i = 25330 / \sqrt{C_{co} + \frac{C_p \cdot C_3}{C_p + C_3}} \cdot L_o \quad (16)$$

The solution to these equations means that the tracking error is indeed made equal to zero at these points.

Let's tackle the padder first. Define the ratio  $(f_1 + f_i)/(f_3 + f_i)$  as "A" and call  $(f_2 + f_i)/(f_3 + f_i)$  as "B," then by dividing eq. 14/eq. 16 we find that:

$$C_{co} = \frac{A^2 \cdot C_p \cdot C_1 / (C_p + C_1) - (C_p \cdot C_3) / (C_p + C_3)}{1 - A^2} \quad (17)$$

Similarly, division of eq. 15 by eq. 16 yields:

$$C_{co} = \frac{B^2 \cdot C_p \cdot C_2 / (C_p + C_2) - (C_p \cdot C_3) / (C_p + C_3)}{1 - B^2} \quad (18)$$

These two equations can be used to solve for  $C_p$ :

$$C_p = \frac{C_1 C_2 (B^2 - A^2) + C_1 C_3 (A^2 B^2 - B^2) + C_2 C_3 (A^2 - A^2 B^2)}{C_1 (A^2 - A^2 B^2) + C_2 (A^2 B^2 - B^2) + C_3 (B^2 - A^2)}$$

(This looks neater when the terms in parentheses are called X, Y, and Z respectively, as in the program.)

$C_{co}$  is found by entering  $C_p$  in eq. 17 or 18 and then:

$$L_o = \frac{25330}{(f_2 + f_i)^2 \cdot \left( C_{co} + \frac{C_p \cdot C_2}{C_p + C_2} \right)} \quad (19)$$

This completes the coilset design. In this example:

$$C_p = 585.7 \text{ pF}, C_{co} = 41.9 \text{ pF}, L_o = 84.66 \text{ } \mu\text{H for } f_i = 450 \text{ kHz.}$$

### tracking curve

Plotting the tracking curve on the screen depends on the graphic capability of your microcomputer. High resolution plotting in assembly language is definitely not necessary: what you want to see is the general trend and the peak errors, not an accurate graph. The method used in plotting the tracking curve is described below.

First the tuning range is divided into as many equal sections as the micro has columns. Because of rounding off, the range must be extended above  $f_H$ ; otherwise, the plot sometimes won't reach this value. For a 40-column machine and half a column extra margin the command would be:

for  $f = f_L$  to  $f_H + (f_H - f_L)/80$  step  $(f_H - f_L)/40$

For each  $f$  calculate the total capacitance across the signal coil:

$$C = 25330 / (L_s \cdot f^2) \quad (1C)$$

So the capacitance to the right of the lines is equal to  $C_v = C - C_{cs}$ . From this we can calculate the oscillator frequency corresponding to  $f$ :

$$f_o = \sqrt{\frac{25330}{L_o \left( C_{co} + \frac{C_p \cdot C_v}{C_p + C_v} \right)}} \quad (20)$$

Then print  $f_o - f - f_i$  together with  $f$  for a tracking table or use  $f_o - f - f_i$  as the row- and  $f$  as the

# AEA

BRINGS YOU ANOTHER

# BREAKTHROUGH

## THE TI-1

# RTTY TUNING INDICATOR



SHOWN ACTUAL SIZE

- TRUE SPECTRAL DISPLAY SHOWS BOTH MARK AND SPACE TONES
- 10hz RESOLUTION FOR THE TUNING ACCURACY OF A SCOPE
- WITHOUT THE EXPENSE OF A SCOPE
- ALLOWS FAST AND EASY TUNING OF RTTY SIGNALS
- IDEAL FOR DIFFICULT TO TUNE AMTOR SIGNALS
- DISPLAYS 170, 425 AND 850hz STANDARD SHIFTS
- SHOWS NON-STANDARD SHIFTS FOR EASY TUNING
- AUDIO DRIVEN - EASY TO HOOK UP - COMPACT SIZE
- BUILT IN SPEAKER - CAN BE SWITCHED ON OR OFF
- WORKS WITH ANY INTERFACE
- DOES NOT REQUIRE SCOPE OUTPUTS
- REQUIRES 12vdc AT LESS THAN 60ma
- COMPLETE WITH MANUAL AND CONNECTORS
- SUGGESTED RETAIL \$119.95

**C & A ROBERTS, INC.**

18511 Hawthorne Blvd., Torrance, CA 90504  
213-370-7451 24 Hours call 213-834-5868

**AEA** Brings you the  
Breakthrough!



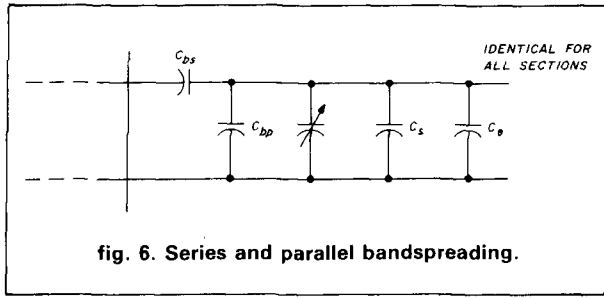

fig. 6. Series and parallel bandspreading.

column parameter. To avoid crashing from incorrect row data, first display the table and examine the size of the error values, then enter a corrective multiplication factor via an INPUT command if necessary.

For this example the errors (rounded off) were -3.2, +4.26, -6.97 and +8.5 kHz. This indicates excellent tracking and implies that everything is correct — an assurance I never had before.

**the program**

The program listing in table 1 was written for the TI-99/4A which is suitable for this application because of its upper and lower case capability, which makes for easy reading, its wide choice of variables, and high degree of precision in mathematics. Note that when the program runs, very small values are subtracted from other very small values so that you may have to use double precision. I have left out everything that is not essential and used the simplest BASIC commands for easy translation. One version I have draws all coils and capacitors in HiRes and inserts their values next to them for added finesse. The listing takes less than 4k of memory, and can still be adapted for your particular machine. A printer is not necessary; the program warns you to "NOTE" the values displayed.

**bandspreading**

As supplied, the program already includes parallel bandspreading, because parallel capacitance is added in the form of  $C_{CS}$  by your independent choice of  $f_H$ . But let's look at bandspreading in more detail (fig. 6).

Parallel bandspreading with  $C_{bp}$  improves the tuning curve. Ordinary tuning capacitors provide logarithmic coverage, with compression at the high end. For straight-line frequency coverage you need a tuning capacitor with pointed plates (the BC-221 has one), but these are exceptionally rare. Adding  $C_{bp}$  reduces the top end compression. The disadvantage of adding parallel capacitance is that the L/C ratio of the tuned circuit is lowered and Q is reduced, especially at the high end. You may assume that the effect on the Q is acceptable if  $C_{bp}$  is smaller than:

$$2 \cdot \{C_L + \text{reasonable value for trimmer (e.g. 15 pF)} + \text{value found for } C_w\}$$

Series bandspreading  $C_{bs}$  raises the L/C ratio, but

table 1. Program listing for superhet coilset design.

```

100 CALL CLEAR
110 PRINT " SUPERHETERODYNE COILSETS": : : : : : " for Ham Radio Magazine":
: : "by Frithjof A.S. Sterrenburg": : : : " ** 1984 **": : : : :
120 FOR DELAY=1 TO 1000
130 NEXT DELAY
140 CALL CLEAR
145 REM for colpitts type oscillator
150 INPUT "does the oscillator have a capacitive divider? y/n":A$
160 IF A$="y" THEN 170 ELSE 230
170 INPUT "enter Cx,Cy ":CX,CY
180 CE=(CX*CY)/(CX+CY)
190 CALL CLEAR
200 PRINT "an extra parallel condenser Ce of";CE,"pF will be specified for these
final sections in the final print-out"
210 FOR DELAY=1 TO 1000
220 NEXT DELAY
230 CALL CLEAR
235 REM define tuning range
240 INPUT "enter minimum capacitance of tuning condenser (pF)":CM1
250 PRINT : :
260 INPUT "enter maximum capacitance of tuning condenser (pF)":CMA
270 PRINT : :
280 INPUT "enter estimated stray capacitance in pF":CS
290 PRINT "the calculated earlier will be printed at the end if it was required":
: :
300 CL=CM1+CS+CE
310 CH=(CMA+CS+CE)
320 INPUT "enter lower frequency of tuning range in MHz":FL
330 PRINT : :
340 FM=SQR(CH/CL)*9FL
350 PRINT "the tuning range would be";FL;"to";FM;"MHz without trimmer or wind-
ing capacitance": :
360 INPUT "enter desired top frequency of tuning range":FH
370 R=FM/FL
380 CCS=(CH-(R^2*CL))/(R^2-1)
390 CALL CLEAR
400 PRINT " NOTE": "total desired coil capacitor(trimmer + coil capa-
citance)";CCS;"pF": :
410 INPUT "does this seem feasible? y/n":B$
420 IF B$="n" THEN 360
430 CALL CLEAR
440 CL=C1+CCS
450 CH=C2+CCS
460 LS=25330/(FL^2*(CH))
465 REM total specification of signal coils
470 PRINT " NOTE": "Ls=";LS;" microH": "assumed stray capacitance="
:CCS;"pF": "trimmer + coil capacitance=";CCS;"pF": :
480 PRINT "for all preselector sections add extra parallel capacitor";CE;"pF(Ce
)": :
490 INPUT "enter c to continue":CS
500 IF CS="n" THEN 510 ELSE 490
510 G=1+(CH/FL)^2+.025
520 F1=FL*G
530 F2=SQR(FL*FH)
540 F3=FM/G
550 CALL CLEAR
555 REM determine the tracking points and oscillator components
560 PRINT " NOTE": "low trimpoint=";F1;" MHz": "mid trimpoint=";F2;"
MHz": "high trimpoint=";F3;" MHz": : :
570 C1=(25330/(F1^2*LS))-CCS
580 C2=(25330/(F2^2*LS))-CCS
590 C3=(25330/(F3^2*LS))-CCS
600 INPUT "enter intermediate frequency in MHz":F1
610 LET A=(F1+F1)/(F3+F1)
620 LET B=(F2+F1)/(F3+F1)
630 X=B^2-A^2
640 Y=(A^2*B^2)-B^2
650 Z=A^2-(A^2*B^2)
660 CP=(Y*(C1*C2)+(Y*(C1*C3)+(Z*(C1)+X*(C3)+(Y*(C2))
670 CO=(A*(C1*C2)/(C1+C1)-(C1*(C1)-(C1*(C3)/(C1+C3))/(1-A^2)
680 LO=25330/(F1*(F1)*Z*(C1)+((C1*(C1)/(C1+C2))))
690 CALL CLEAR
695 REM total specification oscillator components
700 PRINT " NOTE": "padding=";F1;"pF": "trimmer including winding
capacitance=";CCS;"pF": :
710 PRINT "(for signal coil";CCS;"pF was allowed)": "Lo=";LO;"microH": "capa-
citive divider";CX;"and";CY;"pF": :
720 INPUT "enter 1 for next set,2 for tracking table,3 for graph, 4 to end":X
730 ON X GOTO 140,740,820,990
740 CALL CLEAR
745 REM printout of tracking errors for range,for 30 frequencies
750 FOR F=FL TO FH*(FH-FL)/60 STEP (FH-FL)/30
760 C=25330/(LS*F^2)
770 FV=C-C15
780 FCS=SQR(25330/(F1)*((CO)+((CP*CV)/(CP+CV))))
790 PRINT F;1000,(F+F1)-(F)*1000
800 NEXT F
810 GOTO 740
820 CALL CLEAR
825 REM plot of tracking curve for 24 lines/30 columns
830 INPUT "for error plot enter multi- plication factor,maximum deviation=0":
M
840 CALL CLEAR
845 REM draw plotting grid (for 99/4A)
850 CALL CHARK(128,"10101010F101010")
860 PRINT TAB(16);"factor=";M: :
870 CALL HCHAR(13,1,128,31)
880 CALL VCHAR(1,16,128,24)
890 Y=1
895 REM for 30-column machine this is identical to 750-780 inclusive and can b
e a
sub
900 FOR F=FL TO FH*(FH-FL)/60 STEP (FH-FL)/30
910 C=25330/(LS*F^2)
920 CV=C-C15
930 FO=SQR(25330/(LO*(CO)+((CP*CV)/(CP+CV))))
940 X=(F+F1)-(FO)*1000*M
945 REM plot asterisks
950 CALL HCHAR(12+X,Y,42)
960 Y=Y+1
970 NEXT F
980 GOTO 720
990 END

```

A LIMITED INTRODUCTORY  
**FREE OFFER**  
**FOR HAMS ONLY**

DURING NOVEMBER 1984

For only \$12 (one-third off our regular price) we'll send you one year (4 issues) of **Audio Amateur** and a free gift—a pair of self-powered speaker overload indicator kits worth \$10. Just for trying **Audio Amateur!** And we guarantee your satisfaction. *Money back if you're not satisfied for any reason.* Keep the kits, keep the magazines. You can't lose.

**At Audio Amateur we're just as serious about high quality sound as you are about clean transmissions.**

For 15 years now we've been publishing very high quality audio system circuits that are fun to build, outstanding in performance and low cost. Plus lots of mod articles on updating old gear for superior performance. If you like building ham projects, you'll like **Audio Amateur** magazine.

✓ 117

Send one year of Audio Amateur at \$12 and my free kits. I enclose  check  MC  VISA.

NAME \_\_\_\_\_

ADDRESS \_\_\_\_\_

CITY \_\_\_\_\_ STATE \_\_\_\_\_ ZIP \_\_\_\_\_

CARD NUMBER \_\_\_\_\_

CARDHOLDER SIGNATURE \_\_\_\_\_ EXPIRE DATE \_\_\_\_\_

**Audio Amateur, Peterborough, N. H. 03458**

Outside USA add \$4.00 per year for postage.

tuning at the top end is even more compressed. Series and parallel bandspread techniques can, of course, be combined. For series bandspreading, a series capacitor  $C_{bs}$  is added to the right hand side and this is identical for all tuning capacitor sections. In fact, we construct a new tuning capacitor with different  $C_{min}$  and  $C_{max}$  and then run the program as normally.

To determine  $C_{bs}$  for a desired range we define new constants. Let  $C_{cs} = j$ , desired range  $k = f_H/f_L$ ,  $m = C_H$ ,  $n = C_L$  and the unknown bandspread capacitor =  $b$ . Then starting with the equation for the tuning range:

$$k^2 = \frac{j + \frac{b \cdot m}{b + m}}{j + \frac{b \cdot n}{b + n}} \quad (21A)$$

you will arrive at this:

$$(b \cdot m) \cdot (b + n) - (b + m) \cdot \{k^2 \cdot n + (k^2 - 1) \cdot j\} \cdot b + (k^2 - 1) \cdot j \cdot n = 0 \quad (21B)$$

Now let's call  $k^2 \cdot n + (k^2 - 1) \cdot j = p$  and  $(k^2 - 1) \cdot j \cdot n = q$ , then:

$$b^2 \cdot m + b \cdot m \cdot n - (q \cdot b^2 + p \cdot b + q \cdot m \cdot b + p \cdot m) = 0 \quad (21C)$$

$$\text{or } b^2 + \frac{m \cdot n - p - q \cdot m}{(m - q)} \cdot b - \frac{p \cdot m}{(m - q)} = 0 \quad (21D)$$

If we call the two fractions "r" and "s" respectively, this is the common equation  $b^2 + r \cdot b - s = 0$ . One root is negative, the other is the value of the bandspread capacitor:

$$C_{bs} = \frac{-r + \sqrt{r^2 + 4 \cdot s}}{2} \quad (22)$$

Although all bandspread capacitors have been lumped with the right hand half of the circuits in this derivation, they are switched for other ranges and will therefore be *physically present in the left hand half* (in the coil cans, for instance). In the end, you can properly combine all the capacitances calculated.

### conclusion

Although any coilset can now be designed in a few minutes, the main value of this project was something else. For the first time, I could plot tracking curves, and these showed that all the literature I could lay hands on gave unreliable formulas! The microcomputer freed me from the nightmare of calculating, so I could begin to *think* and rediscover a bit of neglected theory for myself. A microcomputer may have its practical uses, but above all, it's a powerful tool for learning!

ham radio



### 74LS

|       |      |       |      |
|-------|------|-------|------|
| LS00  | .29  | LS162 | .65  |
| LS01  | .24  | LS163 | .50  |
| LS02  | .29  | LS164 | .65  |
| LS03  | .27  | LS165 | .90  |
| LS04  | .29  | LS166 | .99  |
| LS05  | .25  | LS169 | 1.25 |
| LS08  | .29  | LS174 | .60  |
| LS09  | .27  | LS175 | .50  |
| LS10  | .24  | LS181 | 1.99 |
| LS11  | .24  | LS191 | .90  |
| LS12  | .30  | LS192 | .80  |
| LS13  | .50  | LS193 | .80  |
| LS14  | .50  | LS194 | .65  |
| LS15  | .32  | LS195 | .65  |
| LS20  | .27  | LS196 | .75  |
| LS21  | .28  | LS197 | .85  |
| LS27  | .28  | LS221 | .80  |
| LS30  | .30  | LS240 | 1.00 |
| LS32  | .38  | LS241 | 1.00 |
| LS33  | .50  | LS242 | 1.00 |
| LS37  | .33  | LS243 | 1.00 |
| LS38  | .34  | LS244 | 1.25 |
| LS42  | .50  | LS245 | 1.50 |
| LS51  | .24  | LS251 | .50  |
| LS54  | .25  | LS253 | .55  |
| LS55  | .27  | LS257 | .55  |
| LS73  | .35  | LS258 | .55  |
| LS74  | .45  | LS259 | 2.50 |
| LS85  | .75  | LS260 | .50  |
| LS86  | .39  | LS266 | .50  |
| LS90  | .50  | LS273 | 1.25 |
| LS93  | .55  | LS279 | .45  |
| LS97  | 2.00 | LS280 | 1.50 |
| LS107 | .37  | LS283 | .60  |
| LS109 | .39  | LS290 | .85  |
| LS112 | .39  | LS293 | .85  |
| LS122 | .45  | LS298 | .89  |
| LS123 | .75  | LS299 | 1.60 |
| LS124 | 2.75 | LS323 | 2.60 |
| LS125 | .50  | LS348 | .75  |
| LS126 | .49  | LS366 | .45  |
| LS132 | .50  | LS367 | .50  |
| LS133 | .55  | LS368 | .40  |
| LS138 | .65  | LS373 | 1.30 |
| LS139 | .65  | LS374 | 1.35 |
| LS151 | .50  | LS375 | 1.00 |
| LS153 | .50  | LS377 | 1.49 |
| LS154 | 1.75 | LS378 | .85  |
| LS155 | .50  | LS390 | 1.19 |
| LS156 | .55  | LS393 | 1.19 |
| LS157 | .60  | LS399 | 1.25 |
| LS160 | .65  | LS670 | 1.50 |
| LS161 | .60  |       |      |

25LS2569 3.00

### 6500

|      |      |      |      |
|------|------|------|------|
| 6502 | 4.50 | 6545 | 7.50 |
| 6522 | 6.95 | 6551 | 7.50 |

### STATIC RAM

|                         |         |
|-------------------------|---------|
| 2016-2KX8 200 n.s.      | 8/32.00 |
| 2101-1 - 256X4 500 n.s. | .75     |
| 21L02-1 350 n.s.        | .65     |
| 2102AL-4 L.P. 450 n.s.  | .49     |
| 2111-1 256X4 500 n.s.   | 2.00    |
| 2114L-3 1KX4 300 n.s.   | 1.50    |
|                         | 8/10.00 |
| 2125A-2 1KX1 70 n.s.    | 2.20    |
| 2142-3 1KX4 300 n.s.    | 1.50    |
| TMS4044 (MCM6641 C-25)  |         |
| 4KX1 250 n.s.           | 8/6.00  |
| 5101 - 256X4 - CMOS     | \$1.00  |
| 6116P-4-2KX8            |         |
| 200 n.s. CMOS           | 8/37.50 |
| 6501-5 256X4 - CMOS     | 1.00    |

### TTL

|       |     |       |      |
|-------|-----|-------|------|
| 7400  | .22 | 74121 | .27  |
| 7402  | .22 | 74123 | .40  |
| 7408  | .24 | 74125 | .49  |
| 7410  | .19 | 74151 | .50  |
| 7413  | .33 | 74153 | .50  |
| 7420  | .22 | 74154 | 1.19 |
| 7425  | .25 | 74157 | .50  |
| 7427  | .25 | 74160 | .80  |
| 7428  | .25 | 74162 | .60  |
| 7432  | .27 | 74163 | .60  |
| 7433  | .25 | 74164 | .80  |
| 7440  | .19 | 74165 | .80  |
| 7442  | .40 | 74166 | 1.00 |
| 7451  | .20 | 74173 | .75  |
| 7473  | .34 | 74174 | .85  |
| 7474  | .40 | 74175 | .80  |
| 7483  | .45 | 74185 | 1.70 |
| 7485  | .55 | 74192 | .70  |
| 7486  | .30 | 74193 | .80  |
| 7490  | .35 | 74195 | .80  |
| 7493  | .33 | 74273 | 1.75 |
| 7496  | .40 | 74367 | .60  |
| 74107 | .28 | 74390 | 1.40 |
| 74109 | .45 |       |      |

### 6800

|        |       |       |       |
|--------|-------|-------|-------|
| 6800   | 2.50  | 6821  | 2.95  |
| 6802   | 5.00  | 6840  | 10.00 |
| 6803   | 10.00 | 6845P | 7.50  |
| 6809EP | 10.00 | 6850  | 2.60  |
| 6810   | 2.00  | 68A21 | 4.95  |
| 6820   | 3.25  | 68B45 | 17.50 |

### EPROM

|                        |      |
|------------------------|------|
| 2708 1KX8 450 n.s.     | 2.20 |
| 27A08 1KX8 350 n.s.    | 3.95 |
| 2758 1KX8 +5V 450 n.s. | 2.50 |
| 2716 2KX8              |      |
| 450 n.s.               | 3.20 |
| 2716-1 2KX8 350 n.s.   | 4.95 |
| 2732 4KX8 450 n.s.     | 4.75 |
| 2732A-3                | 5.70 |
| 2732A-35               | 5.20 |
| 2532 4KX8 450 n.s.     | 4.00 |
| 2764-3                 | 5.95 |

### 4K STATIC RAMS

LESS THAN 50¢ EACH  
MK4104J-4 - 250 N.S. 18 Pin  
Ceramic Computer Mfg.  
Surplus. PRIME. Fully Static.  
Easy to Use. Has Same Pin Out  
as TMS4044, but slightly  
different timing. With Specs.  
(Mostek)

8 for 5.00 32 for 15.95  
VERY LOW POWER!

### EPROM SPECIAL

We bought a large quantity of 2708s from a computer manufacturer who redesigned their boards. We removed them from sockets, erased and verified them, and now we offer the savings to you. Complete satisfaction guaranteed.

2708  
\$1.49 or 10/\$12.00

### SPECIAL

AY3-8910  
W/60 Page Manual  
New Price — \$7.00

### DYNAMIC RAM

|                             |         |
|-----------------------------|---------|
| 2108-4 8KX1                 | 1.50    |
| 2118-4 16KX1-5Volt          | 1.50    |
| 4027-4KX1-250 n.s.          | .80     |
| 4116-16KX1-250 n.s.         | 8/8.00  |
| 4116-16KX1-200 n.s.         | 8/11.50 |
| 4116 16KX1-150 n.s.         | 8/12.95 |
| 4164+ +5v 64K 200 n.s.      | 8/42.00 |
| MK4516-15 16KX1-5Volt       | 1.50    |
| 5280N-5 (2107B-4 • TMS4060) |         |
| 4KX1                        | 8/3.95  |

### UART

|                       |      |
|-----------------------|------|
| TR1602B (COM 2017)    | 2.20 |
| 1863 +5v              | 2.95 |
| IM6402+5v High speed  |      |
| UART-AY5-1013 pin out | 2.95 |
| INS 8250B             | 9.95 |

### Z80

|                 |       |
|-----------------|-------|
| Z80 2.5 MHZ CPU | 3.50  |
| Z80CTC          | 3.75  |
| Z80DMA-DMA      | 9.95  |
| Z80PIO          | 3.95  |
| Z80SIO/O        | 11.50 |
| Z80A-4MHZ CPU   | 4.00  |
| Z80A DART       | 9.95  |
| Z80A-PIO        | 4.00  |
| Z80A SIO/O      | 19.95 |
| Z80B 6 MHZ CPU  | 9.50  |

### F.D. CONTROLLERS

|                     |       |
|---------------------|-------|
| 1771 Single Density | 15.00 |
| 1791 Double Density | 20.00 |
| 1793                | 22.00 |
| 1797                | 24.95 |
| 2793                | 35.95 |

### CONTROLLER SET

THREE CHIP SET  
1797, 2143-03, 1691 by W.D.  
Compare at up to 86.85.  
B.G. SPECIAL  
All 3 for only \$29.95

### 8000

|       |       |        |        |
|-------|-------|--------|--------|
| Z8002 | 29.95 | 8085A  | 5.95   |
| 8035  | 5.00  | 8086-2 | 24.95  |
| 8039  | 5.00  | 8087-3 | 175.00 |
| 8080A | 2.00  | 8088   | 20.00  |

### 8200

|        |       |       |       |
|--------|-------|-------|-------|
| 8202A  | 15.95 | 8251  | 4.20  |
| 8212   | 1.50  | 8257  | 6.00  |
| 8214   | 2.00  | 8259A | 4.95  |
| 8216   | 1.75  | 8275  | 19.95 |
| 8228   | 3.25  | 8287  | 5.75  |
| 8237-5 | 10.50 | 8288  | 24.95 |
| 8250B  | 9.95  |       |       |

### SPECIALS

|         |      |
|---------|------|
| 1408L8  | 2.00 |
| 19411   | 5.95 |
| LM311   | .40  |
| LF353   | .60  |
| LF356   | .60  |
| TL494   | 2.50 |
| LM555   | .30  |
| 733     | .60  |
| 9401    | 5.00 |
| DS8835  | 1.50 |
| MC4024P | 2.50 |
| NE592   | 1.75 |
| LM319   | 1.00 |
| MC1350  | 1.00 |
| LM2917  | 1.50 |
| LM339   | .50  |

### SOCKETS

|                         |         |
|-------------------------|---------|
| Low Profile SOLDER TAIL |         |
| 6 Pin                   | 14/1.00 |
| 8 Pin                   | 13/1.00 |
| 14 Pin                  | 10/1.00 |
| 16 Pin                  | 8/1.00  |
| 18 Pin                  | 8/1.00  |
| 20 Pin                  | 7/1.00  |
| 24 Pin                  | 6/1.00  |
| 28 Pin                  | 6/1.00  |
| 40 Pin                  | 5/1.00  |

BUY \$10

GET \$1.00 - FREE CHOICE

### 2114 SPECIAL!

COMPUTER  
MANUFACTURERS  
EXCESS INVENTORY  
SALE!  
PRIME! 2114-300 n.s.  
INCREDIBLE PRICE!  
YOU SAVE!  
8/\$9.00  
GUARANTEED

### CRYSTALS

|                    |      |
|--------------------|------|
| 32.768 Khz SPECIAL | .65  |
| 262.144            | .75  |
| 300.000            | 1.00 |
| 307.200            | 1.25 |
| 1.5432 Mhz         | .75  |
| 1.8432             | 2.49 |
| 2.000000           | 2.49 |
| 2.560              | 1.49 |
| 3.000              | 1.15 |
| 3.120              | 1.20 |
| 3.2                | 1.49 |
| 3.4560             | 1.49 |
| 3.579545 - HC18    | 1.00 |
| 4.000              | 2.49 |
| 4.194304           | 1.50 |
| 4.433618           | .75  |
| 4444.000           | 1.25 |
| 4.9152             | 2.49 |
| 4.916 Bd. Rate     | 1.25 |
| 5.000000           | 1.50 |
| 5.0688             | 3.75 |
| 5.616              | 1.59 |
| 6.000              | 2.49 |
| 6.176              | 1.49 |
| 7.164112           | 1.49 |
| 7.3728             | 1.49 |
| 8.000              | 1.99 |
| 9.000              | 1.49 |
| 9.90000            | 1.25 |
| 10.69425           | 3.75 |
| 10.8864            | 1.49 |
| 10.920             | 1.49 |
| 11.088             | 1.59 |
| 12.000             | 2.75 |
| 13.440             | 1.00 |
| 14.31818           | 2.49 |
| 15.2               | 1.10 |
| 16.00000           | 1.50 |
| 16.5888            | 1.49 |
| 17.430             | 2.49 |
| 18.2259            | 1.00 |
| 20.000             | 3.75 |
| 21.87108           | 1.00 |
| 22.092             | 1.00 |
| 32.000             | 2.49 |
| 40.000             | 2.00 |
| 87.3333            | 1.00 |
| 91.000             | 1.00 |
| 104.8              | 1.00 |

TERMS: (Unless specified elsewhere) Add \$1.50 postage, we pay balance. Orders over \$50.00 add 95¢ for insurance. No C.O.D. Texas Res. add 6% Tax. 90 Day Money Back Guarantee on all items. All items subject to prior sale. Prices subject to change without notice. Foreign order - US funds only. We cannot ship to Mexico. Countries other than Canada, add \$3.50 shipping and handling.



**Big Computer Mfg. Makes \$900,000 Goof!!**

## COMPUTER/DISK DRIVE SWITCHING POWER SUPPLY

ORIGINALLY DESIGNED TO RUN A Z-80  
BASED SINGLE BOARD COMPUTER  
WITH TWO 5-1/4 IN. DISK DRIVES AND  
CRT MONITOR.

ORIGINAL  
OEM COST  
\$72 EACH!

BRAND NEW: UNUSED!

**\$37<sup>50</sup>** EA

**3 FOR \$95<sup>00</sup>**

ADD \$1.50 PER UNIT FOR UPS

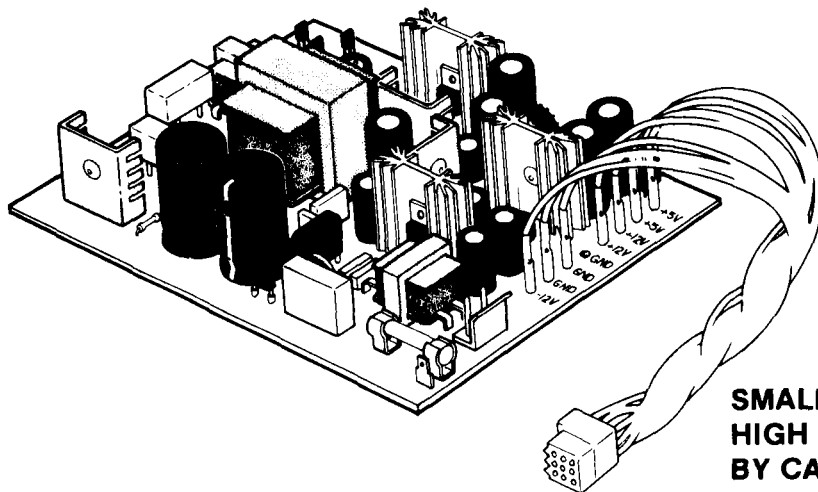

SPECS: + 5VDC 5 AMPS MAX  
#1 + 12 VDC 2.8 AMPS MAX  
#2 + 12 VDC 2.0 AMPS MAX  
- 12 VDC .5 AMPS MAX

INPUT: 115 or 230 VAC 60Hz

SMALL SIZE: 6-1/8 x 7-3/8 In.  
HIGH EFFICIENCY SWITCHER MFG.  
BY CAL. DC IN USA!

The poor Purchasing Agent bought about 10 times as many of these DC switchers as his company would ever use! We were told that even in 10,000 piece lots they paid over \$72 each for these multi-output switchers. When this large computer manufacturer discontinued their Z-80 Computer, guess what the Big Boss found in the back warehouse; several truckloads of unused \$72.00 power supplies. Fortunately we heard about the deal and made the surplus buy of the decade. Even though we bought a huge quantity, please order early to avoid disappointment. Please do not confuse these high quality American made power supplies with the cheap import units sold by others.

✓ 123

TERMS: (Unless specified elsewhere) Add \$1.50 postage, we pay balance. Orders over \$50.00 add 85¢ for insurance. No C.O.D. Texas Res. add 6% Tax. 90 Day Money Back Guarantee on all items. All items subject to prior sale. Prices subject to change without notice. Foreign order - US funds only. We cannot ship to Mexico. Countries other than Canada, add \$3.50 shipping and handling.



## Z80\* SINGLE BOARD COMPUTER!

64K RAM — 80 x 24 VIDEO DISPLAY — FLOPPY DISK CONTROLLER  
RUNS CP/M\* 2.2!

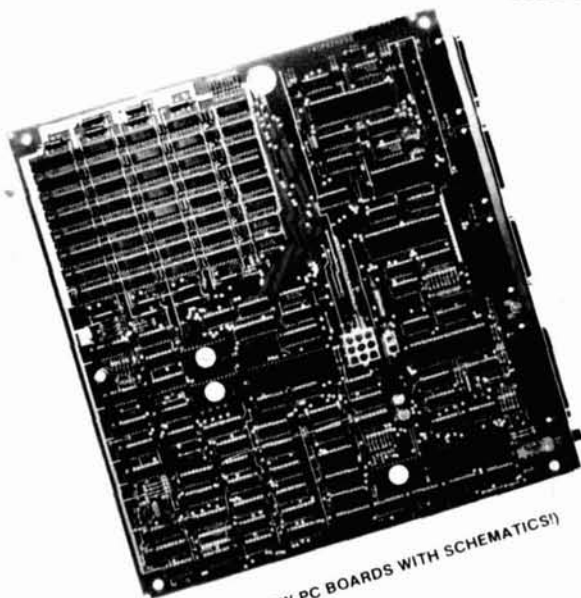

(BRAND NEW PC BOARDS WITH SCHEMATICS!)

**\$29.95**

(BLANK BOARD WITH  
DATA AND ROM'S.)

**NEW PRICE**

**GROUP SPECIAL:  
BUY 6 FOR \$165!**

**USES EASY  
TO GET PARTS!**

**BOARD MEASURES  
11½" x 12½"**

**ALL ORDERS WILL BE  
PROCESSED ON A STRICT,  
FIRST COME, FIRST SERVED  
BASIS! ORDER EARLY!**

**NEW PRICE!  
\$159.95**

### GIANT COMPUTER MANUFACTURER'S SURPLUS! UNBELIEVABLE LOW PRICE!!!

Recently Xerox Corp. changed designs on their popular 820\* computer. These prime, new, 820-1 PC boards were declared as surplus and sold. Their loss is your gain! These boards are 4 layers for lower noise, are solder masked, and have a silk screened component legend. They are absolutely some of the best quality PC boards we have seen, and all have passed final vendor QC. Please note, however, these surplus boards were sold by Xerox to us on an AS IS basis and they will not warranty nor support this part.

We provide complete schematics, ROM'S, and parts lists. If you are an *EXPERIENCED* computer hacker, this board is for you! Remember, these are prime, unused PC boards! But since we have no control over the quality of parts used to populate the blank board, we must sell these boards as is, without warranty. You will have to do any debugging, if necessary, yourself!

ADD \$2 PER PC BOARD FOR SHIPPING. (USA and Canada)

\*CP/M TM OF DIGITAL RESEARCH INC. (CALIF.) 820 TM OF XEROX CORP. Z80 TM OF ZILOG

✓ 124

**WE'VE GOT EM!**

**5-1/4"  
HALF SIZE DRIVES**

- 40 Track per side
- Double-sided, double density
- Same as SA455
- Latest head & drive technology
- Fast access time

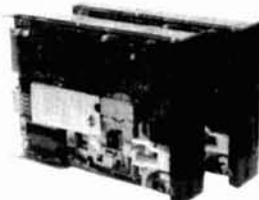

Two of These Half Size Drives will  
Fit in the Same Space as 1 Full Size Drive!

**\$159.95**

Compare at up to \$349 ea.  
ADD \$3.00 UPS PER DRIVE

TERMS: Orders over \$50 add 85¢ insurance. No COD. Tex. Res. Add 6% Sales Tax. Subject to prior sale. Foreign orders: US funds only. We cannot ship to Mexico. Foreign countries other than Canada add \$6 per board shipping.

# receiver sweep alignment system

No sweep generator?  
Try these handy  
throwaway circuits

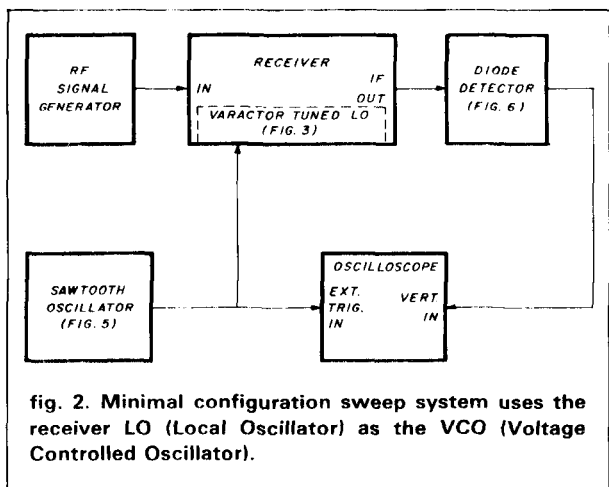
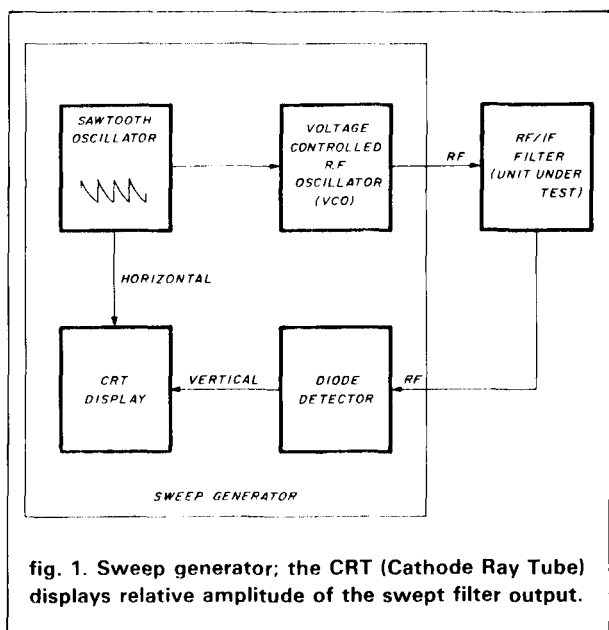

When a circuit just "doesn't sound right," the obvious solution is to use a sweep generator to evaluate and align the filters. But a sweep generator may not be available; for most of us, it's too expensive a piece of equipment for the occasional use it receives.

This article describes how I approached this problem in the development of an SSB receiver by adding a few extra circuits during construction, then removing and discarding them after use. A separate signal generator and oscilloscope were also required.

## sweep measurement basics

Fig. 1 illustrates a typical sweep measurement system. The sawtooth oscillator generates a voltage "ramp" which tunes the voltage controlled oscillator frequency across the filter passband. For small frequency changes, the voltage controlled oscillator often uses a varactor ("varicap") diode to change circuit capacitance. The amplitude of the RF/IF signal coming through the filter varies with (and helps define — Ed.) the filter's frequency response, and is detected by the diode detector. The detector output is displayed by the oscilloscope vertical channel while the sawtooth oscillator drives the oscilloscope horizontal channel in step. The resulting display plots the filter's amplitude versus frequency response. This display is used to align filters since it gives an instant indication of circuit adjustment results. This is very handy when a large number of interrelated circuit manipulations must be made.

The proposed minimal sweep alignment system uses the existing receiver local oscillator as the voltage controlled oscillator. This is similar to a panoramic receiver with a much smaller sweep range. Fig. 2 shows this scheme as implemented in an HF SSB receiver project. Three new circuits are added; a varactor tuning diode, a diode AM detector, and a sawtooth oscillator circuit.

## detailed circuit description

Because the three circuits were designed to be dis-

By Cliff Klinert, WB6BIH, 1126 Division Street, National City, California 92050

carded after use, careful consideration was given to parts availability.

The familiar 1N4000-series of silicon rectifiers make good "varactor" diodes when biased in the linear region. Fig. 3 shows the varactor tuning circuit using a 1N4007 connected to a typical 5 MHz oscillator tank circuit. The circuit was tested by applying an adjustable DC bias voltage and measuring the corresponding frequency with a counter. Fig. 4 shows the results of this experiment for DC bias voltages from 14 to almost 28 volts. Note that the curve is almost linear. Good linearity throughout the sweep system is required to provide an undistorted picture of the filter's passband response.

The sawtooth oscillator, the heart of the system, generates a periodic linearly increasing voltage ramp waveform. If the oscilloscope used in this project had

provided a sweep output connection, the external oscillator might not have been required. The varactor circuit requires a linear sawtooth voltage providing a 14 to 24 volt ramp per frequency sweep. Simple sawtooth

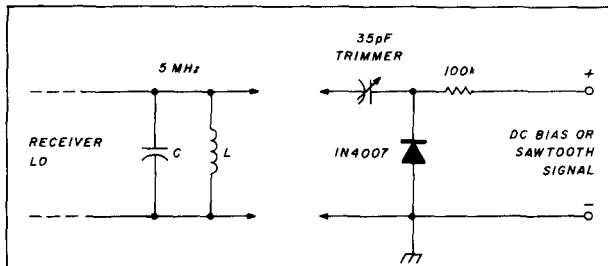

fig. 3. The varactor diode acting as a voltage variable capacitor changes the resonant frequency of an LC circuit in step with a varying DC bias.

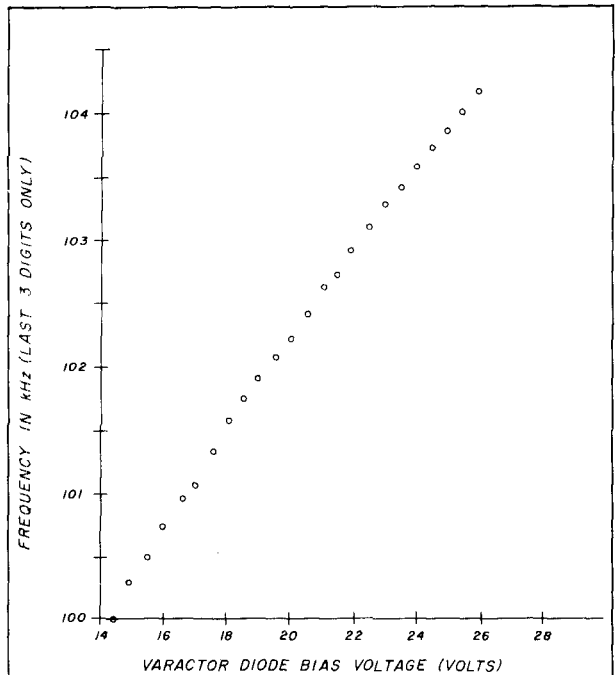

fig. 4. Varactor diode tuning curve is a plot of actual data taken from the circuit of fig. 3. The range of the swept frequency is adequate for the SSB filter tested.

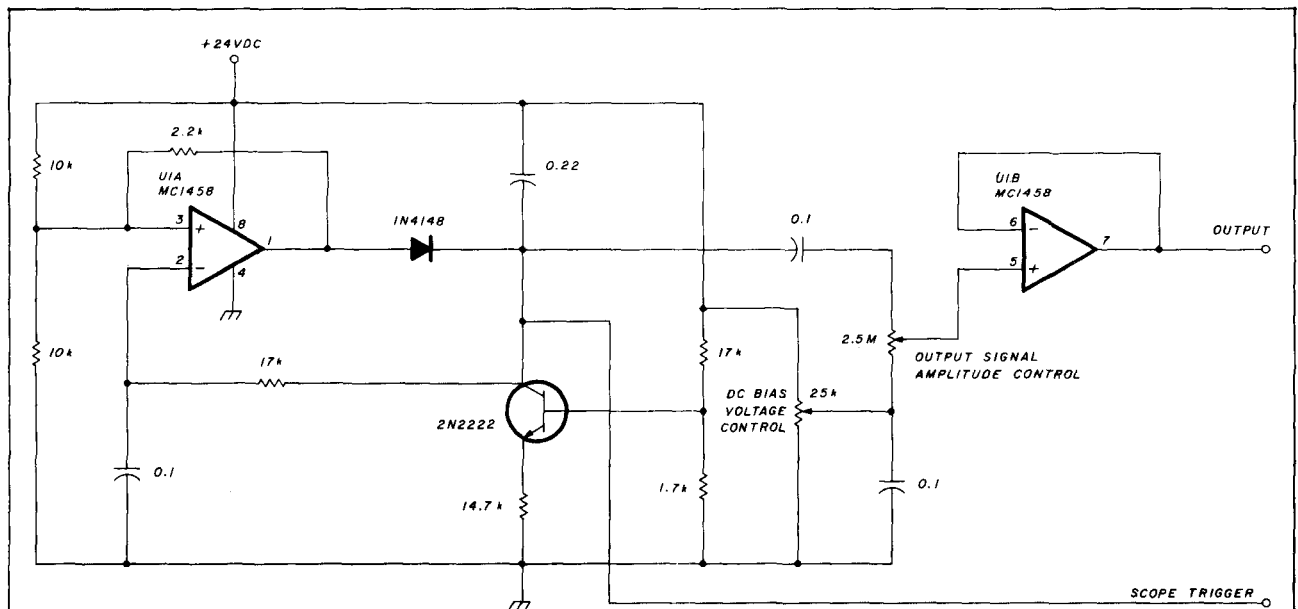

fig. 5. The sawtooth oscillator uses an inexpensive IC (MC1458) to both generate the ramp waveform and buffer its output. Mylar capacitors are used for best results.

oscillator circuits are normally designed around uni-junction transistors and in this case, to keep costs down, a less expensive IC, an MC1458, (U1 of fig. 5), was used. The 0.22  $\mu$ F capacitor is charged by a 2N2222 constant current source until the MC1458 "triggers" and briefly shorts the capacitor back to the positive supply voltage line. The cycle is then immediately repeated. Since the 2N2222 collector current is determined by its base and emitter bias circuit, it is nearly constant while charging the 0.22  $\mu$ F capacitor. This constant current ensures a linear capacitor voltage rise with time. The other half of the MC1458, U1B, is used as a voltage follower and provides a low

impedance, higher current version of the sawtooth voltage at its output. The 2.5 Megohm potentiometer controls the amount of frequency excursion, while the 25 kilohm potentiometer tunes the voltage controlled oscillator frequency.

The diode detector provides a DC voltage that is proportional to the RF swept signal output amplitude. A hot carrier diode such as a 1N5711, shown in fig. 6A, can be used. If a hot carrier diode is not available, an inexpensive germanium diode that is slightly forward biased can be used in its place as shown in fig. 6B. A DC return is required for the *biased* diode, and the diode impedance decreases as the current in-

fig. 7. Oscilloscope photographs. Unless otherwise noted, the sweep speed is 5 milliseconds per division and vertical sensitivity is 0.1 volt per division. The unit under test is a 9.0 MHz SSB IF amplifier using an MC1350 and surplus crystal filter.

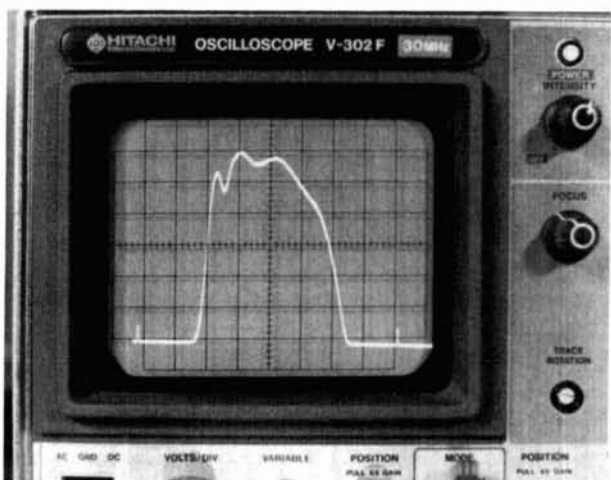

fig. 7A. This shows a typical frequency sweep about 3.5 kHz wide.

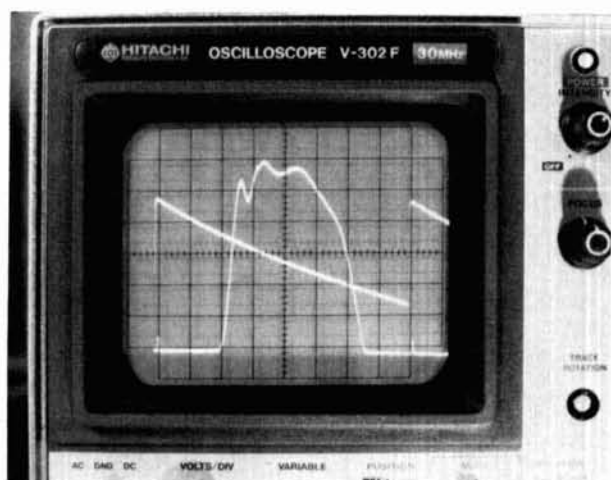

fig. 7B. The second channel is used to display the sawtooth signal showing its relationship to the frequency sweep.

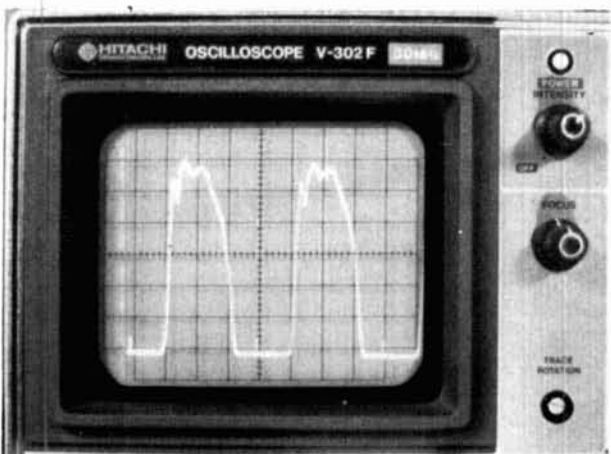

fig. 7C. The sweep speed is too low (10 milliseconds per division). This indicates that the speed should be adjusted to provide the desired display.

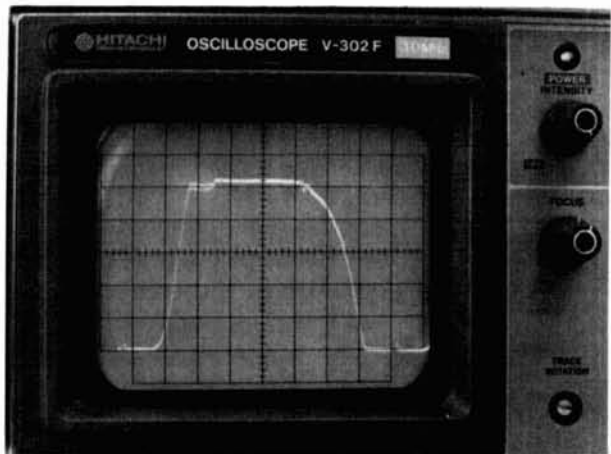

fig. 7D. The IF amplifier is "flat topping." The gain or input signal must be reduced to remove the distortion at the top of the display.



creases. A high impedance tuned circuit will be "shorted out" by the biased diode. Adjusting the diode bias control will produce a sharp peak in the detected signal output. Reducing the control's resistance near zero will, of course, destroy the diode. A silicon diode such as a 1N914 works very poorly as a detector.

### construction and installation proceed smoothly

The circuit requires 24 volts DC which can be provided by either a bench power supply or batteries. Connect the varactor circuit (fig. 3) to the receiver local oscillator. Apply a variable DC bias voltage and adjust the varactor-tuned circuit to achieve results similar to those in fig. 4. Make a notation of the voltage variation required to obtain the full frequency sweep.



fig. 7E. Crystal filter load impedance is too low, resulting in a noticeable loss of audio frequency response and confusion in setting the BFO frequency.

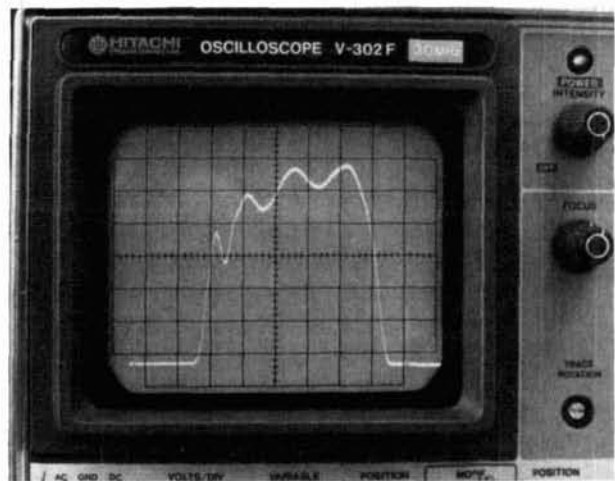

fig. 7F. The crystal filter load impedance is high, about 6000 ohms.

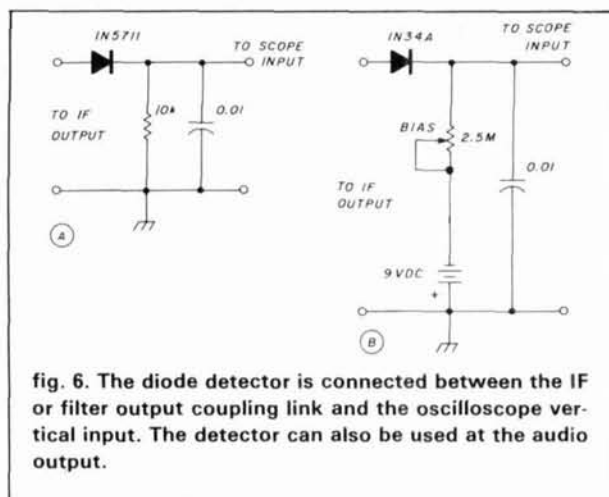

fig. 6. The diode detector is connected between the IF or filter output coupling link and the oscilloscope vertical input. The detector can also be used at the audio output.

Assemble the sawtooth oscillator (fig. 5) and check the results with the oscilloscope. The output voltage should be capable of a swing nearly equal to the power supply limits with a period of approximately 50 milliseconds. The circuit can be assembled on a circuit board, but for temporary use, just solder the components together by their leads on the bench. Stray noise pickup may be a problem, but the large signal makes this unlikely. The varactor diode circuit is quite sensitive because of its high impedance, but no problems were encountered when connected to the sawtooth oscillator output.

Connect the detector probe (fig. 6) to the receiver IF amplifier output at a point of maximum available signal. Some experimentation is necessary with a signal generator and oscilloscope to obtain the maximum detected output without saturating the IF amplifier.

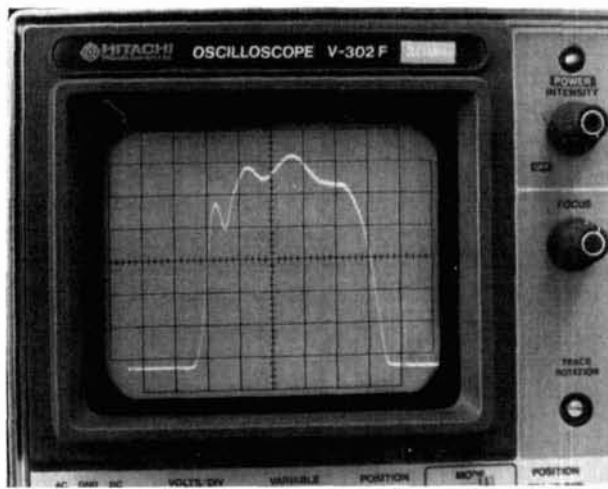

fig. 7G. The best response was obtained with approximately 3000 ohms load impedance. This is an unusually high load impedance for a crystal filter, and may indicate some problem in the filter.

## WHAT'S REALLY HAPPENING IN HOME SATELLITE TV?

# STV<sup>SM</sup> SATELLITE TELEVISION MAGAZINE

A monthly of 100-plus pages, has all you need to know about where to find equipment, how it performs, how to install it, legal viewpoint, & industry insights.

- \$24.95 per yr. (12 monthly issues)
- \$ 2.00 for Sample Issue

MONEY BACK GUARANTEE if not satisfied (subscription orders only). Keep first issue with our compliments.

If you already have a dish, then you need

# OnSat<sup>SM</sup>

—the best in satellite TV programming.

- ★ Weekly Updated Listings
- ★ All Scheduled Channels
- ★ Complete Movie Listing
- ★ All Sports Specials
- ★ Prime Time Highlights

- \$39.00 per yr. (52 weekly issues)
- \$ 1.00 for Sample Copy

Visa® MasterCard® accepted (subscription orders only). All prices in US funds only. Write for foreign rates.

Send this ad along with your order to:

**STV<sup>SM</sup>/OnSat<sup>SM</sup>**  
P.O. Box 2384 - Dept. PS  
Shelby, NC 28151-2384  
Subscription calls only  
Toll Free **1-800-438-2020**

The oscilloscope must be DC coupled with at least 0.1 volt per cm sensitivity.

Connect the sawtooth oscillator output to the varactor circuit. It's easier to start with a relatively low sweep amplitude when finding the frequency, so reduce the sweep signal amplitude in the beginning. Connect the diode detector output to the oscilloscope vertical input and synchronize the oscilloscope sweep from the sawtooth oscillator signal. The sawtooth signal could also be connected to the oscilloscope horizontal amplifier input if access is available. Tune the receiver to the signal generator frequency and make adjustments as required. Slowly increase the sawtooth signal amplitude until a sweep display indication is obtained. **Fig. 7** shows the results obtained from an SSB crystal filter sweep. In this case, the crystal filter output impedance was varied with a potentiometer in series with the filter output. The photographs show IF sweeps, but similar results were obtained by connecting the detector to the outputs of the product detector and audio amplifier. This provides analysis of other points in the receiving system that would be useful for troubleshooting or design evaluation.

### conclusions

This article presented the concept of using expendable circuits as built-in test equipment for use during project construction. A handy sawtooth oscillator was presented for those who collect simple circuits for afternoon projects. This oscillator will find many applications in oscilloscope or spectrum analysis projects. No construction details were presented, since the concept was to show that circuits can be assembled without circuit boards for prototype or temporary use and discarded later.

### ham radio

#### COMPUTER PROGRAMS FOR THE RADIO AMATEUR

by Wayne Overbeck, N6NB, and Jim Steffen, KC6A

#### NOW WITH DISKS

Here's the first source book of computer programs for the Radio Amateur. Besides covering computer basics, this book gives you programs that will help you log, determine sunrise/sunset times, track the Moon's path across the sky, use Greyline propagation and set up record systems for WAS, DXCC and VUCC, or any other award. You can either buy the book alone or you can buy the book with the programs already on disk. Take full advantage of your computer with this well written source book. ©1984, 1st edition, 327 pages.

- HA-0657 **Softbound \$16.95**
- HA-0657 with program **\$29.95**  
specify computer (see list below)
- Program disk alone **\$19.95**

Programs available for: Apple II (DOS and CP/M), IBM (DOS), TRS-80 Model I and Model III and Commodore C-64. Please mark your order with the program disk you want.

NOW  
WITH  
COMPUTER DISKS

Uncle Ben says...

**"I give you  
much more than  
just the lowest price..."**



"Uncle Ben" Snyder, W2SOH  
the head man of

**HARRISON**

"HAM HEADQUARTERS,  
USA®" ...Since 1925!

When you get that exciting new piece of equipment *from me*, you know you are going to be completely happy... I see to it, personally! I also give you earliest delivery, greatest trade-in allowances, my friendly assistance in every possible way.

Just ask any of the many thousands of hams all over the world who have been enjoying my friendly good service for over a half a century.

73, Uncle Ben, W2SOH

• **CALL ME...**

(516) 293-7995

**HARRISON**  
**HAS THEM ALL!**  
**KENWOOD**

• **WRITE ME...**

For my prompt,  
personal reply.

• **SEE ME...**

At one of the world's largest  
Ham Supply Centers!



KENWOOD TS-930



**NEW**

KENWOOD  
TH-21A

KENWOOD  
TR-2600



KENWOOD TS-711A



KENWOOD TS-830



KENWOOD TS-430S



**NEW**

KENWOOD  
TH-41AT

KENWOOD  
TH-21AT



**HARRISON** RADIO

...Since 1925!

**"HAM HEADQUARTERS, USA®"**

2263 Route 110 (at Smith St.)

E. Farmingdale, NY 11735

1-(516) 293-7995

**CHARGE IT!**

# John J. Meshna Jr., Inc.

19 Allerton Street • Lvnn. MA 01904 • Tel: (617) 595-2275

**LIMITED QUANTITY!**

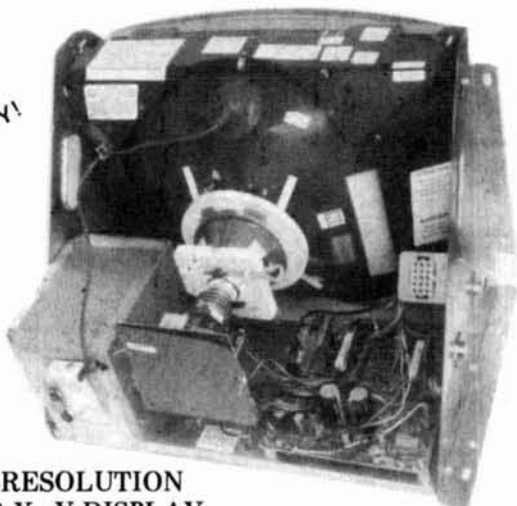

## 19" HI-RESOLUTION COLOR X-Y DISPLAY

Thru a special purchase we got hold of 50 brand new 19" color displays. They were made by Wells Gardner for one of the largest arcade video game manufacturers in the world. The displays feature built in red, green and blue amplifiers, 19" color tube made by Wells Gardner. User supplied external horizontal and vertical scan oscillators which allows precise user control over screen resolution. A real plus! Requires 25 V - 0 - 25 V input for amps, available separately. Some spec's for you technical people: signal inputs "X" horizontal 16 V P-P  $\pm 8$  V, "Y" vertical 12 V P-P  $\pm 6$  V; "Z" beam drive, 4 V max brightness, 1.0 volt black level. Writing rates "X" amp is .05 inch/usec, "Y" amp is .0375 inch/usec. Great for making your own video games, oscilloscope monitors, or adapting for home computer use. Supplied with schematic. **\$199.00 ea.** Shpg. Wt. 45 Lbs. MOT-19C **2 / \$375.00**

Supplied with schematic. Quantity pricing available. Shpg. Wt. 45 Lbs. MOT-19C **\$199.00 ea, \$375.00/2**

TRANSFORMER FOR ABOVE Shpg. Wt. 15 Lbs. **\$12.00**

## CAD CAM KEYBOARD



We only have a very limited quantity of these high reliability, beautifully layed out 8 bit, serial output keyboards. These were made by Keytronics for use in a Cad-Cam system. The board is made up of 3 sections. The typewriter format section has 2 control keys plus full upper and lower case alpha-nums. The 42 keyswitch pad, when used with appropriate logic, allows extensive, precise manipulations of displayed data such as close up, moving information, sketching, etc. The third section consists of 27 keys which include a numeric scratch pad, 4 way cursor control plus some command keys. On board are 3 LSI's including an Intersil IM6402, INS8048, and NS2716 UV PROM which contains the programs for manipulating data, plus other circuitry and an alert beeper. The keyboard requires +5 V and -12 V. Each one will come with schematics. New and unused. Shpg. Wt. 4 Lbs. KYBRD No. 6 **\$45.00**  
Less than 100 on hand - Order Now!

**PHONE ORDERS for FASTEST SERVICE!**  
call (617) 595-2275 and Charge It!

## Multi-Voltage MICRO-PROCESSOR POWER SUPPLY BOARD

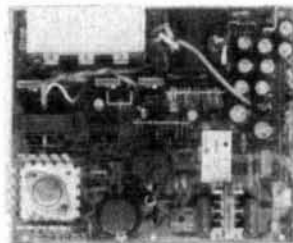

This regulated multi-voltage switching power supply board is made by KEPCO (their part no. MRM 174 KF) and is still in production (. . . regular price \$124.95). It was originally part of the Zorba portable PC. The four outputs are as follows: & +5 VDC @ 5 A, +12 VDC @ 2.8 A, +12 VDC @ 2 A, and -12 VDC @ .5 A. The +12 VDC @ 2 A is very heavily filtered so it could be used on a glitch free monitor. The -12 VDC @ .5 A can be changed to -5 VDC just by changing the onboard 7912 regulator chip to a 7905. The board's lightweight and small size should make it perfect for many projects. All new and provided with a schematic. The input is jumper selectable 110/220. New, unused. Quantity prices available. **\$49.95**  
Shpg. Wt. 2 Lbs. ea. SPL-471-33B **2 / \$90.00**

## EPSON PRINTERS

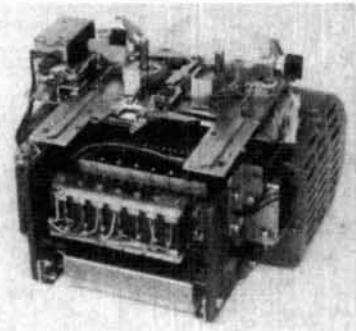

Two surplus printers made for the computer industry by Shimshu Seiki/Epson. One prints alpha-numeric characters and the other prints numeric characters plus other symbols. These may have been intended for use in cash registers but other uses come to mind. Good enough to print program listings, using hard copy verification on timing devices or just for parts. Heck, the price is right. Runs on +5 V and 12 V. With pinout data. Shpg. Wt. 8 Lbs. (either printer).

Alpha numeric type SPL-465-33A **\$17.50**  
Numeric only SPL-466-33A **\$15.00**

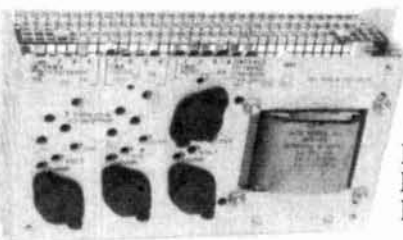

## LOGIC and DISC DRIVE POWER SUPPLIES

2 New, surplus power supplies made by N. J. E. . Both feature 115/230 50/60 Hz. inputs, fully regulated and filtered d. c. outputs, built-in adjustable overvoltage protection, and built-in adjustable current limiting. The supplies are enclosed and come with data. 2 models listed below.

Dual Outputs: +12 or +15 vdc 3 amps and -12 or -15 vdc 3 amps shpg. weight 6 lb. Model no. PS-5 A **\$30.00**  
Triple Outputs: 5 vdc 6 amps, +12 or +15 vdc 1 amp and -12 or -15 vdc 1 amp. Shpg. wt. 6 lb. Model no. PS-6 A **\$35.00**

Send for our free 72 page catalogue jam packed with goodies.



**Surplus Computer and Electronic Materials**

# John J. Meshna Jr., Inc.

19 Allerton Street • Lynn, MA 01904 • Tel: (617) 595-2275

## DUAL FLOPPY DISC DRIVES

BRAND NEW, single sided, dual floppy disc drives made for Digital Equipment Corp. (DEC). This beautiful piece of computer hardware consists of 2 Shugart compatible TEAC 40 track, double density, 5 1/4" mini-floppy disc drives brand new in the case with their own regulated, switching power supply, cooling fan & on/off switch. Each unit also comes with a line cord & documentation. These were made for DEC, but are also compatible with other personal computers such as IBM, TRS 80 models I, II, & the Color Computer, and other Shugart compatible interfaces. Naturally, you supply the cables and disc controller card to suit your particular system. The RX-180 AB runs off of 115/230 VAC 50/60 Hz. w/out any modifications to the drives. Each system comes in the original factory box and are guaranteed functional. A blockbuster of a buy !!

Shpg. wt. 21 lb. stock no. RX 180AB \$250.00

RX 180 AB modified to run w/ the TI 99/4A \$285.00

Disc drive cable for Radio Shack Model I \$15.00

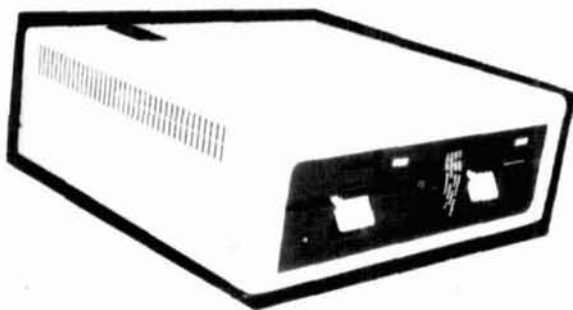

## HIGH SPEED KSR PRINTER TERMINAL

World famous, high speed G. E. Terminet 1200 RS 232 KSR printer terminals are now in stock ready for shipment to you. This has to be one of the finest letter quality printers ever offered at a bargain price. These terminals can be used as an RS 232 asynchronous communications terminal or used in the local mode as a typewriter. The terminals were removed from service for upgrading. Highlights of these machines are: Standard RS 232, full duplex, asynchronous data comm., fully formed upper and lower case letters, 128 character ASCII set, selectable baud rates of 110, 300, or 1200 BPS, 80 columns on pin feed paper, and less weight & size than an ASR 35 teletype with far less racket. They are virtually electronically foolproof as every pc board is Pico fuse protected. Should your machine not work, just check the on board fuses & 9 out of 10 times that is where the problem lies. Schematics are provided w/ each machine sold. Current price of this machine new is over \$2000.00 ! Our meager price for this fantastic printer is only 10% of this: \$200.00 each!!! Visually inspected prior to shipment to insure completeness. Shpd. truck freight collect. \$200.00



## IBM 745 SELECTRIC BASED TYPEWRITER PRINTERS



Send S.A.S.E. for free data sheet

These rugged, handsome printers were made for one of the giants of the computer industry. They can be used as a standard typewriter or as a printer in a word processing system for true letter quality printing. Solenoids were added to the selectric mechanism which disabled the manual repeat function but still allows electronic repeat functions. It uses standard IBM typing balls. The voltage requirements are standard 115 VAC, 5 VDC at 100 ma, and 24 VDC at 4 amps. All are new in factory boxes, but may require adjustments. We provide literature and schematics with 1 ribbon and cleaning tools. With the addition of our Centronics to Selectric I/O adapter, you could easily interface this printer to almost any micro computer system. Typewriter Printer stock no. RE 1000 A \$375.00, 745 manual \$30.00 Shpg wt approx. 80 Lbs, shpd by truck, collect.

## CENTRONICS TO SELECTRIC INTERFACE

This interface will adapt a Redactron Selectric I/O typewriter mechanism to be used as a parallel ASCII compatible printer. The parallel input port provides compatibility to Centronics standards for both "busy" and "acknowledge" protocols. The interface requires only +5 VDC at 350 ma. This interface is fully built, less power supply, is guaranteed operational, and comes with data. Shpg wt. 15 lbs DE 201 A, \$245.00

These compact, lightweight switching power supply boards were originally made for the Texas Instrument 99/4 A micro computer. It measures only 4-3/4 x 4-1/8 x 1-1/4" and puts out +5 VDC @ 1.2 A, -5 VDC @ 0.120 A, and +12 VDC @ .350 A. Input is 14.4 VAC to 21.6 VAC. A simple transformer or plug in the wall adapter will do. Our SPL 461-33 supply listed below is perfect for this board. Each one is new, individually packaged with data. For short money, you can get a nice little power supply or spare parts for your TI 99/4 A. Shpg. Wt. 1 Lb.  
Power Supply Board SP-53 A \$10.00

AC Adapter for same, Shpg. Wt. 2 Lbs.  
SP-461-33 \$6.50

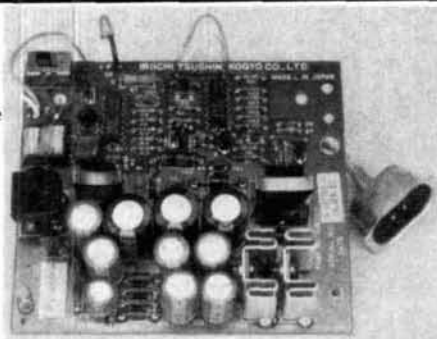

REGULATED  
LOGIC  
POWER  
SUPPLY  
BOARD  
for  
TI 99/4A



Phone Orders accepted on MC, VISA, or AMEX Surplus Electronic Material  
No COD's. Tel. 1-617-595-2275

Send for our free 72 page catalogue jam packed with goodies.

# TUBES

| TYPE           | PRICE    | TYPE             | PRICE    | TYPE               | PRICE    |
|----------------|----------|------------------|----------|--------------------|----------|
| 2C39/7289      | \$ 34.00 | 1182/4600A       | \$500.00 | ML7815AL           | \$ 60.00 |
| 2E26           | 7.95     | 4600A            | 500.00   | 7843               | 107.00   |
| 2K28           | 200.00   | 4624             | 310.00   | 7854               | 130.00   |
| 3-500Z         | 102.00   | 4657             | 84.00    | ML7855KAL          | 125.00   |
| 3-1000Z/8164   | 400.00   | 4662             | 100.00   | 7984               | 14.95    |
| 3B28/866A      | 9.50     | 4665             | 500.00   | 8072               | 84.00    |
| 3CX400U7/8961  | 255.00   | 4687             | P.O.R.   | 8106               | 5.00     |
| 3CX1000A7/8283 | 526.00   | 5675             | 42.00    | 8117A              | 225.00   |
| 3CX3000F1/8239 | 567.00   | 5721             | 250.00   | 8121               | 110.00   |
| 3CW30000H7     | 1700.00  | 5768             | 125.00   | 8122               | 110.00   |
| 3X2500A3       | 473.00   | 5819             | 119.00   | 8134               | 470.00   |
| 3X3000F1       | 567.00   | 5836             | 232.50   | 8156               | 12.00    |
| 4-65A/8165     | 69.00    | 5837             | 232.50   | 8233               | 60.00    |
| 4-125A/4D21    | 79.00    | 5861             | 140.00   | 8236               | 35.00    |
| 4-250A/5D22    | 98.00    | 5867A            | 185.00   | 8295/PL172         | 500.00   |
| 4-400A/8438    | 98.00    | 5868/AX9902      | 270.00   | 8458               | 35.00    |
| 4-400B/7527    | 110.00   | 5876/A           | 42.00    | 8462               | 130.00   |
| 4-400C/6775    | 110.00   | 5881/6L6         | 8.00     | 8505A              | 95.00    |
| 4-1000A/8166   | 444.00   | 5893             | 60.00    | 8533W              | 136.00   |
| 4CX250B/7203   | 54.00    | 5894/A           | 54.00    | 8560/A             | 75.00    |
| 4CX250FG/8621  | 75.00    | 5894B/8737       | 54.00    | 8560AS             | 100.00   |
| 4CX250K/8245   | 125.00   | 5946             | 395.00   | 8608               | 38.00    |
| 4CX250R/7580W  | 90.00    | 6083/AZ9909      | 95.00    | 8624               | 100.00   |
| 4CX300A/8167   | 170.00   | 6146/6146A       | 8.50     | 8637               | 70.00    |
| 4CX350A/8321   | 110.00   | 6146B/8298       | 10.50    | 8643               | 83.00    |
| 4CX350F/8322   | 115.00   | 6146W/7212       | 17.95    | 8647               | 168.00   |
| 4CX350FJ/8904  | 140.00   | 6156             | 110.00   | 8683               | 95.00    |
| 4CX600J/8809   | 835.00   | 6159             | 13.85    | 8877               | 465.00   |
| 4CX1000A/8168  | 242.50*  | 6159B            | 23.50    | 8908               | 13.00    |
| 4CX1000A/8168  | 485.00   | 6161             | 325.00   | 8950               | 13.00    |
| 4CX1500B/8660  | 555.00   | 6280             | 42.50    | 8930               | 137.00   |
| 4CX5000A/8170  | 1100.00  | 6291             | 180.00   | 6L6 Metal          | 25.00    |
| 4CX10000D/8171 | 1255.00  | 6293             | 24.00    | 6L6GC              | 5.03     |
| 4CX15000A/8281 | 1500.00  | 6326             | P.O.R.   | 6CA7/EL34          | 5.38     |
| 4CW800F        | 710.00   | 6360/A           | 5.75     | 6CL6               | 3.50     |
| 4D32           | 240.00   | 6399             | 540.00   | 6DJ8               | 2.50     |
| 4E27A/5-125B   | 240.00   | 6550A            | 10.00    | 6DQ5               | 6.58     |
| 4PR60A         | 200.00   | 6883B/8032A/8552 | 10.00    | 6GF5               | 5.85     |
| 4PR60B         | 345.00   | 6897             | 160.00   | 6GJ5A              | 6.20     |
| 4PR65A/8187    | 175.00   | 6907             | 79.00    | 6GK6               | 6.00     |
| 4PR1000A/8189  | 590.00   | 6922/6DJ8        | 5.00     | 6HB5               | 6.00     |
| 4X150A/7034    | 60.00    | 6939             | 22.00    | 6HF5               | 8.73     |
| 4X150D/7609    | 95.00    | 7094             | 250.00   | 6JG6A              | 6.28     |
| 4X250B         | 45.00    | 7117             | 38.50    | 6JM6               | 6.00     |
| 4X250F         | 45.00    | 7203             | P.O.R.   | 6JN6               | 6.00     |
| 4X500A         | 412.00   | 7211             | 100.00   | 6JS6C              | 7.25     |
| 5CX1500A       | 660.00   | 7213             | 300.00*  | 6KN6               | 5.05     |
| KT88           | 27.50    | 7214             | 300.00*  | 6KD6               | 8.25     |
| 416B           | 45.00    | 7271             | 135.00   | 6LF6               | 7.00     |
| 416C           | 62.50    | 7289/2C39        | 34.00    | 6LQ6 G.E.          | 7.00     |
| 572B/T160L     | 49.95    | 7325             | P.O.R.   | 6LQ6/6MJ6 Sylvania | 9.00     |
| 592/3-200A3    | 211.00   | 7360             | 13.50    | 6ME6               | 8.90     |
| 807            | 8.50     | 7377             | 85.00    | 12AT7              | 3.50     |
| 811A           | 15.00    | 7408             | 2.50     | 12AX7              | 3.00     |
| 812A           | 29.00    | 7609             | 95.00    | 12BY7              | 5.00     |
| 813            | 50.00    | 7735             | 36.00    | 12JB6A             | 6.50     |

NOTE \* = USED TUBE

NOTE P.O.R. = PRICE ON REQUEST

"ALL PARTS MAY BE NEW, USED, OR SURPLUS. PARTS MAY BE SUBSTITUTED WITH COMPARABLE PARTS IF WE ARE OUT OF STOCK OF AN ITEM.

NOTICE: ALL PRICES ARE SUBJECT TO CHANGE WITHOUT NOTICE.

For information call: (602) 242-3037

**Toll Free Number**  
**800-528-0180**  
**(For orders only)**

"All parts may be new or surplus, and parts may be substituted with comparable parts if we are out of stock of an item."

**MHz electronics**

PRICES SUBJECT TO CHANGE WITHOUT NOTICE

# "FILTERS"

## COLLINS Mechanical Filter #526-9724-010 MODEL F455Z32F

455KHZ at 3.2KHz wide. May be other models but equivalent. May be used or new, \$15.99

### ATLAS Crystal Filters

|  |       |
|--|-------|
| 5.595-2.7/8/LSB, 5.595-2.7/LSB   |       |
| 8 pole 2.7KHz wide Upper sideband. Impedance 800ohms 15pf In/800ohms 0pf out.  | 19.99 |
| 5.595-2.7/8/U, 5.595-2.7/USB   |       |
| 8 pole 2.7KHz wide Upper sideband. Impedance 800ohms 15pf In/800ohms 0pf out.  | 19.99 |
| 5.595-.500/4, 5.595-.500/4/CW  |       |
| 4 pole 500 cycles wide CW. Impedance 800ohms 15pf In/800ohms 0pf out.          | 19.99 |
| 9.0USB/CW  |       |
| 6 pole 2.7KHz wide at 6dB. Impedance 680ohms 7pf In/300ohms 8pf out. CW-1599Hz | 19.99 |

### KOKUSAI ELECTRIC CO, Mechanical Filter #MF-455-ZL/ZU-21H

|  |       |
|--|-------|
| 455KHz at Center Frequency of 453.5KC. Carrier Frequency of 455KHz 2.36KC Bandwidth. |       |
| Upper sideband. (ZU)   | 19.99 |
| Lower sideband. (ZL)   | 19.99 |

\*\*\*\*\*

### CRYSTAL FILTERS

|          |            |  |         |
|----------|------------|--|---------|
| NIKKO    | FX-07800C  | 7.8MHz   | \$10.00 |
| TEW      | FEC-103-2  | 10.6935MHz   | 10.00   |
| SDK      | SCH-113A   | 11.2735MHz   | 10.00   |
| TAMA     | TF-31H250  | CF 3179.3KHz                                       | 19.99   |
| TYCO/CD  | 001019880  | 10.7MHz 2pole 15KHz bandwidth                      | 5.00    |
| MOTOROLA | 4884863B01 | 11.7MHz 2pole 15KHz bandwidth                      | 5.00    |
| PTI      | 5350C      | 12MHz 2pole 15KHz bandwidth                        | 5.00    |
| PTI      | 5426C      | 21.4MHz 2pole 15KHz bandwidth                      | 5.00    |
| PTI      | 1479       | 10.7MHz 8pole bandwidth 7.5KHz at 3dB, 5KHz at 6dB | 20.00   |
| COMTECH  | A10300     | 45MHz 2pole 15KHz bandwidth                        | 6.00    |
| FRC      | ERXF-15700 | 20.6MHz 36KHz wide                                 | 10.00   |
| FILTECH  | 2131       | CF 7.825MHz  | 10.00   |

\*\*\*\*\*

### CERAMIC FILTERS

|            |                |   |       |
|------------|----------------|---|-------|
| AXEL       | 4F449          | 12.6KC Bandpass Filter 3dB bandwidth 1.6KHz from 11.8-13.4KHz | 10.00 |
| CLEVITE    | TO-01A         | 455KHz+2KHz bandwidth 4-7% at 3dB                             | 5.00  |
|            | TCF4-12D36A    | 455KHz+1KHz bandwidth 6dB min 12KHz, 60dB max 36KHz           | 10.00 |
| MURATA     | BFB455B        | 455KHz  | 2.50  |
|            | BFB455L        | 455KHz  | 3.50  |
|            | CFM455E        | 455KHz +5.5KHz at 3dB, +8KHz at 6dB, +16KHz at 50dB           | 6.65  |
|            | CFM455D        | 455KHz +7KHz at 3dB, +10KHz at 6dB, +20KHz at 50dB            | 6.65  |
|            | CFR455E        | 455KHz +5.5KHz at 3dB, +8KHz at 6dB, +16KHz at 60dB           | 8.00  |
|            | CFU455B        | 455KHz +2KHz bandwidth +15KHz at 6dB, +30KHz at 40dB          | 2.90  |
|            | CFU455C        | 455KHz +2KHz bandwidth +12.5KHz at 6dB, +24KHz at 40dB        | 2.90  |
|            | CFU455G        | 455KHz +1KHz bandwidth +4.5KHz at 6dB, +10KHz at 40dB         | 2.90  |
|            | CFU455H        | 455KHz +1KHz bandwidth +3KHz at 6dB, +9KHz at 40dB            | 2.90  |
|            | CFU455I        | 455KHz +1KHz bandwidth +2KHz at 6dB, +6KHz at 40dB            | 2.90  |
|            | CFW455D        | 455KHz +10KHz at 6dB, +20KHz at 40dB                          | 2.90  |
|            | CFW455H        | 455KHz +3KHz at 6dB, +9KHz at 40dB                            | 2.90  |
|            | SFB455D        | 455KHz  | 2.50  |
|            | SFD455D        | 455KHz +2KHz, 3dB bandwidth 4.5KHz +1KHz                      | 5.00  |
|            | SFE10.7MA      | 10.7MHz 280KHz +50KHz at 3dB, 650KHz at 20dB                  | 2.50  |
|            | SFE10.7MS      | 10.7MHz 230KHz +50KHz at 3dB, 570KHz at 20dB                  | 2.50  |
|            | SFG10.7MA      | 10.7MHz   | 10.00 |
| NIPPON     | LF-B4/CFU455I  | 455KHz +1KHz  | 2.90  |
|            | LF-B6/CFU455H  | 455KHz +1KHz  | 2.90  |
|            | LF-B8          | 455KHz  | 2.90  |
|            | LF-C18         | 455KHz  | 10.00 |
| TOKIN      | CF455A/BFU455K | 455KHz +2KHz  | 5.00  |
| MATSUSHIRA | EFC-L455K      | 455KHz  | 7.00  |

\*\*\*\*\*

### SPECTRA PHYSICS INC, Model 088 HeNe LASER TUBES

|                       |                 |                 |                         |
|-----------------------|-----------------|-----------------|-------------------------|
| POWER OUTPUT 1.6MW.   | BEAM DIA. .75MM | BEAM DIR. 2.7MR | 8KV STARTING VOLTAGE DC |
| 68K OHM 1WATT BALLAST | 1000VDC +100VDC | At 3.7MA        | \$59.99                 |

### ROTRON MUFFIN FANS Model MARK4/MU2A1

|                 |               |          |                       |                |         |
|-----------------|---------------|----------|-----------------------|----------------|---------|
| 115 VAC         | 14WATTS       | 50/60CPS | IMPEDENCE PROTECTED-F | 88CFM at 50CPS | \$ 7.99 |
| 105CFM at 60CPS | THESE ARE NEW |          |                       |                |         |

# MHz electronics

PRICES SUBJECT TO CHANGE WITHOUT NOTICE

**Toll Free Number**  
**800-528-0180**  
**(For orders only)**

All parts may be new or surplus, and parts may be substituted with comparable parts if we are out of stock of an item "

For information call: (602) 242-3037

# RF TRANSISTORS

| TYPE          | PRICE   | TYPE       | PRICE    | TYPE           | PRICE   | TYPE           | PRICE   |
|---------------|---------|------------|----------|----------------|---------|----------------|---------|
| 2N1561        | \$25.00 | 2N5920     | \$ 70.00 | 40608 RCA      | \$ 2.48 | BFY90          | \$ 1.50 |
| 2N1562        | 25.00   | 2N5921     | 80.00    | 40673 RCA      | 2.50    | BLW60C5        | 15.00   |
| 2N1692        | 25.00   | 2N5922     | 10.00    | 40894 RCA      | 1.00    | BLX67          | 12.25   |
| 2N2857        | 1.55    | 2N5923     | 25.00    | 60247 RCA      | 25.00   | BLX67C3        | 12.25   |
| 2N2857JAN     | 4.10    | 2N5941     | 23.00    | 61206 RCA      | 100.00  | BLX93C3        | 22.21   |
| 2N2857JANTX   | 4.50    | 2N5942     | 40.00    | 62800A RCA     | 60.00   | BLY87A         | 7.50    |
| 2N2876        | 13.50   | 2N5944     | 10.35    | 62803 RCA      | 100.00  | BLY88C3        | 13.08   |
| 2N2947        | 18.35   | 2N5945     | 10.00    | 430414/399ORCA | 50.00   | BLY89C         | 13.00   |
| 2N2948        | 13.00   | 2N5946     | 12.00    | 3457159 RCA    | 20.00   | BLY90          | 45.00   |
| 2N2949        | 15.50   | 2N5947     | 9.20     | 3729685-2 RCA  | 75.00   | BLY92          | 13.30   |
| 2N3118        | 5.00    | 2N6080     | 6.00     | 3729701-2 RCA  | 50.00   | BLY94C         | 45.00   |
| 2N3119        | 4.00    | 2N6081     | 7.00     | 3753883 RCA    | 50.00   | BLY351         | 10.00   |
| 2N3134        | 1.15    | 2N6082     | 9.00     | 615467-902     | 25.00   | BLY568C/CF     | 30.00   |
| 2N3287        | 4.90    | 2N6083     | 9.50     | 615467-903     | 40.00   | C2M70-28R      | 92.70   |
| 2N3288        | 4.40    | 2N6084     | 12.00    | 2SC568         | 2.50    | C25-28         | 57.00   |
| 2N3309        | 4.85    | 2N6094     | 11.00    | 2SC703         | 36.00   | C4005          | 2.50    |
| 2N3375        | 17.10   | 2N6095     | 12.00    | 2SC756A        | 7.50    | CD1659         | 20.00   |
| 2N3478        | 2.13    | 2N6096     | 16.10    | 2SC781         | 2.80    | CD1899         | 20.00   |
| 2N3553        | 1.55    | 2N6097     | 20.70    | 2SC1018        | 1.00    | CD1920         | 10.00   |
| 2N3553JAN     | 2.90    | 2N6105     | 21.00    | 2SC1042        | 24.00   | CD2188         | 18.00   |
| 2N3632        | 15.50   | 2N6136     | 21.85    | 2SC1070        | 2.50    | CD2545         | 24.00   |
| 2N3733        | 11.00   | 2N6166     | 40.24    | 2SC1216        | 2.50    | CD2664A        | 16.00   |
| 2N3818        | 5.00    | 2N6267     | 142.00   | 2SC1239        | 2.50    | CD3167         | 92.70   |
| 2N3866        | 1.30    | 2N6304     | 1.50     | 2SC1251        | 24.00   | CD3353         | 95.00   |
| 2N3866JAN     | 2.20    | 2N6368     | 30.00    | 2SC1306        | 2.90    | CD3435         | 26.30   |
| 2N3866JANTX   | 3.80    | 2N6439     | 55.31    | 2SC1307        | 5.50    | CD3900         | 152.95  |
| 2N3866JANTXV  | 4.70    | 2N6459     | 18.00    | 2SC1424        | 2.80    | CM25-12        | 20.00   |
| 2N3866AJANTXV | 5.30    | 2N6567     | 10.06    | 2SC1600        | 5.00    | CM40-12        | 27.90   |
| 2N3924        | 3.35    | 2N6603     | 13.50    | 2SC1678        | 2.00    | CM40-28        | 56.90   |
| 2N3926        | 16.10   | 2N6604     | 13.50    | 2SC1729        | 32.40   | CME50-12       | 30.00   |
| 2N3927        | 17.25   | 2N6679     | 44.00    | 2SC1760        | 1.50    | CTC2001        | 42.00   |
| 2N3948        | 1.75    | 2N6680     | 80.00    | 2SC1909        | 4.00    | CTC2005        | 55.00   |
| 2N3950        | 25.00   | 021-1      | 15.00    | 2SC1945        | 10.00   | CTC3005        | 70.00   |
| 2N3959        | 3.85    | 01-80703T4 | 65.00    | 2SC1946        | 40.00   | CTC3460        | 20.00   |
| 2N4012        | 11.00   | 35C05      | 15.00    | 2SC1947        | 10.00   | DV2820S        | 25.00   |
| 2N4037        | 2.00    | 102-1      | 28.00    | 2SC1970        | 2.50    | DXL1003P70     | 22.00   |
| 2N4041        | 14.00   | 103-1      | 28.00    | 2SC1974        | 4.00    | DXL2001P70     | 19.00   |
| 2N4072        | 1.80    | 103-2      | 28.00    | 2SC2166        | 5.50    | DXL2002P70     | 14.00   |
| 2N4080        | 4.53    | 104P1      | 18.00    | 2SC2237        | 32.00   | DXL350 IAP100F | 47.00   |
| 2N4127        | 21.00   | 163P1      | 10.00    | 2SC2695        | 47.00   | EFJ4015        | 12.00   |
| 2N4416        | 2.25    | 181-3      | 15.00    | A2X1698        | POR     | EFJ4017        | 24.00   |
| 2N4427        | 1.25    | 210-2      | 10.00    | A3-12          | 14.45   | EFJ4021        | 24.00   |
| 2N4428        | 1.85    | 269-1      | 18.00    | A50-12         | 24.00   | EFJ4026        | 35.00   |
| 2N4430        | 11.80   | 281-1      | 15.00    | A209           | 10.00   | EN15745        | 20.00   |
| 2N4927        | 3.90    | 282-1      | 30.00    | A283           | 6.00    | FJ9540         | 16.00   |
| 2N4957        | 3.45    | 482        | 7.50     | A283B          | 6.00    | FSX52WF        | 58.00   |
| 2N4959        | 2.30    | 564-1      | 25.00    | A1610          | 19.00   | G65739         | 25.00   |
| 2N5016        | 18.40   | 698-3      | 15.00    | AF102          | 2.50    | G65386         | 25.00   |
| 2N5026        | 15.00   | 703-1      | 15.00    | AFY12          | 2.50    | GMO290A        | 2.50    |
| 2N5070        | 18.40   | 704        | 4.00     | AR7115         | 20.00   | HEP76          | 4.95    |
| 2N5090        | 13.80   | 709-2      | 11.00    | AT41435-5      | 6.35    | HEPS3002       | 11.40   |
| 2N5108        | 3.45    | 711        | 4.00     | B2-8Z          | 10.70   | HEPS3003       | 30.00   |
| 2N5109        | 1.70    | 733-2      | 15.00    | B3-12          | 10.85   | HEPS3005       | 10.00   |
| 2N5160        | 3.45    | 798-2      | 25.00    | B12-12         | 15.70   | HEPS3006       | 19.90   |
| 2N5177        | 21.62   | 3421       | 28.00    | BAL0204125     | 152.95  | HEPS3007       | 25.00   |
| 2N5179        | 1.04    | 3683P1     | 15.00    | BF25-35        | 56.25   | HEPS3010       | 11.34   |
| 2N5216        | 56.00   | 3992       | 25.00    | B40-12         | 19.25   | HF8003         | 10.00   |
| 2N5470        | 75.00   | 4164P1     | 15.00    | B70-12         | 55.00   | HFET2204       | 112.00  |
| 2N5583        | 3.45    | 4243P1     | 28.00    | BF272A         | 2.50    | HP35821        | 38.00   |
| 2N5589        | 9.77    | 4340P3     | 18.00    | BFQ85          | 2.50    | HP35826B       | 32.00   |
| 2N5590        | 10.92   | 4387P1     | 27.50    | BFR21          | 2.50    | HP35826E       | 32.00   |
| 2N5591        | 13.80   | 7104-1     | 28.00    | BFR90          | 1.00    | HP35831E       | 30.00   |
| 2N5596        | 99.00   | 7249-2     | 10.50    | BFR91          | 1.65    | HP35832E       | 50.00   |
| 2N5636        | 12.00   | 7283-1     | 37.50    | BFR99          | 2.50    | HP35833E       | 50.00   |
| 2N5637        | 15.50   | 7536-1     | 30.00    | BFT12          | 2.50    | HP35859E       | 75.00   |
| 2N5641        | 12.42   | 7794-1     | 10.50    | BFW16A         | 2.50    | HP35866E       | 44.00   |
| 2N5642        | 14.03   | 7795       | 15.00    | BFW17          | 2.50    | HXTR2101       | 44.00   |
| 2N5643        | 25.50   | 7795-1     | 15.00    | BFW92          | 1.50    | HXTR3101       | 7.00    |
| 2N5645        | 13.80   | 7796-1     | 24.00    | BFX44          | 2.50    | HXTR5101       | 31.00   |
| 2N5646        | 20.70   | 7797-1     | 36.00    | BFX48          | 2.50    | HXTR6104       | 68.00   |
| 2N5651        | 11.05   | 40081 RCA  | 5.00     | BFX65          | 2.50    | HXTR6105       | 31.00   |
| 2N5691        | 18.00   | 40279 RCA  | 10.00    | BFX84          | 2.50    | HXTR6106       | 33.00   |
| 2N5764        | 27.00   | 40280 RCA  | 4.62     | BFX85          | 2.50    | J310           | 1.00    |
| 2N5836        | 3.45    | 40281 RCA  | 10.00    | BFX86          | 2.50    | JO2000         | 10.00   |
| 2N5842        | 8.45    | 40282 RCA  | 20.00    | BFX89          | 1.00    | JO2001         | 25.00   |
| 2N5847        | 19.90   | 40290 RCA  | 2.80     | BFY11          | 2.50    | JO4045         | 24.00   |
| 2N5849        | 20.00   | 40292 RCA  | 13.05    | BFY18          | 2.50    | KD5522         | 25.00   |
| 2N5913        | 3.25    | 40294 RCA  | 2.50     | BFY19          | 2.50    | KJ5522         | 25.00   |
| 2N5916        | 36.00   | 40341 RCA  | 21.00    |                |         | M1106          | 13.75   |

**Toll Free Number**  
**800-528-0180**  
**(For orders only)**

"All parts may be new or surplus, and parts may be substituted with comparable parts if we are out of stock of an item."

For information call: (602) 242-3037

PRICES SUBJECT TO CHANGE WITHOUT NOTICE

**MHz electronics**



## RF TRANSISTORS (CONTINUED)

|             |         |                  |         |              |          |           |         |
|-------------|---------|------------------|---------|--------------|----------|-----------|---------|
| M1107       | \$16.75 | MRF458           | \$20.70 | NEO2160ER    | \$100.00 | SD1009    | \$15.00 |
| M1131       | 5.15    | MRF464           | 25.30   | NEO21350     | 5.30     | SD1009-2  | 15.00   |
| M1132       | 7.25    | MRF466           | 18.97   | NE13783      | 61.00    | SD1012    | 10.00   |
| M1134       | 13.40   | MRF472           | 1.50    | NE21889      | 43.00    | SD1012-3  | 10.00   |
| M9116       | 29.10   | MRF475           | 3.10    | NE57835      | 5.70     | SD1012-5  | 10.00   |
| M9579       | 6.00    | MRF476           | 3.16    | NE64360ER-A  | 100.00   | SD1013    | 10.00   |
| M9580       | 7.95    | MRF477           | 20.00   | NE64480 (B)  | 94.00    | SD1013-3  | 10.00   |
| M9587       | 7.00    | MRF479           | 8.05    | NE73436      | 2.50     | SD1013-7  | 10.00   |
| M9588       | 5.20    | MRF492           | 23.00   | NE77362ER    | 100.00   | SD1016    | 15.00   |
| M9622       | 5.95    | MRF502           | 1.04    | NE98260ER    | 100.00   | SD1016-5  | 15.00   |
| M9623       | 7.95    | MRF503           | 6.00    | PRT8637      | 25.00    | SD1018-4  | 13.00   |
| M9624       | 9.95    | MRF504           | 7.00    | PT3127A      | 5.00     | SD1018-6  | 13.00   |
| M9625       | 15.95   | MRF509           | 5.00    | PT3127B      | 5.00     | SD1018-7  | 13.00   |
| M9630       | 14.00   | MRF511           | 10.69   | PT3127C      | 20.00    | SD1018-15 | 13.00   |
| M9740       | 27.90   | MRF515           | 2.00    | PT3127D      | 20.00    | SD1020-5  | 10.00   |
| M9741       | 27.90   | MRF517           | 2.00    | PT3127E      | 20.00    | SD1028    | 15.00   |
| M9755       | 16.00   | MRF525           | 3.45    | PT3190       | 20.00    | SD1030    | 12.00   |
| M9780       | 5.50    | MRF559           | 1.76    | PT3194       | 20.00    | SD1030-2  | 12.00   |
| M9827       | 11.00   | MRF587           | 11.00   | PT3195       | 20.00    | SD1040    | 5.00    |
| M9848       | 35.00   | MRF605           | 20.00   | PT3537       | 7.80     | SD1040-2  | 20.00   |
| M9850       | 13.50   | MRF618           | 25.00   | PT4166E      | 20.00    | SD1040-4  | 10.00   |
| M9851       | 20.00   | MRF626           | 12.00   | PT4176D      | 25.00    | SD1040-6  | 5.00    |
| M9860       | 8.25    | MRF628           | 8.65    | PT4186B      | 5.00     | SD1043    | 12.00   |
| M9887       | 2.80    | MRF629           | 3.45    | PT4209       | 25.00    | SD1043-1  | 10.00   |
| M9908       | 6.95    | MRF641           | 25.30   | PT4209C/5645 | 25.00    | SD1045    | 3.75    |
| M9965       | 12.00   | MRF644           | 27.60   | PT4556       | 24.60    | SD1049-1  | 2.00    |
| MM1500      | 25.00   | MRF646           | 29.90   | PT4570       | 7.50     | SD1053    | 4.00    |
| MM1550      | 10.00   | MRF648           | 33.35   | PT4577       | 20.00    | SD1057    | 10.00   |
| MM1552      | 50.00   | MRF816           | 15.00   | PT4590       | 5.00     | SD1065    | 4.75    |
| MM1553      | 50.00   | MRF823           | 20.00   | PT4612       | 20.00    | SD1068    | 15.00   |
| MM1607      | 8.45    | MRF846           | 44.85   | PT4628       | 20.00    | SD1074-2  | 18.00   |
| MM1614      | 10.00   | MRF892           | 35.50   | PT4640       | 20.00    | SD1074-4  | 28.00   |
| MM1810      | 15.00   | MRF894           | 46.00   | PT4642       | 20.00    | SD1074-5  | 28.00   |
| MM1810      | 15.00   | MRF901 3 Lead    | 1.00    | PT5632       | 4.70     | SD1076    | 18.50   |
| MM1943      | 1.80    | MRF901 4 Lead    | 2.00    | PT5749       | 25.00    | SD1077    | 4.00    |
| MM2608      | 5.00    | MRF902/2N6603JAN | 15.00   | PT6612       | 25.00    | SD1077-4  | 4.00    |
| MM3375A     | 17.10   | MRF902B          | 18.40   | PT6619       | 20.00    | SD1077-6  | 4.00    |
| MM4429      | 10.00   | MRF904           | 2.30    | PT6708       | 25.00    | SD1078-6  | 24.00   |
| MM8000      | 1.15    | MRF905           | 2.55    | PT6709       | 25.00    | SD1080-7  | 7.50    |
| MM8006      | 2.30    | MRF911           | 2.50    | PT6720       | 25.00    | SD1080-8  | 6.00    |
| MM8011      | 25.00   | MRF965           | 2.55    | PT8510       | 15.00    | SD1080-9  | 3.00    |
| MPSU31      | 1.01    | MRF966           | 3.55    | PT8524       | 25.00    | SD1084    | 8.00    |
| MRA2023-1.5 | 42.50   | MRF1000MA        | 32.77   | PT8609       | 25.00    | SD1087    | 15.00   |
| MRF134      | 10.50   | MRF1004M         | 31.05   | PT8633       | 25.00    | SD1088    | 22.00   |
| MRF136      | 16.00   | MRF2001          | 41.74   | PT8639       | 25.00    | SD1088-8  | 22.00   |
| MRF171      | 35.00   | MRF2005          | 54.97   | PT8659       | 25.00    | SD1089-5  | 15.00   |
| MRF208      | 11.50   | MRF5176          | 24.00   | PT8679       | 25.00    | SD1090    | 15.00   |
| MRF212      | 16.10   | MRF8004          | 2.10    | PT8708       | 20.00    | SD1094    | 15.00   |
| MRF221      | 10.00   | MSC11720-12      | 225.00  | PT8709       | 20.00    | SD1095    | 15.00   |
| MRF223      | 13.00   | MSC1821-3        | 125.00  | PT8727       | 29.00    | SD1098-1  | 30.00   |
| MRF224      | 13.50   | MSC1821-10       | 225.00  | PT8731       | 25.00    | SD1100    | 5.00    |
| MRF227      | 3.45    | MSC2001          | 30.00   | PT8742       | 19.10    | SD1109    | 18.00   |
| MRF230      | 2.00    | MSC2010          | 93.00   | PT8787       | 25.00    | SD1115-2  | 7.50    |
| MRF231      | 10.00   | MSC2223-10       | 245.00  | PT8828       | 25.00    | SD1115-3  | 7.50    |
| MRF232      | 12.07   | MSC2302          | POR     | PT9700       | 25.00    | SD1115-7  | 2.10    |
| MRF237      | 3.15    | MSC3000          | 35.00   | PT9702       | 25.00    | SD1116    | 5.00    |
| MRF238      | 13.80   | MSC3001          | 38.00   | PT9783       | 16.50    | SD1118    | 22.00   |
| MRF239      | 17.25   | MSC72002         | POR     | PT9784       | 32.70    | SD1119    | 5.00    |
| MRF245      | 35.65   | MSC73001         | POR     | PT9790       | 56.00    | SD1124    | 50.00   |
| MRF247      | 31.00   | MSC80064         | 35.00   | PT31083      | 20.00    | SD1132-1  | 15.00   |
| MRF304      | 36.00   | MSC80091         | 10.00   | PT31962      | 20.00    | SD1132-4  | 12.00   |
| MRF306      | 50.00   | MSC80099         | 3.00    | PTX6680      | 20.00    | SD1133    | 9.50    |
| MRF313      | 11.15   | MSC80593         | POR     | RE3754       | 25.00    | SD1133-1  | 10.00   |
| MRF314      | 29.21   | MSC80758         | POR     | RE3789       | 25.00    | SD1134-1  | 2.50    |
| MRF315      | 28.86   | MSC82001         | 33.00   | RF35         | 16.00    | SD1134-4  | 12.00   |
| MRF316      | 55.43   | MSC82014         | 33.00   | RF85         | 17.50    | SD1134-7  | 12.00   |
| MRF317      | 63.94   | MSC82020M        | 130.00  | RF110        | 21.00    | SD1135    | 10.25   |
| MRF412      | 18.00   | MSC82030         | 33.00   | S50-12       | 23.80    | SD1135-3  | 12.00   |
| MRF420      | 20.12   | MSC83001         | 40.00   | S3006        | 15.00    | SD1136    | 12.50   |
| MRF421      | 25.00   | MSC83003         | 82.00   | S3007        | 10.00    | SD1136-2  | 12.50   |
| MRF422      | 38.00   | MSC83005         | 70.00   | S3031        | 22.00    | SD1143-1  | 10.00   |
| MRF427      | 17.25   | MSC83026         | POR     | SCA3522      | 5.00     | SD1143-3  | 17.00   |
| MRF428      | 63.00   | MSC83303         | POR     | SCA3523      | 5.00     | SD1144    | 4.00    |
| MRF433      | 12.07   | MSC84900         | 60.00   | SD345        | 5.00     | SD1145-5  | 15.00   |
| MRF449/A    | 12.65   | MT4150           | 14.40   | SD445        | 5.00     | SD1146    | 15.00   |
| MRF450/A    | 14.37   | MT5126           | 25.00   | SD1004       | 15.00    | SD1147    | 15.00   |
| MRF452/A    | 17.00   | MT5596(2N)       | 99.00   | SD1007       | 15.00    | SD1188    | 10.00   |
| MRF453/A    | 18.40   | MT5768(2N)       | 95.00   | SD1007-2     | 15.00    | SD1189    | 24.00   |
| MRF454/A    | 20.12   | MT8762           | 25.00   | SD1007-4     | 15.00    | SD1200    | 1.50    |
| MRF455/A    | 16.00   | NEO2136          | 2.00    | SD1007-5     | 15.00    | SD1201-2  | 15.00   |

**Toll Free Number**  
**800-528-0180**  
**(For orders only)**

"All parts may be new or surplus, and parts may be substituted with comparable parts if we are out of stock of an item."

For information call: (602) 242-3037

# MHz electronics

PRICES SUBJECT TO CHANGE WITHOUT NOTICE





# PRICE SLASHED!

**Even Further**

**WAS \$39.95 retail**

**NOW \$9.95**

**SAVE 75% off the  
regular retail price**

**SUPER deal with the publisher allows us to drop the price of the Bill Orr RADIO HANDBOOK to the low, low price of just \$9.95!**

## **RADIO HANDBOOK** by William Orr, W6SAI

Some selected subjects covered include:

|                                  |                                |                                   |
|----------------------------------|--------------------------------|-----------------------------------|
| Electronic Fundamentals          | FM and Repeaters               | HF General Purpose Antennas       |
| Semiconductor Devices            | RFI                            | Fixed Directive Arrays            |
| Vacuum Tube Principles           | Equipment Design               | Rotary Beam Antennas              |
| Special Microwave Tubes          | Transmitter Keying and Control | VHF & UHF Antennas                |
| Radio Frequency Power Amplifiers | Power Supplies                 | Test Equipment                    |
| SSB Transmission and Reception   | Radiation and Propagation      | The Oscilloscope                  |
| Amplification of RF Energy       | The Transmission Line          | Construction Practices            |
| Frequency Synthesis              | Antenna Matching Systems       | Electronics Math and Calculations |

This book certainly is one of the finest reference sources available today. The 22nd edition reflects the very latest in state-of-the-art techniques in a comprehensive single source reference book. Invaluable for hams, electronics technicians, design engineers, and hobbyists alike. Over 1,000 pages of information found in earlier editions plus more on antennas, amplifiers, theory, and semiconductors to name just a few of the updated sections. The *Radio Handbook* is chock-full of practical, tested projects that run from high powered RF amplifiers and state-of-the-art equipment to "Weekender" type projects to upgrade overall station performance. This book will be of interest to all levels of electronic expertise. At this special price, you can't afford to pass up a value like this. Order yours today. 1136 pages. ©1981. 22nd edition.

**21874 Hardbound**

Limited quantities are available. Order now. **\$9.95**

Please add \$3.00 to cover shipping & handling.

*This is the very latest edition. No new edition is about to be issued. This is not a close out.*

**ham  
radio** magazine  
GREENVILLE, NH 03048

# BOOKSTORE

(603) 878-1441

# RAMSEY

# THE FIRST NAME IN ELECTRONIC TEST GEAR



## 20 MHz DUAL TRACE OSCILLOSCOPE

Unsurpassed quality at an unbeatable price, the Ramsey oscilloscope compares to others costing hundreds more. Features include a component testing circuit for resistor, capacitor, digital circuit and diode testing • TV video sync filter • wide bandwidth & high sensitivity • internal graticule • front panel trace rotator • Z axis • high sensitivity x-y mode • regulated power supply • built-in calibrator • rock solid triggering. \*USA — add \$10.00 per unit for postage, overseas orders add 15% of total order for insured surface mail.

**\$399.95\***

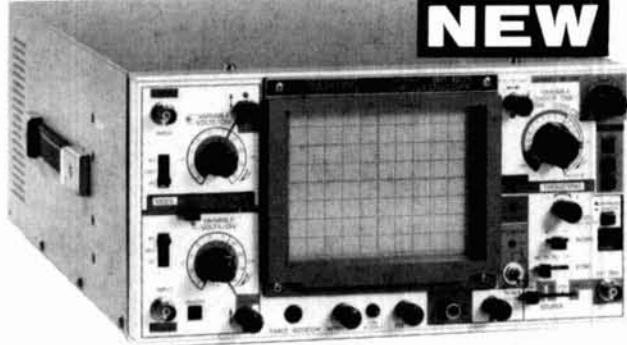

**NEW**

## 45 MHz DUAL SWEEP OSCILLOSCOPE

The Ramsey 625 is a dual time base, delayed sweep unit that includes a built-in signal delay line to permit clear viewing during very short rise times of high frequency waveforms. Other features include: variable trigger holdoff • 20 calibrated sweep time ranges from 0.5 ns/div. to 0.2 μs/div. • fully adjustable sweep time • X5 sweep magnification • five trigger sources: CH1, CH2, LINE EXTERNAL and INTERNAL (TV mode) • front panel x-y operation, Z axis input • sum difference of CH1 and CH2 waveforms displayed as single trace • sweep gate and sweep output • auto focus • single sweep. \*USA — add \$10.00 per unit for postage, overseas orders add 15% of total order for insured surface mail.

**\$799.95\***



### RAMSEY D-1100 VOM MULTITESTER

Compact and reliable, designed to service a wide variety of equipment. Features include • mirror back scale • double-jeweled precision moving coil • double overload protection • an ideal low cost unit for the beginner or as a spare back-up unit.

**\$1.95** test leads and battery included



### NEW RAMSEY 1200 VOM MULTITESTER

Check transistors, diodes and LEDs with this professional quality meter. Other features include: decibel scale • 20K volt metering system • 3 1/2" mirrored scale • polarity switch • 20 measuring ranges • safety probes • high impact plastic case.

**\$2.495** test leads and battery included

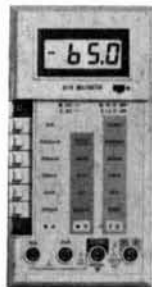

### RAMSEY D-3100 DIGITAL MULTIMETER

Reliable, accurate digital measurements at an amazingly low cost • in-line color coded push buttons, speeds range selection • abs plastic tilt stand • recessed input jacks • overload protection on all ranges • 3 1/2 digit LCD display with auto zero, auto polarity & low BAT. indicator.

**\$4.95** test leads and battery included



### CT-70 7 DIGIT 525 MHz COUNTER

Lab quality at a breakthrough price. Features • 3 frequency ranges each with pre amp • dual selectable gate times • gate activity indicator • 50mV @ 150 MHz typical sensitivity • wide frequency range • 1 ppm accuracy

**\$11.995** wired includes AC adapter

CT-70 kit ..... \$99.95  
BP-4 nicad pack ..... 8.95



### CT-90 9 DIGIT 600 MHz COUNTER

The most versatile for less than \$300. Features 3 selectable gate times • 9 digits • gate indicator • display hold • 25mV @ 150 MHz typical sensitivity • 10 MHz timebase for WWV calibration • 1 ppm accuracy

**\$14.995** wired includes AC adapter

CT-90 kit ..... \$129.95  
OV-1 0.1 PPM oven timebase ..... 59.95  
BP-4 nicad pack ..... 8.95



### CT-125 9 DIGIT 1.2 GHz COUNTER

A 9 digit counter that will outperform units costing hundreds more. • gate indicator • 24mV @ 150 MHz typical sensitivity • 9 digit display • 1 ppm accuracy • display hold • dual inputs with preamps

**\$16.995** wired includes AC adapter

BP-4 nicad pack ..... 8.95



### CT-50 8 DIGIT 600 MHz COUNTER

A versatile lab bench counter with optional receive frequency adapter, which turns the CT-50 into a digital readout for most any receiver • 25 mV @ 150 MHz typical sensitivity • 8 digit display • 1 ppm accuracy

**\$16.995** wired

CT-50 kit ..... \$139.95  
RA-1 receiver adapter kit ..... 14.95



### DM-700 DIGITAL MULTIMETER

Professional quality at a hobbyist price. Features include 26 different ranges and 5 functions • 3 1/2 digit, 1/2 inch LED display • automatic decimal placement • automatic polarity

**\$11.995** wired includes AC adapter

DM-700 kit ..... \$99.95  
MP-1 probe set ..... 4.95



### PS-2 AUDIO MULTIPLIER

The PS-2 is handy for high resolution audio resolution measurements, multiplies UP in frequency • great for PL tone measurements • multiplies by 10 or 100 • 0.01 Hz resolution & built-in signal preamp/conditioner

**\$4.995** wired

PS-2 kit ..... \$39.95



### PR-2 COUNTER PREAMP

The PR-2 is ideal for measuring weak signals from 10 to 1,000 MHz • flat 25 db gain • BNC connectors • great for shifting RF • ideal receiver/TV preamp

**\$4.495** wired includes AC adapter

PR-2 kit ..... \$34.95



### PS-1B 600 MHz PRESCALER

Extends the range of your present counter to 600 MHz • 2 stage preamp • divide by 10 circuitry • sensitivity: 25mV @ 150 MHz • BNC connectors • drives any counter

**\$5.995** wired includes AC adapter

PS-1B kit ..... \$49.95

### ACCESSORIES FOR RAMSEY COUNTERS

- Telescopic whip antenna—BNC plug . . . \$ 8.95
- High impedance probe, light loading . . . 16.95
- Low pass probe, audio use . . . . . 16.95
- Direct probe, general purpose use . . . . 13.95
- Tilt ball, for CT-70, 90, 125 . . . . . 3.95



**PHONE ORDERS CALL  
716-586-3950**

TELEX 466735 RAMSEY CI

TERMS: • satisfaction guaranteed • examine for 10 days; if not pleased, return in original form for refund • add 6% for shipping and insurance to a maximum of \$10.00 • overseas add 15% for surface mail • COD add \$2.50 (COD in USA only) • orders under \$15.00 add \$1.50 • NY residents add 7% sales tax • 90 day parts warranty on all kits • 1 year parts & labor warranty on all wired units.



**RAMSEY ELECTRONICS, INC.**  
2575 Baird Rd.  
Penfield, N.Y. 14626



# NEW products

## the Century 22

Ten-Tec has announced the return of the Ten-Tec Century transceiver. The Century 22 is a 50-watt, 6-band CW transceiver that features a variable audio filter, automatic gain control, an SWR bridge, automatic level control, and an electronically switched "S" meter.

The Century 22 measures 4 x 10 x 10.5 inches (25 x 101 x 29 cm), weighs 6 pounds (2.7 kg), and is priced at \$389.

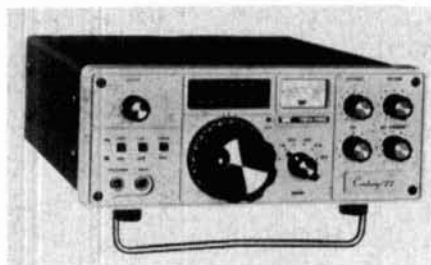

For information, contact Ten-Tec, Inc., Sevierville, Tennessee 37862.

## 7-band scanning radio

Heath Company has introduced the only kit-built scanner to cover aircraft, marine and public service bands, *all in one unit*. The GR-740 40-Channel Scanning Radio covers all seven UHF/VHF radio bands, scans 40 user-selected frequencies and provides direct access to any frequency in the seven bands.

The 24-key keyboard is divided into program and operate sections for simplified operation. Forty different channels (frequencies) are easily programmed into the two 20-channel memory banks. Either bank can be scanned at five or 15 channels per second; the GR-740's search can be programmed or changed at the touch of a button. A priority channel can be sampled every two seconds, with interruption when a signal is detected.



Patented track tuning permits receiving frequencies across the full band without adjustments; circuitry is automatically aligned to each monitored frequency. A large digital, front-panel display shows the channels and features selected. All circuit boards are factory-assembled and pre-aligned to ensure that even the first-time kit builder can build and operate one of the world's best scanning radios, with a minimum of time and at a substantial savings.

For more information about the GR-740 40-Channel Scanning Radio, contact Heath Company, Dept. 150-315, Benton Harbor, Michigan 49022.

Circle #301 on Reader Service Card.

## TAPR packet radio controller

Advanced Electronic Applications, Inc. has announced the introduction of the Model PKT-1, packet radio controller, through an arrangement with Tucson Amateur Packet Radio, Inc. (TAPR), Tucson, Arizona. While the end user price is \$589.95, Amateur Radio operators can take advantage of a discounted price of \$499.95 through participating AEA dealers.

The PKT-1 is a packaged and warranted version of the well-known do-it-yourself TAPR kit board with version 3.1 software. The purchase price includes application assistance and a year's conditional warranty.

Packet Radio is a burst mode of data or text transmission utilizing AFSK, FSK, or PSK modulation. On VHF it runs at 1200 Baud typically and uses CRC error checking, ensuring an extremely low error rate. Multiple users may share a simplex or duplex channel simultaneously on a timeshare multiplexed basis.

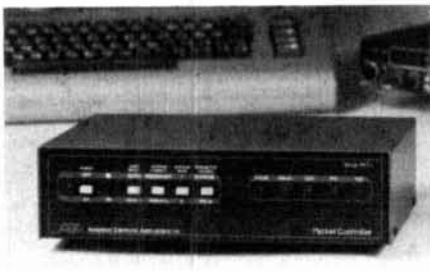

Any packet station using the PKT-1 may operate as a store-and-forward repeater (Digipeater) for someone else's transmission while concurrently functioning as a regular packet station. Up to 8 Digipeating stations may be used between two terminal stations. Digipeating allows routing the transmission path around physical obstacles blocking a line-of-sight radio path and allows extending the link beyond line-of-sight distances.

For detailed information, contact Advanced Electronic Applications, Inc., P.O. Box C2160, Lynnwood, Washington 98036-0918

Circle #304 on Reader Service Card.

## TOUCHTONE™ DECODER KIT

### DTMF Receiver Kit



- Complete DTMF Receiver (SSI 201)
- Receive all 16 standard DTMF digits
- No front end filters needed
- Output either hex or BCD format
- CMOS low power (29ma @ 12 V D.C.)
- Excellent speech immunity
- Includes 3.58Mhz crystal, 22 pin IC socket, resistor and capacitors, data sheet, schematics
- "Digit Valid" detection, "DV" goes high after a valid tone pair is sensed
- Make your own "SELLCALL" repeater decoder, etc.
- Quantity discounts available

**\$22.95** Includes shipping USA (Add 6% CA address)

SEND CHECK OR MONEY ORDER TO:  
**ENGINEERING CONSULTING**  
583 CANDLEWOOD ST., BREA, CA 92621  
714/671-2008

## FREE CATALOG!

Features Hard-to-Find Tools  
and Test Equipment



Jensen's new catalog features hard-to-find precision tools, tool kits, tool cases and test equipment used by ham radio operators, hobbyists, scientists, engineers, laboratories and government agencies. Call or write for your free copy today.

**JENSEN TOOLS INC.** 7815 S. 46th Street  
Phoenix, AZ 85040  
(602) 968-6231

✓ 172

## COMMODORE -USER WRITTEN SOFTWARE-

Supporting all COMMODORE computers  
Written by users, for users  
★ GAMES ★ UTILITIES ★ EDUCATIONAL ★  
**VIC 20™**

Vic 20 collections #1 thru 11  
50+ programs per collection-Tape/Disk \$10.00 each

**COMMODORE 64™**  
64 collections # 1 thru 11  
25+ programs per collection-Tape/Disk \$10.00 each

**PET®/CBM®** Software Available  
Other products available are  
**P.D.I. PROGRAM MANUAL - \$5.00**  
Each Vic 20 and Commodore 64 program will have instructions operation, use, commands and other information to make using it as easy as possible.

**DINSET™: Reset Switch**  
**SERIAL CABLES**  
**LOC-LITE™** Operation Status Indicator

Prices include U.S. shipping and handling only.  
**CHECK, MONEY ORDERS, VISA and MASTERCARD**  
accepted. **NO C.O.D.'s**  
Write For A Free Flyer Or Send 60¢ In Coin Or Stamps  
For A Complete Catalog.

**'PUBLIC DOMAIN™, INC.** ✓ 204  
5025 S. Rangeline Rd., W. Milton, OH 45383  
10:00 a.m. - 5:00 p.m. EST - Mon. thru Fri.  
(513) 698-5638 or (513) 339-1725





### TVRO cable

Nemal Electronics International of North Miami, Florida, has introduced a new addition to its line of direct burial combination cable for use in TVRO installations. Nemal type-4 satellite control cable is the first combination cable available to the satellite industry containing an RG-6/U, 18 gauge, 95 percent copper shielded signal cable. SCC-4 also contains two conductors of 12 gauge, three conductors of 18 gauge, three conductors of 20 gauge shielded plus drain wire, and three conductors of 22 gauge shielded plus drain wire.

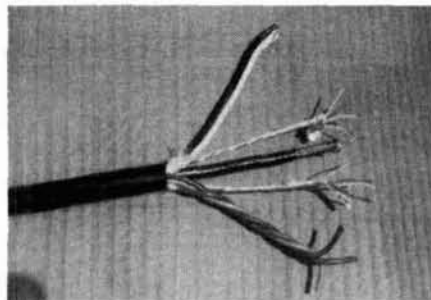

All Nemal satellite control cables utilize a patented direct-burial polyethylene jacket as well as tinned copper drain wires. Nemal also offers a complete line of over 500 types of cable, connectors, and SMATV products.

For additional information, contact Nemal Electronics International, Inc., 12240 N.E. 14th Avenue, North Miami, Florida 33161.

Circle #303 on Reader Service Card.

### outdoor scanner antenna

Hamtronics, Inc. has announced a new antenna for scanner and monitor buffs. The compact ACT-1 Power Antenna, which may be installed easily on the side of a house, outside a window, in an attic, etc., without any special masts or brackets, is a broadband whip antenna with a low-noise preamplifier in its base. Although smaller than a full-size outdoor antenna (only 25 inches tall), the ACT-1 provides good coverage of distant signals and often outperforms larger antennas because of its active booster amplifier. A low-noise microwave transistor in the preamp provides excellent results from 30 MHz right up through the new 800-MHz band, and covers low-band, high-band, and UHF.

The ACT-1 Power Antenna is mounted to any flat vertical surface with four wood screws. The 50-foot cable plugs directly into the "antenna" and "12V" jacks on the rear of most scanner radios. If your particular scanner doesn't have

# Choosing the Best Antenna is... DUCK SOUP!



There are a lot of companies claiming to have the best rubber duck antennas, but when all the claims are boiled down, one rises to the top, CENTURION.

Besides having the advantage of peak performance and reliable quality assurance management backed by the most sophisticated RF testing equipment, Centurion gives you the quality visual appearance so important in the sale of your radio.

Centurion is the most popular original equipment antenna among leading manufacturers of hand-held radios, and variety of styles is another reason.

Centurion has created many different models with nine standard styles to choose from, including 1/4 wave models designed for high and low band VHF and UHF, 1/2 wave gain models for UHF and 5/8 wave telescoping models for VHF. Featured in the standard line are miniature models for UHF and VHF and pagers. Twenty-five different connectors are now available. And in the event the connector you need has not yet been invented, Centurion will design and manufacture it to meet your specifications.

Every antenna is factory-tuned. Field-tunable models are also available. When you want the best looking, best performing antenna for your radios, it's DUCK SOUP when you specify Centurion.



800/228-4563

P.O. Box 82846 Lincoln, NE 68501-2846

133

## DESIGN ENGINEERS

### CONSIDER OPPORTUNITIES IN THE SOUTHWEST

A rapidly expanding general aviation electronics manufacturer is seeking action-oriented, advancement-motivated engineers who are challenged by the exciting field of avionics.

Candidates with a BSEE and 2-5 years experience are sought for the design and development of aviation communication and navigation products. Successful applicants will be provided with an outstanding benefit package including educational assistance, profit-sharing and paid relocation.

Whether on the mountain slopes or on the courts and courses in the city, Albuquerqueans enjoy outdoor sports and recreation throughout the year.

We are a dynamic, growing Corporation . . .

CONSIDER THE OPPORTUNITIES

Send resume to:  
Vice President, Engineering  
Terra Corporation  
3520 Pan American Freeway N.E.  
Albuquerque, N.M. 87107



**Digital vs Analog Battle Is Over**

The Winner Fluke  
New Fluke 70 Series combining digital & analog displays at low cost

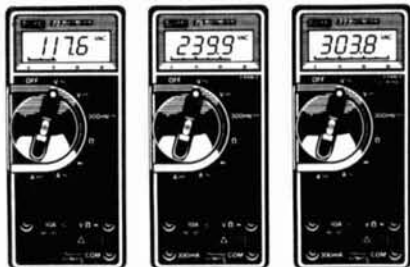

|  |   |  |
|--|---|--|
| <b>Fluke 73</b><br>\$85  | <b>Fluke 75</b><br>\$99   | <b>Fluke 77</b><br>\$129   |
| Analog/digital display<br>Volts ohms 10A diode test                                | Analog/digital display<br>Volts ohms 10A mA diode test  | Analog/digital display<br>Volts ohms 10A mA diode test   |
| Autorange<br>0.7% basic dc accuracy<br>2000 + hour battery life<br>3-year warranty | Audible continuity<br>Autorange/range hold<br>0.5% basic dc accuracy<br>2000 + hour battery life<br>3-year warranty | "Touch Hold" function<br>Autorange/range hold<br>0.3% basic dc accuracy<br>2000 + hour battery life<br>3-year warranty<br>Multipurpose holster |

**FLUKE** Dealer Inquiries Invited

**ESKA RX99PL NEW**

Professional Receiver  
PLL-Synthesized AM/SSB  
99 Memories - AM PL DET.

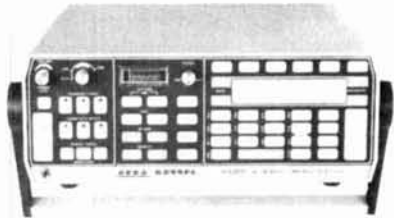

Hi tech from Europe never before available a receiver with so much  
Price range \$800-\$1500  
Delivery Dec. 1984  
Free SWL Catalog  
Dealer inquiries invited

**BIRD** Electronics  
East Coast's #1 Distributor  
Complete Line Available

Call for quotes on all your Bird needs Dealer inquiries invited

**800-368-3270**

**Electronic Equipment Bank**  
(703) 938-3350  
516 Mill Street N.E.  
Vienna, VA 22180 ✓ 149

**ENGINEERING CONSULTING INTRODUCES**

**'REMOTE A PAD' MODEL RAP-1**

2 FOUR DIGIT DTMF DECODERS, PLUS 16 DIGIT KEYPAD CONTROL

**TUNE THE WORLD FROM YOUR HANDHELD VHF/UHF RADIO**

- Audio tones from any source are converted to solid state switches which control any 16 digit keypad of a radio or other device.
- Some examples you can control include the Pro-Search™ Rotator (rotator beam remotely), ICOM IC-701 or ICOM IC-211 when using the RM-2 controller (ICOM 7050 & 751), Adren PCS-4000, handhelds such as Yaesu FT-208 B1, 709, ICOM IC-102AT, and many more.
- Anything you can do manually with your 16 digit keypad, the RAP-1 will do remotely using audio touch tones from any source.
- Two (four digit) programmable access codes are used to operate relays of other on/off functions.
- LED decoder status indicators and momentary plus/minus state decoder outputs are provided.
- 22 gold pin card edge connector, 16 pin dip socket and ribbon cable are supplied.
- All CMOS low power drain (30mA), S.S.I. 201 Decoder.
- Hook eight wires (4 rows and 4 columns) in parallel with the existing keypad of the radio you wish to control remotely. Connect audio from any source 12 volts D.C. and you are in control.
- The dual 4 digit decoders will turn your lines on and off using your programmable access code.
- Detailed interface diagrams and instructions included with purchase. Interface cable for Pro-Search™ \$9.95 (single pack socket).

Model RAP-1  
**\$149.95**  
'Remote A Pad' Remote control interface board and DTMF decoder

**ICOM IC-02AT USER'S "AUDIO BLASTER"™ MODULE**

Now Available for IC-2AT

- Module installs inside the radio in 10 minutes.
- Boosts audio to really "blast".
- Low power drain (100 mA stand by).
- Complete step by step instructions included.
- Corrects the 100W audio problem!
- Drive external speakers to full volume even signals with low deviation.

152  
More Audio Punch

Model AB-1 **\$19.95**  
Price includes postage and handling. U.S.A. CA res. add 6%

Send check or money order to:  
**ENGINEERING CONSULTING**  
583 CANDLEWOOD ST., BREA, CA 92621  
(714) 671-2009

**ALL BAND TRAP ANTENNAS**

PRE-TUNED-ASSEMBLED ONLY ONE NEAT SMALL ANTENNA FOR ALL BANDS! EXCELLENT FOR APARTMENTS! IMPROVED DESIGN!

FOR ALL MAKES AMATEUR TRANSCEIVERS GUARANTEED FOR 200K WATTS SSB INPUT FOI NOVICE AND ALL CLASS AMATEURS!

COMPLETE with 90 ft. RG58U-52 ohm feedline, an PL259 connector, insulators, 30 ft. 300 ohm test dacron ant supports, center connector with built in lightning arrester and static discharge. Low SWR over all bands - Tuners usually NOT NEEDED! Can be used as inverted V's - slopers - in attics, or building tops or narrow lots. The ONLY ANTENNA YOU WILL EVER NEED FOR ALL BANDS! NO BALUNS NEEDED!

60-40-20-15-10 -- 2 trap - 104 ft. - Model 998BUC...\$99.95  
40-20-15-10 -- 2 trap -- 54 ft. - Model 1001BUC...\$98.95  
20-15-10 meter - 2 trap - 26 ft. - Model 1007BUC...\$97.95

SEND FULL PRICE FOR POSTPAID INSURED DEL. IN USA (Canada is \$5.00 extra for postage - clerical - customs etc) or order using VISA - MASTER CARD - AMER. EXPRESS Give number and exp. date. Ph 1-308-236-5333 9AM - 6PM week days. We ship in 2-3 days. ALL PRICES MAY INCREASE! SAVE - ORDER NOW! All antennas guaranteed for 1 year 10 day money back trial if returned in new condition! Made in USA. FREE INFO. AVAILABLE ONLY FROM WESTERN ELECTRONICS ✓ 232

Dept. AR-11 Kearney, Nebraska, 68847

**CADDELL COIL CORP.**

35 Main Street  
Poultney, VT 05764  
802-287-4055

**BALUNS**

Get POWER to your antenna! Our Baluns are already wound and ready for installation in your transmatch or you may enclose them in a weatherproof box and connect them directly at the antenna. They are designed for 3-30 MHz operation. (See ARRL Handbook pages 19-9 or 6-20 for construction details.)

|   |         |
|---|---------|
| 100 Watt (4:1, 6:1, 9:1, or 1:1 impedance - select one) | \$ 8.50 |
| Universal Transmatch 1 KW (4:1 impedance)               | 12.50   |
| Universal Transmatch 2 KW (4:1 impedance)               | 15.00   |
| Universal Transmatch 1 KW (6:1, 9:1 or 1:1-select one)  | 14.00   |
| Universal Transmatch 2 KW (6:1, 9:1 or 1:1-select one)  | 16.50   |

Please send all reader inquiries directly.

**TUNE IN THE WORLD OF HAM-TV!**

Under the guidance of the "United States ATV Society," Amateur TV (FSTV-SSTV-FAX) is growing in activity. And, we've been promoting it now for over 18 years!

Sample Issue - Just \$2.50 ppd.  
Special Trial Subscription - \$10.00.

(Published Monthly)  
**A5 ATV Magazine**  
P.O. Box H,  
Lowden, Iowa  
52255

A Division of  
QCD Publications, Inc.

master charge  
VISA

Hams should be "seen" as well as heard! Thousands of ATV operators across the country are sending great looking color TV pictures (with sound) to each other. FSTV-DX can go hundreds of miles. There are now over 80 Ham Television "Repeaters" relaying these video signals over rough terrain.

Ham Radio UHF-TV is as simple as hooking up a 2 meter rig and antenna. Our "Everything You Always Wanted To Know About ATV" 112-page manual will teach you how to do it (\$9.95).

✓ 120





a 12V terminal, a simple 12 VDC plug-in adapter is available.

The price of the ACT-1 Power Antenna is only \$79 plus \$3 for shipping and handling.

For more information, contact Hamtronics, Inc., 65 Moul Road, Hilton, New York 14468-9535.

Circle #305 on Reader Service Card.

## RTTY interface

HAL Communications RTTY Personal Computer Interface, PCI-2000, is a real RTTY modulator/demodulator, not a "computer compromise." All three shifts (170-425-850) transmit and receive. The full "103 type" modem for up to 300 baud may be set for either FDX (answer or originate) or HDX (either set on tones). The "202

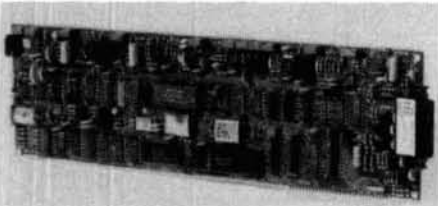

type" modem may be used HDX up to 1200 baud, and may be jumper-selected for either "COM1" or "COM2" operation. Compatible with existing PC communications software (external DAA required for phone line connections, the PCI-2000 offer the multimode features of the CT2100 and CT2200 plus companion software that includes features such as split screen, TX and RX buffers, HERE IS storage, and disk message storage and retrieval. Of course, all PCI-2000 modes are set with the Personal Computer's FN keys.

For further information, contact HAL Communications Corporation, P.O. Box 365, Urbana, Illinois 61801.

Circle #302 on Reader Service Card.

## 150-MHz mini-catalog

Sinclair Radio Laboratories has issued a new mini-catalog describing its line of 150-MHz products, which includes base station antennas, transmitter combiners, duplexers, receiver multicouplers and ferrite isolators.

Featured in this line-up is the Q-Circuit Base Station Duplexer, Model Q-201G, a six-cavity unit that provides high attenuation at close frequency separations in the 132-174 MHz band. Its Q-Circuit design provides 100 dB isolation at 300 kHz spacing with 50 dB mid-band isolation.

For a copy, contact Sinclair Radio Laboratories, 122 Rayette Road, Concord, Ontario, Canada L4K 2G3.

Circle #306 on Reader Service Card.

# Time to talk on a Ten-Tec Talkie

Made in the U.S.A. And it's priced right.



The Ten-Tec 2591 offers everything you've ever wanted in a 2-meter handheld.

- ★ Memory Lockout permits the scanner to temporarily bypass channels for quick lockout of busy frequencies, yet retain them in memory for normal operation on demand
- ★ 10 Memories with stored offset
- ★ Channel 0 accepts any non-standard offset
- ★ Modifiable Band Scan without complete reprogramming. Scan any section of the band within user defined upper and lower limits in steps of 5, 10, 15, 25, or 30 kHz.. Change step size, upper and lower limits independently. Manual Scan also up or down, in 5 kHz steps
- ★ Selectable Skip or Hold
- ★ 2.5 Watts or .4 Watts
- ★ Covers 143.5-148.995 MHz
- ★ LCD Readout with Back Light
- ★ Quick-Release 450 mA NI-CAD Battery Back
- ★ 16-Key Dual Tone Encoder, built-in
- ★ LED shows battery status and transmit mode
- ★ Designed and Manufactured in Tennessee. And it carries the famous TEN-TEC one year warranty. Put it to work for excellent 2 meter performance.



HOLIDAY SPECIAL  
Free case with each Model 2591 —  
Nov. 1 through Jan. 31.

**TEN-TEC, INC.**  
SEVIERVILLE, TENNESSEE 37862

Homebrew  
Headquarters



ANTENNA TUNER

Viewstar — Mod. VS300A

Fully Assembled and Tested **\$89.95**

Plus \$3.00 Shipping & Handling

## MATCH MOST ANTENNA-FEEDLINE COMBINATIONS TO YOUR RIG

**MATCHES:** dipoles, inverted vees, beams quads, verticals, mobile whips, random wire, etc. that are fed by coax, balanced line or single wire

**MAXIMUM POWER:** 300 watts RF INPUTS (selectable from front panel):

3-coax: 1-direct, 2-direct or thru tuner  
1-balanced line (4:1 balun inc.) or single wire

**IN-LINE CALIBRATED WATTMETER INCLUDED**

### ALSO IN STOCK

**KITS:** for HF, VHF, UHF & Test Equipment

**COMPONENTS:** Toroids, Rods & Beads, Resistors, Inductors, Capacitors, Antenna Components & Wire

1984-85 CATALOG 50¢

**RADIOKIT**

Box 411H, Greenville, NH 03048  
(603) 878-1033, telex 887697

CALL TOLL FREE FOR QUOTES

# TNT RADIO SALES INC.

1-800-328-0250

1-612-535-5050

(IN MINNESOTA—COLLECT)

## ICOM SPECIAL VALUE!

### IC-02AT 2 METER HT and IC-04AT 440 MHz HT

- Digital LCD Readout
- Scanning
- Programmable PL Tones
- Optional 5W Battery
- S-Meter Function
- 10 Memories
- Offset Storage
- Lithium Memory Backup
- 13.8VDC Operation!
- Sealed Case

**S.A.S.E. NOW! FOR FREE TNT HOT SHEET OF USED (AND NEW) EQUIPMENT—NOVICE TO EXTRA**



with  
**FREE  
CP-1  
MOBILE  
PWR/CHG  
CORD**

IC-02AT  
**\$299**

IC-04AT  
**\$339**

**KENWOOD  
ICOM  
MIRAGE  
AEA  
KANTRONICS  
SANTEC  
KDK  
AZDEN  
NYE VIKING  
MFJ  
TELEX HY-GAIN  
HUSTLER  
KLM  
ROHN  
HEIL  
AMERITRON  
WELZ  
LARSEN  
BUTTERNUT  
BENCHER**

VISA/MASTERCARD  
DISCOUNT—CASH



WRITE FOR OUR  
"BENCH-TESTED"  
USED EQUIPMENT LISTING

MONDAY - SATURDAY  
9 AM to 6 PM CENTRAL TIME

4124 West Broadway, Robbinsdale, MN 55422 (Mpls./St. Paul)

222

# PRE-PUBLICATION SPECIAL

## NOW'S THE TIME TO ORDER YOUR 1985 Radio Amateur Callbooks

### U.S. CALLBOOK

All the latest calls, addresses and other important information. Fully up-to-date and edited to ensure accuracy. ©1984.

CB-US85

**Softbound \$25**

(\$21.95 + \$3.05 s & h)

### FOREIGN CALLBOOK

The **only** source of DX calls and addresses available. Fully updated and has helpful QSL information. ©1984.

CB-F85

**Softbound \$24**

(\$20.95 + \$3.05 s & h)

1985 US and Foreign CALLBOOKS will be ready for shipping by early December. All orders received before Nov. 15, 1984 will be expedited direct from the printer.

Order Both and SAVE even more  
Regular Price \$45

**HAM RADIO**

**PRE-PUBLICATION SPECIAL \$39.95**

**SAVE \$5**

162

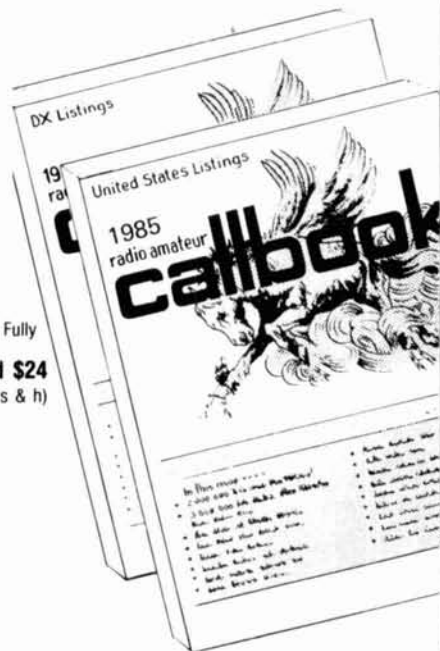

**ham  
radio** magazine

**BOOKSTORE**  
GREENVILLE, NH 03048

# KA2UXR AB/CDE

## Tie Tacks

Handsome 14 karat gold tie tacks with your call individually handwrought in white or yellow gold with a satin finish and antiqued background.

When ordering please specify white or yellow gold large or small (shown actual size) and carefully print your call.

**Small \$41.00 Large \$57.00**

Please add \$3.00 to cover shipping and insurance.

Send check or money order to:

Robert S. Schurmann, KA2UXR  
5031 River Road, Pennsauken, NJ 08110  
(609) 488-2266

New Jersey Residents add 6% sales tax

213

R-T HV Mark II



LT.  
HT

### NEW, EASY-TO-USE DESIGN GET TRANSI-TRAP™ LIGHTNING PROTECTION

Protect your valuable equipment from antenna voltage surges caused by nearby lightning, high wind and static build-up. Keeps harmful ARC-energy off equipment by safely shunting it to ground. Uses tested, field proven, and replaceable ARC-PLUG™ gas filled ceramic cartridge.

Model LT 200 watts @ 50Ω ..... \$19.95  
Model HT 2kw @ 50Ω ..... \$24.95  
Ruggedized Super Low Loss (.1dB @ 500 MHz)  
Model R-T 200 watts @ 50Ω ..... \$29.95  
Model HV 2kw @ 50Ω ..... \$32.95

See your local dealer or order direct. Pse. include \$2 for shipping and handling. MC and VISA accepted.

# ALPHA DELTA COMMUNICATIONS

P.O. Box 571, Centerville, Ohio 45459  
(513) 435-4772

108

## HI TECH KITS

FROM  
MICROBYTE SYSTEMS

### THIS MONTH'S SPECIALS

#### CMOS KEYSER KIT

BATTERY OPERATED SELF-COMPLETING. SMALL ENOUGH TO MOUNT ON KEYBOARD. \$9.95 COMPLETE KIT \$24.95

#### RS-232 LINE MONITOR KIT

MONITOR SEVEN STANDARD DATA LINES AND TWO OPTIONAL. BOARD \$9.95 COMPLETE KIT \$19.95

#### CRT BLANKER KIT

PREVENTS PHOSPHOR BURN — RESTORES SCREEN DATA WITH FIRST KEYSTROKE. BOARD \$9.95 COMPLETE KIT \$19.95

#### DRIVE MOTOR CONTROL KIT

SAVES WEAR AND TEAR ON 8 INCH DRIVES. NO LOST DATA. ONLY FOUR CONNECTIONS. BOARD \$12.95 COMPLETE KIT \$29.95

#### COMMODORE 20/64 RS-232

CONVERTS VIC TTL LEVELS TO RS-232 STANDARDS. BOARD \$14.95 COMPLETE KIT \$29.95

#### MANY MORE KITS AVAILABLE

SEND \$1.00 FOR NEW CATALOG (REFUNDABLE ON FIRST ORDER) NOT REQUIRED WITH ORDERS

VISA MASTER CARD CHECKS C.O.D.

DEALER INQUIRIES WELCOME. ADD \$3.00 SHIPPING AND HANDLING. ILL. RES. ADD 8% SALES TAX.

Microbyte systems 312-870-0555  
6524 N. HIAWATHA AVE. OPEN EVENINGS  
CHICAGO, IL 60646

183

COMMODORE 20/64 REG. TRADEMARKS OF COMMODORE INTL.

# NEMAL ELECTRONICS INTL., INC.

your one stop coax supplier!



Exclusive

## SATELLITE CONTROL CABLE

AVAILABLE IN  
250-500-1000  
FT. ROLLS  
OR BY  
THE FOOT

Designed for easy, one-step installation, providing the required cables for most earth station equipment, all in a direct burial jacket.

**TYPE 1**  
(General Purpose)  
1 — RG59/U 96% Copper Braid  
5 @ 22 Gauge  
2 @ 22 Gauge  
Shielded plus Tinned Copper Drain Wire  
2 @ 18 Gauge  
55¢/ft.

4 TYPES AVAILABLE!

**TYPE 2**  
(MT)

1 — RG59/U 96% Copper Braid  
2 @ 12 Gauge  
3 @ 18 Gauge  
2 @ 20 Gauge  
Shielded plus Tinned Copper Drain Wire  
3 @ 22 Gauge Shielded plus Tinned Copper Drain Wire  
75¢/ft.

**TYPE 3**  
(Interstat)

2 — RG59/U 96% Copper Braid  
2 @ 12 Gauge  
3 @ 18 Gauge  
2 @ 20 Gauge  
Shielded plus Tinned Copper Drain Wire  
95¢/ft.

NEW!!! Lowest Loss

**TYPE 4**

1 — RG6/U 18 Gauge 96% Copper Shield  
2 @ 12 Gauge  
3 @ 18 Gauge  
3 @ 20 Gauge  
Shielded plus Tinned Copper Drain Wire  
3 @ 22 Gauge Shielded plus Tinned Copper Drain Wire  
79¢/ft.

Only Nemal offers the quality construction RG59/U copper shielding made to mil spec JAN C-17, 12 gauge conductors, tinned copper drain wires, and a true direct burial polyethylene jacket.

### HARDLINE

Two styles, two sizes for all installation needs

- Aluminum Outer Conductor with Polyethylene Jacket**
    - 1/2 inch loss .48 dB/100 ft. @ 30 MHz  
3.68 dB/100 ft. @ 1000 MHz ..... \$1.25/ft.
    - 7/8 inch loss .28 dB/100 ft. @ 30 MHz  
2.54 dB/100 ft. @ 1000 MHz ..... \$3.25/ft.
  - Corrugated Copper Outer Conductor with Polyethylene Jacket**
    - 1/2 inch loss .38 dB/100 ft. @ 30 MHz  
(FLC12-50J) 2.78 dB/100 ft. @ 1000 MHz ..... \$1.59/ft.
    - 7/8 inch loss .13 dB/100 ft. @ 30 MHz  
(FLC12-78J) 1.3 dB/100 ft. @ 1000 MHz ..... \$3.92/ft.
- COMPARE RG 213 1.25 dB/100 @ 30 MHz  
8.5 dB/100 @ 1000 MHz !

### HARDLINE CONNECTORS

- 1/2 inch aluminum UHF M/F \$19.00 Type N M/F \$22.00  
7/8 inch aluminum UHF M/F \$49.00 Type N M/F \$49.00  
1/2 inch copper UHF M/F \$22.00 Type N M/F \$22.00  
7/8 inch copper UHF M/F \$49.00 Type N M/F \$49.00

#### shipping

Cable — \$6.00 per 100 ft.  
Connectors — \$3.00 per order.  
Orders under \$20 add \$2 additional plus shipping.  
Charge card — orders over \$30 only.  
COD add \$2.00. Florida Residents add 5%.

FACTORY AUTHORIZED DISTRIBUTOR  
AMPHENOL, CABLEWAVE, COLUMBIA,  
KINGS, BLONDER-TONGUE

- COAXIAL CABLE
- MULTICONDUCTOR CABLE
- CONNECTORS-ADAPTERS
- HARDLINE
- SMATV PRODUCTS
- COAX-SEAL
- COMPUTER CABLE
- CRIMP TOOLS

### COAXIAL CABLE SALE POLYETHYLENE DIELECTRIC

- RG-8/U 96% shield Mil Spec. (\$29.95/100) or 31¢/ft.  
RG11U 96% shield 75 ohm mil spec ..... 25¢/ft.  
RG-58/U double shield (RG-58 size) 50 ohm ..... 45¢/ft.  
RG58U mil spec 96% shield. (\$9.95/100) or 11¢/ft.  
RG62A/U 96% shield mil spec 93 ohm ..... 12¢/ft.  
RG174/U min. 50 Ω mil spec ..... 10¢/ft.  
RG213 noncontaminating 96% shield mil spec ..... 36¢/ft.  
RG214/U double silver shield 50 ohm ..... \$1.65/ft.  
RG214/U tinned copper ..... 65¢/ft.  
RG217/U double shield 50Ω 5/8" OD ..... 85¢/ft.

### LOW LOSS FOAM DIELECTRIC

- RG-8X (Mini 8) 95% shield ..... (\$14.95/100) or 17¢/ft.  
RG8U 80% shield ..... (\$19.95/100) or 22¢/ft.  
RG-8/U 97% shield 11 gu. (eq. Belden 8214) ..... 31¢/ft.  
RG58U 80% shield ..... 07¢/ft.  
RG58U 95% shield ..... 10¢/ft.  
RG59/U 100% foil shield TV type ..... 10¢/ft.  
RG59/U 70% copper shield ..... 09¢/ft.  
HEAVY DUTY ROTOR CABLE 2-16 ga 6-20 ga ..... 36¢/ft.  
Rotor cable 2-18 ga 6-22 ga Poly burial Jkt. .... 19¢/ft.  
Complete line of multiconductor cables available

### CONNECTORS MADE IN USA

- Amphenol PL 259 ..... 79¢  
PL-259 push-on adapter shell ..... 10/\$3.89  
PL-259 and/or SO-239 ..... 10/\$5.89  
Double Male Connector ..... \$1.79  
PL-258 Double Female Connector ..... 98¢  
PL-259 Silver-Teflon Kings ..... \$1.59 ea.  
Reducer UG-175 or 176 ..... 10/\$1.99  
UG-255 (PL-259 to BNC) ..... \$2.95  
Elbow (M359) UHF Elbow ..... \$1.79  
F59A (TV type) ..... 10/\$1.99  
UG 21 D/U Type N Male for RG8, Amphenol ..... \$3.00  
UG-88C/U BNC Male for RG-58, Amphenol ..... \$1.25  
UG 273 BNC-PL259 Amphenol ..... \$3.00  
3/16 inch Mike Plug for Collins etc. (cutoff) ..... \$1.25

#### shipping

Cable — \$3.00 per 100 ft.  
Connectors — add 10%, \$3.00 minimum.  
Orders under \$20 add \$2 additional plus shipping.  
Charge card — orders over \$30 only.  
COD add \$2.00. Florida Residents add 5%.



12240 N.E. 14th Ave.  
No. Miami, FL 33161

Telephone: (305) 893-3924

IN STOCK  
— OVER 500 ITEMS —  
COMPLETE LINES

193

70 cm

## GaAs FET Pre-Amp, 18 dB Gain

2 meter



Since our first ad in May '84 many of your VHF/UHF colleagues have successfully installed this preamp.

- Low noise  $\leq .75$  dB
- 18 dB gain
- Dual gate GaAs FET
- N connectors
- Weatherproof mast mount

EVV-2000 GaAs FET Preamp } \$109.95 + \$5 shipping  
EVV-700 GaAs FET Preamp }  
VV-Interface Bias Insertor } \$29.95 + \$2.50 shipping

171

## INTERNATIONAL MEDIA SERVICE

BOX 26 • TEWKSBURY, MA 01876



*Ham Radio's guide to help you find your local dealer*

## California

**C & A ROBERTS, INC.**  
18511 HAWTHORN BLVD.  
TORRANCE, CA 90504  
213-370-7451  
24 Hour: 800-421-2258  
Not The Biggest, But The Best —  
Since 1962.

**FONTANA ELECTRONICS**  
8628 SIERRA AVENUE  
FONTANA, CA 92335  
714-822-7710  
714-822-7725  
The Largest Electronics Dealer in San  
Bernardino County.

**JUN'S ELECTRONICS**  
3919 SEPULVEDA BLVD.  
CULVER CITY, CA 90230  
213-390-8003  
800-882-1343 Trades  
Habla Espanol

## Connecticut

**HATRY ELECTRONICS**  
500 LEDYARD ST. (SOUTH)  
HARTFORD, CT 06114  
203-527-1881  
Call today. Friendly one-stop shopping  
at prices you can afford.

## Delaware

**AMATEUR & ADVANCED  
COMMUNICATIONS**  
3208 CONCORD PIKE  
WILMINGTON, DE 19803  
(302) 478-2757  
Delaware's Friendliest Ham Store.

**DELAWARE AMATEUR SUPPLY**  
71 MEADOW ROAD  
NEW CASTLE, DE 19720  
302-328-7728  
800-441-7008  
Icom, Ten-Tec, Microlog, Yaesu,  
Kenwood, Santec, KDK, and more.  
One mile off I-95, no sales tax.

## Florida

**AMATEUR ELECTRONIC SUPPLY**  
1898 DREW STREET  
CLEARWATER, FL 33575  
813-461-4267  
Clearwater Branch  
West Coast's only full service  
Amateur Radio Store.  
Hours M-F 9-5:30, Sat. 9-3

**AMATEUR ELECTRONIC SUPPLY**  
621 COMMONWEALTH AVE.  
ORLANDO, FL 32803  
305-894-3238  
Fla. Wats: 1 (800) 432-9424  
Outside Fla: 1 (800) 327-1917  
Hours M-F 9-5:30, Sat. 9-3

**AMATEUR RADIO CENTER, INC.**  
2805 N. E. 2ND AVENUE  
MIAMI, FL 33137  
305-573-8383  
The place for great dependable  
names in Ham Radio.

## Hawaii

**HONOLULU ELECTRONICS**  
819 KEEAUMOKU STREET  
HONOLULU, HI 96814  
(808) 949-5564  
Serving Hawaii & Pacific area for 51  
years. Complete lines of Amateur equip-  
ment, accessories and parts.

## Illinois

**ERICKSON COMMUNICATIONS, INC.**  
5456 N. MILWAUKEE AVE.  
CHICAGO, IL 60630  
312-631-5181  
Hours: 9:30-5:30 Mon, Tu, Wed & Fri;  
9:30-8:00 Thurs; 9:00-3:00 Sat.

## Indiana

**THE HAM SHACK**  
808 NORTH MAIN STREET  
EVANSVILLE, IN 47710  
812-422-0231  
Discount prices on Ten-Tec, Cubic,  
Hy-Gain, MFJ, Azden, Kantronics,  
Santec and others.

## Kentucky

**L & S RADIO**  
307 McLEAN AVENUE  
HOPKINSVILLE, KY 42240  
502-885-8071  
Ten-Tec, Azden, Ameritron Sales and  
Service.

## Massachusetts

**TEL-COM, INC.**  
675 GREAT ROAD, RTE. 119  
LITTLETON, MA 01460  
617-486-3400  
617-486-3040  
The Ham Store of New England  
You Can Rely On.

## Michigan

**ENCON PHOTOVOLTAICS**  
Complete Photovoltaic Systems  
27600 Schoolcraft Rd.  
Livonia, Michigan 48150  
313-523-1850  
Amateur Radio, Repeaters, Satellite,  
Computer applications.  
Call Paul WDBAHO

## Nevada

**AMATEUR ELECTRONIC SUPPLY**  
1072 N. RANCHO DRIVE  
LAS VEGAS, NV 89106  
702-647-3114  
Dale Porray "Squeak," AD7K  
Outside Nev: 1 (800) 634-6227  
Hours M-F 9-5:30, Sat. 9-3

**JUN'S ELECTRONICS**  
460 E. PLUMB LANE — 107  
RENO, NV 89502  
702-827-5732  
Outside Nev: 1 (800) 648-3962  
Icom — Yaesu Dealer

## NEW YORK

**ADIRONDACK ELECTRONICS, INC.**  
1991 CENTRAL AVENUE  
ALBANY, NY 12205  
518-456-0203  
Amateur Radio for the Northeast since  
1943.

**BARRY ELECTRONICS**  
512 BROADWAY  
NEW YORK, NY 10012  
212-925-7000  
New York City's Largest Full Service  
Ham and Commercial Radio Store.

**VHF COMMUNICATIONS**  
915 NORTH MAIN STREET  
JAMESTOWN, NY 14701  
716-664-6345  
Call after 7 PM and save! Supplying all  
of your Amateur needs. Featuring ICOM  
"The World System." Western New  
York's finest Amateur dealer.

**Dealers:** *YOU SHOULD BE HERE TOO!*  
*Contact Ham Radio now for complete details.*

## Amateur Radio Dealer

### Ohio

**AMATEUR ELECTRONIC SUPPLY**  
28940 EUCLID AVE.  
WICKLIFFE, OH (CLEVELAND AREA)  
44092  
216-585-7388  
Ohio Wats: 1 (800) 362-0290  
Outside Ohio: 1 (800) 321-3594  
Hours M-F 9-5:30, Sat. 9-3

**UNIVERSAL AMATEUR RADIO, INC.**  
1280 AIDA DRIVE  
REYNOLDSBURG (COLUMBUS), OH  
43068  
614-866-4267  
Featuring Kenwood, Yaesu, Icom,  
and other fine gear. Factory author-  
ized sales and service. Shortwave  
specialists. Near I-270 and airport.

### Pennsylvania

**HAMTRONICS,  
DIV. OF TREVOSE ELECTRONICS**  
4033 BROWNSVILLE ROAD  
TREVOSE, PA 19047  
215-357-1400  
Same Location for 30 Years.

**LaRUE ELECTRONICS**  
1112 GRANDVIEW STREET  
SCRANTON, PENNSYLVANIA 18509  
717-343-2124  
Icom, Bird, Cushcraft, Beckman,  
Larsen, Hustler, Astron, Belden,  
Antenna Specialists, W2AU/W2VS,  
AEA, B&W, Amphenol, Saxton, J.W.  
Miller/Daiwa, Vibroplex.

**THE VHF SHOP**  
BOX 349 RD 4  
MOUNTAINTOP, PA 18707  
717-868-6565  
Lunar, Microwave Modules, ARCOS,  
Astron, KLM, Tama, Tonna-F9FT,  
UHF Units/Parabolic, Santec, Tokyo  
Hy-Power, Dentron, Mirage,  
Amphenol, Belden

### Texas

**MADISON ELECTRONICS SUPPLY**  
1508 MCKINNEY  
HOUSTON, TX 77010  
713-658-0268  
Christmas?? Now??

### Wisconsin

**AMATEUR ELECTRONIC SUPPLY**  
4828 W. FOND DU LAC AVE.  
MILWAUKEE, WI 53216  
414-442-4200  
Wisc. Wats: 1 (800) 242-5195  
Outside Wisc: 1 (800) 558-0411  
M-F 9-5:30  
Sat 9-3

## MOVING?

KEEP HAM RADIO COMING...

If possible let us know four to six weeks before you move and we will make sure your HAM RADIO Magazine arrives on schedule. Just remove the mailing label from this magazine and affix below. Then complete your new address (or any other corrections) in the space provided and we'll take care of the rest.

**ham  
radio**  
Magazine

Greenville, NH 03048

Allow 4-6 weeks for  
correction.

Thanks for helping us to serve you better.

Here's my new address:

Name \_\_\_\_\_  
Address \_\_\_\_\_  
City \_\_\_\_\_ State \_\_\_\_\_ Zip \_\_\_\_\_  
Call \_\_\_\_\_

AFFIX  
LABEL  
HERE

## ICOM USERS

### IMPROVE YOUR SELECTIVITY

Install Fox-Tango's top-quality 8-pole FL-44A 2.4KHz bandwidth 455KHz SSB filter. Guaranteed to equal or exceed Icom specifications. (Shape factor: 1.75)

### EASY DROP-IN INSTALLATION

For Models: IC-720, IC-730,  
IC-740, and R-70.

Complete instructions.



SAVE!



Reg. Icom price .....\$159  
Reg. Fox-Tango price ...\$125  
**Fox-Tango SALE PRICE . \$100**



Limited Quantities - Order  
Today - Write or Phone.  
SHIPPING: \$3, Air \$5,  
COD add \$1, Overseas \$10  
FL Residents add  
5% Sales Tax. ✓ 156

### FOX TANGO CORPORATION

Box 15944 H. W. Palm Beach, FL 33416  
(305) 683-9587

## 10GHz GUNNPLEXER transceiver



- Complete ready to use 10 GHz fm voice/cw transceiver
- 10 mW power output
- Typical frequency coverage 10.235-10.295 GHz
- Full duplex operation
- Internal Gunnplexer for portable operation
- Gunnplexer removable for tower mounting in fixed location service — three shielded cables required for interconnection
- Powered by 13 volts dc nominal at 250 mA
- 30 MHz i-f
- 10-turn potentiometer controlled VCO tuning
- 220 kHz ceramic i-f filter
- Extra diode switched filter position for optional filter
- Dual polarity afc
- Rugged two-tone grey enclosure
- Full one year warranty
- \$389.95 with 10 mW Gunnplexer
- \$269.95 without Gunnplexer

**Advanced  
Receiver  
Research**

Box 1242 • Burlington CT 06013 • 203 582-9409

Postpaid for U.S. and Canada. CT Residents  
add 7-1/2% sales tax. C.O.D. orders add \$2.00.  
Air mail to foreign countries add 10%



# NCG CO.

*Just Slightly Ahead*

## 10/160M

THE 10/160M GIVES YOU THAT EXTRA BIT OF QUALITY THAT REALLY GETS YOU THROUGH TO THAT SPECIAL DX STATION, OR JUST ENJOYING A FULLY RELAXED QSO WITH ANOTHER AMATEUR THE OTHER SIDE OF THE COUNTRY. YOUR 10/160M GIVES YOU THE EASE OF OPERATION THAT YOU WANT WITH 4 MEMORYS OR THE 3 WAY AUTO SCAN, DUAL VFO, IF SHIFT, CW-W CW-N, HAND MIC AND BUILT IN AC/DC POWER. ALL BANDS ARE FULLY OPERATIONAL INCLUDING THE NEW WARC BANDS. YOUR CHOICE OF EASY OPERATING USB, LSB, CW OR RTTY IS AT YOUR FINGER TIPS. WITH A FULL 200 WATTS PEP OUTPUT YOUR FINALS ARE PROTECTED FROM HIGH SWR.

YOUR 10/160M IS ALL SOLID STATE WITH MODULAR BOARDS THAT ARE EASY ACCESSIBLE. A BRIGHT BLUE FLUORESCENT DIGITAL DISPLAY IS EASY TO READ AT ALL TIMES. BEST OF ALL THERE ARE NO EXTRA OPTIONS TO BUY TO GET YOU ON THE AIR, ITS ALL THERE. JUST TAKE YOUR 10/160M HOME AND 1. CONNECT A ANTENNA. 2. PLUG INTO 120V AC OUTLET. 3. TURN THE SWITCH ON. 4. SELECT THE BAND AND FREQUENCY AND YOUR ON THE AIR. YOUR RECEIVING AUDIO IS CRISP AND CLEAR, YOUR TRANSMITTED SIGNAL WILL GET YOU A PRAISE FROM EACH CONTACT. THE 10/160M GIVES YOU A SUPERIOR TRANSCEIVER THAT IS UNCOMPARABLE.

MORE INFORMATION IS AVAILABLE FROM NCG. CO.

1275 N. Grove St., Anaheim, CA 92806

## 15M

15M-MOBILE IS YOURS TO CONTINUE YOUR QSO WITH THAT SPECIAL FRIEND WHEN YOU GO ON A VACATION OR JUST GOING TO OR FROM WORK. A TRULY QRP RIG WITH THE BIG RIG SIGNAL EITHER CW OR USB. THE DIGITAL FREQUENCY DISPLAY IS EASY TO READ AND YOUR 10 WATTS OR 2 WATTS ON USB OR CW WITH A BUILT IN SIDE TONE, HIGHLY EFFECTIVE NOISE BLANKER, AUDIO ALC GIVES DISTORTION FREE TRANSMISSION. THE VFO BALANCE WITH GEARS ALLOWS HIGH-PRECISION TUNING. DIGITAL DISPLAY OFFSET WHEN RIT IS IN OPERATION (A MODIFICATION THAT TAKES 5 MINUTES CHANGES THE RIT TO A FINE TUNE CONTROL). A LARGE S/RF METER IN THE CENTER AND A TOP 8 OHM .5W SPEAKER, YOUR RECEIVE AUDIO IS DIRECTED UP.

EXTERNAL SPEAKER AND CW JACKS, MOBILE MOUNTING BRACKET AND A 400 OHM PT DYNAMIC MICROPHONE. FULL 15 METER BAND OPERATION FROM 21 to 21.450 MHZ, YOU OFFSET FREQUENCY RANGE OR FINE TUNE IS  $\pm 4$  KHZ. THE SIGNAL TO NOISE SENSITIVITY IS MORE THAN 10DB DOWN AT -6DB INPUT POWER SOURCE IS 13.8V DC, 3 AMPS. THE SMALL SIZE WILL ALLOW MOBILE OPERATION FROM EVEN THE SMALL CARS, ITS ONLY 9"H x 2.5W x 9.5D, THE LIGHT WEIGHT OF ONLY 5.5 LBS. MAKES THE 15M A POSSIBLE BACKPACKERS DREAM.

WITH YOUR 15M YOU WILL NOT HAVE A BIG EXPENSIVE PIECE OF EQUIPMENT SETTING IN YOUR VEHICLE, IT CAN BE UNDER THE DASHBOARD OUT OF SIGHT.



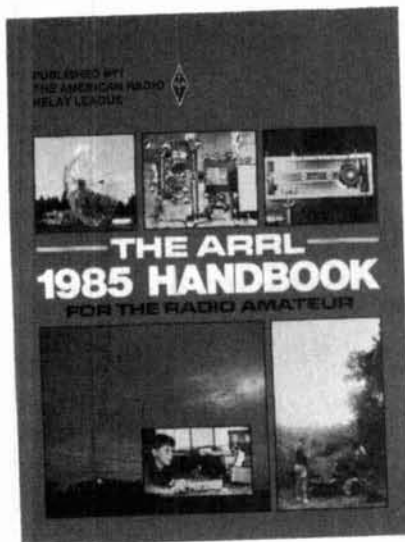

# COMING SOON THE 1985 ARRL HANDBOOK

1. It's BRAND NEW
2. It's BIGGER. Over 350 pages.
3. It's EXPANDED. Covers everything from basic electronics to esoteric radio gear.
4. It's chockfull of NEW PROJECTS.
5. It's the MOST COMPLETE reference text available.
6. Reserve your copy TODAY. Handbooks will be shipped as soon as they are received from the printer. (Scheduled for early November)

## PRE-PUBLICATION SPECIAL

1985 HANDBOOK Reg. Price \$15.00 (plus \$2.50 shipping)

**NOW \$12.95** (plus \$2.50 shipping)  
**SAVE \$2**

OFFER EXTENDED EXPIRES DEC. 15, 1984



**ham  
radio** magazine  
GREENVILLE, NH 03048

**BOOKSTORE**  
(603) 878-1441

## MOSLEY...A BETTER ANTENNA...

Antennas For 40 Meters...

- \*ALL STAINLESS HARDWARE
- \*NO MEASURING
- \*2 YEAR WARRANTY
- \*5 KW P.E.P.
- \*BROAD BAND WIDTH
- \*BUILT TO LAST
- \*NO BALUN NEEDED



S-401 M

Easy as... 1 - S-401 M. A 40 Meter Rotatable Dipole which gives you excellent bandwidth and performance, MOSLEY's S-401 M is the best 40 Meter Dipole ever built. All stainless hardware is standard. We have made it even stronger than before! We have added 2 extra insulator blocks and 2 feet more rectangle. The center of the elements are reinforced with an unbreakable non-conductive rod which makes it just about indestructible. Our link coupled feed system provides for an efficient match which enables you to direct feed the antenna with no need for a balun. This is why we give a 2 year warranty on parts, material, and workmanship.

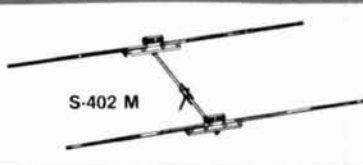

S-402 M

2 - Our S-402 M is now on a 24 foot boom and has all of the new improved structural changes. This antenna will give you years of outstanding mechanical and electrical performance in any climate. We feel this is the best performing, maintenance free, 2 element 40 Meter beam built anywhere in the world. Check it out! We believe you will agree. The elements are heavier constructed than other brands, and only reduces to 1 1/8 x .058 wall at their ends. Compare this to the other manufacturers. The S-402 M also comes with our 2 year warranty!



S-403

3 - The S-403 is the killer of the three models. This antenna gives you full size performance and is built to last. Our 36 foot boom is made out of 2" x .104 wall with a 24 foot sleeve of 1.785 x .125 wall. This gives you a wall thickness of .229 over 24 feet of the boom. Our S-403 is spaced to give you the best front to back and forward gain. It will give you the whole 40 Meter band to chase DX or rag chew. Our S-403 also comes with our 2 year warranty.

If you are a new ham and are not familiar with MOSLEY, ask an older ham about us or call the PRESIDENT of MOSLEY. He will be glad to explain why MOSLEY is A BETTER ANTENNA.

These and other MOSLEY products are available through your favorite DEALER. Or write or call MOSLEY for the DEALER nearest you.

**Mosley Electronics Inc.**

1344 BAUR BLVD. ST. LOUIS, MISSOURI 63132

1-314-994-7872

1-800-325-4016

## COLLINS TUNER

Collins 180Y-1 Antenna TUNER for 2-30 MHz; has dual section air variable 50-1600 and 30-600 pf (0.065" min/0.156" max gap) and 2.9" dia 14-turn roller inductor of 0.19" dia tubing, ceramic tap switch, 3/100 pf 7500 V doorknob capacitors. Controls C and L Select, Var C and L; 7x12.5x16.8, 33 lbs. Used.....\$99.50



**GRAINGER AM 4531** Linear Amp, 120-152 MHz; 10 W in, 50 W out using 8122 tube in P-A. 115/230 VAC; 7x19x14.5, 50 lbs. Used-not tested.....\$195.00  
**JENNINGS UCS-300-7.5** Vacuum Variable Capacitor, 9-300 pf 7500 V max; 3 lbs sh. Unused.....\$99.95

Prices F.D.B. Lima, O. • VISA, MASTERCARD Accepted.  
Allow for Shipping • Send for New FREE CATALOG '84  
Address Dept. HR • Phone: 419/227-6573

## FAIR RADIO SALES

1016 E. EUREKA • Box 1105 • LIMA, OHIO • 45802

## FACSIMILE

COPY SATELLITE PHOTOS. ✓ 116  
WEATHER MAPS, PRESS!

The Faxes Are Clear — on our full size (18-1/2" wide) recorders. Free Fax Guide.

## TELETYPE

RTTY MACHINES, PARTS, SUPPLIES

ATLANTIC SURPLUS SALES (212) 372-0349  
3730 NAUTILUS AVE. BROOKLYN, N.Y. 11224

## Custom Mailing Lists on Labels! Amateur Radio Operator NAMES

Custom lists compiled to your specifications

- Geographic by ZIP and/or State
  - By License Issue or Expiration Date
- Self stick 1x3 labels

Total List 453,000 Price: \$25/Thousand

**Buckmaster Publishing** ✓ 125

Whitehall  
Mineral, VA 23117 U.S.A. (703) 894-5777

IF YOU'RE STILL USING AN OLD STYLE ROTOR CONTROL MAYBE YOU SHOULD CONSIDER THIS...



BUY THE ANTENNA CONTROLLER OF THE FUTURE TODAY!

A PRO-SEARCH™

DIGITAL

ANTENNA CONTROL FULLY COMPUTERIZED

SMALL IN SIZE  
3 1/4" H x 5 1/2" W x 6" D

10 MEMORIES FOR STORING YOUR FAVORITE HEADINGS

ONE YEAR FULL WARRANTY

PRO-SEARCH Is Adaptable To Many Systems, Simple To Install.

No Modifications Are Necessary.

Presently we're having our Fall and Christmas Special. A PSE-1, used with the CDE Series. Now only \$299.95 plus shipping. Regular retail price \$419.91. Offer good until December 15, 1984. Order Early we expect a back order problem due to demand and availability of parts. Also ask about our Fall Rotor, Antenna and Unit Special.

CALL NOW 1-800-325-4016

Controllers also available for other rotors.

Prices and specifications subject to change without notice or obligation.

U.S. and Foreign Patents

**PRO-SEARCH™**  
Reaching The World

Pro-Search Electronics Co.

1344 Baur Boulevard St. Louis, Mo. 63132

1-314-994-7872

1-800-325-4016

**BUTTERNUT ELECTRONICS COMPANY**

**Model 2MCV "Trombone"**    **Model HF6V**    **Model 2MCV-5 "Super Trombone"**

**THE WINNERS**

Model HF6V - Completely automatic bandswitching 80 through 10 plus 30 meters. Outperforms all 4- and 5-band "trap" verticals of comparable size. Thousands in use worldwide since December 81! 160 meter option available now; retrofit kits for remaining WARC bands coming soon. Height: 26 ft/7.8 meters; guying not required in most installations.

Model 2MCV "Trombone" - omnidirectional collinear gain vertical for 2 meters having the same gain as "double-NA" types, but the patented "trombone" phasing section allows the radiator to remain unbroken by insulators for maximum strength in high winds. No coils "plumber's delight" construction and adjustable gamma match for complete D.C. grounding and lowest possible SWR. Height: 9.8 ft/2.98 meters.

Model 2MCV-5 "Super-Trombone" - Same advanced features as the basic 2MCV but a full wavelength taller with additional "Trombone" phasing section for additional gain. Height: 15.75 ft/4.8 meters.

All BUTTERNUT ANTENNAS use stainless steel hardware and are guaranteed for a full year. For further information on these and other BUTTERNUT products, write for our FREE CATALOG!

**BUTTERNUT ELECTRONICS**  
405 E. MARKET STREET  
LOCKHART, TX 78644

**MICROCOMPUTER REPEATER CONTROL**

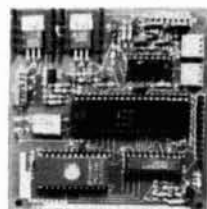

**\$119**

202

Introducing the MICRO REPEATER CONTROLLER RPT-2A, a new concept in LOW COST, EASY TO INTERFACE, microcomputer repeater control. Replace old logic boards with a state of the art microcomputer that adds NEW FEATURES, HIGH RELIABILITY, LOW POWER, SMALL SIZE, and FULL DOCUMENTATION to your system. Direct interface (drop in) with most repeaters. Detailed interface information included. Original MICRO REPEATER CONTROL article featured in QST Dec 1983.

- Two CW ID Messages
- Time Out Timer
- Pre-Timeout Warning MSG
- Post Timeout CW MSG
- Courtesy Beep
- Auxiliary Inputs
- Reconfigurable COR Input
- High Current PTT Interface
- Sine Wave Tone Generator
- Low Power 9.15 VDC @ 200 ma
- Size 3.5" x 3.5"
- All Connectors Included

RPT-2A Kit Only \$119 plus \$3.00 shipping

**PROCESSOR CONCEPTS**

P.O. BOX 185

FORT ATKINSON, WI 53538

(414) 563-4962 7pm-10pm evenings



CALL OR WRITE FOR FREE CATALOG AND SPECIFICATIONS

**WE GOT IT ALL**

- QUALITY ELECTRONIC COMPONENTS
- ELECTRONIC PROJECT KITS.
- COMPUTER KITS

**THIS MONTH'S SPECIALS**

**COMPUTER KITS FOR VIC AND COMMODORE 64**

|                          |         |
|--------------------------|---------|
| CASSETTE INTERFACE KIT   | \$15.95 |
| RS-232 INTERFACE KIT     | \$29.95 |
| VIC 20 BUSS EXPANDER KIT | \$24.95 |
| COM 64 BUSS EXPANDER KIT | \$29.95 |

**ELECTRONIC PROJECT KITS**

|                            |         |
|----------------------------|---------|
| CMOS MORSE KEYS KIT        | \$19.95 |
| 1 WATT AUDIO AMPLIFIER KIT | \$11.95 |
| FLUID LEVEL DETECTOR KIT   | \$17.95 |
| AUDIO OSCILLATOR KIT       | \$12.95 |

**COMPONENTS**

|                      |           |
|----------------------|-----------|
| 1N4007 1KV 1A DIODES | 25/\$2.00 |
| 14 PIN IC SOCKETS    | 10/\$1.00 |
| 28 PIN IC SOCKETS    | 5/\$1.00  |
| .01 DISC CAPACITORS  | 25/\$1.00 |

**SEND \$1 FOR OUR NEW CATALOG**

(REFUNDABLE ON FIRST ORDER). NO CHARGE FOR CATALOG WITH ORDERS. DEALER INQUIRIES WELCOME. ADD \$2.50 SHIPPING ON ORDERS OVER \$5.00. ADD \$1.00 SHIPPING ON ORDERS UNDER \$5.00.

CHECKS    MASTER CARD    VISA    C.O.D.

Daytapro Electronics, Inc.

312-870-0555

OPEN EVENINGS

3079 N. WILSHIRE LN. ARLINGTON HTS. ILL 60004

COMMODORE 2064 REG. TRADEMARKS OF COMMODORE INTL.

**SYNTHESIZED SIGNAL GENERATOR**

MADE IN USA



**MODEL SG-100E**  
**\$399.95**

plus shipping

- Covers 100 MHz to 185 MHz in 1 kHz steps with thumbwheel dial
- Accuracy +/- 1 part per 10 million at all frequencies
- Internal FM adjustable from 0 to 100 kHz at a 1 kHz rate
- External FM input accepts tones or voice
- Spurs and noise at least 60 dB below carrier
- Output adjustable from 5-500 mV at 50 Ohms
- Operates on 12 Vdc @ 1/2 Amp
- Available for immediate delivery • \$399.95 plus shipping
- Add-on accessories available to extend freq range, add infinite resolution, AM, and a precision 120 dB attenuator
- Call or write for details • Phone in your order for fast COD shipment.

**VANGUARD LABS**

196-23 Jamaica Ave., Hollis, NY 11423

Phone: (212) 468-272

225



# NEWS we'll treat you

## BULLETIN

For more than 40 years we have been serving the amateur community with QUALITY PRODUCTS and DEPENDABLE "S-E-R-V-I-C-E" and, we fully intend to carry on this proud tradition with even MORE new product lines plus the same "fair" treatment you've come to rely on. Our reconditioned equipment is of the finest quality with 30, 60 and even 90-day parts and labor warranties on selected pieces. And, remember...

### — WE SERVICE WHAT WE SELL —

|             |               |                  |
|-------------|---------------|------------------|
| AEA         | DRAKE         | MOSELEY          |
| AMECO       | ENCOMM        | NYE              |
| AMERITRON   | HUSTLER       | PALOMAR          |
| ANTEK       | ICOM          | RADIO CALLBOOK   |
| ARRL        | JANEL         | ROBOT            |
| ASTRON      | KANTRONICS    | ROHN             |
| ANTENNA     | KDK           | TELEX / HYGAIN   |
| SPECIALISTS | KLM           | TEN-TEC          |
| B & W       | LARSEN        | TRIO-KENWOOD     |
| BENCHER     | MFJ           | UNADILLA / REYCO |
| BUTTERNUT   | MINI-PRODUCTS | YAESU            |
| CUSHCRAFT   | MIRAGE        |                  |
| DIAWA       |               |                  |

Write today for our latest

Bulletin/Used Equipment List.

SELECTION  
SERVICE  
and  
SATISFACTION!

#### STORE HOURS:

9-5 P.M. (CST)  
MONDAY thru FRIDAY  
OPEN SATURDAYS  
from 9-1 P.M. (CST)  
CLOSED  
SUNDAYS/HOLIDAYS



P.O. Box 73  
208 East Kemp  
Watertown, SD 57201

# Burghardt INC.

## AMATEUR CENTER

"AMERICA'S MOST RELIABLE AMATEUR RADIO DEALER"

## SELL-TRADE

New & Reconditioned

## HAM EQUIPMENT

Call or Write Us Today For a Quote!  
You'll Find Us to be Courteous, Knowledgeable and Honest

PHONE (605) 886-7314

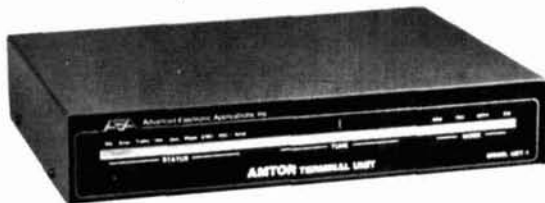

AEA AMT-1. REGULARLY \$479.95  
NOW ONLY \$299.95

THE AMTOR TERMINAL UNIT!!! Works with any ASCII terminal or personal computer with a terminal program. Also works RTTY, CW, ASCII.  
ORDER YOURS TODAY! Limited quantities.

126

## APPLIED INVENTION

THE SOURCE FOR SOLID STATE / STATE-OF-ART

### GaAs FETS by MITSUBISHI

|  |         |
|--|---------|
| 2M — Ku Band. Very low noise and medium power.                 | 1.4     |
| MGF 1100 Dual Gate GaAs FET 2.5dBNF @ 4GHz                     | \$ 7.35 |
| MGF 1202 (1402 chip in a 1200 package)                         | \$ 9.70 |
| MGF-1404 GUARANTEED 0.65dBNF @ 4GHz                            | \$66.60 |
| MGF-1402 0.4 dBNF @ 432, 1.1 dBNF @ 4GHz                       | \$14.00 |
| MGF-1412 GUARANTEED 0.8, 0.9 or 1.0 dBNF @ 4GHz \$21 — \$34.75 |         |
| Also: MGF1200, MGF1400, MGF1403 and medium power MGF1801       |         |

### MICROWAVE MODULES

|  |         |
|--|---------|
| MITSUBISHI X BAND Hybrid Integrated Circuits with Dielectric Resonator (0.12MHz/°C) GaAs FET Oscillators |         |
| FO-1010X 10.4 GHz, 15mw out, UER100 Flange   | \$39.37 |
| FO-1210Y 11.5 or 12.0 GHz, UER120 Flange   | \$39.37 |
| * FO-UP11KF Complete Heterodyne Rx, 10.468 GHz LO  | \$36.22 |
| Use with 2 GHz F for 12 GHz Satellite TVRO   |         |
| * FO-DP13KF Doppler Module 10.525 GHz UER100 Flange  | \$43.05 |
| * X Band 15 dBG die cast horn antenna (UER100)   | \$17.85 |
| * GaAs FET Preamp 1.7-2.1 GHz, 2.0-2.35 GHz, 2dBNF   | \$49.00 |

### COMPONENTS

|  |                            |
|--|----------------------------|
| AE: THE SOURCE for RETICON Universal Active Filters  |                            |
| R5620 digitally programmed switched capacitor filter | NEW \$ 7.85                |
| R5621 dual resistor programmed SCF                   | \$ 6.51                    |
| R5622 quad resistor programmed SCF                   | \$11.07                    |
|  | Application notes: \$ 2.00 |

OPTOELECTRONICS from MITSUBISHI and SIEMENS  
CW LASER DIODES, HIGH OUTPUT LEDs, PIN PHOTO DIODES, FIBER OPTICS, MORE!

|   |             |
|---|-------------|
| MRF 901 Substitute 25C2876, F1=7GHz, 2.2dBNF @ 1GHz     | \$ 1.50     |
| NEC 64535 direct replacement: Siemens BFQ 74            | \$ 9.66     |
| LEADLESS DISK CAPS 100, 220, 470, 680, 1000 pF          | 10¢ \$ 2.50 |
| MICROWAVE CHIP CAPS Very low loss VITRAMON P7800 series |             |
| G02(0.7 1.4 GHz) G04(1.3 2.6 GHz) G012(6.4 20GHz)       | \$ 1.25     |
| VITRAMON VHF/UHF/NP0 chips: 10, 100, 1000 pF            | 5¢ \$ 2.50  |
| A-B type FWSN 1000pF Feedthru                           | \$ 0.75     |

STRIPLINE SHUTTLE TRIMMERS (VOLTRONICS) 0.1-2.5, 0.5-9.9 dP¢ \$ 3.34  
HI-O SEALED CERAMIC PISTON TRIMMERS (VOLTRONICS) 0.6-9.9 dP¢ \$ 3.58

Thermo Electric Heat Pumps & Sub Miniature Cryogenic Refrigerators CALL  
3M 6X250 glass/te board, Er=2.55 @ 10GHz 0.031 \$0.31/sq. in.  
0.062 \$0.52/sq. in.

JOHNSON SMA's: Sq. flange female \$3.50. Male cable \$ 2.88  
PROMPT SERVICE SEND FOR CATALOG. MINIMUM ORDER \$5.00  
VISA/MASTERCARD Accepted. CASH prepay take 5% discount.  
S&H \* ITEMS (UPS) \$3.75 ALL OTHER ITEMS \$2.50 (1st CLASS)  
NY STATE RESIDENTS ADD 6% SALES TAX

R.D.2 ROUTE 21 HILLSDALE, NY 12529  
518-325-3911

## RECEIVER GUARD 2000

TOTAL PROTECTION AGAINST RF BURN OUT OF SOLID STATE FRONT ENDS

installs easily between the antenna and receiver input. When RF voltage to the receiver line exceeds 1 volt, the unit activates by shunting the over voltage to ground and increasing the resistance in the receiver line. If over voltage exceeds design parameters, an internal fuse lamp opens (easy to replace). Perfect for contest stations, field day operations, areas saturated with broadcast services and those who use separate transmit and receive antennas. Less than .3 dB insertion loss between 1.8 and 30 MHz.



### UHF CONNECTORS

Please add \$4 for shipping and handling. U.S. only. Foreign orders: FOB Groveport.

Can also be used with most transceivers with minor modifications.

DESIGN ELECTRONICS OHIO

### 3 Models available

|                      |         |
|----------------------|---------|
| P (with phone plugs) | \$29.95 |
| U (with SO-239)      | \$29.95 |

|   |         |
|---|---------|
| CTT (with SO-239 and Alpha Delta Transtrap for RF and Transient protection) | \$49.95 |
|---|---------|

142



4925 S. HAMILTON RD  
GROVEPORT, OHIO 43125

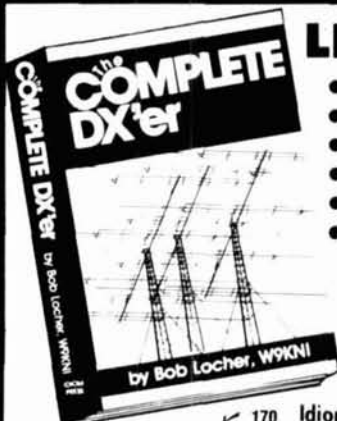

## LEARN THE SECRETS!!

- "Spills the beans about operating" —DX Bulletin
- "A timeless work" —DX Bulletin
- "A first-class treatise" —Ham Radio
- "A solid gold treasure trove—a smash hit" —73
- "Sure to increase competition for DX" —QST
- "Simply the best book of its type ever written. Worth every penny!" —Westlink Report

A complete course for the DX'er,—beginner to Honor Roll. 192 pages of solid DX—no charts, graphs or other fillers. Available now at dealer for \$10.95 or add \$2.00 postage and handling.

170 Idiom Press Dept. D Box 583 Deerfield, IL 60015

here is the next generation Repeater

# MARK 4CR

The **only** repeaters and controllers with REAL SPEECH!

No other repeaters or controllers match Mark 4 in capability and features. That's why Mark 4 is the performance leader at amateur and commercial repeater sites around the world. Only Mark 4 gives you Message Master™ real speech • voice readout of received signal strength, deviation, and frequency error • 4-channel receiver voting • clock time announcements and function control • 7-helical filter receiver • extensive phone patch functions. Unlike others, Mark 4 even includes power supply and a handsome cabinet.

Create messages just by talking. Speak any phrases or words in any languages or dialect and *your own voice* is stored instantly in solid-state memory. Perfect for emergency warnings, club news bulletins, and DX alerts. Create unique ID and tail messages, and the ultimate in a real speech user mailbox — only with a Mark 4.

Call or write for specifications on the repeater, controller, and receiver winners.



**MICRO CONTROL SPECIALTIES** ✓ 184

Division of Kendecom Inc.

23 Elm Park, Groveland, MA 01834 (617) 372-3442

See Sept. 73 for ZX-81 article.



AT LAST!! A VERY AFFORDABLE COMPUTER AT A VERY AFFORDABLE PRICE

POWERFUL FULLY PROGRAMMABLE WITH 2K OF MEMORY PORTABLE 6.75 X 1.38 INCH MODULE SINGLE KEY ENTRY COMMANDS DURABLE 40 KEY MEMBRANE TYPE KEYBOARD Z80A BASED FOUR CHIP DESIGN EDUCATIONAL UNIQUE SYNTAX CHECK REPORT CODES FOR ERROR IDENTITY GRAPH DRAWING AND ANIMATED DISPLAY ACCURATE TO 9 1/2 DECIMAL PLACES FOR FULL RANGE MATH AND SCIENTIFIC FUNCTIONS AT AN AFFORDABLE PRICE

WE CANNOT TELL YOU THE MAKE OF THE COMPUTER BUT IT WAS MADE BY A FAMOUS WATCH COMPANY THEY USED TO SELL FOR \$99.95

WE BOUGHT OUT WHAT THE FACTORY HAD LEFT IN STOCK AND HAD TO REMOVE THE LABELS THESE UNITS ARE UNPACKAGED LESS THE 9V WALL ADAPTER AND MANUAL BECAUSE THIS IS A DISCONTINUED ITEM THERE IS NO WARRANTY

GET THEM WHILE THEY LAST LIMITED SUPPLY

BUY 1st UNIT FOR \$19.95 - BUY 2nd FOR \$16.95 9V DC WALL ADAPTOR \$4.95  
BUY THE 3rd UNIT (NON OPERATING FOR PARTS) \$10.95 MANUAL (OVER 150 PAGES) \$2.95

INFORMATION ON OTHER TOP QUALITY MICRO PRODUCTS AND MODULES VISIT OUR WEBSITE AT: [WWW.MICROCONTROL.COM](http://WWW.MICROCONTROL.COM)

### CHIP BONANZA (AT THESE PRICES THEY ARE A STEAL)

|  |                             |
|--|-----------------------------|
| 2708 8K EPROMS (REG. \$4.95)                     | \$1.50 EA OR 10 FOR \$12.50 |
| 2716 16K EPROMS (REG. \$5.95)                    | \$3.00 EA OR 10 FOR \$25.00 |
| 2764 64K EPROMS (REG. \$6.95)                    | \$5.50 EA OR 10 FOR \$50.00 |
| 6810 (REG. \$3.95)                               | \$1.95 EA OR 10 FOR \$18.00 |
| 68A09 (REG. \$19.95)                             | \$5.95 EA OR 10 FOR \$50.00 |
| 68A21 (REG. \$9.95)                              | \$2.95 EA OR 10 FOR \$25.00 |
| 4116 AMD 9016EPC 200 ns                          | \$1.25 EA OR 8 FOR \$ 8.00  |
| TMS 9900NL MICRO-P 64 PIN 8 BIT D/B + 16 BIT CPU | \$ 4.95                     |
| TMS 9901NL MICRO-P PSI                           | \$ 2.95                     |
| T1M 9904ANL MICRO-P CLOCK GEN. AND DRIVER        | \$ 5.95                     |
| TMS 9918ANL MICRO-P COLOR GRAPHICS AND DISPLAY   | \$ 9.95                     |
| KEY BOARD (99/4) 48 KEYS MEASURE 4 X 10 (HI-TEK) | \$ 9.95                     |

### SWITCHING POWER SUPPLY

MODEL 4A1PS (99/4) 3 DC OUTPUT VOLTAGES 12 V AT 40 AMPS +5 V AT 1 AMP -5 V AT 2 AMP HIGHLY FILTERED REQUIRES 24 V AT 40 WATT TRANSFORMER AS USED IN THE T1 99 SUGGESTED LIST OF \$39.95

HAL-TRONIX PRICE \$12.95 OR 2 FOR \$20.00 LIMITED SUPPLY

FSK DEMODULATOR/TONE DECODER XR-2211 (SPECIAL) \$2.95 LIMITED QUANTITY - 5 PER CUSTOMER

((HOT ITEM)) IF YOUR TRYING TO BUILD THE CABLE DECODER AS FEATURED IN THE FEB. ISSUE OF RADIO ELECTRONICS WE HAVE THE HARD TO GET COILS AND MOST OF THE PARTS BKAN K552 AXK \$2.50 EA ES20HN 3000023 \$1.50

6 PIECE JEWELER'S SCREW DRIVER SET PACKED IN PLASTIC CASE \$1.99

SPECIAL RED MINI LEADS WITH 2" WIRE LEADS 15 FOR \$1.00

"F" MALE PLUG FOR RG-59U WITH 1/4" RING 7 FOR \$1.00

SHIPPING INFORMATION: ORDERS OVER \$25 WILL BE SHIPPED POST PAID EXCEPT ON ITEMS WHERE ADDITIONAL CHARGES ARE REQUESTED ON ORDERS LESS THAN \$25. PLEASE INCLUDE ADDITIONAL \$2.50 FOR HANDLING AND MAILING CHARGES. MICHIGAN RESIDENTS ADD 4% SALES TAX SEND 20¢ STAMP OR SASE FOR FREE FLYER. CANADIAN ORDERS ADD \$10.00 POSTAGE IN U.S. FUNDS.

**HAL-TRONIX, INC.**  
P.O. BOX 1101 - DEPT. N  
SOUTHGATE, MICH. 48195  
PHONE (313) 285-1782 ✓ 160



"HAL" HAROLD C. NOWLAND W8ZCX

# CB-10 FM SPECIAL



- Hy Gain 40-Channel Board
- 40-Channel Switch
- Volume & Squelch Control
- FM Detector Module
- Full Instructions Included

**\$14.95** Add \$2.00 shipping & handling BOARD ONLY \$6.95

**QRP TRANSCEIVER SET - \$34.95**

**VHF CONVERTER SET - \$24.95**

Add \$2.00 For Shipping & Handling - Send For FREE Brochure

SEND \$2.00 FOR FULL MANUAL WITH CIRCUIT DIAGRAMS  
MANY OTHER MODULES AVAILABLE

**MORNING DISTRIBUTING CO.**

P.O. BOX 717, HIALEAH, FLA. 33011  
(305) 884-8686 ✓ 188





\$20.00. No table sales at door. Ticket and table deadline October 20. All classes of exams given. Send Form 610 and SASE to: V.E. Coordinator, FWRC, P.O. Box 15127, Fort Wayne, IN 46885 by October 26. Large indoor flea market and commercial vendors. The infamous Ham Band directed by Luke Matthew, WB9DWJ. Vendor setup 5 AM to 7 AM. Public 8 to 4. Talk in .88. For information, tickets, tables: Hamfest Chairman AC-ARTS, PO Box 10342, Fort Wayne, IN 46851 or call Dave Smith, KA9FFET (219) 493-2439.

**MICHIGAN:** The Oak Park High School Electronics Club presents a Swap & Shop, Thanksgiving Sunday, November 25, Oak Park HS, Oak Park. Donations \$2.00. Tables \$6.00. Refreshments. For information: SASE to Herman Gardner, Oak Park HS, 13701 Oak Park Blvd., Oak Park, MI 48237. (313) 968-2675.

**OHIO:** The Massillon ARC will sponsor Auctionfest 84 on November 11, Massillon K of C Hall off Rt. 21. 8 AM to 5 PM. Sellers set up 7 AM. Admission \$2.50 advance, \$3.50 door. Tables available \$7.00/8'. Refreshments. Dinner. Auction 11 AM. Talk in on W8NP, 147.78/18. For information/registration: MARC, 920 Tremont Avenue S.W., Massillon, OH 44646. SASE please.

## OPERATING EVENTS

"Things to do..."

**NOVEMBER 25 AND 26:** The BOMB Squad (Best of Mt. Baldy) will operate W6HCP (Hollywood Christmas Parade) from 1600Z, November 25 to 0400Z, November 26. Frequencies: 7.284, 14.284, and 21.284 MHz SSB. SASE to W6GVR for special commemorative QSL.

**NOVEMBER 22, THANKSGIVING DAY:** A special events station (WA1NPO) will be operating from Plymouth Plantation in the museum's 1627 Pilgrim Village from 1300 GMT to 2000 + GMT with participation of the UK Club Station GB0UST, GB2UST, GB4UST. To receive a certificate, send proof of contact and \$1.00 domestic or 4 IRC's to Whitman ARC, PO Box 48, Whitman, MA 02382. For information: KA1CZS (617) 826-4772; WB1CNM (617) 586-7524. Rosemary Carroll, Plymouth Plantation, PO Box 1620, Plymouth, MA 02360. (617) 746-1622 or Peter Jackson, G3ADV, 32 Brown Avenue, Parkfield, Nantwich, Cheshire, UK Phone 0270-627149.

**NOVEMBER 10 AND 11:** The Armored Force Amateur Radio Nationwide Emergency Team (A FAR NET) will sponsor a Veteran's Day special event station event station from 1200 GMT Saturday to 2400 GMT Sunday. Primary frequencies: 7.285, 14.325, 21.375 and 28.640 ± QRM. For a certificate send QSL and large SASE to Alfred G. Beutler, 36 Manchester Road, East Aurora, New York 14052.

**NOVEMBER 17 AND 18:** VK versus the World. Sponsored by the CW Operators QRP Club. Contestants may work DX or own country for scoring. QRP stations must sign QRP for identification. 0000Z Nov. 17 to 2400Z Nov. 18. Exchange: All stations 6 digits comprise RST followed by serial number, commencing with 001 to 999 then commence again. For information SASE to Contest Manager, PO Box 109, Mt. Druitt, N.S.W. 2770 Australia.

**DECEMBER 1 AND 2:** The 20th annual Telephone Pioneer QSO Party starts 1900 UTC Saturday to 0500 UTC Monday. 1.8-420 MHz ±. Exchange: Contact number and chapter number. ITPA Club or chapter name. Send logs showing date, time station worked, chapter name and number, contact number and claimed score prior to January 15, 1985 to: Ted Phelps, WBTP, c/o John D. Burle Chapter No. 89, TPA, 6200 East Broad St., Columbus, OH 43213.

**DECEMBER 2:** "Packet Radio Overview and Prospective" will be the subject of the 2nd North American Teleconference Radio Net (TRN). Learn about packet radio from two of its leading developers by tuning into TRN at 6 PM CST (0000Z). For a complete list of gateway station locations and frequencies write TRN Manager, c/o Midway Amateur Radio Club, PO Box 1231, Kearney, NE 68847-1231 SASE please.

**THE AMATEUR RADIO MOTORCYCLE CLUB NET** has moved to 3.888 MHz each Thursday night at 0300Z. All brands of bikers and riders are welcome. For more info send large SASE to Gary McDuffie, Rte. 1 Box 464, Bayard, NE 69334.

**THE DELAWARE-LEHIGH ARC (W3OK)** will operate Dec. 21, 22, 23, 1984 on 3.990, 7.299, 14.225, 21.325 and 28.525 MHz speeding Holiday best wishes from Bethlehem, PA, The Christmas City. Large SASE to colorful certificate c/o DLARC Greystone Bldg. Gracedale, Nazareth, PA 18064.

**VIRGINIA FONE NET 50th ANNIVERSARY CERTIFICATE** commemorating 50 years of continuous operation on the 75 meter band passing traffic in Virginia is being offered by the VFN. Work 25 VFN members and send log to K4IEC with #10 SASE for certificate. Contacts must be made between 9/30/84 and 6/30/85.

# BEST BUY!

## EASY-TO-ASSEMBLE KIT

only **\$660<sup>00</sup>** freight prepaid in 48 states

40 ft. M-13 aluminum tower and FB-13 fixed concrete base (beautiful!)

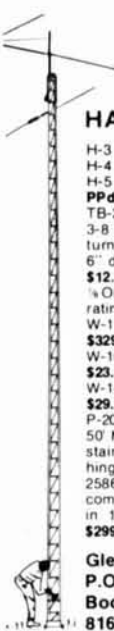

Othersizes at comparablesavings. HAZER - Tower Truss System Lowers antenna with winch. Complete system comes to ground level in upright position.

### HAZER your Rohn 20-25G

H-3 - 8 sq. ft. ant. **\$213.00 Ppd.**  
H-4 - 16 sq. ft. ant. **\$278.00 Ppd.**  
H-5 - 12 sq. ft. ant. (for M-13 above) **\$302.00 Ppd.** All Hazers include winch, cable & hdw.

TB-25 - Thrust bearing **\$42.50**  
3-8 EE - 1/2" x 6 forged steel eye and eye turnbuckle **\$10.75**

6" diam. - 4 ft. long earth screw anchor **\$12.75**

1/4 OD - 7x7 Aircraft cable guy wire 1700 lb. rating - **12 ft.**

W-115 - 115 VAC winch - 1000 lb. load **\$329.95**

W-1000 - Manual winch 1000 lb. capacity **\$23.95**

W-1400 - Manual winch 1400 lb. capacity **\$29.95**

P-2068 - Pulley block for 3/16 cable **\$5.65**

50' M-18S - 18 inch face aluminum tower, stainless bolts HAZER, TB-25 bearing and hinged base system **\$1523.00 freight prepaid**

25860 - Marlin Super Tower (nothing else compares) 60' galv. steel, totally freestanding in 100 MPH wind with 30 sq. ft. antenna **\$2992.00**

Glen Martin Engr.  
P.O. Box H-253  
Boonville, Mo. 65233  
816-882-2734

✓ 180



## GLEN MARTIN ENGR

# RF Porta-Tenna

VHF/UHF Telescopic 1/4 & 5/8 Wavelength Antennas for Hand-Held Transceivers & Test Equipment

### 1/4 WAVELENGTH

| Model No. | Freq. MHz | Description            | Price  |
|-----------|-----------|------------------------|--------|
| 196-200   | 144-148   | 5/16-32 stud w/spring  | \$5.95 |
| 196-204   | "         | BNC connector w/spring | 7.95   |
| 196-214   | "         | BNC connector          | 6.95   |
| 196-224   | 144-UP    | BNC conn. adj. angle   | 7.95   |
| 196-814   | 220-225   | BNC connector          | 6.95   |

### 5/8 WAVELENGTH

|         |         |                       |       |
|---------|---------|-----------------------|-------|
| 191-210 | "       | 5/16-32 for old TEMPO | 22.95 |
| 191-214 | "       | BNC connector         | 19.95 |
| 191-219 | "       | PL-259 w/M-359 adpt.  | 22.95 |
| 191-810 | 220-225 | 5/16-32 for old TEMPO | 22.95 |
| 191-814 | "       | BNC connector         | 19.95 |
| 191-940 | 440-450 | 5/16-32 for HT-220    | 22.95 |
| 191-941 | "       | 1/4-32 stud           | 22.95 |
| 191-944 | "       | BNC connector         | 19.95 |

Largest Selection of Telescopic Antennas. Write for info. Price are postpaid via UPS to 48 States. For air delivery via UPS Blue add \$1.50. Florida add 5% sales tax. Payment by M.O. or Cashiers Check only. ✓ 206

## RF PRODUCTS

P.O. Box 33, Rockledge, FL 32955, U.S.A.  
(305) 631-0775

# WARNING

SAVE YOUR LIFE OR AN INJURY

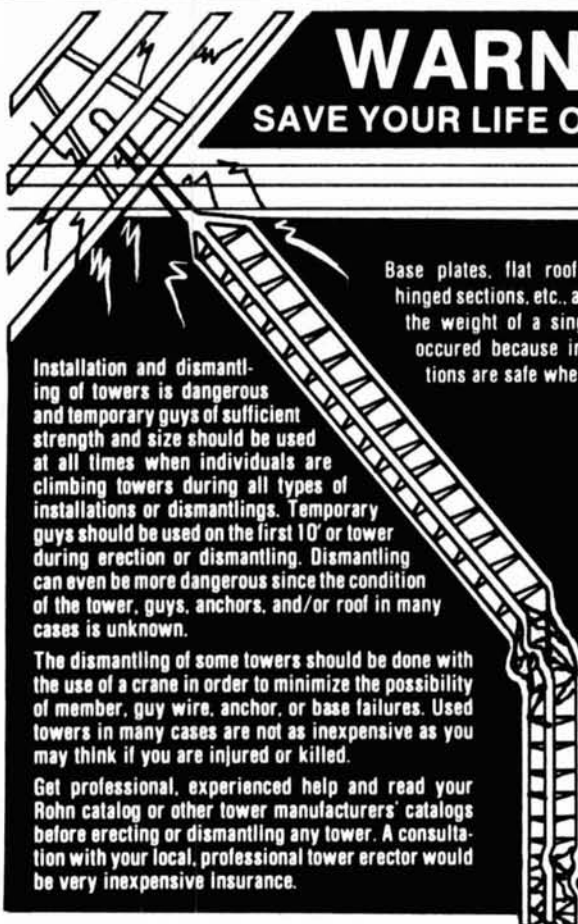

Base plates, flat roof mounts, hinged bases, hinged sections, etc., are not intended to support the weight of a single man. Accidents have occurred because individuals assume situations are safe when they are not.

Installation and dismantling of towers is dangerous and temporary guys of sufficient strength and size should be used at all times when individuals are climbing towers during all types of installations or dismantlings. Temporary guys should be used on the first 10' or tower during erection or dismantling. Dismantling can even be more dangerous since the condition of the tower, guys, anchors, and/or roof in many cases is unknown.

The dismantling of some towers should be done with the use of a crane in order to minimize the possibility of member, guy wire, anchor, or base failures. Used towers in many cases are not as inexpensive as you may think if you are injured or killed.

Get professional, experienced help and read your Rohn catalog or other tower manufacturers' catalogs before erecting or dismantling any tower. A consultation with your local, professional tower erector would be very inexpensive insurance.

Paid for  
By the  
Following:

**ROHN®**  
P.O. Box 2000  
Peoria, IL 61656

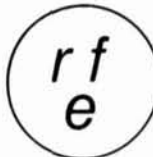

**rf enterprises** ANTENNAS & TOWERS  
 Route No. 7 (612) 255-0855  
 St. Cloud, Minnesota 56301

**AMERITRON** ALPHA DELTA PRODUCTS Ameritron Amps  
 Write or Call

Ameritron RCS 8 Remote Coax Switch \$119.95

|               |                       |                |
|---------------|-----------------------|----------------|
| A3 \$205.00   | A50-5 \$74.95         | ARX-2B \$34.95 |
| A4 264.95     | 617-B 189.95          | A147-11 44.95  |
| A743 67.95    | 32-19 88.00           | A147-22 119.95 |
| A744 67.95    | 214B 73.00            | 416TB 54.95    |
| R3 254.95     | 220B 88.00            | A144-20T 64.95 |
| AV3 49.95     | 410B 54.95            | A144-10T 46.00 |
| AV4 87.95     | 424B 74.95            | A14T-MB 26.00  |
| AV5 95.00     | Stacking & Quad Kits! | AOP-1 139.95   |
| 40-2CD 269.95 |                       |                |

**cushcraft**



**hy-gain**

|                       |                    |                  |
|-----------------------|--------------------|------------------|
| TH7DXS \$419.95       | 18AVT/WB-S \$99.95 | <b>BUTTERNUT</b> |
| TH5Mk2S 364.95        | 14AVQ/WB-S 64.95   | HF6V \$109.00    |
| Explorer-14 295.00    | 12AVQ-S 47.95      | HF2V 100.00      |
| QK-710 add-on 82.50   | 14RMQ 36.95        | 2MCV 28.95       |
| 392S Conv. Kit 142.95 | 18HTS 399.95       | 2MCV-5 35.00     |
| 204BAS 245.00         | V2S 41.95          |                  |
| 205BAS 339.95         |                    |                  |

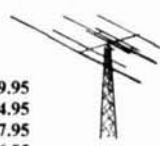

**WIRE & CABLE** (Coax quality guaranteed. 95%+plus shielding)

|                      |  |
|----------------------|--|
| RG-213/U \$0.29/ft.  | Rotor cable-standard 450 ohm line \$0.09/ft. |
| RG-8/U 0.28/ft.      | (6-22, 2-18) \$0.19/ft.                      |
| RG-8/U foam 0.27/ft. | 14 ga. Copperweld (solid) 0.10/ft.           |
| RG-8X 0.16/ft.       | Rotor cable-hvy. duty (6-18, 2-16) 0.33/ft.  |
|                      | 12 ga. Copperweld (solid) 0.12/ft.           |

**Unarco-Rohn**

We stock 25G, 45G, HBX, & HDBX towers.

|                 |                 |
|-----------------|-----------------|
| 25G \$46./sect. | HBX-40 \$195.00 |
| 45G 109/sect.   | HBX48 250.00    |
|                 | HBX56 320.00    |
|                 | HDBX40 230.00   |
|                 | HDBX48 315.00   |

FOLD-OVERS: Get our freight pre-paid quote and save.

Let us bid the self-supporting crank-up tower of your choice with the accessories you select.

**hy-gain**

|                  |
|------------------|
| HG-37SS \$700.00 |
| HG-52SS 1000.00  |
| HG-54HD 1565.00  |
| HG-70HD 2540.00  |

Shipped freight paid. Order tower with Hy-Gain antenna, rotor & other accessories. Receive free shipping on all.

**ROTORS:**

|                |
|----------------|
| AR-40 \$99.95  |
| CD-45II 136.95 |
| HAM-IV 217.00  |
| T2X 259.95     |
| HDR-300 475.00 |



**SANTEC**  
 ST-142 \$275.00



**KDK**

Prices subject to change without notice or obligation. Minnesota residents add 6% tax. Shipping not included except as indicated.



**IT'S INCREDIBLE!**

Master code or upgrade in a matter of days. **Code Quick** is a unique breakthrough which simplifies learning Morse Code. Instead of a confusing maze of dits and dahs, each letter will magically begin to call out its own name! Stop torturing yourself! Your amazing kit containing 5 power-packed cassettes, visual breakthrough cards and original manual is only \$39.95! Send check or money order today to WHEELER APPLIED RESEARCH LAB, P.O. Box 3261, City of Industry, CA 91744. Ask for **Code Quick #103**, California residents add 6% sales tax.

**One User Comments:**  
 "First new idea in code study and the darn thing works! So much fun you don't realize how much you're learning."

M.S. Greneda, Miss.

**Hundreds of satisfied customers!**  
 You can't lose! Follow each simple step. You must succeed or return the kit for a total immediate refund!

**FCC LOWERS REQUIREMENTS — GET YOUR RADIO TELEPHONE LICENSE**

FCC changes make obtaining a High-level Radio Telephone License much easier now. Eliminate unnecessary study with our short-cuts and easy to follow study material. Obtaining the General Radio Telephone License can be a snap! Sample exams, also section covering **Radar Endorsement**.

A small investment for a high-paying career in electronics.

**\$19.95 ppd.**

Satisfaction Guaranteed

**SPI-RO DISTRIBUTING**

P.O. Box 1538

Hendersonville, N. C. 28793 ✓ 219

We now accept MC and VISA  
 Give card #, exp. date, and signature



**\$\$\$ GIANT SAVINGS \$\$\$**  
 HIGH QUALITY AT LOW PRICES

**ECHO™ DISKETTES**

Each recording surface is individually certified and guaranteed to be 100% error free... with a **LIFETIME WARRANTY!**

**\$1 35** 5 1/4" SS/DD  
**\$1 85** 5 1/4" DS/DD

Echo head cleaning kit no harsh abrasives no fluids to apply (30 applications). 5 1/4" - \$6.95.

**DYSAN™ DISKETTES**  
 PREMIUM QUALITY AT HUGE SAVINGS

**\$210** ~~\$230~~ 5 1/4" SS/DD  
~~\$305~~ **\$260** 5 1/4" DS/DD

All diskettes are in boxes of 10 with labels, envelopes and reinforced hubs.

DISK STOR holds 50 5 1/4" Diskettes. \$12.95 + \$2.00 shipping.

SHIPPING: 5 1/4" DISKETTES - Add \$3.00 per 100 or less. PAYMENT: VISA, M/C or check with order. COD orders add \$2.00. \$1.50 credit on long distance phone orders. TAXES: Illinois customers add 8%. ✓ 212

**SCAMP SYSTEMS, INC.**  
 BOX 59451 - CHICAGO, ILLINOIS 60659  
 1-312-267-9858

Iron Powder and Ferrite  
**TOROIDAL CORES**

Shielding Beads, Shielded Coil Forms  
 Ferrite Rods, Pot Cores, Baluns, Etc.

Small Orders Welcome  
 Free 'Tech-Data' Flyer

**AMIDON**  
 Associates

Since 1963

12033 Otsego Street, North Hollywood, Calif. 91607



In Germany: Elektronladen, Wilhelm — Mellies Str. 88, 4930 Detmold 18, West Germany  
 In Japan: Toyomura Electronics Company, Ltd., 7-9, 2-Chome Sota-Kanda, Chiyoda-Ku, Tokyo, Japan

PUBLISHED BY:  
THE AMERICAN RADIO  
RELAY LEAGUE

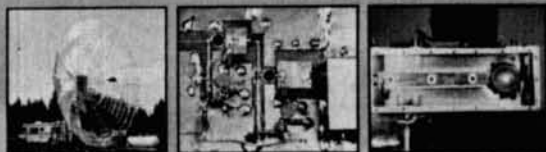

## THE ARRL 1985 HANDBOOK FOR THE RADIO AMATEUR



- **376 MORE PAGES THAN LAST YEAR**
- **17 MORE CHAPTERS**
- **OVER 1700 CIRCUIT DIAGRAMS AND ILLUSTRATIONS**

The ARRL 1985 HANDBOOK FOR THE RADIO AMATEUR is the largest ever! Besides the new name and cover, this edition contains new typesetting throughout. There are more construction projects than ever before. A separate section has been added containing PC etching patterns on special paper which can be used as positive film. Compare the contents of this book with an older edition and see how much material really has been added. The 1985 HANDBOOK is the biggest and best ever!.



Price: Paper edition: \$15 in the U.S., \$16 in Canada and elsewhere. Cloth edition: \$22.50 in the U.S., \$24.00 in Canada and elsewhere. Payment in U.S. funds, checks must be drawn on a bank in the U.S. Available from your radio store or from:

**ARRL, 225 MAIN STREET  
NEWINGTON, CT 06111 U.S.A.**

# CONTENTS

## INTRODUCTION

1. AMATEUR RADIO
2. ELECTRICAL FUNDAMENTALS
3. RADIO DESIGN TECHNIQUE AND LANGUAGE
4. SOLID STATE FUNDAMENTALS
5. VACUUM TUBE PRINCIPLES

## RADIO PRINCIPLES

6. POWER SUPPLIES
7. AUDIO AND VIDEO
8. DIGITAL BASICS
9. MODULATION AND DEMODULATION
10. RADIO FREQUENCY OSCILLATORS AND SYNTHESIZERS
11. RADIO TRANSMITTING PRINCIPLES
12. RADIO RECEIVING PRINCIPLES
13. RADIO TRANSCEIVERS
14. REPEATERS
15. RF POWER AMPLIFIERS
16. TRANSMISSION LINES
17. ANTENNA FUNDAMENTALS

## MODULATION METHODS

18. VOICE COMMUNICATION
19. DIGITAL COMMUNICATIONS
20. IMAGE COMMUNICATIONS
21. SPECIAL MODULATION TECHNIQUES

## TRANSMISSION

22. RADIO FREQUENCIES AND PROPAGATION
23. SPACE COMMUNICATIONS

## CONSTRUCTION AND MAINTENANCE

24. CONSTRUCTION TECHNIQUES
25. TEST EQUIPMENT AND MEASUREMENTS
26. TROUBLESHOOTING AND REPAIR
27. POWER SUPPLY PROJECTS
28. AUDIO AND VIDEO EQUIPMENT
29. DIGITAL EQUIPMENT
30. HF RADIO EQUIPMENT
31. VHF RADIO EQUIPMENT
32. UHF RADIO EQUIPMENT
33. ANTENNA PROJECTS
34. STATION ACCESSORIES
35. COMPONENT DATA

## ON THE AIR

36. HOW TO BECOME A RADIO AMATEUR
37. ASSEMBLING A STATION
38. OPERATING A STATION
39. MONITORING AND DIRECTION FINDING
40. INTERFERENCE

## ETCHING PATTERNS

# 1024 PAGES!

# Advertisers check-off

... for literature, in a hurry — we'll rush your name to the companies whose names you "check-off"

Place your check mark in the space between name and number. Ex: **Ham Radio** ✓ 234

|                              |                              |
|------------------------------|------------------------------|
| ADM.....101                  | JRS Dis.....173              |
| ACC.....102                  | Kantronics.....174           |
| ARRL.....103                 | KCS Elect.....175            |
| AEA.....104, 304             | Kerwood *.....               |
| Alden.....105                | Lewis Elect.....176          |
| ALL.....106                  | MFJ.....177                  |
| Alpha Delta.....107, 108     | MHz.....178                  |
| Aluma.....109                | Madison.....179              |
| AMS.....110                  | Martin Eng.....180           |
| Amateur Wholesale.....111    | Merrimac Sat.....181         |
| ARRL.....112                 | Medeva.....182               |
| Amdion.....113               | Microbyte.....183            |
| Applied Inv.....114          | Micro Control Spec.....184   |
| Astron.....115               | Microwave Filter.....185     |
| Atlantic Surplus.....116     | Midwest.....186              |
| Audio Amateur.....117        | Missouri Radio.....187       |
| Auto Techniques.....119      | Morning Dist.....188         |
| ATV Mag.....120              | Mosley.....189               |
| Azotic.....121               | NGC.....190                  |
| B & W *.....                 | Nampa.....191, 192           |
| Barry *.....                 | Nemal.....193, 303           |
| B.G. Micro.....122, 123, 124 | N. A. Soar.....194           |
| Break.....128                | NEV.....195                  |
| Buckmaster.....125           | Orbit.....196                |
| Burghardt.....126            | Paulin.....197               |
| Burtons.....127              | P.C. Elec.....198, 199       |
| Butternut *.....             | Phillips Tech.....200        |
| C & A Roberts.....129        | Precision Sat.....201        |
| Caddell *.....               | Processor Concepts.....202   |
| CeCo.....131                 | Pro Search.....203           |
| CES.....132                  | Public Domain.....204        |
| Centurion.....133            | RF Enterprises.....205       |
| Coaxial Dynamics.....134     | RF Products.....206          |
| Comm. Con.....135            | Callbook.....207             |
| Comm. Spec.....136           | Radokit.....208              |
| Computer Trader.....137      | Radio Warehouse *.....       |
| Connect.....138              | Ramsey.....209               |
| Daytaro.....139              | SAROC.....                   |
| Delaware.....140             | Sartor.....210               |
| DEO.....141, 142             | Sat. TV Mag.....211          |
| Digital Ins.....143          | Scamp Systems.....212        |
| Discount Discs.....144       | Schurmann.....213            |
| Dixie Elect.....145          | Shure.....214                |
| Doppler.....146              | Sinclair.....306             |
| Dynetic Systems.....147      | S.M.C.....215                |
| Electro Com.....148          | Skyline.....216              |
| EEB.....149                  | Spectrum Inter.....217       |
| Encomm.....150               | Spectrum West.....218        |
| Eng. Cons.....151, 152       | Spl Ro Dist.....219          |
| Epakon.....153               | Ten Tec *.....               |
| Faltron.....154              | Terra *.....                 |
| Falcon *.....                | TE Systems.....220           |
| Fair.....155                 | Texas Towers.....221         |
| Fluke *.....                 | TNT Radio.....222            |
| Fox Tango.....156, 157       | Transleteronic.....223       |
| GLB Elec.....158             | UNR Rohm *.....              |
| Hal Comm.....159, 302        | Universal Elec.....224       |
| Hal Tronix.....160           | University Microfilms *..... |
| HamMaster Tapes.....161      | Vanguard.....225             |
| HRB.....162                  | Varian.....226               |
| HR Mag.....163               | Vector Radio.....227         |
| HRD.....166, 167             | Vid Com.....228              |
| Ham Shack *.....             | VHF Comm.....229             |
| Hamtronics, N.Y.....305      | Walter Test Equip.....230    |
| Harrison.....164             | Westcom.....231              |
| Hatry.....165                | Western Elec.....232         |
| Health.....301               | Western Sat.....233          |
| ICOM.....168, 169            | Wheeler *.....               |
| Idiom Press.....170          | Williams.....234             |
| Inter Med.....171            | Yaesu.....235                |
| Jensen.....172               |                              |

\*Please contact this advertiser directly.

Limit 15 inquiries per request.

## November 1984

Please use before December 31, 1984

Tear off and mail to

**HAM RADIO MAGAZINE** — "check off"  
Greenville, N. H. 03048-0498

NAME.....  
CALL.....  
STREET.....  
CITY.....  
STATE.....ZIP.....

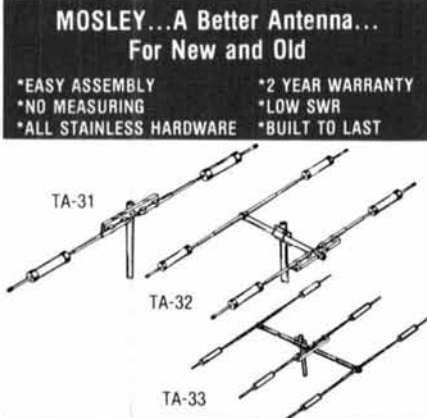

Whether you are just starting out or trying to complete the Honor Roll, Mosley offers a Full Line of Tri-Banders which will mechanically and electronically outperform the competition. For the new ham with limited space and pocket book, start with our TA-31 Jr. rotatable dipole. You can make our TA-31 Jr. into a 2 or 3 element as your needs increase. If you start with the need to run higher power, then the TA-31 is for you. This also can be made into a 2 or 3 element beam as you expand your station.

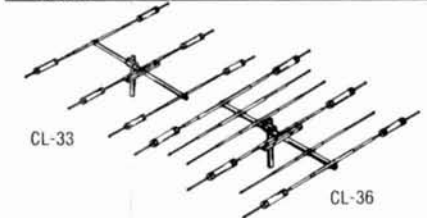

For the ham that wants a little more performance out of a Tri-Bander but is limited in room, then our CL-33 on a 18 foot boom is the way to go. For those that want MONO BAND performance out of a Tri-Bander, want to hear better, and be louder, the CL-36 is for you.



For the ham that wants to start right at the top, the PRO-37 is the antenna that will give you kind of the hill performance. It is the broadest-banded, highest power, best performing Tri-Bander in our line.

Compare ours before buying any other antenna. All stainless standard, all heavy telescoping aluminum elements which means better quality and no measurement. Ease of assembly gives you a quality antenna with consistent performance. Our elements are pre-drilled so you will get the same performance as we do. All of our Tri-Banders come with a 2 year warranty.

If you are a new ham and are not familiar with MOSLEY, ask an older ham about us or call the PRESIDENT of MOSLEY. He will be glad to explain why MOSLEY is A BETTER ANTENNA.

These and other MOSLEY products are available through your favorite DEALER. Or write or call MOSLEY for the DEALER nearest you.



1344 BAUR BLVD ST. LOUIS, MISSOURI 63132  
1-314-994-7872      1-800-325-4016

# Advertisers index

|   |   |
|---|---|
| ADM.....17                                  | Advanced Computer Controls, Inc.....21      |
| Advanced Receiver Research.....147          | AEA.....76                                  |
| Alden Electronics.....40                    | ALL Electronics.....116                     |
| Alpha Delta Communications.....45, 145      | Aluma Tower Co.....60                       |
| Amateur Electronic Supply.....111           | Amateur Wholesale Electronics.....87        |
| American Radio Relay League.....157         | Amidon Associates.....156                   |
| Barny Electronics.....140                   | Applied Inventions.....151                  |
| Astron Corp.....112                         | Atlantic Surplus Sales.....149              |
| Audio Amateur.....120                       | Automation Techniques, Inc.....79           |
| ATV Magazine.....142                        | Azotic Industries.....140                   |
| Barker & Williamson.....45                  | Barny Electronics.....140                   |
| Castle Hill Coil Corp.....64                | CeCo.....64                                 |
| CES.....1                                   | Centurion International.....141             |
| Coaxial Dynamics, Inc.....96                | Coaxial Dynamics.....90                     |
| Communications Concepts, Inc.....180        | Communications Specialists.....160          |
| Computer Trader Magazine.....64             | Computer Systems.....74                     |
| Daytaro Electronics.....150                 | Delaware Amateur Supply.....91              |
| DEO.....32, 151                             | Digital Instruments.....90                  |
| Discount Discs.....90                       | Dixie Electronics.....22                    |
| Doppler Systems.....140                     | Dynetic Systems.....13                      |
| Electro-Com.....142                         | Electronic Equipment Bank.....96            |
| Encomm, Inc.....139, 142                    | Engineering Consulting.....90               |
| Epakon.....106                              | Fabtron.....106                             |
| Falcom Communications.....90                | Fair Radio Sales.....149                    |
| John Fluke Manufacturing Co., Inc.....12    | Fox Tango Corp.....147, 159                 |
| GLB Electronics.....36                      | Hal Communications Corp.....152             |
| Ham Tronix.....152                          | HamMaster Tapes.....56                      |
| Ham Radio's Bookstore.....70, 137, 144, 149 | Ham Radio Magazine.....72, 73               |
| Ham Radio Outlet.....105                    | The Ham Shack.....46, 47                    |
| Hamtronics, NY.....86                       | Harrison Radio.....129                      |
| Hatry Electronics.....86                    | ICOM America, Inc.....Cover II, 65          |
| Idiom Press.....151                         | International Media Service.....139         |
| Jensen Tools, Inc.....106                   | JRS Distributors.....106                    |
| Kantronics.....66                           | KCS Electronics.....2, 10, 11, Cover IV     |
| Lewis Electronics Co.....35                 | MFJ Enterprises.....132, 133, 134, 136, 136 |
| MHz Electronics.....153                     | Madison Electronic Supply.....155           |
| Glen Martin Engineering.....36              | Merrimac Satellite.....130, 131             |
| John J. Meshna, Jr., Co., Inc.....145       | Microbyte.....152                           |
| Micro Control Specialties.....32            | Microwave Filter, Inc.....88, 89            |
| Missouri Radio Center.....159               | Morning Distributing.....152                |
| Mosley Electronics.....149, 158             | NGC.....106, 107                            |
| Nampa Satellite Systems.....106, 107        | Nemal Electronics.....18                    |
| North American Soar Corp.....70             | Nuts & Volts.....70                         |
| Orbit Magazine.....90                       | Paulin Industries.....30, 34                |
| P.C. Electronics.....27                     | Phillips Tech Electronics.....27            |
| Precision Satellite.....27                  | Processor Concepts.....150                  |
| Pro Search Electronics.....156              | Public Domain.....156                       |
| RF Enterprises.....155                      | RF Products.....62                          |
| Radio Amateur Callbook.....143              | Radokit.....94                              |
| Radio Warehouse.....138                     | Ramsey Electronics.....159                  |
| SAROC.....159                               | Sartor Associates.....78                    |
| Satellite TV Magazine.....140               | Scamp Systems, Inc.....145                  |
| Shure Brothers.....140                      | Skyline Products.....148                    |
| South Midlands Communications, Ltd.....106  | Spectrum International.....34               |
| Spectrum West.....156                       | Spl Ro Distributing.....143                 |
| Ten Tec.....141                             | Terra Corporation.....80, 81                |
| TE Systems.....78                           | Texas Towers.....152                        |
| TNT Radio Sales.....78                      | Transleteronic, Inc.....106                 |
| UNR Rohm.....106                            | Universal Electronics.....159               |
| University Microfilms International.....159 | Vanguard Labs.....9                         |
| Varian/Emac.....30                          | Vector Radio.....106                        |
| Vid Com Communications.....94               | VHF Communications.....94                   |
| James Walter Test Equipment.....30          | Westcom Engineering.....142                 |
| Western Electronics.....94, 95              | Western Satellite.....156                   |
| Wheeler Applied Research Labs.....156       | Williams Radio Sales.....148                |
| Yaesu Electronics Corp.....Cover III        |   |



## ANTENNA SALE

### BEARCAT SPECIAL SALE

| HY-GAIN       |       |
|---------------|-------|
| TH3RJS        | \$169 |
| TH5MK2S       | \$355 |
| TH7BX3S       | \$410 |
| EXPLORER 14   | \$269 |
| 14AVQB        | \$59  |
| 18AVT/WBS     | \$95  |
| V2S           | \$37  |
| V3            | \$40  |
| V4            | \$49  |
| 66BS          | \$109 |
| CD45 II       | \$125 |
| HAM IV        | \$199 |
| T2X           | \$245 |
| ALLIANCE HD73 | \$99  |

| HY-GAIN TOWERS |         |
|----------------|---------|
| HG37SS         | CALL    |
| HG5OMT2        | FOR     |
| HG52SS         | SPECIAL |
| HG54HD         | PRICING |
| HG70HD         |         |
| <b>KLM</b>     |         |
| KT34A          | \$329   |
| KT34XA         | \$479   |
| 40M-2          | \$290   |
| 2M-13LBA       | \$77    |
| 2M-14C         | \$85    |
| 435-18C        | \$59    |
| 432-16LB       | \$65    |

| CUSHCRAFT |       |
|-----------|-------|
| A-3       | \$209 |
| A-4       | \$279 |
| 40-2CD    | \$279 |
| R-3       | \$265 |
| AV5       | \$98  |
| 32-19     | \$91  |
| 214B-FB   | \$77  |
| ARX-2B    | \$37  |
| A144-11   | \$46  |

|              |          |
|--------------|----------|
| BC 350       | \$375.00 |
| BC 300       | \$339.00 |
| BC 20/20     | \$279.00 |
| BC 210XL     | \$219.00 |
| BC 200       | \$169.00 |
| BC 180       | \$159.00 |
| BC 260       | \$249.00 |
| BC 100       | \$279.00 |
| BC WA        | \$34.95  |
| *CP2100      | \$279.00 |
| ALL SOFTWARE | \$39.95  |

| BUTTERNUT |       |
|-----------|-------|
| HF6V      | \$109 |

**AEA CALL**

**LARSEN CALL** **NEW**

**HUSTLER CALL**

✓ 187

Call "TOLL FREE" For All Antennas & Accessories



2900 N.W. VIVION RD. / KANSAS CITY, MISSOURI 64150 / 816-741-8118

This Publication is available in Microform.

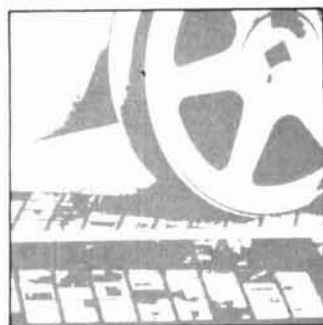

University Microfilms International

Please send additional information for \_\_\_\_\_  
 Name \_\_\_\_\_  
 Institution \_\_\_\_\_  
 Street \_\_\_\_\_  
 City \_\_\_\_\_  
 State \_\_\_\_\_ Zip \_\_\_\_\_

300 North Zeeb Road  
 Dept. P.R.  
 Ann Arbor, MI 48106

# SAROC™ NEWS

Due to an unavoidable scheduling problem, SAROC 1985 has been cancelled. Plans are presently being formulated for SAROC 1986. Details will be announced as soon as they are completed.

**SAROC™**

P.O. BOX 945  
 BOULDER CITY, NV 89005

## TS430S FILTERS

You can select 3 optional \$60 Fox Tango filters for your TS430S: SSB Narrow (1.8 or 2.1KHz bandwidth), CW Narrow (250 or 400Hz), and AM (6.0KHz). To improve CW or AM reception, you must use one of the filters indicated. For SSB there is a choice: you can add one of the narrow filters, or you can use the improved Filter Cascading Kit.

We recommend the Cascading Kit because it is more effective. It benefits both SSB and CW reception without affecting the other modes or TX. When you just add a narrow SSB filter, the mode switch lets you select either the stock (2.4KHz) filter or the narrow one. Either way, the i-f signal passes through only one filter — the other is idle! In the Fox Tango Cascading Kit two filters are active: the signal first passes through the stock filter and, near the end of the i-f chain, through a second filter — the high quality 8-pole Fox-Tango 2.1 KHz unit and its amplifier board. Here are the results:

|                   | BEFORE<br>(with Stock SSB) | AFTER<br>(with Cascade Kit) |
|-------------------|----------------------------|-----------------------------|
| 30dB Bandwidth    | 3.2 KHz                    | 2.16KHz                     |
| IMD Dynamic Range | 83dB                       | 100dB (50KHz Spacing)       |
| Idle Noise (1-F)  | 0dB (Reference)            | -6dB (below reference)      |

The narrower bandwidth improves selectivity. The greater dynamic range reduces QRM. The reduced noise makes weak-signal reception easier. And, as a bonus, the Shift control works much better. Installation is inboard, instructions are complete, no drilling is required, and only a few soldered connections are needed. However, skill is necessary; your dealer can help if desired.

**INTRODUCTORY MONEY-SAVING SPECIALS**  
 FTK-430S CASCADING KIT (including filter, board, instructions, etc.) ..... \$ 85  
 FTK-430S with one additional filter (CW or AM - reg. \$60 ea.) ..... \$140  
 FTK-430S with two additional filters (CW and AM) ..... \$185



SPECIFY: Type desired and CW bandwidth if ordered.  
 SHIPPING: \$3, Air \$5, ✓ 157  
 COD add \$1, Overseas \$10.  
 FL Residence add 5% Tax.

**FOX TANGO CORPORATION**  
 Box 15944 H, W. Palm Beach, FL 33416  
 (305) 683-9587



## Stuck with a problem?

Our TE-12P Encoder might be just the solution to pull you out of a sticky situation. Need a different CTCSS tone for each channel in a multi-channel Public Safety System? How about customer access to multiple repeater sites on the same channel? Or use it to generate any of the twelve tones for EMS use. Also, it can be used to access Amateur repeaters or just as a piece of versatile test equipment. Any of the CTCSS tones may be accessed with the TE-12PA, any of the audible frequencies with the TE-12PB. Just set a dip switch, no test equipment is required. As usual, we're a stickler for 1day delivery with a full 1 year warranty.

- Output level flat to within 1.5db over entire range selected.
- Immune to RF.
- Powered by 6-30vdc, unregulated at 8 ma.
- Low impedance, low distortion, adjustable sinewave output, 5v peak-to-peak.
- Instant start-up.



### TE-12PA

|         |          |          |          |          |          |
|---------|----------|----------|----------|----------|----------|
| 67.0 XZ | 85.4 YA  | 103.5 1A | 127.3 3A | 156.7 5A | 192.8 7A |
| 71.9 XA | 88.5 YB  | 107.2 1B | 131.8 3B | 162.2 5B | 203.5 M1 |
| 74.4 WA | 91.5 ZZ  | 110.9 2Z | 136.5 4Z | 167.9 6Z |          |
| 77.0 XB | 94.8 ZA  | 114.8 2A | 141.3 4A | 173.8 6A |          |
| 79.7 SP | 97.4 ZB  | 118.8 2B | 146.2 4B | 179.9 6B |          |
| 82.5 YZ | 100.0 1Z | 123.0 3Z | 151.4 5Z | 186.2 7Z |          |

- Frequency accuracy,  $\pm .1$  Hz maximum – 40°C to +85°C
- Frequencies to 250 Hz available on special order.
- Continuous tone

### TE-12PB

| TEST-TONES: | TOUCH-TONES: | BURST TONES: |      |      |      |
|-------------|--------------|--------------|------|------|------|
| 600         | 697 1209     | 1600         | 1850 | 2150 | 2400 |
| 1000        | 770 1336     | 1650         | 1900 | 2200 | 2450 |
| 1500        | 852 1477     | 1700         | 1950 | 2250 | 2500 |
| 2175        | 941 1633     | 1750         | 2000 | 2300 | 2550 |
| 2805        |              | 1800         | 2100 | 2350 |      |

- Frequency accuracy,  $\pm 1$  Hz maximum – 40°C to +85°C
- Tone length approximately 300 ms. May be lengthened, shortened or eliminated by changing value of resistor

**\$89.95**

**COMMUNICATIONS SPECIALISTS**

426 West Taft Avenue, Orange, California 92667  
(800) 854-0547/California: (714) 998-3021



# The Yaesu FT-209RH. 5 watts that your batteries can live with.

Have the power you need when you need it with Yaesu's new 5-watt, 2-meter handheld. Power to get out in situations where ordinary HTs just won't make it.

We designed our HT with a unique user-programmable Power Saver that puts the rig to "sleep" while you're monitoring and "wakes it up" when the squelch breaks. So you can listen for hours and still have plenty of power to hit those hard-to-reach repeaters when you need to.

With the FT-209RH there's no need to fiddle with knobs when you change from one memory channel to another. That's because you can independently store everything you need in each of the ten memories: receive frequency, standard or non-standard offset, even tone encode/decode with an optional module. And then recall any channel at the touch of a button.

It's easy to hear what's happening on your favorite repeaters or simplex frequencies. Just touch a button and scan all memory channels, or selected ones. Or all frequencies between any two adjacent memories. Use the priority feature to return automatically to your special frequency when it becomes active.

Bring up controlled-access machines with the optional plug-in subaudible tone encoder/decoder, independently programmed from the keyboard for each channel. Listen for tone-encoded signals on selected channels — without having to hear a bunch of chatter — by enabling the decode function.

The FT-209RH, which covers 10 MHz for CAP and MARS use, comes complete with a 500-mAh battery, charger and soft case.

For those who want a basic radio without the bells and whistles, consider the compact, lightweight FT-203R. This economical HT features 2.5 watts of power and an optional DTMF keypad. Most all the accessories for the 209 work with the 203, including an optional VOX headset that gives you hands-free operation that's perfect for public service events.

So when you visit your dealer, let him know you won't settle for anything but the best. A radio built by Yaesu.

## YAESU

### Yaesu Electronics Corporation

6851 Walthall Way, Paramount, CA 90723  
(213) 633-4007

### Yaesu Cincinnati Service Center

9070 Gold Park Drive, Hamilton, OH 45011  
(513) 874-3100

Prices and specifications subject to change without notice.



# KENWOOD

...pacesetter in amateur radio

## Digital Code Squelch... TR-2600A

Kenwood's TR-2600A introduces DCS (Digital Code Squelch) circuitry, a signaling concept developed by Kenwood. DCS allows each station to have its own "private call" code or to respond to a "group call" or "common call" code. There are 100,000 different 5-digit ASCII code combinations possible. You can program in call signs up to 6 digits in the ASCII code. When operating in the DCS mode, this information can then be automatically transmitted each time the transmit key is depressed. This revolutionary feature is only the beginning! The TR-2600A also sports a high impact plastic case, that is extra rugged and scuff-resistant. The molded-in color adds to the attractive appearance. The large L.C.D. display is easy to read in direct sunlight or in the dark with a convenient lamp switch. It displays transmit/receive frequencies, memory channels, and five arrow indicators for "F LOCK" frequency lock, "REV" repeater reverse, "PROG.S" programmed scan, "MS" memory scan, "ALERT.S" alert scan. A star indicates "MEMORY LOCK-OUT" is activated, and repeater offset indicated by "+, -, S and M." The TR-2600A has 10 memories, nine for simplex or transmit with frequency offset  $\pm 600$  kHz and one (memory 0) for non-standard split frequencies. Memory scan and programmable band scan have the added convenience of "Time operated Resume" that stops on busy channel and holds for approximately 5 seconds; then resumes scanning, or "Carrier Operated Resume" that stops on busy channel and resumes when signal ceases. Memory scan, scans only those memories in which data is stored, and memory lock-out allows you to skip selected memory channels



without loss of data previously stored! Manual Scanning UP/DOWN in 5-kHz steps and programmable automatic band scan are also useful features. The TR-2600A has a built-in "S" meter on the top panel which also indicates battery level when in transmit mode. Extended frequency coverage, 142.000-148.995 MHz allows transmit capability in 5-kHz steps for simplex or repeater operation on most MARS and CAP frequencies. Receive frequency coverage includes 140.000-159.995 MHz.

These features only tell part of the story. The TR-2600A also has keyboard frequency selection, built-in 16-key autopatch encoder, "TX STOP" switch, HI (2.5)/LOW (300 mw) power switch, REV switch, "SLIDE-LOC" battery pack, high efficiency speaker, BNC antenna terminal, and all of this in an extremely compact and lightweight package!

Kenwood's TR-2600A, with D.C.S., leads the way in high technology handheld transceivers!

### Optional accessories:

- TU-35B built-in programmable sub-tone encoder
  - ST-2 Base Stand
  - MS-1 Mobile Stand
  - PB-26 Ni-Cd Battery
  - DC-26 DC-DC Converter
  - HMC-1 Headset with VOX
  - SMC-30 Speaker Microphone
  - LH-3 Deluxe Leather Case
  - SC-9 Soft Case
  - BT-3 AA Manganese/Alkaline Battery Case
  - EB-3 External C Manganese/Alkaline Battery Case
  - RA-3, 5, Telescoping Antenna
  - CD-10 Call Sign Display
- More information on the TR-2600A is available from authorized dealers of Trio-Kenwood Communications, 1111 West Walnut Street, Compton, CA 90220.

*Specifications and prices are subject to change without notice or obligation.*