

# ham radio magazine

## YAGI ELEMENT TAPER AFFECTS GAIN & F/B RATIO

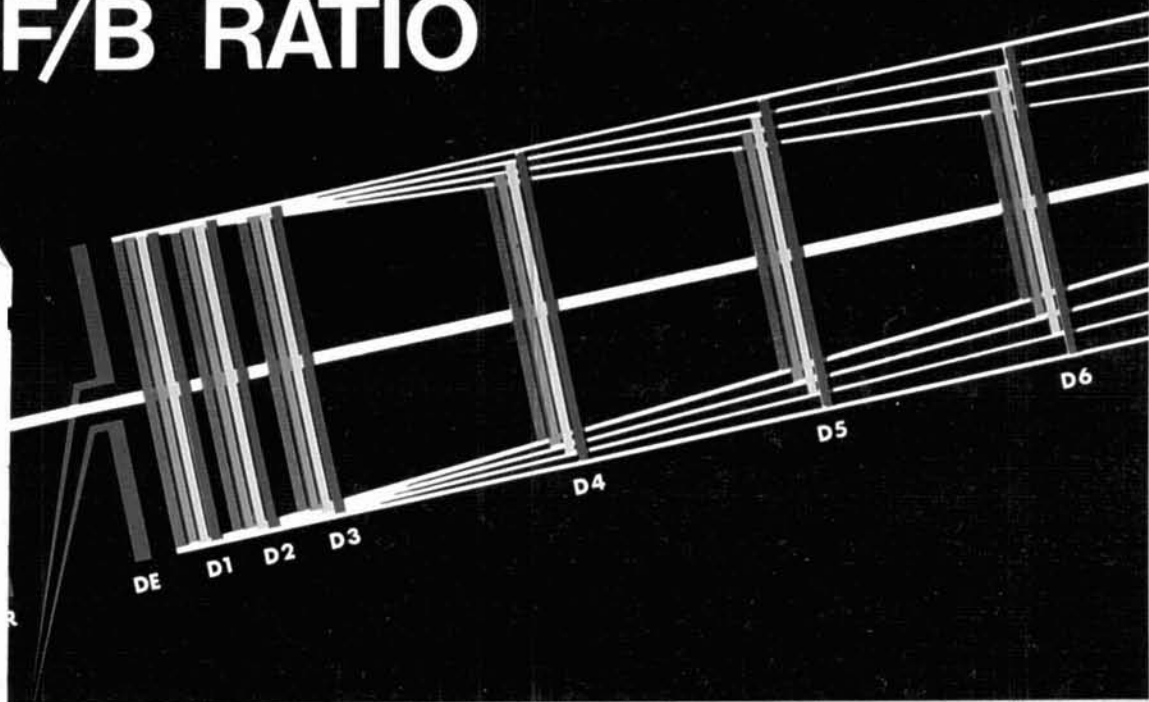

*also: remote-controlled 40/80/160-meter vertical  
• end-fed multiband 8JK • computerized  
antenna matching • high-performance dipole  
• branch-line hybrids • simple wire plow  
• and the conclusion of K2BT's series on  
vertical phased arrays*

# IC-271H

## Now a 100 Watt, 2 Meter Base!



For the ultimate in two-meter communications, ICOM presents the IC-271H transceiver with a high dynamic range receiver and a 100 watt transmitter. Operating from the IC-PS30, IC-PS15, or the internal IC-PS35 (optional), the IC-271H brings all the advanced functions of the latest CPU controlled radios to your shack.

**100 Watts.** Now a two-meter base station with 100 watts of internal power! The IC-271H provides all the power required for operation from remote places to repeaters, or for simplex.

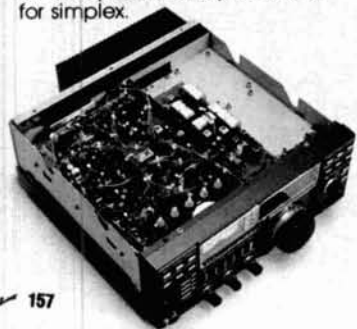

IC-PS30  
Power Supply

**Subaudible Tones.** Included as a standard feature are 32 built-in subaudible tones which are easily selected by rotating the main tuning knob. PL tones may be stored into memory.

**32 Full-Function Memories.** Each tunable memory holds frequency, offset, offset direction, mode and subaudible tone. Each parameter is selected by rotating the main tuning knob in conjunction with the switches on the front panel.

**PLL Locked at 10Hz.** An extremely low-noise, professional receiver and a good signal-to-noise ratio PLL allows the IC-271H's synthesizer to lock to 10Hz providing receiver performance unparalleled by any other VHF receiver.

**Fluorescent Display.** ICOM's high-visibility, multicolor display gives easy-to-read display of all information necessary for logging a contact. Frequency, mode, duplex, offset direction, RIT frequency, memory channel and PL tone can be displayed.

**Scanning.** The IC-271H can scan memories and programmed sections of the band or modes. Mode-S scan can be used to scan only memories with a particular mode or lock out frequencies continuously busy so the receiver will not stop at that memory channel while scanning.

**Other Standard Features.** To facilitate the operation of the IC-271H, ICOM has incorporated a duplex check switch, all-mode squelch, receive audio tone control, S-meter, center meter, seven-year lithium battery memory backup, accessory connector and microphone.

**Optional Features.** IC-271H options are: switchable preamplifier, CTCSS encoder/decoder (encoder is standard), computer interface and voice synthesizer.

**Size.** Only 11 1/4 inches wide by 4 3/8 inches high, the IC-271H styled to look good and engineered for ease of operation.



IC-271H  
Shown with internal  
power supply IC-PS35

**The IC-271A.** The IC-271A with 25 watt output is available and has the same features as the IC-271H, plus an optional IC-PS25 internal power supply to make it a compact, go-anywhere two-meter base station. See the IC-271A(H) and other fine ICOM equipment at your ICOM dealer today.



# ICOM

## The World System

# The small dish that captures all the entertainment.

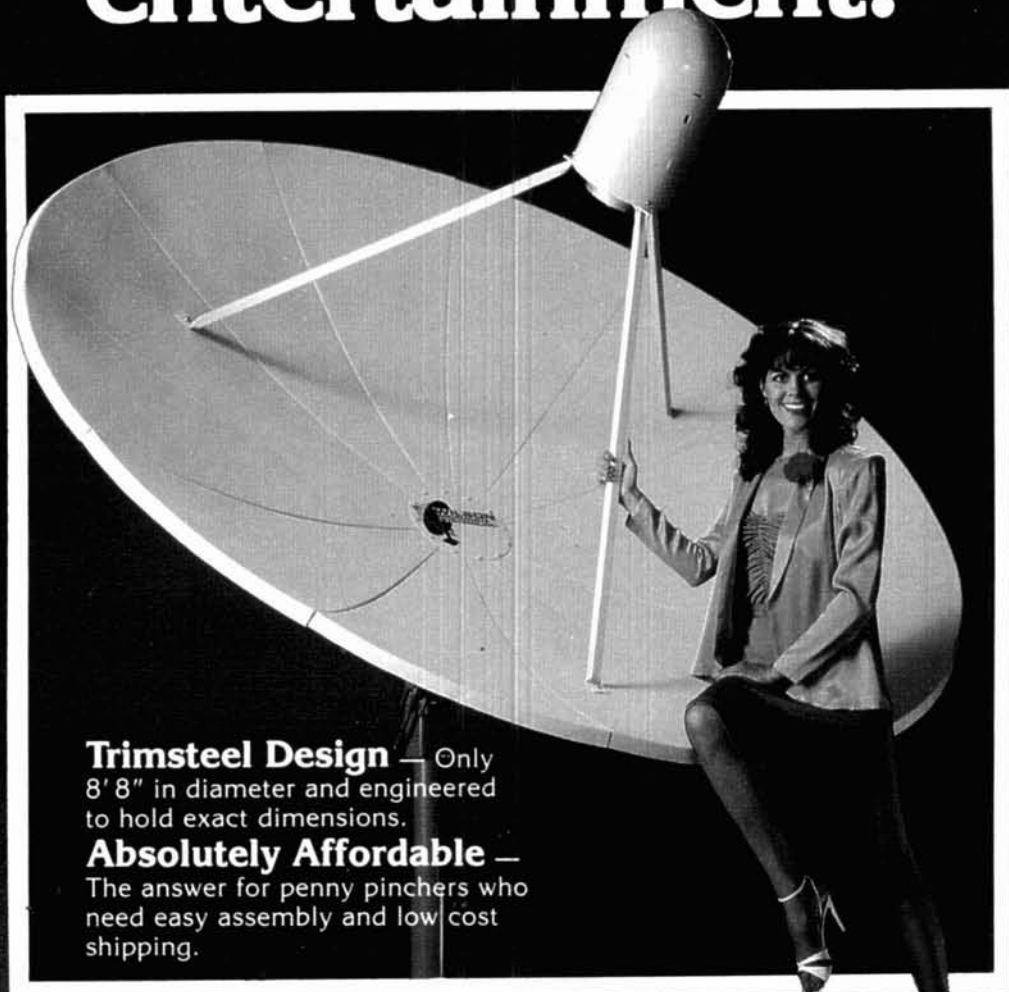

**Trimsteel Design** — Only 8'8" in diameter and engineered to hold exact dimensions.

**Absolutely Affordable** — The answer for penny pinchers who need easy assembly and low cost shipping.

**Versatile Mounting Capability** —

Approximately 3 feet smaller than ordinary dishes. May be mounted in environments unable to accommodate larger dishes.

**Four Year Limited Warranty** — Unsurpassed in the industry, it's built to last.

**Rugged Construction** — Galvanized steel, 18 gauge thickness and can easily handle all weather conditions.

*Toll Free (800) 634-6898*

**P. O. Box 50070  
Henderson, Nevada 89016**

**WILSON  
MICROWAVE  
SYSTEMS, INC.**

Antenna is shown with optional LNA cover.

# KENWOOD

pacesetter in amateur radio

## TS-430S "Digital DX-terity!"

### TS-430S

Digital DX-terity... that outstanding attribute built into every KENWOOD TS-430S that lets you QSY from band to band, frequency to frequency, and from mode to mode with the speed and ease that will give you a dominant position in DX operations.

KENWOOD'S TS-430S, a revolutionary, ultra-compact, HF transceiver has already won the hearts of radio Amateurs the world over. It covers 160-10 meters, including the new WARC bands (easily modified for HF MARS). Its high dynamic range receiver tunes from 150 kHz-30 MHz. It utilizes an innovative UP conversion PLL circuit for superior frequency stability and accuracy. Two digital VFO's allow fast split-frequency operations. A choice of USB, LSB, CW, or AM, with FM optional, are at the operators fingertips. All Solid-state technology permits inputs of 250 watts PEP on SSB, 200 watts DC on CW, 120 watts on FM (optional), or 60 watts on AM. Final amplifier protection circuits and a cooling fan are built-in.

Eight memories store frequency, mode, and band data, with Lithium battery memory back-up. Memory scan and programmable automatic band scan help speed up operations. An IF shift circuit, a tuneable notch filter, and a Narrow-Wide switch for IF filter selection help eliminate QRM. It has a built-in speech processor. A fluorescent tube digital display makes tuning easy and fast. An all-mode squelch circuit, a noise blanker, and an RF attenuator control help clean up the signal. And there's a VOX circuit, plus semi-break-in, with side-tone. All-in-all, it just could be that the expression "Digital DX-terity" is a bit of an understatement.

#### TS-430S Optional Accessories:

In typical KENWOOD fashion, there are plenty of optional accessories for this great HF transceiver. There is a special power supply, the PS-430. An external speaker, the SP-430, is also available. And the MB-430 mounting bracket is available for mobile operation. The

AT-250 automatic antenna tuner was designed primarily with the TS-430S in mind, and for those who prefer to "roll their own," the AT-130 antenna tuner is available. The FM-430 FM unit is available for FM operations. The YK-88C (500 Hz) or YK-88CN (270 Hz) CW filters, the YK-88SN SSB filter, and the YK-88A AM filter may be easily installed for serious DX-ing. An MC-60A deluxe desk microphone, MC-80 and MC-85 communications microphones, an MC-42S mobile hand mic., and an MC-55 8-pin mobile microphone, are available, depending on your requirements. TL-922A linear amplifier (not for CW QSK), SM-220 station monitor, PC-1A phone patch, SW-2000 SWR/power meter 160 ~ 6 meter, SW100A SWR/power/volt meter 160-2m, HS-4, HS-5, HS-6, HS-7 headphones, are also available.

More information on the TS-430S is available from authorized dealers of Trio-Kenwood Communications, 1111 West Walnut Street, Compton, California 90220.



Specifications and prices are subject to change without notice or obligation.



# SAVE \$10.50\* with home delivery

Payment enclosed

Bill me later

\*(One year newsstand cost \$30.00)

Here's my address label, enter my subscription.

1 Year . . . . . 12 issues . . . . . \$19.50

2 Years . . . . . 24 issues . . . . . \$32.50

3 Years . . . . . 36 issues . . . . . \$42.50

U. S. prices only

Name \_\_\_\_\_ Zip \_\_\_\_\_

Address \_\_\_\_\_ State \_\_\_\_\_

City \_\_\_\_\_

Check here if this is your renewal (attach label)

## Subscribe to **ham radio** magazine

Please allow 4-6 weeks for delivery of first issues.

**Foreign rates:** Europe, Japan and Africa, \$28.00 for one year by air forwarding service. All other countries \$21.50 for one year by surface mail.

Please  
enter my  
subscription



**BUSINESS REPLY CARD**

First Class    Permit No. 1    Greenville, NH

Postage Will Be Paid By Addressee

**ham  
radio**

Greenville, NH 03048

NO POSTAGE  
NECESSARY  
IF MAILED  
IN THE  
UNITED STATES

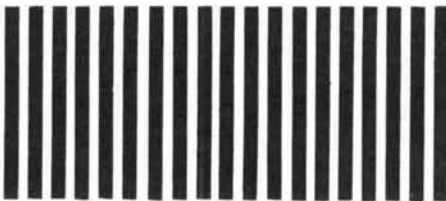

# ham radio

magazine

**MAY 1984**

**volume 17, number 5**

**T. H. Tenney, Jr., W1NLB**  
publisher

**Rich Rosen, K2RR**  
editor-in-chief  
and associate publisher

**Dorothy Rosa, KA1LBO**  
assistant editor

Joseph J. Schroeder, W9JUV  
associate editor

Susan Shorrock  
editorial production

#### editorial review board

Forrest Gehrke, K2BT  
Bob Lewis, W2EBS  
Mason Logan, K4MT  
Ed Wetherhold, W3NQN

#### publishing staff

**J. Craig Clark, Jr., N1ACH**  
assistant publisher

**Rally Dennis, KA1JWF**  
director of advertising sales

Dorothy Sargent, KA1ZK  
advertising production manager

Susan Shorrock  
circulation manager

Therese Bourgault  
circulation

Wayne Pierce, K3SUK  
cover design

ham radio magazine is published by  
Communications Technology, Inc.  
Greenville, New Hampshire 03048-0498  
Telephone: 603-878-1441

#### subscription rates

United States:  
one year, \$19.50; two years, \$32.50; three years, \$42.50  
Canada and other countries (via surface mail):  
one year, \$21.50; two years, \$40.00; three years, \$57.00  
Europe, Japan, Africa (via Air Forwarding Service): one year, \$28.00  
All subscription orders payable in U.S. funds, via international  
postal money order or check drawn on U.S. bank

international subscription agents: page 146

Microfilm copies are available from  
University Microfilms, International  
Ann Arbor, Michigan 48106  
Order publication number 3076

Cassette tapes of selected articles from ham radio  
are available to the blind and physically handicapped  
from Recorded Periodicals,  
919 Walnut Street, Philadelphia, Pennsylvania 19107

Copyright 1984 by Communications Technology, Inc.  
Title registered at U.S. Patent Office

Second-class postage paid  
at Greenville, New Hampshire 03048-0498  
and at additional mailing offices  
ISSN 0148-5889

Postmaster send form 3579 to ham radio  
Greenville, New Hampshire 03048-0498



## contents

**14 applied Yagi antenna design, part 1:  
a 2-meter classic revisited**

Stanley Jaffin, WB3BGU

**33 the high-performance, capacitively  
loaded dipole**

David Atkins, W6VX

**38 remote-controlled 40, 80, and  
160-meter vertical**

Robert Leo, W7LR

**45 vertical phased arrays: part 6**

Forrest Gerhke, K2BT

**63 ham radio techniques**

Bill Orr, W6SAI

**67 easy antenna matching**

James A. Sanford, WB4GCS

**81 an end-fed multiband 8JK**

R.C. Marshall, G3SBA

**93 branch-line hybrids: part 2**

Ernie Franke, WA2EWT

**107 build a simple wire plow**

Harry R. Hyder, W7IV

**110 VHF/UHF world**

Joe Reisert, W1JR

**129 matching dipole antennas**

George A. Wilson, W1OLP

**148 advertisers index**      **125 ham notebook**  
**and reader service**      **135 new products**

**12 comments**      **11 presstop**

**119 DX forecaster**      **6 reflections**

**146 flea market**      **125 short circuit**

**144 ham mart**

# REFLECTIONS REFLECTIONS

## One year ago . . .

It's hard to believe a year has passed since we put together the 1983 annual antenna issue. That was my first May special as Editor-in-Chief (though I had joined *ham radio* in the fall of the previous year). Gracing the pages of that issue was the start of a series of articles on vertical phased arrays that promised to examine in detail every important aspect of that subject from design through construction. Most appropriately, the final article in that series appears in this special antenna issue. I would not for a moment suggest that it is either easy reading or the answer to everyone's antenna requirements, but as the author has repeatedly stated, the series takes the mystery out of antenna development and squarely places that topic into the realm of science. Though the author has primarily concentrated on the 75-meter band (where his interests lie — and considering the present sunspot cycle trend, it's not a bad idea), the concept he presents is well suited for use on other bands. It's a series I heartily recommend reading and rereading.

While still on the subject of verticals, how would you like to be able to remotely control a fine performing antenna on your three favorite low bands: 160, 80, and 40? Robert Leo, W7LR shows you how with his 70-foot vertical that uses inexpensive irrigation pipe and a five position switching control head and RF deck. It's simple and effective, and with a flick of a switch, gives you *full* coverage of the three bands without any retuning . . . a very nice addition, I might add, to any installation that uses a no-tune synthesized transceiver.

From the United Kingdom comes an ingenious and quite effective design for an antenna and tuner that enables operation on the three highest bands (20, 15, and 10). R.C. Marshall, G3SBA, shows how an old standby antenna, an "8JK," can be end-fed to provide performance comparable to that of the standard center-fed version. The more remarkable aspect of his development is a sophisticated antenna control unit that enables the operator to step through each of the bands in narrow segments using a BCD switching circuit. The original motivation for this elaborate design was the author's need for an unobtrusive, high performance three-band antenna installation. Food for thought for those with small lots and big ambitions (DX, that is).

On a different angle, *ham radio* received an innocent enough sounding call several months ago from a gentleman who said that he had carefully read Lawson's series on Yagis for the HF bands and would be interested in providing a somewhat similar presentation for the VHF/UHF bands. From subsequent conversations with Stan Jaffin, WB3BGU, it soon became obvious that not only had he thoroughly understood Lawson's series, but that he'd also investigated the works of several prominent VHF/UHF designers including Kmosko and Johnson, Greenblum, Tilton, Vierzicke and Knadle. With the aid of a computer (a mainframe, I believe), he generated a series of tables and associated patterns which examined in fine detail the effect of iterating Yagi parameters for the enhancement of gain and front-to-back ratio. His first article, appearing in this issue, is concerned with the 2-meter band with emphasis on the weak signal segment. Very methodically various director tapering schemes are shown and logical conclusions drawn. The series will continue over the next several months, with the same care given to the examination of Yagis for the 220 and 432 MHz bands. Like Lawson's series, Stan's is not meant for casual reading, but rather for use by experimenters who wish to build a strong foundation in their understanding of Yagi antenna design.

While in the VHF/UHF World; Joe Reisert, W1JR, one of our featured columnists, has done it again. The no-nonsense delivery of information he's famous for has carried into this special antenna issue. In his column on page 110, he examines the "slightly" important area of performance parameters. Gain, beamwidth, front-to-back ratio, sidelobes and VSWR are defined and their interrelationships explored. He doesn't stop there, but continues to discuss other areas of considerable importance to the antenna designer such as feed systems, wind load, structural strength and preventive maintenance. In the second part of his article — of special interest to those who attend antenna measuring contests — Joe shows how one can actually determine gain and come pretty close with an estimate once the major side lobe levels are known. In reading the article perhaps you'll recognize several of the common mistakes that can turn a VHFer's hair a lighter shade of white.

Sometimes it appears that very few new antenna ideas are generated, and that recent developments are old concepts introduced to meet new needs. A case in point is what's known as a "stretch" or phase compensated dipole. The concept, first introduced in the 40s and possibly a decade earlier, illustrates a technique whereby the addition of series capacitors, periodically located throughout an antenna's legs, create a uniform current distribution over the entire length of the radiator. The particular version explored by David Atkins, W6VX, sports a low angle of radiation, high efficiency and wideband performance.

This annual antenna issue continues with techniques using just a GDO, noise or RF bridge — or more elaborately, a microcomputer — to match simple antennas.

For those intrigued with verticals, a large ground radial system is a must and W7IV shows you how it can be done with the use of a home-built wire plow.

Naturally pleased with this month's useful editorial content, we also take considerable satisfaction in setting a new *ham radio* record: because of the outstanding support of you, our readers, and our advertisers, this issue sets an all-time record for advertising space sales. To all involved, a hearty THANK YOU.

Remember, I always have room for just one more manuscript. If you have an idea for an article you'd like to write, send it in or stop by the *ham radio* booth at the Dayton Hamvention, April 27-29. Let's talk about it.

**Rich Rosen, K2RR/1**  
Editor-in-Chief



# MFJ ACCESSORIES

**300 WATT ANTENNA TUNER HAS SWR/WATTMETER, ANTENNA SWITCH, BALUN. MATCHES VIRTUALLY EVERYTHING FROM 1.8 TO 30 MHz.**



**\$99.95** MFJ-941D

**NEW FEATURES**

- **MFJ's fastest selling tuner packs in plenty of new features!**
- **New Styling!** Brushed aluminum front. All metal cabinet.
- **New SWR/Wattmeter!** More accurate. Switch selectable 300/30 watt ranges. Read forward/reflected power.
- **New Antenna Switch!** Front panel mounted. Select 2 coax lines, direct or through tuner, random wire/balanced line or tuner bypass for dummy load.
- **New airwound inductor!** Larger more efficient 12 position airwound inductor gives lower losses and more watts out. Run up to 300 watts RF power output. Matches everything from 1.8 to 30 MHz: dipoles, inverted vee, random wires, verticals, mobile whips, beams, balanced and coax lines. Built-in 4:1 balun for balanced lines. 1000V capacitor spacing. Black. 11x3x7 inches. Works with all solid state or tube rigs. Easy to use, anywhere.

## RTTY/ASCII/CW COMPUTER INTERFACE MFJ-1224 \$99.95



Send and receive computerized RTTY/ASCII/CW with nearly any personal computer (VIC-20, Apple, TRS-80C, Atari, TI-99, Commodore 64, etc.). Use Kantronics or most other RTTY/CW software. Copies both mark and space, any shift (including 170, 425, 850 Hz) and any speed (5-100 WPM RTTY/CW, 300 baud ASCII). Sharp 8 pole active filter for CW and 170 Hz shift. Sends 170, 850 Hz shift. Normal/Reverse switch eliminates retuning. Automatic noise limiter, Kantronics compatible socket plus exclusive general purpose socket. 8x1 1/2x6 in. 12-15 VDC or 110 VAC with adapter, MFJ-1312, \$9.95.

## RX NOISE BRIDGE

Maximize your antenna performance!



**\$59.95** MFJ-202B

Tells whether to shorten or lengthen antenna for minimum SWR. Measure resonant frequency, radiation resistance and reactance.

**New Features:** Individually calibrated resistance scale, expanded capacitance range ( $\pm 150$  pF). Built-in range extender for measurements beyond scale readings. 1-100 MHz. Comprehensive manual. Use 9 V battery. 2x4x4 in.

## INDOOR TUNED ACTIVE ANTENNA

"World Grabber" rivals or exceeds reception of outside long wires! Unique tuned Active Antenna minimizes intermod, improves selectivity, reduces noise outside tuned band, even functions as preselector with external antennas. Covers 0.3-30 MHz. Telescoping antenna.

Tune, Band, Gain, On-off bypass controls. 6x2x6 in. Uses 9V battery, 9-18 VDC or 110 VAC with adapter, MFJ-1312, \$9.95.



**\$79.95** MFJ-1020

## POLICE/FIRE/WEATHER 2 M HANDHELD CONVERTER

Turn your synthesized scanning 2 meter handheld into a hot Police/Fire/Weather band scanner! 144-148 MHz handhelds receive Police/Fire on 154-158 MHz with direct frequency readout. Hear NOAA maritime coastal plus more on 160-164 MHz. Converter mounts between handheld and rubber ducky. Feedthru allows simultaneous scanning of both 2 meters and Police/Fire bands. No missed calls. Crystal controlled. Bypass/Off switch allows transmitting (up to 5 watts). Use AAA battery. 2 1/4x1 1/2x1 1/2 in. BNC connectors.

**\$39.95** MFJ-313



## MFJ/BENCHER KEYSER COMBO

**\$104.95**

The best of all CW worlds—a deluxe MFJ Keyer in a compact configuration that fits right on the Bencher iambic paddle! MFJ Keyer - small in size, big in features. Curtis 8044-B IC, adjustable weight and tone, front panel volume and speed controls (8-50 WPM). Built-in dot-dash memories. Speaker, sidetone, and push button selection of semi-automatic/tune or automatic modes. Solid state keying. Bencher paddle is fully adjustable; heavy steel base with non-skid feet. Uses 9 V battery or 110 VAC with optional adapter, MFJ-1305, \$9.95.



## VHF SWR/WATTMETER

Low cost

VHF SWR/Wattmeter! Read SWR (14 to 170 MHz) and forward/reflected power at 2 meters. Has 30 and 300 watts scales. Also read relative field strength. 4x2x3 in.

**\$29.95** MFJ-812

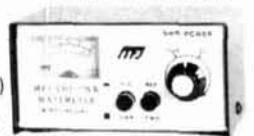

## 1 KW DUMMY LOAD

**\$34.95** MFJ-250

Tune up fast, extend life of finals, reduce QRM! Rated 1KW CW or 2KW PEP for 10 minutes. Half rating for 20 minutes, continuous at 200 W CW, 400 W PEP. VSWR under 1.2 to 30 MHz, 1.5 to 300 MHz. Oil contains no PCB. 50 ohm non-inductive resistor. Safety vent. Carrying handle. 7 1/2x6 1/4 in.



## 24/12 HOUR CLOCK/ID TIMER

**\$34.95** MFJ-103

Switch to 24 hour GMT or 12 hour format!

Battery backup maintains time during power outage. ID timer alerts every 9 minutes after reset. Switchable seconds readout. Elapsed timer. Just start clock from zero and note time of event up to 24 hours. Bright blue 6" digits. Alarm with snooze function. Synchronizable with WWV. Lock function prevents mis-setting. Power out, alarm on indicators. Black. 5x2x3 in. 110 VAC, 60 Hz.



## DUAL TUNABLE SSB/CW FILTER

**\$89.95** MFJ-752B



Dual filters give unmatched performance! The primary filter lets you peak, notch, low pass or high pass with extra steep skirts. Auxiliary filter gives 70 db notch, 40 Hz peak. Both filters tune from 300 to 3000 Hz with variable bandwidth from 40 Hz to nearly flat. Constant output as bandwidth is varied; linear frequency control. Switchable noise limiter for impulse noise. Simulated stereo sound for CW lets ears and mind reject QRM. Inputs for 2 rigs. Plugs into phone jack. Two watts for speaker. Off bypasses filter. 9-18 VDC or 110 VAC with optional adapter, MFJ-1312, \$9.95.

ORDER ANY PRODUCT FROM MFJ AND TRY IT-NO OBLIGATION. IF NOT DELIGHTED, RETURN WITHIN 30 DAYS FOR PROMPT REFUND (LESS SHIPPING).  
• One year unconditional guarantee • Made in USA.  
• Add \$4.00 each shipping/handling • Call or write for free catalog, over 100 products.

# MFJ

MFJ ENTERPRISES, INC.  
Box 494, Mississippi State, MS 39762

TO ORDER OR FOR YOUR NEAREST DEALER, CALL TOLL-FREE  
**800-647-1800.** Call 601-323-5869 in Miss. and outside continental USA.  
Telex 53-4590 MFJ STKV



# Mosley.....

A BETTER ANTENNA .....

## WHY SETTLE FOR LESS? LOOK WHAT THE MOSLEY TA-33 OFFERS

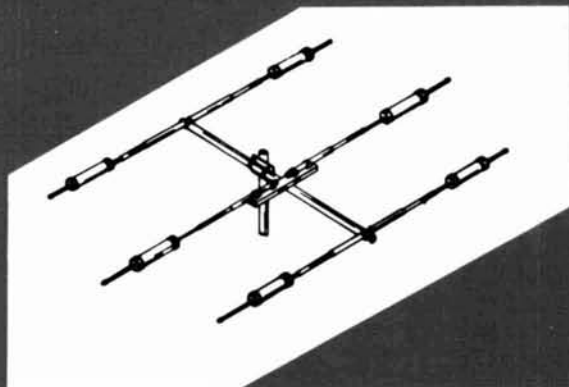

- 3 Element full power
- All stainless steel hardware
- Ease of assembly
- No balun required
- Now a 2 year limited warranty
- Now a standard 2" mast adapter
- Built to last

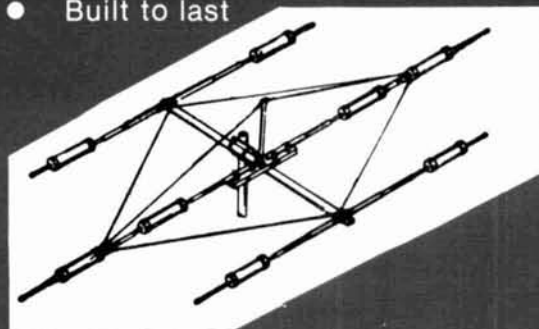

- Expandable to 30 or 40 meters
- Superb front to back ratio
- Excellent gain
- Outstanding SWR

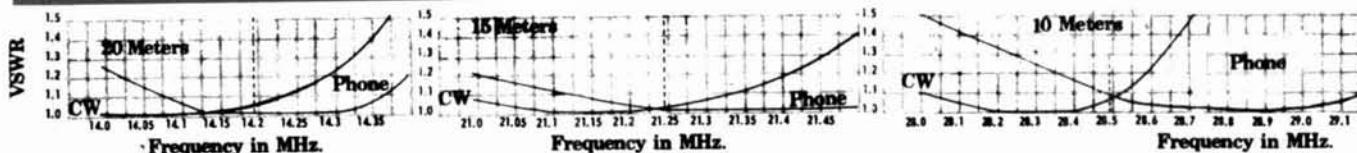

### SPECIFICATIONS:

Forward gain	
Front-to-Back Ratio	
Power rating	1KW
	CW
	2KW P.E.P.
Feedpoint Impedance	52 ohm
VSWR HT Resonance	1.5 to 1 or better
Matching System	Mosley
Number of Elements	3
Longest Element	28'
Boom Length	14'
Mast Size	1 1/2" or 2"
Turning Radius	15'6"
Wind surface area (in. sq. ft.)	5.7
Wind load (EIA standard 80 mph)	114 lbs.
Assembled Wt.	39 lbs
Shipping Wt.	44 lbs.

- Used around the world
- Work CW or phone without tuning or adjusting antenna
- A great antenna for the new solid state rigs

ALL MOSLEY ANTENNAS  
AND CATALOGS AVAILABLE  
AT QUALITY DEALERS  
OR CALL TOLL FREE

1-800-325-4016

ASK ABOUT OUR FALL SPECIAL

Prices and specifications  
subject to change  
without notice or  
obligation.

REMEMBER WHETHER YOU USE TRAPS OR LINEAR LOADING, 8db GAIN IS 8db GAIN

YOUR RECEIVER CAN'T TELL THE DIFFERENCE . . . MOSLEY . . . TRAP MASTERS QUALITY STILL SETTING THE PACE . . .

**Mosley Electronics**

A DIVISION OF WURDACK & ASSOCIATES INC. 1344 BAUR BOULEVARD ST. LOUIS, MO. 63132 1-314-994-7872

# NOW THE PRO-SEARCH™ BASIC MODEL PSE-1A DIGITAL ROTOR CONTROL

ONLY \$199.95

For Contesters,  
DX'ers, Handicapped  
Operators and General  
Purpose Ham  
Operators:

The Most Advanced  
Antenna Control  
Available...

- Bright Easy to see 1/2" LED's.
- Automatic Brake Control
- Single Button Movement
- 2 Memories
- Punch in Headings

#### Contesters:

Pro-Search Rotor Controls handles your Rotor for you! No Mods to your Rotor just connect your present 8 wire cable to our unit and it will allow you Hands Off Operation while brightly displaying your Rotors position on 1/2 inch LEDs.

#### DX'ers:

The PSE-1A automatically handles the Rotors brake protecting you against accidentally dropping it in while your Rotor is still moving.

#### New or Old Hams:

Need a complete system? Add a new Telex Ham-IV for only \$100.00 when purchased as a package! Don't miss this one offer only available for a limited time...Pro-Search The Quality Controller Company.



Current Heading Display

Programmable Keyboard and Memory Functions

PSE-1A + Ham IV\* 299.95  
PSE-1A + T2X\* 344.95

\*Printed with permission of TELEX/HY-GAIN

WHY NOT HAVE THE BEST IN CONTROL SYSTEMS  
FOR PENNIES MORE?

Compare Our Price To A Manual System  
— Very Close —  
In Performance Light Years Away!

Remember You Only Make This Purchase Once.

Pro-Search is  
Adaptable To Many  
Systems, Simple  
To Install.

No modifications are  
necessary.

Disconnect your  
present antenna  
control system and  
connect ours.

PSE-1A is used with  
HAM-M, HAM-II,  
III, IV, and TX.  
Other models  
available.

#### To Order:

1-800-325-4016  
1-314-994-7872 (Missouri)

#### Or Write:

Pro-Search Electronics Inc.  
1344 Baur Boulevard  
St. Louis, Mo. 63132

\*Patent Pending

**PRO-SEARCH**  
Reaching The World



# NEC

## Linear Power Bipolars

### NEL1300

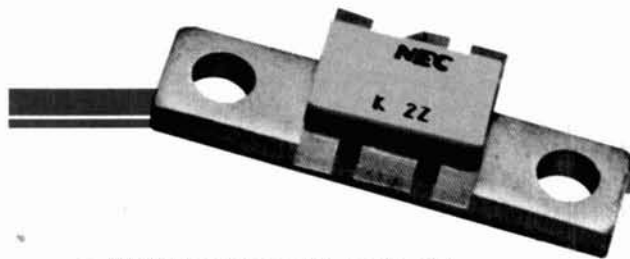

- High linear power and gain
  - NEL1306  $P_{1dB} = 38$  dBm typ.  
 $G_{1dB} = 7.5$  dBm typ.
  - NEL1320  $P_{1dB} = 43$  dBm typ.  
 $G_{1dB} = 6.0$  dB typ.
- 13.5 volt operation
- Pt-Si/Ti/Pt/Au metallization system
- Emitter ballasting
- Silicon nitride passivation

From our latest line of NPN epitaxial power transistors, NEC now introduces the NEL1300 range of linear power bipolar devices. The series is available in a low cost metal-ceramic stripline package offering linear power output levels of 6 watts and 20 watts. Designed primarily for mobile and base station operation in the 1300 MHz band, the series is compatible with single sideband and other popular modulation modes requiring high linearity combined with high output power and gain.

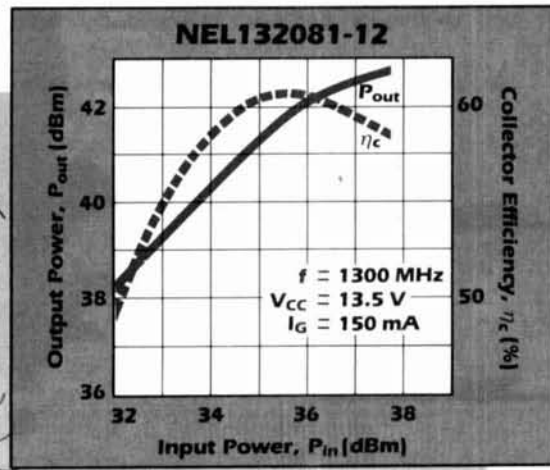
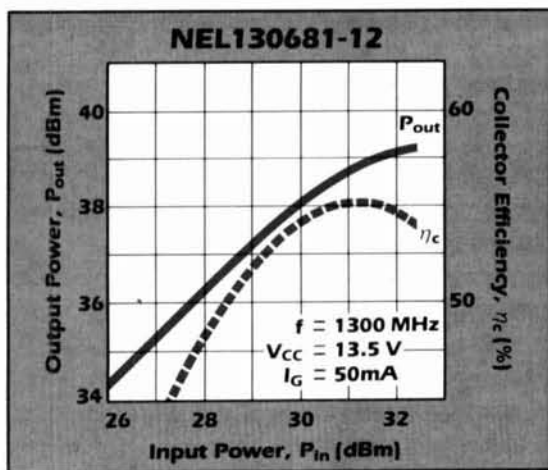

1300 MHz 450 MHz

NE0801 NEL1306 NEL1320

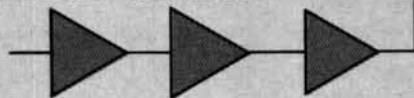

NE41137  
NE720  
NE645

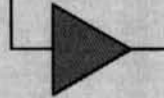

**CALIFORNIA EASTERN LABORATORIES, INC.**—U.S. and Canada  
Exclusive sales agents for **NEC Corporation**, Microwave Semiconductor Products.

Headquarters, Santa Clara, CA 95050 • 3260 Jay Street • (408)988-3500 • Tlx. 34-6393 or 171197

In Europe Contact: **NEC Electronics (Europe) GmbH** • Oberrather Strasse 4 • 4000 Düsseldorf 30 • West Germany  
Tel 0211/650301 • Tlx. 841/8581353 or 8587419

TOP ARRL OFFICES WERE SHAKEN UP IN A STRONGLY CONTESTED ELECTION March 26. Elected to League presidency was First Vice President Larry Price, W4RA, while Great Lakes Division Director Len Nathanson, W8RC, was named First Vice President. Gar Anderson, K0GA, retained his Vice Presidency, while Southwestern Division Director Jay Holladay, W6EJJ, was also elected a Vice President. Out entirely is Carl Smith, W0BBWJ, who had moved up to President from First Vice President after the death of Vic Clark, W4KFC, in November.

Just What This Means To The League's Future is hard to gauge as yet, though some knowledgeable League observers believe it's just the beginning of a period of internal strife and major policy shifts. It's no secret that many of the staff have been very unhappy over recent changes in work schedules, and the new administration is not believed to be very sympathetic to their complaints.

AN UNCOORDINATED REPEATER HAS BEEN SHUT DOWN by the FCC in southern California. The action came after the operator of a coordinated repeater (to which the uncoordinated repeater had caused interference) and the area coordinator, TASMA (the Two Meter Area Spectrum Management Association), filed complaints with the FCC. Cited in the FCC's action was a policy letter written last April by the FCC's Jim McKinney to WA2DHF of the Tri-State Repeater Group, in which he stated that in cases of interference the FCC would support coordinated repeaters and the organizations that provided their coordination.

IT'S ALMOST A HORSE RACE TO SEE WHICH VEC WILL ADMINISTER the first Amateur exams under the new Volunteer Exam Program. DARA plans to give exams at the Dayton Hamvention the last weekend in April, the Anchorage Amateur Radio Club is believed to be on about the same timetable, and the DeVry ARS plans its first exam session by May 8 at DeVry's Chicago campus. The proposal of a sixth VEC, "VEC Region Four, Inc.," has also been accepted for the fourth call area, but a fifth district group's proposal has been returned for revision.

The FCC's Proposal To Permit Reimbursement Of VEC Expenses was released March 9, with a Comment due date of April 16 and Reply Comments due May 1. In it the Commission proposed letting either the VEC or VE collect the fee, with the VEC setting up procedures by which VEs could also be reimbursed for their expenses. Despite the unusually short comment period on this NPRM, Commission procedures make it unlikely that VECs can actually begin collecting fees before late summer. Since the ARRL directors have taken the firm position that they won't make their VEC proposal to the FCC until fees are in place, other VEC programs will be up and running in much of the country before the League can even start its own. Even the work the League has already done on the volunteer program isn't being utilized. When one of the newly appointed VECs approached the League recently with the suggestion that the VECs already in place and the League share their efforts on the exam question and answer pool, in order to assure uniform exams throughout the country, that VEC was told "the League has invested a lot of time and money in that effort and doesn't feel it can share it!" A further unknown factor is the new League administration, which could make radical changes in the direction the League is taking in the VEC program.

A Volunteer Amateur Exam Program In Those Parts Of The Country not yet represented by a VEC will become a must before much longer, with or without the ARRL. The FCC's intention is to get out of Amateur license exams entirely before the end of 1984, with the exception of possible special review exams for Amateurs whose licenses are suspect.

THE CHICAGO AREA FCC-AMATEUR 2-METER INTERFERENCE COMMITTEE held its second meeting March 14, drawing repeater representatives from all over northern Illinois and southeast Wisconsin. DFing techniques and equipment, both Amateur and FCC, were discussed at some length, and the Commission representatives distributed forms they'd like used for documentation and reporting of jamming problems.

This Program Is Being Watched By Washington As A Possible Prototype for the long-awaited program to incorporate Amateur volunteers in the FCC's enforcement effort. At present the Chicago Field Office wants to know about on-going interference problems, but on an "organized" basis through designated representatives of each repeater.

The Group Voted Unanimously To Continue The Program, and expressed very positive sentiments toward the Chicago Field Office people and their willingness to work with and for the area Amateur community. The next meeting will probably be held in June.

FULL PRIVILEGES ON THE 1900-2000 kHz PORTION OF 160 METERS were restored to U.S. Amateurs in a March 22 FCC action, which noted that Canadian Loran-A operation on 160 has ended.

W2NSD's PROPOSAL TO REQUIRE CW RETESTING OF ALL AMATEURS has been rejected by the FCC as being "without merit" and "not presenting any new or novel issues...."

A PROPOSAL TO GIVE NOVICES ALL-MODE PRIVILEGES ON 220 MHZ is being prepared for FCC submission in mid-May by WA2MCT/5 and WD5DON. Rationale for the proposal, which would limit Novices to 233.40-233.75 MHz, is to improve usage of the band while allowing Novices to take part in public service activities and gain "hands-on" experience with other modes.

AMATEUR STATIONS WILL BE PERMITTED IN THE OLYMPIC VILLAGES in Los Angeles after all, it now appears. After drawn-out, on-and-off negotiations due largely to concerns about security, the Olympic Committee has agreed to permit three stations in the competitor's compounds. A limited number of volunteer operators, all subject to detailed security clearances, will be permitted to operate the stations and provide a communications link back home for those Olympic competitors whose countries permit it.

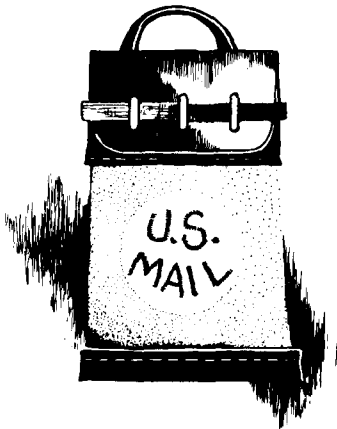

## comments

### smoke signals

Dear HR:

In response to Fred Norvick's comment on heat sinks (Comments, October, 1983), the use of a capacitor in the power line feeding a heat sink cooling fan might cause the fan to increase speed to the point that it might start sending "smoke signals." If the added capacitance and the inductance (of the fan) are (series) resonant at 60 cycles, only the ohmic resistance remains in the circuit, causing the fan to draw more current than it is designed for. You will have to experiment with different capacitor values to find the one that will make the fan rotate more slowly. I increase fan speed in my 2-meter linear (4X250A) during the SSB transmit cycle and let it "coast" during receive periods.

**Rudolf Frank, DJ4BZ**  
Burgkirchen, Germany

### AM update

Dear HR:

In Bill Orr's comments on "ancient modulation" in the February issue of *ham radio* (page 65), Bill correctly points out how Amateur Radio voice quality has deteriorated since the advent of SSB. Today, even on VHF-FM, a medium fully capable of extremely good audio quality, voices typically sound more like they are coming from tin can telephones than from sophisticated communications equipment. Many of the most expensive HF and

VHF transceivers, loaded with all the latest "bells and whistles," come equipped with cheap CB-style hand mikes and tiny speakers. The prevailing philosophy seems to have been that in Amateur Radio, voice quality does not matter. Certainly we can do better than that.

I must take issue with one statement in Bill's article, however. Users of AM have not "gradually retreated to obscure regions of 160 and 10 meters." AM activity can be heard daily on most of the HF bands. AM'ers, now a minority, tend to operate within certain portions of the bands, much in the same manner as RTTY and SSTV operators. The most commonly used AM frequencies are 1880-1900, 1985, 3860-3890, 7160, 7285-95, 14286, and 29,000-29,200 kHz. If anything, there has been a renewed interest in Amateur AM in recent years. It is interesting to note in looking through the ads that AM is being increasingly included on the newer "all-mode" transceivers. Moreover, some of the latest rigs are capable of very decent voice quality on AM and SSB. The Amateur equipment market is extremely cost competitive, yet the inclusion of AM on a transceiver must add considerably to its selling price. The major Amateur equipment manufacturers are large companies with worldwide markets. It is inconceivable that marketing research data would not be a factor in the design of their products. These manufacturers simply would not drive up the cost of their transceivers by including the AM mode if they were not convinced that there is a substantial demand for Amateur equipment with AM capability.

Most AM'ers are particularly interested in voice quality; some of the AM signals heard on the ham bands would put many broadcast stations to shame. There has already been some Amateur experimentation with pulse duration modulation, and AM'ers routinely use advanced techniques such as equalizers, delay/reverb (not CB-style echo boxes), and other processing techniques. Many AM operators use older equipment they have

refurbished themselves, and there are even some home-built stations on the air! Modern AM techniques have not completely bypassed Amateur Radio. The "Amateurs" in our ranks who deride those of us who operate and experiment with amplitude modulation usually turn out to be individuals who take pride in their ignorance.

**Donald Chester, K4KYV**  
Woodlawn, Tennessee

### volunteer examiners: keep standards high

Dear HR:

I am concerned about the honesty of the Volunteer Examination Program. Right now we have many licensed "Amateurs" who could not pass an honest General Class examination. I have suggested to the ARRL that all volunteer examiners be Extra Class with at least 10 years of experience, and furthermore, that the volunteer examiners be required to affirm and certify that they meet the requirements for Extra Class in all respects, including code and theory, and that improper conduct in the administration of the examination would lead to license revocation. The ARRL has not yet responded to these suggestions.

The government recognizes that the skilled Amateur is a valuable asset. During the war all of the Electronic Field Engineers at Raytheon were Amateurs. (Clark Rodimon from ARRL Headquarters headed up this group.) The four senior people in the Bureau of Ships Radar Design Branch were Amateurs. At that point you knew what to expect of an Advanced or General Class Amateur, but I doubt if the same standards are applicable today.

**I.L. McNally, K6WX**  
Sun City, California

#### SHORT CIRCUIT HOTLINE

Building a current *ham radio* project? Call the Short Circuit Hotline any time between 9 AM and Noon, or 1 to 3 PM — Eastern time — *before* you begin construction. We'll let you know of any changes or corrections that should be made to the article describing your project.

(See "Publisher's Log," April, 1984, page 6, for details.)

**603-878-1441**

# AEA Brings You The AMTOR Breakthrough

We are pleased to announce three new AMTOR products. Our new software package that will allow you to operate AMTOR with your CP-1 is called AMTORTEXT™. A complete hardware terminal unit and AMTORTEXT software plug-in cartridge for the Commodore 64 computer is called the MICROAMTOR PATCH™. We also have new applications software packages for the AMT-1 and Commodore 64 or VIC-20 computers.

## NEW AMTORTEXT™

**AMTORTEXT™** is a LOW COST software package that will allow the CP-1 and Commodore 64 computer to be used as a multi-mode AMTOR TERMINAL. Compare the outstanding FEATURES and PRICE of the AT-64 (AMTORTEXT for Commodore 64) to the competition:

- KEYBOARD OVERLAY instructions (eliminates constant referral to manual)
- STATUS INDICATORS on screen
- Easy to follow MENU
- ARQ, MODE A- MASTER OR SLAVE
- FEC MODE B
- MODE L (LISTEN TO MODE A)
- SPLIT SCREEN with 2000 CHARACTER TYPE AHEAD transmit buffer
- WORD MODE for error correcting with DEL KEY until space or CR is sent
- REMOTE ECHO shows characters transmitted as they are validated by other station
- easy entry of your SELCALL for automatic response to ARQ calls
- BREAK-IN MODE to interrupt sending station
- LTRS/FIGS REVERSE for assistance in MODE L synchronizing
- TEN MESSAGE BUFFERS of 256 CHARACTERS EACH
- AMTOR timing synced to host computer internal CRYSTAL OSCILLATOR
- PROGRAMMABLE TRANSMIT DELAY can be saved to tape
- AUTOMATIC PTT
- POWERED BY HOST COMPUTER
- includes INTERFACE CABLE for AEA model CP-1 COMPUTER PATCH™.



The AMTOR software TIMING ROUTINES have been written by Peter Martinez, G3PLX (father of AMTOR) which means you can be sure of having NO SYNCHRONIZING problems with other AMTOR stations adhering to the established international AMTOR standard. PROPER SYNCHRONIZATION is an ABSOLUTE must for AMTOR!

## NEW MICROAMTOR PATCH™

**\$89.95 List CALL FOR PRICE C-64 AMTORTEXT**



**MICROAMTOR PATCH™** is a NEW LOW-COST, HIGH-PERFORMANCE AMTOR SOFTWARE/HARDWARE computer interface package. The MICROAMTOR PATCH (model MAP-64) INCORPORATES AMTORTEXT software (described above) for the Commodore 64 computer. All circuitry and software is incorporated on a single, plug-in cartridge module featuring the following:

- TRUE DUAL CHANNEL MARK AND SPACE MULTI-STAGE 4 POLE, CHEBYSHEV ACTIVE FILTERS
- AUTOMATIC THRESHOLD CORRECTION for good copy when one tone is obliterated by QRM or SELECTIVE FADING
- EASY, POSITIVE TUNING with TRIPLE LED INDICATOR
- NOT a low-cost, easily "pullable" phaselocked loop detector!!!
- SWITCH SELECTED 170 Hz or WIDE SHIFT on receive
- AUTOMATIC PTT
- demodulator circuitry powered by your 12 VDC

supply to AVOID OVERLOADING HOST COMPUTER and for maximum EMI ISOLATION

- EXAR 2206 SINE GENERATOR for AFSK output
- SHIELDED TRANSCIEVER AFSK/PTT INTERFACE CABLE PROVIDED
- FSK keyed output.

The MicroAmTOR Patch is structured for easy upgrading to the AEA CP-1 Computer Patch™ advanced interface unit without having to buy a different software package! Simply unplug the external computer interface cable (supplied with the MicroAmTOR Patch) from the MicroAmTOR Patch and plug it into the Computer Patch.

**\$149.95 List MAP64 CALL**  
**\$239.95 / MAP-64/2 FOR PRICE**

The Model MAP-64/2 incorporates the C-64 MBATEXT™ PROM on the same board with AMTORTEXT for low cost RTTY/CW/ASCII/AMTOR operation.

The **AMT-1** is the DEFINITIVE AMTOR TERMINAL UNIT which all future AMTOR units will be measured against. All you need for full AMTOR operation is a dumb ASCII terminal (or personal computer and emulation software) and a normal HF transceiver and antenna. With the AMT-1 you will receive the following features:

- SENSITIVE FM DEMODULATOR
- FOUR POLE ACTIVE RECEIVE FILTER
- TOTAL CONTROL FROM KEYBOARD or by COMPUTER, PROGRAM CONTROL
- 16 LED PANADAPTOR TYPE TUNING INDICATOR
- CRYSTAL CONTROLLED AFSK MODULATOR
- RECEIVE/TRANSMIT standard RTTY
- TRANSMIT MORSE CW
- MORSE RECEIVE field installable option
- AUTOMATIC PTT
- 13 front panel LED STATUS INDICATORS
- all METAL ENCLOSURE for maximum RFI immunity
- operates from your 800 ma 12 VDC power source.

## AMT-1



Shown with optional AMT-1 Console Stand, COMM-64 with CRT Monitor and cassette recorder (Not included)

**\$589.95 List CALL FOR PRICE AMT-1**

## Applications software for C-64 or VIC-20

AEA also offers an applications software package for the Commodore VIC-20 (model AMT-1/VIC20-1) or 64 computer that is resident on a plug-in PROM CARTRIDGE and includes the INTERFACE CABLE to go between the computer and the AMT-1. KEYBOARD OVERLAY instructions are also included for easy operation without the instruction manual. The COMM-64 program (model AMT-1/C64-1) offers SPLIT SCREEN OPERATION with ten MESSAGE BUFFERS. It also offers UNATTENDED OPERATION with automatic MESSAGE RECORDING and AUTOMATIC STATION IDENTIFICATION.

**\$89.95 List \$69.95\***

\*SUGGESTED AMATEUR DISCOUNT PRICE THROUGH PARTICIPATING DEALERS ONLY

PLEASE SEND AEA CATALOG	
Name	
Address	
City	
State	Zip

## C & A ROBERTS, INC.

18511 Hawthorne Blvd., Torrance, CA 90504  
213-370-7451 800-421-2258

**AEA** Brings you the Breakthrough!

# applied Yagi antenna design

## part 1: a 2-meter classic revisited

Computer model  
analyzes, updates  
Kmosko-Johnson designs

The Yagi antenna model developed by the late James Lawson, W2PV, provided a rigorous method for exploring Yagi antenna design and performance.<sup>1</sup> Because his primary interest was the HF region, Lawson's nine-part series<sup>2</sup> emphasized the two-through six-element Yagis that, because of boom length, are useful mainly below 30 MHz; the ability of his model to measure the performance of the multi-element and multi-wavelength Yagis found in VHF and UHF applications, however, was also discussed.<sup>3</sup>

This series adapts Lawson's model for use with specific VHF and UHF antenna designs. A computer model is used to optimize forward gain and front-to-back (F/B) ratios for the weak signal area of given VHF/UHF bands. Each resulting antenna design can be polarized either horizontally or vertically, or stacked for enhancement of specific performance parameters.

### basic technical parameters

Several technical assumptions underlie the analyses in this series. First, all Yagi antenna designs are based on non-conductive booms. Methods for conversion of element lengths to round or square conductive booms are readily available.<sup>4</sup> Second, a non-reactive driven element is used; this means a self-impedance value of  $73 + j0$ . Third, antenna feeding methods are left to the user's discretion; any number of proven feeding methods are available for VHF and UHF Yagis.<sup>5</sup> Finally, wherever it is possible, common intervals such as 0.125 or 0.0625 inches are used for Yagi antenna elements or iterations. Few Radio Amateurs can readily measure and cut antenna elements to smaller tolerances, and the use of computer iteration assures finding optimized lengths at these intervals. However, as stated above, the driven element is an exception and will be stated to the nearest 0.000001 inch.

The purpose of this series is to provide analyses of Yagi antenna designs for application above 50 MHz. There is no real limit to the number of iterations that can be run against a given antenna design. However, the practical side of any design effort requires that some sort of sampling be made, particularly in terms of the analyses that are performed and the select few that are reported. This is the rationale for limiting this first article to six variations of a basic design, with each variation presented in terms of gain and F/B optimization.

### the classic Kmosko-Johnson design

One of the best known designs for a 144 MHz antenna was published 28 years ago.<sup>6</sup> Combining variable director spacing, tapered elements, and a 3.44 wavelength boom, this design represents the results of a long empirical process on the part of James Kmosko, W2NLY, and Herbert Johnson, W6QKI, the designers. Another version of this same antenna, but with different reflector length and spacing as well as a different element mounting method, was published later.<sup>7</sup> As the original design is more widely known, it is the one selected for computer analysis.

Table 1 contains the original Kmosko-Johnson antenna dimensions and wavelength values for 144.0 MHz. The element diameter is 0.09375 inches, and each element is spotwelded across the diagonal of a 0.75 inch square metal plate. The plate is screwed to the top of a 1.25 inch diameter aluminum boom.

Conversion of this antenna to its non-conducting boom equivalent presented several problems. While information for preliminary estimates was available,<sup>8</sup> it was decided to sidestep the issue via the use of the brute force computer iteration method.

As the design frequency was also to be shifted to 144.5 MHz, initial iterations of reflector and director lengths were made across a wide range of values. The element diameter remained as in the original design; two samples of the intermediate results are presented in table 2 and table 3.\* Because the designers

\*In reading these and the tables that follow, it should be noted that only the length of the first director is specified. Each table's title contains the tapering scheme to apply to subsequent directors.

By Stanley Jaffin, WB3BGU, 800 Stonington Road, Silver Spring, Maryland 20902



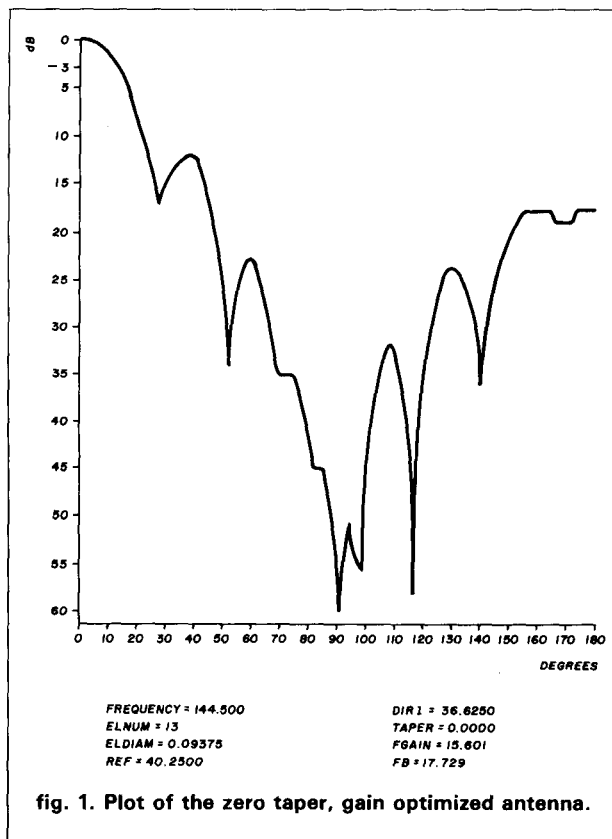

asserted that their non-tapered antenna was in fact the optimal gain antenna, locating the parasitic element lengths for maximum gain at the new design frequency would result in a comparable antenna.

In terms of the actual antenna undergoing computer iteration, the designers specified that to move the design frequency within the 2-meter band, only the element lengths had to be changed. The spacing between the elements for frequencies between 144.0 and 148.0 MHz remains the same as at 144.0 MHz. Therefore, the experimental 144.5 MHz antenna was used as a standard for comparison, as shown in **table 4**. The apparent changes in element spacings are due to slight shortening in wavelength at the new design frequency. The lengths of the parasitic elements are supplied with each iteration.

Frequency response parameters are provided for each of 12 optimized antennas. Since 144.5 MHz is the design frequency and the designers specifically showed how performance was made to drop dramatically above 146.0 MHz, a range of 142.5 to 146.5 MHz is used. Each frequency performance table contains nine data points, with 144.5 MHz as the frequency center.

### computer-designed Kmosko-Johnson antennas

Performance measurements were supplied for

table 1. Original Kmosko-Johnson antenna design for 144.0 MHz.

element	length (inches)	element spacing ( $\lambda$ )	cumulative length ( $\lambda$ )*
1 reflector	41.500	0.0000	0.0000
2 driven	39.500	0.2440	0.2440
3 director 1	37.750	0.0854	0.3294
4 director 2	37.625	0.0915	0.4209
5 director 3	37.500	0.0915	0.5124
6 director 4	37.375	0.1952	0.7076
7 director 5	37.250	0.3904	1.0980
8 director 6	37.125	0.3904	1.4884
9 director 7	37.000	0.3904	1.8788
10 director 8	36.875	0.3904	2.2692
11 director 9	36.750	0.3904	2.6596
12 director 10	36.625	0.3904	3.0500
13 director 11	36.500	0.3904	3.4404

\*cumulative length ( $\lambda$ ) of antenna.

tapers of 0.000, 0.125, and 0.25 inch. The last was a special taper wherein the first three directors used a 0.125 inch taper and the remaining directors tapered at 0.25 inch.

In order to analyze the Kmosko-Johnson design more thoroughly, and to illustrate the ease and utility of computer-based Yagi antenna design, three additional tapers (0.0625, 0.1875, and 0.25 inch) are included. Here, 0.25 is a linear taper applied equally to directors two through eleven.

E-plane (cartesian) plots (**figs. 1-13**) are presented for the Yagis in each tapering procedure and are calculated at 144.5 MHz. A computer line printer served as the output device, with the attendant limitations of the standard 11 x 14 7/8-inch page size. The dB range is 0 to 60, with calculated values in excess of 60 shown as 60 dB. For some antennas this may indicate a trough instead of a null, but little accuracy is lost as nulls of this magnitude are rarely achieved in practice. The degree range is 0 to 180, with every second degree (0,2,4,6, and so on) being plotted. Because computer printers are discrete output devices, only full integer dB values can be plotted, meaning that 10.75 dB at 100 degrees is printed with an "E" (for E-plane) at 11 dB at 100 degrees. A skilled artist (WA9MXB) has drawn curves in place of the discrete E's; these are the fine plots that appear as **figs. 1** through **13**. The plots in the rest of this series are generated in a similar manner.

General observations are presented after the discussions of the major attributes of each of the six tapers. As has often been the case with antennas, there are no absolutes. Often the "best" antenna is more a function of the station operator than of any of the antenna's electrical or mechanical attributes.

# LARSEN ANTENNAS SCALE THE ANDES.

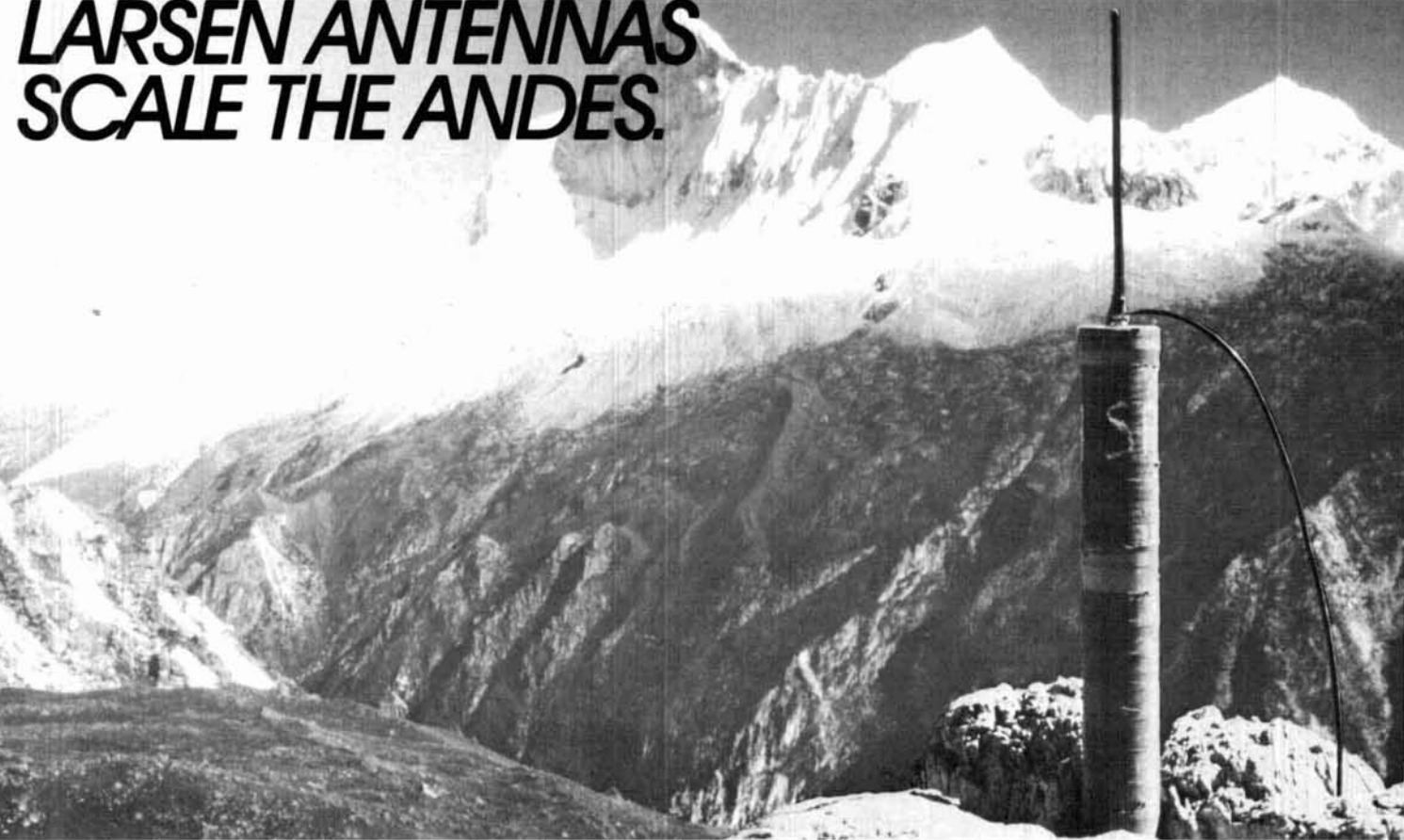

**Communications in the Andes Mountains takes an antenna that'll go the distance in performance and durability. It's a long walk back down the hill for a replacement.**

Larsen Kùlduckie™ portable antennas used for seismological surveying in the Andes are meeting that challenge. Proving they can scale mountains without scaling down their performance.

Larsen makes over 20 VHF and UHF models to mate with most popular handhelds. All designed with double protected electrical connections at the maximum stress points so the antenna can bend 180 degrees in any direction. With a copper plated radiating element that uses power to communicate, not for dielectric heating. Two layers of low dielectric

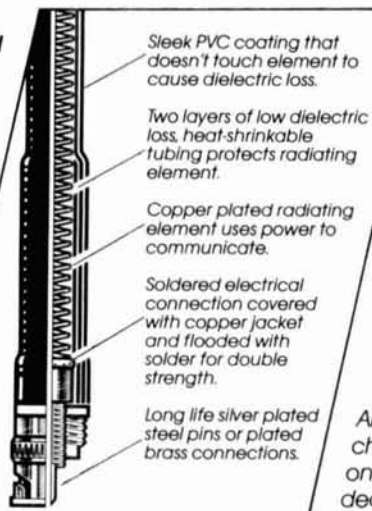

Sleek PVC coating that doesn't touch element to cause dielectric loss.

Two layers of low dielectric loss, heat-shrinkable tubing protects radiating element.

Copper plated radiating element uses power to communicate.

Soldered electrical connection covered with copper jacket and flooded with solder for double strength.

Long life silver plated steel pins or plated brass connections.

Kùlduckie™ is a trademark of Larsen Electronics, Inc. USA and Canadian Larsen, Ltd., Canada.

loss heat-shrinkable tubing that protect the element without deteriorating performance. And a top coat of PVC that gives the Kùlduckie portable antenna a sleek finish.

Even if your communications don't take you to the Andes, these antennas deliver peak performance at most anywhere.

That full measure of performance goes into our product integrity too. With a no nonsense warranty that won't leave you high and dry.

So whether you're climbing the Andes with your portable, or rag-chewing from a local fishing hole, try on Larsen. See your favorite Ham dealer, and ask to hear a Larsen Kùlduckie portable antenna demonstration.



For the Larsen dealer nearest you, call or write:

**Larsen Antennas**

IN USA: Larsen Electronics, Inc.  
P.O. Box 1799 Vancouver, WA 98668 Phone 206-573-2722

IN CANADA: Canadian Larsen Electronics, Ltd.  
283 E. 11th Avenue, Unit 101  
Vancouver B.C., V5T 2C4 Phone 604-872-8517



taper = 0.000

The designers specified that a zero taper resulted in an optimized forward gain and a comparatively poor F/B. **Table 5** depicts the iteration producing the zero taper's optimum gain of 15.601 dBi (**fig. 1**), and **table 6** depicts the iteration producing the F/B optimization of 32.918 dB (**fig. 2**). The differences in reflector and director length indicate that these are in fact two

**table 2.** Iteration of the Kmosko-Johnson antenna with a reflector length of 39.75 inches at 144.5 MHz.

director 1 (inches)	gain (dBi)	F/B (dB)
36.500	15.199	11.426
36.625	15.277	11.559
36.750	15.351	11.796
36.875	15.421	12.174
37.000	15.486	12.750
37.125	15.542	13.619
37.250	15.583	14.952
37.375	15.593	17.112
37.500	15.546	21.106
37.625	15.385	32.100
37.750	14.998	23.112

**table 3.** Iteration of the Kmosko-Johnson antenna with a reflector length of 41.375 inches at 144.5 MHz.

director 1 (inches)	gain (dBi)	F/B (dB)
36.500	14.968	12.975
36.625	15.075	13.204
36.750	15.182	13.545
36.875	15.288	14.038
37.000	15.388	14.745
37.125	15.476	15.766
37.250	15.538	17.285
37.375	15.577	18.953
37.500	15.492	23.907
37.625	15.302	29.637
37.750	14.903	22.009

**table 4.** Baselined antenna at 144.5 MHz with fixed parasitic element spacings and parasitic element lengths supplied during iteration.

element	length (inches)	element spacing ( $\lambda$ )	cumulative length ( $\lambda$ )
1 reflector	—	0.0000	0.0000
2 driven	39.320721	0.2449	0.2449
3 director 1	—	0.0857	0.3306
4 director 2	—	0.0918	0.4224
5 director 3	—	0.0918	0.5142
6 director 4	—	0.1959	0.7101
7 director 5	—	0.3918	1.1019
8 director 6	—	0.3918	1.4937
9 director 7	—	0.3918	1.8855
10 director 8	—	0.3918	2.2773
11 director 9	—	0.3918	2.6691
12 director 10	—	0.3918	3.0609
13 director 11	—	0.3918	3.4527

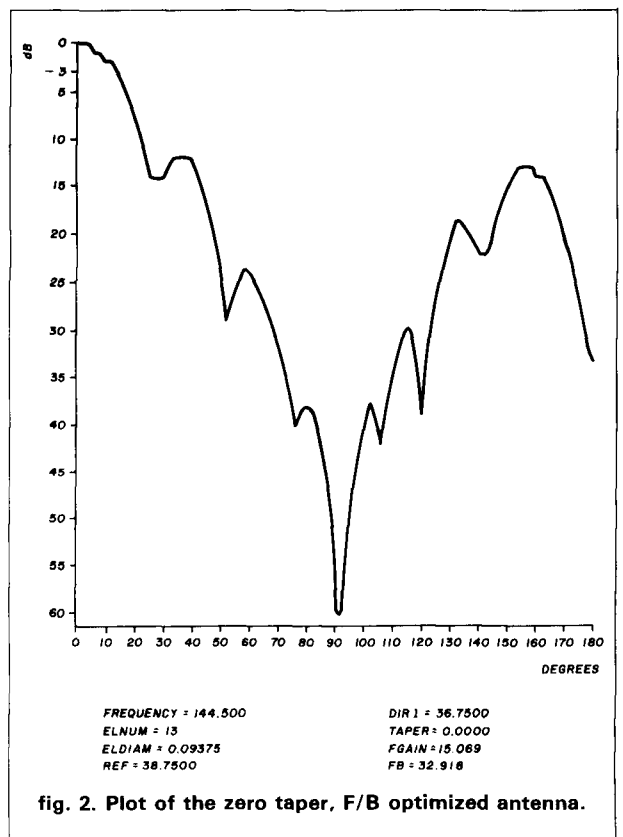

**fig. 2.** Plot of the zero taper, F/B optimized antenna.

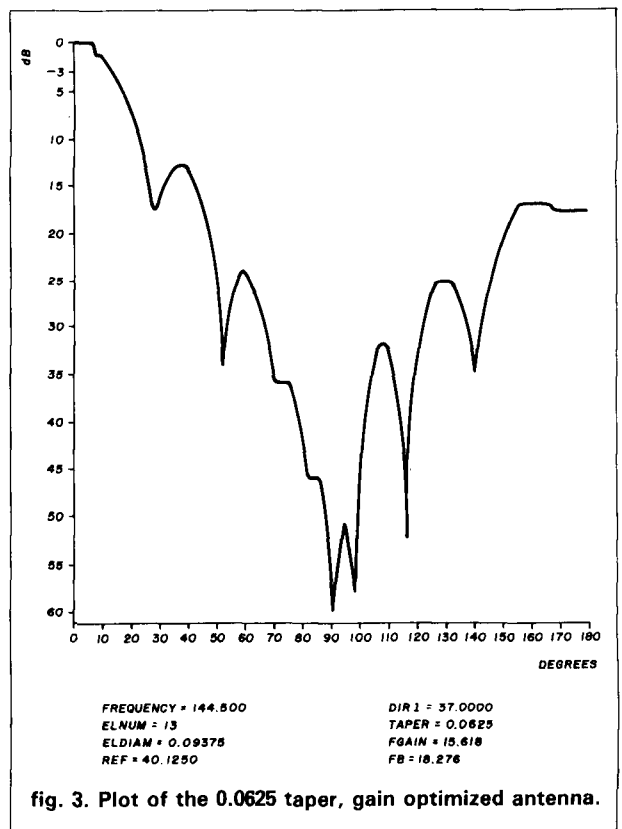

**fig. 3.** Plot of the 0.0625 taper, gain optimized antenna.

**table 5. Maximized gain iteration for taper of 0.000 with a reflector length of 40.250 inches.**

director 1 (inches)	gain (dBi)	F/B (dB)
36.500	15.540	15.365
36.625	15.601	17.729
36.750	15.543	19.153
36.875	15.190	15.053
37.000	14.230	9.410
37.125	11.340	6.648
37.250	9.259	-0.370†
37.375	5.347	-4.911
37.500	1.635	-8.585
37.625	0.580	-8.842
37.750	1.319	-7.336

**table 6. Maximized F/B iteration for taper of 0.000 with a reflector length of 38.750 inches.**

director 1 (inches)	gain (dBi)	F/B (dB)
36.500	13.248	21.148
36.625	15.190	17.977
36.750	15.069	32.918
36.875	14.744	18.295
37.000	13.996	9.756
37.125	12.430	4.130
37.250	9.601	-0.571
37.375	5.489	-4.758
37.500	1.348	-7.580

**table 7. Frequency response parameters for gain maximized antenna with a 0.000 taper.**

frequency	gain (dBi)	F/B (dB)
142.5	15.259	11.162
143.0	15.344	12.022
143.5	15.440	13.266
144.0	15.537	15.126
144.5	15.601	17.729
145.0	15.524	18.591
145.5	15.082	13.846
146.0	13.920	8.321
146.5	11.736	3.390

**table 8. Frequency response parameters for F/B maximized antenna with a 0.000 taper.**

frequency	gain (dBi)	F/B (dB)
142.5	14.872	9.832
143.0	14.989	11.304
143.5	14.508	12.832
144.0	15.104	17.813
144.5	15.069	32.918
145.0	14.844	18.294
145.5	14.113	9.726
146.0	12.310	3.985
146.5	9.032	-0.944

† This computer model calculated negative F/B because the rear lobe radiated greater amplitude than the forward lobe.

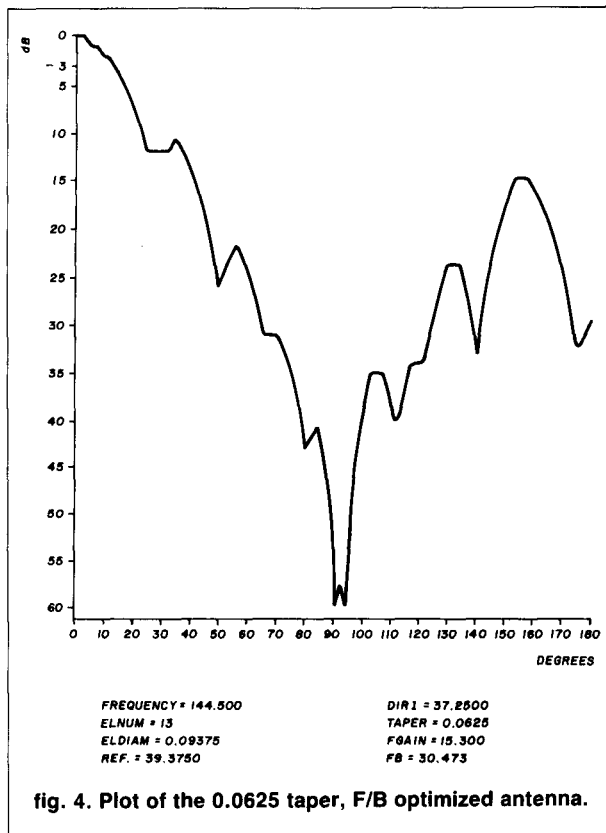

**fig. 4. Plot of the 0.0625 taper, F/B optimized antenna.**

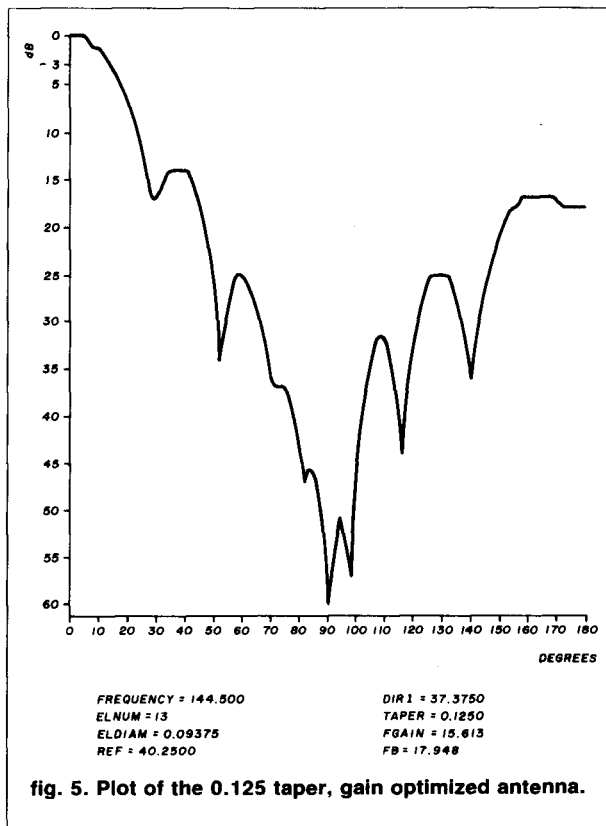

**fig. 5. Plot of the 0.125 taper, gain optimized antenna.**

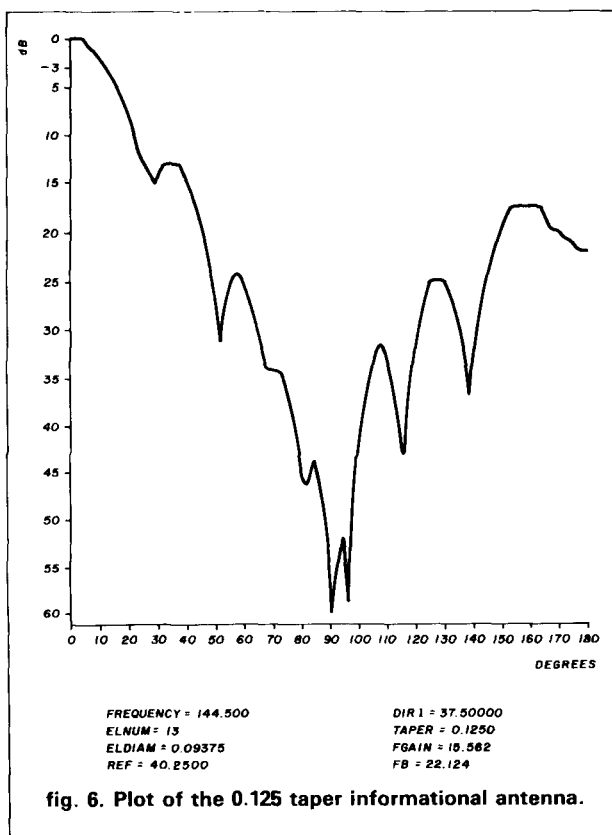

fig. 6. Plot of the 0.125 taper informational antenna.

significantly different antennas. **Table 7** presents the optimized gain antenna's computer performance across the 4 MHz bandwidth, and **table 8** does likewise for the F/B optimized antenna. Using this taper, a superior design frequency F/B ratio can apparently be obtained at a sacrifice of only 0.5 dB in gain.

### taper = 0.0625

This antenna was not presented by the designers and is totally a product of computer iteration. **Table 9** presents this antenna's optimized gain iteration for 15.618 dBi (**fig. 3**), and **table 10** does likewise for the optimized F/B iteration for 30.473 dB (**fig. 4**). As was the case with the zero taper, these two optimized antennas are significantly different antennas. **Table 11** presents the gain optimized antenna's performance across the 4 MHz bandwidth, and **table 12** does likewise for the F/B optimized antenna. Compared to the zero-taper antenna, this antenna can be optimized to a slightly higher gain or to a higher F/B ratio within the weak signal area part of the band.

### taper = 0.125

Of the three antennas they presented, the designers specified this antenna (**fig. 5**) as their best all-around performer. **Table 13** presents the optimization iteration that produced the highest gain and F/B calcula-

**table 9. Maximum gain iteration for taper of 0.0625 with a reflector length of 40.125 inches.**

director 1 (inches)	gain (dBi)	F/B (dB)
36.500	15.345	12.341
36.625	15.454	11.532
36.750	15.510	13.955
36.875	15.581	15.538
37.000	15.618	18.276
37.125	15.573	23.686
37.250	15.344	24.391
37.375	14.742	15.243
37.500	13.474	9.103
37.625	11.192	4.135
37.750	7.587	-0.538

**table 10. Maximum F/B iteration for taper of 0.0625 with a reflector length of 39.375 inches.**

director 1 (inches)	gain (dBi)	F/B (dB)
36.500	15.330	11.114
36.625	15.399	11.803
36.750	15.460	12.798
36.875	15.510	14.395
37.000	15.533	17.195
37.125	15.491	23.497
37.250	15.300	30.473
37.375	14.778	15.783
37.500	13.579	9.177

**table 11. Frequency response parameters for gain maximized antenna with a 0.0625 taper.**

frequency	gain (dBi)	F/B (dB)
142.5	15.341	11.401
143.0	15.422	12.240
143.5	15.503	13.435
144.0	15.577	15.248
144.5	15.618	18.276
145.0	15.565	23.786
145.5	15.288	22.055
146.0	14.580	14.019
146.5	13.168	8.283

**table 12. Frequency response parameters for F/B maximized antenna with a 0.0625 taper.**

frequency	gain (dBi)	F/B (dB)
142.5	15.306	11.839
143.0	15.391	13.622
143.5	15.451	16.556
144.0	15.455	22.877
144.5	15.300	30.473
145.0	14.756	15.518
145.5	13.421	8.826
146.0	10.878	3.697
146.5	6.892	-1.099

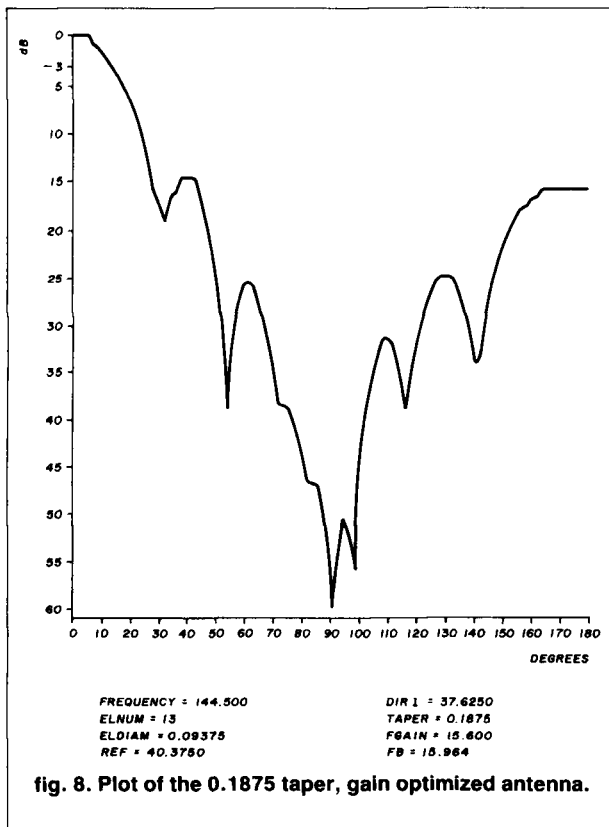
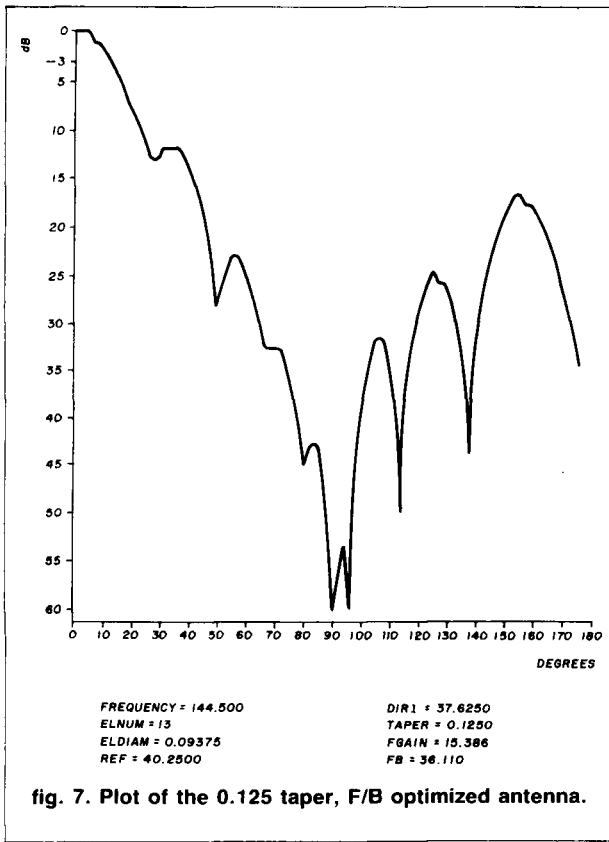

**table 13. Maximized gain and F/B iteration for taper of 0.125 with a reflector length of 40.250 inches.**

director 1 (inches)	gain (dBi)	F/B (dB)
36.500	15.156	12.144
36.625	15.241	12.282
36.750	15.324	12.524
36.875	15.404	12.909
37.000	15.481	13.494
37.125	15.548	14.377
37.250	15.598	15.734
37.375	15.613	17.948
37.500	15.562	22.124
37.625	15.386	36.110
37.750	14.982	23.407

**table 14. Frequency response parameters for gain maximized antenna with a 0.125 taper.**

frequency	gain (dBi)	F/B (dB)
142.5	15.409	12.006
143.0	15.481	12.794
143.5	15.546	13.879
144.0	15.597	15.457
144.5	15.613	17.948
145.0	15.554	22.586
145.5	15.353	36.116
146.0	14.902	22.227
146.5	14.014	14.837

**table 15. Frequency response parameters for the "informational" antenna with a 0.125 taper.**

frequency	gain (dBi)	F/B (dB)
142.5	15.473	12.544
143.0	15.540	13.618
143.5	15.593	15.171
144.0	15.613	17.609
144.5	15.562	22.124
145.0	15.370	36.809
145.5	14.925	22.548
146.0	14.035	14.849
146.5	12.286	9.831

**table 16. Frequency response parameters for F/B maximized antenna with a 0.125 taper.**

frequency	gain (dBi)	F/B (dB)
142.5	15.529	13.351
143.0	15.584	14.877
143.5	15.609	17.257
144.0	15.566	21.623
144.5	15.386	36.110
145.0	14.952	22.941
145.5	14.066	14.902
146.0	12.326	9.816
146.5	8.892	5.353

WHO ELSE HAS A ~~ONE~~ TWO YEAR WARRANTY?

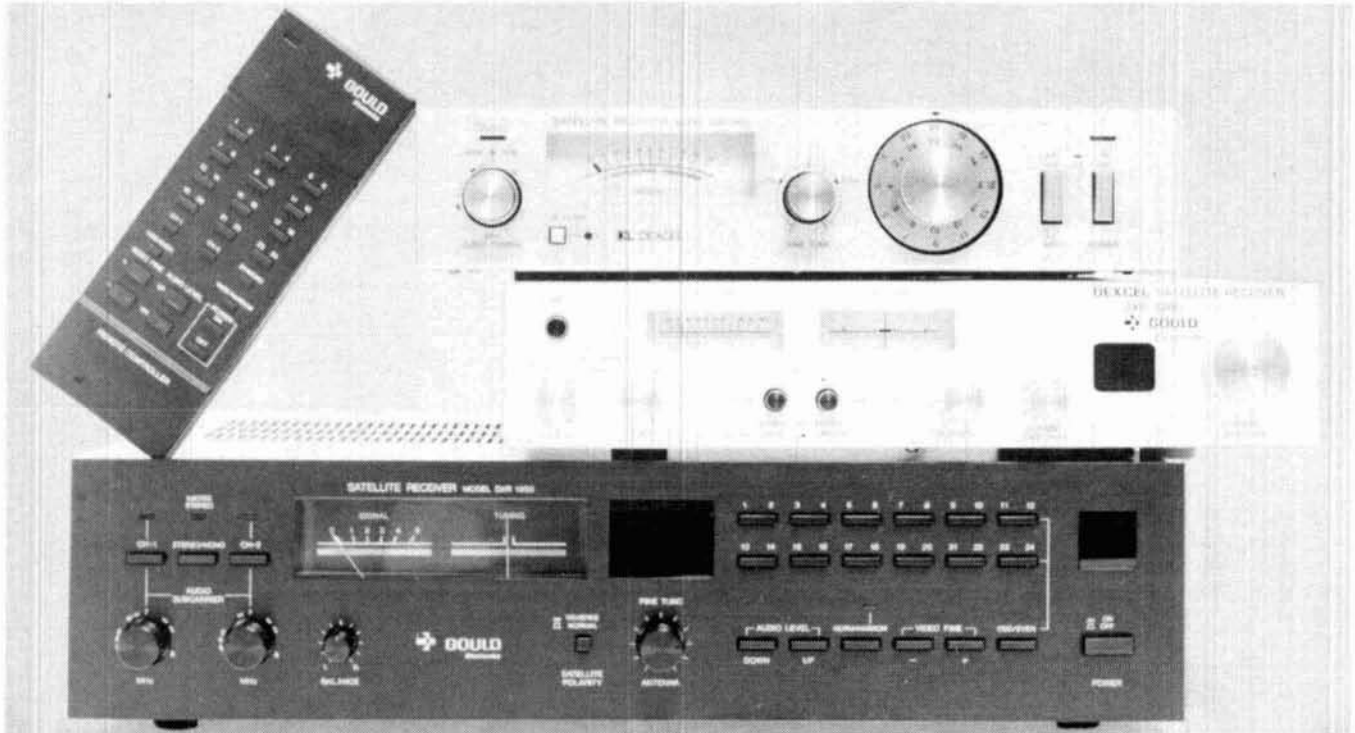

**DEXCEL**



**GOULD**  
*Electronics*

Master Distributor for DEXCEL in Florida and the Caribbean

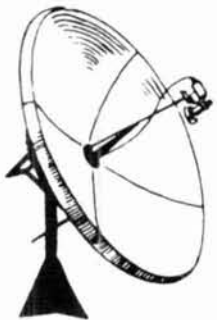

**Southeast Satellite**

PIONEER MEMBER OF  
**SPACE**

DISTRIBUTORS, INC.

U.S. 1 North Tall Pines Industrial Park  
P.O.Box 3229 St. Augustine, Florida 32085

✓ 201

Call Toll Free (800) 824-3474 - In Florida (800) 824-3300

We Ship Worldwide

For Technical Assistance Call (904) 824-1915

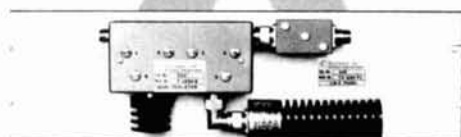

**IM Suppression Panels**



**R.F. Power Monitoring**

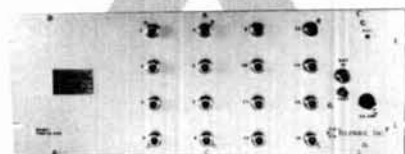

**Receiver Multicoupling**

# The Problem Solvers

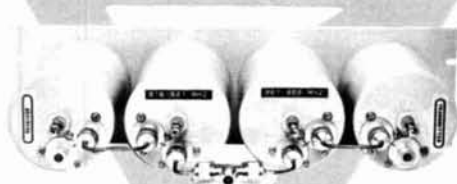

**Duplexers & Preselectors**

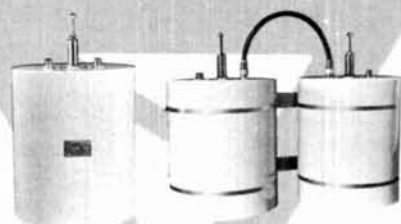

**Bandpass, Pass-Reject  
and Notch Cavity Filters**



**Transmitter Combining  
150 - 900 MHz**

**\*COMPLETE SYSTEM ENGINEERING ASSISTANCE\***



# TELEWAVE, INC.

1155 TERRA BELLA, MOUNTAIN VIEW, CA 94043  
(415) 968-4400 • TWX 910-379-5055

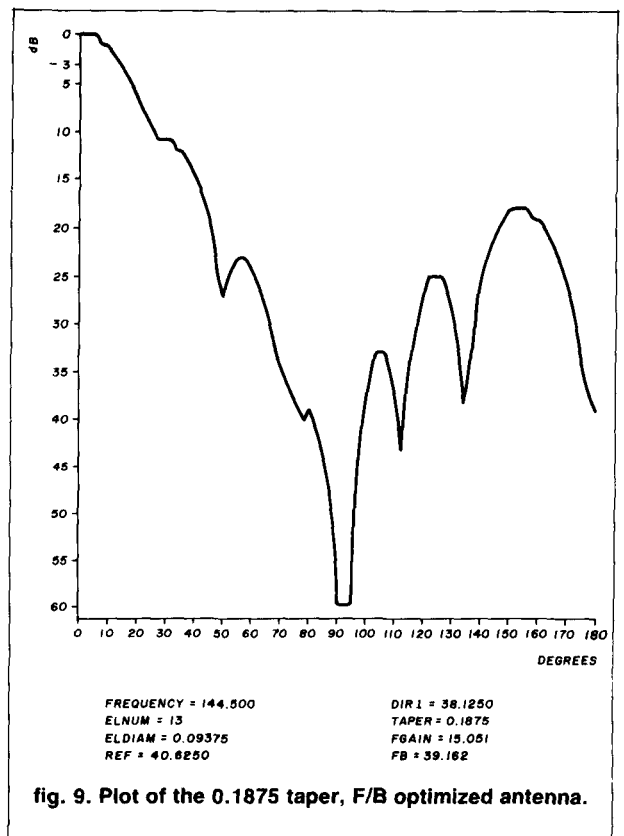

**table 17. Maximized gain iteration for taper of 0.1875 with a reflector length of 40.375 inches.**

director 1 (inches)	gain (dBi)	F/B (dB)
36.500	15.571	14.823
37.625	15.600	15.964
37.750	15.592	17.662
37.875	15.526	20.356
38.000	15.369	25.303
38.125	15.051	38.017
38.250	14.392	25.944
38.375	12.946	29.015
38.500	9.932	17.654

**table 18. Maximized F/B iteration for taper of 0.1875 with a reflector length of 40.625 inches.**

director 1 (inches)	gain (dBi)	F/B (dB)
37.500	15.563	15.153
37.625	15.596	16.300
37.750	15.590	17.990
37.875	15.524	20.638
38.000	15.367	25.413
38.125	15.051	39.162
38.250	14.397	27.566
38.375	12.935	20.931
38.500	9.828	17.129



**fig. 9. Plot of the 0.1875 taper, F/B optimized antenna.**

tions of 15.613 dBi and 36.110 dB, respectively. These two antennas appear to be similar because each optimized value lies directly next to an antenna with a director 1 length of 37.500 inches.

Frequency response calculations are provided for all three antennas. **Table 14** presents these calculations for the gain-optimized director length. This antenna's gain is virtually identical to its 0.0625 tapered counterpart, but its excellent F/B peak occurs far from the design frequency. **Table 15** presents the informational antenna's frequency response characteristics (**fig. 6**), which when compared to the gain optimized antenna, indicate a slightly lower gain and an excellent F/B ratio somewhat closer to the design frequency. **Table 16** presents the F/B optimized antenna's (**fig. 7**) frequency response calculations. They include a slightly lower gain than the gain optimized antenna and an excellent F/B at the design frequency and across the weak signal area. The designers' contentions for this antenna are largely supported by the computer iterations.

### taper = 0.1875

This antenna, not presented by the designers, is a product of computer iteration. **Table 17** presents the gain optimized iteration for 15.600 dBi (**fig. 8**), and **table 18** presents the F/B optimized iteration for 39.162 dB (**fig. 9**). These two antennas are very dif-

**table 19. Frequency response parameters for gain maximized antenna with a 0.1875 taper.**

director 1 (inches)	gain (dBi)	F/B (dB)
142.5	15.389	12.283
143.0	15.458	12.861
143.5	15.520	13.608
144.0	15.571	14.602
144.5	15.600	15.964
145.0	15.590	17.904
145.5	15.517	20.841
146.0	15.342	25.865
146.5	14.994	39.126

**table 20. Frequency response parameters for F/B maximized antenna with a 0.1875 taper.**

frequency	gain (dBi)	F/B (dB)
142.5	15.593	15.293
143.0	15.588	16.761
143.5	15.536	20.048
144.0	15.379	25.109
144.5	15.051	39.162
145.0	14.356	28.320
145.5	12.702	21.392
146.0	8.963	14.093
146.5	2.610	4.235

**table 21. Maximized gain iteration for taper of 0.25 (linear) with a reflector length of 40.625 inches.**

director 1 (inches)	gain (dBi)	F/B (dB)
37.625	15.479	14.317
37.750	15.535	14.871
37.875	15.570	15.619
38.000	15.572	16.625
38.125	15.529	17.973
38.250	15.424	19.764
38.375	15.224	22.055
38.500	14.848	24.520
38.625	14.060	25.524
38.750	12.332	22.659

**table 22. Maximized F/B iteration for taper of 0.25 (linear) with a reflector length of 39.750 inches.**

director 1 (inches)	gain (dBi)	F/B (dB)
37.500	15.420	12.601
37.625	15.471	13.028
37.750	15.506	13.627
37.875	15.520	14.466
38.000	15.506	15.652
38.125	15.454	17.378
38.250	15.348	20.059
38.375	15.154	24.938
38.500	14.784	43.202
38.625	14.006	25.211
38.750	12.344	17.292

**table 23. Frequency response parameters for gain maximized antenna with a 0.25 (linear) taper.**

frequency	gain (dBi)	F/B (dB)
142.5	15.421	13.148
143.0	15.525	13.779
143.5	15.536	14.474
144.0	15.570	15.420
144.5	15.572	16.625
145.0	15.525	18.120
145.5	15.407	19.816
146.0	15.175	21.245
146.5	14.713	21.394

**table 24. Frequency response parameters for F/B maximized antenna with a 0.25 (linear) taper.**

frequency	gain (dBi)	F/B (dB)
142.5	15.405	14.944
143.0	15.383	16.913
143.5	15.308	19.852
144.0	15.141	25.027
144.5	14.784	43.202
145.0	13.993	27.017
145.5	12.251	20.323
146.0	8.938	15.485
146.5	4.032	8.960

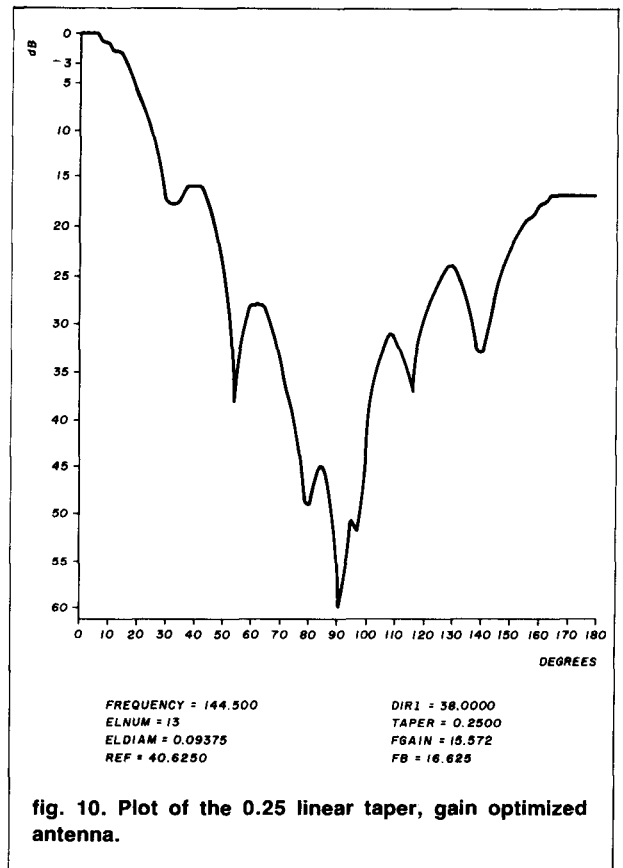

**fig. 10. Plot of the 0.25 linear taper, gain optimized antenna.**

ferent antennas. **Table 19** presents the gain optimized antenna's frequency response parameters, and **table 20** does likewise for the F/B optimized antenna. Both tables reflect gain figures that have fallen from comparable 0.125 taper antennas, but optimized F/B ratios have risen slightly.

### taper = 0.25 (linear)

This antenna, also not presented by the designers, is another product of computer iteration. **Table 21** presents the gain optimized iteration for 15.572 dBi (**fig. 10**), and **table 22** does likewise for the F/B optimized value of 43.202 dB (**fig. 11**). These two antennas are significantly different. **Table 23** presents the gain optimized antenna's frequency response parameters, and **table 24** does likewise for the F/B optimized antenna. Within the 2-meter weak signal area, the gain optimized 0.25 (linear) antenna is virtually identical to its 0.1875 counterpart. This is also substantially true for the F/B optimized antennas for these two tapers.

### taper = 0.25 (special)

The designers specified this antenna as having the best bandwidth characteristics of the three antennas they presented. No other rationale was specifically given for the somewhat unusual tapering. **Table 25**

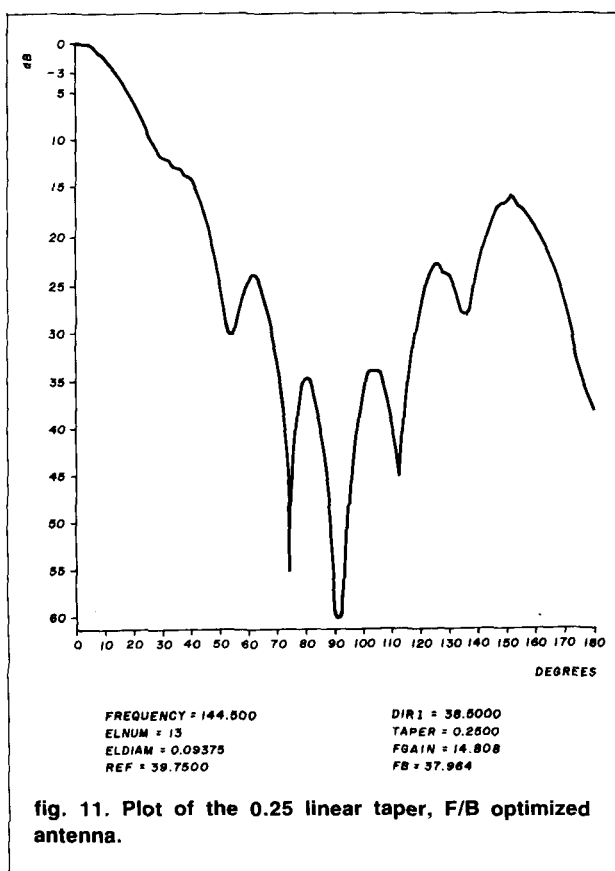

presents the gain optimized iteration for 15.573 dBi (fig. 12), and table 26 does likewise for the F/B optimized iteration for 45.281 dB (fig. 13). Table 27 presents the gain optimized antenna's frequency response parameters, and table 28 does likewise for the F/B optimized antenna. When optimized for gain this antenna is quite similar to its 0.25 linear taper counterpart, but when optimized for F/B, this antenna has slightly more vectorial cancellation than its 0.25 linear taper counterpart.

### computer iteration: summary

In terms of obtaining an optimized forward gain, any of the gain optimized antennas are satisfactory. The maximum calculated gain was realized with the 0.0625 taper antenna, one of the three antennas created solely by computer iteration. A very close second was the designers' 0.125 taper antenna. However, there is more to Yagi antenna selection than finding the absolute maximum forward gain among antennas that all have excellent forward gain.

A long Yagi should provide a sharp pattern for rejecting unwanted signals. This pattern should exist across the entire weak signal area. For the most part this is not the case with the F/B optimized antennas. With the possible exception of the zero taper Yagi, these Yagis are single frequency antennas, meaning

**table 25. Maximized gain iteration for taper of 0.25 (special) with a reflector length of 40.5 inches.**

director 1 (inches)	gain (dBi)	F/B (dB)
37.500	15.524	14.331
37.625	15.564	15.021
37.750	15.573	15.963
37.875	15.540	17.252
38.000	15.446	19.024
38.125	15.261	21.456
38.250	14.913	24.637
38.375	14.200	27.554
38.500	12.619	25.724
38.625	9.461	18.102
38.750	4.606	9.264

**table 26. Maximized F/B iteration for taper of 0.25 (special) with a reflector length of 40.0 inches.**

director 1 (inches)	gain (dBi)	F/B (dB)
37.500	15.527	13.709
37.625	15.555	14.421
37.750	15.556	15.420
37.875	15.518	16.836
38.000	15.423	18.905
38.125	15.239	22.129
38.250	14.894	28.033
38.375	14.194	45.281
38.500	12.676	26.475
38.625	9.693	18.000
38.750	5.115	9.767

**table 27. Frequency response parameters for gain maximized antenna with a 0.25 (special) taper.**

frequency	gain (dBi)	F/B (dB)
142.5	15.409	12.698
143.0	15.472	13.248
143.5	15.526	13.939
144.0	15.563	14.823
144.5	15.573	15.963
145.0	15.539	17.420
145.5	15.435	19.205
146.0	15.226	21.079
146.5	14.813	22.092

**table 28. Frequency response parameters for F/B maximized antenna with a 0.25 (special) taper.**

frequency	gain (dBi)	F/B (dB)
142.5	15.463	16.081
143.0	15.394	18.454
143.5	15.235	22.110
144.0	14.904	28.787
144.5	14.194	45.281
145.0	12.578	28.781
145.5	9.242	18.969
146.0	3.994	8.522
146.5	-2.248	-0.753

# SWL HEADQUARTERS

NATIONS LEADING SHORTWAVE EQUIPMENT SUPPLIER

Designed for Serious DXing

## ICOM R71

THE ULTIMATE RECEIVER

ICOM DID IT AGAIN



Sale Price  
**\$699**

→ BUY FROM EEB WITH CONFIDENCE ←

- We are ICOM's #1 Receiver Dealer
- Our factory authorized service center and modification department know ICOM receiver in depth.
- You get (at no charge) our double extended warranty covering your receiver parts and labor for 6 months.

- 100KHz-30MHz
- Keyboard entry
- 32 memories
- Remote control (optional)
- Scanning
- Pass band & notch tuning
- Memory back-up
- Wide dynamic range
- Voice synthesizer (optional)

EEB Options Installed —

1. Mechanical filter (Replaces SSB ceramic filter) ..... \$95.00
2. FL44A 8 pole crystal filter replaces SSB ceramic filter \$159. Installed ..... \$179.
3. FM (Detection) 10 meter band \$39.50. Installed ..... \$49.50
4. 12V DC Kit \$9.95. Installed ..... \$15.00

### \* KENWOOD R-2000



- 100 KHz to 30 MHz
- All mode AM-CW-SSB-FM
- 10 memories (memorizes mode)
- Memory backup
- Memory scan
- Programmable band scan
- 24-hour clock-timer
- VC-10 VHF converter 118-174 MHz \$139

R-2000 \$599.95 ..... SALE \$499  
R-1000 \$499.95 ..... SALE \$429  
R-600 \$399.95 ..... SALE \$329  
ADD \$6.50 UPS

### \* PANASONIC RF-B600



Sale  
**\$429**

List \$595  
(\$6.00 UPS)

- 1.6 to 30 MHz, FM/LW/MW/SW
- Micro computer multi-tuning system
- 9 memory stations, scan
- Slow/Fast rotary tuning
- 10 key direct access tuning
- Universal voltage

RF-9 \$99.95 ..... SALE \$89.00  
RF-B50 \$159.95 ..... SALE \$129.00  
RF-085 ..... CLOSE OUT \$49.95  
RF-B300 \$249.95 ..... SALE \$209  
RF-3100 \$379 ..... SALE \$279  
ADD \$4.00 UPS

### \* G.E. WORLD MONITOR



Sale  
**\$169**

List \$229.95  
(\$4.00 UPS)

Digital readout, wide and narrow selectivity BFO for SSB & CW.

- 3.5 - 31 MHz SW/MW/FM
- 120V/220V or battery

### \* 1984 WORLD RADIO TV HANDBOOK



Sale  
**\$17.50**

- The shortwave listeners' Bible
- A reference guide for the beginner and serious DXer
- 145 pages devoted entirely to listings of SW, MW, LW, and TV stations around the world
- Listings of English SW broadcasts
- An annual review of shortwave receivers
- \$17.50 post paid USA book rate (add \$4 Air)

### \* YAESU FRG-7700

Sale **\$399**



- 150 KHz-30MHz
- All mode AM-CW-SSB-FM
- Digital frequency and clock

Options:

- FRA-7700 active antenna ..... \$59
- MU-7700 12 channel memory ..... \$135
- FR7-7700 antenna tuner ..... \$59
- FF-5 VLF low pass filter ..... \$20
- DC-7700 12 VDC kit ..... \$8
- FRV-7700 VHF converter ..... \$135
- ADD \$6.50 UPS



### \* SONY ICF-2002



Introductory  
Special  
**\$229**

List \$249.95

Features: Ten memory channels • 12/24 hour quartz clock/PLL tuning for drift-free performance • Dual conversion Super-heterodyne for high sensitivity • SSB/CW

ICR-4800 \$99.95 ..... SALE \$69.95  
ICF-6500W \$199.95 ..... SALE \$99.95  
ICF-6800W \$699.95 ..... SALE \$549  
ICF-7600A \$169.95 ..... SALE \$139  
AN-1 \$79.95 (AC Adapt \$9.95)  
ADD \$4.00 UPS

EEB

- We ship worldwide
- Shipping charges not included
- Prices & specifications subject to change without notice
- Canadian Orders: VISA, MC or POSTAL MAIL ORDERS ONLY!

VISA



10 Miles West of Washington, D.C.  
Sorry—No COD's  
10-5 Tues. Wed. Fri  
10-9 Thursday  
10-4 Saturday  
Closed Sunday and Monday

✓ 140

Electronic Equipment Bank

516 Mill Street, N.E.  
Vienna, Virginia 22180

Order Toll Free 800-368-3270  
Virginia 703-938-3350

EEB

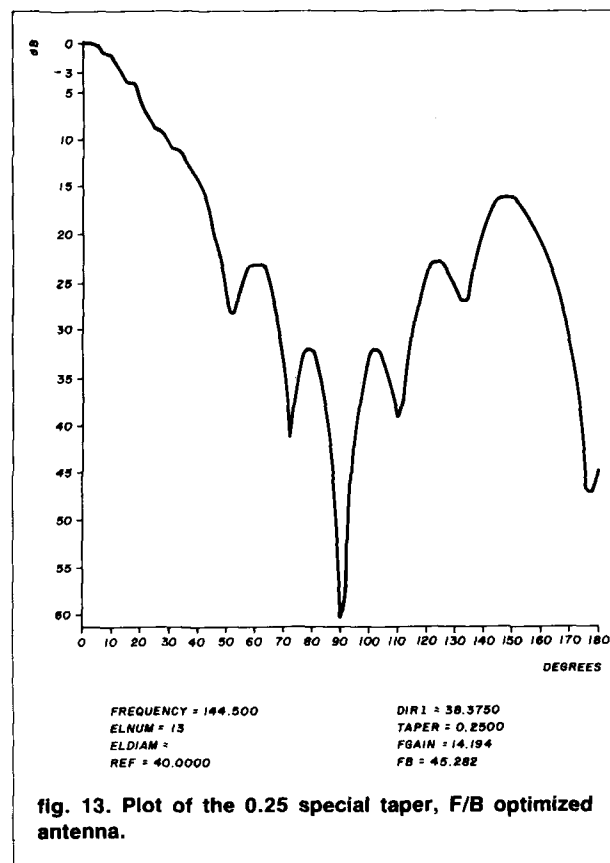
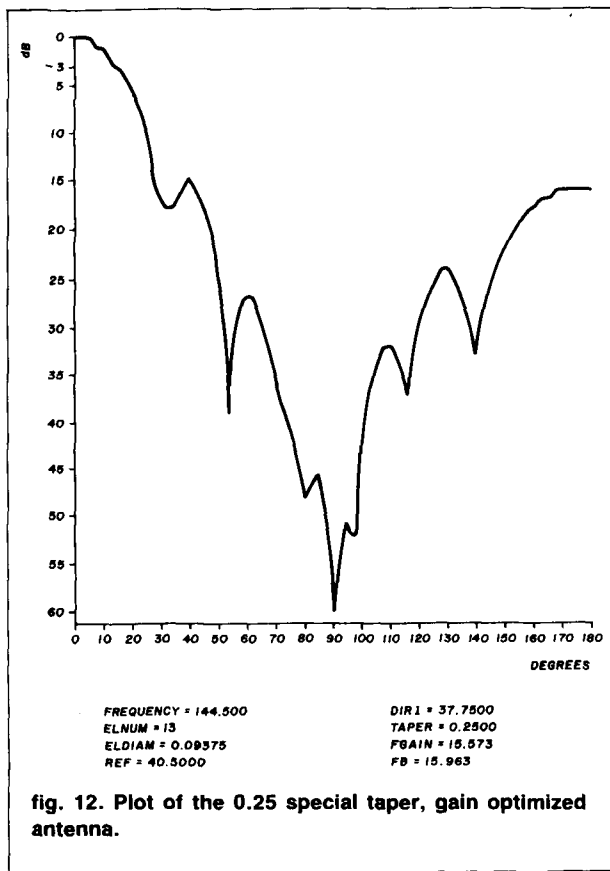

their excellent F/B ratios are the result of single frequency vectorial cancellation. Their main lobes are broader and less clearly defined as compared to their gain optimized counterparts. While a high F/B is commendable, interfering or other unwanted signals do not always originate from the rear of a rotating antenna. A sharp main lobe peaks the desired signal and the Yagi's overall pattern reduces unwanted signals. For these reasons none of the F/B optimized Yagis would be the antenna of choice.

The zero, .0625, 0.125, and 0.1875 tapering procedures provided the highest optimized gains. In terms of the definition of the main lobe and the reduced amplitude of the first minor lobe, the 0.1875 gain optimized Yagi would be an antenna of choice. The calculated differences among these gain optimized Yagis are small and unlikely to be measurable in practice. While none of these Yagis has a notable F/B, their patterns are clean and have well defined nulls. The stacked Yagis at WB3BGU have a pattern similar to these single optimized Yagis. During the January 1984 VHF Sweepstakes, two important multipliers were worked in successive QSO's. One was from the front of the array (5-9), the other from the rear (5-1). A higher F/B would have resulted in the loss of the second multiplier. The array's clean pattern did noticeably reduce contest-level QRM.

Computer iteration has also helped underscore the use of even slight director tapering in long Yagis. Tapering up to approximately 0.55 degrees (0.125 inch at 144.5 MHz) appears to contribute to optimizing both gain and F/B ratios. Even when loops instead of rods are used for the reflector and driven element, a director taper of 0.125 inch (at 144.5 MHz) has been empirically found to provide maximum gain.<sup>9</sup>

It is also worth noting that in spite of the designers' claims to the contrary, tapered director Yagis require a longer first director than a comparable non-tapered Yagi. Arbitrarily tapering non-tapered director lengths that have been optimized for gain or F/B will result in measurably less gain and considerably less F/B. Tapering requires a distinct protocol for directors that when followed can result in a Yagi with superior performance levels.

Other problems with the designers' claims were found. Kmosko and Johnson made unusually high gain claims for their antennas. None of the iterations substantiated these claims. However, the designers do state that they never measured the actual gain of their antennas, but relied on a gain formula based on half power points. This inaccurate method always overstates forward gain. The measured gain for the NBS 3.2 wavelength antenna is 13.2 dBd. If based on the formula Kmosko and Johnson used, this same gain would be given as 15.53 dBd. It is also interesting to note that the designers stated they made careful pattern plots of what they found to be optimal designs.

# Two great ways to get Q5 copy

## Ask:

G4HUW KB5DN WA4FNP WD5DMP  
 KJ2E K61MV WD4BKY WD8QHD  
 K4XG K8MKH WD4CCI WB9NOV  
 KA4CFF KBØTM WD4CCZ WD9DYR  
 KA5DXY W4YPL W5GAI

### 444D SSB/FM

#### Base-Station Microphone

Shure's most widely used base-station microphone is a ham favorite because it really helps you get through... with switch-selectable dual impedance low and high for compatibility with any rig! VOX/NORMAL switch and continuous-on capability make the 444D easy to use even under tough conditions. If you're after more Q5's, you should check it out.



### 526T Series II SUPER PUNCH® Microphone

Truly a microphone and a half! Variable output that lets you adjust the level to match the system. The perfect match for virtually any transceiver made, regardless of impedance. Turns mobile-NBFM unit into an indoor base station! Super for SSB operation, too. These and many other features make the 526T Series II a must-try unit.

FREE! Amateur Radio Microphone Selector Folder. Write for AL645.

# SHURE®

THE SOUND OF THE PROFESSIONALS®... WORLDWIDE  
 Shure Brothers Inc., 222 Hartrey Ave., Evanston, IL 60204

It is hard to believe that a measurement as basic as actual forward gain would not have been made along with the rather tedious plots. Some of the problems attendant with reproducing the results the designers state for their antennas have also been mentioned by Reisert.<sup>10</sup>

An interesting comparison can be made between the NBS 3.2 wavelength Yagi and the above mentioned Kmosko-Johnson gain optimized Yagis. The NBS Yagi had a calculated forward gain of 15.20 dBi while the designers' Yagis averaged 15.60 dBi. The difference in gain is more than could be expected on the basis of the increased boom length (0.24 wavelengths). The variable parasitic element spacing used in the designers' antenna provided higher forward gain figures with a comparable minor lobe structure. The NBS Yagi provides the higher F/B, and measurably so. The 144 MHz operator concerned about F/B and desiring a shorter boom might opt for the NBS Yagi.

Computer iteration has been used to explore a large range of the larger total number of possibilities of the Kmosko-Johnson design. Selections made from among the twelve optimized antennas is a function of the user's needs and desires. There is no such thing as the single best antenna for everyone.

## to be continued

The balance of this series will address individual VHF and UHF antenna designs. Next month I'll present new findings on the Greenblum antenna design approach, as illustrated by a long Yagi specifically designed for the 220 MHz band.

## references

1. James L. Lawson, W2PV, "Yagi Antenna Design: Performance Calculations," *ham radio*, January, 1980, pages 22-27.
2. James L. Lawson, W2PV, *ham radio*, January, February, May, June, July, September, October, November, December, 1980. (For limited time only a set of nine back issues containing W2PV's series of articles on Yagi antenna design will be made available at the reduced price of \$9.95 postpaid to U.S. addresses, \$16.95 to addresses outside the U.S. Foreign payment accepted in U.S. funds drawn on U.S. bank only. Address request to Ham Radio's Bookstore, Greenville, N. H. 03048. Supplies are limited; order promptly. — Editor)
3. James L. Lawson, W2PV, "Yagi Antenna Design: Experiments Confirm Computer Analysis," *ham radio*, February, 1980, pages 19-27.
4. Peter Viezbicke, "Yagi Antenna Design," *NBS Technical Note 688*, U.S. Department of Commerce, Washington, D.C., 1976. See also, John Brosnahan, Technical Correspondence, *QST*, March, 1983, pages 43-44.
5. Joseph Reisert, W1JR, "VHF/UHF Techniques: Feeding and Matching Techniques for VHF and UHF Antennas," *ham radio*, May, 1976, pages 54-59.
6. James A. Kmosko, W2NLY, and Herbert G. Johnson, W6QKI, "Long, Long Yagis," *QST*, January, 1956, pages 19-24.
7. William I. Orr, W6SAI, *Radio Handbook*, 19th edition, Editors and Engineers, Indianapolis, Indiana, 1972, page 27.21.
8. James L. Lawson, W2PV, "Yagi Antennas: Practical Designs," *ham radio*, December, 1980, pages 36-37.
9. Wayne Overbeck, N6NB, "The VHF Quagi," *QST*, April, 1977, pages 11-17.
10. Joe Reisert, W1JR, "VHF/UHF World," *ham radio*, February, 1984, pages 46-47.

ham radio

# WE'RE THE NUMBER 1 EARTH STATION FOR DEALERS.

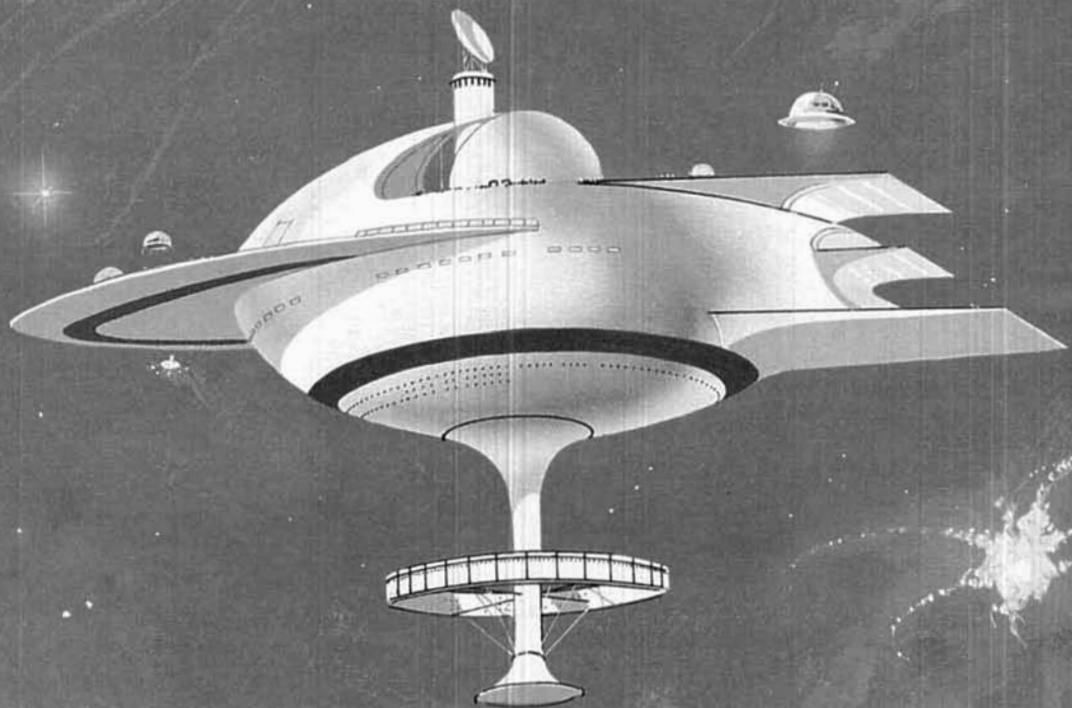

## WE'RE QUARLES SATELLITE SYSTEMS.

### HERE ARE SOME OF THE TOP NAMES IN THE INDUSTRY THAT WE CARRY:

- Prodelin
- Luxor
- Dexcel
- ACM
- KLM
- ParaClipse
- Chaparral
- Tracker Systems
- Janeil

Call Toll Free 1-800-845-6952  
In South Carolina 1-800-922-9704

If you've never dealt with Quarles Satellite Systems before, you're in for a pleasant surprise. Because we provide exactly what the dealer is looking for: the best line of products in the industry, complete in-house inventory, authorized service, and competitive pricing.

So, to provide your customers a space-age adventure in the world of satellites, tune to Quarles Satellite Systems...We are the "#1 Earth Station" for you.

*Tomorrows Communications...Today*



## QUARLES SATELLITE SYSTEMS

1616 CALHOUN ROAD  
GREENWOOD, SC 29646

# With SMART PATCH You are in CONTROL

With CES 510SA Simplex Autopatch, there's no waiting for VOX circuits to drop. Simply key your transmitter to take control.



SMART PATCH is all you need to turn your base station into a personal autopatch. SMART PATCH uses the only operating system that gives the mobile complete control. Full break-in capability allows the mobile user to actually interrupt the telephone party. SMART PATCH does not interfere with the normal use of your base station. SMART PATCH works well with any FM transceiver and provides switch selectable tone or rotary dialing, toll restrict, programmable control codes, CW ID and much more.

**To Take CONTROL with Smart Patch  
— Call 800-327-9956 Ext. 101 today.**



COMMUNICATIONS ELECTRONIC SPECIALTIES, INC.  
P.O. Box 2930 • Winter Park, Florida 32790  
Phone (305) 645-0474 • Order Only (800) 327-9956

✓ 131

## UHF DECODER

ZENITH SSAVI-1 — \$250.00

## COMMERCIAL MDS

XTAL CONTROLLED UNITS — \$189.95

M/C & VISA SORRY NO C.O.D.

ORDER  
1-800-433-5169

INFO  
1-817-460-7073

P  
B  
RADIO

✓ 186

# 1984 CALLBOOKS

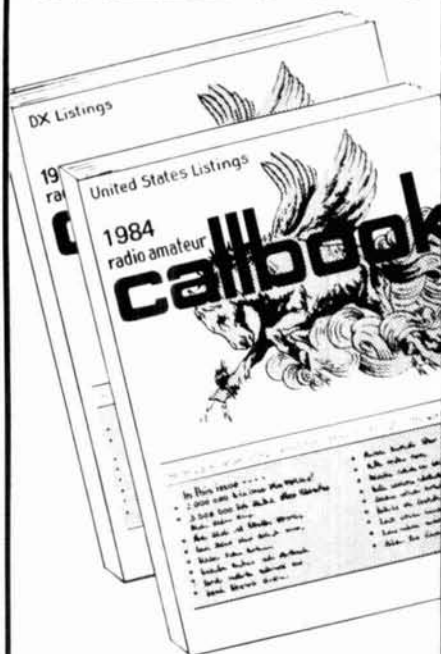

**Order today!  
NEW 1984  
RADIO AMATEUR CALLBOOKS**

Known throughout the world for accuracy, the 1984 Callbooks are a better value than ever before. The U.S. Callbook contains over 433,000 listings; the Foreign Callbook has over 413,000. More than 100,000 changes have been made in each edition since last year. Special features include call changes, Silent Keys, census of amateur licenses, world-wide QSL bureaus, international postal rates, prefixes of the world, and much more. You can't beat this value! Order your 1984 Callbooks now.

Each Shipping Total

<input type="checkbox"/> U.S. Callbook	\$19.95	\$3.05	\$23.00
<input type="checkbox"/> Foreign Callbook	18.95	3.05	22.00

Order both books at the same time for \$41.95 including shipping within the USA.

Order from your dealer or directly from the publisher. Foreign residents add \$4.55 for shipping. Illinois residents add 5% sales tax.

**Keep your 1984 Callbooks up to date.** The U.S. and Foreign Supplements contain all activity for the previous three months including new licenses. Available from the publisher in sets of three (March 1, June 1, and September 1) for only \$12.00 per set including shipping. Specify U.S. or Foreign Supplements when ordering. Illinois residents add 5% sales tax. Offer void after November 1, 1984.

RADIO AMATEUR **callbook** INC. ✓ 194



Dept. F  
925 Sherwood Dr., Box 247  
Lake Bluff, IL 60044, USA

Tel: (312) 234-6600





# JPC/AZDEN<sup>®</sup>

## 4000 SERIES FM TRANSCEIVERS

10 METERS & DOWN

*New!*

COMMERCIAL-GRADE  
QUALITY AT AMATEUR PRICES

EXCLUSIVE 1 YEAR LIMITED WARRANTY! COMPARE!



PCS-4000  
2-m FM Transceiver

### THE 4000 SERIES



PCS-4300 70-cm FM Transceiver



PCS-4500 6-m FM Transceiver



PCS-4800 10-m FM Transceiver

- **WIDE FREQUENCY COVERAGE:** PCS-4000 covers 142,000-149,995 MHz in selectable steps of 5 or 10 kHz. PCS-4200 covers 220,000-224,995 MHz in selectable steps of 5 or 20 kHz. PCS-4300 covers 440,000-449,995 MHz in selectable steps of 5 or 25 kHz. PCS-4500 covers 50,000-53,995 MHz in selectable steps of 5 or 10 kHz. PCS-4800 covers 28,000-29,990 MHz in selectable steps of 10 or 20 kHz.
- **CAP/MARS BUILT IN:** PCS-4000 includes coverage of CAP and MARS frequencies.
- **TINY SIZE:** Only 2"H x 5.5"W x 6.8"D. COMPARE!
- **MICROCOMPUTER CONTROL:** At the forefront of technology!
- **UP TO 8 NONSTANDARD SPLITS:** Ultimate versatility. COMPARE!
- **16-CHANNEL MEMORY IN TWO 8-CHANNEL BANKS:** Retains frequency and standard simplex or plus/minus offsets. Standard offsets are 600 kHz for PCS-4000, 1.6 MHz for PCS-4200, 5 MHz for PCS-4300, 1 MHz for PCS-4500, and 100 kHz for PCS-4800.
- **DUAL MEMORY SCAN:** Scan memory banks either separately or together. COMPARE!
- **TWO RANGES OF PROGRAMMABLE BAND SCANNING:** Limits are quickly reset. Scan the two segments either separately or together. COMPARE!
- **FREE AND VACANT SCAN MODES:** Free scanning stops 5 seconds on a busy channel; auto-resume can be overridden if desired. Vacant scanning stops on unoccupied frequencies.
- **DISCRIMINATOR SCAN CENTERING (AZDEN EXCLUSIVE PATENT):** Always stops on frequency.
- **TWO PRIORITY MEMORIES:** Either may be instantly recalled at any time. COMPARE!
- **NICAD MEMORY BACKUP:** Never lose the programmed channels!
- **FREQUENCY REVERSE:** The touch of a single button inverts the transmit and receive frequencies,

no matter what the offset.

- **ILLUMINATED KEYBOARD WITH ACQUISITION TONE:** Unparalleled ease of operation.
- **BRIGHT GREEN LED FREQUENCY DISPLAY:** Easily visible, even in direct sunlight.
- **DIGITAL S/R METER:** Shows incoming signal strength and relative power output.
- **BUSY-CHANNEL AND TRANSMIT INDICATORS:** Bright LEDs show when a channel is busy and when you are transmitting.
- **FULL 16-KEY TOUCHTONE<sup>®</sup> PAD:** Keyboard functions as autopatch when transmitting (except in PCS-4800).
- **PL TONE:** Optional PL tone unit allows access to private-line repeaters. Deviation and tone frequency are fully adjustable.
- **TRUE FM:** Not phase modulation. Unsurpassed intelligibility and audio fidelity.
- **HIGH/LOW POWER OUTPUT:** 25 or 5 watts selectable in PCS-4000; 10 or 1 watt selectable in PCS-4200, PCS-4300, PCS-4500, and PCS-4800. Transmitter power is fully adjustable.
- **SUPERIOR RECEIVER:** Sensitivity is 0.2 uV or better for 20-dB quieting. Circuits are designed and manufactured to rigorous specifications for exceptional performance, second to none. COMPARE!
- **REMOTE-CONTROL MICROPHONE:** Memory A-1 call, up/down manual scan, and memory address functions may be performed without touching the front panel! COMPARE!
- **OTHER FEATURES:** Dynamic microphone, rugged built-in speaker, mobile mounting bracket, remote speaker jack, and all cords, plugs, fuses, and hardware are included.
- **ACCESSORIES:** CS-7R 7-amp ac power supply, CS-4.5R 4.5-amp ac power supply, CS-AS remote speaker, and Communications Specialists SS-32 PL tone module.
- **ONE YEAR LIMITED WARRANTY!**

**SALE**

PLEASE CALL FOR  
SPECIAL PRICE

PCS-300  
2m Handheld  
FM Transceiver  
142-149.995 MHz

✓ 106

EXCLUSIVE DISTRIBUTOR:

**AMATEUR-WHOLESALE ELECTRONICS**

8817 S.W. 129th Terrace, Miami, Florida 33176

DEALER INQUIRIES INVITED

**TOLL FREE... 800-327-3102**

Telephone (305) 233-3631

Telex: 80-3356

MANUFACTURER:

**JPC/AZDEN**

**JAPAN PIEZO CO., LTD.**

1-12-17 Kamirenjaku, Mitaka, Tokyo, 181 Japan

Telex: 781-2822452



# The Digital vs. Analog battle is over.

\$85\* buys you the new champion.  
**The new Fluke 70 Series.**

They combine digital and analog displays for an unbeatable two-punch combination.

Now, digital users get the extra resolution of a 3200-count LCD display.

While analog users get an analog bar graph for quick visual checks of continuity, peaking, nulling and trends.

Plus unparalleled operating ease, instant autoranging, 2,000+ hour battery life and a 3-year warranty.

All in one meter.

Choose from three new models. The Fluke 73, the ultimate in simplicity. The feature-packed Fluke 75. Or the deluxe Fluke 77, with its own multipurpose protective holster and unique "Touch Hold" function (patent pending) that captures and holds readings, then beeps to alert you.

Each is Fluke-tough to take a beating. American-made, to boot. And priced to be, quite simply, a knockout.

For your nearest distributor or a free brochure, call toll-free anytime **1-800-227-3800, Ext. 229**. From outside U.S., call 1-402-496-1350, Ext. 229.

FROM THE WORLD LEADER  
 IN DIGITAL MULTIMETERS.



#### Fluke 73

\$85\*  
 Analog/digital display  
 Volts, ohms, 10A, diode test  
 Audible continuity  
 0.7% basic dc accuracy  
 2000+ hour battery life  
 3-year warranty



#### Fluke 75

\$99\*  
 Analog/digital display  
 Volts, ohms, 10A, mA, diode test  
 Audible continuity  
 Autorange/range hold  
 0.5% basic dc accuracy  
 2000+ hour battery life  
 3-year warranty



#### Fluke 77

\$129\*  
 Analog/digital display  
 Volts, ohms, 10A, mA, diode test  
 Audible continuity  
 "Touch Hold" function  
 Autorange/range hold  
 0.3% basic dc accuracy  
 2000+ hour battery life  
 3-year warranty  
 Multipurpose holster

\* Suggested U.S. list price, effective October 1, 1983.

# the high-performance, capacitively loaded dipole

Use distributed components  
for greater efficiency,  
higher gain

The **capacitively loaded** or "stretch" antenna is a wire dipole, one wavelength long, with each leg broken up periodically by equal value capacitors. The effect is to create a uniform current distribution over the entire length of the radiator without the use of phasing stubs or lossy inductors.

The stretch dipole, classified as a version of the Franklin antenna by E.A. Laport of RCA,<sup>1</sup> offers the following advantages:

- Low angle radiation as a vertical antenna.
- Higher efficiency (because its radiation resistance is at least twice as high as a quarter-wave monopole or dipole).

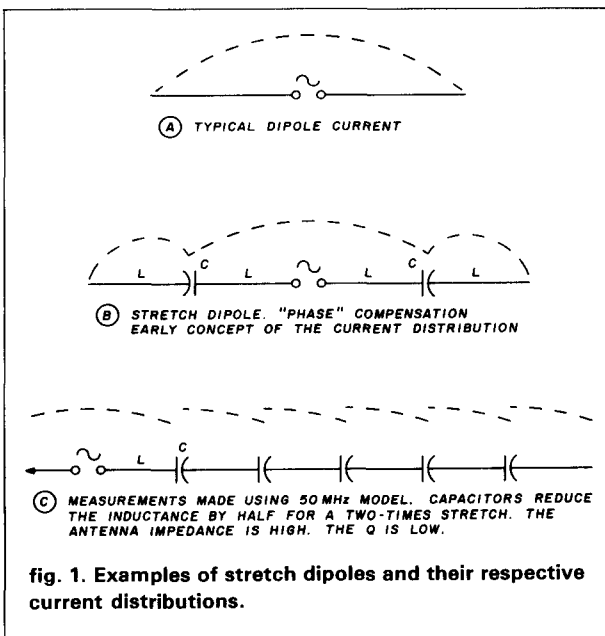

- Proximity to trees, towers, downspouts, and other antennas does not affect performance unless these structures are resonant at the operating frequency.
- Shape is not too important; the stretch dipole can be bent to fit into a confining area.
- The voltage and current are low compared to a quarter or half-wave antenna fed with the same power (input).
- The bidirectional pattern (figure-eight) is narrower, corresponding to higher gain.
- Sidelobes do not exist at the design frequency, because there is no phase reversal.
- It provides wideband performance.
- Deep nulls exist off the ends.

## antenna development

Forty years ago the technique of phase compensation in antennas was introduced.<sup>1,2</sup> Patents were applied for in both the United States and the United Kingdom. In 1960 F.J. "Dud" Charman, G6CJ, derived and tested antennas stretched to four times their normal length (fig. 1).<sup>3</sup> Recently W4FD and W4ATE produced the CCD design, which uses up to 48 sections and 46 capacitors.<sup>4</sup> VK5NN has built several of the twelve-section versions with a two- and three-times stretch.<sup>5</sup> The greater the stretch factor, the greater the gain because of the narrower figure-eight pattern.

The logic used in the design of this antenna stems from increasing the inductance of a radiator by a factor, (in my case, two), then reducing this inductance with capacitive reactance equal to half this amount. If twelve sections are used, each joined by a capacitor, each wire length is 360 degrees divided by 12, or 30 degrees long. Its inductance can be found by using published curves<sup>2</sup> or the formula:

$$L(\mu h) = 0.00508 \ell [2.303 \log_{10} (4 \ell / d - 0.75)]$$

where both  $\ell$  and  $d$  are in inches.

By David Atkins, W6VX, 130 North Westgate Avenue, Los Angeles, California 90049

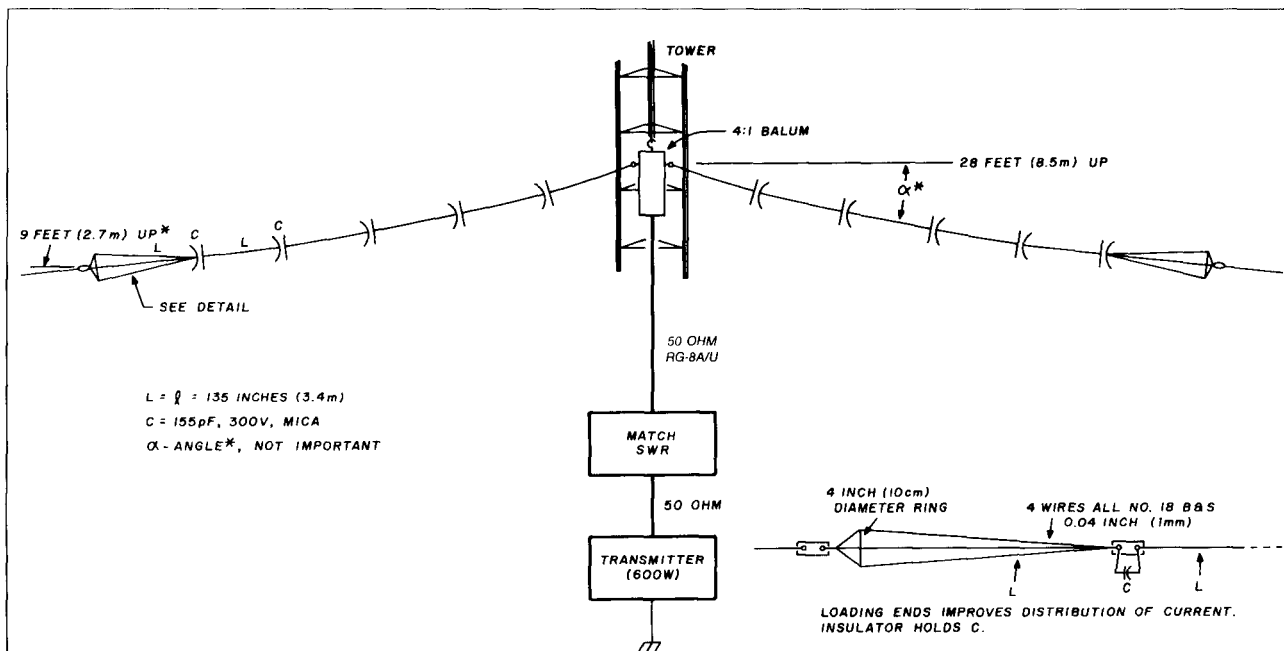

fig. 2. The 7 MHz stretch dipole measuring 132 feet in length can be supported from a tower in an inverted Vee configuration.

## construction

Three different antennas were built. The first was designed for 40-meter operation at two-times stretch with an overall length of 132 feet (40.2 m) — see fig. 2. The second antenna, built to test the distribution of current and voltage, is also a two-times stretch dipole for operation on 6 meters. It was suspended at 6 feet (1.8 m) for convenience in measuring. (Fig. 1C shows the current distribution measured.) A GDO was coupled to a 300 ohm twin-lead, one wavelength feed via a 1:4 miniature balun. The current test meter used is shown in fig. 3. The third antenna was designed for 2-meter operation and features the same two-times stretch. Built using ceramic NPO 5 percent capacitors, this antenna is enclosed in 3/4 inch (2.5 cm) outer diameter thin-wall plastic conduit. End caps support the antenna within. A 3/4-inch "T" fitting at the center holds the third piece of conduit. An end-cap is drilled and terminals supplied for the 300 ohm twin-lead feeder, (see fig. 4).

For the lower frequency antennas, fig. 5 gives values of section lengths in inches. Choose a frequency at the bottom of the graph. Where this value meets the " $\lambda$ " line, read the wire length at the right edge of the chart. The wire size, plus or minus a size, is not critical, as the antenna is fairly wideband. Smaller diameters lower the chosen frequency slightly; No. 18 is a good choice. The capacitor values may be chosen for the same frequency by using the "C" line.

If the chosen frequency is off the graph, interpolation will give the desired values. For instance, for 144 MHz, use 14.4 MHz and divide the values by 10. For 7 MHz, use 70 and multiply by 10.

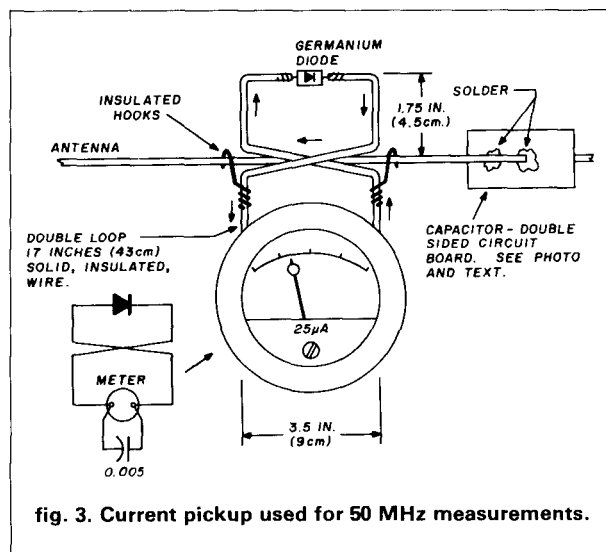

fig. 3. Current pickup used for 50 MHz measurements.

## capacitors

The 40-meter full-wave dipole uses 300 volt mica capacitors. If micas are not available, double-sided circuit board makes a fine substitute. (So do the NPO ceramics.)

I measured a sheet, and it came to 18 pF per square inch. It is Polyclad-M, and 0.059-inch (1.5 mm) thick. This comes to 8.3 square inches, at 40 meters. Each piece would be, for example, 1.25 inches wide by 6.66 inches long (3.2 by 17 cm). The value should be approximately 150 pF. Measure any of this double-sided circuit board, because it can vary from type to type as much as 3 to 1. Solder the sections of wire to the

center of the boards, and again just in from the narrow dimension as shown in **fig. 3**.

I weatherproofed the capacitors using a mixture of one part resin (the kind used by violinists and sold in music stores) to two parts beeswax. This clings even in hot weather. It is best to heat the mixture (over low to moderate heat) over water — preferably in the top of a double boiler — and dip the assembled junctions into the solution when the temperature reaches approximately 150 degrees F (63 degrees C). Dip each piece for 5 seconds; remove; allow to drip and cool well away from the flame or burner, and then dip it

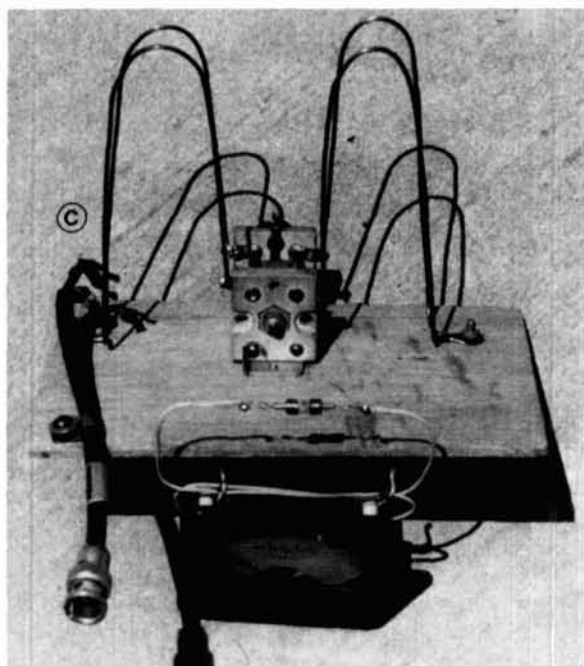
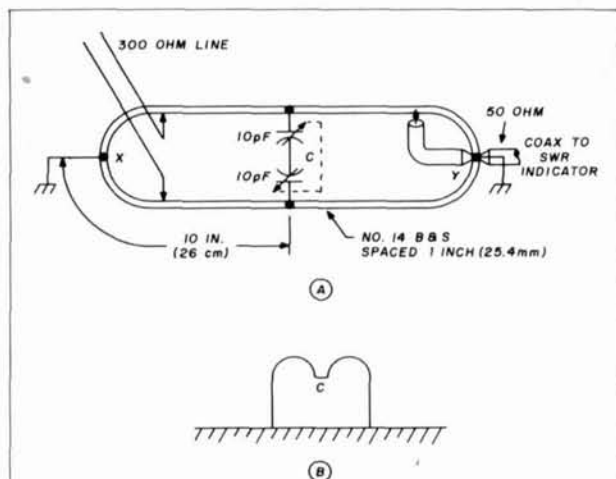

**fig. 4. (A)** Matching device transforms 50-ohm coaxial cable to 300-ohm open-wire feeders using a 40-inch (1.2 mm) conductor. Points X and Y are grounded and may be spaced 5 inches (13 cm) apart by bending the lines into inverted U's as illustrated in (B). The capacitor C is not grounded. (C) photo illustrates U-shaped matching device, capacitor, and current probe.

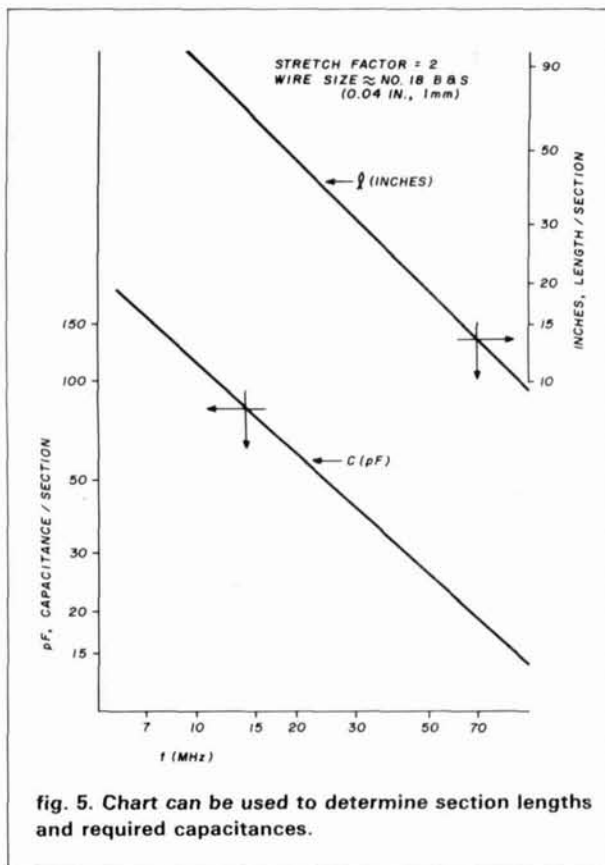

**fig. 5.** Chart can be used to determine section lengths and required capacitances.

again quickly, lowering it in and pulling it out almost immediately. This builds up the coating. This weatherproofing is used on the capacitors for all three antennas.

### conclusion

I have experimented with a version of the phase-compensated wire antenna with a stretch factor of two. This two-times factor keeps the size practical from 7 MHz upward. Half of this antenna may be used as a vertical against ground-mounted radials or a counterpoise. The feed is higher impedance, resulting in lower heat losses in both the wire and ground. End loading helps develop uniform current at the top or ends in a full-wave horizontal or vertical dipole. These antennas may be used on all frequencies above the design band. The toroidal pattern, however, changes and minor lobes develop with increased frequencies due to changes in L and C reactances. A trans-match is a necessity.

### references

1. Henry Jasik, Editor, *Antenna Engineering Handbook*, McGraw-Hill, 1961.
2. F.E. Terman, *Radio Engineers Handbook*, McGraw-Hill, 1943, pages 48 and 773.
3. F.J.H. "Dud" Charman, G4CJ, "Loaded Wire Aerials," *RSGB Bulletin*, July, 1961, page 10.
4. Harry Mills, W4FD, and E.E. Brizendine, W4ATE, "Antenna Design: Something New," 73, October, 1973, page 282.
5. P.M. Williams, VK5NN, "Stretched UHF/VHF Antennas," *Technical Topics, Radio Communication*, June, 1981, page 530.

ham radio

# Kantronics Interface II

The Interface For  
*Apple, Atari, TI-99/4A, TRS-80C,  
VIC-20, and Commodore 64  
Computers*

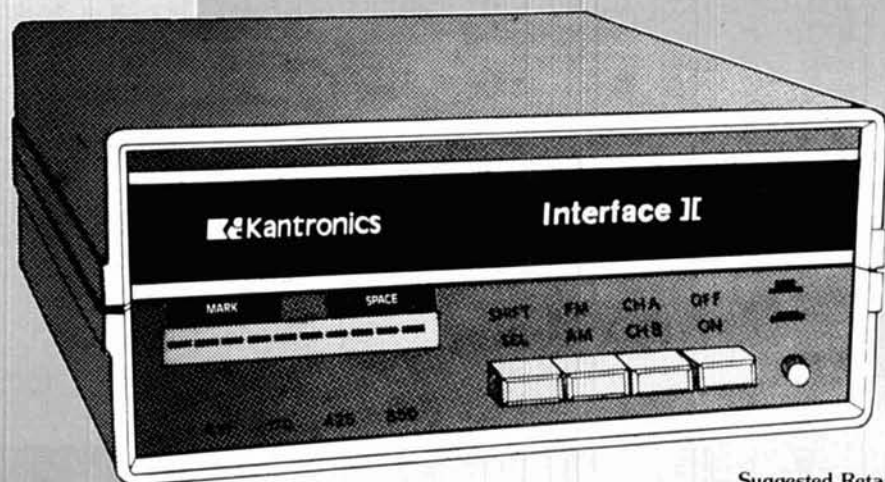

Suggested Retail Price 269.95

Interface II is the new Kantronics transceiver-to-computer interface. Interface II features a highly sensitive front end with mark and space filtering. Even the most discerning operator will be surprised with the Interface II's ability to dig out signals in poor band conditions. Our unique tuning system even displays signal fading.

X-Y scope outputs and dual interface outputs for VHF and HF connections make Interface II compatible with almost any shack. All three standard shifts are selectable, and Interface II is AMTOR compatible. Interface II is designed for use with Kantronics software.

## Kantronics Software — The Industry Standard

### Hamsoft

Our original program for reception and transmission of CW/RTTY/ASCII. Features include Split Screen Display, Message Ports, Type-ahead buffer, and printer compatibility. Apple Diskette \$29.95, VIC-20 cartridge \$49.95, Atari board \$49.95, TRS-80C board \$59.95, TI-99/4A cartridge \$99.95.

### Hamtext

All the features of Hamsoft with the following additional capabilities: text editing, received message storage, variable buffer sizes, diddle, word wraparound, time transmission, and text transmission from tape or disc. The program is available on cartridge for the VIC-20 or Commodore 64, and diskette for the Apple. Suggested Retail \$99.95.

### Hamsoft/Amtor

This program has Hamsoft features with the added ability of communicating in the newest coded amateur format-AMTOR. AMTOR offers error free low power communication. Hamsoft/Amtor is available for the Atari, TRS-80C, VIC-20, and Commodore 64 computers. Suggested Retail \$79.95.

### Amtorsoft

For the serious AMTOR operator using a VIC-20, Commodore 64, or Apple computer. This program is similar to Hamtext in capabilities, but can only be used for AMTOR. The Apple version includes both Hamtext and Amtorsoft on one diskette (\$139.95), while the Vic-20 and Commodore 64 cartridge is just Amtorsoft (\$89.95).

# Kantronics UTU

## The Universal Terminal Unit For Everyone Else



Suggested Retail Price 199.95

### KANTRONICS SETS A NEW STANDARD WITH THE KANTRONICS UNIVERSAL TERMINAL UNIT.

UTU allows any computer with an RS232 port and a terminal program to interface with any transceiver. Additional software isn't necessary with UTU, as an internal microcomputer gives the unit data processing capabilities to send and receive in four coded amateur formats; Morse code, Radioteletype, ASCII, and AMTOR.

Sample terminal programs for IBM, TRS-80 Model III and IV, Kaypro, and other computers are included in the manual. Enhanced features can be user defined by altering the terminal program, giving you

flexibility to program for your specific needs.

The Kantronics Universal Terminal Unit can send and receive CW at 6-99 WPM; RTTY 60, 67, 75, 100, and 132 WPM; ASCII 110, 150, 200, and 300 baud; and AMTOR. Dual tone detection and our unique bargraph tuning system make tuning fast and easy. Additional LEDs indicate Lock and Valid status during AMTOR operation. The RS232 port is TTL or RS232 level compatible.

If you've been waiting for a Kantronics system for your computer, the wait is over.

For more information contact an **Authorized Kantronics Dealer,**

or write: **Kantronics**

1202 E. 23rd Street  
Lawrence, Kansas 66044

# remote-controlled 40, 80, and 160-meter vertical

70-foot irrigation pipe and switched L,C components provide 3-band coverage

A vertical antenna with an extensive ground system is effective on 40, 80, and 160 meters because it has a low angle of radiation; a horizontal antenna would have to be very high to achieve the same low radiation angle.

This article describes a vertical antenna system that I have designed, built, and tested. It operates over the entire 40, 80, and 160-meter bands and features remotely switched antenna base matching networks controlled from a simple box at the operating position.

The antenna is built from two 40-foot lengths of 4-inch diameter thin-wall irrigation pipe, available for approximately \$35 per length. One length is left uncut; the other is cut into two pieces, one 30 feet long and one 10 feet long. The antenna is constructed from the 30 and 40 foot pieces joined together for a total

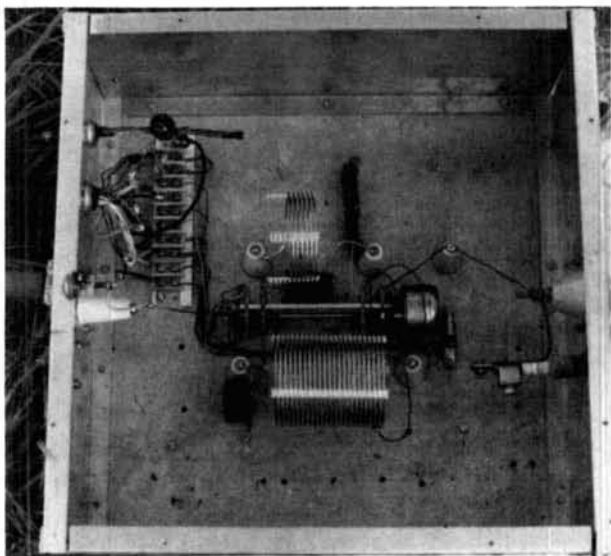

fig. 1. Large metal enclosure houses matching networks, Ledex solenoid and switch wafers while preserving high-Q of coils.

height of 70 feet. The remaining 10-foot section is cut lengthwise, spread over the antenna sections, and clamped with four hose clamps to join the two main sections of the antenna.

The bottom of the antenna is about a foot off the ground, bolted to a short piece of PVC pipe — positioned in the center of a 2-foot square of aluminum and sunk approximately one foot into the ground. The ends of the radial wires are bolted to the aluminum square. For efficient operation, about fifty 100-foot radial wires are used as a good ground mat. Guys are set at 10-foot intervals, with four nylon cords at each level. (S-shaped metal hooks can be used to fasten around the hose clamps and around guy thimbles, which in turn secure the nylon guys. The hook ends should be squeezed down so that they don't come loose from either the clamps or the thimbles. Black plastic tape wrapped around the nylon guy knots helps prevent the knots from working loose.)

## installation

The antenna is light but quite flexible, so be sure to erect it on a calm day, with plenty of helpers. For safety's sake, check for nearby power lines that could be hit if the antenna gets away from you. I used a husky helper pulling a rope threaded through a pulley near the top of a temporary 25-foot mast to help raise the antenna. Another helper pushed from below (a temporary light A-frame might help here), and several helpers held nylon guys to prevent side sway. A bolt through the PVC pipe and near the bottom of the antenna provides a pivot point; I put a 2-foot piece of round wooden fence post inside the bottom of the antenna so that tightening the bolts there wouldn't squash the tubing.

## matching networks

The 70-foot length of antenna is close to a quarter wavelength on 80 meters, about one-eighth wavelength on 160 meters, and about a half wavelength on 40 meters. It is therefore necessary to use matching networks at the base of the antenna on all three bands. The networks are remotely switched from the shack

By Robert Leo, W7LR, 6790 South Third Road, Bozeman, Montana 59715



by means of a Ledex solenoid that turns a wafer switch, moving the shaft one position — a 45-degree

rotation for each pulse. The switch wafers connect any one of the three networks and provide position information to illuminate appropriate indicator lamps in the shack. The five positions required by the three switch wafers coincide with the Ledex rotation positions.

The fixed component networks for 40 and 80 allow the antenna to be used over those entire bands without retuning and with a low VSWR. For 160 meters, the same kind of network is used over the entire band, but requires three coil taps that must be switched in to maintain low VSWRs for that band. The five switch positions are used as follows: one for 40, one for 80, and three for 160. In order to design the matching networks, it is necessary to obtain an estimate of the antenna base impedance for each band from handbook charts. The 70-foot antenna is inductive over the 80-meter band, with the resistive part of the impedance close to 50 ohms. It can be matched over the entire 80-meter band with nothing more than a series capacitor. For 40 and 160 meters, L networks are necessary.

I used a Smith chart to plot the antenna base impedance for the 80-meter band; that plot showed high VSWR at the high end of the band. Using a series capacitor changed the impedance plot so that the VSWR was always less than 2.0:1 over the entire band. Selection of the optimum size of series capacitor for these

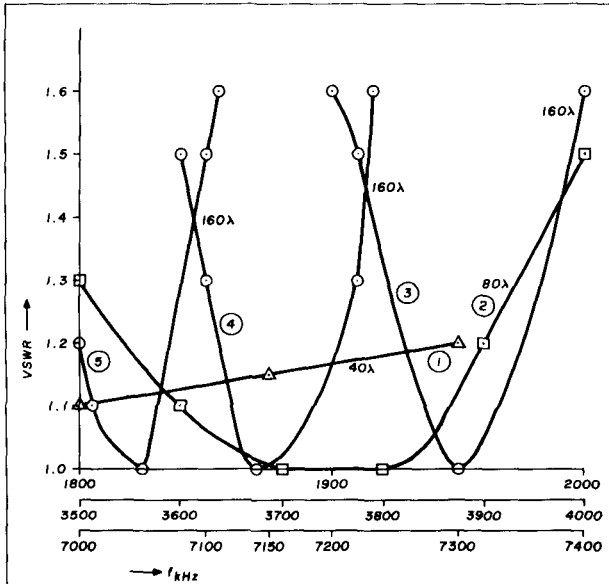

fig. 2. Five separate VSWR plots versus frequency of the 70-foot vertical and matching networks are illustrated with "1" for 40 meters, "2" for 80 meters, and "3" through "5" for the 160-meter band. Notice how flat both the 40 and 80-meter curves are.

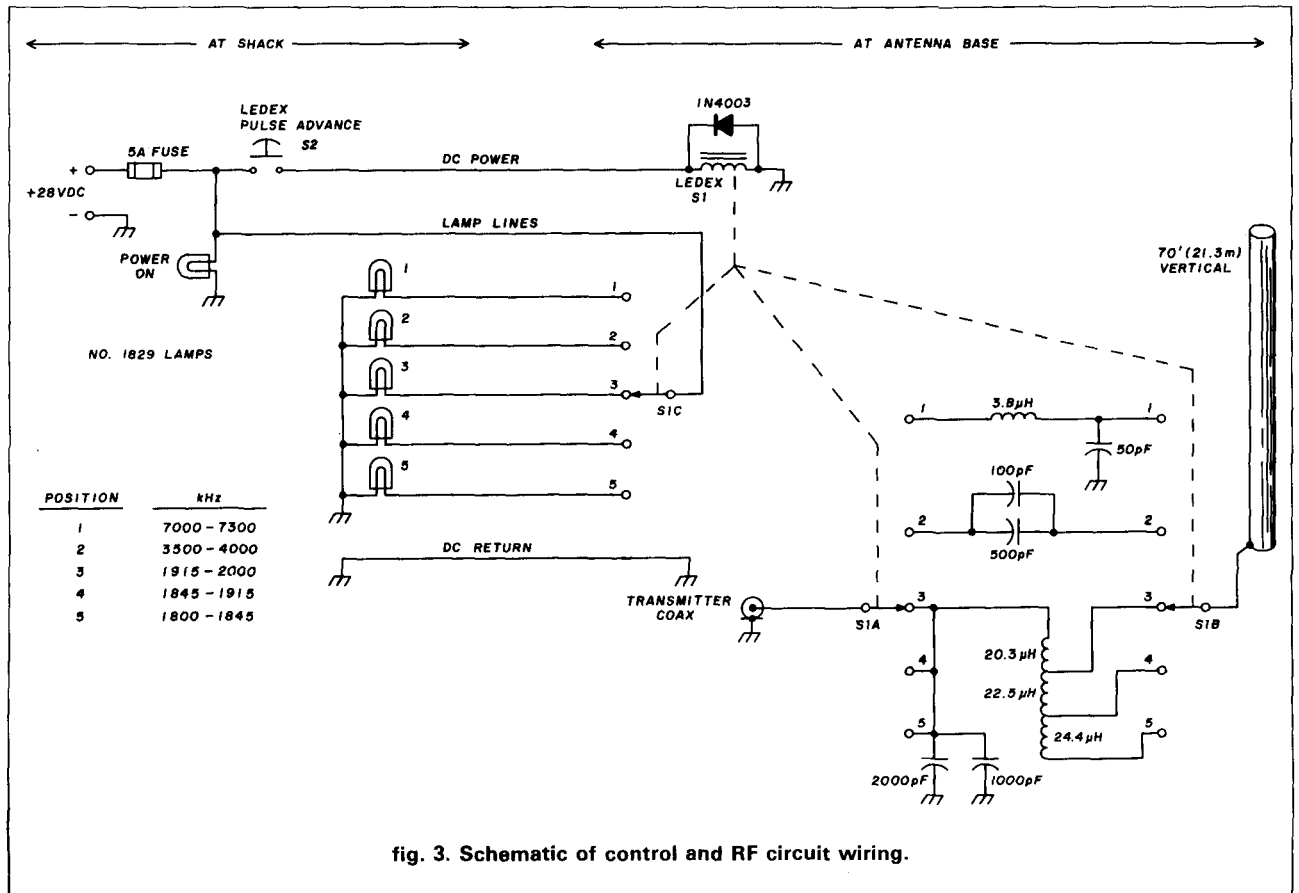

fig. 3. Schematic of control and RF circuit wiring.

Smith chart plots to give the least band edge VSWR provided an estimate of what size capacitor should be tried at the antenna base during field tests. Both the plots and the field tests showed that 600 pF was optimum. The 40 and 160-meter L networks were designed using standard handbook information.

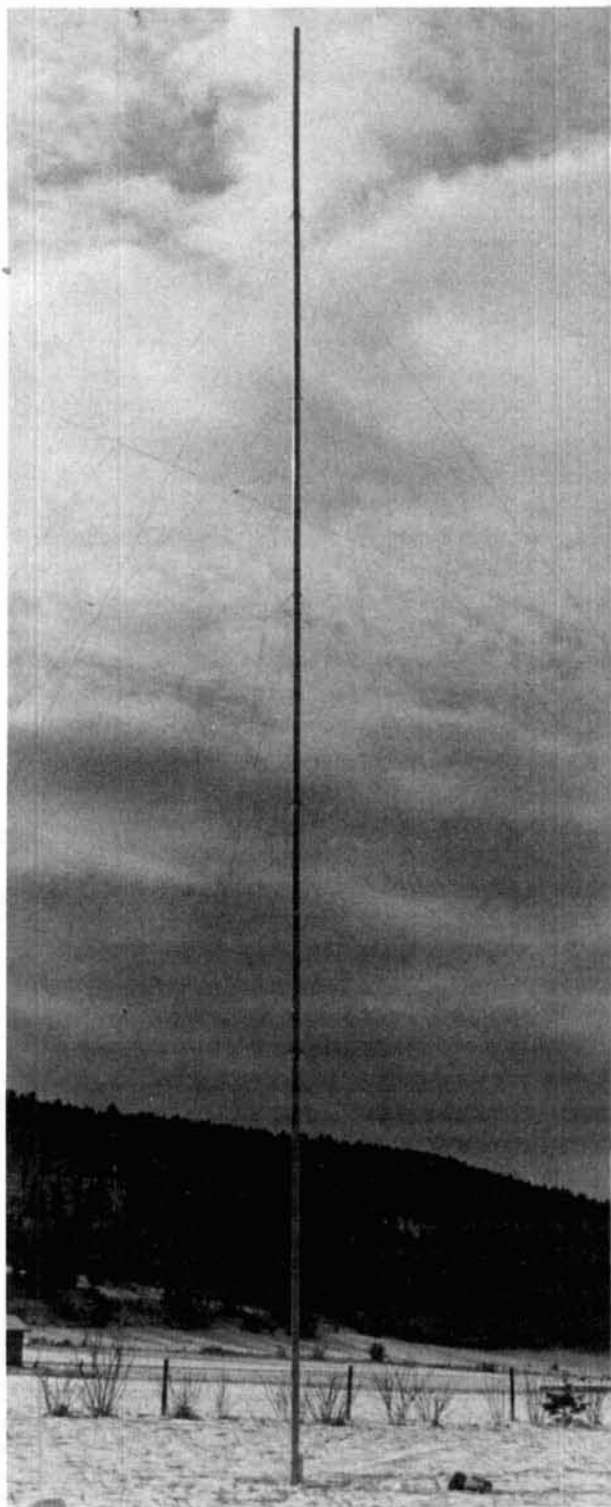

fig. 4. Four-inch irrigation pipe provides good mechanical and electrical performance for the 70-foot vertical.

## network values

To refine the network values, I built a test network for each band and then tuned or changed each one for minimum VSWR over each band at the base of the antenna, using a small exciter and a VSWR meter. Next I measured the network component values and then built the final networks.

I made a final check of the VSWR at the base of the antenna using these final networks, and found that some pruning was still necessary. The tap locations on the 160-meter coil are quite critical. On my coil the tap for the 1800 to 1845 kHz segment was at the very end of the coil; the 1845 to 1915 kHz tap was about 1-1/2 turns from the end; and the 1915 to 2000 kHz tap was about 3 turns from the end. As **fig. 1** shows, a large metal enclosure houses the networks, Ledex, and switch. This box helps preserve the high  $Q$  of the coils by keeping metal surfaces some distance from the coils and also preserves essentially the same tuning for the L networks regardless of whether the box cover is on or off, so that you can tune with the cover off and still have the same tuning when the cover is replaced. As shown in the handbooks, the VSWR is lower back in the shack than out at the antenna, and in my case I find that for a 200-foot length of coax between antenna and shack, the maximum

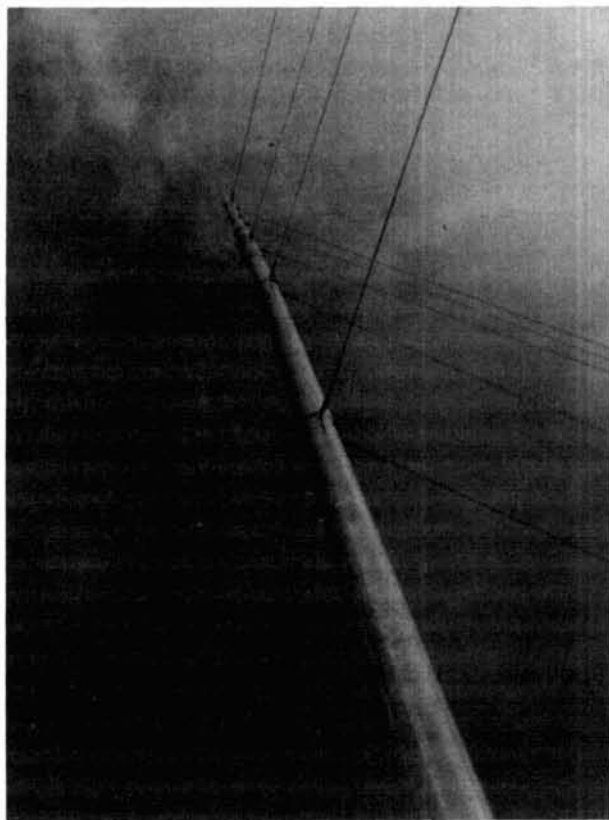

fig. 5. Six separate sets of four guy wires are fastened to the vertical at 10 foot intervals using S-shaped metal hooks and hose clamps.

# AEA Brings You The RTTY Breakthrough

**NEW MBATEXT™ \$109.95 List / \$89.95\* VIC-20 MBATEXT or C-64 MBATEXT**



**MBATEXT™** is the most advanced MBA (Morse, Baudot, ASCII) software plug-in cartridge available for the VIC-20 or Commodore 64 computer. Compare our outstanding features and price to the competition.

- KEYBOARD OVERLAY instructions to avoid constant referral to the manual
- RTTY and ASCII SPEED ESTIMATE MODE
- BREAK-IN CW MODE
- QSO BUFFER RECORD TOGGLE
- WORD PROCESSOR style insertion, deletion, and correction in TEXT EDIT MODE
- CW AUTO SPEED TRACKING plus SPEED LOCK
- BREAK-IN BUFFER that is easy to use
- Low speed FARNSWORTH CW TRANSMISSION (between 5 and 14 WPM)
- RE-TRANSMIT

RECEIVED TEXT DIRECTLY without need of disk or cassette • DISK, CASSETTE, OR PRINTER storage of message and QSO buffers • RECEIVE AND TRANSMIT 5-99 WPM MORSE • 10 SOFT-PARTITIONED™ MESSAGE (OR TEST) BUFFERS • WORD WRAP • TIME OF DAY CLOCK • PRECOMPOSE SPLIT SCREEN OPERATION • STATUS INDICATORS on screen • EASY START-UP by simply typing SYS 44444 or SYS 33333 • DEDICATED FUNCTION KEYS for quick operation • Ability to IMBED CONTROL FUNCTIONS in type-ahead buffer • WORD OR CHARACTER mode • SELECTABLE BAUDOT UNSHIFT ON SPACE (USOS) • SEND/RECEIVE 60, 67, 75, 100, 132 WPM BAUDOT PLUS 100, 300 BAUD ASCII • RTTY BLANK-FILL and MORSE BT option for idle transmit periods • AUTOMATIC PTT • computer control of TONE REVERSE • MASTER MENU, COMMAND MENU, and OPTIONS MENU makes MBATEXT™ easy to use with no prior experience • INCLUDES CABLE TO INTERFACE WITH AEA model CP-1 COMPUTER PATCH™ • POWERED BY HOST COMPUTER.

## NEW MICROPATCH™



**MICROPATCH™** IS A NEW LOW-COST, HIGH-PERFORMANCE Morse, Baudot and ASCII SOFTWARE/HARDWARE computer interface package. The MICROPATCH™ model MP-20 or MP-64 incorporates the complete MBATEXT software ROM (described above) for either the VIC-20 or Commodore 64 computers. All circuitry and software is incorporated on a single, plug-in cartridge module featuring the following: • TRUE DUAL CHANNEL MARK AND SPACE MULTI-STAGE 4 POLE, CHEBYSHEV ACTIVE FILTERS • AUTOMATIC THRESHOLD CORRECTION for good copy when one tone is obliterated by QRM or SELECTIVE FADING • EASY, POSITIVE TUNING with TRIPLE LED INDICATOR • NOT a low-cost, low-performance phase-locked loop detector!!! • SWITCH SELECTED 170 Hz or WIDE SHIFT on receive • 800 Hz multi-stage active CW FILTER • AUTOMATIC PTT • RTTY ANTI-SPACE • demodulator circuitry powered by external 12VDC (not supplied) to AVOID OVERLOADING HOST COMPUTER and for maximum EMI ISOLATION • EXAR 2206 SINE GENERATOR for AFSK output • SHIELDED TRANSCIEVER AFSK/PTT INTERFACE CABLE PROVIDED • PLUS or MINUS CW KEYED OUTPUT • FSK keyed output.

The Micropatch is structured for easy upgrading to the AEA Computer Patch™ advanced interface unit without having to buy a different software package! Simply unplug the external computer interface cable (supplied with the Micropatch) from the Micropatch and plug it into the Computer Patch.

**\$149.95 List \$129.95\*  
MP-20 or MP-64**

## COMPUTER PATCH™



**COMPUTER PATCH™** is the name of our most advanced computer interface equipment for Morse, Baudot, ASCII, or AMTOR operation. The CP-1 will allow you to patch most of the popular personal computers to your transceiver when used with the appropriate AEASOFT™ TU software such as AEA MBATEXT, AMTOR TEXT™, or the MBATEXT RESIDENT ON THE MICROPATCH units. AEA also offers a full feature software package for the Apple II, II plus and IIE; TRS-80 Models I, III and IV; and the IBM-PC. The CP-1 will also work with certain other computers using commonly available software packages.

The CP-1 offers the following advanced and high quality features: • HANDSOME ALL METAL ENCLOSURE FOR MAXIMUM RF IMMUNITY • DUAL CHANNEL, MULTI-STAGE ACTIVE MARK AND SPACE FILTERS • AUTOMATIC THRESHOLD CORRECTION • RECEIVE 170 HZ FIXED OR 100-1000 HZ VARIABLE SHIFT • 800 HZ multi-stage CW FILTER • PRE-LIMITER AND POST-LIMITER FILTERS • SERIAL RS-232 FIELD INSTALLABLE OPTION • 117 VAC WALL ADAPTOR SUPPLIED • PLUS (+) and MINUS (-) CW OUTPUT JACKS • MAGIC EYE STYLE BAR GRAPH TUNING INDICATOR • SCOPE OUTPUT JACKS • NORMAL/REVERSE front panel switch • MANUAL (override) PTT switch • VARIABLE THRESHOLD for CW • ANTI-SPACE RTTY • KEY INPUT JACK for narrow shift CW ID on RTTY, CW practice, or keyboard bypass.

The CP-1 is made in the U.S. with high quality components including double-sided glass epoxy through-hole plated boards, complete with solder mask and silk screened parts designators.

**\$239.95 List \$199.95\* CP-1**

## PACKAGE SPECIALS

**\$239.95\***

Combine the VIC-20 or COMM-64 MBATEXT™ software with the CP-1 at time of purchase and you receive a SPECIAL PACKAGE PRICE. NOW the best RTTY COMPUTER INTERFACE SYSTEM is available at prices comparable only to vastly inferior systems.

CP-1/20 (CP-1 with VIC 20 MBATEXT) CP-1/64 (CP-1 with C-64 MBATEXT)

\*SUGGESTED AMATEUR DISCOUNT PRICE THROUGH PARTICIPATING DEALERS ONLY

## MIDWEST AMATEUR RADIO SUPPLY

3454 Fremont Avenue, North  
Minneapolis, MN 55412

Store Hours: Mon.-Fri. 9-6, Saturday 9-3

(612) 521-4662

# AMATEUR TELEVISION



## KPA5 1 WATT 70 CM ATV TRANSMITTER BOARD

- **APPLICATIONS:** Cordless portable TV camera for races & other public service events, remote VCR, etc. Remote control of R/C airplanes or robots. Show home video tapes, computer programs, repeat SSTV to local ATVers. DX depends on antennas and terrain typ. 1 to 40 miles.
- **FULL COLOR VIDEO & SOUND** on one small 3.25x4" board.
- **RUNS ON EXTERNAL 13.8 VDC** at 300 ma supply or battery.
- **TUNED WITH ONE CRYSTAL** on 426.25, 434.0, or 439.25 MHz.
- **2 AUDIO INPUTS** for a low Z dynamic and line level audio input found in most portable color cameras, VCRs, or home computers.
- **APPLICATION NOTES & schematic** supplied for typical external connections, packaging, and system operation.
- **PRICE ONLY \$159** delivered via UPS surface in the USA. Technician class amateur license or higher required for purchase and operation.

**WHAT IS REQUIRED FOR A COMPLETE OPERATING SYSTEM?** A TV set with a TVC-2 or TVC-4 420-450 MHz to channel 3 downconverter, 70 cm antenna, and coax cable to receive. Package up the KPA5, add 12 to 14 vdc, antenna, and any TV camera, VCR, or computer with a composite video output. Simple, eh?

**CALL OR WRITE FOR OUR COMPLETE CATALOG** & more info on atv downconverters, antennas, cameras, etc., or who is on in your area.

**TERMS:** Visa, Mastercard, or cash only UPS COD by telephone or mail. Telephone orders & postal MO usually shipped within 2 days, all other checks must clear before shipment. Transmitting equipment sold only to licensed amateurs verified in 1984 Callbook. Calif. include sales tax.

(818) 447-4565 m-f 8am-6pm pst.

**P.C. ELECTRONICS**  
Tom W60RG Maryann WB6YSS



2522 Paxson Lane  
Arcadia CA 91006

187

## HIGH PERFORMANCE PRESELECTOR-PREAMP

The solution to most interference, intermod, and desense problems in **AMATEUR** and **COMMERCIAL** systems.



- 40 to 1000 Mhz - tuned to your frequency
- 5 large helical resonators
- Low noise - High overload resistance
- 8 dB gain - ultimate rejection > 80 dB
- 10 to 15 volts DC operation
- Size - 1.6 x 2.6 x 4.75" exc. connectors
- **FANTASTIC REJECTION!**

**Typical rejection:**  
± 600 Khz@144 Mhz: -28dB  
± 1.6 Mhz@220 Mhz: -40dB  
± 5 Mhz@450 Mhz: -50dB

Price - **\$89.95** bipolar w/RCA jacks  
Connector options: BNC \$5, UHF \$6,  
N \$10  
**SUPER HOT! GaAs Fet option \$20**

## AUTOMATIC IDENTIFIERS

ID-1

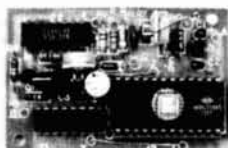

ID-2



- For transceivers and repeaters - **AMATEUR** and **COMMERCIAL**
- Automatic operation - adjustable speed and amplitude
- Small size - easy installation - 7 to 15 volts DC
- 8 selectable, reprogrammable messages - each up to 2 min. long
- Wired, tested, and programmed with your message(s)
- Model ID-1 - \$49.95 Model ID-2 w/2 to 10 minute timer - \$69.95

We offer a complete line of transmitter and receiver strips and synthesizers for amateur and commercial use.

Request our free catalog. Allow \$2 for UPS shipping - Mastercard and VISA welcome

**GLB ELECTRONICS**

1952 Clinton St. Buffalo, NY 14206  
716-824-7936, 9 to 4

147

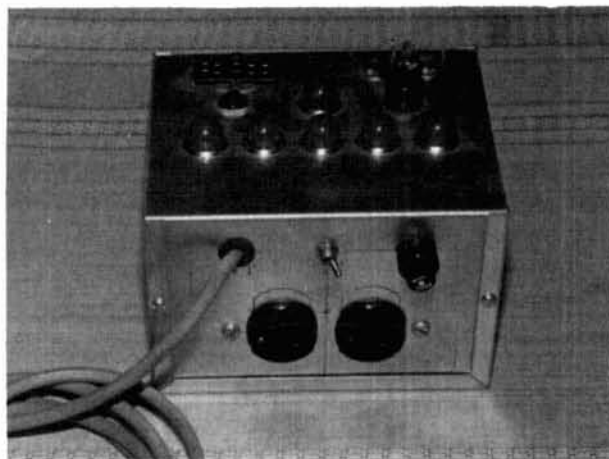

fig. 6. Simple control box allows for almost instantaneous no-tune band change.



fig. 7. The remote control box should be located as close as possible to the base of the vertical.

VSWR at the shack is 1.6:1, as shown in fig. 2. I used surplus RG-17 coax cable to reduce losses over such a distance.

Fig. 3 provides the schematic of the networks and control system. Fig. 4 shows the 70-foot vertical from a distance, while fig. 5 is a view of the antenna from below. Fig. 6 shows the control box, fig. 7 the antenna base.

### materials

- L1 6 turns Barker and Williamson coil stock No. 3033
- L2 23 turns Barker and Williamson coil stock No. 3033
- Ledex S8210-025

For sources of Ledex, contact author. A 10-inch length of B-W coil stock No. 3033, sufficient for both L1 and L2 may be obtained from Amp Supply Co., P.O. Box 421, Twinsburg, Ohio 44087, for \$12.50, plus \$2.25 shipping and handling. The aluminum pipe may be obtained from any irrigation supply company.

ham radio

# Gillaspie 9600

*Micro Processor Controlled Satellite Receiver*

*with wireless remote*

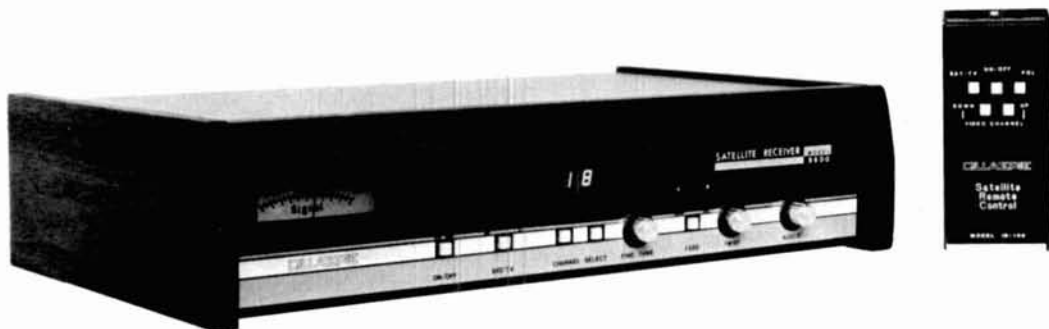

- Clear sharp pictures
- Automatic Feed Rotation Control
- Built-in Satellite TV Switch
- Super Reliability
- Channel 3 - 4 Switchable Modulator
- Fine Wood Cabinet with Distinctive Styling

DEALER AND DISTRIBUTOR INQUIRIES WELCOME!

## Gillaspie L.N.A.



*Low Noise Amplifier*

*Model #  
GLN-3742*

- Full Band Coverage (3.7 GHz - 4.2 GHz)
- 100°K Max. Noise Temperature (GLN - 3742 - 100)
- 120°K Max. Noise Temperature (GLN - 3742 - 120)
- 50 db Gain (typical)
- DC Bias at 15v to 28v (150 mA max)
- CPR 229 Waveguide Input
- Input VSWR 1.3 - Output VSWR 1.5
- Single "N" Female Connector for RF Output & DC Bias
- Compact Design 3.1" x 3.9" x 8.4"
- Hermetically sealed
- Replaces any TVRO LNA
- 1 Year Warranty

DEALER AND DISTRIBUTOR INQUIRIES WELCOMED

**NEVADA SATELLITE 702 • 452-5509**

P.O. Box 2 - Las Vegas, Nevada 89125

# ungar® HEAT GUN

# 1000



## Lightweight Heat Gun for Heavyweight Jobs

Quality Engineered for the Toughest Applications

- paint stripping • wood restoration
- electrical • plumbing
- home • auto • marine

**UNGAR®**

Division of Eldon Industries, Inc. Compton, California 90224-6005

211

## SURPLUS BARGAINS

### G.E. "Terminet 1200" featuring:

110, 300, & 1200 Baud (11, 30 & 120 cps), full KSR & RS-232-C I/O, compact, table-top configuration, upper & lower case continuous band, made in USA by General Electric, tested and operational.



Only!!  
**\$349.00**  
ea.  
Plus Shipping

120 CPS!  
RS-232

### CRT Terminals

Built by a major OEM, these terminals include 3 microprocessor boards (Interface, CPU & CRT) plus composite video & switching power supply 48K or roms. "Ergonomic" design and more. Experimenter special, includes Data, Keyboard, RS-232 I/O plus much more. Seems to be quite powerful.



Only!!  
**\$289.00**  
ea.  
Plus Shipping

### Parallel, TTL Input I/O "Selectric"

TYPEWRITER/PRINTER These machines have built-in driver and decoder circuitry and take TTL level, 6-bit character, plus a 4-bit function input signals. Easily driven by most any micro. Use as a typewriter (with add'l "repeat" circuitry) or as a KSR I/O printer or both. "Table Top" style case.



Only!!  
**\$329.00**  
ea.  
Plus Shipping

TESTED AND  
OPERATIONAL!

### 9" Composite Video Input CRT Monitor

Requires approx. 12 VDC @ 1-2A VDC in attractive case. With schematics.



Only!!  
**\$89.00**  
ea.  
Plus Shipping

### Shugart SA-400 "Mini-Floppy" Drives

Model SA-400, used, whole, untested, less power supply & case. Data and schematics included. Removed from Equipment.



Only!!  
**\$119.00**  
ea.  
Plus Shipping

134

Write or Call for Our Latest Flyer NOW!!! "Selectric" is a registered trademark of IBM Corporation

**Computer  
Products &  
Peripherals  
Unlimited**

WAREHOUSE: 18 Granite St., Haverhill, Mass. 01830  
MAIL ORDERS: Box 204, Newton, New Hampshire 03858

**617/372-8637**

Sorry No Collect Calls  
MasterCard & VISA Accepted



## Your Ham Tube Headquarters!

TUBES BOUGHT, SOLD AND TRADED  
SAVE \$\$\$—HIGH \$\$\$ FOR YOUR TUBES

Call Toll Free 800-221-0860

### Tubes

3-400Z .....	\$85.00	7360 .....	\$10.00
3-500Z .....	85.00	7735A .....	27.50
4-400A .....	80.00	8122 .....	105.00
4CX250B .....	50.00	8156 .....	12.50
572B .....	48.50	8643 .....	82.50
811A .....	12.00	8844 .....	26.50
813 .....	30.00	8873 .....	175.00
6146B .....	6.50	8874 .....	185.00
6360 .....	4.25	8877 .....	500.00
6883B .....	6.75	8908 .....	12.50

### MAJOR BRANDS ON RECEIVER TUBES

75% off list

#### Semiconductors

MRF 245/SD1416 .....	\$30.00	MRF 644/SD1088 .....	19.95
MRF 454 .....	14.95	2N3055 .....	75¢
MRF 455 .....	10.95	2N6084 .....	12.50

#### RF Connectors

PL259 .....	10/\$4.95	M358 .....	2.50 ea.
PL258 .....	10/8.95	M359 .....	1.75 ea.
UG 175/176 .....	10/1.60	Type "N" Twist on	
UG255/u .....	2.50 ea.	(RG8/u) .....	\$4.75 ea.
UG273/u .....	2.25 ea.	Minimum Order	\$25.00

Allow \$3.00 min. for UPS charges

126

**CeCo**

COMMUNICATIONS, Inc.

2115 Avenue X Brooklyn, NY 11235

SERVING THE INDUSTRY SINCE 1922

Phone (212) 646-6300

Call CECo For Your CCTV Security And Color Production Requirements



# vertical phased arrays: part 6

## Building the array and measuring performance

In this final article of my series on vertical phased arrays I will discuss some of the practical aspects of putting up an array — how to build it, how to construct networks, and how to take measurements. I will also address a few questions readers have raised about my previous articles.

### siting elements: with respect to the world

Situating elements by eye can be deceiving. Having said this, I am absolutely certain that some will try it, nevertheless. Hopefully, you will discover any errors before a large radial ground system has been installed. Unlike adjusting the elements of a rotatable Yagi, adjusting the spacing of a ground-mounted vertical phased array is a major undertaking that may require several weeks of effort. If you know the variation from true north that your magnetic compass tells you is north, fine. Otherwise, the best way is to line up with the north star, Polaris. This star is easy to locate; the outer two stars outlining the dipper of the Big Dipper form a pointer to Polaris. I have a 4-square array whose major lobes are turned off of the desired directions because I failed to determine the local magnetic variation. Sources for this information include your local airport, any office of the FAA, or persons associated with private aviation. Determine whether the variation is east or west. Generally, this variation will be west for those located east of a line running

through Chicago and Miami and east if located west of that line. For example, at New York City the variation is approximately 12 degrees west. This means that true north for a magnetic compass pointing at north is 12 degrees rotated clockwise toward the east. This variation from true north slowly changes with time; if your information is more than 10 years old, find a more recent source.

Since most of these arrays have half-power beam widths of 90 degrees or more, why be so concerned over a few degrees? For forward gain small errors in pointing do not matter much; we are more interested in the directions in which the beam should *not* be pointing. Just as with Yagis, it is far easier to determine the *direction of nulls* than maxima. This is important diagnostic information: to the extent that these are in the directions and reduced with respect to forward gain as predicted, we have a reliable validation of the design.

### siting elements: within the array

Accurately locating the elements of an array, particularly if they are not to be in line, isn't as easy as it might appear. Getting the correct angles is the problem. Euclid had the right idea; three points not in a straight line uniquely define any triangle. Using wire with little or no stretch (steel or aluminum fence wire is excellent), carefully measure out three lengths, each equal to a side of any triangle that outlines all or part of your array. Join the ends, and with two helpers, pull the wires taut, you'll have three points accurately located with respect to each other. If your array is triangular, you're all set. If it's a 4-square, you have only to locate the fourth element with the same wire triangle by turning it over on its diagonal. Triple-check

By Forrest Gehrke, K2BT, 75 Crestview Road,  
Mountain Lakes, New Jersey 07046

**table 1. Single 80-meter element tubing requirements.**

quantity	length	diameter	wall	cumulative height
3	10' (3.05 m)	1-1/2" (3.81 cm)	0.125" (3.18 mm)	30' ( 9.14 m)
1	10' (3.05 m)	1-1/4" (3.18 cm)	0.125" (3.18 mm)	39'4-1/2" (12.00 m)
1	8' (2.44 m)	1" (2.54 cm)	0.057" (1.45 mm)	46'8" (14.22 m)
1	8' (2.44 m)	7/8" (2.22 cm)	0.057" (1.45 mm)	54'2" (16.51 m)
1	8' (2.44 m)	3/4" (1.91 cm)	0.049" (1.24 mm)	61'8" (18.80 m)
1	4' (1.22 m)	1/2" (1.27 cm)	0.049" (1.24 mm)	63'6" (19.35 m)

**Additional material requirements for a single element.**

2	15" (0.38 m)	1-1/4" (3.18 cm)	0.125" (3.18 mm)	mating inserts
1	24" (0.61 m)	1-1/4" (3.18 cm)	0.125" (3.18 mm)	extender
1	18" (0.46 m)	7/8" (2.22 cm)	0.049" (1.24 mm)	reinforcement
7	S.S. helical hose clamps approximately 2 inches (5.08 cm) OD			
9	S.S. 1/4" - 20 1/2" screws			
8	S.S. 8-32 1/2" screws			
1	0.250" (6.36 mm) female quick disconnect terminal			
1	0.250" (6.36 mm) male quick disconnect terminal			
1	SO-238 UHF female terminal			
12" (30.5 cm) flat tinned copper braid				
500' (152.4 m) 1/8" (3.18 mm) nylon woven cord				
7800' (2377 m) PVC insulated No. 24 solid copper wire (100 0.3 wavelength radials)				

everything to be sure, because array element layout is one of the few *physical* items under your complete control among the factors determining array symmetry. In prior articles I showed that electronic beam switching requires every element to operate *identically* in each of the *different* electrical positions of the array. This is a severe requirement; the best we can hope for is to get within 5 percent of meeting it, realizing that *reaching within 10 percent results in a significant loss in F/B performance.*

For those who may want to check array patterns, I have observed that reception of a 1-watt signal source located between a 1/4 to 1-mile distance is consistent with the pattern that is seen at the vertical angle of maximum radiation (but without QSB). However, at 20 miles this is no longer true because high vertical angle reflections predominate, sometimes so strongly that a positive F/B is seen.

### monopole construction

After much experimentation with a variety of ways to put together tubular quarter-wave length ground-mounted 80-meter vertical elements, I hit upon a method of construction which has held up for over six years. It's relatively inexpensive, but has withstood the rigors of northeastern winters, including icing followed by 80 MPH winds. After failures with lighter designs I decided that, at least for 80 meters, any tubular construction must be able to withstand being raised in one piece. If a vertical can withstand such stress, then it should also be able to survive high winds, icing, and even the temporary loss of one or two of its nine guys.

**Table 1** lists dimensions of aluminum tubing that, when assembled into a quarter-wave element, will meet this criterion. Included with the table is a complete list of materials for a single element. If care is taken not to raise the antenna abruptly, it will stand tall and straight — despite all appearances to the contrary — as it is brought upright.

All tubing will telescope into its next larger diameter mating member except the lower 1 1/2 inch (3.81 cm) diameter lengths. For two of these lengths, a 15-inch (38.1 cm) section of 1 1/4 inch (3.18 cm) diameter 0.125 inch (3.18 mm) wall tubing is bolted (using three 1/4 - 20 screws) at one end with 7 1/2 inches (19.05 cm) protruding, forming a mating junction with the next lower identical diameter tubing. The 1-inch (2.54 cm) diameter length of tubing requires a 15-inch (38.1 cm) length of 7/8 inch (2.22 cm) diameter tubing to be inserted for its entire length at the lower end to act as reinforcement because of the abrupt change in wall thickness at this junction. All lighter tubing is drilled and tapped for stainless steel 8-32 screws at two places spaced about 5 inches (12.7 cm) apart, at junctions. This is necessary to prevent the development of intermittent continuity after a few months due to wind vibration. The tubing, having little weight in this part of the vertical, cannot be depended upon to maintain good contact by gravity.

This element will resonate at approximately 3800 kHz. Inevitably, multiple elements will not resonate at precisely the same frequency even though they are identical in physical length. For exact matching of resonant frequencies, a 2 foot (61 cm) length of the 1 1/4 inch (3.18 cm) diameter 0.125 inch (3.18 mm) wall



tubing is used at the bottom of the vertical. This piece has tapped holes every 2 inches (5 cm) for a stainless steel 1/4 inch-20 screw, which determines the amount of its length that can be inserted into the bottom of the vertical. This may be adjusted as measurements dictate.

Flat braid [approximately 12 inches (30.5 cm)] is doubled, a 0.250 inch (6.36 mm) female quick disconnect terminal soldered at one end, and clamped to the bottom of the vertical with a helical hose clamp. I wrap PVC electrical tape around this to keep the doubled braid together. This makes a flexible, low inductance connection to the feeder. The coax termination is an SO-238 UHF female connector to which is soldered a male 0.250 inch (6.36 mm) quick disconnect terminal. The reason for these terminals will become quite obvious as measurements begin.

Glass bottles, corked to prevent accumulation of rain, may be used as standoff insulators for the verticals, since the necks happen to fit within the element base.

### guy wires

Three sets of three guys, one set every 16 feet (4.88 m) from the base, are connected by two hose clamps at each attachment point. One clamp acts as a backstop for the clamp immediately above it, which clamps around the nylon guys. The nylon guy ends are tied with their own guy and also with one of the adjacent guys as additional insurance (falling tree branches can tear away the first tie but the fall, once arrested, seldom takes out the second tie). The attachment areas are waterproofed with PVC tape.

An element is raised by threading one of the three middle guys (usually made longer than those adjacent, specifically for this purpose) through a pulley which may be as low as 35 feet (10.7 m) from the ground. Since my array is among trees, I chose one to serve as a ginpole — which, of course, requires a real ginpole if you have no trees. Identify all guys with their ground anchor location, and lay them out so that no crossovers will be necessary later. During raising, the two remaining middle guys should be controlled by helpers to restrain the element from moving to the right or left, and as it arrives near the vertical position, to restrain it from continuing in the direction of the raising pulley. Don't forget to instruct your helpers in this latter point; more than one vertical has been successfully raised, only to continue unrestrained on its path to an inglorious end as it passes the upright position!

I've found that 1/8 inch (3 mm) diameter white woven nylon cord (sometimes called parachute shroud) is an economical, strong, long life material for guy stays. This is available at K-Mart stores in 50- and 100-foot (15 and 30 meter) lengths. I have some still in use after

six years. The same cannot be said for polypropylene rope. Even 1/4 inch (6 mm) UV resistant material will fail in just two years.

### radial systems

Installing radial systems is the dog work of building a low band array. It is also where the payoff — which too few Amateurs collect — is. There are two benefits to be gained with an extensive radial system: low losses and, more importantly, a low vertical radiation angle. But there's no free lunch: forget the loose talk you've heard on the bands about the benefit of water tables a foot below the surface, or being located over high conductivity earth. Pure water is a very good insulator, and most fresh water is too. And "high earth conductivity" is relative; it is very poor compared to the conductivity of copper. (For a perspective, see table 2.) Metal stakes in the ground at the base of your vertical give you good lightning protection, but *not* a good ground plane. Nor are there any rediscovered long-lost shortcuts; forty-eight radials raised a few feet above the ground won't provide any more efficiency than the same number on the ground. Undoubtedly, the best of all worlds would be an island surrounded by seawater, but for the near-field we'd *still* want an extensive copper radial system.

table 2. Conductivity comparisons.<sup>1</sup>

low conductivity earth	0.0005 mho/meter
high conductivity earth	0.03 mho/meter
sea water	5.00 mho/meter
copper	58,000,000.00 mho/meter

The best indicator of a good ground plane is how close the resistive component of the radiator's apparent self-impedance is to its theoretical resistance. The factors affecting theoretical radiation resistance are the electrical length and effective radius of the element, assuming a uniform cross-section monopole. Top hats, loading coils, and other means of shortening are also amenable to calculation, though the mathematics in some cases is more complicated.<sup>2</sup> For quarter-wave radiators this value is approximately 36 ohms.

In practice, there's another way to make this determination for any radiator without knowing the theoretical radiation resistance. It is the kind of analysis we usually wind up doing anyhow. Lay out radials, say ten at a time, distributed equally in all directions, taking measurements of the radiator's apparent self-impedance for each group of added radials. Plot these points on a graph as in fig. 1 (open circuit any other elements of the array to avoid coupling). You will find that each lot of radials has less effect upon radiation

# Attention Moonbouncers and Satellite Communications Enthusiasts

## Introducing New Ultra High Performance Antennas from KLM Electronics, Inc.

KLM Electronics is fueling the Moonbounce and Oscar 10 revolution with Antenna Equipment that delivers truly Out-of-This-World performance.

For the Moonbouncer, our New 2M-16LBX is designed to be the highest gain 2 meter antenna available on the market today by more than a full db, making the 2M-16LBX an outstanding performer as a single antenna or in Moonbounce (EME) arrays.

The New 432-30LBX follows the same pattern as the 2M-16LBX, and soon will become the industry's standard of comparison.

Featuring straight forward construction, and an innovative tapered boom that greatly reduces windload and adds strength and durability. Virtually unbreakable, insulated, 3/16" rod parasitic elements are anchored through the boom to insure years of trouble-free performance.

For the satellite enthusiasts, the 2M-22C high gain 2 meter, circular polarized antenna, features the same rugged construction and total flexibility as our very popular 2M-14C with a 2db increase in gain.

Four or more 2M-22Cs make an excellent array for Moonbounce (EME) by eliminating Faraday fading.

Fiberglass/aluminum stacking frames are available as well as 2 and 4 port power dividers and phasing harnesses to optimize the performance of these type arrays. Watch for our new elevation drive system coming soon.

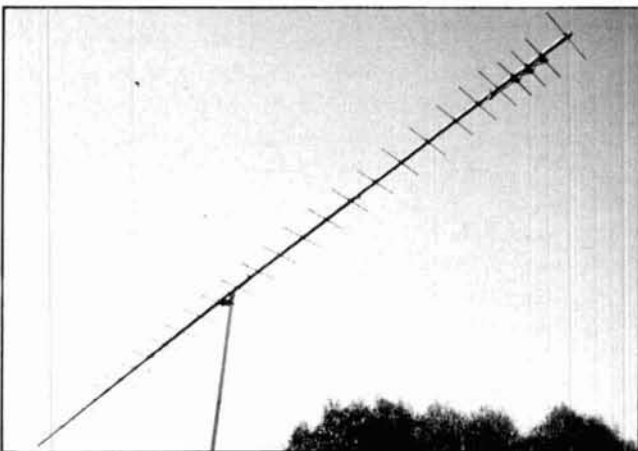

### 432-30LBX

BANDWIDTH .....	430-440 MHz
GAIN .....	17.3 dBd
BEAMWIDTH .....	20°
FEED IMP .....	50 ohms unbal.
BALUN .....	included
BOOM LENGTH .....	21 ft. 9 in.
F/B .....	20 dB F/S
VSWR .....	1.5:1
WINDLOAD .....	1.43 sq. ft. (typical)
TURNING RADIUS .....	12 ft. 5 in.
WT. (lbs.) .....	9 lbs.

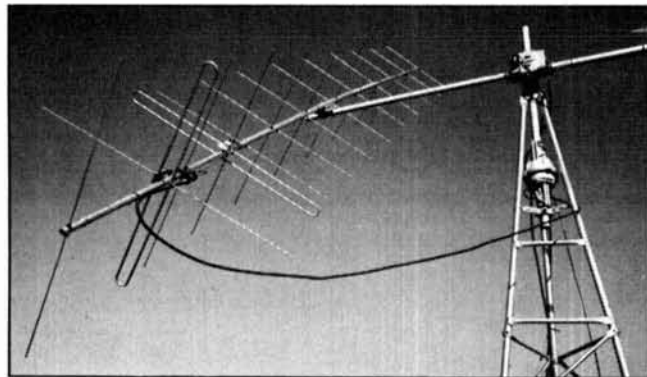

BANDWIDTH .....	144-148 MHz
GAIN .....	13 dBd
BEAMWIDTH .....	34°
FEED IMP .....	50 ohms unbal.
BALUN .....	(2) 4:1 coax
BOOM LENGTH .....	19 ft. 1 in. (tapered)
VSWR .....	1.5:1
WINDLOAD .....	1.85 sq. ft.
ELLIPTICITY .....	3 dB max.
CIRCULARITY SWITCHER .....	CS-3 included
WT. (lbs.) .....	11 lbs.

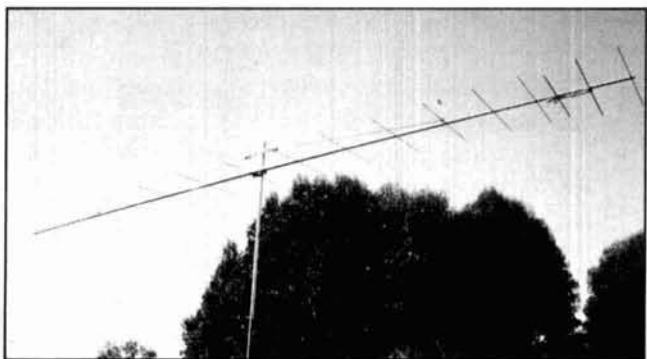

BANDWIDTH .....	143-146 MHz
GAIN .....	(144 MHz) 14.8 dBdc
BEAMWIDTH .....	(V) 28°, (H) 33°
FEED IMP .....	50 ohms unbal.
BALUN .....	4:1 RG303, Teflon
BOOM LENGTH .....	28 ft. 1 in. (tapered)
VSWR .....	1.4:1
WINDLOAD .....	(H) 1.75 sq. ft. (V) 2.44 sq. ft.
WT. (lbs.) .....	10 lbs.
TURNING RADIUS .....	15 ft. 6 in.

See all our new antennas and equipment at the Dayton Hamfest, Booth #25.

**KLM** electronics, Inc.  
P.O. Box 816  
Morgan Hill, CA 95037

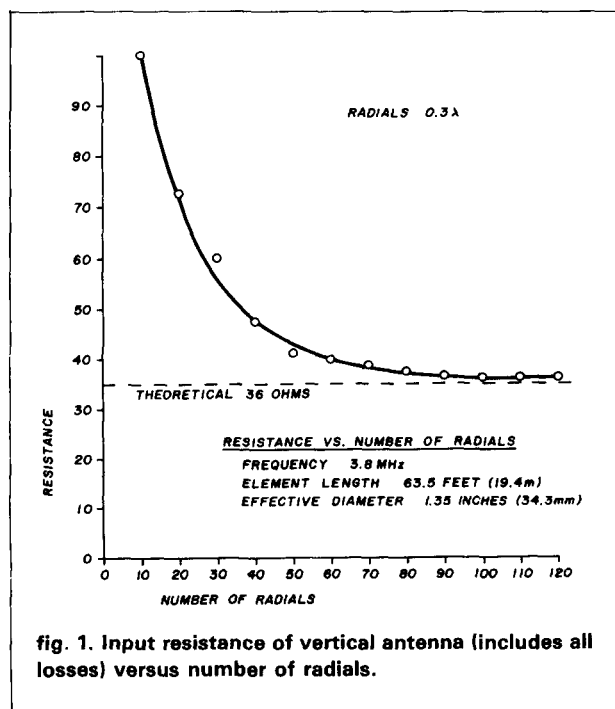

resistance than the previous lot. Assuming radial lengths of a quarter-wave or more, after about 100 radials, the reduction in resistance with each added lot of radials is almost constant, but becomes vanishingly small (approximately 0.1 ohm). You'll notice that the curve on your graph has begun to flatten out; if you fit a French curve to this plot, you'll see that the plotted curve will nearly meet some horizontal line. In scientific terms, this is described as having become *asymptotic* with the theoretical resistance of the radiator; the horizontal line is a prediction of that theoretical value. (I am assuming negligible radiator element circuit losses. This is a fairly safe assumption for aluminum monopoles, but less safe if loading coils are present. More rigorously, the plot is becoming asymptotic with theoretical radiation resistance *plus* radiator circuit resistance.) Put another way, you've reached the point of diminishing returns. Although that point is self-definable, most experimenters would agree that it begins at the knee of that curve — i.e., at about 50 quarter-wave radials.

An aside to single vertical users accustomed to rating an antenna's merits according to VSWR readings: don't misinterpret an increase in VSWR as a negative indication when adding radials. Assuming VSWR is 1:1 with 50-ohm coax to a quarter-wave vertical, an appreciable ratio of output power (approximately 28 percent) is being used to heat the ground around the radiator. A higher VSWR after adding radials is desirable.

How should the radials be laid? This depends upon your personal aesthetics and also upon how the area occupied by the array is used. If you need to bury the radials (see "Build a Simple Wire Plow," page 107 — Editor), some form of protection against corrosion, such as PVC insulation or enamel coating, is necessary. Don't bury them too deeply; the closer radials are to the surface, the more effective they are. Some Amateurs have laid them flat on the surface and let grass cover them so well that limited traffic and even lawnmowers can be allowed.

What about wire size? I often hear people talk about laying No. 6 or No. 8 BS gauge radials. Unless you have to protect your system from farm animal traffic, this is calling for a hawser when thread will do. Consider: 1000 watts output to a single vertical with 25 radials (and assuming an apparent radiation resistance of 50 ohms). Each radial will be carrying all of 179 milliamperes, and *that* only near the base of the vertical.<sup>3</sup> Given a reasonable number of radials, a base current measured in amperes is divided into individual radial currents of milliamperes, and even this small current rapidly decreases as we move away from the base of the radiator. In the absence of concern about possible fragility, the wire size may be quite small.

Many articles in Amateur publications have suggested using steel fence wire or steel mesh as an economical substitute for copper. *Don't.* Unless the material has cost you nothing, and your labor is worth nothing, and you plan to abandon the antenna in less than a year, forget it. In just a matter of months, galvanizing — if present at all — is penetrated and corrosion proceeds. Steel, being magnetic, has a high permeability, making for a skin effect much thinner than copper when carrying RF current. Iron oxides are lossy semi-conductors. The thin skin effect, combined with a lossy surface, results in a wire which conducts *nearly zero* RF current long before it fails to conduct DC or has lost physical integrity — which takes only about three years after installation, and much less time if the system is buried. My first radial system consisted of a combination of aluminum, steel, and copper radials. It took a couple of years to solve the mystery of a slow but continually rising self-impedance of some of the elements in the array. In my efforts to overcome this rise, I compounded the mystery by adding more radials, which at first were — *more steel radials!*

### array operation measurements

So you've constructed an array. Now you'd like to see how well it works. On-the-air tests are understandably at the top of your list. Unfortunately, this is not likely to be a good proof test of proper drive conditions, primarily because these arrays *want* to work and may show fair performance despite being poorly driven. This is almost always true for gain

characteristics, and during some propagation conditions may even apply to F/B. So continue these tests, but give some thought to an old antenna man's advice, said to have been first enunciated during the period of Maunder's Minimum: "One swallowe prouveteth not that summer is neare."<sup>\*\*</sup>

A much more definitive test is a measurement of element currents in each of the array directions. Assuming you have designed the feed network for a 1:1 VSWR, then element base current amplitudes measured within  $\pm 5$  percent of design values and an array VSWR no greater than 1.15:1 in any direction is almost complete proof that drive is in the proper range, including current phase angles. Measurement of element current amplitude *and* phase is, of course, the ultimate test for drive conditons. A wideband dual-trace CRT is needed for this test, and since this equipment is quite expensive, may be beyond the reach of most Amateurs unless it can be borrowed. On the chance you have access to this equipment, a method is described in the next section of this article.

Measurement of current amplitude, a must for any serious array builder, is quite easy to do. At the lower frequencies a high degree of absolute accuracy is not difficult to achieve, but good linearity is really all that is necessary. For example, if actual current is doubled (power multiplied by 4), does the reading double? For this purpose the meter readings might just as well go from 1 ampere to 2 amperes, or 400 mA to 800 mA; we are more interested in good linearity of readings than in absolute value because phased array design considerations are concerned only with element current amplitude ratios.

Fig. 2 shows a schematic of an RF ammeter (photo 1). The basic meter movement may be anything up to 1 milliamperes. I use germanium diodes for the rectifier because of their low turn-on voltage. This simple design works well for absolute accuracy and linearity up to 14 MHz. Low capacitance of the pickup coil to RF line is important and is increasingly so as frequency is raised. For this reason we want a high permeability factor for the toroidal core (for least number of coil turns). A Faraday shield will provide even more isolation, but this additional protection is not necessary at lower frequencies.

Since this ammeter is easy to duplicate, you may find it useful to have one for each element of the array because the efficiency of data collection is considerably improved. Note the use of quick disconnects for element terminals and associated measurement devices.

<sup>\*\*</sup>From 1645 to 1715 there were no observable sunspots, and no Northern Lights. (Imagine a 70-year period in which the 10-meter band never opens and the 20-meter band is only so-so during the day, and dead at night!) A British astronomer, E.W. Maunder, in 1895, was the first to call attention to this strange behavior of the sun.

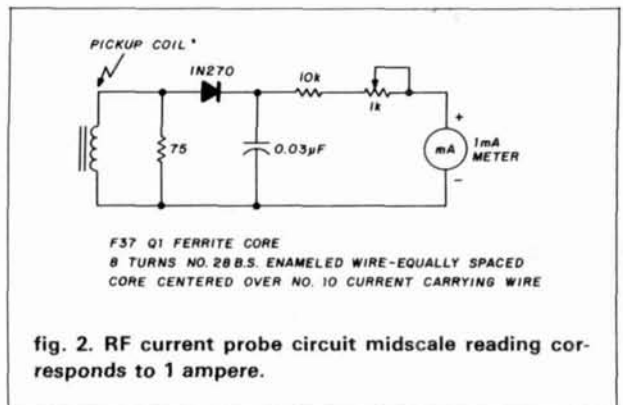
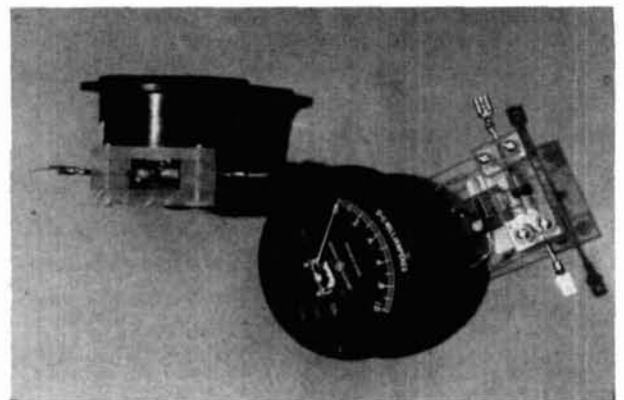

fig. 2. RF current probe circuit midscale reading corresponds to 1 ampere.



Solidly constructed RF ammeter uses quick connect/disconnect terminals.

## dual-trace CRT measurements

Measurement of RF current phase angles involves an instantaneous comparison of sinusoidal currents at the bases of the elements. Since the elements are widely separated physically (and distance is proportional to phase), we must take special precautions to be sure we are really observing events in time coincidence. One way is to make these observations at another location of our own choosing in such a manner that all events have been equally delayed. Though we will see events at some time later than they occurred, they will be in time coincidence. Identical coax lines will meet this requirement nicely. Obviously the pickup coils for sampling base currents also must be alike, with the further proviso that the terminations of these lines must be alike, resistive, and match the characteristic impedance of the lines. (Most dual-trace CRTs provide 50-ohm inputs.) The line length chosen should be long enough to allow measurements of the most widely separated elements. I am sure you've anticipated my comment that the assurance of identical electrical length is not provided by a tape measure. Furthermore, to help ensure line identity for other characteristics, it would be a good idea to cut these

# ODOM. The one the others copy.

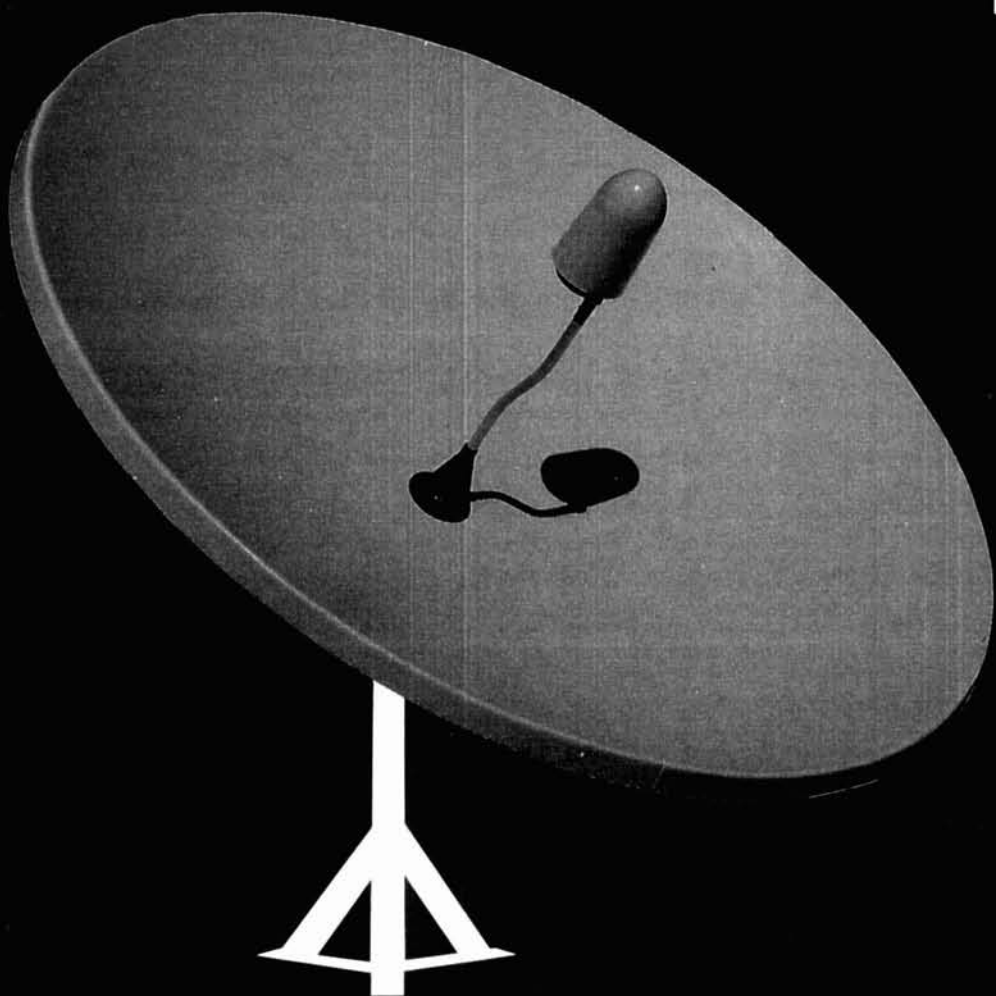

Some enterprising people out there have found that it's a cinch to make an antenna that LOOKS LIKE an Odom.

You simply buy an Odom antenna and copy its shape. To save more time and money, you stamp it out with a press.

You certainly don't waste money designing the master plugs from scratch, by computer, like Odom does. Or hand-layering the fiberglass and resins, like Odom does. And why go to all the trouble of flame-spraying a reflective layer of molten zinc, when you can just sandwich in some aluminum mesh?

Your customers can tell you why. Because they'll see the difference. Not by looking at the antenna, but by looking at their TV sets.

Others may try to copy the Odom shape. But they'll never copy Odom performance. And to your customers, performance is what really matters.

Dial 1-800-643-2950 for the facts on Odom's complete line of TVRO components. In Arkansas, dial (501) 882-6485. It's SOME DISH.

 **ODOM**  
**ANTENNAS, INC.**  
The one the others copy.

lines from a single piece of cable. (For an enlightening discussion on the variations that may be found in coaxial cable, see Bill Orr's "Ham Radio Techniques" in the January, 1984, issue.)

**Photo 2** shows the construction of a pickup coil fixture. This is essentially the same as that used for an ammeter, but without the rectifier and filtering circuit. More attention must be paid to ensure that the pickup circuits have identical RF characteristics, however. We can test this by connecting both pickups in series as sensors in the same RF current circuit, preferably a resistive load. The amplitude and phase of the displayed current waveforms should be identical and should remain so when positions of pickups are interchanged. If reasonable care has been taken, the phase difference due to pickup coils should not exceed 2 or 3 degrees. Any small difference may be corrected for a particular band by connecting a mica capacitor (5-25 pF) across that pickup coil which lags in phase. My guess is that toroid core material variations are the probable cause of any slight differences. It is possible that substitution of another sample of the same core might also work; I did not investigate this.

In my experience with this measurement technique, I found it to be the most productive method for fine tuning a feed network to get the last bit of F/B performance improvement. Because both phase and amplitude changes are displayed, a much more rapid and intelligent analysis of cause and effect is possible. This comment applies with ever-increasing emphasis with the number of elements in the array. Lacking this capability, my advice is, "If it ain't broke, don't fix it!"; this can be as frustrating as attempting to adjust the color matrix board of a TV receiver without a crosshatch generator. The fact is that if self and mutual impedances are accurately read and used for the design and careful construction of the feed network, the array will be operating very close to, if not exactly at, optimum. The few adjustments determined with the dual-trace CRT are surprisingly miniscule "tweaks." Although the effect on F/B can be quite marked, for example, improving F/B from -20 dB to -30 dB, don't be carried away by these numbers: the effective frequency range over which this occurs is extremely narrow.

### alternate methods of phase measurement

One would expect that considering its importance in antenna applications, measurement of phase angles at lower RF frequencies would have received more attention in the Amateur press than it has. A survey of Amateur publications did not yield much except one very interesting article directly applicable to phased array applications.<sup>4</sup> While the author's concept is ingenious and well chosen, it used a differential phase

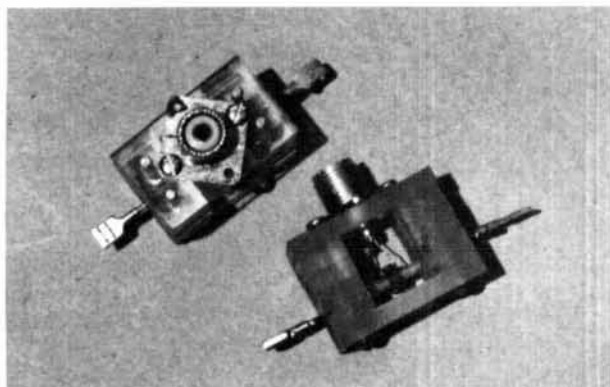

Pickup coils provide signals for dual trace scope.

angle readout that was analog rather than digital. Considering the tremendous advances in semiconductor technology during the ten years since the article appeared, a digital readout should be possible. I hope that I may interest some enterprising experimenter to take up this challenge.

### network construction

Several readers have commented that although the no-compromise advantage of 4-terminal feed networks is obvious, and that matrix algebra for the modular design of the networks is a powerful tool, they had apprehensions about how to turn the mathematics into working hardware. Some, familiar with the Pi networks seen in linear amplifiers, were discouraged by visions of the need for the same size of components and the cost of construction. Still others thought the networks might be difficult to tune.

None of these concerns are justified. Construction is actually quite simple, and with an accurate noise bridge,<sup>5</sup> tuning is easy. Tuning with an impedance bridge is done in the same step-by-step manner as is the design, and one of the prime advantages of this method is that it allows tuning to be done at the design frequency. The impedance levels of these networks are low, being generally in the 35- to 125-ohm range. Since each network chain is designed to appear resistive at its input and deals with only a portion of the transmitter power, voltages are seldom above 300 volts, even when driven by kilowatt linears. For example, I use postage stamp size mica capacitors extensively (500 volt rating) and I've yet to have one fail. Where high impedances are encountered, for instance, with elements requiring very little direct drive because of drive coupled from other elements, the current is so low that high voltage is not developed.

**Photo 3** illustrates the simplicity and small component sizes. This is the feed network for my 80-meter 4-square array.<sup>6</sup> It is built into a 3 × 6 × 8 inch (7.6 × 15.2 × 20.32 cm) box on PC board, with each network chain individually removable. This takes the

# Morse Keyers & Trainers by AEA

AEA produces the finest Morse keyers and trainers in the world. All AEA keyers operate with any standard keyer paddle and offer selectable monitor tone, selectable dot and dash ratios, full weighting and selectable dot and/or dash memory. In addition, all our keyers offer full, semi-automatic or straight key modes. The keyers and trainers are keypad controlled which significantly reduces the complexity of operation for all the features offered. Each keyer has separate + and - keyed outputs for keying any modern transmitter. All keyers and trainers operate from 12 VDC (or 117 VAC with optional model AC-1 wall adaptor) which makes them ideal for portable operation. AEA microcomputer-based products are all subjected to a full burn-in and test prior to shipment, as well as being designed for maximum R.F. immunity.

## NEW BT-1



The **BT-1 Basic Trainer** is a hand-held computerized unit which teaches the code one character at a time at 18 or 20 words per minute. The BT-1 contains a self-paced training program that allows serious students the possibility of learning Morse to 20 wpm in as little as one month! Each character represents a separate practice session in which the character is first introduced by itself, and then presented 50% of the time along with all previously learned characters. There are no tapes to memorize, wear out, or break. No programming skills are necessary; the BT-1 is very easy to use. The tone oscillator can also be keyed for sending practice. An earphone jack is provided for private listening. The BT-1 will go as high as 99 WPM in 1 WPM increments. A battery operated version, the BT-1P, is available with wall charger and internal NICAD batteries.

The **KT-3 Keyer-Trainer** unit uses the teaching program used in the BT-1 trainer. In addition, the KT-3 features a full function Morse automatic keyer for keying any modern transceiver, or for sending practice. Speed range is 18-99 wpm for transmitting and 1-99 wpm for training.

The **KT-2 Keyer-Trainer** is a computerized keyer with all the features shown above, plus

## KT-2 Keyer Trainer



a Morse proficiency trainer. It is designed to increase your existing code as quickly as possible. The unit can be set for beginning practice speed, ending practice speed, and duration of practice. The microcomputer does all the rest by gradually increasing the speed during the practice time selected. You can even select between fast code (Farnsworth) or slow code methods. The characters are sent in 5 letter groups, or random word lengths. Two levels of difficulty can be selected; common Morse characters or all English Morse characters. A 24,000 character answer book is provided for the 10 separate starting positions. There is also random practice mode for which no answers are available.

The **CK-2 Contester™ Keyer** is the lowest cost automatic keyer available featuring an automatic serial number generator for contesting. The CK-2-keyer features a large 500 character message memory that can be soft-partitioned into as many as 10 sections. An exclusive AEA edit mode makes it possible to correct mistakes made while entering messages or to insert words into previously established messages. Two different speeds can be set for fast recall in addition to

## MM-2 MorseMatic™



a stepped variable speed control. The CK-2 features an automatic message repeat mode with variable delay-before-repeat for automatic CQ transmissions or TVI testing.

The **MM-2 Morsematic Keyer** represents the most sophisticated paddle keyer ever designed and features two powerful microcomputers. The Morsematic incorporates virtually all the features (except the preset and stepped variable speeds) of both the CK-2 and KT-2 shown above. In addition, the MM-2 offers an exclusive automatic beacon mode which is invaluable for meteor scatter, moonbounce scheduling, or beacon operation.

## NEW KT-3



## CK-2 Contester™



**AEA** Brings you the Breakthrough!

**ADVANCED ELECTRONIC APPLICATIONS, INC.**

P.O. Box C-2160, Lynnwood, WA 98036  
206/775-7373 Telex: 152571 AEA INTL

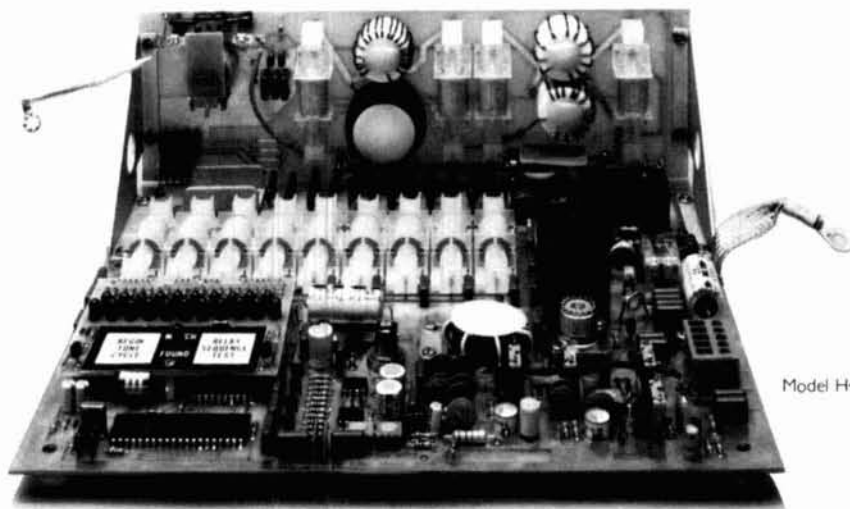

Model H402CU

## Hull Electronics Automatic Antenna Couplers New Solutions To An Old Problem

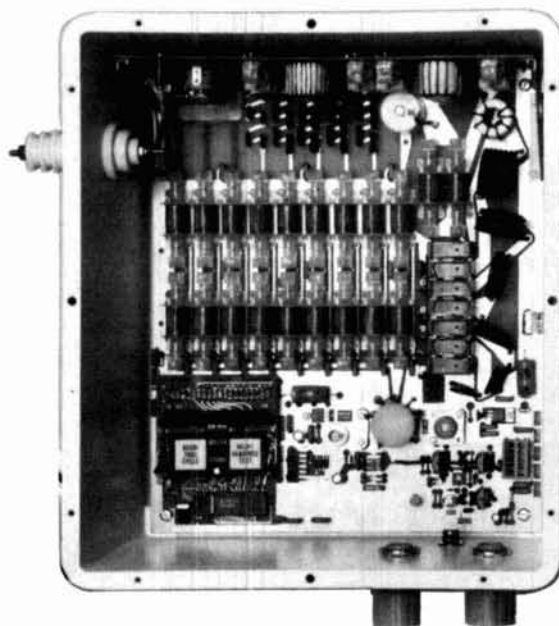

Model H-402/1000

To augment its line of Marine SSB Radiotelephones, Hull Electronics has developed a line of Automatic Antenna Couplers that harness the Microprocessor to the task of matching a wide variety of antennas to the 50-ohm transmitter output. The job is done whenever a new channel is selected, typically in less than one second.

The antenna may be any length greater than 8 feet. Frequency range is as much as 2 through 30 MHz depending on the model. The Coupler is easily interfaced with virtually any SSB transceiver and can be arranged to operate automatically when the channel is selected or manually by the operator. Either way, a VSWR of less than 1.25:1 is accurately and quickly obtained.

Presently, two models are available.

Model H402-CU handles power levels to 250 watts PEP output. Model 402/1000 is rated to a full 1000 watts PEP.

Hull also manufactures automatic couplers as a part of SSB transceivers to provide a one-piece package from microphone to antenna terminal.

**HULL**

Write or call for information today.  
**HULL ELECTRONICS COMPANY**

7563 Convoy Court  
San Diego, California 92111  
(619) 278-6140

**Career Opportunities:** If the application of microprocessors to improve HF communications interests you and you are technically qualified to work in the commercial SSB manufacturing field, Hull would like to talk about a variety of interesting career opportunities. Call (619) 278-6140, and ask for our Director of Engineering.



place of other feed methods which require 130 feet (39 meters) or more of coax for this band. At today's prices for good quality 50-ohm coax, this alone should be the deciding factor, without even considering the superior technical merits of 4-terminal feed networks.

As can be seen from the photograph, small 100 pF air variable capacitors are used as trimmers. Mica capacitors, singly or paralleled, using their color coded values, are chosen to make the required network capacitance fall in the middle of the trimmer range. All inductors carrying significant current (and these tend to fall between 0.5  $\mu$ H to 5  $\mu$ H) are air core using No. 10 or No. 12 B.S. enamelled copper. I wind these on 1-inch (2.54 cm) diameter wooden dowels, letting them spring up to a slightly increased diameter. Inductances significantly above 5  $\mu$ H are wound on powdered iron toroids using No. 18 B.S. wire. Using single layer charts for the air wound coils or toroid core manufacturer charts, all inductors are wound to be well above the inductance required. A grid dip meter, together with a known capacitance, is used to trim the inductors to slightly above the required values (5 to 10 percent). The network is constructed with these components and is completed with the exception that no network interconnections are made nor are any connections made to the *shack line* coax terminal.

### tune-up procedure

We have to choose which direction the impedance bridge will look into the network for tuning it. Each network chain was designed to transform a complex impedance to a pure resistance. Since it is much easier to duplicate resistances than complex impedances, this usually determines the choice. Assuming this case, consider a cascaded network consisting of a shunt L-match followed by a Pi circuit, which is the typical chain from the feeder of the  $-180$  degree phased element of a 4-square array. For example, from Part 4<sup>6</sup> of this series, the input impedances as seen at the various points of a network chain are reproduced for element No. 4 of a 4-square array:

element No. 4 driving-point impedance	63.4 + j47.5
input impedance to 100 degree	
length feeder	22.73 - j11.37
input impedance to L-match	114.83 + j0
input impedance to Pi circuit	114.83 + j0

You will recall the reason for the Pi circuit was for phase matching, not impedance matching; therefore, its input impedance is the same as the impedance to the shunt L-match.

The impedance bridge unknown terminal is connected to the coax terminal, to which the element feeder would normally be connected. The resistor simulating the input resistance of the L-match (115 ohms is ok) is temporarily soldered to the input of the L-match at the shunt arm and ground (i.e., at the con-

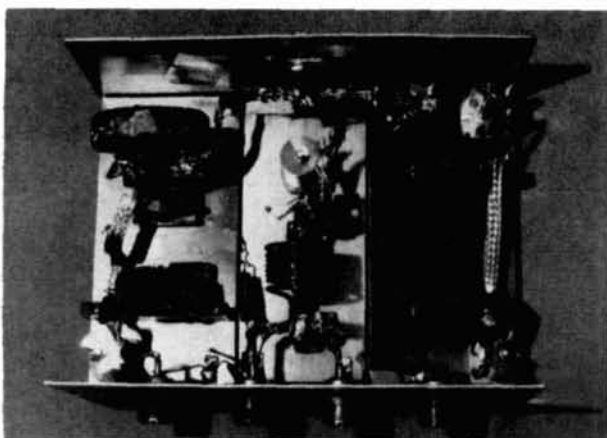

Matching network for four square vertical array measures 3 x 6 x 8 inches (7.6 x 15.2 x 20.32 cm).

nection point normally going to the Pi circuit). Since we have chosen to measure conditions in the *reverse* direction through this network, we must consider what we want the bridge to "see" and set it accordingly. At first glance, it might seem reasonable to expect this to be equivalent to the impedance as seen at the input to the element feeder. Not so; this is not a bilateral case. Instead we should expect to see the *conjugate* of this impedance: i.e., 22.73 + j11.37. If the impedance bridge reads parallel circuit equivalents, these must be calculated and the bridge set accordingly. If the reactance is beyond the basic bridge range, an appropriate extender must be used. The tuning procedure is simplicity itself; without touching the bridge settings, adjust the L-match shunt trimmer for minimum detector output (being sure this minimum is within the trimmer range). If this is the normal impedance bridge null, the adjustment is complete. More likely, it is merely a minimum. Begin spreading out one of the outer turns of the inductor and readjust the trimmer. Since the null is sharp and deep, use care in spreading coil turns to be sure you have not passed through the null. (I use the tapered end of a pencil for this.) When the L-match is tuned, move the simulating resistor to the input of the Pi circuit (the point normally connected to the shack coax line terminal). Install an interconnection between the L-match and Pi circuit. With the bridge remaining connected and set as before, adjust the Pi circuit trimmers for minimum detector output and then reduce inductance by turn spreading. Since the Pi circuit has three interdependent adjustments, be sure to recheck the other two with each tuning change. The two trimmers should end up in approximately the same part of their range, assuming the fixed padders are similar. Since the tune-up of the Pi circuit is done with the bridge looking into the L-match, a separate procedure for integrating the two networks is unnecessary. Remove the resistor, but

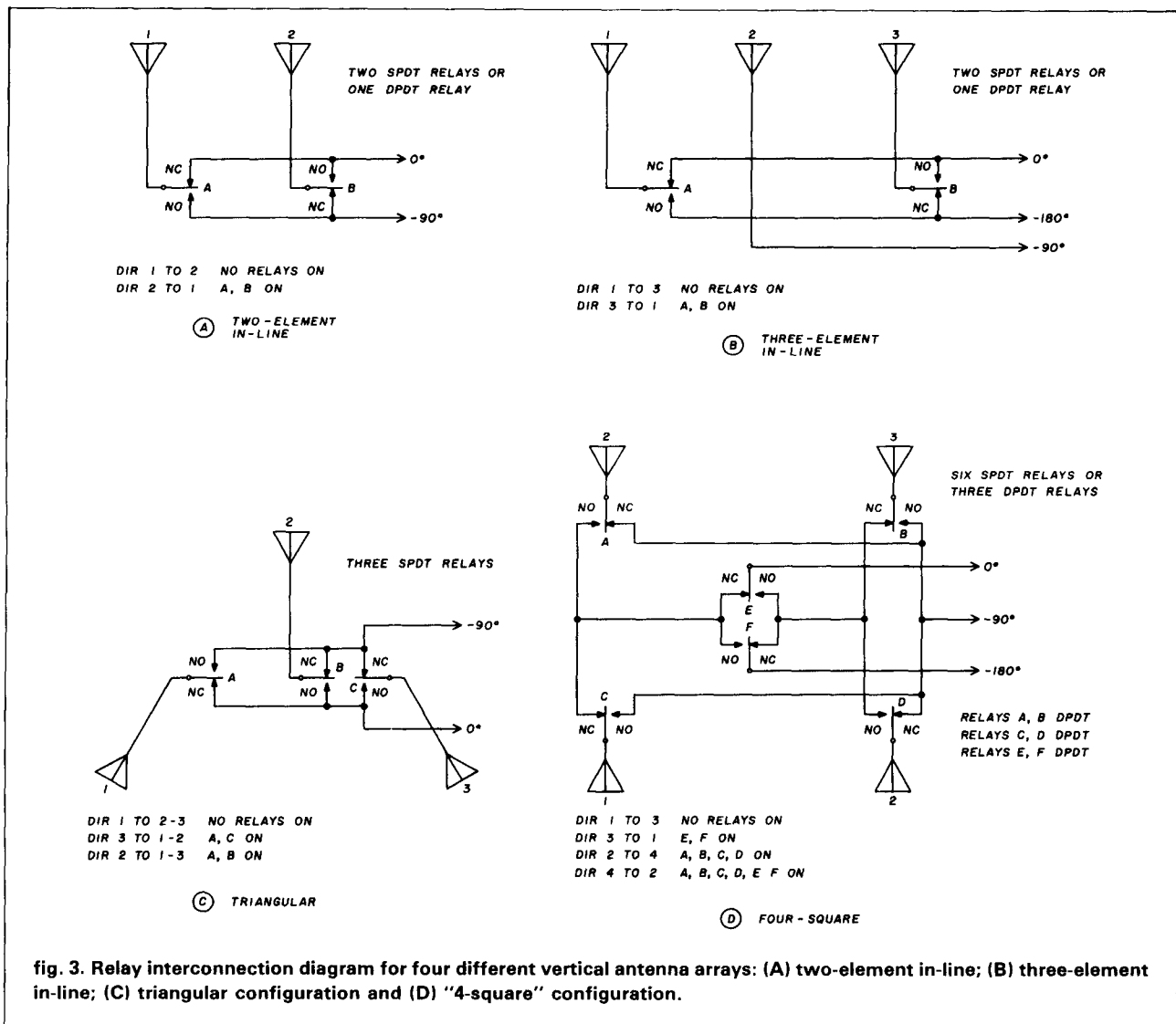

fig. 3. Relay interconnection diagram for four different vertical antenna arrays: (A) two-element in-line; (B) three-element in-line; (C) triangular configuration and (D) "4-square" configuration.

do not connect this chain to the shack line coax terminal until completing the adjustment of all chains.

In some circumstances it may be easier to simulate the calculated termination impedance of a network, in which case the bridge will look into this network in the same direction as the transmitter would. The impedance bridge is set to the pure resistance expected at the network input and it is connected to the shack line terminal. The simulated impedance (the same as calculated, not the conjugate) is connected to the coax terminal where the element feeder is normally connected. Assuming we are tuning the same network chain as above, a temporary connection of the shack line coax terminal is made to the input of the L-match (the same point at which the resistor was connected in the previous case). Except for these differences, the tuning procedure is the same. After tuning the L-match, the temporary bridge connection is transferred to the input of the Pi circuit, and an inter-

connection is made between the two networks in readiness for tuning the Pi circuit. After completion of tuning the Pi circuit, remove the shack line connection to it in preparation for tuning the next chain. Incidentally, there is nothing wrong with connecting the feeder coax into the chain to check out the entire network chain, making the appropriate changes to the bridge settings and/or the simulated network loads. However, do not connect an actual array element to this feeder in the expectation the element will present its array drive-point impedance, saving you the bother of simulating it. This simply won't work; part 4 of this series (October, 1983) explains why it will not.

### directional switches

Relay interconnection diagrams for directionally switching four different vertical arrays is provided by fig. 3. When selecting relays for this application, remember that no one relay is switching all of your

transmitter power; consequently ratings may be safely reduced. Since RF is being handled, ceramic insulation is advised, though I found no problem with linen bakelite at 80 meters. Always avoid "hot" switching relays. Even if they can stand it, your linear will not — and neither will the network, since high voltages will be present during switching.

**Photo 4** shows a 4-square array relay construction that use three small telephone-type DPDT military surplus relays. At first I lost several relays each summer due to sympathetic discharges from lightning which would burn out the solenoids. This was cured by connecting a silicon high current diode in reversed direction across the coil in parallel with a 0.1  $\mu$ F ceramic disc capacitor. I have since lost a few diodes to these discharges, but no more relays. Failed diodes are "shorts," so the 28 VDC supply to this system requires a protective series resistance to guard against this possibility and to prevent damage to the power supply from the discharge.

### on rounding-off calculations

Calculator algorithms and computer operating system programs use guard digits as a means of restricting degradation of accuracy due to round-off in repetitive calculations. All values begin with and are calculated to one or two digits more than shown to the user. For example, if a calculator displays ten significant digits, it actually keeps values to eleven or twelve digits in its internal registers. Round-off errors thus tend to be restricted to these extra figures and seldom affect anything more than the least significant displayed digit. Since these extra digits rarely convey additional accuracy, they aren't displayed.

This concept also applies to calculations done by hand or with a slide rule. For example, using 3.14 for Pi reduces accuracy to only three significant figures *before* any calculations are done. A few computations immediately reduce that accuracy. Let's watch what happens with a simple calculation:

$$\begin{aligned}
 & (\text{Pi} \times 5)^2 - (\text{Pi} \times 78) \\
 & = 1.57 \text{ if } 3.14 \text{ is substituted for Pi.} \\
 & \text{If } 3.1416 \text{ is used the result is } 1.6965. \\
 & \text{If } 3.141593 \text{ then the result is } 1.69591.
 \end{aligned}$$

Note that the first approximation for Pi, accurate to three significant figures, has produced results accurate to *only a single significant figure* in just a few computations. What is happening is that every time this rounded off value for Pi is used, a small error is re-introduced, and in effect, the error is compounded.

Although many calculators round off to the nearest decimal, most small computers, and many large ones too, merely truncate values to some number of digits without adjustment to the nearest decimal, causing even more rapid divergence from accuracy if truncation is occurring after only a few digits.

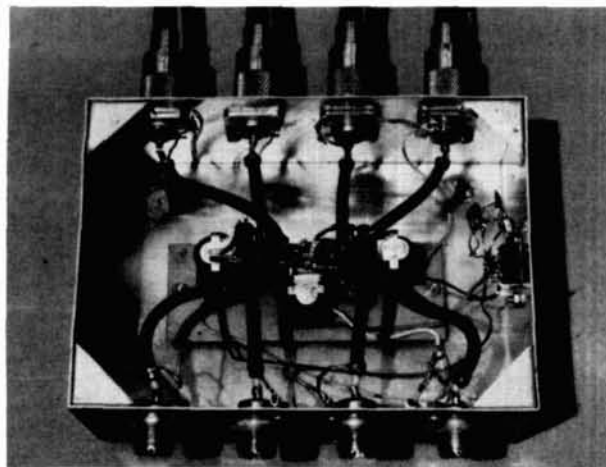

3 x 5 x 7 inch (7.6 x 12.7 x 17.8 cm) box houses all relays for switching four square vertical array.

The point of this discussion is to convince you to keep computations to several significant digits more than the accuracy you'd like to end up with. Except in determining rough approximations, constants such as 3.14 for Pi, or the number 984, expressing the speed of light in millions of feet per second, should always have two or more additional significant digits. This becomes particularly important when trigonometric functions involving angles approaching quadrant boundaries (for example, 0, 90, 180, or 270 degrees) are being used. Anyhow, in this day of ubiquitous calculators and computers, calculation to ten significant figures represents no personal mental effort.

The following constants, important to many calculations, are given to a level of precision more than sufficient for most applications:

Pi	3.141592654
e	2.718281828 Naperian logarithm base
c	299.792456 x 10 <sup>6</sup> velocity of light, meters/second 983.571049 x 10 <sup>6</sup> velocity of light, feet/second
cm/in	2.54 (exact) Metric to English unit conversion

Readers have inquired about the values given in these articles for inductances and capacitors in 4-terminal networks. Where, for instance, is a capacitor of value 734.8 pF to be obtained? Obviously no capacitor of that value will be listed in any catalogue; neither could we hope to find it to such accuracy by a measurement and selection process without also controlling temperature, humidity, aging, and so on. Measuring a capacitor or an inductance to just *three* places requires careful technique. I showed values to greater precision in an effort to prevent (mostly unsuccessfully) confusion caused by round-off errors if readers attempted to work backwards from my values for a capacitance or inductance to compute reactances, voltages and currents.

The Only  
Factory  
Authorized  
**SALES &  
SERVICE**  
in  
New England



# TEL-COM★

*Electronic Communications*

Authorized Dealers For

**KENWOOD & ICOM**

Also displaying the popular accessories needed to complete a HAM STATION . . .

- ARRL PUBLICATIONS • AEA • ALPHA DELTA • ASTRON •  
AUSTIN • BENCHER • B&W • DAIWA • MIRAGE •  
TELEX/HY-GAIN • VIBROPLEX • WELZ • ETC.

**TRY US FOR YOUR  
MAIL ORDER  
PURCHASES**

VISA and  
MASTER CARDS  
*Accepted*

**OPEN SIX DAYS A WEEK**

✓ 205

**Telephone 617/486-3400, 3040**  
675 Great Rd., (Rte. 119) Littleton, MA 01460  
1 1/4 miles from Rte. 495 (Exit 31) toward Groton, Mass.

**ENGINEERING  
POSITIONS  
AVAILABLE  
RF  
TECHNOLOGY**

The job  
openings are:

- RF Engineer (UHF)**
- PCB Designer**
- Microprocessor Programmer**
- Engineering Technicians**

Want to relocate near the Pacific Ocean and Carlsbad in North San Diego? The move from Inglewood, California to San Diego is scheduled for mid-August.

Linear Electronics, a Southern California designer and manufacturer of radio control equipment has openings for engineers interested in RF and automatic control design and development. The Company is over 20 years old in the business of security products, garage door and gate controls, infrared sensors, paging equipment, and energy monitoring/conservation systems.

Excellent opportunity for technical challenge and growth with a stable, profitable, publicly held electronics corporation with eight divisions. Work place located near ocean. Non-military work.

Send resume to Ronald T. Guerin, Assistant to the President.

**Linear electronics** P.O. Box H-170,  
Inglewood, California 90306

## MOVING?

**KEEP HAM RADIO COMING . . .**

If possible let us know four to six weeks before you move and we will make sure your HAM RADIO Magazine arrives on schedule. Just remove the mailing label from this magazine and affix below. Then complete your new address (or any other corrections) in the space provided and we'll take care of the rest.

**ham radio**  
Magazine  
Greenville, NH 03048  
Allow 4-6 weeks for correction.

**Thanks for helping us to serve you better.**

Here's my new address:

Name \_\_\_\_\_  
Address \_\_\_\_\_  
City \_\_\_\_\_ State \_\_\_\_\_ Zip \_\_\_\_\_

**AFFIX LABEL HERE**

**SAY  
YOU SAW  
IT IN**

*ham radio*

*magazine*

✓ 166



The author, beside his modest station, has proven that over 260 countries can be worked on 75 meters with legal power and a good antenna system.

## concluding comments

I thoroughly enjoyed putting this series together, even though it required far more time and effort than I could possibly have imagined. I hope it proves useful and educational, though I'm not sure whether the author or his readers gained more! I tried to leaven the theoretical with the practical, well aware of the difficulties and pitfalls of doing so in such a technical subject.

I introduced the topic of matrix algebra as a tool of nearly limitless versatility that literally begs to be used. It not only reduces the tedium of network design calculations and simplifies transformation of one network to another, but also makes child's play out of the calculations of input/output conditions when networks are cascaded. It is particularly well suited to computer programmed calculations because the fundamental algorithms are unchanging; only the specific network parameter calculations differ. I did not begin to plumb the possibilities in these articles; there are ABCD parameters specific to lattices (bridge circuits), bridged Tee's, all types of transformers, real coax (with loss) and on and on. I sincerely hope this alone has found fertile imaginations in which to take root. It mystifies me that so powerful a tool has found so little welcome in our engineering educational institutions.

Antenna experimentation has always been of absorbing interest to Radio Amateurs, whether for DXing, for propagation studies, superior contesting, or to satisfy one's curiosity. Even though we have the ability, most of us don't have the time to devote to exploring the complexities of our station equipment.

But anyone can innovate with a piece of wire, and would that it will always be so. However, antenna experimentation isn't magic; it's a technology like any other. Most of the fundamental principles were established two generations ago, though many of the pioneers, whom we find referenced and footnoted in articles and texts, are still with us.

To Bob Booth, WB6SXV, and Mason Logan, K4MT, for their encouragement, advice, and careful proof-reading — which more than once kept me honest — much deserved words of appreciation. Finally, I want to thank you, my readers, for the many kind comments you sent my way via letters and on the air, and most of all — for your patient attention.

## references

1. *Reference Data for Radio Engineers*, Fifth Edition, Howard W. Sams & Co., Indianapolis, Indiana, pages 26-3 and 4-21.
2. W.J. Byron, W7DHD, "Short Verticals for the Low Bands," *ham radio*, May 1983, page 36.
3. Jerry Sevick, W2FMI, "The Ground Mounted Vertical Antenna," *QST*, July, 1971, page 16.
4. R.G.A. Breatly, VE2AYU, and Werner H. Korth, "RF Phase Meter," *ham radio*, April, 1973, page 28.
5. Forrest Gehrke, K2BT, "A Precision Noise Bridge," *ham radio*, March, 1983, page 50.
6. Forrest Gehrke, K2BT, "Vertical Phased Arrays: Part 4," *ham radio*, October, 1983, page 44.

ham radio

**DESOLDER-IT,  
CLEAN-IT, COAT-IT,  
FREEZ-IT...SEND FOR IT!**  
Our new electronic problem solving catalog!

**Chemtronics**  
681 Old Willets Path  
Hauppauge, N.Y. 11788  
800-645-5244  
In NY 516-582-3322  
Telex 968567

# THE MOST AFFORDABLE REPEATER

## ALSO HAS THE MOST IMPRESSIVE PERFORMANCE FEATURES

(AND GIVES THEM TO YOU AS STANDARD EQUIPMENT!)



### JUST LOOK AT THESE PRICES!

Band	Kit	Wired/Tested
10M,6M,2M,220	\$680	\$880
440	\$780	\$980

Both kit and wired units are complete with all parts, modules, hardware, and crystals.

### CALL OR WRITE FOR COMPLETE DETAILS.

Also available for remote site linking, crossband, and remote base.

### FEATURES:

- SENSITIVITY SECOND TO NONE; TYPICALLY 0.15 uV ON VHF, 0.3 uV ON UHF.
- SELECTIVITY THAT CAN'T BE BEAT! BOTH 8 POLE CRYSTAL FILTER & CERAMIC FILTER FOR GREATER THAN 100 dB AT  $\pm 12$  KHZ. HELICAL RESONATOR FRONT ENDS. SEE R144, R220, AND R451 SPECS IN RECEIVER AD BELOW.
- OTHER GREAT RECEIVER FEATURES: FLUTTER-PROOF SQUELCH, AFC TO COMPENSATE FOR OFF-FREQ TRANSMITTERS, SEPARATE LOCAL SPEAKER AMPLIFIER & CONTROL.
- CLEAN, EASY TUNE TRANSMITTER; UP TO 20 WATTS OUT (UP TO 50W WITH OPTIONAL PA).

## HIGH QUALITY MODULES FOR REPEATERS, LINKS, TELEMETRY, ETC.

### HIGH-PERFORMANCE RECEIVER MODULES

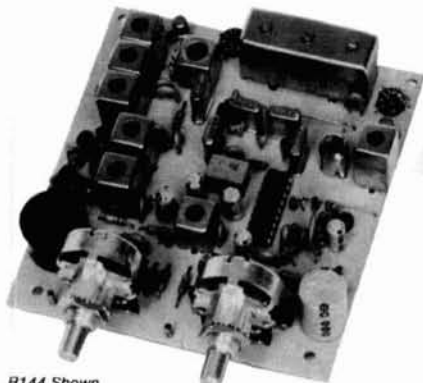

R144 Shown

- **R144/R220 FM RCVRs** for 2M or 220 MHz. 0.15uV sens.; 8 pole xtal filter & ceramic filter in-i-f, helical resonator front end for exceptional selectivity, more than -100 dB at  $\pm 12$  kHz, best available today. Flutter-proof squelch. AFC tracks drifting xmtrs. Xtal oven avail. Kit only \$138.
- **R451 FM RCVR** Same but for uhf. Tuned line front end, 0.3 uV sens. Kit only \$138.
- **R76 FM RCVR** for 10M, 6M, 2M, 220, or commercial bands. As above, but w/o AFC or hel. res. Kits only \$118. Also avail w/4 pole filter, only \$98/kit.
- **R110 VHF AM RECEIVER** kit for VHF aircraft band or ham bands. Only \$98.
- **R110-259 SPACE SHUTTLE RECEIVER**, kit only \$98.

### TRANSMITTERS

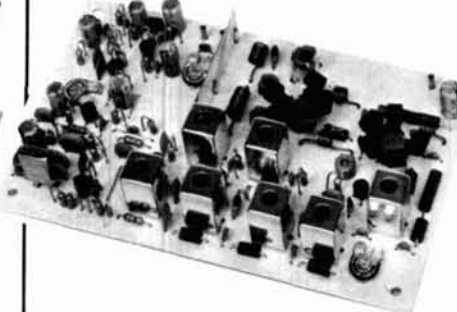

- **T51 VHF FM EXCITER** for 10M, 6M, 2M, 220 MHz or adjacent bands. 2 Watts continuous, up to 2 1/2 W intermittent. \$68/kit.



- **T451 UHF FM EXCITER** 2 to 3 Watts on 450 ham band or adjacent freq. Kit only \$78.
- **VHF & UHF LINEAR AMPLIFIERS.** Use on either FM or SSB. Power levels from 10 to 45 Watts to go with exciters & xmtg converters. Several models. Kits from \$78.

- **A16 RF TIGHT BOX** Deep drawn alum. case with tight cover and no seams. 7 x 8 x 2 inches. Designed especially for repeaters. \$20.

### ACCESSORIES

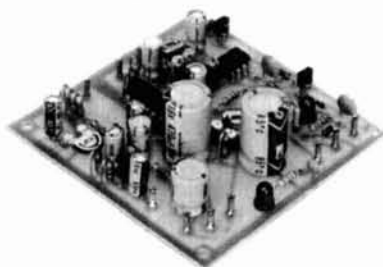

- **COR KITS** With Audio mixer, speaker amplifier, tail & time out timers. Kit only \$38.
- **CWID KITS** 158 bits, field programmable, clean audio, rugged TTL logic. Kit only \$68.
- **DTMF DECODER/CONTROLLER KITS.** Control 2 separate on/off functions with touchtones®, e.g., repeater and autopatch. Use with main or aux. receiver or with Autopatch. Only \$90
- **AUTOPATCH KITS.** Provide repeater autopatch, reverse patch, phone line remote control of repeater, secondary control via repeater receiver. Many other features. Only \$90. Requires DTMF Module.

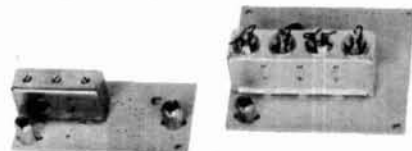

- **HELICAL RESONATOR FILTERS** available separately on pcb w/connectors.
  - HRF-144 for 143-150 MHz \$38
  - HRF-220 for 213-233 MHz \$38
  - HRF-432 for 420-450 MHz \$48

**hamtronics®**

# NEW LOW-NOISE PREAMPS RECEIVING CONVERTERS TRANSMIT CONVERTERS



**Hamtronics Breaks the Price Barrier!**



**No Need to Pay \$80 to \$125 for a GaAs FET Preamp.**

**FEATURES:**

- Very Low Noise: 0.7 dB VHF, 0.8 dB UHF
- High Gain: 18 to 28 dB, Depending on Freq.
- Wide Dynamic Range for Overload Resistance
- Latest Dual-gate GaAs FET, Stable Over Wide Range of Conditions
- Rugged, Diode-protected Transistors
- Easy to Tune
- Operates on Standard 12 to 14 Vdc Supply
- Can be Tower Mounted

MODEL	TUNES RANGE	PRICE
LNG-28	26-30 MHz	\$49
LNG-50	46-56 MHz	\$49
LNG-144	137-150 MHz	\$49
LNG-220	210-230 MHz	\$49
LNG-432	400-470 MHz	\$49
LNG-40	30-46 MHz	\$64
LNG-160	150-172 MHz	\$64



Models to cover every practical rf & if range to listen to SSB, FM, ATV, etc. NF = 2 dB or less.

	Antenna Input Range	Receiver Output
<b>VHF MODELS</b>	28-32	144-148
	50-52	28-30
Kit with Case \$49	50-54	144-148
Less Case \$39	144-146	28-30
Wired \$69	145-147	28-30
	144-144.4	27-27.4
	146-148	28-30
	144-148	50-54
	220-222	28-30
	220-224	144-148
	222-226	144-148
	220-224	50-54
	222-224	28-30

	Antenna Input Range	Receiver Output
<b>UHF MODELS</b>	432-434	28-30
	435-437	28-30
Kit with Case \$59	432-436	144-148
Less Case \$49	432-436	50-54
Wired \$75	439.25	61.25

**SCANNER CONVERTERS** Copy 72-76, 135-144, 240-270, 400-420, or 806-894 MHz bands on any scanner. Wired/tested Only \$88.

For SSB, CW, ATV, FM, etc. Why pay big bucks for a multi mode rig for each band? Can be linked with receive converters for transceive. 2 Watts output vhf, 1 Watt uhf.

	Exciter Input Range	Antenna Output
For VHF, Model XV2 Kit \$79 Wired \$149 (Specify band)	28-30	144-146
	28-29	145-146
	28-30	50-52
	27-27.4	144-144.4
	28-30	220-222*
	50-54	220-224
	144-146	50-52
	50-54	144-148
	144-146	28-30

	Exciter Input Range	Antenna Output
For UHF, Model XV4 Kit \$99 Wired \$169	28-30	432-434
	28-30	435-437
	50-54	432-436
	61.25	439.25
	144-148	432-436*

\*Add \$20 for 2M input



**VHF & UHF LINEAR AMPLIFIERS.** Use with above. Power levels from 10 to 45 Watts. Several models, kits from \$78.

## ECONOMY PREAMPS

Our traditional preamps, proven in years of service. Over 20,000 in use throughout the world. Tuneable over narrow range. Specify exact freq. band needed. Gain 16-20 dB. NF = 2 dB or less. VHF units available 27 to 300 MHz. UHF units available 300 to 650 MHz.

- P30K, VHF Kit less case \$18
- P30W, VHF Wired/Tested \$33
- P432K, UHF Kit less case \$21
- P432W, UHF Wired/Tested \$36

## HELICAL RESONATOR PREAMPS

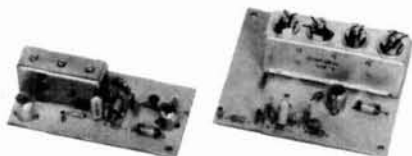

Our lab has developed a new line of low-noise receiver preamps with helical resonator filters built in. The combination of a low noise amplifier and the sharp selectivity of a 3 or 4 section helical resonator provides increased sensitivity while reducing intermod and cross-band interference in critical applications. See selectivity curves at right. Gain = approx. 12 dB.

Model	Tuning Range	Price
HRA-144	143-150 MHz	\$49
HRA-220	213-233 MHz	\$49
HRA-432	420-450 MHz	\$59
HRA-( )	150-174MHz	\$69
HRA-( )	450-470 MHz	\$79

## SAVE A BUNDLE ON VHF FM TRANSCEIVERS!

**FM-5 PC Board Kit - ONLY \$178** complete with controls, heatsink, etc. 10 Watts, 5 Channels, for 2M or 220 MHz.



Cabinet Kit, complete with speaker, knobs, connectors, hardware. Only \$60.

**REPEAT OF A SELLOUT!**

While supply lasts, get \$60 cabinet kit free when you buy an FM-5 Transceiver kit. Where else can you get a complete transceiver for only \$178

## LOOK AT THESE ATTRACTIVE CURVES!

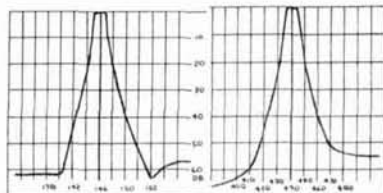

Typical Selectivity Curves of Receivers and Helical Resonators.

## IMPORTANT REASONS WHY YOU SHOULD BUY FROM THE VALUE LEADER:

1. Largest selection of vhf and uhf kits in the world.
2. Exceptional quality and low prices due to large volume.
3. Fast delivery; most kits shipped same day.
4. Complete, professional instruction manuals.
5. Prompt factory service available and free phone consultation.
6. In business 21 years.
7. Sell more repeater modules than all other mfrs. and have for years. Can give quality features for much lower cost.

- Call or Write for **FREE CATALOG**
- (Send \$1.00 or 4 IRC's for overseas mailing)
- Order by phone or mail • Add \$3 S & H per order (Electronic answering service evenings & weekends) Use VISA, MASTERCARD, Check, or UPS COD.

# hamtronics, inc.

65-E MOUL RD. • HILTON NY 14468

Phone: 716-392-9430

Hamtronics® is a registered trademark

ALL ITEMS ARE  
GUARANTEED OR SALES  
PRICE REFUNDED.

PRICES F.O.B.  
HOUSTON

PRICES SUBJECT TO  
CHANGE WITHOUT  
NOTICE

ITEMS SUBJECT TO  
PRIOR SALE



# MADISON Electronics Supply

Call for Quotes 713-658-0268

We stock what we advertise, and much more.

## NIGHT NUMBERS

5-10 p.m. CST

Mon., Wed., Fri.

1-800-231-1064

INSIDE TEXAS

1-713-331-2235

- KDK FM2033 ..... \$289.00
- SANTEC ST142 ..... 299.00
- ST440up ..... (limited) ..... 250.00
- Accessories Available
- TOKYO HC200 Tuner ..... 89.00
- HC2000 ..... 299.00
- NEW HC400L Ant Coupler 6:1 Verniers,  
dual needle meter ..... 139.00
- TOKYO HiPower Amps ..... LESS 15%
- WELZ Meters ..... LESS 10%
- TRIPLETT Model 50 VOM ..... 59.00
- COBRA 49MHZ headset ..... 39.95
- AMECO Books, Codetapes ..... STOCK
- FOXTANGO, SHERWOOD ..... LESS 10%
- MIRAGE AMPS ..... LESS 12%
- TS930S Great Radio ..... CALL
- FT980 Excellent Buy ..... 1299.00
- FT757GX Mobile delight ..... 748.00
- TS430S ..... RING US UP FOR A PRICE
- ROHN 50' 25G tower 4 section 25G, 1  
section 25AG-2 or 25AG-3 ..... 269.00
- TOKYO 70CM mast mounted  
preamp ..... 139.00
- YAESU FT726R OSCAR package includes  
430 modules, satellite  
duplex module ..... 1149.00
- GE 572B ..... 65.00
- 6146B ..... 9.95
- VALOR mobile antennas  
75-10M ..... 20.00ea.
- AVANTI ASP151-3G glass mount ..... 33.00
- BOOKS-ARRL, AMECO, GILFER, SAMS, TAB,  
RIDER, UNIVERSAL, WRTVH, RADIO PUB.



KDK 2033  
new FM .. \$289.00



- WM NYE MB-V Tuner 3kw, Wattmeter, Coax  
Switch with Balun ..... 479.00
- MB-4 with Balun,  
less Coax Switch ..... 399.00
- MB-1 with Balun, 100W ..... 185.00
- ALPHA DELTA MACC-8  
Control Consoles ..... 73.00
- CALRAD 65-287 relative power/SWR  
meters, 2 meters, 3-150MHZ ..... 29.95
- BENCHER ST1, BY1 ..... 42.00
- ST2, BY2 ..... 54.00
- VIBROPLEX ..... LESS 10%
- BIG HAM CLOCK 2 LCD Clocks  
12/24 or 24/24 hr format ..... 25.00
- AMECO preamps ..... LESS 10%
- LARSEN extended 1/4 wave  
kuhiduck-2M ..... 17.00
- AEA HR1 hot rod 1/2 wave-2M ..... 16.00

## ANTENNAS

- ANTECO 5/8 2M mag mount antenna,  
complete with cable ..... \$25.00
- BIRD 43 ~ Elements ..... STOCK
- WE WANT SPECIAL BIRD ORDERS.
- TRIPPLITE PR25  
20A regulated supply ..... 99.00
- ROHN 25G, 45G, 55G,  
accessories ..... CALL
- FK2548 foldover prepaid ..... 799.00
- TELEX/HYGAIN HG52SS  
crankup prepaid ..... 949.00
- TH7DXS ..... 429.00
- Explorer 14 ..... 289.00
- HAM 4 ..... 199.00
- V2S, ARX2B, Isopole 144 ..... 39.00 ea.
- KLM 2M13LBA ..... 78.00
- KT34A ..... 309.00
- KT34XA ..... 469.00
- 420-470-18C ..... 64.00
- ALLIANCE HD73 ..... 99.00
- Consumers Wire  
8 wire rotor cable ..... 20¢/ft.
- BARKERS & WILLIAMSON AV25 ..... 90.00
- AR25 Radial Kit ..... 19.00
- B&W dipoles ..... STOCK
- BUTTERNUT HF6V ..... 125.00
- ALPHA DELTA transitraps ..... STOCK

## BELDEN

- BELDEN 9913 solid center coax  
foil ~ braid shield ..... 45¢/ft.
- 8214 RG8 foam ..... 43¢/ft.
- 8237 RG-8 ..... 36¢/ft.
- 8267 RG213 ..... 52¢/ft.
- 8235 300 ohm KW twinlead ..... 23¢/ft.
- 8000 14GA  
stranded antenna wire ..... 13¢/ft.
- 8448 8 wire rotor cable ..... 31¢
- 9405 HD 8 wire rotor cable  
2#16, 6#18 ..... 52¢
- 100' 8214 ~ ends installed ..... 42.00

## AMPHENOL

- 831SP PL259 ..... 1.25
- 831R SO239 ..... 1.25
- 82-61 NMALE ..... 3.00
- 831J Double female UHF ..... 2.00
- 82-101 Double female N ..... 5.00
- 2900 BNCMALE-S0239 ..... 4.00

## SHORT WAVE

- BEARCAT DX1000 ..... 499.00
- KENWOOD R2000 ..... CALL
- R1000 ..... RING US!

## HANDIE TALKIES

- KENWOOD TR2500 ..... CALL
- YAESU FT208R ..... 259.95
- SANTEC ST142 ..... 299.00
- TENTEC 2591 HT ..... 269.00

## COMPUTERS

- AMTOR MFJ 1228 RTTY, CW ..... \$59.95
- SOFTWARE
- MFJ 1250 for VIC 20 ..... 40.00
- MFJ 1251 for COMM. 64 ..... 40.00
- MFJ 1224 RTTY, CW, ASCII ..... 79.95
- AEA CP1 ..... 179.95
- AEA AMTOR AMT-1 ..... 499.95
- AEA AMTORTXT Allows CP1 & Comm. 64  
to be used as multimode Amtor  
terminal ..... 69.95
- AEA MICROAMTOR PATCH low cost, high  
performance computer interface pack-  
age uses Amtortext software for the  
Commodore 64 ..... 119.95
- AEA Applications Software for  
C-64 or VIC-20 ..... 79.95
- MICROPATCH best low cost unit  
available ..... 129.95
- CP1/VIC20/MBATEXT ..... 209.95
- CP1/COMM64/MBATEXT ..... 209.95
- IBM PC Software ..... 29.95

## SURPLUS

- TCG 2.5A/1000 PIV epoxy  
diode ..... 29¢ ea. or 19.00/100
- RELAY 2PDT, enclosed, 12VDC/10A ..... 5.00
- Transformer 25V/1A-117VAC 3x2x3 ..... 5.00
- CDE .001/20kv axial lead cap ..... 1.95
- Transmitting Tubes ..... CALL

## POLICIES

### MASTERCARD, VISA, C.O.D.

All prices FOB Houston, except when noted,  
subject to change, prior sale. Used gear  
sale price refunded, if not satisfied. Call  
anytime on the status of your order.

## REPAIR DEPT:

Want repair better than the factory? Usual-  
ly faster and cheaper. Five service techs  
complete with soldering irons ready to  
work on any equipment, even the closet  
ones.

## DON'S CORNER

Kudo's to Yaesu. Tang, our spy in Japan,  
heard of the demise of the IC-2 series of  
portables. "Old Faithful" to HT users. Well,  
Yaesu is introducing a similar design for  
less money. Bells and whistles are nice, but  
the plain-jane thumbwheels are still most  
demanded by experienced users. Way to  
go Yaesu.

73,  
Don

AEA	Belden	Bugcatcher	ETO-Alpha	Heil
Alliance	Butternut	Antennas	Finc	IRL
Alpha Delta	Bird	Benchner	Fox iango	Hustler
Amphenol	Cushcraft	Dawkey	Gilfer	HyGain
Anteco	CDE	Drake	GE Tubes	Consumers Wire

1508 McKinney  
Houston, Texas 77010

McKay-Dymek	Rockwell-Collins	Santec
Radio Callbook	Ientec	Surplus
Rider	Telex	Triplett
Robot	TCG	Signal One
Rohn	Triex	Sprague
		W6TOG



# ham radio TECHNIQUES

Bill Owen  
W6SAI

Fifty years ago this month a young junior high school lad walked into the New York office of the newly-formed Federal Communications Commission. The nameplate on the door in the old Federal Building still said "Federal Radio Commission." The Commission room was a typical 1930's government office with walls of varnished wood, dusty, oversize furniture and a heating system going full-blast.

It was close to zero outside and there was still some snow on the window ledges. After filling out an application form and enduring an interminable wait, I was instructed to sit at a table next to a window and to prepare myself for the code test for the Amateur examination.

I was a bundle of nerves and the room was stifling hot. When the Radio Inspector wasn't looking I quietly opened the window for a breath of fresh air.

The exam began. First I sent a minute or two of Morse on the hand key mounted on the desk. No problem. My pulse was still racing as the Inspector handed out earphones, paper, and pencil to me and a few other nervous wretches aspiring to become Radio Amateurs. We were cautioned to listen to the code for a short time; the inspector would tell us when to begin copying.

It seemed easy enough. Code speed was 10 WPM and I had practiced for hours, sending and receiving, at 12 and 15 WPM. I started to write down the code coming at me out of the headphones.

Suddenly there was a loud racket and a flurry of wings as two of New York City's infamous pigeons landed

on the windowsill, only a few inches away from my left arm. I shut my mind to the distraction and grimly forged ahead, copying the torrent of code issuing from the spring-wound code machine at the front of the room.

But the pigeons would have none of this. One of them boldly stepped over the window ledge and onto my arm and started pulling at the threads in my sweater. I gestured furiously with my free arm, trying to scare the bird away. But no. The second bird observed the commotion, jumped over the window ledge, and started walking about on my desk, finally coming to rest upon the paper I was trying to write on.

I pushed back my chair and beat away at the birds, who responded immediately. One flew out the window, squawking loudly; the other deposited a large lump of foul-smelling debris on my exam paper. I heard snickers from the other examinees around me, but I frantically scribbled on, no longer aware of where I was, or what I was copying. It seemed an inglorious end to all of my months of hard work!

After what felt like centuries passed, the code mercifully stopped. The Inspector, who had observed my battle with the birds, took my paper with a grin, as the second bird strutted about on the windowsill. I closed the window with a sigh.

Now the Inspector was grading the code test; in just a few moments I would know the results. Luck was with me — I had passed! The Inspector congratulated me and predicted that I would become a good CW man, able to copy successfully through the toughest QRM.

Fifty years have passed since that

eventful day, which was not only a turning point in my life, but an introduction to the world of electronics and radio communication as well. If I had failed the exam, would I have found the fortitude to take it again? Would fate have turned me toward a different profession?

On that cold spring day in 1934, two pigeons came very close to irrevocably altering my destiny. Today — a half century later — I still don't like pigeons.

## new sources of RFI

The VCR is a popular item, to be sure, and more and more of them are appearing in American homes. But along with the VCR comes interference caused by the intrusion of HF and VHF signals into the recording circuits: complaints range from blanking out of the picture to herringbone pattern interference and an absence of color. In the majority of cases, the interference was traced to a nearby Amateur operating on the 80-meter band.

The problem is complex. Modern VCRs are built on plastic frames enclosed in unshielded plastic boxes, leaving them wide open to RFI intrusion (See Vaughn Martin's "EMI/RFI Shielding: New Techniques," Parts 1 and 2, *ham radio*, January and February, 1984). In addition, the black and white portion of the video signal is recorded onto the tape as an FM signal over a frequency range of 3.4 MHz to 4.4 MHz. 3.4 MHz is "sync-tip" and 4.4 MHz is "peak white." Thus the 80-meter band falls between black level and about fifty percent white.

According to Bill Bowen, K8YGT, of the JVC Company of America, the

only sure cure for the problem is proper shielding of the video head drum and head amplifier, and the addition of a line filter to the VCR. Even with all these precautions, some of the newer all-plastic chassis VCRs are almost impossible to clean up!

As an example, Bill cites his work on cleaning up an RCA VCT400, a 1979 model made for RCA by Panasonic. After some effort, Bill obtained a shielding kit from RCA that, when installed, solved the problem. It is suggested, therefore, that unless you are an expert on the innards of a VCR, the prudent thing to do is to contact the supplier and find out if a filter kit is available.

Bill says that a quick way to get a "fix" on a VCR's resistance to RFI is to take a 2-meter HT into the store and transmit while the VCR is running. Although the frequency of the HT is far removed from the sensitive 80-meter area, when operated closely to the VCR it may produce RFI on the tape. This should be helpful in selecting a model that would be relatively "clean" of interference.

I should add that in any case, a good line filter on the VCR should help because RFI travels the power lines from ham transmitter to TV or VCR. If you have a stereo, TV, or VCR in your house, a line filter on your transmitter (and possibly on the entertainment equipment as well) is mandatory for peaceful coexistence with your family.

## video disc players

The CED-type of video disc players (such as the RCA models) can be affected by even very low levels of RF in the 900-925 MHz region. In fact, one store that displayed a video disc player couldn't get it to play at all. The problem was finally solved by a technician who discovered that the "Sens-o-Matic" anti-shoplifting system was causing the interference. This device consists of an RF proximity alarm that sounds whenever merchandise tagged with a small series-tuned trap disturbs the RF field at a sensor, usually located near a store exit. In the case of the disc

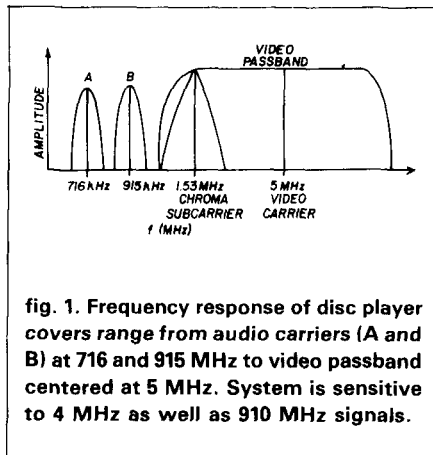

fig. 1. Frequency response of disc player covers range from audio carriers (A and B) at 716 and 915 MHz to video passband centered at 5 MHz. System is sensitive to 4 MHz as well as 910 MHz signals.

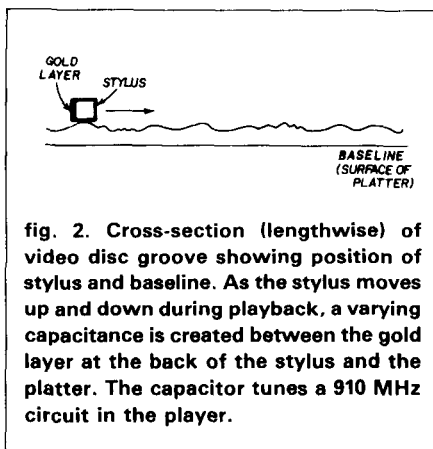

fig. 2. Cross-section (lengthwise) of video disc groove showing position of stylus and baseline. As the stylus moves up and down during playback, a varying capacitance is created between the gold layer at the back of the stylus and the platter. The capacitor tunes a 910 MHz circuit in the player.

player, the 908 MHz carrier radiated by the sensor was invading the disc player through the stylus flyback circuit. Retuning the disc player circuit solved the problem.

## how the disc player works

When a disc is cut, a combined video/audio signal on an FM subcarrier modulates a piezoelectric cutter, causing the depth of the grooves to vary with respect to the baseline (fig. 1). The audio carriers are centered about 716 kHz and 915 kHz, the video carrier is centered about 5 MHz, and the chroma subcarrier is at 1.53 MHz.

A lengthwise view of the platter groove is shown in fig. 2. During playback, as the stylus moves up and down, a varying capacitance is created between the gold layer at the back of the stylus and the platter. This capacitance is one element of a 910 MHz series-tuned circuit that works some-

what on the principle of slope detection of an FM signal. The recovered signal is then split into its components (audio, video, chroma) for processing.

The sensitive portion of the machine is the flylead that connects the stylus to the circuit, which is a large portion of a wavelength long. Even though the whole circuit is enclosed in a two-compartment metal box and seems well shielded, the flyhead is very sensitive to RF in the 900 MHz region.

There will soon be a lot of RF activity — Amateur and otherwise — in the 900 MHz region. Cases of video disc RFI are already appearing in homes near military installations where 900 MHz radar is operating.

So far, there seems to be no easy solution to the problem. The basic circuit of the playback mechanism is shown in fig. 3. Any ideas from readers on this interesting and vexing problem would be appreciated.

## light bulb RFI

What's next? A recent article in a broadcast industry newspaper pointed out that "the potential of RF lighting devices to cause interference to AM radio and certain other broadcast services has given rise to a regulatory debate at the FCC.

"Most broadcasters want the Commission to impose federal regulations on RF lighting devices, according to comments filed in response to an FCC Notice of Inquiry. But the FCC and most lighting producers would prefer to see the interference potential of these lighting devices controlled by a voluntary industry standard."

What are these lighting devices? I understand they are oversize bulbs that are not incandescent lamps, but are instead a variety of fluorescent lamp having a standard socket and a folded tube that is excited by a built-in VLF oscillator. In some versions of this RF-excited lamp, the oscillator runs continuously when the lamp is on; in others, the oscillator stops when the lamp is lit.

In either case, according to the article, "tests at the Commission show RF

# ANTENNAS & TOWERS

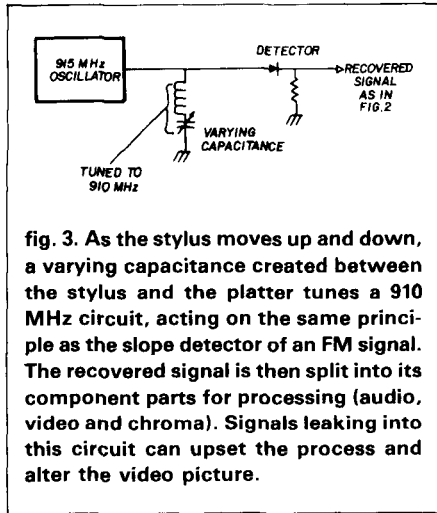

fig. 3. As the stylus moves up and down, a varying capacitance created between the stylus and the platter tunes a 910 MHz circuit, acting on the same principle as the slope detector of an FM signal. The recovered signal is then split into its component parts for processing (audio, video and chroma). Signals leaking into this circuit can upset the process and alter the video picture.

lighting emissions to be very broad-band, with measurable emanations ranging from 10 kHz to 80 MHz.

"Referring to tests conducted by Harold Kassens of A.D. Ring and Associates, the NRBA found the interference potential of RF lighting 'alarming.' According to preliminary reports, AM radios were able to pick up objectionable radiation interference from as near as several meters from RF light bulbs.

"Mr. Kassens warns that if the development of this new technology is not regulated, it is the public which will suffer most when the uncontrolled use of the new product interferes with the reception of established broadcast services".

The article continues, "While broadcasters were skeptical about the lighting industry's willingness to establish an industry standard, General Electric, a leading manufacturer of RF lighting devices, expressed enthusiasm over voluntary limits." General Electric, moreover, presented proposed limits on radiation and measurement techniques for use in determining whether RF lighting devices meet the proposed limits.

It seems to me that Radio Amateurs would be vitally interested in this new RFI hazard. The Docket number on the FCC Notice of Inquiry is GEN 83-806; a copy can be obtained by calling the FCC at (202) 653-8247.

ham radio

## cushcraft

A3 3-element 10-15-20m Triband	215.95
A4 4-element 10-15-20m Triband	279.95
R3 10-15-20m Vertical	269.95
214B SSB/214FB FM 2m Boomers	77.95
ARX-2B 2m Ringo Ranger	36.50
A3219 2m Boomer	90.95
410B 10-element 432-435 MHz	54.95
424B 24-element 435-437 MHz	76.95
10-4CD 4-element 10m	104.95
15-4CD 4-element 15m	118.95
40-2CD 2-element 40m	279.95
Other Cushcraft models available	CALL

## TELEX hy-gain

391S TH7DX 7-ele 10-15-20m Triband	412.95
393S TH5DX 5-ele 10-15-20m Triband	355.95
395S Explorer 14 10-15-20m Triband	269.95
203 3-element 2-meter Beam	16.95
208 8-element 2-meter Beam	28.95
214 14-element 2-meter Beam	34.75
BN86 Beam Balun	16.50
V2S 2-meter Vertical	37.50
V4S 440 MHz Vertical	55.95
Other Hy-Gain models available	CALL

## KLM

KT34A 4-element 10-15-20m Triband	337.95
KT34XA 6-element 10-15-20m Triband	485.95
2M-13LBA 13-element 2-meter	78.95
432-16LB 16-element 430 MHz	64.95
CS-2 Polarity Switcher	50.95

## M.E.I.

### Mosley Electronics, Inc.

CL-33 3-element Triband Beam	269.95
TA-33 3-element 10-15-20m Triband	242.95
Pro 37 T-element 10-15-20m Triband	468.95
RV-4C 10-40m Vertical	CALL

## HUSTLER

6-BTV 10-80m Vertical with 30m	126.95
5-BTV 10-80m Vertical	107.95
4-BTV 10-40m Vertical	84.95
MO-1/MO-2 Mast	19.95
BM-1 Bumper Mount	15.50
G6-144B 2-meter Base Vertical	76.95
G7-144 2-meter Base Vertical	112.50
G6-440 440 MHz Base Vertical	89.95
MOBILE RESONATORS	
10 and 15 meter	10.95 16.95
20 meters	14.50 20.85
30 and 40 meters	16.95 22.95
75 meters	18.95 34.95

### AEA ISOPOLES

144 2-meter Antenna	41.95
220 220 MHz Vertical	41.95
440 440 MHz Vertical	57.95

### MOORE ANTENNAS

AVANTI HM 151.3G 2m On-glass	30.95
LARSEN LM-150 5/8 Mag Mount	38.95
MINIQUAD HQ-1	147.95
BUTTERNUT HF6V 10-80m Vertical	114.95
BUTTERNUT 2MVCV5 2m	37.50
VOCOM 5/8-wave 2m Handheld	14.95

### ANTENNAS FOR OSCAR

Cushcraft 416TB Twist	58.95
Cushcraft A14410T 10-ele	48.95
Cushcraft A14420T 20-ele	69.95
Cushcraft AOP1 Package	139.95
KLM 2m-14C 2m 14-ele Circular	88.95
KLM 435-18C 18-ele Circ Polar	65.95

## ege, inc.

Prices subject to change without notice or obligation

13646 Jefferson Davis Highway  
Woodbridge, Virginia 22191  
(703) 643-1063

Order Hours: M-F 11 a.m.-7 p.m.  
Saturday 10 a.m.-4 p.m.

## Unarco-Rohn

### Self-supporting towers:

HBX40 40-foot with Base	201.60
HBX48 48-foot with Base	276.20
HBX56 56-foot with Base	350.00
HDBX40 40-foot/higher load	253.95
HDBX48 48-foot/higher load	344.30

### Guyed foldover towers:

FK2548 48-foot, 25G	825.00
FK2558 58-foot, 25G	891.00
FK2568 68-foot, 25G	924.00
FK4544 44-foot, 45G	1155.00
FK4554 54-foot, 45G	1254.00
FK4564 64-foot, 45G	1353.00

Foldovers shipped freight paid.  
10% higher west of the Rockies.

### Straight Sections:

20G Straight Section	33.85
20AG Top Section	37.45
25G Straight Section	47.25
25AG 2, 3, 4 Top Section	60.75
45C Straight Section	110.10
45AG 3, 4 Top Section	120.15
25G Foldover Double Guy Kit	306.00
45G Foldover Double Guy Kit	324.00

## TELEX hy-gain

HG37SS 37-foot tall	627.95
HG52SS 52-foot tall	903.95
HG54HD 54-foot/higher load	1468.95
HG70HD 70-foot/higher load	2323.85

Shipped freight paid. Order Hy-Gain tower, Hy-Gain antenna, and Hy-Gain rotor to receive free shipping on all.



W36 36-foot tall	549.00
WTS1 51-foot tall	929.00
LM354 54-foot/higher load	1575.00
DX86 86-foot/motor/highest load	Call

Shipping not included. Shipped direct from factory to save you money.

### TOWER ACCESSORIES

3/16" EHS Guywire	18¢/ft
1/4" EHS Guywire	20¢/ft
3/8 x 6 Turnbuckle	9.50
1/2 x 12 Turnbuckle	17.50
Insulators 504	3.60
1/2 x 12 Base Bolt	2.90
3/4 x 12 Pier Pin	2.90

### ROTORS

Alliance HD73	97.95
Hy-Gain CD45 II	124.95
Hy-Gain Ham IV	195.95
Hy-Gain Tailtwister T2X	245.95
Hy-Gain Heavy-duty 300	474.95

### CABLE BY SAXTON

RG213 Mil Spec	29¢/ft
RG8/U Foam 95% Shield	25¢/ft
8-wire Rotor 2#18, 6#22	17¢/ft
Mini-8	13¢/ft

### HARDLINE BY CABLEWAVE

## PACKAGES

Call for Special Pricing on Tower/Antenna Packages

Ask for Don

Orders & Quotes Toll Free:  
**800-336-4799**

In Virginia: 800-572-4201

Dealer Inquiries Invited



137

ADVANCED  
CONSUMER  
ELECTRONICS

# WE CAN PUT THE WORLD AT YOUR FINGERTIPS WITH... KENWOOD, ICOM, AND YAESU TRANSCEIVERS.

Over the past 58 years Harvey Electronics has offered its customers the finest products in the HAM category. And for 1984, Harvey Electronics has picked the most innovative HF Transceivers to provide the best possible communications in the amateur field.



**KENWOOD TS-930S HF TRANSCEIVER**  
The TS-930S is a solid state HF Transceiver keyed to the exacting requirements of the DX and contest operator. It covers all Amateur bands from 160 through 10 meters, and incorporates a 150kHz to 30MHz general coverage receiver having an excellent dynamic range. It also features SSB slope tuning, CW, VBT, IF notch filter, CW pitch control, dual digital VFO's, full break-in on CW and an automatic antenna tuner.



**ICOM IC-751 HF TRANSCEIVER**  
The IC-751 is ICOM's most advanced amateur transceiver. It is a 100kHz to 30MHz continuous tuning general coverage receiver, and a full featured all mode solid state ham band transmitter, that covers all the new WARC bands. And with an optional internal AC power supply it becomes a compact portable. It also features dual VFOs, 32 tunable memories, SSB filter, FM squelch and more.



**YAESU FT-980 COMPUTER AIDED HF TRANSCEIVER**  
The FT-980 CATX presents a new leap forward in the amateur field, incorporating an 8-bit microprocessor (80C85) for the highest level of built-in computer control ever offered in an all mode, all solid state HF transceiver. Plus, it features continuous general coverage reception from 150kHz to 30MHz, a 12 channel memory system, Dual VFOs and programmable bands for tuning limits.

# HARVEY ELECTRONICS

Pro Division  
25 West 45th Street, New York, NY 10036  
(212) 921-5920 (800) 223-2642

## QUALITY PARTS AT DISCOUNT PRICES!

### SUB-MINIATURE D TYPE CONNECTOR

SOLDER TYPE SUB-MINIATURE CONNECTORS USED FOR COMPUTER HOOK UPS

DB-15 PLUG	\$2.75
DB-15 SOCKET	\$4.00
DB-15 HOOD	\$1.50
DB-25 PLUG	\$2.75
DB-25 SOCKET	\$3.50
DB-25 HOOD	\$1.25

### KEY ASSEMBLY 5 KEY

MOTOROLA #MP 120DZ  
CONTAINS 5 SINGLE-POLE NORMALLY OPEN SWITCHES. MEASURES 3 1/4" LONG.

\$1.00 EACH

### SOLID STATE RELAYS 2 AMP

MOTOROLA #MP 120DZ  
RATED:  
CONTROL - 3-6-6VDC  
LOAD - 120VAC 2 AMPS  
I.T.L. COMPATIBLE  
SIZE 1 1/2" x 1/2" x 1 1/2" HIGH  
\$3.50 EACH 10 FOR \$32.00

### "PARALLEL" PRINTER CONNECTOR

SOLDER STYLE 36 PIN MALE USED ON "PARALLEL" DATA CABLES

\$5.50 EACH

### BCD DIP SWITCH

10 POSITION ROTARY SCREWDRIVER ADJUST FITS 6 PIN DIP

\$1.85 EACH

### 120V INDICATOR

NEON INDICATOR RATED 120 V 1/3 W MOUNTS IN 5/16" HOLE RED LENS  
75¢ EACH 10 FOR \$7.00  
100 FOR \$65.00

FREE! FREE! FREE! SEND FOR NEW 1984 48 PAGE CATALOG

### MINIATURE TOGGLE SWITCHES ALL ARE RATED 5 AMPS @ 125 VAC

<b>S.P.D.T. (on-on)</b> P.C. STYLE NON-THREADED BUSHING 75¢ EACH 10 FOR \$7.00	<b>S.P.D.T. (on-on)</b> SOLDER LUG TERMINALS \$1.00 EACH 10 FOR \$9.00 100 FOR \$80.00	<b>S.P.D.T. (on-off-on)</b> SOLDER LUG TERMINALS \$1.00 EACH 10 FOR \$9.00 100 FOR \$80.00
<b>S.P.D.T. (on-off-on)</b> NON-THREADED BUSHING P.C. STYLE 75¢ EACH 10 FOR \$7.00	<b>S.P.D.T. (on-on)</b> P.C. LUGS THREADED BUSHING \$1.00 EACH 10 FOR \$9.00 100 FOR \$80.00	<b>D.P.D.T. (on-on)</b> SOLDER LUG TERMINALS \$2.00 EACH 10 FOR \$19.00 100 FOR \$180.00

### EDGE CONNECTORS

22/44 22/44 GOLD PLATED CONTACTS  
156 CONTACT SPACING  
\$2.00 EACH 10 FOR \$18.00

### 5 STATION INTERLOCKING

MADE BY ALPS 3-2PDT AND 2-6PDT SWITCHES ON FULLY INTERLOCKING ASSEMBLY 3 1/4" BETWEEN MOUNTING CENTERS  
\$2.50 EACH

### 5 STATION NON-INTERLOCKING

SAME AS ABOVE, EXCEPT EACH SWITCH OPERATES INDEPENDENTLY  
\$2.50 EACH

## ALL ELECTRONICS CORP.

905 S. VERMONT • P.O. BOX 20406 • LOS ANGELES, CA 90006

TOLL FREE ORDERS • 1-800-826-5432  
(IN CALIFORNIA: 1-800-258-6666) ✓ 102

AK, HI, OR INFORMATION • (213) 380-8000

- QUANTITIES LIMITED
- FOREIGN ORDERS INCLUDE SUFFICIENT SHIPPING
- MINIMUM ORDER \$10.00
- USA \$2.50 SHIPPING
- CALIF. RES. ADD 6.12%
- NO C.O.D.

# ungar® Quality Soldering Tool Line

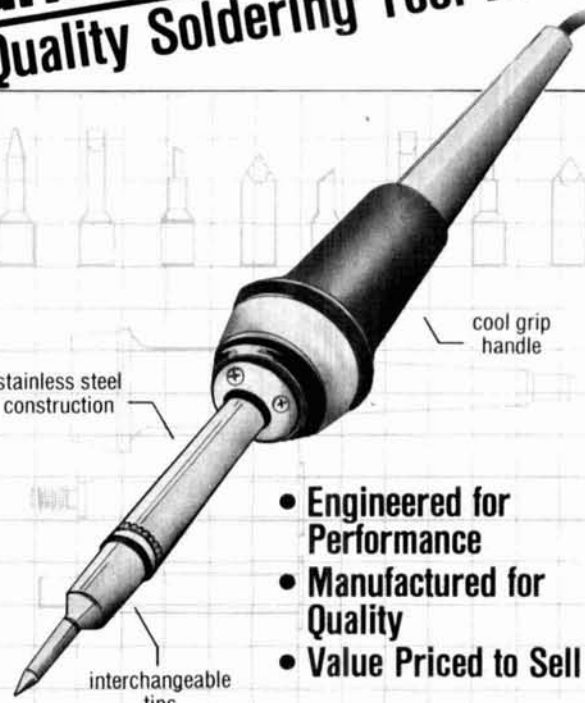

- Engineered for Performance
- Manufactured for Quality
- Value Priced to Sell

ungar® Division of Eldon Industries, Inc.  
Compton, California 90224-6005

# easy antenna matching

Use a home computer  
and a noise bridge  
to solve for  
T-network values

**Matching a transmission line** to an unknown impedance can be done either by trial and error (probably most common method) or by measuring the actual impedance and designing a matching network. The latter method is faster and the availability of low cost noise bridges makes it much easier.

One of these noise bridges is the MFJ 202B. It comes with a very explicit manual and is easy to use except for one thing: the equations for converting from indicated values to actual impedances are a bit unwieldy. I took one look at those and decided that there was no way I'd do *that* more than once; instead, I wrote a program to do the calculations by computer. From there, it made sense to have the computer calculate the matching network, provide a printout of several measurements, and graphically summarize the data.

The program shown in **fig. 1** does all these things. It is written for the Radio Shack Color Computer™\* but will run (except for the color graphics) as is on the TRS-80 Model 1™\* and, with minor modifications, on any of the other popular machines. Its self-prompting feature makes it easy to use.

## using the program

First, make the actual measurements. Write down, in order of increasing frequency, the frequency, indi-

cated resistance, and indicated reactance. Treat capacitive reactance as a negative value.

Then load and RUN the program. The program will ask for the line impedance (used for SWR calculations) and then for frequency in MHz. Next you will be asked for the indicated values of resistance and reactance.

The screen will display the calculated impedance and SWR. (These values are also being stored internally for later use.) You will then have the opportunity to input more data, obtain a hard copy, calculate a matching network, or see a graphic display.

To input more data, merely repeat the process above. To calculate a matching network, answer "YES" when the question "MATCH?" appears on the screen. The display will now show the reactances to be used in the network of **fig. 2** and the necessary component values. You can influence the bandwidth and component values by specifying the value of  $Q$  to be used in the network. If the reactance for L1 is negative, a capacitor will have to be used.

To obtain a printout of the impedances as a function of frequency, answer "YES" to the "PRINT?" prompt. The printer first gives you the opportunity to name the antenna and then proceeds to tabulate.

To obtain a color graph of impedance versus frequency, answer "YES" to the "PLOT?" prompt. The screen will clear, axes will be drawn, and real and reactive impedances will be plotted. The resistance plot will consist of yellow blocks; the reactance plot, white. When the display is complete, the program will stop and wait for you to press any key. This allows you time to evaluate the plot. Pressing any key will resume program operation and erase the graph. At the completion of any of these operations, you will again be given the opportunity to input more data, calculate a match, and so forth.

To keep the program simple there is not a large

**By James A. Sanford, WB4GCS, 248 Worden Street, Portsmouth, Rhode Island 02840.**

\*Radio Shack Color Computer and TRS-80 Model 1 are trademarks of the Tandy Corporation.

amount of error-trapping, so your data must be reasonable. For example, the program assumes the antenna impedance is *lower* than the line impedance — this is certainly true of most antennas I've needed to measure. The matching network calculation does in-

clude any antenna reactance; if there is no reactance at all, there is not much point in plotting the response: the plot will not work if there is no reactive data. If the data is not entered in order of increasing frequency, the printer output will not be in the proper order.

```

1 DIMF(20),R(20),X(20)
  :K=1
5 PI=3.1415926535
10 CLS
  :PRINT@224,"MFJ NOISE BRIDGE CALCULATOR"
  :PRINT"BY JAMES A. SANFORD"
  :PRINT
  :PRINT
  :PRINT
  :INPUT"LINE IMPEDANCE (OHMS)";ZL
15 FOR I = 1 TO 500
  :NEXTI
20 CLS
  :INPUT"FREQUENCY (MHZ)";F
  :INPUT"RESISTANCE (OHMS)";RD
  :INPUT"REACTANCE (PF, XC NEGATIVE)";XD
  :INPUT "EXPANDER";ES
  :PRINT
  :PRINT
  :PRINT
  :IF ES="YES"THENGOTO1000
30 XU=(888/F)-(160000/(F*(180+XD)))
  :RU=RD
39 S=SQR(RU^2+XU^2)/ZL
  :IFS<1THENS=1/S
40 PRINT"IMPEDANCE = ";RU;" + ";INT(100*XU)/100;"J OHMS";
  :PRINTTAB(10);"=";INT(100*SQR(RU^2+XU^2))/100;" ANGLE ";INT(100*(ATN(XU/RU
)))*(180/3.1415926535))/100
  :PRINT"SWR = ";S
45 S(K)=S
  :F(K)=F
  :R(K)=RU
  :X(K)=XU
  :K=K+1
47 INPUT"ANOTHER RUN";RS
  :IFRS="YES"THEN20ELSEINPUT"PRINT";RS
  :IFRS="YES"THEN2000ELSEINPUT"MATCH";RS
  :IFRS="YES"THEN3000ELSEINPUT"PLOT";RS
  :IFRS="YES"THEN4000ELSECLS
  :END
1000 XEQ=888*XD/(F*(XD+180))
  :XU=(40000*XEQ/((200-RD)^2+XEQ^2))
  :RU=200*(200*RD-RD^2-XEQ^2)/((200-RD)^2+XEQ^2)
  :GOTO39
2000 INPUT"ANTENNA";AS
  :PRINT#-2,TAB((80-(LEN(AS)))/2);AS
  :PRINT#-2,CHR$(10);CHR$(10),CHR$(10);"NUMBER","FREQUENCY","REAL","IMAGINARY
","SWR";CHR$(10)
2010 FORJ=1TOK-1
  :PRINT#-2,TAB(2);J,F(J),R(J),X(J),S(J)
  :NEXTJ
  :PRINT#-2,CHR$(10);CHR$(10);"FEEDLINE IMPEDANCE = ";ZL;" OHMS"
  :PRINT#-2,CHR$(10)
  :GOTO47
3000 CLS
  :INPUT"CHOOSE Q FACTOR";Q
  :A=RU*(1+Q^2)
  :B=SQR(A/ZL-1)
  :X1=RU*Q

```

fig. 1. Antenna matching program is written for Radio Shack Color Computer,<sup>TM</sup> but will run on TRS-80 Model 1<sup>TM</sup> or, with modification, on any other personal computer.

Some other comments regarding interpretation of the data are appropriate. First, the MFJ 202B is not intended to be a laboratory instrument. Even though the computer prints out answers to 9 digits, there is no point in believing anything past the first or second

digit after the decimal point. This is simply because the input data is not that good.

Second is the issue of SWR. Much has been written about misconceptions of SWR; suffice to say that SWR is an *indication* of the impedance match. Some

```

: X2=ZL*B
: XC=A/(Q+B)
3010 PRINT"REACTANCES OF
:"
: PRINTTAB(5); "L1 = "; X1-XU; " OHMS"
: PRINTTAB(5); "L2 = "; X2; " OHMS"
: PRINTTAB(5); " C = "; XC; " OHMS"
3015 PRINT"VALUES OF
:"
: PRINTTAB(5); "L1 = ";
: IF X1+XU>0 THEN PRINT (X1+XU)/(2*PI*F); "MICROHENRIES" ELSE PRINT 1E6*1/(2*PI*F*
(XU+X1)); "PICOFARADS"
3016 PRINTTAB(5); "L2 = "; X2/(2*PI*F); " MICROHENRIES"
3017 PRINTTAB(5); " C = "; 1E6*1/(2*PI*F*XC); "PICOFARADS"
3020 GOTO47
4000 CLS0
: FOR I = 1 TO 417 STEP 32
: PRINT @I, "!";
: NEXT I
: PRINT@448, STRING$(31, "-")
: L=64
: FOR Q = 1 TO9
: READ D$
: PRINT@L, D$;
: L=L+32
: NEXT
: DATA I, M, P, E, D, A, N, C, E
4010 PRINT@490, "FREQUENCY";
4020 BW=F(K-1)-F(1)
: FOR I = 1 TO K-1
4021 IF RH<R(I) THEN RH = R(I)
4022 IF RL>R(I) THEN RL = R(I)
4023 NEXT I
4025 FOR I = 1 TO K-1
4026 IF X(I)>P THEN P = X(I)
:
4027 IF X(I)<T THEN T =X(I)
4028 NEXT I
4030 PRINT@480, F(1);
: PRINT@505, F(K-1);
: PRINT@32, INT(RH);
: PRINT@57, INT(P);
: PRINT@416, INT(RL);
: PRINT@443, INT(T);
4035 FOR I=1TOK-1
: W=2+(F(I)-F(1))*(61/BW)
: Y=28-28*INT(R(I)-RL)/(RH-RL)
: SET(W, Y, 2)
: Y=28-28*INT(X(I)-T)/(P-T)
: SET(W, Y, 5)
: NEXT I
4037 PRINT@13, "R";
: PRINT@17, "X";
: SET(32, 0, 2)
: SET(40, 0, 5)
4040 IF INKEY$="" THEN4040 ELSECLS
: GOTO47
5000 '***** THIS PROGRAM CALCULATES RESULTS USING READINGS
FROM MFJ NOISE BRIDGE, MATCHING NETWORKS, AND SHOWS A GRAPH OF RESPONSE.
<RUN> IT TO USE.

```

fig. 1. (continued)

*John Bevan*

State of the art



by  
**K.V.G.**

**9 MHz CRYSTAL FILTERS**

MODEL	Appli- cation	Band- width	Poles	Price
XF-9A	SSB	2.4 kHz	5	\$53.15
XF-9B	SSB	2.4 kHz	8	72.05
XF-9B-01	LSB	2.4 kHz	8	95.90
XF-9B-02	USB	2.4 kHz	8	95.90
XF-9B-10	SSB	2.4 kHz	10	125.65
XF-9C	AM	3.75 kHz	8	77.40
XF-9D	AM	5.0 kHz	8	77.40
XF-9E	FM	12.0 kHz	8	77.40
XF-9M	CW	500 Hz	4	54.10
XF-9NB	CW	500 Hz	8	95.90
XF-9P	CW	250 Hz	8	131.20
XF910	IF noise	15 kHz	2	17.15

**10.7 MHz CRYSTAL FILTERS**

XF107-A	NBFM	12 kHz	8	\$67.30
XF107-B	NBFM	15 kHz	8	67.30
XF107-C	WBFB	30 kHz	8	67.30
XF107-D	WBFB	36 kHz	8	67.30
XF107-E	Pix/Data	40 kHz	8	67.30
XM107-SO4	FM	14 kHz	4	30.15

Export Inquiries Invited.

Shipping \$3.50

**MICROWAVE MODULES VHF & UHF EQUIPMENTS**

Use your existing HF or 2M rig on other VHF or UHF bands.

**LOW NOISE RECEIVE CONVERTERS**

1691 MHz	MMk1691-137	\$249.95
1296 MHz	MMk1296-144	149.95
432/435	MMc432-28(S)	74.95
439-ATV	MMc439-Ch x	84.95
220 MHz	MMc220-28	69.95
144 MHz	MMc144-28	54.95

Options: Low NF (2.0 dB max., 1.25 dB max.), other bands & IF's available

**LINEAR TRANSVERTERS**

1296 MHz	1.3 W output, 2M in	MM1296-144	\$339.95
432/435	10 W output, 10M in	MM1432-28(S)	269.95
144 MHz	10 W output, 10M in	MM144-28	179.95

Other bands & IFs available.

**LINEAR POWER AMPLIFIERS**

1296 MHz	20 W output	UT1296BL	\$450.00
432/435	100 W output	MML432-100	399.95
	50 W output	MML432-50-S	239.95
	30 W output	MML432-30-LS	189.95
144 MHz	100 W output	MML144-100-LS	269.95
	50 W output	MML144-50-S	214.95
	30 W output	MML144-30-LS	109.95
	25 W output	MML144-25	99.95

All models include VOX T/R switching.

"L" models 1 or 3W drive, others 10W drive.

Shipping: FOB Concord, Mass.

**ANTENNAS**



**420-450 MHz MULTIBEAMS**

48 Element	70/MBM48 15.7 dBd	<del>\$75.75</del>	\$59.95
88 Element	70/MBM88 18.5 dBd	<del>105.50</del>	84.95

**144-148 MHz J-SLOTS**

8 over 8 Hor. pol	D8/2M	12.3 dBd	\$63.40
8 by 8 Vert. pol	D8/2M-vert	12.3 dBd	76.95
10 + 10 Twist	10XY/2M	11.3 dBd	79.95

**UHF LOOP YAGIS**

1250-1350 MHz	29 loops	1296-LY 20 dBi	\$44.95
1650-1750 MHz	29 loops	1691-LY 20 dBi	55.95

Order Loop-Yagi connector extra:

Type N \$14.95, SMA \$5.95

Send 40¢ (2 stamps) for full details of all your VHF & UHF equipment and KVG crystal product requirements.



**si**

(617) 263-2145  
**SPECTRUM**  
INTERNATIONAL, INC.  
Post Office Box 1084  
Concord, MA 01742, U.S.A.

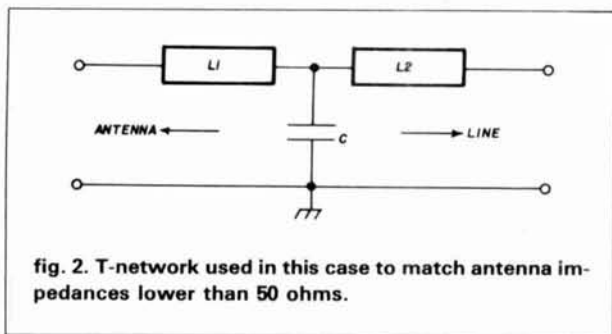

fig. 2. T-network used in this case to match antenna impedances lower than 50 ohms.

transmitters may not tolerate the reactive load even though the SWR is not excessive.

Third, temper results with reality. If a matching network calls for 10 Henries and 0.0001 picofarads, try a different value of  $Q$ , or change the effective line impedance with a broadband transformer.

Although I have talked about measuring antenna impedances, the MFJ bridge and these techniques can be used to measure other parameters. Linear amplifier input impedance can be measured and even the input impedance of a properly biased transistor stage can be determined. This could make matching easier. Realize that the MFJ bridge has limits on what it can measure, and that large voltage or RF will destroy it. So don't try to measure the plate impedance of a 2-kilowatt linear at 4 GHz!

**how it works**

Program operation is straightforward. Lines 1 through 10 initialize the program. Line 20 allows input of the measured information. If the noise bridge expanded range is not used, line 30 calculates the actual impedances. Otherwise, this is done by line 1000. These calculations are in accordance with the equations in the MFJ manual (see appendix). Line 39 calculates the magnitude of the SWR. Line 40 displays the result and line 45 updates the stored data. Line 47 gives you the opportunity to select what to do next. The printer output routine is at line 2000 and the matching network calculations at line 3000. The equations used are shown in the appendix.

The plotting routine begins at line 4000. For use in the TRS-80 Model I or III, simply change the scaling calculations and delete references to colors. To plot on other color computers, check the User's Manual that accompanies your machine.

**conclusion**

Impedance matching can be simplified by using a noise bridge to make actual measurements and a computer to do the brute force number-crunching. This program will help in that effort. Now, matching strange new antennas can be easier and a lot less frustrating.



## references

1. MFJ Noise Bridge Owner's Manual, MFJ Enterprises, Box 494, Mississippi State, Mississippi 39762.
2. Application Note No. 721: Impedance Matching Networks (Applied to RF Power Transistors), Motorola Corporation, 1974.
3. Reference Data for Radio Engineers, 6th Edition, Howard W. Sams Co., Indianapolis, Indiana, 1979.
4. J. J. DeFrance, Communications Electronics Circuits, Rinehart Press, 5643 Paradise Drive, Corte Madera, California 94925, 1972.

## appendix

1. Calculating reactance without expander:

$$R = Rd$$

$$X = \frac{888}{f} - \frac{160,000}{f(180 + Cd)}$$

- where  $f$  = frequency in MHz  
 $Cd$  = reactance dial reading in pF  
 - for capacitance, + for inductance  
 $X$  = reactance in ohms  
 $R$  = resistance in ohms  
 $Rd$  = indicated resistance

2. Calculating reactance with expander:

$$X_{eq} = \frac{(888)(Cd)}{f(Cd + 180)}$$

$$R = \frac{200[200Rd - Rd^2 - (X_{eq})^2]}{(200 - Rd)^2 + (X_{eq})^2}$$

$$X = \frac{40,000 X_{eq}}{(200 - Rd)^2 + (X_{eq})^2}$$

3. Three element matching network:

$$X_{L1} = R_A Q$$

$$X_{L2} = Z_{Line} \sqrt{\frac{R_A(1 + Q^2)}{Z_{Line}} - 1}$$

$$X_C = \frac{R_A(1 + Q^2)}{Q + \sqrt{\frac{R_A(1 + Q^2)}{Z_{Line}} - 1}}$$

- where  $R_A$  = antenna resistance  
 $Z_L$  = line impedance  
 $Q$  = quality factor  
 $X$  = reactance

For a copy of the program on tape, send \$10.00 to James A. Sanford, 248 Worden Street, Portsmouth, Rhode Island 02840.

## ham radio

*Dear Reader:*  
 Thanks to your support,  
 May '84 is our largest  
 issue ever in pages of  
 advertising. Help us keep it  
 that way. Tell our adver-  
 tisers you saw it here in  
 ham radio.

Rally Dennis, KA1JWF  
 Director of Advertising Sales

## HI-Q BALUN

- For dipoles, yagis, inverted vees and doublets
- Replaces center insulator
- Puts power in antenna
- Broadbanded 3-40 MHz.
- Small, lightweight and weatherproof
- 1:1 Impedance ratio
- For full legal power and more
- Helps eliminate TV!
- With SO 239 connector
- Built-in DC ground helps protect against lightning



Only \$14.95

## HI-Q ANTENNA CENTER INSULATOR



- Small, rugged, lightweight, weatherproof
- Replaces center insulator
- Handles full legal power and more
- With SO 239 connector

\$6.95

## THE ALL-BANDER DIPOLE

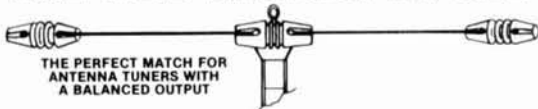

- Completely factory assembled ready to use
- Heavy 14 (7/22) gauge stranded copper antenna wire to survive those severe storms
- Center fed with 100 feet of low loss PVC covered 450 ohm balanced transmission line
- Includes center insulator with an eye hook for center support
- Includes custom molded insulators molded of top quality material with high dielectric qualities and excellent weatherability
- Complete installation instructions included
- Overall length 135 feet, less when erected as an inverted vee or sloper
- Handles 2 kw PEP & covers 160 through 10 meters
- May be trimmed to fit small city lots

Only \$29.95

## DIPOLES

MODEL	BANDS	LENGTH	PRICE
<b>Dipoles</b>			
D-80	80/75	130'	\$31.95
D-40	40/15	66'	28.95
D-20	20	33'	27.95
D-15	15	22'	26.95
D-10	10	16'	25.95
<b>Shortened dipoles</b>			
SD-80	80/75	90'	35.95
SD-40	40	45'	33.95
<b>Parallel dipoles</b>			
PD-8010	80,40,20,10/15	130'	43.95
PD-4010	40,20,10/15	66'	37.95
PD-8040	80,40/15	130'	39.95
PD-4020	40,20/15	66'	33.95
<b>Dipole shorteners — only, same as included in SD models</b>			
S-80	80/75		\$13.95/pr.
S-40	40		12.95/pr.

All antennas are complete with a HI-Q Balun, No. 14 antenna wire, insulators, 100' nylon antenna support rope (SD models only 50'), rated for full legal power. Antennas may be used as an inverted V, and may also be used by MARS or SWLs.

**Antenna accessories** — available with antenna orders  
 Nylon guy rope, 450 lb. test, 100 feet \$4.49  
 Molded Dogbone Type antenna insulators 1.00/pr.  
 SO-239 coax connectors .55  
 No. 14 7/22 Stranded hard drawn copper antenna wire .08/ft.

ALL PRICES ARE UPS PAID CONTINENTAL USA

Available at your favorite dealer or order direct from:

**Van Gorden Engineering**

P.O. Box 21305 • South Euclid, Ohio 44121

Dealer Inquiries Invited

✓ 214

Get those  
demons  
downing  
your  
electronic  
gear!



# Nothing matches the MACC in voltage surge protection and component-by-component on-off control

- compact, attractive desk-top console
- eight clean AC power outlets
- individual and master on-off control
- superior three-stage auto-restore circuit with manual reset circuit breaker
- individually lighted rocker switches

Lightning striking miles away, electric motors running on the same power line, fluorescent lighting and even wind-driven snow static buildup can cause problems with delicate circuits and miniature electronic chips. But the MACC, within nanoseconds, can recognize the current disturbance, then clip it off and dissipate it, while maintaining clean current flow to your system's equipment. The MACC protects all semi-conductor, solid-state circuitry. The MACC is designed with three 2000-amp surge discharge protection circuits — one between each of the AC input's hot, neutral and ground lines. Other surge devices may use a single 100-amp surge protector between the hot and neutral lines only. Its resettable circuit breaker adds further protection.

MACC gives you control convenience, too. It provides 8 plug-in "U" ground outlets for your components — including one "hot" outlet for a continuously powered application such as your clock. Seven "on/off" rocker switches let you control individual components. And you can turn your entire system on or off with a single master rocker switch.

## ALPHA DELTA'S MASTER AC CONTROL CONSOLE PROTECTS AGAINST ALL THESE DAMAGING SURGE PROBLEMS

Problems caused in circuitry by surging and transient voltages:

- Melting of "hot spots" within semi-conductor devices
- Thermal runaway of transistors
- Welding, pitting and metal transfer on switch contacts
- Switch contact corrosion
- Insulation breakdown causing arcing of components
- Shortening of component life

The MACC is tested to IEEE pulse standards and rated at 15A, 125V-AC, 60 Hz, 1875 watts continuous

duty total for the console. A label on the unit describes the surge protection limitations.

### MACC Specs

Alpha Delta Master AC Control Console	
Amperage	15
Volt (AC)	125
Hertz	60
Total	
Wattage	1875
Size	
MACC	11" x 2-3/4" x 2-3/4"
MACC-4	5-1/2" x 2-3/4" x 2-3/4"
Shipping	
Weight	4-1/2 lbs. approximately

Alpha Delta Model MACC Systems are designed to reduce the hazards of lightning-induced surges. These devices, however, will not prevent fire or damage caused by a direct stroke to an AC line or a structure. Specifications, availability and price are subject to change without notice.

Warranted against defects in materials or workmanship.

# ALPHA DELTA COMMUNICATIONS, INC.

P.O. Box 571, Centerville, Ohio 45459 • (513) 435-4772



*current solutions to current problems*

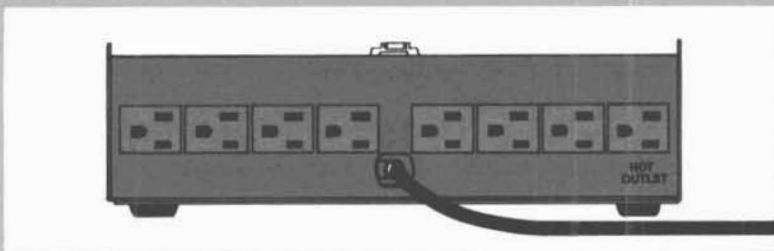
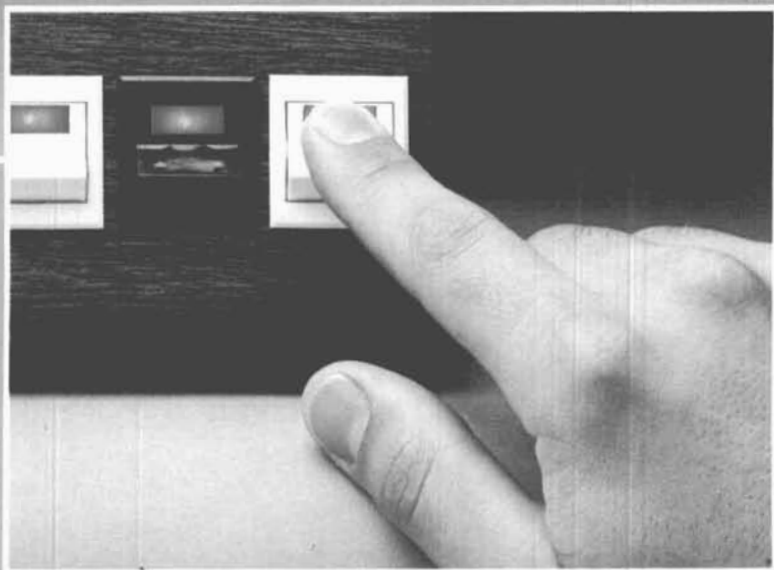
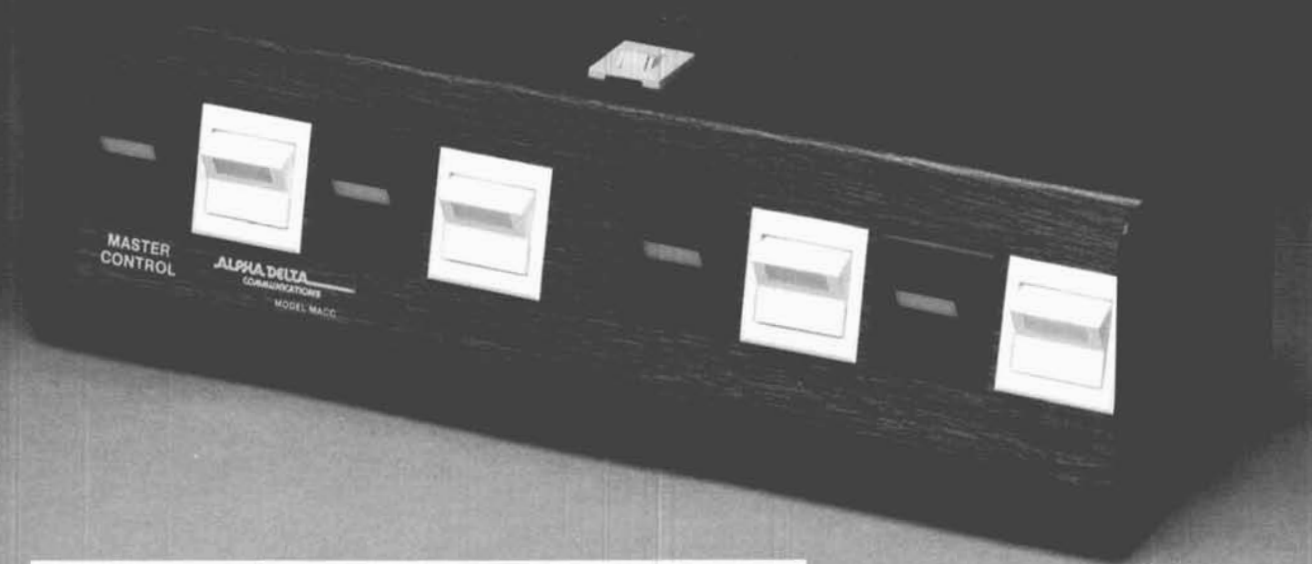

The MACC is unique in voltage surge/transient suppression and convenient, desk-top individual component control. Nothing matches the MACC in value and performance. Put one on duty on your AC line.

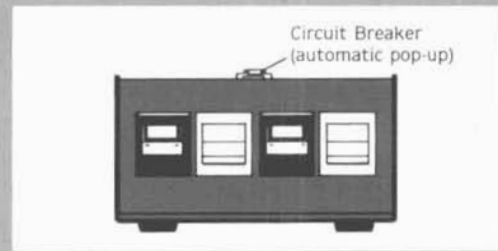

**MACC only \$79.95**  
**MACC-4 only \$59.95**



The MACC-4 is a four clean-line output version of the MACC with all the same features. It gives you a cost- and space-saving solution for your application, without sacrificing performance. Rated a full 1875 total wattage. Includes master rocker switch, three independently switchable lines, one "hot" line and resettable circuit breaker.



At your Alpha Delta dealer. Or in U.S., order direct, adding \$4 for postage/handling to check or money order. (Approx. shipping wt.: 4-1/2 lbs. each) MasterCard and VISA accepted. Ohio residents add Sales Tax. Sorry no C.O.D.'s



The only manufacturer offering Amateurs the advantages of MOSFET RF Power Amps brings you its latest offerings.

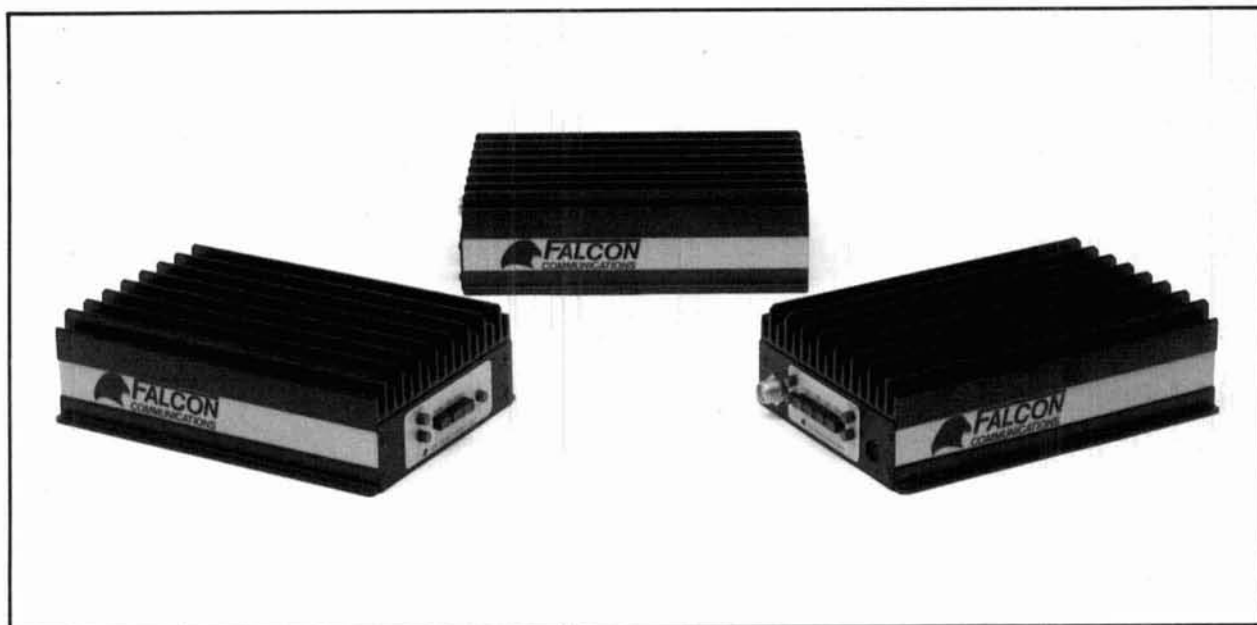

## MOSFET Mobile Power Amplifiers

**4101** Complete 2 Meter Handie Talkie Accessory - All mode RF power amp., 2 Watts in = 25 Watts out, 50 Watt max.. Regulated power supply, with adjustable current limit, for HT power or battery charge. 4 Watt speaker amplifier. Optional plug-in receive preamp. You must fabricate a cable to connect to HT; plug supplied. **\$215**

**4102** Complete 2 Meter Handie Talkie Accessory - All mode RF power amp., 2 Watts in = 100 Watts out. Regulated power supply, with adjustable current limit, for HT power or battery charge. 4 Watt speaker amplifier. Optional plug-in receive preamp. You must fabricate a cable to connect to HT; plug supplied. **\$325**

**4103** All Mode 100 Watt 2 Meter Amplifier - 10 Watts in = 90 Watts out, 2 Watts in = 30 Watts out. No harm with 25 Watt transceivers. Optional plug-in receive preamp. **\$245**

**4104** All mode 100 Watt 220 MHz amplifier - 10 Watts in = 70 Watts out, 2 Watts in = 25 Watts out. No harm with 25 Watt transceivers. Optional plug-in receive preamp. **\$245**

**4105** All mode 100 Watt 2 Meter amplifier - 2 Watts in = 100 Watts out. Optional plug-in receive preamp. **\$295**

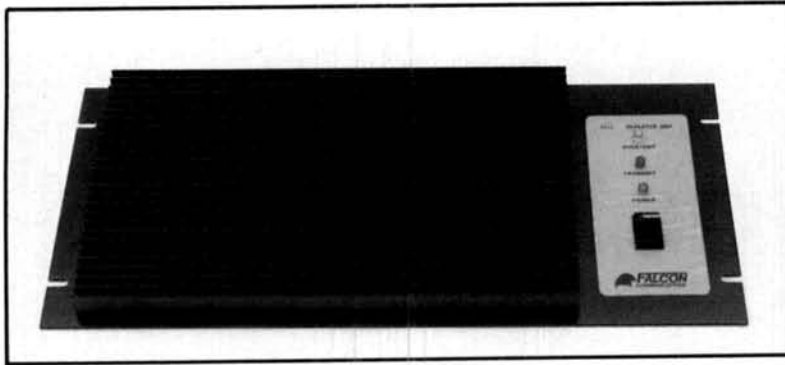

## MOSFET Repeater Amplifiers

**Basic Amplifiers with the low noise advantages of MOSFET's.**

**4111** 100 Watt 2 Meter Amplifier - At 13.6 Volts; 10 Watts in = 90 Watts out. At 16 Volts; 10 Watts in = 100 Watts out. **\$255**

**4112** 100 Watt 220 MHz Amplifier - At 13.6 Volts; 10 Watts in = 70 Watts out. At 16 Volts; 10 Watts in = 80 Watts out. **\$255**

**Other repeater amplifiers available.**

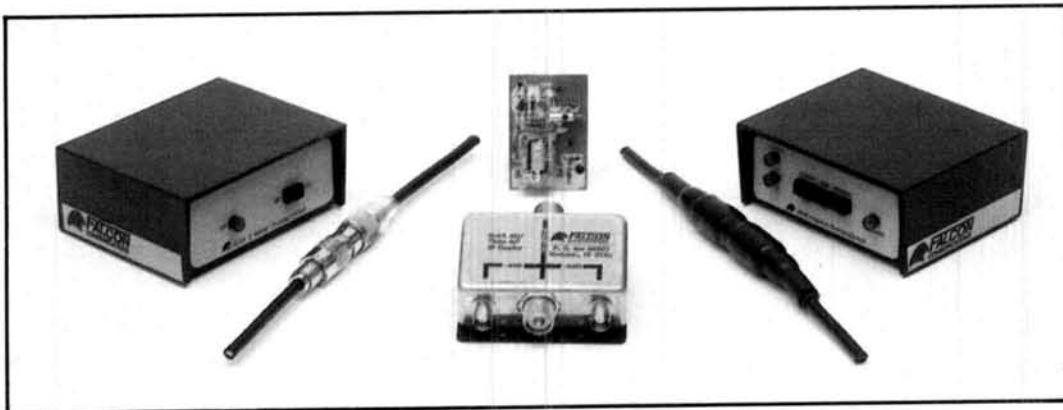

## Useful Accessories

**4109** Plug-in 2 meter Receive Preamp - For Falcon power amplifiers. 12 dB gain, 2dB noise figure. **\$36**

**4110** Plug-in 220 MHz Receive Preamp - For Falcon power amplifiers. 12 dB gain, 2.5 dB noise figure. **\$39**

**4116** 2 Meter Receive Preamp - Base or mobile use. 16 dB gain, 2 dB noise figure. Automatic T/R switching. Use with up to 45 Watt transceivers. Requires 12 VDC. **\$63**

**4117** Twin 40 dB RF Coupler - Two 40 dB attenuators coupled to thru signal line. Works with various test equipment. Thru line handles transmitter power and is used with wattmeters and dummy loads. Attenuated ports are used to; insert receiver power; sample transmitter power for counters and spectrum analyzers; etc.. The 40 dB attenuation protects the test equipment from damage due to transmitter power. Flat to 520 MHz, useful to 1000 MHz. Maximum transmitter power, 50 Watts. **\$42**

**4118** Splice Kote - Special heat sink tubing with thermoplastic inner coating is used to weather seal coaxial fittings, rotator cable splices, etc.. Good for direct burial. Five 6" lengths provide enough material for 5-15 splices. **\$12**



(415) 851-8779  
P.O. Box 620625  
Woodside, CA 94062

# KENWOOD

pacesetter in amateur radio

## TR-7950, watts to see!

### TR-7950/7930

The TR-7950/7930 has become the unanimous choice of the 2 meter FM operator! It stands alone in features, performance and reliability, with no other rig even close!

The TR-7950/7930 features a large L.C.D. display that is easy to read in direct sunlight and is back lighted for comfortable night-time viewing. It displays TRANS/REC frequencies, memory channel, repeater offset (t.s.-), sub-tone number (F-0, 1, 2, 3) tone, scan, and memory scan lock-out. It includes an LED S/R/F bar meter, and LED indicators for reverse, center TUNING, PRIORITY and ON AIR. The 21 multi-function memory channels store frequency, repeater offset, and optional sub-tone channels. Memories 1 through 15 are for simplex or  $\pm 600$  Hz offset. Memory pairs 16/17 and 18/19 are paired for non-standard repeater offset. Memories "A" and "B" set upper and lower scan limits, or are for simplex or  $\pm 600$  kHz offset. In MEMORY mode, a circle of light appears around the memory selector

knob. When the memory selector knob is rotated in either direction to channel 1, an audible "beep" sounds.

With 45 big watts, the TR-7950 is the most powerful 2 meter FM rig you can buy. The TR-7930 with a modest 25 watts is also available. A HI/LOW power switch allows power reduction to approx. 5 watts.

Other key features include: Programmable band-scan width, Center stop during band-scan, with indicator. Scan stops on busy channel and resume scan is automatic (time 5 sec. adjustable) or carrier operated. A scan delay of approx. 1.5 sec. is built-in. Scanning can also be accomplished with UP/DOWN microphone or "SC" key on front panel. Programmable priority alert can be set into any of 21 memory channels. With Alert switch "ON," a dual "beep" sounds when signal is present. The microprocessor is pre-programmed for simplex or  $\pm 600$  kHz offset in accordance with the 2 meter band plan, with an

"OS" key to allow manual changes in offset. The keyboard functions as a 16-key autopatch encoder during transmit. Frequency coverage is 142.000-148.995 MHz, and it has a repeater reverse switch and mobile mounting bracket. All these features are available in one compact, lightweight rig.

Yes, Kenwood is on top with the TR-7950! Its field proven reliability and matchless performance makes the TR-7950 the rig of tomorrow, today!!

#### TR-7950 optional accessories:

TU-79, three frequency tone unit, KPS-12 fixed-station power supply (7950), KPS-7A fixed-station power supply (7930), SP-40 mobile speaker, SP-50 mobile speaker, MC-55 mobile microphone with time-out timer, MC-46 16-key autopatch UP/DOWN mic, SW-100A/B power meters, PG-3A noise filter.

More information on the TR-7950/7930 is available from authorized dealers of Trio-Kenwood Communications, 1111 West Walnut Street, Compton, CA 90220.

*Specifications and prices are subject to change without notice or obligation.*



# KENWOOD

pacesetter in amateur radio



## TM-201A/TM-401A

**TM-201A/TM-401A "comp-ACT"... tough act to follow.**

The word "compact" best describes the TM-201A VHF (a big 25 watts!) or the TM-401A 70-cm (12 watts) mobiles. Measures 5.6Wx1.6Hx7.2D inches (the TM-201A and TM-401A are the most compact rigs available). Ideal in size,

their performances are superlative. Each features a HI/LO power switch, dual digital VFO's built-in, 5 memories plus a "COM" channel with lithium battery back-up, memory scan, programmable band scan, priority alert scan, and GaAs FET RF (front end) amplifiers. They have a highly visible yellow LED digital display, a repeater offset switch, a reverse switch,

and a "beeper" to confirm operation of various switches. For superior sound quality, the separate, external speaker, can be easily mounted to project the sound in the desired direction. A 16-key autopatch UP/DOWN mic. allows easy remote operation of major front panel functions. Thanks to KENWOOD, compact radios are now available for the popular VHF and UHF bands providing high performance and superior sound quality.



### Optional FC-10 Frequency Controller

Connects to the TM-201A or TM-401A. Convenient control keys for frequency UP/DOWN, MHz shift, VFO A/B, and MR (memory recall or change memory channel). A green LCD display indicates transmit/receive frequencies, memory channel number, ALERT, and SCAN (with blinking MHz decimal).

### Other TM-201A/TM-401A Optional Accessories:

TU-3 Programmable two-frequency CTCSS encoder, KPS-7A fixed station power supply, MA-4000 dual-band mobile antenna with duplexer, SW-100A/B SWR/power meter, MC-55 mobile microphone with time-out timer.



## TW-4000A

**TW-4000A FM "Dual-Bander"**  
KENWOOD'S TW-4000A FM "Dual-Bander" provides new versatility in VHF and UHF operations, uniquely combining 2-m and 70-cm FM functions in one compact package. It covers the 2-m band (142,000-148,995 MHz), including certain MARS and CAP frequencies, and the 70-cm band (440,000-449,995 MHz), all in a package

only 6-3/8 W x 2-3/8 H x 8-9/16 D inches. RF output power measures 25 watts on either band. The TW-4000A features a large, easy-to-read LCD display, front panel illumination for night operations, 10 memories with OFFSET recall and lithium battery backup, programmable memory scan, band scan in selected 1-MHz segments, priority watch function, common channel scan, dual digital VFO's, repeater reverse switch, GaAs FET front ends, rugged die-cast chassis,

"beeper" through speaker, a mobile mount, and a 16-key autopatch UP/DOWN mic.

The new optional VS-1 voice synthesizer has everyone talking! A voice announces the frequency, band, VFO A or B, repeater offset, and memory channel number when these functions are selected.

### Other TW-4000A optional accessories:

VS-1 voice synthesizer, TU-4C programmable two-frequency CTCSS encoder, KPS-7A fixed

station power supply, SP-40 compact mobile speaker, SP-50 compact mobile speaker, MA-4000 dual-band mobile antenna with duplexer, MC-55 mobile microphone with time-out timer, and a SW-100B SWR/power meter.

More information on the TM-201A/TM-401A and TW-4000A is available from authorized dealers of Trio-Kenwood Communications, 1111 West Walnut Street, Compton, California 90220.

Specifications and prices are subject to change without notice or obligation.



# SANTEC presents the smarter handhelds

FOR 144 VHF, 220 VHF & 440 UHF

SANTEC Handhelds just got a little smarter, with new computer-control software designed by U.S. Hams who are also professional programmers. Now SANTEC Handhelds, which were the first to offer you varactor diode tuning in a handheld, first to offer you thick-film technology, first to provide 3.5W as a selectable handheld option and first to give you the time of day on a handheld read-out, have made another user-friendly leap forward in the logical progression of computer-controlled handhelds.

Now three SANTEC Handhelds can lock out selected memory channels from the memory scan, allowing you to check your favorite frequencies much faster, without interruption from less commonly used ones or from unprogrammed memory channels. SANTEC Handheld's new operating programs now allow you to store variable offset values in all 10 user-written memory channels; and, as always with SANTEC Handhelds, your stored offset automatically comes back when you select a channel through the memory mode, and the plus or minus indication shows on the LCD display.

Other new features are the provision in Memory 9 for split memory offset operation, for those really unusual offset situations, and the capacity for hardware storage of a special PL tone for each memory channel (requires an optional encoder, available December, 1983). The new SANTEC Handhelds will also accept the keyboard input of all frequencies as either short, fast 4-digit numbers or the familiar 6-digit versions; your SANTEC Handheld is smart enough to know what you want, either way.

The handhelds with the most now have more for you. Don't you dare settle for anything less: get your hands on a SANTEC Handheld today!

Shown above is just one of the three new smarter handhelds from SANTEC: the ST-142 VHF, the ST-442 UHF and the ST-222 VHF. Owners of earlier SANTEC models ST-144, ST-440 and ST-220, please write for information on how your SANTEC Handhelds can be upgraded to the new state of the art in handheld transceivers.



©1983, Encomm, Inc.  
2000 Avenue G, Suite 800, Plano, Texas 75074  
Phone (214) 423-0024 • TLX 79-4783 ENCOMM DAL

Repairs, Parts & Services Available...

Export orders invited.

All stated specifications are subject to change without notice or obligation.



The Smarter Handhelds, clockwise from upper left: ST-142 VHF Transceiver; ST-442 UHF Transceiver; ST-222 VHF Transceiver, operating from the ST-4QC Quick-Charge Battery Charger & Power Supply; ST-LC Leather Case and Strap; ST-MC Mobile Charger; MS-505 Remote Speaker; ST-500B3 Rechargeable 500 mAh NiCd Battery Pack; ST-EC External Charge Adapter; SM-3 Speaker Mic; ST-HA-1/HBM-1 Head Set Boom Mic & Adapter.



# hy-gain<sup>®</sup>

## "Heavy Duty is Relative!"

In our lineup of rotators, the CD45 II is rated as medium duty. Some of our worthy competitors offer similar rotators which they rate as "heavy duty" and, within their product line, they are. But if you compare all rotators, it's a different picture. Here is a comparison of our CD45 II, our HAM IV and the Alliance HD73 (Specifications as stated by the manufacturer).

	HD73	CD45 II	HAM IV
Output Torque	400 in. lbs.	600 in. lbs.	800 in. lbs.
Gears	Plastic and Steel	All Steel	All Steel
Control Box Weight	3.8 lbs.	6.8 lbs.	6.8 lbs.
Rotor Unit Weight	6.5 lbs.	8.5 lbs.	10.5 lbs.
Direction Indicator Potentiometer	Carbon	Precision wire wound	Precision wire wound
Rotation Limiter	Mechanical stop only	Limit switches with mechanical stop	Limit switches with mechanical stop
Braking Power	1600 in. lbs. "Windmilling"	800 in. lbs. "Holding"	5000 in. lbs. "Holding"
Antenna Size Rating	10.7 sq. ft.	8.5 sq. ft.	15 sq. ft.

Wind load rating is an important specification too. Unfortunately, there is no standard method of measurement. For example, a long boom antenna with an unbalanced wind load is a much tougher problem than the calculated square area of the antenna would suggest. So we take a conservative "worst case" approach and rate the CD45 II at 8.5 square feet. Yet, the HD73, a lighter unit, is rated at 10.7 square feet. You be the judge.

Here is a complete listing of Hy-Gain rotators and the typical antenna systems that each will comfortably and reliably manage.

**AR40**—Primarily used for small to medium size VHF and UHF beams. Can also be used with a 10 or 15 meter, 3 element Yagi.

**CD45 II**—Recommended for a 3 element tribander such as our Explorer 14. Will also manage a medium sized VHF stack and is a good choice for the Azimuth rotator on a good sized satellite system.

**HAM IV**—A favorite for long boom tribanders such as our TH7DX. Would also be a good choice for an Explorer 14 stacked with a VHF DX antenna or a satellite system.

**HAM SP**—A modified Ham IV with a special control unit for a blind operator. Single knob directional control system includes a compass rose with braille markings. An audible beep indicates rotator start and stop.



**T2X**—The well-known Tail Twister manages combinations such as a TH7DX stacked with a small 2 element 40 meter beam. Also a great choice for a substantial VHF "weak signal" array. Of course, the ever popular stack of 3 or 4 element 10, 15, and 20 meter monobanders is a safe match for the T2X.

**HDR300**—This 5000 inch pound torquer is our idea of heavy duty. This is the choice for stacked HF "Long Johns" or the full sized 3 element 40 meter monsters. A favorite too for the giant VHF "weak signal" systems where the 1" rotator control and indicator accuracy is a must.

**CHOOSING THE RIGHT MODEL**—The mistake most commonly made is selecting a rotator for the antenna being installed at the time and not looking forward to the antenna system that you ultimately plan. A rotator that is not over-loaded will deliver many years of reliable service. So, when you choose yours, plan ahead and buy the model that will handle the ultimate load. If in doubt, drop us a note. We will share our experience with you. Long term, you will save money.



**HDR300**



**AR40**



**CD45 II**



**HAM IV**



**T2X**

**TELEX hy-gain<sup>®</sup>**

TELEX COMMUNICATIONS, INC.  
9600 Aldrich Ave. So., Minneapolis, MN 55420 U.S.A.  
Europe: Le Bonaparte—Office 711, Centre Affaires Paris-Nord,  
93153 Le Blanc-Mesnil, France.

# ICOM IC-04AT

## 440MHz, PL Tones, Scanning, Plus...

ICOM is proud to announce the latest in 440MHz handheld transceiver technology. The IC-04AT represents the best in a multifunction, multifeature handheld for 440 — 450 MHz.

**Features. Features. Features.** The IC-04A and IC-04AT cover from 440 — 449.995 MHz. Frequency entry, control functions and the 32 PL tones are controlled by the 16-button pad on the face of the radio. Also included are priority, scanning (both of memories and programmable band scan) and DTMF (04AT only). For scanning, 5, 10, 15, 20, or 25 KHz increments are front panel selectable. Ten memories with internal lithium battery backup give the ultimate in flexibility for channelizing operation of this sophisticated handheld for easy access to most used channels. Thus, the IC-04A(T) may be used to individually bring up any frequency between 440 and 449.995MHz with 5kHz spacing, or favorite frequencies may be stored in the memory and recalled at the touch of a button. The IC-04A(T) has all the features you could want in a handheld.



**Compatible Accessories.** The IC-04A(T) has the same styling, control features and functions of the IC-02A(T). The IC-04A(T) utilizes the existing accessory line available for the IC-2A



and IC-2AT, plus new accessories such as long-life and high-power battery packs and a boom headset. Multiple battery packs allow the widest flexibility in charging: either from a wall charger, cigarette lighter plug, stand-up desk charger, or through the top of the radio. Twelve volts applied through the top of the radio not only provides operation of the radio at high power, but provides charging of the battery packs at the same time — a feature not commonly found in handheld units.



**Built to Last.** The IC-04A(T) comes with a sealed case, providing resistance to moisture, dust, and other elements detrimental to the operation of the radio. An aluminum back provides a massive heatsink for the power module allowing the IC-04A(T) to run at a standard 3 or 5 watts (optional battery required). A battery lock is provided to ensure the battery will remain secure, and the unit will continue to operate even if mishandled. A custom LCD readout with S-meter is unique to the ham industry.

Expanding on our line of available accessories, the IC-04A and IC-04AT become the most versatile handhelds in their class. See the IC-04A(T) at your nearest ICOM dealer.

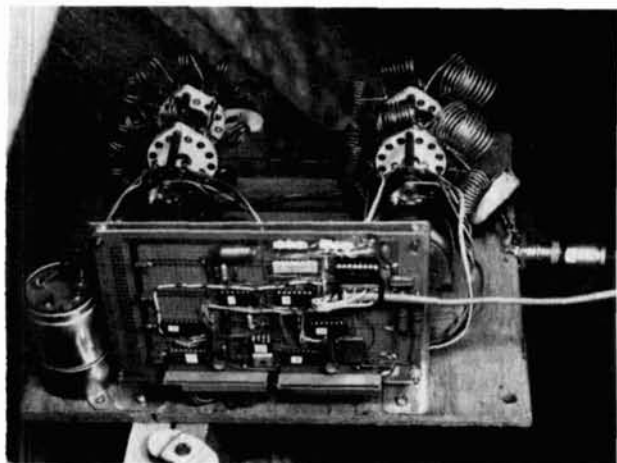

## an end-fed multiband 8JK

A new approach  
to tuning and feeding  
for multiband operation

A wire that is 2-1/4 wavelengths long at the high-frequency end of the 10 meter band can be provided with adjustable series inductive loading to give a low feed impedance throughout the 10, 15, and 20 meter bands. Two such wires in an "end-fed W8JK" arrangement can form a multiband antenna whose dimensions and feed arrangements are well-suited to small backyards, and which combines useful gain with an SWR better than 1.4:1 across the whole of the three bands. Further possibilities exist for using the basic element and feed arrangement in other configurations.

### design requirements

Several years of experimentation and experience convinced me that an HF band antenna for my location had to meet five requirements.

First, since I live in the suburbs, it had to be a fixed wire with unobtrusive supports, optimized to perform at a maximum height of about 30 feet.

Second, it had to be multiband so that I could follow my changing interests and also respond to varying

propagation conditions. However, since rotatable arrays have already been ruled out by the first requirement, and I have no specialized geographical interests, there is no particular merit in having the same horizontal polar diagram on each band. Therefore, "long wire" arrangements were quite acceptable — particularly if they avoided the losses inherent in trapped dipoles.

Third, end feed was desired. My "shack" is inside the pitched roof of my house, quite near to the end of any practical long wire. Feeder cables running across the lawn to a center feed point are unsightly and subject to serious losses in humid weather. (I used to think that a 300 ohm tubular feed was ideal until I emptied a pint of water out of a length of such a feeder that was tied along a fence!)

Fourth, the feed should be a balanced two-wire arrangement. Early experiments with a single wire fed against ground and with Zepp feed had produced RFI to both household electronics and to my equipment in the shack.

Fifth, a little gain would be nice! Rotatable arrays get gain by narrowing the horizontal beamwidth, but in the case of a fixed wire antenna intended to provide coverage of all directions, this is impossible. The main option is to shape the vertical radiation pattern so as to concentrate energy into useful angles of elevation, ideally between 10 and 20 degrees above the horizontal — and minimize ohmic losses in the antenna

By R.C. Marshall, G3SBA, 30 Ox Lane, Harpenden, Hertfordshire AL5 4HE, United Kingdom

**Have a name—but  
need the Call Sign?  
Traveling—and want  
to meet local Hams?**

NOW AVAILABLE—

1983-1984 Amateur Radio

## NAME INDEX

By Name and Call.

1983-1984 Amateur Radio

## GEOGRAPHICAL INDEX

By State, City, Street No. and Call.

No frills directories of over 435,000 U.S. Radio Amateurs. 8½x11, easy to read format. Companion directories to the 1983-1984

AMATEUR RADIO

## CALL DIRECTORY U.S. Listing

- NAME INDEX—\$25.00
- GEOGRAPHICAL INDEX—\$25.00
- CALL DIRECTORY—\$14.95

Add \$3.00 shipping to all orders.

Dealer/Club inquiries welcome.

Send your order—enclosing check or money order in U.S. dollars to

**Buckmaster Publishing**

Whitehall  
Mineral, VA 23117 U.S.A.  
(703) 894-5777

✓ 121

## Versatile Lab Power Supply



**EXCEPTIONAL  
VALUE!**

Only **\$125<sup>00</sup>**

- 0-30 VDC at 0-2A • Excellent Regulation
- Ripple & Noise - 500 uV • Built-in Short-Circuit and Overload Protection

Model 3002A features continuously adjustable current limiting and precision constant voltage/constant current operation with "automatic crossover." This lab-grade unit can also be used as a current regulated power source.

Optional 10-turn voltage & current controls: \$25 each. Add \$3.00 for UPS shipping in Continental U.S. Check, Money Order or C.O.D. accepted. Illinois residents add 6% sales tax.



**ELECTRO INDUSTRIES**  
4201 W. IRVING PARK BLVD.  
CHICAGO, IL 60641  
312/736-0999

✓ 139

### ACOA QUAD ANTENNA FOR 2-METERS



220-225 MHz Quad Available

420-450 MHz Quad Available

- All metal (except insulators) rugged construction
- Withstands any weather conditions
- Copper radiator and reflector elements
- Covers entire 2-meter band
- Ready to mount on your rotor
- Weight — 9 pounds
- Wind surface area — 0.85 square feet
- Dimensions — 19 x 26 x 17 inches
- Price — \$159.00

Order direct or from your dealer

*California residents add sales tax*

DEALER INQUIRIES INVITED

**ANTENNA COMPANY OF AMERICA**

POST OFFICE BOX 794

MOUNTAIN VIEW, CALIFORNIA

94042-0794

(408) 246-2051

✓ 112

### SYNTHESIZED SIGNAL GENERATOR

MADE IN  
USA



MODEL  
SG1000  
\$349.95  
plus shipping

- Covers 100 to 185 MHz in 1 kHz steps with thumb-wheel dial • Accuracy 1 part per 10 million at all frequencies • Internal FM adjustable from 0 to 100 kHz at a 1 kHz rate • Spurs and noise at least 60 dB below carrier • RF-output adjustable from 5-500 mV at 50 ohms • Operates on 12 Vdc @ 1/2 Amp • Available for immediate delivery • \$349.95 plus shipping
- Add-on Accessories available to extend freq. range, add infinite resolution, voice and sub-audible tones, AM, precision 120 dB calibrated attenuator
- Call for details • Dealers wanted worldwide.

### VANGUARD LABS

196-23 Jamaica Ave., Hollis, NY 11423  
Phone: (212) 468-2720

✓ 215

### FACSIMILE

COPY SATELLITE PHOTOS, ✓ 115  
WEATHER MAPS, PRESS!

The Faxes Are Clear — on our full size (18-1/2" wide) recorders. Free Fax Guide.

### TELETYPE

RTTY MACHINES, PARTS, SUPPLIES

ATLANTIC SURPLUS SALES (212) 372-0349  
3730 NAUTILUS AVE BROOKLYN, N.Y. 11224

### P.C. BOARDS AND ART SERVICES

FACE  
PLATES



ENCLOSURES

WRITE OR CALL

For Literature or Quotes

Let us quote you on any stage of your product from proto types to production.

**FABTRON DIV.**  
P.O. Box 925  
Columbia, TN 38401  
(615) 381-1143

✓ 142

## WARNING SAVE YOUR LIFE OR AN INJURY

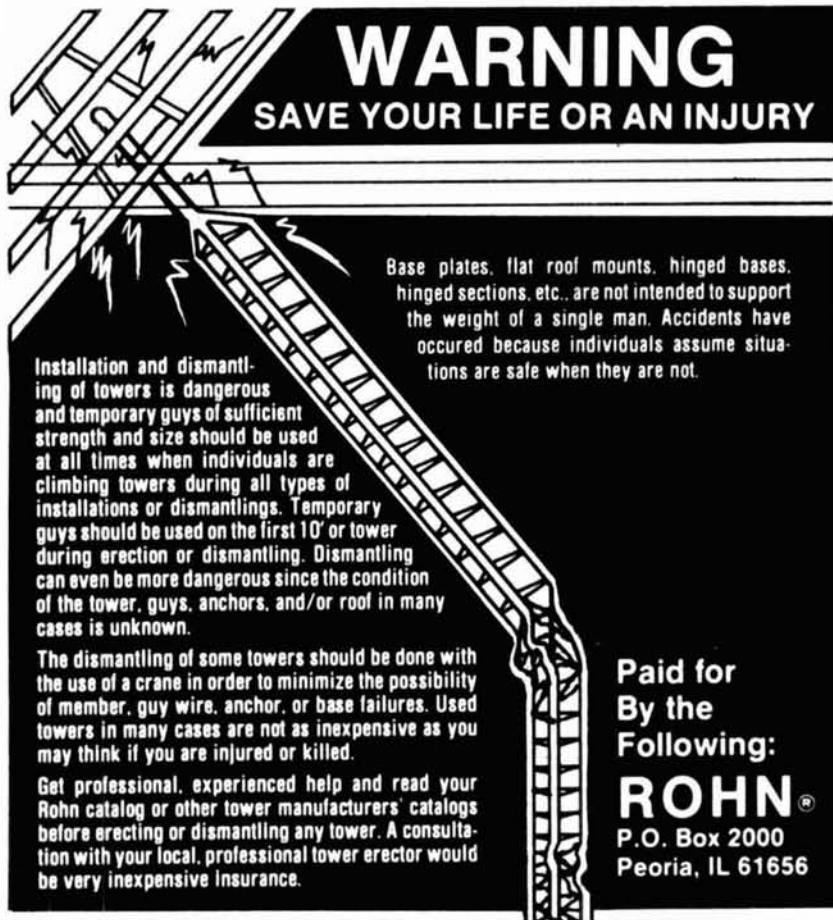

Base plates, flat roof mounts, hinged bases, hinged sections, etc., are not intended to support the weight of a single man. Accidents have occurred because individuals assume situations are safe when they are not.

Installation and dismantling of towers is dangerous and temporary guys of sufficient strength and size should be used at all times when individuals are climbing towers during all types of installations or dismantlings. Temporary guys should be used on the first 10' or tower during erection or dismantling. Dismantling can even be more dangerous since the condition of the tower, guys, anchors, and/or roof in many cases is unknown.

The dismantling of some towers should be done with the use of a crane in order to minimize the possibility of member, guy wire, anchor, or base failures. Used towers in many cases are not as inexpensive as you may think if you are injured or killed.

Get professional, experienced help and read your Rohn catalog or other tower manufacturers' catalogs before erecting or dismantling any tower. A consultation with your local, professional tower erector would be very inexpensive insurance.

Paid for  
By the  
Following:

**ROHN®**  
P.O. Box 2000  
Peoria, IL 61656

and in the surrounding ground. A second possibility is to use two or more antennas driven with different phases so as to provide steerable maxima and nulls. This is a choice that may be considered *after* the basic antenna is selected. Therefore, the choice was limited to arrangements that provide zero radiation both up and down — that is, the three families shown in **fig. 1**.

Study of the literature disclosed no clear evidence to support the choice of vertical polarization on the HF bands at the heights proposed, although, since the performance of horizontal antennas is more strongly affected by height, there might be a good case for a vertical antenna if the available height were much less. In a vertical antenna such as that shown in **fig. 1A**, the current is zero at the top and so the effective height is less than the actual height. If the radiator is trapped for multiband operation the top section may not be used, further reducing the effective height and with it the efficiency.

The so-called "Lazy H" array (**fig. 1B**) uses two dipoles stacked one above the other and fed in phase so as to provide maximum radiation horizontally and minimum radiation in the vertical direction. However, the effective height of the array is only the average height of the two elements, and the lower element would be inconveniently near ground level.

In contrast, the effective height of the "W8JK" array (**fig. 1C**) equals its actual height. The two dipoles are fed out of phase, and so straight-up-and-straight-down radiation is zero regardless of spacing, giving a potential for multiband operation with high efficiency. However, all the published multiband designs that I could find used center feed. So the question became, "how can two parallel long wires be end-fed out of phase?"

### the horizontal loop

I spent a long time experimenting with the horizontal loop antenna of **fig. 2**. A 40-meter length of wire formed into a loop presents a low impedance when its length is any multiple of a full wavelength: in this case it is resonant at 7, 14, 21, and 28 MHz. Unfortunately, the resonances follow the simple harmonic relationship only when the wire forms a circular loop. For more complex shapes, the resulting concentrations of inductance and capacitance disturb the relative resonant frequencies so much that an ATU is still needed for multiband operation. Furthermore, while the currents in opposite sides of the loop flow in opposite directions (as is required for "W8JK" operation) it is not possible to find a shape where the whole length of the opposite sides are spaced by the 0.1 wavelength to 0.25 wavelength that is desirable. For example, in the rectangular loop of **fig. 2**, although the *long* sides are spaced correctly there are also current maxima in the *short* sides, which are spaced by 1.5 wavelength at

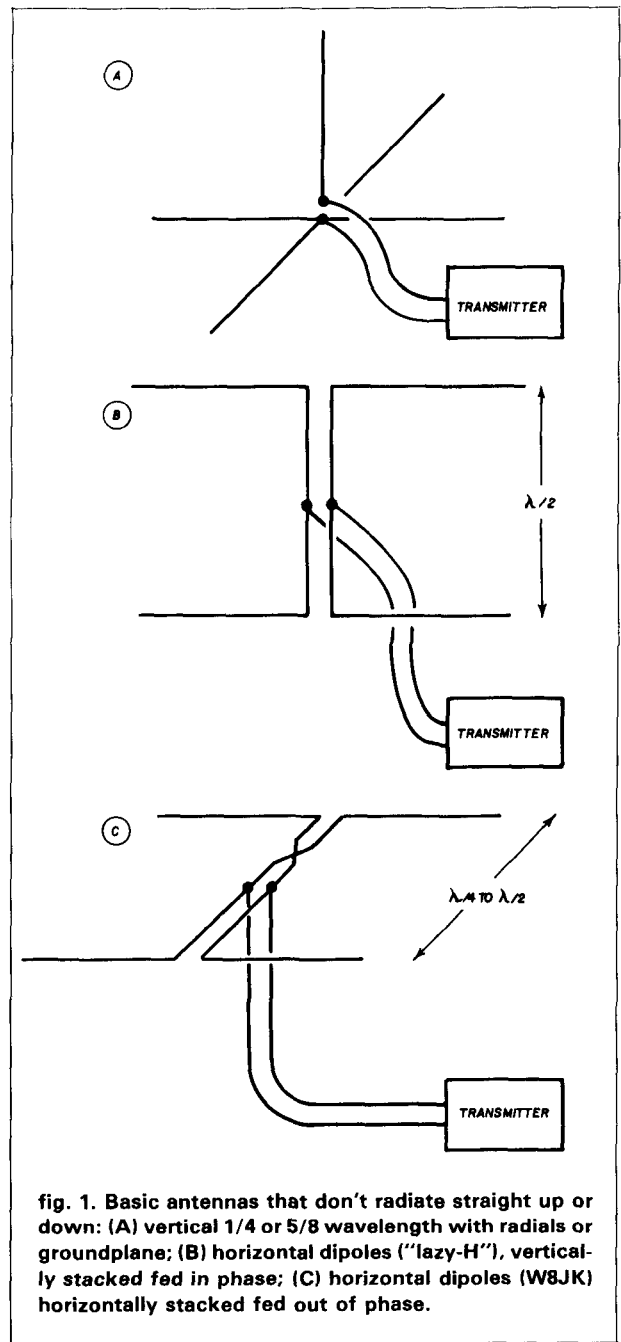

**fig. 1.** Basic antennas that don't radiate straight up or down: (A) vertical 1/4 or 5/8 wavelength with radials or groundplane; (B) horizontal dipoles ("lazy-H"), vertically stacked fed in phase; (C) horizontal dipoles (W8JK) horizontally stacked fed out of phase.

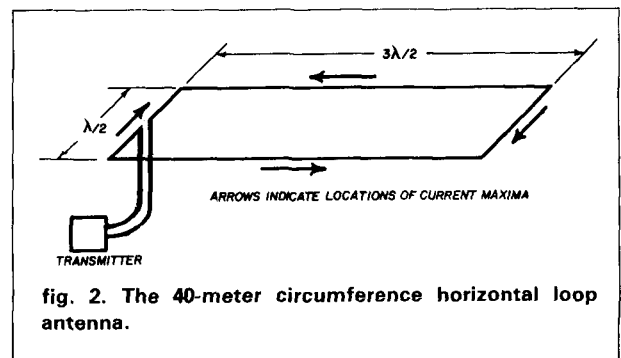

**fig. 2.** The 40-meter circumference horizontal loop antenna.

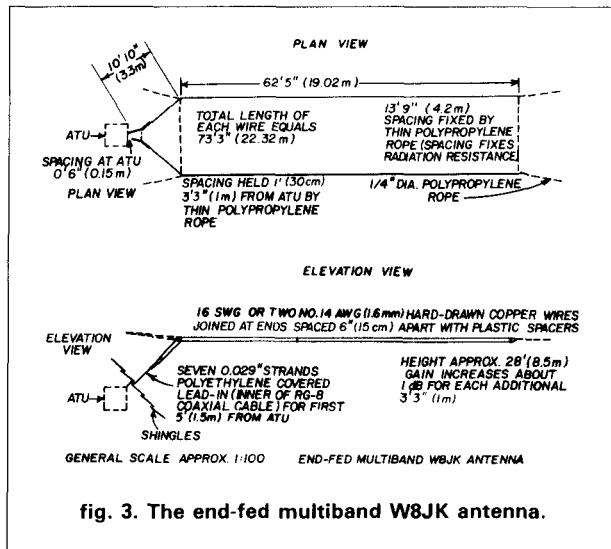

fig. 3. The end-fed multiband W8JK antenna.

30 MHz, and so provide strong horizontally-polarized end-fire radiation at directions 70 degrees above and below the horizontal plane, with a consequent loss of gain in useful directions.

### the end-fed W8JK

At about this stage I read G6XN's book.<sup>1</sup> His words confirmed my faith in the W8JK type of antenna, gave me new insights about how to feed the end of an antenna, and provided useful cautions about the RF resistance of long wires. With confidence restored, I settled down to think about ways of eliminating the radiation from the short sides of the loop antenna, and came up with the arrangement of fig. 3. This retains both the basic horizontal radiation pattern of an end-fed long wire (2 wavelengths at 28 MHz: 1-1/2 wavelengths at 21 MHz and 1 wavelength at 14 MHz) and the gain of the W8JK, but has much reduced end-fire radiation. It will be seen that the far end of the loop has been removed altogether since it was not meeting its original objective of simplifying the tuning. The near-end "fan-out" from the ATU to the parallel wires has been shaped to minimize its end-fire radiation. The design of this section is based on study of the voltage distribution along either wire of the antenna, which is plotted in fig. 4. It can be seen that in every case the voltage is high, and hence the current is low, at a distance of about 19 to 21.5 meters from the open ends. It is in this region that the most rapid "fan out" of the feeder may be allowed without too much wasted high angle radiation.

### antenna tuning unit

The length of each antenna wire is chosen so that at the highest design frequency (29.7 MHz), the antenna is resonant; that is the feed voltage is at a minimum. This occurs 22.32 meters from the open end; at this

point the wires are terminated just inside the pitched roof of the house, at an antenna tuning unit that is in a dry location and easily accessible. In fact, at 29.7 MHz no tuning is required since the spacing of the parallel section of the antenna can be adjusted to obtain a radiation resistance of 50 ohms. At lower frequencies the effective length of the wires must be increased to obtain resonance; it can be seen from fig. 4 that 1.5 meters must be added at 28 MHz, and about 2.4 meters and 4.3 meters, respectively, are required for 21 and 14 MHz operation. In practice this length can be added by the ATU in the form of adjustable series inductances. On the lower frequency bands radiation resistance decreases with smaller array size. On 14 MHz it was measured at about 25 ohms. However, the capacitance of the ATU and fan-out section can be chosen so that with the ATU inductance it forms a matching section that gives a low SWR on all three bands.

While a 2-gang roller inductor would be the ideal form of variable inductance to provide the balanced tuning network that is necessary, one was not available. Instead, "units" and "tens" steps of inductance were provided by two 2-gang ceramic wafer switches (driven by semi-rotary solenoids to be described shortly). As can be seen in the photograph (fig. 5) the coils

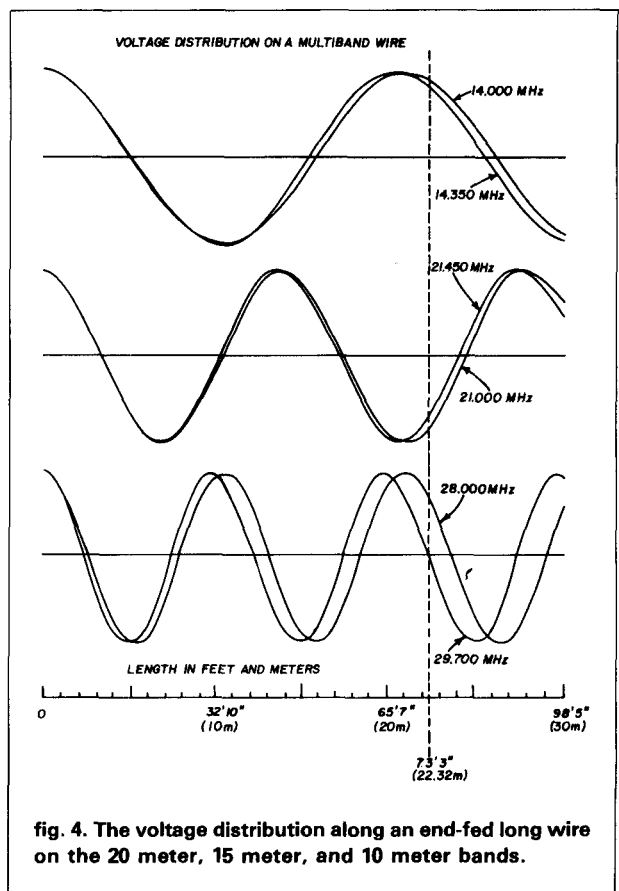

fig. 4. The voltage distribution along an end-fed long wire on the 20 meter, 15 meter, and 10 meter bands.

Uncle Ben says...

**"I give you  
much more than  
just the lowest price..."**

When you get that exciting new piece of equipment *from me*, you know you are going to be completely happy... I see to it, personally! I also give you earliest delivery, greatest trade-in allowances, my friendly assistance in every possible way.

Just ask any of the many thousands of hams all over the world who have been enjoying my friendly good service for over a half a century.

73, Uncle Ben, W2SOH

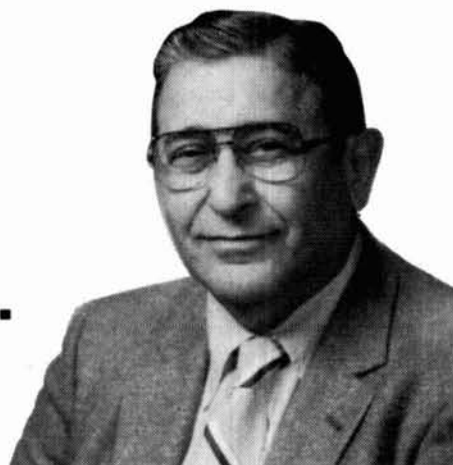

"Uncle Ben" Snyder, W2SOH  
the head man of

**HARRISON**

"HAM HEADQUARTERS,  
USA®" ...Since 1925!

• **CALL ME...**

(516) 293-7995

• **WRITE ME...**

For my prompt,  
personal reply.

• **SEE ME...**

At one of the world's largest  
Ham Supply Centers!

**ALLIANCE  
MFG. CO.**

**cushcraft**  
CORPORATION

CROSS NEEDLE METER  
**DAIWA**

**Larsen Antennas**

**KENWOOD**

**HARRISON**  
HAS THEM ALL  
IN STOCK!



**ICOM**

**HUSTLER**

**DRAKE**

**NYE VIKING**

**K&K Kantronics**

**TELEX hy-gain**  
TELEX COMMUNICATIONS, INC



**HARRISON RADIO**

**CHARGE IT!**

...Since 1925!

**"HAM HEADQUARTERS, USA®"**  
2263 Route 110 (at Smith St.)  
E. Farmingdale, NY 11735  
1-(516) 293-7995

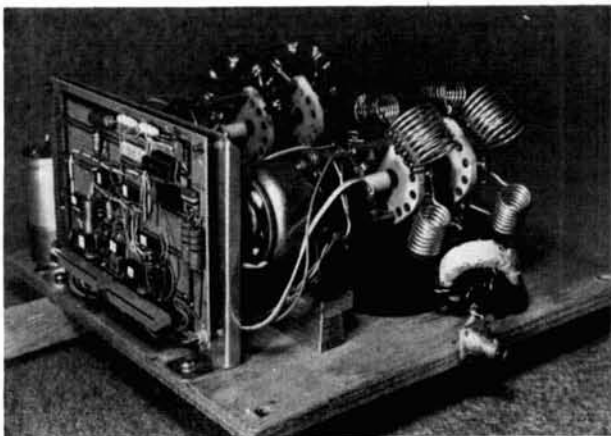
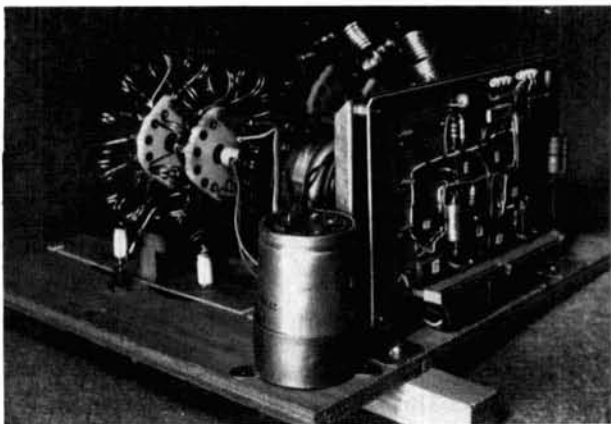

fig. 5. Side views of the remotely controlled antenna tuning unit.

are connected directly to the wafers, and the wafers spaced approximately 1.5 inches (40 mm) apart to optimize the stray capacitance. Fig. 6 shows that an SWR of better than 1.4 can be obtained across almost all of the three bands by varying the inductance alone; no variable capacitor is necessary.

The RF circuits of the ATU are shown in fig. 7. Immediately next to the antenna connections are two lightning arrester gaps, connected by a substantial conductor to a nearby copper water pipe. Next comes the "units" inductance providing up to 0.9  $\mu\text{H}$  in nine switched steps. This is followed by the "tens" inductance, whose switch is wired so that unused inductor sections are short-circuited to avoid losses due to resonance with stray capacitance. The balun is of W1JR's original "supertoroid" design.<sup>2</sup> The criticisms of K4KJ do not apply to applications such as this where there is substantial capacitance to ground in the antenna itself.<sup>3</sup> The balun should be wound with 50 ohm cable to ensure that no reflection occurs at the connection to the main 50 ohm cable. This is the cable that leads from the ATU to the transmitter (which in my case, is also within the pitched roof some 33 feet or 10 meters away from the ATU).

The bandwidth of this antenna system is quite large on 10 meters, where little or no series inductance is used, and a single inductance setting may be used over a 200 kHz portion of the band. On 20 meters, however, it is necessary to change the inductance switch settings every 20 kHz or so. Control of the "tens" and "units" inductors is therefore provided by two thumbwheel switches at the transmitter. DC power and the multiplexed BCD thumbwheel settings are sent along an 8 conductor cable to the ATU and used to position the two inductor switches.

### ATU control circuits

The solenoids that drive the ATU switches require considerable power for the short time that is needed

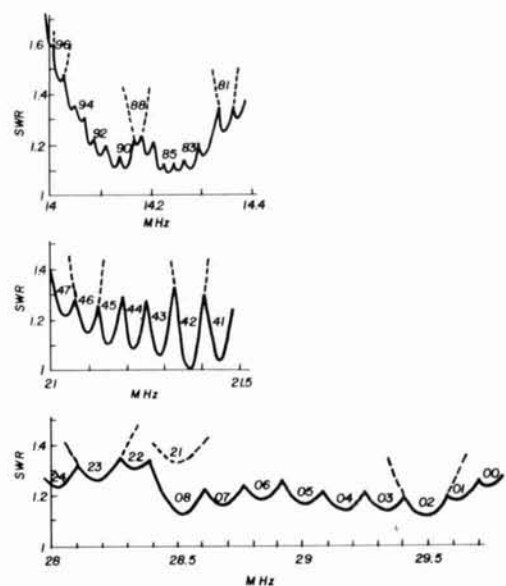

fig. 6. SWR plot achieved by the end-fed W8JK and series-inductance ATU. The numbers against each curve specify the 'tens' and 'units' inductance switch settings.

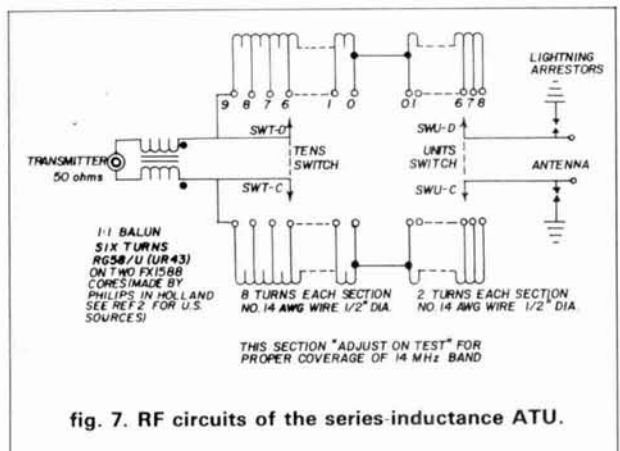

fig. 7. RF circuits of the series-inductance ATU.



to move the switch from one position to the next. The ones I used (SWT and SWU in fig. 8) need 4 amps at 12 volts, and so, to allow the use of thin telephone-type cable to the operating position, energy is stored at the ATU in a 22,000 microfarad capacitor. Circuit operation will be described with references to the "tens" switch SWT; operation of the "units" switch is similar but occurs on the other half-cycle of the clock waveform provided by divider U6A. When SWT is energized the solenoid pawl moves the switch ratchet to the next position and opens the interrupter contact SWT-A. In this circuit the interrupter contact tells the logic to turn off the power Darlington transistor that drives the solenoid; comparator U5B and its asso-

ciated circuit then ensure that power cannot be re-applied until the pawl has returned to its rest position and the storage capacitor has been recharged to at least 14 volts.

The actual position of the "working" switch wafers SWT-C and SWT-D (fig. 7) is sensed by the all-but-one-connected wafer SWU-B (fig. 8) which is driven from the BCD — decimal converter U2. If the position is incorrect, then on the appropriate phase of the clock the output of U4C will be low. This stops the clock oscillator (U4A and U5A) and allows the solenoid to step repeatedly under the control of U5B until the correct position is reached. The clock oscillator then restarts, so that the position of the other sole-

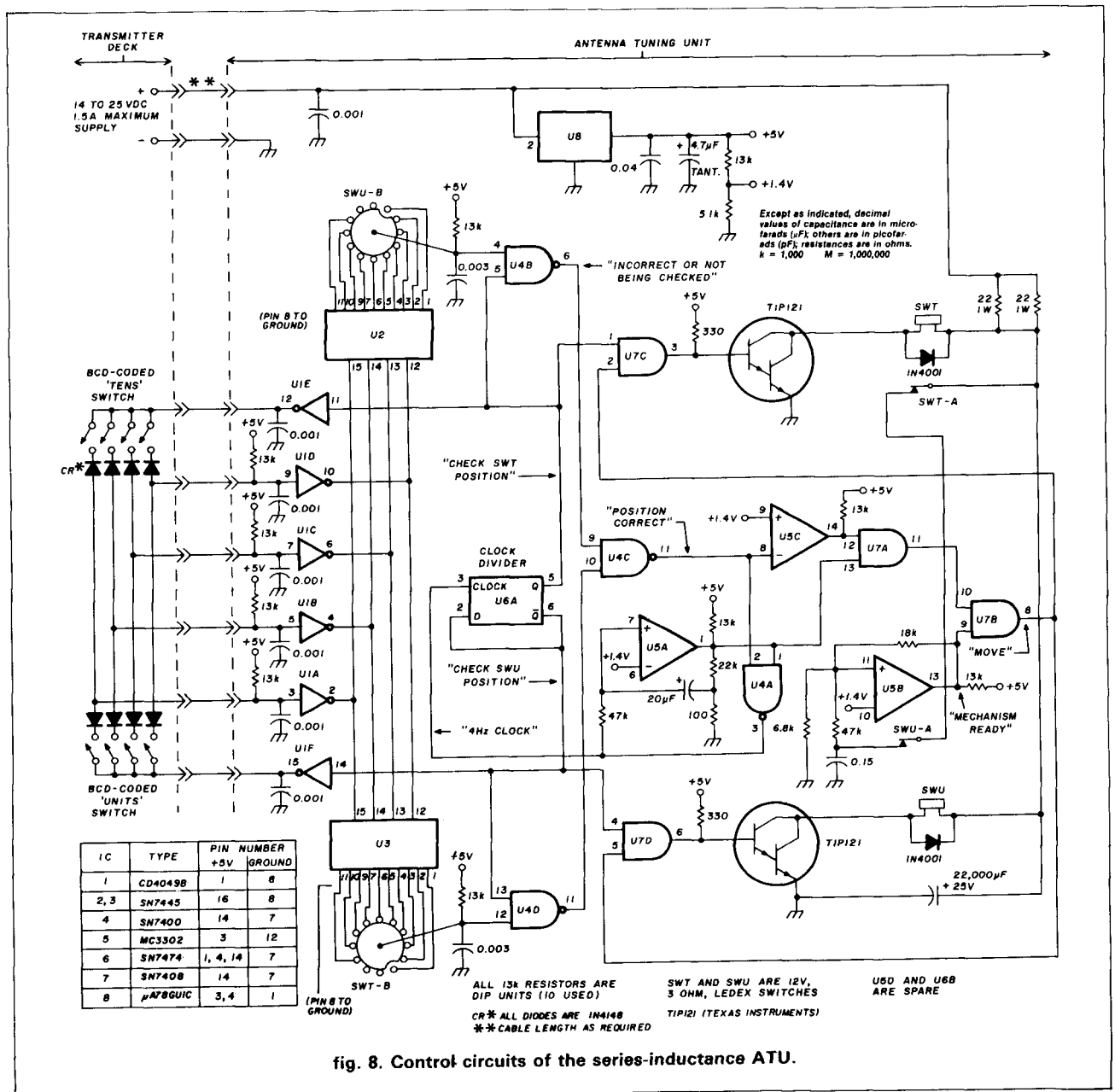

fig. 8. Control circuits of the series-inductance ATU.

# NCG WORLD BAND COMMUNICATIONS



**15M**

Tested and Proven 15 Meter Mobile Transceiver USB and CW  
 Power-High 10 watts, Low 2 watts  
 VFO Tuning, Noise Blanker  
 Fine Tune  $\pm 1$  kHz  
 Digital Frequency Counter  
 13.8 VDC @ 3A Neg. Ground  
 9.5" L x 9" W x 2.5" H  
 All this PLUS the freedom of DXing

*Just  
Slightly  
Ahead*



**160/10M**

ALL NEW, with the features you have been waiting for  
 HF 160-10 meters SOLID STATE Transceiver 200 watt PEP  
 All 9 HF Bands ready to go  
 AC/DC Power supply built in  
 3-Step Tuning 1 kHz/100Hz/25Hz  
 4 memories, Auto Scan  
 Automatic Up/Down Tuning Advanced Systems  
 Dual VFO, Solid State-Adjustment Free, IF Tuning, IF Offset  
 Noise Blanker, Mic. Compressor  
 VOX, CW Side tone, AC 120V DC 13.8 RTTY-Fax operation  
 USB-LSB CW (Narrow CW filter optional).



**1275 North Grove Street  
 Anaheim, CA 92806  
 (714) 630-4541**

Mail Order COD Visa Master Charge  
 Cable: NAT COLGLZ

*Prices and specifications subject to change without notice or obligation  
 Calif. Res. add Sales Tax*



**COMING SOON!**

**Triband Transceiver  
 40-15 & 6 Meter**

**26 Watts PEP. Built-in AC/DC Power Supply**

✓ 179

## Free Antenna Accessories Catalog



### ◀ Coaxial Antenna Relays

Remotely select up to 9 antennas from your transmitter, using only one coaxial cable. Environmentalized, high power and low loss.

### W2AU and W2DU Baluns▶

Our baluns, center insulators and insulators have been preferred for 20 years by Hams, industry, and the armed forces. Protect against TVI and lightning 1.8-200 MHz.



### ◀ W2VS Antenna Traps

Add these traps to your dipole and get low SWR on 2 to 6 bands, depending on how many you add. Antenna wire and custom kits also available.

### Send For Yours Today▶

Don't delay. Call or write today, and we will send you free literature which fully describes our Ham antenna accessory product line.

Dealer inquiries also welcome.



6743 Kinne St., East Syracuse, NY 13057  
 Toll Free 1-800-448-1666 TWX 710-541-0493  
 NY/HI/AK/Canada (Collect) 315-437-3953

✓ 174

## Paracclipse Midwest

Your Picture Window to the World

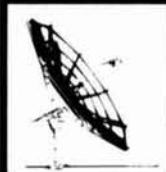

**High Performance  
 Satellite Antenna**

**STOCKING DISTRIBUTORS FOR**

Paracclipse Luxor Bowman  
 Amplica MTI Drake  
 Chaparral DX General Instrument

**Guaranteed Lowest Prices  
 SYSTEM PRICES STARTING AT**

**\$1795.00**

**VIDEO ELECTRONICS INC.**

4416 Outer Loop  
 Louisville, Kentucky 40219  
**(502) 964-DISH**

**Outside Kentucky 1-800-55-VIDEO**

✓ 217

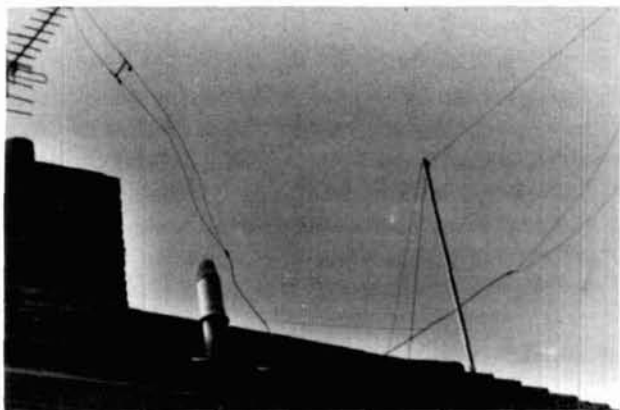

fig. 9. Feed-end of the antenna.

noid may be checked. To minimize interference that might be coupled into the antenna circuit, the clock oscillator is run at the lowest frequency that does not noticeably degrade the response of the circuit to changes of thumbwheel position — that is, 4 Hz. Consideration of the threshold levels resulting from the diode "or" circuit associated with the thumbwheel switches shows that a CMOS interface U1 must be used, even though the other circuits are all TTL. This is unfortunate, since the circuit is exposed to induced transients from lightning. It is recommended that a socket be used to mount the chip. The position-sensing switch wafers are not shielded from the high RF voltages on the working wafers; with 100 watts of RF it proved necessary to add the 3 nF capacitors to the rotors of SWT-B and SWU-B. Shielding is clearly desirable and would probably be essential with higher power.

### choice of antenna conductor size

As previously mentioned, the radiation resistance at 14 MHz is only 25 ohms, and care is needed to ensure that resistive losses in the 44.64 meters of resonant radiating elements are not significant. The lowest frequency band represents the worst case, since measurement of this antenna has shown that the radiation resistance is roughly proportional to frequency, whereas the wire loss resistance due to skin effect only increases with the square root of frequency. With the two parallel No. 14 AWG (1.6 mm) conductors specified for each element (see fig. 3) the effective resistance is about 2.5 ohms giving less than 1 dB loss. The 1.5 meters of each element nearest the ATU are made from polyethylene-covered stranded conductors to provide good insulation and flexibility at the point of entry through the roof structure as shown in fig. 9.

### conclusion

This antenna performs much like any other long wire; it would be difficult to make comparisons on the

Amateur bands with sufficient accuracy to make any other claim. However, its losses are small and its directivity well defined, and therefore theory would suggest 3 to 5 dB gain relative to a dipole in the best directions. Its real advantages are the balanced end feed and multiband operation.

However, the principle of the tuning unit may be applied to many other antennas. What has been described is a way of using a single balanced variable to tune and match two long wire elements. It has been suggested to me that if these wires formed an Echelon array then one of the elements could be moved to provide steerable nulls. A "V" beam is possible, although the angle would have to be a compromise between the three bands. With the two elements co-linear, the design should display characteristics similar to the G5RV and offer the advantage of an alternative feed arrangement.

Finally, it may be noted that the antenna as described in fig. 3 is also exactly resonant at 10 MHz, though its radiation resistance is very low and a different tuning arrangement is necessary.

### references

1. L.A. Moxon, G6XN, *HF Antennas for All Locations*, Radio Society of Great Britain, 1982.
2. Joseph Reiser, W1JR, "Broadband Balun," *ham radio*, September, 1978, pages 12-15.
3. J.J. Nagle, K4KJ, "High Performance Broadband Balun," *ham radio*, February, 1980, pages 28-34.

### ham radio

## AMATEUR TELEVISION

### ATV TRANSMITTER/CONVERTER

ALL YOU NEED IN ONE BOX



**\$399 delivered**  
TC-1 plus

- **OVER 10 WATTS PEP OUTPUT.** Crystal controlled continuous duty transmitter. Specify 439.25, 434.0, 426.25 standard or other 70 cm frequency. 2 freq. option add \$26.
- **BASE, MOBILE, or PORTABLE.** Use the builtin AC supply or external 13.8 vdc. Do parades, Marathons, CAP searches, etc.
- **TWO VIDEO AND AUDIO INPUTS** for camera, TVRO, VCR, or computer. Wide bandwidth for broadcast quality color video and computer graphics. Standard broadcast subcarrier sound which is heard thru the TV speaker.
- **RECEIVE ON YOUR STANDARD TV SET** tuned to channel 3 or 4. Sensitive varicap tuned TVC-2L downconverter covers simplex and repeater freq. over the whole 420-450 mHz 70 cm amateur band.
- **ATTRACTIVE 10.5 x 3 x 9 CABINET.**

CALL OR WRITE FOR OUR CATALOG or more information on ATV antennas, transmit modules, cameras, etc. or who is on in your area. See chapter 14 1984 ARRL Handbook.

TERMS: Visa, Mastercard, or cash only UPS CODs by telephone or mail. Postal money orders and telephone orders usually shipped within 2 days. All other checks must clear before shipment. Transmitting equipment sold only to licensed amateurs, verifiable in the 1984 call book.

(818) 447-4565 m-f 8am-6pm pst.

**P.C. ELECTRONICS**

Tom W6ORG Maryann WB6YSS



2522 Paxson Lane  
Arcadia CA 91006

# B. G. MICRO

P. O. Box 280298 Dallas, Texas 75228  
(214) 271-5546



## 74LS

LS00	.24	LS164	.60
LS01	.24	LS165	.90
LS02	.24	LS166	.99
LS03	.24	LS169	1.25
LS04	.24	LS174	.60
LS05	.24	LS175	.50
LS08	.24	LS181	1.99
LS10	.24	LS191	.90
LS11	.24	LS192	.80
LS12	.30	LS193	.80
LS13	.50	LS195	.65
LS14	.50	LS197	.85
LS20	.24	LS221	.80
LS21	.25	LS240	.95
LS27	.24	LS241	.80
LS30	.28	LS242	.90
LS32	.36	LS243	.90
LS42	.49	LS244	1.25
LS51	.24	LS245	1.50
LS74	.40	LS251	.50
LS85	.60	LS257	.55
LS86	.39	LS258	.55
LS90	.50	LS266	.50
LS93	.55	LS273	1.25
LS109	.39	LS279	.45
LS112	.39	LS283	.60
LS123	.75	LS290	.85
LS124	2.75	LS293	.85
LS125	.45	LS298	.89
LS132	.50	LS299	1.60
LS133	.49	LS366	.45
LS138	.60	LS367	.50
LS139	.60	LS368	.40
LS151	.50	LS373	1.25
LS153	.50	LS374	1.35
LS154	1.75	LS375	1.19
LS155	.50	LS377	1.49
LS156	.55	LS378	.85
LS157	.60	LS390	1.19
LS161	.60	LS393	1.19
LS162	.65	LS399	1.25
LS163	.50		

## TTL

7400	.19	74125	.49
7402	.19	74151	.50
7404	.19	74154	1.19
7408	.24	74157	.50
7410	.19	74164	.75
7440	.19	74174	.85
7474	.35	74175	.79
7486	.29	74367	.59
74109	.45		

## 6500

6502	4.50	6545	10.00
6522	6.95	6551	10.00

## 6800

6800	2.50	6840	10.00
6802	5.00	6845P	10.00
6803	14.95	6850	2.60
6810	2.00	68A21	4.95
6820	3.25	68B45	17.50
6821	2.95		

## EPROM

2708 1KX8 450 n.s.	2.20
27A08 1KX8 350 n.s.	3.95
2758 1KX8 +5V 450 n.s.	2.50
<b>2716 2KX8</b>	
450 n.s.	3.20
<b>2716-1 2KX8 350 n.s.</b>	
2732 4KX8 450 n.s.	4.75
2532 4KX8 450 n.s.	5.50
2764-25 250 n.s.	7.50

## EPROM SPECIAL

We bought a large quantity of 2708s from a computer manufacturer who redesigned their boards. We removed them from sockets, erased and verified them, and now we offer the savings to you. Complete satisfaction guaranteed.  
2708  
\$1.49 or 10/\$12.00

## STATIC RAM

<b>TMM2016-2KX8</b>	
200 n.s.	8/39.95
<b>2101-1 - 256X4</b>	
500 n.s.	.75
21L02-1 350 n.s.	.65
2102AL-4 L.P. 450 n.s.	.49
<b>2114L-3 1KX4 300 n.s.</b>	
L. P.	2.75 8/16.00
<b>TMS4044 (MCM6641 C-25)</b>	
4KX1 250 n.s.	8/6.00
TMS4046 450 n.s.	.65
<b>5101E-8 - 256X4 - CMOS</b>	
	\$1.00
<b>HM6116P-4-2KX8</b>	
200 n.s. CMOS	8/39.95
<b>6501-5 256X4 - CMOS - Data Retention 2 Volts - 22 Pin - 200 n.s. Typ. - 5V - Very Low Power</b>	
8108-5 1KX8 NMOS 500 NS	2.00

## 4K STATIC RAMS

LESS THAN 50¢ EACH  
MK4104J-4 - 250 N.S. 18 Pin  
Ceramic Computer Mfg.  
Surplus. PRIME. Fully Static.  
Easy to Use. Has Same Pin Out as TMS4044, but slightly different timing. With Specs. (Mostek)  
8 for 5.00 32 for 15.95  
VERY LOW POWER!

## DMA CONTROLLER

<b>SPECIAL</b>	
9517A-4 (8237-4)	10.50

## DYNAMIC RAM

<b>5280N-5 (2107B-4 • TMS4060)</b>			
4KX1			8/3.95
4027-4KX1-250 n.s.			1.00
4116-16KX1-250 n.s.			8/9.00
4116-16KX1-200 n.s.			8/11.50
4164- +5v 64K 200 n.s.			8/48.00
<b>8000</b>			
Z8002	29.95	8085A	5.95
8035	4.50	8086-2	30.00
8039	5.00	8087-3	175.00
8080A	2.00	8088	20.00

## 8200

8202A	15.95	8253	4.95
8212	1.25	8253-5	5.95
8214	2.00	8255-5	5.50
8216	1.50	8257	6.00
8224	1.50	8259A	4.95
8228	3.00	8275	19.95
8237-4	10.50	8279-5	7.95
8250B	9.95	8287	5.75
8251	3.95		

## DIP SWITCH

<b>DT08 BY ALCO</b>	
<b>8 POSITION DIP SWITCH</b>	
Super low profile -	
Made for automatic insertion -	
<b>SPECIAL</b>	— .90 10/7.50
DT-10	10/8.50

## Z80

Z80 2.5 MHZ CPU	3.50
Z80CTC	3.75
Z80DMA-DMA	9.95
Z80PIO	3.95
Z80SIO/O	16.95
Z80A-4MHZ CPU	4.95
Z80A DART	9.95
Z80A-PIO	5.95
Z80A SIO/O	19.95
Z80B 6 MHZ CPU	14.95

## UART

1602 (COM 2017)	2.95
1863	3.95
IM6402-+5v High speed	
UART-AY5-1013 pin out	2.95
INS 8250B	9.95

## 2114 SPECIAL!

COMPUTER  
MANUFACTURERS  
EXCESS INVENTORY  
SALE!

PRIME! 2114-300 n.s.  
INCREDIBLE PRICE!  
YOU SAVE!

8/\$9.00

GUARANTEED

## SOCKETS

### Low Profile SOLDER TAIL

6 Pin	14/1.00
8 Pin	13/1.00
14 Pin	10/1.00
16 Pin	8/1.00
18 Pin	8/1.00
20 Pin	7/1.00
24 Pin	6/1.00
28 Pin	6/1.00
40 Pin	5/1.00

BUY \$10

GET \$1.00

FREE CHOICE

## F.D. CONTROLLERS

1771 Single Density	15.00
1791 Double Density	20.00
1793	22.00
1797	24.95
2793	35.95

## CONTROLLER SET

THREE CHIP SET  
1797, 2143-03, 1691 by W.D.  
Compare at up to 86.85.  
B.G. SPECIAL  
All 3 for only \$29.95

## CRYSTALS

32.768 KHz SPECIAL	.65
262.144	.75
300.000	1.00
307.200	1.25
1.5432 Mhz	.75
1.8432	2.49
2.000000	2.49
3.000	1.15
3.120	1.20
3.579545 - HC18	1.00
4.000	2.49
4.194304	1.50
4.433618	.75
4444.000	1.25
4.9152	2.49
4.916 Bd. Rate	1.25
5.000000	1.50
5.0688	3.75
5.616	1.59
8.000	1.99
9.90000	1.25
10.69425	3.75
10.8664	1.49
11.088	1.59
13.440	1.00
12.000	2.75
15.2	1.10
14.31818	2.49
16.00000	1.50
17.430	2.49
18.2259	1.00
20.000	3.75
21.87108	1.00
22.092	1.00
32.000	2.49
40.000	2.00
87.3333	1.00
91.000	1.00
104.8	1.00



## Z80\* SINGLE BOARD COMPUTER!

64K RAM — 80 x 24 VIDEO DISPLAY — FLOPPY DISK CONTROLLER  
RUNS CP/M\* 2.2!

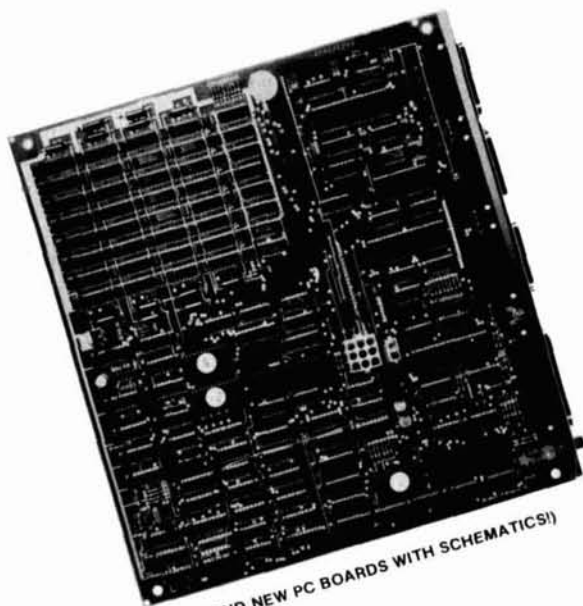

(BRAND NEW PC BOARDS WITH SCHEMATICS!)

**\$29.95**

(BLANK BOARD WITH  
DATA AND ROM'S.)

**NEW PRICE**

**GROUP SPECIAL:  
BUY 6 FOR \$165!**

USES EASY  
TO GET PARTS!

BOARD MEASURES  
11½" x 12½"

ALL ORDERS WILL BE  
PROCESSED ON A STRICT,  
FIRST COME, FIRST SERVED  
BASIS! ORDER EARLY!

### GIANT COMPUTER MANUFACTURER'S SURPLUS! UNBELIEVABLE LOW PRICE!!!

Recently Xerox Corp. changed designs on their popular 820\* computer. These prime, new, 820-1 PC boards were declared as surplus and sold. Their loss is your gain! These boards are 4 layers for lower noise, are solder masked, and have a silk screened component legend. They are absolutely some of the best quality PC boards we have seen, and all have passed final vendor QC. Please note, however, these surplus boards were sold by Xerox to us on an AS IS basis and they will not warranty nor support this part.

We provide complete schematics, ROM'S, and parts lists. If you are an **EXPERIENCED** computer hacker, this board is for you! Remember, these are prime, unused PC boards! But since we have no control over the quality of parts used to populate the blank board, we must sell these boards as is, without warranty. You will have to do any debugging, if necessary, yourself!

ADD \$2 PER PC BOARD FOR SHIPPING. (USA and Canada)

\*CP/M TM OF DIGITAL RESEARCH INC. (CALIF.) 820 TM OF XEROX CORP. Z80 TM OF ZILOG

### WE'VE GOT EM! 5-1/4" HALF SIZE DRIVES

- 40 Track per side
- Double-sided, double density
- Same as SA455
- Latest head & drive technology
- Fast access time

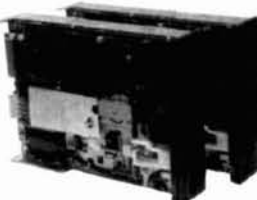

Two of These Half Size Drives will  
Fit in the Same Space as 1 Full Size Drive!

**\$179.00 per drive**

Compare at up to \$349 ea.  
ADD \$3.00 UPS PER DRIVE

TERMS: Orders over \$50 add 85¢ insurance. No COD. Tex. Res. Add 6% Sales Tax. Subject to prior sale. Foreign orders: US funds only. We cannot ship to Mexico. Foreign countries other than Canada add \$6 per board shipping.

# High Performance vhf/uhf preamps

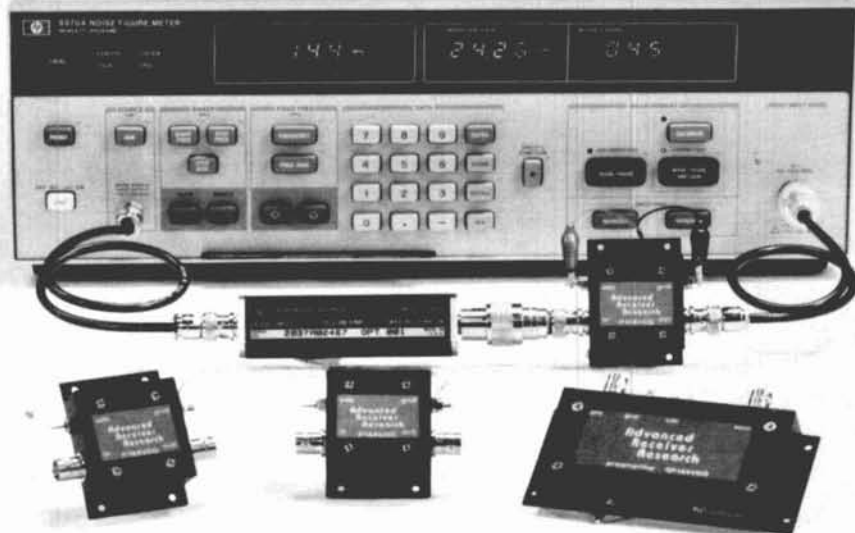

Receive Only	Freq. Range (MHz)	N.F. (dB)	Gain (dB)	1 dB Comp. (dBm)	Device Type	Price
P28VD	28-30	< 1.1	15	0	DGFET	\$29.95
P50VD	50-54	< 1.3	15	0	DGFET	\$29.95
P50VDG	50-54	< 0.5	24	+12	GaAsFET	\$79.95
P144VD	144-148	< 1.5	15	0	DGFET	\$29.95
P144VDA	144-148	< 1.0	15	0	DGFET	\$37.95
P144VDG	144-148	< 0.5	24	+12	GaAsFET	\$79.95
P220VD	220-225	< 1.8	15	0	DGFET	\$29.95
P220VDA	220-225	< 1.2	15	0	DGFET	\$37.95
P220VDG	220-225	< 0.5	20	+12	GaAsFET	\$79.95
P432VD	420-450	< 1.8	15	-20	Bipolar	\$32.95
P432VDA	420-450	< 1.1	17	-20	Bipolar	\$49.95
P432VDG	420-450	< 0.5	16	+12	GaAsFET	\$79.95

### Inline (rf switched)

SP28VD	28-30	< 1.2	15	0	DGFET	\$59.95
SP50VD	50-54	< 1.4	15	0	DGFET	\$59.95
SP50VDG	50-54	< 0.55	24	+12	GaAsFET	\$109.95
SP144VD	144-148	< 1.6	15	0	DGFET	\$59.95
SP144VDA	144-148	< 1.1	15	0	DGFET	\$67.95
SP144VDG	144-148	< 0.55	24	+12	GaAsFET	\$109.95
SP220VD	220-225	< 1.9	15	0	DGFET	\$59.95
SP220VDA	220-225	< 1.3	15	0	DGFET	\$67.95
SP220VDG	220-225	< 0.55	20	+12	GaAsFET	\$109.95
SP432VD	420-450	< 1.9	15	-20	Bipolar	\$62.95
SP432VDA	420-450	< 1.2	17	-20	Bipolar	\$79.95
SP432VDG	420-450	< 0.55	16	+12	GaAsFET	\$109.95

Every preamplifier is precision aligned on ARR's Hewlett Packard HP8970A/HP348A state-of-the-art noise figure meter. RX only preamplifiers are for receive applications only. In-line preamplifiers are rf switched (for use with transceivers) and handle 25 watts transmitter power. Mount in-line preamplifiers between transceiver and power amplifier for high power applications. Other amateur, commercial and special preamplifiers available in the 1-1000 MHz range. Please include \$2 shipping in U.S. and Canada. Connecticut residents add 7-1/2% sales tax. C.O.D. orders add \$2. Air mail to foreign countries add 10%. Order your ARR Rx only or In-line preamplifier today and start hearing like never before!

## Advanced Receiver Research

Box 1242 • Burlington, CT 06013 • 203 582-9409



✓ 101

## Ducks are getting smaller! and...



## better!



Actual Size

Because you and the leading radio manufacturers want the best looking, best performing antenna you can buy, Centurion has grown to be the Duck leader. We've developed many smaller and thinner antennas to make hand-held radio perform better and look better. The Style S is the newest Tuf Duck...it measures 3" in length and only 3/8" in diameter, yet it's a full 1/4 wave radiator on VHF.

## CENTURION TUF DUCK ANTENNAS

**CENTURION**  
Phone 402/467-4491  
Telex 48-4377 CENTURION LCN  
P.O. Box 82846 Lincoln, NE 68501 9846

OVER 70 BRANDS IN STOCK

LAND-MOBILE RADIO

BIRD HYGAIN • ARRIL

DRAKE

ICOM

SHORTWAVE

SCANNERS

BEARCAT • MORGAIN • MANY MORE

TEM-TEC

BAW • GDE

CLOSED SUNDAYS, HOLIDAYS

Full Service Shop • Spectrum Analysis • Antennas  
New and Used Equipment • CW-SSB-FM, Etc. • Towers  
FCC Study Guides • Code Tapes • Books • Accessories

# SPECTRONICS

Specialists in Amateur Radio,  
Short-Wave Listening  
And Contemporary  
Electronic Gear.

HOURS  
MON, TUES, WED.: 9:30-6:00 PM  
THURS, FRI.: 9:30-8:00 PM  
SAT.: 9:30-3:00 PM

CLOSED SUNDAYS, HOLIDAYS

**SPECTRONICS INC.**  
1009 GARFIELD ST. OAK PARK, IL 60304

(312) 848-6777

VISA

✓ 127

Applications include  
power splitting/combining,  
impedance transformation  
and attenuation

## the branch-line hybrid: part 2



At frequencies below 30 MHz, lumped constants offer less loss than coaxial cable to form compact hybrids.

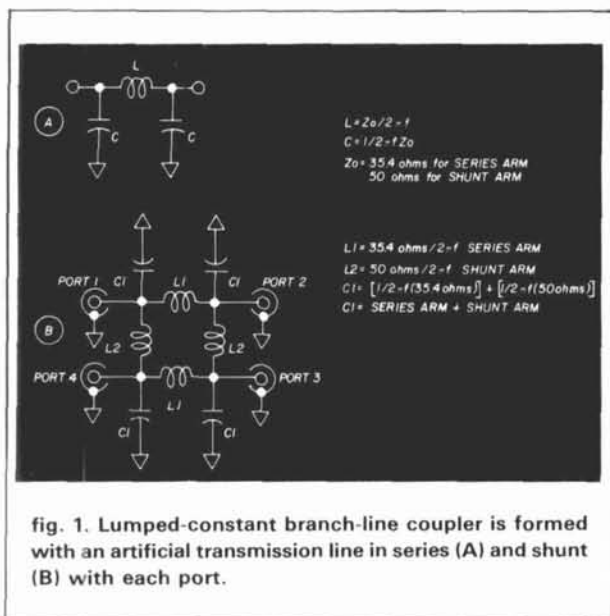

fig. 1. Lumped-constant branch-line coupler is formed with an artificial transmission line in series (A) and shunt (B) with each port.

REPRINTED FROM ELECTRONIC PRODUCTS JULY 23 1982

### lumped-constant branch line

Below 100 MHz the coaxial cable form of a branch-line hybrid becomes excessively bulky. At these frequencies the branch-line hybrid can be formed using capacitors and inductors. An artificial transmission line may be formed using either the tee or  $\pi$  network. The  $\pi$  network is normally chosen because it functions as a lowpass filter. The inductance and capacitance values given in **fig. 1A** are calculated using the characteristic impedance of the transmission line. The single-section branch-line coupler (**fig. 1B**), is formed by two series and two shunt artificial transmission lines. Inductance L1 in the series line is calculated using the 35.4-ohm characteristic impedance calculated earlier. The 50-ohm shunt line is formed using L2. The capacitors, C, from each artificial line are added together to form a composite value, C1. The element values for a 3-dB 50 ohm branch-line hybrid are given in **table 1**. The theoretical and experimental response of the lumped-constant hybrid is shown in **fig. 2**. Note that the bandwidth is only slightly reduced from that in the transmission-line case. The curves are slightly skewed when using lumped constants.

The lumped-constant branch-line hybrid is adjusted by individually resonating the inductors with the shunt capacitances present at each port. Capacitors are well marked and can also be easily and accurately measured; therefore, only the inductors are trimmed. Values close to the calculated capacitance found in **table 1** are soldered in shunt with each port. Inductor L1 is then soldered from port 1 to port 2 to form a  $\pi$  network, as shown in **fig. 2A**. The coil is adjusted to resonance according to:

$$f = 1 / (2\pi \sqrt{L1 \cdot C1/2}) \quad (5)$$

By Ernie Franke, WA2EWT, 10484 138th Street, N., Largo, Florida, 33544.

# MORE PERFORMANCE FOR YOUR DOLLAR! COMPETITORS KNOW ABOUT THE ISOPOLE™

## DO YOU? STUDY THE FACTS ...

The IsoPole antenna is building a strong reputation for quality in design and superior performance. Innovative IsoPole conical sleeve decouplers (pat. pend.) offer many **new** design advantages.

All IsoPole antennas yield the **maximum gain attainable** for their respective lengths and a zero degree angle of radiation. Exceptional decoupling results in simple tuning and a significant reduction in TVI potential. Cones offer greater efficiency over obsolete radials which radiate in the horizontal plane and present an unsightly bird's roost with an inevitable "fallout zone" below. The IsoPoles have the broadest frequency coverage of any comparable VHF base station antenna. This means no loss of power output from one end of the band to the other when used with SWR protected solid state transceivers.

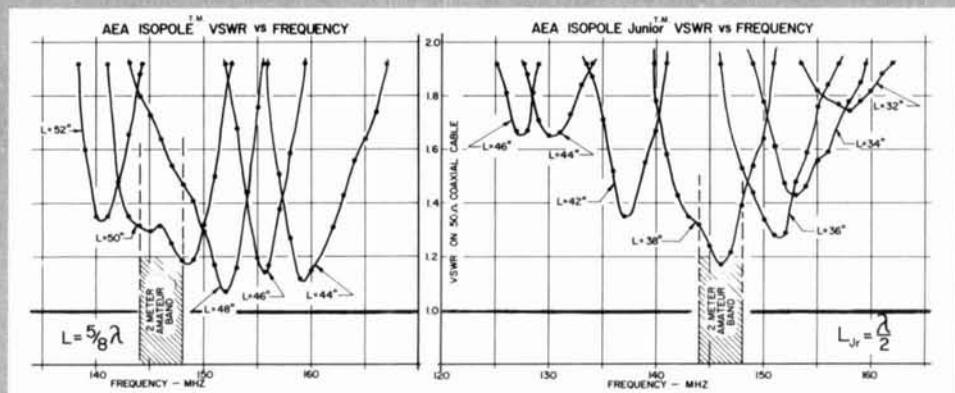

Outstanding mechanical design makes the IsoPole the only logical choice for a VHF base station antenna. A standard Amphenol 50 Ohm SO-239 connector is recessed within the base sleeve (fully weather protected). With the IsoPole, you will not experience aggravating deviation in SWR with changes in weather. The impedance matching network is weather sealed and designed for maximum legal power. All IsoPole antennas are D.C. grounded. The insulating material offers superb strength and dielectric properties, plus excellent long-term ultra-violet resistance. All mounting hardware is stainless steel. The decoupling cones and radiating elements are made of corrosion resistant aluminum alloys. The aerodynamic cones are the only appreciable wind load and are attached directly to the support (a standard TV mast which is **not supplied**).

IsoPole antennas have also become the new standard for repeater applications. They all offer low angle of radiation, low maintenance, easy installation, and low cost with gain comparable to units costing several times as much. Some repeater installations have even eliminated the expense of a duplexer by using two IsoPole antennas separated vertically by about twenty feet. This is possible because of the superior decoupling offered by the IsoPole antennas.

The IsoPole antenna is now available in a 440 MHz version which is fully assembled and tuned.

Our competitors have reacted to the IsoPole, maybe you should too! Order your IsoPole or IsoPole Jr. today from your favorite Amateur Radio Distributor.

**AEA** Brings you the  
**Breakthrough!**

PRICES AND SPECIFICATIONS SUBJECT TO CHANGE WITHOUT NOTICE OR OBLIGATION.

**ADVANCED ELECTRONICS  
APPLICATIONS**

P.O. Box C-2160,  
Lynnwood, WA 98036  
(206) 775-7373  
TELEX: 152571 AEA INTL



ISOPOLE 440

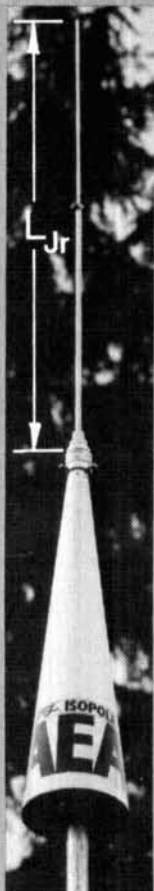

ISOPOLE  
144JR

ISOPOLE  
220JR

MAST NOT  
SUPPLIED

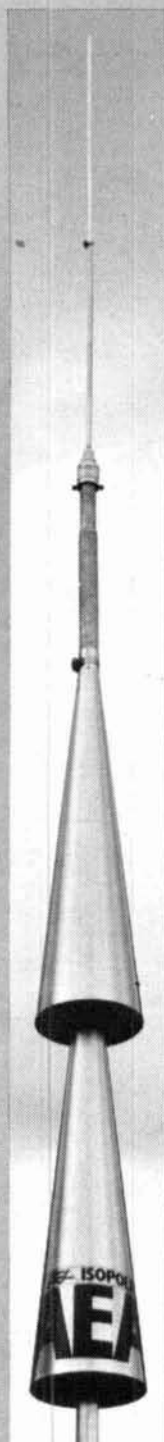

ISOPOLE 144  
ISOPOLE 220  
MAST NOT  
SUPPLIED



fig. 2. Experimental results using a lumped-constant hybrid are very close to the theoretical values (solid line). 2A shows input return loss vs. frequency; 2B shows isolation vs. frequency; 2C shows coupling versus frequency.

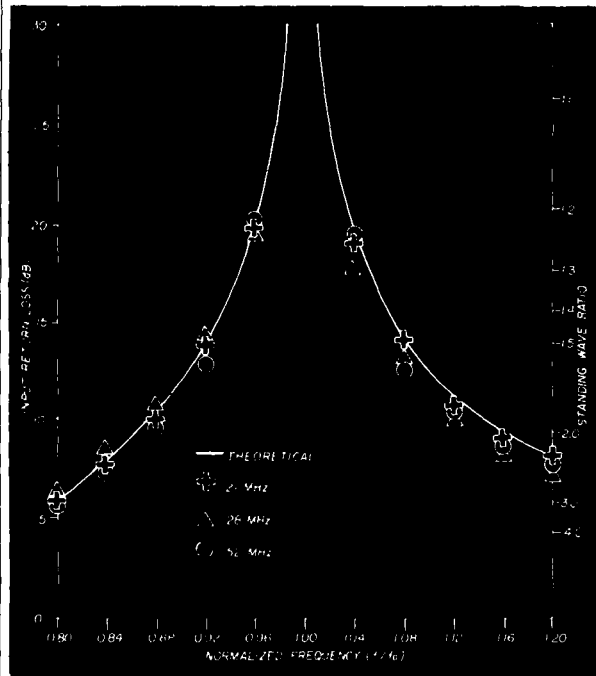

table 1. Lumped constant values for branch-line hybrids.

frequency (MHz)	L1 (nH)	L2 (nH)	C1 (pF)
3.75	1500.0	2122.0	2049.0
7.15	787.0	1113.0	1075.0
14.18	397.0	561.0	542.0
21.25	265.0	375.0	362.0
28.85	195.0	276.0	266.0
52.00	108.0	153.0	148.0
146.00	38.5	54.5	52.6
222.00	25.3	35.8	34.6

The  $C1/2$  term indicates that the  $C1$  capacitors are in series, with the center tap grounded and the inductor floating. For example, the series inductor in a 28-MHz hybrid should be adjusted to resonate at 31.2 MHz. Next, L1 is removed and L2 is placed between ports 2 and 3. A grid-dip meter is again used to resonate L2 with the series combination of the shunting capacitors. For the 28-MHz hybrid, the resonant frequency of the shunt arm is 26.2 MHz. After each coil is individually resonated, all are replaced, and the hybrid is ready for use. The experimental results shown in fig. 2 were achieved by adjusting the hybrids in the above manner.

### impedance transformation

Often it is required for a signal source to deliver two equal signals at loads other than 50 ohms. The input and output impedances of an RF transistor power amplifier, for example, are in the 1 to 10 ohm region. This impedance transformation may be incorporated directly into the branch-line hybrid. The series arm, as before, is made equal to the square root of the input impedance times one-half the output impedance. The

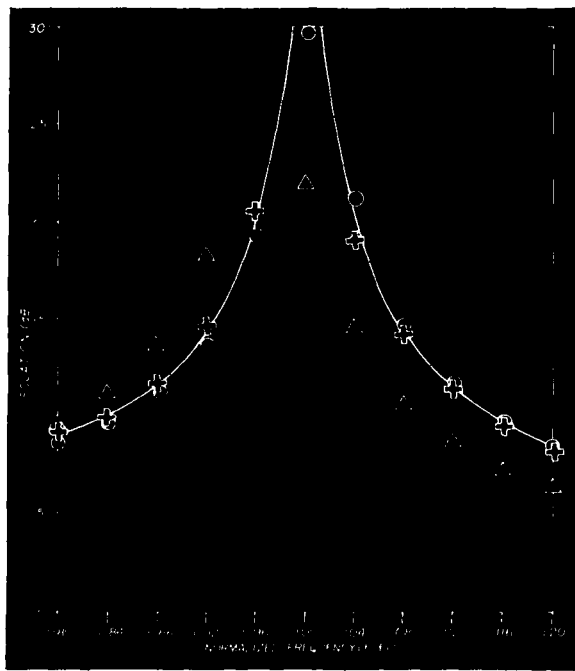

fig. 2B.

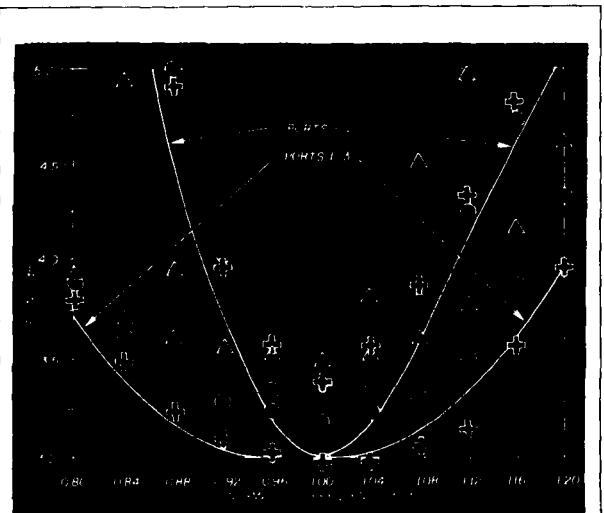
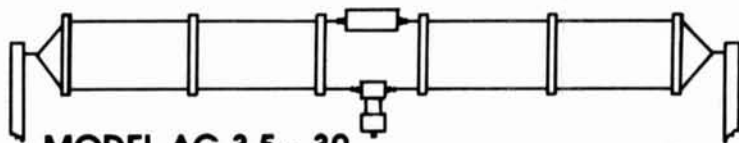

fig. 2C.

# CONTINUOUS COVERAGE FOLDED DIPOLE ANTENNA



**MODEL AC 3.5 - 30**  
(formerly Model 370-15)

- Fully Assembled • 52 OHM • Only 90 feet long
- SWR less than 2:1 from 3.5 thru 30 MHz. Average SWR 1.4:1
- Will handle 1 KW power (2 KW PEP)
- Can be installed as flat top, sloper, or inverted "V"
- Used the world over in government & commercial communication installations
- Ideal for all operations - amateur, commercial, MARS - any frequency from 3.5 - 30 MHz

**PRICE \$149.50**

PLUS \$3.00 Shipping and Handling

PATENTED

ALL OUR PRODUCTS MADE IN USA



**BARKER & WILLIAMSON**

Quality Communication Products Since 1932

At your Distributors. Write or call.

10 Canal Street, Bristol PA 19007

(215) 788-5581



## Iron Powder and Ferrite TOROIDAL CORES

Shielding Beads, Shielded Coil Forms  
Ferrite Rods, Pot Cores, Baluns, Etc.

Small Orders Welcome  
Free 'Tech-Data' Flyer

**AMIDON**  
*Associates*

Since 1963



12033 Otsego Street, North Hollywood, Calif. 91607

In Germany Elektronkladen, Wilhelm — Mellies Str 88, 4930 Detmold 18, West Germany  
In Japan Toyomura Electronics Company, Ltd., 7-9, 2-Chome Sota-Kanda, Chiyoda-Ku, Tokyo, Japan

✓ 109

## CALL LONG DISTANCE ON 2 METERS

Only 10 watts drive will deliver 75 watts of RF power on 2M SSB, FM, or CW. It is biased Class AB for linear operation. The current drain is 8-9 amps at 13.6 Vdc. It comes in a well constructed, rugged case with an oversized heat sink to keep it cool. It has a sensitive C.O.R. circuitry, reliable SO-239 RF connectors, and an amplifier IN/OUT switch. The maximum power input is 15 watts.



Our products are backed by prompt factory service and technical assistance. To become familiar with our other fine products in the amateur radio market, call or write for our free product and small parts catalog.

Model 875  
Kit \$109.95  
Wired & Tested \$129.95

**CCI** Communication Concepts Inc.

2648 North Aragon Ave. • Dayton, Ohio 45420 • (513) 296-1411



## New CMOS DTMF Chip Kit

Teltone's TRK-957 Kit makes it easier and less expensive to breadboard a low-power, central office quality DTMF detection system. All you need is a power source from 5 to 12 VDC. The sensitivity, wide dynamic range, noise immunity, and low-power consumption make the TRK-957 ideal for telephone switching, computer, and remote control applications. The TRK-957 DTMF Kit is only \$24.75. To order call:

(800) 227-3800, ext. 1130.

**TELSTONE** ✓ 207

## "LET'S COMPARE RTTY TUNERS"

Other RTTY tuners will tune Hi Tone and Lo Tone pairs by a "cross" display. They do an excellent job. Cost? Between \$295.00 and \$695.00.

"BLINKY" will tune Hi and Lo Tone pairs, International Shortwave, European Lo Tone pairs, Extra wide shifts,

Reverse tone signals and Commercial shifts. "BLINKY" will POSITIVELY IDENTIFY exactly the kind of shift you're receiving. IN ADDITION "BLINKY" will accurately tune SSTV, FAX and CW. It can also function as a very accurate alignment tool for SSTV, FAX and RTTY.

**"BLINKY"**  
SSTV-RTTY-FAX TUNER

COST? ONLY  
**\$99.95**

ORDER YOUR "BLINKY"  
TODAY!

"BLINKY", Model 959, measures only 2" x 3" x 5", and installs with no transceiver modification.

Model 60 power supply available for \$9.95.

FEATURED IN DAVE INGRAM'S "RTTY TODAY"

**TimeKit**

P.O. Box 22277  
Cleveland, OH 44122  
(216) 464-3820



Add \$2.00 for shipping and handling. Ohio residents add 8 1/2% sales tax.

✓ 208

## FCC LOWERS REQUIREMENTS — GET YOUR RADIO TELEPHONE LICENSE

FCC changes make obtaining a High-level Radio Telephone License much easier now. Eliminate unnecessary study with our short-cuts and easy to follow study material. Obtaining the General Radio Telephone License can be a snap! Sample exams, also section covering Radar Endorsement.

A small investment for a high-paying career in electronics.

**\$19.95 ppd.**

Satisfaction Guaranteed

**SPI-RO DISTRIBUTING**

P.O. Box 1538

Hendersonville, N. C. 28793

We now accept MC and VISA



✓ 204

one-half term occurs because the two output ports (2 and 3) are in parallel.

impedance ratio (ohms)	series arm (ohms)	shunt arm (ohms)
50/10 (5:1)	15.8	10.0
50/12.5 (4:1)	17.7	12.5
50/16.7 (3:1)	20.4	16.7
50/25 (2:1)	25.0	25.0
50/50 (1:1)	35.4	50.0

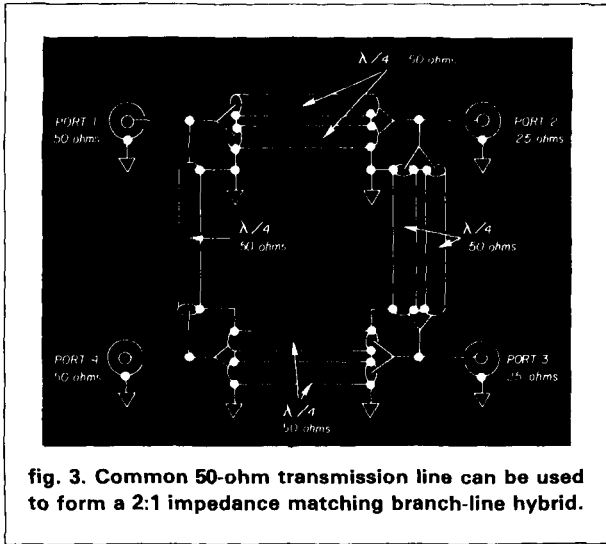

fig. 3. Common 50-ohm transmission line can be used to form a 2:1 impedance matching branch-line hybrid.

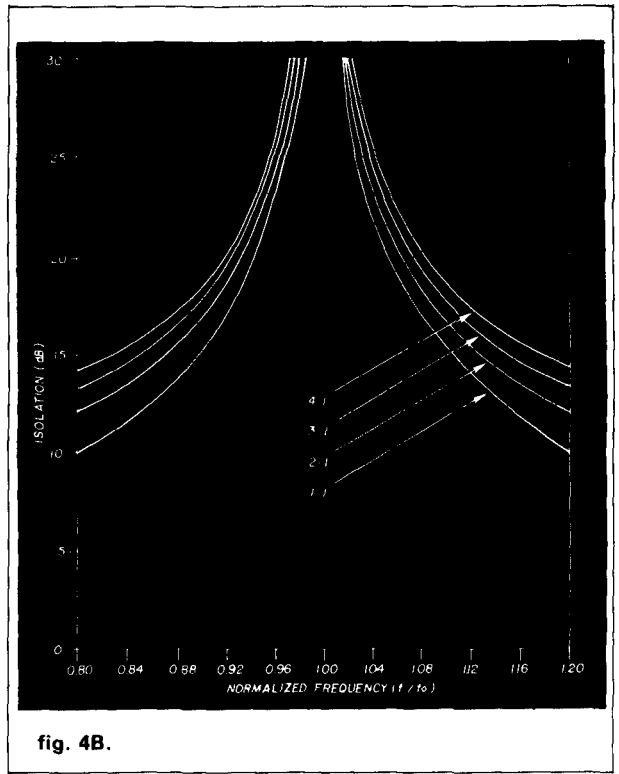

fig. 4B.

fig. 4. Theoretical response of transmission line branch-line hybrids used to transform 50 ohms to a lower value. 4A shows input return loss versus frequency; 4B shows isolation versus frequency; 4C shows coupling versus frequency.

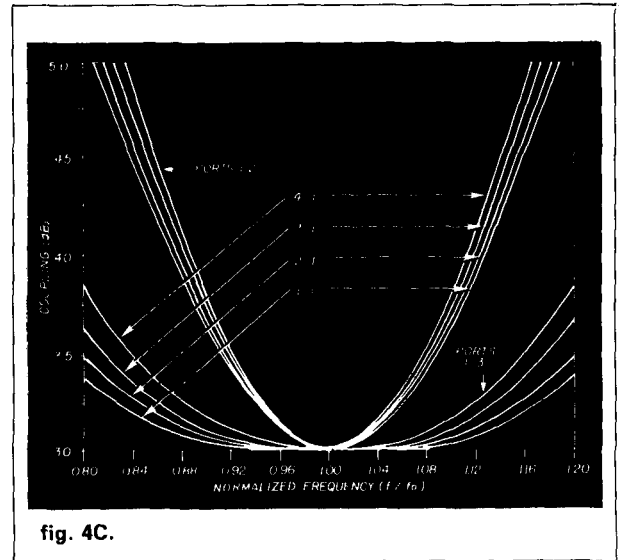
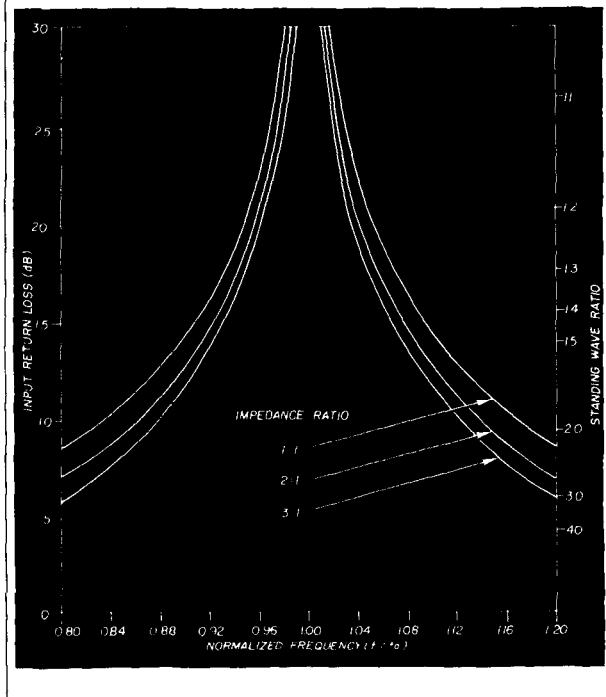

fig. 4C.

A convenient form of a 2:1 (50-ohm to 25-ohm) branch-line, impedance-matching hybrid is shown in fig. 3. The theoretical responses for several 50-ohm, input impedance matching branch-line hybrids are shown in fig. 4 for various impedance transformation ratios. The response does not degrade significantly, even for an impedance matching ratio of 4:1.

Lumped constants can also be used to form artificial transmission lines for an impedance transforming branch-line hybrid. The theoretical response, (fig. 5A),

fig. 5. Theoretical response of impedance-matching hybrids using lumped-constant components. 5A shows input return loss versus frequency; 5B shows isolation versus frequency; 5C shows coupling versus frequency.

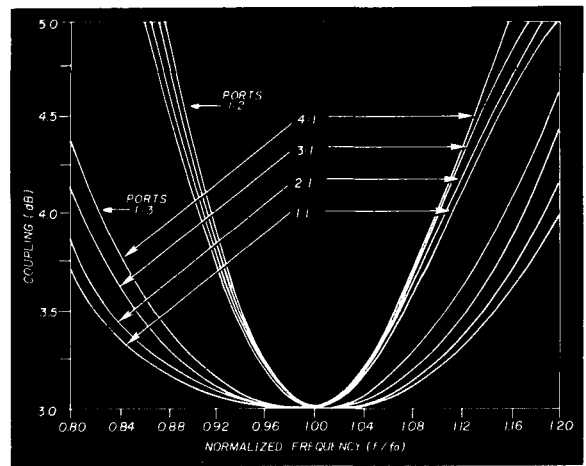
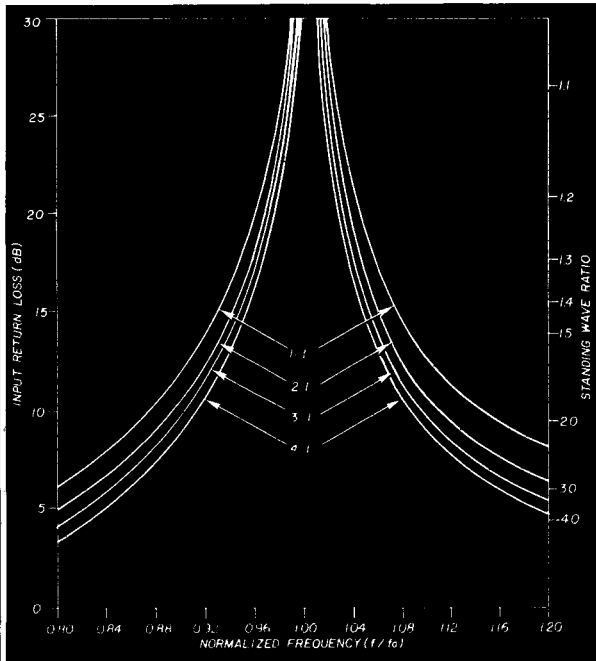

fig. 5C.

is only slightly degraded from that achieved using coaxial cable.

### PIN-diode attenuator

The PIN-diode attenuator circuit,<sup>3</sup> fig. 6, is included to demonstrate that the input match remains constant despite large variations in the loads placed at ports 2 and 3. The resistance of a PIN diode decreases with forward bias. With zero bias current, the coupler behaves as a terminated hybrid with maximum attenuation from port 1 to port 4. As the diodes are forward biased, the resistance decreases. When each diode has a resistance of approximately 50 ohms, the attenuator has a loss of 10 dB, fig. 7; the diodes represent a mismatch. The reflected signals at ports 2 and 3 add in phase at the output, port 4, and out of phase to

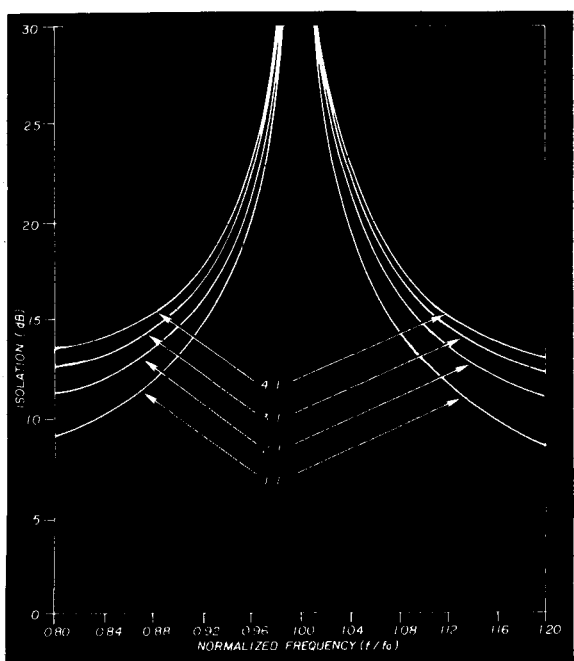

fig. 5B.

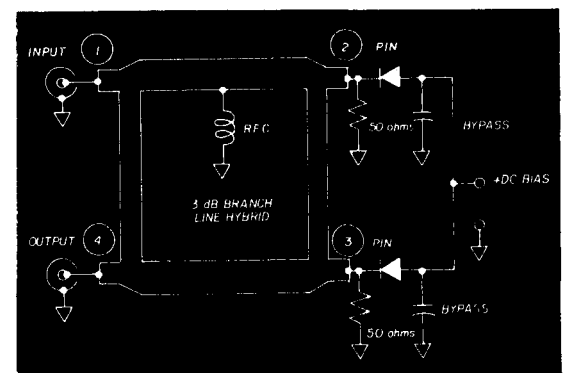

fig. 6. PIN diode attenuator with a constant input impedance of 50 ohms.



**ham radio** magazine **BOOKSTORE**

**NEW BOOKS**

**1984 38th EDITION WORLD RADIO AND TV HANDBOOK**

Shortwave listening is a fascinating way to add enjoyment to your radio hobby. The brand new 1984 edition is jam-packed with station addresses, frequencies, schedules and all the other information needed to get the most enjoyment out of SWL'ing. Also includes latest equipment reviews, handy hints and tips on how to improve reception and much more. It's the only complete reference guide to international broadcasting available today. ©1984.

WR-TV **Softbound \$17.50**

**THE SATELLITE EXPERIMENTER'S HANDBOOK**

In 1961, a new era was begun in Amateur Radio with the launch of the first Orbiting Satellite Carrying Amateur Radio, OSCAR. Since then, thousands of electronic hobbyists, around the world, have used OSCARs for communication, experimentation and for educational purposes. Besides Amateur satellites, this new League publication also carries information on Weather and TV Satellites. This book covers it all, in an easy-to-read format. Subjects include a wealth of information on satellites in orbit and satellite design as well as how to build a ground station and antennas. No matter what your interest, from beginner to expert, you'll find this book to be indispensable. ©1984.

AR-SE **Softbound \$10.00**

**RTTY TODAY**

**A Modern Guide to Amateur Radio Teletype**  
by Dave Ingram, K4TWW

Brand New and Fully up-to-date. Dave Ingram is a noted RTTY enthusiast. His clear, concise writing style and a wealth of illustrations, diagrams and photos, make RTTY as easy as 1-2-3! Extensive coverage is given to using home computers for RTTY. Eleven chapters start with an overview of RTTY operation, then give you coverage of operating parameters, computers, equipment you can build, dedicated systems and four chapters on RTTY SWL'ing info. 135 pages. ©1984. 1st edition.

UE-AR **Softbound \$8.95**

**1984 U.S. RADIO AMATEUR CALLBOOK**

This is the latest edition of the grand daddy of all the others. The Callbook is the only directory with an in-house editorial department that checks the FCC info as it comes in to ensure accuracy. U.S. and foreign hams swear this is the most important reference book in their files. Order your copy today. Ensure you have the very latest QSL information available at your fingertips. Over 410,000 listings. Also contains helpful and hard-to-find operating and station aids. ©1983.

CB-US84 **Softbound \$16.95**

**1984 FOREIGN RADIO AMATEUR CALLBOOK**

The only foreign callbook available! DXCC is the goal of many hams. To others, casual rag chews with foreign hams are the real joy of Amateur Radio. Whatever your interest, if you want a QSL, you should have a copy of the latest Foreign Callbook in your shack. Fully up-dated with the latest lists direct from the overseas licensing authorities. ©1983.

CB-F84 **Softbound \$15.95**

Please add \$2.50 to all orders for shipping and handling (USA). Foreign orders FOB Greenville.

**THE UHF COMPENDIUM**

by K. Weiner, DJ9HO

This 413 page book is an absolute must for every VHF and UHF enthusiast. Special emphasis has been placed on state-of-the-art techniques. Author Weiner fully describes test equipment, alignment tools, power measuring equipment and other handy gadgets. All of the projects and designs have been tested and proven and are not engineer's pipe dreams. Antennas are also fully covered with a number of easy-to-build designs as well as large mega-element arrays. ©1980.

KW-UHF **Softbound \$23.95**

**1984 ARRL RADIO AMATEUR'S HANDBOOK**

Known worldwide as THE standard reference for Radio Amateurs. Reserve your copy today and we will ship immediately as soon as it becomes available. Great for gift giving or for yourself. This book is jam-packed with just about every possible fact and figure you will ever need. Also has plenty of up-to-date projects. ©1983.

AR-HB **Softbound \$12.00**  
 AR-BB **Hardbound \$17.75**

**AMATEUR RADIO — THEORY AND PRACTICE**

by Robert L. Shrader, W6BNB

W6BNB's Electronic Communication has been considered the absolute "Cadillac" of radio theory license manuals. But the high price of this superb book has kept many from owning a copy. Now Mr. Shrader has come out with a book which presents just those parts of Electronic Communication which are necessary to pass all five classes of Amateur licenses. You save 1/3 off the price of the larger book. A complete guide to Amateur Radio including self-check examinations and quizzes. ©1982, 340 pages (taken from 4th Edition Electronic Communication).

MH-57146 **Softbound \$24.95**

**RF CIRCUIT DESIGN**

by Chris Bowick, WB4UHY

This book has been written for those who desire a practical approach to the design of rf amplifiers, impedance measuring devices and filters. Experts will find this book to be an invaluable reference source. Students will bridge from classroom studies to practical application. The hobbyist will find plenty of projects and design ideas. 7 chapters cover from basics to advanced design concepts. You get a complete design run down for multiple pole Butterworth, Chebyshev and Bessel filters. RF Circuit Design also includes a bibliography of books and technical papers to help further your knowledge of circuit design. ©1983, 176 pages, 1st edition.

21868 **Softbound \$22.95**

**ARRL ANTENNA BOOK 14th Edition**

The Amateur Antenna bible. Includes just about every bit of information you'd ever want to know about antenna design, construction and theory. Starts with wave propagation, antenna fundamentals and transmission line theory, progresses through coupling the transmitter and antenna to the feedline to 9 big, inclusive chapters on how to build different antennas. ©1982, 14th edition, 200 pages.

AR-AM **Softbound \$8.00**

**THE FCC RULE BOOK**

by Rick Palm, K1CE

This book is more than the FCC part 97 Amateur Rules and Regulations. It presents detailed explanations of rules and is written in an easy-to-read, conversational style. Palm gives you the insider's view of how FCC rules are made and how you can influence FCC decisions. You also get a broad overview of how international treaties and agreements impact your hobby. Every U.S. Amateur should have a copy of this most important and up-to-date book in their shack. ©1984, 2nd edition.

AR-RB **Softbound \$3.00**

**VHF-UHF MANUAL**

by G.R. Jessop, G6JP

This revised 4th edition is jam-packed with circuits, antennas, converters, cavity amplifiers and much, much more. Practical theory and construction projects cover from 70 MHz to 24 GHz. The chapter on Microwaves has been expanded to 83 state-of-the-art pages. Receiver and transmitters for all VHF and UHF bands are covered in 181 pages. The balance of this book contains information on propagation, tuned circuits, space communications, filters, test equipment, antennas, plus a handy easy-to-use data section. Equipment designed for the British 4 meter band can be adapted fairly easily to the U.S. 6 meter allocation. ©1983, 512 pages, 4th edition.

RS-VH **Hardbound \$17.50**

**AMATEURS LISTED BY AREA AND CALL SIGN**

1983-84 Edition

It's finally been done. A complete directory of all licensed Radio Amateurs in the U.S. at three-quarters the price of the other well-known book. Information taken from latest FCC list available. This book is a full 8 1/2" x 11" and is very easy to handle. Generic in appearance but, **oh what a value!** Over 410,000 licensed Amateurs listed. ©1983.

BM-CD **Softbound \$17.95**  
(\$14.95 + \$3.00 shipping)

**THE ARRL ANTENNA ANTHOLOGY**

by the ARRL staff

This book pulls together a wide selection of antenna articles from QST. Written for all levels and interests. Included are phased arrays, verticals, Yagi's, the bobtail curtain . . . even the VHF Quagi! Detailed instructions and full illustrations make this a really useful book for any Amateur. ©1979, 152 pages.

AR-AA **Softbound \$4.00**

**THE RADIO AMATEUR ANTENNA HANDBOOK**

by William I. Orr, W6SAI and Stuart Cowan, W2LX

Contains lots of well illustrated construction projects for vertical, long wire, and HF/VHF beam antennas. There is an honest judgment of antenna gain figures, information on the best and worst antenna locations and heights, a long look at the quad vs. the yagi antenna, information on baluns and how to use them, and new information on the popular Sloper and Delta Loop antennas. The text is based on proven data plus practical, on-the-air experience. 190 pages. ©1978, 1st Edition.

RP-AH **Softbound \$7.95**

**RADIOS THAT WORK FOR FREE**

by K. F. Edwards

It's not often that you can get something for nothing in this world. This book will tell you how to come as close to it as possible. "Radios that Work for Free" tells you how to build several circuits, each of which will provide you with music, news and entertainment while using only the intercepted power of the station itself. The parts used are inexpensive, or if you are a good scrounger and salvage expert, you'll find most of the parts for free, just as the signals are. Descriptions are amazingly complete. More than just a trip into nostalgia, the book is a lesson in basic radio principles and techniques — and you can dance to the results. 137 pages. ©1977.

HO-RWF **Spiralbound \$5.00**

**HAM RADIO LOGBOOK**

A real Ham Radio bestseller. Lies flat just like the other one . . . But uses both sides of each page to give you twice as many entries per book! Plenty of e-x-t-r-a features make this the Logbook for you. 8 1/2 x 11. ©1982.

HR-LB **Spiralbound \$1.95 ea.**  
**SPECIAL 3 Logs for \$4.95**

# DO YOU KNOW WHAT IS GOING TO BE THE HOTTEST SELLING ITEM AT DAYTON 84?

NO, IT'S NOT A NEW MODEL HANDHELD OR A FANCY DELUXE HF TRANSCEIVER . . . .



SHOW SPECIAL  
PRICE  
**\$19.95**

AMATEUR RADIO  
**HAMFEST!** ©1984  
FUN FOR THE ENTIRE FAMILY!

A simple roll of the dice, lets you begin to "build" your ham shack. Purchase all the ham gear spaced around the board (from the retail store) that you can afford to buy. Study hard for those F.C.C. tests to advance you from Novice to Extra! Beware of QRM interference and rejoice when getting those rare QSL cards. Hours of great fun for the entire family. Invite your other ham friends and standby for excitement!

**LIMITED QUANTITIES  
AVAILABLE AT BOOTH #279  
A5 ATV MAGAZINE**

Also Available By Mail Order  
Please include \$3.00 for postage & handling  
Send your order to :

**QCD MARKETING SERVICES**

A Division of QCD Publications, Inc.  
P.O. Box H  
Lowden, Iowa 52255

✓ 191

## Hi Pro Repeaters **ELCO**

MAGGIORE ELECTRONIC LAB.

**Manufacturers of Quality Communications Equipment**

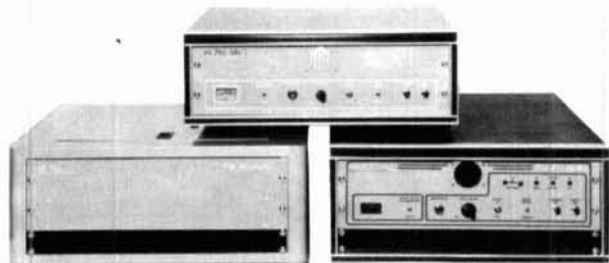

- Repeaters
- Links
- Remote Base
- Low Band VHF UHF
- Receivers
- Transmitters
- Antennas

- Standard and Computerized Controllers
- Standard and Computerized Auto Patches
- Duplexers

MAGGIORE ELECTRONIC LAB.

590 Snyder Ave.. Phone (215) 436-6051  
West Chester, PA 19380 Telex 499 0741 MELCO

**WRITE OR CALL FOR OUR COMPLETE CATALOG**

## RF DESIGNER

DATAPOINT, a Fortune 500 corporation, manufactures, markets and services local area networks, multifunction workstations, and dispersed computing and office automation systems worldwide. In 1977 we introduced the world's first local area network ARC® and ignited a revolution in business communications. A lead DATAPOINT still holds today!

If you are experienced in RF communications design in the 30-500 MHz range, our San Antonio headquarters has a career opportunity for you. Previous RF design experience is required and video knowledge is desired.

CALL  
**1-800-531-5770**  
**1-800-292-5106**  
(In Texas)

Join the #1 team in networking! DATAPOINT offers a competitive salary, excellent benefits and a superior relocation package. Ignite your career by calling or mailing your resume to: Technical Recruiter, Datapoint Corporation, 9725 Datapoint Drive, MSG-05-808, San Antonio, Texas 78284. We are an equal opportunity employer m/f/h/v. (refer to ad 808)

**DATAPOINT**  
We sparked the revolution.

cancel at the input, port 1. As the bias is increased the loss of the attenuator decreases. When the PIN diodes' resistance is about 3 ohms, the loss decreases to 1 dB.

### intermodulation performance

Even during a transmission the antenna operates as a receiving antenna for interference. Signals very close to the operating frequency,  $F_0$ , easily pass through

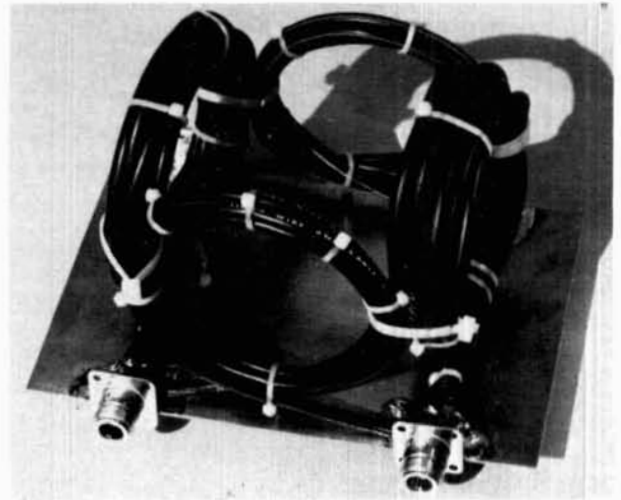

At VHF frequencies, hybrids can be easily formed using several quarter-wave sections of 50 and 75-ohm coaxial cable.

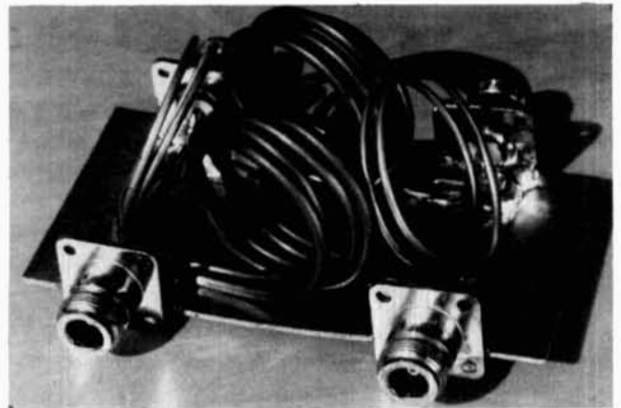
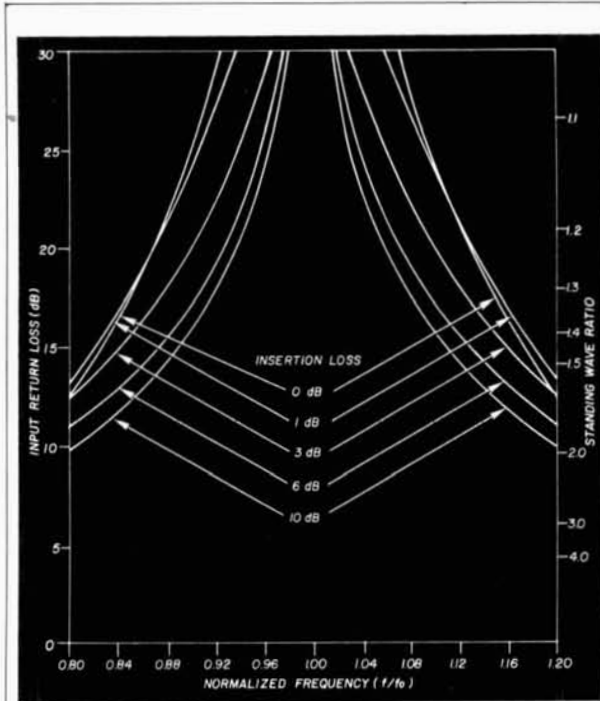

For lower frequencies the semi-rigid cable must be coiled to contain the hybrid.

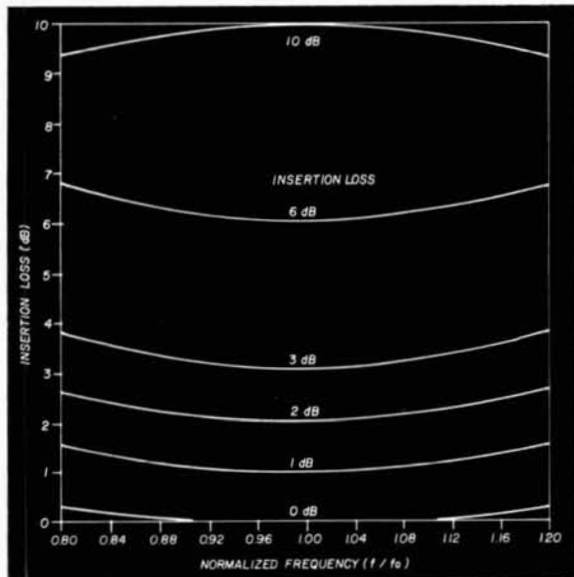
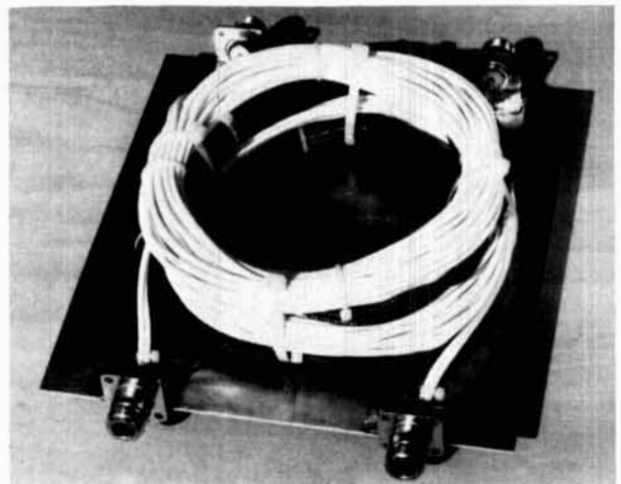

fig. 7. Input return loss remains greater than 15 dB (SWR  $\leq 1.5$ ) as the loss is varied between 0 and 10 dB.



At low frequencies the loss in miniature coaxial cable increases the insertion loss.

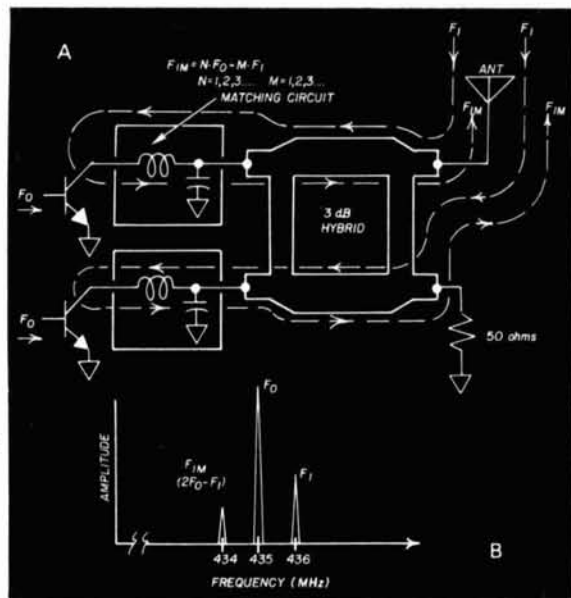

fig. 8. Intermodulation performance of a transmitter may be improved by adding a branch-line hybrid.

filters and arrive at the collectors of the final RF power transistors, fig. 8(A). Because the final stage is operated Class C, mixing products are produced at these

nonlinear transistor junctions. The most troublesome intermodulation product is produced by mixing the interfering signal,  $F_I$ , with the second harmonic of the operating frequency, fig. 8(B). That is,

$$F_{IM} = 2F_O - F_I \quad (6)$$

where  $F_{IM}$  is the intermodulation signal.

Because the collector ports of the branch-line hybrid<sup>4</sup> are offset by 90 degrees, the interfering signal must travel a quarter-wave longer from the antenna port to reach one collector compared with the other collector. The intermodulation product produced at the collector must also travel an additional quarter wave to reach the antenna port. Thus the intermodulation products from each collector will cancel at the antenna port because of the half-wave difference in round-trip paths.

### references

1. James R. Fisk, W1HR, "Microstrip Transmission Line," *ham radio*, January, 1978, page 28.
2. Ernie Franke, WA2EWT, "The Hybrid Ring," *ham radio*, August, 1983, page 50.
3. Henry H. Cross, W100P, "Low-Noise Preamplifiers with Good Impedance Match," *ham radio*, November, 1982, page 36.
4. Ernie Franke, WA2EWT, "Capacitively Coupled Hybrids" *ham radio*, March, 1983, page 70.

ham radio

## CQ CQ HAMS

### - SPECIAL OFFER TO LICENSED HAMS -

Do you think *Ham Radio* is the number 1 Amateur Publication?

Are you interested in Satellite Television?

Then why not read *Satellite TV Magazine*?

Believe me - this is the number 1  
Satellite TV Publication!

Now ... as a special offer to licensed amateurs only - we will send you a sample copy of *Satellite TV Magazine* for only \$1.00\* (Reg. \$2.95) and offer you an annual subscription for only \$19.95\* (Reg. \$24.95).

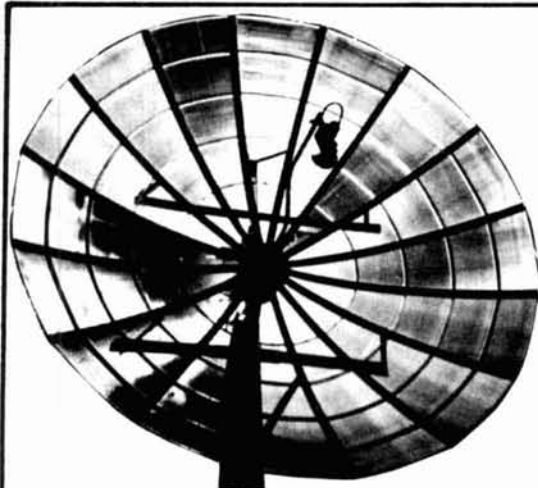

If you're still not convinced - QSX the Satellite TV Net each Sunday at 2:00 pm Eastern Time on 14.310 MHz and hear what the other HAMS are saying about *Satellite TV Magazine*.

Chris J. Schultheiss VE 2FRJ  
Editor & Publisher

Just give us your name and QTH

Name \_\_\_\_\_ Call \_\_\_\_\_

Address \_\_\_\_\_

State \_\_\_\_\_ Zip \_\_\_\_\_

Please Enclose Check or Money Order or if you prefer we accept Visa® & Mastercard®.

Card Number \_\_\_\_\_ Exp. Date \_\_\_\_\_

\*All Prices in US Funds.



Satellite TV Magazine  
P.O. Box 2384  
Shelby, North Carolina 28150



Call Toll Free  
✓ 226 1-800-438-2020





# RAMSEY

## THE FIRST NAME IN ELECTRONIC TEST GEAR



### NEW FROM RAMSEY-20 MHz DUAL TRACE OSCILLOSCOPE

Unsurpassed quality at an unbeatable price, the Ramsey oscilloscope compares to others costing hundreds more. Features include a component testing circuit that will allow you to easily test resistors, capacitors, digital circuits and diodes • TV video sync filter • wide bandwidth & high sensitivity • internal graticule • high quality rectangular CRT • front panel trace rotator • Z axis • high sensitivity x-y mode • very low power consumption • regulated power supply • built-in calibrator • rock solid triggering • high quality hook-on probes

**\$399.95** high quality hook-on probes included



#### RAMSEY D-1100 VOM-MULTIMETER

Compact and reliable, designed to service a wide variety of equipment. Features include • mirror back scale • double-jeweled precision moving coil • double over-load protection • an ideal low cost unit for the beginner or as a spare back-up unit.

**\$19.95**

test leads and battery included



#### RAMSEY D-2100 DIGITAL MULTIMETER

A compact easy to use unit designed to operate like a pro. Featuring • 3 1/2 digit LCD • low BAT. indicator • all range over-load protection • overrange indication • auto-polarity • Transistor tester • dual-slope integration • vinyl carrying case

**\$54.95**

hFE test leads, battery & vinyl carrying case included

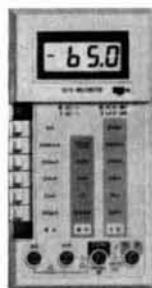

#### RAMSEY D-3100 DIGITAL MULTIMETER

Reliable, accurate digital measurements at an amazingly low cost • In-line color coded push buttons, speeds range selection • abs plastic tilt stand • recessed input jacks • over-load protection on all ranges • 3 1/2 digit LCD display with auto zero, auto polarity & low BAT. indicator

**\$59.95**

test leads and battery included



#### CT-70 7 DIGIT 525 MHz COUNTER

Lab quality at a breakthrough price. Features • 3 frequency ranges each with pre amp • dual selectable gate times • gate activity indicator • 50mV @ 150 MHz typical sensitivity • wide frequency range • 1 ppm accuracy

**\$119.95**

wired includes AC adapter

CT-70 kit ..... \$99.95  
BP-4 nicad pack ..... 8.95



#### CT-90 9 DIGIT 600 MHz COUNTER

The most versatile for less than \$300. Features 3 selectable gate times • 9 digits • gate indicator • display hold • 25mV @ 150 MHz typical sensitivity • 10 MHz timebase for WWV calibration • 1 ppm accuracy

**\$149.95**

wired includes AC adapter

CT-90 kit ..... \$129.95  
OV-1 0.1 PPM oven timebase ..... \$9.95  
BP-4 nicad pack ..... 8.95



#### CT-125 9 DIGIT 1.2 GHz COUNTER

A 9 digit counter that will outperform units costing hundreds more. • gate indicator • 24mV @ 150 MHz typical sensitivity • 9 digit display • 1 ppm accuracy • display hold • dual inputs with preamps

**\$169.95**

wired includes AC adapter

BP-4 nicad pack ..... 8.95



#### CT-50 8 DIGIT 600 MHz COUNTER

A versatile lab bench counter with optional receive frequency adapter, which turns the CT-50 into a digital readout for most any receiver • 25 mV @ 150 MHz typical sensitivity • 8 digit display • 1 ppm accuracy

**\$169.95**

wired

CT-50 kit ..... \$139.95  
RA-1 receiver adapter kit ..... 14.95



#### DM-700 DIGITAL MULTIMETER

Professional quality at a hobbyist price. Features include 26 different ranges and 5 functions • 3 1/2 digit, 1/2 inch LED display • automatic decimal placement • automatic polarity

**\$119.95**

wired includes AC adapter

DM-700 kit ..... \$99.95  
MP-1 probe set ..... 4.95



#### PS-2 AUDIO MULTIPLIER

The PS-2 is handy for high resolution audio resolution measurements, multiplies UP in frequency • great for PL tone measurements • multiplies by 10 or 100 • 0.01Hz resolution & built-in signal preamp/conditioner

**\$49.95**

wired

PS-2 kit ..... \$39.95



#### PR-2 COUNTER PREAMP

The PR-2 is ideal for measuring weak signals from 10 to 1,000 MHz • flat 25 db gain • BNC connectors • great for sniffing RF • ideal receiver/TV preamp

**\$44.95**

wired includes AC adapter

PR-2 kit ..... \$34.95



#### PS-1B 600 MHz PRESCALER

Extends the range of your present counter to 600 MHz • 2 stage preamp • divide by 10 circuitry • sensitivity 25mV @ 150 MHz • BNC connectors • drives any counter

**\$59.95**

wired includes AC adapter

PS-1B kit ..... \$49.95

#### ACCESSORIES FOR RAMSEY COUNTERS

Telescopic whip antenna—BNC plug ..... \$ 8.95  
High impedance probe, light loading ..... 16.95  
Low pass probe, audio use ..... 16.95  
Direct probe, general purpose use ..... 13.95  
Tilt ball, for CT-70, 90, 125 ..... 3.95



PHONE ORDERS CALL  
**716-586-3950**

TELEX 466735 RAMSEY CI

TERMS • satisfaction guaranteed • examine for 10 days, if not pleased, return in original form for refund • add 6% for shipping and insurance to a maximum of \$10.00 • overseas add 15% for surface mail • COD add \$2.50 (COD in USA only) • orders under \$15.00 add \$1.50 • NY residents add 7% sales tax • 90 day parts warranty on all kits • 1 year parts & labor warranty on all wired units

**RAMSEY**

RAMSEY ELECTRONICS, INC.  
2575 Baird Rd.  
Penfield, N.Y. 14626

We now have available a bunch of goodies too good to bypass. Items are limited so order today.

716-586-3950

Call your Phone Order in Today. TERMS: Satisfaction guaranteed or money refunded. C.O.D. add \$2.50. Minimum order \$6.00. Orders under \$10.00 add \$1.50. Add 6% for postage, insurance, handling. Overseas add 15%. N.Y. residents add 7% tax.

**MINI KITS - YOU HAVE SEEN THESE BEFORE NOW HERE ARE OLD FAVORITE AND NEW ONES TOO. GREAT FOR THAT AFTERNOON HOBBY.**

**FM MINI MIKE**

A super high performance FM wireless mike kit! Transmits a stable signal up to 300 yards with exceptional audio quality by means of its built in electret mike. Kit includes case, mike, on-off switch, antenna, battery and super instructions. This is the finest unit available.

FM-3 Kit **\$14.95**  
FM-3 Wired and Tested **\$22.95**

**Color Organ**

See music come alive! 3 different lights flicker with music. One light each for high, mid-range and lows. Each individually adjustable and drives up to 300 W runs on 110 VAC

Complete kit, ML-1 **\$8.95**

**Video Modulator Kit**  
Converts any TV to video monitor. Super stable, tunable over ch. 4-6. Runs on 5-15V accepts std. video signal. Best unit on the market! Complete kit, VD-1 **\$8.95**



**Led Blinky Kit**  
A great attention getter which alternately flashes 2 jumbo LEDs. Use for name badges, buttons, warning panel lights, anything! Runs on 3 to 15 volts. Complete kit, BL-1 **\$2.95**

**Super Sleuth**  
A super sensitive amplifier which will pick up a pin drop at 15 feet! Great for monitoring baby's room or as general purpose amplifier. Full 2 W rms output, runs on 6 to 15 volts, uses 8-45 ohm speaker. Complete kit, BN-9 **\$5.95**

**CPO-1**  
Runs on 3-12 Vdc. Alarm, Audio O. **SOLD OUT** Good for CPO. Complete kit **\$2.95**

**FM Wireless Mike Kit**

Transmits up to 300' to any FM broadcast radio, uses any type of mike. Runs on 3 to 9V. Type FM-2 has added sensitive mike preamp stage.

FM-1 kit **\$3.95** FM-2 kit **\$4.95**

**Whisper Light Kit**

An interesting kit, small mike picks up sounds and converts them to light. The louder the sound, the brighter the light. Includes mike, controls up to 300 W, runs on 110 VAC. Complete kit, WL-1 **\$6.95**

**Tone Decoder**

A complete tone decoder on a single PC board. Features 400-5000 Hz adjustable range via 20 turn pot, voltage regulation, 567 IC. Useful for touch-tone burst detection, FSK, etc. Can also be used as a stable tone encoder. Runs on 5 to 12 volts. Complete kit, TD-1 **\$5.95**



**Universal Timer Kit**

Provides the basic parts and PC board required to provide a source of precision timing and pulse generation. Uses 555 timer IC and includes a range of parts for most timing needs. UT-5 Kit **\$5.95**

**Mad Blaster Kit**

Produces LOUD ear shattering and attention getting siren like sound. Can supply up to 15 watts of obnoxious audio. Runs on 6-15 VDC. MB-1 Kit **\$4.95**

**Siren Kit**

Produces upward and downward wail characteristic of a police siren. 5 W peak audio output, runs on 3-15 volts, uses 3-45 ohm speaker. Complete kit, SM-3 **\$2.95**

**60 Hz Time Base**  
Runs on 5-15 VDC. Line current 125 mA. 1 min. month accuracy. TB-1 Kit **\$5.50**

**SATELLITE TV KIT**



image rejection, fully tunable audio to recover hidden subcarriers, divide by two PLL demodulator for excellent threshold performance, light tracking AFC to avoid drift, free reception, and of course, full 24 channel tunable coverage.

Build your satellite TV system around the R2B, close to ten thousand others already have and now it's available in kit form at a new low price. Order yours today.

THE POPULAR SAT-TEC RECEIVER IN KIT FORM!

**NEW, LOWER PRICES!**

Featured in a Radio Electronics magazine cover story (May 82), the reliable R2B Sat-Tec TV receiver is now operating in thousands of locations. The R2B is easy to build, pre-etched plated boards with screened component layout assures accurate component placement and the critical IF section and filters are pre-assembled and tested. Tools are included for the R2B kit. Case, power supply, descriptive operating manual as well as complete assembly instructions. Features of the receiver include, dual conversion design for best

A complete Satellite TV System requires a dish antenna, LNA (low noise amplifier), Receiver and Modulator.  
R2B Receiver Kit **\$295.00**  
R2B Receiver, Wired and Tested **\$385.00**  
120" K. LNA **\$285.00**  
RM3 RF Modulator **\$49.95**  
Prices include domestic UPS shipping and insurance.

**PARTS PARADE**

**IC SPECIALS**

LINEAR	TTL
301 <b>\$3</b>	74500 <b>\$ .40</b>
324 <b>\$1.50</b>	7447 <b>\$ .65</b>
380 <b>\$1.50</b>	7475 <b>\$ .50</b>
555 <b>\$ .45</b>	7490 <b>\$ .50</b>
556 <b>\$1.00</b>	74196 <b>\$1.35</b>

SPECIAL
567 <b>\$1.25</b>
741 <b>10/\$2.00</b>
1458 <b>\$ .50</b>
3900 <b>\$ .50</b>
8038 <b>\$2.95</b>

CMOS	FERRITE BEADS
4011 <b>.50</b>	With info and specs <b>15/\$1.00</b>
4013 <b>.50</b>	6 Hole Bead Kit <b>5/\$1.00</b>
4046 <b>\$1.85</b>	
4049 <b>.50</b>	
4059 <b>\$9.00</b>	
4511 <b>\$2.00</b>	
4518 <b>\$1.35</b>	
5639 <b>\$1.75</b>	

READOUTS	Sockets
FND 359 4" C.C. <b>\$1.00</b>	8 Pin <b>10/\$2.00</b>
FND 507 5" 5" C.A. <b>1.00</b>	14 Pin <b>10/\$2.00</b>
MAN 72/HP730 33" C.A. <b>1.00</b>	16 Pin <b>10/\$2.00</b>
HP 7651 43" C.A. <b>2.00</b>	24 Pin <b>4/\$2.00</b>
	28 Pin <b>4/\$2.00</b>
	40 Pin <b>3/\$2.00</b>

TRANSISTORS	Diodes	25 AMP 100V Bridge	Mini-Bridge 50V 1 AMP
2N3904 NPN C-F <b>15/\$1.00</b>	5 1 V Zener <b>20/\$1.00</b>	<b>\$1.75 each</b>	<b>2 for \$1.00</b>
2N3906 PNP C-F <b>15/\$1.00</b>	1N914 Type <b>50/\$1.00</b>		
2N4403 PNP C-F <b>15/\$1.00</b>	1KV 2Amp <b>8/\$1.00</b>		
2N4410 NPN C-F <b>15/\$1.00</b>	100V 1Amp <b>15/\$1.00</b>		
2N4916 PNP C-F <b>4/\$1.00</b>			
2N5401 PNP C-F <b>5/\$1.00</b>			
2N6808 C-F <b>4/\$1.00</b>			
2N3771 NPN Silicon <b>1.50</b>			
2N5179 UHF NPN <b>3/\$2.00</b>			
Power Tab NPN 40W <b>3/\$1.00</b>			
Power Tab PNP 40W <b>3/\$1.00</b>			
MPP 102/2N5484 <b>.50</b>			
NPN 3904 Type T-R <b>50/\$2.50</b>			
PNP 3908 Type T-R <b>50/\$2.50</b>			
2N3055 <b>.80</b>			
2N2846 UJT <b>3/\$2.00</b>			

Resistor Ass't	Crystals
Assortment of Popular values - 1/4 watt. Cut lead for PC mounting. 3" center. 1/2" leads, bag of 300 or more. <b>\$2.00</b>	3 579545 MHZ <b>\$1.50</b> 10 00000 MHZ <b>\$5.00</b> 5 248800 MHZ <b>\$5.00</b>

Switches	Earphones	Mini 8 ohm Speaker	Small State Buzzers
Mini toggle SPDT <b>\$1.00</b> Red Pushbuttons N.O. <b>3/\$1.00</b>	3" leads, 8 ohm good for small tone speakers, alarm clocks, etc. <b>5 for \$1.00</b>	Approx 2" diam Round type for radios, mike etc. <b>3 for \$2.00</b>	small buzzer 450 Hz 86 dB sound output on 5-12 vdc at 10-30 mA. TTL compatible. <b>\$1.50</b>

Slug Tuned Coils	AC Outlet
Small 3/16" Hex Slugs turned coil 3 turns <b>10 for \$1.00</b>	Panel Mount with Leads <b>4/\$1.00</b>

CAPACITORS	DC-DC Converter	Geramic IF Filters
TANTALUM Dipped Epoxy 1.5 uF 25V 3/\$1.00 1.8 uF 25V 3/\$1.00 22 uF 25V 3/\$1.00	+5 vdc input prod. -9 vdc @ 30ma -9 vdc produces -15vdc @ 35ma <b>\$1.25</b>	07 16V disk <b>20/\$1.00</b> 1 16V <b>15/\$1.00</b> 500 uF 20V Axial <b>3.50</b> 150 uF 16V Axial <b>\$1.00</b> 100 pf <b>20/\$1.00</b> 10 uF 15V Radial <b>10/\$1.00</b> 047 16V <b>20/\$1.00</b>

Crystal Microphone	9 Volt Battery Clips	Trimmer Caps
Small 1" diameter 1/2" thick crystal mike cartridge <b>.75</b>	Nice quality clips <b>5 for \$1.00</b> 1/4" Rubber Grommets <b>10 for \$1.00</b>	Sprague - 3-40 pf Stable Polypropylene <b>.50 ea.</b>

Parts Bag	Connectors
Ass't of chokes, disc. caps, tantal resistors, transistors, diodes, MICA caps etc. am bag (100 pc) <b>\$1.00</b> big bag (300 pc) <b>\$2.50</b>	6 pin type gold contacts for mA-1003 car clock module. <b>.75 ea.</b>

Leds	Vanectors
your choice, please specify Mini Red, Jumbo Red, High Intensity Red, Illuminator Red <b>8/\$1</b> Mini Yellow, Jumbo Yellow, Jumbo Green <b>8/\$1</b>	Motorola MV 2209 30 PF Nominal cap 20-80 PF - Tunable range - <b>50 each or 3/\$1.00</b>

Audio Prescaler
Make high resolution audio measurements, great for musical instrument tuning, PL tones, etc. <b>Multiplies audio UP in frequency</b> selectable x10 or x100, gives 01 HZ resolution with 1 sec gate time! High sensitivity of 25 mv, 1 meg input z and built-in filtering gives great performance. Runs on 9V battery, all CMOS. PS-2 kit <b>\$39.95</b> PS-2 wired <b>\$49.95</b>

600 MHz PRESCALER
Extend the range of your counter to 600 MHz. Works with all counters. Less than 150 mv sensitivity. specify -10 or -100. Wired, tested, PS-1B <b>\$59.95</b> Kit, PS-1B <b>\$49.95</b>

30 Watt 2 mtr PWR AMP
Simple Class C power amp features 8 times power gain. 1 W in for 8 out, 2 W in for 15 out, 4 W in for 30 out. Max output of 35 W. incredible value, complete with all parts, less case and T-R relay. PA-1, 30 W pwr amp kit <b>\$24.95</b> TR-1, RF sensed T-R relay kit <b>\$6.95</b>

MRF-238 transistor	Power Supply Kit
as used in PA-1 8-10db gain 150 mhz <b>\$15.95</b>	Complete triple regulated power supply provides variable 6 to 18 volts at 200 ma and +5 at 1 Amp. Excellent load regulation, good filtering and small size. Less transformers, requires 6.3 V 1/4 1 A and 24 VCT. Complete kit, PS-3LT <b>\$6.95</b>

RF actuated relay
senses RF (1W) and closes DPDT relay. For RF sensed T-R relay TR-1 Kit <b>\$6.95</b>

OP-AMP Special
BI-FET LF13741 - Direct pin for pin 741 con. input z, super low 50 pa input current. <b>50 for \$9.00</b> but 500,000 MEG power drain <b>10 for \$2.00</b>

SOLD OUT	Regulators
723 <b>3.50</b> 309K <b>\$1.15</b> 7805 <b>\$1.00</b>	7812 <b>\$1.00</b> 7815 <b>\$1.00</b> 7905 <b>\$1.25</b> 7912 <b>\$1.25</b> 7915 <b>\$1.25</b>

Shrink Tubing Nubs	Mini TO-92 Heat Sinks
Nice pre-cut pieces of shrink size 1" x 1/2" shrink to 1/4". Great for splices. <b>50/\$1.00</b>	Thermalloy Brand To-220 Heat Sinks <b>3 for \$1.00</b>

Opto Isolators - 4N28 type	Opto Reflectors - Photo diode + LED	Molex Pins	CDS Photo Cells
<b>\$1.50 ea.</b>	<b>\$1.00 ea.</b>	Molex already precut in length of 7. Perfect for 14 pin sockets. <b>20 strips for \$1.00</b>	Resistance varies with light. 250 ohms to over 3 meg. <b>3 for \$1.00</b>

## HY-GAIN

TH7DXS	7 element tribander	420 00
TH5MK2S	5 element tribander	365 50
EX-14	4 element tribander	276 00
TH3JRS	3 element 750W PEP	172 50
18AVT/WBS	5 band trapped vert	95 50
14AVQ/WBS	4 band trapped vert	58 65
V2S	2 meter omnidirectional	38 00
V4S	70 cm omnidirectional	48 50
HB-14Mag	2 meter mag mount	16 25
HB-144TLM	2 meter trunk mount	13 75
HG52SS	52 ft Self Supp Fnt Paid	923 00

## HY-GAIN ROTORS

HDR 300	25 sq ft	497 00
T2X	20 sq ft	261 60
Ham IV	15 sq ft	210 00
CD45II	8.5 sq ft	130 00

## ALLIANCE

HD73	10.7 sq ft rotor	105 50
U-110	3 sq ft rotor	44 00

## VAN GORDEN

PD8010	80 10 meter dipole kit	32 50
PD4010	40 10 meter dipole kit	28 75
PD8040	80-40 meter dipole kit	30 00
SD80	80 meter shortened dipole	26 25
SD40	40 meter shortened dipole	23 75

## MINI PRODUCTS

HQ-1	mini quad 6/10/15/20	148 30
B-24	mini beam 10/15/20	110 95

## ROHN

25G	10 ft stacking sect	48 30
25AG(2.3.4)	top sections	62 10
SB25G	short base section	20 65
AS25G	accessory shelf	10 85
45G	10 ft stacking sect	112 50
45AG(2.3.4)	top sections	122 85
SB45G	short base section	48 75
AS45G	accessory shelf	26 25
20G	10 ft stacking section	32 45
20AG	top section	35 90
BX-48	self supporting 6 sq ft	231 79
HBX-48	self supporting 10 sq ft	287 70
HDBX-48	self supporting 18 sq ft	358 65

## CUSHCRAFT

A-4	4 element tribander	279 00
A-3	3 element tribander	210 00
R-3	10 15 20 remote tuned vert	265 00
AV-5	5 band trapped vert	98 00
32-19	19 element 2 meter boomer	91 00
214B/FB	14 element 2 meter boomer	77 00
424B	24 element 70 cm boomer	77 00
416-1B	16 element OSCAR 435MHz	56 00
A144-10T	10 element OSCAR 145 9MHz	49 00
ARX-2B	2 meter vert 5 db gain	35 00
ARX-2	2 meter vert ringo ranger	28 00
AR-2	2 meter vert ringo	23 00

## KLM

KT34A	4 element triband	339 00
KT34XA	6 element triband	493 00
2m-14C	2M satellite ant	87 50
435-18C	70 cm satellite ant	61 00
CS-2	Circularly switch	59 95

## TET

HB433SP	3 Ele 7/14/21/28	276 00
HB433DX	3 Ele 7/14/21/28	374 00
HB33SP	3 Ele 14/21/28	247 00
HB43SP	4 Ele 14/21/28	275 00
HB33M	Mini 3 Ele 14/21/28	260 00
HB23M	Mini 2 Ele 14/21/28	205 00
SQ22	144MHz Swiss Quad	87 00
SQ10	28 MHz Swiss Quad	134 00
SQ61	50 MHz Swiss Quad	79 00
MLA-4	Loop 3 5/7/21/28	158 00
MV4BHR	Vert w/ Radials 7/14/21/28	107 00
MV4BH	Vertical 7/14/21/28	67 00
MV3AH	Vertical 7/21/28	55 00
MV3BH	Vertical 7/14/21	55 00
KR-500	Elevation Rotor	189 95

## HUSTLER

6RTV	6 band trapped vert	138 00
5BTV	5 band trapped vert	115 85
4BTV	4 band trapped vert	89 70
G7-144	7DB 2m Collinear	117 30
MO1-2	Mobile mast	20 15
RM 10 15	10 & 15 M mobile resonator (std)	10 00
RM 10 15	(sup)	15 80
RM 30	30 meter mobile resonator (std)	15 25
RM 40	40 meter mobile resonator (std)	15 80
RM 40	(sup)	22 15
RM 75 80	75 & 80 M mobile resonator (std)	16 70
RM 75 80	(sup)	33 95
BM 1	Bumper Mount	15 25
SSM 2	Stainless Ball mt	16 70
OD 1	Quick disconnect	13 25
SF 2	2 meter mobile 5-8 wave	10 00
SGM-2	2 meter 5-8 mag mt	25 60
HOT	Trunk mt w/ swivel ball	15 80

111

NO COD—we ship UPS daily

Allow two weeks for delivery

Shipping cost is NOT included except where noted

We reserve right to limit quantities

We gladly accept VISA &amp; MASTERCARD

703-938-3818

516 Mill Street, N.E.

Vienna, VA 22180

800-336-8473

All prices subject to change without notice

CABLE TV  
CONVERTERS  
VIDEO  
ACCESSORIES

BUY DIRECT &amp; SAVE

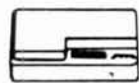
40 CHANNEL  
CONVERTER

\$38 Regular \$69

Advanced Solid State design and circuitry allows you to receive mid & super band channels. Restores programming to Video Recorders.

36 CHANNEL  
REMOTE CONTROL  
CABLE CONVERTER

\$88.00

DIAMOND D-56 WIRELESS  
THE ULTIMATE CABLE T.V.  
CONVERTER56 CHANNEL  
INFRARED  
REMOTE CONTROL

\$139.00

✓ 136

Send \$1 for Complete Catalog  
VISA • MASTERCARD • COD

## DIRECT VIDEO SALES

P.O. BOX 1329

JEFFERSONVILLE, INDIANA 47130

CALL

1-800-626-5533

AMAZING  
SCIENTIFIC and ELECTRONIC  
DEVICES

## LASER DEVICES

- LC5 BURNING CUTTING CO2 LASER ..... \$15 00
- RUB3 RUBY LASER RAY PISTOL ..... 15 00
- LRG3 IR LASER RIFLE/PISTOL ..... 10 00
- LUG3 VISIBLE RED LASER RIFLE ..... 10 00
- LHP/LLD LASER LIGHT XMTR/RCVR SYS ..... 10 00
- LHC2 BEGINNER simulated VISIBLE LASER ..... 5 00

## SCIENTIFIC &amp; ELECT

- TCL3 SOLID STATE TESLA COIL 35KV ..... 6 00
- BTC3 25C THOUSAND VOLT TESLA COIL ..... 9 00
- BTC5 1.5 MILLION VOLT TESLA COIL ..... 15 00
- HVM3 125 THOUSAND VOLT DC SUPPLY ..... 8 00
- IOG3 ION RAY FORCE FIELD GUN ..... 8 00
- HEG1 MILLION WATT 500 JOULE SOURCE ..... 10 00

## ULTRASONIC ACOUSTICAL

- PPF1 PHASOR PAIN FIELD GENERATOR ..... 15 00
- PSP3 PHASOR SHOCK WAVE PISTOL ..... 7 00
- IPG5 POCKET PAIN FIELD GENERATOR ..... 7 00
- RAT2 RAT AND PEST ELIMINATOR ..... 6 00
- HT9 HIGH FREQ. LISTENING DEVICE ..... 8 00

## SECURITY &amp; PROTECTION

- DEVI DEVASTATING DEVICES ..... 10 00
- PPG1 PHASOR PROPERTY GUARD ..... 15 00
- MFT1 MINI VOICE XMTR 2-3 MILE ..... 7 00
- INF1 INFINITY TRANSMITTER ..... 15 00
- PSW3 PHASOR BURNING STUN WAND ..... 8 00
- PG1 PARALYZING WAND ..... 10 00

WE STOCK ALL PARTS NECESSARY FOR  
CONSTRUCTION OF THE ABOVE PROJECTS

• CATALOG CONTAINING HUNDREDS MORE OF ALL NEW AMAZING and FASCINATING PLANS. EASY TO BUILD KITS AND ASSEMBLED ITEMS \$1.00. CATALOG INCLUDED FREE WITH ANY OF THE ABOVE PROJECT PLANS. SEND CASH, CHECK, MO, VISA, MC TO

## INFORMATION UNLIMITED

P.O. BOX 716, DEPT. HR AMHERST, NH 03031

✓ 159

Bind 'em  
and  
Find 'em

Keep those valuable issues of Ham Radio like new. Prevent smears, tears and dog ears. Bind 'em together and enjoy for years to come. You'll be happy you did!

## HAM RADIO BINDERS

Beautiful buckram bound, rich brown material with gold embossing. These binders will really dress up your collection of Ham Radio. Year stickers included.

☐ HR-BDL

\$6.95 ea.

3 for \$17.95

Please add \$2.50 for shipping  
and handling, U.S. onlyHAM RADIO'S BOOKSTORE  
GREENVILLE, NH 03048

# build a simple wire plow

Save time, effort  
with easy-to-build  
ground system  
installation aid

Any Amateur planning to erect a vertical antenna thinks long and hard about the labor involved in putting in the necessary number of radials. When I helped W7IR put in his radials, we used a small trencher, a tool used for installing the pipes for underground sprinkler systems. This worked fine, but it dug a trench much larger than was necessary for No. 14 wire, and replacing the soil after the wire was laid in was tedious work.

I had heard of the self-propelled wire plows used to install radials for broadcast stations, and I had seen one used in the installation of underground telephone lines. These tools simultaneously cut a slit in the ground and lay the wire. I wondered if it would be possible to make a smaller version of a wire plow that could be towed by a car or a garden tractor.

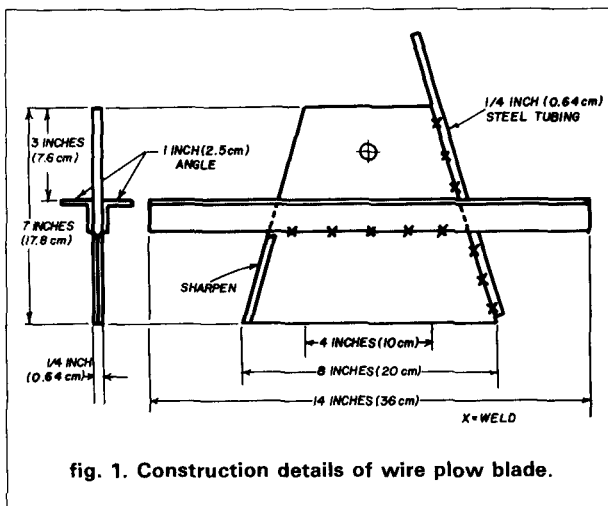

fig. 1. Construction details of wire plow blade.

My land was flat, reasonably unobstructed, and free of stones, at least to a depth of several inches. I convinced myself that the idea was practical. When I described my plans to friends at the local radio club, I got some skeptical comments, but my stubborn nature made me more determined than ever to go ahead. A little pencil-scratching produced a rough design, and the rest evolved as I went along.

Only the blade and some hardware had to be purchased. Everything else came from the scrap pile.

The blade, figs. 1 and 2, was cut from 1/4-inch (6.4 mm) sheet steel by a local blacksmith for \$10. I drilled the holes for fastening it to the frame and sharpened the leading edge on a bench grinder. For the wire guide, I bought a length of 1/4-inch (6.4 mm) steel brake line from an auto supply store. A friend with a welding outfit tack-welded it to the trailing edge of the blade (fig. 2).

## radials

I planned to put in 36 radials, spaced at 10 degree intervals. These would vary in length from 80 feet (24.4 m) to 120 feet (36.6 m), keeping them inside the property line. I found that I could buy 2000-foot spools of No. 14 bare copper wire (fig. 3) from an electrical supply house.

The first thing to do was calculate the points at the edges of the property where the radials would terminate; then, with a 100-foot (30.5 m) tape measure and a friend's help, drive stakes at these points. The radials would be laid from the stakes toward the center, where a concrete pad had been poured for mounting the antenna.

## plowing begins

I will admit that it was with some trepidation that the actual wire plowing was begun. I had invested a lot of time and labor in building the plow. Would it work?

At the first stake, W7IR and I dug a small hole, just large enough for the blade to enter the soil to its full depth. We drove a wooden stake into the hole and fastened the end of the wire to it (fig. 4).

I connected the plow to the trailer hitch on my car

By Harry R. Hyder, W7IV, 1638 Inverness Drive, Tempe, Arizona 85282

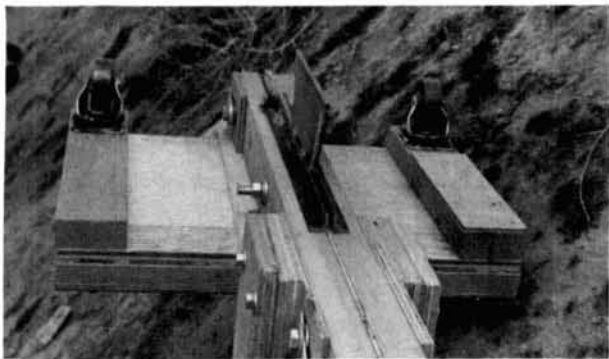

fig. 2. Bottom view shows blade, tack-welded to angle iron screwed into position. Wire guide tube is welded to trailing edge of blade (foreground).

with a tow cable. W7IR steered the plow (fig. 5). I shifted the car into its lowest gear and inched forward. After a few feet I stopped, jumped out, and ran back to see how it was going.

It was working perfectly!

We laid half of the radials that morning, and completed the job the following Saturday. It took less time to install all the radials than it took to build the plow.

Only one minor problem emerged: during construction of my house, the builders had buried some chunks of concrete, and these had to be removed before the plow could proceed.

There was no reason to fill in the narrow slits left by the plow. Natural erosion took care of this, and after a few months they were barely visible.

### securing the radials

In attaching the radials to the large sheet of copper on top of the concrete pad, I discovered that the copper sheet made a wonderful heatsink. My largest soldering iron — at the end of 200 feet of extension cable — could not solder the radials to the copper. A propane torch worked fine.

Another problem developed after the radials had been installed, but before the antenna was erected. The local telephone company, with their king-size wire plow, took a shortcut across the back of my property while laying a cable. While there was an eight-foot (2.5 m) easement running along the rear property line, specifically for utilities, they ignored this and cut several of my radials. (My radials did not extend into the easement.)

After working my way up through the telephone company bureaucracy, I was finally able to extract a promise that their cable would be relocated to its proper position; they did so a few months later. I chose to splice the severed radials myself.

Whether you can use a plow like mine depends on your circumstances. If your property is rocky and full of trees and brush, forget it. If it is clear with only light cover, the wire plow will work fine. It's a lot easier than using a pick and shovel!



fig. 3. Wire is fed from mounted spool through guide tube into trench.



fig. 4. Wire plow in position over starting hole. Handle guides plow; 100-pound sandbag provides necessary weight.



fig. 5. W7IR, shown here, guided plow while author drove 4 × 4 in low gear; plow can also be pulled by garden tractor or conventional auto.

ham radio

# THE STANDARD OF EXCELLENCE

*The world of CW, RTTY, and new DUAL AMTOR\* is as close as your fingertips with the new brilliantly innovative state-of-the-art microcomputer controlled EXL-5000E.*

**Automatic Sender/Receiver:** Due to the most up to date computer technology, just a console and keyboard can accomplish complete automatic send/receive of Morse Code (CW), Baudot Code (RTTY), ASCII Code (RTTY) and new ARQ/FEC (AMTOR).

**Code:** Morse (CW includes Kana), Baudot (RTTY), ASCII (RTTY), JIS (RTTY), ARQ/FEC (AMTOR).

**Characters:** Alphabet, Figures, Symbols, Special Characters, Kana. **Built-in Monitor:** 5" high resolution, delayed persistence green monitor — provides sharp clear image with no jiggle or jitter even under fluorescent lighting. Also has a provision for composite video signal output.

**Time Clock:** Displays Month, Date, Hour and Minute on the screen.

**Time/Transmission/Receiving Feature:** The built-in timer enables completely automatic TX/RX without operator's attendance.

**Select (Selective Calling) System:** With this feature, the unit only receives messages following a preset code. Built-in Demodulator for High Performance: Newly designed high speed RTTY demodulator has receiving capability of as fast as 300 Baud. Three-step shifts select either 170Hz, 425Hz or 850Hz shift with manual fine tune control of space channel for odd shifts. HIGH (Mark Frequency 2125Hz)/LOW (Mark Frequency 1275Hz) tone pair select. Mark only or Space only copy capability for selective fading. ARQ/FEC features incorporated.

**Crystal Controlled AFSK Modulator:** A transceiver without FSK function can transmit in RTTY mode by utilizing the high stability crystal-controlled modulator controlled by the computer.

**Photocoupler CW, FSK Keyer built-in:** Very high voltage, high current photocoupler keyer is provided for CW, FSK keying.

**Convenient ASCII Key Arrangement:** The keyboard layout is ASCII arrangement with function keys. Automatic insertion of LTR/FIG code makes operation a breeze.

**Battery Back-up Memory:** Data in the battery back-up memory, covering 72 characters x 7 channels and 24 characters x 8 channels, is retained even when the external power source is removed. Messages can be recalled from a keyboard instruction and some particular channels can be read out continuously. You can write messages into any channel while receiving.

**Large Capacity Display Memory:** Covers up to 1,280 characters. Screen Format contains 40 characters x 16 lines x 2 pages.

**Screen Display Type-Ahead**

**Buffer Memory:** A 160-character buffer memory is displayed on the lower part of the screen.

The characters move to the left erasing one by one as soon as they are transmitted. Messages can be written during the receiving state for transmission with battery back-up memory or SEND function.

**Function Display System:** Each function (mode, channel number, speed, etc.) is displayed on the screen.

**Printer Interface:** Centronics Para Compatible interface enables easy connection of a low-cost dot printer for hard copy.

**Wide Range of Transmitting and Receiving:** Morse Code transmitting speed can be set from

the keyboard at any rate between 5-100 WPM (every word per minute). AUTOTRACK on receive. For communication in Baudot and ASCII Codes, rate is variable by a keyboard instruction between 12-300 Baud when using RTTY Modem and between 12-600 Baud when using TTL level. The variable speed feature makes the unit ideal for amateur, business and commercial use.

**Pre-load Function:** The buffer memory can store the messages written from the keyboard instead of sending them immediately. The stored messages can be sent with a keyboard command.

**"RUB-OUT" Function:** You can correct mistakes while writing messages in the buffer memory. Misspellings can also be erased while the information is still in the buffer memory.

**Automatic CR/LF:** While transmitting, CR/LF automatically sent every 64, 72 or 80 characters.

**WORD MODE operation:** Characters can be transmitted by word groupings, not every character, from the buffer memory with keyboard instruction.

**LINE MODE operation:** Characters can be transmitted by line groupings from the buffer memory.

**WORD-WRAP-AROUND operation:** In receive mode, WORD-WRAP-AROUND prevents the last word of the line from splitting in two and makes the screen easily read.

**"ECHO" Function:** With a keyboard instruction, received data can be read and sent out at the same time. This function enables a cassette tape recorder to be used as a back-up memory, and a system can be created just like telex which uses paper tape.

**Cursor Control Function:** Full cursor control (up/down, left/right) is available from the keyboard. Test Message Function: "RY" and "QBF" test messages can be repeated with this function.

**MARK-AND-BREAK (SPACE-AND-BREAK) System:** Either mark or space tone can be used to copy RTTY.

**Variable CW weights:** For CW transmission, weights (ratio of dot to dash) can be changed within the limits of 1:3-1:6.

**Audio Monitor Circuit:** A built-in audio monitor circuit with an automatic transmit/receive switch enables checking of the transmitting and receiving state. In receive mode, it is possible to check the output of the mark filter, the space filter and AGC amplifier prior to the filters.

**CW Practice Function:** The unit reads data from the hand key and displays the characters on the screen. CW keying output circuit works according to the key operation.

**CW Random Generator:** Output of CW random signal can be used as CW reading practice. **Bargraph LED Meter for Tuning:** Tuning of CW and RTTY is very easy with the bargraph LED meter. In addition, provision has been made for attachment of an oscilloscope to aid tuning.

**Built-in AC/DC:** Power supply is switchable as required; 100-120 VAC; 220-240 VAC/ 50/60Hz + 13.8VDC.

**Color:** Light grey with dark grey trim — matches most current transceivers. **Dimensions:** 363(W) x 121(H) x 351(D) mm. Terminal Unit.

**Warranty:** One Year Limited

Specifications Subject to Change



*Everything built in — nothing else to buy!*

EXCLUSIVE DISTRIBUTOR:

**AMATEUR-WHOLESALE ELECTRONICS**

8817 S.W. 129th Terrace, Miami, Florida 33176

DEALER INQUIRIES INVITED

FOR YOUR NEAREST DEALER OR TO ORDER:

**TOLL FREE ... 800-327-3102**

Telephone (305) 233-3631

Telex: 80-3356



MANUFACTURER:

**TONO CORPORATION**

98 Motosoja Machi, Maebashi-Shi, 371, Japan

\*Dual Amtor: Commercial quality, the EXL-5000E incorporates two completely separate modems to fully support the amateur Amtor codes and all of the CCIR recommendations 476-2 for commercial requirements.

# VHF/UHF WORLD

Joe Reiser  
W1JR

In my February column,<sup>1</sup> I broached the subject of antenna performance but space did not permit a full treatment at that time; therefore, — and because this month's issue is dedicated specifically to antennas — I'll discuss several ways to determine antenna performance and offer some tips on how to obtain peak performance from the antennas you are now using.

## performance parameters

When it comes to measuring antenna performance, most Amateurs measure only VSWR, and in the case of a rotary beam, front-to-back ratio. Consequently, commercial antenna manufacturers usually try to make sure that these parameters are good. All other specifications of a commercial antenna (or someone else's design you are duplicating) have to be accepted more or less on faith! This is unfortunate; you're at the mercy of the designer and may not be obtaining the performance you think you are.

Gain is surely one of the most important antenna parameters. However, other antenna parameters such as beamwidth, front-to-back ratio, side lobe level, VSWR, feed system, wind load and structural strength are likewise important and may be indirectly linked to gain. With this in mind, I will try to give you some guidelines to evaluate antenna performance as well as various measurements you can perform with a minimum of test equipment. Finally some rules of thumb and graphs will be presented that can help

you approximate the gain and performance of your antenna or antenna system *even without test equipment!*

**Gain.** There is probably no other antenna parameter that is more widely discussed and confused by Amateurs than gain. *Gain is the property of an antenna which enables it to direct or radiate power in a desired direction as well as to receive signals from that same direction.* Note that when transmitting, an antenna doesn't really amplify or change the signal as in a power amplifier but does affect the direction of radiation similar to using a passive voice megaphone. Likewise, when receiving the antenna discriminates against noise and signals from undesired directions by not focusing on them. However, gain is a relative quantity that cannot be defined in terms of physical quantities such as watts or volts. Hence, gain must be referenced to something such as a dipole or an isotropic radiator (a theoretical antenna that radiates power equally well in every direction).

Herein lies the problem. *An isotropic radiator does not exist* (more on this later), but dipoles do! A lossless dipole has a theoretical gain of approximately 2.15 dB over an isotropic radiator, but a dipole is an extremely poor reference because it radiates power in many directions other than the desired one. This is why reflections from local objects, reflections from the ground, height above ground, and many other factors enter into the measurement of gain over a dipole.<sup>2</sup>

However, all is not lost! Over the years, VHF/UHF antenna manufacturers have developed acceptable gain standards that are accurate if properly used. The most common reference used by VHF/UHF Amateurs is the "EIA (Electronic Industries Association) Standard Antenna"<sup>3</sup> originally designed by Richard F.H. Yang.<sup>4</sup> It consists of two  $\lambda/2$  dipoles which are spaced  $\lambda/2$  apart and located  $\lambda/4$  above a square groundplane with one-wavelength sides. It is easily duplicated and often used at antenna gain measurement parties (more on this subject later) on 432 and 1296 MHz and has a gain of  $7.7 \pm 0.15$  dBd (dB over a lossless dipole) or 9.85 dBi (dB over an isotropic radiator). This antenna is often confused with the "NBS Standard Gain Antenna,"<sup>5</sup> which is considerably larger and has a gain of  $9.31 \pm 0.2$  dBd. On the microwave frequencies accurate pyramidal standard gain horns<sup>6</sup> specified in dBi are usually used because they can be accurately designed and tailored to the desired reference gain. *It really doesn't matter whether we reference gain to a dipole or an isotropic radiator as long as we indicate what the reference is!*

**Beamwidth.** This is probably the most important parameter because it tells you how wide an area you are transmitting to and receiving from. It should be intuitive that in order to increase gain, the beamwidth of the antenna must become narrower. Wide beamwidth implies low gain and narrow beamwidth suggests high gain.



You cannot have high gain with wide beamwidth! It will be shown later in this column that the beamwidth parameter of an antenna can be used to mathematically determine gain.

**Front-to-back ratio.** This is a frequently quoted but somewhat elusive parameter. Yes, high front-to-back ratio does imply a high gain, but this is not necessarily the only important parameter for high gain. In fact, small (2 to 5 elements) Yagi antennas optimized for gain frequently have higher gain when the front-to-back ratio is only 10 to 15 dB.<sup>7</sup> Likewise, once the front-to-back ratio exceeds 20 dB, further increases will have little or no effect on gain or noise temperature since the rear signal is already so far down from the front one. It must also be remembered that the front-to-back ratio is measured over a small angle to the rear of the antenna and can be difficult to measure accurately due to its narrow angular width and reflections from other objects in your local area. High front-to-back ratio will, however, cut down QRM from strong local stations directly off the rear of an antenna.

**Side Lobes.** It wasn't that many years ago that side lobes on common Yagi type antennas were only 10 dB down from the main lobe. A typical "E" plane (azimuth) pattern on a widely used 144, 432, and 1296 MHz Yagi antenna is shown in fig. 1.<sup>8,9,10</sup> Unfortunately, the presence of side lobes on an antenna pattern is almost a fact of life. The higher the gain of an antenna, the more likely you are to have a greater number of lobes. *What is really important is how far down these lobes are with respect to the main beam, because they represent additional signal and noise pickup as well as lower gain.*

Fortunately the NBS Yagi designs<sup>7</sup> (an NBS 4.2λ Yagi's E plane pattern is shown in fig. 2) and other more modern techniques,<sup>11</sup> sometimes involving computers,<sup>12</sup> have improved design parameters, especially on Yagi antennas. Suffice it to say that it is desirable for serious work to have side lobes down at least 13 to 15 dB from

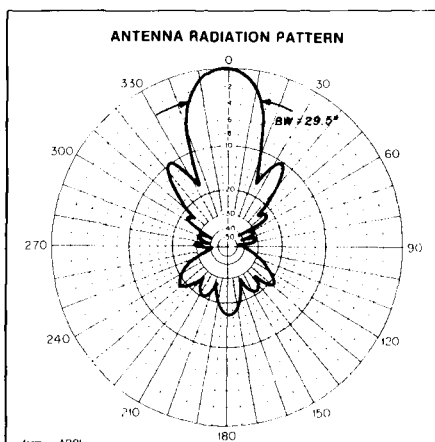

fig. 1. "E" plane plot of W2NLY/W6QKI 13-element 144 MHz Yagi. (See text and references 8, 9, and 10.) Note that beamwidth in "E" plane is approximately 29.5 degrees, and that the first side lobes are down only -10 dB. "H" plane beamwidth is the same (plotted on ARRL antenna radiation pattern paper.)

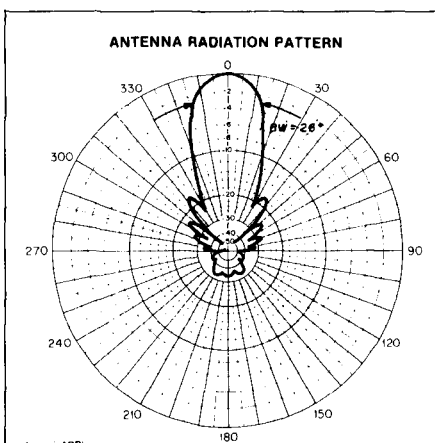

fig. 2. "E" plane plot of NBS 4.2λ 15-element Yagi adapted from reference 7. Note that the beamwidth is 26 degrees and "H" plane, not shown, is 29 degrees. First side lobes are down approximately -18 dB. (Plotted on ARRL antenna radiation pattern paper.)

the main forward lobe. What isn't always considered is that there may be numerous side lobes and therefore it is desirable to have all side lobes — not just the first one — down as far as possible, especially for EME operation.

**VSWR.** Antenna experts may tell you that you don't have to have a good VSWR to achieve full performance. However, VHF/UHFers have some slightly different problems than HFers

do mainly because of mismatch losses. Let me be more specific. In the typical VHF/UHF station, 1-2 dB transmission line losses are quite common. If your antenna VSWR is 3:1, there will be an additional mismatch loss of 0.5 to 0.8 dB.<sup>13</sup> Therefore, your actual transmission line loss will be 1.5 to 2.8 dB respectively! Good VSWR is particularly desired when two or more antennas are stacked and fed with an in-phase power divider. Furthermore, a mismatch can frequently cause the noise figure of a low-noise preamplifier to increase since the preamplifier is no longer "seeing" the optimum source impedance it was designed for. Fortunately this parameter is seldom a problem nowadays, since low VSWR (1.2:1 typically) is quite common on most VHF/UHF antennas in use.

**Feed System.** Most VHF/UHFers agree that for best performance, an antenna should have a balanced feed system. Gamma and similar unbalanced matching systems can cause problems such as radiation from the feedline or asymmetry in the antenna pattern — two things we don't want! In the last few years, I have been doing some testing on various feed systems for Yagi antennas. Over all, I feel that the optimum feed system is a "T" match with a built in λ/2 coaxial type balun. Feed systems and baluns are covered in detail elsewhere<sup>14</sup> so I will not spend any more time on them in this column.

**Wind Load.** The modern VHF/UHFer is starting to challenge the HFers when it comes to antenna size. As a result, more attention has to be paid to wind survivability. Suffice it to say that the optimum antenna should have the least number of elements necessary to attain the electrical specifications, especially when stacking is employed. Don't forget that the wind load will increase rapidly when a large diameter stacking frame is used. In this respect, it may be prudent when selecting Yagi antennas to use the fewest number of long Yagis rather than a larger number of smaller models. Only by calculating the overall wind load on the array<sup>15</sup> can

you be sure that your tower and rotator will adequately support the antenna.

**Structural Strength.** It wasn't too long ago that VHF/UHF Yagi antennas were almost always constructed with heavy-wall tubing. Nowadays it is becoming more popular to use various lengths of thin-wall tubing. As a result, more attention must be paid to tubing diameter, wall thickness, tubing overlap, and the hardware used to connect sections of tubing. Often overlooked is the fact that a 25-30 percent smaller width square tubing may have the same strength as its round cousin. Square tubing is usually much easier for the homebrewer to drill. Trusses are strongly recommended on long antennas especially where wind and ice are prevalent. Never skimp when choosing adequate size bolts and nuts with lockwashers. Stainless steel hardware, despite its initial higher cost, is highly recommended because it will not rust out at the least desirable moment!

**Preventive Maintenance.** One area in which I think we are all lax is in preventive maintenance. Time should be scheduled at least once a year for checking all bolts and nuts for tightness as well as cleaning corroded joints. All connectors should be checked for moisture or corrosion as well as coax shield integrity. I've had good luck keeping water out of connectors by using "Coax Seal."<sup>®</sup> One problem I've noticed over the years is "center pin creep," particularly on "N" and "LC" connectors, especially when extreme temperature variations are encountered. After connectors are in place for a while, and definitely where some pulling or twisting is present such as on a cable going around a rotator, the center pins may push forward or pull back. At the least opportune time the pin may disengage or break the connector pin to which it is mated.

There are two reasons why I've covered so much background material in this month's column. The first is that

<sup>®</sup> Registered trademark of Universal Electronics, Inc., 4555 Groves Rd., Columbus, Ohio 43232.

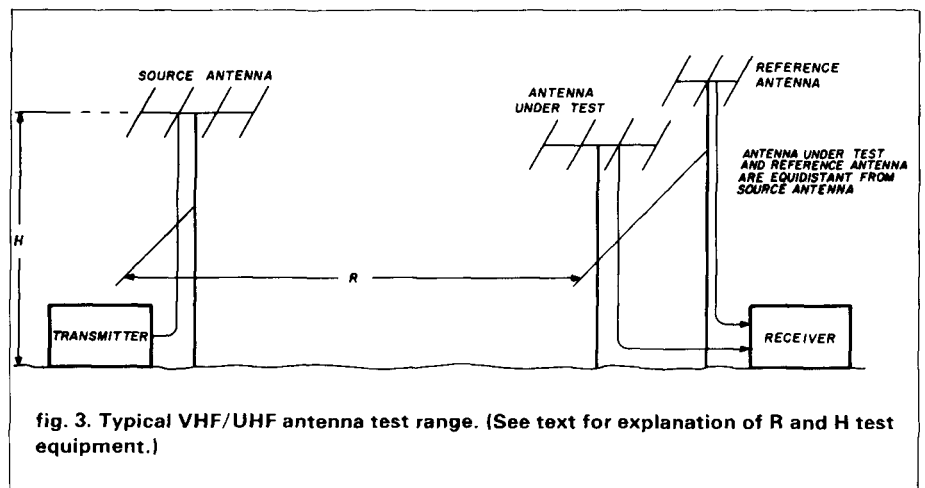

fig. 3. Typical VHF/UHF antenna test range. (See text for explanation of R and H test equipment.)

I wanted you to be aware of all the areas that should be considered in the selection of a VHF/UHF antenna, whether it be homebrew or purchased. The second reason is that certain parameters can be used to determine other parameters. Furthermore, in some cases you may be able to substitute tests or just evaluate a data sheet parameter to determine other performance data on an antenna *but only if these parameters are well understood!* Read on.

### making measurements

**Antenna Gain.** This is probably the parameter you are most interested in testing. Gain can be measured on an antenna range. (A typical antenna range is shown in fig. 3.) A low-power transmitter is set up at one end and the antenna under test at the other end of the range. The transmitter is usually low power (1 watt maximum) with 1 kHz amplitude modulation. Typical circuitry has been published<sup>16</sup> for 144 MHz, and other frequencies through 432 MHz can be generated using the circuitry in my column in the March, 1984, issue of *ham radio*<sup>17</sup>. Note that the distance between the transmitter and receiver, "R," should be at least  $2D^2/\lambda$  where D is the largest aperture dimension of the antenna and  $\lambda$  is the free space wavelength in the same units as D. I find that this yields only a 1.0 dB accuracy and hence I recommend  $10D^2/\lambda$ , which should yield 0.2 dB or better accuracy. "H" is the

height of the source antenna and is described in detail in reference 2.

Basically what takes place is that the antenna under test is compared to the gain of a reference standard or antenna with a known gain, as discussed earlier in this article. Then the difference in gain between the two antennas is added to or subtracted from the reference as required to obtain the true measured gain. Many factors must be taken into consideration, but they are all well documented elsewhere.<sup>2,18</sup>

I want to point out that many VHF/UHFers have become quite competent at measuring gain and their results have been quite instrumental in making antenna designers "more honest" when it comes to gain specifications. We are very fortunate here in the USA in that antenna measuring parties are becoming quite common. They are usually held at various conferences such as the Central States VHF Conference, the West Coast VHF Conference, the Eastern VHF/UHF Conference, and more recently, at the Dayton Hamvention (did I miss anyone?), *weather permitting* of course. Therefore, if you want to measure the gain of your favorite antenna, attend one of these gatherings and see for yourself how the tests are conducted, as well as how your antenna stacks up against the competition!

So, you say, how do I measure antenna gain without assembling all this test gear? I'm glad you asked. There

is a way you can obtain reasonable performance evaluation using your own equipment. You'll note that earlier I mentioned the importance of knowing the half-power (-3 dB) beamwidth of your antenna because it is the most important parameter in terms of actual antenna gain. Measuring the beamwidth of an antenna is not a difficult task if you have a rotator with reasonable relative accuracy in the azimuthal plane.

It almost takes longer to explain the test procedure used to measure beamwidth than it takes to do the actual test. The idea is to first peak your antenna on a test signal such as a local Amateur *not on an obstructed path*, preferably near the frequency of interest ( $\pm$  QRM!). Note this reference level on your receiver "S" meter. Then rotate the antenna until the signal drops by 3 dB or about one half an "S" unit. This should be done as carefully as possible to maintain accuracy. Carefully note the direction. Now rotate the antenna toward the other direction, through the peak, and note the half-power point on the other side of boresight (boresight as in "straight ahead," and in this case, maximum response). Subtract the readings to obtain the true half-power beamwidth of the antenna under test. Then check how far down the first side lobes are and note this value for future reference.

The easiest way to insure "S" meter calibration accuracy of the half-power point is to place a 3 dB attenuator pad (as described below) in your IF line. (Note that attenuator accuracy is usually easier to obtain at lower frequencies). However, you can put the attenuator at the antenna input to your receiver if you have an accurate pad for the frequency of interest. For more accurate results, it is better to use three separate 3 dB pads, one ahead of, and one behind the reference pad as shown in **fig. 4**. This insures that the 3 dB reference is relatively unaffected by any impedance mismatches on the line.

An improvement in accuracy can usually be obtained by reversing the procedure as follows: first place the refer-

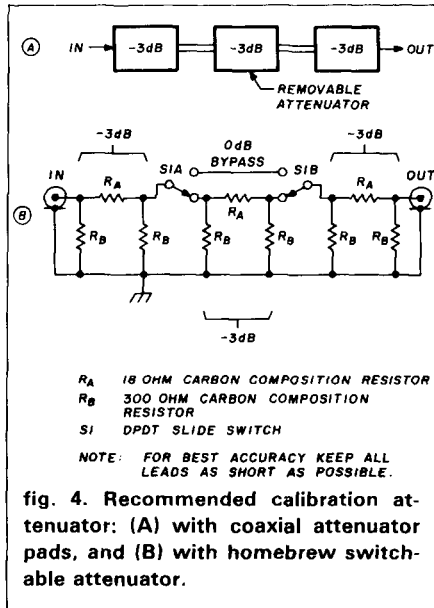

ence 3 dB attenuator in the line per **fig. 4** and peak your antenna on the signal of interest, noting the reading on your "S" meter. Next remove this attenuator. The signal will increase, hopefully by 3 dB, but the reading is not important. Next rotate the antenna to either side of boresight until the meter returns to the original value before the attenuator was removed. The rotator directions indicated are the -3 dB points.

If this test is too difficult or too time-consuming to perform, you may want to try a less accurate but faster method. Basically you modify the above procedure this way: first peak the antenna on the test signal and then rotate the antenna in either direction for the first null. Note the direction of the null and rotate back through boresight for the corresponding null on the other side of the pattern. Subtract the rotator readings. The antenna 3 dB beamwidth is approximately 47.5 percent of the difference between nulls.<sup>19</sup> For example, if the first nulls are 60 degrees apart, the approximate 3 dB beamwidth is 28.5 degrees.

Finally we're ready to apply your test results to see what the gain of your antenna really is! Many years ago John Kraus, W8JK, pointed out that the gain of an antenna could be roughly approximated if the "E" and "H" beam-

widths of an antenna were known.<sup>20</sup> He also noted that the method was accurate only if the antenna beamwidth is narrow (less than 27 degrees), the side lobes are low (greater than 30 dB down), and the feed system is highly efficient. The equation he derived is:

$$G = \frac{41253}{\theta_E \times \theta_H} \quad (1)$$

where  $G$  is the directivity gain as a numeric (Gain in dB =  $10 \log_{10} G$ ) over an isotropic antenna and  $\theta_E$  and  $\theta_H$  are the antenna -3 dB beamwidth in degrees in the horizontal and vertical plane.

Over the years this equation has been widely accepted by the professional antenna community where -20 to -30 dB side lobes are quite common. This formula also seems to be usable over a much greater range of beamwidths than originally intended with surprising accuracy if the side lobes are low. I have noticed that if you use the following equations, you can also account for side lobes and thus improve accuracy even further.

$$G = \frac{38400}{\theta_E \times \theta_H} \text{ for } -25 \text{ dB side lobes} \quad (2)$$

$$G = \frac{35000}{\theta_E \times \theta_H} \text{ for } -20 \text{ dB side lobes} \quad (3)$$

$$G = \frac{32600}{\theta_E \times \theta_H} \text{ for } -15 \text{ dB side lobes} \quad (4)$$

$$G = \frac{30000}{\theta_E \times \theta_H} \text{ for } -10 \text{ dB side lobes} \quad (5)$$

To save you some time and math I have drawn a graph (**fig. 5**) which includes not only the answers to **eq. 1** directly in dBi, but also includes the answers to **eq. 5** for -10 dB side lobes. You can easily interpolate for intermediate side lobe levels or just use the appropriate equation above.

Let's take a few examples to see how this system works. In **fig. 1**, we see that the beamwidth of this once-popular Yagi antenna is approximately 29.5 degrees and the side lobes are down approximately -10 dB. Now locate 29.5 degrees on the graph in **fig. 5**. If we were to ignore the side lobes (as the original authors did in reference 8), and use the upper line, the gain would be 16.8 dBi or 14.65 dBd. However, if you account for the side lobes per **fig. 5**, and therefore use the

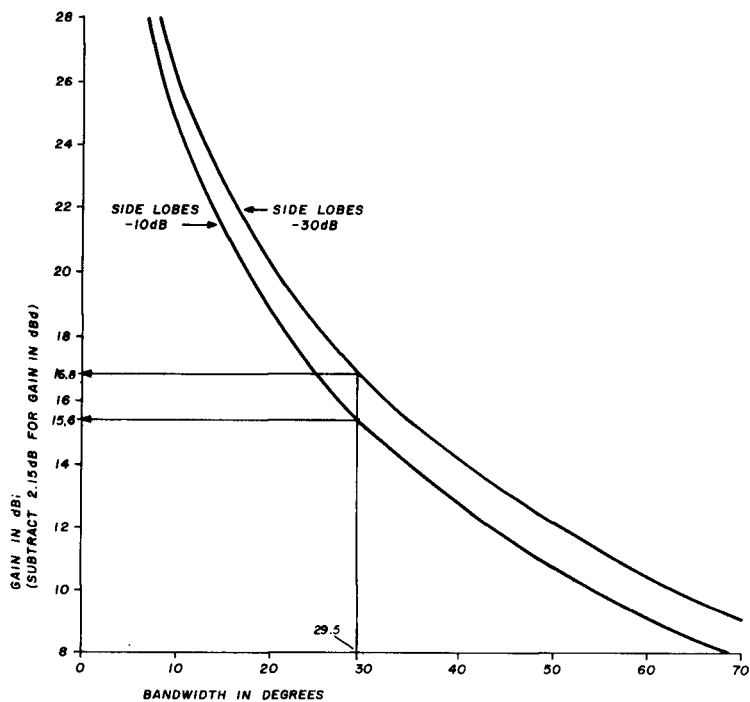

fig. 5. Beamwidth versus gain for antennas with square aperture and  $-30$  dB side lobes or  $-10$  dB side lobes. (See text for example shown.)

lower line on the graph, the gain is only 15.4 dBi or 13.25 dBd, a gain figure that was often measured on this Yagi on a good antenna range.

Next let's look at the NBS  $4.2 \lambda$  Yagi in fig. 2 which has a 26 degree beamwidth and  $-18$  dB sidelobes. Using the upper line on the graph for no side lobes we see a gain of 18 dBi or 15.85 dBd but using eq. 4 for 15 dB side lobes we obtain 16.83 dBd or 14.58 dBi. So you say NBS claims 16.35 dBi or 14.2 dBd? Well, I've left out one small factor. Some antennas do not have the same beamwidth in both planes. The error, however, is usually slight for antennas with rectangular apertures such as the Yagi. The "H" plane beamwidth for the NBS  $4.2 \lambda$  Yagi is actually 29 degrees. If we go back and recalculate these numbers using eq. 4 we obtain a gain of 16.35 dBi or 14.2 dBd. Not bad accuracy for just using simple equations!

As you've probably surmised, you needn't go through all this testing if you have accurate antenna data. In this respect, the commercial antenna manufacturers and Amateur designers usually include beamwidth data since it is easy to measure accurately. Now

you can check the gain figures claimed and see how honest they are! (Always make sure that you use the correct data since some sources quote *half-beamwidth*. In this case, just double the number and proceed as shown above. And remember, is the gain quoted in the optimistic *dBi* figure or the lower *dBd*?

**Other Testing.** The front-to-back ratio can be tested using the methods above but may be influenced by local reflections and the accuracy of your rotator. If it is over 15 to 20 dB down from the main lobe, it is probably acceptable. VSWR, on the other hand, should always be tested before the antenna is raised to its final resting point as mentioned in the next section. Use a good VSWR indicator, not the "Monimatch" type. I recommend that you buy or borrow a Bird model 43 or equivalent with the appropriate power slug. If VSWR is not 1.2:1 or better, try to adjust the match until the optimum is attained. If it's above 1.5:1, you probably have trouble and better find the problem and fix it before placing the antenna in its final location!

**Caveat Emptor.** Sometimes commercial manufacturers make errors. This can sometimes be irritating even when the problem is simple and easily detected, such as in the case of a missing part. It's the undetected errors that cause real inconvenience — such as a wrong element length, for example, or a hole drilled in the wrong place in the boom. It is very easy to assemble directors on a Yagi improperly when the elements do not taper in a linear fashion. Nowadays most antenna manufacturers include mechanical drawings with element lengths and spacings clearly marked. *After final antenna assembly check carefully to see that all dimensions agree exactly!* If they don't, try to locate the source of the problem. If it is not obvious, contact the manufacturer and *get the problem resolved before you put the antenna on a tower.*

Let me share with you some problems I've encountered over the years so that you'll be alerted to things that can and do happen. One manufacturer copied another's design, forgot to correct the element lengths for a different element attachment method, and therefore had very high side lobes. Another drilled a boom improperly and thereby placed one director several inches off the proper location, causing high VSWR and poorer pattern. Another apparently had a mechanical resonance in the boom. The forward boom section would vibrate at certain wind speeds and eventually fall off because of metal fatigue. This was easily corrected by placing some weight inside the boom to dampen the effect.

One manufacturer uses end caps on certain elements. Neglecting to use these or having them fall off after mounting causes VSWR to increase. Some manufacturers use connectors that are screwed in place; during assembly, check these to make sure they are properly tightened. Another recent problem was a connector plate that was reversed during manufacturing and hence caused the antenna phase to be reversed by 180 degrees. This is not a problem with a single antenna, but a null on boresight can occur when the new antenna is stacked with a properly built model.

Most of these problems could have been caught prior to installation if the assembler paid attention to details, especially by cross-checking with the mechanical diagrams enclosed with the antenna. A VSWR check with the antenna mounted a wavelength or more above ground could also have pointed out other problems. Still other anomalies could have been noticed by testing the beamwidth, side lobes, and other parameters, using tests just described.

## summary

In the past this information on determining antenna performance has been scattered throughout many different articles, with the gain methods mentioned, seldom used by Amateurs, buried in the math or appendices at the end, with little explanation. I hope that this column has provided some practical guidance and that you will use it to compare one antenna's performance against another's. I'll refer to this information in future columns;

good luck in selecting or evaluating your antenna!

## references

1. Joe Reisert, W1JR, "VHF/UHF Antennas and Antenna Systems, *ham radio*, February, 1984, page 46.
2. Dick Turrin, W2IMU, "Antenna Performance Measurements," *QST*, November, 1974, page 35.
3. "Minimum Standards for Land-Mobile Communications Antennas, Part 1 — Base or Fixed Antennas," EIA Standard RS-329A.
4. Richard F.H. Yang, "A Proposed Gain Standard for VHF Antennas," *IEEE Transactions on Antennas and Propagation*, November, 1966, page 792.
5. H.V. Cottony, "Methods for Accurate Measurement of Antenna Gain," *NBS Report 5539*, November 18, 1957.
6. Henry Jasik, *Antenna Engineering Handbook*, Chapter 10, McGraw-Hill, 1961.
7. P. Viezbicke, "Yagi Antenna Design," *NBS Technical Note 688*, now out of print. (See *ham radio*, August, 1977, pages 22-31, for a summary of same.)
8. James A Kmosko, W2NLY, and Herbert G. Johnson, W6QKI, "Long Long Yagis," *QST*, January, 1956, page 38.
9. "The K2RIW 13-Element 432-MHz Yagi," *ARRL Antenna Handbook*, 13th Edition 1974, page 243.
10. Reed Fisher, W2CQH, "A Successful 1296-MHz Yagi," *ham radio*, May, 1972, page 24.
11. Günter Hoch, DL6WU, "Extremely Long Yagi Antennas," *VHF Communications*, Autumn, 1982.
12. James L. Lawson, W2PV, "Yagi Antenna Design Experiments Confirm Computer Analysis," *ham radio*, February, 1980, page 19.

13. *The ARRL Antenna Handbook*, 14th Edition, page 3-12.
14. Joe Reisert, W1JAA, "Feeding and Matching Techniques for VHF and UHF Antennas," *ham radio*, May, 1976, page 54.
15. John J. Nagle, K4KJ, "How to Calculate Wind Loading on Towers and Antenna Structures," *ham radio*, August, 1974, page 16.
16. Joe Reisert, W1JAA, "Matching Techniques for VHF/UHF Antennas," *ham radio*, July, 1976, page 50.
17. Joe Reisert, W1JR, "VHF/UHF Receivers," *ham radio*, March, 1984, page 42.
18. Richard T. Knadle, K2RIW, "Antenna Ratiometry," *QST*, February, 1976, page 22.
19. Private communications with Günter Hoch, DL6WU.
20. John D. Kraus, Ph.D., "Antennas," page 25, McGraw-Hill.

## Important VHF/UHF Events in May, 1984:

- May 2: ARRL 432 MHz Sprint Contest
- May 4: 0730 UTC, predicted peak of Eta Aquarids Meteor shower
- May 4,5,6: Tenth Annual Eastern VHF/UHF Conference, Sheraton Tara, Nashua, NH. (Contact K1LOG for further information.)
- May 5,6: West Coast VHF Conference, Paso Robles, CA. (Contact K6HXW, Box 493, Arroyo Grande, CA 93420.)
- May 10: ARRL 1296 MHz Sprint Contest
- May 12,13: EME Perigee weekend
- May 19: ARRL 6-meter Sprint Contest

ham radio

HAM Shack

806 N. Main  
Evansville, IN 47711  
812-422-0231  
812-422-0252

Prices and Availability Subject to Change

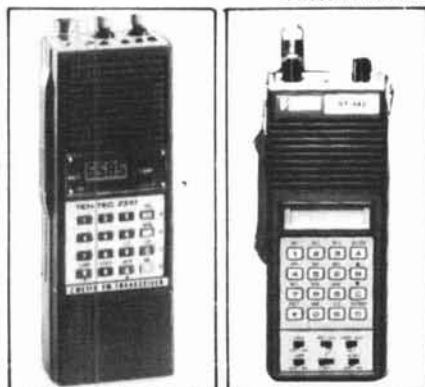

TEN-TEC 2591

SANTEC ST 142

<b>AEA</b>	
CP-1/C-64 or VIC-20 Software Package	Call
MP-20 or MP-64 Interface Package	\$129.00
AMT-1 Amtor/RTTY/CW	449.00
<b>ALLIANCE</b>	
HD73 (10.7 sq. ft.) Rotator	\$99.00
U110 Small Elevation Rotator	49.00
<b>AMERITRON</b>	
AL-80 QSK Amp	\$599.00
<b>ASTRON</b>	
RS7A 5-7 Amp Power Supply	\$49.00
RS10A 7.5-10 Amp Power Supply	59.00
RS12A 9-12 Amp Power Supply	69.00
RS20A 16-20 Amp Power Supply	89.00
RS20M 16-20 Amp w/meter	109.00
RS35A 25-35 Amp	135.00
RS35M 25-35 Amp w/meter	149.00
RS50A 37-50 Amp	199.00
RS50M 37-50 Amp w/meter	225.00
<b>AZDEN</b>	
PCS4000 2M mobile rig	\$280.00
<b>BENCHER</b>	
BY-1 Paddle/BY-2 Chrome	\$39.00/49.00



YAESU FT-757GX

<b>BUTTERNUT</b>	
HF6V 80-10 Meter Vertical	\$119.00
<b>CONNECT SYSTEMS</b>	
Private Patch II	\$425.00
<b>CUSHCRAFT</b>	
A3 Tribander 3EL	\$215.00
A4 Tribander 4EL	279.00
214B/214FB Boomers 14EL 2M	75.00 each
32-19 Super Boomer 19EL 2M	89.00
<b>DAIWA</b>	
CN-520 1.8-60 MHz SWR/Pwr Mtr	\$63.00
CN-620B 1.8-150 MHz SWR/Pwr Mtr	110.00
CN630 140-450 MHz SWR/Pwr Mtr	129.00
CN720B 1.8-150 MHz SWR/Pwr Mtr	150.00
<b>ENCOM (SANTEC)</b>	
ST-142, 222, 442, Also Stocking KDK FM-2033	
The Handhelds Still Offering the Most Features	
Call for Your Discount Price	
<b>HAL</b>	
CRI 200 Computer Interface	\$270.00
CRI 100 Computer Interface	225.00
<b>HY-GAIN</b>	
TH7 DXS 7EL Tribander	\$439.00
TH5 MK2S 5EL Tribander	389.00
Explorer 14 Tribander	279.00
CD45 8.5 sq. ft. Rotator	129.00
Ham IV 15 sq. ft. Rotator	199.00
T2X 20 sq. ft. Rotator	249.00
<b>Free Shipping on all Crank-up Towers</b>	
<b>ICOM</b>	
IC-02AT Now Available	\$315.00
27A New Ultra-Small 2M	335.00
271H 100W All Mode	Call
471A Deluxe Base Xcvr	Call
751 Ultimate Transceiver	1200.00



ICOM IC-27A

25H With Free Memory Backup	Call
745 Amazing Transceiver	\$869.00
IC-2AT	\$215.00
3AT/4AT Handhelds	235.00
45A 440MHz	335.00
R71A New & Improved Receiver	Call
<b>KLM</b>	
Oscar Antennas in Stock. Call for Prices.	
<b>KANTRONICS</b>	
The Interface II. The brand new computer interface for CW, RTTY, ASCII. Software Available for VIC20, C-64, APPLE, ATARI, TR80C, TI99	
Amtor Software Now Available	
<b>KEN-PRO</b>	
KR-500 Elevation Rotator	\$179.00
<b>LARSEN</b>	
NLA-150-MM5/8 Wave 2M Mag Mt.	\$39.00
<b>MFJ</b>	
1228 New Computer Interface w/AMTOR	Call
1224 New Computer Interface	Call
313 VHF Conv for HT	\$36.00
<b>Very Large Stock of MFJ Products. Call for Discount Pricing.</b>	
<b>MIRAGE</b>	
D24N 440 MHz Amp	\$179.00
D1010N 440 MHz Amp	279.00
B1016 10-160 Amp/Preamp	245.00
B3016 30-160 Amp/Preamp	199.00
<b>SHURE</b>	
444D Desk Mic	\$55.00
<b>TEN-TEC</b>	
The Fantastic Corsair	\$1020.00
2510 Oscar Transverter	740.00
2591 2M Handheld	\$ 425.00
Available	
<b>TOKYO HY-POWER</b>	
HL 160V 3 or 10/160W Preamp	\$295.00
HL 160V 25/160W Preamp	269.00
HL90U 10/80W UHF Amp/Preamp	305.00
HL82V 10/80W Preamp	139.00
HL45U 10/45W UHF Amp/Preamp	175.00
<b>YAESU</b>	
FT-980 Computer Aided Xcvr System	\$1289.00
FT-757GX Super Buy	740.00
FT-208R 2M Handheld	265.00
FT-726R Triband Xcvr	Call
FT-203R New H.T.	Call

## KENWOOD



### TS 930S



### R2000

Gen. Cov. Rcvr.  
W/memories



### TS 430S

Now a general coverage receiver/ham band transceiver at an affordable price.



### TR 7950

45 Watts! Multi-featured.



### TW 4000A

2M & 440MHz "Dual-Bander"  
25 watts on both bands.

Call for YOUR Low Price!



### TR 2500

Full Featured  
2M Handheld

UPS Brown Paid on  
TR 2500

2900 N.W. VIVION RD. / KANSAS CITY, MISSOURI 64150 / 816-741-8118

## APPLIED INVENTION

THE SOURCE FOR SOLID STATE / STATE OF THE ART

### GaAs FETS by MITSUBISHI

144 Mhz — 12 GHz lowest noise and best price available

MGF1100—Dual Gate	MGF1202
MGF1203	MGF1402
MGF1203	MGF1404
MGF1412	MGF1801

Full Data and Pricing in Current Catalog

### MITSUBISHI X BAND MITSUBISHI GaAs FET DR0 Modules — Gold

FO-1010X 10.4 GHz, 15mw out, UER100 Flange	\$39.37
FO-1210Y 11.5 or 12.0 GHz, UER120 Flange	\$39.37
FO-UP11KF Complete Heterodyne Rx, 10.468 GHz LD	\$36.22

Can be used for 12.5 GHz terrestrial and DBS

FO-OP13KF "DPLEXER" Transceiver Module	\$43.05
X-Band 15 dBG die cast horn antenna (UER100)	\$17.85

### AT: THE SOURCE FOR RETICON Universal Audio Active Filters

RS628 digitally programmed switched capacitor audio filter	\$ 7.85
RS621 dual section resistor programmed SCF	\$ 6.51
RS622 quad section resistor programmed SCF	\$11.07
Our performs National MF-10!	Application notes \$ 2.00

### OPTOELECTRONICS — MITSUBISHI Lasers and Avalanche PD's

High Output IRLEDS, PIN Photodiodes, IR Phosphor Screens

### MITSUBISHI BIPOLAR POWER TRANSISTORS FOR 900/1296

MRF 901 Substitute 2SC2876, F1=7GHz, 2.28BW @ 1GHz	\$ 1.50
NEC 64535 direct replacement: Siemens BFQ 74	\$ 9.66

### UHf and Microwave Low Loss Capacitors

Small signal and transmitting type chips  
Leadless discs, Feedthroughs

STRPLINE SHUTTLE TRIMMERS (VOLTRONICS) 0.1 2.5, 0.5 9.0pf	\$ 3.34
H-Q SEALED CERAMIC PISTON TRIMMERS (VOLTRONICS) 0.6-9.0pf	\$ 3.58
SAPPHIRE TRIMMERS Johanson 0.4-2.5pf	\$ 9.47
For WA2GFP preamp Sprague 0.6-4.5pf	\$ 9.47

Thermo Electric Heat Pumps & Sub-Minature Cryogenic Refrigerators

3M GX250 glass/te PC board 0.031 and 0.062

E.F. Johnson SMA Connectors

WA2GFP 2304 and WGPO 1296 Preamp Kits

PROMPT SERVICE. SEND FOR CATALOG MINIMUM ORDER \$5.00

VISA/MASTERCARD Accepted. CASH prepay take 5% discount

S&H \* ITEMS (UPS) \$3.75 ALL OTHER ITEMS \$2.50 (1st CLASS)

NY STATE RESIDENTS ADD 7% SALES TAX

R.D.2 ROUTE 21 HILLSDALE, NY 12529

518-325-3911

114

## R-390A HF RECEIVER



Famous military receiver covers 0.5-32 Mhz AM-CW in 31 one Mhz bands using mechanical digital tuning. 455 KHz IF; has four Collins mechanical filters for selectable 2-4-8-16 KHz bandwidth, 100 KHz calibrator; BFO. No covers. 115/230 VAC 60 Hz; 10 1/2 x 19 x 16 3/4". 95 lbs. sh. (UPS in 2 pkgs.). Used-repairable \$215. Checked \$335. Manual, partial repro \$15.

CV-1982/TSC-26 SSB CONVERTER, compatible with R-390A and other rec. Used-repairable, \$155.

RYCOM R-2174/URR, selective voltmeter used by military as 1.0-420 KHz AM-LSB-USB receiver; 0.1-3-10 KHz selectable bandwidth. Built-in speaker. 9x19x7". 25 lbs. sh. Used-repairable \$125. Checked \$195.

Prices F.O.B. Lima, O. • VISA, MASTERCARD Accepted. Allow for Shipping • Send for New FREE CATALOG '84 Address Dept. HR • Phone: 419/227-6573

### FAIR RADIO SALES

1016 E. EUREKA • Box 1105 • LIMA, OHIO • 45802

## ALL BAND TRAP ANTENNAS!



PRETUNED-ASSEMBLED ONLY ONE NEAT SMALL ANTENNA FOR ALL BANDS! EXCELLENT FOR APARTMENTS! IMPROVED DESIGN!

FOR ALL MAKES AM-ATEUR TRANSCEIVERS! GUARANTEED FOR 2000 WATTS SSB INPUT FOR NOVICE AND ALL CLASS AMATEURS!

COMPLETE with 90 ft. RG58U-52 ohm feedline, and PL259 connector, insulators, 30 ft. 300 lb. test dacron end supports, center connector with built in lightning arrester and static discharge. Low SWR over all bands -Tuners usually NOT NEEDED! Can be used as inverted V's - slopers - in attics, on building tops or narrow lots. THE ONLY ANTENNA YOU WILL EVER NEED FOR ALL BANDS! NO BALUNS NEEDED!

80-40-20-15-10 -- 2 trap - 104 ft. - Model 998BUC - \$99.95  
40-20-15-10 -- 2 trap -- 54 ft. - Model 1001BUC - \$98.95  
20-15-10 meter- 2 trap - 26ft. - Model 1007BUC - \$97.95

SEND FULL PRICE FOR POSTPAID INSURED. DEL. IN USA. (Canada is \$5.00 extra for postage - clerical - customs etc.) or order using VISA - MASTER CARD - AMER. EXPRESS. Give number and ex. date. Ph 1-308-236-5333 9AM - 6PM week days. We ship in 2-3 days. ALL PRICES MAY INCREASE SAVE - ORDER NOW! All antennas guaranteed for 1 year. 10 day money back trial if returned in new condition! Made in USA. FREE INFO. AVAILABLE ONLY FROM

WESTERN ELECTRONICS

Dept. AR-5 Kearney, Nebraska, 68847

143

176



July 28 thru Aug. 10, 1984

Our 25th year

TAKE A VACATION WITH  
A PURPOSE THIS YEAR

Join students from around the world at  
OAK HILL'S  
SILVER ANNIVERSARY  
Session

Over 25 years of successful teaching experience means upgrading is as easy as 1-2-3.

Your vacation is spent in the beautiful Blue Ridge Mountains of Virginia with expert instructors in friendly surroundings and with excellent accommodations.

Oak Hill also has a ham lab set up for all to use.

Courses offered are:

- Novice to General
- General or Tech to Advanced
- Advanced to Extra

Learn — don't just memorize the answers to the exam questions.

C. L. PETERS, K4DNJ, Director  
Oak Hill Academy Amateur Radio Session  
Box 43

Mouth of Wilson, VA 24363

Name \_\_\_\_\_ Call \_\_\_\_\_

Address \_\_\_\_\_

City/State/Zip \_\_\_\_\_

# The Problem Solver..

The RF Wattmeter Model 81000-A from Coaxial Dynamics, Inc. does more than provide accurate rf measurements. Testing of transmission lines, antennas, connectors, filters and related components can reveal unknown problems and assure optimum equipment performance.

The 81000-AK Wattkit features this easy-to-read RF Wattmeter (pictured here), with its optional carrying case and an array of elements and accessories. Coaxial Dynamics elements can be purchased separately for use in other manufacturer's Wattmeters. For more information on the 81000-A Wattmeter or any of the complete line of Coaxial Dynamics RF products and OEM components please contact Coaxial Dynamics, Inc.



**COAXIAL  
DYNAMICS, INC.**

15210 Industrial Parkway, Cleveland, OH 44135 • (216) 267-2233  
Outside Ohio, WATS: (800) Coaxial, Telex: 980-630

129

## ORR BOOKS

### BEAM ANTENNA HANDBOOK

by Bill Orr, W6SAI

Recommended reading. Commonly asked questions like: What is the best element spacing? Can different yagi antennas be stacked without losing performance? Do monoband beams outperform tribanders? Lots of construction projects, diagrams, and photos. 198 pages. ©1977. 1st edition.

RP-BA Softbound \$7.95

### SIMPLE LOW-COST WIRE ANTENNAS

by Bill Orr, W6SAI

Learn how to build simple, economical wire antennas. Apartment dwellers take note! Fool your landlord and your neighbors with some of the "invisible" antennas found here. Well diagramed. 192 pages. ©1972.

RP-WA Softbound \$7.95

### THE RADIO AMATEUR ANTENNA HANDBOOK

by William I. Orr, W6SAI and Stuart Cowan, W2LX

Contains lots of well illustrated construction projects for vertical, long wire, and HF/VHF beam antennas. There is an honest judgment of antenna gain figures, information on the best and worst antenna locations and heights, a long look at the quad vs. the yagi antenna, information on baluns and how to use them, and new information on the popular Sloper and Delta Loop antennas. The text is based on proven data plus practical, on-the-air experience. The Radio Amateur Antenna Handbook will make a valuable and often consulted reference. 190 pages. ©1978.

RP-AH Softbound \$7.95

### ALL ABOUT CUBICAL QUAD ANTENNAS

by Bill Orr, W6SAI

The cubical quad antenna is considered by many to be the best DX antenna because of its simple, lightweight design and high performance. You'll find quad designs for everything from the single element to the multi-element monster quad, plus a new, higher gain expanded quad (X-Q) design. There's a wealth of supplementary data on construction, feeding, tuning, and mounting quad antennas. 112 pages. ©1977.

RP-CQ Softbound \$6.95

Please add \$1.00 to cover shipping and handling.

**HAM RADIO'S BOOKSTORE**  
GREENVILLE, NH 03048

## HOBBY KITS®

EXPERIMENT — LEARN ELECTRONICS  
BUILD AND DESIGN YOUR OWN AM, FM, CW,  
OR SSB RECEIVERS, TRANSMITTERS AND ETC.  
WITH OUR MINI-LINEAR CIRCUIT KITS

All kits Come Complete With Etched and Drilled Circuit Boards  
and All Parts Needed To Function As Described

AFA-1 AUDIO AMP, LM-380 1-2 Watts 4-16 OHM Output	\$4.95
AFP-1 AUDIO PREAMP, Dual Audio Preamp — For Mike Etc.	\$3.95
BMD-1 BAL. MIX, LM 1496 Mixer — S B Modulator Tuned Output	\$9.95
DET-1 AM DET, Am Envelope Detector With AGC Output	\$3.95
DET-2 FM DET, LM 3065 FM Detector (455 KHZ or 4-11 MHz)	\$7.95
DET-3 SSB DET, LM 1496 SSB Detector (Needs OSC-1 or OSC-4)	\$9.95
DET-4 DETECTOR CW/SSB using a dual gate FET transistor	\$4.95
IFA-1 IF AMP, CA 3028 30 DB Gain, Optional AGC (455 KHZ or 9-11 MHz)	\$6.95
FLS-9 SSB FILTER 9 MHz/2 1 KHZ BW with USB XAL for GSC-1	\$49.95
IFA-2 IF AMP, CA 3028 30 DB Gain 1-100 MHz Optional AGC	\$6.95
MBA-1 FREQ. MULT, Tuned Output Buffer-Mult-Amplifier To 250 MHz	\$5.95
OSC-1 CRYSTAL OSC, 100 KHZ — 20 MHz Not Tuned	\$3.95
OSC-2 CRYSTAL OSC, Ov 18-200 MHz Tuned Output	\$4.95
PSV-1 POWER SUPPLY LM 723 With Pass Transistor, 3 amps max	\$7.95
PLL-2 TONE DETECTOR LM567 PLL Tone Detector	\$5.95
RF/MIX-1 RF-AMP/MIXER CA 3028 — Tuned RF AMP/Mixer 1-100 MHz	\$7.95
RF/MIX-2 RF-AMP/MIXER 3N204 Tuned RF AM/Mixer 1 — 250 MHz	\$7.95
VCO-3 VARIABLE HI STAB. OSC, Varactor tuned 400 to 600 KHz output	\$7.95
VCO-4 VARIABLE HI STAB OSC, Varactor tuned, 3 to 20 Mhz output	\$7.95

Add \$2.00 For Shipping & Handling — Send For FREE Brochure

SEND \$2.00 FOR FULL MANUAL WITH CIRCUIT DIAGRAMS AND

TYPICAL RECEIVER AND TRANSMITTER HOOK-UPS

MANY OTHER MODULES AVAILABLE

**MORNING DISTRIBUTING CO.**

P.O. BOX 717, HIALEAH, FLA. 33011

177

This tower is ready for shipment to one of our customers, or is it? If we were an ordinary tower company, this tower would have already been sent.

We are not an ordinary tower company and that is why this tower did not go out.

We have the best quality control in the business and we are not afraid to say so. That is why when John Pasillas

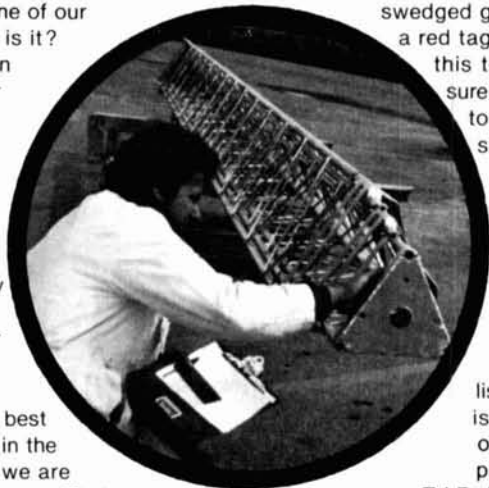

found a 1/8" clearance on the swedged guide, he placed a red tag of rejection on this tower and made sure it was corrected to 1/16" before he stamped his final approval for shipment.

Every employee at Tri-Ex knows that the reputation you establish in an industry is what will make or break his company. That is why Tri-Ex has been in business continually since 1955.

When you purchase your tower from Tri-Ex, you can be assured that all welds have been done by certified welders, all construction and galvanizing has met ASTM standards, all towers have been constructed in precision jigs, all steel has been tested for carbon content and tensile strength.

When it goes to shipping, John is ready.

When you decide on Tri-Ex you have many models to choose from.

#### STACKED:

Light, medium, heavy duty 10 feet and up.

#### CRANK UPS:

Light, medium, heavy duty 25 feet to 88 feet standard.

#### SPECIAL TOWERS:

Sky needle, Clementower 37 feet to 180 feet & higher

Introducing Tri-Ex's new DX-86 — 86 feet tall, 25 square feet in a 50 mph wind.

Call you local dealer for details.

FOR ADDITIONAL INFORMATION WRITE TO:



**TOWER CORPORATION**

7182 Rasmussen Ave.  
Visalia, Calif. 93291

P.O. Box 5009

Visalia, California 93278

(209) 651-2171

209



**Fox Tango Filters**

Your rig — old or new — is no better than its i.f. filter.

#### TOP PERFORMANCE

Fox Tango Filters contain eight specially treated discrete quartz crystals, unlike miniature ceramic or monolithic corner-cutting designs. Give your set *new life* with a Fox Tango implant or transplant. It's a lot cheaper than buying a new rig with features you don't need and probably won't use!

#### VARIETY

Fox Tango stocks superior CW, SSB, and AM filters for practically all Yaesu, Kenwood, and Heath models. Also for Drake R-4C, 7-line; Collins 75S3-B/C, and some ICOM's. More than 80% of our filters sell for \$60. Most are designed for easy *drop-in* installation. For the others, complete instructions and all needed parts are included in the price.

#### INFORMATION

Tell us the make and model of your set. You'll get the complete information on FT filters to fill optional spots, replace your present tired or inferior stock units or supplement them with Fox Tango Filter-Cascading kits. If you phone you can order at the same time; we accept VISA/MC or ship C.O.D.

**GO FOX-TANGO — to be SURE!**

*Ask the ham who has one.*

#### FOX TANGO CORPORATION

Box 15944, Dept. H  
West Palm Beach, FL 33416  
Telephone: (305) 683-9587

Dealer inquiries invited.

145

**CADELL COIL CORP.**  
POULTNEY, VT. 05764 802-287-4055

WE LIKE TO WIND COILS—TRY US  
COILS FOR HOMEBILT

Sardine Sender 80 Meter QRP Rig	
QST Oct '79 p 15	\$9.00
QRP Transmatch-25 Watt Max	
ARRL Handbook p 350	7.50
Tuna Tin 2-WAS 40 Meter Transmitter	
QST May '76 p 21	5.75
Mini Miser's Dream Receiver	
QST Sep '76 p 21	13.75
20 Meter Direct Conversion Receiver	
QST Apr '78 p 12	7.50
Amplifier for HW-8 QRP Transceiver	
QST Apr '79 p 18	13.80
Harmonic Filter (for above) per band	5.00
Low Frequency Transmitter	
S9 Sep '79 p 23	9.50

Prices include postage.

#### BALUNS

Get POWER into your antenna. See ARRL Handbook p. 585 or 19-9 or 6-20.	
1KW—4:1 Impedance	\$12.50
2KW—4:1	15.00
1KW—6:1, 9:1, or 1:1 (pick one)	14.00
2KW—6:1, 9:1, or 1:1 (pick one)	16.50
100KW—4:1, 6:1, 9:1, or 1:1 (pick one)	8.50

Many other interesting coil kits in our NEW LIST 5C. You must send a stamped envelope to receive our coil kit list.

124



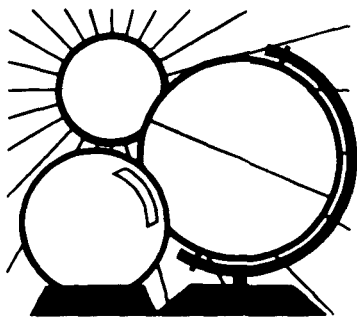

# DX FORECASTER

Garth Stonehocker, KØRYW

## sporadic-E propagation

In summer the overhead sun fills the lower ionosphere with ions which support short skip propagation, even multiple short skips. The geomagnetic field clusters these ions into cloud-like patches known as sporadic-E ( $E_s$ ). To make best use of  $E_s$  DX openings, which are enhanced from late May until mid-September, a short review is in order.

$E_s$  is a thin layer of intense ionization about 60 miles (100 km) above the earth. It gives rise to strong, mirror-like signal reflections over short-skip distances of 600 to 1200 miles (1000 to 2000 km). Signals remain strong for about a half-hour up to a couple of hours after the onset of the first strong signals, on the average; they're generally stronger than long-skip. Station location also determines how strongly the sunspot/geomagnetic disturbances affect sporadic-E propagation, with mid-latitudes the least affected and equatorial and polar paths the most. The highest frequency propagated by  $E_s$  occurs at local noon, since it follows the sun across the sky. However, the highest probability of occurrence is near sunrise and again around sunset. These two characteristics of  $E_s$  affect short-skip openings differently. Openings on the higher-frequency bands occur near local noontime; the lower bands tend to have openings near sunrise and sunset.

Because  $E_s$  is related to the summer sun, the best locations for these  $E_s$  openings are in the Northern Hemisphere from June through September and in the Southern Hemisphere during their summer, December through March. The best  $E_s$  is on either side of the geomagnetic equator; it's especially good where the geomagnetic equator is furthest from the geographic equator and during geomagnetic disturbances. These special areas are Southeast Asia in the Northern Hemisphere and South America in the Southern Hemisphere, with the former the better of the two.

To look for  $E_s$  openings on the higher-frequency bands, monitor beacons on 6 and 10 meters and CB channel 19. Also monitor unused TV channels 2 through 5 for 6- and 2-meter openings. The lower bands don't need beacon monitoring because  $E_s$  openings (sunrise and sunset) are available most nights.

## last-minute forecast

A slight solar flux increase, with the possibility of a few flares about May 18th, should enhance DX on the higher-frequency bands (10-30 meters) the third week of the month. During the first and last weeks, look to the lower frequency bands (40-160 meters) for the best DX. Long periods in which the geomagnetic field will be disturbed are expected around the 1-9, 13, 23-26, and 31st.

An annual eclipse of the sun begins on May 30 at 1354 UTC near Hawaii, but stretching from the equator to Canada. It then crosses the Americas to Europe, stretching from northwest Africa to Norway, where it ends at 1935 UTC. Maximum duration is 62 seconds as it swings through the path. You might try some DX propagation experiments and compare your results to propagation or DX the day before and after.

The lunar perigee and full moon, of interest to moonbounce DXers, occurs on the 12th and 15th of this month. An Aquarid meteor shower of interest to meteor-scatter and meteor-burst DXers peaks between May 4th and 6th, with rates of 10 and 25 per hour for the northern and southern hemispheres, respectively.

## band-by-band summary

*Six meters* will provide occasional openings to South Africa and South America around local noontime by short-skip  $E_s$ .

*Ten and fifteen meters* will have many short-skip  $E_s$  openings, and long skip during high solar flux to most areas of the world during daylight. Some trans-equatorial openings associated with disturbed ionospheric conditions may occur in the evening hours.

*Twenty, thirty, and forty meters* will have DX from most areas of the world during the daytime and into the evening hours almost every day, either long-skip to 2500 miles (4000 km) or short-skip  $E_s$  to 1250 miles (2000 km) per hop. The length of daylight is now approaching maximum, providing many hours of good DXing.

*Thirty, forty, eighty, and one-sixty meters* are all good for nighttime DX. On many nights 30 and 40 meters will be the only usable bands because of thunderstorm QRN, but signal strength via short-skip  $E_s$  may overcome the static when  $E_s$  is available. Although  $E_s$  is scarce in May, it should occur often the following two months.

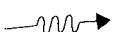

**WESTERN USA**

GMT	PDT										
		N	NE	E	SE	S	SW	W	NW		
0000	5:00	20	15	15	10	20*	10	10	15		
0100	6:00	20	15	15	10	20	10	10	15		
0200	7:00	20	15	20	10	20	10	10	15		
0300	8:00	20	20	20	10	20	10	10	15		
0400	9:00	20	20	20	10	20	10	10	15		
0500	10:00	20	20	20	10	20	10	10	15		
0600	11:00	15	20	20	15	20	10	15	15		
0700	12:00	15	20	20	15	30	15	15	20		
0800	1:00	15	20	20	15	30	15	15	20		
0900	2:00	15	20	20	15	30	15	20	20		
1000	3:00	20*	20	20	20	20	20	20	20		
1100	4:00	20	20	20*	20	30	20	20	20		
1200	5:00	20	20	15	20	30	20	20	20		
1300	6:00	20	20	15	20	30	20	20	30		
1400	7:00	20	20	15	20	30	20	20	30		
1500	8:00	20	20	15*	20	20	20	20	30		
1600	9:00	20	20	10	20	20	20	20	20		
1700	10:00	20	20	10	20	20	15	20	20		
1800	11:00	20	20	10	15	20	15	15	20		
1900	12:00	20	20	10	15	20	15	15	20		
2000	1:00	20	20	10	15	20	15	15	20		
2100	2:00	20	20	10	15	20	10	15	20		
2200	3:00	20	15	15	15	20*	10	10	20		
2300	4:00	20	15	15	10	15	10	10	20*		

**MID USA**

GMT	MDT										
		N	NE	E	SE	S	SW	W	NW		
0000	6:00	20	15	15	15	20	10	10	15		
0100	7:00	20	15	15	20*	20	10	10	15		
0200	8:00	20	20*	20	20	20	10	10	15		
0300	9:00	20	20	20	20	20	10	10	15		
0400	10:00	20	20	20	20	20	10	10	15		
0500	11:00	20	20	20	20	30	10	15	15		
0600	12:00	20	20	20	20	30	10	15	20		
0700	1:00	20	20	20	20	30	10	15	20		
0800	2:00	20	30	20	20	30	15	15	20		
0900	3:00	20	30	20	20	30	15	15	20		
1000	4:00	20	30	20	20	30	20	20	20		
1100	5:00	20	30*	15	15	30	20	20	20		
1200	6:00	20	20	15	15	30	20	20	20		
1300	7:00	20	20	15	15	30	20	20	20		
1400	8:00	20	20	15	15	30	20	20	30		
1500	9:00	20	20	10	10	20	20	20	30		
1600	10:00	20	20	10	10	20	20	20	20		
1700	11:00	20*	20	10	10	20	15	15	20		
1800	12:00	15	20	10	10	20	15	15	20		
1900	1:00	15	20	10	10	20	15	15	20		
2000	2:00	15	20	10	10	20	15	15	20		
2100	3:00	15	20	10	10	20	15	15	20		
2200	4:00	20*	20*	15*	15	20	10	15*	20		
2300	5:00	20	15	15	15	20	10	10	20*		

**EASTERN USA**

GMT	EDT										
		N	NE	E	SE	S	SW	W	NW		
0000	8:00	20	20	15	15	20	10	10	20*		
0100	9:00	20	20	15	15	20	10	10	15		
0200	10:00	20	20	20	20	20	10	10	15		
0300	11:00	20	20	20	20	20	10	10	15		
0400	12:00	20	20	20	20	20	10	10	15		
0500	1:00	20	20	20	20	20	10	10	15		
0600	2:00	20	20	20	20	20	10	10	15		
0700	3:00	20	30	20	20	30	10	10	15		
0800	4:00	20	30	20	20	30	15	15	20		
0900	5:00	20	30	20	20	30	15	15	20		
1000	6:00	20	30	20	20	30	20	20	20		
1100	7:00	20	30	15	15	30	20	20	20		
1200	8:00	20	20	15	15	30	20	20	20		
1300	9:00	20	20	15	15	30	20	20	20		
1400	10:00	20	20	15*	15	30	20	20	20		
1500	11:00	20	20	10	10	20	20	20	20		
1600	12:00	20	20	10	10	20	20	20	20		
1700	1:00	15	20	10	10	20	15	15	20		
1800	2:00	15	20	10	10	20	15	15	20		
1900	3:00	15	20	10	10	20	15	15	20		
2000	4:00	15	20	10	10	20	15	15	20		
2100	5:00	15	20	10	10	20	15	15	20		
2200	6:00	20	20	15	15	20	10	15*	20		
2300	7:00	20	20	15	15	20	10	10	20*		

The italicized numbers signify the bands to try during the transition and early morning hours, while the standard type provides the MUF during 'normal' hours.  
 \*Look at next higher band for possible openings.

Actual slow motion frames from Ham MasterTapes



1. Larry, N2NY, Lee, KA2RNV



2. Lee discharges cap

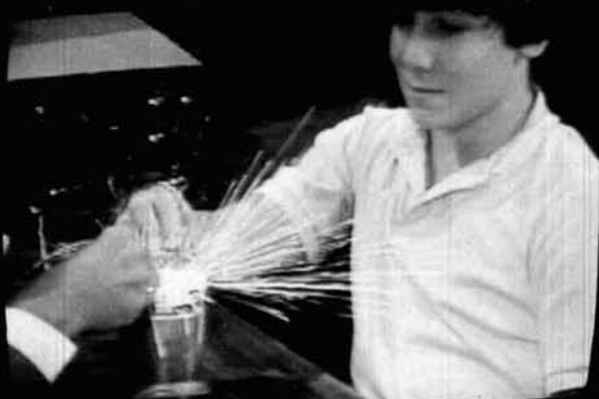

3. In slow motion it's dazzling



4. Wow. Can we see it again?

**You've never seen this, like this,  
before this!**

**And you can see it—in color—again and again  
when you own the N2NY Ham MasterTapes.**

Ever see a cap discharge in slow motion? You will on Ham MasterTapes. Ham MasterTapes can perform the dozens of complicated demonstrations necessary for a beginner's understanding of Ham Radio Theory.

Finally, a step-by-step course in Ham Radio Theory is available on color videotape. The Larry Horne N2NY Ham MasterTapes video course is a unique, effective teaching technique expertly produced by New York's leading professionals in studio and field videotape.

- Video Graphics highlight important details.
- Carefully worked-out demonstrations on video avoid the problem of getting complex gadgets to work on command in front of a class.
- Working examples of every ham radio component, device, or system covered in the FCC guide can be clearly understood.

The N2NY Ham MasterTapes give you a basic grasp of concepts that build theory background—not only for passing the FCC tests, but for understanding electronics.

The hobby has long needed better, clearer, high-tech teaching aids to help newcomers into our wonderful world of Ham Radio.

These six-hour tapes cover completely all the material needed to understand Novice and Tech/General Theory and operations, and include the new 200-question FCC syllabus used beginning September 1983.

Only \$199.95. Order direct and specify Beta or VHS format. Call or write: Larry Horne, N2NY

**Ham MasterTapes™**

THE N2NY HAM RADIO COURSE ON VIDEOTAPE

Ham MasterTapes  
136 East 31st Street  
New York, N.Y. 10016 212-673-0680.

© 1983 N2NY Productions, Inc.

**Get Your Best Deal . . .**  
**Then CALL US . . . TOLL FREE!**  
**1-800-238-6168** (In Tennessee, call 901-683-9125)



**KENWOOD**

When you call, talk to a Qualified Ham Operator!  
 (Ask for MARSHALL, KU4O, or BILL, W4TNP)



**ICOM**

**AUTHORIZED DEALER FOR:** Kenwood, ICOM, Drake, Ten-Tec, Santec, MFJ, Astron, AEA, Mirage, B&W, Hustler, Cushcraft, Larsen, Hy-Gain, and others. . . . **PLUS CURRENT USED GEAR**

**WE TRADE!**

Call for free appraisal

After the sale,  
 it's the service  
 that counts!

**Memphis Amateur  
 Electronics, Inc.**

1465 Wells Station Rd., Memphis, TN 38108

Monday-Friday, 9 to 5,  
 Saturday 9 to 12 (Central Time)



✓ 172

**TOWERS**  
 by ALUMA

**HIGHEST QUALITY ALUMINUM**

- TELESCOPING (CRANK-UP)
- GUYED (STACK-UP)
- TILT-OVER MODELS

Easy to install. Low Prices.  
 Crank-ups to 100 ft.

EXCELLENT FOR AMATEUR COMMUNICATIONS

Mobile Trailer Type

Mobile Truck Type

Over 36 types aluminum and steel towers made—specials designed and made—write for details

SPECIAL Four Section 50 Ft. Van Mounted Crank-Up Aluma Tower

ALUMA TOWER CO.  
 BOX 2806HR  
 VERO BEACH, FLA. 32960-2806  
 (305) 567-3423 TELEX 80-3405

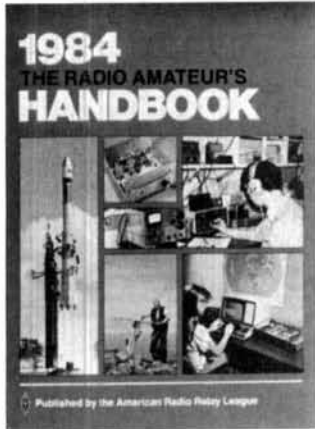

**STATE OF THE ART**

The 1984 Edition of *The Radio Amateur's Handbook* carries on the tradition of the previous editions by presenting 640 pages of comprehensive information for the radio amateur, engineer, technician and student. Paper edition: \$12 in the U.S., \$13 in Canada, \$14.50 elsewhere. Cloth: \$17.75 in the U.S., \$20 elsewhere. In U.S. funds.

THE AMERICAN RADIO RELAY LEAGUE  
 225 MAIN ST.  
 NEWINGTON, CT 06111

**This Publication is available in Microform.**

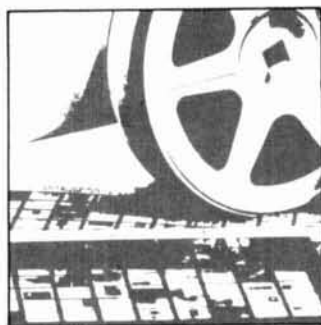

University Microfilms International

Please send additional information for \_\_\_\_\_  
 Name: \_\_\_\_\_  
 Institution: \_\_\_\_\_  
 Street: \_\_\_\_\_  
 City: \_\_\_\_\_  
 State: \_\_\_\_\_ Zip: \_\_\_\_\_

300 North Zeeb Road  
 Dept. PR  
 Ann Arbor, MI 48106

**BUTTERNUT  
ELECTRONICS  
COMPANY**



Model 2MCV "Trombone"  
Model HF6V  
Model 2MCV-5 "Super Trombone"

**THE  
WINNERS**

Model HF6V—Completely automatic bandswitching 80 through 10 plus 30 meters. Outperforms all 4- and 5-band "trap" verticals of comparable size. Thousands in use worldwide since December '81! 160 meter option available now, retrofit kits for remaining WARC bands coming soon. Height: 26 ft/7.8 meters; guying not required in most installations.

Model 2MCV "Trombone"—omnidirectional collinear gain vertical for 2 meters having the same gain as "double-A" types, but the patented "trombone" phasing section allows the radiator to remain unbroken by insulators for maximum strength in high winds. No coils, "plumber's delight" construction and adjustable gamma match for complete D.C. grounding and lowest possible SWR. Height: 9.8 ft/2.98 meters.

**NEW**  
Model 2MCV-5 "Super-Trombone"—Same advanced features as the basic 2MCV but a full wavelength taller with additional "Trombone" phasing section for additional gain. Height: 15.75 ft/4.8 meters.

All BUTTERNUT ANTENNAS use stainless steel hardware and are guaranteed for a full year. For further information on these and other BUTTERNUT products write for our FREE CATALOG!

**BUTTERNUT  
ELECTRONICS**  
405 E. MARKET STREET  
LOCKHART, TX 78644

# Features never before available in one handheld.

Made in the U.S.A. And it's priced right.



The Ten-Tec 2591 offers everything you've ever wanted in a 2-meter handheld.

- \* Memory Lockout permits the scanner to temporarily bypass channels for quick lockout of busy frequencies, yet retain them in memory for normal operation on demand
- \* 10 Memories with stored offset. Channel 0 accepts any non-standard offset
- \* Modifiable Band Scan without complete reprogramming. Scan any section of the band within user defined upper and lower limits in steps of 5, 10, 15, 25, or 30 kHz..
- Change step size, upper and lower limits independently. Manual Scan also up or down, in 5 kHz steps
- \* Selectable Skip or Hold \* 2.5 Watts or .4 Watts \* Covers 143.5-148.995 MHz \* LCD Readout with Back Light \* Quick-Release 450 mAh NI-CAD Battery Back \* 16-Key Dual Tone Encoder, built-in \* LED shows battery status and transmit mode \* Designed and Manufactured in Tennessee. And it carries the famous TEN-TEC one year warranty. Put it to work for excellent 2 meter performance.

See your Ten-Tec dealer or write for details.

**TEN-TEC, INC.**  
SEVIERVILLE, TENNESSEE 37862

## Homebrew Headquarters



**SPLIT-  
BAND  
SPEECH  
PROCESSOR  
KIT \$69.95**

hr 8/79

plus \$2.50 shipping & handling

## PUNCH THRU THE PILEUPS WITH 10X MORE TALK POWER

**Increased talk power:** Up to 15 dB, adjustable (10 dB recommended under most operating conditions)

**Frequency response:** 350 Hz — 2.4 kHz at 3 dB down (200 Hz — 3 kHz at 12 dB down)

**Harmonic Distortion:** Less than 12% at 1 kHz with 10 dB clipping

Requires 12 Vdc at 200 mA

### ALSO IN STOCK:

Kits for HF, VHF & UHF  
Test Equipment Kits  
Toroids, Rods & Beads  
Resistors & Capacitors  
Antenna Components

See Catalog

1984-85 CATALOG 50c

**RADIOKIT**

Box 411H, Greenville, NH 03048  
(603) 878-1033

# THE ULTIMATE SCANNER RADIO HAS ARRIVED.

Starting today, we're standing the scanner radio on its ear. Because we've forged ahead—way ahead—in radio frequency and digital technology.

Introducing the Bearcat® CompuScan™ 2100.

It's the first scanner radio designed to put the power of a personal computer to work for you. Now you can scan up to two hundred channels. Stack levels of priority so you'll hear vital calls in order of importance. Automatically search, store and count transmissions for accurate "pictures" of activity within frequency limits you select.

And with automatic video memos you'll know more than you've ever known before. The channel user, special codes, jurisdictions, phone numbers, alternate frequencies—any information you've programmed is automatically displayed when the channel is active.

With ten bands including 70-centimeter, 2, 6 and 10 meter FM Amateur, Military Land Mobile, AM Aircraft, plus Low, High, UHF and UHF-T bands.

For a real earful—and eyeful—see your Bearcat scanner dealer. For the name of the dealer nearest you, just call 1-800-S-C-A-N-N-E-R.

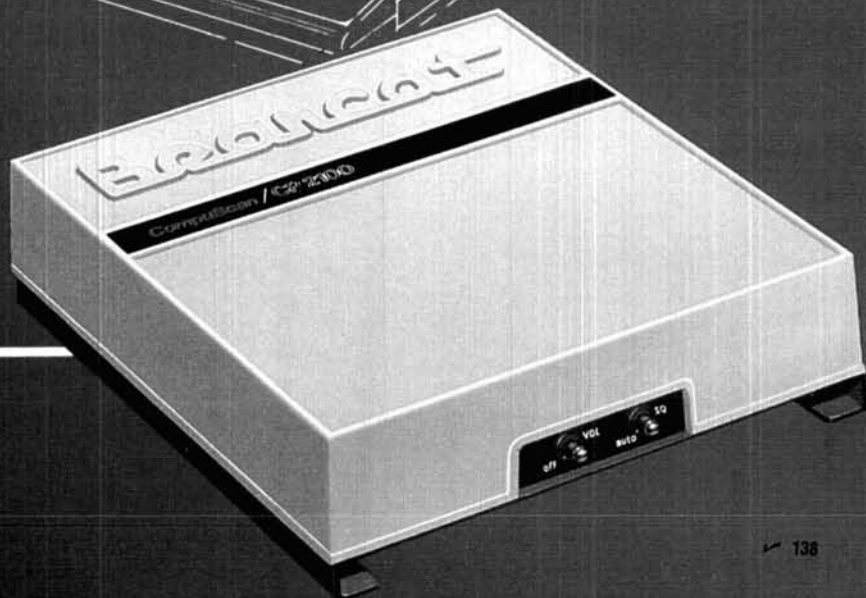

## BEARCAT® SCANNERS

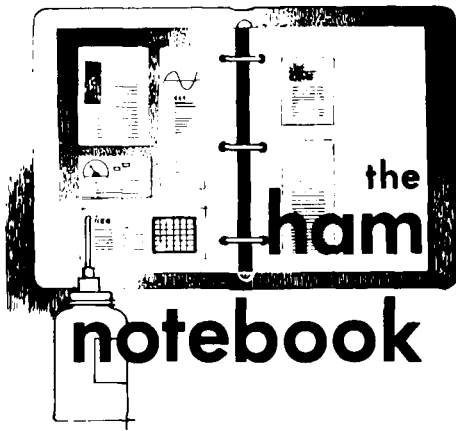

## TS-430S IF filter mod

The Kenwood TS-430S allows for great flexibility in selecting different IF filters. It comes with a 2.4 kHz (6 dB) wide filter for SSB and CW and has a slot for both narrow SSB (1.8 kHz) and narrow CW (either 270 or 500 Hz) filters. In addition, a 6 kHz wide filter is available for AM.

The filters are automatically selected according to the mode selection (CW, USB, LSB, etc.) and according to the narrow/wide switch. One limitation of this is that the narrow CW filter cannot be used in the LSB mode. Most RTTY operation with this rig will be done in the LSB mode, and having a narrower filter would reduce the effects of QRN and QRM.

The original circuit (fig. 1A) uses a diode switching approach to select the appropriate filter. Connector No. 27 (may be labeled No. 29 in the instruction manual) comes from the narrow/wide switch on the front panel. Either of the control lines SSW or CWW go high in the wide position, depending on the mode (SSB or CW respectively). Similarly, SSN or CWN go high in the narrow position, according to the mode selected. These control lines connect through resistors (and sometimes diodes) to the appropriate IF filter. A modified circuit (fig. 1B) is shown which allows for the use of the narrow CW filter in the SSB mode. In the LSB mode, in particular, this filter ends up being centered around an audio frequency of about 2 kHz, which is ideal for RTTY interfaces using audio tones in that area. The IF shift control can be used to adjust this frequency, if necessary.

In normal transceiver operation,

switching from CW or SSB often results in the narrow position selected in the SSB mode. If no narrow SSB filter is installed, the IF section is simply left open and no signals can be heard. The suggested but untested circuit shown in fig. 1C will enable the wide filter in SSB mode regardless of the narrow/wide switch position.

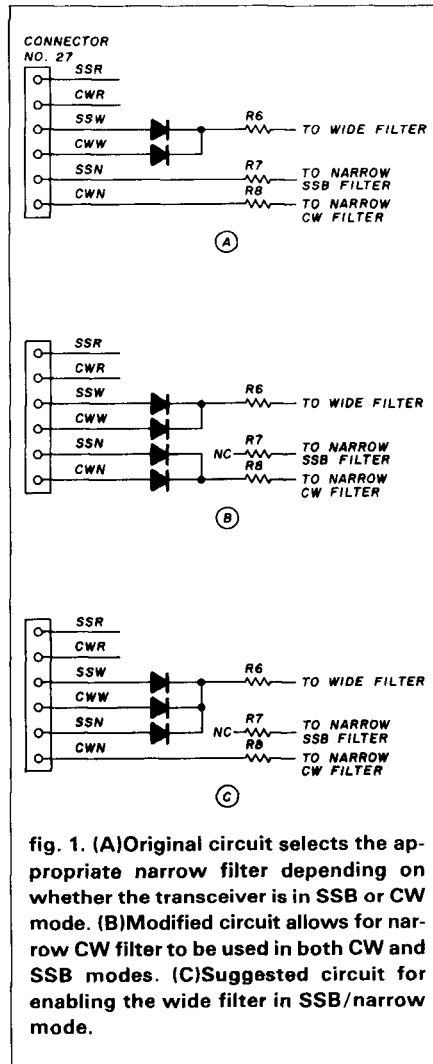

fig. 1. (A)Original circuit selects the appropriate narrow filter depending on whether the transceiver is in SSB or CW mode. (B)Modified circuit allows for narrow CW filter to be used in both CW and SSB modes. (C)Suggested circuit for enabling the wide filter in SSB/narrow mode.

To locate the appropriate area inside the transceiver, follow the instructions for installing the optional filters. R7 and R8 are located towards the rear of the IF filters. The ends of R7 and R8 nearest the rear of the transceiver go to connector No. 27. (Be careful in unsoldering the resistors because the printed circuit board traces are delicate.)

Robert A. Witte, KB0CY

## short circuits

### PL tone generator

In the April, 1984 article, "A Programmable PL Tone Generator," the component labeled "C7" in the upper left-hand corner (immediately below "U7") of the parts placement diagram (fig. 5, page 56) should be labeled "C17."

### RF synthesizers

In the three-part series "RF Synthesizers for HF Communications," (August, September, October, 1983), three corrections are required. First, the labeling of the vertical axis in the phase noise plots in figs. 15 and 20 of Part 2 (September) and fig. 13 of Part 3 (October) should read " $P_n$  dBc (IN 1 HZ BANDWIDTH)."

A second error appears in the last paragraph of the September article (page 50) and under "Using Bode Plot" on page 26 of the October issue. The open-loop unity gain frequency ( $f_{\beta 0}$ ) is not exactly equal to the closed loop 3 dB frequency ( $f_{\beta}$ ). While it is a reasonable approximation, the two are more accurately related by:

$$f_{\beta 0}/f_{\beta} = \frac{\sqrt{2\xi^2 + \sqrt{(2\xi^2)^2 + 1}}}{\sqrt{2\xi^2 + 1 + \sqrt{(2\xi^2 + 1)^2 + 1}}}$$

This difference is caused by the fact that at open-loop unity gain, the phase lag is not exactly 90 degrees. The closer this lag approaches 180 degrees (i.e., damping decreasing), the larger the difference between the open-loop unity gain frequency and closed-loop 3 dB frequency. (This ratio is approximately 0.755 at  $\xi = 0.707$ , 0.829 at  $\xi = 1$ , and 0.943 at  $\xi = 2$ .)

Finally, in fig. 9 of Part 3 (October) a 0.01  $\mu$ F capacitor should be connected between pins 2 and 6 of the NE5534 op-amp (as described in the text).

# Ham Radio's BOOK STORE BUILDERS' SPECIAL

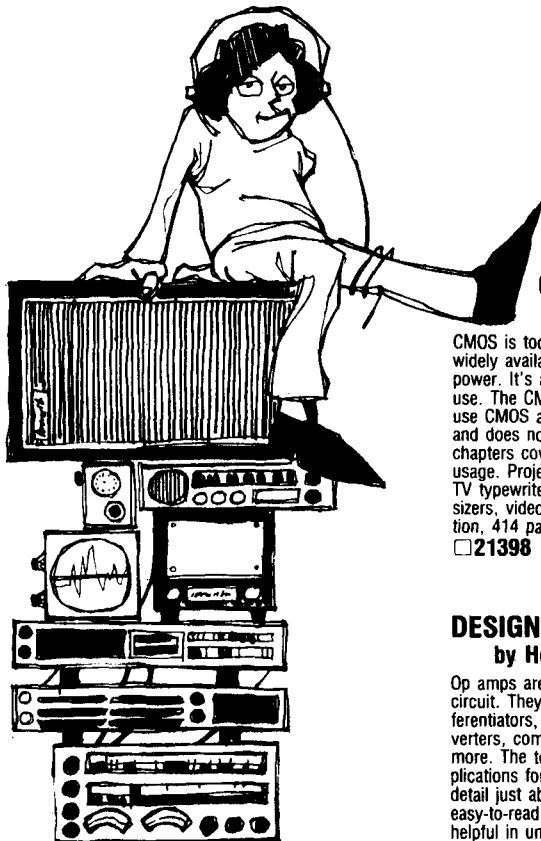

## CMOS COOKBOOK by Don Lancaster

CMOS is today's state-of-the-art! It's low cost, widely available and uses an absolute minimum of power. It's also fun to work with and very easy to use. The CMOS Cookbook is written to help you use CMOS and is chock-full of practical circuits and does not dwell on math or heavy theory. Eight chapters cover just about every aspect of CMOS usage. Projects include high-performance op-amps, TV typewriter, digital instruments, music synthesizers, video games and more. ©1977, 1st edition, 414 pages.

21398 **Softbound \$13.95**

## IC OP AMP COOKBOOK by Walter Jung

This second edition is broadly updated in terms of device coverage. It includes the latest in state-of-the-art developments such as J Fet and MosFet in both single and multiple formats. This cookbook is edited into three basic parts. Part I introduces the IC op amp and discusses general considerations. Part II covers practical circuit applications. Part III is an appendix consisting of manufacturers and data sheets and other pertinent information. With the same clear, easy-to-read format of the first edition, you'll find the wealth of information, as well as over 200 practical circuit applications, to be invaluable. ©1980, 2nd edition, 480 pages.

21695 **Softbound \$15.95**

## DESIGN OF OP AMP CIRCUITS by Howard Berlin, W3HB

Op amps are a versatile and inexpensive integrated circuit. They can be used for linear amplifiers, differentiators, integrators, voltage and current converters, comparators, rectifiers, oscillators and more. The text includes 37 different uses and applications for op-amps. Ten complete chapters detail just about every facet of the op-amp in an easy-to-read format. Beginners will find this book helpful in understanding exactly how an op-amp works. 1st edition, ©1977, 221 pages.

21537 **Softbound \$11.95**

## SOLID STATE CIRCUIT FILES by Ed Noll, W3FQJ

These two volumes are full of interesting circuits. Volume 1 covers in three major sections; bipolar transistors, field effect transistors and linear integrated circuits. Volume 2 has two major sections; transistor logic digital circuits and CMOS circuit design. Over 60 basic and more advanced circuits allow for experimentation and study. Wherever possible, low cost devices are used to facilitate breadboarding. Ideal for schools or home study. Both editions ©1980, 1st edition.

Vol. 1 Bipolar Transistor FET and Linear IC  
 21753 **\$8.95**

Vol. 2 TTL and CMOS Circuits  
 21754 **\$8.95**

## MODERN DICTIONARY OF ELECTRONICS — 6th Edition by Rudolf Graf

This book should be in every ham's library. It has over 20,000 terms unique to electronics and other closely related fields. 3000 additions to the 5th edition and twice the size of the 1st edition! From A or angstrom to zoom lens, you'll find it in this updated dictionary. 6th edition, ©1984, 1152 pages.

22041 **Hardbound \$39.95**

## TTL COOKBOOK by Don Lancaster

Despite the advent of CMOS, there is still plenty of design work being done with TTL circuitry. This book gives you a broad overview of exactly what TTL is, how it works and is full of design ideas and practical circuits. Some areas that receive attention are, flip-flops, clocked logic, counters and counting techniques, noise generators and much more. You also get a complete discussion of practical TTL applications including digital counter, events counter, stopwatch and voltmeter to name just a few. ©1974, 1st edition, 333 pages.

21035 **Softbound \$12.95**

## ACTIVE FILTER COOKBOOK by Don Lancaster

Active filters are unique combinations of integrated circuits, resistors and capacitors. They give excellent performance from sub-audible to ultrasonic frequencies. And they are relatively low in cost, simple to design and construct. This book is written for the user and will help you tailor filters to specific needs or applications. Ten chapters are full of helpful information and are illustrated with plenty of drawings and circuits. ©1975, 1st edition, 240 pages.

21168 **Softbound \$14.95**

## DESIGN OF ACTIVE FILTERS WITH EXPERIMENTS by Howard Berlin, W3HB

Here's an excellent introduction to the theory, implementation and design of active filters using the 741 op-amp. This book starts the reader with an introduction to the 741 op-amp and then progresses to filter design basics. Also covered are first order low and high pass filters, second order voltage controlled voltage source filters, second order multiple feedback filters and more. Throughout the book, experiments are given to enable you to gain first hand experience on just how each filter operates. Great for all levels of electronic interest. 1st edition, ©1977, 239 pages.

21539 **Softbound \$10.95**

## DESIGN OF PHASE LOCKED LOOP CIRCUITS WITH EXPERIMENTS

by Howard Berlin, W3HB

Due to prohibitive costs, the phase loop circuit did not become widely used until the development of the monolithic IC and the incorporation of complete PLL circuitry inside these solid state devices. This book serves as an introduction to the theory, design and implementation of PLL using a variety of TTL and CMOS devices. Opening with an introduction of PLL, this book covers in a basic building block approach, the phase detector, voltage controlled oscillator and the loop filter. Appendices include manufacturers design information and description of breadboarding techniques. Experiments are included to ensure the reader fully understands PLL design nuances. 1st edition, ©1978, 255 pages.

21545 **Softbound \$10.95**

## MICROPROCESSOR CIRCUITS by Ed Noll, W3FQJ

Volume 1 presents basic concepts and fundamental circuits of microprocessor systems. Volume 2 presents microprocessor I/O circuits and programmable controllers. Each volume is written and edited in an uncomplicated manner. By using the experience gained from these books, the reader can progress to higher levels of computer complexity with a minimum of problems. Every attempt is made to keep costs down so that experimentation is facilitated. Both books, 1st edition, ©1983.

Vol. 1 Fundamentals & Microcontrollers  
 21877 **\$9.95**

Vol. 2 I/O Interfacing and Programmable Controllers  
 21977 **\$9.95**

## ELECTRONIC PROTOTYPE CONSTRUCTION

by Stephen D. Kasten

Here's a great book for either the beginner looking to try electronic prototyping for the first time or the expert looking for a handy reference guide. Areas covered include wire wrap and related techniques such as solder pad and perf. board assembly. When rough schematics are converted to PC boards, this book will help you through all the pitfalls of PC board design. It will also give you handy tips on how to make PC boards simply, with a minimum of fuss. Finally, when the project is nearing completion, you must consider packaging or how to put it all together in an attractive but functional package. Great reference book! 1st edition, ©1983, 399 pages.

21895 **Softbound \$17.95**

PLEASE ADD \$2.50 FOR SHIPPING AND HANDLING  
FOREIGN ORDERS FOB GREENVILLE



149  
**ham  
radio** magazine **BOOKSTORE**



**Exclusive!**

# SATELLITE CONTROL CABLE

3 TYPES AVAILABLE!!!

## TYPE 1 (General Purpose)

- 1 — RG59/U 96%  
Copper Braid
- 5 @ 22-Gauge
- 2 @ 22-Gauge  
Shielded plus  
Tinned Copper  
Drain Wire
- 2 @ 18-Gauge

## TYPE 2 (MTI)

- 1 — RG59/U 96%  
Copper Braid
- 2 @ 12-Gauge
- 3 @ 18-Gauge
- 3 @ 20-Gauge  
Shielded plus  
Tinned Copper  
Drain Wire
- 3 @ 22-Gauge Shielded  
plus Tinned Copper  
Drain Wire

## TYPE 3 (Intersat)

- 2 — RG59/U 96%  
Copper Braid
- 2 @ 12-Gauge
- 6 @ 18-Gauge
- 3 @ 22-Gauge  
Shielded plus  
Tinned Copper  
Drain Wire

AVAILABLE  
IN 250-500-1000  
FT. ROLLS  
OR BY THE FOOT

Designed for easy, one-step installation, providing the required cables for most earth station equipment . . . all in a direct burial jacket.

Only Nemal offers the quality construction RG59/U copper shielding made to mil spec JAN C-17, 12-gauge conductors, tinned copper drain wires, and a true direct burial jacket.

## NEMAL ELECTRONICS, INC.

12240 N.E. 14th AVE., NO. MIAMI, FL 33161

Telephone: (305) 893-3924

✓ 181

- COMPLETE MULTICONDUCTOR LINE
- PRICING AVAILABLE FOR ALL QUANTITIES

\* Also available: Complete line of coaxial and multi-conductor cables, top-quality connectors and SMATV equipment

FRANCHISED DISTRIBUTOR KINGS CONNECTORS AUTHORIZED AMPHENOL DISTRIBUTOR

\* Call or write for compete dealer pricing

- WE'LL BE GLAD TO CUT ANY OF OUR CABLES TO MEET YOUR EXACT LENGTH REQUIREMENTS

## LATE NEWS..

Get the news  
As it happens



Westlink Report is *your* source for information on all the late breaking stories in the exciting world of Amateur Radio. Westlink Report summarizes the news that will impact the future of Amateur Radio. Westlink digs into its stories and gives you the latest from Newington, summarizes the actions of the FCC, reports on the important international news, keeps you fully informed about space and AMSAT news and much, much more.

Subscribe to Westlink Report today. Be informed. Don't be surprised by the latest developments in this fast paced hobby.

26 issues just \$22.50 per year U.S., Canada, Mexico. \$42.50 per year Air Mail.

### THE WESTLINK REPORT

11119 Allegheny Street  
Sun Valley, CA 91352

✓ 220

**avanti® antennas**

MOBILE ANTENNAS

Larsen

Cushcraft

antenna specialists

**HUSTLER**

**Hatry Electronics**  
The Elect in Electronics  
500 LEDYARD STREET  
HARTFORD, CONN. 06114  
Phone 203-527-1881

MasterCard VISA

✓ 154

# RADIO WAREHOUSE

Division of HARDIN Electronics

**NO FRILLS — JUST LOW PRICES**

• **KENWOOD**

TS 430 TR 2500 TW 4000  
HF \$Call 2m 285.00 UHF/VHF \$Call

• **YAESU**



FT 980  
HF \$Call

2AT  
2M \$219

• **ICOM**

IC-751  
HF \$Call

FT 757 \$ CALL IC-745 \$ CALL  
FT 726R \$ CALL IC-02AT \$ CALL

For information on our other lines . . .

CALL TOLL FREE  
**1-800-433-3203**



IN TEXAS CALL 817-496-9000  
5635 EAST ROSEDALE  
FT. WORTH, TEXAS 76112

## 1296 & PHASE III

MAKI UTV 1200 - \$499<sup>95</sup>  
MAKI 20W AMP - \$430<sup>00</sup>

**MICROWAVE MODULES**  
432/435 TRANSVERTERS  
432/1296 YAGI-18 + dB

**0-10 TRACKING PROG.**  
TIMEX/ZX - 16K  
Vic-Basic \$12.95  
Also Avail. w/RS & STS

See the Timex/ZX AUTOTRAK  
ROTOR CONTROLLER AT DAYTON '84  
SASE for full details

## SPECTRUM WEST

5717 NE 56th, SEATTLE, WA 98105  
206-641-7461 ✓ 203

## DRAKE R-4/T-4X OWNERS AVOID OBSOLESCENCE

**PLUG-IN SOLID STATE TUBES!**  
Get state-of-the-art performance.  
Most types available

**INSTALL KITS TO UPGRADE PERFORMANCE!**

- BASIC Improvement
- Audio Bandpass Filter
- Audio IC Amplifier

TUBES \$23 PPD KITS \$25 PPD

OVERSEAS AIR \$7

**SARTORI ASSOCIATES, W5DA**  
BOX 832085  
RICHARDSON, TX 75083  
214-494-3093 ✓ 198

## BIRD Wattmeters

Authorized BIRD Distributor



Model 4381  
\$695.00

Complete inventory of all Bird wattmeters, dummy loads, switches, carrying cases and accessories.

Order by phone  
1-800-431-7777  
In Ohio call 216-828-2071  
Free shipping with certified check orders.

Model 43  
\$162.00



All BIRD Elements in Stock

5A through 1000E elements (5W - 1000W; 25 - 1000 MHz) \$48

50H through 1000H elements (50W - 1000W; 2 MHz - 30 MHz) \$59

2500H and 5000H elements (2500W and 5000W; 2 MHz - 30 MHz) \$75



✓ 189

## PARAMOUNT

COMMUNICATIONS ELECTRONICS  
PO Box 506, Burnett Ave., Dalton, OH 44618

## DX'ERS SPECIAL

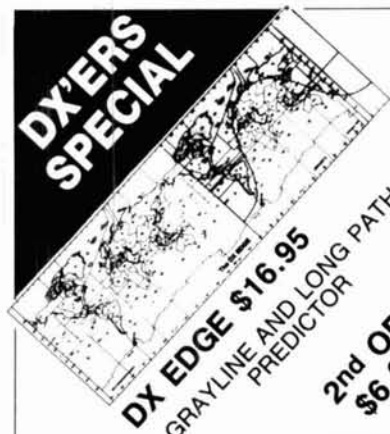

**DX EDGE \$16.95**  
GRAYLINE AND LONG PATH PREDICTOR

**2nd OP \$6.95**



PREFIX CALLS  
TIME ZONES  
BEAM HEADINGS

REGULAR \$23.90 PLUS SHIPPING  
**JUST \$19.95** plus \$2.50 S&H  
**HAM RADIO'S BOOKSTORE**  
GREENVILLE NH 03048

QUADS — TOWERS — QUADS — TOWERS — QUADS —

## DO YOU WANT THE STRAIGHT DOPE ON QUADS?

Dope on verticals, dipoles, mini-quads, Yagis, including comparative performances? Without pulling any punches. Our references are ANY AMATEUR WHO USES A SKYLANE QUAD. Our prices are lower than any comparable Quad or tower.

Dope on quads **half a buck**, and dope on BOTH towers and quads for a **buck**. Charge due to increased cost of postage and printing.

## SKYLANE PRODUCTS

359 Glenwood Avenue  
Satellite Beach, FL 32937  
(305) 773-1342

QUADS — TOWERS — QUADS — TOWERS — QUADS — TOWERS — QUADS — TOWERS — QUADS —

✓ 200

Use GDO, noise or RF bridge  
to determine resonance

## matching dipole antennas

**This article describes** how to use a grid dip oscillator (GDO), RF bridge, or noise bridge to measure an antenna's resonant frequency and its resistance at resonance. While the article specifically addresses dipole antennas, the procedure described is applicable to any antenna, and is meant for those Amateurs who wish to feed antennas directly without the need for a transmatch or other matching device.

### cutting to formula

The starting point for finding a dipole's resonant length is:

$$L = \frac{468}{f} \quad (1)$$

where  $L$  = length in feet  
 $f$  = frequency in MHz

This length allows for "end effects." Specific height above ground, length-to-diameter ratio and proximity to other objects (particularly conductors) also influence the resonant length.

As an example, a recently erected 10- and 15-meter

dipole cut to formula had to be adjusted by removing six inches from one dipole and adding even more to the other. These are appreciable changes in 33- and 22-foot dipole lengths — about 2 percent. These length changes also represent about a 2 percent frequency variation: 280 kHz on 20 meters and 420 kHz on 15 meters. These changes are about as large as the bands are wide! Even though the resonant frequency of the antenna is "off," this information is still useful in determining correct length by working with "percentages." For example, if you find that the resonant frequency of the antenna *at its operating height* is 2 percent low, correct by reducing the overall length of the antenna by approximately 2 percent. Because this change is still relatively small, the 2 percent reduction can be made to one side only.

### eliminating feedline ambiguities

If possible, it's best to make measurements at the antenna terminals directly (fig. 1). If you try to measure the resonant frequency of the antenna from the transmitter end of the cable, you'll see a combination of effects related to the antenna, feedline, and matching devices between the antenna and yourself.

However, if your feedline is a multiple of an electrical half-wave at your antenna's resonant (and desired operating) frequency, the feedline will reflect the antenna's characteristics at its input end (at the transmitter) (fig. 1). This way the antenna can be checked at its final height. To do this, determine the approximate feedline length using eq. 2:

$$L_{\lambda/2} = \frac{492 \cdot V_F}{f} \quad (2)$$

where  $L_{\lambda/2}$  is electrical half wavelength in feet  
 $V_F$  is velocity factor (between 0 and 1)  
 $f$  is frequency in MHz

Because the velocity factor of cables can vary from manufacturer to manufacturer, and even within the

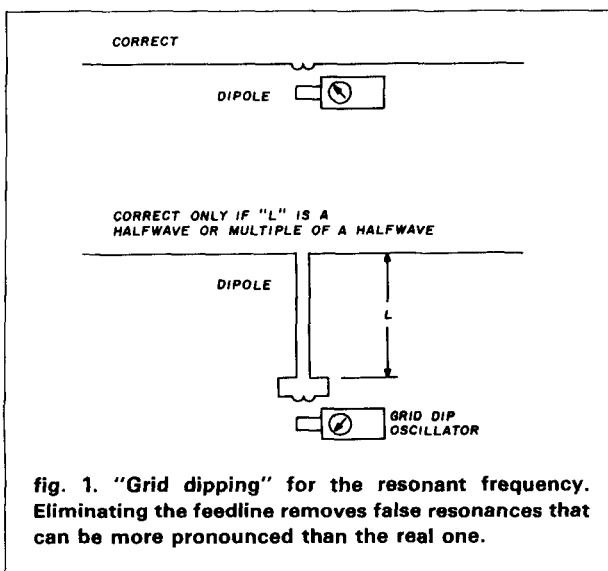

fig. 1. "Grid dipping" for the resonant frequency. Eliminating the feedline removes false resonances that can be more pronounced than the real one.

By George A. Wilson, Jr., W1OLP, 318 Fisher Street, Walpole, Massachusetts 02081

# John J. Meshna Jr., Inc.

19 Allerton Street • Lynn, MA 01904 • Tel: (617) 595-2275

## DUAL FLOPPY DISC DRIVES

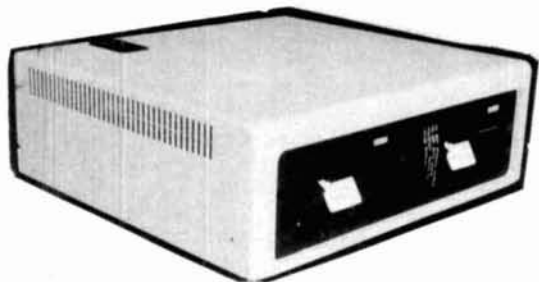

BRAND NEW, dual floppy disc drives made for Digital Equipment Corp. (DEC model no. RX 180 AB). This beautiful piece of computer hardware consists of 2 Shugart compatible TEAC 40 track, double density, 5¼" mini-floppy disc drives brand new in the case with their own regulated, switching power supply, cooling fan & on/off switch. Each unit also comes with a line cord & documentation. These were made for DEC, but are also compatible with other personal computers such as IBM, TRS 80 models I, II, III, & the Color Computer, and other Shugart compatible interfaces. Naturally you supply the cables and disc controller card to suit your particular system. The RX 180 AB runs off of 115/230 VAC 50/60 Hz. w/out any modifications to the drives. Each system comes in the original factory box and are guaranteed functional. A blockbuster of a buy !! Shpg. wt. 20 lb. Stock no. RX 180 AB \$250.00

## HIGH SPEED KSR PRINTER TERMINAL



World famous, high speed G. E. Terminet 1200 RS 232 KSR printer terminals are now in stock ready for shipment to you. This has to be one of the finest letter quality printers ever offered at a bargain price. These terminals can be used as an RS 232 asynchronous communications terminal or used in the local mode as a typewriter. The terminals were removed from service for upgrading. Highlights of these machines are: Standard RS 232, full duplex, asynchronous data comm., fully formed upper and lower case letters, 128 character ASCII set, selectable baud rates of 110, 300, or 1200 BPS, 80 columns on pin feed paper, and less weight & size than an ASR 35 teletype with far less racket. They are virtually electronically foolproof as every pc board is Pico fuse protected. Should your machine not work, just check the on board fuses & 9 out of 10 times that is where the problem lies. Schematics are provided w/ each machine sold. Current price of this machine new is over \$2000.00 ! Our meager price for this fantastic printer is only 10% of this: \$200.00 each!!! Visually inspected prior to shipment to insure completeness. Shpd. truck freight collect. \$200.00

## 5 MEGABYTE SEAGATE ST 506 5¼" MICROWINCHESTER HARD DISC DRIVES



The Seagate Technology ST 506 MicroWinchester hard disc drives are identical in size and mounting configuration to the industry standard 5¼" mini-floppy disc drives. These drives utilize 2 5¼" fixed platters as storage media. Each surface employs 1 read/write head to service 153 tracks. The storage capacity is 5 megabytes formatted ! The voltage requirements are only 5vdc 700ma & 12vdc 1.6 amps. hardly more than a regular mini-floppy drive. The drives we have are in beautiful condition and look to be unused. Each one comes with factory literature which includes the pinouts. The ST 506's will run with computer systems from Kaypro, IBM, Xerox, and other Shugart compatible interfaces when used with the proper controller card (not provided). Only 10 pieces in stock, so order early. Seagate ST 506 Shpg. wt. 9 lb. \$300.00 2/\$575.00

IBM model no. 745

## NEW IBM SELECTRIC BASED TYPEWRITER PRINTERS



Send for free data sheet.

These rugged, handsome printers were made for one of the giants of the computer industry. They can be used as a standard typewriter or as a printer in a word processing system for true letter quality printing. Solenoids were added to the selectric mechanism which disabled the manual repeat function but still allows electronic repeat functions. It uses standard IBM typing balls. The voltage requirements are standard 115 vac, 5 vdc @ 100 ma, & 24 vdc @ 4 amps. All are new in factory boxes, but may require adjustments. We provide literature and schematics with 1 ribbon & cleaning tools. With the addition of our Centronics to Selectric I/O adapter, you could easily interface this printer to almost any micro computer system.

Typewriter Printer stock no. RE 1000A \$375.00 shpg wt. approx. 80 lb. shpd. by truck collect. Centronics to Selectric adapter. Fully tested & operational \$245.00 Shpd. UPS 15 lb.

## SHUGART 901 8" FDD

We just got in a small lot of nice clean world reknown Shugart 8" disc drives. Single side, single density units. Each drive will come with data on using the 901's in 801 compatible systems which should make them very versatile. Schematics are also provided. Used, good condition. Shpg. wt. 15 lb. \$75.00



## BA 279 BATTERIES

Unused surplus from Uncle Sam. Output is 135v, 67½ v, 6v, & 1¼v. Socket is made to fit plug from PRC 8,9,& 10. May fit other rigs as well. Current list price is \$42.25. Our price is only \$15.00 Shpg. wt. 9 lb.



Phone Orders accepted on MC, VISA, or AMEX No COD's. Tel. 1-617-595-2275

Surplus Electronic Material

Send for our free 72 page catalogue jam packed with goodies.

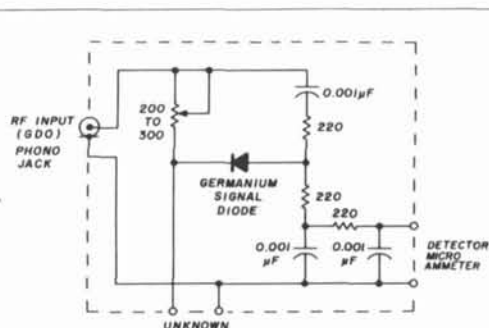

quantity	description
1	enclosure RS-270-235
4	binding posts RS-274-661
1	phone jack RS-274-1575
1	potentiometer, 200 to 300 ohms carbon composition (typically, Allen Bradley type AB; Claristat, type 53; or Ohmite, type J)
3	resistors, 1/4 watt, 220 ohm 5 percent RS-271-1313
3	capacitors, disc 0.001 $\mu$ F RS-272-126
1	germanium signal diode (IN34A) RS-276-1123

Note: Radio Shack™ part numbers are shown

fig. 2. RF bridge circuit.

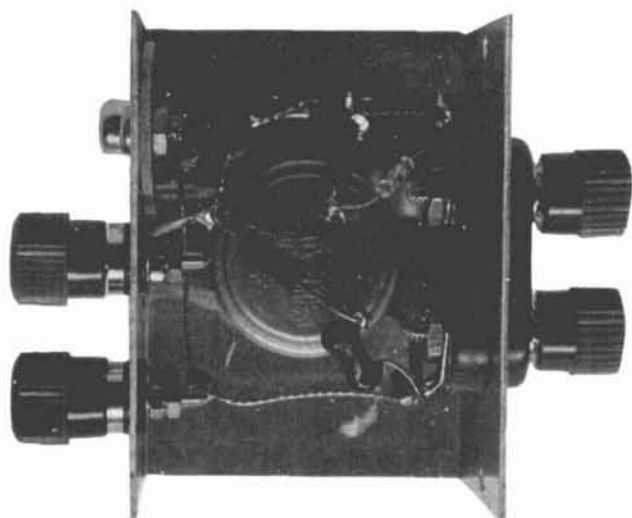

fig. 3. Interior view of the RF bridge shows the parts arrangement. The layout is not critical. Be sure to use non-inductive, carbon composition resistors. Terminals may be substituted to suit your test equipment.

same manufacturer's run of cable, more accurate approaches — such as a GDO, noise or RF bridge — should be used to determine the exact half wavelength of cable. The input end of a cable is resonant when it is shorted at a half or multiples of a half wavelength or when it is open-circuited at a quarter wavelength or at multiples of an *odd* quarter wavelength. These factors make a simple measurement possible.

To find an electrical half wavelength using a GDO, cut the cable a little longer and short its far end. Connect a small coupling coil (a single shorted turn might

be sufficient) and bring the GDO up close. Use the smallest coupling coil possible to minimize error. Trim the far end as needed. (A more accurate frequency indication can be achieved by listening to the GDO on an accurately calibrated receiver.) If you want a quarter wave cable length rather than a half wave, repeat the procedure with half the length of cable, but do not short the far end.

When using a noise or RF bridge, the technique for determining a half wavelength of cable requires setting the bridge for zero resistance (and reactance if your bridge is equipped to measure reactance), cutting and shorting the cable as above and connecting the bridge to the input end of the cable. Resonance is indicated by a reduction in received noise in the case of the noise bridge or a minimum reading on an RF bridge's null detector. Trim the cable until the resistance at the input end goes to zero (or as close to zero as is practical to obtain). A quarter wavelength is determined in the same manner, but the far end of the cable is open-circuited.

The RF bridge and GDO combination can be used for outdoor antenna work because these devices are usually quite portable. Noise bridges themselves are easily portable, but the combination of bridge and receiver presents a real challenge to mobility. On the other hand, noise bridges are simpler to set up and handle than the RF bridge and GDO combination. If you plan to do more complex antenna and/or RF circuit work, noise bridges will provide accurate reactance and resistance measurements over a very wide range of frequencies.

### building an RF bridge

The bridge shown in fig. 2 uses an outboarded 100 microampere meter for sharp and deep nulls. Parts placement is not critical, but a metal enclosure should be used to minimize "hand-capacity" variations. All parts are available from Radio Shack except the balance potentiometer, which should be a linear carbon composition type: typically, Allen Bradley, Type AB; Claristat, Type 53; or Ohmite, Type J.\* Its value should be about 200 ohms. Most of the measurements will be in the order of 50 ohms. A low value potentiometer will assure that the scale is expanded enough to read easily (see fig. 3).

The bridge is calibrated using an ohmmeter. (1 percent resistors would provide greater precision — Ed). Mount a paper scale (see fig. 4 and 5) behind the pointer, marking each 10-ohm point between 10 and 100 ohms and each 50-ohm point above 100 ohms. Calibration may be done with the circuit wired up since

\*Most electronic supply houses carry these types of potentiometers but have minimum order amounts of at least \$20.00. Group ordering is a possibility; the potentiometers are in the \$4 to \$5 price range. Most large cities have one or two suppliers that will sell to Amateurs over the counter. One such is Linear Electronics in Waltham, Massachusetts.



fig. 4. Panel view of the RF bridge shows the calibration of the variable (balance) resistor. This is done using an ohmmeter — no trick to it all! Make sure the variable resistor value increases in a clockwise direction.

the potentiometer is isolated by capacitors. Make sure the correct potentiometer ends are connected such that the scale increases in a clockwise direction.

The GDO is coupled to the bridge using a small coil and a short length of twisted hook-up wire. A two-turn loop slightly larger than the coil in the GDO is usually adequate. Tight coupling initially may make the dip easier to find, but afterward use as little coupling as practical to assure minimum interaction between the GDO and the circuit being measured.

### using the bridge

Connect the bridge, null indicator (microammeter) and GDO as shown in fig. 6. The dipole should be connected as directly to the bridge as possible. Turn the GDO on and adjust the coupling for about a half-scale reading on the null detector. Set the resistance knob to about 50 ohms. Vary the GDO frequency until the detector microammeter, *not* the meter on the GDO, goes through a minimum (dip). Set the frequency for the lowest dip and then adjust the resistance knob to further increase the dip. Loosen the GDO coupling until the dip is barely perceptible and again set the frequency and resistance for the best possible dip. Now read the GDO frequency and bridge resistance. These are the antenna's resonant frequency and its resistance at that frequency, respectively. If corrections in length (shorter to increase and longer to decrease the frequency) are necessary, proceed as previously discussed and then recheck the frequency as just described. Fig. 7 illustrates the use of a noise bridge and a receiver to determine antenna resonant conditions.

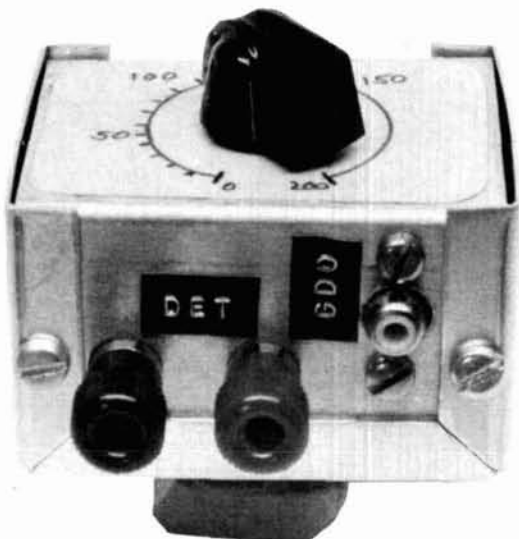

fig. 5. Top view of the RF bridge shows the jack for connecting the grip dip oscillator and the detector terminals.

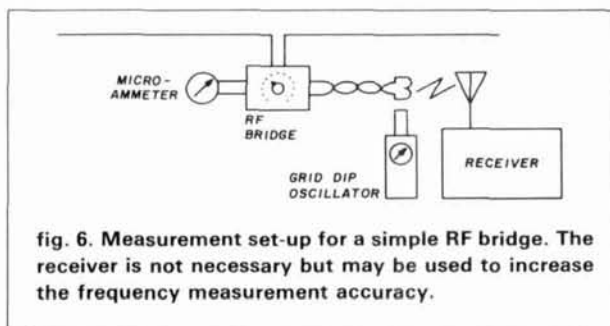

fig. 6. Measurement set-up for a simple RF bridge. The receiver is not necessary but may be used to increase the frequency measurement accuracy.

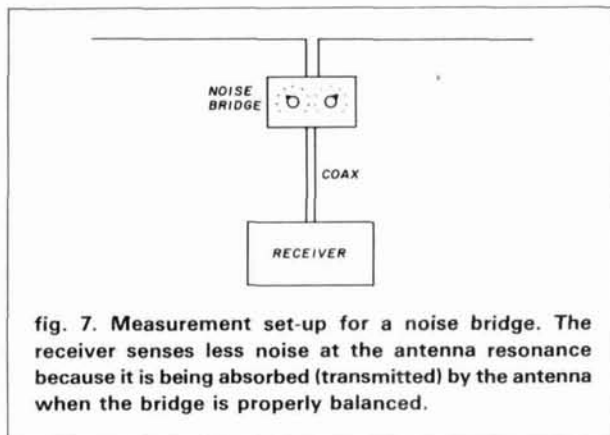

fig. 7. Measurement set-up for a noise bridge. The receiver senses less noise at the antenna resonance because it is being absorbed (transmitted) by the antenna when the bridge is properly balanced.

### conclusion

The material in this article should be particularly useful to those wishing to take their first steps toward antenna experimentation. More importantly, it may stimulate deeper interest in antennas and other tuned RF devices. The kind assistance of Domenic Mallozzi, N1DM, Robert Doherty, K1VV, and Clyde Shappee, KA1CRV, are gratefully acknowledged.

ham radio

# The small dish that captures all the entertainment.

**WILSON  
MICROWAVE  
SYSTEMS, INC.**



Only Wilson Microwave Systems can give you the versatility of hand-held control of the total satellite television spectrum at such a remarkably low price.

## **Total System Design.**

From the solid steel antenna to the state-of-the-art electronic receiver and hand-held control unit, Wilson gives you the most complete, integrated system you can own.

*At Wilson Microwave Systems, we put the world of entertainment in the palm of your hand.*



**BUILT BY YAESU**

**1 year warranty on receivers  
4 year limited warranty on dish**

**NOW ONLY**

**\$1695.00** F.O.B. Nampa, ID

Includes: 110° LNA - Polarizer I - 100' Cable  
Wilson MD9 Dish - YM1000 Receiver

**Dealerships  
Available**

Antenna is shown with optional LNA cover.

**Distributed by**

# **NAMPA SATELLITE SYSTEMS**

312 12th Avenue South • Nampa, Idaho 83651

(208) 466-6727

**In State Wats 1-800-654-1319 • Out of State Wats 1-800-654-0795**

**YES, WE HAVE IT!**

TWO 5' x 1/2" ROLLS  
FOR \$5.95 ppd. **OR:**  
FOUR 12' x 1/2" ROLLS  
FOR \$13.95 ppd.

Send payment with order  
**OR**, call for faster service  
(have charge card  
number ready).

120

BIRCH HILL SALES  
P.O. Box 234,  
Peterborough, NH 03458  
**(603) 924-7959**



R-T HV Mark II



**NEW, EASY-TO-USE DESIGN  
GET TRANSI-TRAP™  
LIGHTNING PROTECTION**

Protect your valuable equipment from antenna voltage surges caused by nearby lightning, high wind and static build-up. Keeps harmful ARC-energy off equipment by safely shunting it to ground. Uses tested, field proven, and replaceable ARC-PLUG™ gas filled ceramic cartridge.

Model LT 200 watts @ 50Ω \$19.95  
Model HT 2kw @ 50Ω \$24.95  
Ruggedized Super Low Loss (.1dB @ 500 MHz)  
Model R-T 200 watts @ 50Ω \$29.95  
Model HV 2kw @ 50Ω \$32.95

See your local dealer or order direct. Pse. include \$2 for shipping and handling. MC and VISA accepted.

**ALPHA DELTA COMMUNICATIONS**

P.O. Box 571, Centerville, Ohio 45459  
(513) 435-4772

104

**BUY! SELL! TRADE!**  
COMPUTER & HAM EQUIPMENT

**COMPUTER TRADER**

**ANNUAL SUBSCRIPTION \$15.00**

Low Ad Rates — Mailed Monthly  
Foreign Subscriptions - \$30.00 Year  
FREE 50 Word Classified Ad with Subscription Order

**COMPUTER TRADER**

Chet Lambert, W4WDR  
1704 Sam Drive • Birmingham, AL 35235  
(205) 854-0271

Sample Copy — \$1.00

135

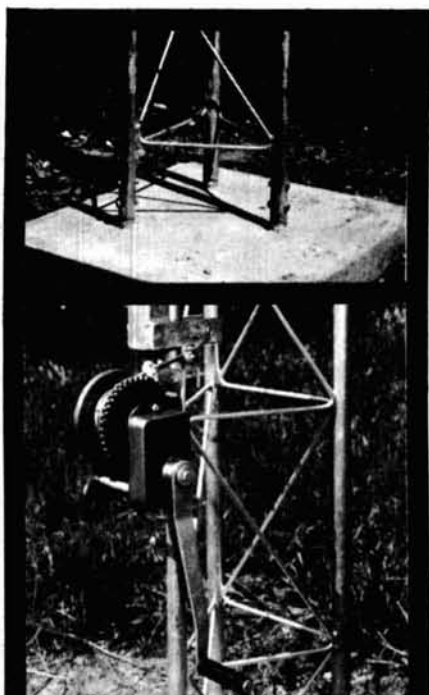

**ROHN**  
"FOLD-OVER"  
TOWERS

**EASE OF INSTALLATION**  
ROHN "Fold-Over" Towers are quickly and easily installed. The "Fold-Over" is fast and easy to service.

**ADAPTABILITY**  
ROHN has several sizes to fit your applications or you can purchase the "Fold-Over" components to convert your ROHN tower into a "Fold-Over".

**HOT DIP GALVANIZED**  
All ROHN towers are hot dip galvanized after fabrication.

**REPUTATION**  
ROHN is one of the leading tower manufacturers, with over 25 years of experience.

Write today for complete details.

QUALITY STEEL PRODUCTS BY

**ROHN**

Box 2000 Peoria, Illinois 61656  
U.S.A.

**GO MOBILE WITH YOUR H.T.!**



Model I—Icom IC-2A/T, Etc.  
Model K-1 for TR-2500  
—slides on bottom of radio

Guaranteed!



Model K—TR-2400;  
—powered thru battery plug  
Model N—FT-208R  
Model T—Simple mod for Tempo  
and all Santec

NOW FOR FT-208R & TR-2500



Model Y—FT-207R, Wilson  
—fits into battery compartment  
"A unique battery eliminator"  
HANDI-TEK Regulator allows  
constant hand-held operation  
from auto DC or base supply  
with no nicad drain and  
WITHOUT RADIO MODIFICA-  
TION! \$24.95 PPD in USA.  
Calif. add \$1.50 Sales Tax.

151  
HANDI-TEK

P.O. BOX 2205, LA PUENTE, CA 91746

**PRECISION PROCESSING**



The E-CLIPS Model III  
Provides total dynamic range control  
with very low distortion

- Selectable processing modes—envelope compression or peak limiting
- Variable high and low frequency response equalization
- Five segment LED display
- Easy to install and use with any transmitter/transceiver

110

Introductory price—\$189.95 ppd.

For brochure with complete technical specifications contact:

**ANALOG TECHNOLOGY**  
P.O. Box 8964 • Fort Collins CO 80525

**TUNE IN THE WORLD OF HAM-TV!**

Amateur Radio operators in the 1980's are discovering the fascinating "World of Amateur Television". Be it Fast Scan TV (FSTV), Slow Scan TV (SSTV), Facsimile (FAX) or somewhere in between, Video communications modes are growing at an exciting pace!

New advancements are taking place in High-Resolution/Color SSTV and the use of personal computers for ATV graphics. SSTV—FAX—RTTY communications. Interest is even growing in MICROWAVE and TVRO applications.

A5 ATV MAGAZINE™ has supported these modes of Amateur Specialized Communications since 1967—over 17 years! And now, under guidance of the UNITED STATES ATV SOCIETY, HAM-TV will continue to grow rapidly. Interested?

Send SASE for "free" information brochures today!

Special six month TRIAL subscription only \$10.00

One year subscription (12 issues) of the "USATV Journal" \$20.00

Sample issue available for \$2.50 ppd.

**A5 ATV MAGAZINE™**  
P.O. BOX H  
LOWDEN, IOWA 52255

A DIVISION OF QED PUBLICATIONS, INC.

116







# NEW products

## digital communications terminal

The EXL-5000 digital communications terminal from Amateur-Wholesale Electronics features a built-in high-resolution, long-persistence green monitor for sharp, clear images with no jiggle or jitter even under fluorescent lighting. Also featured are an external plug-in keyboard and a versatile built-in power supply for 117/234 AC or 13.8 VDC. Operation is greatly simplified by front-panel pushbutton controls.



The EXL-5000 includes capability for operating in AMTOR modes A, B, and L. A high-speed demodulator allows Baudot and ASCII operation from 12 to 300 bauds with AFSK and 12 to 600 bauds at TTL level, in increments of 0.1 baud. The demodulator will work with high or low tones. For transmitting, AFSK or FSK keying can be used. Morse sending and receiving speed is adjustable from 5 to 100 WPM in 1-WPM steps, with receive autotracking and variable transmitting weight.

A 1280-character display memory is split into two pages of 40 characters by 16 lines. Seven independently programmable 72-character channels and eight independently programmable 24-character channels allow storage of messages for permanent use. The memories can be pre-loaded and easily reprogrammed. Errors are easily corrected. The programmable memories are backed up by an internal battery so that they are never lost.

Other features of the EXL-5000 include full cursor control, function display, split-screen operation, automatic send/receive switching, automatic carriage return and line feed, automatic letters-code insertion, word-mode and line-mode operation, word wrap-around, simultaneous send-receive capability, selective calling, automatic timer-controlled transmission, RY and "quick-brown-fox" test signals, automatic ID, random-character generator for code practice, a printer interface, provision for an external mon-

itor, a built-in audio monitor, a bar-graph LED tuning meter, noise-reduction receiving circuit, and time clock.

Further information about the EXL-5000 may be obtained from Amateur-Wholesale Electronics, Inc., 8817 S.W. 129th Terrace, Miami, Florida 33176.

Circle #301 on Reader Service Card.

## IC-R71A

ICOM has introduced the new IC-R71A 100 kHz to 30 MHz professional-grade general coverage receiver, offering the same performance of the IC-R70 as well as several new features at the price of \$799. This easy-to-use, versatile receiver features keyboard frequency entry, 32 programmable memories, SSB/AM/RTTY/CW/FM (optional), scanning, selectable AGC and noise blanker, passband tuning, and three tuning rates: 10 Hz/50 Hz/1 kHz. Two optional CW filters FL32 (500 Hz) and FL63 (250 Hz), are available, as well as an optional FL44A high-grade crystal filter (455 kHz).

The IC-R71A makes it possible for anyone, even without previous shortwave receiver experience, to listen to worldwide communications. Utilizing ICOM's DFM (Direct Feed Mixer), a 100 dB dynamic range, deep IF notch filter and adjustable AGC and noise blanker, the IC-R71A provides clear reception even in the presence of strong interference or high noise levels. A quartz-locked synthesized tuning system provides stable operation.



The pushbutton keyboard provides instant selection of frequencies which is accomplished by pushing the digit keys in sequence of frequency. Memory channels can be called up by pressing the VFO/M switch, then keying in the memory channel digit/s.

Options include FM, synthesized voice frequency readout, a wireless remote controller, a DC adapter for 12V operation, a mounting bracket, two CW filters and a high-grade crystal filter-455 kHz.

For further details, contact ICOM, 2112 116th Avenue, N.E., Bellevue, Washington 98004.

Circle #302 on Reader Service Card.

## improved autopatch

A new simplex autopatch from CES will work on any Amateur or commercial simplex radio. CES engineers have redesigned the VOX enhancement circuitry and mobile presence detectors in the Model 510SA Smart Patch. The improvements allow the advanced microcomputer in the Smart Patch to keep the user from missing words or information. After trial testing at over 400 customer locations, it was concluded that the Smart Patch is now easier to install and



is the only simplex patch that gives the mobile unit complete and immediate full break-in capability without loss of information. The immediate control feature allows operation in the Amateur service because Smart Patch cannot transmit on top of another mobile. Transmission can be terminated by simply keying the transmitter. Installation consists of connecting RX audio, TX audio, PTT and power.

For further information about the Smart Patch, contact Communications Electronics Specialties, Inc., P.O. Box 2930, Winter Park, Florida 32790.

Circle #303 on Reader Service Card.

## feather-weight headset

Telex has introduced an ultra-light headset for hand-held land-mobile transceivers. The ProCom 352-IC weighs 2.6 ounces when worn with the headband, but only one ounce without, and can be clipped directly onto eye or sunglass frames for convenience. Priced at \$129.95, the headset plugs directly into ICOM or Ten-Tec hand-held transceivers.



A soft ear tip channels incoming messages directly into the operator's ear so that communications are essentially private. The noise canceling electret microphone is designed for very close talking and transmits the operator's voice clearly even in high-noise environments. The electret microphone is also immune to electromagnetic or RFI so it can be operated effectively near power lines, large transformers, generators, broadcast towers, and other equipment that often interferes with radio communications.

For more information, contact Telex Communications, Inc., 9600 Aldrich Avenue, South, Minneapolis, Minnesota 55420.

# Clean up the radio/computer clutter.

**For less than \$250 you can make your investment in yourself pay off!**

Chances are you have spent a couple thousand dollars on setting up a computer system that gets a lot of your work done. But sometimes it gets to be work to work at it.

I know that when I have to move two program manuals and a pencil holder to boot up the disk drive, it is work. When there is an unlabeled floppy (that I am going to identify some day) on top of the monitor and the business check-book is on top of the printer . . . and I will remember (I hope) before the next "report" comes through . . . that is work.

I found the annoyance of my own "computer clutter" was even worse than the extra work the disorder created. And that is when I started looking for some practical furniture for my computer set up. Since I had already spent a lot of money on the system itself, I was really dismayed when I found out how much it would cost to get a decent-looking desk or even a data table for my equipment. \$400 . . . \$500 . . . even more for a sleazy unit that looked like junk! In fact, it was junk! And it took a long time for me to find something that was really worth the money . . . and more.

A lot of my working day is spent with my computer, and I will bet a lot of your time is too. So I figure a "home" for my system—a housing that is good looking as well as efficient to work at—will pay off two ways:

1. Less work: an efficient and orderly layout will save me time and energy.
2. Personal satisfaction: good quality furnishings look better; they just plain feel better to work at too.

So imagine how good I felt to find the "Micro-Office" Work Center! These are fine pieces of computer system furniture that make my office-at-home as pleasant a place to work as it ought to be. And the



## MICRO-OFFICE WORK CENTER

biggest and best surprise is the low, low price for such good quality.

Here is what you get—all for only \$249.50 plus shipping.

- Mar-resistant work surface. Your choice of oak or walnut grained. Work surface height is adjustable to your keyboard, your chair, your height.
- Two shelves plus work surface extender. Both shelves tilt to lock in position so that monitor faces you—in a position that does away with screen glare squinting and neck craning forever. Retainer bar keeps equipment from sliding off shelf. Snap-in bookends hold reference manuals and programs.
- Strong, sturdy and steady. All-steel welded frame construction is concealed by top-quality wood grain surfaces with finished trim. Adjustable floor levelers included. The work center is really a piece of fine furniture.
- There is no risk in buying from us either. We will make a full refund of purchase

price plus shipping charges if you return the workcenter within 30 days for any reason whatsoever. In addition, the product is warrantied for any defects in materials or construction for a full year from date of purchase. This is a no-risk investment in your own productivity and work efficiency that will pay off for years to come—even if you do not yet have a microcomputer of your own.

- Take your choice for your own work center decor:

Order 48-inch unit in walnut, #2KPO-945, or in oak, #2KPO-947. Only \$249.50 for each unit plus \$20.00 shipping charge. On orders for two or more units at the same time, shipping charge applies to only the first unit ordered. Shipment made UPS, so we cannot ship to post office box. Illinois residents please add \$15 per unit sales tax. Please allow 10 extra days for personal checks to clear. Sorry—at these special offer prices we cannot ship c.o.d. or bill direct.

**CALL TOLL FREE TODAY WHILE SUPPLIES LAST: 1-800/323-8064.**

**In Illinois call 1-312/251-5699. Or mail check with order to:**

### Micro-Mart Distributors

Dept. HR • 1131 Central Street • Wilmette, IL 60091

**TUBES, SEMICONDUCTORS, IC'S  
DIODES AT SUPER LOW PRICES  
IN DEPTH INVENTORY  
EIMAC, SYLVANIA, GE, CETRON**



**Sylvania**

**RCA**

**RAYTHEON**

**NATIONAL**



OA2.....	\$2.75
3-400Z.....	115.00
3-500Z.....	90.00
4CX250B/7203.....	58.00
4CX1000A/8168.....	430.00
4PR60C/8252W.....	295.00
4X150A/7034.....	45.00
5AR4.....	6.24
5C22.....	165.00
5R4GB.....	3.85
6AK5.....	4.91
6AL5.....	3.86
6AQ5.....	3.77
6CA7.....	7.41
6DJ8.....	2.75
6JG6A.....	7.53
6JS6C.....	8.00
6KD6.....	8.85
6KV6A.....	6.92
6L6GC.....	6.83
6LF6.....	8.85
6LQ6.....	8.85
6MJ6.....	8.99
12AT7.....	3.87
12AU7.....	3.47
12AX7A.....	3.48
572B/T160L.....	49.50
705A.....	10.00
811A.....	13.50
813.....	40.00
829B.....	40.00
832A.....	38.00
833A.....	145.00
866A.....	9.50
872A.....	24.00
M-2057.....	15.00
5670.....	4.40
5684.....	33.00
5687.....	4.00
5751.....	4.00
5814A.....	3.70
5879.....	5.75
5894.....	65.00
6005.....	5.25
6146B.....	8.75
6360.....	6.50
6528A.....	75.00
6550A.....	7.50
6883B.....	10.00
7360.....	12.25
7558.....	7.00
7591A.....	6.20
7868.....	6.68
8072.....	95.00
8417.....	8.99
8874.....	210.00
8875.....	220.00
8877/3CX1500A7.....	475.00
8908.....	12.95
8950.....	11.50
MRF-453.....	19.95
MRF-454/A.....	19.95
MRF-455/A.....	19.95
2N6084.....	15.00



**NATIONAL**

**RAYTHEON**

**RCA**

**Sylvania**

✓ 210

Full line of Sylvania ECG Replacement Semiconductors Always in Stock. All Major Manufacturers Factory Boxed. Hard To Get Receiving Tubes At Discount Prices.

Minimum Order \$25.00. Allow \$3.00 For UPS Charges. Out of Town, Please Call Toll Free: 800-221-5802 and Ask For "ABE".

**TRANSLETERONIC INC.**

1365 39th STREET, BROOKLYN, N. Y. 11218H  
Tel. 212-633-2800/Wats Line 800-221-5802  
TWX 710-584-2460 ALPHA NYK.

**Barry Electronics Corp.**  
WORLD WIDE AMATEUR RADIO SINCE 1950  
Your one source for all Radio Equipment!



"MAY" we serve you the best in ham and commercial radios? Call us: Mark K2CON, Kitty WA2BAP, Jan KB2RV, Douglas WA2NCB.

**KITTY SAYS: WE ARE NOW OPEN 7 DAYS A WEEK.**  
**Saturday & Sunday 9 to 6 PM**  
Monday-Friday 9 to 6:30 PM Thurs. to 8 PM  
Come to Barry's for the best buys in town.  
For Orders Only Please Call: 800-221-2683

For the best buys in town call: 212-925-7000  
Los Precios Mas Bajos en Nueva York.

R-600, R-1000, R-2000, TS-930S/AT, TS 430S, TR 2500/3500, TR-9130, TR 7950, TW-4000A.  
Kenwood Service Repair.

**ROCKWELL/COLLINS KWM-380**  
VoCom/Mirage/Daiwa ONV Safety Tokyo Hy-Power Amplifiers & 518 HT Gain Antennas IN STOCK

Computer Interfaces stocked: MFJ-1224 AEA CP-1, Kantronics Big Ham Clock/Ham Tags

**KANTRONICS Field Day 2, Mini-Reader, Interface II, software and code Tapes**

EIMAC 3-500Z, 572B, 6JS6C, 12BY7A & 4-400A  
BIRD Wattmeters & Elements In Stock  
AEA 144 MHz, AEA 440 MHz ANTENNAS

FT-ONE, FT-980, FT-102, FT-77, FT-230R FT-757GX FT-726R, FT-720RU, FT-290R, FRG-7700, FT-203R  
YAesu IC2AT, IC3AT, IC4AT, IC02AT  
Land Mobile HT Midland Wilson Mini Com II Yaesu FT-2202, FT-4703 Icom IC M12 (Marine) Tempo M-1



Repeater in Stock: Yaesu FTR-2410, Wilson ICOM IC-RP 3010 (440 MHz) ICOM IC-RP 1210 (1.2 GHz) Spectrum

Complete Butternut Antenna Inventory in Stock!

**ROBOT 450C-800C-1200C Color Mod Kits**  
Long range Wireless Telephone for export in stock

**BENCHER PADDLES & Vibroplex Keys in Stock!!**  
New TEN-TEC 2591 HT, Corsair in Stock  
DENTRON IS BACK IN STOCK!



**ICOM**  
IC-R71A, IC-7510A, IC-745, IC-27A, IC-37A, IC-47A, IC-271AH, IC-2KL, IC-471A, IC-290H.



**SMART PATCH**  
CES Simplex AutoPatch 510 SA Will Patch FM Transceiver To Your Telephone Great For Telephone Calls From Mobile To Base Simple To Use \$319.99  
DRAKE TR-7A, R7A, L7, Earth Satellite Receiver ESR-24, THETA 900XE & 500, EARTH SATELLITE STATION ESS-2250



**Nye-MB5 3 Kilowatt Tuner**

SANTEC ST-222UP, ST-142UP, ST-442UP  
NEW IMPROVED MURCH Model UT2000B  
MFJ Models 900, 940B, 841C, & 951D  
HAM MasterTapes - Beta or VHS Tapes



**DIGITAL FREQUENCY COUNTER**  
Trioxys Model TR 1000 0-600 MHz Digital Model D-510 50 Hz-1 GHz  
Tri-Ex Towers & Antennas and Rotors will be shipped direct to you FREE of shipping cost!

MAIL ALL ORDERS TO BARRY ELECTRONICS CORP., 512 BROADWAY, NEW YORK CITY, NY 10012.

**New York City's LARGEST STOCKING HAM DEALER COMPLETE REPAIR LAB ON PREMISES**

**"Aqui Se Habla Espanol"**  
BARRY INTERNATIONAL TELEX 12-7670  
TOP TRADES GIVEN ON USED EQUIPMENT  
Monday-Friday 9 A.M. to 6:30 P.M.  
Thursday to 8 P.M.  
Saturday & Sunday 9 A.M. to 6 P.M. (Free parking)  
Paid parking lot across the street anytime  
AUTHORIZED DIST. MCKAY DYMEK FOR SHORTWAVE ANTENNAS & RECEIVERS  
IRTXLEX "Spring St. Station"  
Subways: BMT "Prince St. Station"  
IND "F" Train Bwy. Station"  
Bus: Broadway #6 to Spring St.  
Path—9th St. 66th Ave. Station.

**ORDER LINE CALL 800-221-2683**

We Stock: AEA, ARRL, Alpha, Ameco, Antenna Specialists, Astatic, Astron, B & K, B & W, Bash, Bencher, Bird, Butternut, CDE, CES, Collins, Communications Spec. Connectors, Covercraft, Cubic (Swan), Cushcraft, Daiwa, Dentron, Digimax, Drake, ETO (Alpha), Eimac, Encom, Hell-Sound, Heary, Hustler (Newtronics), Hy-Gain, Icom, KLM, Kantronics, Larsen, MCM (Daiwa), MFJ, J.W. Miller, Mini-Products, Mirage, Newtronics, Nye Viking, Palomar, RF Products, Radio Amateur Callbook, Robot, Rockwell Collins, Saxton, Shure, Swan, Telex, Tempo, Ten-Tec, Tokyo Hi Power, Trioxys TUBES, W2ALI, Water, Wilson, Yaesu Ham and Commercial Radios, Vocom, Vibroplex, Curtis, Tri-Ex, Wacom Duplexers, Repeaters, Phelps Dodge, Fanon Intercoms, Scanners, Crystals, Radio Publications.

WE NOW STOCK COMMERCIAL COMMUNICATIONS SYSTEMS  
DEALER INQUIRIES INVITED. PHONE IN YOUR ORDER & BE REIMBURSED  
COMMERCIAL RADIOS stocked & serviced on premises.  
**Amateur Radio & Computer Courses Given On Our Premises, Call**  
Export Orders Shipped Immediately. TELEX 12-7670

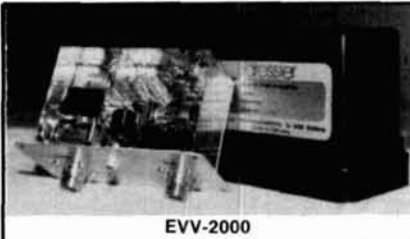

EVV-2000

**NEW FROM DRESSLER**

**UP TO 18 dB GAIN**  
Mounts at antenna for maximum gain

Up to 18 dB gain. Low noise ( $\leq .75$  dB) mounts at antenna — overcomes feedline loss. Automatic COR circuit switches preamp out on transmit. Uses dual gate GaAs Fet followed by low noise J-FET and silver plated tank inductor for low noise and good dynamic range. 4 MHz bandwidth (144-148 MHz) eliminates out-of-band responses. High quality glass epoxy board ensures temperature stability and sealed weatherproof metal box for RF shielding. N connectors 12-15 VDC can be supplied through accessory VV-Interface, bias inserter.

EVV-2000 GaAs FET Preamp \$109.95 + \$5 shipping  
VV-Interface Bias Inserter \$29.95 + \$2.50 shipping

**INTERNATIONAL MEDIA SERVICES**  
BOX 26 • TEWKSBURY, MA 01876 ✓ 160

# RF TRANSISTORS, MICROWAVE DIODES

TYPE	PRICE	TYPE	PRICE	TYPE	PRICE	TYPE	PRICE
2N1561	\$ 25.00	2SC1678	\$ 2.00	M1134	\$ 16.90	MSC1821-3	\$125.00
2N1562	25.00	2SC1729	20.00	M9579	7.95	MSC1821-10	225.00
2N1692	25.00	2SC1760	1.50	M9588	7.50	MSC2001	40.00
2N2957	1.55	2SC1909	4.00	M9622	7.95	MSC2223-10	200.00
2N2857JANTX	4.10	2SC1946	36.00	M9623	9.95	MSC3000	50.00
2N2857JANTXV	4.10	2SC1946A	40.00	M9624	11.95	MSC3001	50.00
2N2876	13.50	2SC1970	2.50	M9625	17.95	MSC73001	50.00
2N2947	18.35	2SC1974	4.00	M9630	18.00	MSC82001	40.00
2N2948	13.00	2SC2166	5.50	M9740	29.90	MSC82014	40.00
2N2949	15.50	2SC2237	32.00	M9741	29.90	MSC82020	40.00
2N3375	17.10	2SC2695	47.00	M9755	19.50	MSC82030	40.00
2N3553	1.55	A50-12	25.00	M9848	37.00	MSC83001	50.00
2N3632	15.50	A209	10.00	M9850	16.90	MSC83005	100.00
2N3733	11.00	A283	5.00	M9851	20.00	MT4150	14.40
2N3818	5.00	A283B	6.00	M9887	5.25	MT5126	FOR
2N3866	1.30	AF102	2.50	MEL80091	25.00	MT5596/2N5596	99.00
2N3866JAN	2.20	AFY12	2.50	MM1550	10.00	MT5768/2N5768	95.00
2N3924	3.35	BF272A	2.50	MM1552	50.00	MT8762	FOR
2N3927	17.25	BFR21	2.50	MM1553	50.00	NB02136	2.50
2N3950	25.00	BFR90	1.00	MM1614	10.00	NE13783	FOR
2N4012	11.00	BFR91	1.65	MM1943/2N4072	1.80	NE21889	FOR
2N4041	14.00	BFR99	2.50	MM2608	5.00	NE57835	5.70
2N4072	1.80	BFT12	2.50	MM3375A	17.10	NE73436	2.50
2N4080	4.53	BFW16A	2.50	MM4429	10.00	TRW	
2N4127	21.00	BFW17	2.50	MM8000	1.15	PRT8637	FOR
2N4427	1.30	BFW92	1.50	MM8006	2.30	PT3190	FOR
2N4428	1.85	BFX44	2.50	MM8011	25.00	PT3194	FOR
2N4430	11.80	BFX48	2.50	MFP102	.45	PT3195	FOR
2N4957	3.45	BFX65	2.50	MPSU31	1.01	PT3537	7.80
2N4959	2.30	BFX84	2.50	MRA2023-1.5	42.50	PT4166E	FOR
2N5090	13.80	BFX85	2.50	MRF208	16.10	PT4176D	FOR
2N5108	3.45	BFX86	2.50	MRF212	16.10	PT4186B	FOR
2N5109	1.70	BFX89	1.00	MRF223	13.25	PT4209	FOR
2N5160	3.45	BFY11	2.50	MRF224	15.50	PT4209C/5645	
2N5177	21.62	BFY18	2.50	MRF231	10.92	PT4556	24.60
2N5179	1.04	BFY19	2.50	MRF232	12.07	PT4570	7.50
2N5216	56.00	BFY39	2.50	MRF233	12.65	PT4577	FOR
2N5583	3.45	BFY90	1.00	MRF237	3.15	PT4590	FOR
2N5589	9.77	BLX67	15.24	MRF238	13.80	PT4612	FOR
2N5590	10.92	BLX68C3	15.24	MRF239	17.25	PT4628	FOR
2N5591	13.80	BLX93C3	22.21	MRF245	35.65	PT4640	FOR
2N5637	15.50	BLY87A	8.94	MRF247	35.65	PT4642	FOR
2N5641	12.42	BLY88C3	13.08	MRF304	43.45	PT5632	4.70
2N5642	14.03	BLY94C	21.30	MRF309	33.81	PT5749	FOR
2N5643	15.50	BLY351	10.00	MRF314	28.52	PT6629	FOR
2N5645	13.80	BLY568C/CF	30.00	MRF315	28.86	PT6709	FOR
2N5646	20.70	C458-617	25.00	MRF316	FOR	PT6720	FOR
2N5651	11.05	C4005	20.00	MRF317	63.94	PT8510	FOR
2N5691	18.00	CD1899	20.00	MRF420	20.00	PT8524	FOR
2N5764	27.00	CD2188	18.00	MRF421	36.80	PT8609	FOR
2N5836	3.45	CD2545	25.00	MRF422A	41.40	PT8633	FOR
2N5842/MM1607	8.45	CTC3005	100.00	MRF427	17.25	PT8639	FOR
2N5849	20.00	Dexcel GaAs FET		MRF428	46.00	PT8659	FOR
2N5913	3.25	DXL3501A-P100F	49.30	MRF433	12.07	PT8679	FOR
2N5916	36.00	Fujitsu GaAs FET		MRF449/A	12.65	PT8708	FOR
2N5922	10.00	FSX52WF	58.00	MRF450/A	14.37	PT8709	FOR
2N5923	25.00	GMO290A	2.50	MRF453/A	18.40	PT8727	29.00
2N5941	23.00	HEP76	4.95	MRF454/A	20.12	PT8731	FOR
2N5942	40.00	HEPS3002	11.40	MRF455/A	16.00	PT8742	19.10
2N5944	10.35	HEPS3003	30.00	MRF458	20.70	PT8787	FOR
2N5945	11.50	HEPS3005	10.00	MRF463	25.00	PT9783	16.50
2N5946	14.40	HEPS3006	19.90	MRF472	1.00	PT9784	32.70
2N6080	10.35	HEPS3007	25.00	MRF475	3.10	PT9790	56.00
2N6081	12.07	HEPS3010	11.34	MRF476	2.00	PT31962	FOR
2N6082	12.65	Hewlett Packard		MRF477	14.95	PT31963	FOR
2N6083	13.25	HFET2204	112.00	MRF492	23.00	PT31083	FOR
2N6084	15.00	35821E	38.00	MRF502	1.04	PTX6680	FOR
2N6094	11.00	35826B	32.00	MRF503	6.00	RCA	
2N6095	12.00	35826E	32.00	MRF504	7.00	40081	5.00
2N6096	16.10	35831E-H31	30.00	MRF509	5.00	40279	10.00
2N6097	20.70	35831E	30.00	MRF511	10.69	40280	4.62
2N6105	21.00	35832E	50.00	MRF515	2.00	40281	10.00
2N6136	21.85	35833E	50.00	MRF517	2.00	40282	20.00
2N6166	40.24	35853E	71.50	MRF559	2.05	40290	2.80
2N6201	50.00	35854E	75.00	MRF605	20.00	40292	13.05
2N6304	1.50	35866E	44.00	MRF618	25.00	40294	2.50
2N6459	18.00	HXTR3101	7.00	MRF628	8.65	40341	21.00
2N6567	10.06	HXTR3102	8.75	MRF629	3.45	40608	2.48
2N6680	80.00	HXTR5104	30.00	MRF644	27.60	40894	1.00
2SC703	3.00	HXTR6104	68.00	MRF646	29.90	40977	10.00
2SC756A	7.50	HXTR6105	31.00	MRF816	15.00	62800A	60.00
2SC781	2.80	HXTR6106	33.00	MRF823	20.00	RE3754	25.00
2SC1018	1.00	J310	.70	MRF901 (3) Lead	1.00	RE3789	25.00
2SC1042	12.00	TRW		MRF901 (4) Lead	2.00	RF110	25.00
2SC1070	2.50	JO2000	10.00	MRF904	2.30	S50-12	25.00
2SC1239	2.50	JO2001	25.00	MRF911	3.00	S3006	5.00
2SC1251	12.00	JO4045	25.00	MRF961	2.30	S3031	5.00
2SC1306	2.90	Motorola Comm.		MRF8004	2.10	SCA3522	5.00
2SC1307	5.50	M1131	8.50	MS261F	FOR	SCA3523	5.00
2SC1424	2.80	M1132	11.95	MSC1720-12	225.00	PRICE ON REQUEST = FOR	

**Toll Free Number**  
**800-528-0180**  
**(For orders only)**

"All parts may be new or surplus, and parts may be substituted with comparable parts if we are out of stock of an item."

For information call: (602) 242-3037

PRICES SUBJECT TO CHANGE WITHOUT NOTICE

**MHz electronics**

# GaAs, TUNNEL DIODES, ETC.

\* R F TRANSISTORS \*

TYPE	PRICE	TYPE	PRICE	TYPE	PRICE	TYPE	PRICE
THOMSON CSF							
SD345	\$ 5.00	SD1119	\$ 5.00	SD1278-5	\$18.00	SD1453-1	\$48.00
SD445	5.00	SD1124	50.00	SD1281-2	8.00	SD1454-1	48.00
SD1004	15.00	SD1127	3.50	SD1283	10.00	SD1477	48.00
SD1009	15.00	SD1133	14.00	SD1289-1	15.00	SD1478	21.00
SD1009-2	15.00	SD1133-1	14.00	SD1290-4	15.00	SD1480	60.00
SD1012	9.90	SD1134-1	3.00	SD1290-7	15.00	SD1484	1.50
SD1012-3	9.90	SD1135	8.00	SD1300	3.00	SD1484-5	1.50
SD1012-5	9.90	SD1136	15.00	SD1301-7	3.00	SD1484-6	1.50
SD1013-3	13.50	SD1136-2	15.00	SD1305	3.00	SD1484-7	1.50
SD1013-7	13.50	SD1143-1	12.00	SD1307	3.00	SD1488	39.00
SD1014	11.00	SD1143-3	17.00	SD1308	3.00	SD1488-1	28.00
SD1014-6	11.00	SD1144-1	3.00	SD1311	1.00	SD1488-7	27.00
SD1016	15.00	SD1146	15.00	SD1317	10.00	SD1488-8	28.00
SD1016-5	15.00	SD1147	15.00	SD1335	3.00	SD1499-1	39.00
SD1018-4	15.00	SD1188	10.00	SD1345-6	5.00	SD1520-2	18.00
SD1018-6	15.00	SD1189	24.00	SD1365-1	2.50	SD1522-4	33.00
SD1018-7	15.00	SD1200	1.50	SD1365-5	2.50	SD1528-1	24.00
SD1018-15	15.00	SD1201-2	10.00	SD1375	7.50	SD1528-3	34.00
SD1020-5	10.00	SD1202	10.00	SD1375-6	7.50	SD1530-2	38.00
SD1028	15.00	SD1212-11	4.00	SD1379	15.00	SD1536-1	41.00
SD1030-2	12.00	SD1212-12	4.00	SD1380-1	1.00	SD1545	34.00
SD1043	12.00	SD1212-16	4.00	SD1380-3	1.00	SD1561	79.00
SD1043-1	10.00	SD1214-7	5.00	SD1380-7	1.00	SF4557 Mot.	25.00
SD1045	3.75	SD1214-11	5.00	SD1405	40.00	SK3048 RCA	5.00
SD1049-1	2.00	SD1216	12.00	SD1409	18.00	SK3177 RCA	15.00
SD1053	4.00	SD1219-4	15.00	SD1410	22.00	SMS7714 Mot.	2.50
SD1065	4.75	SD1219-5	15.00	SD1410-3	21.00	SFR750 Mot.	36.00
SD1068	15.00	SD1219-8	15.00	SD1413-1	18.00	SFR1018 Mot.	5.00
SD1074-2	18.00	SD1220	8.00	SD1416	50.00	SFR2147 Mot.	22.00
SD1074-4	28.00	SD1220-9	8.00	SD1422-2	24.00	SFR2356 Mot.	38.00
SD1074-5	28.00	SD1222-8	16.00	SD1428	33.00	SFR2378 Mot.	16.00
SD1076	20.00	SD1222-11	7.50	SD1429-2	15.00	SFR2584 Mot.	40.00
SD1077-4	4.00	SD1224-10	18.00	SD1429-3	15.00	SFR2821 Mot.	25.00
SD1077-6	4.00	SD1225	18.00	SD1429-5	15.00	SFR2857 Mot.	20.00
SD1078-6	24.00	SD1228-8	FOR	SD1430	12.00	TAB894 RCA	15.00
SD1080-8	6.00	SD1229-7	13.00	SD1430-2	18.00	TIS189/MRF966	3.55
SD1080-9	3.00	SD1229-16	13.00	SD1434-5	30.00	TP312	2.50
SD1084	8.00	SD1232	4.00	SD1434-9	30.00	TP1014 TRW	5.00
SD1087	15.00	SD1240-8	15.00	SD1438	26.00	TP1028 TRW	15.00
SD1089-5	15.00	SD1244-1	14.00	SD1441	91.00	01-80703T04/ 458-949 Mot. Comm.	65.00
SD1095	15.00	SD1262	12.00	SD1442	15.00	TKVP2201 H.P.	450.00
SD1100	5.00	SD1263	15.00	SD1444	6.00	62803 RCA	100.00
SD1109	18.00	SD1263-1	15.00	SD1444-8	6.00	TA7205/2N5921	80.00
SD1115-2	8.00	SD1272	13.00	SD1450-1	28.00	TA7487/2N5920	75.00
SD1115-3	8.00	SD1272-2	15.00	SD1451	18.00	TA7995/2N6267	150.00
SD1115-7	2.50	SD1272-4	15.00	SD1451-2	18.00	SFR2092 Mot.	18.00
SD1116	5.00	SD1278	20.00	SD1452	20.00	MRF479	8.05
SD1118	22.00	SD1278-1	18.00	SD1452-2	20.00		

We Can Cross Reference Most RF Transistors, Diodes, Hybrid Modules And Any Other Type Of Semiconductor.

\* DIODES (HOT CARRIER, MICROWAVE, PIN, SCHOTTKY, TUNNEL, VARACTOR, GUNN) \*

LN21	\$ 3.40	LN21B	\$ 3.40	LN21BR	\$ 3.40	LN21C	\$ 3.40
LN21D	4.00	LN21DR	4.00	LN21ER	6.00	LN21RF	5.00
LN21WE	5.80	LN21WG	5.80	LN22	5.00	LN23A	10.00
LN23B	3.40	LN23C	3.40	LN23CR	3.40	LN23D	4.95
LN23DR	4.00	LN23WE	5.00	LN25	7.50	LN25AR	18.00
LN28WE	10.00	LN29	10.00	LN32	20.00	LN53A	55.50
LN76	26.00	LN76R	28.00	LN78	26.00	LN78A	20.00
LN78B	26.00	LN78D	28.00	LN78DR	28.00	LN78R	28.00
LN149	6.00	LN150MR	18.00	LN415	4.00	LN415C	4.00
LN415G	15.00	LN416D	5.00	LN416E	6.00	LN446	10.00
LN831	10.00	LN833	10.00	LN950	4.00	LN1084	2.00
LN2930	15.00	LN2932	15.00	LN3540	15.00	LN3712	11.00
LN3713	18.00	LN3714	11.00	LN3715	16.00	LN3716	10.00
LN3717	14.00	LN3718	10.00	LN3721	14.00	LN3733	10.00
LN3747	21.00	LN4386	20.00	LN4396	15.00	LN4785	11.00
LN4812B	9.00	LN5139A/B	4.25	LN5140A/B	4.25	LN5141A/B	4.25
LN5142A/B	4.25	LN5143A/B	4.25	LN5144A/B	4.25	LN5145A/B	4.25
LN5146A/B	4.25	LN5147A/B	4.25	LN5148A/B	4.25	LN5167	5.50
LN5453	3.75	LN5465	7.65	LN5711	1.00	LN5711 JAN	2.00
LN5713	5.00	LN5767	2.00	LN6263	1.00	LS2199	15.00
LS2200	15.00	LS2208/9	1.00	8B1087/48R869558	65.00	8D3020	65.00
AZ1116M Aertech	50.00	BB105B	1.00	BB105G	1.00	BD4/4JFB04 G.E.	15.00
BL161 Bomac	5.00	DM6514AB C.M.	FOR	D4060 Alpha	FOR	D4159 Alpha	FOR
D4233B Alpha	FOR	D4900 Alpha	FOR	D4959 Alpha	FOR	D4987M Alpha	FOR
D6047C Alpha	FOR	D5147D Alpha	FOR	D5503 Alpha	FOR	D5506 Alpha	FOR
DG86158-98 Alpha	FOR	DMD6022 Alpha	FOR	DMD6460A Alpha	FOR	DP20054 Crown	FOR
GC1691-89 GHz	31.35	GC1602-89 GHz	31.35	GC1607-40 GHz	31.35	GC2531-88 GHz	37.40
GC2542-46 GHz	37.40	GC3208-40 GHz	37.40	GC17044 GHz	50.00	HP33644A-HD1	125.00
HP5082-0112	14.20	HP5082-0241	75.60	HP5082-0253	105.00	HP5082-0320	58.00
HP5082-0375	FOR	HP5082-0386	FOR	HP5082-0401	FOR	HP5082-0438	FOR
HP5082-1028	FOR	HP5082-1332	FOR	HP5082-2254	FOR	HP5082-2302	10.70
HP5082-2303	5.20	HP5082-2696	FOR	HP5082-2711	23.15	HP5082-2727	FOR
HP5082-2806	1.00	HP5082-2805	4.45	HP5082-2835	1.00	HP5082-2884	FOR
HP5082-3039	6.70	HP5082-3040	36.00	HP5082-3080	2.00	HP5082-3188	1.00
HP5082-3379	1.50	HP5082-6459	FOR	HP5082-6462	FOR	HP5082-6888	FOR
HP5082-8016	FOR	HP5082-8323	FOR	K3A Kemtron	7.00	MA450A	FOR
MA475	FOR	MA40008	FOR	MA41487	FOR	MA41765	FOR
MA41766	FOR	MA43004	48.00	MA43589	FOR	MA43622	FOR
MA43636	FOR	MA45104	27.00	MA47044	FOR	MA47051	25.50
MA47100	3.05	MA47202	30.80	MA47771	FOR	MA47838*	FOR
MA47852	FOR	MA49106	37.95	MA49558	FOR	MA86731	125.00

\* OUR STOCK CHANGES DAILY SO CALL IF THE PART YOU NEED IS NOT LISTED \*

For information call: (602) 242-3037

**Toll Free Number**  
**800-528-0180**  
**(For orders only)**

"All parts may be new or surplus, and parts may be substituted with comparable parts if we are out of stock of an item."

## MHz electronics

PRICES SUBJECT TO CHANGE WITHOUT NOTICE

COAXIAL RELAY SWITCHES SPDT

Electronic Specialty Co./Raven Electronics FSN 5985-556-9683 \$49.00  
 Part # 25N28 Part # SU-01  
 26Vdc Type N Connector, DC to 1 GHz.



Amphenol  
 Part # 316-10102-8  
 115Vac Type BNC DC to 3 GHz.

FXR  
 Part # 300-11182  
 120Vac Type BNC DC to 4 GHz.  
 FSN 5985-543-1225

FXR  
 Part # 300-11173  
 120Vac Type BNC Same  
 FSN 5985-543-1850

\$29.99

\$39.99

\$39.99

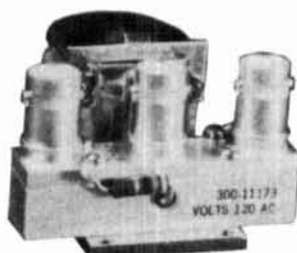
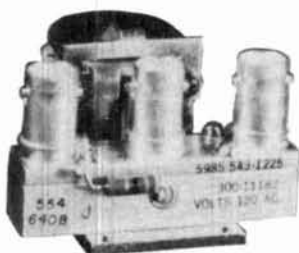
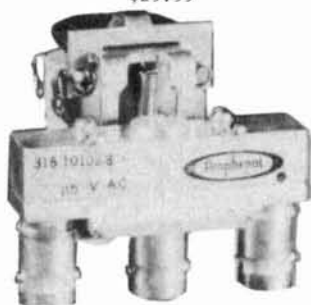

BNC To Banana Plug Coax Cable RG-58 36 inch or BNC to N Coax Cable RG-58 36 inch.

\$7.99 or 2 For \$13.99 or 10 For \$50.00

\$8.99 or 2 For \$15.99 or 10 For \$60.00



SOLID STATE RELAYS

P&B Model ECT1DB72 5vdc turn on  
 PRICE EACH \$5.00

Digisig, Inc. Model ECS-215 5vdc turn on  
 PRICE EACH \$7.50

Grigsby/Barton Model GB7400 5vdc turn on  
 PRICE EACH \$7.50

120vac contact at 7amps or 20amps on a 10"x 10" .124 aluminum. Heatsink with silicon grease.

240vac contact 14amps or 40amps on a 10"x 10" .124 aluminum. Heatsink with silicon grease.

240vac contact at 15amps or 40amps on a 10"x 10" .124 aluminum. Heatsink with silicon grease.

NOTE: \*\*\* Items may be substituted with other brands or equivalent model numbers. \*\*\*

For information call: (602) 242-3037

**MHz** electronics

"All parts may be new or surplus, and parts may be substituted with comparable parts if we are out of stock of an item."

**Toll Free Number**  
**800-528-0180**  
 (For orders only)

PRICES SUBJECT TO CHANGE WITHOUT NOTICE

# TUBES

TYPE	PRICE	TYPE	PRICE	TYPE	PRICE
2C39/7289	\$ 34.00	1182/4600A	\$500.00	ML7815AL	\$ 60.00
2E26	7.95	4600A	500.00	7843	107.00
2K28	200.00	4624	310.00	7854	130.00
3-500Z	102.00	4657	84.00	ML7855KAL	125.00
3-1000Z/8164	400.00	4662	100.00	7984	14.95
3B28/866A	9.50	4665	500.00	8072	84.00
3CX400U7/8961	255.00	4687	P.O.R.	8106	5.00
3CX1000A7/8283	526.00	5675	42.00	8117A	225.00
3CX3000F1/8239	567.00	5721	250.00	8121	110.00
3CW30000H7	1700.00	5768	125.00	8122	110.00
3X2500A3	473.00	5819	119.00	8134	470.00
3X3000F1	567.00	5836	232.50	8156	12.00
4-65A/8165	69.00	5837	232.50	8233	60.00
4-125A/4D21	79.00	5861	140.00	8236	35.00
4-250A/5D22	98.00	5867A	185.00	8295/PL172	500.00
4-400A/8438	98.00	5868/AX9902	270.00	8458	35.00
4-400B/7527	110.00	5876/A	42.00	8462	130.00
4-400C/6775	110.00	5881/6L6	8.00	8505A	95.00
4-1000A/8166	444.00	5893	60.00	8533W	136.00
4CX250B/7203	54.00	5894/A	54.00	8560/A	75.00
4CX250FG/8621	75.00	5894B/8737	54.00	8560AS	100.00
4CX250K/8245	125.00	5946	395.00	8608	38.00
4CX250R/7580W	90.00	6083/AZ9909	95.00	8624	100.00
4CX300A/8167	170.00	6146/6146A	8.50	8637	70.00
4CX350A/8321	110.00	6146B/8298	10.50	8643	83.00
4CX350F/8322	115.00	6146W/7212	17.95	8647	168.00
4CX350FJ/8904	140.00	6156	110.00	8683	95.00
4CX600J/8809	835.00	6159	13.85	8877	465.00
4CX1000A/8168	242.50*	6159B	23.50	8908	13.00
4CX1000A/8168	485.00	6161	325.00	8950	13.00
4CX1500B/8660	555.00	6280	42.50	8930	137.00
4CX5000A/8170	1100.00	6291	180.00	6L6 Metal	25.00
4CX10000D/8171	1255.00	6293	24.00	6L6GC	5.03
4CX15000A/8281	1500.00	6326	P.O.R.	6CA7/EL34	5.38
4CW800F	710.00	6360/A	5.75	6CL6	3.50
4D32	240.00	6399	540.00	6DJ8	2.50
4E27A/5-125B	240.00	6550A	10.00	6DQ5	6.58
4PR60A	200.00	6883B/8032A/8552	10.00	6GF5	5.85
4PR60B	345.00	6897	160.00	6GJ5A	6.20
4PR65A/8187	175.00	6907	79.00	6GK6	6.00
4PR1000A/8189	590.00	6922/6DJ8	5.00	6HB5	6.00
4X150A/7034	60.00	6939	22.00	6HF5	8.73
4X150D/7609	95.00	7094	250.00	6JG6A	6.28
4X250B	45.00	7117	38.50	6JM6	6.00
4X250F	45.00	7203	P.O.R.	6JN6	6.00
4X500A	412.00	7211	100.00	6JS6C	7.25
5CX1500A	660.00	7213	300.00*	6KN6	5.05
KT88	27.50	7214	300.00*	6KD6	8.25
416B	45.00	7271	135.00	6LF6	7.00
416C	62.50	7289/2C39	34.00	6LQ6 G.E.	7.00
572B/T160L	49.95	7325	P.O.R.	6LQ6/6MJ6 Sylvania	9.00
592/3-200A3	211.00	7360	13.50	6ME6	8.90
807	8.50	7377	85.00	12AT7	3.50
811A	15.00	7408	2.50	12AX7	3.00
812A	29.00	7609	95.00	12BY7	5.00
813	50.00	7735	36.00	12JB6A	6.50

NOTE \* = USED TUBE

NOTE P.O.R. = PRICE ON REQUEST

"ALL PARTS MAY BE NEW, USED, OR SURPLUS. PARTS MAY BE SUBSTITUTED WITH COMPARABLE PARTS IF WE ARE OUT OF STOCK OF AN ITEM.

NOTICE: ALL PRICES ARE SUBJECT TO CHANGE WITHOUT NOTICE.

For information call: (602) 242-3037

**Toll Free Number**  
**800-528-0180**  
**(For orders only)**

"All parts may be new or surplus, and parts may be substituted with comparable parts if we are out of stock of an item."

**MHz electronics**

PRICES SUBJECT TO CHANGE WITHOUT NOTICE

# HEWLETT PACKARD SIGNAL GENERATORS

606A	50KHz to 65MHz in 6 bands $\pm 1\%$ Output level adjustable 0.1uV to 3V into 50 ohms. Built-in crystal calibrator. 400 - 1000Hz modulation.	\$ 650.00	616B	Same as above but later model.	\$ 600.00
606B	Same as above but has frequency control feature to allow operation with HP 8708A Synchronizer.	\$1100.00	618B	3.8 to 7.6GHz range, with calibrated output and selection of pulse-FM or square wave modulation.	\$ 600.00
608C	10MHz to 480MHz, 0.1uV-1V into 50 ohms, AM, CW, or pulse modulation, calibrated attenuator.	\$ 500.00	618C	Same as above but later model.	\$2200.00
608D/TS510	10MHz to 420MHz, 0.1uV-0.5V into 50 ohms, $\pm 0.5\%$ accuracy, built-in crystal calibrator, AM-CW or pulse output.	\$ 375.00	620A	7 to 11GHz range, with calibrated output and selection of pulse-FM or square wave modulation.	\$ 750.00
608E	Improved version of popular 608C. Up to 1V output. Improved stability, low residual FM.	\$1450.00	620B	Same as above but later model.	\$2200.00
608F	10MHz to 455MHz in 5 bands $\pm 1\%$ frequency accuracy with built-in crystal calibrator. Can be used with HP 8708A Synchronizer. Output continuously adjustable from .1uV to .5V into 50 ohms.	\$1100.00	626A	10 to 15GHz, 10mW output power with calibrated output and pulse-square wave or FM modulation.	\$4200.00
612A	450-1230MHz .0.1uV-0.5V into 50 ohms, calibrated output.	\$ 750.00	8708A	Synchronizer used with 606B, 608F. The synchronizer is a phase-lock frequency stabilizer which provides crystal-oscillator frequency stability to 430MHz in the 608F signal generator. Phase locking eliminates microphonics and drift resulting in excellent frequency stability. The 8708A includes a vernier which can tune the reference oscillator over a range of $\pm 0.25\%$ permitting frequency settability to 2 parts in 10 to the seventh. Provides a very stable signal that satisfies many critical applications.	(With HP 606B or 608F) \$ 350.00 (Without) \$ 450.00
614A	900-2100MHz with many features including calibrated output and all modulation characteristics.	\$ 500.00	EMC-10	ELECTROMETRICS EMC-10 RF/EMI RECEIVER Low frequency analyzer covering 20Hz to 50KHz frequency range. Extendable to 500 KHz in wideband mode.	\$2500.00
616A/TS403	Direct reading and direct control from 1.8 to 4.2GHz. The H.P. 616A features $\pm 1.5$ dB calibrated output accuracy from -31.27dBm to -8dBm. The output is directly calibrated in microvolts and dBm with continuous monitoring. Simple operation. Frequency dial accuracy is $\pm 1\%$ and stability exceeds 0.005% / C change in ambient temperature. Calibrated attenuator is within $\pm 1.5$ dB over entire output band. 50 ohm impedance unit has internal pulse modulation with rep rate variable from 40 Hz to 4KHz, variable pulsewidth (1 to 10usec) and variable pulse delay (3 to 300usec). External modulating inputs increase versatility.	\$ 375.00	NF-105F	Empire Devices Field Intensity Meter. Models: NF-105/T1, NF-105/TX, NF-105/T1, NF-105/T2, NF-105/T3. Covers 14KHz to 1000MHz.	\$2100.00

ALL EQUIPMENT CARRY A 30 DAY GUARANTEE.  
EQUIPMENT IS NOT CALIBRATED.

TERMS: DOMESTIC: Prepaid, C.O.D. or Credit Card  
FOREIGN: Prepaid only, U.S. Funds, Money Order, or Cashier's Check Only

C.O.D.: Acceptable by telephone or mail. Payment from customer will be by Cash, Money Order, or Cashier's Check. We are sorry but we cannot accept personal checks for C.O.D.'s. C.O.D.'s are shipped by air only and thru United Parcel Service.

CONFIRMING ORDERS: We would prefer that confirming orders not be sent after a telephone order has been placed. If company policy necessitates a confirming order, please mark "CONFIRMING" boldly on the order. If problems or duplicate shipments occur due to an order which is not properly marked, the customer will be held responsible for any charges incurred, plus a 15% restock charge on the returned parts.

CREDIT CARDS: We are now accepting MASTERCARD, VISA, AND AMERICAN EXPRESS

DATA SHEETS: When we have data sheets in stock on devices we will supply them with the order.

DEFECTIVE MATERIALS: All claims for defective materials must be made within 30 DAYS after receipt of the parcel. All claims must include the defective material (for testing purposes), a copy of our invoice, and a return authorization number which must be obtained prior to shipping the merchandise back to us. This can be obtained by calling (602) 242-8916 or sending us a postcard. Due to Manufacturer warranties we are unable to replace or issue credit on items which have been soldered to or have been altered in any way. All return items must be packed properly or it will void all warranties. We do not assume responsibility for shipping and handling charges incurred.

DELIVERY: Orders are usually shipped the same day they are placed or the next business day, unless we are out of stock on an item. The customer will be notified by post card if we are going to backorder the item. Our normal shipping method is UPS or U.S. Mail depending on size or the weight of the package. Test Equipment is shipped only by air and is freight collect, unless prior arrangements have been made and approved.

FOREIGN ORDERS: All foreign orders must be prepaid with a Cashier's Check, or Money Order made out in U.S. FUNDS ONLY. We are sorry but C.O.D. is not available to foreign countries and letters of credit are unacceptable as a form of payment. Further information is available on request.

HOURS: Monday thru Friday 8:30 a.m. to 5:00 p.m. Saturdays 8:30 a.m. to 4:00 p.m.

INSURANCE: Please include 25¢ for each additional \$100.00 over \$100.00. UPS ONLY. All insured packages are shipped thru UPS only. If you wish to have it shipped through the post office there is a \$5.00 fee which is additional to the shipping, handling and insurance.

OPEN ACCOUNTS: We regret that we do not issue open accounts.

ORDER FORMS: New order forms are included with each order for your convenience. Additional order forms are available on request.

PARTS: We reserve the right to substitute or replace any item with a part of equal or comparable specification.

POSTAGE: Minimum shipping and handling in the U.S., Canada, and Mexico is \$3.00 for ground shipments, all other countries is \$5.50. Air rates are available at the time of your order. All foreign orders please include 25% of the ordered amount for shipping and handling. C.O.D.'s are shipped AIR ONLY.

PREPAID ORDERS: Orders must be accompanied by a check.

PRICES: Prices are subject to change without notice.

PURCHASE ORDERS: We accept purchase orders only when they are accompanied by a check.

RESTOCK CHARGES: If parts are returned to MHZ ELECTRONICS, INC. due to customer error, the customer will be held responsible for all fees incurred and will be charged a 15% RESTOCK CHARGE with the remainder in CREDIT ONLY. The following must accompany any return: A copy of our invoice, return authorization number which must be obtained prior to shipping the merchandise back. Returns must be done within 10 DAYS of receipt of parcel. Return authorization numbers can be obtained by calling (602) 242-8916 or notifying us by post card. Return authorizations will not be given out on our 800 number.

SALES TAX: ARIZONA residents must add 6% sales tax, unless a signed ARIZONA resale tax card is currently on file with us. All orders placed by persons outside of ARIZONA, but delivered to persons in ARIZONA are subject to the 6% sales tax.

SHORTAGE OR DAMAGE: All claims for shortages or damages must be made within 5 DAYS of receipt of parcel. Claims must include a copy of our invoice, along with a return authorization number which can be obtained by contacting us at (602) 242-8916 or sending a post card. Authorizations cannot be on our 800 number. All items must be properly packed. If items are not properly packed make sure to contact the carrier so that they can come out and inspect the package before it is returned to us. Customers which do not notify us within this time period will be held responsible for the entire order as we will consider the order complete.

OUR 800 NUMBER IS STRICTLY FOR ORDERS ONLY (800) 528-0180. INFORMATION CALLS ARE TAKEN ON (602) 242-8916 or (602) 242-3037.



## MHz electronics

2111 W. CAMELBACK ROAD  
PHOENIX, ARIZONA 85015

"All parts may be new or surplus, and parts may be substituted with comparable parts if we are out of stock of an item."

For information call: (602) 242-3037

Toll Free Number  
800-528-0180  
(For orders only)

PRICES SUBJECT TO CHANGE WITHOUT NOTICE.



**DENTRON  
LIVES THROUGH  
COILCO ELECTRONICS, INC.**

Coilco has purchased the inventory of Dentron Radio Co., Inc. Coilco has excellent and fast repair service and parts available for most Dentron Equipment. Our factory will be manufacturing similar equipment in the near future.

For further information on parts and service, contact:

✓ 130

**COILCO ELECTRONICS, INC.  
223 NORTH MICHIGAN AVENUE  
EDGERTON, OHIO 43517  
(419) 298-2346**

# ADM-10'

When cost is a factor,  
don't sacrifice performance.

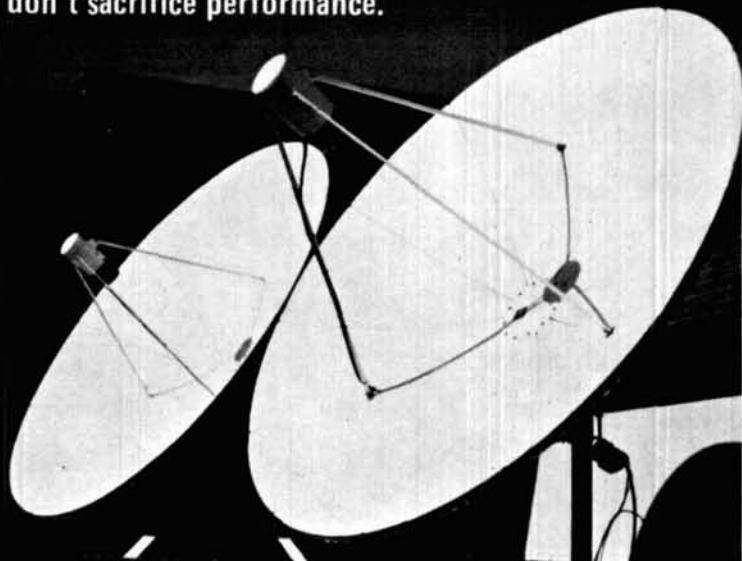

The ADM-10' satellite antenna system gives you the most for your investment. At the cost of an 8' dish, the ADM-10' provides performance margins to account for loss of signal due to satellite aging. Constructed of rugged steel or aluminum with fully adjustable polar mount. ADM-10'—the competitive edge in the private TVRO market.

For the competitive edge,  
call—

**ANTENNA  
DEVELOPMENT &  
MANUFACTURING, INC.**

P.O. BOX 1178 • POPLAR BLUFF, MO 63901 • (314) 785-5988

✓ 113

## SPEAKER QUALITY IS THE PRIMARY KEY TO YOUR STEREO SYSTEM'S SOUND

And speakers are easy to make—and very difficult to design. *Speaker Builder*, a new quarterly from the publishers of *Audio Amateur*, has all the design answers you novice-to-experts need to dramatically improve the quality of sound you're getting from your stereo system. The drivers are relatively cheap and the sources for them are all listed in *Speaker Builder's* pages. As an experienced ham, you probably know your way around your audio system already. Here's an easy way to make what you have sound a whole lot better at minimum cost.

*Speaker Builder* can save up to two thirds of the cost of the speakers—which translates to almost one third of your outlay for your stereo system. Over 110,000 Americans will build their own enclosures this year—and you can too! Your dream speaker is probably well within reach if you build it yourself. There's a lot of help around already and now, *Speaker Builder* brings it all together in an assortment of articles that are comprehensive and a mix of both simple and advanced projects to help you choose and build the best type for your listening room.

✓ 117

- ★ Bass Reflex
- ★ Electrostatics
- ★ Infinite Baffle
- ★ Specials: Ribbon, Air motion transformers
- ★ Basic data on passive and electronic crossovers.
- ★ Horns
- ★ Transmission Lines

There will be reports on building the many kit speakers and enclosures now available, and a roundup of suppliers for drivers, parts, and kits. Articles range from the ultimate (650 lbs. each) to tiny plastic pipe extension speakers. From time delayed multi-satellites to horn loaded subwoofers, as well as modifications of many stock designs.

SPEAKER BUILDER, P.O. Box 494H, Peterborough NH 03458-0494 USA H14

- Enter my subscription to *SPEAKER BUILDER* for one year at the special rate of \$10.00.  
 Make that a two year subscription at \$18.00.  
 Check enclosed     Charge to my     MasterCard    Visa  charge card.

# \_\_\_\_\_

Expire \_\_\_\_\_/\_\_\_\_\_/\_\_\_\_\_

Phone Orders (603)924-6526

Name \_\_\_\_\_

Street & No. \_\_\_\_\_

Town \_\_\_\_\_ State \_\_\_\_\_ ZIP \_\_\_\_\_

I understand that the unexpired portion of my subscription will be refunded after my first issue if the magazine is unsatisfactory for any reason. Make checks and money orders payable to Speaker Builder. Rates above are for USA only. Outside USA add \$2.00 per year for postage. Non U.S. checks must be drawn in U.S. currency only.



*Ham Radio's guide to help you find your local*

## California

**C & A ROBERTS, INC.**  
18511 HAWTHORN BLVD.  
TORRANCE, CA 90504  
213-370-7451  
800-421-2258  
Not The Biggest, But The Best —  
Since 1962.

**FONTANA ELECTRONICS**  
8628 SIERRA AVENUE  
FONTANA, CA 92335  
714-822-7710  
714-822-7725  
The Largest Electronics Dealer in San  
Bernardino County.

**JUN'S ELECTRONICS**  
3919 SEPULVEDA BLVD.  
CULVER CITY, CA 90230  
213-390-8003  
619-463-1886 San Diego  
800-882-1343 Trades  
Habla Espanol

## Connecticut

**HATRY ELECTRONICS**  
500 LEDYARD ST. (SOUTH)  
HARTFORD, CT 06114  
203-527-1881  
Call today. Friendly one-stop shopping  
at prices you can afford.

## Delaware

**DELAWARE AMATEUR SUPPLY**  
71 MEADOW ROAD  
NEW CASTLE, DE 19720  
302-328-7728  
800-441-7008  
Icom, Ten-Tec, Microlog, Yaesu,  
Azden, Santec, KDK, and more.  
One mile off I-95, no sales tax.

## Florida

**AMATEUR ELECTRONIC SUPPLY**  
1898 DREW STREET  
CLEARWATER, FL 33575  
813-461-4267  
Clearwater Branch  
West Coast's only full service  
Amateur Radio Store.  
Hours M-F 9-5:30, Sat. 9-3

**AMATEUR ELECTRONIC SUPPLY**  
621 COMMONWEALTH AVE.  
ORLANDO, FL 32803  
305-894-3238  
Fla. Wats: 1 (800) 432-9424  
Outside Fla: 1 (800) 327-1917  
Hours M-F 9-5:30, Sat. 9-3

**AMATEUR RADIO CENTER, INC.**  
2805 N. E. 2ND AVENUE  
MIAMI, FL 33137  
305-573-8383  
The place for great dependable  
names in Ham Radio.

## Hawaii

**HONOLULU ELECTRONICS**  
819 KEEAUMOKU STREET  
HONOLULU, HI 96814  
(808) 949-5564  
Serving Hawaii & Pacific area for 51  
years. Complete lines of Amateur equip-  
ment, accessories and parts.

## Illinois

**ERICKSON COMMUNICATIONS, INC.**  
5456 N. MILWAUKEE AVE.  
CHICAGO, IL 60630  
312-631-5181  
Hours: 9:30-5:30 Mon, Tu, Wed & Fri;  
9:30-8:00 Thurs; 9:00-3:00 Sat.

## Indiana

**THE HAM SHACK**  
808 NORTH MAIN STREET  
EVANSVILLE, IN 47710  
812-422-0231  
Discount prices on Ten-Tec, Cubic,  
Hy-Gain, MFJ, Azden, Kantronics,  
Santec and others.

## Kansas

**ASSOCIATED RADIO**  
8012 CONSER, P.O. BOX 4327  
OVERLAND PARK, KS 66204  
913-381-5900  
America's No. 1 Real Amateur Radio  
Store. Trade — Sell — Buy.

## Kentucky

**L & S RADIO**  
307 McLEAN AVENUE  
HOPKINSVILLE, KY 42240  
502-885-8071  
Ten-Tec, Azden, Ameritron Sales and  
Service.

## Massachusetts

**TEL-COM, INC.**  
675 GREAT ROAD, RTE. 119  
LITTLETON, MA 01460  
617-486-3040  
617-486-3400 (this is new)  
The Ham Store of New England  
You Can Rely On.

## Michigan

**ENCON PHOTOVOLTAICS**  
Complete Photovoltaic Systems  
27600 Schoolcraft Rd.  
Livonia, Michigan 48150  
313-523-1850  
Amateur Radio, Repeaters, Satellite,  
Computer applications.  
Call Paul WD8AHO

## Nevada

**AMATEUR ELECTRONIC SUPPLY**  
1072 N. RANCHO DRIVE  
LAS VEGAS, NV 89106  
702-647-3114  
Dale Porray "Squeak," AD7K  
Outside Nev: 1 (800) 634-6227  
Hours M-F 9-5:30, Sat. 9-3

**JUN'S ELECTRONICS**  
460 E. PLUMB LANE — 107  
RENO, NV 89502  
702-827-5732  
Outside Nev: 1 (800) 648-3962  
Icom — Yaesu Dealer

## New Hampshire

**POLCARI'S ELECTRONICS CENTER**  
61 LOWELL ROAD  
HUDSON, NH 03051  
603-883-5005  
Southern New Hampshire's only Ham  
Store. Call today for quotes.

**Dealers:** *YOU SHOULD BE HERE TOO!*  
*Contact Ham Radio now for complete details.*

### New Jersey

#### RADIOS UNLIMITED

P.O. BOX 347  
1760 EASTON AVENUE  
SOMERSET, NJ 08873  
201-469-4599  
800-526-0903  
New Jersey's only factory authorized Yaesu and Icom distributor. New and used equipment. Full service shop.

#### ROUTE ELECTRONICS 17

777 ROUTE 17 SOUTH  
PARAMUS, NJ 07625  
201-444-8717  
Drake, Cubic, DenTron, Hy-Gain, Cushcraft, Hustler, Larsen, MFJ, Butternut, Fluke & Beckman Instruments, etc.

### New York

#### BARRY ELECTRONICS

512 BROADWAY  
NEW YORK, NY 10012  
212-925-7000  
New York City's Largest Full Service Ham and Commercial Radio Store.

#### VHF COMMUNICATIONS

915 NORTH MAIN STREET  
JAMESTOWN, NY 14701  
716-664-6345  
Call after 7 PM and save! Supplying all of your Amateur needs. Featuring ICOM "The World System." Western New York's finest Amateur dealer.

### Ohio

#### AMATEUR ELECTRONIC SUPPLY

28940 EUCLID AVE.  
WICKLIFFE, OH (CLEVELAND AREA)  
44092  
216-585-7388  
Ohio Wats: 1 (800) 362-0290  
Outside Ohio: 1 (800) 321-3594  
Hours M-F 9-5:30, Sat. 9-3

#### UNIVERSAL AMATEUR RADIO, INC.

1280 AIDA DRIVE  
REYNOLDSBURG (COLUMBUS), OH  
43068  
614-866-4267  
Featuring Kenwood, Yaesu, Icom, and other fine gear. Factory authorized sales and service. Shortwave specialists. Near I-270 and airport.

### Pennsylvania

#### HAMTRONICS,

DIV. OF TREVOSE ELECTRONICS  
4033 BROWNSVILLE ROAD  
TREVOSE, PA 19047  
215-357-1400  
Same Location for 30 Years.

#### LaRUE ELECTRONICS

1112 GRANDVIEW STREET  
SCRANTON, PENNSYLVANIA 18509  
717-343-2124  
Icom, Bird, Cushcraft, Beckman, Larsen, Hustler, Astron, Belden, Antenna Specialists, W2AU/W2VS, AEA, B&W, Amphenol, Saxton, J.W. Miller/Daiwa, Vibroplex.

#### THE VHF SHOP

BOX 349 RD 4  
MOUNTAINTOP, PA 18707  
717-868-6565  
Lunar, Microwave Modules, ARCOS, Astron, KLM, Tama, Tonna-F9FT, UHF Units/Parabolic, Santec, Tokyo Hy-Power, Dentron, Mirage, Amphenol, Belden

### Texas

#### MADISON ELECTRONICS SUPPLY

1508 MCKINNEY  
HOUSTON, TX 77010  
713-658-0268  
Christmas?? Now??

### Virginia

#### ELECTRONIC EQUIPMENT BANK

516 MILL STREET, N.E.  
VIENNA, VA 22180  
703-938-3350  
Metropolitan D.C.'s One Stop Amateur Store. Largest Warehousing of Surplus Electronics.

### Wisconsin

#### AMATEUR ELECTRONIC SUPPLY

4828 W. FOND DU LAC AVE.  
MILWAUKEE, WI 53216  
414-442-4200  
Wisc. Wats: 1 (800) 242-5195  
Outside Wisc: 1 (800) 558-0411  
M-F 9-5:30  
Sat 9-3

**SAY  
YOU SAW  
IT IN  
ham radio!**

# HUSTLER DELIVERS RELIABLE ALL BAND HF PERFORMANCE

Hustler's new 6-BTV six-band trap vertical fixed station antenna offers all band operation with unmatched convenience. The 6-BTV offers 10, 15, 20, 30, 40, and 75/80 meter coverage with excellent bandwidth and low VSWR. Its durable heavy gauge aluminum construction with fiberglass trap forms and stainless steel hardware ensures long reliability.

Thirty meter kits (30-MTK) for 4-BTV and 5-BTV are also available.



Don't miss our 30 meter excitement.  
HUSTLER -  
STILL THE STANDARD OF PERFORMANCE.



3275 North "B" Avenue  
Kissimmee, Florida 32741

An **ARTIMEDIA** Company

# flea market



**RATES** Noncommercial ads 10¢ per word; commercial ads 60¢ per word **both payable in advance.** No cash discounts or agency commissions allowed.

**HAMFESTS** Sponsored by non-profit organizations receive one free Flea Market ad (subject to our editing) on a space available basis only. Repeat insertions of hamfest ads pay the non-commercial rate.

**COPY** No special layout or arrangements available. Material should be typewritten or clearly printed (not all capitals) and must include full name and address. We reserve the right to reject unsuitable copy. **Ham Radio** cannot check each advertiser and thus cannot be held responsible for claims made. Liability for correctness of material limited to corrected ad in next available issue.

**DEADLINE** 15th of second preceding month.

**SEND MATERIAL TO:** Flea Market, Ham Radio, Greenville, N. H. 03048.

**QSLs & RUBBER STAMPS** — Top Quality! Card Samples and Stamp info — 50¢ — Ebbert Graphics 5R, Box 70, Westerville, Ohio 43081.

**TRAVEL-PAK QSL KIT** — Converts post cards, photos to QSLs. Stamp brings circular. Samco, Box 203-c, Wynantskill, New York 12198.

**RADIO ITEMS** before 1930 wanted. Buying battery operated radios, horn and cone speakers, radio tubes and parts, radio literature — books, catalogs, magazines, radio advertising signs, posters. Gary Schneider, 6848 Commonwealth Blvd., Parma Heights, Ohio 44130.

**FOREIGN PAPER MONEY** wanted for my hobby. Old and new. Will accept free or will buy or trade. Buddy Hinckle, 1854 East Bay Drive, North Bend, Oregon 97459. WA6LJF.

**ENGINEERING SOFTWARE** — Free brochure. PLOTPRO — scientific graph printing program prints linear/log/semi-log plots on any printer. Multiple plots forced or autoscale, grid lines, labeling, \$49.95. ACNAP — fast machine code analyzes active/passive electronic circuits. MonteCarlo, Worst Case, and sensitivity analysis, \$49.95. SPP — Signal processing program analyzes linear/nonlinear systems and circuits, Laplace transfer functions, 512 point FFT, transient analysis, more, \$59.95. All programs share data files. Add \$3.00 each S&H. BV Engineering, PO Box 3429, Riverside, CA 92519. (714) 781-0252.

**120' GUYED TOWER.** Extremely strong \$700. 20' sections \$150. Tim Colbert, 13609 Colony, Burton, Ohio 44021.

**ELECTRONIC CMOS** Keyer kit pcb + parts only \$9.95 plus \$1.50 shipping. WI. res. add 5% tax. Send for free information. BEL-TEK, PO Box 125H, Beloit, WI 53511.

**FREE, FREE** gift. Interested in Amateur Radio, computers, video. Large SASE pse and mention Ham Radio ad. Free gift to all. Narwid Electronics, 61 Bellot Rd., Ringwood, NJ 07456.

**CRYSTALS** . . . brand new 230.400 kHz, 4.000 MHz, 10.000 MHz; \$1.00 each! Satisfaction guaranteed or your money back. Send for free electronics parts catalog. Technical Electronics, PO Box 2361H, Woburn, MA 01888.

**RUBBER STAMPS:** 3 lines \$4.50 PPD. Send check or MO to G.L. Pierce, 5521 Birkdale Way, San Diego, CA 92117. SASE brings information.

**RADIO SPECIALTIES** FM deviation scope \$250, Singer M-19 spectrum analyzer \$150, Narda 8400 RF power meter .01-12.4 GHz \$95, North Eastern 7-18 frequency meter 100 mc-10 GHz \$95, North Eastern TTS-26B telephone system test set \$250. K6KZT, 2255 Alexander, Los Osos, CA 93402.

**"THE SWAP LIST"** has bargains galore. Subscribe now! 6 months for \$4.00; 1 year only \$6.50. The Swap List, Box 988-H, Evergreen, CO 80439.

**REPAIR, ALIGNMENT**, calibration. Collins written estimates \$25; non Collins \$50. K1MAN. (207) 495-2215.

**CHASSIS** and cabinet kits. SASE K3IWK.

**DIGITAL DISPLAYS** for FT-101's, TS-520's, and most others. Write for information. Grand Systems, PO Box 2171, Blaine, Washington 98230.

**SAN ANTONIO, TEXAS QTH** for sale. 4-2-2 with 70 foot tower, etc. W8CM, (512) 684-6129.

**YOU KNOW** it's fun to build — if you can find the parts. Maybe we can help. Stamp brings flyer. Midnight Engineering, RR, Maquon, IL 61458.

**WANTED:** Cash paid for used speed radar equipment. Write or call: Brian R. Esterman, PO Box 8141, Northfield, Illinois 60093. (312) 251-8901.

**STERLING SILVER** calsign jewelry pin or tack; \$11.95, alligator tie clip; \$19.95, all ppd. Info-SASE Tom's Silver, PO Box 3758, Manchester, NH 03105.

**RECONDITIONED TEST EQUIPMENT** \$1.00 for catalog. Walter, 2697 Nickel, San Pablo, CA 94806.

**NOTICE** to all 2 meter RTTY operators — a new MSO (Message Storage Operation) system is being established here in the New York metro area by Lenny N2CKA. Frequency of operation is 145.680 MHz - FM, using 100 WPM (74 Baud) Baudot code. All Amateurs in the NY, NJ, Conn. area, or for that matter, anyone who can "hit" the MOS from elsewhere are encouraged to leave items of interest, bulletins, or just exchange "mail". The MSO uses standard DS 3100 type format. Access code is MSOCCA. HELP will bring up a list of commands to assist the new user. EXIT is used to "close" or deactivate the system. Lenny N2CKA or Rich N2EO, will be glad to help new users not familiar with SMO operation to get off on the right foot.

**FOX-TANGO** Newsletters — Since 1972, the prime source of modifications, improvements, and repair of Yaesu gear, free to Club members. Calendar year dues still only \$8 U.S., \$9 Canada, \$12 elsewhere. Includes five year cumulative index by model numbers, or send \$1 for index and sample Newsletter. Fox Tango Club, Box 15944, W. Palm Beach, FL 33416.

**SENCORE VA48**, Mint condition, all manuals & probes \$850.00. CES 500SA simplex patch \$325.00. Eden, Sr. (513) 932-3117.

**RTTY-EXCLUSIVELY** for the Amateur Teleprinter. One year \$7.00. Beginners RTTY Handbook \$8.00 includes journal index. P.O. Box RY, Cardiff, CA 92007.

**IMRA** International Mission Radio Assn. helps missionaries — equipment loaned; weekday net, 14.280 MHz, 2-3 PM Eastern. Br. Frey, 1 Pryer Manor Rd., Larchmont, NY 10538.

**"HAMS FOR CHRIST."** Reach other Hams with a gospel tract sure to please. Clyde Stanfield, WA6HEG, 1570 N. Albright, Upland, CA 91786.

**TENNATEST** — Antenna noise bridge — out-performs others, accurate, costs less, satisfaction guaranteed. Send stamp for details, W8URR, 1025 Wildwood Road, Quincy, MI 49082.

**WANTED:** Early Hallicrafter "Skyriders" and "Super Skyriders" with silver panels, also "Skyrider Commercial", early transmitters such as HT-1, HT-2, HT-8, and other Hallicrafter gear, parts, accessories, manuals. Chuck Dachis, WD5EOG, The Hallicrafter Collector, 4500 Russell Drive, Austin, Texas 78745.

**VERY in-ter-est-Ing!** Next 4 issues \$2. Ham Trader "Yellow Sheets", POB356, Wheaton, IL 60189.

**NEEDED:** Model 14-X D.C. module for Swan 350. Kurt R. Fritsch, 7882-103 Americana Cir., Glen Burnie, MD 21061. (301) 768-7903.

**WANTED:** Old microphones, remote mixers, other mic related items. All pre 1935. Bob Paquette, 107 E. National Avenue, Milwaukee, WI 53204.

## Coming Events ACTIVITIES

"Places to go..."

**COLORADO:** Rocky Mountain VHF Society's annual Spring Hamfest, Sunday, May 20, 9 AM to 3 PM, rain or shine, Boulder National Guard Armory, 4750 North Broadway, Boulder. Admission \$3 per family, no seller's charge. Sellers please bring own tables. Tech demonstrations and seminars on packet radio, fast-scan ham TV, microwaves, satellite communications, etc. Food and drink available. Talk in on 146.16/76 and 146.52. For more information: Richard Ferguson, KA0DXM, 1150 Albion Rd., Boulder, CO 80303. (303) 499-2871.

**GEORGIA:** The Atlanta Hamfestival 1984, sponsored by the Atlanta Radio Club, June 16 and 17, at the Atlanta Civic Center. 70,000 square feet of air-conditioned exhibitor space and over 800 outdoor flea market spaces will be available. Flea Market \$12.50 per space in advance; \$15.00 at the gate for both days. Hamfest registration \$5.00 in advance, \$6.00 at the door. To be pre-registered for the Flea Market or Hamfest, we must receive your application and check by June 8. Pre-registration applications received after June 8 will be returned. Hours 8 AM to 5 PM on Saturday, 8 AM to 2:30 PM on Sunday. Talk in on 3.97 MHz, 146.22/82 and 146.94 simplex. For pre-registration or other information write Atlanta Radio Club, PO Box 77171, Atlanta, GA 30357.

**IDAHO:** Kootenai Amateur Radio Society presents Hamfest '84 at the North Idaho Fairgrounds, Cœur D'Alene, June 9, 8 AM to 4 PM. Swap tables available at no charge. RV's are welcome but no hookups available at the site. Come early for our Friday program including pot luck and dancing afterwards. For further information write Avon Anderson, WB7WBZ.

**ILLINOIS:** The Six Meter Club of Chicago will hold its 27th annual Hamfest, Sunday, June 10, Santa Fe park, 91st and Wolf Road, Willow Springs. Gates open 6 AM. Advance registration \$2.00, \$3.00 at gate. Large swapper's row, picnicking, displays in the pavillion, plenty of parking, refreshments, AFMARS meeting and more. For advance tickets: Val Hellwig, K9ZVV, 3420 South 60th Court, Cicero, IL 60650 (or any club member). Talk in K9ONA 146.52 or K9ONA/R 37-97.

**INDIANA:** The Wabash Valley Amateur Radio Association's 38th annual Hamfest, Sunday, June 3, Vigo County Fairgrounds, Terre Haute. For more information SASE to WVARA, PO Box 81, Terre Haute, IN 47808.

**INDIANA:** The 18th annual Wabash County Hamfest, May 20, 4-H Fairgrounds, Wabash. 6 AM to 4 PM. Contact Don Spangler, W9HNO, 235 Southwood Drive, Wabash, IN 46992. (219) 563-5564.

**INDIANA:** The Annual Evansville TARS Hamfest, May 20, all indoors at the Vanderburgh County 4-H Fairgrounds. Open 6 AM CDT. Admission \$3.00. Indoor tables \$7.50. Outdoor flea market \$3.00. Talk in on 147.75/15 and 146.19/79. For table reservations and information contact Mike Anderson, KA9LQM, PO Box 3284, Evansville, IN 47732.

**MARYLAND:** The Maryland FM Association's annual Hamfest, Sunday, May 27, Howard County Fairgrounds, West Friendship, 30 miles west of Baltimore. 8 AM to 4 PM. Donation \$3.00. Tailgating \$3.00. Inside tables \$6.00 each in advance, \$10.00 at the door if available. Talk in on 146.16/76 and 146.52. For table reservations or information: MFMA Hamfest Committee, c/o John Elgin, WA3MNN, 8216 Styers Ct., Laurel, MD 20707. (301) 621-2352.

**MICHIGAN:** The Chelsea Swap and Shop, Sunday, June 3, 8 AM to 2 PM, Chelsea Fairgrounds, Chelsea. Setups 5 AM. Donation \$2.50 advance and \$3.00 at the gate. Children under 12 and non-ham spouses admitted free. Talk in on 146.52 simplex and 147.855 Chelsea Repeater. For information: William Altenberndt, 3132 Timberline, Jackson, MI 49201.

**MINNESOTA:** The North Area Repeater Association will sponsor the state's largest Swapfest and Exposition for Amateur Radio operators, Saturday, June 2, Minnesota State Fairgrounds, St. Paul. Admission \$4.00. Exhibits, booths, giant outdoor flea market. Free overnight parking for self-contained campers on June 1. Call wide area repeaters 25/85 or 16/76 for directions. For information write Amateur Fair, PO Box 857, Hopkins, MN 55343. (612) 420-6000.

**NEW ENGLAND:** The Hosstraders Spring Tailgate Swapfest, Saturday, May 12, sunrise to sunset at Deerfield, NH, Fair-

### Foreign Subscription Agents for Ham Radio Magazine

Ham Radio Austria  
Karin Ueber  
Postfach 2454  
D-7850 Loerrach  
West Germany

Ham Radio Holland  
Postbus 413  
NL 7800 Ar Emmen  
Holland

Ham Radio Belgium  
Stereohouse  
Brusselsesteenweg 416  
B-9218 Gent  
Belgium

Ham Radio Italy  
Via Pordenone 17  
I-20132 Milano  
Italy

Ham Radio Canada  
Box 400, Goderich  
Ontario, Canada N7A 4C7

Ham Radio Switzerland  
Karin Ueber  
Postfach 2454  
D-7850 Loerrach  
West Germany

Ham Radio Europe  
Box 2084  
S-194 02 Upplands Vasby  
Sweden

Ham Radio UK  
P.O. Box 63, Harrow  
Middlesex HA3 6HS  
England

Ham Radio France  
SM Electronic  
20 bis, Ave des Clarions  
F-89000 Auxerre  
France

Holland Radio  
143 Greenway  
Greenside, Johannesburg  
Republic of South Africa

Ham Radio Germany  
Karin Ueber  
Postfach 2454  
D-7850 Loerrach  
West Germany

grounds. Admission \$2 includes tailgaters and commercial. Friday night camping for self-contained rigs at nominal fee. None admitted before 4 PM Friday. No reserved spaces. Profits benefit Boston Burns Unit of Shriners' Hospital. Last year's donation over \$4700.00. For map to northeast's biggest Ham Flea Market SASE to Norm, WA 11VB, RFD Box 57, West Baldwin, ME 04091 or Joe, K1RQG, Star Route Box 56, Bucksport, ME 04416 or Bob, W1GWU, Walton Road, Seabrook, NH 03874.

**NEW HAMPSHIRE:** The 10th annual Eastern VHF/UHF Conference, May 4-6, Sheraton Tara, Exit 1, US 3, Nashua. Friday night hospitality room. Tech talks by well-known VHFers. Pre-registration \$14.50 to Rick Commo, K1LOG, 3 Pryor Rd., Natick, MA 01760 before April 29. Registration at door \$20.00. Saturday night banquet is \$15.00 payable before April 29. For information: Lewis D. Collins, W1GXT, 10 Marshall Terrace, Wayland, MA 01778. (617) 358-2854 before 10 PM.

**NEW JERSEY:** The Jersey Shore Chaverim is sponsoring the third annual Ham & Computerfest, June 10, 9 AM to 4 PM, Jewish Community Center, 100 Grant Avenue, Deal, 7300 sq. ft. of indoor space. Admission \$3 per person (children under 12 and XYL's free). Refreshments available. Indoor table \$8 and tailgating \$3.50 per space. For reserved space SASE with advance payment to Jersey Shore Hamfest, PO Box 192, West Long Branch, NJ 07764 by June 1. Talk in on 147.045 +6, 145.110 +6 and 146.52 simplex. Deal, NJ is less than 50 miles from NYC and 70 miles from Philadelphia. For information call Arnold, W2GDS (201) 222-3009.

**NEW JERSEY:** TCRA Hamfest Tri County Radio Association, rain or shine, Sunday, May 13, Passaic Valley Community Center off Valley Road, Stirling, NJ. 9 AM to 4 PM. Indoors, refreshments, rest rooms, free parking. Tables \$6, registration \$2.50. Table reservations call or write Dick Franklin, W2EUF (201) 232-5955 or 270-3193, PO Box 182, Westfield, NJ 07090.

**NEW YORK:** "ROME HAM FAMILY DAY", Sunday, June 3, Beck's Grove in Rome. Presented by the Rome Radio Club, Inc. This event features something for everyone. Games, contests and the largest Flea Market in the area. Good food and beverages available throughout the day. Educational and scientific displays and presentations climaxed by a fine dinner and our "Ham of the Year" award. For further information: Rome Radio Club, PO Box 721, Rome, NY 13440.

**NEW YORK:** The 25th annual Southern Tier Amateur Radio Club's Hamfest, Saturday, May 5, Treadway Inn, Owego. Flea market opens at 8 AM. Vendor displays and sales. Tech and non-tech talks. Refreshments available. Dinner is at 6:30 PM by advance tickets only. Talk in on 22/82, 167/6, or 146.52 simplex. For further information SASE to KF2X, C. England, RD #1, Box 144, Vestal, NY 13850.

**OHIO:** The Sandusky County and Ottawa County Combined Hamfest, May 20, Ottawa County Fairgrounds, state Rt. 163, 3 miles east of Oak Harbor. Advance tickets \$2.50, \$3.00 at gate. Free trunk space and parking. Tables available. For information: John Dickey, 545 N. Jackson St., Fremont, OH 43420. Talk in on 147.675/075 or 52 simplex.

**OHIO:** The Champaign-Logan Amateur Radio Club's annual Hamfest, Sunday, June 10, Logan County Fairgrounds, Bellefontaine. Gates open 8 AM. Tickets \$2.00 advance, \$2.50 at the door. Tables \$3.00. Plenty of free parking. Call in 147.60/00. Mobile check 146.52 simplex. For ticket info: Steve Kidder, N8ETD, Box 265, Russells Point, OH 43348 or (513) 843-6099.

**OKLAHOMA:** The Broken Arrow ARC and the Tulsa ARC will sponsor the Greencountry Hamfest, May 18, 19, and 20, Western Hills Lodge, 6 miles east of Wagoner at Sequoyah State Park. Pre-registration \$2.50 or \$3.00 at the door. There will be programs for the whole family. For information: Broken Arrow ARC, PO Box 552, Broken Arrow, OK 74012.

**OHIO:** Medina County Hamfest, sponsored by the Medina Two Meter Group, May 13, Medina County Community Center Building, Lafayette Rd., State Rt. 42 S.W. 8 AM to 4 PM. Vendor setup 7 AM. Refreshments and free parking. Tickets \$2.50 advance, \$3.00 at door. Tables \$5.00. Some elec. hookups available. Talk in on 147.63/03, K8TV/R. For tables and tickets write PO Box 452, Medina, OH 44258. (216) 725-5021 or (216) 723-5010.

**OKLAHOMA:** The Great Plains ARC's third annual Northwest Oklahoma Eyeball & Swapmeet, Sunday, May 20, starting at 9 AM in Mooreland. Covered dish dinner at noon. Local airport. Dealer and swap tables free. Talk in on 147.72/12 and 146.52 simplex. Campsites available. For further information call (405) 994-5394 or write KB5XI, Gordon Richmond, Rt. 1, Box 12, Mooreland, OK 73852.

**PENNSYLVANIA:** The Murgas ARC (K3YTL) will sponsor the annual Wilkes-Barre Hamfest, Sunday, June 3, 109th Army, Market St., Kingston (across the river from Wilkes-Barre). General admission 8 AM. Setup at 6 AM. Admission \$3.00. XYL's and children under 16 free. Tailgating \$2.00 per space in door/outdoor rain or shine. Talk in on 146.01/61 and 52 simplex. For further information: Hamfest Committee, PO Box 1094, Wilkes-Barre, PA 18703.

**PENNSYLVANIA:** The tenth annual Warmistown Amateur Radio Club's Hamfest, Sunday, May 20, Middletown Grange Fairgrounds, Penns Park Road, Wrightstown, rain or shine. Gates open 7 AM (Vendors at 6 AM). Donation \$3.00. Pre-registration \$2.00. XYL's and children free. Tailgaters \$2.00 add. per 10' space. Food and drink available. Talk in on 147.69/09 or 146.52. For information and pre-registration contact: Bill Cusick, W3GJC, Apt. 706 - Garner House, Hatboro, PA 19040. (215) 441-8048.

**PENNSYLVANIA:** The 2nd annual Southern Alleghenies Hamfest, May 13, 8 AM to 5 PM, Bedford County Fairgrounds one mile west of Bedford on Rt. 30 and 1/2 mile west of Rt. 220 bypass. Sponsored by the Bedford, Altoona, Somerset, PA, and Cumberland, MD ARCs and Blue Knob Repeater Association. Admission \$3.00. Inside spaces \$5.00 each, outside tailgating \$2.00. Visit nearby restored Old Bedford Village at special Hamfest rates. Talk in on Bedford repeater 145.49 and 146.52 simplex. For more information call Tom Gutshall, W3BZN (814) 942-7334.

**PENNSYLVANIA:** The tenth annual Northwestern Pennsylvania Hamfest, May 5, Crawford County Fairgrounds, Meadville. Gates open 8 AM. Bring your own tables. \$5 per table to display inside. \$2 per car space outside. \$3 admission, children under 12 free. Refreshments. Commercial displays welcome. Talk in on 145.13, 147.21, 147.03. Details: C.A.R.S., PO Box 653, Meadville, PA 16335. Attn: Hamfest Committee.

**PENNSYLVANIA:** The 30th annual Breeze Shooters' Hamfest, Sunday, June 3, 9 AM to 4 PM, White Swan Amusement Park, PA. Rt. 60 near greater Pittsburgh International Airport. Free flea market and free admission. Family amusement park, food on site. Registration \$2.00 or 3/\$5.00. Talk in on 28/88 or 29 MHz. For information: Don Myslewski, K3CHD, 359 McMahon Road, North Huntingdon, PA 15642. (412) 863-0570.

**TENNESSEE:** The Radio Amateur Club of Knox County will hold its 18th annual Hamfest, May 26 and 27, Korbella Temple Auditorium, Knoxville. Saturday 9 to 5. Sunday 10 to 4. Admission \$3.00. Radio and computer forums, dealers, indoor/outdoor flea market. Free parking. Talk in on 147.90/30. For information: Larry Poore, N4EHR, 4320 Felty Drive, Knoxville, TN 37918. (615) 687-3154.

**VIRGINIA:** The Tenth annual Manassas Hamfest, Sunday, June 3, Prince William County Fairgrounds, VA. RT. 234, 1/2 mile south of Manassas. 7 AM tailgate setup. 8 AM general admission. Tailgating, indoor exhibits, food available on grounds, YL program, CW proficiency awards. Admission \$4 per person, under 12 free. Contact: Bob Kelly, KA4NES, General Chairman, Manassas Hamfest, c/o Ole Virginia Hams ARC, Inc., Manassas, VA 22110. (703) 361-9468.

**WASHINGTON:** The Yakima ARC's Central Washington State Hamfest, May 12 and 13, Hobby Building, Central Washington State Fairgrounds, Yakima. Saturday from 9 AM to 5 PM with lunch available. Sunday from 8 AM to 2 PM, breakfast and lunch available. Registration \$4.00 advance, \$5.00 at the door. Dealers' displays and a free swap and shop with plenty of tables. Talk in on 146.01/61 and 146.34/94. For pre-registration: Bob Rutherford, PO Box 9211, Yakima, WA 98909.

**THE 574TH AND 565TH S.A.W. BNS.** will hold their second reunion July 1984 in St. Louis, MO. Former members please write to Chas. A. McGaffin, San Mateo Rd., San Mateo, FL 32088. Phone (904) 328-9576 or to Angel M. Zaragoza, W6ZPR, 1571 - 9th St., San Bernardino, CA 92411. Phone (714) 889-2380 for full details.

## OPERATING EVENTS

"Things to do..."

**MAY 11 AND 12:** HANDI-HAM System's special events station, W0EQO, will operate from Camp Courage, Maple Lake, MN, during the System's 15th annual Spring Convocation. For a special certificate SASE to: Handi-Hams, 3915 Golden Valley Rd., Golden Valley, MN 55422.

**MAY 12 AND 13:** ARMED FORCES DAY AT WEST POINT. The Meadowlands ARA will operate at the U.S. Military Academy in honor of Armed Forces Day 1984 using the club station call N2BMM. To confirm QSO send large SASE (8 1/2 x 11) with 37¢ U.S. postage to POB 324, Little Ferry, NJ 07643.

**MAY 19:** In observance of Armed Forces Day, the U.S. Air Force Museum at Wright-Patterson Air Force Base, will host the operation of an Amateur Radio special event station. Listen for K8DMZ from 1400Z to 2200Z. To commemorate the event, the Museum will issue a special certificate for each two-way contact.

**MAY 19:** In recognition of the 35th annual Armed Forces Day celebration, Amateur Radio Station W4ODR, located aboard Naval Air Station Memphis, Millington, Tennessee, will be operating from 1400Z to 2200Z. Special certificates and QSL cards will be available to those who work W4ODR. QSL to ARS W4ODR, PO Box 54278, Millington, TN 38054.

**MAY 19:** ARMED FORCES DAY military-to-Amateur cross

band operations will be conducted from 19/1300 UTC to 20/0245 UTC May 1984. East coast stations commence operations at 19/1300 UTC and west coast stations commence operations at 19/1600 UTC May 1984. Military stations will transmit on selected military frequencies. The military operator will announce the specific Amateur band frequency being monitored. Entries must be postmarked no later than 26 May 1984 and submitted to the respective military commands. Stations copying AIR send entries to: Armed Forces Day Test, 2045CG/DONJIM, Andrews AFB, DC 20331. NAM, NAV or NPG to: Armed Forces Day Test, HQ Navy-Marine Corps MARS, 4401 Massachusetts Ave., N.W., Washington, DC 20390. WAR to: Armed Forces Day Test, Commander 7th Signal Command, Attn: CCN-PO-OX, Fort Ritchie, MD 21719.

**MAY 25 AND 26:** ROYAL CANADIAN Air Force (RCAF) Telecommunications reunion. To honor the 50th anniversary of Air Force communications the reunion will be held at the Canadian Forces School of Communications and Electronics at Kingston, Ontario, for all active duty and retired members and spouses. For more information write to Air Force Telecom Reunion Committee, CFB Kingston, Kingston, Ontario K7L 2Z2.

**MAY 26:** NISKA-DAY '84. The Niskayuna, NY, High School Club Station, W2DKK, (OK Kids) will operate from 1500Z to 2100Z to commemorate the 175th anniversary of the community of Niskayuna. For a commemorative QSL card SASE to ARS W2DKK, Niskayuna High School, 1626 Balltown Road, Niskayuna, NY 12309.

**JUNE 2 AND 3:** W.I.N.O., the Wireless Institute of Northern Ohio, an organization sponsored by the Lake County ARA, will operate a special events station to commemorate Ohio Wine Week. Listen for K080 operating from an actual winery in Madison, Ohio. A special 8 1/2 x 11 certificate will be available from: K080, WINO Weekend, 7126 Andover Drive, Mentor, Ohio 44060.

**JUNE 8 AND 9:** Madison County ARC will operate club station W9VCF, portable from the historic Eight Street Festival in Anderson, Indiana. A special certificate will be offered to persons contacting the club station during the festival or any club member during the month of June. Send log info and \$1.00 donation to Madison County ARC, c/o Frank M. Dick, WA9JWL, 921 Isabelle Drive, Anderson, IN 46013.

**JUNE 9 AND 10:** The Knox County ARC will operate a special event station to commemorate Galesburg Railroad Days, an annual event for Galesburg, Illinois. Listen for W9GFD. For a special commemorative QSL card SASE to Knox County ARC, W9GFD, 1694 Bluebird Drive, Galesburg, IL 61401.

## RF Porta-Tenna

VHF/UHF Telescopic 1/4 & 5/8 Wavelength Antennas for Hand-Held Transceivers & Test Equipment

### 1/4 WAVELENGTH

Model No.	Freq. MHz	Description	Price
196-200	144-148	5/16-32 stud w/spring	\$5.95
196-204	"	BNC connector w/spring	7.95
196-214	"	BNC connector	6.95
196-224	144-UP	BNC conn. adj. angle	7.95
196-814	220-225	BNC connector	6.95

### 5/8 WAVELENGTH

191-210	"	5/16-32 for old TEMPO	22.95
191-214	"	BNC connector	19.95
191-219	"	PL-259 w/M-359 adpt.	22.95
191-810	220-225	5/16-32 for old TEMPO	22.95
191-814	"	BNC connector	19.95
191-940	440-450	5/16-32 for HT-220	22.95
191-941	"	1/4-32 stud	22.95
191-944	"	BNC connector	19.95

Largest Selection of Telescopic Antennas. Write for info. Price are postpaid via UPS to 48 States. For air delivery via UPS Blue add \$1.50. Florida add 5% sales tax. Payment by M.O. or Cashiers Check only. ✓ 193

**RF PRODUCTS**  
P.O. Box 33, Rockledge, FL 32955, U.S.A.  
(305) 631-0775

# Advertisers check-off

... for literature, in a hurry — we'll rush your name to the companies whose names you "check-off"

Place your check mark in the space between name and number. Ex: Ham Radio  234

- |                    |               |                       |          |
|--------------------|---------------|-----------------------|----------|
| AEA                | *             | KLM                   | 163      |
| ARR                | 101           | Larsen                | 165      |
| All Elec.          | 102           | Linear                | 166      |
| Alpha Delta        | 103, 104      | Lunar                 | 167      |
| Aluma              | 105           | MFJ                   | 168      |
| Amateur Wholesale  |               | MHZ Elec.             | 169      |
|                    | 106, 107, 301 | Madison               | 170      |
| ARRL               | 108           | Maggiore              | 171      |
| Amidon             | 109           | Memphis Amateur       |          |
| Anglog Tech.       | 110           | Elec.                 | 172      |
| Antenna Bank       | 111           | Meshna                | 173      |
| Ant. Co. America   | 112           | Micro-Mart *          |          |
| ADM                | 113           | Microwave Filter      | 174      |
| Applied Inv.       | 114           | Midwest Am.           | 175      |
| Atlantic Surplus   | 115           | Missouri Radio        | 176      |
| ATV Mag.           | 116           | Morning Dist.         | 177      |
| Audio Amateur      | 117           | Mosley                | 178      |
| B. G. Micro        | 118           | NCG                   | 179      |
| B & W *            |               | Nampa                 | 180      |
| Barry *            |               | Nemal                 | 181      |
| Bial               | 119           | Nevada Sat.           | 182      |
| Birch Hill         | 120           | N & V                 | 183      |
| Buckmaster         | 121, 122      | Oak Hill Academy *    |          |
| Butternut *        |               | Odom Antennas         | 184      |
| C & A Roberts      | 123           | Outprint              | 185      |
| Caddell Coil       | 124           | P. B. Radio           | 186      |
| Cal. Eastern Labs  | 125           | P. C. Elec.           | 187, 188 |
| Ceco               | 126           | Paramount             | 189      |
| Centurion          | 127           | Pro Search            | 190      |
| Chemtronics        | 128           | QCD Marketing         | 191      |
| Coaxial Dynamics   | 129           | Quarles               | 192      |
| Coilco             | 130           | RF Products           | 193      |
| CES                | 131, 303      | Callbook              | 194      |
| Comm. Concepts     | 132           | Radiokit              | 195      |
| Comm. Spec.        | 133           | Radio Warehouse *     |          |
| CPU                | 134           | Ramsey                | 196, 197 |
| Comp. Trader       | 135           | Sartori               | 198      |
| Datapoint *        |               | Satellite TV Magazine | 226      |
| Direct Video       | 136           | Shure Brothers        | 199      |
| EGE                | 137           | Skyline Prod.         | 200      |
| Electra            | 138           | SE Satellite          | 201      |
| Electro Industries | 139           | Spectronics *         |          |
| EEB                | 140           | Spectrum Int.         | 202      |
| Encomm             | 141           | Spectrum West         | 203      |
| Fabtron            | 142           | Spi-Ro Dist.          | 204      |
| Fair Radio         | 143           | Tel-Com               | 205      |
| Falcon Comm.       | 144           | Televave              | 206      |
| Fluke *            |               | Telex Comm. *         |          |
| Fox Tango          | 145           | Telphone              | 207      |
|                    |               | Ten-Tec *             |          |
| GLB Elec.          | 147           | Timekit               | 208      |
| Ham Master Tapes   | 148           | Transletronic         | 210      |
| HFB                | 149           | Tri-Ex                | 209      |
| Ham Shack *        |               | Ungar                 | 211, 212 |
| Hamtronics, N. Y.  | 150           | Universal Elec.       | 213      |
| Handi-Tek          | 151           | UNR-Rohn *            |          |
| Harrison Radio     | 152           | Univer. Microfilms *  |          |
| Harvey Radio       | 153           | Van Gorden            | 214      |
| Hatry Elec.        | 154           | Vanguard              | 215      |
| Hull Elec.         | 155           | Vector Radio          | 216      |
| Hustler            | 156           | Video Elec.           | 217      |
| Icom               | 157, 158, 302 | VoCom Prod.           | 218      |
| Info. Un.          | 159           | Western Elec.         | 219      |
| Inter. Media       | 160           | Westlink              | 220      |
| Jensen Tools       | 161           | Williams Radio        | 221      |
| Kantronics         | 162, 164      | Wilson Microwave      | 222      |
| Kenwood *          |               | Yaesu                 | 223      |

\*Please contact this advertiser directly.

Limit 15 inquiries per request.

May 1984

Please use before June 30, 1984

Tear off and mail to  
HAM RADIO MAGAZINE — "check off"  
Greenville, N. H. 03048-0498

NAME .....

CALL .....

STREET .....

CITY .....

STATE ..... ZIP .....

## COMPUTER DISKS

CONTROL DATA  
5 1/4" SSDD

**\$22 Box of 10**  
(5 or more \$21/Box)

FREE SUPPLIES CATALOG  
Write Today

Payment: Mastercard/Visa (include Number and expiration date), Money Order, Cashier's Check, Personal Checks (allow 10 days to clear). Shipping 3%, \$3 minimum, by UPS mainland USA. Sorry no APO/FPO/COD's. New Jersey add 6%. Prices and availability subject to change without notice.

## OUTPRINT

COMPUTER AND WORD PROCESSING SUPPLIES

44 FORREST ROAD  
RANDOLPH, NEW JERSEY 07869

✓ 185

## FREE CATALOG!

Features Hard-to-Find Tools  
and Test Equipment



Jensen's new catalog features hard-to-find precision tools, tool kits, tool cases and test equipment used by ham radio operators, hobbyists, scientists, engineers, laboratories and government agencies. Call or write for your free copy today.

**JENSEN TOOLS INC.** | 7815 S. 46th Street  
Phoenix, AZ 85040  
(602) 968-6231

✓ 161

## the smarter SANTEC

**ST-142 289<sup>00</sup>**  
For 2 Meters

Free \$9.95 Mob. Quick Charge Cable  
We Stock ALL Santec Accessories!

ST-222...\$299 ST-442...\$319

**KDK FM-2033**  
25 Watt 2-Meter FM

**289<sup>00</sup>** with Touchtone Mike  
and Mobile Bracket

KDK 220, 440, 6M-Call-Availability!

FREE UPS Brown Shipping-Add \$1.65 for COD  
N.C. Res. Add 4 1/2% Sales Tax. Sorry No Cards.

**WELZ** SWR&POWER METER

**TOKYO HY-POWER AMPLIFIERS**

The Nation's Largest Mail Order Santec Dealer

**WILLIAMS RADIO SALES**

600 LAKEDALE ROAD, DEPT. H  
COLFAX, N.C. 27235 ✓ 221  
(919) 993-5881 Noon to 10 P.M. EST

# Advertisers index

Advanced Electronic Applications	53, 94
Advanced Receiver Research	92
All Electronics	66
Alpha Delta Communications	72, 73, 134
Aluma Tower Co.	122
Amateur Wholesale Electronics	31, 109
American Radio Relay League	122
Amidon Associates	96
Analog Technology	134
Antenna Bank	106
Antenna Company of America	82
Antenna Development & Man.	116
Applied Invention	82
Atlantic Surplus Sales	134
ATV Magazine	143
Audio Amateur/Speaker Builder	134
B. G. Micro	90, 91
Barker & Williamson	96
Barry Electronics	137
Bial Co.	103
Birch Hill Sales	134
Buckmaster Publishing	82, 103
Butternut Electronics	123
C & A Roberts, Inc.	13
Caddell Coil Corp.	118
California Eastern Labs	10
Ceco	44
Centurion International	92
Chemtronics	59
Coaxial Dynamics, Inc.	117
Coilco Electronics, Inc.	143
Communications Electronics Specialists, Inc.	30
Communications Concepts, Inc.	96
Communications Specialists	152
Computer Products and Peripherals Unlimited	44
Computer Trader	100
Datapoint	100
Direct Video Sales	106
EGE, Inc.	65
Electra	124
Electro Industries	82
Electronic Equipment Bank	26
Encomm, Inc.	118
Fabtron Division, Rhoades National Corp.	82
Fair Radio Sales	116
Falcon Communications	74, 75
John Fluke Manufacturing Co., Inc.	32
Fox Tango Corp.	118
GLB Electronics	42
Ham Master Tapes	121
Ham Radio's Bookstore	58, 106, 117, 126, 128
The Ham Shack	115
Hamtronics, N.Y.	60, 134
Handi-Tek	134
Harrison Radio	85
Harvey Radio	66
Hatry Electronics	127
Hull Electronics	54
Hustler, Inc.	145
Icom America, Inc.	Cover II, 83
Information Unlimited	106
International Media Service	137
Jensen Tools	148
Kantronics, Inc.	36, 37
Trio-Kenwood Communications	2, 76, 77, Cover IV
KLM Electronics, Inc.	16
Larsen Electronics	48
Linear Corp.	58
Lunar Electronics	151
MFJ Enterprises	7
MHZ Electronics	138, 139, 140, 141, 142
Madison Electronic Supply	100
Maggiore Electronic Lab	100
Memphis Amateur Electronics	122
John J. Meshna, Jr., Co., Inc.	130
Micro-Mart Distributors	136
Microwave Filter, Inc.	88
Midwest Amateur Radio Supply	117
Missouri Radio Center	116
Morning Distributing	117
Mosley Electronics	8
NCG	88
Nampa Satellite Systems	133
Nemal Electronics	127
Nevada Satellite	43
Nuts & Volts	103
Oak Hill Academy ARS	116
Odom Antennas, Inc.	51
Outprint	148
P. B. Radio	127
P. C. Electronics	42, 89
Paramount Communications	128
Pro Search Electronics	9
QCD Marketing Services	100
Quarles Satellite Systems	29
RF Products	147
Radio Amateur Callbook	30
Radiokit	123
Radio Warehouse	128
Ramsey Electronics	104, 105
Sartori Associates	128
Satellite TV Magazine	102
Shure Brothers	28
Skyline Products	128
Southeast Satellite	21
Spectronics	92
Spectrum International	78
Spectrum West	120
Spi-Ro Distributing	28
Tel-Com	58
Televave, Inc.	22
Telex Communications	79
Telphone Corp.	96
Ten-Tec	123
Timekit	96
Transletronic	137
Tri-Ex Tower Corp.	118
Ungar	44, 66
Universal Electronics	103
UNR Rohn	82, 134
University Microfilms International	122
Van Gorden Engineering	71
Vanguard Labs	82
Vector Radio	103
Video Electronics	88
VoCom Products	103
Western Electronics	116
Westlink Report	126
Williams Radio Sales	148
Wilson Microwave Systems	1
Yaesu Electronics	Cover III

# ham radio

## Reader Service

For literature or more information, locate the Reader Service number at the bottom of the ad, circle the appropriate number on this card, affix postage and send to us. We'll hustle your name and address to the companies you're interested in.

101 113 125 137 149 161 173 185 197 209 221 233 245 257 269 281 293 305 317 329 341  
102 114 126 138 150 162 174 186 198 210 222 234 246 258 270 282 294 306 318 330 342  
103 115 127 139 151 163 175 187 199 211 223 235 247 259 271 283 295 307 319 331 343  
104 116 128 140 152 164 176 188 200 212 224 236 248 260 272 284 296 308 320 332 344  
105 117 129 141 153 165 177 189 201 213 225 237 249 261 273 285 297 309 321 333 345  
106 118 130 142 154 166 178 190 202 214 226 238 250 262 274 286 298 310 322 334 346  
107 119 131 143 155 167 179 191 203 215 227 239 251 263 275 287 299 311 323 335 347  
108 120 132 144 156 168 180 192 204 216 228 240 252 264 276 288 300 312 324 336 348  
109 121 133 145 157 169 181 193 205 217 229 241 253 265 277 289 301 313 325 337 349  
110 122 134 146 158 170 182 194 206 218 230 242 254 266 278 290 302 314 326 338 350  
111 123 135 147 159 171 183 195 207 219 231 243 255 267 279 291 303 315 327 339  
112 124 136 148 160 172 184 196 208 220 232 244 256 268 280 292 304 316 328 340

Limit 15 inquiries per request.

NAME \_\_\_\_\_ CALL \_\_\_\_\_

ADDRESS \_\_\_\_\_

CITY \_\_\_\_\_ STATE \_\_\_\_\_ ZIP \_\_\_\_\_

Please use before June 30, 1984

May 1984

\_\_\_\_\_  
\_\_\_\_\_  
\_\_\_\_\_

AFFIX POSTAGE  
OR  
POST OFFICE  
WILL NOT  
DELIVER

**ham  
radio**

*magazine*

READER SERVICE CENTER  
P.O. BOX 358  
ARLINGTON, MA 02174

ATTN: Reader Service Dept.



# TET<sup>®</sup>

# ANTENNA SYSTEMS

The Full Line Antenna Company

## TOWERS

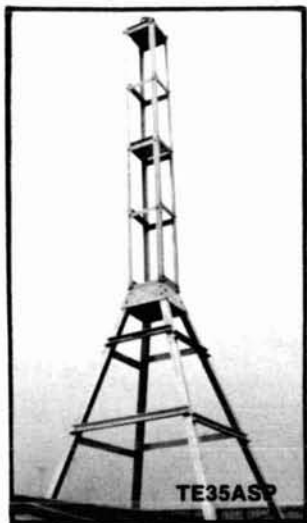

11 FOOT TOWERS FOR  
ROOF TOP MOUNTING  
and PORTABLE USE  
6 FOOT ADD ON SECTION

## TRI BAND BEAMS

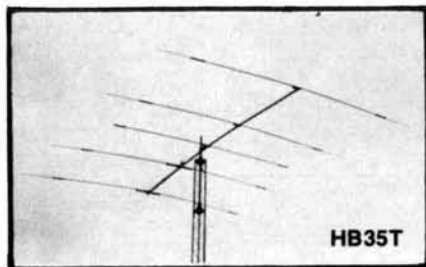

HB35T

3, 4, or 5 ELEMENT DESIGNS

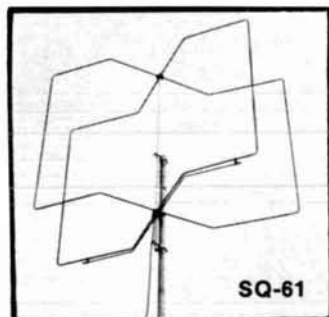

SQ-61

## HF MONO BANDERS

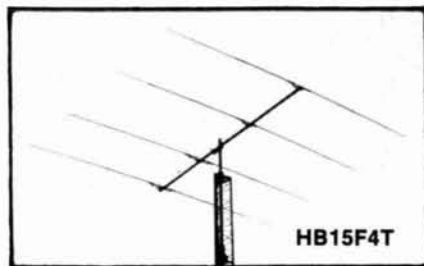

HB15F4T

40 METER	.....	2, 3 ELEMENT
20 METER	.....	2-4 ELEMENT
15 METER	.....	2-5 ELEMENT
10 METER	.....	2-5 ELEMENT
6 METER	.....	4, 6, 8 ELEMENT
2 METER	...	10, 14, 18 ELEMENT
70 CENTIMETER	....	17 ELEMENT

## OMNI LOOPS

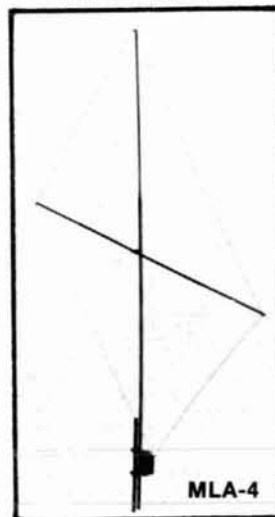

MLA-4

80 - 10 LOOP  
TRI BAND DELTA LOOP

## VERTICALS

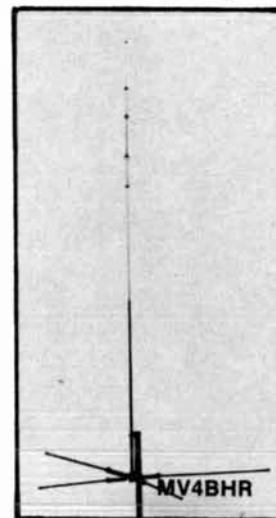

MV4BHR

HF 3, 4, 5 BAND  
50 Mhz - 450 Mhz

## 2 ELEMENT SWISS QUADS

SQ 21	.....	144 Mhz
SQ 61	.....	50 Mhz
SQ 28	.....	28 Mhz
SQ 15	.....	21 Mhz

## QUAD BAND BEAMS

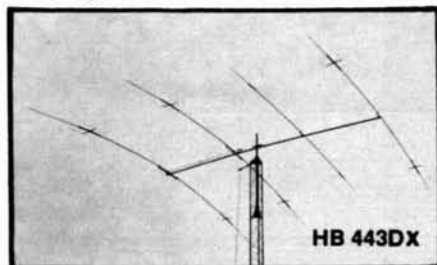

HB 443DX

MINI SP SERIES  
3, 4 ELEMENT  
FULL SIZE  
3, 4 ELEMENT

## MINI BEAMS

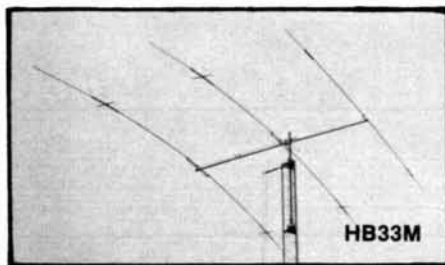

HB33M

10 METER	.....	2, 3 ELEMENT
15 METER	.....	2, 3 ELEMENT
20 METER	.....	2, 3 ELEMENT
10 - 20	.....	2, 3 ELEMENT

## OSCAR 10

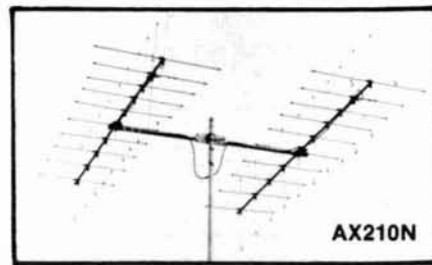

AX210N

SWISS QUADS  
SKELETON SLOTS  
CIRCULAR AX for  
144 Mhz and 432 Mhz BANDS

## 2M SWISS QUADS

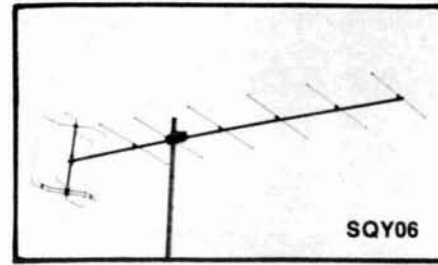

SQY06

SQ 22	.....	DUAL QUAD
SQY 06	.....	6 ELEMENT QUAGI
SQY 08	.....	8 ELEMENT QUAGI
SQY06N	.....	2,6 ELEMENT

# TET ANTENNA SYSTEMS

AVAILABLE FROM YOUR LOCAL DEALER

OR  
CALL  
OR  
WRITE



2775 KURTZ STREET, SUITE 11  
SAN DIEGO, CALIFORNIA 92110-3171  
TELEPHONE (619) 299-9740 - TELEX 181747  
LOUIS N. ANCIAUX, WB6NMT



## Stuck with a problem?

Our TE-12P Encoder might be just the solution to pull you out of a sticky situation. Need a different CTCSS tone for each channel in a multi-channel Public Safety System? How about customer access to multiple repeater sites on the same channel? Or use it to generate any of the twelve tones for EMS use. Also, it can be used to access Amateur repeaters or just as a piece of versatile test equipment. Any of the CTCSS tones may be accessed with the TE-12PA, any of the audible frequencies with the TE-12PB. Just set a dip switch, no test equipment is required. As usual, we're a stickler for 1day delivery with a full 1 year warranty.

- Output level flat to within 1.5db over entire range selected.
- Immune to RF.
- Powered by 6-30vdc, unregulated at 8 ma.
- Low impedance, low distortion, adjustable sinewave output, 5v peak-to-peak.
- Instant start-up.



### TE-12PA

67.0 XZ	85.4 YA	103.5 1A	127.3 3A	156.7 5A	192.8 7A
71.9 XA	88.5 YB	107.2 1B	131.8 3B	162.2 5B	203.5 M1
74.4 WA	91.5 ZZ	110.9 2Z	136.5 4Z	167.9 6Z	
77.0 XB	94.8 ZA	114.8 2A	141.3 4A	173.8 6A	
79.7 SP	97.4 ZB	118.8 2B	146.2 4B	179.9 6B	
82.5 YZ	100.0 1Z	123.0 3Z	151.4 5Z	186.2 7Z	

- Frequency accuracy,  $\pm 1$  Hz maximum  $-40^{\circ}\text{C}$  to  $+85^{\circ}\text{C}$
- Frequencies to 250 Hz available on special order.
- Continuous tone

### TE-12PB

TEST-TONES:	TOUCH-TONES:	BURST TONES:
600	697 1209	1600 1850 2150 2400
1000	770 1336	1650 1900 2200 2450
1500	852 1477	1700 1950 2250 2500
2175	941 1633	1750 2000 2300 2550
2805		1800 2100 2350

- Frequency accuracy,  $\pm 1$  Hz maximum  $-40^{\circ}\text{C}$  to  $+85^{\circ}\text{C}$
- Tone length approximately 300 ms. May be lengthened, shortened or eliminated by changing value of resistor

**\$89.95**

**COMMUNICATIONS SPECIALISTS**

426 West Taft Avenue, Orange, California 92667 ✓ 133  
(800) 854-0547/California: (714) 998-3021





# INTRODUCING . . . THE FT-980 CAT SYSTEM !!!



Join the computer revolution in Amateur Radio with the Computer Aided Transceiver  
... the new FT-980 from Yaesu Electronics!

- 8-Bit microprocessor for greater operating flexibility.
- High-voltage, all solid state transmitter PA for excellent linearity.
- Keyboard entry of frequencies into any of twelve independent VFO/memory registers.
- Amateur band transmit plus general coverage receive capability.
- Full CW break-in with quiet solid state switching.
- CW Spot switch on front panel.
- Digital frequency display with resolution to 10 Hz. Digital readerboard-type coarse frequency sub-display.
- Keyboard entry of sub-bands for Novice, General, or Advanced Class operators. Separate sub-bands may be programmed on each memory.
- Up/Down scanning plus instant  $\pm 5$  kHz/step QSY from front panel.
- SSB/CW/AM/FSK/FM operation built in. CW and AM Wide/Narrow selection using optional filters.
- Wide dynamic range and noise floor maintenance provided by husky front end design and IF filter gain balancing.
- 10 Hz synthesizer steps. Quick frequency change via keyboard or scanning controls.
- IF Notch filter at 455 kHz for interference rejection.
- Audio Peak Filter for narrow band CW signal enhancement.
- RX Audio Tone Control for signal laundering in AF line.
- Variable IF Bandwidth and IF Shift using cascaded filters.
- Memory storage of both frequency and operating mode.
- Pushbutton Memory Check feature for verification of memory frequencies without actually changing operating frequency in use.
- Pushbutton Offset Check feature for verification of memory-to-VFO frequency difference.
- Variable Pulse Width Noise Blanker.
- IF Monitor with front panel volume control.
- RF Speech Processor.
- Dual metering of Vcc, Ic, ALC, Compression, Discriminator Center, Relative PO, and SWR (Calibrated).
- Selectable AGC: Slow/Fast/Off.
- Separate RX-only antenna jack.
- Three FSK shifts built in.
- Optional Electronic Keyer Module.
- Optimization of audio passband for mode in use, for preservation of noise figure with changing bandwidth.
- Computer interface optional module available mid-1983, for remote transceiver control from personal computer terminal.

For a detailed brochure covering the FT-980 CAT System, call or write your Authorized Yaesu Dealer.

Price And Specifications Subject To  
Change Without Notice Or Obligation

**YAESU**  
*The radio.*



✓ 223  
0183R

YAESU ELECTRONICS CORPORATION 6851 Waltham Way, Paramount, CA 90723 • (213) 633-4007  
YAESU CINCINNATI SERVICE CENTER 9070 Gold Park Drive, Hamilton, OH 45011 • (513) 874-3100

# KENWOOD

pacesetter in amateur radio

## TS-930S "DX-traordinary" TS-930S

We call it "DX-traordinary" because the TS-930S has now become the favorite rig of the serious contesters! Its superior capability for full break-in split-frequency operation, the speed and convenience with which its eight memory channels can be accessed, its unsurpassed receiver dynamic range and its remarkable ability to select the desired signal during periods of heavy QRM, utilizing VBT, Slope tuning, IF Notch filtering, and tuneable audio filtering, have all combined to make this the rig that gives you the EXTRA EDGE!

The TS-930S is loaded with all the special features that you always wanted in an HF transceiver. Full coverage of the 160 through 10 meter bands, including the new WARC frequencies, (easily modified for HF MARS), plus a general coverage receiver that can tune any frequency from 150 kHz to 30 MHz. Operation in the SSB, CW, FSK, and AM modes, with selectable full or semi CW break-in. All solid-state, with 250 watts PEP input on SSB,

CW, FSK, and 80 watts input on AM. SWR/power meter. Triple final protection circuits plus two cooling fans built-in. 10-Hz step synthesized frequency control. Available with optional automatic antenna tuner built-in, another industry first! Dual digital VFO's. Eight memory channels that store both frequency and band information, with internal battery back-up, (batteries not supplied). Dual mode adjustable noise blankers, especially effective in eliminating "woodpecker" type interference. SSB IF slope tuning, for maximum rejection of interference. CW variable bandwidth, with pitch and side-tone control. IF notch filter. Tuneable audio peaking filter. Unique six digit white fluorescent tube digital display is easy-on-the-eyes during those long contests. RF speech processor, for higher average "talk-power". SSB monitor circuit. 4-step RF attenuator. VOX. 100-kHz marker. AC power supply built-in, 120, 220, or 240 VAC.



**TS-930S Optional Accessories:**  
AT-930 automatic antenna tuner, SP-930 external speaker, with selectable audio filters, YG-455C-1 (500 Hz), YG-455CN-1 (250 Hz), YK-88C-1 (500 Hz) CW filter, YK-88A-1 (6 kHz) AM filter, all plug-in type. SO-1 commercial stability TCXO, MC-60A deluxe desk microphone, MC-80 and MC-85 communications microphones, MC-42S mobile hand microphone, TL-922A linear amplifier (not for CW QSK), SM-220 station monitor, PC-1A phone patch, SW-2000 SWR/power meter, 160~6 meter, SW100A SWR/power/volt meter 160-2m HS-4, HS-5, HS-6, and HS-7 headphones.

Isn't it about time you stepped into the winner's circle?

More information on the TS-930S is available from authorized dealers of Trio-Kenwood Communications, 1111 West Walnut Street, Compton, California 90220.



Specifications and prices are subject to change without notice or obligation.

