

Season's Greetings from

ham radio magazine

- auto-dialer
- photovoltaics
- lightning protection
- vertical phased arrays
- time and frequency standards
- PCBs in the ham shack
- relative index



communications
technology

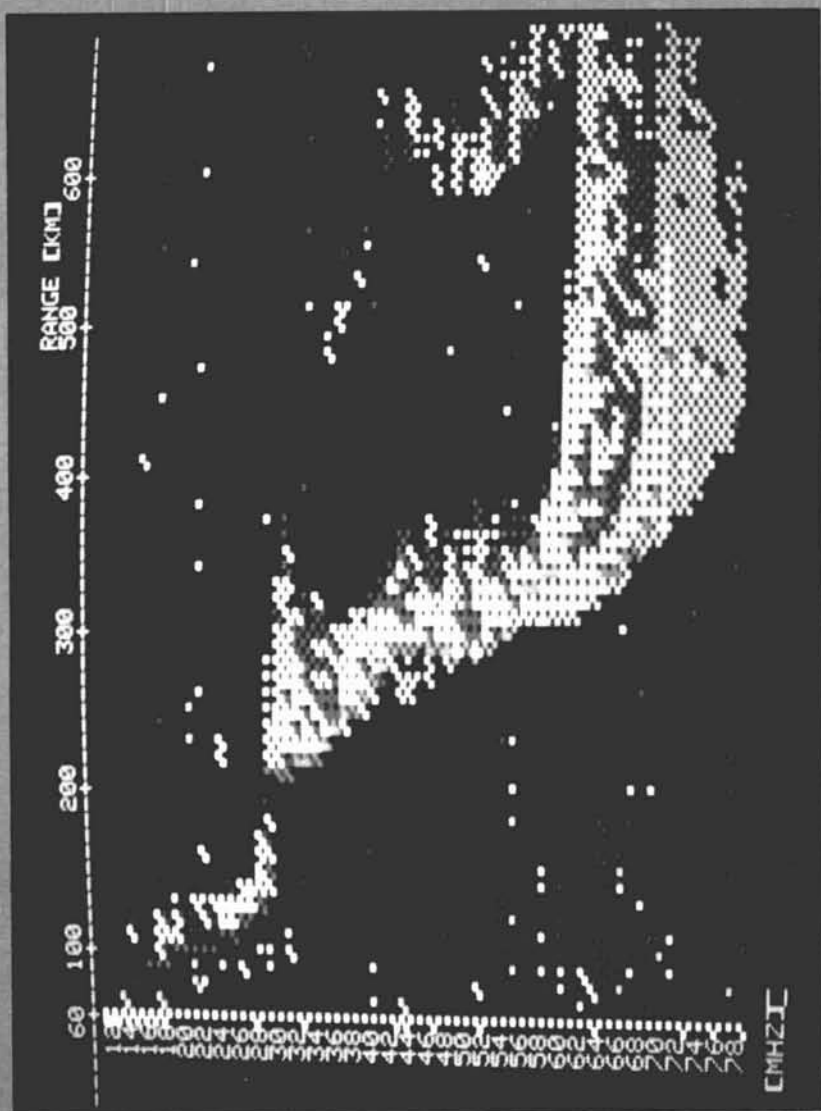

PROBING THE IONOSPHERE:
DIGITAL IONOSONDES

IC-271H

Now a 100 Watt, 2 Meter Base!



For the ultimate in two-meter communications, ICOM presents the IC-271H transceiver with a high dynamic range receiver and a 100 watt transmitter. Operating from the IC-PS30, IC-PS15, or the internal IC-PS35 (optional), the IC-271H brings all the advanced functions of the latest CPU controlled radios to your shack.

100 Watts. Now a two-meter base station with 100 watts of internal power! The IC-271H provides all the power required for operation from remote places to repeaters, or for simplex.

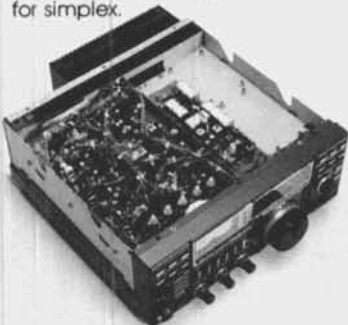

IC-PS30
Power Supply

Subaudible Tones.

Included as a standard feature are 32 built-in subaudible tones which are easily selected by rotating the main tuning knob. PL tones may be stored into memory.

32 Full-Function Memories.

Each tunable memory holds frequency, offset, offset direction, mode and subaudible tone. Each parameter is selected by rotating the main tuning knob in conjunction with the switches on the front panel.

PLL Locked at 10Hz. An extremely low-noise, professional receiver and a good signal-to-noise ratio PLL allows the IC-271H's synthesizer to lock to 10Hz providing receiver performance unparalleled by any other VHF receiver.

Fluorescent Display. ICOM's high-visibility, multicolor display gives easy-to-read display of all information necessary for logging a contact. Frequency, mode, duplex, offset direction, RIT frequency, memory channel and PL tone can be displayed.

Scanning. The IC-271H can scan memories and programmed sections of the band or modes. Mode-S scan can be used to scan only memories with a particular mode or lock out frequencies continuously busy so the receiver will not stop at that memory channel while scanning.

Other Standard Features. To facilitate the operation of the IC-271H, ICOM has incorporated a duplex check switch, all-mode squelch, receive audio tone control, S-meter, center meter, seven-year lithium battery memory backup, accessory connector and microphone.

Optional Features. IC-271H options are: switchable preamplifier, CTCSS encoder/decoder (encoder is standard), computer interface and voice synthesizer.

Size. Only 11¼ inches wide by 4½ inches high, the IC-271H is styled to look good and engineered for ease of operation.



IC-271H
Shown with internal
power supply IC-PS35

The IC-271A. The IC-271A with 25 watt output is available and has the same features as the IC-271H, plus an optional IC-PS25 internal power supply to make it a compact, go-anywhere two-meter base station. See the IC-271A(H) and other fine ICOM equipment at your ICOM dealer today.



ICOM

The World System

The Digital vs. Analog battle is over.

\$85* buys you the new champion. **The new Fluke 70 Series.**

They combine digital and analog displays for an unbeatable two-punch combination.

Now, digital users get the extra resolution of a 3200-count LCD display.

While analog users get an analog bar graph for quick visual checks of continuity, peaking, nulling and trends.

Plus unparalleled operating ease, instant autoranging, 2,000+ hour battery life and a 3-year warranty.

All in one meter.

Choose from three new models. The Fluke 73, the ultimate in simplicity. The feature-packed Fluke 75. Or the deluxe Fluke 77, with its own multipurpose protective holster and unique "Touch Hold" function (patent pending) that captures and holds readings, then beeps to alert you.

Each is Fluke-tough to take a beating. American-made, to boot. And priced to be, quite simply, a knockout.

For your nearest distributor or a free brochure, call toll-free anytime **1-800-227-3800,**

Ext. 229. From outside U.S., call 1-402-496-1350, Ext. 229.

FROM THE WORLD LEADER
IN DIGITAL MULTIMETERS.



Fluke 73

\$67*

Analog/digital display.
With 100mA, 10A decade test.

Autorange.

0.5% basic dc accuracy.

2000+ hour battery life.

3-year warranty.



Fluke 75

\$79*

Analog/digital display.
With 100mA, 10A decade test.

Audible continuity.

Autorange/zero hold.

0.5% basic dc accuracy.

2000+ hour battery life.

3-year warranty.



Fluke 77

\$79*

Analog/digital display.
With 100mA, 10A decade test.

Audible continuity.

"Touch Hold" function.

Audible zero hold.

0.5% basic dc accuracy.

2000+ hour battery life.

3-year warranty.

Multipurpose holster.

*Suggested U.S. list price when available. ©1993

FLUKE

TS-930S

"DX-traordinary"... superior dynamic range, auto. antenna tuner, QSK, dual NB, 2 VFO's, general coverage receiver.

A superlative, high-performance, all solid-state HF transceiver, that covers all Amateur HF bands, and incorporates a 150 kHz to 30 MHz general coverage receiver having an excellent dynamic range.

TS-930S FEATURES:

- 160-10 Meters, with 150 kHz-30 MHz general coverage receiver. Covers all Amateur frequencies, plus WARC, on SSB, CW, FSK, and AM. UP conversion digital PLL circuit.
- Excellent receiver dynamic range. Typical two-tone dynamic range, 100 dB (20 meters, 50-kHz spacing, 500 Hz CW bandwidth).
- All solid-state 28 volt operated final amplifier. Lowest IM distortion. Power input 250 W on

SSB/CW/FSK, 80 W on AM, SWR/ Power meter.

- Available with AT-930 automatic antenna tuner built-in, or as an option. Covers 80-10 meters, including WARC bands.
- CW full break-in. CMOS logic IC, plus reed relay. Switchable to semi break-in.
- Dual digital VFO's, 10-Hz steps, includes band information.
- Eight memory channels. Stores frequency and band data. Internal battery memory back-up, est. 1 yr. life. (Battery not Kenwood supplied.)
- Dual mode noise blanker. NB-1, with threshold control, for "pulse" noise. NB-2 for "woodpecker."
- SSB IF slope tuning, allows independent adjustment of the low and/or high frequency slopes of the IF passband.
- CW VBT and pitch control. VBT tunes out interfering signals, CW pitch control shifts IF pass-band and beat frequency. "Narrow-Wide" filter switch.
- Tuneable, peak-type audio filter for CW.
- AC power supply built-in.
- Fluorescent tube digital display (100 Hz resolution, modifiable to 10 Hz) with digitalized sub-scale, in 20-kHz steps.
- RF speech processor.
- One year limited warranty.

• SSB monitor circuit.

Optional Accessories:

- AT-930 Auto. antenna tuner.
- SP-930 External speaker with selectable audio filters.
- YG-455C-1 (500 Hz) or YG-455CN-1 (250 Hz) plug-in CW filters for 455 kHz IF.
- YK-88C-1 (500 Hz) CW plug-in filter for 8.83 MHz IF.
- YK-88A-1 (6 kHz) AM plug-in filter for 8.83 MHz IF.
- SO-1 commercial grade TCXO.
- MC-42S UP/DOWN hand mic.
- MC-60A deluxe desk mic.
- MC-80 desk top UP/DOWN mic.
- MC-85 multi-function desk mic.



TS-430S

"Digital DX-terity"... General coverage, Superior dynamic range, 2 VFO's, 8 memories, Scan, Notch, COMPACT!

Combines compact styling with state-of-the-art circuit design and performance.

TS-430S FEATURES:

- 160-10 meters, with 150 kHz-30 MHz general coverage receiver. Covers all Amateur frequencies, plus WARC. UP-conversion digital PLL circuit.
- USB, LSB, CW, AM, and FM (optional) all mode.
- Compact lightweight design. Only 10-5/8 (270) W x 3-3/4 (96) H x 10-7/8 (275) D, inches (mm); only 14.3 lbs. (6.5 kg.).
- Superior receiver dynamic range with Dyna-Mix high sensitivity direct mixing system.

- 10-Hz step dual digital VFO's. Operate independently, include band and mode information. Dial torque adjustable. Step switch for 10-Hz or 100-Hz steps. A-B switch shifts "B" VFO to "A" VFO frequency and mode, or vice versa. VFO LOCK switch. RIT for VFO or memory. UP/DOWN manual scan with optional UP/DOWN microphone.
- Eight memories store frequency, mode, and band data. 8th memory stores RX/TX frequencies independently.
- Lithium battery memory back-up. (Est. 5 yr. life.)
- Memory Scan.
- Programmable automatic band scan width.
- IF shift circuit for minimum QRM.
- Tuneable notch filter, built-in.
- Narrow-wide filter selection on SSB and CW (filter optional).
- Speech processor, built-in.
- All solid state. Input rated 250 W PEP on SSB, 200 W DC on CW, 120 W on FM (optional), 60 W on AM. Operates on 12 VDC or on 120 VAC, or 220/240 VAC with optional PS-430 AC power supply.
- Fluorescent tube digital display indicates frequency to 100 Hz (10 Hz modifiable).
- All-mode squelch circuit, built-in.
- Built-in noise blanker.
- RF attenuator (20 dB).
- VOX circuit, plus semi break-in with side-tone.

Optional accessories:

- PS-430, PS-30 or KPS-21 AC power supplies.
- SP-430 external speaker.
- MB-430 mobile mounting bracket.
- AT-250 automatic antenna tuner, 160-10 m, incl. WARC.
- AT-130 compact antenna tuner, 80-10 m, incl. WARC.
- FM-430 FM unit.
- YK-88C (500 Hz) or YK-88CN (270 Hz) CW filters.
- YK-88SN (1.8 kHz) SSB filter.
- YK-88A (6 kHz) AM filter.
- MC-42S UP/DOWN hand mic.
- MC-55 (8P) mobile mic.
- MC-60A deluxe desk mic.
- MC-80 desk top UP/DOWN mic.
- MC-85 multi-function desk mic.

KENWOOD

TRIO-KENWOOD COMMUNICATIONS

1111 West Walnut, Compton, California 90220

ham radio

magazine

DECEMBER 1983

volume 16, number 12

T. H. Tenney, Jr., W1NLB
publisher

Rich Rosen, K2RR
editor-in-chief
and associate publisher

Dorothy Rosa Leeds
assistant editor

editorial staff

Alfred Wilson, W6NIF
Joseph J. Schroeder, W9JUV
Leonard H. Anderson
associate editors

Susan Shorrock
editorial production

Cover photo:
Bodo W. Reinisch

publishing staff

J. Craig Clark, Jr., N1ACH
assistant publisher

Rally Dennis, KA1JWF
director of advertising sales

Dorothy Sargent, KA1ZK
advertising production manager

Susan Shorrock
circulation manager

Therese Bourgault
circulation

ham radio magazine
is published monthly by
Communications Technology, Inc
Greenville, New Hampshire 03048-0488
Telephone: 603-878-1441

subscription rates

United States: one year, \$19.50
two years, \$32.50; three years, \$42.50

Canada and other countries (via Surface Mail)
one year, \$21.50; two years, \$40.00
three years, \$57.00

Europe, Japan, Africa (via Air
Forwarding Service) one year, \$28.00

All subscription orders payable in
United States funds, please

foreign subscription agents

Foreign subscription agents are
listed on page 125

Microfilm copies
are available from
University Microfilms, International
Ann Arbor, Michigan 48106
Order publication number: 3076

Cassette tapes of selected articles
from *ham radio* are available to the
blind and physically handicapped
from Recorded Periodicals
919 Walnut Street, 8th Floor
Philadelphia, Pennsylvania 19107

Copyright 1983 by
Communications Technology, Inc.
Title registered at U.S. Patent Office

Second-class postage
paid at Greenville, N. H. 03048-0488
and at additional mailing offices
ISSN 0148-6588

Postmaster send Form 3579 to *ham radio*
Greenville, New Hampshire 03048-0488



contents

14 digital ionosondes

Rich Rosen, K2RR

21 state-of-the-art auto-dialer

Alan Lefkow, K2MWU

**31 time and frequency standards:
part 2**

Vaughn D. Martin

**42 when hazardous waste comes home:
PCBs in the ham shack**

Dorothy Rosa Leeds

**52 photovoltaic cells:
a progress report**

Paul J. DeNapoli, WD8AHO

**59 vertical phased arrays:
part 5**

Forrest Gehrke, K2BT

**73 lightning and electrical
transient protection**

Bradley Wells, KR7L

81 ham radio techniques

Bill Orr, W6SAI

**87 the weekender:
2-meter weather converter**

Ladimer S. Nagurney, WA3EEC

111 cumulative index: 1979 — 1983

- | | |
|---|--------------------------|
| 134 advertisers index
and reader service | 96 ham notebook |
| 10 comments | 97 new products |
| 92 DX forecaster | 6 presstop |
| 125 flea market | 97 product review |
| 128 ham mart | 4 reflections |
| | 11 short circuits |

REFLECTIONS
REFLECTIONS

*We couldn't think of a nicer way to
end the year than with a wish for peace
— at least on the airwaves.*

*Best wishes for a joyous holiday
season from the "Skipper" and crew
of ham radio magazine.*

MFJ RTTY / ASCII / CW COMPUTER INTERFACE

Lets you send and receive computerized RTTY/ASCII/CW. Copies all shifts and all speeds. Copies on both mark and space. Sharp 8 Pole active filter for 170 Hz shift and CW. Plugs between your rig and VIC-20, Apple, TRS-80C, Atari, TI-99, Commodore 64 or most other personal computers. Uses MFJ, Kantronics software and most other RTTY/CW software.

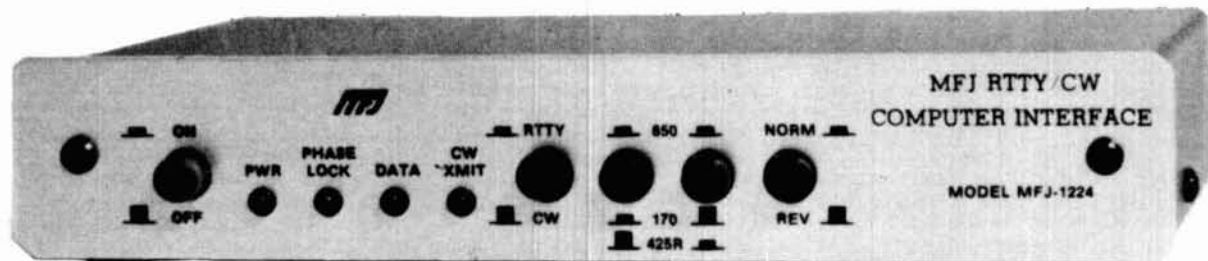

NEW!

MFJ Software plus MFJ Interface for VIC-20 or Commodore 64

(Software cartridge alone, \$49.95.
Order MFJ-1250 for VIC-20.
MFJ-1251 for Commodore 64)

\$129⁹⁵

Powerful RTTY/ASCII/CW software for VIC-20, Commodore 64.
Developed by MFJ. Cartridge plugs into expansion port.
Features split screen display, type ahead buffer, message ports,
RTTY/ASCII/CW send and receive plus much more.
Includes cable to interface MFJ-1224 to VIC-20 or Commodore 64.

\$ 99⁹⁵
MFJ-1224

This new MFJ-1224 RTTY/ASCII/CW Computer Interface lets you use your personal computer as a computerized full featured RTTY/ASCII/CW station for sending and receiving.

It plugs between your rig and your VIC-20, Apple, TRS-80C, Atari, TI-99, Commodore 64, and most other personal computers.

Powerful MFJ software available for VIC-20 (MFJ-1250, \$49.95) and Commodore 64 (MFJ-1251, \$49.95). Features split screen display, type ahead buffer, message ports, RTTY/ASCII/CW send and receive plus more.

Uses Kantronics software for Apple, TRS-80C, Atari, TI-99 as well as VIC-20 and Commodore 64.

You can also use most other RTTY/CW software with nearly any personal computer.

A 2 LED tuning indicator system makes tuning fast, easy and positive. You can distinguish between RTTY/CW without even hearing it.

Once tuned in, the interface allows you to copy any shift (170, 425, 850 Hz and all shifts between and beyond) and any speed (5 to 100 WPM on RTTY/CW and up to 300 baud on ASCII).

Copies on both mark and space, not mark only or space only. This greatly improves copy under adverse conditions.

A sharp 8 pole active filter for 170 Hz shift and CW allows good copy under crowded, fading and weak signal conditions.

An automatic noise limiter helps suppress static crashes for better copy.

A Normal/Reverse switch eliminates retuning while stepping thru various RTTY speeds and shifts.

The demodulator will even maintain copy on a slightly drifting signal.

A +250 VDC loop output is available to drive your RTTY machine. Has convenient speaker output jack.

Phase continuous AFSK transmitter tones are generated by a clean, stable Exar 2206 function generator. Standard space tones of 2125 Hz and mark tones of 2295 and 2975 Hz are generated. A set of microphone lines is provided for AFSK out, AFSK ground, PTT out and PTT ground.

FSK keying is provided for transceivers with FSK.

High voltage grid block and direct outputs are provided for CW keying of your transmitter. A CW transmit LED provides visual indication of CW transmission. There is also an external hand key or electronic keyer input jack.

In addition to the Kantronics compatible socket, an exclusive general purpose socket allows interfacing to nearly any personal computer with most appropriate software. The following TTL compatible lines are available: RTTY demod out, CW demod out, CW-ID input, +5 VDC, ground. All signal lines are buffered and can be inverted using an internal DIP switch.

For example, you can use Galo software with Apple computers, RAK software with VIC-20's, or Clay Abrams software with TRS-80C, N4EU software with TRS-80 III, IV. Some computers with some software may require some external components.

DC voltages are IC regulated to provide stable

AFSK tones and RTTY/ASCII/CW reception.

Aluminum cabinet. Brushed aluminum front panel. 8x1 1/4x6 inches. Uses 12-15 VDC or 110 VAC with optional adapter, MFJ-1312, \$9.95.

MFJ-1223, \$29.95, RS-232 adapter for MFJ-1224.

RTTY/ASCII/CW Receive Only SWL Computer Interface



\$ 69⁹⁵
MFJ-1225

Use your personal computer to receive commercial, military and amateur RTTY/ASCII/CW traffic.

The MFJ-1225 automatically copies all shifts (850, 425, 170 Hz shift and all others) and all speeds.

It plugs between your receiver and VIC-20, Apple, TRS-80C, Atari, TI-99, Commodore 64 and most other personal computers.

Use MFJ-1250 (\$49.95) software cartridge for VIC-20 or MFJ-1251 (\$49.95) software cartridge for Commodore 64. Use Kantronics software for Apple, TRS-80C, Atari and TI-99.

An automatic noise limiter helps suppress static crashes for better copy, while a simple 2 LED tuning indicator system makes tuning fast, easy and positive.

In addition to the Kantronics compatible socket, a general purpose socket provides RTTY out, RTTY inverted out, CW out, CW inverted out, ground and +5VDC for interfacing to nearly any personal computer with most appropriate software.

Audio in, speaker out jacks. 4 1/2x1 1/4x4 1/4 in. 12-15 VDC or 110 VAC with adapter, MFJ-1312, \$9.95.

ORDER ANY PRODUCT FROM MFJ AND TRY IT-NO OBLIGATION. IF NOT DELIGHTED, RETURN WITHIN 30 DAYS FOR PROMPT REFUND (LESS SHIPPING).

- One year unconditional guarantee • Made in USA.
- Add \$4.00 each shipping/handling • Call or write for free catalog, over 100 products.

MFJ

MFJ ENTERPRISES, INC.
Box 494, Mississippi State, MS 39762

TO ORDER OR FOR YOUR NEAREST DEALER, CALL TOLL-FREE

800-647-1800. Call
601-323-5869 in Mississippi and out-
side continental U.S.A. Telex 53-4590.



AN UNPRECEDENTED FCC-AMATEUR ANTI-INTERFERENCE PROJECT was kicked off in Chicago October 19 by the FCC Chicago Field Office. Introduced to about 70 area repeater representatives by the plan's originator, new Chicago Engineer-in-Charge Joe Monie, WB0PAW, the "unconventional approach" program will be conducted strictly on a trial basis to see if such FCC-Amateur cooperation is workable. Though strictly local in scope, the project is being conducted with the knowledge and agreement of appropriate FCC Washington bureaus.

Initial Thrust Of The Experiment Is Against Intentional Interference to area 2-meter repeaters. Several Chicago-area machines have long been plagued by this problem, and the project was initially conceived in response to their specific difficulties. All liaison between FCC and participating Amateurs will be conducted under strict guidelines, with very specific criteria as to what types of information will be acceptable for FCC use in hunting down and eliminating interfering stations.

Reaction To The Proposed Program Was Quite Positive, with some urging that its scope should eventually be expanded to cover other kinds of interference and other bands. If it is successful Monie feels that it could also be adopted by other FCC Field Offices as well. Though at this time the project is not a part of the long-planned Amateur-FCC enforcement program made possible by the Goldwater Communications Act rewrite bill, it could well become a significant aspect of it if the project does prove workable.

A Fringe Benefit Of The FCC-Sponsored Meeting was the reactivation of the long-dormant Illinois Repeater Council. All Illinois repeaters should contact WD9GMZ to register their interest in participating in future IRC activities.

GRENADA'S POLITICAL UPHEAVAL WAS GRAPHICALLY BROUGHT HOME to listening Amateurs by KA2ORK/J3A, a student at St. George's University School of Medicine, who came on shortly after military operations began early October 25. Though Mark was able to confirm no U.S. medical students on the island appeared to be casualties, he reported both artillery and small arms fire plus frequent overflights of helicopter gunships and other military aircraft. Sometimes operating while prone on the floor of his shack to avoid possible stray bullets, he and J37AH provided the only real-time reports of the invasion action.

Interested Amateurs Were Joined By Other Amateur Stations with inputs to various government agencies and news media on 14250, 14303, 21300, 21309, and 21375. Many found themselves featured on TV and radio, as normal news sources were unavailable.

STS-9'S OCTOBER 28 LAUNCH WAS SCRUBBED due to severe erosion of launch vehicle rocket nozzles, with consequent delay in W5LFL's operation from space. Though an alternate date of November 28 seems probable at press time, it's also possible that the nozzle problem or other considerations might further delay the STS-9 launch to February 22.

Unfortunately, Limitations On W5LFL's Operating May Be Much Greater than originally expected. Unless the mission's operating schedule is changed, only nine orbits will have the proper combination of spaceship orientation and W5LFL's free time to put his signal into the U.S. In addition, most of these orbits favor the east coast. Unless there's a further change, he'll be active on orbits 49, 56 (descending), 64, 80, 96, 112, 113, and 129. It's also possible that he may be able to operate during some additional orbits, or that the radiation pattern from the spaceship may permit contacts even when his window antenna is oriented away from the earth. Check the phone numbers in November Presstop for updates, but note that Westlink's number for STS-9 news is now 213-465-1500.

THE 10-YEAR AMATEUR LICENSE BECAME A REALITY OCTOBER 6, when the Commissioners acted favorably on PR Docket 83-337. At the same time they also extended the grace period for station license renewal from one year to two (operator licenses already are five years).

Current Licenses Will Not Automatically Be Extended. Instead 10-year licenses will be phased in with renewals. Just when the new 10-year licenses will actually begin to be issued depends on when new computer programs can be implemented.

TECHNICIANS MAY RUN FOR ARRL OFFICE, League directors decided at their fall meeting in Houston. The previous requirement was for candidates to be General Class or higher.

FCC's Volunteer Exam Program Was Endorsed By The Directors in a unanimous resolution, which also specified, however, that League participation in the program would commence only "...upon governmental authorization for recoupment of VEC expenses..."

220 MHz CONTINUES TO ATTRACT POTENTIAL USERS, with Waterway Communications System, Inc., pushing its FCC Petition for Rule Making (RM-4560) for a dedicated inland waterways band from 216 to 220 MHz. In addition, the FCC's Private Radio Bureau has also issued a "Final Report" on a study by its planning staff on future land-mobile needs that urges "Reallocation of 2 MHz from the 216-225 MHz band to the private land-mobile radio services for narrowband systems using 5 kHz spacing." RM-4560 is being strongly opposed by the Association of Maximum Service Telecasters because of possible channel 13 interference.

The 420-450 MHz Band May Also Be Hearing More Non-Amateur QRM soon. Westlink reports that Hughes Aircraft has a new contract for a military "Position Location and Reporting System" in that band for use by the Army and Marine Corps.

WELZ



SP-600

SP-600

Select 1 of 3 sensors by soft touch switch. Three wide bandwidth sensors cover 1.6-500MHz. **\$159.00**
RS-1: 1.6-60MHz 0-2kW RS-2: 1.6-150MHz 0-200W RS-3: 130-500MHz 0-200W

SP-200

Two position antenna switch and indicators. Three power ranges to 1kW, 1.8-160MHz. **\$107.00**

SP-400

Three band sensors (2m, 220, 450MHz), 10 percent accuracy, 0-150W CW, LED power range indicators. **\$109.00**

Distributed by

Encomm, Inc.

2000 Avenue G, Suite 800, Plano, Texas 75074

Phone (214) 423-0024 TLX 79-4783 ENCOMM DAL

WELZ

DUMMY LOADS



CT-300

Oil-less aircooled, 1kW peak for 3 min., 300W avg. DC-250MHz **\$68.00**

CT-150

Oil-less aircooled, 400W peak for 3 min., 150W avg. DC-250MHz **\$46.00**



CT-15A

50W peak, 15W avg. SO-239 Screw-on dummy DC-500MHz, VSWR < 1:1.2 **\$12.00**

CT-15N

50W peak, 15W avg., Type N Dummy Load. DC-500MHz, VSWR < 1:1.1 **\$21.00**



SURGE SUPPRESSOR



CA-35A

Contains replaceable, chip-type surge voltage protector. Low loss, low VSWR. DC-500MHz, 350V breakdown. **\$22.00**

COAXIAL SWITCH

CH-20N

Two-way coaxial switch. SO-239 type connector. DC-900MHz, 1kW power. **\$54.00**



TERMINATION POWER METERS



TP-05X

BNC connector, 5W talkie checker. Field calibratable, 3W avg. Dummy Load, 1W center. 50-500MHz. **\$21.00**

TP-25A

25 watt version of TP-05X for mobile use. Larger Dummy Load. 50-500MHz. **\$40.00**



All prices are suggested retail and subject to change.

Distributed by

Encomm, Inc.

2000 Avenue G, Suite 800, Plano, Texas 75074

Phone (214) 423-0024 TLX 79-4783 ENCOMM DAL

WELZ

SP-250



SWR & POWER METERS

SP-250

Low-profile, economy 2kW wattmeter. 1.6-60MHz bandwidth. 3W SWR sensitivity. Three ranges. A Best Buy! **\$75.00**

SP-15M

1.8-150MHz, 200 watt, low-profile wattmeter. VSWR, FWD PWR, REF PWR, 1.5W SWR sensitivity. Great for mobile HF. **\$60.00**

SP-45M

VHF-UHF to 100 watts. 3W sensitivity for SWR, 10 percent accuracy. All metal shielded construction. **\$85.00**

Distributed by

Encomm, Inc.

2000 Avenue G, Suite 800, Plano, Texas 75074

Phone (214) 423-0024 TLX 79-4783 ENCOMM DAL

RAMSEY

THE FIRST NAME IN ELECTRONIC TEST GEAR



NEW FROM RAMSEY 20 MHz DUAL TRACE OSCILLOSCOPE

Unsurpassed quality at an unbeatable price, the Ramsey oscilloscope compares to others costing hundreds more. Features include a component testing circuit that will allow you to easily test resistors, capacitors, digital circuits and diodes • TV video sync filter • wide bandwidth & high sensitivity • internal graticule • high quality rectangular CRT • front panel trace rotator • Z axis • high sensitivity x-y mode • very low power consumption • regulated power supply • built-in calibrator • rock solid triggering • high quality hook-on probes

\$399.95 high quality hook-on probes included



RAMSEY D-1100 VOM-MULTITESTER

Compact and reliable, designed to service a wide variety of equipment. Features include • mirror back scale • double-jeweled precision moving coil • double overload protection • an ideal low cost unit for the beginner or as a spare back-up unit.

\$19.95

test leads and battery included



RAMSEY D-2100 DIGITAL MULTITESTER

A compact easy to use unit designed to operate like a pro. Featuring • 3 1/2 digit LCD • low BAT indicator • all range overload protection • overrange indication • auto-polarity • transistor tester • dual-slope integration • vinyl carrying case

\$54.95

HF test leads, battery & vinyl carrying case included

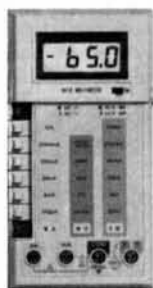

RAMSEY D-3100 DIGITAL MULTIMETER

Reliable, accurate digital measurements at an amazingly low cost • in-line color coded push buttons, speeds range selection • abs plastic tilt stand • recessed input jacks • overload protection on all ranges • 3 1/2 digit LCD display with auto zero, auto polarity & low BAT. indicator

\$59.95

test leads and battery included



CT-70 7 DIGIT 525 MHz COUNTER

Lab quality at a breakthrough price. Features • 3 frequency ranges each with pre amp • dual selectable gate times • gate activity indicator • 50mV @ 150 MHz typical sensitivity • wide frequency range • 1 ppm accuracy

\$119.95

wired includes AC adapter

CT-70 kit \$99.95
BP-4 nicad pack 8.95



CT-90 9 DIGIT 600 MHz COUNTER

The most versatile for less than \$300. Features 3 selectable gate times • 9 digits • gate indicator • display hold • 25mV @ 150 MHz typical sensitivity • 10 MHz timebase for WWV calibration • 1 ppm accuracy

\$149.95

wired includes AC adapter

CT-90 kit \$129.95
OV-1 0.1 ppm Oven Time base 59.95
BP-4 nicad pack 8.95



CT-125 9 DIGIT 1.2 GHz COUNTER

A 9 digit counter that will outperform units costing hundreds more. • gate indicator • 24mV @ 150 MHz typical sensitivity • 9 digit display • 1 ppm accuracy • display hold • dual inputs with preamps

\$169.95

wired includes AC adapter

CT-125 kit \$149.95
BP-4 nicad pack 8.95



CT-50 8 DIGIT 600 MHz COUNTER

A versatile lab bench counter with optional receive frequency adapter, which turns the CT-50 into a digital readout for most any receiver • 25 mV @ 150 MHz typical sensitivity • 8 digit display • 1 ppm accuracy

\$169.95

wired

CT-50 kit \$139.95
RA-1 receiver adapter kit 14.95



DM-700 DIGITAL MULTIMETER

Professional quality at a hobbyist price. Features include 26 different ranges and 5 functions • 3 1/2 digit, 1/2 inch LED display • automatic decimal placement • automatic polarity

\$119.95

wired includes AC adapter

DM-700 kit \$99.95
MP-1 probe set 4.95



PS-2 AUDIO MULTIPLIER

The PS-2 is handy for high resolution audio resolution measurements, multiplies UP in frequency • great for PL tone measurements • multiplies by 10 or 100 • 0.01Hz resolution & built-in signal preamp/conditioner

\$49.95

wired includes AC adapter

PS-2 kit \$39.95



PR-2 COUNTER PREAMP

The PR-2 is ideal for measuring weak signals from 10 to 1,000 MHz • flat 25 db gain • BNC connectors • great for sniffing RF • ideal receiver/TV preamp

\$44.95

wired includes AC adapter

PR-2 kit \$34.95



PS-1B 600 MHz PRESCALER

Extends the range of your present counter to 600 MHz • 2 stage preamp • divide by 10 circuitry • sensitivity: 25mV @ 150 MHz • BNC connectors • drives any counter

\$59.95

wired includes AC adapter

PS-1B kit \$49.95

ACCESSORIES FOR RAMSEY COUNTERS

Telescopic whip antenna—BNC plug \$ 8.95
High impedance probe, light loading 16.95
Low pass probe, audio use 16.95
Direct probe, general purpose use 13.95
Tilt ball, for CT-70, 90, 125 3.95



PHONE ORDERS CALL
716-586-3950

TELEX 466735 RAMSEY CI

TERMS: • satisfaction guaranteed • examine for 10 days; if not pleased return in original form for refund • add 6% for shipping and insurance to a maximum of \$10.00 • overseas add 15% for surface mail • COD add \$2.50 • orders under \$10.00 add \$1.50 • NY residents add 7% sales tax • all kits have a 90 day parts warranty. All wired units have 1 year parts and labor warranty.

RAMSEY

RAMSEY ELECTRONICS, INC.
2575 Baird Rd., Dept. HR
Penfield, N. Y. 14526

We now have available a bunch of goodies too good to bypass. Items are limited so order today.

2575 Baird Rd.
Penfield, NY 14526
716-586-3950

MINI KITS - YOU HAVE SEEN THESE BEFORE NOW HERE ARE OLD FAVORITE AND NEW ONES TOO. GREAT FOR THAT AFTERNOON HOBBY.

FM MINI MIKE

A super high performance FM wireless mike kit! Transmits a stable signal up to 300 yards with exceptional audio quality by means of its built in electret mike. Kit includes case, mike on-off switch, antenna, battery and super instructions. This is the finest unit available.

FM-3 Kit **\$14.95**
FM-3 Wired and Tested **19.95**

Color Organ

See music come alive! 3 different lights flicker with music. One light each for high, mid-range and lows. Each individually adjustable and drives up to 300 W. runs on 110 VAC.

Complete kit.
ML-1 **\$8.95**

Video Modulator Kit
Converts any TV 10 video monitor. Super stable, tunable over ch. 4-6. Runs on 5-15V. accepts sid video signal. Best unit on the market! Complete kit VD-1 **\$7.95**

Led Blinky Kit
A great attention getter which alternately flashes 2 jumbo LEDs. Use for name badges, buttons, warning panel lights, anything! Runs on 3 to 15 volts. Complete kit BL-1 **\$2.95**

Super Sleuth
A super sensitive amplifier which will pick up a pin drop at 15 feet! Great for monitoring baby's room or as general purpose amplifier. Full 2 W rms output, runs on 6 to 15 volts, uses 8-45 ohm speaker. Complete kit BN-9 **\$5.95**

CPO-1
Runs on 3-12 Vdc. 1 watt out. 1 KHZ good for CPO. Alarm, Audio Oscillator. Complete kit **\$2.95**

FM Wireless Mike Kit

Transmits up to 300' to any FM broadcast radio, uses any type of mike. Runs on 3 to 9V. Type FM-2 has added sensitive mike preamp stage.

FM-1 kit **\$3.95** FM-2 kit **\$4.95**

Whisper Light Kit

An interesting kit, small mike picks up sounds and converts them to light. The louder the sound, the brighter the light. Includes mike, controls up to 300 W. runs on 110 VAC. Complete kit WL-1 **\$6.95**

Tone Decoder

A complete tone decoder on a single PC board. Features 400-5000 Hz adjustable range via 20 turn pot. voltage regulation. 567 IC. Useful for touch-tone burst detection, FSK, etc. Can also be used as a stable tone encoder. Runs on 5 to 12 volts. Complete kit TD-1 **\$5.95**

Universal Timer Kit

Provides the basic parts and PC board required to provide a source of precision timing and pulse generation. Uses 555 timer IC and includes a range of parts for most timing needs. UT-5 Kit **\$5.95**

Mad Blaster Kit

Produces LOUD ear shattering and attention getting siren like sound. Can supply up to 15 watts of obnoxious audio. Runs on 6-15 VDC. MB-1 Kit **\$4.95**

Siren Kit

Produces upward and downward wail characteristic of a police siren. 5 W peak audio output, runs on 3-15 volts, uses 3-45 ohm speaker. Complete kit SM-3 **\$2.95**

50 Hz Time Base
Runs on 5-15 VDC. Low current. 2.5 mA. 1 min. output. All circuitry on TR-7 Kit. TR-7 Assy **\$5.50**
TR-7 Kit **\$9.95**

CLOCK KITS

Your old favorites are here again. Over 7,000 Sold to Date. Be one of the gang and order yours today!



Try your hand at building the finest looking clock on the market. Its satin finish anodized aluminum case looks great anywhere, while six 4" LED digits provide a highly readable display. This is a complete kit, no extras needed, and it only takes 1-2 hours to assemble. Your choice of case colors: silver, gold, black (specify).
Clock kit, 12/24 hour, DC-5 **\$24.95**
Clock with 10 min. ID timer, 12/24 hour, DC-10 **\$29.95**

For wired and tested clocks add \$10.00 to kit price. SPECIFY 12 OR 24 HOUR FORMAT

SATELLITE TV KIT

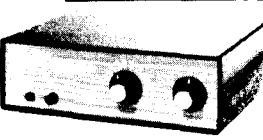

image rejection, fully tunable audio to recover "hidden" subcarriers, divide by two PLL demodulator for excellent threshold performance, light tracking AFC to assure drift free reception, and of course, full 24 channel tunable coverage.

Build your satellite TV system around the R2B, close to ten thousand others already have and now it's available in kit form at a new low price. Order yours today.

THE POPULAR SAT-TEC RECEIVER IN KIT FORM!

NEW, LOWER PRICES!

Featured in a Radio Electronics magazine cover story (May 82), the reliable R2B Satellite TV receiver is now operating in thousands of locations. The R2B is easy to build, pre-etched, plated boards with screened component layout assures accurate component placement and the critical IF section and local oscillator are pre-assembled and aligned! All parts are included for the R2B, attractive case, power supply, descriptive operating manual as well as complete assembly instructions. Features of the receiver include: dual conversion design for best

A complete Satellite TV System requires a dish antenna, LNA (low noise amplifier), Receiver and Modulator.
R2B Receiver Kit **\$295.00**
R2B Receiver, Wired and Tested **\$395.00**
120" K. LNA **\$265.00**
RM3RF Modulator **\$49.95**
Prices include domestic UPS shipping and insurance.

PARTS PARADE

IC SPECIALS

LINEAR

301	\$.35
324	\$1.50
380	\$1.50
555	\$.45
556	\$1.00
565	\$1.00
566	\$1.00
567	\$1.25
741	10/\$2.00
1458	\$.50
3900	\$.50
3914	\$.50
8038	\$2.95

TTL

74S00	\$ 4.40
7447	\$.65
7475	\$.50
7490	\$.50
74196	\$1.35

SPECIAL

11C90	\$15.00
10116	\$ 1.25
7208	\$17.50
7207A	\$ 5.50
7216D	\$21.00
7107C	\$12.50
5314	\$ 2.95
5375AB/G	\$ 2.95
7001	\$ 6.50

CMOS

4011	\$.50
4013	\$.50
4046	\$1.85
4049	\$.50
4059	\$.50
4511	\$9.00
4518	\$2.00
5639	\$1.35
	\$1.75

READOUTS

FND 359 4 C.C.	\$1.00
FND 507-510 S.C.A.	1.00
MAN 72/HP7730 33 C.A.	1.00
HP 7651 43 C.A.	2.00

TRANSISTORS

2N3904 NPN C-F	15/\$1.00
2N3906 PNP C-F	15/\$1.00
2N4403 NPN C-F	15/\$1.00
2N4410 NPN C-F	15/\$1.00
2N4916 FET C-F	4/\$1.00
2N5401 PNP C-F	5/\$1.00
2N5602 C-F	4/\$1.00
2N3771 NPN Silicon	\$1.50
2N5179 UHF NPN	3/\$2.00
Power Tab NPN 40W	3/\$1.00
Power Tab PNP 40W	3/\$1.00
MFF 102-2N5484	\$.50
NPN 3904 Type T-R	50/\$2.50
PNP 3904 Type T-R	50/\$2.50
2N3055	\$.80
2N2646 UJT	3/\$2.00

Diodes

5.1 V Zener	20/\$1.00
1N914 Type	50/\$1.00
1KV 2Amp	8/\$1.00
100V 1Amp	15/\$1.00

25 AMP 100V Bridge \$1.50 each

Mini-Bridge 50V 1 AMP 2 for \$1.00

Resistor Ass't

Assortment of Popular values. 1/2 watt. Cut lead for PC mounting. 1/4" center. 1/2" leads, bag of 300 or more. **\$1.50**

Switches

Mini toggle SPDT **\$1.00**
Red Pushbuttons N/O **3/\$1.00**

Earphones

3' leads, 8 ohm, good for small tone speakers, alarm clocks, etc. **5 for \$1.00**

Mini 8 ohm Speaker

Approx 2" diam Round type for radios, mike etc. **3 for \$2.00**

Slug Tuned Coils

Small 3/16" Hex Slugs turned coil. 3 turns **10 for \$1.00**

CAPACITORS

TANTALUM	ALUMINUM	DISK CERAMIC
Dipped Epoxy	Electrolytic	01 16V disk 20/\$1.00
1.5 uF 25V 3/\$1.00	1000 uF 16V Radial 50	1 16V 15/\$1.00
	500 uF 20V Axial 50	001 16V 20/\$1.00
	1.8 uF 25V 3/\$1.00	150 uF 16V Axial 5/10 20/\$1.00
	22 uF 25V 3/\$1.00	10 uF 15V Radial 10/\$1.00
		047 16V 20/\$1.00

DC-DC Converter

-5 vdc input prod. -9 vdc @ 30ma
-9 vdc produces -15 vdc @ 35ma **\$1.25**

25K 20 Turn Trim Pot

1K 20 Turn Trim Pot **\$1.50**

Crystal Microphone

Small 1" diameter 1/4" thick crystal/mike cartridge. **75¢**

Coax Connector

Chassis mount BNC type **\$1.00**

Parts Bag

Ass't of chokes, disc caps, tant. resistors, transistors, diodes, MICA caps etc. sm bag 1000 pcs **\$1.00** lg bag 3000 pcs **\$2.50**

Leads - your choice, please specify

Mini Red, Jumbo Red, High Intensity Red, Illuminator Red **8/\$1**
Mini Yellow, Jumbo Yellow, Jumbo Green **6/\$1**

Varactors

Motorola MV 2209 30 PF Normal cap 20-80 PF - Tunable range - **50 each or 3/\$1.00**

Crystals

3 579545 MHZ	\$1.50
10 00000 MHZ	\$5.00
5 248800 MHZ	\$5.00

AC Adapters

Good for clocks, nicad chargers, all 110 VAC plug one end.
8.5 vdc @ 20 mA **\$1.00**
15 vdc @ 160mA **\$2.50**
12 vdc @ 250mA **\$3.00**

Solid State Buzzers

small buzzer 450 Hz 86 dB sound output on 5-12 vdc at 10-30 mA TTL compatible. **\$1.50**

AC Outlet

Panel Mount with Leads **4/\$1.00**

Ceramic IF Filters

Min 1.5 MHz **\$1.50 ea.**

Trimmer Caps

Sprague - 3-40 pf Stable Polypropylene **50 ea.**

9 Volt Battery Clips

Nice quality clips **5 for \$1.00**
1/2" Rubber Grommets **10 for \$1.00**

Connectors

6 pin type gold contacts for mA-1003 car clock module price **.75 ea.**

Shrink Tubing Nubs

Nice precut pcs of shrink size 1" x 1/2" shrink to 1/4". Great for splices. **50/\$1.00**

Opto Isolators - 4N28 type

Opto Reflectors - Photo diode + LED **\$1.00 ea.**

Molex Pins

Molex already precut in length of 7 Perfect for 14 pin sockets. **20 strips for \$1.00**

CDS Photocells

Resistance varies with light. 250 ohms to over 3 meg **3 for \$1.00**

Audio Prescaler

Make high resolution audio measurements, great for musical instrument tuning, PL tones, etc. Multiplies audio UP in frequency, selectable x10 or x100, gives 01 HZ resolution with 1 sec gate time! High sensitivity of 25 mw. 1 meg input z and built-in filtering gives great performance. Runs on 9V battery, all CMOS. PS-2 kit **\$29.95**
Kit, PS-1B **\$39.95**

30 Watt 2 mtr PWR AMP

Simple Class C power amp features 8 times power gain. 1 W in for 8 out, 2 W in for 15 out, 4W in for 30 out. Max output of 35 W, incredible value, complete with all parts, less case and T-R relay. PA-1, 30 W pwr amp kit **\$22.95**
TR-1, RF sensed T-R relay kit **6.95**

MRF-238 transistor as used in PA-1

8-10db gain 150 mhz **\$11.95**

RF actuated relay senses RF (1W) and closes DPDT relay

For RF sensed T-R relay TR-1 Kit **\$6.95**

OP-AMP Special

BI-FET LF 13741 - Direct pin for pin 741 op amp but 500,000 MEG input z, super low 50 pa input current, power drain **50 for only \$9.00**

Regulators

78MG	\$1.25
79MG	\$1.25
723	\$.50
309K	\$1.15
7805	\$1.00

Mini TO-92 Heat Sinks

Thermalloy Brand To-220 Heat Sinks **5 for \$1.00**
3 for \$1.00

Opto Isolators - 4N28 type

Opto Reflectors - Photo diode + LED **\$1.00 ea.**

Molex Pins

Molex already precut in length of 7 Perfect for 14 pin sockets. **20 strips for \$1.00**

CDS Photocells

Resistance varies with light. 250 ohms to over 3 meg **3 for \$1.00**

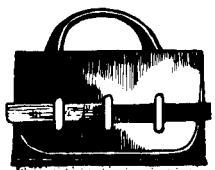

U.S.
MAIL

comments

power supply

Dear HR:

WB2UAQ's comment (July, 1983) on the March, 1983, article, "Dual Voltage Power Supply," suggested replacing the LM317 with a 723-type regulator. I did just that (see fig. 1).

Paul B. Johnson, VE7DHM
Sooke, British Columbia

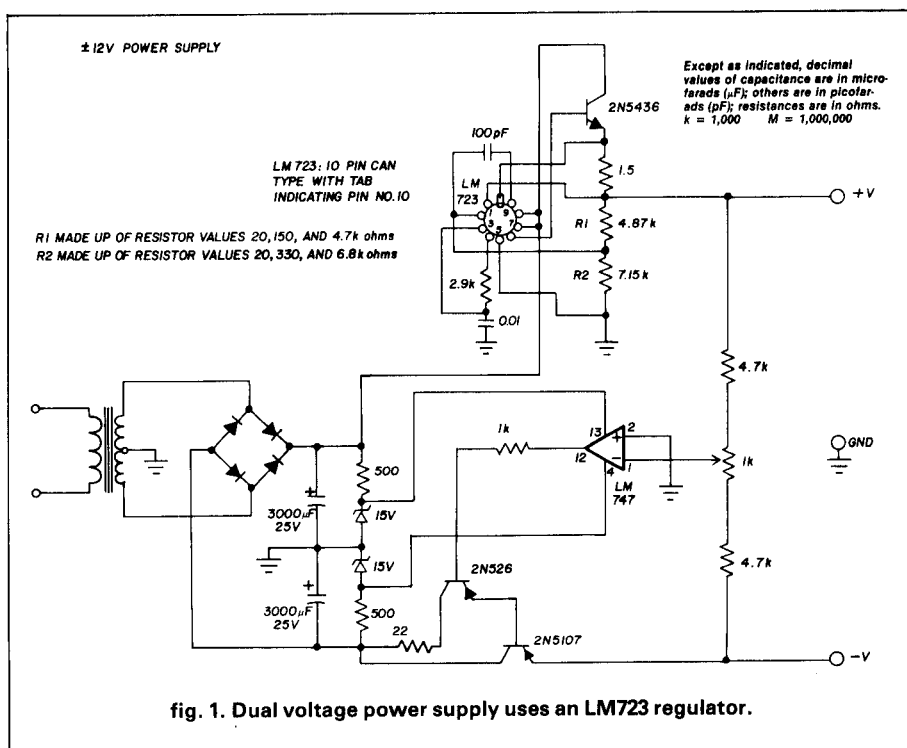

fig. 1. Dual voltage power supply uses an LM723 regulator.

loaded antennas

Dear HR:

Bill Orr's column on loaded antennas (*ham radio*, April, 1983) impressed me because although I generally operate on 20 meters, I'd like to use the 80-meter band and would like to have an antenna that doesn't require a ground.

Using the information on pages 54 and 55 of that issue, I wound the 40 µH loading coils but used No. 14 instead of No. 16 wire and checked the results on a Heath inductance bridge. Although the inductance was just about at the bottom of the scale (the bridge operates at 100 Hz, I believe) the results were accurate to two places.

I could not measure the center inductance but wound 11 turns of No. 14 wire on a 3/8-inch danvas impregnated form I had previously used for RF work.

It's OK to use the inductances if you have the equipment to measure them. Perhaps it would be better to indicate the coils not in inductance value, but rather in frequency, using a 10 pF capacitor to resonate with it. (Mine resonated at 14.25 MHz using a Millen meter for measurement.)

My friend WB6AFJ has an LC loaded 80-meter antenna. He's had plenty of trouble with the capacitors burning up. The absence of the capacitor, and the high voltage developed on these coils makes them difficult to manufacture for powers up to the legal limit which he uses now and then, as I do. I tend to shy away from coils as a result, but these — without the loading capacitors — look good.

One thing, however. Using the old compression insulators in which the wires overlap, how does one calculate the full dimensions of the lines? I

used small ceramic insulators, and made the wires to full dimension plus about three feet; these I folded back and secured. I like the adjustability of this method. The doubled-back lengths may add a little capacitance on the ends of the wires, and may assist in loading. The antenna has not been dipped as yet; I have to get the noise bridge out and adjust it to specs.

I did not attempt to dip the 1.86 µH coil, but I ought to. I may have to use 52 ohm coaxial; right now I have RG-59 which is 75 ohms instead of 52 ohms.

Someone might want to run a program showing the resonant frequency of the coils mentioned in fig. 4 (page 54) for benefit of those using the figures and not having other equipment.

Hank B. Plant, W6DKZ
San Jose, California

clean it up

Dear HR:

In his Ham Note, "Low Duty Cycle Transmitter Tune-up," (August, 1983), K4KI recommends using an automatic keyer in the dot mode during transmitter tune-up in order to reduce the duty cycle by approximately 50 percent and thereby save wear and tear on the tubes. But although an editor's note recommending the use of a dummy load at all times was included, we all know not every ham has a dummy load. Those who do have dummy loads don't always use them, and there are times when loading must be done into a radiating antenna, even if only briefly.

Therefore, K4KI's alternatives of either feeding the keyer's audio sidetone through the microphone, or feeding in audio generated by a relay connected in an RC time-constant circuit to make it buzz were both most unfortunate suggestions. Hopefully anyone currently using either of these techniques while loading into anything other than a dummy load will discontinue the practice.

While it is true that a pure sine wave carefully fed into the microphone input of an SSB transmitter can produce, for all practical purposes, a sine wave RF carrier in the output, this should never be attempted casually. The signal should be monitored on an oscilloscope, as the slightest distortion of the input sine wave will result in trash signals in the RF output which may vary from mild to an RF carrier output composed of numerous signals. Add in some flat-topping in the finals, and this garbage will extend perhaps several hundred kHz above and below the intended frequency of operation.

Few, if any, audio sidetones are pure sine waves. This is true whether it is electronic keyer sidetone, or the CW sidetone audio now included in all modern transceiver designs. At least one commercial electronic keyer I've seen uses a diode in series with the speaker, clipping one half of the audio waveform and generating a truly unique sidetone signal! Sidetone sig-

nals also tend to have an abundance of clicks or chirps, often both. Many of the CB to 10-meter conversions have no provision for operating CW if they are ex-CB SSB transceivers. It is common to feed keyed sidetone audio into them through either the mike or mike input circuit, and the result is spectacular. A number of these are currently loose on 10 meter CW and their signals are characterized by what can only be described as sounding like keyed steam calliopes — numerous carriers, usually accompanied by a bad case of chirps and/or clicks. A fairly clean one will occupy 5 or 10 kHz.

Audio sidetone-generated signals fed into the mike or mike input circuit will invariably generate unsanitary RF output from an SSB transmitter. Sending it into a dummy load is one thing, but radiating this garbage is quite another. Where on-the-air transmitter tuning is unavoidable, only the CW mode utilizing the transmitter's internal CW keying circuit and a keyer set for fast dots is appropriate. Hopefully the internal keying circuitry will provide proper shaping to avoid generating key clicks (approximately 5 ms rise and decay times), and if the dot/space ratio is correct, this will reduce the duty cycle to something less than 50 percent.

Robert G. Wheaton, W5XW
San Antonio, Texas

short circuit

phased verticals

One line of K2BT's article, "Phased Vertical Arrays: part 4" (October, 1983) was inadvertently omitted. The second-to-last sentence on page 45 should read as follows:

"The calculation procedures are structured and identical for any circuit (except for the differing equations for matrix values), making the method ideal for programmable calculators or small computers."

Ducks are getting smaller! and...



better!



Actual Size

Because you and the leading radio manufacturers want the best-performing, the best looking antenna; Centurion has grown to be the Duck leader. We've developed many smaller antennas to make the hand-held radio perform better, and now the newest duck...the Tuf Duck "mini". It's shorter (about 3") yet it's a full 1/4 wave radiator on VHF.

CENTURION
TUF DUCK™
ANTENNAS

CENTURION
Phone 402/467-4491
Telex 48-4377 CENTURION LCN
P.O. Box 82846 Lincoln, NE 68501 2846

THE MOST AFFORDABLE REPEATER

ALSO HAS THE MOST IMPRESSIVE PERFORMANCE FEATURES

(AND GIVES THEM TO YOU AS STANDARD EQUIPMENT!)



JUST LOOK AT THESE PRICES!

Band	Kit	Wired/Tested
10M, 6M, 2M, 220	\$680	\$880
440	\$780	\$980

Both kit and wired units are complete with all parts, modules, hardware, and crystals.

CALL OR WRITE FOR COMPLETE DETAILS.

Also available for remote site linking, crossband, and remote base.

FEATURES:

- SENSITIVITY SECOND TO NONE; TYPICALLY 0.15 μ V ON VHF, 0.3 μ V ON UHF.
- SELECTIVITY THAT CAN'T BE BEAT! BOTH 8 POLE CRYSTAL FILTER & CERAMIC FILTER FOR GREATER THAN 100 dB AT \pm 12KHZ. HELICAL RESONATOR FRONT ENDS. SEE R144, R220, AND R451 SPECS IN RECEIVER AD BELOW.
- OTHER GREAT RECEIVER FEATURES: FLUTTER-PROOF SQUELCH, AFC TO COMPENSATE FOR OFF-FREQ TRANSMITTERS, SEPARATE LOCAL SPEAKER AMPLIFIER & CONTROL.
- CLEAN, EASY TUNE TRANSMITTER; UP TO 20 WATTS OUT (UP TO 50W WITH OPTIONAL PA).

HIGH QUALITY MODULES FOR REPEATERS, LINKS, TELEMETRY, ETC.

HIGH-PERFORMANCE RECEIVER MODULES

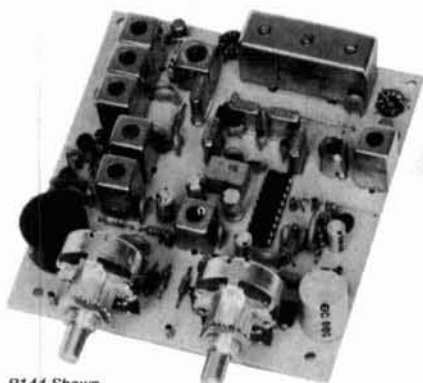

R144 Shown

- **R144/R220 FM RCVR** for 2M or 220 MHz. 0.15 μ V sens.; 8 pole xtal filter & ceramic filter in i-f, helical resonator front end for exceptional selectivity, more than -100 dB at \pm 12 kHz, best available today. Flutter-proof squelch. AFC tracks drifting xmtrs. Xtal oven avail. Kit only \$138.
- **R451 FM RCVR** Same but for uhf. Tuned line front end, 0.3 μ V sens. Kit only \$138.
- **R76 FM RCVR** for 10M, 6M, 2M, 220, or commercial bands. As above, but w/o AFC or hel. res. Kits only \$118. Also avail w/4 pole filter, only \$98/kit.
- **R110 VHF AM RECEIVER** kit for VHF aircraft band or ham bands. Only \$98.
- **R110-259 SPACE SHUTTLE RECEIVER**, kit only \$98.

TRANSMITTERS

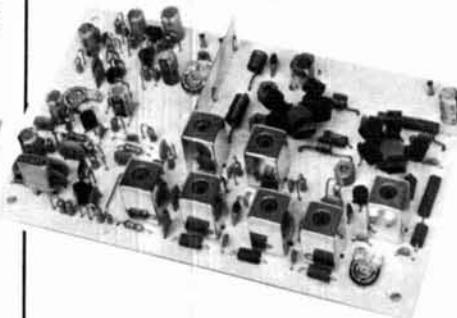

- **T51 VHF FM EXCITER** for 10M, 6M, 2M, 220 MHz or adjacent bands. 2 Watts continuous, up to 2 1/2 W intermittent. \$68/kit.

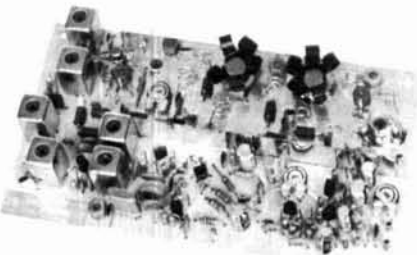

- **T451 UHF FM EXCITER** 2 to 3 Watts on 450 ham band or adjacent freq. Kit only \$78.
- **VHF & UHF LINEAR AMPLIFIERS.** Use on either FM or SSB. Power levels from 10 to 45 Watts to go with exciters & xmtg converters. Several models. Kits from \$78.
- **A16 RF TIGHT BOX** Deep drawn alum. case with tight cover and no seams. 7 x 8 x 2 inches. Designed especially for repeaters. \$20.

ACCESSORIES



- **COR KITS** With Audio mixer, speaker amplifier, tail & time out timers. Kit only \$38.
- **CWID KITS** 158 bits, field programmable, clean audio, rugged TTL logic. Kit only \$68.
- **DTMF DECODER/CONTROLLER KITS.** Control 2 separate on/off functions with touchtones®, e.g., repeater and autopatch. Use with main or aux. receiver or with Autopatch. Only \$90
- **AUTOPATCH KITS.** Provide repeater autopatch, reverse patch, phone line remote control of repeater, secondary control via repeater receiver. Many other features. Only \$90. Requires DTMF Module.



- **HELICAL RESONATOR FILTERS** available separately on pcb w/connectors.
 - HRF-144 for 143-150 MHz \$38
 - HRF-220 for 213-233 MHz \$38
 - HRF-432 for 420-450 MHz \$48

hamtronics®

NEW LOW-NOISE PREAMPS RECEIVING CONVERTERS TRANSMIT CONVERTERS

New low-noise microwave transistors make preamps in the 0.9 to 1.0 dB noise figure range possible without the fragility and power supply problems of gas-fet's. Units furnished wired and tuned to ham band. Can be easily retuned to nearby freq.



Models LNA(), P30, and P432 shown

Model	Tunable Freq Range	Noise Figure	Gain	Price
LNA 28	20-40	0.9 dB	20 dB	\$39
LNA 50	40-70	0.9 dB	20 dB	\$39
LNA 144	120-180	1.0 dB	18 dB	\$39
LNA 220	180-250	1.0 dB	17 dB	\$39
LNA 432	380-470	1.0 dB	18 dB	\$45
LNA 800	470-960	1.2 dB	15 dB	\$45

ECONOMY PREAMPS

Our traditional preamps, proven in years of service. Over 20,000 in use throughout the world. Tuneable over narrow range. Specify exact freq. band needed. Gain 16-20 dB. NF = 2 dB or less. VHF units available 27 to 300 MHz. UHF units available 300 to 650 MHz.

- P30K, VHF Kit less case \$18
- P30W, VHF Wired/Tested \$33
- P432K, UHF Kit less case \$21
- P432W, UHF Wired/Tested \$36

P432 also available in broadband version to cover 20-650 MHz without tuning. Same price as P432; add "B" to model #.

HELICAL RESONATOR PREAMPS

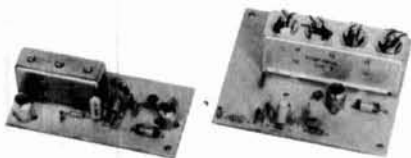

Our lab has developed a new line of low-noise receiver preamps with helical resonator filters built in. The combination of a low noise amplifier similar to the LNA series and the sharp selectivity of a 3 or 4 section helical resonator provides increased sensitivity while reducing intermod and cross-band interference in critical applications. See selectivity curves at right. Noise figure = 1 to 1.2 dB. Gain = 12 to 15 dB.

Model	Tuning Range	Price
HRA-144	143-150 MHz	\$49
HRA-220	213-233 MHz	\$49
HRA-432	420-450 MHz	\$59
HRA-()	150-174 MHz	\$69
HRA-()	450-470 MHz	\$79



Models to cover every practical rf & if range to listen to SSB, FM, ATV, etc. NF = 2 dB or less.

	Antenna Input Range	Receiver Output
VHF MODELS	28-32	144-148
Kit with Case \$49	50-52	28-30
Less Case \$39	50-54	144-148
Wired \$69	144-146	28-30
	145-147	28-30
	144-144.4	27-27.4
	146-148	28-30
	144-148	50-54
	220-222	28-30
	220-224	144-148
	222-226	144-148
	220-224	50-54
	222-224	28-30

	Antenna Input Range	Receiver Output
UHF MODELS	432-434	28-30
Kit with Case \$59	435-437	28-30
Less Case \$49	432-436	144-148
Wired \$75	432-436	50-54
	439.25	61.25

SCANNER CONVERTERS Copy 72-76, 135-144, 240-270, 400-420, or 806-894 MHz bands on any scanner. Wired/tested Only \$88.

SAVE A BUNDLE ON VHF FM TRANSCIEVERS!

FM-5 PC Board Kit - ONLY \$178 complete with controls, heatsink, etc. 10 Watts, 5 Channels, for 2M or 220 MHz.



Cabinet Kit, complete with speaker, knobs, connectors, hardware. Only \$60.

REPEAT OF A SELLOUT!

While supply lasts, get \$60 cabinet kit free when you buy an FM-5 Transceiver kit. Where else can you get a complete transceiver for only \$178

For SSB, CW, ATV, FM, etc. Why pay big bucks for a multi mode rig for each band? Can be linked with receive converters for transceive. 2 Watts output vhf, 1 Watt uhf.

	Exciter Input Range	Antenna Output
For VHF, Model XV2	28-30	144-146
Kit \$79	28-29	145-146
Wired \$149 (Specify band)	28-30	50-52
	27-27.4	144-144.4
	28-30	220-222*
	50-54	220-224
	144-146	50-52
	50-54	144-148
	144-146	28-30

	Exciter Input Range	Antenna Output
For UHF, Model XV4	28-30	432-434
Kit \$99	28-30	435-437
Wired \$169	50-54	432-436
	61.25	439.25
	144-148	432-436*

*Add \$20 for 2M input

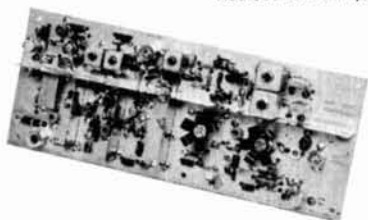

VHF & UHF LINEAR AMPLIFIERS. Use with above. Power levels from 10 to 45 Watts. Several models, kits from \$78.

LOOK AT THESE ATTRACTIVE CURVES!

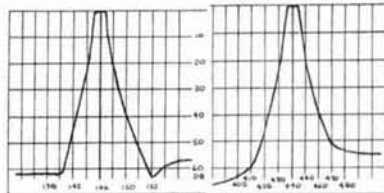

Typical Selectivity Curves of Receivers and Helical Resonators.

IMPORTANT REASONS WHY YOU SHOULD BUY FROM THE VALUE LEADER:

1. Largest selection of vhf and uhf kits in the world.
2. Exceptional quality and low prices due to large volume.
3. Fast delivery; most kits shipped same day.
4. Complete, professional instruction manuals.
5. Prompt factory service available and free phone consultation.
6. In business 21 years.
7. Sell more repeater modules than all other mfrs. and have for years. Can give quality features for much lower cost.

- Call or Write for FREE CATALOG
- (Send \$1.00 or 4 IRC's for overseas mailing)
- Order by phone or mail • Add \$3 S & H per order (Electronic answering service evenings & weekends)
- Use VISA, MASTERCARD, Check, or UPS COD.

hamtronics, inc.

65-C MOUL RD. • HILTON NY 14468
Phone: 716-392-9430

Hamtronics® is a registered trademark

Note: the front cover illustrates state-of-the-art techniques in the reception and processing of ionospheric sounding returns. The color-enhanced display was recorded by a *Digisonde* installed at Goose Bay, Labrador. It combines in one ionogram both vertical and oblique echo returns where: *yellow* signifies vertical echoes with ordinary polarization; *green*, vertical echoes with extraordinary polarization; *blue*, oblique echoes; *magenta*, automatically identified ordinary F trace; *red*, automatically identified ordinary E trace and extraordinary F trace. (Photo courtesy of Professor Bodo W. Reinisch, Technical Director, Center for Atmospheric Research, University of Lowell, Massachusetts.)

digital ionosondes

A second-generation probe of the ionosphere

HF radar is practically a household word to Radio Amateurs these days with almost everyone familiar with the Russian woodpecker and some with the quieter U.S. equivalent installation in Maine. These are known as Over-The-Horizon Backscatter Radars or OTH-Bs for short. Their purpose is one of long range aircraft detection. Another type of HF radar, known as ionospheric sounder, also operates using the echo principle. The basic differences between these two radars are range and type of object detected. While both radars utilize ionized layers, OTH-Bs use them as a means to an end, while sounders concentrate on the layers themselves. Information provided by the sounders enables communicators to design radio systems, choosing frequencies and times of operation more effectively. It is this latter type of probe that will be discussed.

Sweep-frequency ionospheric sounding equipment was first developed more than 50 years ago,¹ but until recently there was only one type of sounder or ionosonde. It operated in an analog mode, in the 1 to 30 MHz frequency range, by transmitting pulses vertically or obliquely to the D, E, and F ionospheric regions and receiving the weaker returning signals. The round trip time of the signal determined height, while the intensity of the echo could be related to the degree of ionization of the D region(s), where radio wave energy is absorbed while signals propagate through it to the higher reflecting layers. Though extremely useful data became available in the form of ionograms (see **fig. 1**) it still represented a two-dimensional display in a multi-dimensional world. What was needed was instrumentation that determined not only amplitude but also phase, direction of arrival, and polarization of the signal returns.

The next logical step in sounder development took advantage of the high speed capabilities inherent in digital data processing techniques. By combining a general computer with a specialized RF processor, a digital ionosonde was created. It now had the capability of real-time data analysis and display by processing the (complex vector) numerical description of signal returns as they varied with range and frequency.² Manipulation of this data provided additional signal parameters including phase, group delay, and doppler spectrum. When combined with an array of receiving antennas, the digital ionosonde was also able to determine signal direction of arrival, wave polarization, and other diffraction pattern information. The significance of this development lies in the fact that a single piece of equipment could now provide all this information, whereas in the past, several different equipment systems — along with elaborate measurements — were necessary. The insight provided enabled ionospheric researchers to re-examine basic concepts in light of this new information.

ionospheric regions and layers

December 12, 1901, marks the date when the first successful reception of transatlantic signals occurred. It also marks the start of inquiries into the mechanism that allowed this radio transmission around the curvature of the earth. A.E. Kennelly from the United States and O. Heaviside (remember the Heaviside layer?) in Great Britain independently conceived of the existence of an ionized region in the upper atmosphere capable of reflecting radio waves back to earth.^{3,4,5}

The ionosphere, a term first used by Sir Robert Watson-Watt, was defined as "that part of the atmosphere in which free ions exist in sufficient quantities to affect the propagation of radio waves."⁶

By Rich Rosen, K2RR, Editor-in-Chief, *ham radio*

(However, when Sir Edward Appleton looked into the physics of radio wave propagation in a plasma, he found that the refractive index of the plasma, which controls the propagation of the wave through it by changing the phase velocity of the wave, depends mainly on the electron density of the plasma. The ions, because of their large mass — compared to that of an electron — have little impact on wave propagation. But since charge neutrality requires that the number of ions equal the number of electrons, it could be said that Sir Robert was partially right.) It is accepted as existing from approximately 31 miles (50 km) to as high as several earth radii. There are three commonly-known sections of the atmosphere called the D, E, and F regions occurring at heights of 31 to 56 miles (50 to 90 km), 56 to 87 miles (90 to 140 km) and above 65 miles (120 km), respectively. (The regions are not clearly defined and merge with one another.) These regions can also be divided into smaller layers of ion distributions, with the E region occasionally showing E1, E2, and Es layers while the F region divides into F1, F1 ½, and F2 layers.

The F1 layer has a maximum between 160 and 180 km, exists only in the presence of sunlight, and has a maximum density at local noon. The F2 layer peaks between 200 and 600 km, depending on factors such as time of day, season, phase of solar cycle, neutral winds, ion composition, etc. Due to the low densities at these altitudes, recombination (electron/s + ion = neutral) is very slow; the ionization exists for many hours after sunset. The F1 ½ layer occurs sometimes after eclipse events, but rarely under normal conditions.

The F2 layer is the most important layer for radio communications, since it generally has the largest electron densities and therefore reflects the highest frequencies; it is found at the greatest height, and therefore results in the largest possible 1-hop distance.

Some claims have been made for the existence of two other regions: C and G. The C region is thought to exist at the bottom edge of the D region, approximately 60 kilometers up, and is formed by cosmic rays and is therefore always present (since impinging cosmic rays are always present). The G region appears on ionograms as a little kink during a storm when the critical frequency of the F2 layer is greatly diminished. It's possibly not a distinct region but rather a phenomenon that occurs at special times only.

ionospheric terminology

To understand the role these layers play in communications it's necessary to define a few related terms. For radio communications the most important characteristics of the ionospheric layers are their *critical*

frequencies and *virtual heights*. If one were to slowly vary the frequency of a generator that was transmitting pulses vertically (straight up) to the E region, a frequency would be reached where the signal was no longer being reflected down. The highest frequency that reflects back down from the E region is known as the E-region critical frequency or foE for short. Similar terms can be defined for the F1 and F2 layers: foF1 and foF2. Note that the subscript zero in the terms for critical frequencies represents zero distance (surface separation) between a pulse's origin and return location.

Virtual height is the equivalent height of the layer based on length or round trip time and apparent uniform velocity. In actuality, due to the interaction between the radio waves and the electrons, a radio wave is slowed down as it enters ionospheric layers, resulting in non-uniform velocity. Consequently, actual layer height differs from virtual height. Nevertheless, virtual height represents an accepted and useful convention as we shall soon see.

Up to now vertically launched signals have been considered. If the same transmitter drives an antenna that produces a *low* angle (elevation) pattern, additional useful information becomes available. Let us define MUF (2000) E and MUF (4000) F as the highest frequencies which the E or F layer will carry over a 2000, 4000 km path, respectively. These low angle terms when divided by their respective layer critical frequency equal what's known as the M-factor, i.e.

$$M(2000)E = \frac{MUF(2000)E}{foE} \text{ and}$$

$$M(4000)F = \frac{MUF(4000)F}{foF2}$$

Note that the F layer is not often high enough to give a 4000 km 1 hop. Knowledge of these sets of frequencies is one of the beginning steps in determining communication paths and the corresponding operating frequencies. This is where sounders come in.

analog sounders

An early form of an ionosonde was a pulsed radar device in which the frequency was repetitively varied from approximately 1 MHz to 30 MHz (some started even lower, at 0.1 MHz). The equipment was designed to measure the time it took a pulsed radio wave to travel up to the ionosphere and back as a function of frequency. The transmitter and receiver were synchronized either electronically or mechanically while the receiver output was displayed on a CRT. Markers were introduced that interrupted the sweep trace every one third of a millisecond and multiples thereof to provide equivalent height indicators of 50, 100, 150, . . . kilometers. (These are indicated

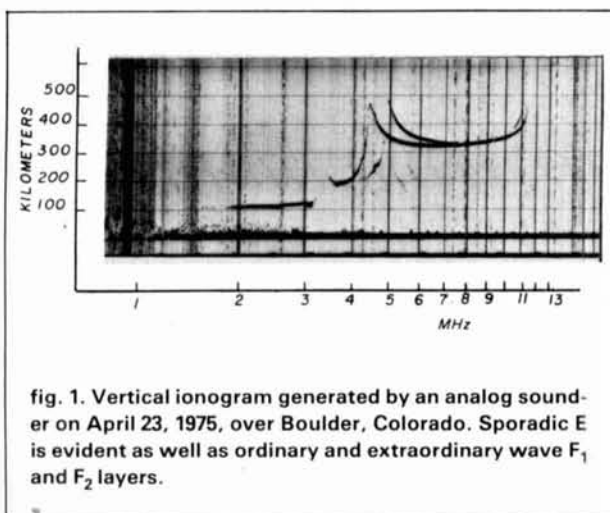

fig. 1. Vertical ionogram generated by an analog sounder on April 23, 1975, over Boulder, Colorado. Sporadic E is evident as well as ordinary and extraordinary wave F₁ and F₂ layers.

as thin horizontal lines in fig. 1 and in this case are multiples of 100 kilometers or 0.66 milliseconds.) In addition, frequency markers were generated that

corresponded to each integer MHz. (Note that the spacing between vertical frequency marker lines is non-uniform and in this case, logarithmic).

A common ionosonde, designed in the mid-1950's for the International Geophysical Year, that operates along these lines is the National Bureau of Standards (NBS) C-4 machine, still used today. It consists of a 10 kW peak pulse transmitter and a wideband receiver. The pulse transmitter uses a 31 to 55 MHz swept CW oscillator that mixes with a 30 MHz pulsed oscillator to provide a 1 to 25 MHz pulsed output. This signal is then amplified in a broadband power amplifier. The receiver uses the same CW (swept) oscillator in a balanced mixer to mix with the incoming echoes down to a fixed 30 MHz IF signal for further amplification and processing. The same antenna in an analog sounder is normally used both for transmitting and receiving and should show a relatively constant resistive impedance over the entire frequency range. Typical antennas utilized are vertically-oriented delta loops, terminated rhombics or log periodics.

A panoramic display of the returning echoes is ac-

ionograms explained

The dark, basically horizontal line on the left side of the ionogram represents the E region (specifically the sporadic E layer — a thin layer at about the same height as the normal E layer which varies, unpredictably). Signals from between 2 and 3 MHz (2nd and 3rd vertical lines) have apparently been reflected from a height starting at 110 and ending at 120 km on this film strip.

The second set of curves on the same ionogram illustrates several important features of ionospheric propagation. The first curve from start to cusp represents the F1 layer, while the next continuous segment from cusp to cusp represents the F2 layer. *The cusps or rapid increase in "height" with small change in frequency corresponds to the previous layer's critical frequency and indicates a maximum layer electron density. Furthermore, a cusp indicates that the electron density profile has a vertical tangent, i.e., that the specific layer has a maximum. The F1 layer often has no discrete maximum; it is merely a ledge on the F2 layer electron density profile — an inflection of the trace, not a cusp. It corresponds to points where the radio wave penetrates the layer. At the critical frequency, the rate of travel of the incident wave is slow, producing the large virtual heights.*

The last curve also shows the F1 and F2 layers (though it's hard to see the F1 trace in this case). The reason for the existence of two traces is related to the fact that the transmitted wave splits into two separate waves (ordinary and extraordinary) under the influence of the earth's magnetic field.⁷ (This is known as magneto-ionic effects.) This trace separation is important to all communicators because these two waves propagate differently: traveling at different velocities and being absorbed in differing amounts. Depending upon a transmitting station's geographical location, the transmitting antenna's configuration and orientation (polarization and direction) as well as a number of other factors determines which wave is launched and how strongly it is reflected *if at all*.

Note that the following critical frequencies can be picked off the ionogram and are approximately:

foEs = 3.5 MHz	(Sporadic E critical frequency)
foF1 = 4.4 MHz	(Ordinary wave F1 critical frequency)
fxF1 = 5.0 MHz	(Extraordinary wave F1 critical frequency)
foF2 = 11.0 MHz	(Ordinary wave F2 critical frequency)
fxF2 = 11.4 MHz	(Extraordinary wave critical frequency)

completed by applying a voltage to the X plate of the CRT that is a function of the sweeping transmitter frequency. The time base voltage is applied to the Y plates which equates to the virtual height of the layers (round trip time between transmission and reception). The actual receiver output and height pips are applied as blanking pulses to the CRT. In examining the display (see **fig. 1**) two different curved lines (O and X) are seen that rise with increasing frequency to a cusp at the critical frequency of the F layer. This makes sense since higher frequencies are reflected at greater (layer) heights until penetration occurs (see "ionograms explained").

A second type of analog sounder used FMCW, which provided a linear frequency swept transmitted signal. Use of CW gave high average power eliminating the need for high peak powers. It also permitted the use of very narrow receivers (100-200 Hz bandwidth), and was therefore less susceptible to interference from fixed frequency communication signals. The analog output of this FMCW system is a delayed and distorted (by the ionosphere) replica of the transmitted FMCW waveform and not an ionogram. A mathematical operation called a Fourier Transform (or spectral analysis) on the signal determines the delay of each frequency component, which is a measure of the reflection height. This output provides the information which is plotted and recorded as an ionogram. In general the main advantage of using FMCW versus pulse was in its reduced level of interference to itself and other users of the spectrum. However, pulsed systems had an advantage over FMCW types when multichannel receivers or multiple antenna

receiving arrays were used. It's easier to switch between multichannel receivers or sample multiple receiving antenna outputs on a pulsed system. By using the positive features of a pulsed system and adding some software controlled equipment for signal enhancement the basic digital ionosonde was created.

digital sounders

A simplified block diagram of one of the few digital ionosondes (fig. 2) in the world, the Space Environment Laboratory model,² is shown in fig. 3. The heart of the system incorporates a 16-bit processor. Data is displayed on a 6-inch (15 cm) XY CRT that



fig. 2. One of the few digital ionosondes in the world, this system developed by the Space Environment Laboratory provides new capabilities — within a single system — to determine ionospheric structure and magneto-ionic effects in general.

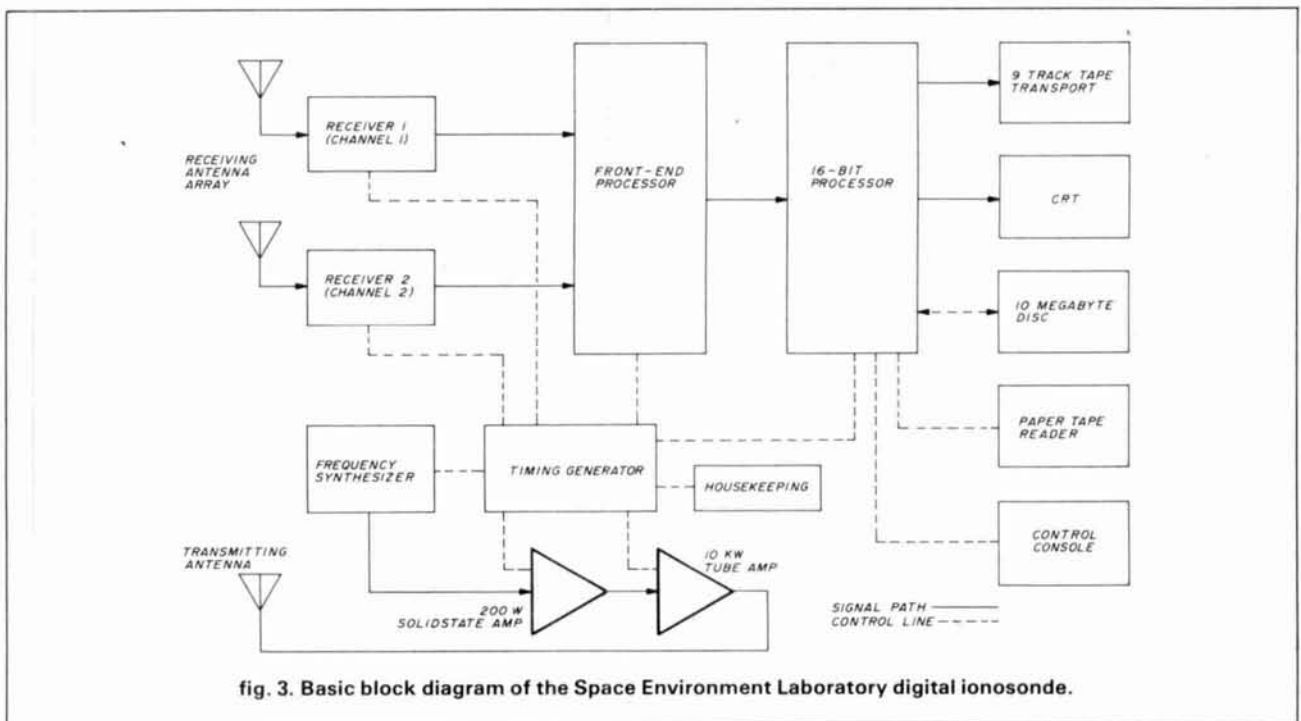

fig. 3. Basic block diagram of the Space Environment Laboratory digital ionosonde.

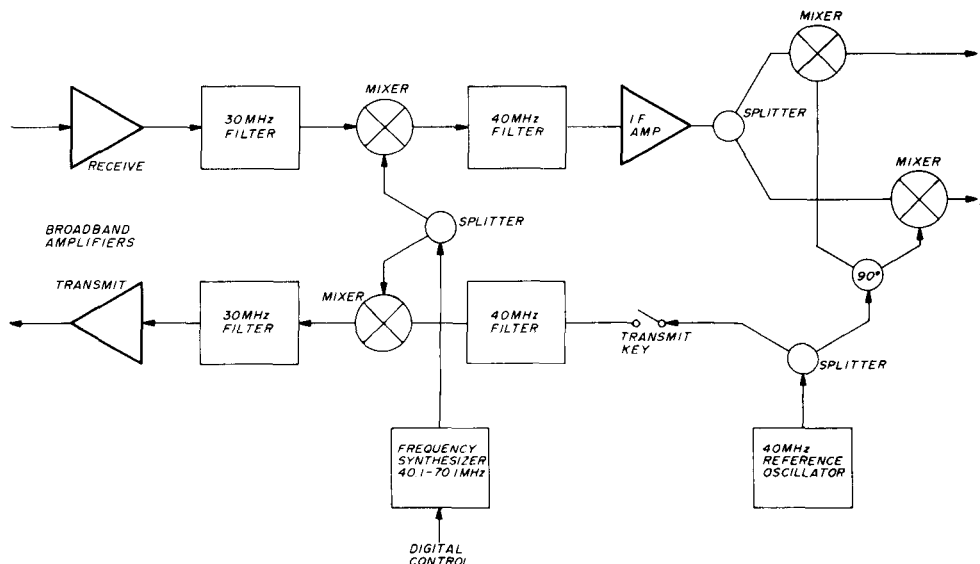

fig. 4. Simplified block diagram of the RF section of the SEL digital ionosonde.

has 1024×1024 addressable points. The display appears animated (is refreshed) by direct memory access to the computer's core. This makes rapid changes in the display possible and provides a time sequence presentation of the data. Program loading is provided by a 1600 BPI (byte per inch), 9 track, 3-ips tape transport while a 10 Megabyte disc memory is used for recording data. The operator talks to the system via a graphics display console and hard copy unit.

The RF section of the digital ionosonde has two functions: it generates the transmitted signals and coherently receives the echoes (see fig. 4). A symmetrical up/down conversion scheme is used with two oscillators. The first oscillator, a general-purpose synthesizer, generates a frequency between 40.1 and 70 MHz and up converts the receive band of 0.1 — 30 MHz to a 40 MHz IF. The second generator, a fixed-frequency 40 MHz crystal oscillator, mixes with the same synthesizer output to form the transmitted frequency.

In the receive mode the 40 MHz oscillator provides the reference signal while the frequency of operation is selected by the computer which controls the synthesizer.

An important question asked during the design phase was what is the best choice of output signal representation? Previous ionospheric sounding systems have, for the most part, used a logarithmic signal scale. The use of a logarithmic scale, however, is inconvenient for many kinds of digital signal processing. The justification for this choice of signal representation (as opposed to linear, for example) has been that it is otherwise difficult or impossible to achieve the received signal dynamic range any other

way. Recent developments in solid-state technology have shown that stable, wideband linear amplifiers with extremely wide dynamic ranges, typically > 140 dB in a 30 kHz noise bandwidth *are* achievable. Using these amplifier techniques, passive filters and a well-designed mixer and detector, a linear receiver can be built that is limited only by degree of (digital) quantization and DC stability.

Through careful design, the receiver section exhibits a high degree of linearity with low intermodulation products and achieves a 1 dB compression point of +15 dBm with a third order intercept of +26 dBm with 0 dB RF attenuation thrown in. In addition the receiver gain varies less than ± 2 dB from 0.2 to 29 MHz and has a tangential sensitivity of $\leq 1 \mu\text{V}$. An additional benefit of the strong signal handling performance of the receiver is that preselection filters are not required for operation under typical site conditions.

Two transmitted output levels can be used: 200 W or 10 kW. The low level transmitter drive output is amplified first by a solid-state class A amplifier to the 200 W level. This can be used directly or can be used to drive a pulsed class A wideband vacuum tube amplifier with a 10 kW output. Since the transmitter outputs are nominally 50 ohms, unbalanced wideband balun transformers must be used to drive typical sounding antennas.

operation

Since the key feature of this system is flexibility — i.e. it is software controlled and not hardware constrained — the digital ionosondes' modes of operation can be greatly modified almost at will. Initially, software has been written to operate the system as a

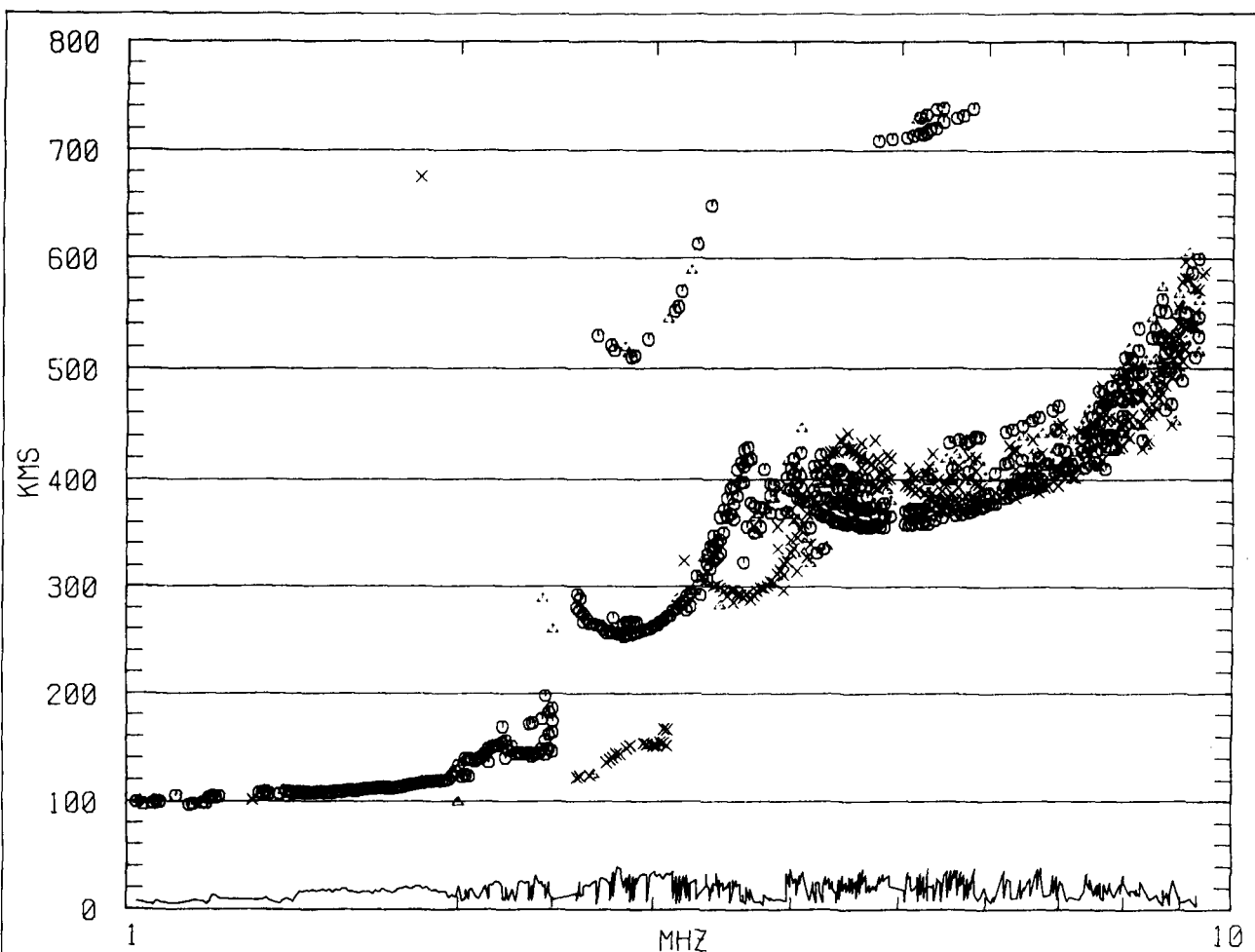

fig. 5. Digital ionosonde generated display depicting sporadic E, F1 and F2 layer ordinary wave returns as well as F1 and F2 layer extraordinary returns. The ordinary wave appears as red "O" symbols and the extraordinary wave as green "X" symbols on the display.

basic vertical pulse sounder, incorporating flexible sweep modes as well as fixed frequency operation (up to ten operator-selected frequencies.) Four pulses are transmitted per frequency, two at f and two at $f + \Delta f$ (Δf is usually chosen at 8 kHz). Four antennas are sampled, using two at a time with two receivers. The amplitude of the "returning signal" is examined (interference is removed) and transferred to the computer. After more processing, the data is recorded on tape and disc and displayed on the system CRT. Of particular interest to users of the standard frequency stations and Radio Amateurs is the frequency deletions of 2.5, 5, 10 MHz and the 160 and 80 meter bands by the system.

Fig. 5 shows a typical graphics display ionogram. The original, in color, shows the Es and F1 and F2 ordinary wave returns plotted as red letter O's while the F1 and F2 extraordinary wave returns are shown as green X's. The additional trace at the top is the second return trip echo (signal transmitted up to the F region, reflected back down, reflected by the earth,

returned once again by the same F region. These are also seen on ionograms produced by the conventional analog sounders.)

digital ionosonde programs

In the Space Environment Laboratory Program in Boulder, planning calls for six of the SEL digital ionosonde systems to be built and coordinated as part of an international research program to primarily study the problems of magneto-ionospheric interaction in the Arctic and Antarctic ionospheres. Considerable software development needs to be done in order to take advantage of even a part of the possibilities of the system.

On the east coast, a series of digital ionosondes — the latest version known as Digisonde 256 — has been developed over the last decade by the University of Lowell[®] in cooperation with the Air Force Geophysics Laboratory at Hanscom Air Force Base in Massachusetts. The Digisonde is in use at military and civilian research and geophysical monitoring sta-

More reasons to call Calvert first:

Lowest prices in America. Service you can depend on.

Now introducing the additional convenience of



or



**ALL OUR TUBES ARE NEW UNUSED.
FULL FACTORY WARRANTY.**

0A2	\$ 2.00	6KD6	6.90	6528A	75.00
2C39WA	45.00	6KV6A	6.02	6550A	6.50
2D21	2.45	6L6GC	3.85	6883B/8032A	6.75
2E24	9.50	6LF6	7.19	6907	100.00
2E26	7.50	6LQ6	6.83	6939	28.00
3-400Z	85.00	6MJ6	7.28	7054/8077	5.00
3-500Z	85.00	12AT7	2.93	7056	4.00
3-1000Z	367.00	12AU7	2.63	7058	5.75
3B28	12.50	12AX7-ECC83	2.64	7059	5.00
3CX400U7	325.00	304TH	355.00	7060	6.00
3CX800A7	250.00	304TL	320.00	7061	6.75
3CX1500A7 8877	450.00	572B-T160L	56.00	7167	3.67
3E29	20.00	(572B) can also be replaced with 851A at much lower cost.		7258	6.00
4-65A	59.00	807	6.50	7360	9.15
4-125A	70.00	811A	11.00	7551	8.50
4-250A	80.00	812A	35.00	7558	7.00
4-400A C	80.00	813	35.00	7591A	4.70
4-400B 7525	99.00	816	15.00	7701	8.00
4-1000A	440.00	829B	15.00	7716	6.00
(4-1000A) <small>can be replaced with 851B</small>	69.95	832A	12.00	7854/YL1060	114.00
4CX250B EIMAC	58.00	833A	80.00	7905	16.00
4CX250BC	65.00	866A	7.50	8072	92.00
4CX350A	110.00	1625	10.00	8102	3.75
4CX350F <small>Surplus</small>	35.00	2050A	3.75	8106	8.00
4CX1000A	431.00	4657	95.00	8121	115.00
4CX1500B	515.00	5670	4.40	8122	98.00
4X150A/7034	25.00	5687	4.00	8156	10.95
4X150D/7609	35.00	5751	4.00	8417	6.85
4X150G/8172	55.00	5763	4.50	8458/YL1240	35.00
5AR4/GZ34	4.37	5814A	3.70	8505A/YL1250	95.00
5R4WGB	5.00	5894A	48.00	8509	140.00
5Z3	5.00	5965	2.50	8560AS	78.00
6AK5/EF95	4.26	6005	5.25	8595	39.00
6AL5	2.93	6080	7.50	8624	105.00
6AQ5	2.85	6146	6.50	8643	117.00
6CA7	5.61	6155	75.00	8753	60.00
6DJ8/ECC88	2.75	6156	85.00	8873	210.00
6JE6	6.55	6201	5.35	8874	190.00
6JG6A	6.56	6252	55.00	8875	200.00
6JM6	4.65	6360	4.25	8908	14.00
6JS6C	6.05	6397	\$8.50	8950	11.50

SK406 Chimney for 3-500Z, 4-400A/C 50.00
 SK506 Chimney for 4-1000A 72.00
 SK606 Chimney for 4X150A, 4CX250B, 4CX350F 10.00

✓ 123

**Minimum order \$25.00 • Shipping charges extra
F.O.B. East Rutherford, NJ.**

Prices and items subject to change or withdrawal without prior notice.

TOLL FREE: 800-526-6362 (except from NJ)

CALVERT ELECTRONICS, INC.

One Branca Road, East Rutherford, NJ 07073
 201-460-8800 • TWX 710-989-0116 • Telex 4990274

1283

tions (Patrick Air Force Base, Florida; Ft. Monmouth, New Jersey; University of Lowell, Lowell, Massachusetts; Millstone Hill Incoherent Scatter Facility, Westford, Massachusetts; Air Force Geophysics Laboratory, Goose Bay Ionospheric Observatory, Goose Bay, Labrador; and at stations in the United Kingdom, Belgium, Germany and Italy). Additional sounders are being built for Australia, China, and France.

The Digisondes provide as routine station sounders digital ionograms⁹ in the standard format (similar to fig. 1) measuring and displaying amplitudes, Doppler, angle of arrival and polarization of the ionospheric echoes in selectable combinations. These selections depend on station or experimental requirements. A special subsystem, the Automatic Real Time Ionogram Scaler with True Height Analysis (ARTIST) scales the ionograms in real time and transmits via teletype ionospheric parameters and the complete trace defining the overhead ionosphere to users such as the Air Force Global Weather Center at Offutt Air Force Base in Nebraska, and the Air Force Over-the-Horizon Backscatter Radar at Columbia Falls, Maine. The system can also be operated in the so-called Drift-Mode, measuring ionospheric tilts and motions, and in a bistatic mode using two or more systems to provide propagation ionograms for communication link analysis.

acknowledgments

I thank Richard N. Grubb of the Space Environment Laboratory in Boulder, Colorado, for information on the NOAA SEL HF radar system. I also extend my appreciation to Jurgen Buchau of the Ionospheric Physics Division at the Air Force Physics Laboratory, and Bodo W. Reinisch of the University of Lowell, Lowell, Massachusetts, for information on the Digisonde 256 and their constructive comments on the material presented in this article.

references

1. T. R. Gilliland, "Note on a Multifrequency Automatic Recorder of Kennelly-Heaviside Layer Height," *Proceedings of IRE*, June, 1933, Vol. 21, pages 759-760.
2. R. N. Grubb, "The NOAA SEL HF Radar System (Ionospheric Sounder)," *NOAA technical memorandum ERL SEL-55*, Space Environment Laboratory, October, 1979.
3. Charles R. Burrows, "The History of Radio Wave Propagation up to the End of World War I," *Proceedings of the IRE*, May, 1962, page 682.
4. A. E. Kennelly, "On the Elevation of the Electrically-Conducting Strata of the Earth's Atmosphere," *Electronic World and Engineer*, March 15, 1902, Vol. 39, page 473.
5. O. Heaviside, *Encyclopedia Britannica*, 1902, 10th edition.
6. Kenneth Davies, "Ionospheric Radio Propagation," *National Bureau of Standards, Monograph 80*, April, 1965.
7. Rich Rosen, K2RR, "An Interview with Dr. Kenneth Davies," *ham radio*, January, 1983, page 28.
8. B. Klaus, B. Reinisch, "The Universal Digital Ionosonde," *radio science*, Volume 13, Number 3, May/June, 1978.
9. Dr. Bodo W. Reinisch and Huang Xueqin, "Automatic Calculation of Electron Density Profile from Digital Ionograms: Processing of Bottom-Side Ionograms," *radio science*, Volume 18, No. 3, May/June, 1983.

ham radio



state-of-the-art auto-dialer

It stores 21 telephone numbers,
uses only 3 chips, and may save your life

Some time ago I designed a Touch-Tone® auto-dialer because I always had trouble dialing an auto-patch call and driving at the same time. The dialer stored sixteen telephone numbers and was easily programmed from the keypad, but I had to use ten chips to make it work.¹ Now, because of a new chip on the market, I've found it possible to design a much better dialer that mounts directly on the dashboard. The new dialer has only three chips, and the parts were easy to get. To really simplify things, I even designed a printed circuit board. Anyone with a modest junkbox should be able to duplicate my auto-dialer for \$50 or less.

features

The dialer has many features that make it attractive for Amateur use:

- It can store twenty-one telephone numbers, eleven of which can be twenty-one digits long.
- All programming and dialing is through a standard Touch-Tone® keypad; no other controls are needed.

- Any one of eight dialing speeds are available.
- Pauses can be programmed, with or without a carrier drop.
- An autopatch access code can be dialed at slow speed, followed by the telephone number at high speed.
- Manual dialing includes automatic PTT (push-to-talk) with a two-second hang-on time.
- PTT is keyed one second before any auto-dialed number starts.
- Audible feedback includes unique tones to distinguish between programming and dialing key-strokes. PTT is inactive during programming.
- Last manually dialed number can be redialed automatically.
- Battery backup retains memory and programming for five to ten years.

By Alan Lefkow, K2MWU, 17 Jacobs Road,
Thiells, New York 10984

circuit description

A new CMOS Touch-Tone® auto-dialer chip called the MD-22 is the key to this design. It's available directly from the manufacturer² and comes in a 40-pin DIP package. The chip handles all housekeeping and dialing functions, including a standby mode for battery backup, the reading and writing of memory, tone generation, and a PTT output. It's used in conjunction with a standard 256x4 CMOS RAM for maximum number storage. To monitor tones, I added an audio amplifier chip and used an earphone as a loud-speaker.

For proper operation, the central part of the circuit follows the recommendations given in the data sheet

for the MD-22. The schematic for the dialer is shown in fig. 1. Resistor network RN1 is an 8-bit R-2R ladder array. The network sums eight binary outputs from the MD-22 to produce a stepped approximation of a sine wave. (Most Touch-Tone® generator chips use the same approach, but the summing network is on the chip.) Capacitor C7 filters out the steps to produce a smooth waveform. Trim pot R4 acts as a volume control for amplifier U4, and R5 adjusts the tone output level.

Because of their low voltage drop, germanium diodes are used for CR4 through CR8. Silicon diodes are necessary for CR2 and CR3 because they carry higher current; their voltage drop is compensated for

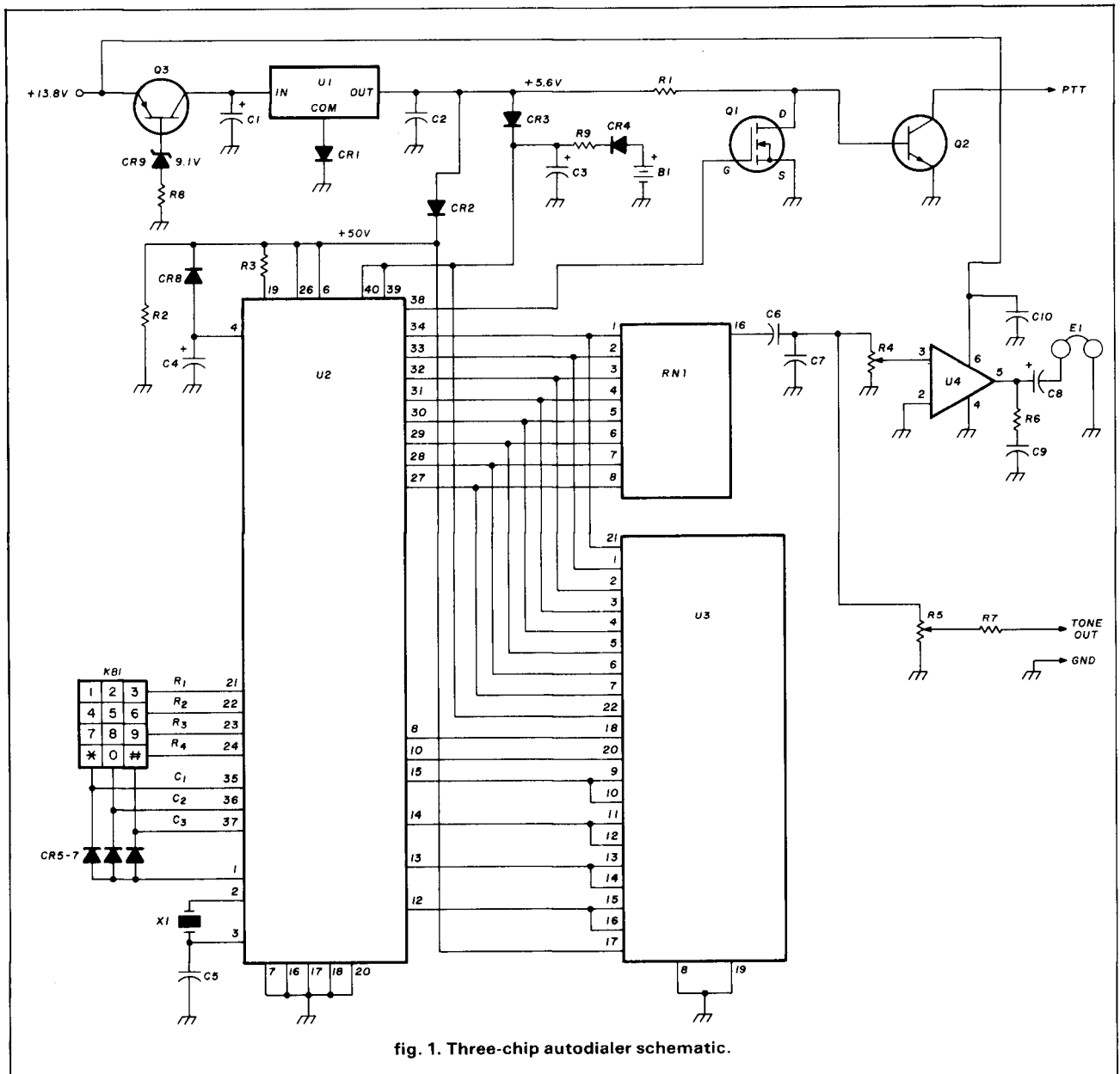
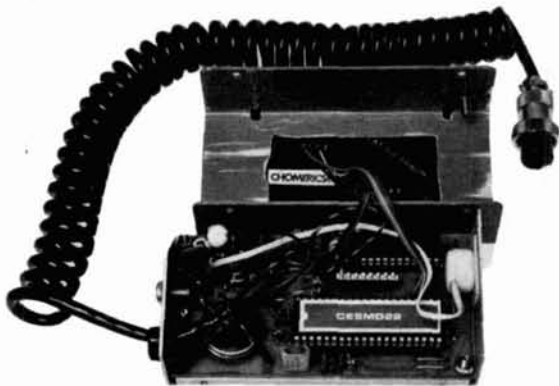

fig. 1. Three-chip autodialer schematic.



Inside view of the finished autodialer. The PC board shown here is an earlier design, slightly larger than the final version shown in *fig. 2*.

by using CR1 to raise the output voltage of regulator U1. This keeps the voltage for the MD-22 in its recommended range of 4.5 to 5.5 volts.

My first try at using the MD-22 pointed out some unexpected problems. The first one concerned the PTT output at pin 38. Most rigs require a switch closure to ground for PTT. Pin 38 goes low when PTT is on, but it must be buffered before connecting it to any rig. That I did with two transistors, using one as an inverter and the other as an open-collector output. Then I discovered that pin 38 remained high when the MD-22 was powered by the backup battery. That kept one transistor turned on and significantly increased the drain on B1.

To eliminate that drain, I followed a recommendation by Reiss³ and changed the inverting transistor, Q1, to a VMOS FET. In this circuit the VMOS FET behaves much like a bipolar but draws negligible current from U2, which is just what I wanted. With this change, the drain on the battery during backup turned out to be less than 0.1 μ A. At that rate, the battery should last five to ten years. When it does have to be replaced, the residual charge on capacitor C3 will provide ample time to replace the battery without any memory loss.

Another problem involved simply shutting off the unit. When power is removed, CR2, CR3, and CR4 switch in battery B1 to preserve memory. I discovered that if the supply voltage to the MD-22 doesn't drop fast enough when power is turned off, memory is erased. This can be a real problem if the autodialer is powered from a rig. The supply voltage doesn't drop abruptly when a rig is turned off because of large filter capacitors in the rig.

The manufacturer of the MD-22 explained the quirk. As the supply voltage falls to zero, there is one point when the backup battery is called upon to deliver current abnormally high for a small watch bat-

tery. This causes the backup voltage to the chip to collapse for a moment, and that erases memory.

The problem can be solved in one of several ways. The manufacturer recommended changing B1 to 4.5 volts and shorting R9 to provide higher current capacity. I tried that by adding a 1 1/2 volt calculator battery in series with B1 and it worked, but I still preferred the compactness and simplicity of using a watch battery. That led me to add transistor Q3 with zener diode CR9 wired in series with its base. When the supply voltage drops below the zener voltage, Q3 turns off current to the dialer chip. The sharp knee in the diode's voltage curve switches off Q3 fast enough to prevent the loss of memory no matter how slowly the supply voltage falls. (On some samples of the MD-22 the Q3/CR9 combination may not work; if so, use the 4 1/2 volt battery scheme.)

construction

You can make your own printed circuit board using the pattern in *fig. 2*, or you can order one from the source given in the parts list. Other construction techniques can also be used since parts layout is not critical.

If you use the board, the parts are installed following *fig. 3*. Use insulated wire for jumpers that might

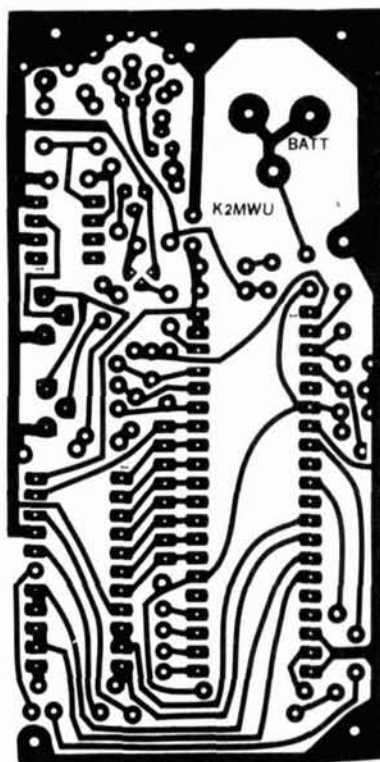

fig. 2. Printed circuit pattern for the autodialer. A drilled and plated PC board is available from the source indicated in the parts list.

parts list

item	description
B1	#2320 lithium watch battery (Radio Shack No. 23-163)
C1,C4	2.2 μ F dipped tantalum
C2,C6,C10	0.1 μ F
C3	100 μ F dipped tantalum
C5	22 pF
C7	0.0039 μ F mylar or polystyrene
C8	50 μ F electrolytic or dipped tantalum
C9	0.05 μ F
CR1-CR3	1N3600
CR4-CR8	1N270
CR9	1N757 9.1V Zener diode
E1	miniature earphone
K1	12-digit Touch-Tone [®] keypad, matrix switching
Q1	VN10KM VMOS FET (Radio Shack No. 276-2070 or similar)
Q2	2N2222A
Q3	2N3906
R1,R8	1K
R2,R9	10K
R3	5.1K
R4,R5	100K miniature trim pot, vertical mounting
R6	10 ohm
R7	75K or 2.2M (see text)
RN1	50K R/2R ladder network (Allen-Bradley No. 316L08503)
U1	78L05 5.0V low power regulator
U2	MD-22 Touch-Tone [®] autodialer
U3	5101 CMOS RAM
U4	LM386 audio amplifier
X1	6.0 MHz crystal, HC18/u holder (Jameco Electronics #CY6.00 or similar)
Case	LMB No. CR-425, 4-1/4 x 2-1/4 x 1-1/4 inches (L x W x H)

Except as noted, resistors are 1/4 watt, 5%, and capacitors are disc ceramic.

A drilled and plated printed circuit board is available for \$7.50 per board, plus \$1.50 for shipping up to 5 boards, from Dynacal Industries, P.O. Box 296, Meadow Lands, Pennsylvania 15347. The MD-22 (U2) and 50K - R/2R network (RN1) are available for \$15.00 and \$2.50 respectively, including shipping, from CES Inc., P.O. Box 507, Winter Park, Florida 32790.

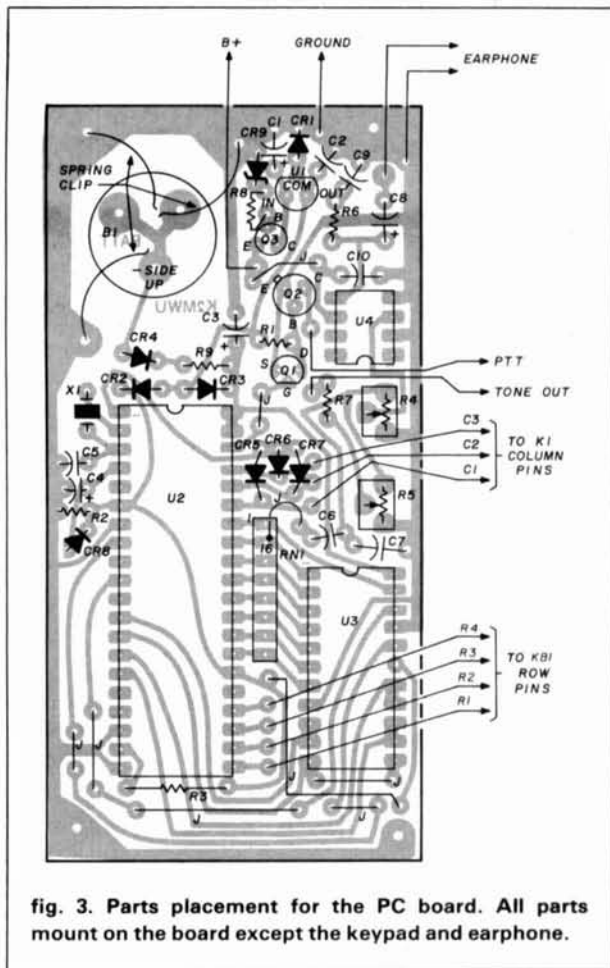

fig. 3. Parts placement for the PC board. All parts mount on the board except the keypad and earphone.

contact other components. And beware of static discharges when handling U2 and U3; they're both CMOS chips.

Most components mount as shown. However, the battery and resistor network require some additional work to install them on the board. The network comes in a 16-pin DIP package but only nine of its pins are used in this circuit. To simplify the PC pattern only one edge of the network is attached to the board. Pins 1 through 8 are soldered in place and bent such that the network is perpendicular to the surface of the board. Pins 9 through 15 are cut off, and pin 16 is connected to the board with a short jumper.

Fig. 4 shows how the battery is held in place using common nickel-plated safety pins fashioned into spring clips. The head and point of three pins are cut off and the pins soldered to the board. Some heat-shrink tubing should cover the portion of the pins closest to the board to keep the edge of the battery from shorting out to them. If desired, eliminating the middle pin at the corner of the board will make it easier to insert and remove the battery.

Another three holes on the board under the battery are used for soldering either eyelets, short pieces of bus wire, or small screws. They should project slight-

ly above the surface of the board to make contact with the "+" side on the battery. The battery will be held against them by the spring clips.

Any standard 12-digit Touch-Tone[®] keypad that connects a row and column together whenever a key is depressed (called matrix switching) can be used for KB1. I used a discontinued Chomerics keypad purchased on the surplus market. The PC board was sized to fit neatly in the LMB Crown Royal case listed in the parts list. The earphone mounts in the small metal box too; just drill a hole and glue the earphone behind it.

interfacing to your rig

Other than the keypad and earphone, the only connections to the board are for power, ground, PTT and tone output. Power should come from a switched line in your rig that carries 12 - 15 VDC. The cable connecting the dialer to the rig should have a separate ground lead in addition to a shielded lead for the tone output line. Ground the shield at one end only, not at both.

Resistor R7 is used to attenuate the tones from the

dialer to match the requirements of your rig. Its value must be carefully selected. If too small, tones can get through to your rig due to crosstalk, even with R5 turned down to zero. This won't occur if R7 is large enough. When tones just begin to cause over deviation at the maximum setting of R5, R7 is at the right value. Use the # digit to check this because it generates the greatest deviation of any Touch-Tone® pair.

As examples, consider my two FM rigs. Touch-Tone® signals connect to the microphone input in both. In one, the 500 ohm microphone is always connected across the mike input, whether or not the PTT button is depressed. That means the dialer sees a load of 500 ohms. I found that 75K for R7 worked out just right. In my other rig the microphone impedance is 10K. There, the best value for R7 turned out to be 2.2 megohms. If your situation isn't covered by these two examples, experiment with R7, starting with a value that's 150 times the load impedance seen by the dialer.

programming and operation

Table 1 lists all the operations of the dialer and provides room for writing in programmed telephone numbers. Note that a # precedes every programming operation, while a * precedes an auto-dialing operation.

Let's cover manual dialing first. Pressing any key brings up the PTT line and outputs the Touch-Tones®, unless the first digit is a * or #. In that case, the * or # must be pressed *twice* to tell the dialer that no address or programming follows. The first of this double keystroke produces a special tone that's not transmitted, while the second one produces the normal * or # tones. After the last digit, the PTT line stays on for two seconds, at which time a warning

table 1. Chart of dialer programming instructions and list of addresses (telephone numbers) aids mobile operation.

TO DIAL	TO PROGRAM	DIGITS																				
		1	2	3	4	5	6	7	8	9	0	1	2	3	4	5	6	7	8	9	0	1
#	LAST NO.	X	X	X	X	X	X	X	X	X	X	X	X	X	X	X	X	X	X	X	X	X
#1	#1																					** (OPTIONAL END)
#2	#2																					
#3	#3																					
#4	#4																					
#5	#5																					
#6	#6																					
#7	#7																					
#8	#8																					
#9	#9																					
#01	#01																					
#02	#02																					
#03	#03																					
#04	#04																					
#05	#05																					
#06	#06																					
#07	#07																					
#08	#08																					
#09	#09																					
#0#	#0#																					
#0#	#0#																					

MANUAL DIALING—IF FIRST DIGIT * OR #, PRESS TWICE

PROGRAMMED PAUSES FOR ACCESS CODES (TAKES ONE DIGIT STORAGE)

#8	3 s.	PTT DROPPED	—
#9	3 s.	PTT DROPPED	UP-SPEED
#0	2 s.	PTT ON	UP-SPEED

PROGRAMMED SPEED:

SPEED	TO NE ON	TO NE OFF	RATE
#1	80ms	40ms	8.3/sec.
#2	80ms	80ms	6.3/sec.
#3	160ms	80ms	4.2/sec.
#4	160ms	160ms	3.1/sec.
#5	300ms	140ms	2.3/sec.
#6	300ms	300ms	1.7/sec.
#7	600ms	300ms	1.1/sec.
#8	600ms	600ms	0.8/sec.

tone sounds. (That tone won't be transmitted, either.) Any sequence of digits dialed before the warning tone can be redialed automatically by pressing * #.

Programming a telephone number is also simple. Key in the #, followed by the address, followed by the telephone number. Twenty-one addresses are available, consisting of the digits 1 through 9, and the combinations 01 through 0#, 00 excluded. You have two seconds to go from one digit to another before the warning tone sounds, indicating the end of programming for that number. (The end of the number can also be denoted by keying in # *, as shown on the first line in the table.) During programming, address digits produce special tones to distinguish them from the telephone number digits being stored. If the # is one of the digits to be stored, it must be keyed twice, just as before.

Any one of eight dialing speeds can be programmed from the keypad. Generally, telephone lines will accept the dialer's top speed, but many repeater autopatches need to be accessed at a slower rate. Rather than slow everything down, the dialer can be programmed to dial an access code slowly, and the telephone number fast. That's accomplished with the pause feature.

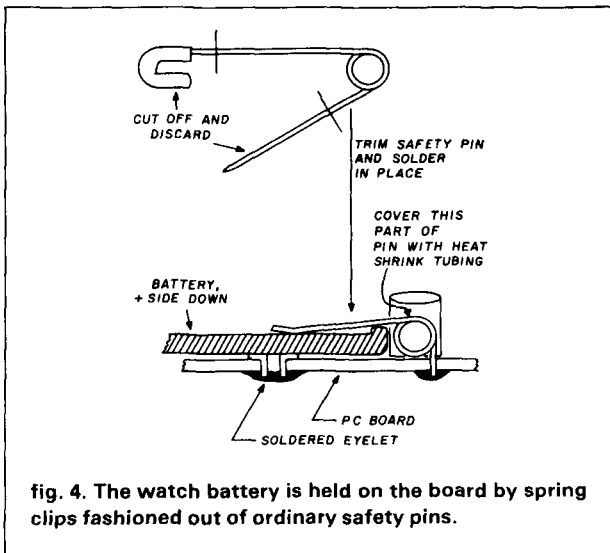

fig. 4. The watch battery is held on the board by spring clips fashioned out of ordinary safety pins.

The T.E.L. Model CS-1100 Total Communication System.

AT LAST! There is a state-of-the-art CW/RTTY/ASCII communications system that meets the sophisticated operator's demands for a quality product.

Feature	Benefit
CMOS uprocessor based.	No RFI problems.
Membrane Switch front panel.	Insures reliability.
16 chr Intelligent LED display.	Readable to 12 feet.
Super Narrow Filters.	No tuning required.
Built-in 110 VAC supply.	No extras to buy.
500 chr Buffer (all modes).	Review received text.
Parallel Data Port.	Connect to any printer or computer.

CW Operation: Send/Rcv 5-90 wpm with Automatic Speed Tracking, Four-99 chr memories with ability to insert text, will key any rig.

RTTY/ASCII: Receive at 60, 67, 75, 100 wpm and 110, 300 Baud with One Button Speed Selection.

A 30 day unconditional guarantee and 1 year parts/labor warranty assure satisfaction. Dealer inquiries invited.

Send for a free data package and comparison sheet.



Random Access Inc.
P.O. Box 61117 Raleigh, N.C. 27661

✓ 192

HAL-TRONIX, INC.

HAL 2304 MHz DOWN CONVERTERS (FREQ. RANGE 2000/2500 MHz)
2304 MODEL #1 KIT BASIC UNIT W/PREAMP LESS HOUSING & FITTINGS... \$19.95
2304 MODEL #2 KIT (with preamp)... \$29.95
2304 MODEL #3 KIT (with High Gain preamp)... \$39.95

MODELS 2 & 3 WITH COAX FITTINGS IN & OUT AND WITH WEATHER-PROOFED DIE CAST HOUSINGS

BASIC POWER SUPPLY... \$19.95
POWER SUPPLY KIT FOR ABOVE WITH CASE... \$24.95

ANTENNAS & OTHER ACCESSORIES AVAILABLE. SEND FOR MORE INFO.



2100-2500 MHz

*AMR-II COMPLETE UNIT
COMPLETE SYSTEM AS SHOWN. NOT A KIT. INCLUDES A PC BOARD, POWER SUPPLY, CABLES & CONNECTORS—PRE-ASSEMBLED AND TESTED. 24dB GAIN OR GREATER.

BUY YOUR FIRST UNIT AT \$99.95
3 OR MORE UNITS AT \$89.95 ea.

*HAM MICROWAVE RECEIVER

NTSC RF Modulator with saw filter... kit \$19.95
(for use with computers, satellite systems and interfacing)

Cabinet, power supply and hardware... \$12.95

HAL Proximity Keyer... \$19.95

HAL 1.2 GHz Prescaler built and tested... \$69.95

PRE-AMPLIFIER

HAL-PA-19 WIDE BAND PRE-AMPLIFIER, 2-200 MHz BANDWIDTH (-3dB POINTS), 19dB GAIN FULLY ASSEMBLED AND TESTED \$8.95

HAL-PA-1.4 WIDE BAND PRE-AMPLIFIER, 10 MHz TO 1.4 GHz, 12dB GAIN FULLY ASSEMBLED AND TESTED \$12.95

HAL-PA-2.1 GHz 2 STAGE PRE-AMPLIFIER, DESIGNED FOR 2304 DOWN CONVERTER. MADE TO PIGGIE-BACK ON THE 2304 BOARD. OFFERS 20dB GAIN. ALSO HAS AN IMAGE REJECTION FILTER. FULLY ASSEMBLED AND TESTED \$34.95

SHIPPING INFORMATION: ORDERS OVER \$25 WILL BE SHIPPED POST-PAID EXCEPT ON ITEMS WHERE ADDITIONAL CHARGES ARE REQUESTED. ON ORDERS LESS THAN \$25, PLEASE INCLUDE ADDITIONAL \$2.50 FOR HANDLING AND MAILING CHARGES. SEND 20¢ STAMP FOR FREE FLYER.

HAL-TRONIX INC.

P.O. BOX 1101
SOUTHGATE, MICH. 48195
PHONE (313) 285-1782



"HAL" HAROLD C. NOWLAND
W8ZXH

✓ 149

As shown in the table, there are three types of pauses that can be programmed anywhere in a stored number. If the up-speed option is selected, the digits before the pause will be dialed at whatever speed the dialer is programmed for, but digits after the pause will go at top speed. The idea is to set the dialing speed slow enough to access the autopatch, and use an up-speed pause to send the rest of the number quickly.

When any number is autodialed, the PTT line is keyed one second before the number starts dialing. This also holds true when dialing resumes after a pause. This compensates for any delays introduced by mechanical switching in your rig or repeater.

Note that of the twenty-one addresses, eleven can store twenty-one digits and the rest, fewer. The table indicates how many may be stored for each. As a reminder, the dialer emits a unique tone when you enter the last digit an address can store. Since the dialer holds so many numbers, I suggest you make a photocopy of **table 1**, fill it in, and keep it near the dialer as a record of what you've programmed.

conclusion

The only real drawback to the MD-22 is the absence of the fourth Touch-Tone® column. For most Amateurs that's not likely to be a problem. The real problem is driving with your eyes on the road and keying in ten digits to make a patch call. That's where the dialer serves its purpose well.

references

1. Alan Lefkow, K2MWU, "A Portable Touch-Tone® Auto-Dialer," *ham radio*, August, 1982, page 12.
2. CES Inc. See parts list.
3. R.A. Reiss, K1HOP, "Low-Power Keyer and Interface," *ham radio*, February, 1983, page 68.

ham radio

Great Novice Gift Idea

HOW TO TROUBLESHOOT & REPAIR AMATEUR RADIO EQUIPMENT

by Joseph J. Carr, K4IPV

Not everyone is lucky enough to have someone to teach them the basics of troubleshooting. For many of us the only way to learn was by trial and error. Joe Carr has put in one comprehensive guide, a complete step-by-step program on how to troubleshoot electronic equipment. Chapters include how to use simple test equipment like the voltmeter and ammeter and the more complex kinds of equipment like the oscilloscope. You also get plenty of helpful hints, the kind you can only get from someone who knows how to repair broken gear. Fully illustrated to help insure that you understand what you are doing.
©1980.

☐ T-1194

Softbound \$9.95

Please add \$1.00 for shipping and handling.

Ham Radio's Bookstore

Greenville, NH 03048



hy-gain[®] V Series Antennas

More ERP* for your Repeater

Hy-Gain V Series antennas focus the omnidirectional pattern evenly at the horizon, without high angle lobes or horizontally polarized content. By concentrating the power at the horizon you get cleaner transmissions over longer distances, improved communications in valleys and reduced picket fencing of the signal between tall structures. A Hy-Gain V antenna is like adding an amplifier and receiver pre amp. And, because antennas which "talk" louder, also "hear" better, a V Series antenna is also ideal for your home QTH.

Extended double zepp V Series antennas consist of two stacked .64 wave vertical sections in phase. Two sets of 1/4 wave radials decouple the antenna from the mast and feed line so all RF goes into the antenna and is not radiated by the coax. The feed line connects through the lower section to the center matching coil. This not only provides weather protection for the connector (SO-239 connectors for V2, V3. Type N connector for V4) but also places the entire antenna at dc ground to reduce lightning hazard and QRN.

V Series antennas are easily assembled in one hour or less. Rugged and maintenance free, they're made of seamless, corrosion resistant 6063-T832 aluminum and all critical hardware is of passivated stainless steel. They'll withstand winds of 100 mph (160 km/h). V models accept mast diameters up to 2" (50 mm) so you can readily mount a V above your HF antenna.

Since a Hy-Gain V Series antenna costs only a fraction of a re-tuned landmobile antenna, you can now realize the *full* potential of your communications with the *repeater* or your home station, economically.

For unbiased information ask any of several thousand V2 users or read the product review in QST May '82 or Amateur Radio Profiles Vol. 2, No. 3.

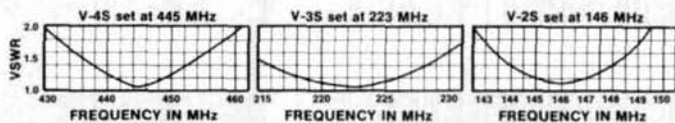
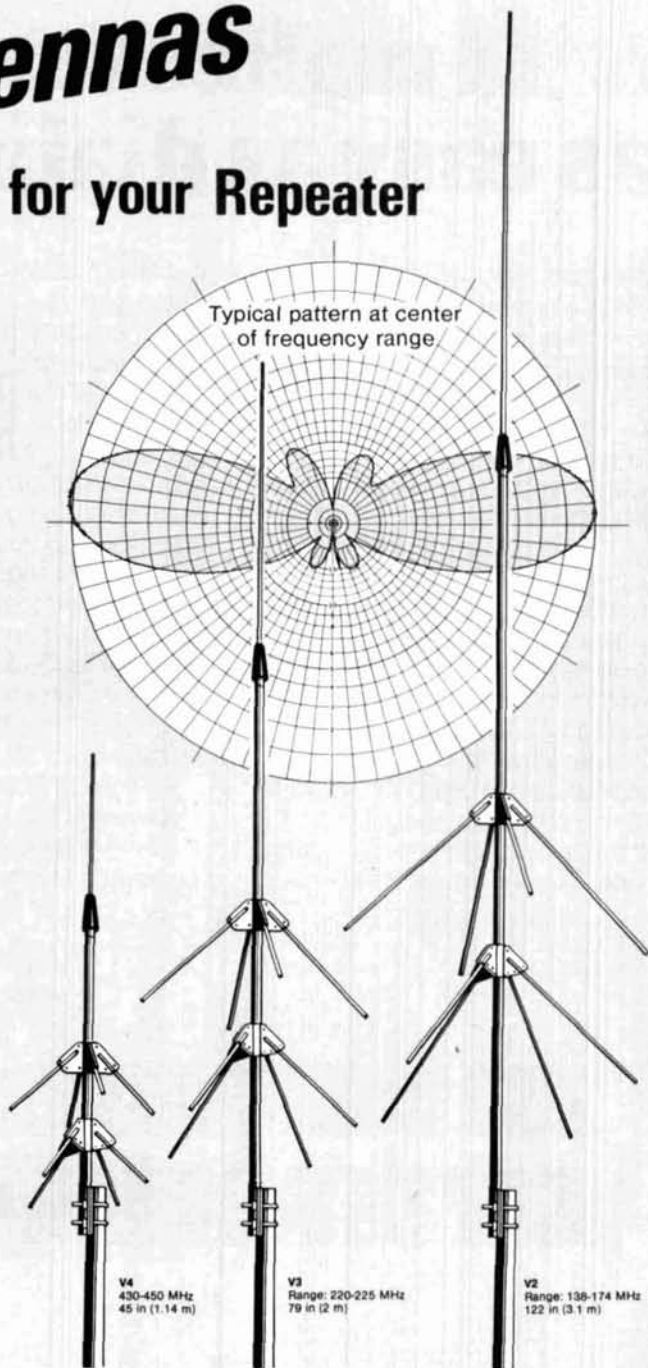

V Series antennas cover the entire band with VSWR below 1.5:1. Broadband characteristics insure optimum repeater performance on both input and output frequencies.

*Effective Radiated Power

TELEX hy-gain[®]

TELEX COMMUNICATIONS, INC.

9600 Atarck Ave. So., Minneapolis, MN 55420 U.S.A.
Europe: Le Bonaparte - Office 711, Centre Affaires Paris-Nord, 93153 Le Blanc-Mesnil, France



The Bearcat® DX1000 makes tuning in London as easy as dialing a phone.

Direct access keyboard tuning brings a new level of simplicity to shortwave radio. With the *Bearcat® DX 1000*, dialing in the BBC in London is as easy as dialing a telephone. And you can switch from the BBC to Peruvian Huayno music from Radio Andina instantly. Without bandswitching.

Featuring the innovative microprocessor digital technology made famous by *Bearcat* scanner radios, the *DX 1000* covers 10 kHz to 30 MHz continuously, with PLL synthesized accuracy. But as easy as it is to tune, it has all the features even the most sophisticated "DXer" could want. 10 memory channels let you store favorite stations for instant recall—or for faster "band-

scanning" during key openings.

The digital display measures frequencies to 1 kHz, or at the touch of a button, doubles as a two time zone, 24-hour digital quartz clock. A built-in timer wakes you to your favorite shortwave station. Or, it can be programmed to activate peripheral equipment like a tape recorder to record up to ten different broadcasts—any frequency, any mode—while you are asleep or at work.

The *DX 1000* also includes independent selectivity selection to help you separate high-powered stations on adjacent

frequencies. Plus a noise blanking system that stops Russian pulse radar interference.

There's never been an easier way to hear what the world has to say. With the *Bearcat DX 1000* shortwave radio, you have direct access to the world.

For the name of your nearest retailer dial toll-free... 1-800-SCANNER.



Frequency Range: 10 kHz to 30 MHz continuously. **Tuning:** Direct keyboard entry, selectable 3 or 24 kHz per revolution knob tuning, or manual step tuning in selectable 1-99 kHz steps. **Sensitivity:** 1.0 μ V AM, 0.5 μ V CW/SSB/FM, 1.6-30 MHz. **Image and IF Rejection:** 70 dB or more. **Memory:** 10 frequency capacity. **Frequency Stability:** Better than 100 Hz after warm-up. **Modes:** AM/LSB/USB/CW/FM. **AGC:** Selectable Fast/Slow release times. **Filter Bandwidths:** 2.7 kHz, 6 kHz and 12 kHz. **Filter Selection Independent of Mode.**

Bearcat® DX 1000 shortwave radio.

Direct Access To The World.

✓ 138



Electra

Electra Company
Division of Masco Corp. of Indiana
300 East County Line Road
Cumberland, Indiana 46229



Cards and plaque courtesy W6TC

EIMAC's new DX champion! The 3CX800A7.

Varian EIMAC continues to commit its development of reliable tubes for HAM radio.

The new, rugged 3CX800A7 power triode provides 2 kW PEP input for voice service or 1 kW cw rating up to 30 MHz. Two tubes will meet the new, higher power ratings authorized by the FCC.

Designed for today's low profile, compact linear amplifiers, the 3CX800A7 powerhouse is only

2½ inches (6.35 cm) high. Cooling requirements are modest and a matching socket, air chimney and anode clamp are available.

A data sheet and more information is available from Varian EIMAC. Or the nearest Electron Device Group sales office. Call or write today.

Varian EIMAC
301 Industrial Way
San Carlos, California 94270
Telephone: 415-592-1221

✓ 210



Call TOLL FREE 1-800-238-6168

(In Tennessee, Call 901-683-9125)

For The Deal You Want—On The Brands You Know!



**WE
TRADE!**



Call Marshall!

AUTHORIZED DEALER FOR: Kenwood, ICOM, Drake, Ten-Tec, Mirage, MFJ, AEA, B&W, Astron, Hustler, Cushcraft, Larsen, Hy-Gain & Santec. PLUS CURRENT USED GEAR.

Deal with M.A.E. and Have A Good Day!

Memphis Amateur Electronics

1465 Wells Station Rd., Memphis, TN 38108

Monday-Friday, 9-5
Saturday 9-12 (Central Time)

More BLOCKBUSTER BARGAINS!!

Parallel, TTL Input I/O "Selectric"® TYPEWRITER / PRINTER

TESTED AND OPERATIONAL!



Removed from working systems, these fantastic machines have built-in driver and decoder circuitry and take TTL level, 6-bit character, plus 4-bit function input signals. Easily driven by most any micro. Use as a typewriter (with add'l repeat circuitry) or as a KSR I/O printer or both. Requires 115 60Hz for typewriter motor, 5 VDC for TTL and 24 VDC for solenoids. Table Top style case. Each "Selectric" I/O machine is complete and in operational condition. Includes schematics, data case, platen and ribbon.

\$329.00 ea.

Type Element \$21.00ea.

I/O Selectric

Add \$20 for Packaging and Handling. Pay shipping on Delivery.

SAVE!!! Untested version of the above, otherwise whole & complete. May require some service. **\$279.00 ea.**

Diablo Daisy Printer Hi-Type II



1355-WP Word Processing Daisy Printer

- Pre-owned, TESTED & Operational!
- Uses Xerox Metal Wheels or Plastic Wheels
- Original OEM Interface (Diablo Interface)
- Requires ±15V (or 5A & 5VDC, or 5A)
- Positional access to 1/120 "Horiz." 1/48 "Vertical"
- USED BY XEROX, WANG, & OTHERS.
- Heavy Duty Printwheel Motor and 15" Frame

These fabulous daisy printers feature 35-40cps, 10 & 12 pitch as well as proportional space, and plotter capabilities. Only a power supply and interface are required for full printer capability. Fully tested and operational, ready to configure for the interface of your choice. Platen and I/O data included.

- Forms tractor for the above \$ 99.00
- Spare P.C. Board Set (6 P.C. Cards) \$279.00
- Spare Printwheel carrier assembly \$329.00
- Serial & Parallel Interface for Above \$295.00
- Power Supply \$ 79.00

**Just
\$549.00 ea.**

Add \$15.00 for Packaging and handling

We Offer New & Used FLOPPY DRIVES, DISK DRIVES, PRINTERS & MORE at BARGAIN PRICES!!

Write or Call for Our Latest Flyer NOW!!!

Scientific is a registered trademark of IBM Corporation.

131

**Computer
Products &
Peripherals
Unlimited**

WAREHOUSE: 18 Granite St., Haverhill, Mass. 01830
MAIL ORDERS: Box 204, Newton, New Hampshire 03858

617/372-8637

Sorry No Collect Calls
MasterCard & VISA Accepted



**NEW
FROM
LUNAR**

HIGH PERFORMANCE COMMERCIAL QUALITY UHF/VHF CONVERTER KITS



Professionally engineered using the high performance DBM, these kits are designed with the active VHFer in mind. All parts, components and circuit board are of the highest quality. Gold plated case ensures circuit integrity. Each kit includes easy-to-read, fully illustrated instructions. VHF units use crystal control. UHF converters are tunable. Crystal control UHF models available soon. In the unlikely event of construction problems, complete factory back-up assistance is available from trained technicians.

Typical Specs:

Input freq.	144 MHz
image rejection	-65 dB
LO specs	+7-10 dBm output
Conversion gain	15 dB
Noise fig (tuned min. N.F.)	1.75 dB
Noise fig (tuned max. gain)	2.4 dB
Harmonics	-50 dBi

MODEL	INPUT FREQ	OUTPUT FREQ	PRICE
RCK 6/10	50	28	\$39.95
6/2	50	144	39.95
2/10	144	28	39.95
2/6	144	50	39.95
1.3/10	220	28	39.95
1.3/6	220	50	39.95
1.3/2	220	144	39.95
ATV	439	60	34.95
ATV P	439	60	39.95

Crystals for VHF models available

\$14.95 ea.

Other frequency conversions available. Specify requirements.

170



2775 Kurtz St., Suite 11,
San Diego, CA 92110



time and frequency standards: part 2

Multiple-frequency VLF techniques offer extreme accuracy

In part 1 (November) the atomic (non-quartz oscillator) frequency standards by which time and frequency measurements are made were identified; individual VLF comparison techniques used in the precise determination of each were examined. In part 2, the methods by which frequency standard oscillators are compared against precise (usually atomic) house standards such as the rubidium and cesium standards covered in part 1 are discussed, and multiple VLF techniques, typically used in navigation, which allow for time and frequency determinations to submicrosecond accuracies, are described.

comparing frequency standards

Since all aspects of determining time are usually based on the accuracy of an oscillator, let's see first how we can measure the absolute accuracy of oscillators. To be useful, any method for comparing oscillators against an atomic frequency standard must be able to resolve extremely small frequency differences. The following is an examination of five methods for doing this. The first two methods use an oscilloscope, while the last three methods use a period-measuring technique.

Lissajous patterns

Two frequencies can be compared by examining the Lissajous pattern that results from their introduction on an oscilloscope's horizontal and vertical

inputs, respectively (fig. 1). If the two frequencies form an integer ratio (a whole number), then the pattern will consist of a number of stationary loops in direct proportion to this ratio (see fig. 1).

If the two frequencies are very close to one another, an ellipse results. Slight frequency differences cause this ellipse to roll repeatedly through all orientations from 0° to 360°. If this duration (time of one "roll") is timed, then the difference in frequency is equal to the reciprocal of this time. Consequently, to match the frequency of any oscillator to that of a known standard adjust the oscillator until the ellipse is stationary. This method can be used to provide resolution approaching 1 part in 10⁹.

oscilloscope pattern drift

An oscillator can be compared to a frequency standard by externally triggering the oscilloscope from the standard while a pattern of several cycles of the oscillator output is displayed. (Fig. 2 illustrates this technique.) The ratio of the drift displayed on the oscilloscope is directly proportional to the error frequency of the oscillator under test. Using fig. 2 as a guide, assume that an oscilloscope is used to check the time base in an HP5345A frequency counter against a time and frequency standard such as the HP5065A¹ Rubidium Vapor Frequency Standard.

If it takes 100 seconds for the pattern of two 10 MHz signals, to drift one cycle, then the error is 1 part in 10⁹. Since:

$$\frac{\Delta f}{f} = \frac{0.01}{10^7} = 1 \times 10^{-9}$$

If two 100 kHz signals are being compared and the

By Vaughn D. Martin, 114 Lost Meadows,
Cibolo, Texas 78108

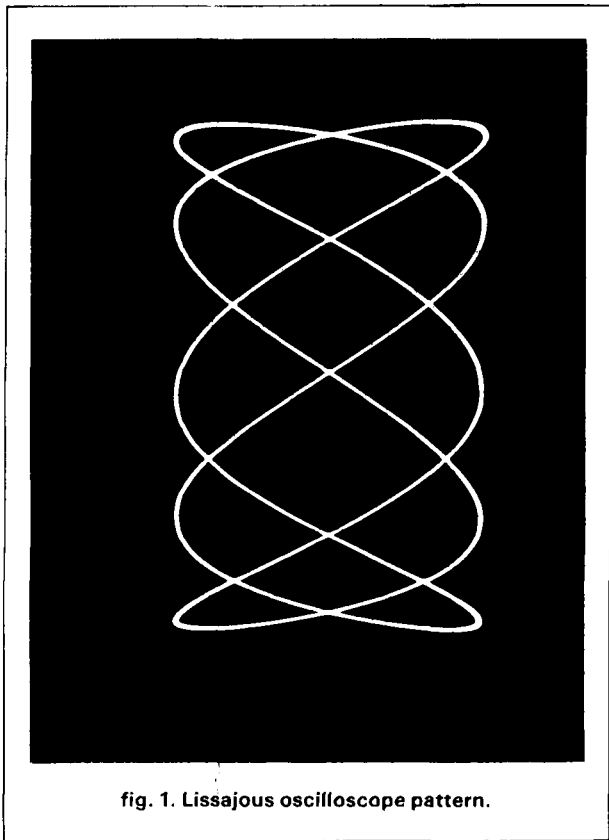

fig. 1. Lissajous oscilloscope pattern.

width of one cycle takes one second, then the frequency error is:

$$\frac{\Delta f}{f} = \frac{1}{100 \times 10^3} = 1 \times 10^{-5}$$

direct frequency comparison with a counter

You may have been wondering, as I used to, how a frequency counter operating on the principle of counting a set number of events during a fixed interval of time (typically one second), could measure a standard crystal oscillator and resolve any minute inaccuracies to a fine degree. After all, a typical frequency counter's timebase itself is far less accurate than the unknown standard crystal oscillator being tested. This "constructive skepticism" goes to the very heart of the issue in that the frequency counter is merely an instrument that takes the difference of two frequencies by having its own internal frequency standard substituted or bypassed by a standard of known accuracy.

As recent as the late 1960's the industry standard frequency was 1 MHz; it is now 10 MHz, with 1 MHz output still available as an option. (This division by ten is easily accomplished by applying the 10 MHz signal to a divide-by-10 IC such as a 74LS90.)

This method substitutes the reference oscillator for the frequency counter's time base to establish the sampling interval or period. Several cycles from the unknown oscillator are counted during this very precisely defined interval. Assume we are measuring a 1 MHz crystal oscillator against a known 1 MHz crystal oscillator standard. The counter's inherent \pm count ambiguity limits the precision to 1 part in 10^6 for a one-second interval or sampling period. A ten-second interval or sampling period increases the accuracy to \pm 1 count in 10^7 . Let us assume we want to resolve the frequency to a very fine degree and have \pm 1 count in 10^{11} as our goal. This would take a sampling period of 27.78 hours or 100,000 seconds.

Since this is not practical, another method has been devised to speed this process. The oscillator under test is frequency translated by a factor of 1,000 to a 1 GHz rate. (This can be done with a phase-locked loop.) What results is not only an increase in the fundamental frequency of 1 MHz to 1 GHz but, also an increase in the errors or deviations from 1 MHz by a factor of 1,000. Magnifying these errors by 1,000 also decreases the sampling period required by a factor of 1,000.

Some counters incorporate electronic counter-heterodyne frequency converters which enable the determination of frequency offset, relative aging characteristics, and fractional frequency comparison of deviations (if the measurement interval is kept below 10 seconds).

In modern frequency counters such as the HP5345A time base substitution by an extremely accurate standard can be effected. The same technique used to determine the crystal's accuracy as outlined in the previous section is used. Error is introduced by:

- 1) least significant digit (LSD) count
- 2) time base inaccuracy (the quality of the standard used)

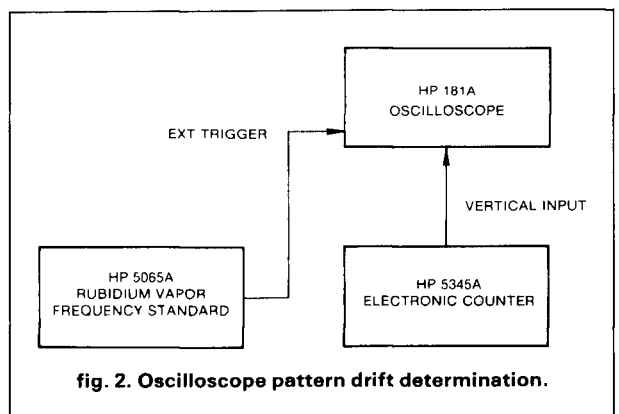

fig. 2. Oscilloscope pattern drift determination.

3) trigger error (start of sampling period)

Trigger error for this specific counter is less than 0.3% divided by the number of periods averaged for a 10 mV input sinewave, with noise specified at 40 dB below the signal level. The setup is shown in **fig. 3**. Let's go through a typical measurement and see how the calculations are done. Returning to our basic equation for error sources:

$$\text{error max} = \pm \text{count} \pm \text{trigger error} \pm \text{oscillator errors}$$

Worst-case conditions for accuracy determination must assume errors as being all in the same direction and cumulative, although in actuality some errors could partially cancel or offset one another.

$$\text{Error Max} = \pm 2 \text{ counts} \pm \frac{0.3\%}{5 \times 10^6} \pm 1 \times 10^{-11}$$

*5 MHz cesium beam standard

$$= \pm 4.61 \times 10^{-9}$$

for a 10 second gate time

$$= \pm 4.7 \times 10^{-10}$$

for a 1,000 second gate time

$$= \pm 0.46 \times 10^{-11}$$

Note how the accuracy is improved or the maximum error minimized as the sampling period increases, as previously discussed.

frequency comparison with a vector voltmeter

This is the last of the five methods of frequency comparison. A phase-sensitive or vector voltmeter is a special type of AC voltmeter with a high input impedance which minimizes the effects of circuit loading. It possesses some special features, including a filter to suppress harmonics and noise from the input source and a phase-sensitive demodulator. This circuit gives the instrument the ability to accept two input signals and determine how closely the unknown input signal's frequency overlaps or coincides in time with a frequency standard used as a reference input.

If the two signals are exactly in phase and at the same frequency, the phase angle generated is zero. As the frequencies depart from one another, the phase angle increases. In our particular case, the two frequencies, that of the standard or reference and that of the unknown frequency being measured, are so close that the angle will be very small. Therefore, a vector voltmeter is used that produces an output voltage in direct proportion to the meter's reading. This small voltage, which usually comes out the instrument's rear panel through a jack, can be ampli-

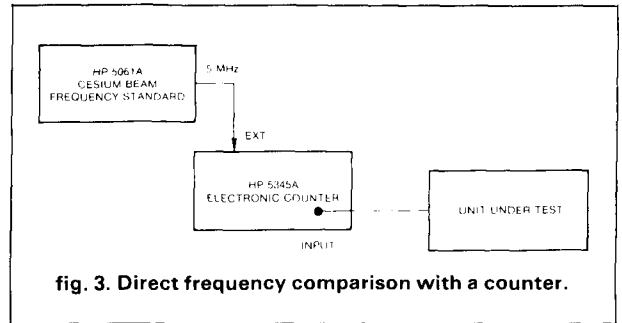

fig. 3. Direct frequency comparison with a counter.

fied and a hard copy recorded on a chart recorder. This method of measurement can resolve differences in frequency to 1 part in 10^{13} in a matter of several minutes. A typical calculation will illustrate this technique:

$$\frac{\Delta f}{f} = \frac{\Delta \theta}{360 t \cdot f}$$

Where:

Δf = frequency difference between the two signal sources (Hz).

f = frequency of the standard source (Hz).

$\Delta \theta$ = phase change in degrees during the measurement time.

t = time, in seconds, during which $\Delta \theta$ was measured.

$\frac{\Delta f}{f}$ = fractional offset of the source being checked.

If our standard and source to be tested both have 10 MHz outputs, and the angle indication of $\Delta \theta$ is 2.5° and the time is 120 seconds, then:

$$\begin{aligned} \frac{\Delta f}{f} &= \frac{2.5^\circ}{360^\circ (120 S)(10 \cdot 10^6 \text{ Hz})} \\ &= 5.78 \text{ parts in } 10^{12} \end{aligned}$$

time comparison systems

Maintaining a consistent local system of time and frequency standards requires that they be compared against one another with a reference being established and maintained. The transfer of time information from one location to another is referred to as "time synchronization," whereas the transfer of data concerning frequency is referred to as "calibration." **Table 1** lists some of the more common methods of accomplishing the transfer of time and frequency data.

Radio broadcasts from frequency and time standard stations are the method most often used to establish the link that maintains this reference. The following is a discussion of both HF and LF/VLF techniques for maintaining local frequency standards

* See fig. 3

table 1. A comparison of time and frequency transfer techniques.

TRANSFER TECHNIQUES	COMMUNICATION/SFR GBR, NBS, WWVL	STATUS (1)	ACCURACY/FREQUENCY SYNCRONIZATION	ACCURACY FOR DATE TRANSFER	AMBIGUITY (4)	COVERAGE FOR STATED ACCURACY	% OF TIME AVAILABLE	RELIABILITY	RECEIVER COST FOR STATED ACCURACY	COST PER CALIBRATION	NUMBER OF USERS THAT CAN BE SERVED	OPERATOR SKILL REQUIRED FOR STATED ACCURACY
VLF RADIO	COMMUNICATION/SFR GBR, NBS, WWVL	O	$1 \cdot 10^{-11}$	$500 \mu s$	PHASE $\sim 50 \mu s$	GLOBAL						
	NAVIGATION SYSTEM OMEGA	O/P	$< 1 \cdot 10^{-11}$	$\leq 10 \mu s$	PROPOSED CODE 1 yr PHASE $\sim 100 \mu s$	GLOBAL			MODERATE			TIME CODE
LF RADIO	STANDARD FREQ BROADCAST (WWVB)	O	$1 \cdot 10^{-11}$	ENVELOPE $\sim 1 \text{ ms}$	1 YR	USA (WWVB) LIMITED			MODERATE			USA (WWVB) EUROPE OTHERS
	NAVIGATION SYSTEM LORAN C	O	$1 \cdot 10^{-12}$	$\sim 1 \mu s$ (GND) $50 \mu s$ (SKY)	50 ms PHASE $30 \mu s$	SPECIAL AREAS						SPECIAL AREAS
HF/MF RADIO	STANDARD FREQ BROADCASTS (WWV)	O	$1 \cdot 10^{-12}$	1000 μs	1 DAY	HEMISPHERE		DEPENDS ON CONDITIONS				
	NAVIGATION SYSTEM LORAN A	O	$5 \cdot 10^{-13}$	2.5 μs NOT UTC	0.5 min	LIMITED AREAS		DEPENDS ON CONDITIONS				SPECIAL AREAS
TELEVISION (VHF/SHF RADIO)	PASSIVE LINE 10	O	$1 \cdot 10^{-11}$ (24h)	$\sim 1 \mu s$	1 DAY $\sim 33 \text{ ms}$	NETWORK COVERAGE	'LIVE' PROGRAMS					USA FOR EXAMPLE
	ACTIVE LINE 1 (NBS TV TIME SYSTEM)	E	$1 \cdot 10^{-11}$ (< 30 min)	$< 100 \mu s$	1 DAY $\sim 33 \text{ ms}$	NETWORK COVERAGE						USA FOR EXAMPLE
SATELLITES (VHF/UHF/SHF RADIO)	STATIONARY SATELLITES (TRANSPONDER) ONE WAY	E/O	$1 \cdot 10^{-11}$ (24h)	10-50 μs	DEPENDS ON FORMAT	HEMISPHERE	STATIONARY					
	STATIONARY SATELLITES (TRANSPONDER) TWO WAY	E/O	$1 \cdot 10^{-11}$ (24h)	$\sim 100 \text{ ns}$	DEPENDS ON FORMAT	HEMISPHERE				MODERATE		
	ON BOARD CLOCK (ACTIVE) ONE WAY LOW ALTITUDE	O	$\sim 1 \cdot 10^{-10}$ (24h)	0.5-50 μs	DEPENDS ON FORMAT	WORLD	10-15 min PER PASS 2-4 PER DAY	CLOCK NEEDS ADJUSTMENT				
SHF RADIO	MICROWAVE	E/O	$\sim 1 \cdot 10^{-11}$ (PER WEEK)	$\leq 100 \text{ ns}$	PHASE COMPARISON	LOCAL LINKS						
	VLBI	P	$5 \cdot 10^{-14}$	$\sim 1 \text{ ns}$	DEPENDS ON FORMAT	HEMISPHERE	AS NEEDED					
PORTABLE CLOCKS	PHYSICAL TRANSFER	O	$1 \cdot 10^{-12}$	100 ns	1 DAY	LIMITED BY TRANSPORTATION	AS NEEDED		NONE			
	AIRCRAFT FLYOVER 2 WAY	E	$1 \cdot 10^{-12}$	$\leq 100 \text{ ns}$	DEPENDS ON FORMAT	LIMITED BY TRANSPORTATION	AS NEEDED					
PULSARS	OPTICAL SIGNAL \rightarrow NP 0532	P	$1 \cdot 10^{-11}$	$\sim 10 \mu s$	$\sim 33 \text{ ms}$	HEMISPHERE	NIGHTTIME					
AC POWER LINE	POWER NETWORK SYSTEM	P	$1 \cdot 10^{-8}$	$\sim 1 \text{ ms}$	16.7 ms	CONTINENTAL USA			MINIMAL	MINIMAL	CONTINENTAL USA	

GOOD FAIR POOR

NOTES: (1) Status of technique indicated as follows: O—Operational; P—Proposed; E/O—Experimental operational. (2) Estimates of day to day measurements within 2000 km (1250 mi) of Loran-A stations. These emissions not coordinated with UTC and manually operated crystal clocks drift. (3) From day to day phase measurements e.g., 1 μs per day phase change approximates 1 pt. in 10^{11} in frequency difference. (4) Left-hand designation gives the shortest time interval that cannot be resolved. Right hand number gives basic ambiguity. ♦, by ground wave 1600 km; by sky wave thousands of kilometers depending upon conditions. ■, with proposed time code. ●, closure after 1 day. ▲, within local service area of TV transmitter and path delay known.

traceable to the NBS (National Bureau of Standards).

HF radio reception

HF radio transmission links suffer from propagation delays that are difficult to determine to better than 1 millisecond because of the changing ionosphere which is continually affected by sunspot, diurnal and seasonal variations. In addition, the number of propagational hops is also difficult to determine for distances greater than 2135 miles (3500 km).

Therefore, to use HF timing signals most effectively in the tick phasing adjustment method, to be explained next, these four recommendations should be followed:

- Select the highest frequency that provides consistent reception.
- Make all measurements in the day or night; avoid twilight or transitional hours.
- Observe tick transmissions for a few minutes to judge propagation conditions. Signals must exhibit minimum jitter and fade.
- Make time comparisons using ticks with the earliest arrival time (shortest propagation distance mode).

time comparison by tick phasing adjustment

This technique (fig. 4) compares local time against

PRIVATE PATCH II



STANDARD FEATURES

- CW identification
- Tone to pulse — no wrong numbers ever!
- Five digit access code — 60,000 code combinations
- Speed dialer compatible
- Sophisticated toll restrict—user programmed digits
- Single chip xtal controlled tone decoder
- Ringback — pages with CW ID
- Busy channel ringback inhibit — will not page if channel is busy
- Operates simplex
- Operates through "any" repeater — no optional tone equipment required
- Three/six minute "time out" timer — resettable from the mobile. Four CW ID warnings during final minute
- Control interrupt timer — assures reliable control
- Glass circuit board — reflow soldered, machine clipped
- Self contained 115VAC supply — 230V 50/60 HZ available at slight additional cost.
- Modular phone jack — and seven foot cord
- One year factory warranty
- 14 day return privilege — when ordered factory direct

CONTACT A DEALER NEAR YOU

AMATEUR ELECTRONIC SUPPLY

Milwaukee WI, Wickliffe OH, Orlando FL,
Clearwater FL, Las Vegas NV, Chicago IL

HAM RADIO OUTLET

Anaheim CA, Burlingame CA, Oakland CA,
San Diego CA, Van Nuys CA

HENRY RADIO

Los Angeles CA, Anaheim CA, Butler MO

JUNS ELECTRONICS

Culver City CA, Reno NV

N&G DISTRIBUTING CORP.

Miami FL

PIZA ELECTRONICS

Ponce, PR

CANADA:

DOLLARD ELECTRONICS

Vancouver, BC

PHILIPPINES:

CORONA INTERNATIONAL

Cubao, Quezon City

Private Patch II is for the discriminating amateur who demands the finest in simplex autopatch performance/quality. Our digitally processed vox and simplex loop create a level of communications quality which is not even closely rivaled. Do not confuse our technique with sampling . . . Private Patch II is totally kerchunkless! Private Patch II will interface with any FM radio in 15 minutes, connects only to the mic and speaker jacks! No options are required for superb performance through "any" repeater!

CUSTOMER FEEDBACK:

Gentlemen:

I received my "Private Patch II" today and immediately put the unit into service. I had to sit down and write to you upon completion because in all the years I have spent as a ham, (27) I have NEVER purchased any piece of equipment that has made so positive an impression on me as has the "Private Patch II."

The unit was delivered to me in less than one week (coast to coast) from the time I mailed my order. It arrived in perfect working condition and proved to be the easiest piece of equipment I have ever had the pleasure of learning to use.

Since putting the "patch" into service, I have had more compliments than I can count. The audio quality is nothing short of SUPERB!! It is hard to believe that you are not actually conversing on a telephone. The VOX control circuitry is probably the best I have ever had the pleasure to use. Its responsiveness is almost instantaneous and when properly adjusted, yields control that is so fine that no words or syllables are lost. The control circuitry was well thought out; the sequences and operational methods chosen have proven to be easy to master and even easier to use in the field than ever hoped for.

I could go on and on . . . the merits of the equipment are many and each feature is "better than the next". Congratulations on the production of one of the best and most useful pieces of gear to come along in quite a while.

Sincerely yours,

Edmund Schneider, K2RCO

Gentlemen:

I received my Private Patch II via UPS today—exactly one week to the day after mailing in my order to you. That's very fast service.

A comment about the Private Patch II: This unit has surpassed my dreams about a simplex patch. I cannot believe how it is like a half-duplex patch. I have run patches before and have never had such ease of installation (about 12 minutes) and such excellent performance. Thank you again for this product!!! Sampling patch manufacturers had better give up because they just cannot compete with this model!

Incidentally, no adjustments were needed to the level pots . . . it worked "right out of the box".

Sincerely,

Richard Norton, WB5FRO

Gentlemen:

Patch works great. Much superior to Sampling Interconnects, the (censored) as an example. Excellent product! Keep up the good work!

Michael Chisholm, KA6DAC



P.O. Box 4155 Torrance, CA 90510

Phone (213) 373-6803

Phone (213) 540-1053

time signals transmitted by an HF standards station such as WWV. The local frequency standard, typically a rubidium standard with a 10 MHz output, has this signal divided down to a frequency of 100 kHz and applied to a frequency divider and clock. This instrument further divides this signal to produce a 1 PPS pulse. These pulses are applied to the external sync of an oscilloscope while the vertical input to the scope is driven by an HF receiver that supplies the WWV ticks. This HF receiver is usually a good communications-quality instrument which can be tuned to the required frequencies (2.5, 5.0, 10, 15, and 20 MHz for WWV). It is preferable to use an antenna

that is directional and is oriented in a manner favorable to the transmission mode consistently providing the shortest propagation path.

The clock incorporates time delay thumbwheel switches to control the start of the oscilloscope sweep by delaying it until the WWV "tick" begins the sweep. By successive adjustments of this control, the two ticks are brought to near-coincidence. The WWV tick is a 5 ms pulse of 1 kHz energy.

The operator must be skillful at determining when the tick arrives. A tick-averaging scheme helps in this regard. An oscilloscope with a variable persistence screen permits the operator to view repeated sweeps of WWV displayed together (see fig. 5). An alternative tick-averaging method is to make an oscillogram using a scope camera. With either method, time comparison readings are possible once the scope's sweep time has been properly calibrated.

LF and VLF compared to HF signals

Variations in the ionosphere ion and electron density versus height cause propagation time of a signal to change continually, refer to fig. 6. This necessitates that the data recorded from stations such as WWV be averaged for days to remove anomalies in the data in order to obtain at best 1 part in 10^8 accuracy — note that WWV signals are stable to 5 parts in 10^{11} as transmitted.

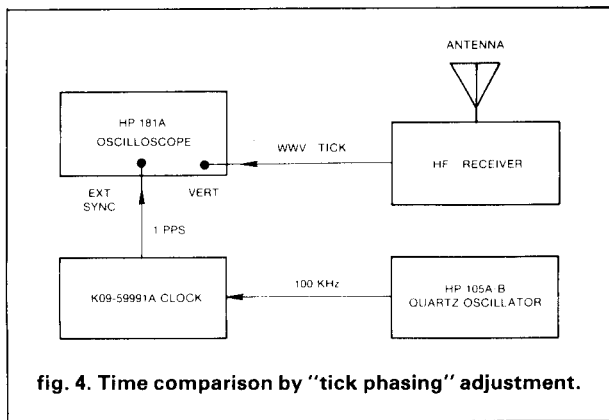

fig. 4. Time comparison by "tick phasing" adjustment.

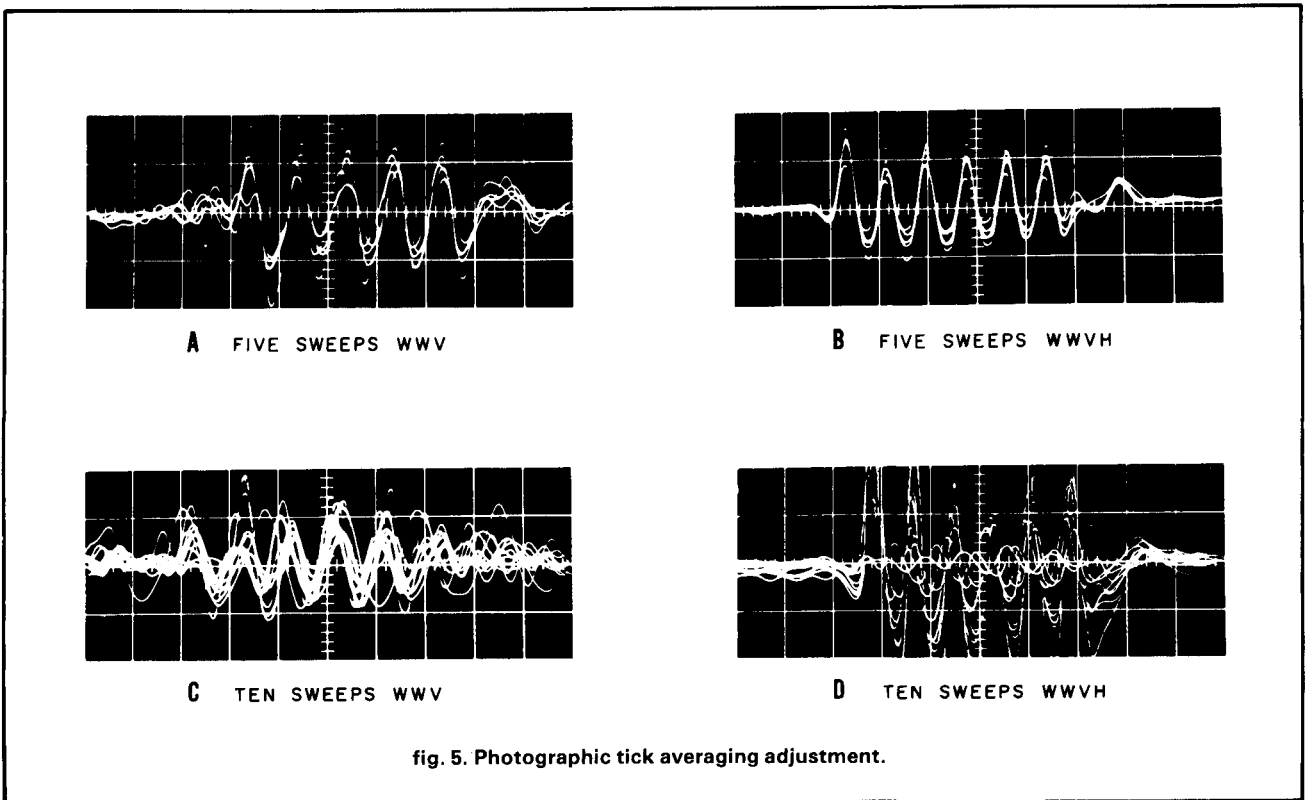

fig. 5. Photographic tick averaging adjustment.

Quality. For Less!



HF linear amplifier PT-2500A

The PT-2500A is a one stage class AB₂ Linear Amplifier using two glass envelope, high performance Eimac 3-500Z power tubes. It is a completely self contained table top unit capable of providing output powers of 1500 watts PEP or 1500 watts CW thus meeting the latest FCC rules. Conservatively designed to assure reliable, stable operation, the PT-2500A is equipped with a pressurized plenum cooling system, providing optimum operation over extended periods of use. The circuit and components have been selected to allow effortless operation under all modes available to the amateur service.

FEATURES

- Designed for SSB, CW, RTTY, AM or ATV operation on the amateur bands between 1.8 MHz and 21.45 MHz (including the WARC bands and MARS operation). May be customer modified to cover 28.0 to 29.7 MHz in accordance with FCC rules.
- Can be supplied for commercial or military use on frequencies outside the amateur bands.
- Quick heating high performance 3-500Z tubes ensure rapid turn-on.
- Continuous duty squirrel cage blower plus optional muffin fan for extreme extended use.
- Pi-L tank circuit for optimum reduction of harmonics.
- Heavy duty 7KV rotary band switch with silver plated contacts.

- A high quality dual section 6 KV plate tuning capacitor maintains constant Q over the full frequency range of operation.
- Pi network input provides excellent match of $\leq 1.5:1$ VSWR to the exciter.
- Grid overdrive protection circuit.
- The power supply features a heavy duty continuous rated plate transformer, a separate filament transformer and computer grade filter capacitors.
- Transient protection provided to all transformers.
- By-pass switch on front panel.
- Adjustable ALC control (up to -30V).
- Dual back-lit meter system monitors all critical circuit parameters.
- Mode switch for optimum operational efficiency.
- Vernier tuning for smooth and accurate settings.
- Safety interlock disconnects AC line voltage when cover is removed.
- Semi break-in. Optional QSK kit available (can be customer installed).



VIEWSTAR INC.
COMMUNICATIONS DIVISION

55 Milner Ave., Scarborough,
Ont. Canada, M1S 3P6
Phone: (416) 298-9919 Telex: 065-26242

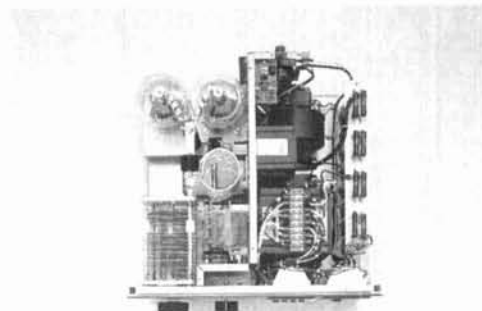
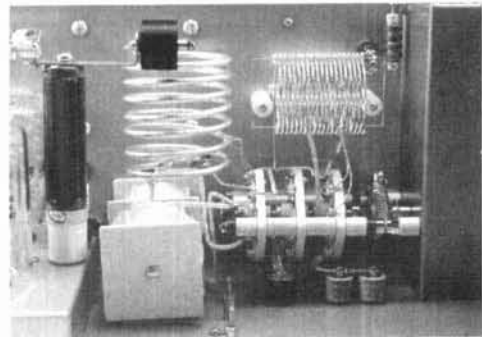
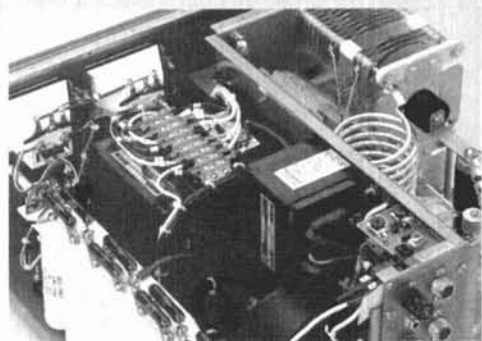



TU-470 WIRED
HOLIDAY SPECIAL \$429.95



TU-300
WIRED \$349.95

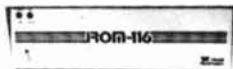

ROM-116 TRS-80 RTTY/CW

- Split Screen Video
- Real Time
- Fourteen Buffers
- Text Editor
- Auto CW/ID
- Selcal, WRU
- Word Wrapping
- For Model I, III, IV
- Many More Features
- Mail Box software available too
- Call for Prices

*TRS-80 Trademark of TANDY CORP.

RTTY

TU-170	TU-170A	TU-300	TU-470	DM-170	TERMINAL UNIT FEATURES
		•	•		3 Shifts (Hi-Tones Standard)
•	•				Single Shift (Hi-Tones)
•	•	•	•		3 Stage Active Filters
•	•	•	•		AFSK Crystal Controlled
•	•	•	•		RS-232C Compatible
•	•	•	•		TTL Compatible
•	•	•	•		FSK Output
				•	Demod Loop Transistor Keying Output
		•			Remote Send RS-232C Compatible
	•	•			Remote Send TTL Compatible
		•			Remote Controlled Bi-Polar PIT output.
•	•	•	•		Autostart AC Output
•	•	•	•		Scope Outputs
•					Meter Tuning
•	•				Bar Graph Tuning
•	•				Status Indicators
•	•				Receive & Send Up To 300 Baud
•					Receive & Send Up To 110 Baud
•					Loop Supply Internal
	•	•			Loop Supply External & Optional
					170 HZ Preselector Filter
					CW Demodulator Standard
	•				CW Demodulator Optional
•	•	•	•		Complete Assembly In Case
•	•	•	•		Board & Parts Only
•	•	•	•		Complete With Connectors



TU-170A
WIRED \$289.95
KIT \$189.95



TU-170
KIT \$149.95



DM-170
KIT \$47.95

For more information & sales
1-800-HAM-RTTY
SERVICE 1-913-234-0198



Flesher Corporation
P.O. Box 976
TOPEKA, KS 66601

Hi we're
Hatry Electronics



AMPHENOL



DAIWA



J. W. Miller



THE ANTENNA COMPANY

Bash Books



Used Equipment



Hatry Electronics

The Elect in Electronics

500 LEDYARD STREET
HARTFORD, CONN. 06114
Phone 203-527-1881



✓ 157

THE SEARCH IS OVER FOR A FULL-FUNCTION DTMF DECODER

The **FASTRAK**® model 2009 Dual Tone Multifrequency Decoder module makes using DTMF signaling as easy as pushing the buttons. Used with a microcomputer or dedicated logic, it allows you to perform almost any control task possible over radio or wire links.

The model 2009 is a full-function decoder which includes such features as: crystal controlled accuracy, on-board voltage regulation, switch-capacitor filters, latched outputs, digital counter detection with period averaging to assure minimum falsing, CMOS technology requiring only 40 mA at 12.5 V dc, and only 1 setup adjustment. Driven by 50 mV to 1 V of audio, the model 2009 decodes all 16 digits and produces 4-bit digital output codes in either binary or row/column format plus a valid code strobe pulse.

One evening assembly using 3.6 x 2.0 inch pc board and comprehensive instruction manual. Bare board with manual, \$9.95; board, manual, filter and decoder chips, \$44.95; complete kit, \$99.95; manual only, \$5.00. All prices include postage in U.S.A. (Ohio residents add 5% sales tax.)



PROHAM ELECTRONICS INCORPORATED
34620 LAKELAND BLVD EASTLAKE OH 44094
(216) 951-2110

✓ 187

Low frequency and VLF signals are far more stable than HF signals. This is because, unlike HF signals, they follow the curvature of the earth and follow a "duct" created by the earth's surface and the ionosphere. Since the earth's ionosphere acts as a boundary rather than as a reflector, as it does with HF signals, its variations have a much less pronounced effect. Therefore, for standard frequency transmissions this more phase stable method is used. When precise timekeeping is of paramount importance, most users still rely though upon the HF service provided by WWV. This is because of two factors: First, information bandwidth characteristics have limited to some extent the use of lower frequency signals for time-of-day and time comparison information. Secondly, to realize very high precision in clock synchronization, a fast risetime signal for a time marker is required; unfortunately the LF/VLF antennas used have large time constants which prevent this from being possible or practically realizable.

LORAN-C using cesium beam standards

Now that we have a better appreciation of the characteristics of sky and groundwaves, let's examine a navigation system that is stabilized by cesium beam standards and is one of the most accurate time transfer media available through radio waves.

LORAN-C (*L*ong *R*ange *N*avigation) is a navigation system used in some parts of the Northern Hemisphere as a method of time and frequency distribution. Operated by the U.S. Coast Guard, this navigation system uses pulsed transmissions on a carrier frequency of 100 kHz with a 20 kHz bandwidth.

The LORAN-C system has the following advantages and disadvantages, respectively:

- 1) The transmitters are controlled by cesium standards.
- 2) Propagation delays of groundwaves still provides ± 0.3 microsecond accuracies.
- 3) The TOC (time of coincidence), to be explained shortly, is provided in advance by the USNO (United States Naval Observatory).
- 4) Equipment costs are reasonable.

The disadvantages are:

- 1) Mixed terrain (sea and land) result in hard-to-predict effects of the propagation delays of skywaves.
- 2) Local clock time must be very exactly known, as will be shown shortly.
- 3) Coverage is not yet global.
- 4) Cycle selection requires a skilled operator.

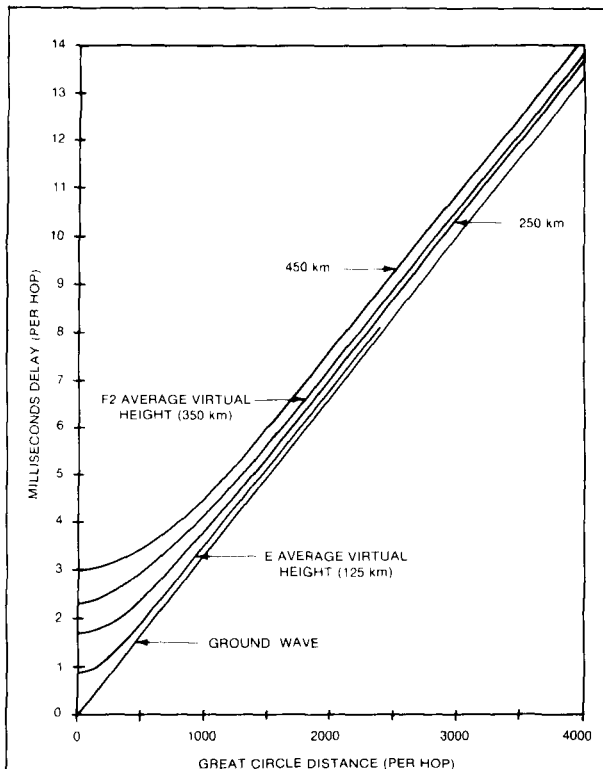

fig. 6. Transmission delay experienced on groundwave, E and F2 layer propagation modes.

time and frequency determination using LORAN-C

This navigation system *does not* broadcast a time code signal. It is therefore necessary to know the time-of-coincidence (TOC) of a LORAN-C signal relative to a UTC (universal coordinated time) second. Each LORAN-C chain transmits a unique format. Within the GRP (Group Recognition Period), which is unique to each chain, the master station transmits precisely spaced groups of nine pulses (fig. 7). Each of the slaves transmits eight pulses within the GRP.

There is only one GRP that will provide a TOC every second. And the period between a pulse coinciding with one UTC second and another pulse-UTC second is a function of the repetition rate of the whole chain. Each chain is assigned a different repetition rate and this and other data typical of this chain can be found in USNO documents.

Figure 8 is a typical system to utilize LORAN-C transmissions for time transfer. This system has a 1 PPS signal used to start a time interval counter with the output of the LORAN-C receiver used to stop the interval counter. The output of the LORAN-C receiver is a 1 PPS signal phaselocked to the received signal and in sync with the TOC. By using the count

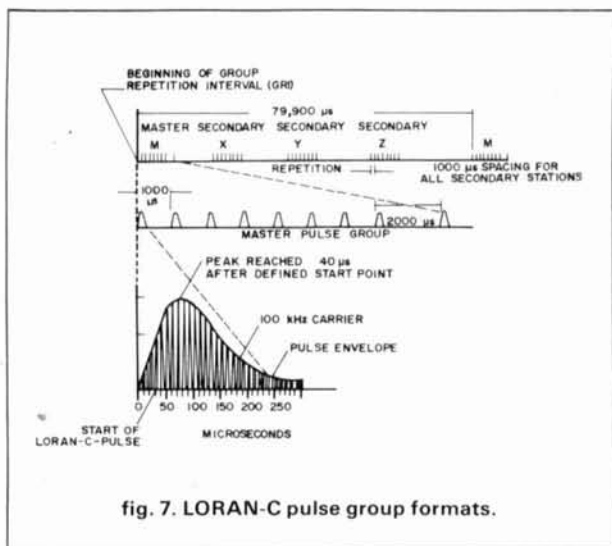

fig. 7. LORAN-C pulse group formats.

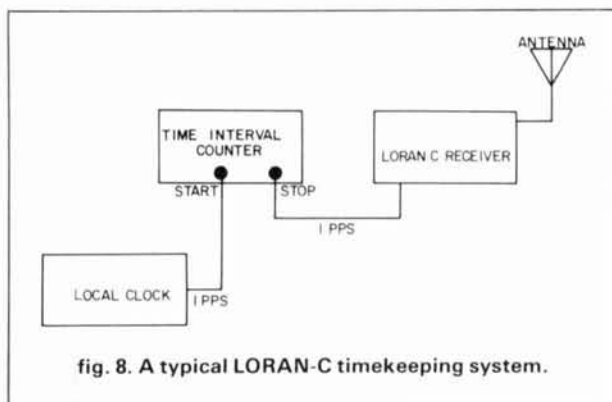

fig. 8. A typical LORAN-C timekeeping system.

on the interval counter in conjunction with USNO published data, you can determine the difference between UTC, USNO, and the local clock.

multiple VLF systems

Single VLF systems, with their less precise clock synchronizations, are unacceptable in highly demanding applications such as LORAN-C and Omega navigation systems. What is required in these instances is submicrosecond accuracies, obtainable only with multiple-frequency VLF techniques which use two or more closely spaced, coherently related, sequentially transmitted signals.

The multiple-carrier VLF techniques function by extracting timing data in the difference frequencies of two carriers. This allows for individual cycle identification of one of the carrier frequencies. Used successfully with WWVL and Omega frequencies, this technique requires signals, transmission media and receiving/comparison equipment that are extremely stable. The system functions by setting coarse time

using an HF radio transmission (link) having an accuracy of several milliseconds which serves to resolve any initial frequency ambiguities. The multiple carrier VLF method includes a local calibration signal for simulating the frequency of the received signal to relate the local time scale to that of the transmitter. Agreement between the received and calibrated VLF phases is made systematically, and the local clock phase-shifter adjusted, until all simulated signal phases are identical to the actual received signal phases for a single setting of the phase shifter. This phase relationship remains essentially unchanged (except for clock interruption and phase loss), and the VLF receiver can be turned off and on without affecting the calibration.

The development of precise time and frequency standards, and the design of equipment to perform extremely accurate tests and measurements, is one of the most promising areas in the field of communications. As satellite communications technology advances, an equivalent degree of progress should be evident in this specialized field.

references

1. Vaughn Martin, "Time and Frequency Standards: Part 1," *ham radio*, November, 1983, page 36.

ham radio

MICROWAVE VIDEO RECEIVER



THE HAM XI



34+ dB GAIN • FREQUENCY 2.1 to 2.6 GHz
 ABSOLUTELY WATERPROOF
 COMPLETE • READY TO INSTALL
 1 YEAR WARRANTY
 \$124.95 — INCLUDES:
 TAX - SHIPPING - HANDLING

SEND CHECK - MONEY ORDER - OR
 CERTIFIED FUNDS TO:
K & S MICRO ELECTRONICS
 1920 WEST GRANADA
 PHOENIX, ARIZONA 85009

FOR LOWEST PRICES ON
 QUANTITY ORDERS CALL:
(602) 253-8605

INDIVIDUAL COMPONENTS AVAILABLE
 FAST-EXPERT REPAIR ON ALL TYPES

AEA Brings You The AMTOR Breakthrough

We are pleased to announce three new AMTOR products. Our new software package that will allow you to operate AMTOR with your CP-1 is called AMTORTEXT™. A complete hardware terminal unit and AMTORTEXT software plug-in cartridge for the Commodore 64 computer is called the MICROAMTOR PATCH™. We also have new applications software packages for the AMT-1 and Commodore 64 or VIC-20 computers.

NEW AMTORTEXT™

AMTORTEXT™ is a LOW COST software package that will allow the CP-1 and Commodore 64 computer to be used as a multi-mode AMTOR TERMINAL. Compare the outstanding FEATURES and PRICE of the AT-64 (AMTORTEXT for Commodore 64) to the competition:

- KEYBOARD OVERLAY instructions (eliminates constant referral to manual)
- STATUS INDICATORS on screen
- Easy to follow MENU
- ARQ, MODE A- MASTER OR SLAVE
- FEC MODE B
- MODE L (LISTEN TO MODE A)
- SPLIT SCREEN with 2000 CHARACTER TYPE AHEAD transmit buffer
- WORD MODE for error correcting with DEL KEY until space or CR is sent
- REMOTE ECHO shows characters transmitted as they are validated by other station
- easy entry of your SELCALL for automatic response to ARQ calls
- BREAK-IN MODE to interrupt sending station
- LTRS/FIGS REVERSE for assistance in MODE L synchronizing
- TEN MESSAGE BUFFERS OF 256 CHARACTERS EACH
- AMTOR timing synced to host computer internal CRYSTAL OSCILLATOR
- PROGRAMMABLE TRANSMIT DELAY can be saved to tape
- AUTOMATIC PTT
- POWERED BY HOST COMPUTER
- includes INTERFACE CABLE for AEA model CP-1 COMPUTER PATCH™.

The AMTOR software TIMING ROUTINES have been written by Peter Martinez, G3PLX (father of AMTOR) which means you can be sure of having NO SYNCHRONIZING problems with other AMTOR stations adhering to the established international AMTOR standard. PROPER SYNCHRONIZATION is an ABSOLUTE must for AMTOR!

NEW MICROAMTOR PATCH™

\$89.95 List \$69.95* C-64 AMTORTEXT



MICROAMTOR PATCH™ is a NEW LOW-COST, HIGH-PERFORMANCE AMTOR SOFTWARE/HARDWARE computer interface package. The MICROAMTOR PATCH (model MAP-64) INCORPORATES AMTORTEXT software (described above) for the Commodore 64 computer. All circuitry and software is incorporated on a single, plug-in cartridge module featuring the following:

- TRUE DUAL CHANNEL MARK AND SPACE MULTI-STAGE 4 POLE, CHEBYSHEV ACTIVE FILTERS
- AUTOMATIC THRESHOLD CORRECTION for good copy when one tone is obliterated by QRM or SELECTIVE FADING
- EASY, POSITIVE TUNING with TRIPLE LED INDICATOR
- NOT a low-cost, easily "pullable" phaselocked loop detector!!!
- SWITCH SELECTED 170 Hz or WIDE SHIFT on receive
- AUTOMATIC PTT
- demodulator circuitry powered by your 12 VDC

supply to AVOID OVERLOADING HOST COMPUTER and for maximum EMI ISOLATION • EXAR 2206 SINE GENERATOR for AFSK output • SHIELDED TRANSCIEVER AFSK/PTT INTERFACE CABLE PROVIDED • FSK keyed output.

The MicroAmtor Patch is structured for easy upgrading to the AEA CP-1 Computer Patch™ advanced interface unit without having to buy a different software package! Simply unplug the external computer interface cable (supplied with the MicroAmtor Patch) from the MicroAmtor Patch and plug it into the Computer Patch.

\$149.95 List \$129* MAP64
\$239.95 / \$199.95* MAP-64/2

The Model MAP-64/2 incorporates the C-64 MBATEXT™ PROM on the same board with AMTORTEXT for low cost RTTY/CW/ASCII/AMTOR operation.

The **AMT-1** is the DEFINITIVE AMTOR TERMINAL UNIT which all future AMTOR units will be measured against. All you need for full AMTOR operation is a dumb ASCII terminal (or personal computer and emulation software) and a normal HF transceiver and antenna. With the AMT-1 you will receive the following features:

- SENSITIVE FM DEMODULATOR
- FOUR POLE ACTIVE RECEIVE FILTER
- TOTAL CONTROL FROM KEYBOARD or by COMPUTER PROGRAM CONTROL
- 16 LED PANADAPTOR TYPE TUNING INDICATOR
- CRYSTAL CONTROLLED AFSK MODULATOR
- RECEIVE/TRANSMIT standard RTTY
- TRANSMIT MORSE CW
- MORSE RECEIVE field installable option
- AUTOMATIC PTT
- 13 front panel LED STATUS INDICATORS
- all METAL ENCLOSURE for maximum RFI immunity
- operates from your 800 ma 12 VDC power source.

\$589.95 List \$499.95* AMT-1



Shown with optional AMT-1 Console Stand, COMM-64 with CRT Monitor and cassette recorder (Not included)

Applications software for C-64 or VIC-20

AEA also offers an applications software package for the Commodore VIC-20 (model AMT-1/VIC20-1) or 64 computer that is resident on a plug-in PROM CARTRIDGE and includes the INTERFACE CABLE to go between the computer and the AMT-1. KEYBOARD OVERLAY instructions are also included for easy operation without the instruction manual. The COMM-64 program (model AMT-1/C64-1) offers SPLIT SCREEN OPERATION with ten MESSAGE BUFFERS. It also offers UNATTENDED OPERATION with automatic MESSAGE RECORDING and AUTOMATIC STATION IDENTIFICATION.

\$89.95 List \$69.95*

*SUGGESTED AMATEUR DISCOUNT PRICE THROUGH PARTICIPATING DEALERS ONLY

PLEASE SEND AEA CATALOG	
Name	
Address	
City	
State	Zip

Advanced Electronic Applications, Inc.

P.O. BOX C-2160 • LYNNWOOD, WA 98036 • (206) 775-7373 • Telex: 152571 AEA INTL

when hazardous waste comes home — PCBs in the ham shack

What's inside
your dummy load?
Knowing the answer
may be important.

So far we at *ham radio* have been lucky: hazardous waste has usually been a matter of concern for somebody else. Because we didn't live near the Love Canal, or along the 210-mile stretch of North Carolina highway poisoned by a "moonlight dumper," there seemed to be time and room for complacency.

But within recent months, two public wells near *ham radio's* office — one fifteen miles east, the other fifteen miles west — were added to the EPA list of over 500 contaminated sites eligible to compete for \$1.6 billion in "Superfund" money. Even closer to home, reports in the Amateur press have pinpointed dummy loads as a potential source of PCB contamination in the hamshack.

CDC warning

Katherine Hevener, WB8TDA, called attention to the possible hazard in the May 15 issue of *New England Report/Crossbander*:

...According to CDC Public Health Advisor David Forney, the potential danger from the dummy loads could come from a type of transformer oil containing polychlorinated biphenyl (PCB), a substance known to cause liver damage in humans and animals. Fifteen samples of transformer oil will be taken from dummy loads in Houston, Atlanta, St. Louis, Denver, Columbus (Ohio), and Boston. ...Although hams should not panic, Forney urges those con-

cerned to take precautionary measures, such as using dummy loads in well-ventilated rooms, and preventing the possible PCB-contaminated transformer oil from vaporizing.¹

When we called Forney for an update in early September, he was careful to note that these precautions apply even to *non-leaking* dummy loads — loads without visible defects and functioning without apparent cause for concern — which could release invisible airborne PCBs when they overheat. Consequently, it's important to give your dummy load a rest. *Don't let it overheat:* inhaled PCBs may be as dangerous as PCBs that are ingested or absorbed through the skin. *Follow the rating curve (fig. 1) for your dummy load;* one should be found in your copy of the owner's manual for the model you have. If you don't have a rating curve, get a copy from the manufacturer.

According to Forney, *leaking dummy loads require immediate attention.* A leaking canister — regardless of how slight the leak — suggests the immediate possibility of direct absorption through the skin, regardless of whether the dummy load is in use or not.

Don't risk handling a leaking dummy load until you know what's in it.

what's inside?

If your dummy load was sold with oil already in it, contact the manufacturer to determine whether or not it was filled with transformer oil containing PCBs. Obviously, if you built your dummy load from a kit and installed your own oil, you know whether it contains mineral oil or transformer oil. If it's mineral oil, there's no cause for concern beyond the knowledge

By Dorothy Rosa Leeds, assistant editor, *ham radio*

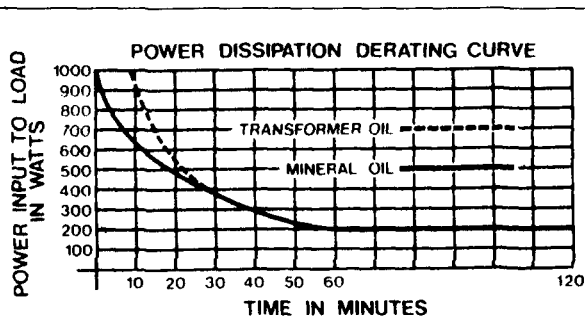

fig. 1. Rating curves for Heathkit Cantenna (Model HN-31A) provide data for dummy load in mineral oil as well as in transformer oil. Since specifications differ, product literature or manufacturer should be consulted for capacity of other dummy loads. (Note: Transformer oils made without PCBs are available: for example, Dow Corning manufactures a silicone-based liquid said to offer excellent dielectric properties, yet be environmentally safe.)

that mineral oil will burn at a comparatively low temperature. PCB oil will not; in fact, it was its excellent thermal and chemical stability, as well as its superior dielectric and insulation qualities that made PCB oil such a resounding commercial success from its introduction in the late 1920s through its decline in the late 1970s.

If your kit-built dummy load contains transformer oil, then identifying its composition may be more difficult. Testing for PCBs, down to the parts-per-million level, can be done in any laboratory with a gas chromatograph and a mass spectrometer, but this testing can be expensive — more than the cost of a new air-cooled or silicone oil-cooled dummy load.

biomagnification

The same qualities that made PCBs a boon to industry have made them an environmental scourge: they simply don't break down into new chemical arrangements. According to a U.S. Navy report, PCBs "biomagnify in the food chain — that is, they accumulate in the tissues of living organisms and as one organism feeds on another, progressively greater concentrations occur as the food chain progresses upward towards man."² Current estimates are that 99 percent of Americans carry a measurable amount of PCBs in their fatty tissues.³ But unfortunately, the human body has no way to break the compound down into its less harmful components.

In structure, PCBs are similar to DDT (see fig. 2). Once contaminated by DDT, the human body requires up to fifteen years to rid itself of the chemical, but this can happen only if no additional DDT is absorbed. The federal ban on DDT in 1972 has effectively controlled this hazard, but despite their struc-

tural similarity to DDT, PCBs are significantly more dangerous, more prevalent and much more difficult to eliminate both from the body and the environment.

advice from the experts

Throughout their nearly 50 years of manufacture, PCBs were used primarily in electrical transformers — including the familiar "pole pig" sometimes acquired for use as a power supply — and capacitors, heat transfer systems, and hydraulic systems. They were also extensively used as plasticizers in paints, inks, adhesives, sealants, caulking compounds, coatings, and in carbonless copy paper, as well as in fluorescent lamp fixture ballasts and in pesticides and weed-control products.⁴

Suppose you've concluded that your dummy load contains, or may contain, PCB's. What then?

Don't put it out with the trash.

Al Hyer, of the EPA public affairs office in Washington, D.C., told us that the individual owner of any suspect device is solely responsible for its disposal, and urged that concerned Amateurs get professional advice before disposing of any questionable dummy load. He suggested calling your state environmental agency first; if an appropriate response and timely

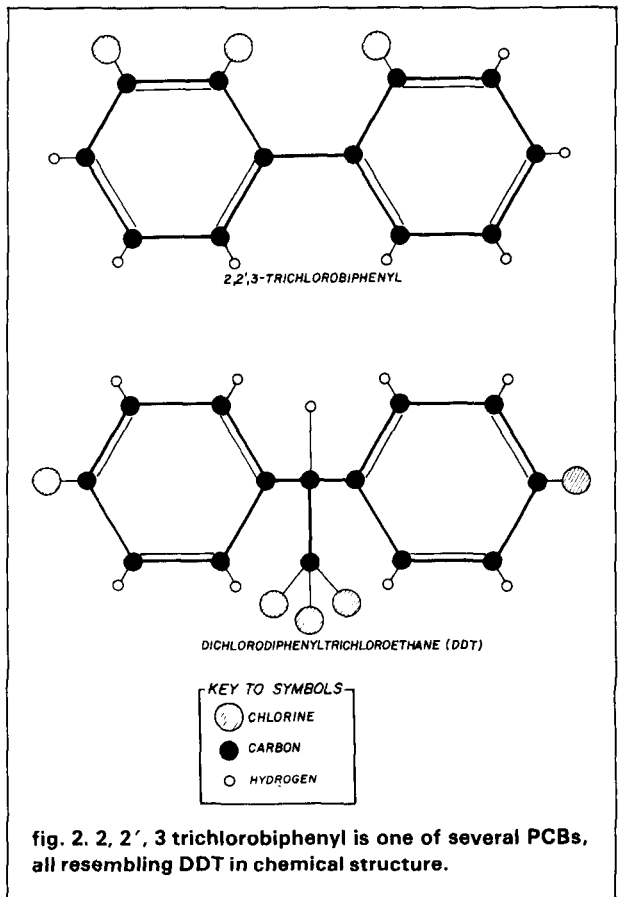

fig. 2. 2, 2', 3 trichlorobiphenyl is one of several PCBs, all resembling DDT in chemical structure.

When two recent American Everest expeditions mounted the Larsen® Kūlduckie® antenna on their radios, it wasn't just because it was there. It was because they knew Larsen performance and reliability would be there when needed the most—even at the top of the world.

Extreme altitude, sub-zero temperatures and unpredictable conditions demand more than most antennas give in a lifetime. For Larsen Kūlduckie antennas, it's all in a day's work.

We design our portable antennas to give more than what's expected. Copper plated radiating elements turn power into stronger communications—not heat. Double-soldered connections at maxi-

mum stress points allow 180 degree bends in all directions. And not one, but two layers of low dielectric loss, heat-shrinkable tubing protect the element, while a top coat of PVC provides a sleek finish.

You can expect more from our service too. Our prompt delivery, personal attention and no nonsense warranty back you up every step of the way.

So whether you're leading an expedition up the face of Everest, or just hiking through the back country, Larsen Kūlduckie portable antennas will keep you on top of the situation with peak performance. We'd be glad to show you how they'll work for you.

Write for our free amateur catalog.

LARSEN IS ON TOP OF THE WORLD



A World Of Difference
In Performance

Larsen Antennas

IN USA: Larsen Electronics, Inc. /11611 N.E. 50th Ave. /P.O. Box 1799/Vancouver, WA 98668 /206-573-2722
Telex 152-813 LARSEN ELC VANC

IN CANADA: Canadian Larsen Electronics, Ltd. /283 E. 11th Ave., Unit 101/Vancouver, B.C. V5T
2C4/604-872-8517 Telex 04-54666 CDN LARSEN VCR

Larsen®, Kūlrod® and Kūlduckie® are registered trademarks of Larsen Electronics, Inc.

✓ 168

assistance are not immediately forthcoming, then the regional office of the EPA should be called (see **table 1**). "Help is available," Hyer said, "and it may not cost a dime."

Another knowledgeable source we contacted was less optimistic about obtaining help from the public sector. Alan Borner, Executive Director of the Environmental Hazards Management Institute, an independent, non-profit educational and consulting firm in Portsmouth, New Hampshire, cited the potential difficulty of calling the attention of a large bureaucratic state agency to a seemingly minor — yet perhaps dangerous — problem. Borner suggested that Amateurs turn to utilities or industries instead of state or federal agencies. "Call the environmental manager for the local public service company," he said. "Try any major chemical corporation or utility. Ask for the national environmental program manager and get his or her advice. These people have been walking through this morass for years."

Public utilities are especially sensitive to PCB questions, Borner noted, because under federal law, owners of potentially hazardous materials are responsible for them. Even though vandals still shoot out transformers for sport, it's the utilities who foot the bill for replacements and any lawsuits that may result.

According to Borner, the number and availability of disposal facilities for PCBs is extremely limited, so disposal, however it is ultimately accomplished, may be complicated by red tape and delay. But if only because PCBs are the only compound specifically singled out for immediate restriction as hazardous in the Toxic Substances Control Act of 1976, their handling and ultimate disposal should be taken seriously.

Another option open to Amateurs seeking to dispose of questionable or contaminated dummy loads is to contact an independent hazardous waste contractor. Some firms will deal only with industrial clients and have minimum quantities they will accept. A few large firms — SCA Chemical Services was one we spoke with — have limited programs designed to help individuals dispose of hazardous materials in a responsible manner. (SCA sponsored a "household cleanup" program on Cape Cod last fall, and other efforts are planned in certain areas of the Northeast.)

There are also smaller firms that will accommodate small quantities of waste as well as industrial quantities. Transformer Service, Inc. (TSI), of Concord, New Hampshire, for example, offers testing and disposal services. Louis LaSalle, TSI's Northeast Sales Manager, told us his firm would assist Amateurs in disposing of contaminated dummy loads. Group rates are negotiable for both testing and disposal services.

table 1. List of administrators designated as "hazardous waste contact persons" at regional offices of the Environmental Protection Agency (as of July 29, 1983).

Region I — Ira Leighton, Environmental Protection Agency, John F. Kennedy Building, Boston, Massachusetts 02203, (617) 223-3468

Region II — Dr. Ernest Regna, Environmental Protection Agency, 26 Federal Plaza, New York, New York 10278, (212) 264-0504/5

Region III — Anthony Donatoni, Environmental Protection Agency, 6th and Walnut Streets, Philadelphia, Pennsylvania 19106, (215) 597-7937

Region IV — Allan Autley, Environmental Protection Agency, 345 Courtland Street N.E., Atlanta, Georgia 30308, (404) 881-3016

Region V — Karl J. Klepitsch, Jr., Environmental Protection Agency, 230 South Dearborn Street, Chicago, Illinois 60604, (312) 886-7435

Region VI — Ms. Pat Hull, Environmental Protection Agency, 1201 Elm Street, First International Building, Dallas, Texas 75207, (214) 767-9736

Region VII — Chet McLaughlin, Environmental Protection Agency, 324 E. 11th Street, Kansas City, Missouri 64106, (816) 374-6534

Region VIII — Jon P. Yeagley, Environmental Protection Agency, 1860 Lincoln Street, Denver, Colorado 80295, (303) 837-2221

Region IX — Laura Yoshii, Environmental Protection Agency, 215 Fremont Street, San Francisco, California 94105, (415) 974-8127

Region X — Tobias A. Hegdahl, Environmental Protection Agency, 1200 6th Avenue, Seattle, Washington 98101, (206) 442-2808

Note: The EPA operates a special hotline dedicated specifically to questions about PCBs: 1-800-424-9065. Questions about other hazardous wastes should be directed to another EPA hot line: 1-800-424-9346.

LaSalle cautioned Amateurs to choose their disposal contractor with care, and to insist on receiving documentation confirming appropriate incineration of the waste oil. He confirmed Hyer's and Borner's warning that the owner is responsible for safe disposal: "You can't contract your liability away...anytime the material leaves your premises, you've lost control; be sure you know where it goes," he warned.

don't inhale

According to LaSalle, dummy loads can be shipped; check with your contractor for specific instruction for safe handling and packaging.

In a letter to *ham radio*,⁵ Tom Runyon, VE5UK, took the media to task for "overrating" the potential

hazards of PCBs, but at the same time expressed appreciation that the question had been brought to the attention of Amateurs as a group. He gave this advice for distinguishing PCB oil from mineral oil in dummy loads:

1. *The smell of PCBs is somewhat similar to that of moth balls. Ordinary vegetable or mineral transformer oils smell like "oil."*
2. *Pure PCB is heavier than water, and a drop dropped into a bottle of water will sink. Ordinary transformer oil will float on water.*

(We don't recommend that you actually sniff the oil in your dummy load; inhalation, as noted before, may be hazardous. And before you follow any of VE5UK's advice, check with your regional EPA office or other appropriate authority.)

Runyon pointed out what may be an important distinction in any review of this issue: that there's a difference between acute poisoning with PCB's in high concentrations and short or long-term exposure to materials containing PCB's in lesser concentrations. Serious health effects have been documented in episodes involving heavy concentrations of PCB's, but to our knowledge, there is no evidence at this point to confirm the common fear that incidental exposure to low levels of PCBs has any documentable health effects. *We just don't know. Nobody knows.*

Hearing that nobody really knows for sure about the effects — if any — of low-level exposure to PCBs usually causes one of two reactions: either people assume that since nobody knows, there's nothing to be afraid of, or that *because* nobody knows, there's reason to be gravely concerned.

toward solving the problem

Congress was sufficiently concerned about the possibility of serious PCB-induced health hazards and passed The Resource Conservation and Recovery Act of 1976, in which the manufacture of PCBs or products containing PCBs, and the importation of any polychlorinated biphenyls, were declared illegal. No longer could industries or utilities drain the oil from a malfunctioning transformer, perform a repair, and replace the oil. It had to be discarded. *Where and how* became an entirely new problem.

With increased understanding of the importance of responsible disposal of hazardous wastes, industry has turned to two main means of disposal: incineration and detoxification by dehalogenation. (PCB waste in low concentrations may still be buried, but only in approved landfills under close EPA supervision. High-concentration PCB materials may not be buried.)

Incineration is effective only at temperatures in ex-

cess of 2300 degrees Fahrenheit; incomplete incineration at lower temperatures has been known to release dioxin (tetrachlorodibenzo-para-dioxin, TCDD), estimated to be approximately 500,000 times more dangerous than PCBs. (Its levels of contamination are measured in the parts-per-trillion, rather than in the more modest parts-per-million used to calculate the levels of PCBs.)

Several state-of-the-art incinerators are in operation now; the Rollins Environmental Services, Inc., facility in Deer Park, Texas, was the first to receive a permit from the EPA to incinerate PCBs in liquid and solid form. Rollins claims an efficiency level of 99.9999.⁶ Several major chemical corporations have developed elaborate incineration systems (see **figs. 3, 4**), but the cost remains high — \$9 to \$12 per gallon, plus fifty cents per gallon for transportation alone.

Industries seeking to develop effective disposal systems face a costly and time-consuming challenge, however, because citizen resistance to incinerators remains intense. No wonder: even with high-efficiency incineration, the possibility of accident or unwanted emissions remains.

At least two experimental incinerators are currently operating at sea, with more in the planning stages, and Sunohio, Inc., has developed five mobile units that process PCB waste on-site.

Unfortunately, we read less about progress in the development of effective means of detoxification and effective solutions to the problem of disposal than we read about accidents involving PCB contamination of people, wildlife, and the environment. The stories *are* shocking. While research has yet to conclusively link inordinately high levels of cancer in certain areas with PCB contamination, studies have documented liver damage, digestive disturbances, jaundice, impotence, swollen limbs, and serious skin problems, including lesions, chloracne,* and pigmentation disturbances. The most notorious episode of PCB poisoning occurred in Japan in 1968, when 1,291 adults and children consumed rice oil contaminated with PCBs. Twenty-four died — nine of malignant neoplasms. In *Laying Waste: The Poisoning of America by Toxic Chemicals*, three-time Pulitzer Prize nominee Michael Brown, who covered the infamous Love Canal story in the *Niagara Gazette*, reports on a study of thirteen women who had ingested the contaminated rice oil during pregnancy. Of the thirteen, "nine bore children with impaired liver function and other defects...."⁷

Japan outlawed the production of PCBs in 1972.

According to EPA estimates, there are 9,131 *abandoned* waste disposal sites. 440 million pounds of

*While chloracne is not life-threatening, it is disfiguring; its treatment — drainage and surgery — is said to be painful.

REG.
\$19.50

Please enter my gift subscriptions
to HAM RADIO Magazine as follows:

EACH GIFT JUST \$14.50

SAVE OVER 25%

Prices U.S. only

SAVE 25% \$AVE 25% \$AVE 25%

FIRST

Name _____ Call _____

Address _____

City _____ State _____ Zip _____

new renewal

SECOND

Name _____ Call _____

Address _____

City _____ State _____ Zip _____

new renewal

THIRD

Name _____ Call _____

Address _____

City _____ State _____ Zip _____

new renewal

Start or Renew my own HR subscription

Enclosed is a check or money order for \$_____ for
_____ subscriptions (use separate envelope)

VISA MasterCard Bill me later

Acct # _____ Expires _____ MC Bank # _____

My Name _____ Call _____

Address _____

City _____ State _____ Zip _____

Prices U.S. only

Please
enter my
subscription



BUSINESS REPLY CARD

First Class Permit No. 1 Greenville, NH

Postage Will Be Paid By Addressee

**ham
radio**

Greenville, NH 03048

NO POSTAGE
NECESSARY
IF MAILED
IN THE
UNITED STATES



SUPER GIFT IDEA GIVE HAM RADIO THIS YEAR!

*It's simple and easy and
You save over 25%.*

That's right. You save over 25% off the regular one year rate of \$19.50. Just \$14.50 brings 12 big, fat, issues, jam-packed with all the latest from state-of-the-art electronics to easy-to-build projects. We will even send an attractive personalized gift card to the recipient(s) so they will know about your interest in their future as hams.

1984 is going to be an exciting year for Amateur Radio. The only way to stay on top of all of the late breaking developments is with a subscription to **ham radio** Magazine.

There has never been a better time than now to "gift" **ham radio** to that hard-to-buy-for friend . . . or yourself.

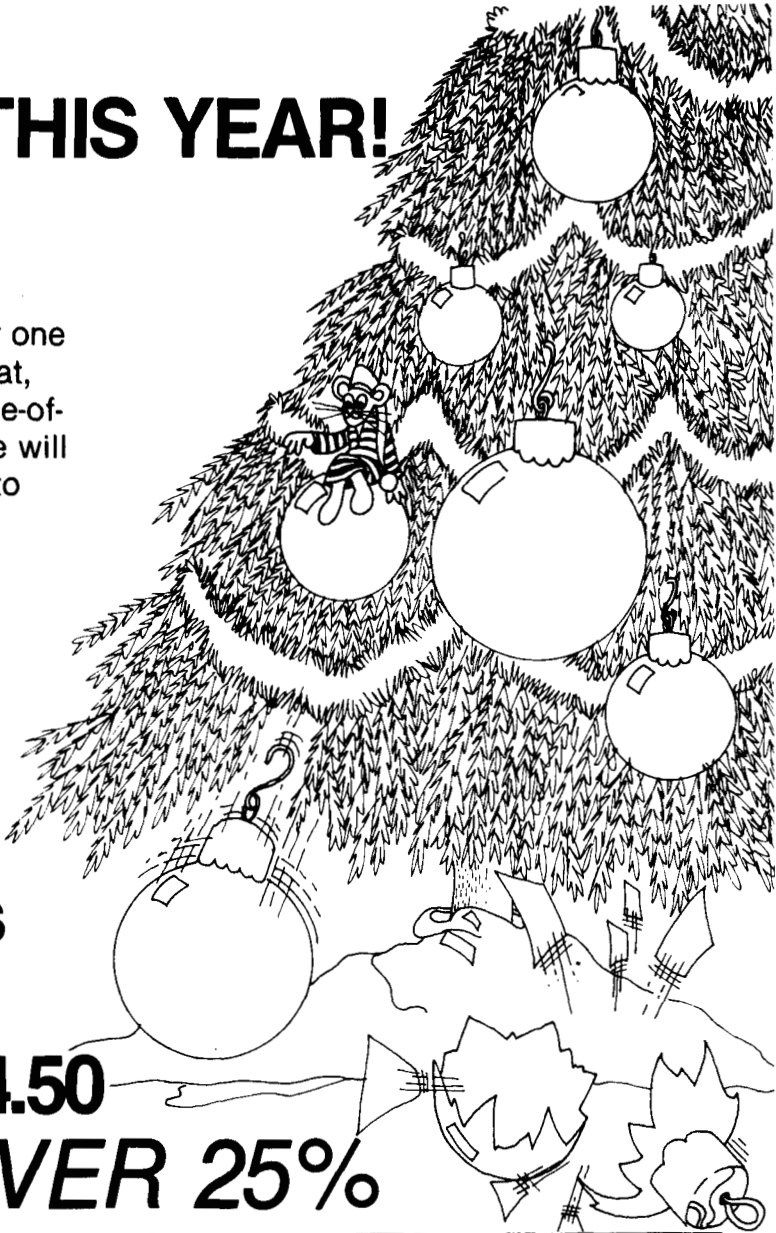

**One year, 12 issues
Reg. \$19.50
SPECIAL PRICE \$14.50
SAVE OVER 25%**

Please send my **hamradio** gift subscriptions as indicated. Also send a handsome gift acknowledgement card. (Gift card will be sent if your order is received before Dec. 16, 1983.)

From:
Name _____
Address _____
City _____ State _____ Zip _____

Payment enclosed \$ _____
(check or money order)

Mastercard VISA/BAC
Acct.# _____ Exp. _____ Bank# _____
(MC only)

Bill me after Jan. 1, 1984.

**FILL OUT AND MAIL TO:
HAM RADIO MAGAZINE
Greenville, NH 03048
(603) 878-1441**

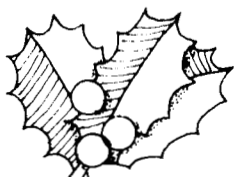

**\$14.50
Save 25%**

SEND TO:
Name _____
Address _____
City _____ State _____ Zip _____

New Subscription Subscription Renewal

**\$14.50
Save 25%**

SEND TO:
Name _____
Address _____
City _____ State _____ Zip _____

New Subscription Subscription Renewal

**\$14.50
Save 25%**

SEND TO:
Name _____
Address _____
City _____ State _____ Zip _____

New Subscription Subscription Renewal

**PRICES U.S. Only. CANADA \$21.50 per year.
Use Handy Bind-in Card or this Form.**

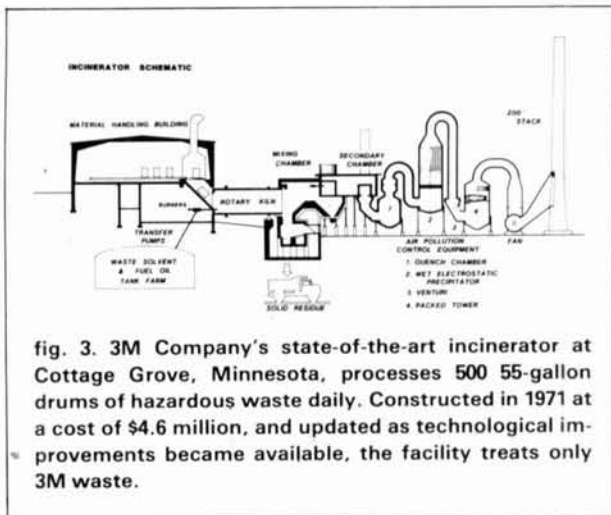

fig. 3. 3M Company's state-of-the-art incinerator at Cottage Grove, Minnesota, processes 500 55-gallon drums of hazardous waste daily. Constructed in 1971 at a cost of \$4.6 million, and updated as technological improvements became available, the facility treats only 3M waste.

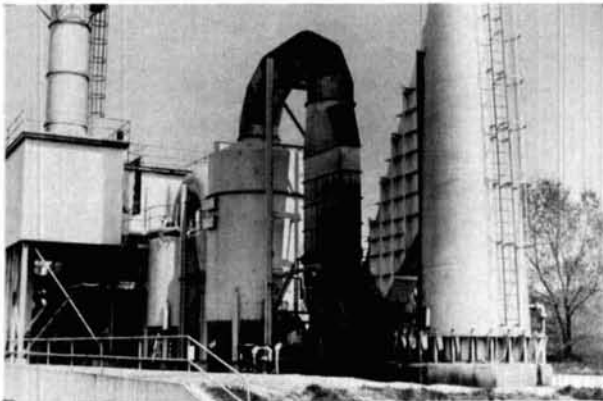

fig. 4. 3M incinerator air pollution control train includes a series of water showers designed to remove gas and particulate matter from air stream before it passes through 500-horsepower fan at base of stack, which measures 5 feet in diameter, 200 feet in height.

PCBs await disposal, and 750 million pounds remain in use or storage, with 40,000 of the 20 million transformers in use by utilities today containing Askarel, a fluid composed of 60 to 100% PCBs.⁸ Of the 200 or more varieties of PCBs made, most can be identified by name; tradenames include Aroclor, Pydraul, Therminol, Pyroclor, Santotherm, Pyralene, Pyranol, Inerteen, Asbestol, Chlorextol, Diachlor, Dykanol, Elemex, Hyvol, NO-Flamol, Saf-T-Kuhl, Clorinol, Clorphen, and Eucarel.⁸

Because the number of approved incinerators is limited, and because the issue of incineration is controversial, industry has turned to detoxification as an alternative. In 1980, Goodyear Tire & Rubber announced the development of a method of breaking down PCBs into sodium chloride and sludge.

Only recently have the EPA, FDA, and Department of Agriculture ordered removal of equipment containing PCBs from food and feed preparation and

storage areas. Currently under EPA study is a proposal to eliminate equipment containing PCBs from public buildings. (In 1976, 95 percent of all oil-filled capacitors manufactured in the United States were made with PCB oil.) PCBs are still very much with us.

By the time serious health implications were first suspected — in the early 1970s — the annual rate of PCB production in the United States had reached 34,000 tons (30,844 metric tons). But it was too late to reverse the worldwide spread; by 1970, traces of the compound had been found in almost every American river and even at the Arctic Circle, in the bodies of nonmigratory bears. Commercial and sport fishing, and duck hunting on many waterways has been seriously disrupted or destroyed by PCB contamination.

With the banning of PCB production in the United States, it would seem that at least one part of the problem has been solved. But the question of how to handle what we have already remains; the fact is that we as individuals, families, and as a nation, generate more household and industrial waste than we can effectively dispose of.

So the next time you sit down to operate, cast a wary eye on your dummy load. It may be a small piece of a very large puzzle.

references

1. Kitty Hevener, WB8TDA, *New England Report/Crossbander*, Volume 5, No. 5, May 15, 1983.
2. "Polychlorinated Biphenyls," *OPNAV Notice 6240*, Department of the Navy, Office of the Chief of Naval Operations, Washington, D.C., 20350, June 29, 1981.
3. John Bransford and Arthur J. Palotta, "Industry Wrestles with the PCB Problem," *Hazardous Materials Waste Management*, July-August, 1983, page 23.
4. "Polychlorinated Biphenyls and Polybrominated Biphenyls," Volume 18, *International Agency for Research on Cancer (IARC) Monographs on the Evaluation of the Carcinogenic Risks of Chemicals to Humans*, World Health Organization, October, 1978. Available from WHO Publications Center, 49 Sheridan Avenue, Albany, New York 12210.
5. Tom Runyon, VE5UK, *ham radio*, September, 1980, p. 66.
6. Rollins Environmental Services, Inc., advertisement in *Hazardous Materials Waste Management*, July-August, 1983, page 11.
7. Michael Brown, *Laying Waste: The Poisoning of America by Toxic Chemicals*, Pantheon Books (a division of Random House), 1979, pages 246-247.
8. "Polychlorinated Biphenyls," *OPNAV Notice 6240*, June 29, 1981.

bibliography

- Culhane, John, "PCBs: The Poison That Won't Go Away," *Readers Digest*, December, 1980.
- Fischbein, Alf, M.D. et al, "Dermatological Findings in Capacitor Manufacturing Workers Exposed To Dielectric Fluids Containing Polychlorinated Biphenyls (PCBs)," *Archives of Environmental Health*, Volume 37, Number 2, March/April, 1982.
- "Polychlorinated Biphenyls and Polybrominated Biphenyls," Volume 18, *International Agency for Research on Cancer (IARC) Monographs on the Evaluation of the Carcinogenic Risks of Chemicals to Humans*, World Health Organization, October, 1978. Available from WHO Publications Center, 49 Sheridan Avenue, Albany, New York 12210.
- Morgan, Robert E., WB5AOH, letter, *QST*, June, 1976, page 59.

Reiger, George, "The Poisons We Eat," *Field and Stream*, May, 1983.

Smith, A.B., et al, "Metabolic and Health Consequences of Occupational Exposure to Polychlorinated Biphenyls," *British Journal of Industrial Medicine*, November, 1982.

Stellman, Jean M., Ph.D., *Work is Dangerous to Your Health: A Handbook of Health Hazards in the Workplace*, Vintage Books, a division of Random House.

Environmental Protection Agency — Hazardous Waste and Consolidated Permit Regulations, Federal Register, Part II, May 19, 1980.

"PCBs: Good Works from Goodyear," *Newsweek*, September 1, 1980.

ham radio

CDC confirms PCBs in dummy loads

As this issue went to press, the CDC had reportedly found at least one PCB-contaminated dummy load in its study of samples taken from Amateur equipment in six cities (see page 42).

The contaminated dummy load belonged to Richard P. Beebe, K1PAD, ARRL section manager for eastern Massachusetts. Of the 15 samples taken from the Boston area, Beebe's was the only one found to contain PCBs.

Beebe told *ham radio* that he had been advised by the CDC to undergo a blood test in order to determine whether he had experienced any negative health effects as a result of exposure to the material.

According to CDC epidemiologist Paul Stehr, the CDC study will continue, as leads in which potential problems were identified are followed up and owners of questionable dummy loads notified.

Katherine Hevener, WB8TDA

Join the Utility Free Folks

WIND/SOLAR ENERGY FOR RADIO COMMUNICATIONS AND LOW POWER ELECTRICAL SYSTEMS

by Edward M. Noll, W3FQJ

Author Noll's book is your first step toward energy independence. Chapter 1 covers solar energy and photovoltaic converters. Chapter 2 tells how to convert wind power into energy. Chapter 3 deals with the systems required to store the power and how to convert it to 110 volts AC. Chapter 4 discusses how the author has used solar power to run a QRP Amateur station and various other interesting applications. Finally, Chapter 5 deals with the larger practical applications that we may see as future power sources. Take advantage of cheap natural power sources and put them to work. ©1981, 2nd edition, 264 pages.

□21827

Softbound \$12.95

Please add \$1.00 for shipping and handling.

Ham Radio's Bookstore
Greenville, NH 03048

ORR BOOKS

BEAM ANTENNA HANDBOOK

by Bill Orr, W6SAI

Recommended reading. Commonly asked questions like: What is the best element spacing? Can different yagi antennas be stacked without losing performance? Do monoband beams outperform tribanders? Lots of construction projects, diagrams, and photos. 198 pages. ©1977. 1st edition.

□RP-BA

Softbound \$7.95

SIMPLE LOW-COST WIRE ANTENNAS

by Bill Orr, W6SAI

Learn how to build simple, economical wire antennas. Apartment dwellers take note! Fool your landlord and your neighbors with some of the "invisible" antennas found here. Well diagrammed. 192 pages. ©1972.

□RP-WA

Softbound \$7.95

THE RADIO AMATEUR ANTENNA HANDBOOK

by William I. Orr, W6SAI and Stuart Cowan, W2LX

Contains lots of well illustrated construction projects for vertical, long wire, and HF/VHF beam antennas. There is an honest judgment of antenna gain figures, information on the best and worst antenna locations and heights, a long look at the quad vs. the yagi antenna, information on baluns and how to use them, and new information on the popular Sloper and Delta Loop antennas. The text is based on proven data plus practical, on-the-air experience. **The Radio Amateur Antenna Handbook** will make a valuable and often consulted reference. 190 pages. ©1978.

□RP-AH

Softbound \$7.95

ALL ABOUT CUBICAL QUAD ANTENNAS

by Bill Orr, W6SAI

The cubical quad antenna is considered by many to be the best DX antenna because of its simple, lightweight design and high performance. You'll find quad designs for everything from the single element to the multi-element monster quad, plus a new, higher gain expanded quad (X-Q) design. There's a wealth of supplementary data on construction, feeding, tuning, and mounting quad antennas. 112 pages. ©1977.

□RP-CQ

Softbound \$6.95

Please add \$1.00 to cover shipping and handling.

HAM RADIO'S BOOKSTORE
GREENVILLE, NH 03048

STUMPED FOR A GIFT IDEA?

I.D. BADGES

No ham should be without an I.D. badge. It's just the thing for club meetings, conventions, and get-togethers, and you have a wide choice of colors. Have your name and call engraved in either standard or script type on one of these plastic laminated I.D. badges. Wear it with pride! Available in the following color combinations (badge/lettering): white/red, woodgrain/white, blue/white, white/black, yellow/blue, red/white, green/white, metallic gold/black, metallic silver/black.

□UID Engraved I.D. Badge

\$2.50



HERE'S A GIFT IDEA!

How about an attractive **BASEBALL** style cap that has name and call on it. It's the perfect way to keep eyes shaded during Field Day, it gives a jaunty air when worn at Hamfests and it is a great help for friends who have never met to spot names and calls for easy recognition. Great for birthdays, anniversaries, special days, whatever occasion you want it to be. Hats come in the following colors: **GOLD, BLUE, RED, KELLY GREEN**. Please send call and name (maximum 6 letters per line).

□UFBC-81

\$5.00

REGULAR PRICE HAT AND BADGE \$7.50 + SHIPPING

SPECIAL

\$6.49

SAVE \$1.00

Please enclose \$1 to cover shipping and handling.

HAM RADIO'S BOOKSTORE
GREENVILLE, NH 03048
(603) 878-1441

photovoltaic cells: a progress report

Seminar covers PV basics,
"breeder" concept, and
Amateur Radio applications

In November, 1982, 400 people participated in what has been termed the "largest publicly held seminar" on photovoltaics in the world. The gathering, presented by ENCON and SOLAREX in Dearborn, Michigan, provided the latest information on this subject to a group consisting of Radio Amateurs, corporate engineers and building contractors. The following article discusses the important features presented at the seminar.

Early photovoltaic cells were manufactured solely for space applications, and between 1958 and 1973 cost \$500 to produce one (peak) watt. At this rate, the early cells would have had to operate for 40 years to pay back the energy expended in their manufacture alone; in order to compete with conventional electrical power generation, the cost of the cells would have to decrease dramatically. By 1977 the cost of solar cells had dropped to \$20 per peak watt, with a calculated energy payback of less than six and a half years. Today, costs are lower than \$10 per peak watt, with an energy payback of less than three and a half years. Both the cost and energy payback are continuing to decrease.



fig. 1. "Breeder concept" structure uses solar energy to provide power for production of solar cells.

What this indicates is that the technology, productivity, and energy consumption problems are being resolved, and that the solutions to the remaining issues are in hand. It is believed that by the time photovoltaic demand rises to the 100 megawatt level, costs will drop below \$4 per watt and the energy payback will be reduced to less than one year.

photovoltaic cell material

Historically, several materials have been used for experimentation in photovoltaic devices: gallium arsenide, cadmium sulphide, and silicon, among others. Silicon has been chosen for widespread use and is the logical material since it is the second most abundant element on earth, is low in cost when used in a relatively low purity form and provides high photovoltaic efficiency. One key to lowering costs of solar cells has been the development of semicrystalline silicon — a form of polycrystalline silicon developed specifically for photovoltaic applications.

Semicrystalline silicon is fabricated using a procedure known as Ubiquitous Crystallization Process (UCP), in which the silicon takes on the shape of the mold in which it is crystallized. One common configuration* is that of square wafers, which lends itself to high density packing in a solar panel. Perhaps most importantly, UCP uses inexpensive, low-purity raw silicon. This means that the expensive, highly pure and energy-demanding raw material used in the conventional single crystal process can be bypassed.

the breeder concept

One way to decrease the price of a product is to increase its productivity. One successful means of increasing productivity, called the breeder concept method, incorporates a large industrial structure completely powered by the sun. With its sloping, south-facing roof, the building features a 28,000 square foot (2600 square meter) array of SOLAREX semicrystalline silicon solar cell panels (see fig. 1).

By Paul J. DeNapoli, WD8AHO, ENCON Corp., 27600 Schoolcraft, Livonia, Michigan 48150

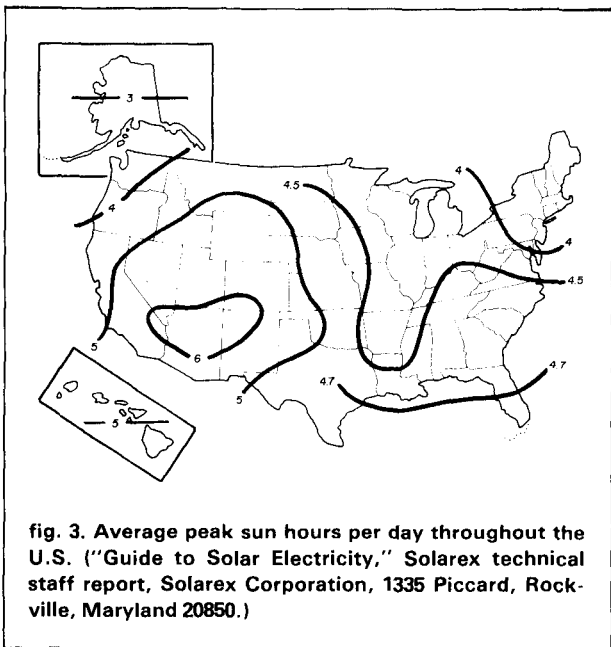
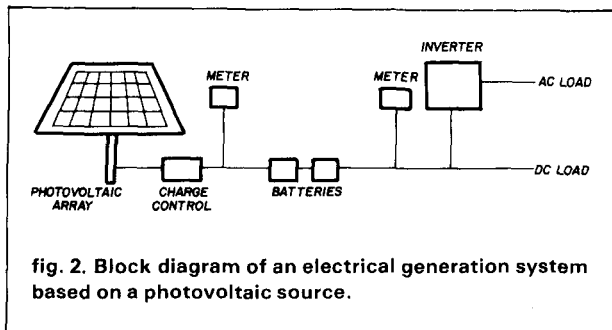

The 200 kW rooftop photovoltaic array converts sunlight directly into electricity to provide power for the facility's production lines, which produce photovoltaic cells and panels. So the facility actually uses power provided by the solar cells on its roof to manufacture, or "breed," more solar cells. It derives all of its electric power, including power for lights, air conditioning, and production equipment, from the more than 3000 semicrystalline panels mounted on its roof. Its photovoltaic system, aided by solar thermal energy and thermal storage, also provides for all facility heating requirements, eliminating the need for oil or gas heating. The 200 kW array produces an average of 800 kWh per day of energy coupled with a 2.5 MWh battery storage system. This storage capacity provides steady, uninterrupted power of 60 kW in the unlikely event of four dark days in succession.

powering an Amateur station

A complete system sufficient to power an Amateur

Radio station under ordinary circumstances or during times of crisis would consist of photovoltaic panels, charge-controlling devices, and deep-cycle renewable energy batteries, (see fig. 2). A typical "bare-foot" installation allowing for three hours of operation per day (one hour transmit, two hours receive) would require an average of four peak hours of sun in an area such as Michigan (see fig. 3), where ENCON and SOLAREX test facilities are maintained.

The transmitter load in this case would be 15 amperes for one hour or 15 ampere-hours. The receiver load would be 0.6 amperes for two hours or 1.2 ampere-hours. The combined load requirement would be 16.2 amperes, or more simply, 17 ampere-hours.

It's usual to factor in a system loss term of 20%, which raises our design requirements to a total of 20.4 ampere-hours. Referring to fig. 3 and dividing 20.4 by 4 (average peak sun hours) provides our design goal of 5.1 amperes. Examining the industrial literature shows that the SX-100** PV panel produces 1.9 amperes at 17.0 volts or 32 watts under these conditions. Use of three of these panels meets our requirements ($1.9 \times 3 = 5.7$ amperes) conservatively. Fig. 4 has been included to assist readers in designing installations according to their own specific requirements.

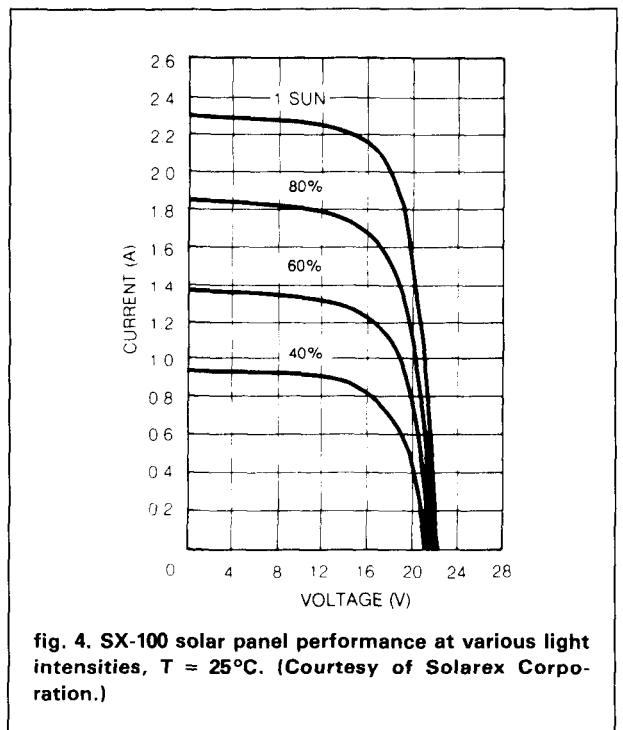

*Manufactured by Semix Incorporated, a subsidiary of Solarex Corporation
 **Manufactured by Solarex Corporation

ANYWAY YOU LOOK AT IT.... ADM HAS YOUR ANTENNA

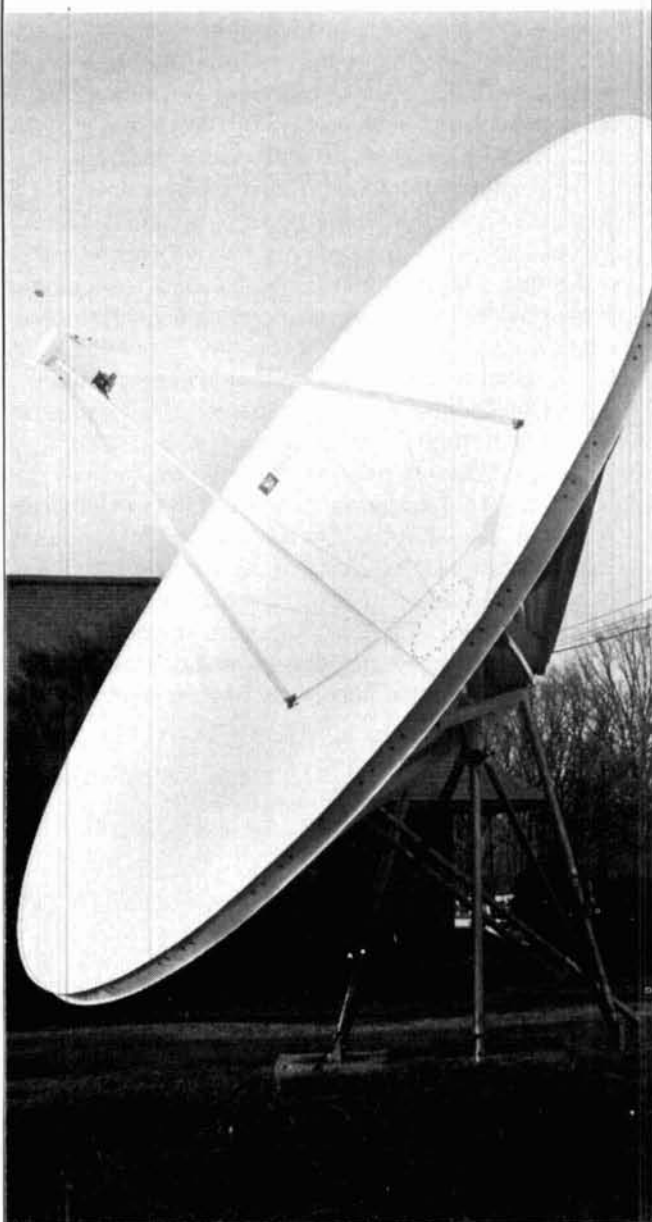

ADM 11, ADM 13, ADM 16, ADM 20
Sturdy Aluminum & Steel
Construction
Easy Assembly & Installation

**ANTENNA DEVELOPMENT &
MANUFACTURING, INC.**
P.O. Box 1178, Hwy. 67 South
Poplar Bluff, MO 63901
(314) 785-5988 686-1484

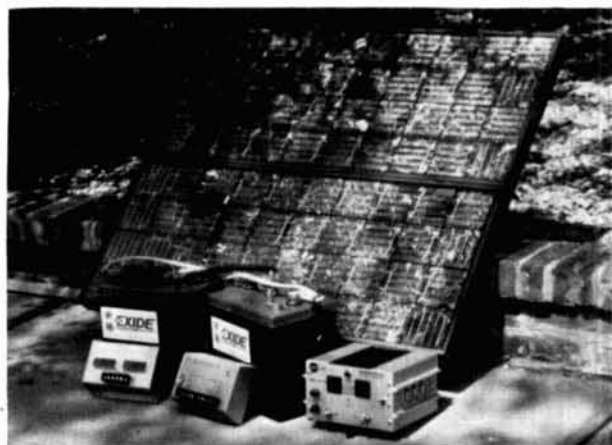

fig. 5. A typical "barefoot" ham station can be powered by a two-PV panel array with two 6 VDC 185 ampere-hour batteries as backup.

battery calculations

For battery (or storage) calculations, use a NO SUN day number for added reliability.

$$20.4 \text{ ampere-hour load} \times 7 (\text{No SUN days}) \\ = 143 \text{ ampere-hours}$$

$$143 \text{ ampere-hours} \times 2 (50\% \text{ battery drain}) \\ = 286 \text{ ampere-hours}$$

Four 6 VDC 185 ampere-hour batteries will supply 370 ampere-hour capability at double the voltage or 12 volts DC (series-parallel configuration).

A list of materials for this system would include 3 SX-100 panels, 4 Exide 6 volt DC batteries, 1 charge controller, 1 mounting hardware kit, and 1 meter package and cable.

Due to SSB characteristics, a transmitter will never really see the full ampere output in transmitting. A system containing 2 SX-100 panels and 2 batteries with accessories can be utilized in a very energy-efficient manner for normal and emergency operations, (see fig. 5).

when will the price come down?

PV's have been dropping in price for twenty years. The pricing structure of photovoltaics is now at an affordable level, but without consumer support, we'll never see another decrease because of the elementary laws of supply and demand. A prime example of how consumer-supported products decrease in price are calculators and personal computers. The same principles apply to photovoltaics: until the Amateur Radio community chooses to support PV products, the industry will be slow to meet its ultimate goal of supplying reliable, cost-effective, primary and emergency power for communication, residential and commercial needs.

ham radio

EVEN SANTA SHOPS

KENWOOD



KENWOOD, in its new TR-7950/TR7930 2 meter FM mobile transceivers, introduces a completely new concept of versatility and performance in 2 meter operations. Among the more important convenience features providing enhanced ease of operation is a new large, easy-to-read (direct sunlight or dark) LCD display, 21 new multi-function memory channels that store such information as frequency, offset, and sub-tone channel data (sub-tone unit optional), a choice of output powers, with a hefty 45 watts in the TR-7950, or 25 watts in the TR-7930, and the use of microprocessor technology throughout.



The TS-430S combines the ultimate in compact styling with its counterparts in advanced circuit design and performance. An all solid-state SSB, CW, and AM transceiver, with FM optional, covering the 160 - 10 meter Amateur bands including the new WARC bands, this remarkable radio also incorporates a 150 kHz - 30 MHz general coverage receiver having an extra wide dynamic range.



Kenwood TS-930S

All solid-state, high performance, all ham band-plus general coverage receiver. Perfect rig for the contester or exacting DXer. SSB slope tuning, CW variable bandwidth tuning, IF notch, CW pitch control and audio peak tuned CW filter. Dual digital VFO's, eight memory channels, switchable QSK or semi break-in, and optional automatic antenna tuner. 250 watts input for plenty of "kick" on CW/SSB/FSK. Wide selection of extra accessories to fine-tune the TS-930 to your personal tastes.



Kenwood TR-2500

Compact, fully featured 2 meter handheld radio. Has LCD readout, 10 channel memory, programmable automatic band scan and keyboard channel selection. 143.9-148.995 MHz for CAP or MARS use too. Built-in 16 key autopatch encoder.

Plus plenty of
Kenwood Accessories
and other station
equipment

CALL FOR PRICE

YAESU



Yaesu FT 980 HF Transceiver

Fully featured, 100 watt, all band transceiver plus general coverage receiver. Can also be controlled, through an interface module, by your own personal computer. FT 980 has SSB/CW/AM/FSK/FM capability built-in. Keyboard for ease of entry of operating frequencies. Full QSK with quiet solid-state switching. Variable IF bandwidth and IF shift using cascaded filters. Optional keyer module available. All this plus scanning, 8 bit microprocessor, high voltage power supply and PA circuitry for excellent linearity plus much more.

Yaesu FT 726 Tribander

Operate 10 & 6 meters and 70 cm with the world's first multiband, multimode Amateur transceiver capable of full duplex operation. Powered by 8 bit CPU the 10 channel memory stores frequency and mode with pushbutton transfer to either VFO register. With optional IF strip, full duplex can be achieved allowing crossband satellite work. Comes with variable receiver bandwidth, IF shift, all mode squelch and IF noise blanker.



Yaesu FT 208R 2 meter Transceiver

Feature packed transceiver with internal microprocessor, 10 memories. Switchable 2.5/1 watt power output. Will scan complete band. Also has 16 key autopatch encoder.



CALL FOR YOUR PRICE

ICOM



IC-02AT

Brand new from Icom. Digital readout, scanning memories and much, much more. 10 memories, duplex storage in memory, odd offsets, 32 keyboard selectable PL tones and lithium battery memory back up. Easy-to-read LCD readout combines frequency, memory, signal strength, xmitter output, PL tone and scanning functions. Aluminum case back provides excellent heat sinking for trouble free operation. A state-of-the-art radio for today's Amateur.



ICOM IC-751 All Band Transceiver

The latest design from Icom staff. Fully engineered to meet the needs of today's Amateur — from enthusiastic contester to casual rag chews. 100 kHz-30 MHz receiver coverage plus all ham bands. 70 MHz 1st IF virtually eliminates spurious responses. 2nd IF features passband tuning. Dual VFO's for split operation. 32 memories with lithium battery back up. For CW either full QSK or semi break-in is offered. Plenty of options are available to fine-tune the unit to specific operator needs. With optional PS-15 power supply the IC-751 becomes a compact portable/Field Day package.

ICOM IC-745 All Band Transceiver

The IC-745 has a super low price but retains many of the features popular on higher priced units. All ham bands plus general coverage receiver. 16 memories, full function meter with built-in SWR bridge, IF shift and passband tuning, optional internal AC power supply available. Width and level adjustable noise blanker, continuously adjustable AGC with off position plus much, much more.



CALL for your ICOM Price

HAMTRONICS — For All Your Ham Needs

Call today for your price

(215) 357-1400

AT HAMTRONICS, INC.

AEA Brings you the Breakthrough!



AEA Computer Patch CP-1

A Personal Computer + Your Transceiver = AEA's CP-1 ... FUN! Get a professional quality RTTY/CW terminal on a beer budget price. Easy to hook up and use. The CP-1 demodulator provides greatly improved performance compared to popular single channel RTTY detectors. With appropriate software and your personal computer, you can have hours of fun.

CALL FOR YOUR PRICE

AEA Contester™ CK-2

Here's great gift idea for your favorite ham. Designed with the needs of the active contester in mind — at a price that is affordable. Has an 800 character message memory that can be soft partitioned into as many as 10 sections. Mistakes are easily corrected with unique edit mode. Also has automatic serial number generator.



CALL FOR YOUR PRICE



AEA Moscow Muffler WB-1

Blank the woodpecker — once and for all. No modifications necessary to your equipment. Hooks up in your antenna so synchronous blanker works where most effective, in the RF stage. Will not overload from strong adjacent signals. Also has low noise, broadband 6 dB preamp. WB-1 will typically display 40-50 dB of attenuation. Two pulse rates blanking speeds available — 10 and 16 Hz.

CALL FOR YOUR PRICE

AEA Amtor Terminal Unit AMT-1

AMTOR is fast growing in popularity. Don't you want to join the fun? Computer based, self correcting mode of transmission virtually ensures error-free copy — even with strong interference or weak signals. AMTOR can get your message through. AMT-1 contains everything you need to get on AMTOR with the addition of your radio and personal computer. Will also work on standard RTTY and CW for additional flexibility. Great Christmas gift idea. State-of-the-art FUN.



CALL FOR YOUR PRICE

HAMTRONICS is your complete ham dealer. Looking for something and can't find it elsewhere? CALL HAMTRONICS TODAY



HAMTRONICS, INC.

4033 BROWNSVILLE ROAD, TREVOSE, PA. 19047

(215) 357-1400

U.S. Orders TOLL FREE
1-800-431-7777

OHIO CALL
216-828-2071

CALL ANY TIME, DAY OR NIGHT PARAMOUNT

COMMUNICATIONS ELECTRONICS
506 Burnett Ave., Dalton, OH 44618

BIRD

STOCKING DISTRIBUTORS



OPTOELECTRONICS, INC.
FREQUENCY COUNTERS

VoCom



Larsen Antennas

RE PRODUCTS

pro-am™

INTERSPACE POWER SUPPLY



ICOM



GENHUTTON

Prepayment (Certified check) 5% discount
and we pay shipping costs



✓ 186

CQ CQ HAMS

- SPECIAL OFFER TO LICENSED HAMS -

Do you think *Ham Radio* is the number 1 Amateur Publication?

Are you interested in Satellite Television?
Then why not read *Satellite TV Magazine*?

Believe me - this is the number 1
Satellite TV Publication!

Now ... as a special offer to licensed amateurs only - we will send you a sample copy of *Satellite TV Magazine* for only \$1.00* (Reg. \$2.95) and offer you an annual subscription for only \$19.95* (Reg. \$24.95).



If you're still not convinced - QSY the Satellite TV Net each Sunday at 2:00 pm Eastern Time on 14.310 MHz and hear what the other HAMS are saying about *Satellite TV Magazine*.

Chris J. Schultheiss VE-2FRJ
Editor & Publisher

Just give us your name and QTH

Name _____ Call _____

Address _____

State _____ Zip _____

Please Enclose Check or Money Order or if you prefer we accept Visa® & Mastercard®.

Card Number _____ Exp. Date _____

*All Prices in US Funds.



Satellite TV Magazine
P.O. Box 2384
Shelby, North Carolina 28150



Call Toll Free
1-800-438-2020

✓ 197

vertical phased arrays: part 5

ABCD matrix parameters simplify network calculations

The most recent article of this series¹ discussed the application of lumped-constant circuits to the drive networks for all-driven element phased arrays. Design equations were presented for the most commonly used four-terminal networks. The design process and general procedures that must be followed for any drive network were reviewed, using typical arrays as examples.

Not discussed in part 4 was how the input/output calculations might be done. Those familiar with complex algebra and the use of a Smith chart can do these calculations one circuit branch at a time with these relatively simple networks. But it is a tedious process at best, prone to human error and cumulative errors resulting from rounding off in chain calculations. And one of Murphy's Laws asserts that errors are always committed at the *beginning* of the longest chain of calculations!

There is an alternative to this drudgery: matrix algebra. Using it allows us to determine the input conditions that result when any load is connected to a network. We do not have to calculate each circuit

branch individually; all we need to know is the circuit type. There is even a built-in method of checking accuracy which aids in eliminating arithmetical errors and the entry of incorrect signs.

Matrix algebra has been used for solving problems of networks, transmission lines, and filters since the late 1940s because of its convenience in rapid circuit analysis and synthesis. With the advent of computers the use of matrices has increased, and it is possible that many readers have been using matrix methods without recognizing them as such, since the methods have often been incorporated into scientific computer programs as special process calls or library functions.

If matrix methods have been neglected in Amateur literature, it is not for lack of suitable applications. Perhaps the method has seemed too esoteric to be applied to such mundane problems as matching antennas to transmission lines, or that the jargon associated with it has frightened experimenters away; perhaps Amateurs have simply not been sufficiently exposed to this powerful mathematical tool.

four-terminal network matrices

Mathematical analyses using matrices require only the algebra of alternating current theory: $a + jb$. Because four-terminal networks happen to have properties which are natural to matrices and because the recurring structure of matrix operations makes them well suited for performance on programmable calculators or small computers, it makes sense for the Amateur to apply matrix algebra to network design.

By Forrest Gehrke, K2BT, 75 Crestview,
Mountain Lakes, New Jersey 07046

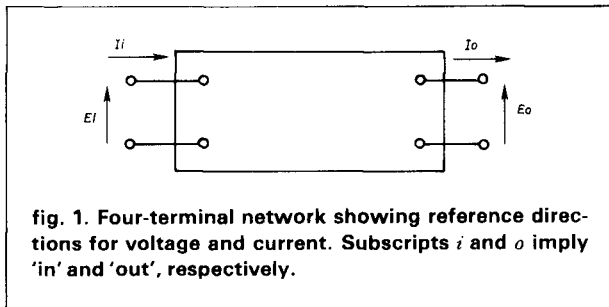

As with many other mathematical concepts, the application of matrix methods does not necessarily require a complete understanding of the underlying theory. It is in this context — i.e., in explanation of the use of matrices — that I address this subject. (For those who may wish to explore matrix algebra in depth, a brief bibliography is supplied at the end of this article.)²

Some fundamentals, such as the assumptions and restrictions and the notation employed, must be understood. Before all else, it should be emphasized that we are dealing only with alternating current steady state. (Matrix methods can be applied to transient and pulsed states, but that is outside the realm of this discussion.)

Four-terminal networks are a special form of a general network having a pair of input terminals and a pair of output terminals. Pictured in fig. 1 is a box with the two pairs of terminals showing the reference directions for voltage and current. We may not know what is in the box, but we will suppose it to consist of any number of circuit branches and impedances with the following restrictions applying:

1. All impedances may be complex, but are linear and constant (time-invariant).
2. The network is passive, i.e., the only generators must be external sources (no dependent or internal sources), represented by E_i or E_o operating alone, or both simultaneously.

Despite not knowing the exact circuit inside the box, enough information can be deduced from measurements (amplitude and phase) made at the four terminals to produce a simple Tee or π circuit which is equivalent to it at any one frequency. We do this by defining a set of matrix parameters as follows:

$$A = (E_i/E_o) \quad \text{with } I_o = 0 \quad (1)$$

Voltage E_i is applied to the input terminals and voltage E_o is measured at the output terminals with no load connected to the output.

$$B = (E_i/I_o) \quad \text{with } E_o = 0 \quad (2)$$

Voltage E_i is applied to the input terminals and the short circuited output current I_o is measured.

$$C = (I_i/E_o) \quad \text{with } I_o = 0 \quad (3)$$

Applying a voltage to the input terminals, measure input current I_i and output voltage E_o with no output load connected.

$$D = (I_i/I_o) \quad \text{with } E_o = 0 \quad (4)$$

Applying a voltage to the input terminals, measure input current I_i and measure the short-circuited output current I_o .

The coefficients A, B, C, D are called general network parameters. Two relationships exist between inputs and outputs of a four-terminal network involving these parameters:

$$E_i = AE_o + BI_o \quad (5a)$$

$$I_i = CE_o + DI_o \quad (5b)$$

A and D are dimensionless transfer ratios, but B and C have the dimensions of impedance and admittance, respectively. In addition, a specific relationship exists between the network parameters because of reciprocity:

$$AD - BC = 1 \quad (6)$$

If we know any three of the four parameters, we can calculate the fourth. On the other hand, if we believe we know all four, this relationship gives us a means of verification, for if calculations using eq. 6 do not hold, there must be an error.

The matrix used to describe four terminal networks is known as a square or network matrix. The network matrix is always portrayed this way:

$$\begin{bmatrix} A & B \\ C & D \end{bmatrix} \quad (7)$$

If the network contains no resistances, i.e., is lossless, A and D are real numbers and B and C are pure imaginary numbers (B and C carry the 'j' operator).*

Several kinds of matrix parameters such as S, H, and ABCD, have been developed for solving particular problems. Though one system is sometimes preferred over the other, it is possible to convert any of these parameter types to any other type, and to use any type of matrix parameter in the calculations discussed herein.

*Complex algebra, real and imaginary, are mathematician's terms. For people working with electronics, these terms may unfortunately convey meanings which are not intended literally. The algebra, although different, is not complicated; the reactances resulting from inductances and capacitances are neither unreal nor imaginary in effects. However, the terms have been with us a long time and are here to stay.

Matrices may be manipulated — added, multiplied, inverted, reversed, partitioned — in many ways, but only according to special rules of procedure and order. For example, when four-terminal networks are cascaded, the effect may be calculated using matrix multiplication. If the individual matrix of each component network is known, the product is a new matrix of ABCD parameters for the overall network chain, allowing calculation of input/output relationships directly, end-to-end. If there is no need to determine the intermediate voltages and currents of the component networks, this is the way to go. (The order of this matrix multiplication is important. Obviously, there will be a great difference in results if the position of a 75-ohm 1/4 wave transformer followed by any length of 50-ohm line, is reversed!)

A four-terminal network is reversible if the A parameter is equal to the D parameter at all frequencies. This is another special case of the network matrix; we may reverse the connections to such a network without causing any change. Physically, a length of coaxial transmission line, a symmetrical Tee or π circuit are examples of such networks. The matrix of reversible networks appears like this:

$$\begin{bmatrix} A & B \\ C & A \end{bmatrix}$$

with $A = \pm \sqrt{1 + BC}$

When designing four-terminal networks, it is often necessary to express the current and voltage at the input side as a linear transformation of the current and voltage on the output side. For instance, with phased arrays we usually know what is wanted on the output side. What we need to know is the current and voltage required on the input side to produce those specific output conditions. Rearranging eq. 5, we can state several useful relationships. If each equation is divided by I_o we have:

$$E_i/I_o = (AE_o/I_o) + B$$

and
$$I_i/I_o = (CE_o/I_o) + D$$

E_o/I_o describes an external load which I will call Z_a . (I have chosen to use the subscript 'a' to avoid confusion with the commonly used 'o' which refers to a transmission line characteristic impedance.)

If the first of the above equations is divided by the second, and Z_a substituted for E_o/I_o , we obtain:

$$E_i/I_i = Z_{in} = (AZ_a + B)/(CZ_a + D) \quad (8)$$

which defines the input impedance of the network in terms of the output load Z_a and the parameters of a network.

This leads to additional useful relationships:

$$E_o/E_i = Z_a/(AZ_a + B) \quad (9)$$

$$I_o/E_i = 1/(AZ_a + B) \quad (10)$$

$$I_o/I_i = 1/(CZ_a + D) \quad (11)$$

$$I_i = I_o(CZ_a + D) \quad (12)$$

$$E_i = I_o(AZ_a + B) \quad (13)$$

If we know the input impedance and want to calculate the load impedance:

$$Z_a = (DZ_{in} - B)/(A - CZ_{in}) \quad (14)$$

If the matrices of the fundamental types of four-terminal networks are known, along with the input or output impedance, all other network characteristics can be computed. Notice the recurrence of the terms $AZ_a + B$ and $CZ_a + D$ in the above relationships. If we program only these two calculations, we have substantially reduced the tedium of network calculations. (Most scientific calculators include the functions rectangular-to-polar and polar-to-rectangular, which takes care of most of the rest of the computations. *) Notice also that the ABCD parameters define the network operating characteristics, independent of the type of network. Therefore, if a length of coax and a π circuit or a Tee circuit have identical parameter values, the circuits will be exactly equivalent (even though the equations for calculating the parameters are different for each of these network types). Though not all types of networks may be transformed from one form to another, it is true often enough not to ignore the possibility. If true, use it to simplify your design.

Part 4 showed the basic building block four-terminal networks most useful to design of the drive networks for phased arrays. Presented in table 1 are the parameter equations for each of those circuits, using the same notation. Note that this discussion is confined to the lossless case, since for low band frequencies losses are usually negligible. In the more general case, the procedure is still valid with loss terms introduced. However, it's not needed in this discussion.

using the ABCD parameters

Example calculations, which usually improve understanding, also help illustrate the versatility of matrix methods. I will first show the relatively simple case of a quarter-wave transformer and then proceed to design a real network for a 2-element array.

*For those familiar with Hewlett-Packard calculators and RPN, an SASE to the author will bring a 98-step program developed for the HP-19C which can calculate eqs. 8 through 13 using complex algebra. Translation for other programmable H-P calculators should not be difficult.

The electrical length of a quarter-wave transformer is 90 degrees. If we are not interested in circuit components values, we do not need to know the frequency. What is required is the angular length and the characteristic impedance of the circuit. "Electrical length" (in any units of length) is always defined as the length under *matched* load conditions. But this does not imply that the current or voltage phase displacement at other than matched conditions is necessarily equal to the electrical length of the circuit.³ The quarter-wave transformer is an exception; this consequently accounts for its great utility. As long as the load is a *pure* resistance, the current and voltage phase displacement is 90 degrees even though not matched. If our transformer is made from a 50-ohm transmission line, it has the following ABCD parameters:

$$\begin{aligned}
 A &= \cos 90^\circ + j0 = 0 + j0 \\
 B &= 0 + j50 \sin 90^\circ = 0 + j50 \\
 C &= 0 + \left(\frac{j \sin 90^\circ}{50} \right) = 0 + j0.02 \\
 D &= \cos 90^\circ + j0 = 0 + j0
 \end{aligned}$$

Assume that the load is a pure resistance of $35 + j0$:

$$\begin{aligned}
 AZ_a + B &= 0 + j50 \\
 CZ_a + D &= 0 + j0.7
 \end{aligned}$$

$$\begin{aligned}
 \text{and } Z_{in} &= (AZ_a + B)/(CZ_a + D) \\
 &= 71.4285 + j0 \text{ ohms}
 \end{aligned}$$

Though we already know the current phase displacement, we can also determine the current amplitude ratio, a factor often required in antenna array calculations:

$$I_o/I_1 = 1/(CZ_a + D) = 1.4285 \angle -90^\circ$$

Assuming the load current, I_o , to be $1 + j0$, the input voltage is $E_i = I_o (AZ_a + B) = 50 \angle 90^\circ$, another value often needed in array network design.

In short, with eqs. 8 through 13, (in some cases assuming values for output current or voltage), we can find any of the input conditions using the ABCD parameters of the circuit.





Suppose we had chosen a π network for our quarter-wave transformer. If we use a reversible π circuit designed to be coax-equivalent we know that¹

$$X_1 = X_3 = -(Z_o \sin \theta)/(1 - \cos \theta)$$

$$\text{and } X_2 = Z_o \sin \theta$$

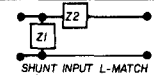
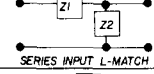
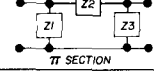
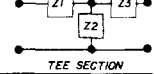
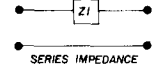
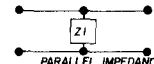
where Z_o and θ is defined the same way as it is for coax. As already indicated, the ABCD parameters define the circuit characteristics. Since the circuit characteristics are supposed to be the same, we

Table 1. Four-terminal network block diagrams and associated matrix forms.

No.	NETWORK	MATRIX = $\begin{bmatrix} A & B \\ C & D \end{bmatrix}$
1	 SHUNT INPUT L-MATCH	$\begin{bmatrix} 1 & Z2 \\ 1/Z1 & (Z1-Z2)/Z1 \end{bmatrix}$
2	 SERIES INPUT L-MATCH	$\begin{bmatrix} (Z1+Z2)/Z2 & Z1 \\ 1/Z2 & 1 \end{bmatrix}$
3	 π SECTION	$\begin{bmatrix} (Z2+Z3) & Z2 \\ Z3 & (Z1+Z2+Z3) \\ (Z1+Z2+Z3) & Z1 \\ Z1 & Z3 \end{bmatrix}$
4	 TEE SECTION	$\begin{bmatrix} (Z1+Z2) & (Z1Z2+Z1Z3+Z2Z3) \\ Z2 & Z2 \\ 1/Z2 & (Z2+Z3)/Z2 \end{bmatrix}$
5	 SERIES IMPEDANCE	$\begin{bmatrix} 1 & Z1 \\ 0 & 1 \end{bmatrix}$
6	 PARALLEL IMPEDANCE	$\begin{bmatrix} 1 & 0 \\ 1/Z1 & 1 \end{bmatrix}$
7	 TRANSMISSION LINE	$\begin{bmatrix} \cos \theta & jZ_o \sin \theta \\ j \sin \theta / Z_o & \cos \theta \end{bmatrix}$
8A		$\begin{bmatrix} L1/M & j\omega(L1L2-M^2)/M \\ -j/M & L2/M \end{bmatrix}$
8B		$\begin{bmatrix} L1 & j\omega L1L2(1-k^2) \\ j\omega k\sqrt{L1L2} & L2 \end{bmatrix}$

should expect to find the parameter values to be identical even though calculated differently.

$$A = \frac{0 + j50 \sin 90^\circ - j \frac{50 \sin 90^\circ}{1 - \cos 90^\circ}}{0 - j \frac{50 \sin 90^\circ}{1 - \cos 90^\circ}} = 0 + j0$$

$$B = 0 + j50 \sin 90^\circ = 0 + j50$$

$$C = \frac{0 - j \frac{50 \sin 90^\circ}{1 - \cos 90^\circ} + j50 \sin 90^\circ - j \frac{50 \sin 90^\circ}{1 - \cos 90^\circ}}{\left(0 - j \frac{50 \sin 90^\circ}{1 - \cos 90^\circ}\right) \left(0 - j \frac{50 \sin 90^\circ}{1 - \cos 90^\circ}\right)} = 0 + j0.02$$

$$D = \frac{0 + j50 \sin 90^\circ - j \frac{50 \sin 90^\circ}{1 - \cos 90^\circ}}{0 - j \frac{50 \sin 90^\circ}{1 - \cos 90^\circ}} = 0 + j0$$

Since the ABCD (parameter) values are identical, all other circuit relationships will be identical also. A similar parameter computation can be carried out with the coax-equivalent Tee circuit where¹

$$X_2 = -Z_o/\sin \theta \text{ and } X_1 = X_3 = Z_o \frac{(1 - \cos \theta)}{\sin \theta}$$

Again the ABCD parameter values will be identical to the first two cases, though their computation requires yet another set of equations from **table 1**.

For the specific quarter-wavelength example we did not have to perform all these calculations to find the input impedance. We know all we need to know from the quarter-wavelength relationship,

$$Z_o = \sqrt{Z_{in}Z_a}$$

but when examining a new procedure it is always reassuring to be able to verify it with a more familiar one. Even for this example, we would not be able to calculate voltage or current input conditions quite so easily if the load were reactive. Best of all, matrix methods are applicable to any circuit without restrictions placed on electrical length. To illustrate this point, let's design a no-compromise feed network for a 2-element vertical phased array. Assuming directional switchability is desired, physical symmetry will dictate equal length element feeders. However, these need only be long enough to meet at a central switching point in the array. At a design frequency of 3.8 MHz, the array in this example has the following characteristics:

Equal amplitude current drive with a 90° phase displacement between elements. The elements are quarter-wave spaced and quarter-wave resonant.

From part 3 of this series⁴ the driving-point impedances are:

$$Z_1 = 21.4 - j15 \text{ for element 1}$$

$$Z_2 = 51.4 + j15 \text{ for element 3}$$

Note: These impedances are for elements with an extensive ground plane.

At 3.8 MHz the element spacing is 64.71 feet. Allowing for some variation in placement of the switching relays and feed network, each feeder is arbitrarily cut to 34 feet. Assuming a line characteristic impedance, Z_o , of 50 ohms and velocity factor of 0.66 the electrical length of the feeders is 71.65°. The drive network will be matched to a 50-ohm line.

For a matched array we must first determine the resistance loads each network chain presents to the shack line. Assuming 1 ampere flowing into each element, the total power going to the array is the sum of I^2R inputs, or

$$21.4 \cdot I^2 + (51.4) \cdot I^2 = 72.8 \text{ watts}$$

table 2. Input conditions and ABCD parameters at each circuit junction with 1 ampere flowing into each element.

element 1		element 2	
Z_1	= 21.4 - j15	Z_2	= 51.4 + j15
E_1	= 26.134 / -35.028°	E_2	= 53.544 / -73.731°
I_1	= 1 / 0°	I_2	= 1 / -90°
71.65° coax		71.65° coax	
A	= 0.3148 + j0	A	= 0.3148 + j0
B	= 0 + j47.458	B	= 0 + j47.458
C	= 0 + j0.01898	C	= 0 + j0.01898
D	= 0.3148 + j0	D	= 0.3148 + j0
$AZ_a + B$	= 6.7372 + j42.7351	$AZ_b + B$	= 16.1819 + j52.1798
$CZ_a + D$	= 0.5995 + j0.4062	$CZ_b + D$	= 0.0300 + j0.9757
Z_1	= 40.7999 + j43.6326	Z_2	= 54.9379 - j14.9217
E_1	= 43.2629 / 81.0410°	E_2	= 54.6314 / -17.2296°
I_1	= 0.7242 / 34.1195°	I_2	= 0.9761 / -1.7656°
shunt L-match (leading)		shunt L-match (lagging)	
A	= 1 + j0	A	= 1 + j0
B	= 0 - j116.2630	B	= 0 + j45.0951
C	= 0 - j0.01047	C	= 0 + j0.0079
D	= -0.21678 + j0	D	= 0.64378 + j0
$AZ_a + B$	= 40.7999 - j72.6303	$AZ_b + B$	= 53.9379 + j30.1733
$CZ_a + D$	= 0.2398 - j0.4270	$CZ_b + D$	= 0.7616 + j0.4260
Z_1	= 170.0934 + j0	Z_2	= 70.8171 + j0
E_1	= 60.3324 / -26.5554°	E_2	= 60.3324 / 27.4573°
I_1	= 0.3547 / -26.5554°	I_2	= 0.8519 / 27.4573°
pi circuit (lag 54.0126°)			
A	= 0.5876 + j0		
B	= 0 + j137.6306		
C	= 0 + j0.004757		
D	= 0.5876 + j0		
$AZ_a + B$	= 99.9479 + j137.6303		
$CZ_a + D$	= 0.5876 + j0.8091		
Z_1	= 170.0934 + j0		
E_1	= 60.3324 / 27.4572°		
I_1	= 0.3547 / 27.4572°		

The voltage at the common connection of the array for matched conditions, i.e., a 50 ohm load, is $E = \sqrt{RW} = \sqrt{(50)(72.8)} = 60.3324 \text{ volts}$. Since the element networks will be transformed individually to pure resistances whose paralleled value is 50 ohms, we must find the individual values. Going back to the resistive components of each driving-point impedance (and knowing the array's impressed voltage amplitude when correctly driven), we can determine what these resistive loads must be. Using the relationship $R = E^2/W$, these transformed loads are respectively:

$$(60.3324)^2/21.4 = \sqrt{70.0935 \text{ ohms, element 1}^*}$$

$$(60.3324)^2/51.4 = 70.8171 \text{ ohms, element 2}$$

*Check whether these resistances when paralleled equal 50 ohms.

As recommended in part 4, the simplest network often results if the drive network for the -90° phased element establishes the voltage amplitude and phase for the array common connection. Proceeding on that basis we will design the network for element 2 first. We need to transform the driving-point impedance of this element to the input end of its coax feeder and to determine the input voltage and current that must exist there. Table 2 lists the input conditions for each element at each junction point and the ABCD parameters for each circuit. For simplicity, 1 ampere is assumed to be flowing into each element.

The design procedure for the lumped-constant part of the network transforms element 2 driving-point impedance, as seen at the input to its coax feeder, to the resistive load required, using a lagging phase shunt L-match. (The design equations for all discussed circuits are found in part 4.) This fixes the voltage amplitude and phase required for the array. Element 1 driving-point impedance, as seen at the input to its coax feeder, is transformed, with a leading phase shunt L-match, to the resistive load required for this chain. At the input to this L-match, the voltage amplitude is correct but the phase displacement has overshoot the objective. (L-match circuits can be designed to produce either a specific resistive input or a specific phase displacement — not both.) The solution is to add a lagging π coax-equivalent circuit with a characteristic impedance of 170.0935 ohms and an electrical length equal to the difference between the phase angle existing at the input to this L-match (-26.5554°) and the angle required at the common connection point (27.4572°). This difference, i.e., the total angular displacement between these two vectors, is 54.0126° . This phase correction circuit can be thought of as though we had somehow magically obtained approximately 26 feet of coax delay line having a characteristic impedance of 170 ohms. When doing chained network calculations, don't forget that Z_a (output load) for the circuit being computed is the *input* impedance of the preceding junction (looking towards the load). For example, when transforming the element driving-point impedance to the input end of its feeder, then the output load, Z_a , is the element's driving-point impedance. But when computing input/output relations for the succeeding L-match circuit, Z_a is now the impedance seen at the input end of the transmission line feeder, and so on.

final 2-element network design

The resulting design for the feed network of this array requires three inductances and four capaci-

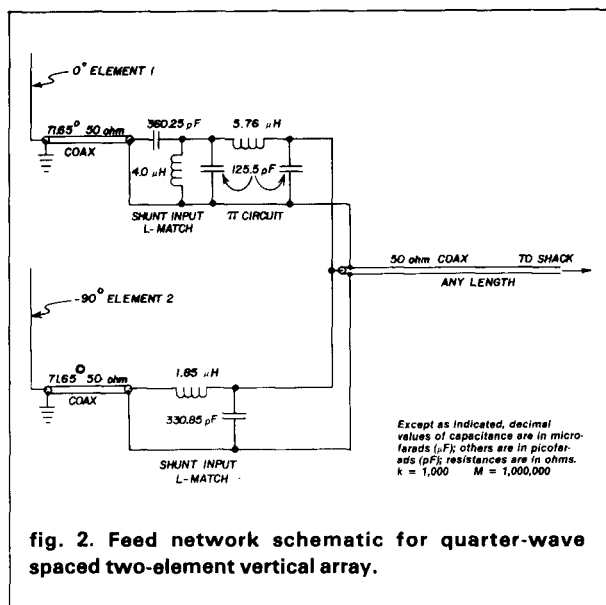

fig. 2. Feed network schematic for quarter-wave spaced two-element vertical array.

tances as seen in fig. 2. The component values are quite realizable. Evaluation of network designs is admittedly somewhat subjective. It is conditioned by the number of individual network circuits required, circuit component values (e.g., at 3.8 MHz lossless air core series arm inductances greater than $10 \mu\text{H}$ become physically large; shunt arm capacitance values less than 50 pF require more rigorous assessment of the unavoidable stray circuit capacitances). Should awkward values of components result from a particular design, it is often possible that using a different element to establish the voltage amplitude and phase at the array common connection point results in more physically realizable components.

In a concluding article of this series I will discuss practical array and feed network construction and measurements.

This information, gleaned during the various phases of the development of my vertical phased arrays, should help the reader convert the theory presented on these pages into an actual physical structure — an antenna array that works the way it was designed to work.

references

1. Forrest Gehrke, K2BT, "Vertical Phased Arrays, part 4," *ham radio*, October, 1983, page 34.
2. Frank Ayres, *Matrices*, (Shaum's Outline Series), McGraw-Hill Book Company; Noble and Daniel, *Applied Linear Algebra*, Prentice-Hall Inc.; L.A. Pipes, *Applied Mathematics for Engineers and Physicists*, McGraw-Hill Co.
3. Forrest Gehrke, K2BT, "Vertical Phased Arrays: part 1," *ham radio*, May, 1983, page 18.
4. Forrest Gehrke, K2BT, "Vertical Phased Arrays: part 3," *ham radio*, July, 1983, page 26.

ham radio

Blueprint for Success

THE INTERFACE

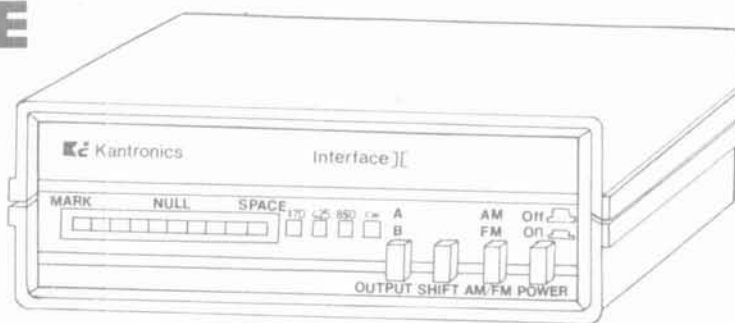
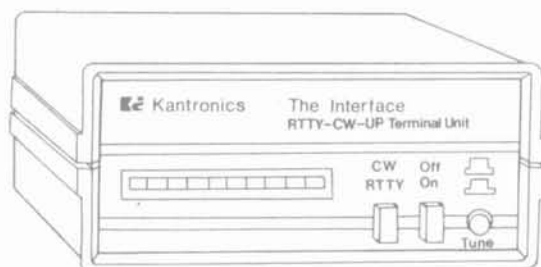

THE INTERFACE II

 Kantronics

TITLE: THE INTERFACE - INTERFACE II PROPOSAL

THE INTERFACE is the original Kantronics terminal unit that broke through the barrier of multi-computer compatibility. **THE INTERFACE** is an amateur modem for transceiver-to-computer communication. With **THE INTERFACE** and Hamsoft or Hamtext for your computer you can send and receive Morse Code, Radioteletype, and ASCII. **THE INTERFACE** is also compatible with our new software for AMTOR communication, AMTORSOFT. **THE INTERFACE** is our most popular unit combining active filtering, easy tuning, six-computer compatibility, and low price for an unbeatable package.

Suggested Retail \$139.95

INTERFACE II is the new Kantronics transceiver-to-computer interface. **INTERFACE II** features a new highly sensitive front end with mark and space filtering and a unique new tuning system. Even the most discerning operator will be surprised with the **INTERFACE II**'s ability to dig out signals in poor band conditions, and our new tuning system even displays signal fading.

X-Y scope outputs and dual interface outputs for VHF and HF connections make **INTERFACE II** compatible with almost any shack. All three standard shifts are selectable and **INTERFACE II** is compatible with the industry standard Kantronics programs: Hamsoft, Hamtext, and Amtorsoft. Step up to state of the art in computer-amateur communications with **INTERFACE II**.

Suggested Retail \$269.95

For more information see your Kantronics dealer, or contact:
 Kantronics 1202 E. 23rd Street Lawrence, KS 66044

KANTRONICS SOFTWARE

Hamsoft,™ Hamtext,™ and Amtorsoft™

MORSE 00:00:00
 TRANSMIT SPEED 25
 RECEIVE SPEED 28

ENJOY YOUR MEAL AND
 WE'LL TALK TO YOU
 REAL SOON . . . 73'S . . .
 WA5RGU
 WEATHER HERE IS WARM TODAY
 WITH LOTS OF SUN. . .XYL SAYS
 TIME FOR DINNER SO 73'S WØXI

Kantronics has led the amateur community in software and total computer communications systems with our original program, **HAMSOFT**. With five-computer compatibility and reasonable prices **HAMSOFT** has become the industry standard. **HAMSOFT** includes split screen display, type ahead buffer, message ports, and complete keyboard control for Morse Code, Radioteletype, and ASCII communications. With THE INTERFACE or INTERFACE II, **HAMSOFT** can make any of five computers a complete amateur communications terminal. All programs are on a ROM board, except the Apple diskette.
 VIC-20 - \$49.95, ATARI - \$49.95, APPLE - \$29.95,
 TRS-80C - \$59.95, TI-99/4A - \$99.95

HAMTEXT is our advanced CW/RTTY/ASCII program for the VIC-20, COMMODORE 64, and APPLE computers. **HAMTEXT** gives you the ability to store incoming messages in the computer's memory, transmit files directly from tape or disk, and use your computer to its fullest potential. Features like Diddle, Time Transmission, Text Transmission, Printer Outputs, and Word Wraparound, make **HAMTEXT** the program for the serious amateur. **HAMTEXT** was created with input from our users as guidelines, and with total use of the computer in mind.
Suggested Retail \$99.95

00:00:00

PROGRAM OPTIONS

- A. RETURN TO BASIC
- B. EDIT MESSAGE PORTS
- C. SAVE MESSAGE PORTS
- D. LOAD MESSAGE PORTS
- E. SET XMIT BUFF SIZE
- F. EDIT HOLDING BUFFER
- G. SAVE HOLDING BUFFER
- H. LOAD HOLDING BUFFER
- I. SET TIME

00:00:00

KANTRONICS AMTORSOFT
 COPYRIGHT 29 JUNE 1983

CHOOSE
 S (AMTOR SLAVE)
 M (AMTOR MASTER)
 L (AMTOR LISTENER)
 P (PROGRAM OPTIONS)
 T (T/R OPTIONS)

On January 27th, 1983, AMTOR, Amateur RadioTeletype Over Radio, became a legal mode for the amateur service. AMTOR is an essentially error-free radioteletype form of communication. **AMTORSOFT**, Kantronics' newest software package, gives your computer the ability to become an AMTOR communications terminal when used with The Interface or interface II. **AMTORSOFT** is currently available for the Apple, VIC-20, and COM-64 computers. **AMTORSOFT** brings you the newest in computer-amateur communications at an affordable price.
Suggested Retail \$89.95

For more information see your Kantronics dealer, or contact:
 Kantronics 1202 E. 23rd Street Lawrence, KS 66044

Get those
demons
downing
your
electronic
gear!



Nothing matches the MACC in voltage surge protection and component-by-component on-off control

- compact, attractive desk-top console
- eight clean AC power outlets
- individual and master on-off control
- superior three-stage auto-restore circuit with manual reset circuit breaker
- individually lighted rocker switches

Lightning striking miles away, electric motors running on the same power line, fluorescent lighting and even wind-driven snow static buildup can cause problems with delicate circuits and miniature electronic chips. But the MACC, within nanoseconds, can recognize the current disturbance, then clip it off and dissipate it, while maintaining clean current flow to your system's equipment. The MACC protects all semi-conductor, solid-state circuitry.

The MACC is designed with three 2000-amp surge discharge protection circuits — one between each of the AC input's hot, neutral and ground lines. Other surge devices may use a single 100-amp surge protector between the hot and neutral lines only. Its resettable circuit breaker adds further protection.

MACC gives you control convenience, too. It provides 8 plug-in "U" ground outlets for your components — including one "hot" outlet for a continuously powered application such as your clock. Seven "on/off" rocker switches let you control individual components. And you can turn your entire system on or off with a single master rocker switch.

ALPHA DELTA'S MASTER AC CONTROL CONSOLE PROTECTS AGAINST ALL THESE DAMAGING SURGE PROBLEMS

Problems caused in circuitry by surging and transient voltages:

- Melting of "hot spots" within semi-conductor devices
- Thermal runaway of transistors
- Welding, pitting and metal transfer on switch contacts
- Switch contact corrosion
- Insulation breakdown causing arcing of components
- Shortening of component life

The MACC is tested to IEEE pulse standards and rated at 15A, 125V-AC, 60 Hz, 1875 watts continuous

duty total for the console. A label on the unit describes the surge protection limitations.

MACC Specs

Alpha Delta Master AC Control Console

Amperage 15
Volt (AC) 125
Hertz 60

Total
Wattage 1875

Size

MACC 11" x 2-3/4" x 2-3/4"

MACC-4 5-1/2" x 2-3/4" x 2-3/4"

Shipping

Weight 4-1/2 lbs. approximately

Alpha Delta Model MACC Systems are designed to reduce the hazards of lightning-induced surges. These devices, however, will not prevent fire or damage caused by a direct stroke to an AC line or a structure. Specifications, availability and price are subject to change without notice.

Warranted against defects in materials or workmanship.

ALPHA DELTA COMMUNICATIONS, INC.

P.O. Box 571, Centerville, Ohio 45459 • (513) 435-4772



current solutions to current problems

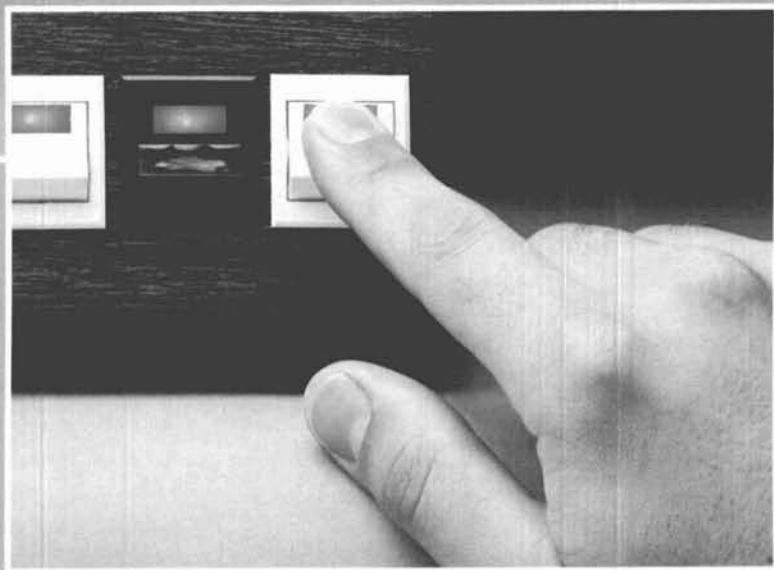
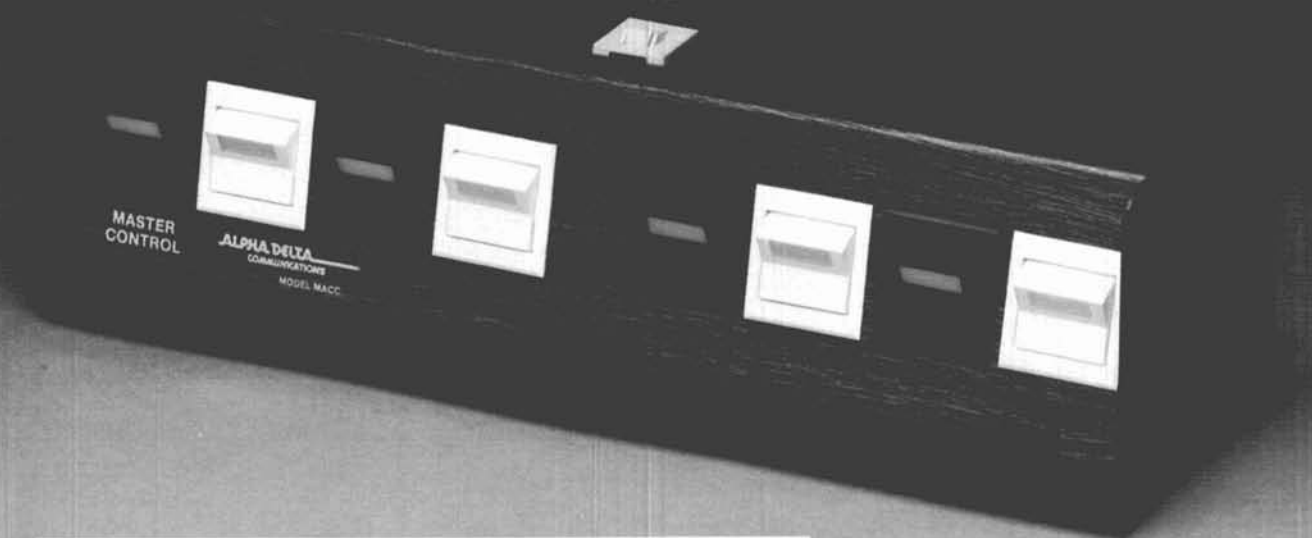

The MACC is unique in voltage surge/transient suppression and convenient, desk-top individual component control. Nothing matches the MACC in value and performance. Put one on duty on your AC line.

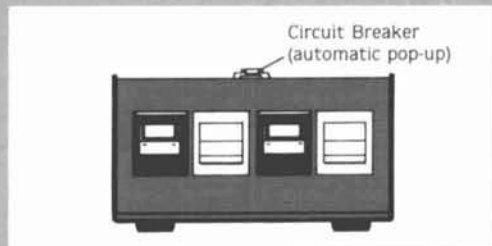
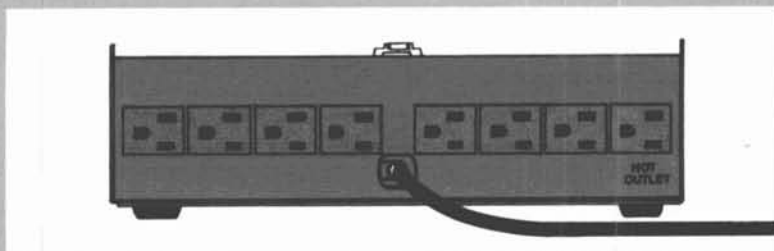

MACC only \$79.95
MACC-4 only \$59.95



The MACC-4 is a four clean-line output version of the MACC with all the same features. It gives you a cost- and space-saving solution for your application, without sacrificing performance. Rated a full 1875 total wattage. Includes master rocker switch, three independently switchable lines, one "hot" line and resettable circuit breaker.



At your Alpha Delta dealer. Or in U.S., order direct, adding \$4 for postage/handling to check or money order. (Approx. shipping wt.: 4-1/2 lbs. each) MasterCard and VISA accepted. Ohio residents add Sales Tax. Sorry no C.O.D.'s

Ham Radio's Gift Catalog



fine gift suggestions for everyone interested in Amateur Radio. Gift subscriptions, license study guides, state-of-the-art publications - all sure to please! Gifts that will be used and enjoyed all year long.

THE UHF COMPENDIUM

by K. Weiner, DJ9HO

This 413 page book is an absolute must for every VHF and UHF enthusiast. Special emphasis has been placed on state-of-the-art techniques. Author Weiner fully describes test equipment, alignment tools, power measuring equipment and other handy gadgets. All of the projects and designs have been tested and proven and are not engineer's pipe dreams. Antennas are also fully covered with a number of easy-to-build designs as well as large mega-element arrays. ©1980.

KW-UHF Softbound \$23.95

RF CIRCUIT DESIGN

by Chris Bowick, WB4UHY

This book has been written for those who desire a practical approach to the design of rf amplifiers, impedance measuring devices and filters. Experts will find this book to be an invaluable reference source. Students will gain a way to bridge from classroom studies to practical application. The hobbyist will find plenty of practical projects and design ideas. 7 chapters cover from basics to advanced design concepts. You get a complete design run down for multiple pole Butterworth, Chebyshev and Bessel filters. RF Circuit Design also includes a bibliography of books and technical papers to help further your knowledge of circuit design. ©1983, 176 pages, 1st edition.

21868 Softbound \$22.95

THE FCC RULE BOOK

A Guide to the FCC Regulations
by Rick Palm, K1CE

This book is more than the FCC part 97 Amateur Rules and Regulations. It presents detailed explanations of rules and is written in an easy-to-read, conversational style. Author Palm gives you the insider's view of how FCC rules are made and how you can influence FCC decisions. You also get a broad overview of how international treaties and agreements impact your hobby. Every U.S. Amateur should have a copy of this most important and up-to-date book in their shack. ©1983, 1st edition.

AR-BB Softbound \$3.00

RADIO ELECTRONICS BUYERS GUIDE

Have you ever found yourself stymied because you couldn't find a particular electronic part? If you had a copy of this handy buyer's guide in your library, you wouldn't have a problem at all. For ease of use, components are listed alphabetically by generic name with suppliers name. If applicable, part numbers are also included for ease of identification. From Actuators to Zener diodes, you'll find this 95 page directory jam-packed with important information. Suppliers are listed alphabetically with addresses and telephone numbers. If you do any building — you've got to have a copy of this book. ©1983, 4th edition, 125 pages.

HW-BG Softbound \$5.95

HEIL HAM RADIO HANDBOOK

by Bob Heil, K9EID

Bob Heil is one of Ham Radio's most dynamic fellows. Dayton's Ham of the Year for 1982 and author of the best selling "10 Meter FM Handbook", he has now come out with a handy handbook for all levels of Amateur Radio interest. 20 chapters cover every aspect of Ham Radio from Day #1 as a new Novice through operating procedures to some basics on how to repair and troubleshoot equipment. Great pains were taken to ensure that 99% of the "most-often-asked" questions are fully and clearly answered. Of particular interest are five chapters dedicated to the art of how to Homebrew. Tools, techniques, p.c. boards and much more. A great gift for a new ham. ©1983, 168 pages.

MP-HH Softbound \$9.95

CONFIDENTIAL FREQUENCY LIST 5th Edition

by Oliver P. Ferrell

Enjoy tuning across the bands looking for who-knows-what? This book is jam-packed with frequencies and call signs. Hundreds of stations are listed first by frequency and then by call sign. You also get helpful hints and tips. Author Ferrell is known worldwide as one of the most knowledgeable folks around when it comes to SWling. ©1983, 5th edition, 249 pages.

GL-CF Softbound \$10.95

RADIO HANDBOOK 22ND EDITION

by Bill Orr, W6SAI

A best seller for over 45 years! The 22nd edition reflects state-of-the-art techniques in a comprehensive, single source reference book. Invaluable for Hams, technicians, and engineers alike. Chock-full of projects and other ideas that are of interest to all levels of electronics expertise. 1136 pages. ©1981, 22nd edition.

21874 Hardbound Reg. \$39.95
SAVE \$7 NOW \$32.95

AMATEUR RADIO THEORY AND PRACTICE

by Robert Shrader, W6BNB

In response to requests from the Amateur community, Mr. Shrader has extracted from his best seller, *Electronic Communication*, just those parts necessary to pass all five classes of Amateur License. You save 1/3 off the price of the larger book, too! A complete step-by-step guide to Amateur Radio including self-check quizzes and a final FCC-like exam for each license class. ©1982, 340 pages. Taken from 4th edition of *Electronic Communication*.

MH-57146 Softbound \$22.95

GUIDE TO RTTY FREQUENCIES

by Oliver P. Ferrell

Fully revised to reflect latest information available. Contains most shortwave military, commercial, press, aeronautical, embassy and weather broadcasting RTTY stations. You also get shift, speed, power, schedules, formats, special ID's plus much more. Author Ferrell gives you the benefit of his years of experience in helpful hints and tips. He also tells you the secrets behind current trends in encoding signals and what it means to you the listener. ©1983, 190 pages, 2nd edition.

GL-RF Softbound \$9.95

BRAND NEW TITLES

RESERVE YOUR COPY NOW!

1984 U.S. RADIO AMATEUR CALLBOOK

This is the latest edition of the grand daddy of all the others. The Callbook is the only directory with an in-house editorial department that checks the FCC info as it comes in to ensure accuracy. U.S. and foreign hams swear this is the most important reference book in their files. Order your copy today. Ensure you have the very latest QSL information available at your fingertips. Over 410,000 listings. Also contains helpful and hard-to-find operating and station aids. ©1983.

CB-US84 Softbound \$23.00
(\$19.95 + \$3.05 shipping)

1984 FOREIGN RADIO AMATEUR CALLBOOK

The only foreign callbook available! DXCC is the goal of many hams. To others, casual rag chews with foreign hams are the real joy of Amateur Radio. Whatever your interest, if you want a QSL, you should have a copy of the latest Foreign Callbook in your shack. Fully up-dated with the latest lists direct from the overseas licensing authorities. ©1983.

CB-F84 Softbound \$22.00
(\$18.95 + \$3.05 shipping)

BUY BOTH CALLBOOKS SAVE OVER \$5.00

CB-USF \$39.95

Includes shipping U.S.A.

Radio Amateur Callbooks will be ready for shipping the week of 12/1/83.

1984 ARRL RADIO AMATEUR'S HANDBOOK

Known worldwide as THE standard reference for Radio Amateurs. Reserve your copy today and we will ship immediately as soon as it becomes available. Great for gift giving or for yourself. This book is jam-packed with just about every possible fact and figure you will ever need. Also has plenty of up-to-date projects. ©1983.

AR-HB Softbound \$12.00

(available late November)

AR-BB Hardbound \$15.75

(available early January 1984)

NOVICE CLASS RADIO AMATEUR FCC TEST

This is the very first book written that is geared to the new FCC Novice exam program. Clear and concise answers are provided for each of the FCC sample questions. Answers are written assuming no technical background in Ameco's easy-to-understand style. This new book is cross-referenced to Ameco's Novice Theory Course, #23-01 and Amateur Theory Course, #102-01 for detailed explanations beyond the scope of a Q&A book. Every instructor and student should have this book. Why not a copy from Ameco, long known for their excellent study material. ©1983, 64 pages, 1st edition.

27-01 Softbound \$2.25

NOVICE CLASS RADIO AMATEUR EXAM

Contains a sealed temper-proof envelope with 20 multiple choice questions selected by computer from a pool of hundreds of professionally written questions. At least 20 different exams will be available. You also get the exam answers in a sealed envelope, a volunteer examiner affidavit and detailed instructions for both examiner and student. This exam package ensures that administration of the Novice exam is uniform, professional and simple. ©1983, 1st edition.

EN-1 \$1.25

BRAND NEW

OFFICIAL ARRL CALL DIRECTORY 1983-84

Brand new, chockfull of all the latest call signs and addresses from the FCC files and compiled by Buckmaster Publishing. 1090 pages of addresses are listed alphabetically by call sign for easy reference and location. Printed on easy-to-read stock. This is a book you should have in your ham shack. ©1983, 1090 pages.

AR-CD Softbound \$18.75
(\$15.75 + \$3.00 shipping)

Have a friend who might want a catalog? Let us know and we'll send them one.

Please add \$2.50 shipping except for Callbook and ARRL Call Directory.
In a hurry? Call (603) 878-1441

HAM RADIO'S BOOKSTORE, Greenville, NH 03048

Actual slow motion frames from Ham MasterTapes



1. Larry, N2NY, Lee, KA2RNV, Virginia, N2EGJ



2. Lee discharges cap

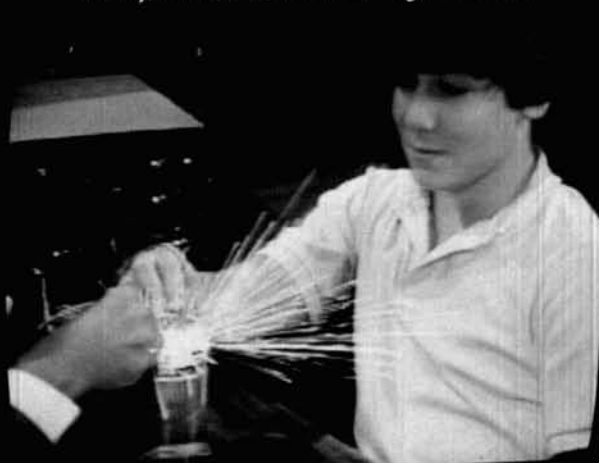

3. In slow motion it's dazzling



4. Wow. Can we see it again?

**You've never seen this, like this,
before this!**

**And you can see it—in color—again and again
when you own the N2NY Ham MasterTapes.**

Ever see a cap discharge in slow motion? You will on Ham MasterTapes. Ham MasterTapes can perform the dozens of complicated demonstrations necessary for a beginner's understanding of Ham Radio Theory.

Finally, a step-by-step course in Ham Radio Theory is available on color videotape. The Larry Horne N2NY Ham MasterTapes video course is a unique, effective teaching technique expertly produced by New York's leading professionals in studio and field videotape.

- Video Graphics highlight important details.
- Carefully worked-out demonstrations on video avoid the problem of getting complex gadgets to work on command in front of a class.
- Working examples of every ham radio component, device, or system covered in the FCC guide can be clearly understood.

150

The N2NY Ham MasterTapes give you a basic grasp of concepts that build theory background—not only for passing the FCC tests, but for understanding electronics.

The hobby has long needed better, clearer, high-tech teaching aids to help newcomers into our wonderful world of Ham Radio.

These six-hour tapes cover completely all the material needed to understand Novice and Tech/General Theory and operations, and include the new 200-question FCC syllabus used beginning September 1983.

Only \$199.95. Order direct and specify Beta or VHS format. Call or write: Larry Horne, N2NY or

Virginia Hamilton, N2EGJ at
Ham MasterTapes
136 East 31st Street
New York, N.Y. 10016 212-673-0680.

Ham MasterTapes™

THE N2NY HAM RADIO COURSE ON VIDEOTAPE

© 1983 N2NY Productions, Inc.

new!

JPC/AZDEN®

4000 SERIES FM TRANSCEIVERS

10 METERS & DOWN

COMMERCIAL-GRADE QUALITY AT AMATEUR PRICES

EXCLUSIVE 1 YEAR LIMITED WARRANTY! COMPARE!



PCS-4000
2-m FM Transceiver

THE 4000 SERIES



PCS-4300 70-cm FM Transceiver



PCS-4500 6-m FM Transceiver



PCS-4800 10-m FM Transceiver

COMING SOON
PCS-4200 1 1/4-m FM Transceiver



PCS-300
2m Handheld
FM Transceiver
142-149.995 MHz

✓ 111

- **WIDE FREQUENCY COVERAGE:** PCS-4000 covers 142.000-149.995 MHz in selectable steps of 5 or 10 kHz. PCS-4200 covers 220.000-224.995 MHz in selectable steps of 5 or 20 kHz. PCS-4300 covers 440.000-449.995 MHz in selectable steps of 5 or 25 kHz. PCS-4500 covers 50.000-53.995 MHz in selectable steps of 5 or 10 kHz. PCS-4800 covers 28.000-29.990 MHz in selectable steps of 10 or 20 kHz.
- **CAP/MARS BUILT IN:** PCS-4000 includes coverage of CAP and MARS frequencies.
- **TINY SIZE:** Only 2"H x 5.5"W x 6.8"D. COMPARE!
- **MICROCOMPUTER CONTROL:** At the forefront of technology!
- **UP TO 8 NONSTANDARD SPLITS:** Ultimate versatility. COMPARE!
- **16-CHANNEL MEMORY IN TWO 8-CHANNEL BANKS:** Retains frequency and standard simplex or plus/minus offsets. Standard offsets are 600 kHz for PCS-4000, 1.6 MHz for PCS-4200, 5 MHz for PCS-4300, 1 MHz for PCS-4500, and 100 kHz for PCS-4800.
- **DUAL MEMORY SCAN:** Scan memory banks either separately or together. COMPARE!
- **TWO RANGES OF PROGRAMMABLE BAND SCANNING:** Limits are quickly reset. Scan the two segments either separately or together. COMPARE!
- **FREE AND VACANT SCAN MODES:** Free scanning stops 5 seconds on a busy channel; auto-resume can be overridden if desired. Vacant scanning stops on unoccupied frequencies.
- **DISCRIMINATOR SCAN CENTERING (AZDEN EXCLUSIVE PATENT):** Always stops on frequency.
- **TWO PRIORITY MEMORIES:** Either may be instantly recalled at any time. COMPARE!
- **NICAD MEMORY BACKUP:** Never lose the programmed channels!
- **FREQUENCY REVERSE:** The touch of a single button inverts the transmit and receive frequencies,

no matter what the offset.

- **ILLUMINATED KEYBOARD WITH ACQUISITION TONE:** Unparalleled ease of operation.
- **BRIGHT GREEN LED FREQUENCY DISPLAY:** Easily visible, even in direct sunlight.
- **DIGITAL S/R F METER:** Shows incoming signal strength and relative power output.
- **BUSY-CHANNEL AND TRANSMIT INDICATORS:** Bright LEDs show when a channel is busy and when you are transmitting.
- **FULL 16-KEY TOUCHTONE® PAD:** Keyboard functions as autopatch when transmitting (except in PCS-4800).
- **PL TONE:** Optional PL tone unit allows access to private-line repeaters. Deviation and tone frequency are fully adjustable.
- **TRUE FM:** Not phase modulation. Unsurpassed intelligibility and audio fidelity.
- **HIGH/LOW POWER OUTPUT:** 25 or 5 watts selectable in PCS-4000; 10 or 1 watt selectable in PCS-4200, PCS-4300, PCS-4500, and PCS-4800. Transmitter power is fully adjustable.
- **SUPERIOR RECEIVER:** Sensitivity is 0.2 uV or better for 20-dB quieting. Circuits are designed and manufactured to rigorous specifications for exceptional performance, second to none. COMPARE!
- **REMOTE-CONTROL MICROPHONE:** Memory A-1 call, up/down manual scan, and memory address functions may be performed without touching the front panel! COMPARE!
- **OTHER FEATURES:** Dynamic microphone, rugged built-in speaker, mobile mounting bracket, remote speaker jack, and all cords, plugs, fuses, and hardware are included.
- **ACCESSORIES:** CS-7R 7-amp ac power supply, CS-4.5R 4.5-amp ac power supply, CS-AS remote speaker, and Communications Specialists SS-32 PL tone module.
- **ONE YEAR LIMITED WARRANTY!**

EXCLUSIVE DISTRIBUTOR:

DEALER INQUIRIES INVITED

AMATEUR-WHOLESALE ELECTRONICS

TOLL FREE... 800-327-3102

8817 S.W. 129th Terrace, Miami, Florida 33176

Telephone (305) 233-3631

Telex: 80-3356

MANUFACTURER:

JPC/AZDEN

JAPAN PIEZO CO., LTD.

1-12-17 Kamirenjaku, Mitaka, Tokyo, 181 Japan.

Telex: 781-2822452



lightning and electrical transient protection

A variety of devices safeguard delicate electronic circuitry

It's a summer afternoon; the air feels heavy, dense. Towering gray-black cumulonimbus clouds advance across the sky. Suddenly lightning knives from cloud to ground, filling the air with thunder. Bolts leap from cloud to cloud, cloud to ground, and from top to bottom within individual clouds. Rain pours down and then, almost as abruptly as it began, the thunderstorm disappears.

Snug at home, a ham fires up his rig to keep a schedule on 20 meters. He's running a few minutes late, but that's better than operating in the middle of an electrical storm. To his dismay, he discovers that his radio can't transceive any more. It sits dead, emitting a quiet hiss on every band.

Unknown to our ham, his rig gave up the ghost five minutes before he turned on the power. The FET in the receiver front-end had its gate destroyed by a lightning-induced static discharge.

Every year, hundreds of hams have the same unfortunate, unnecessary experience. All radio equipment can be protected, easily and inexpensively, but before we can give our rigs complete protection, we must first understand the causes and nature of static discharges.

Thunderstorms develop when warm, moist air is forced to rise. This may be triggered by the meeting of warm and cold air masses, which is especially common in the Midwest and along the Gulf Coast and Eastern seaboard. Or it may be induced by terrain, as frequently happens in the mountainous West. Thunderstorms are most likely to occur in those areas favored by frontal development or terrain or both, as shown in **fig. 1**.

For whatever reason, rising air begins cloud formation at *lifting condensation level* where its temperature drops below the dew point. The larger the temperature differential between the surrounding atmosphere and the rising column of air, the greater the speed and violence of development.

An average cumulonimbus cell will reach upward 6 miles (9.7 km) and develop vertical air drafts with velocities of 15 feet per second. Violent cells may rise to 60,000 feet and create intense drafts with speeds over 200 feet per second.

After the formation of ice crystals, a charge separation occurs within the cloud. The top of the cloud becomes positive; the underside, negative. The reasons for this separation are varied: frictional contact, melting, freezing, inductive charge transfer, water drop breakup, ion attachment. These mechanisms may operate independently or together and turn the cloud into a giant static electricity generator.

The development of extreme potential differences within the cloud leads to atmospheric breakdown and electrical conduction. Lightning strokes begin within the cloud and often between clouds. While nine out of ten discharges during thunderstorms are of this type, it's that remaining ten percent that are of primary concern to us.

lightning development

Development of a ground stroke follows a definite sequence: first, a faintly luminous tendril descends from the cloud base. This is the *stepped leader*. A stepped leader moves downward in jerky spurts of 150 feet (45.7 meters) at speeds of 75 miles (120 km) per second. It may branch out, with a new fork occurring at one of its hesitation points. When this leader is within 100 feet (30.5 meters) of the ground, the local electrical field becomes strong enough to initiate discharge from the ground. This *ground streamer* moves upward in a forked pattern. With the connection of the stepped leader and ground streamer, a heavy current (typically 20,000 amperes)

By Bradley Wells, KR7L, 5053 37th Avenue SW, Seattle, Washington 98126

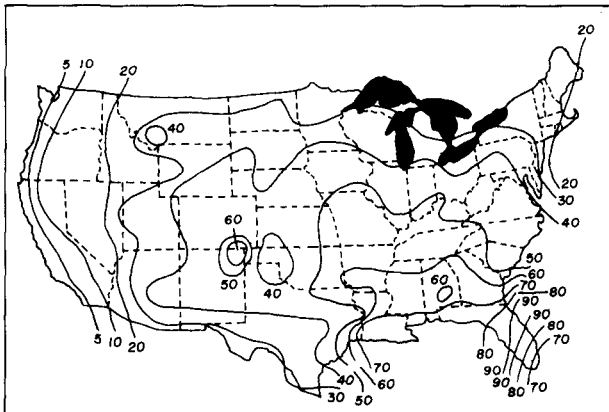

fig. 1. The mean number of thunderstorm days in the United States is related to both mountainous terrain and seasonal weather patterns. (Adapted with permission from *Understanding Lightning* by Martin Uman, copyright 1971, BEK Technical Publications, 1700 Painters Run Road, Pittsburgh, Pennsylvania 15243.)

flows from the ground to the cloud at a speed of 60,000 miles (97,000 km) per second. This *return stroke* produces the lightning flash that we observe.

Approximately 50 milliseconds after the return stroke, another tendril of luminosity descends from the cloud base. This is the *dart leader*, and it traverses the same channel followed by the return stroke. Its ground contact triggers a second return stroke of slightly less power than the first. Most cloud-to-ground discharges consist of three or four return strokes, each successively penetrating farther into the cloud to tap new charge accumulations.

The quantity of energy in an average lightning stroke can approach 1,000,000,000 joules. It transfers some 10 coulombs of charge across a potential difference of 100 million volts. This release of energy in less than 300 *microseconds* is equivalent to many megawatts of power. While lightning strokes are normally measured in thousands of feet, horizontal strokes up to 100 miles (161 km) in length have been observed. Similarly, voltages also vary, and potential differences of as high as one billion volts have been recorded. The sudden energy release of these lightning strokes can generate intense electrostatic and electromagnetic fields miles away from their origin.

lightning protection

Several steps are involved in protecting electronic equipment from lightning-induced static discharge. The first rule is to bond all metal objects to a ground system in order to provide a low resistance, high capacity reservoir for soaking up static charges. Pay particular attention to your tower since it will act just like a giant lightning rod: clean and lubricate all joints with conductive grease, then tie the tower to your

ground system with heavy copper or aluminum wire. *Simply having the tower base in the earth is no guarantee of a good electrical ground.* (Commercial radio towers use wide copper straps run in several directions for some distance to secure a good ground.) Properly grounded, a tower located close to the house can provide a degree of protection for the dwelling and occupants against lightning damage.

The often-repeated suggestion to disconnect antennas during a storm is still good advice. The problem, however, is that the operator may not be home to make this disconnection, or that the storm may be several miles away and out of sight. (see "10 GHz Weather Radar", *ham radio*, September, p. 61, for discussion of a method for detecting nearby thunderstorm activity.) Generally, by the time a ham thinks to unhook the coax, the damage is done.

other hazards

Several other sources of static electricity are common and may severely damage equipment. High winds, especially under conditions of very low humidity, can cause static in much the same manner as does dragging your feet over a carpet. Blowing powder snow may also cause static build-up on exposed metal surfaces.

Conventional lightning arrestors offer little protection for modern equipment because most of us operate with solid-state rigs; older tube-type radios were far more forgiving of static buildup than transistors or field-effect devices. Many tubes could actually arc over with minimal damage to either the tube or related components — but not modern transistors or, in particular, FETs. MOSFETs, particularly those without gate protection, can be irrevocably damaged by simply picking them up. Solid-state devices cannot tolerate any type of overvoltage on their base or gates, for even a microsecond, without sustaining damage. This damage may be total, in which case the receiver is dead; or it may be partial, leaving the operator thinking that propagation just isn't what it used to be.

Air gap lightning arrestors fail to protect equipment because the characteristics that determine their firing ability vary with both the air pressure and humidity of the environment. Under optimal conditions their response time is far too slow; even when these devices do fire, they retain a high enough voltage across the gap to damage sensitive equipment. Normally, 3 to 5 kilovolts is required to trigger the spark gap and when operating will still leave a 50-80 volt potential at the antenna terminal.

What we need is a device that will fire within nanoseconds and clip off high voltage spikes effectively. Two such devices are shown in fig. 2. Unlike conventional air gaps, these lightning protectors util-



fig. 2. While designed for indoor use, both Alpha Delta Transi-Trap and Drake Surge Shunt may be installed outdoors if appropriate weather-proof shielding is provided.



ize a hermetically sealed tube filled with Krypton 85, a gas of known breakdown characteristics. Since these devices are sealed, they remain unaffected by changes in humidity or atmospheric pressure. The tube design is such that their firing properties remain constant under all conditions. The gas conducts very effectively and reduces the voltage to values safe for solid-state devices. The typical firing speed is 100 nanoseconds and conduction begins at 750 volts for transient pulses.

Unlike old-style lightning arrestors, both of these mechanisms shunt the static electricity directly to ground rather than to the receiver chassis. Bypassing the receiver in this manner prevents the chassis potential from being raised to several thousand volts above ground level.

powerline transients

Receivers and transceivers can also be ruined by the effects of voltage transients coming in through the back end via the AC mains. Just as lightning can induce currents in the antenna system, it can also induce voltages in nearby power lines. These transients, running up to thousands of volts, can damage power supplies and internal components.

A lightning return stroke generates an intense RF field over a range of frequencies from kilohertz to Gigahertz. Most of the energy is centered around a frequency of 5 kHz, which makes long power lines

very effective antennas. Since a lightning strike can generate electric fields of 60-80 volts per meter at distances of a mile or more, voltage transients of kilovolt magnitude can easily show up on power lines.

A second type of transient is created by a short circuit in the power distribution system. This may happen any number of times during the year, depending on where you live and how well the local power company maintains the system. The clearing of a short circuit is effected by blowing a fuse or, more commonly, by tripping a circuit breaker. This abrupt termination of current induces a high voltage transient on the power lines from the collapsing magnetic field of the power distribution transformers. Spikes of up to 6000 volts for periods of 5 to 10 microseconds are not uncommon, as shown in fig. 3.

Another source of voltage transients is inductive load switching of motors associated with furnaces, washing machines, and other appliances. When the current flow through motor windings is terminated, the magnetic field collapses and induces a reverse voltage of such magnitude that it may jump across the switch contacts to the power mains. Once an arc is established across the switch contacts, current flow continues to oscillate back and forth until there is insufficient energy to maintain the arc.

The problem of protecting your equipment against these transient voltages is further complicated by mode of transmission to the equipment. These

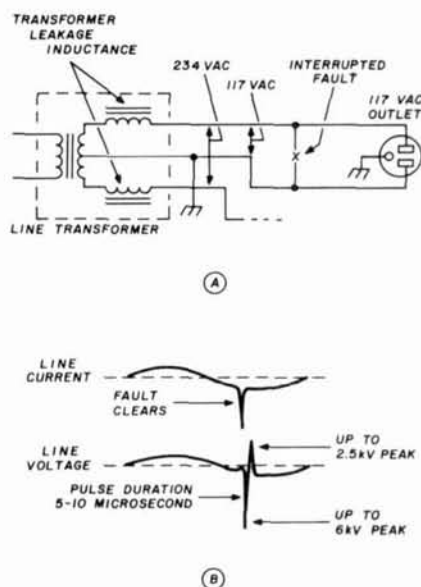
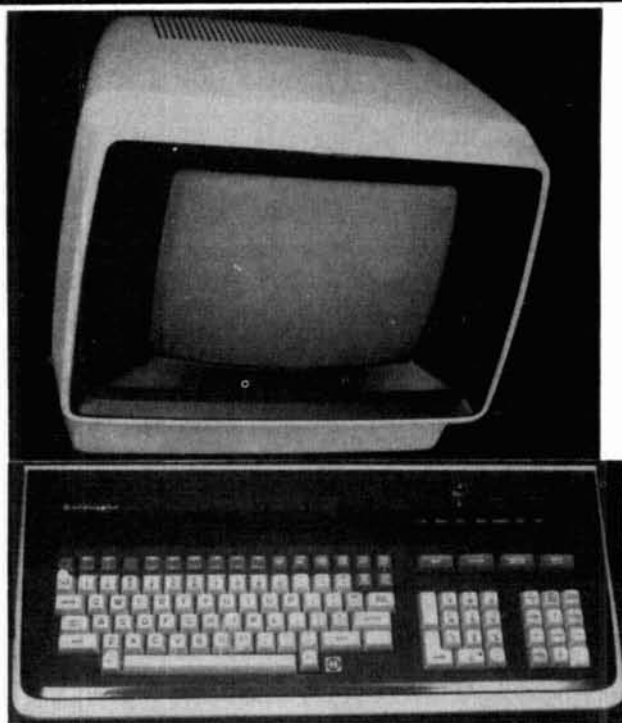

fig. 3. High voltage transients can occur on household 117 volt lines when a short circuit is cleared. (3A) shows circuit condition conducive to transient generation; (3B), current and voltage waveforms of spike. (Adapted from QST, February, 1982.)

John J. Meshna Jr., Inc.

19 Allerton Street • Lynn, MA 01904 • Tel: (617) 595-2275



SELF STANDING COMPUTER TERMINALS

We acquired a small number of these beautifully made computer terminals which were made by a major U. S. computer manufacturer. We do not know all the details about them at press time but we can tell you that these terminals cost someone at least \$2,000.00 each. They lose, you win! The terminals feature the following: 3 separate microprocessors for powerful capabilities, 106 key ASCII keyboard for changing the parameters of the installed EAROMs, 16K RAM, 48K ROM, serial RS-232 asynchronous data communications (synchronous optional), selectable baud rates of 75-38.4K BPS, high resolution, 12" green screen, composite video monitor, 80 x 25 line display with expandable character font (40 x 25), scrolling display, built in reverse video option, light weight, self contained, tightly regulated, switching power supply and much more than can be fit in this space. The terminals can be configured in daisy chain format around a central host computer. All units are new or are in like new condition & are checked for completeness prior to shipping. The terminals are sold untested. Each one comes with set-up data.

UPS shpg. wt. 55 lb. Stock no. MT-686 \$289.00

We offer the following as options: schematic pac. 3 lb. \$10.00
USRT for synchronous data comm. w/ installation data \$10.00
25' RS232 cable 1 male & 1 female DB25 connector \$20.00

For further info. send \$3.00 for a brochure on this terminal which is applicable to your order for and MT 686.

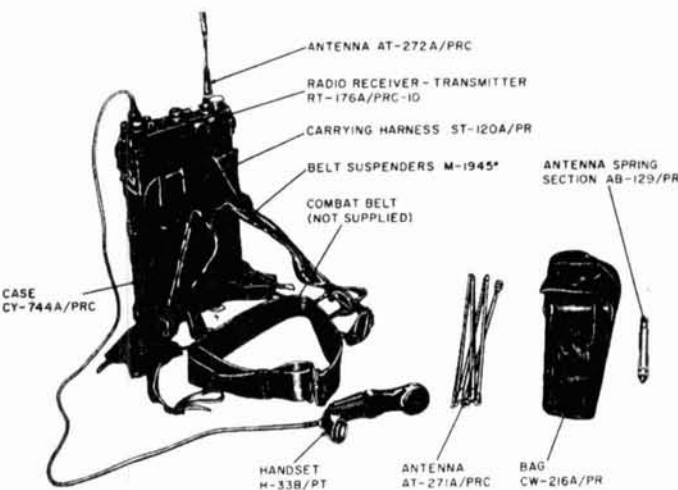

U. S. RECEIVER TRANSMITTER RT 176/PRC 10 RADIOS

Through a very lucky purchase, we just got a small quantity of new, unused PRC 10 radios. They are just beautiful. Any collector would be proud to have one of these babies in his possession. These radios came bulk packed to us just the way they were shipped from the factory to Uncle Sam. They were never released into the field. We are selling these as complete sets. The picture below shows all accessories that will be shipped with each unit.

RT 176/PRC 10 feature: voice communication, tuneable range of 38-55 MC, super heterodyne FM front end, .9 watt xmtr., range of 5 miles (may vary depending on antenna used & siting conditions), & total wt. w/ accessories of only 16 lb.. Each set will include at no extra cost operators manual, schematic, & 4300 KHz. calibration xtal. They do not come w/ batteries, but they are available commercially. We are selling these as complete sets as shown below for \$100.00 / set. Shpg. wt. 18 lb. The quantity is limited, so act fast.

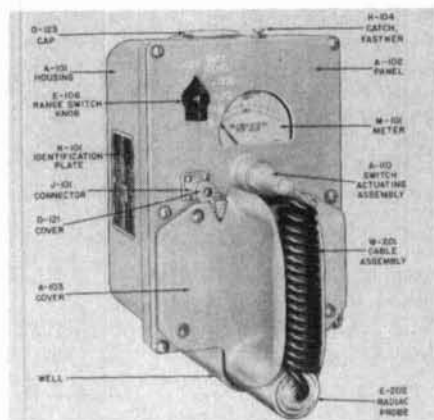

PDR-27 NAVY RADIATION METER

Just released by the US Navy. They appear to be in excellent condition and include the fitted aluminum transit case. Batteries not furnished but are available in most electronic supply houses. 4 ranges 0.5 to 500 mr/hr. Removable hand probe, detection of Beta and Gamma radiation. With today's world conditions and perhaps proximity to a nuke power station, it might provide a little insurance to own one of these instruments. With no facilities to check or test, we offer AS IS, visually OK Schematic provided with each. We have some accessories and offer as an option although not required for operation. Shipping wt. 22 lb. PDR-27 Rad Meter \$50.00

PDR-27 phones \$7.00

Hi Sensitivity GM tube \$10.00

Approx. 100 page Instr. Book \$10.00

Low Sensitivity GM tube \$5.00

The above listed tubes are already installed in the meter.

We are offering these as spares if desired.

PHONE ORDERS accepted on MC, VISA, or AMEX
No COD's. Shpg. extra on above.

Send for free 72 page catalogue jam packed w/ bargains.

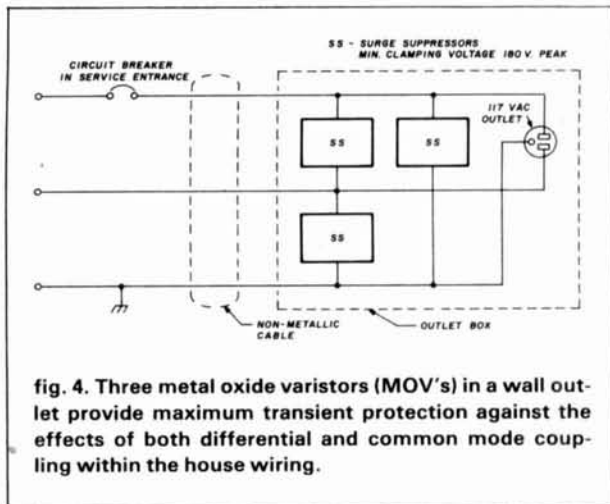

fig. 5. Specially-designed terminal strips available from Drake and other manufacturers offer protection from power line spikes and transients.

pulses can exist between individual lines or between lines and ground in the house wiring. A further complication is the inherent capacitance of the house wiring which allows these transients to move from one wire to another.

transient protection devices

Several devices that will protect equipment from these damaging voltage transients are available. The General Electric Home Lightning Protector, for example, is built to protect electrical devices within the home from lightning-induced voltage transients. Designed for mounting in either the service entrance box or the weatherhead for the incoming AC mains, it intercepts the transients before they enter the house wiring.

The metal-oxide varistor (MOV), also manufactured by General Electric, exhibits a resistance that is inversely proportional to the applied voltage. It is a non-polarized device for installation between wires or from wires to ground as shown in fig. 4. MOVs are built to respond to transients in nanoseconds and have clamping voltages ranging from 10 to 1500 volts. Most have continuous power ratings of 1/2 to 5 watts with peak dissipation of over 600 joules of energy. These may be installed in service entrances or within the equipment itself.

General Semiconductor Industries manufactures the TransZorb, a semiconductor device with a large PN junction for transient protection. TransZorbs are capable of handling very high power levels for short periods of time (100,000 watts for 100 nanoseconds).

Both TransZorbs and MOVs look like oversized disc ceramic capacitors and may be installed with the electronic equipment or more easily at the back of an AC receptacle (after switching off the circuit breaker at the service panel).

Alpha Delta, Drake, and others sell terminal strips

with built-in protective devices (fig. 5). These may be purchased in various configurations depending upon the number of outlets desired. Radio Shack markets the Voltage Spike Protector for single-plug protection. It resembles an oversize AC plug and contains a GE MOV wired across the AC line. It can clamp a 435 volt, 50 ampere, 20 micro-second surge and is the least expensive of the commercially made units.

A list of manufacturers and distributors of lightning protection devices is provided in table 1. Unfortunately, none of these devices will protect your valuable equipment against a direct lightning strike. The

table 1. List of manufacturers of distributors of surge and transient protection devices.

Alpha Delta Communications P.O. Box 571 Centerville, Ohio 45459	Telex/Hy-Gain 9600 Aldrich Avenue South Minneapolis, Minnesota 55420
R.L. Drake Company 540 Richard Street Miamisburg, Ohio 45342	Kalglo Electronics 6584 Ruch Road East Bethlehem, Pennsylvania 18017
Electro Protection Devices, Inc. P.O. Box 673 Waltham, Massachusetts 02254	MFJ Enterprises, Inc. 921 Louisville Road Starkville, Mississippi 39759
Electronic Specialists, Inc. 171 South Main Street Natick, Massachusetts 10760	Newark Electronics 500 North Pulaski Road Chicago, Illinois 60624
Encomm, Inc. 2000 Avenue G, Suite 800 Plano, Texas 75074	Poly Phaser P.O. Box 2001 Kissimmee, Florida 32741
General Electric Company Semiconductor Division West Genesee Street Auburn, New York 13021	Technico, Inc. 9051 Red Branch Road Columbia, Maryland 21045
General Semiconductor Industries P.O. Box 3078 Tempe, Arizona 85281	Trio-Kenwood Communications 1111 West Walnut Compton, California 90220

ALL ITEMS ARE
GUARANTEED OR SALES
PRICE REFUNDED

PRICES F O B
HOUSTON

PRICES SUBJECT TO
CHANGE WITHOUT
NOTICE

ITEMS SUBJECT TO
PRIOR SALE

MADISON

Electronics Supply

1508 McKinney
Houston, Texas 77010
*Call For Quotes
713-658-0268

We stock what we advertise,
and much more.



AMATEUR COMPUTER ACCESSORIES

Microamtor Patchm model MAP-64	\$129.95
This is the lowest priced AMTOR HARDWARE/SOFTWARE unit avail- able in the world today. Utilizes AMTORTEXT software.	
AEA CP1	189.95
CP1/VIC 20	Special Price
CP1/VIC 64	Special Deal
AMTOR & CW	549.00
RS232-1 Option, CP1	
Current Loop	89.00
Software	10% off Amateur Discount Prices
Kantronics Interface	119.00
Interface 2	209.00
Kantronics Software	10% off list
Special TI 99	79.95
Interface plus Hamtext	199.95
MFJ 1224	79.95
HAL CT2200	799.00
KB2 100	159.00
HAL Telereader	699.00
KG 12 12" Monitor	169.00
IRL FSK 500	269.00
FSK 1000/1020AAFSK	575.00
NEW-Hot AEA Micropatch Comm 64 or VIC 20	114.95
VHF/UHF	
MIRAGE B23	79.00
B3016	199.00
B1016	249.00
D1010N	289.00
New A1015	CALL
KDK 2030	259.00
ST144UP	269.00
New Santec ST142	CALL
ST71	209.00
Accessories in stock	
TR7950, TM201A	CALL
TW4000A	HOT PRICE
OSCAR	
FT726R	699.00
SU726	95.00
430 Module	225.00
FT290/FT290 Combo	699.00
TR2500	CALL
FT208RA/FT708R	259.00
TenTec HT	269.00
HT 1200	209.00
HF	
Signal One Millspec	5995.00
Accessories available.	
Rockwell-Collins	
KWM380	Factory Order
ACCESSORIES	
TS930S	CALL
TS430S	DISCOUNT
TS530S	GREAT BARGAIN
TS830S	BUY!
TenTec Corsair	1020.00
Argosy	529.00
Drake TR5	499.00
YAESU FT980	1299.00
FT77	499.00
FT757GX	749.00
FT102	879.00

ANTENNAS

Cushcraft Proline	STOCK
Cushcraft turnstile	\$29.95
Oscar 416TB	58.00
A144201	74.00
A14TMB	29.00
As a package	159.00
KLM	
420-470-18C	59.00
144-148-13LBA	78.00
Antenna special AP151.3G	33.00
432-16LB	59.00
6BTV	129.00
Explorer	269.00
TH7DX	369.00
HF6V	125.00
G7144	108.00
DB plus Enterprises, 2 El Quad	279.00
Alpha Delta	10% off
W1JC, 160/30M, 160/40M dipole	
110' Long	69.95
B&W AV25 Vertical Notrap	85.00
Q5-QRM 80M. coax	
Dipole, Comm. Grade	69.95
40M. Coax dipole	59.95
Belden 8214	40¢/Ft.
9258 RG8X	19¢/Ft.
8267 RG213	49¢/Ft.
Amphenol 8261 N Male	3.00
831SP PL259 Sivilerplate	1.25
UG176	.30
HIQ dogbone insulator	.50

ACCESSORIES

Tripplite 12V20A supply	99.00
Big Ham Clocks	
Dual LCD 12/24 hr	29.95
Books: Gilfer, Radio Pub, Radio Callbook, ARRL, SAMS, AMECO, TAB, RIDER	
AEA MM2	140.00
CK2	119.00
KT2	99.00
BT1	69.00
Sherwood, Fox Tango	10% off
Alpha Delta	ASK
Janel, Vibroplex	10% off
Coax Seal	2.00
QSL Holder	2.00
Bugcatcher	
All band antenna coil	45.00
Single Band Coil	39.95
Valor 1/4 plus 5/8 plus Mag.	25.00
Anteco 5/8 Mag. mt.	25.00
Bencher ZA1A balun	17.00
Single ZA2A	21.00
Paddles ST1	39.00
ST2	49.00

PARTS

CDE .001/20KV doorknob cap	\$1.95
Sprague 100PF/500V Feedthru	1.95
Sprague 500PF/30Kv doorknob Cap	16.00
14, 20, 24 pin 600 Mil dip sockets, solderfill	40¢
14, 16 pin 300 Mil	10¢
20, 24, 40 Pin 600 Mil	25¢
3n201	10¢
Caps to .01 Pc	10¢
Rec Tubes new surplus	1.00 ea.

ALPHA

77DX	\$3770.00
78	2475.00
374	1855.00
76A	1435.00
76PA	1690.00
76CA	1925.00

Remember: We put filters and accessories in for free.
Buy Now!

SWL CORNER

R70	CALL
R2000	SPECIAL
R1000	BUY!
McKay Dymek	STOCK

USED, GUARANTEED

90 day warranty & 6 month trade in, full value,
for new gear.

FT101ZD/Filter	595.00
TS520 or TS520S	395.00 ea.
75A4/KWS1 or 32S1/75S1 Parts	CALL
75S3	250.00
32S3	350.00
32S1	200.00
75S1	200.00
AC Supply (w/rig only)	100.00
R4C	300.00

HOT & NEW

Free upgrade book or call directory with new
HF rig purchase. Tired of counting on "satisfac-
tion" from your present dealer? Try us! Don't
hesitate to call for a little radio advice, we al-
ways try to steer you in the right direction.

Repairs—You bet. Old gear like S/Line Collins
and Drake, and all new state of the art trans-
ceivers. We also repair Hallicrafters, Hammar-
lund, National receivers.

Complete set of **QSTs**, 1924-1976, new bind-
ings. **Radio**, R9, CQ, 1931-1976 \$2000.00 all
bound volumes.

Trades welcome.

POLICIES

MasterCard, Visa, C.O.D Welcome

Note: Many companies use your money until
the item is shipped. We hold charge cards,
checks, until shipment. Call us anytime on
the status of your order. All prices FOB
Houston, subject to change, prior sale. Used
gear sales price refunded if not satisfied.

LINES

AEA	Finco	Robot
Alliance	Fox Tango	Rohn
Alpha Delta	Gilfer	Rockwell-Collins
Amphenol	GE Tubes	Tentec
Anteco	ICOM	Telex
Belden	IRL	TCG
Butternut	Hustler	Triex
Bird	HyGain	TAB
Cushcraft	Consumers Wire	Triplett
CDE	HamKeyer	Signal One
Bugcatcher	Kantronics	Sprague
Antennas	Kenwood	Santec
Bencher	Mirage	Surplus
Dowkey	McKay-Dymek	SAMS
Drake	Nye	Vibroplex
EIO-Alpha	Radio Callbook	W6TOG
	Rider	Yaesu

Many more available, call or ask for anything you don't see.

1-800-231-3057

174

This tower is ready for shipment to one of our customers, or is it? If we were an ordinary tower company, this tower would have already been sent.

We are not an ordinary tower company and that is why this tower did not go out.

We have the best quality control in the business and we are not afraid to say so. That is why when John Pasillas

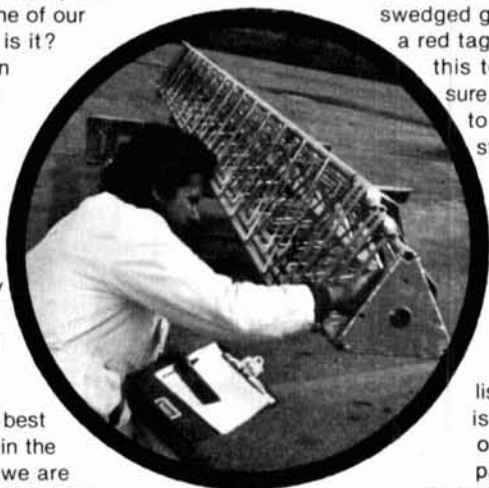

found a 1/8" clearance on the swedged guide, he placed a red tag of rejection on this tower and made sure it was corrected to 1/16" before he stamped his final approval for shipment.

Every employee at Tri-Ex knows that the reputation you establish in an industry is what will make or break his company. That is why Tri-Ex has been in business continually since 1955.

When you purchase your tower from Tri-Ex, you can be assured that all welds have been done by certified welders, all construction and galvanizing has met ASTM standards, all towers have been constructed in precision jigs, all steel has been tested for carbon content and tensile strength.

When it goes to shipping, John is ready.

When you decide on Tri-Ex you have many models to choose from.

STACKED:

Light, medium, heavy duty 10 feet and up.

CRANK UPS:

Light, medium, heavy duty 25 feet to 88 feet standard.

SPECIAL TOWERS:

Sky needle, Clementower 37 feet to 180 feet & higher

Introducing Tri-Ex's new DX-86 — 86 feet tall, 25 square feet in a 50 mph wind.

Call you local dealer for details.

FOR ADDITIONAL INFORMATION WRITE TO:



TOWER CORPORATION

7182 Rasmussen Ave.
Visalia, Calif. 93291

P.O. Box 5009

Visalia, California 93278

(209) 651-2171

207

TOLL FREE ORDERS • 1-800-826-5432

(IN CALIFORNIA: 1-800-258-6666)

AK, HI OR INFORMATION • (213) 380-8000

5 KEY ASSEMBLY

\$1.00 EACH
CONTAINS 5 SINGLE-POLE NORMALLY OPEN SWITCHES MEASURES 3 3/4" LONG

6 KEY ASSEMBLY

\$1.25 EACH
CONTAINS 6 SINGLE-POLE NORMALLY OPEN SWITCHES MEASURES 4 1/4" LONG

120V INDICATOR

NEON INDICATOR RATED 120 V 1/3 W MOUNTS IN 5/16" HOLE... RED LENS.
75¢ EACH
10 FOR \$7.00
100 FOR \$65.00

MINIATURE 6 VDC RELAY

SUPER SMALL SPDT RELAY. GOLD COBALT CONTACTS.
RATED 1 AMP AT 30 VDC. HIGHLY SENSITIVE. TTL DIRECT DRIVE POSSIBLE. OPERATES FROM 4.3 TO 6 V. COIL RES. 220 OHM 1 3/16" • 13/32" • 7/16" AROMAT # RSD-6V
\$1.50 EACH
10 FOR \$13.50

13 VDC RELAY

CONTACT S.P.N.C. 10 AMP @ 120 VAC. ENERGIZE COIL TO OPEN CONTACT. COIL: 13 VDC 650 OHMS. SPECIAL PRICE \$1.00 EACH

SEND FOR **NEW LARGER 48 PAGE CATALOG**

MINIATURE TOGGLE SWITCHES

ALL ARE RATED 5 AMPS @ 125 VAC

S.P.D.T. (on-on)

P.C. STYLE NON-THREADED BUSHING
75¢ EACH
10 FOR \$7.00

S.P.D.T. (on-on)

SOLDER LUG TERMINALS
\$1.00 EACH
10 FOR \$9.00
100 FOR \$80.00

S.P.D.T. (on-off-on)

SOLDER LUG TERMINALS
\$1.00 EACH
10 FOR \$9.00
100 FOR \$80.00

S.P.D.T. (on-off-on)

NON-THREADED BUSHING
75¢ EACH
10 FOR \$7.00

S.P.D.T. (on-on)

P.C. LUGS THREADED BUSHING
\$1.00 EACH
10 FOR \$9.00
100 FOR \$80.00

D.P.D.T. (on-on)

SOLDER LUG TERMINALS
\$2.00 EACH
10 FOR \$19.00
100 FOR \$180.00

ALL ELECTRONICS CORP.
905 S. VERMONT • P.O. BOX 20406 • LOS ANGELES, CA 90006

QUANTITIES LIMITED • FOREIGN ORDERS INCLUDE SUFFICIENT SHIPPING
MINIMUM ORDER \$10.00 • USA \$2.50 SHIPPING • CALIF. RES. ADD 6.1%
NO C.O.D. •

107

FREE! CABLE LOSS CHART IN FALL CATALOG

NEMAL ELECTRONICS COAXIAL CABLE SALE POLYETHYLENE DIELECTRIC

* RG-8/U 96% shield Mil Spec . . . (\$29.95/100) or 31'ft.
RG11U 96% shield 75 ohm mil spec . . . 25'ft.
RG-55B/U double shield (RG-58 size) 50 ohm . . . 45'ft.
* RG58U mil spec 96% shield . . . (\$9.95/100) or 11'ft.
RG62A/U 96% shield mil spec 93 ohm . . . 10'ft.
RG174/U min. 50 Ω mil spec . . . 10'ft.
RG213 noncontaminating 96% shield mil spec . . . 36'ft.
RG214/U double silver shield 50 ohm . . . \$1.55/ft.
RG214/U tinned copper . . . 65'ft.
RG217/U double shield 50 Ω 5/8" OE . . . 85'ft.

LOW LOSS FOAM DIELECTRIC

RG-8X (Mini 8) 95% shield . . . (\$14.95/100) or 17'ft.
* RG8U 80% shield . . . (\$17.95/100) or 21'ft.
RG-8/U 97% shield 11 gu. (eq. Belden 8214) . . . 31'ft.
RG58U 80% shield . . . 07'ft.
RG58U 95% shield . . . 10'ft.
RG59/U 100% foil shield TV type . . . 10'ft.
RG59/U 70% copper shield . . . 09'ft.
HEAVY DUTY rotor cable 2-16 ga 6-18 ga . . . 36'ft.
Rotor cable 2-18 ga 6-22 ga . . . 19'ft.

Complete line of multiconductor cables available

CONNECTORS MADE IN USA

Amphenol PL 259 . . . 79¢
PL-259 push-on adapter shell . . . 10/\$3.89
PL-259 and/or SO-239 . . . 10/\$5.89
Double Male Connector . . . \$1.79
PL-258 Double Female Connector . . . 98¢
PL-259 Silver-Teflon Kings . . . \$1.59 ea
Reducer UG-175 or 176 . . . 10/\$1.99
UG-255 (PL-259 to BNC) . . . \$2.95
Elbow (M359) UHF Elbow . . . \$1.79
F59A (TV type) . . . 10/\$1.99
UG 21 D/U Type N Male for RGB, Amphenol . . . \$3.00
UG-88C/U BNC Male for RG-58, Amphenol . . . \$1.25
UG 273 BNC-PL259 Amphenol . . . \$3.00
3/16 inch Mike Plug for Collins etc. (cutoff) . . . \$1.25

shipping Call or write for Free Catalog

Cable — \$3.00 per 100 ft.
Connectors — add 10%, \$3.00 minimum.
Orders under \$20 add \$2 additional plus shipping.
COD add \$2.00. Florida Residents add 5%.

NEMAL ELECTRONICS

Dept. H, 12240 N.E. 14th Ave., N. Miami, FL 33161
Telephone: (305) 893-3924

181



ham radio TECHNIQUES

Bill W6SAI

intermodulation distortion

Ham radio equipment has come a long way in the last ten years. All you have to do is to pick up a ten-year-old copy of *ham radio* and compare the articles and advertisements of yesterday with those of today.

One of the interesting developments that has taken place during this decade is the gradual improvement in linearity and the reduction of intermodulation distortion. These improvements are particularly noticeable in some of the new transceivers and excitors available today. But before I discuss the improvements, it would be a good idea to review the fundamentals of intermodulation distortion (IMD) and its importance in HF communications.

Intermodulation distortion is a particularly unpleasant form of nonlinearity that should be of interest to those operators using linear amplifiers (either in their excitors or as an auxiliary unit). IMD occurs in a nonlinear device driven by a complex signal having more than one frequency.^{1,2}

As speech is made up of a multitude of frequencies, and the perfect linear amplifier has yet to be built,

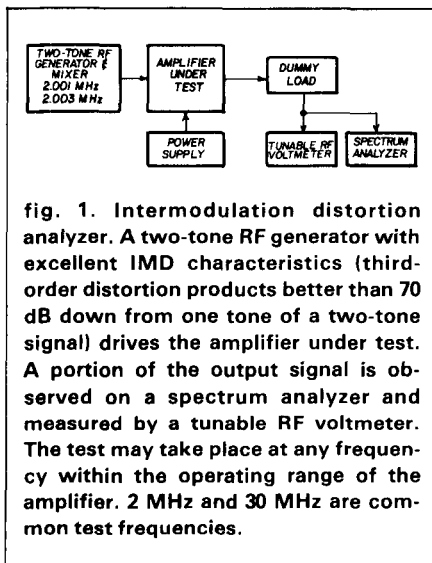

fig. 1. Intermodulation distortion analyzer. A two-tone RF generator with excellent IMD characteristics (third-order distortion products better than 70 dB down from one tone of a two-tone signal) drives the amplifier under test. A portion of the output signal is observed on a spectrum analyzer and measured by a tunable RF voltmeter. The test may take place at any frequency within the operating range of the amplifier. 2 MHz and 30 MHz are common test frequencies.

IMD is of concern to every Amateur interested in voice or multiplex transmission.

A linear amplifier is an amplifier in which the output signal is an exact replica of the input signal. If the output signal does not duplicate the input signal, intermodulation distortion is created. IMD shows up on the air as a "roughening" of the signal accompanied by broad sidebands

("splatter"). Some Amateurs who are acutely sensitive to IMD can actually hear it as a growl on the low-frequency portions of voice transmissions and, in years past, could accurately identify the manufacturer of an SSB transmitter by merely listening to the signal on the air!

Intermodulation distortion may be examined and the amplifier tested by use of a distortion analyzer (fig. 1). An input signal consisting of two sine waves of equal amplitude (for example, 2.001 MHz and 2.003 MHz) is applied to the amplifier. The distortion products in a nonlinear stage appear as spurious signals within the passband of the amplifier and also at the harmonic frequencies, and the intermodulation distortion, as additional signals! In the example in fig. 2, the IMD products are located 2 kHz apart and occupy the span of 1995 kHz to 2009 kHz, or more. Thus, a signal that should be only 2 kHz wide is now 14 kHz wide, thanks to intermodulation distortion (fig. 2). The situation can be worse than this as a greater degree of distortion produces additional spurious signals on each side of the two desired signals.

IMD is independent of the operating frequency. If a 20-meter linear amplifier were tested for IMD at 14.200 MHz using a two-tone test signal whose tones were 2 kHz apart, IMD products would form a spectrum of signals, 2 kHz apart centered around 14.200 MHz. Photos of this type of distortion have appeared from time to time in product reviews.

the IMD rating

Intermodulation distortion is expressed in relation to the output level of an amplifier. The standard method of specifying the magnitude of the distortion products is to specify the reduction in decibels of one distortion product from one tone of a two-equal-tone signal. For example, if an amplifier (or tube or transistor) under a particular set of operating conditions has third-order distortion products of -30 dB, this means that the products have an amplitude 30 dB below one of the two test tones. It is *not* correct to compare one distortion product to the sum of the two tones; that is to say, the PEP value of the signal. If this is done, the resulting distortion figure is 6 dB "better" than the correct example (-30 dB rather than -24 dB). Unfortunately many product reviews and amplifier specifications take advantage of this "one-upmanship" because the better figure looks nicer in the advertisement!

IMD then and now

Has any improvement been made in the intermodulation distortion level of today's exciters and amplifiers, as compared to those products in 1973? I think there's been worthwhile improvement as new devices and circuit techniques have been developed.

Many early exciters used the so-called television "sweep tubes" as linear amplifiers. The popular 6LQ6 tube is a good example. This pint-size "bottle" could squeeze out up to 125 watts PEP at a plate potential of only 800 volts. It was an inexpensive and effective amplifier tube that attained

wide acceptance in yesterday's equipment. Unfortunately, the third-order IMD products of the 6LQ6 when run in this fashion were only 18 dB below one tone of the two-tone power level. And if the signal from this amplifier were run through a second amplifier stage to bring it up to the legal Amateur power-input level,

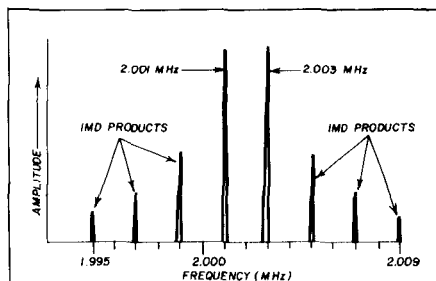

fig. 2. Two-tone IMD test signal has a 2 kHz spacing between the tones. In this representative case, the IMD products form an additional band of frequencies, spaced 2 kHz apart, centered on the test frequency. In this example, the third-, fifth- and seventh-order products are shown. The signal is 14 kHz wide. Higher-order products produced under severe distortion widen the signal even more than shown in this example.

the IMD products would be brought up by 10 dB or so in addition to the wanted signal. The result would be a broad, fuzzy-sounding signal having about 15 watts of splatter power in the third-order distortion products. It may not sound like much, but 15 watts of unwanted splatter on top of the signal you're trying to listen to can be intolerable.

The equally popular 6146 (6146B) was designed for RF services (as opposed to the 6LQ6), and it had much more appealing IMD ratings. At 800 volts and 60 watts power output, the IMD products were 24 dB below one tone of a two-tone test signal. That's 6 dB better than the 6LQ6, a worthwhile improvement.

The Collins Radio Company, now a

division of Rockwell, pioneered the use of RF feedback to improve the linearity of an amplifier. Its use in the famous S-line transmitters provided an IMD level of better than -30 dB compared to one tone of a two-tone test signal.

And there the matter rested for a while. Perceptive Amateurs could pick out the S-line transmitter on the air, as it sounded immeasurably better than other equipment that did not incorporate RF feedback. However, as solid-state amplifiers came into general use, they were able to duplicate the IMD level set by the S-line as they, too, used fairly linear devices and an RF feedback loop. Thus, over the years, the "30-dB level" became an unofficial standard for measuring the excellence (or lack thereof) of IMD in Amateur equipment.

IMD today

Things are looking up. While IMD levels of -50 to -60 dB may be common in deluxe commercial and military gear, such levels are prohibitively expensive and too complicated for the competitive Amateur market. Despite this, improvements in intermodulation distortion in ham gear are here to stay. New solid-state devices skirt the -35 dB level with RF feedback, and at least one Amateur transceiver* has reached this favorable level using the common 6146B tube.

This is a far cry from the old sweep-tube "distortion generator." An IMD level of -35 dB sounds *clean* to the ear, even when the equipment is being run next door. Undoubtedly, significant improvements in IMD reduction will come about in the next few years, and I look forward confidently to an IMD level of -40 dB before the end of this decade.

Unfortunately, the good IMD rating of an exciter can be ruined quickly

*The Yaesu FT-102 HF transceiver boasts three 6146s in the output stage. Excellent linearity (better than -35 dB) is achieved by combining a relatively high resting plate current level with RF feedback.

THE BEST!

... Since 1920

Whether sending QSL's or locating old friends, the new 1984 CALLBOOKS are a "must" for the active amateur. Respected for accuracy since the beginnings of amateur radio, the U.S. and Foreign CALLBOOKS list the address information for over 800,000 hams around the world in an easy-to-use format. Not simply a reprint of license records, CALLBOOK listings are taken from our own extensive master files, updated continuously to bring you the latest information available.

As an added service, optional supplements will keep your 1984 CALLBOOKS up to date throughout the year. Published March 1, June 1, and September 1, each supplement contains all activity for the preceding 3 months. Thousands of new licenses, call changes, and address changes are listed in each issue.

The 1984 CALLBOOKS are loaded with extra features for rag-chewers and DX'ers alike. Order your copies now. See your dealer or order directly from the publisher.

**COMPARE!
YOU CAN'T BEAT CALLBOOK VALUE!**

- 425,000 current U.S. Listings • 400,000 current Foreign Listings • Great Circle Bearings
- Then & Now call changes • Silent Keys • Census of Amateur Licenses in all countries
- Standard Time Charts • International Postal Information • World-wide QSL Bureaus
- Table of Amateur Prefix Allocations • Prefixes of the World • Plus many other features.

Publication: December 1, 1983

	Including shipment to U.S.A. points	Illinois residents, incl. tax & shipping	Including shipment to foreign countries
<input type="checkbox"/> Single 1984 U.S. Callbook	\$23.00	\$24.05	\$24.50
<input type="checkbox"/> Single 1984 Foreign Callbook	22.00	22.99	23.50
<input type="checkbox"/> SPECIAL OFFER: Order both 1984 Callbooks at the same time for shipment to one address.	41.95	43.99	43.45
<input type="checkbox"/> Set of 3, 1984 U.S. Supplements	12.00	12.60	12.00
<input type="checkbox"/> Set of 3, 1984 Foreign Supplements	12.00	12.60	12.00

Name _____ Amount enclosed _____

Address _____

radio amateur
callbook

925 Sherwood Dr., Box 247,
Lake Bluff, IL 60044, USA

Tel: (312) 234-6600



new SIX BAND VERTICAL ANTENNA

**Model AV-25
NO TRAP VERTICAL**
for 80, 40, 30, 20, 15, 10 meters.

\$99.50

UPS SHIPPING & HANDLING
ADD \$11



- Only 25 ft. high.
- Three parallel vertical elements.
- Rugged steel tubing.
- Direct feed with 52 ohm coax, low SWR.
- Broad band.
- Capacity loaded, top and sides.
- Only one coil, high in 80 M element.
- Also available for commercial frequencies.



4 1/2" DIA. SPACERS

AR-25 Radial System for AV-25 antenna. Four multiwire radials that are resonant on each of the six bands. \$19.50

PATENT PENDING



ALL OUR PRODUCTS MADE IN USA

BARKER & WILLIAMSON

Quality Communication Products Since 1932

At your Distributors write or call

10 Canal Street, Bristol PA 19007

(215) 788-5581



by the careless operator who operates with "all knobs to the right." You hear plenty of these lids on the air today; will they be gone by 1990? I doubt it.

HF communication lives!

Remember the days when communications specialists predicted the demise of HF radio for long-distance communications? Why put up with static, fading, and interference on an unreliable HF circuit when you can do so much better with a reliable satellite link? In effect, HF radio was dead and buried by new communications techniques in the microwave satellite range. But times change! An article in the June, 1983, *Defense Systems Review* magazine³ says it this way:

"Ten years ago it was thought that HF long distance communications for fleet operations would soon pass its heyday because of the capabilities of satellite communications. But the real vulnerability of satellite communications to antisatellite attack and potential propagation disruption with a nuclear detonation combined with the improved real-time propagation measurement capability give HF communications a new lease on life. The fact that HF communication is relatively inexpensive, flexible, and its assets are in place should give rise to increased interest to improve HF architecture and capabilities, relatively neglected for far too long."

Well, hurrah! The ionosphere has been rediscovered for long-distance communications as "a satellite that doesn't fall down." Spearheaded by the U.S. Navy (who started using HF communications in approximately 1911), communicators are starting to re-examine the HF spectrum as an alternative to satellite circuits.

CW lives, too!

Did you see the full-page in the September issue of *ham radio*, placed by the Central Intelligence Agency, offering openings for electronics technicians and communications and radio operators *with Morse Code ability preferred*? I wonder what the CIA

thinks of FCC pressure to dilute Amateur Radio with no-code licensees?

a simple antenna for 21-28-50 MHz

Some new triband transceivers on the market cover only the 21-, 28-, and 50-MHz bands. A simple triband antenna for these ranges is shown in **fig. 3**. These dipoles are paralleled at the feedpoint and fed with a coaxial line. The dipoles are trimmed a bit to provide the lowest SWR figure at your chosen point in each band. A simple transmatch placed at the station end of the line may ease loading problems.

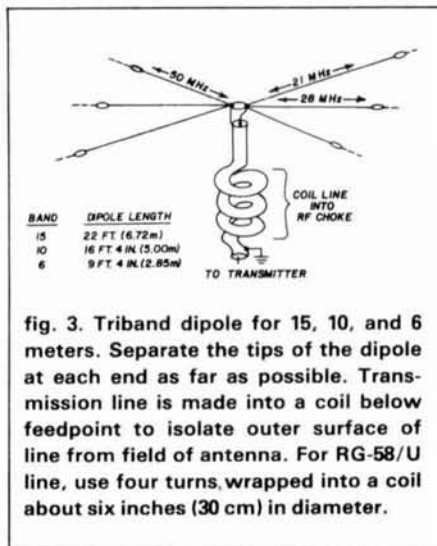

fig. 3. Triband dipole for 15, 10, and 6 meters. Separate the tips of the dipole at each end as far as possible. Transmission line is made into a coil below feedpoint to isolate outer surface of line from field of antenna. For RG-58/U line, use four turns, wrapped into a coil about six inches (30 cm) in diameter.

moonbounce revisited!

Another printing of the *Moonbounce Notes* is at hand. Send four first-class stamps (or four IRCs) to me at EIMAC, 301 Industrial Way, San Carlos, California 94070 and I'll send this interesting information to you.

references

1. Robert I. Sutherland, W6UOV, and William I. Orr, W6SAI, "Rating Tubes for Linear Amplifier Service," *ham radio*, March, 1971, page 50.
2. William I. Orr, W6SAI, "Intermodulation Distortion in Linear Amplifiers," *QST*, September, 1963. (For a reprint of this article, write author and request bulletin AS-21. Include two first-class stamps.)
3. "High Frequency Transmissions Enjoy A Renewed Life," *Defense Systems Review*, June, 1983, published by Cosgriff-Martin & Cutter, Inc., Box 2828, Santa Clara, California 95055.

ham radio

AEA Brings You The RTTY Breakthrough

NEW MBATEXT™ \$109.95 List / \$89.95* VIC-20 MBATEXT or C-64 MBATEXT



MBATEXT™ is the most advanced MBA (Morse, Baudot, ASCII) software plug-in cartridge available for the VIC-20 or Commodore 64 computer. Compare our outstanding features and price to the competition.

- KEYBOARD OVERLAY instructions to avoid constant referral to the manual
- RTTY and ASCII SPEED ESTIMATE MODE
- BREAK-IN CW MODE
- QSO BUFFER RECORD TOGGLE
- WORD PROCESSOR style insertion, deletion, and correction in TEXT EDIT MODE
- CW AUTO SPEED TRACKING plus SPEED LOCK
- BREAK-IN BUFFER that is easy to use
- Low speed FARNSWORTH CW TRANSMISSION (between 5 and 14 WPM)
- RE-TRANSMIT RECEIVED TEXT DIRECTLY without need of disk or cassette
- DISK, CASSETTE, OR PRINTER storage of message and QSO buffers
- RECEIVE AND TRANSMIT 5-99 WPM MORSE
- 10 SOFT-PARTITIONED™ MESSAGE (OR TEST) BUFFERS
- WORD WRAP
- TIME OF DAY CLOCK
- PRECOMPOSE SPLIT SCREEN OPERATION
- STATUS INDICATORS on screen
- EASY START-UP by simply typing SYS 44444 or SYS 33333
- DEDICATED FUNCTION KEYS for quick operation
- Ability to IMBED CONTROL FUNCTIONS in type-ahead buffer
- WORD OR CHARACTER mode
- SELECTABLE BAUDOT UNSHIFT ON SPACE (USOS)
- SEND/RECEIVE 60, 67, 75, 100, 132 WPM BAUDOT PLUS 100, 300 BAUD ASCII
- RTTY BLANK-FILL and MORSE BT option for idle transmit periods
- AUTOMATIC PTT
- computer control of TONE REVERSE
- MASTER MENU, COMMAND MENU, and OPTIONS MENU makes MBATEXT™ easy to use with no prior experience
- INCLUDES CABLE TO INTERFACE WITH AEA model CP-1 COMPUTER PATCH™
- POWERED BY HOST COMPUTER.

NEW MICROPATCH™



MICROPATCH™ IS A NEW LOW-COST, HIGH-PERFORMANCE Morse, Baudot and ASCII SOFTWARE/HARDWARE computer interface package. The MICROPATCH™ model MP-20 or MP-64 incorporates the complete MBATEXT software ROM (described above) for either the VIC-20 or Commodore 64 computers. All circuitry and software is incorporated on a single, plug-in cartridge module featuring the following:

- TRUE DUAL CHANNEL MARK AND SPACE MULTI-STAGE 4 POLE, CHEBYSHEV ACTIVE FILTERS
- AUTOMATIC THRESHOLD CORRECTION for good copy when one tone is obliterated by QRM or SELECTIVE FADING
- EASY, POSITIVE TUNING with TRIPLE LED INDICATOR
- NOT a low-cost, low-performance phase-locked loop detector!!!
- SWITCH SELECTED 170 Hz or WIDE SHIFT on receive
- 800 Hz multi-stage active CW FILTER
- AUTOMATIC PTT
- RTTY ANTI-SPACE
- demodulator circuitry powered by external 12VDC (not supplied) to AVOID OVERLOADING HOST COMPUTER and for maximum EMI ISOLATION
- EXAR 2206 SINE GENERATOR for AFSK output
- SHIELDED TRANSCIVER AFSK/PTT INTERFACE CABLE PROVIDED
- PLUS or MINUS CW KEYED OUTPUT
- FSK keyed output.

The Micropatch is structured for easy upgrading to the AEA Computer Patch™ advanced interface unit without having to buy a different software package! Simply unplug the external computer interface cable (supplied with the Micropatch) from the Micropatch and plug it into the Computer Patch.

\$149.95 List \$129.95* MP-20 or MP-64

COMPUTER PATCH™



COMPUTER PATCH™ is the name of our most advanced computer interface equipment for Morse, Baudot, ASCII, or AMTOR operation. The CP-1 will allow you to patch most of the popular personal computers to your transceiver when used with the appropriate AEASOFT™ TU software such as AEA MBATEXT, AMTOR TEXT™, or the MBATEXT RESIDENT ON THE MICROPATCH units. AEA also offers a full feature software package for the Apple II, II plus and IIE; TRS-80 Models I, III and IV; and the IBM-PC. The CP-1 will also work with certain other computers using commonly available software packages.

The CP-1 offers the following advanced and high quality features:

- HANDSOME ALL METAL ENCLOSURE FOR MAXIMUM RF IMMUNITY
- DUAL CHANNEL, MULTI-STAGE ACTIVE MARK AND SPACE FILTERS
- AUTOMATIC THRESHOLD CORRECTION
- RECEIVE 170 HZ FIXED OR 100-1000 HZ VARIABLE SHIFT
- 800 HZ multi-stage CW FILTER
- PRE-LIMITER AND POST-LIMITER FILTERS
- SERIAL RS-232 FIELD INSTALLABLE OPTION
- 117 VAC WALL ADAPTOR SUPPLIED
- PLUS (+) and MINUS (-) CW OUTPUT JACKS
- MAGIC EYE STYLE BAR GRAPH TUNING INDICATOR
- SCOPE OUTPUT JACKS
- NORMAL/REVERSE front panel switch
- MANUAL (override) PTT switch
- VARIABLE THRESHOLD for CW
- ANTI-SPACE RTTY
- KEY INPUT JACK for narrow shift CW ID on RTTY, CW practice, or keyboard bypass.

The CP-1 is made in the U.S. with high quality components including double-sided glass epoxy through-hole plated boards, complete with solder mask and silk screened parts designators.

\$239.95 List \$199.95* CP-1

PACKAGE SPECIALS \$239.95*

Combine the VIC-20 or COMM-64 MBATEXT™ software with the CP-1 at time of purchase and you receive a SPECIAL PACKAGE PRICE. NOW the best RTTY COMPUTER INTERFACE SYSTEM is available at prices comparable only to vastly inferior systems.

CP-1/20 (CP-1 with VIC 20 MBATEXT) CP-1/64 (CP-1 with C-64 MBATEXT)

*SUGGESTED AMATEUR DISCOUNT PRICE THROUGH PARTICIPATING DEALERS ONLY

C & A ROBERTS, INC.

18511 Hawthorne Blvd., Torrance, CA 90504
213-370-7451 24 Hours call 213-834-5868

AEA Brings you the Breakthrough!

HOBBY KITS®

EXPERIMENT — LEARN ELECTRONICS
BUILD AND DESIGN YOUR OWN AM, FM, CW,
OR SSB RECEIVERS, TRANSMITTERS AND ETC.
WITH OUR MINI-LINEAR CIRCUIT KITS
All kits Come Complete With Etched and Drilled Circuit Boards
and All Parts Needed To Function As Described

AF-1 AUDIO AMP, LM-380 1-2 Watts 4-16 OHM Output	\$4.95
AFP-1 AUDIO PREAMP, Dual Audio Preamp — For Mike Etc.	\$3.95
BMD-1 BAL. MIX, LM 1496 Mixer — S.B. Modulator Tuned Output	\$9.95
DET-1 AM DET, Am Envelope Detector With AGC Output	\$3.95
DET-2 FM DET, LM 3065 FM Detector (455 KHZ or 4-11 MHZ)	\$7.95
DET-3 SSB DET, LM 1496 SSB Detector (Needs OSC-1 or OSC-4)	\$9.95
DET-4 DETECTOR CW/SSB using a dual gate FET transistor	\$4.95
IFA-1 IF AMP, CA 3028 30 DB Gain, Optional AGC (455 KHZ or 9-11 MHZ)	\$6.95
FLS-9 SSB FILTER 9 MHZ/2.1 KHZ BW with USB XAL for OSC-1	\$49.95
IFA-2 IF AMP, CA 3028 30 DB Gain 1-100 MHZ Optional AGC	\$6.95
MBA-1 FREQ. MULT, Tuned Output Buffer-Mult-Amplifier To 250 MHZ	\$5.95
OSC-1 CRYSTAL OSC, 100 KHZ — 20 MHZ Not Tuned	\$3.95
OSC-2 CRYSTAL OSC, Ov. 18-200 MHZ Tuned Output	\$4.95
PSV-1 POWER SUPPLY LM 723 With Pass Transistor, 3 amps max	\$7.95
PLL-2 TONE DETECTOR LM567 PLL Tone Detector	\$5.95
RF/MIX-1 RF-AMP/MIXER CA 3028 — Tuned RF AMP/Mixer 1-100 MHZ	\$7.95
RF/MIX-2 RF-AMP/MIXER 3N204 Tuned RF AMP/Mixer 1 — 250 MHZ	\$7.95
VCO-3 VARIABLE HI STAB. OSC, Varactor tuned, 400 to 600 KHz output	\$7.95
VCO-4 VARIABLE HI STAB OSC, Varactor tuned, 3 to 20 Mhz output	\$7.95

Add \$2.00 For Shipping & Handling — Send For FREE Brochure

SEND \$2.00 FOR FULL MANUAL
WITH CIRCUIT DIAGRAMS AND
TYPICAL RECEIVER AND
TRANSMITTER HOOK-UPS

MANY OTHER MODULES AVAILABLE
MORNING DISTRIBUTING CO.

P.O. BOX 717, HIALEAH, FLA. 33011

CB-10 FM SPECIAL



- Hy Gain 40-Channel Board
- 40-Channel Switch
- Volume & Squelch Control
- FM Detector Module
- Full Instructions Included

\$14.95 Add \$2.00 shipping & handling BOARD ONLY \$6.95

QRP TRANSCEIVER SET — \$34.95

VHF CONVERTER SET — \$24.95

COMPLETE SET OF MODULES TO BUILD A
1-WATT SSB/CW MONO-BAND TRANSCEIVER
LESS CASE, CONTROLS, PWR SUPPLY
(12 VDC), SPK AND MIKE

\$149.95 (Specify Band)

IS SWITCHING PL TONES A HEADACHE?

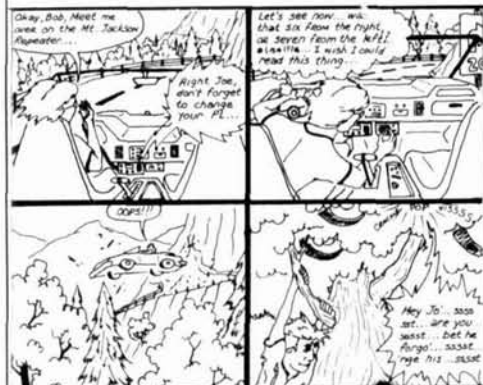

You need a PLD
private line display

- * 2 digit display of all 32 PL channels
- * Compatible with most Communications Specialists encoders/decoders
- * Replaces TE-64 front panel
- * Easy to use and install

Acquis Communications, Inc.
17192 Gillette, Irvine, CA 92414
714/545-3732

ALL BAND TRAP ANTENNAS!

PRETUNED-ASSEMBLED ONLY ONE NEAT SMALL ANTENNA FOR ALL BANDS! EXCELLENT FOR APARTMENTS! IMPROVED DESIGN!

FOR ALL MAKES AM-ATEUR TRANSCEIVERS! GUARANTEED FOR 2000 WATTS SSB INPUT FOR NOVICE AND ALL CLASS AMATEURS!

COMPLETE with 90 ft. RG58U-52 ohm feedline, and PL259 connector, insulators, 30 ft. 300 lb. test dacron end supports, center connector with built in lightning arrester and static discharge. Low SWR over all bands - Tuners usually NOT NEEDED! Can be used as inverted V's - slopers - in attics, on building tops or narrow lots. THE ONLY ANTENNA YOU WILL EVER NEED FOR ALL BANDS! NO BALUNS NEEDED!

80-40-20-15-10 -- 2 trap - 104 ft. - Model 998BUC - \$99.95
40-20-15-10 -- 2 trap -- 54 ft. - Model 100BUC - \$98.95
20-15-10 meter - 2 trap - 26ft. - Model 1007BUC - \$97.95

SEND FULL PRICE FOR POSTPAID INSURED. DEL. IN USA. (Canada is \$5.00 extra for postage - clerical - customs etc.) or order using VISA - MASTER CARD - AMER EXPRESS. Give number and ex. date. Ph 1-308-236-5333 9AM - 6PM week days. We ship in 2-3 days. ALL PRICES MAY INCREASE SAVE - ORDER NOW! All antennas guaranteed for 1 year. 10 day money back trial if returned in new condition! Made in USA. FREE INFO. AVAILABLE ONLY FROM

WESTERN ELECTRONICS 213
Dept. AR-12 Kearney, Nebraska, 68847

SYNTHESIZED SIGNAL GENERATOR



MADE IN USA

MODEL SG100D
\$349.95 plus shipping

- Covers 100 to 185 MHz in 1 kHz steps with thumb-wheel dial • Accuracy 1 part per 10 million at all frequencies • Internal FM adjustable from 0 to 100 kHz at a 1 kHz rate • Spurs and noise at least 60 dB below carrier • RF output adjustable from 5-500 mV at 50 ohms • Operates on 12 Vdc @ 1/2 Amp • Available for immediate delivery • \$349.95 plus shipping
- Add-on Accessories available to extend freq. range, add infinite resolution, voice and sub-audible tones, AM, precision 120 dB calibrated attenuator
- Call for details • Dealers wanted worldwide.

VANGUARD LABS
196-23 Jamaica Ave., Hollis, NY 11423
Phone: (212) 468-2720

TOWERS by ALUMA

HIGHEST QUALITY
ALUMINUM & STEEL

60 Ft. Alum. TELESCOPING (CRANK-UP)
Crank-Up
Model T 60-H
GUYED (STACK-UP)
TILT-OVER MODELS
Easy to install. Low Prices.
Crank-ups to 100 ft.

EXCELLENT FOR
AMATEUR COMMUNICATIONS

Mobile Trailer Type
40' Steel Crank-Up Model SH0-40

Mobile Truck Type

Over 36 types aluminum and steel towers made—specials designed and made—write for details.

Fixed Base
SPECIAL Four Section 50 Ft. Van Mounted Crank-Up Aluma Tower

ALUMA TOWER COMPANY
BOX 2806HR
VERO BEACH, FLA. 32960-2806
(305) 567-3423 TELEX 80-3405

the weekender

In New England they say, "If you don't like the weather, wait a minute." NOAA lets you know what to expect

2-meter weather converter

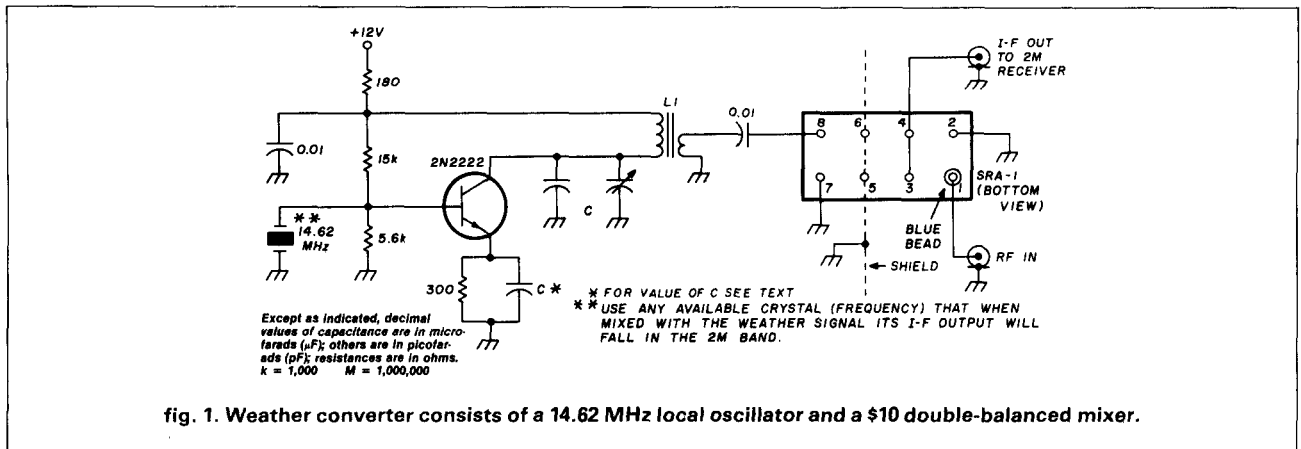

fig. 1. Weather converter consists of a 14.62 MHz local oscillator and a \$10 double-balanced mixer.

Because I sometimes enjoy listening to the VHF public service bands and the NOAA weather broadcasts at 162 MHz, I designed and built a simple converter to convert these frequencies to 2-meter FM for reception on my transceiver.

The 162.40 MHz signal mixes with a 16 MHz local oscillator to produce a signal at 146.40 MHz. A typical converter has four stages: the RF amplifier, mixer, output filter, and local oscillator. Because a mixer is a multiplying device, it produces a signal at both the sum and difference of the input and the local oscillator frequencies. Conversely, for given intermediate and local oscillator frequencies, two input frequencies may be received. Tuned RF stages eliminate all but the desired frequencies.

I chose a passive double balanced mixer (DBM) for this converter. It is an integrated component with a frequency response from DC to 500 MHz. I used a Mini Circuits Lab SRA-1 (\$9.95, in small quantities) that requires oscillator injection of about +7 dBm (5 mW) and has an inherent input impedance of 50 ohms. If IF feedthrough is about -45 dB and conver-

sion loss is 6 dB, it is ideal for mixers when close frequencies are used.

The schematic diagram shown in fig. 1 is the complete circuit. The local oscillator uses a 2N2222 that delivers about +10 dBm. The primary of L1 is selected to have a reactance of about 200 ohms at the crystal frequency. For example, at 15 MHz L1 is 20 turns on a T50-2 toroidal core. The secondary is 4 turns. The combination of the fixed and variable capacitors at the collector should resonate with L1. The emitter bypass capacitor should be about the same value but need not be adjustable. For 15 MHz, a 20 pF fixed and 7-45 pF variable capacitor were used in the collector and a 39 pF fixed value capacitor was used in the emitter. I used a 14.62 MHz crystal from my junkbox and tuned my transceiver to 147.78 MHz in order to receive 162.40 MHz.

The whole circuit was built on a small piece of PC board and mounted in a minibox. No pattern was etched on the board. The DBM was mounted by drilling a grid of eight holes at one end. A shield of PC material was used to separate the local oscillator from the IF and RF. The holes for the ungrounded pins of the DBM were drilled larger for clearance. A blue bead indicates pin 1 of the DBM.

The local oscillator was built using isolated pad

By Ladimer S. Nagurney, WA3EEC, 73 Blackberry Lane, Amherst, Massachusetts 01002

GLB PACKET RADIO CONTROLLER

Now you can get in on the fun on packet radio!

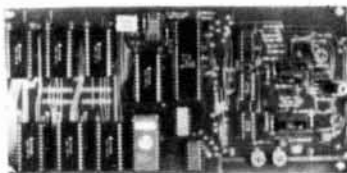

MODEL PK1
(shown with 14K RAM and 8K ROM)

- Low cost!
- Adaptable to any transceiver
- Easy to learn, easy to use
- Nearly 50 commands
- Built-in packet Modem and CW identifier
- Use with teletype machines, computers, terminals
- RS232 serial interface—45 to 9600 baud!
- Uses both ASCII and Baudot
- Vancouver protocol—AX 25 to be released soon
- Stores received messages until requested at a later time
- Operates in "connected" and general modes
- Activates teletype motor to print messages
- Board accepts up to 14K of RAM
- Model PK1 can be customized for Commercial Systems.

Protocol can be changed by swapping ROM chips. Board designed to accept 6264's for up to 56K of RAM with minor modification.

Dimensions: 4.5 x 9.5 inches; 1" vertical clearance.
Power requirement: +12 VDC, approx. 20 ma.

Standard equipment includes 4K of RAM (expandable to 14K).

Model PK1, wired & tested— \$149.95
additional memory, installed & tested (up to 10K) \$10/2K
RTTY adaptor board \$9.95

Connecting cables & enclosure—optional ✓ 145

We offer a complete line of transmitters and receivers, strips, preselector preamps, CWID's & synthesizers for amateur & commercial use. Request our FREE catalog. MC & Visa welcome. Allow \$2 for UPS shipping.

GLB ELECTRONICS

1952 Clinton St. Buffalo, NY 14206
716-824-7936, 9 to 4

SATELLITE CONTROL CABLE

\$495/1000

INTRODUCTORY PRICE!!!

Exclusive from NEMAL ELECTRONICS INTL., INC.

Designed for easy, one-step installation, providing the required cables for most earth station equipment... all in a non-contaminating PVC direct burial jacket.

- 1 - RG59/U 96% Copper Braid Mil Spec
- 5 @ 22 Gauge Stranded Copper, color coded
- 2 @ 22 Gauge Shielded plus 3rd Drain Wire
- 2 @ 18 Gauge Stranded Copper

IN STOCK: 500 or 1000 FT. ROLLS
IMMEDIATE DELIVERY WORLDWIDE

NEMAL ELECTRONICS INTL., INC.

12240 N.E. 14th AVE., NO. MIAMI, FL 33161
Telephone: (305) 893-3924

*Also available: Complete line of coaxial and multi-conductor cables, top-quality connectors and SMATV equipment.
FRANCHISED DISTRIBUTOR - KINGS CONNECTORS
AUTHORIZED AMPHENOL DISTRIBUTOR

*Call or write for complete dealer pricing ✓ 182

techniques. An approximately 3/4-square inch piece of PC board was divided into four equal pads with a hacksaw to cut the foil. This was placed upon the groundplane on the same side as the side on which the DBM pins protrude. It is secured by the resistor and capacitor leads soldered between the various pads and ground. The local oscillator was tested before the DBM was installed by attaching a 47-ohm resistor to the output capacitor as a load and using an oscilloscope to observe the signal. The output was clearly heard on my communications receiver.

The IF output of the mixer utilizes the excellent selectivity capabilities of the front end of a typical 2 meter Amateur transceiver. Since the input of the transceiver is matched to 50 ohms, no additional impedance matching was necessary.

Note no RF filtering is used at the input. Because I could find no interfering signals near 133.16 MHz, I just connected the antenna directly to the input. If one wanted to eliminate this image, a highpass filter with a cutoff below 150 MHz could easily be added. Similarly, a lowpass filter could be used to eliminate the higher image if one wanted to copy a signal below the transceiver frequency.

Even though the mixer exhibits some loss, I found it to be acceptable for local listening. As soon as power was applied, the Providence NOAA weather station was received with full quieting occurring. Either a 162 MHz preamp before or a 2-meter preamp after the converter could be used to eliminate conversion losses.

If one were to choose a common repeater frequency for the IF, a receiver tuned to the weather channel could copy it because of the reciprocity of the mixer.

A note of caution: although DBMs are rugged, they will usually not withstand transmitter power levels. Also, the RF filtering in this simple converter is such that one might put out several signals if the unit were used for transmitting.

ham radio

SPECIAL OFFER

ARRL LICENSE MANUAL — Latest Printing

Slightly Damaged — Super Low Price
— Limited Quantity

Covers the latest FCC exams. The latest printing should be required reading for everyone studying for the Technician, General, Advanced or Extra class license. This "grandfather" of all study guides has been carefully researched and prepared to ensure that you are capable of passing the Amateur exams. Every Amateur should have a copy as it also contains a complete set of the latest FCC Amateur Rules and Regulations. ©1981.

AR-LG Was \$4.00 Softbound \$2.50

Please enclose \$1.00 for shipping and handling.

Ham Radio's Bookstore

Greenville, NH 03048

ham radio

Reader Service

For literature or more information, circle the appropriate number on this card, affix postage and send to us. We'll hustle your name and address to the companies you're interested in.

101 113 125 137 149 161 173 185 197 209 221 233 245 257 269 281 293 305 317 329 341
102 114 126 138 150 162 174 186 198 210 222 234 246 258 270 282 294 306 318 330 342
103 115 127 139 151 163 175 187 199 211 223 235 247 259 271 283 295 307 319 331 343
104 116 128 140 152 164 176 188 200 212 224 236 248 260 272 284 296 308 320 332 344
105 117 129 141 153 165 177 189 201 213 225 237 249 261 273 285 297 309 321 333 345
106 118 130 142 154 166 178 190 202 214 226 238 250 262 274 286 298 310 322 334 346
107 119 131 143 155 167 179 191 203 215 227 239 251 263 275 287 299 311 323 335 347
108 120 132 144 156 168 180 192 204 216 228 240 252 264 276 288 300 312 324 336 348
109 121 133 145 157 169 181 193 205 217 229 241 253 265 277 289 301 313 325 337 349
110 122 134 146 158 170 182 194 206 218 230 242 254 266 278 290 302 314 326 338 350
111 123 135 147 159 171 183 195 207 219 231 243 255 267 279 291 303 315 327 339
112 124 136 148 160 172 184 196 208 220 232 244 256 268 280 292 304 316 328 340

Limit 15 inquiries per request.

NAME _____ CALL _____

ADDRESS _____

CITY _____ STATE _____ ZIP _____

Please use before January 31, 1984

December 1983

AFFIX POSTAGE
OR
POST OFFICE
WILL NOT
DELIVER

ham
radio
magazine

READER SERVICE CENTER
P.O. BOX 358
ARLINGTON, MA 02174

ATTN: Reader Service Dept.

YOU'LL NEVER GET A BETTER DEAL!

CALL TOLL FREE 800-221-0860

HUSTLER ANTENNAS

SF2 - "Buck Buster" 5/8" Wave
2 Meter Antenna
w/3/8 x 24" Threaded Base -
3dB gain

\$8⁹⁵

HOT - EASY ON/OFF TRUNK MOUNT

with 3/8 x 24" Swivel Ball
for CG144 & SF-2



\$14⁹⁵

CG144

5.2dB gain Collinear
w/3/8 x 24"
Threaded Base

\$23⁹⁵

G6144 - 6dB

Base Antenna

\$68⁵⁰

G7144 - 7dB -

Commercial Grade
Base Antenna

\$98⁰⁰



And many other Hustler Antennas & Mounts

BBL144	25 ⁹⁵
BBLT144	35 ⁰⁰
BBLT440	24 ⁷⁵
HLM	13 ⁹⁵

MRK-1	13 ⁷⁵
SFM	24 ²⁵
THF	13 ⁹⁵
UHT-1	8 ⁹⁵

CECO STOCKS THE ENTIRE HUSTLER VHF/UHF & COMMERCIAL LINE
DEALER INQUIRIES INVITED

TC1109 MONITOR

\$140⁰⁰

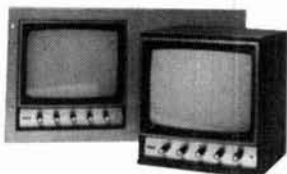

TC1501 CAMERA

\$140⁰⁰



SLOW/FAST SCAN SPECIAL

- TC1109
- TC1501
- 16mm F1.6 Lens
- EEM1 Wallmount for Camera

\$298⁰⁰

WAHL SOLDER STATION

7 Watt DC
with Adjustable
Temperature Control

\$35⁰⁰



WAHL CORDLESS 7700

Quick Charge
Cordless Iron
with Charger

\$25⁰⁰



TOP BRAND Popular Receiving Tube Types FACTORY BOXED 75/80% OFF LIST

SEMI-CONDUCTORS

MRF 245/5D1416	\$30.00
MRF 454	\$18.95
MRF 455	\$12.50
MRF 644/5D1088	\$19.95
2N3055	\$.95
2N6084	\$12.50

TUBES

3-400Z	\$85.00	6146B	\$6.50	8156	\$10.95
3-500Z	\$85.00	6360	\$4.25	8844	\$29.50
4-400A	\$80.00	6883B	\$6.75	8873	\$175.00
4CX250B	\$50.00	7360	\$9.15	8874	\$180.00
572B	\$39.50	7735A	\$29.50	8877	\$450.00
811A	\$12.00	8122	\$98.00	8908	\$10.50
813	\$35.00				

RF CONNECTORS

PL 259	10/\$4.95
PL 258	10/\$8.95
UG 175/176	10/\$1.60
UG 255/U	\$2.50 ea.
UG 273/U	\$2.25 ea.
M358	\$2.50 ea.
M359	\$1.75 ea.
Type "N" twist-on (RG&U)	\$4.75

MINIMUM ORDER \$25.00

ALLOW \$3.00 MINIMUM FOR UPS CHARGES



COMMUNICATIONS, INC.

DEALER INQUIRIES INVITED



2115 AVENUE X • BROOKLYN, N.Y. 11235
800-221-0860 212-646-6300 TWX235125

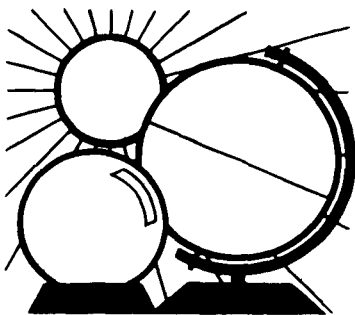

DX FORECASTER

Garth Stonehocker, KØRYW

ray tracing

If Santa were to bring you a ray tracer DX machine for Christmas, you'd have the ultimate DX forecaster right in your home.

Ray tracing between transmitter and receiver locations *is* possible; see this column in the October issue for a diagram showing a trans-equatorial ray path (signal) traced through the ionosphere to give one-long-hop propagation.

Another example of ray tracing technique is to search the ionosphere between your transmitter and the DX QTH, varying the take-off angle, bearing and frequency. (A computer could quickly determine the best path to use and specify these three corresponding parameters.) Ray tracing procedure consists of the following steps:

1. Determine the electron (ion) density at heights above the earth along the ray (signal) path using ionosonde, rocket, or satellite measurements.
2. Generate ionospheric contours using the electron density versus height data.
3. Trace the ray (path) through these contours starting from the transmitted signal. The changing refractive indices along the path determine a new ray direction.
4. Follow the ray as it bends from one point to the next until it emerges from the ionosphere at an angle heading down to earth toward the receiver.

All these steps are depicted in the diagram.

Ray tracing is not commonly done because of the limited availability of electron density profiles around the world. Even if the profiles were available, a substantial computer would be needed for ionosonde data conversion and the electron density profiles storage. However, Radio Amateurs are now using more sophisticated computers, and ionospheric measurements can be made with SSB equipment; maybe someday you *will* be able to get a ray tracing machine for Christmas.

last-minute forecast

December is one of the winter DX season months exhibiting low thunderstorm QRN and low probability of geomagnetic disturbances or at least long quiet periods in between disturbances. However, this year in the 11-year sunspot cycle may see a few more disturbances than in other years. Expect disturbances around December 4, 14, 17, 22, and 27. If WWV is broadcasting a radio flux greater than 140, good trans-equatorial openings might occur on 10-30 meters. If the flux is lower than 140, expect disturbances to last longer and fades to occur on the lower bands on higher latitude east-west paths.

An annular eclipse of the sun is to begin at 0941 UT in northeast North America, traveling across Iceland to England, Southern Europe, North

Africa and ending in Southwest Asia at 1520 UT. The full moon is on the 20th and perigee on the 22nd. Winter solstice is on the 22nd at 1030 UT.

The Geminid meteor shower, which peaks on December 13 and 14, provides the richest and most reliable display of the year, with rates of 60 to 70 meteors per hour (determined mainly by radio, because of the poor weather in December). Also, a smaller portion of the shower (15 to 20 per hour) will be observed on December 22.

band-by-band summary

Ten, fifteen, twenty, and thirty meters will have DX openings from most areas of the world during daylight and into the evening almost every day. Long skip and one-long-hop trans-equatorial openings will occur in the early evening hours. These openings should occur during periods of disturbed geomagnetic field. Otherwise watch for high solar flux days for ten and fifteen meter openings.

Thirty, forty, eighty, and one-sixty meters are the night DXer's bands. Excellent extended periods of long skip, shorter than on the higher bands, will occur. Low noise and quiet geomagnetic conditions generally result in pleasant operating this time of year. Happy Holidays, and lots of DX during the coming New Year!

ham radio

GMT	PST	WESTERN USA							
		N	NE	E	SE	S	SW	W	NW
0000	4:00	20	30	15	10	15	10	10	20
0100	5:00	20	30	15	10	15	10	10	20
0200	6:00	20	30	15	10	15	10	10	20
0300	7:00	20	30	15	10	15	10	10	20
0400	8:00	20	30	15	10	15	10	10	20
0500	9:00	20	30	20	10	15	10	15	20
0600	10:00	20	30	20	10	15	10	15	20
0700	11:00	20	30	20	15	15	15	15	30
0800	12:00	30	30	20	15	20	15	20	30
0900	1:00	30	40	20	15	20	15	20	30
1000	2:00	30	40	20	20	20	20	20	30
1100	3:00	30	40	20	20	20	20	20	30
1200	4:00	30	40	20	20	20	20	20	30
1300	5:00	30	30	20	20	20	20	20	30
1400	6:00	40	30	15	20	20	20	20	30
1500	7:00	40	30	15	20	15	20	20	40
1600	8:00	40	30	15	20	15	15	20	40
1700	9:00	40	20	15	20	15	15	15	30
1800	10:00	40	20	10	15	15	15	15	30
1900	11:00	40	20	10	15	15	10	15	20
2000	12:00	40	20	10	15	15	10	15	20
2100	1:00	30	20	10	15	15	10	10	20
2200	2:00	30	30	15	10	15	10	10	20
2300	3:00	30	30	15	10	15	10	10	20

MST	MID USA								CST
	N	NE	E	SE	S	SW	W	NW	
5:00	30	30	15	10	15	10	10	20	6:00
6:00	30	30	15	10	15	10	10	20	7:00
7:00	30	30	15	10	15	10	10	20	8:00
8:00	30	30	15	10	15	10	10	20	9:00
9:00	30	30	20	10	15	10	15	20	10:00
10:00	30	30	20	10	15	10	15	20	11:00
11:00	30	30	20	15	15	15	15	30	12:00
12:00	30	30	20	15	20	15	15	30	1:00
1:00	30	30	20	20	20	15	20	30	2:00
2:00	30	40	20	20	20	20	20	30	3:00
3:00	30	40	20	20	20	20	20	30	4:00
4:00	30	40	20	20	20	20	20	30	5:00
5:00	20	30	20	20	20	20	20	30	6:00
6:00	20	30	15	20	20	20	20	40	7:00
7:00	20	30	15	20	20	20	20	40	8:00
8:00	20	30	15	20	20	20	20	40	9:00
9:00	20	20	15	20	20	15	20	40	10:00
10:00	30	20	15	20	20	15	15	30	11:00
11:00	30	20	10	15	15	15	15	30	12:00
12:00	30	20	10	15	15	10	15	20	1:00
1:00	30	20	10	15	15	10	15	20	2:00
2:00	30	20	10	10	15	10	10	20	3:00
3:00	40	30	15	10	15	10	10	20	4:00
4:00	40	30	15	10	15	10	10	20	5:00

EST	EASTERN USA							
	N	NE	E	SE	S	SW	W	NW
7:00	30	30	15	10	15	10	10	20
8:00	30	30	15	10	15	10	10	20
9:00	30	30	15	10	15	10	10	20
10:00	30	30	15	10	15	10	15	20
11:00	30	30	20	15	15	15	15	20
12:00	30	30	20	15	15	15	15	30
1:00	30	30	20	15	20	15	15	30
2:00	30	30	20	15	20	20	20	30
3:00	30	40	20	20	20	20	20	30
4:00	30	40	20	20	20	20	20	30
5:00	30	40	20	20	20	20	20	30
6:00	30	40	20	20	20	20	20	30
7:00	20	30	15	20	20	20	20	40
8:00	20	30	15	20	20	20	20	40
9:00	20	30	15	20	20	20	20	40
10:00	20	20	15	20	15	20	20	40*
11:00	20	20	15	20	15	15	15	40
12:00	30	20	10	15	15	15	15	30
1:00	30	20	10	15	15	15	15	30
2:00	30	20	10	15	15	10	15	30
3:00	30	20	10	10	15	10	10	20
4:00	30	20	10	10	15	10	10	20
5:00	40	30	15	10	15	10	10	20
6:00	40	30	15	10	15	10	10	20

DECEMBER

ASIA FAR EAST
EUROPE
S. AFRICA
S. AMERICA
ANTARCTICA
NEW ZEALAND
OCEANIA AUSTRALIA
JAPAN

ASIA FAR EAST
EUROPE
S. AFRICA
S. AMERICA
ANTARCTICA
NEW ZEALAND
OCEANIA AUSTRALIA
JAPAN

ASIA FAR EAST
EUROPE
S. AFRICA
CARIBBEAN S. AMERICA
ANTARCTICA
NEW ZEALAND
OCEANIA AUSTRALIA
JAPAN

The italicized numbers signify the bands to try during the transition and early morning hours, while the standard type provides the MUF during 'normal' hours.
*Look at next higher band for possible openings.

International Crystals & Kits **FOR THE EXPERIMENTER**



\$780
ea.

.02% Calibration Tolerance

EXPERIMENTER CRYSTALS

(HC 6/U Holder)

Cat. No.	Specifications
031300	3 to 20 MHz — For use in OF-1L OSC Specify when ordering.
031310	20 to 60 MHz — For use in OF-1H OSC Specify when ordering.



\$800
ea.

OF-1 OSCILLATOR

The OF-1 oscillator is a resistor/capacitor circuit providing oscillation over a range of frequencies by inserting the desired crystal, 2 to 22 MHz, OF-1 LO, Cat. No. 035108, 18 to 60 MHz, OF-1 HI, Cat. No. 035109. Specify when ordering.

MXX-1 Transistor RF Mixer 3 to 20 MHz, Cat. No. 035105 20 to 170 MHz, Cat. No. 035106	\$8.00 ea.
SAX-1 Transistor RF Amp. 3 to 20 MHz, Cat. No. 035102 20 to 170 MHz, Cat. No. 035103	\$8.00 ea.
BAX-1 Broadband Amp 20 Hz to 150 MHz, Cat. No. 035107	\$8.00 ea.

WRITE FOR BROCHURE



International Crystal Mfg. Co., Inc.

10 North Lee, P.O. Box 26330
Oklahoma City, OK 73126

CONDITIONS OF SALE: Sold on a cash basis. Shipping and postage inside U.S.A. will be prepaid by ICM if full remittance is received with order.
ORDERING INSTRUCTIONS: Order by catalog number. Enclose check or money order with your order.
FOREIGN ORDERS: Prices quoted for U.S. orders only. Orders for shipment to other countries will be quoted on request. Prices subject to change. Minimum foreign order \$25.00.

✓ 159

NEW!



COMPUTER RADIO MODEM

Connect your TRS-80*, Atari*, Apple*, or IBM-PC* to your radio for the ultimate in two way digital communications (CW/RTTY/ASCII).

CALL OR WRITE FOR DETAILS



(209) 667-2888

MACROTRONICS, inc.®
1125 N. Golden State Blvd.
Turlock, CA 95380

*TRS-80 is a registered trademark of Tandy Corp. Atari is a registered trademark of Atari Computer Inc. Apple is a registered trademark of Apple Computer Inc. IBM-PC is a registered trademark of International Business Machine Corp.

✓ 173

KENPRO

WHEN ONLY THE BEST WILL DO...

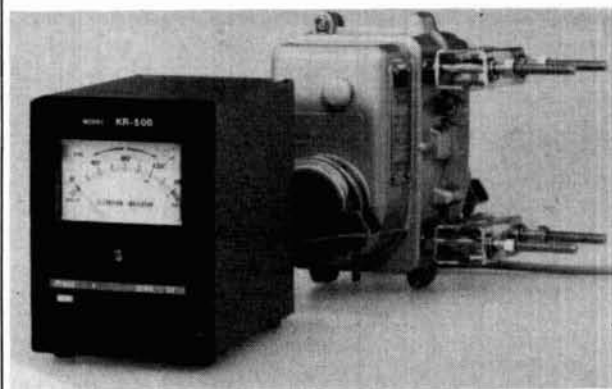

KR 500 ELEVATION ROTOR

THE WORLD STANDARD

AVAILABLE ONLY THROUGH FULL-TIME AMATEUR DEALERS

DISTRIBUTED BY

SPECTRUM WEST

5717 N.E. 56th St. Phone 206/382-2132
Seattle, Washington 98105 TLX DUFFINTLSEA

✓ 200

ASTRON POWER SUPPLIES

• HEAVY DUTY • HIGH QUALITY • RUGGED • RELIABLE •

RS and VS SERIES

SPECIAL FEATURES

- SOLID STATE ELECTRONICALLY REGULATED
- FOLD-BACK CURRENT LIMITING Protects Power Supply from excessive current & continuous shorted output.
- CROWBAR OVER VOLTAGE PROTECTION on all Models except RS-4A.
- MAINTAIN REGULATION & LOW RIPPLE at low line input Voltage.
- HEAVY DUTY HEAT SINK • CHASSIS MOUNT FUSE
- THREE CONDUCTOR POWER CORD
- ONE YEAR WARRANTY • MADE IN U.S.A.

PERFORMANCE SPECIFICATIONS

- INPUT VOLTAGE: 105 - 125 VAC
- OUTPUT VOLTAGE: 13.8 VDC \pm 0.05 volts (Internally Adjustable: 11-15 VDC)
- RIPPLE: Less than 5mv peak to peak (full load & low line)

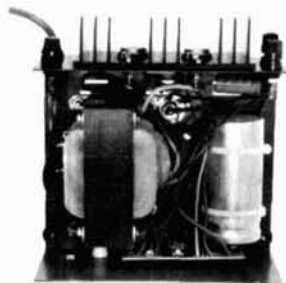

INSIDE VIEW - RS-12A



MODEL RS-50A



MODEL RS-50M



MODEL VS-50M

RM-A Series



MODEL RM-35A

19" X 5 1/4" RACK MOUNT POWER SUPPLIES

Model	Continuous Duty (AMPS)	ICS* (AMPS)	Size (IN) H X W X D	Shipping Wt. (lbs.)
RM-35A	25	35	5 1/4 x 19 x 12 1/2	38
RM-50A	37	50	5 1/4 x 19 x 12 1/2	50

RS-A SERIES



MODEL RS-7A

MODEL	Continuous Duty (Amps)	ICS* (Amps)	Size (IN) H x W x D	Shipping Wt (lbs)
RS-4A	3	4	3 3/4 x 6 1/2 x 9	5
RS-7A	5	7	3 3/4 x 6 1/2 x 9	9
RS-7B	5	7	4 x 7 1/2 x 10 3/4	10
RS-10A	7.5	10	4 x 7 1/2 x 10 3/4	11
RS-12A	9	12	4 1/2 x 8 x 9	13
RS-20A	16	20	5 x 9 x 10 1/2	18
RS-35A	25	35	5 x 11 x 11	27
RS-50A	37	50	6 x 13 3/4 x 11	46

RS-M SERIES



MODEL RS-35M

- Switchable volt and Amp meter

MODEL	Continuous Duty (Amps)	ICS* (Amps)	Size (IN) H x W x D	Shipping Wt (lbs)
RS-12M	9	12	4 1/2 x 8 x 9	13
RS-20M	16	20	5 x 9 x 10 1/2	18
RS-35M	25	35	5 x 11 x 11	27
RS-50M	37	50	6 x 13 3/4 x 11	46

VS-M SERIES



MODEL VS-20M

- Separate Volt and Amp Meters
- Output Voltage adjustable from 2-15 volts
- Current limit adjustable from 1.5 amps to Full Load

MODEL	Continuous Duty (Amps) @13.8VDC@10VDC@5VDC	ICS* (Amps) @13.8V	Size (IN) H x W x D	Shipping Wt (lbs)
VS-20M	16 9 4	20	5 x 9 x 10 1/2	20
VS-35M	25 15 7	35	5 x 11 x 11	29
VS-50M	37 22 10	50	6 x 13 3/4 x 11	46

RS-S SERIES



MODEL RS-12S

- Built in speaker

MODEL	Continous Duty (Amps)	ICS* Amps	Size (IN) H x W x D	Shipping Wt (lbs)
RS-7S	5	7	4 x 7 1/2 x 10 3/4	10
RS-10S	7.5	10	4 x 7 1/2 x 10 3/4	12
RS-10L(For LTR)	7.5	10	4 x 9 x 13	13
RS-12S	9	12	4 1/2 x 8 x 9	13
RS-20S	16	20	5 x 9 x 10 1/2	18

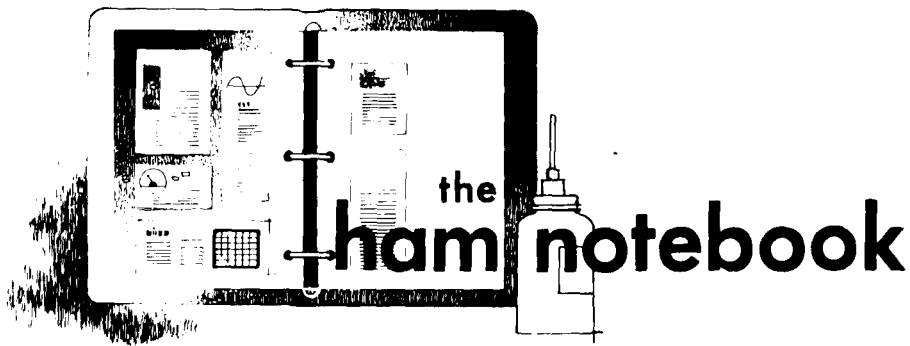

KWM 380 external control circuit

This unit will control external antenna switches or solid-state (relay-actuated) amplifiers from the megahertz BCD output signals from the KWM 380. It was built in an evening with wire wrapping techniques using IC sockets, parts, and boards available at any Radio Shack or similar electronics outlet.

The KWM 380 (fig. 1) powers the circuit and provides BCD information for both the ones and ten digits. When operation is below 10 MHz, both of the "tens" BCD outputs, representing 10 and 20 MHz, are high.

The two 4028 IC's are BCD to decimal decoders. One handles the "ones" input information from the 380; the other handles the "tens" input information. The output from these IC's labeled U3 and U4 go to

common QUAD AND gates U1 and U2 which are 74LS08's. When both inputs of any one of the AND GATES are high, the output goes high. This output goes through a 4.7k resistor to the base of a 2N2222 transistor. When the base goes high, the transistor acts as a switch and completes the circuit to ground for the small relay which in turn actuates an antenna switch (or amplifier bandswitch).

U1 and U2 pin 14 is at +5 volts, and pin 7 is at ground. U1a and U1b have one input each tied to the decimal 3 output of BCD decoder U4. This is because the KWM 380 causes both interface pins 12 and 13 to go high (10's and 20's MHz info) when the radio is tuned to any MHz band below 10.000. Thus U1a, which closes the 3.5 MHz relay, reads 33 MHz from the decoders, and U1b reads 37 MHz to close the 7 MHz relay. U3 and U4 pin 16 is at +5 volts,

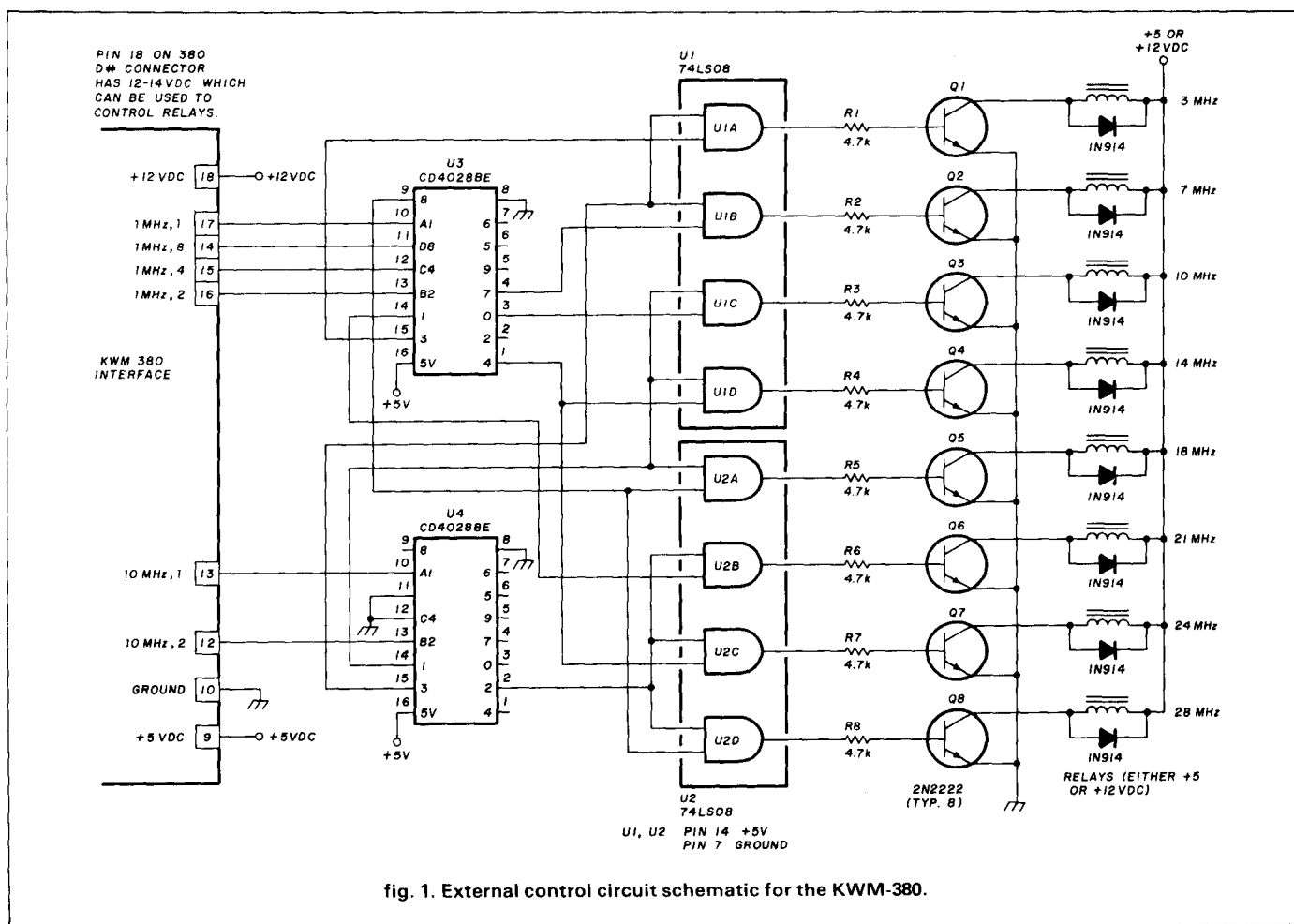

and pin 8 is grounded. Unused BCD inputs U4 pins 11 and 12 must be grounded to prevent instability.

I recommend that the cable from the KWM 380 to the control unit be shielded to prevent EMI. The control circuit can be expanded to as many as 29 AND GATES if necessary to control the bandswitching systems required by some commercial solid-state amplifiers. Bypass capacitors of 0.1 and 0.01 μ F should be added to the 5-volt and 12-volt lines to help reduce RF problems that might occur under high power conditions.

Bill Levy, WA2RUD

turns per inch from wire size

Here's a nice little way of computing the approximate number of turns per inch of enameled wire (of a tightly-wound single-layer coil) if you know the wire gauge.

$$TPI = \left(\left[\frac{G^3}{415} \right] + 5 \right)$$

where G is the wire gauge.

It's easy to put into a computer.

Dennis Mitchell, K8UR

regulator problem solved

For years I had been building 12 volt DC power supplies using the LM-340-K-12 and other three-legged devices without any apparent problems. But suddenly I started having problems, and blew out a dozen of the devices, which the manufacturer swears is well protected and easy to use.

I checked the input voltage to the regulator carefully; it was well below safe limits. The bypass capacitors were soldered close to the input and

output leads, and I'd used a heatsink while soldering to the pins, but the things still blew out.

I wrote to several manufacturers and finally received an answer. Most of the circuits shown in the handbooks and brochures don't show a safety diode placed across the unit from output to input. It seems that when the voltage is removed from the input, the output capacitor discharges through the regulator and damages it. The solution, suggested in fig. 1, seems to solve the problem.

Ed Marriner, W6XM

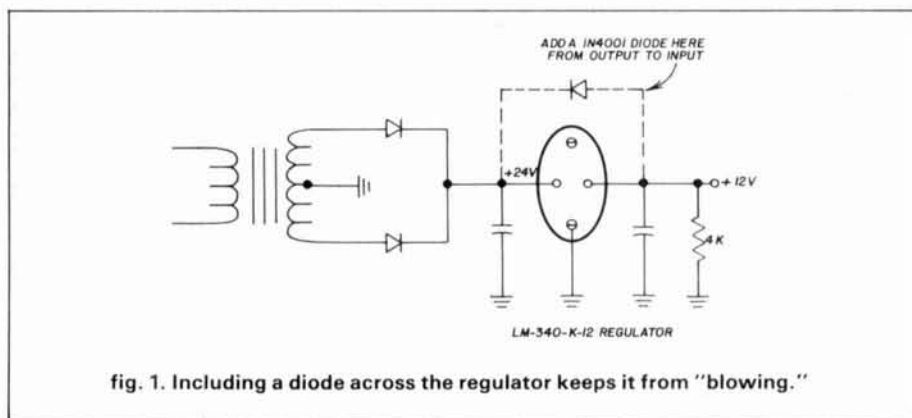
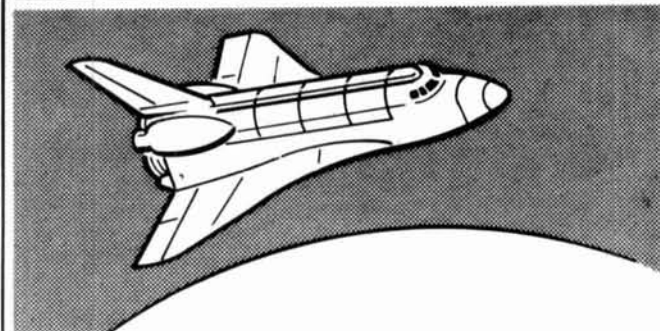

fig. 1. Including a diode across the regulator keeps it from "blowing."

AMATEUR TELEVISION



ATV TRANSMITTER/CONVERTER



\$399 delivered
TC-1 plus

- **OVER 10 WATTS PEP OUTPUT.** Crystal controlled continuous duty transmitter. Specify 439.25, 434.0, 426.25 standard or other 70 cm frequency. 2 freq. option add \$26.
- **BASE, MOBILE, or PORTABLE.** Use the built-in AC supply or external 13.8 vdc. Do parades, Marathons, etc.
- **TWO VIDEO AND AUDIO INPUTS** for camera, TVRO, VCR, or computer. Wide bandwidth for broadcast quality color video and computer graphics. Standard broadcast subcarrier sound which is heard thru the TV speaker.
- **RECEIVE ON YOUR STANDARD TVSET** tuned to channel 3 or 4. Sensitive varicap tuned TVC-2L downconverter covers simplex and repeater freq. over the whole 420-450 mHz 70 cm amateur band.
- **ATTRACTIVE 10.5 x 3 x 9 CABINET.**

FCC & NASA OKs SHUTTLE VIDEO

Want a chance at seeing W5LFL live as he works 2 meters?

It's been great hearing the audio on the various repeaters, but now, if you hold a technician class or higher license, and have a TVRO capable of receiving Satcom IR transponder 13, you can repeat the space shuttle video to your fellow hams using our TC-1 plus. Just connect the composite video and line audio from the Satellite receiver to the video and audio inputs of the TC-1. Depending on your antenna, coverage will be typically the same as 2 meter simplex. Local area hams can receive with just one of our 70 CM downconverters and an antenna.

ATV 70 cm DOWNCONVERTERS

For those who want to see the repeated shuttle video, and other ATV action before they commit to a complete station, the TVC-4 is for you. The TVC-4 contains the TVC-2 module mounted in a cabinet with AC supply ready to go. Tunes 420 to 450 mHz. Just connect 70 cm antenna and your TV set tuned to ch 3 or 4 ... **\$89 delivered.**

- TVC-4L hotter preamp for fringe areas ... **\$99 delivered.**
- TVC-2 wired and tested module. Req. 12 vdc. MRF901 preamp stage. Varicap tuned 420-450 mHz. A low cost start at ... **\$49.**
- TVC-2L hotter NE64535 preamp stage ... **\$59 delivered.**
- TVC-2G GaAsFet preamp stage. Antenna mounting ... **\$79**

CALL OR WRITE FOR OUR CATALOG or more information on ATV antennas, transmit modules, cameras, and much, much more. See chapter 14 pg 30-32 1983 ARRL Handbook.

TERMS: Visa, Mastercard, or cash only UPS CODs by telephone or mail. Postal money orders and telephone orders usually shipped within 2 days. All other checks must clear before shipment. Transmitting equipment sold only to licensed amateurs.

(213) 447-4565 m-f 8am-6pm pst.

P.C. ELECTRONICS

Tom W6ORG Maryann WB6YSS



2522 Paxson Lane
Arcadia CA 91006

LISTEN TO THIS!

UL2M is a FM Transmitter that plugs into the phone jack of most H.F., V.H.F. and U.H.F. radios. You can now monitor your favorite H.F., V.H.F. or U.H.F. frequency up to 100' away using the UL2M and your H.T.

The UL2M is a XTAL controlled F.M. transmitter built inside a standard 1/4" phone plug. The UL2M will transmit the audio from your H.F., V.H.F. or U.H.F. radio to your H.T.

The UL2M requires your H.F., V.H.F. or U.H.F. radio to have a 1/4" phone jack and output impedance of 3.2, 8 or 16 ohms. For radio having an 1/8" headphone jack, use a 1/8" to 1/4" adaptor.

When ordering specify operating frequency of your H.T.

ONLY \$24.95



To order, send check or money order to:

S and T Electronics
1401 Rae Lane
Madison, WI 53711
For C.O.D. order call
Carol at 608/274-2599.

satisfaction guaranteed or
full refund.



product REVIEW

Fluke Model 8026 True RMS Multimeter

My first experience with Fluke equipment came while I was stationed at Letterkenny Army Depot in Pennsylvania. Letterkenny is the prime repair center for the Nike-Hercules and Hawk/Improved Hawk Missile Systems. Our repair and overhaul was a soup-to-nuts mission in that besides rebuilding the actual missiles themselves, we also overhauled all of the electronics systems.

As a member of the Production Engineering Department, I was directly involved in the establishment of the overhaul lines and was responsible for the selection and recommendation of test and production equipment. A number of overhaul steps required specific pieces of test equipment to ensure that all test procedures were done in accordance with manufacturers' specifications. This entailed establishing test and overhaul equipment lists that duplicated exactly what the systems' manufacturers used. This is where I first came into contact with Fluke equipment, which was specified because of its high degree of design accuracy and dependability in a production environment.

When the Fluke Model 8026B Multimeter came in to *ham radio* for review, I was quite interested to see how the unit compared to my memory of Fluke lab grade (read *very expensive*) test equipment. Needless to say, I wasn't disappointed. The Fluke Model 8026B is a handy, easy-to-use, digital multimeter. It is designed to test the following parameters:

DC voltage	100 μ V - 1000 V
AC voltage	100 μ V - 750 V
DC current	1 μ A - 2000 mA
AC current	1 μ A - 2000 mA
Resistance	0.1 ohm - 20 megohm
Diode test	
Conductance	0.1 ns - 200 ns 0.001 ms - 2 ms s = siemens = 1/ohm
Continuity	

It will also give true RMS AC measurement for signals up to 10 kHz. Each range has full auto-polarity operating, overrange indication and is protected from overloads. To ensure

that measurements are accurate and noise free, the Model 8026B utilizes a dual slope integration measurement technique.

The unit measures 7.1 x 3.4 x 1.8 inches (180 x 86 x 45 mm) and weighs just 13 ounces (369 grams). With an alkaline 9 volt battery, the unit is rated at 200 hours of continuous operation. An optional AC power supply is available. The unit fits comfortably into your hand and the case is made of a high impact plastic.

operation

The unit is designed around a Fluke custom LSI chip. The chip contains a dual slope a/d converter and a driver for the LCD display. When an input signal is applied, it is routed through the range switch or to one of four signal conditioners as determined by the function switch setting. The conditioners are designed to scale and convert the input to an acceptable -0.2 to +0.2 VDC that is presented to the a/d converter.

Tuning for the Model 8026 is derived from a precision quartz crystal whose frequency is a multiple of 60 Hz. This allows the conditioned DC input to be measured over an integral number of power line cycles.

Of significant interest is the 103-page owner's manual. It is well written and full of information and goes far beyond owners' manuals found in many other units. Full documentation includes specifications, operating and maintenance instructions, a discussion of its theory of operation, a list of replaceable parts, accessory information, and a schematic.

As you would expect from a company such as Fluke, calibration is a simple process and can be obtained from any Fluke Technical Service Center for a small fee. With all that Fluke has provided, it is hard to believe that I was reviewing a hand-held multimeter. The price of \$219.99 may be a little expensive for the average ham. However, for the ham who wants only the very best or for the service technician who depends upon his equipment to perform without problems, I would highly recommend this or any other Fluke unit. For more information contact the John H. Fluke Mfg. Co., PO Box C9090, Everett, WA 98206. R.S.#302

NIACH

NEW products

hobby kits

"Hobby Kits" are a new line of custom-designed electronic products from Morning Distributing. Designed with the ham or electronic hobbyist in mind, they allow construction of equipment ranging from a simple intercom or

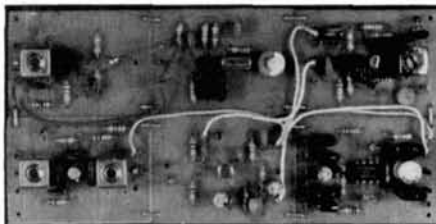

phone amplifier to projects as complex as a state-of-the-art multi-band, multi-mode transceiver. Using this simple approach, beginners will be able to learn as they build. For engineers, it will allow them tremendous flexibility in equipment design. Modules are typically 1.5 to 2 inches long and 1.5 inches wide. All Hobby Kit modules other than the power supply are designed to work from 12-14 VDC. Boards are all predrilled and tinned. The kits come with all parts and instructions necessary. The photo above shows a monoband QRP transceiver built with six Hobby Kit modules for a total cost of about \$35. A complete manual showing all diagrams and board layouts including suggested circuit systems design and hookups is available for \$2.00 from Morning Distributing Company, P.O. Box 717, Hialeah, Florida 33011. RS#301

automatic antenna tuner

While the new AT-250 automatic antenna tuner from Trio-Kenwood has been specifically designed to match Kenwood's popular TS-



Barry Electronics Corp.

WORLD WIDE AMATEUR RADIO SINCE 1950
Your one source for all Radio Equipment!

For the best buys in town call:
212-925-7000
Los Precios Mas Bajos en Nueva York...

KITTY SAYS: WE ARE NOW OPEN 7 DAYS A WEEK.
Saturday & Sunday 10 to 5 PM
Monday-Friday 9 to 6:30 PM Thurs. to 8 PM
Come to Barry's for the best buys in town. For Orders Only Please Call: 800-221-2683



ICOM

IC-R70, IC-751, IC-730, IC-745, IC-25A/H, IC-35A
IC-45A, IC-271A, IC-2KL, IC-471A, IC-290H, IC-120

YAESU

FT-ONE, FT-960, FT-102, FT-77, FT-707, FT-230R FT-757
FT-726R, FT-720RU, FT-290R, FRG-7700, FT-203R



"It's Barry for the Best in Amateur & Commercial Radios"



HEIL MICROPHONE EQUALIZER

ROCKWELL/COLLINS

KWM-380

VoCom/Mirage
Tokyo Hy-Power
Amplifiers &
5/8" HT Gain
Antennas IN STOCK



KANTRONICS
Field Day 2, Mini-Reader,
Interface, Software &
Code Tapes

EIMAC
3-500Z
572B, 6JS6C
12BY7A &
4-400A

AEA 144 MHz
AEA 440 MHz
ANTENNAS

BIRD
Wattmeters &
Elements
In Stock

Computer Interfaces
stocked: MFJ-1224
AEA CP-1, Kantronics
Big Ham Clock/Ham Tags

Complete Butternut Antenna
Inventory In Stock!

Robot 800C - 1200C
Color Mod Kits

Long-range Wireless
Telephone for export
in stock

BENCHER PADDLES &
Vibroplex Keys In Stock!

New TEN-TEC
2591 HT, Corsair In Stock

Land Mobile HT
Midland
Wilson Mini-Com II
Yaesu FTC 2203, FT 4703
Icom IC M12 (Marine)
Tempo II

DRAKE TR-5, TR-7A, R-7A, L-7, L-15, Earth
Satellite Receiver ESR-24, THETA 9000E & 500
EARTH SATELLITE STATION ESS-2250

SMART PATCH
CES Simplex Autopatch 510 SA Will Patch FM
Transceiver To Your Telephone. Great For
Telephone Calls From Mobile To Base Simple
To Use. \$319.95

SAITEC
ST-2200UP
ST-144UP
ST-440UP

NEW IMPROVED
MURCH Model UT2000B

Repeaters in Stock:
Spectrum SCR-1000, 4000, & 77
ICOM IC-RP 3010 (440 MHz)
ICOM IC-RP 1210 (1.2 GHz)

MFJ Models
900, 940B, 941C, & 496

HAM MasterTapes -
Beta or VHS Tapes

DIGITAL
FREQUENCY
COUNTER

Trionyx
Model TR 1000
0-600 MHz
Digimax Model
D-510 50 Hz-1GHz

Tri-Ex Towers
Hy-Gain Towers
& Antennas,
and Rotors
will be shipped direct to you FREE of shipping cost

MAIL ALL ORDERS TO BARRY ELECTRONICS CORP., 512 BROADWAY, NEW YORK CITY, NY 10012.

New York City's LARGEST STOCKING HAM DEALER
COMPLETE REPAIR LAB ON PREMISES

"Aquí Se Habla Español"

BARRY INTERNATIONAL TELEX 12-7670
TOP TRADES GIVEN ON USED EQUIPMENT
STORE HOURS: Monday-Friday 9 to 6:30 PM
Parking Lot Across the Street
Saturday + Sunday 10 to 5 pm (Free Parking)
AUTHORIZED DIST. MCKAY DYMEK FOR
SHORTWAVE ANTENNAS & RECEIVERS.
IRTILEX "Spring St. Station"
Subways: BMT "Prince St. Station"
IND "F" Train-Bwy. Station"
Bus: Broadway #6 to Spring St.

ORDER LINE
CALL
800-221-2683

We Stock: AEA, ARRL, Alpha, Ameco, Antenna Specialists, Astatic, Astron, B & K, B & W, Bash, Bencher, Bird, Butternut, CDE, CES, Collins, Communications Spec. Connectors, Covercraft, Cubic (Swan), Cushcraft, Daiwa, Dentron, Digimax, Drake, ETO (Alpha), Eimac, Encomm, Heil-Sound, Henry, Hustler (Newtronics), Hy-Gain, Icom, KLM, Kantronics, Larsen, MCM (Daiwa), MFJ, J.W. Miller, Mini-Products, Mirage, Newtronics, Nye Viking, Palomar, RF Products, Radio Amateur Callbook, Robot, Rockwell Collins, Saxton, Shure, Swan, Telex, Tempo, Ten-Tec, Tokyo Hi Power, Trionyx TUBES, W2AU, Waber, Wilson, Yaesu Ham and Commercial Radios, Vocom, Vibroplex, Curtis, Tri-Ex, Wacom Duplexers, Repeaters, Phelps Dodge, Fanon Intercoms, Scanners, Crystals, Radio Publications.

WE NOW STOCK COMMERCIAL COMMUNICATIONS SYSTEMS
DEALER INQUIRIES INVITED. PHONE IN YOUR ORDER & BE REIMBURSED
COMMERCIAL RADIOS stocked & serviced on premises.

Amateur Radio & Computer Courses Given On Our Premises, Call
Export Orders Shipped Immediately. TELEX 12-7670

SEMI CONDUCTORS :

MRF-208 - 12.00 MHW-252 - 50.00
MRF-240 - 15.50 MHW-710-1 - 61.00
MRF-247 - 34.80 MPSH-81 - .50
MRF-309 - 27.60 MV2205 - .58
MRF-422 - 41.40 78L08CP - .50
MRF-454 - 20.00 2N4401 - .75
MRF-901 - 1.75 2N5190 - 1.50
SBL-1 Double-Balance Mixer - 6.50

P.C. BOARDS FOR MOTOROLA BULLETINS

EB-18A - 12.00 AN-762 - 14.00
EB-27A - 14.00 AN-791 - 10.00
EB-63 - 14.00 EB-67 - 14.00

KEMET CHIP CAPACITORS: 56 pf, 82 pf,
100 pf, 390 pf, 470 pf; -.50 ea
680 pf, 1000 pf; -.55 ea
5600 pf, 6800 pf, .1 uf; -1.00 ea
.33 uf; -1.90 ea .68 uf; -3.90 ea
CAMBION RF CHOKES: .15 uh, .22 uh, .33 uh, 4.7 uh, 10 uh - 1.20 ea
BROADBAND TRANSFORMERS PER MOTOROLA BULLETINS: AN-762, EB-27A, EB-63
UNDERWOOD/SEMCO METAL-CLAD MICA CAPACITORS: 5pf, 10pf, 15pf, 25pf, 30pf,
40pf, 56pf, 60pf, 68pf, 80pf, 91pf, 100pf, 200pf, 250pf, 390pf, 470pf, 1000pf

We also carry a line of VHF, UHF amplifiers and ATV equipment.

Call or write for our free catalog.



Communication Concepts Inc.



2648 North Aragon Ave • Dayton, Ohio 45420 • (513) 296-1411 ✓ 129

PB RADIO

1950 E. Park Row Arlington, Texas 76010

★ SPECIALIZING IN: ★
MDS Receivers & UHF Decoders

MDS COMPLETE COMMERCIAL UNIT \$169.95
30" DISH — COMPLETE SYSTEM \$249.95
CRYSTAL CONTROL BOGDNER SYSTEM \$189.95

UHF DECODERS: FV 3 INSTRUCTIONS \$5.00
FV 3 BOARD \$30.00 FV 3 IC CHIP KIT \$35.00
POWER SUPPLY KIT \$24.95
EDGE CONNECTORS \$2.95

SATELLITE T.V. SYSTEMS: PRODELIN DISHES, DRAKE RECEIVERS, LNA'S & CHAPARRAL POLAROTORS. SEND \$1.00 FOR MORE INFORMATION.

✓ 184

INFORMATION CALL 817-460-7071
ORDERS ONLY CALL 800-433-5169



430S high-frequency transceiver in size, color, and general appearance, it is functionally compatible with any HF transceiver of 200 watts PEP or less. Used with the TS-430S, its ABC (Automatic Band Change) system handles all switching from band to band; if the transceiver is other than the TS-430S, manual switching from band to band is required. The unit covers 160-10 meters, including the three WARC bands, has a front panel SWR/power meter, features four separate antenna terminals, and comes complete with a built-in AC power supply.

Additional information is available from Trio-Kenwood Communications, 1111 West Walnut Street, Compton, California 90220.

pocket oscilloscope

Calvert Instruments has developed a 4-ounce, pocket-size solid-state digital LED oscilloscope that provides the same functions as oscilloscopes more than twenty times its size, yet performs with only four solid-state controls. Focus and brightness on the 210-point, high-intensity illuminated screen are electronically self-controlled. The trace is always in sharp focus. Zero position and full-screen sweep are maintained automatically. The zero-reference, or cross-over line, is always centered. Full-



trace minimum on the screen is automatically maintained, and the automatic internal circuitry assures a properly positioned wave form.

The Pocket-O-Scope digital display visually reveals the value of the incoming signal during a precise real-time and/or degree envelope of the signal cycle. Every signal received is displayed as a series of lighted LED dots on the screen. These LED dots are for the "Digital Dot Envelope" and represent the digital value of

UP YOUR ERP



For HT owners operating inside a vehicle and wanting increased T/R range, RF PRODUCTS has the low cost solution.

Remove your BNC antenna from the HT and mount on the RF PRODUCTS BNC magnet mount, install the magnet mount on the roof top and connect the BNC co-ax connector.

The magnet mount (part no. 199-445) has 10 feet of small (5/32") co-ax with BNC connector attached and is priced at \$15.95 (including shipping by UPS to 48 states).

TO ORDER - send \$15.95 money order or cashiers check only

Fla. residents add 5% tax, for air UPS add \$1.50

RF Products are 100% field repairable should a problem arise. A large diameter metal plate is used in the base mount to ensure complete capacitive coupling between the antenna and vehicle. Seven other styles of Magnum units are available for other radios. Three choices of RF connectors are available; BNC, UHF and slug. Call, write, check off bingo card for more information.

✓ 189

RF PRODUCTS

P.O. Box 33, Rockledge, FL 32955, U.S.A. (305) 631-0775

DIRECTION FINDING?

- ★ Doppler Direction Finding
- ★ No Receiver Mods
- ★ Mobile or Fixed
- ★ Kits or Assembled Units
- ★ 135-165 MHz Standard Range



- ★ Circular LED Display
- ★ Optional Digital Display
- ★ Optional Serial Interface
- ★ 12 VDC Operation
- ★ 90 Day Warranty

New Technology (patent pending) converts any VHF FM receiver into an advanced Doppler Direction Finder. Simply plug into receiver's antenna and external speaker jacks. Use any four omnidirectional antennas. Low noise, high sensitivity for weak signal detection. Kits from \$270. Assembled units and antennas also available. Call or write for full details and prices.

DOPPLER SYSTEMS, 5540 E. Charter Oak, (602) 998-1151
Scottsdale, AZ 85254

✓ 136

the signal rather than the analog value seen on conventional scopes. The Pocket-O-Scope's digital display provides a definite value for amplitude and its intra-relationship with real time/degrees. No judgment is required.

The Pocket-O-Scope, including carrying case, AC adapter, standard and high voltage probes and 200-page training manual, is being introduced for under \$250. The scope only with standard probes will be available for \$179.95.

For further information, contact Calvert Instruments, 19851 Ingersoll Drive, Cleveland, Ohio 44116. RS#303

remote base intertie

The RB-1 from Heil, Ltd., allows the easy interconnection of two transceivers for remote base operation. With the RB-1, a 220 MHz rig can be intertied with a 146 MHz rig so that the operator of a 220 MHz hand-held unit can control the 146 MHz "base" rig, which can be connected to large amplifiers, antenna systems, etc. This allows the HT to communicate over greater distances.



Very simple to connect and operate, the RB-1 has only two 8-pin microphone type connectors on the back panel to connect the squelch of rig A to the PTT Line of rig B, along with proper logic and audio coupling. With the front panel switch off, both rigs operate normally. The RB-1 can also be used as a repeater control.

The size of the unit is 4-1/4 x 4-1/8 x 1-7/8 inches; the price is \$49.95.

For further information, contact Heil, Ltd., Marissa, Illinois 62257. RS#304

amplifier and power supply

The SCA-100 is a 100 watt, 406-512 MHz amplifier that can be used in either repeater or base station applications. With a unique high efficiency cooling design that combines a high volume forced air system and deep fin heat-sink, failures due to transistor overheating are virtually eliminated.

The Circular Advantage



For OSCAR 10 and Russian Satellite Communications

KLM's Circular Polarized antennas have been specifically designed to optimize OSCAR 10 and Russian satellite operation. Quality workmanship and superior design, yield virtually perfect circular patterns over the satellite operational bandwidth. Enjoy less Multi-Path Distortion, less Flutter, Fade, and better S/N Ratios, with comparable performance on transmit.

Both the 2M-14C and 435-18C sport virtually unbreakable 3/16" rod parasitic elements anchored thru the boom, folded dipole driven elements produce excellent physical and electrical symmetry for years of constant performance.

Specifications: (2M-14C)

BANDWIDTH: .. 144-150 MHz	BOOM LENGTH: 12'9"
GAIN: 11 dBdc	VSWR: 1.2:1
BEAMWIDTH: 48°	WINDLOAD: 1.25 sq. ft.
FEED IMP: 50 ohm unbal.	WT. (LBS): 7.5
BALUN: 4:1,2KW	ELLIPTICITY: ± 3 dB Max.
CIRCULARITY SWITCHER:	INCLUDED

The 435-18C is a star performer, an optional CS-2 circularity switcher puts left, and right-hand circular control in your shack, and doubles as a two port divider/impedance transformer for single feed line convenience.



Specifications: (435-18C)

BANDWIDTH: .. 420-450 MHz	GAIN: 12 dBdc
BOOM LENGTH: 7.3 ft.	VSWR: 1.5:1
BEAMWIDTH: 44°	FEED IMP: 50 ohm unbal.
WT. (LBS): 4.5	BALUN: 2-4:1, 1KW
MAST DIA: Cen-Rear/1/2"	ELLIPTICITY: 3dB MAX.
CIRCULARITY SWITCHER	(CS-2) OPTIONAL

See your local KLM dealer or write for our complete catalog

KLM electronics Inc.
P.O. Box 816, Morgan Hill, CA 95037

SOLAR ELECTRICITY

by



PHOTOWATT
INTERNATIONAL INC

WE OFFER A COMPLETE LINE OF PHOTOVOLTAIC MODULES, BATTERIES, AND D.C. APPLIANCES INCLUDING REFRIGERATORS, LIGHTS, FANS, WATERPUMPS, T.V.'S, STEREOS AS WELL AS INVERTERS FOR A.C. POWER

SYSTEMS START AT UNDER \$1000.
SEND \$3.00 FOR OUR COMPLETE CATALOG

TALMAGE ENGINEERING

BOX 497A, BEACHWOOD ROAD
KENNEBUNKPORT, ME 04046
207-967-5945

✓ 204



The SCA-100 also features automatic high VSWR shutdown designed to self-test the antenna circuit in order to prevent damage to the amplifier should the antenna system fail. Other standard features include power supply failure

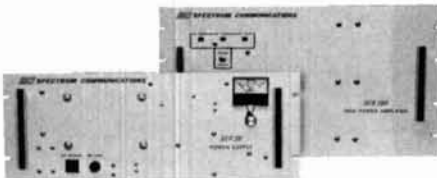

bypass to ensure continuous operation, over-temperature protection in case of cooling system failure and extremely tight RF shielding.

The SCP-30, the matching power supply for the SCA-100 amplifier, is designed to operate at 25 amps continuous, 13.8 VDC. Its features include ferro-resonant power transformer, over-current protection, optional power main failure switch to battery power and heavy-duty construction.

For further information, call Spectrum Communications Corp., 1055, West Germantown Pike, Norristown, Pennsylvania 19401-9616. RS#305

autoranging L/C meter

An instrument that allows accurate measurement and sorting of inductors and capacitors is available from Cambridge Technology. Although less than \$1000, the Model 520 Com-



WARC for FT-101/901

Modernize any model of the original FT-101 Series by adding all three WARC bands for RX and TX!

- Use 10 MHz now; be ready for the others.
- Increase resale value of your rig.
- Easy installation, detailed instructions.
- Includes all crystals, relays, etc.
- Tested, fool-proof design for all but 'ZD.

FT-101 WARC Kit #4N ONLY \$25.
FT-901 WARC Kit #4J (30M only) ONLY \$10.
Shipping \$3 (Air \$5). Florida sales tax 5%.

GO FOX TANGO — TO BE SURE!



Order by Mail
or Telephone
✓ 143

For other great Yaesu modifications get the top-rated FT Newsletter. Still only \$8 per calendar year (US), \$9 Canada, \$12 Overseas.

FOX TANGO CORPORATION

Box 15944 H, W. Palm Beach, FL 33416
(305) 683-9587

DESIGN NARROWBAND MICROWAVE AMPLIFIERS
WITH YOUR PERSONAL COMPUTER



- Maximum Gain Designs
- Minimum Noise Designs
- Gain and Noise Compromise Designs
- Gain and Stability Analysis
- 50 Ohm Stub Circuits
- Quarter Wave Transformer Circuits
- Microsoft BASIC

Manual with listing \$16.95 ppd.
Check or money order drawn on U.S. bank ONLY

Phillip Young
1209 Sunset Road SW
Albuquerque, New Mexico 87105

✓ 215

RF CIRCUIT DESIGN

BY CHRIS BOWICK, WD4C

NEW

RF CIRCUIT DESIGN IS WRITTEN FOR THOSE WHO DESIRE A PRACTICAL APPROACH TO THE DESIGN OF SMALL AND LARGE SIGNAL RF AMPLIFIERS, IMPEDANCE MATCHING NETWORKS, AND FILTERS. AN EXPERT IN THE RF CIRCUIT DESIGN FIELD WILL FIND THE BOOK TO BE A VALUABLE REFERENCE MANUAL, WHILE THE NEWCOMER WILL FIND NUMEROUS EXAMPLES TO GUIDE HIM EVERY STEP OF THE WAY.



PARTIAL CONTENTS:

RESONANT CIRCUITS

LOADED Q - INSERTION LOSS - COUPLING - TOROIDS

FILTER DESIGN

LOW PASS - HIGH PASS - BAND PASS - BAND STOP

IMPEDANCE MATCHING

THE L AND PI NETWORKS - THE SMITH CHART AS A TOOL

RF AMPLIFIER DESIGN

BIASING - MATCHING - Y AND S PARAMETER DESIGN

POWER AMPLIFIER DESIGN

BIASING - MATCHING - BROADBAND TRANSFORMERS - POWER TRANSISTOR CHARACTERISTICS

AND MUCH, MUCH MORE!!!!

✓ 119

PUBLISHED BY HOWARD W. SAMS & CO., INC.

TO ORDER YOUR COPY, SEND CHECK OR MONEY ORDER FOR \$22.95 TO:

CHRIS BOWICK, WD4C
200 ABRI PLACE
LILBURN, GA. 30247

Free Tool Catalog



Thousands of hard-to-find products for building, testing, and repairing electronics. Everything is easy to order by phone or mail, ready for immediate delivery.

Contact East—Dept. 0227
7 Cypress Drive, Burlington, MA 01803
In a hurry to receive your catalog?
Call (617) 272-5051.

✓ 134

BUY! SELL! TRADE!

COMPUTER & HAM EQUIPMENT

COMPUTER*
TRADER

ANNUAL
SUBSCRIPTION
\$15.00

Low Ad Rates — Mailed Monthly
Foreign Subscriptions - \$30.00 Year
FREE 50 Word Classified Ad with Subscription Order
COMPUTER TRADER*

Chet Lambert, W4WDR
1704 Sam Drive • Birmingham, AL 35235
(205) 854-0271

* Sample Copy — \$1.00

✓ 132



parator > < Bridge measures component dissipation and is accurate to 0.25 percent of reading. A built-in comparator allows simultaneous sorting for high and low tolerances, and dissipation limits. The limits are easily set with 10-turn controls and dual-color LEDs that indicate whether the component parameters fall within the ranges set.

The Model 520 may be easily calibrated by the user without any standard components, and has an internally adjustable, 0 to 10 VDC, capacitor bias voltage. Measurement frequencies of 120 Hz or 1 kHz are automatically selected. The instrument autoranges over unusually large measurement range from 199.9 pF/μH full scale to 1999 μF/H full scale. A range-hold feature permits fast, repetitive, true 4-terminal measurements. A full refund within thirty days is available if the instrument is found unsatisfactory for any reason. The Comparator > < Bridge sells for \$785.00.

For more information, contact Cambridge Technology, Inc., 2464 Massachusetts Avenue, Cambridge, Massachusetts 02140. RS#306

new amplifier

Several new amplifiers are available from Henry Radio. The 2002A, a new version of the popular 2002 2-meter amplifier, uses the new Eimac 3CX800A7 power triode. The RF chassis



uses a 1/4-wavelength stripline design for a simple, straightforward, and reliable design. Like its predecessor, the 2002A offers 2000 watts input for SSB and 1000 watts input for CW. Because the tube provides more than 15 dB of gain, only about 25 watts drive is required for full output. The 2904A will be identical to the 2002A except that it is set up for the 430 to 450 MHz band, using a 1/2-wavelength stripline.

AT LAST A MINIATURE BASE STATION AT A MINIATURE PRICE...

The MX-15 is a 15-meter band SSB/CW hand-held transceiver. It measures only 1 1/2" (D) x 2 5/8" (H) and offers 300mW for SSB and CW operation. A single-conversion receiver employing a MOS/FET front-end offers clear and sensitive reception. As a base or portable station, the MX-15 offers an unlimited challenge in QRP operation. Additional accessories are available to extend your operation.

The MX-15 comes with full 90 day warranty and is available from factory direct or **HENRY RADIO (800) 421-6631**



\$129.95



ACCESSORIES SUPPLIED

- Standard Frequency crystal of your choice
- 6 pc. AAA Batteries
- DC Cable
- Instruction sheet

ACCESSORIES AVAILABLE

- | | |
|---|---------|
| ■ MX Channel crystal.... (Standard Frequency) | \$7.00 |
| ■ MS-1 External Speaker-Microphone | \$23.50 |
| ■ Noise Blanking Kit | \$6.50 |
| ■ NB-1 Side Tone Kit | \$11.50 |
| ■ SP-15 Telescoping antenna | \$19.50 |
| ■ 2M2 DC-DC Converter set | \$17.50 |
| ■ PR-1 Mobile Rack Kit | \$23.50 |
| ■ VX-15 External VXO (one crystal supplied) | \$53.50 |
| ■ PL-15 10W Linear amplifier | \$89.50 |



Photo shown MX-15, VX-15, PL-15, SP-15, MS-1 and PR-1

ACE communications, inc. 2832 D WALNUT AVENUE TUSTIN CALIFORNIA 92680 TEL: 544 6281 TELE X: 655-306

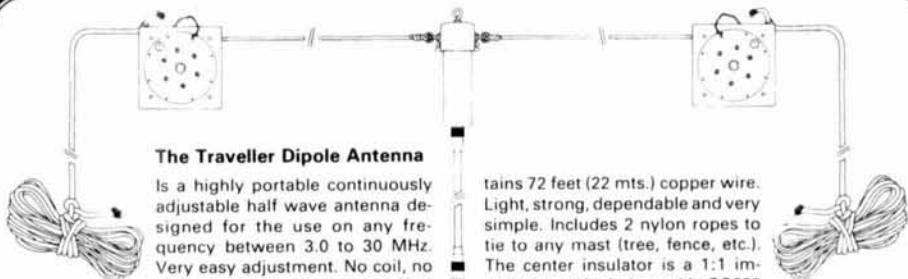

The Traveller Dipole Antenna

Is a highly portable continuously adjustable half wave antenna designed for the use on any frequency between 3.0 to 30 MHz. Very easy adjustment. No coil, no traps. It consists of a two reel (one at each end) - two housing assembly, both built of aviation grade aluminum. Each reel con-

tains 72 feet (22 mts.) copper wire. Light, strong, dependable and very simple. Includes 2 nylon ropes to tie to any mast (tree, fence, etc.). The center insulator is a 1:1 impedance ratio balun with SO239 connector. Power handling capabilities - 2KW PEP or 1KW 100% amplitude modulate.

Price: \$96.75 + shipping

International Union Corporation 7291 N.W. 12th St. - Miami, FL 33126 (305) 591-3655 / 6

PARTNER WANTED

Effective Sales Producer Needed by New Ham Radio Equipment Maker

We need you to set up and monitor a dealer network, and generally promote the product. Initial four VHF power amplifiers will be followed, in a few months, by additional products.

We'll convince you we can ship viable products. You convince us you will make us successful.

Our initial thoughts are:

- Age (high or low), sex, race, etc. not important. Ability is.
- You will be a partner. No initial investment. Your income depends on sales.
- You must be a ham.
- In this electronic world we communicate many ways. Operate out of your home, with only periodic trips to the factory, or set up an office.
- Product is first quality and priced accordingly.
- Dialogs with established companies are welcomed.

All responses acknowledged.

WRITE TO:
COMMUNICATIONS
2995 Woodside Road
Suite 400-550
Woodside, CA 94062



The 1002A, a 2-meter amplifier, follows the same design as the 2002A, but uses an 8874 tube for one-half the power specifications. The 1002A is rated at 600 watts PEP output and 300 watts continuous carrier output. It employs the same stripline design as the 2-02A. The 1004A, a half-power version of the 2004A, also uses the 8874. The 1004A will cover the 430 to 450 MHz band using 1/2-wavelength stripline design.

For further information, contact Henry Radio, 2050 South Bundy Drive, Los Angeles, California 90025. RS#307

HF transceiver

The new IC-745, a full feature HF transceiver and general coverage receiver, is now available from ICOM. Operational modes are SSB, CW, RTTY, AM (receive only) and FM (optional).

The unit offers the user the capability of a general coverage receiver, between 100 kHz and 30 MHz, and all of the HF ham bands from



1.8 to 30.0 MHz including the new WARC bands at 10 MHz, 18 MHz, and 24 MHz. Ham band selection can be activated by simply touching the band button and rotating the main tuning knob. Other innovative standard features found in the IC-745 include 16 tunable memory channels, passband tuning, continuously adjustable AGC, 100 percent duty cycle-rated transmitter, and 12 volt DC operation.

A multi-purpose scanner allows the user to search the 16-memory channel frequencies or scan between two programmed frequencies. The 16 tunable memory channels have the capacity to store not only the desired frequency, but also the desired mode of operation. The frequency called up from memory can be changed by simply adjusting the frequency dial. Installation of the optional IC-PS35 internal power supply makes the IC-745 self-contained.

For further information, contact ICOM America, Inc., at 2112 116th Ave. N.E., Bellevue, Washington 98004. RS#308

new boots

Kilo-Tec announces a new custom weather boot for use with RG-8X, RG-59, RG-58, and RG-213 coaxial cables and PL-259/SO-239 combinations. Designed to keep connections



clean and dry and to keep moisture out of coax cables, the boots are manufactured with a flexible vinyl material that resists moisture and breakdown from the sun's rays. Three models are available: model KTB-58 for RG-58 cables; model KTB-8 for RG-8 cables; and model KTB-8X for RG-8X or RG-59. Custom weather boots can be made for other types of cables and connectors.

For further details, contact Kilo-Tec, P.O. Box 1001, Oak View, California 93022. RS#309

satellite TV receiver

The new Regency satellite receiver links your television set to its outdoor satellite antenna, or "dish." The Model SR 3000 receiver/down-converter combination is capable of receiving programming from a choice of satellites which include some 90 channels covering entertainment, sports, news, religious, and educational media. Its features include automatic Chaparral Polarotor control, detent tuning with AFC, pre-



set and variable audio control, signal strength and center tuning meters, audio and video fine tuning controls, and a rugged weather sealed downconverter.

The suggested retail price on the Regency SR 3000 is \$549.95. For further information, contact Regency Electronics, 7707 Records Street, Indianapolis, Indiana 46226. RS#310

two-meter linear amplifier

The LA2060, Daiwa's new medium power two meter linear amplifier, can take the output of a typical handheld transceiver and boost it to as much as 60 watts with any FM, SSB, or CW input from 0.5 to 3 watts acceptable. Equipped with RF activated transmit/receive switching (manual override option included), the unit features automatic protection circuitry and relative output metering. An input cable with BNC plugs is provided. The LA2060 requires 12 VDC at 12 amps maximum.



For details, contact MCM Communications, 858 E. Congress Park Drive, Centerville, Ohio 45459. RS#311

DESIGN EVOLUTION IN RF P.A.'s

Now with
GaAs FET
Preamp



- Linear (all mode) RF power amp with automatic T/R switching (adjustable delay)
- Receive preamp option, featuring GaAs FETS (lowest noise figure, better IMD). Device NF typically .5 dB.
- Thermal shutdown protection incorporated
- Remote control available
- Rugged components and construction provide for superior product quality and performance
- Affordably priced offering the best performance per dollar
- Designed to ICAS ratings, meets FCC part 97 regulations
- 1 year transistors warranty
- Add \$5 for shipping and handling (Cont. U.S.). Calif. residents add applicable sales tax.
- Specifications/price subject to change

MODEL 1	FREQUENCY 2	OUTPUT POWER	INPUT POWER	SUGG. PRICE LESS TAX
	(MHz)	(W)	(W)	\$
1410	144	160	10	225
1410G				265
1412	144	160	30	199
1412G				239
2210	220	130	10	225
2210G				265
2212	220	130	30	199
2212G				239
4410	440	100	10	225
4410G				265
4412	440	100	30	199
4412G				239

1. Models with G suffix have GaAs FET preamps. Non-G suffix units have no preamp.
2. Covers full amateur band. Specify 10 MHz Bandwidth for 420-450 MHz Amplifier.

★SEND FOR FURTHER INFORMATION★

**TE
SYSTEMS**

TE SYSTEMS
P.O. Box 25845
Los Angeles, CA 90025
(213) 478-0591

digital multi-multimeter™

The new AEMC digital multi-multimeter™ functions as a highly accurate voltage, current, and resistance tester designed for safe and precise testing of both sensitive electronic circuitry and high capacity power distribution net-



works. Its wide measuring capabilities include 24 ranges covering the following spans: 100 micro-volts DC to 1000 volts DC; 10 milli-volts AC to 1000 volts AC; 1 micro-amp DC to 10 amps DC; 10 milli-amps AC to 10 amps AC; and 0.1 ohms to 2 megohms. An extra large LDC digital display (0.7 inch) allows for easy reading. Two models of the multi-multimeter™ are available: Model 2010, the average sensing conversion type, and Model 2011, which is true RMS.

Twelve interchangeable modules are now available for the unit. By using the various plug-in modules in place of the standard plug-

Continuing
MILLEN Tradition of
Quality - Durability - Performance...

SOLID STATE
and TUBE-TYPE

DIPPERS

No. 90651-A GRID DIP METER
1.7 to 300 MHz. standard
\$210.00



No. 90652
SOLID STATE DIPPER
\$210.00 No power cord
Complete with carrying case and 7 coils

**CAYWOOD
ELECTRONICS, INC.**

(617) 322-4455



**Exclusive Manufacturer of
MILLEN Equipment**

P.O. Drawer U
Malden, MA 02148-0921

**SAY YOU SAW IT
IN
HAM RADIO**

Custom Mailing Lists on Labels!
Amateur Radio Operator NAMES

- Custom lists compiled to your specifications
- Geographic by ZIP and/or State
 - By License Issue or Expiration Date
 - On Labels of Your Choice

Total List: 435,000 Price: \$25/Thousand

Buckmaster Publishing

Whitehall, Mineral VA 23117

**TUBES, SEMICONDUCTORS, IC'S
DIODES AT SUPER LOW PRICES
IN DEPTH INVENTORY
EIMAC, SYLVANIA, GE, CETRON**

OA2	\$2.75
3-400Z	115.00
3-500Z	90.00
4CX250B/7203	58.00
4CX1000A/8168	430.00
4PR60C/8252W	295.00
4X150A/7034	58.00
5AR4	4.73
5C22	165.00
5R4GB	3.85
6AK5	4.26
6AL5	2.93
6AQ5	2.85
6CA7	5.61
6DJ8	2.75
6JG6A	6.56
6JS6C	6.05
6KD6	6.90
6L6GC	5.25
6KV6A	6.02
6LF6	7.19
6LQ6	6.83
6MJ6	7.28
12AT7	2.93
12AU7	2.63
12AX7A	2.64
572B/T160L	49.50
705A	10.00
811A	13.50
813	40.00
829B	40.00
832A	38.00
833A	145.00
866A	9.50
872A	24.00
M-2057	15.00
5670	4.40
5684	33.00
5687	4.00
5751	4.00
5814A	3.70
5879	5.75
5894	65.00
6005	5.25
6146B	7.50
6360	6.50
6528A	75.00
6550A	7.50
6883B	9.00
7360	12.25
7558	7.00
7591A	4.70
7868	3.75
8072	95.00
8417	6.87
8874	195.00
8875	210.00
8877/3CX1500A7	475.00
8908	12.95
8950	11.50
MRF-453	19.95
MRF-454/A	19.95
MRF-455/A	19.95
2N6084	15.00



✓ 206

Full line of Sylvania ECG Replacement Semiconductors Always in Stock. All Major Manufacturers Factory Boxed, Hard To Get Receiving Tubes At Discount Prices.

Minimum Order \$25.00. Allow \$3.00 For UPS Charges. Out of Town, Please Call Toll Free: 800-221-5802 and Ask For "ABE".



TRANSLERONIC INC.

1365 39th STREET, BROOKLYN, N.Y. 11218H
Tel. 212-633-2800/Wats Line 800-221-5802
TWX 710-584-2460 ALPHA NYK.



in lead block, it is possible to measure capacitance, temperature, power for fiber optics, sound level, HVAC air flow, AC and DC current, frequency and light—as well as simulating RTDs, thermocouples, and process signals.

Further information is available from AEMC, 99 Chauncy Street, Boston, Massachusetts 02111. RS#312

compact amplifier

After nine years of manufacturing electronic inspection systems, Ham Industries, Inc., has expanded its product base to include several newly developed products designed for the Radio Amateur.



The first product to be released in the PA-25, a compact 25-watt amplifier for the 2-meter band that boosts the output power from a handheld transceiver by a factor of six. The device weighs only eight ounces and can be attached directly to a handheld unit or permanently mounted to the automobile dashboard. An adapter cord allows plugging directly into the car cigarette lighter; a separate power supply can also be used.

For more information, contact Ham Industries, Inc., 835 Highland Road, Macedonia, Ohio 44056. RS#313



**FCC LOWERS
REQUIREMENTS —
GET YOUR RADIO
TELEPHONE LICENSE**

FCC changes make obtaining a High-level Radio Telephone License much easier now. Eliminate unnecessary study with our short-cuts and easy to follow study material. Obtaining the General Radio Telephone License can be a snap! Sample exams, also section covering Radar Endorsement.

A small investment for a high-paying career in electronics.

\$19.95 ppd.

Satisfaction Guaranteed

SPI-RO DISTRIBUTING

P.O. Box 1538

Hendersonville, N. C. 28793

✓ 201



**PHOTOWATT
PHOTOVOLTAICS**

*Best Performance
Best Price*

SEND \$2.00 FOR CATALOG OF PHOTOVOLTAICS, WIND AND WATER EQUIPMENT, INVERTERS, D.C. POWERED LIGHTS, STEREOS AND MUCH MORE.

ALTERNATIVE ENERGY ENGINEERING

P.O. BOX 339 DEPT. HR
REDWAY, CA 95560 (707) 923-2277

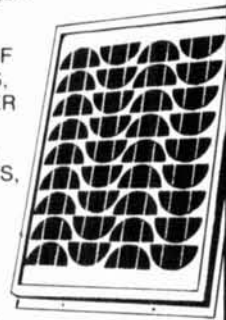

✓ 109

**Our 4th Year
BUY • SELL
TRADE
ELECTRONICS**



**NUTS & VOLTS
The Nation's #1 Electronic
Shopper Magazine**

PO BOX 1111-H • PLACENTIA, CA 92670
(714) 632-7721

Join 1000's of Readers Nationwide
Each Month ✓ 183

U.S.A. SUBSCRIPTIONS

\$ 7.00 - 1 YEAR 3RD CLASS MAIL
\$12.50 - 1 YEAR 1ST CLASS MAIL
\$25.00 - LIFETIME - 3RD CLASS MAIL



With Free Classified Ad



NEW PRODUCT ANNOUNCEMENT



HB443DX

QUAD BAND BEAMS

7-14-21-28 MHz
THE NEWEST INNOVATIVE ADDITIONS to the TET LINE FEATURE TRUE MULTI-ELEMENT PERFORMANCE ON 4, NOT 3, BUT 4 BANDS. ALL ON A SINGLE BOOM !!

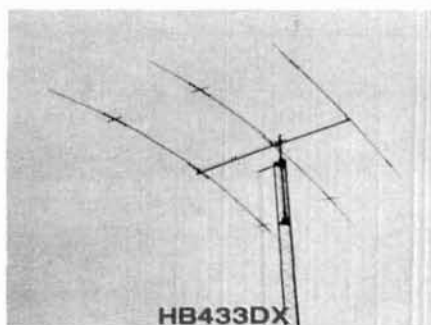

HB433DX

All the usual TET multi-band beam features are included in these two models, including wide bandwidths, increased gain, low SWR, light weight and superior mechanical construction and easy assembly.

Season's
Greetings
from the
gang at
Lunar

Preliminary Specifications:

Active Elements 7 MHz
14 MHz
21 MHz
28 MHz

Gain 7/14/21/28
FB Ratio 9/14/21/28
Power

VSWR 7.0 - 7.1
7.1 - 7.25

14.0 - 14.5 21.0 - 21.45 28.0 - 29.0

Boom Length m/ft.

Max. Element Length m/ft.

Weight kg/lb

Introductory Price

HB443DX

3
4
4
4
4
6.2/9.8/9.1/8.8
12.4/21.8/22.3/20.1
1KW CW

6.0/19.8

9.25/30.5

18.0/39.6

\$450.00

2.0:1 or better adjustable
2.0:1 or better adjustable
1.5:1 or better

HB433DX

2
3
3
3
3
2.1/8.2/8.7/7.3
0/21.7/22.3/20.2
1KW CW

4.0/13.2

9.25/30.5

14.6/32.1

\$325.00

TET ANTENNA SYSTEMS

AVAILABLE FROM YOUR AREA DISTRIBUTORS:
OR:



2775 Kurtz Street, Suite 11
San Diego, CA 92110-3171
Telephone (619) 299-9740
Telex 181747
Louis N. Anclaux WB6NMT



NEW

NEW

The
HAM SHACK

808 N. Main Street • Evansville, IN 47711



ICOM IC-745

**BRAND NEW
STATE-OF-THE-ART
TRANSCEIVER**

**9 Ham Bands
General Coverage Receiver
16 memories**

Scanning Passband Tuning Variable NB & ACG 100 kHz - 30 MHz Receiver with 16 memory positions. Full function metering with a built-in SWR bridge. Also has IF shift and passband tuning as well as several different filter options. Transmitter has 100 watts output, speech compressor, RIT and XIT.

Plenty of optional accessories including an internal power supply for the ultimate in portability.

Call today for pricing information

Ham Shack wants to be your Icom dealer

(812) 422-0231 153

171

CABLE TV CONVERTERS VIDEO ACCESSORIES

BUY DIRECT & SAVE

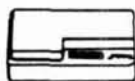

**40 CHANNEL
CONVERTER
\$38** Regular \$69

Advanced Solid State design and circuitry allows you to receive mid & super band channels. Restores programming to Video Recorders.



**36 CHANNEL
REMOTE CONTROL
CABLE CONVERTER
\$88.00**

**DIAMOND D-56 WIRELESS
THE ULTIMATE CABLE T.V.
CONVERTER**



**56 CHANNEL
INFRARED
REMOTE CONTROL
\$139.00**

135

Send \$1 for Complete Catalog
VISA • MASTERCARD • COD

DIRECT VIDEO SALES
P.O. BOX 1329
JEFFERSONVILLE, INDIANA 47130
CALL

1-800-626-5533

1983-1984

**AMATEUR
RADIO**

**CALL
DIRECTORY**

THE BARGAIN AT **\$14.95**
Plus Shipping

A no frills directory of over
435,000 U.S. Radio Amateurs.
8½ x 11, easy to read format.
Completely updated.

Also available for the
first time ever—

(Alphabetically arranged—Sold separately)
Geographical Index
by State, City and Street No. and Call
Name Index
by Name and Call

Ordering Information:

- Directory—\$14.95
- Geographical Index—\$25.00
- Name Index—\$25.00

Add \$3.00 Shipping to all orders.

Dealer / Club inquiries welcome

Send your order—enclosing check or money order in U.S. dollars to:

Buckmaster Publishing

Whitehall
Mineral, VA 23117 U.S.A.

121

Mosley.....

A BETTER ANTENNA

WHY SETTLE FOR LESS? LOOK WHAT THE MOSLEY TA-33 OFFERS

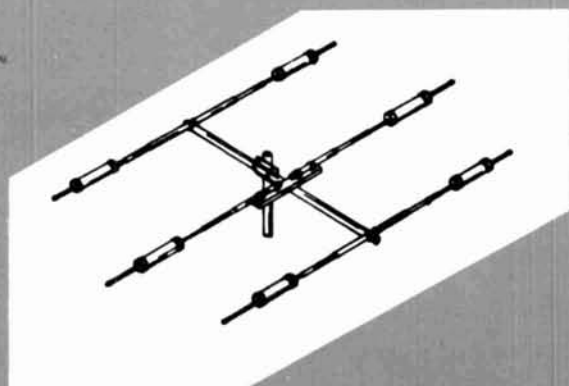

- 3 Element full power
- All stainless steel hardware
- Ease of assembly
- No balun required
- Now a 2 year limited warranty
- Now a standard 2" mast adapter
- Built to last

- Expandable to 30 or 40 meters
- Superb front to back ratio
- Excellent gain
- Outstanding SWR

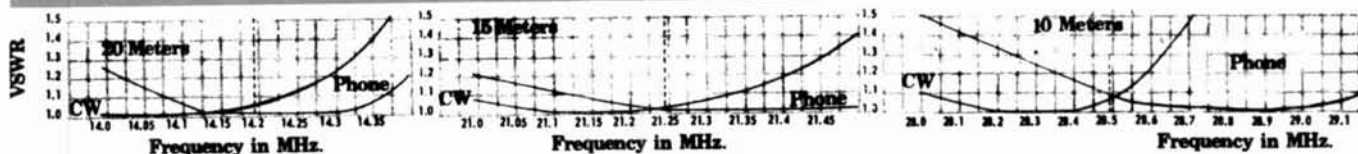
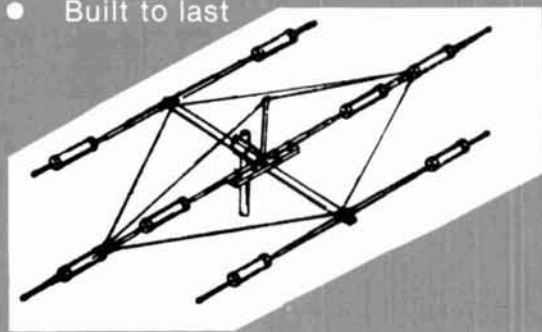

SPECIFICATIONS:

Forward gain	
Front-to-Back Ratio	
Power rating	CW 1KW
	SSB 2KW P.E.P.
Feedpoint Impedance	52 ohm
VSWR HT Resonance	1.5 to 1 or better
Matching System	Mosley
Number of Elements	3
Longest Element	28'
Boom Length	14'
Mast Size	1 1/2" or 2"
Turning Radius	15'6"
Wind surface area (in. sq. ft.)	5.7
Wind load (EIA standard 80 mph)	114 lbs.
Assembled Wt.	39 lbs.
Shipping Wt.	44 lbs.

- Used around the world
- Work CW or phone without tuning or adjusting antenna
- A great antenna for the new solid state rigs

ALL MOSLEY ANTENNAS
AND CATALOGS AVAILABLE
AT QUALITY DEALERS
OR CALL TOLL FREE

1-800-325-4016

ASK ABOUT OUR FALL SPECIAL

Prices and specifications
subject to change
without notice or
obligation.

REMEMBER WHETHER YOU USE TRAPS OR LINEAR LOADING, 8db GAIN IS 8db GAIN
YOUR RECEIVER CAN'T TELL THE DIFFERENCE... MOSLEY... TRAP MASTERS QUALITY STILL SETTING THE PACE...

Mosley Electronics

A DIVISION OF WURDACK & ASSOCIATES INC. 1344 BAUR BOULEVARD ST. LOUIS, MO. 63132 1-314-994-7872

Introducing a new dimension...

COMPUTERIZED ANTENNA CONTROL FROM PRO-SEARCH™

For Contesters,
DX'ers, Handicapped
Operators and General
Purpose Ham
Operators:

The Most Advanced
Antenna Control
Available...

- The Only
Computerized Unit
- The Only Talking
Unit
- The Only Scanning
Unit
- The Only
Programmable Unit
- The Only Automatic
Braking Unit

Contesters:

Pro-Search seeks out a
pre-programmed heading, plus
stores various common head-
ings and automatically scans
for those rare multipliers,
giving the operator hands-free
operation and more time for
contesting.

DX'ers:

Pro-Search loads in short path
and long path headings and
with the touch of a button, the
system works between both
headings. Plus you have all of
the other features of the Pro-
Search to aid you in catching
that rare DX station.

Handicapped Operators:

Pro-Search offers ease of
operation...control the entire
system with just one touch. A
talk loop...vocally calls out the
headings, allowing blind opera-
tors to accurately program and
hear their headings.

General Purpose Operators:

Pro-Search has numerous
uses.

Pre-set beam headings for
SCEDS, VHR WORK, and many
others. Current headings can
be read, by displaying the
present directions with LEDs.
Pro-Search also displays and
stores the last station worked,
which can be recalled by the
Auto-Locate system with the
touch of a button.



Current Heading
Display

Last Heading Display
and Visual Confirmation
of Computer Instructions

Programmable
Keyboard and Memory
Functions

Pro-Search Is
Adaptable To Many
Systems, Simple
To Install.

Pro-Search is NOW
available for most
popular rotors. CDE,
HY-GAIN, TELREX,
WILSON, ALLIANCE,
and PROP-PITCH.

Disconnect your
present antenna
control system and
connect ours.

Some modifications
are necessary
depending on type of
rotor.

To Order:

1-800-325-4016
1-314-994-7872 (Missouri)

Or write:

Pro-Search Electronics
A Division of Wurdack and
Associates, Inc.
10411 Clayton Road
Suite 305
St. Louis, Missouri 63131

*Patent Pending

PRO-SEARCH
Reaching The World



RC-85 REPEATER CONTROL BOARD

NEW!
for only \$849.00

SPEECH SYNTHESIS,
REMOTE PROGRAMMING,
AUTOPATCH/AUTODIAL,
LINKING, AND MORE ...
ALL ON ONE BOARD!

Now any repeater budget can afford the benefits of an ACC controller. We've pioneered modern repeater control, and continue to lead the way in performance, reliability, and value.

Call or write for detailed specifications on the RC-85 Repeater Control Board.

acc advanced computer controls, inc.

10816 Northridge Square • Cupertino, CA 95014
(408) 749-8330

Your Ham Tube Headquarters!

TUBES BOUGHT, SOLD AND TRADED
SAVE \$\$\$—HIGH \$\$\$ FOR YOUR TUBES

Call Toll Free 800-221-0860
Tubes

3-400Z	\$85.00	7360	\$10.00
3-500Z	85.00	7735A	27.50
4-400A	80.00	8122	105.00
4CX250B	50.00	8156	12.50
572B	48.50	8643	82.50
811A	12.00	8844	26.50
813	35.00	8873	175.00
6146B	6.50	8874	185.00
6360	4.25	8877	450.00
6883B	6.75	8908	12.50

Semiconductors

MRF 245/SD1416	\$30.00	MRF 644/SD1088	19.95
MRF 454	18.95	2N3055	95.00
MRF 455	12.50	2N6084	12.50

RF Connectors

PL259	10/\$4.95	M358	2.50 ea.
PL258	10/8.95	M359	1.75 ea.
UG175/176	10/1.60	Type "N" Twist on	
UG255/u	2.50 ea.	(RG8/u)	\$4.75 ea.
UG273/u	2.25 ea.	Minimum Order \$25.00	

Allow \$3.00 min. for UPS charges

CeCo

COMMUNICATIONS, Inc.

2115 Avenue X Brooklyn, NY 11235

SERVING THE INDUSTRY SINCE 1922

Phone (212) 646-6300

Call CEKO For Your CCTV Security And Color Production Requirements

CHIRP CHIRP CHIRP CHIRP CHIRP

INTRODUCTION TO AND THE OPERATION OF AMTOR

by Phil Anderson, WØXI

Here's a great new book to answer all of your questions about AMTOR, Amateur Teletype Over Radio — It's the error free mode of Amateur communication. AMTOR is a special form of RTTY, radio teletype, that uses a seven bit code and a special operating procedure. TOR, Teletype Over Radio, was first developed for ship-to-shore communications where reliability is an absolute must. AMTOR allows hams to take advantage of this unique technology and benefit from reliable, nearly 100% error free communication. Phil Anderson gives you an easy-to-read description of the basics of AMTOR, how to set up a station, equipment, operating procedures, software and theory of operation. From there it's up to you to get your very own AMTOR station up and running. This is the only book of its kind available today. ©1983, 1st edition, 36 pages.

KT-AMT Softbound \$3.95

Please add \$1.00 to cover shipping and handling

Ham Radio's Bookstore
Greenville, NH 03048

STUDY TAPES

CODE PRACTICE TAPES FROM HRPQ — Practice copying Morse Code anytime, anywhere. Whether you're upgrading your present license or just trying to up your code speed, a large assortment allows you to choose exactly the kind of practice you need.

QSO SERIES

each tape \$4.95 2/\$8.95 3/\$12.95

Here's the way to go for those planning to upgrade their present license to General or Extra Class. Both QSO tapes are reproductions of actual on-the-air CW contacts, similar in content to the FCC code exams. Both tapes are recorded at speeds faster than those encountered in the exams. Get the best practice for that all-important code test by mastering these tapes.

A 90 minute tape of 25 QSOs sent at 15 wpm.

HR-QSO-1 \$4.95

A 90 minute tape of 30 QSOs sent at 22.5 wpm.

HR-QSO-2 \$4.95

PLAIN LANGUAGE TEXT SERIES

Now, there's an opportunity to practice copying code in plain language text, any time of the day. The PLT series is excellent for those who are learning code by the word method. These tapes can also be used to improve sending speed and accuracy by using the provided text and a code practice oscillator to send in time with the tape.

HR-PLT1 — \$4.95

HR-PLT2 — \$4.95

15 wpm code for 20 minutes

30 wpm code for 20 minutes

18 wpm code for 20 minutes

35 wpm code for 15 minutes

22 wpm code for 20 minutes

40 wpm code for 15 minutes

25 wpm code for 20 minutes

45 wpm code for 15 minutes

50 wpm code for 15 minutes

Please add \$1 for shipping.

Ham Radio's Bookstore

Greenville, NH 03048

603-878-1441

ham radio cumulative index

1979-1983

antennas and transmission lines

general

Antenna gain and directivity
W2PV p. 12, Aug 79

Antenna geometry for optimum performance
N4HI p. 60, May 82

Antenna parameters, equations for determining
KG6B p. 40, Mar 82

Antenna restrictions: another solution
N4AQD p. 46, Jun 80

Antenna restrictions (letter)
K3SRO p. 6, Nov 81

Beam antenna mast lock
W4KV p. 68, Jun 81

Best way to get an antenna into a tree (HN)
WA5VLX p. 84, Mar 81

Coaxial connections, sealing (HN)
W5XW p. 64, Mar 80
letter, K7ZFG p. 6, Oct 80

De-icing the quad (HN)
W5TRS p. 75, Aug 80

Dipole antenna length reference chart (HN)
W6XM p. 75, Oct 81

Earth anchors for guyed towers
W5QJR p. 60, May 80

Ground current measuring on 160-meters
W0KUS p. 46, Jun 79

Ground systems (letter)
ZL2BJR p. 6, Nov. 80

Ground systems, installing effective
KR7L p. 67, Sep 83

Light-bulb dummy loads (HN)
W6HPH p. 74, Oct 81

Neglected antenna for 40 and 80 meters
W0WL p. 44, Jan 82
Comments, W0WL p. 8, May 82

Radials, installing, for vertical antennas
K3ZAP p. 56, Oct 80

Rain static resolved (Tech. forum)
W1FYX p. 83, Sep 83

Scaling antenna elements
W7ITB p. 58, Jul 79

Solid-state T-R switch for tube transmitters
K1MC p. 58, Jun 80

Static mystery (Tech. forum)
HB9FU p. 85, Jul 83

The Zepp (letter)
W2RHQ p. 63, Aug 82

Vertical antenna, folded umbrella, top-loaded
VE2CV p. 12, Sep 82

Vertical-vee, converting (letter)
KA5KWV p. 8, Sep 82

VSWR and power meter, automatic
W0INK p. 34, May 80

Wattmeter, low power (letter)
W0DLQ p. 6, Jan 80

high-frequency antennas

Aligning Yagi beam elements (HN)
WA2SON p. 92, May 81

Base-loaded vertical antenna for 160 meters
W6XM p. 64, Aug 80

Beverage antenna for 40 meters
KG6RT p. 40, Jul 79

Big quad — small yard
W6SUN p. 56, May 80

Bobtail curtain and inverted ground plane: part 1
W6BCX p. 82, Feb 83
Short circuit p. 92, Nov 83
Comments, WA7BPO p. 12, Jul 83
Short circuit p. 92, Nov 83

Bobtail curtain and inverted ground plane: part 2
W6BCX p. 28, Mar 83
Short circuit p. 16, May 83
Comments, WA7BPO p. 12, Jul 83

Butterfly beam
W1XU p. 30, May 81

Compact loop antenna for 80 and 40 meters
W6TC p. 24, Oct 79

Debunking myths (letter)
WB9VWA p. 8, Mar 83

De-icing the quad (HN)
W5TRS p. 75, Aug 80

Dipole antenna over sloping ground
N4HI p. 18, May 82

Dipole antenna, trimming the (HN)
W5NPD p. 69, Jul 81

Folded end-fire radiator
N7WD p. 44, Oct 80

Folded umbrella antenna
WB5IIR p. 38, May 79

Four-vertical collinear element 20-meter array
WA8Db p. 57, May 83

Grounded monopole with elevated feed
VE2CV p. 87, May 83

Ground-mounted vertical for the lower bands, improved (HN)
W5NPD p. 68, Nov 80

Ground systems for vertical antennas
WD8CBJ p. 31, Aug 79

Half-delta loop
VE2CV p. 37, May 82

Half-square antenna, the
N0AN p. 48, Dec 81
Short circuit p. 79, Oct 82

Half-wave vertical
VE2CV p. 36, Sep 81

Ham radio techniques
W6SAI p. 32, Sep 81

HF antenna (HN)
W2GQK p. 22, Jul 83

High-frequency Yagi antennas, understacking
W1XT p. 62, Jun 80

High-gain phased array, experimental
KL7IEH p. 44, May 80
Short circuit p. 67, Sep 80

Junk-box portable antenna
W3SMT p. 24, Oct 81

K7CW quad
K7CW p. 36, Sep 82

Log-periodic antennas for high-frequency Amateur bands
W4AEO, W6PYK p. 67, Jan 80

Log-periodic fixed-wire beams for 75-meter DX
W4AEO, W6PYK p. 40, Mar 80

Log-periodic fixed-wire beams for 40 meters
W4AEO, W6PYK p. 26, Apr 80

Log periodic design
W6PYK, W4AEO p. 34, Dec 79

Log-Yagis simplified
W3EB p. 78, May 83

Loop antenna, compact (letter)
W6WR p. 6, Feb 80

Making verticals quieter (Tech forum)
WA6RYZ p. 98, Jun 83

Mobile high-frequency antenna, refinements to
W3NZ p. 34, Jun 81

Mobile vertical, 20-meter
K9CZB p. 26, May 83

Multiband antenna system
VK2AOU p. 62, May 79

Open quad antenna
I2RR p. 36, Jul 80

Phased vertical antenna for 21 MHz
W6XM p. 42, Jun 80

Phased vertical arrays, pattern calculations for
WB5HGR p. 40, May 81

Quad for 7-28 MHz W3NZ	p. 12, Nov 80	3.5-MHz broadband antennas N6RY	p. 44, May 79	Efficient matching (Tech. forum) VE7BS	p. 83, Sep 83
Quad owner switches N6NB, W6AQ	p. 12, May 82	3.5-MHz sloping antenna array W2LU	p. 70, May 79	Half-wave balun: theory and application K4KJ	p. 32, Sep 80
Comments, W6BQD	p. 8, Dec 82			Ham radio techniques W6SAI	p. 42, Oct 81
Quad, three-element, for 15-20 meters using circular elements W4OVO	p. 12, May 80			Helical antenna matching (Tech. forum) Belliveau, John	p. 73, May 83
Quad, three-element switchable, for 40 meters N8ET	p. 26, Oct 80			HF hybrid descriptions W5TRS	p. 80, Oct 83
Quad variations, more (HN) W5TRS	p. 72, Oct 80			High-frequency mobile antenna matcher, simple W6BCX	p. 28, Jun 81
Short circuit	p. 70, Feb 82			Hybrid ring WA2EWT	p. 50, Aug 83
Quads vs Yagis revisited N6NB	p. 12, May 79			Impedance matching (Tech. forum) WB2NTQ	p. 85, Jul 83
Comments, WB6MMV, N6NB	p. 80, Oct 79			Comment, K0CQ	p. 95, Nov 83
Short antennas, efficiency of W1GVI/4	p. 18, Sep 82			Johnson Matchbox, improved K4IHV	p. 45, Jul 79
Short vertical antennas for low bands: part 1 W7DHD	p. 36, May 83			Short circuit	p. 92, Sep 79
Short vertical antennas for low bands: part 2 W7DHD	p. 17, Jun 83			L-matching network, appreciating the WA2EWT	p. 27, Sep 80
Shunt-fed tower (HN) N6HZ	p. 74, Nov 79			Lowpass antenna matching unit, inductance-tuned W0YBF	p. 24, May 82
Six-element wide-beam for 10 (ham radio techniques) W6SAI	p. 30, Dec 81			Low swr, how important? W1GVI/4	p. 33, Aug 81
Small beams, high performance G6XN	p. 12, Mar 79			Comments K1KSY, W1GVI/4	p. 6, Dec 81
Stagger-tuned dipoles increase bandwidth K4MT	p. 22, May 83			Macromatcher: increasing versatility K9DCJ	p. 68, Jun 80
Suspended long Yagi (ham radio techniques) W6SAI	p. 34, Nov 81			Matching complex antenna loads to coaxial transmission lines WB7AUL	p. 52, May 79
The K2GNC Giza beam K2GNC	p. 52, May 81			Matching sections KL7HT	p. 68, Mar 82
Trapped antenna, trapping the mysteries of N3GO	p. 10, Oct 81			Matching 432-MHz helical antenna (Tech. forum) W8NWU	p. 44, Mar 83
Comments, K9CZB	p. 8, Feb 82			Optimum pi-network design DL9LX	p. 50, Sep 80
Traps and trap antennas W8FX	p. 34, Aug 79			Swr meter, how accurate? (HN) WB9TQG	p. 78, Jan 81
Triband Yagi beam (ham radio techniques) W6SAI	p. 68, Jan 81			Swr meter for the high-frequency bands WB6AFT	p. 62, Oct 81
Two delta loops fed in phase W8HXR	p. 60, Aug 81			Swr, what is your? N4OE	p. 68, Nov 79
Vertical antenna for 40 and 75 meters W6PYK	p. 44, Sep 79			Tandem pi networks W6MUR	p. 32, Jul 82
Vertical phased arrays: part 1 K2BT	p. 18, May 83			Testing baluns K4KJ	p. 30, Aug 83
Vertical phased arrays: part 2 K2BT	p. 25, Jun 83			Transformers, coaxial-line W6TC	p. 18, Mar 80
Vertical phased arrays: part 3 K2BT	p. 26, Jul 83				
Short circuit	p. 70, Oct 83				
Vertical phased arrays: part 4 K2BT	p. 34, Oct 83				
Short circuit	p. 11, Dec 83				
Vertical phased arrays: part 5 K2BT	p. 59, Dec 83				
WBJK antenna, a new look at OD5CG	p. 60, Jul 81				
Wilson Mark II and IV, modifications to (HN) W9EPT	p. 89, Jan 80				
Yagi antenna design: performance calculations: part 1 W2PV	p. 23, Jan 80				
Short circuit	p. 66, Sep 80				
Yagi antenna design: experiments confirm computer analysis: part 2 W2PV	p. 19, Feb 80				
Yagi antenna design: performance of multi-element simplistic beams: part 3 W2PV	p. 18, May 80				
Yagi antenna design: multi-element simplistic beams: part 4 W2PV	p. 33, Jun 80				
Yagi antenna design: optimizing performance: part 5 W2PV	p. 18, Jul 80				
Yagi antenna design: quads and quagis: part 6 W2PV	p. 37, Sep 80				
Yagi antenna design: ground or earth effects: part 7 W2PV	p. 29, Oct 80				
Yagi antenna design: stacking: part 8 W2PV	p. 22, Nov 80				
Yagi antennas: practical designs: part 9 W2PV	p. 30, Dec 80				
Yagi beam elements, aligning (HN) WA2SON	p. 79, Jan 81				
ZL special antenna, 10-meter, for indoor use K5AN	p. 50, May 80				
		vhf antennas			
		Antenna-performance measurements using celestial sources W5CQ/W4RXY	p. 75, May 79		
		Dual quad array for two meters W7SLO	p. 30, May 80		
		Efficient matching (Tech. forum) VE7BS	p. 83, Sep 83		
		Folded whip antenna for vhf mobile (weekender) WB2IFV	p. 50, Apr 79		
		Ham radio techniques W6SAI	p. 32, Sep 81		
		Handi-antennas AA6PZ	p. 42, May 83		
		Helical antenna matching (Tech. forum) Belliveau, John	p. 73, May 83		
		Inexpensive five-eighth wave groundplane (HN) W7CD	p. 84, Mar 81		
		Matching 432-MHz helical antenna (Tech. forum) W8NWU	p. 44, Mar 83		
		Microwave-antenna designers, challenge for W6FOO	p. 44, Aug 80		
		Microwave antenna, homebrew WB0VGI, Johnson	p. 68, Sep 82		
		Re-entrant cavity antenna for the VHF bands W4FXE	p. 12, May 81		
		Repeater antenna beam tilting K7NM	p. 29, May 83		
		Short circuit	p. 80, Jul 83		
		True north, how to determine for antenna orientation K4DE	p. 38, Oct 80		
		Comments, N6XQ, K4DE	p. 7, Mar 81		
		Using a 2-meter quarter-wave whip on 450 MHz (HN) K1ZJH	p. 92, May 81		
		VHF antenna null, achieving the perfect K3ED	p. 48, May 83		
		Yagi uhf antenna simplified (HN) WA3CPH	p. 74, Nov 79		
		144-MHz mobile antenna WD8QIB	p. 68, May 79		
				towers and rotators	
				Antenna carriage and track pole mount KB3K	p. 46, Aug 83
				Antenna hinge N4LI	p. 70, Aug 83
				Antenna position display AE4A	p. 18, Feb 79
				Armstrong beam rotator KP4DM	p. 68, Feb 82
				CDE tailtwister rotor, pulse-position control of WB4EXW	p. 30, Jan 81
				Ham-M rotator control box, modification of (HN) K4DLA/W1RDR	p. 68, Nov 80
				KLM antenna rotor, computer control for (HN) W8MQW	p. 66, Feb 81
				Rotator starting capacitors (letter) W6WX	p. 92, Sep 79
				Short circuit	p. 70, Mar 80
		matching and tuning			
		A coreless balun WA2SON	p. 62, May 81		
		Active antenna coupler for VLF Burhans, Ralph W.	p. 46, Oct 79		
		Antenna bridge calculations K6GK	p. 85, Mar 81		
		Short circuit	p. 84, Nov 81		
		Antenna match, quick and simple Anderson, Leonard H.	p. 58, Jan 81		
		Short circuit	p. 70, Feb 82		
		Antenna tuner (HN) W6XM	p. 94, May 83		
		Antenna tuners (ham radio techniques) W6SAI	p. 30, Jul 81		
		Balun design, another W6HPH	p. 54, May 82		
		Broadband balun, high performance K4KJ	p. 28, Feb 80		
		Broadband reflectometer and power meter VK2ZTB, VK2ZZQ	p. 28, May 79		
		Capacitively coupled hybrids WA2EWT	p. 70, Mar 83		
		Coaxial-line transformers, a new class of W6TC	p. 12, Feb 80		
		Short circuit	p. 70, Mar 80		
		Short circuit	p. 67, Sep 80		
				transmission lines	
				Antiflex coaxial cable connection (HN) W4KV	p. 42, May 82
				Cheapie coax (letter) WB4AHZ	p. 8, May 82

Coax cable, repairing water damage (HN)
 W5XW p. 73, Dec 79

Coax cable, salvaging water-damaged (HN)
 W5XW p. 88, Jan 80

Coaxial cable connectors, homebrew hardline-to-uhf
 K2YOF p. 32, Apr 80

Coaxial connectors, sealing, (HN)
 W5XW p. 64, Mar 80
 Letter K7ZFG p. 6, Oct 80

Coaxial-line transformers, a new class of
 W6TC p. 12, Feb 80
 Short circuit p. 70, Mar 80
 Short circuit p. 67, Sep 80

Coax, measuring with an RCL bridge (HN)
 WB9TQG p. 78, Oct 82

Connectors for CATV coax cable
 W11IM p. 52, Oct 79

Hardline connectors, inexpensive
 WB4GCS p. 62, May 83
 Comments, KM1H p. 8, Nov 83

Hardline, matching 75 to 50-ohm
 W4VRV p. 43, Oct 82

Hybrid coupler
 W10OP p. 36, Jun 82

Measuring coax cable loss with an swr meter
 WB9TQG p. 35, May 81
 Comments, WD4KMP, WB9TQG p. 6, Sep 81
 Comments, W4PPB p. 8, Feb 82

Pi, pi-L, and tandem quarter-wave line matching
 networks, response of
 W6MUR p. 12, Feb 82

Plumber's delight coax connector (weekender)
 N4LI p. 50, May 81

PL-259 connectors, attaching to RG-58/U cable (HN)
 W5BVF p. 81, Jan 82

Rf power divider (HN)
 W5TRS p. 80, Feb 82

T coupler, the (HN)
 K3NXU p. 68, Nov 80

Time domain reflectometer
 VE3EFC p. 49, Nov 83

Time-domain reflectometry, checking transmission
 lines with
 K7CG p. 32, Jul 80

Transformers, coaxial-line
 W6TC p. 18, Mar 80

Transmission-line circuit design for 50 MHz and
 above
 W6GGV p. 38, Nov 80

Transmission-line design, Pt. 2: distributed resonant
 circuits in uhf/vhf lines
 W6GGV p. 62, Jan 81

Transmission-line design, Pt. 3: distributed resonant
 circuits in vhf/uhf lines
 W6GGV p. 56, Feb 81

Transmission-line design, Pt. 4: distributed resonant
 circuits in vhf/uhf lines
 W6GGV p. 64, Mar 81

Transmission-line design, Pt. 5: 50 MHz and above
 W6GGV p. 72, Apr 81

Transmission lines, long, for optimum antenna
 location
 N4UH p. 12, Oct 80

Handheld transceiver, audio amplifier for
 N1RM p. 38, Jul 81

Headphones, dual-impedance (HN)
 AB9Q p. 80, Jan 79

Heath HW-2036 mods (letter)
 Mosher, E.A. p. 8, Jun 81

Microphones and simple speech processing
 W1OLP p. 30, Mar 80
 Letter, W5VWR p. 6, Sep 80

Phone patch using junk-box parts
 K7NM p. 40, Oct 80

Simulated carbon microphones, using with Amateur
 transmitters
 W9MKV p. 18, Oct 81

Speech processor, split-band (letter)
 WA2SSO p. 6, Dec 79

Speech processors (letter)
 K3ND p. 6, Aug 80

Speech processing, split-band (letter)
 Schreuer, N7WS p. 74, Feb 80

TR-2400, external microphone for (HN)
 WB2IFV p. 64, Mar 82

Variable-frequency audio filter
 W4VRV p. 62, Apr 79

Voice-band equalizer
 WB2GCR p. 50, Oct 80

Drake TR-7 transceiver, Woodpecker noise blanker
 for (HN)
 K1KSY p. 67, Feb 81

Drake TR-22C sensitivity improvement (HN)
 K7OR p. 78, Oct 79

Drake T-4X transmitters, improved tuning
 on 160 meters (HN)
 W1IBI, W1HZH p. 81, Jan 79

Factory service (letter)
 W6HK p. 6, Jul 80

FT-101E, 10-meter preamp for
 K1NYY p. 26, Jul 81

Hallcrafters HT-37, improving
 W6NIF p. 78, Feb 79

Ham-M rotator control box, modifications of (HN)
 K4DLA/W1RDR p. 68, Nov 80

Ham-M rotator torque loss (HN)
 W1JR p. 85, Jun 79

Short circuit
 Ham-3 rotator, digital readout for
 K1DG p. 56, Jan 79

Heath Model 10-4530 oscilloscope, modifications
 Bailey p. 20, Aug 82

Heath HW-8, improved keying for (HN)
 W3HVK p. 60, Aug 82

Heath HW-101 sidetone control (HN)
 AD9M p. 79, Jul 79

Heath HW-2036 antenna socket (HN)
 W3HCE p. 80, Jan 79

Heath HW-2036, carrier-operated relay for
 WD5HYQ p. 58, Feb 80

Heath HX1681 (Tech. forum)
 W2UWO p. 83, Sep 83

Heath HW-2036, updating to the HW-2036A
 WB6TMH, WA6ODR p. 62, Mar 79

Heath SB-400/SB-401, simple speech amplifier for
 (HN)
 W8LMH p. 72, Jun 81

Heathkit Micoder adapted to low-impedance
 input (HN)
 WB2GXF p. 78, Aug 79

Heathkit HW-8, increased break-in delay (HN)
 K6YB p. 84, Jun 79

Heathkit HW-2036, updating the
 WA4BZP p. 50, Nov 80

Heathkit SB-104A, improved receiver performance for
 N2EO p. 78, Apr 81

Heath's new all-band transceiver, the SS-9000
 W9JUV p. 12, Nov 82

ICOM IC-2A(T), odd splits
 N7AAD p. 65, Jul 82

ICOM IC-22S, using below 146 MHz (HN)
 W1IBI p. 92, Apr 79

ICOM 701 owners' report
 WB1CHQ p. 56, Oct 81

IC2AT, carrying case for (HN)
 W6XM p. 62, Aug 83

Johnson Matchbox, improved
 K4IHV p. 45, Jul 79

Short circuit
 Kenwood TR-7400A, scanner for (the Kencana 74)
 WB7QYB p. 50, Jan 81

Kenwood TS-520-SE transceiver, counter mixer for
 W5NPD p. 60, Sep 80

KLM antenna rotor, computer control for (HN)
 W8MQW p. 66, Feb 81

Ni-cad battery charging (letter)
 W6NRM p. 6, Jul 80

Owners' survey, TR7
 WB1CHQ p. 66, Nov 81

Owners survey: 2-meter handhelds
 KA1ZM p. 35, Jul 82

R-1000 mod (HN)
 W6XM p. 60, Aug 82

S-line, QSK noise (HN)
 N1FB p. 66, Mar 82

SB-220 transceiver, inrush current protection for
 (weekender)
 W3BYM p. 66, Dec 80

SB-303 receiver, noise reduction (HN)
 Suzuki p. 70, Jun 82

Sony ICF-2001, eight-channel memory scanner for
 W3CSW p. 54, Aug 82

Swan 350, curing frequency drift
 WA6IPH p. 42, Aug 79

Ten-Tec Horizon/2 audio modification (HN)
 WB9RKN p. 79, Oct 79

Ten-Tec Omni-D, improved CW agc for (HN)
 W6OA p. 88, Jan 80

Triton IV, 30-meter operation (HN)
 AA4LL p. 68, Jun 83

commercial equipment

Amateur Radio equipment survey number two
 W1SL p. 52, Jan 80

Atlas 210 transceiver, sidetone (HN)
 ZL2RP p. 67, Mar 82
 Short circuit p. 79, Oct 82

Atlas 350 AGC circuit, modifications (HN)
 K0RL p. 42, May 82

Autek filter (HN)
 K6EVQ, WA6WZQ p. 83, May 79

CDE tailwister rotor, pulse-position control of
 WB4EXW p. 30, Jan 81

Collins KWM-2, updating
 W6SAI p. 48, Sep 79

Collins KWM-2 KWM-2A, owners' reports
 WB1CHQ p. 22, Mar 81

Collins S-line backup power supply (HN)
 N1FB p. 78, Oct 79

Collins S-line monitoring (HN)
 N1FB p. 78, Aug 79

Collins S-line, owners' report
 WB1CHQ p. 12, Apr 81

Collins 32S cooling (HN)
 N1FB p. 74, Nov 79

Collins 32S, improved stability for (HN)
 N1FB p. 83, May 79

Collins 32S PA disable jacks
 N1FB p. 65, Mar 80

Collins 75S CW sidetone (HN)
 N1FB p. 93, Apr 79

Collins 516F-2 high-voltage regulation (HN)
 N1FB p. 85, Jun 79

Collins 516F-2 solid-state rectifiers (HN)
 N1FB p. 91, Feb 79

Collins 75S-3 alignment (HN)
 N1FB p. 79, Jan 81

Collins 516F-2 low-voltage and bias modification
 (HN)
 N1FB p. 68, Jul 81

Collins 516F-2 power supply, transient protection for
 W6AD p. 31, Apr 81

DenTron 160XV transverter, stabilizing the
 (weekender)
 WB2QLL p. 46, Jun 81

Drake R4C backlash, cure for (HN)
 W3CVS p. 82, May 79

Drake R-4C receiver audio improvements (HN)
 W3CVS p. 79, Jan 81

Drake R-4B and TR-4,
 split-frequency operation
 WB8JCQ p. 66, Apr 79

Drake R-4C, new audio amplifier for
 WB0JGP, K8RRH p. 48, Apr 79

Drake R-4C product detector, improving (HN)
 W3CVS p. 64, Mar 80

audio

Add-on selectivity for communications receivers
 G4GMQ p. 41, Nov 81

Audio filter building blocks
 KB0CY p. 74, Jul 83

Audio processor, communications for reception
 W6NRW p. 71, Jan 80

Audio response, tailoring (HN)
 N1FB p. 42, May 82

Better audio for mobile operation
 K6GCO p. 48, Feb 81

CW acoustical filter (Tech. forum)
 W7BI p. 22, Jan 83

CW and RTTY, digital audio filter for
 W1OER p. 60, Aug 83

Duplex audio-frequency generator
 with AFSK features
 WB6AFT p. 66, Sep 79

TS-820/TS-820S, reducing interference in (HN)
 W4MB p. 88, Jan 80
 TS-820 filter switching modification (HN)
 K7OAK p. 72, Jun 80
 Wilson Mark II and IV, modifications to (HN)
 W9EPT p. 89, Jan 80
 Yaesu FT-227R memorizer, improved memory (HN)
 WA2DHF p. 79, Aug 79
 3-500Z tube failure (HN)
 AG6K p. 78, Oct 82
 5CX1500A power pentode (HN)
 K9XI p. 77, Oct 82

construction techniques

Anodize dyes (letter)
 W4MB p. 6, Sep 79
 Anodizing aluminum
 VE7DKR p. 62, Jan 79
 Comments, WA9UXK p. 6, Nov 79
 Antenna carriage and track pole mount
 KB3K p. 46, Aug 83
 Antenna hinge
 N4LI p. 70, Aug 83
 AN/UPX-6 cavities, converting surplus
 W6NBI p. 12, Mar 81
 Audio filter building blocks
 KB0CY p. 74, Jul 83
 Short circuit p. 92, Nov 83
 Cabinet construction techniques
 W7KDM p. 76, Mar 79
 Cheap dots (HN)
 W6XM p. 77, Sep 82
 Ciplead carousel (HN)
 WB1AQM p. 79, Oct 79
 Coaxial cable connectors, homebrew hardline-to-uhf
 K2YOF p. 32, Apr 80
 Coax cable, salvaging water-damaged (HN)
 W5XW p. 88, Jan 80
 Custom resistors, nomogram design
 WA5EKA p. 68, Jun 83
 Crystal switching, remote (HN)
 WA8YBT p. 91, Feb 79
 Dust buildup, decreasing (HN)
 K4KI p. 77, Sep 82
 Fan, speed control (HN)
 K4KI p. 77, Sep 82
 Heatsink cooling fan (HN)
 W6XM p. 22, Jul 83
 Comments, W2GH p. 8, Oct 83
 IC2AT, carrying case for (HN)
 W6XM p. 62, Aug 83
 Lightning protection (letter)
 K9MM p. 12, Dec 79
 Metal cleaning with dip-type cleaners (HN)
 W5XW p. 82, Jan 82
 Comment, K6YPD p. 8, Jun 82
 Metalized capacitors (HN)
 W8YFB p. 82, May 79
 Phone plug wiring (HN)
 N1FB p. 85, Jun 79
 Printed circuit layout and drilling template
 WA4WDL p. 73, Jul 82
 Set screws, taming (HN)
 W5PGG p. 64, Mar 82
 Ten-Tec Omni-D, improved CW agc (HN)
 W6OA p. 72, Dec 79
 Turns per inch from wire size (HN)
 K8UR p. 97, Dec 83
 Wilson Mark II and IV modifications (HN)
 W9EPT p. 73, Dec 79

digital techniques

Basic rules and gates
 Anderson, Leonard H. p. 76, Jan 79

Counters and weights
 Anderson, Leonard H. p. 66, Aug 79
 Digiscope
 WB0CLH p. 50, Jun 79
 Digital-circuit problems, avoiding built-in, part one
 W1BG p. 43, Sep 81
 Comments VE2QO p. 6, Dec 81
 Digital-circuit problems, avoiding built-in, part two
 W1BG p. 50, Oct 81
 Comments VE2QO p. 6, Dec 81
 Digital techniques: gate arrays for control
 Anderson, Leonard H. p. 82, Jan 80
 Digital techniques: inside a phase-frequency detector
 Anderson, Leonard H. p. 28, Sep 82
 Digital techniques: shocking truths about semiconductors
 Anderson, Leonard H. p. 36, Oct 82
 Down counters
 Anderson, Leonard H. p. 72, Sep 79
 Flip-flop internal structure
 Anderson, Leonard H. p. 86, Apr 79
 Gate arrays for pattern generation
 Anderson, Leonard H. p. 72, Oct 79
 Gate structure and logic families
 Anderson, Leonard H. p. 66, Feb 79
 Making waves
 W6HDM p. 44, Mar 82
 Multivibrators and analog input interfacing
 Anderson, Leonard H. p. 78, Jun 79
 Packet radio, introduction to
 VE2BEN p. 64, Jun 79
 Packet radio: part 1
 KV7D, KV7B p. 14, Jul 83
 Packet radio: part 2
 KV7D, KV7B, WA7GXD p. 18, Aug 83
 Propagation delay and flip-flops
 Anderson, Leonard H. p. 82, Mar 79
 Self-gating the 82S90/74S196 decade counter (HN)
 W9LL p. 82, May 79
 Synthesizers, VHF and UHF, design of digital components
 G4CLF p. 26, Jul 82
 Talking digital clock
 K9KV p. 30, Oct 79

features and fiction

DXer's Diary
 W9KNI p. 18, Mar 81
 DXer's Diary
 W9KNI p. 26, Apr 81
 Comments p. 6, Sep 81
 DXer's Diary
 W9KNI p. 22, Jun 81
 DXer's Diary
 W9KNI p. 60, Aug 81
 DXer's Diary
 W9KNI p. 70, Dec 81
 James R. Fisk memorial
 W1XU p. 2, Jun 80
 James R. Fisk, W1HR — some reflections
 W6NIF p. 6, Jun 80
 Jim Fisk, tribute to, publisher's log
 W1NLB p. 8, Jun 80
 From Amateur to professional
 K12U p. 54, Aug 81
 Hallicrafters history
 W6SAI p. 20, Nov 79
 Hallicrafters story (letter)
 K0ADM p. 6, May 80
 Hallicrafters story (letter)
 W1TVN p. 6, May 80
 Hallicrafters story (letter)
 WA2JVD p. 6, Sep 80
 Ham radio techniques: triband Yagi beam for 20, 15, and 10 meters
 W6SAI p. 68, Jan 81
 Short circuit p. 84, Nov 81
 Ham radio techniques: earth-moon-earth
 W6SAI p. 40, Feb 81
 Ham radio techniques: more about moonbounce
 W6SAI p. 34, Mar 81

Ham radio techniques: ten-meter band
 W6SAI p. 38, Apr 81
 Ham radio techniques: 160-meter band
 W6SAI p. 46, May 81
 Ham radio techniques: amateur radio, 1933
 W6SAI p. 41, Jun 81
 Ham radio techniques: antenna tuners
 W6SAI p. 30, Jul 81
 Ham radio techniques: amateur radio 1941
 W6SAI p. 30, Aug 81
 Ham radio techniques
 W6SAI p. 32, Sep 81
 Ham radio techniques
 W6SAI p. 42, Oct 81
 Ham radio techniques: radio-frequency interference
 W6SAI p. 34, Nov 81
 Ham radio techniques: radio-frequency interference
 W6SAI p. 30, Dec 81
 Ham radio techniques
 W6SAI p. 66, Jan 83
 Ham radio techniques
 W6SAI p. 77, Feb 83
 Ham radio techniques
 W6SAI p. 47, Mar 83
 Ham radio techniques
 W6SAI p. 52, Apr 83
 Comments, W6DKZ p. 8, Dec 83
 Ham radio techniques
 W6SAI p. 52, May 83
 Ham radio techniques
 W6SAI p. 46, Jun 83
 Ham radio techniques
 W6SAI p. 42, Jul 83
 Ham radio techniques
 W6SAI p. 40, Aug 83
 Ham radio techniques
 W6SAI p. 41, Sep 83
 Ham radio techniques
 W6SAI p. 64, Oct 83
 Hellschreiber, a rediscovery
 PA0CX p. 28, Dec 79
 Interview with Dr. Kenneth Davies
 K2RR p. 28, Jan 83
 Jammer problem, solutions for
 UX3PU p. 56, Apr 79
 Comments p. 6, Sep 79
 Jim, a tug at your memory
 W4VT p. 28, May 81
 Observation and opinion
 W9KNI p. 6, Jul 81
 Q signals (letter)
 W4MB p. 8, Feb 83
 Reinartz, John L., father of shortwave radio
 WA6CBQ p. 10, Aug 81
 Shopping for parts by mail
 W8FX p. 16, Jul 81
 Comments K1THP p. 6, Dec 81
 Tune in on the world
 WA4PYQ p. 12, Jun 81

fm and repeaters

Add fm to your receiver (weekender)
 K3NXU p. 74, Mar 81
 Amateur fm, close look at
 W2YE p. 46, Aug 79
 Antenna design for omnidirectional repeater coverage
 N9SN p. 20, Sep 79
 Autopatch, simplex
 WB6GTM p. 42, Jan 83
 Deviation, measuring
 N6UE p. 20, Jan 79
 External frequency programmer (HN)
 WB9VWM p. 92, Apr 79
 Folded whip antenna for vhf mobile (weekender)
 WB2IFV p. 50, Apr 79
 Forget memory, Ni-Cd discussion
 K0OV p. 62, Jan 83
 IC-255A switching circuit (HN)
 WB6IQV p. 70, Jan 83
 Comments, WA4MZZ p. 8, Jun 83

THE PERFECT FAMILY CHRISTMAS GIFT

Satellite TV Earth Station

\$1362.00

Your Choice

Drimatics DRS 200 or Drake ESR 224
with 9 ft. Ranger or 9 ft. Wilson Antenna
All Cables, Polarizer, 110° LNA included



DRAKE ESR 224



DRIMATICS DRS 200
Infra-red remote control
stereo.

Options:

- 11' Ranger Radar Mesh Dish
... **\$195.00**
- NSS PBZ Motordrive
... **\$350.00**
- 100° LNA
... **\$95.00**



9 FT. WILSON

12 panel 16 gauge
steel dish with polarmount.
Motor freight F.O.B. Nampa

9 FT. RANGER

24 panel aluminum dish
with polarmount

**36 Month Financing Available \$136.00 Down and
\$48.90 mo.**

DEALER INQUIRIES INVITED

NAMPA SATELLITE SYSTEMS

**312 12th Ave. So. • Nampa, Id. 83651 • (208) 466-6727
Idaho Wats 1-800-654-1319 • Nat. Wats 1-800-654-0795**

Linear translators	
WB6JNN	p. 14, Sep 83
Microprocessor repeater controller	
KB5F	p. 56, Apr 83
Ni-cad charger, any-state	
WA6TBC	p. 66, Dec 79
Repeater antenna beam tilting	
K7NM	p. 29, May 83
Short circuit	p. 80, Jul 83
Repeater etiquette (letter)	
W1OLP	p. 8, Oct 83
Speech processor for fm transmitters	
G4CLF, G3RZP	p. 76, Mar 82
Squelch, smart	
W6NRW	p. 37, Jun 83
State-of-the-art auto dialer	
K2MWU	p. 21, Dec 83
Synthesizer, 144 MHz, 800-channel	
K4VB, WA4GJT	p. 10, Jan 79
Synthesizer, 144-MHz CMOS	
K9LHA	p. 14, Dec 79
Tone decoder, ultimate	
WD9EIA	p. 33, Sep 82
Comments, WD9EIA	p. 8, Feb 83
Tone generator, IC (HN)	
W6IPB	p. 88, Mar 79
Touch-tone autodialer, portable	
K2MWU	p. 12, Aug 82
Comments, K2MWU	p. 8, Feb 83
Touch-tone decoder	
K9C	p. 27, Apr 83
Touch-tone decoder, third generation	
WA7DPX	p. 36, Feb 80
Short circuit	p. 67, Sep 80

hazards

Lightning and electrical transient protection	
KR7L	p. 73, Dec 83
When hazardous waste comes home:	
PCBs in the ham shack	
Leeds, Dorothy	p. 42, Dec 83

integrated circuits

Binary coded decimal addition (HN)	
WA9HUV	p. 66, Apr 82
Comment, Schiffler, Jeffrey L.	p. 8, Dec 82
Exar XR-205 waveform generator as capacitance meter (HN)	
W6WR	p. 79, Jul 79
FSK tone generator using an IC tone dialer (HN)	
Nagei, David	p. 88, Apr 83
TouchTone decoder, an improved	
N6JH	p. 24, Dec 82
TTL ICs, simple tests for	
W6ALF	p. 37, Mar 82
555 timer operational characteristics	
WB6FOC	p. 32, Mar 79
2716 EPROM programmer	
N3CA	p. 32, Apr 82

keying and control

Accu-keyer speed readout	
K5MAT	p. 60, Sep 79
Biquad bandpass filter for CW	
NØDE	p. 70, Jun 79
Short circuit	p. 92, Sep 79
Comments	p. 6, Nov 79
Cathode key with the Heath HD-1410 (HN)	
K9XM, N9MX	p. 80, Jan 82

CMOS keyer, simple	
HB9ABO	p. 70, Jan 79
Code speed counter	
K8TT	p. 86, Feb 79
CW break-in, quieting amplifiers for	
W1DB	p. 46, Jan 79
CW identifier, versatile	
WB2BWJ	p. 22, Oct 80
Short circuit	p. 70, Feb 82
CW keyboard using the APPLE II computer	
W6WR	p. 60, Oct 80
CW memory modification (HN)	
WØDLQ	p. 93, May 81
CW operator's PAL	
W2YE	p. 23, Apr 79
Dasher	
KH6JF	p. 68, Mar 79
Deluxe memory keyer with 3072-bit capacity	
W3VT	p. 32, Apr 79
Short circuit	p. 92, Sep 79
Short circuit	p. 89, Jan 82
End-of-transmission K generator	
G8KGV	p. 58, Oct 79
Keyer, single-chip, for QRP (weekender)	
W3HVK	p. 70, Oct 82
Keyer with memory (letter)	
Hansen, William	p. 6, Dec 79
Key toggle	
W6NRW	p. 50, Mar 79
Latching relay control (HN)	
K6HTM	p. 94, May 83
Low-power keyer and interface	
K1HOP	p. 68, Feb 83
Short circuit	p. 97, Aug 83
Memory keyer, W7BBX (letter)	
SP2DX	p. 6, Jan 80
Memory keyer, (letter)	
W3VT	p. 6, Feb 80
Memory keyer, 2048-bit (HN)	
GW4CQT	p. 73, Jun 80
Microcomputer-based contest keyer	
K9CW	p. 36, Jan 81
Microprocessor repeater controller	
KB5F	p. 56, Apr 83
Morse time synthesis	
N3SE	p. 17, Apr 83
Programmable keyer, Autek MK-1, expanded memory for	
N9AKT	p. 58, Jan 80
Radio Shack ASCII keyboard encoder for microprocessor-controlled CW keyboard, using (HN)	
VE7ZV	p. 72, Oct 80
Remote control hf operation	
K5QY	p. 32, Apr 83
Short circuit	p. 97, Aug 83
Sending CW	
KA4QVK	p. 75, Jun 83
Solid-state CW T-R system	
W4RNL	p. 62, Mar 83
Ten-Tec 645 ultramatic keyer mods (HN)	
K4JST	p. 70, Dec 82
Testing baluns	
K4KJ	p. 30, Aug 83
Transceiver diplexer: an alternative to relays	
N6RY	p. 71, Dec 80
WPM readout for deluxe memory keyer (weekender)	
WA1OEH	p. 50, Apr 82

measurements and test equipment

Battery charger sensor	
W3BYM	p. 54, Dec 82
BC221, unusual (Tech. forum)	
VK2ZH	p. 22, Jan 83
Broadband reflectometer and power meter	
VK2ZTB, WB2ZZQ	p. 28, May 79
Capacitance measurements with a frequency counter (weekender)	
Moran, John	p. 62, Oct 79
Capacitance meter, (simplified), improvements to	
WA3CPH	p. 54, Mar 80

Capacitive-reactance meter multiplier (HN)	
K4KI	p. 89, Apr 83
Counter control pulses (HN)	
W9LL	p. 70, Apr 80
Deviation, measuring	
N6UE	p. 20, Jan 79
Digital capacitance meter	
K4GOK	p. 66, Aug 80
Diode noise source for receiver noise measurements	
W6NBI	p. 32, Jun 79
Diode tester (HN)	
W2OLU	p. 90, Apr 83
Dip meters, a new look at	
W6GXN	p. 25, Aug 81
Dip-meter converter for VLF	
W4YOT	p. 26, Aug 79
Electrical calibration standards	
Martin, Vaughn	p. 10, Oct 83
Electrolytic capacitors, measuring capacitance of	
KP4DIF	p. 24, Sep 80
Field-strength meter for the high-frequency Amateur bands	
WB6AFT	p. 42, Jul 81
Frequency counter, capacitance-measurement accuracy for	
W1ZUC	p. 44, Apr 80
Short circuit	p. 67, Sep 80
Frequency counter, miniature	
K5WKQ	p. 34, Oct 79
Frequency counter, K4JIU, modifications for (HN)	
K4JIU	p. 65, Mar 80
Frequency counters, uhf and microwave	
W6NBI	p. 34, Sep 79
Function generator, integrated circuit	
N3FG	p. 30, Aug 80
Gallon-size dummy load	
W4MB	p. 74, Jun 79
Impedance bridge measurement errors and corrections	
K4KJ	p. 22, May 79
Impedance matching (Tech. forum)	
WB2NTQ	p. 85, Jul 83
Inductance meter, easy-to-build	
W6XM	p. 76, Apr 82
Comments, WB2LAO	p. 8, Sep 82
Short circuit	p. 79, Oct 82
K4EEU frequency standard, battery backup for (HN)	
N4BA	p. 68, Jul 81
Light-bulb dummy loads (HN)	
W6HPH	p. 74, Oct 81
Logic mate	
N9CZK	p. 57, Jan 83
Logic probe	
K9CW	p. 83, Feb 79
Logic probe (HN)	
Rozenthal, J.	p. 81, Apr 83
Logic probe, digital	
N6UE	p. 38, Aug 80
Measuring inductances (Tech. forum)	
K6HIK	p. 85, Jul 83
Measuring small values (Tech. forum)	
W6SDM	p. 74, Aug 83
Noise bridge, precision	
K2BT	p. 51, Mar 83
Comments	p. 8, Jun 83
Short circuit	p. 97, Aug 83
Noise-figure meter, automatic, for preamplifiers and converters	
K9IMM	p. 12, Feb 81
Panoramic adaptor/spectrum analyzer design notes	
WA6NCX/1	p. 12, Sep 83
Comments, K2C8Y	p. 12, Sep 83
Short circuit	p. 70, Oct 83
PEP output power measurement	
VK3AFQ	p. 10, Jun 83
Comments, K4KYV	p. 12, Sep 83
Prescaler, 600-Hz, for use with electronic counters	
WA1SPI	p. 50, Apr 80
Required dynamic range and design guides for EMI/RFI test receivers	
DJ2LR	p. 70, Nov 83
Rf power meter, part 1: instrument description and construction	
N6YC	p. 70, May 81
Rf power meter, part 2: measurements and measurement accessories	
N6YC	p. 55, Jun 81
Comments W3NQN	p. 8, Oct 81
Solid-state replacements (Tech. forum)	
AK7N	p. 46, Apr 83

24th
ANNUAL

TROPICAL HAMBOREE

FEBRUARY 4 - 5, 1984
FLAGLER DOG TRACK . . . MIAMI, FLORIDA



- Technical Forums
- DX Forum & Dinner
- ARRL Programs
- RTTY Forum
- FCC Exams
- Organizational Meetings
- New Product Exhibits
- Hamboree Dealer Specials
- Mammoth Swap Shop
- Personal Computer Forum
- QCWA Homestyle Hospitality
- International Displays

FREE OVERNIGHT RV PARKING AT HAMBOREE SITE
SPECIAL HOTEL RATES AT HEADQUARTERS HOTEL
WRITE FOR OUR BROCHURE WITH FULL INFORMATION

Registration: \$4.00 Advance . . \$5.00 Door (Valid both days)
Swap Tables, 2 Days: \$14.00 Advance . . \$16.00 Door (plus regis. ticket)
(Advance price deadline, January 31st)

Make checks payable to: DADE RADIO CLUB, INC., P.O. Box 350045, Miami, FL 33135

Exhibit Booth Information: Mrs. Evelyn Gauzens, W4WYR, Chairman
2780 N.W. 3 Street, Miami, FL 33125
Telephone: 305-642-4139

THE CHAMP



BIRD MODEL 4304

NO ELEMENTS
25-1000 MHZ
RF SAMPLING PORT

AUTHORIZED BIRD DISTRIBUTOR



WEBSTER COMMUNICATIONS INC.
115 BELLARMINE
ROCHESTER, MI 48063
313-375-0420

CALL TOLL FREE

800-521-2333
800-482-3610

TET ANTENNA SYSTEMS

"THE PERFECT MATE FOR YOUR SOLID-STATE"

FEATURES

- Dual-Drive For Total Broadband
- Machined Aluminum Boom-To-Mast And Element Mounts
- Lightweight Yet Rugged
- Excellent Gain & F/B Balun (Non Ferrite) Included
- All Elements Active
- Stainless Steel Electrical Hardware Included
- Air Dielectric Coaxial Trap Capacitors
- Precision Machined Aluminum Alloy
- Easy One Afternoon Assembly
- Lower Wind Load
- U.P.S. Shippable

TRIBAND YAGIS

HB33SP	3 El -13'2" Boom-27 Lb. 3KW Max. Pwr. - Compact	\$189.95 +ship.
HB43SP	4 El -19'8" Boom-38 Lb. 3KW Big Signal Performance	\$249.95 +ship.
HB34D	4 El -16'5" Boom-34 Lb. 3KW Slightly Larger Than 33SP	\$219.95 +ship.
HB35T	5 El -24'7" Boom-50 Lb. 3KW "THE ULTIMATE"	\$349.95 +ship.

ALSO AVAILABLE

HB40NL3	3 El 40M Monoband	\$379.95
HB40NL2	2 El 40M Monoband	\$254.95

SPECIALS

TELEX *hygain*

TH7 DX	\$369.95/ + ship
The New EXPLORER 14	\$287.95/ + ship



IC730	\$595.00/ + ship
-------	------------------

CASH, CHECK, M.O. VISA & MASTERCARD

"Swiss Quads" - Thrust Bearings - Rotors

Many Other Models Available

Call Or Write For Complete Catalog.

(513)376-2700

SULTRONICS

15 Sexton Dr., Xenia, Ohio 45385

INVENTORY REDUCTION SALE!

Huge savings on
used and demonstrator
Video and CCTV
equipment.

OFFER GOOD WHILE QUANTITIES LAST

CCTV Cameras
And Monitors **\$69⁵⁰**

Video
Recorders **\$139⁵⁰**

Lenses And
Wall Mounts **\$9⁹⁷**

- Similar Savings On Other Items!
- All In Good Working Condition!
- No Limits! First Come, First Served!

Ask for Mr. Lewis

TOLL-FREE **800-221-2240**

N.Y. STATE **212-989-4433**

GBC TV CORP.

315 Hudson Street, New York, N.Y. 10013

Standing wave indicator (Tech. forum)	
GW8FKB	p. 97, Nov 83
Sweep generator, stable wideband	
W7BAR	p. 18, Jun 81
Short circuit	p. 84, Nov 81
SWR measuring at high frequencies	
DJ2LR	p. 34, May 79
SWR meter for the high-frequency bands	
WB6AFT	p. 62, Oct 81
Comments, WA4UPN, WB6AFT	p. 36, Mar 82
Test-equipment mainframe	
W4MB	p. 52, Jul 79
Time and frequency standards: part 1	
Martin, Vaughn D.	p. 36, Nov 83
Time and frequency standards: part 2	
Martin, Vaughn D.	p. 31, Dec 83
Tune-up method, low duty-cycle for transmitters (HN)	
K4KI	p. 62, Aug 83
Comments, W5XW	p. 11, Dec 83
Two-tone generator	
N1RM	p. 32, Jun 82
Two-tone signal generator (HN)	
K4KI	p. 77, Sep 82
Using the Astro 103 as a frequency counter (HN)	
W4ATE	p. 69, Jun 83
Video monitor, inexpensive	
K8CG	p. 12, Apr 83
Comments, K9TA	p. 10, Aug 83
VLF dip meter, no-adjust bias for (HN)	
WB3IDJ	p. 69, Jul 80
VSWR bridge, broadband power-tracking	
K1ZDI	p. 72, Aug 79
VSWR and power meter, automatic	
W0INK	p. 34, May 80
Wattmeter, low power (letter)	
W0DLQ	p. 6, Jan 80
Weather radar, 10-GHz	
K4TWJ	p. 61, Sep 83
Wide range inductance meter (Tech. forum)	
K9EBA	p. 52, Feb 83
Wien Bridge oscillators, voltage-controlled resistance for	
W4SSNZ	p. 56, Feb 80
Zener diode test circuit (Tech. forum)	
W3PHK	p. 52, Feb 83

miscellaneous technical

Ac-line switching precautions (HN)	
W5PGG	p. 69, Jul 81
Air pressure, measuring across transmitting tubes (HN)	
W4PSJ	p. 89, Jan 80
Amplifier for 220 MHz, stripline kilowatt	
W2GN	p. 12, Apr 82
Amplitude companded sideband	
WB6JNN	p. 48, Dec 80
Analog-to-digital display converter for the visually handicapped	
KB7JW	p. 44, Jan 81
Battery charging (letter)	
Carlson	p. 6, Nov 80
CATV (letter)	
WBANMA	p. 10, Aug 83
Circuit figure of merit (letter)	
W2JTP	p. 6, Dec 80
Commutating filters	
W6GXN	p. 54, Sep 79
Computer for the blind (HN)	
W8MQW	p. 69, Jun 82
Crystal use locator	
W46SWR	p. 36, Nov 80
CW identifier, versatile	
WB2BWJ	p. 22, Oct 80
Short circuit	p. 70, Feb 82
CW identifier, versatile, an improved memory for	
WB2BWJ	p. 24, Feb 82
CW station, updating (HN)	
KM5T	p. 77, Oct 82
Data bandwidths compared	
W9JD/2	p. 50, Dec 82
Comments, W6JTH	p. 8, Jun 83
DSB generators, audio-driven (HN)	
W5TRS	p. 68, Jul 80
Earth anchors for guyed towers	
W5QJR	p. 60, May 80
Eimac 5CX1500A power pentode, notes on	
K9XI	p. 60, Aug 80
Electrolytic capacitors (letter)	
WB8MKU	p. 6, Jun 81
Field-strength meter and volt-ohmmeter	
WB6AFT	p. 70, Feb 79
Filters (letter)	
W6XM	p. 8, Feb 83
Comments, W3NQW	p. 8, Apr 83
Filters, bridged	
W6MUR	p. 51, Oct 82
Four-quadrant curve tracer/analyzer	
W1QXS	p. 46, Feb 79
Frequency divider, diode	
W5TRS	p. 54, Aug 80
Ground systems, notes on	
K6WX	p. 26, May 80
Ham radio techniques: radio-frequency interference	
W6SAI	p. 34, Nov 81
Ham radio techniques: radio-frequency interference	
W6SAI	p. 30, Dec 81
Harmonic product detector for QRP transceivers	
W5FG	p. 44, Jun 83
Hyperbolic navigation (letter)	
Burhans, Ralph W.	p. 6, Feb 81
Impedance bridge measurement errors and corrections	
K4KJ	p. 22, May 79
Impedance measurements using an SWR meter	
K4QF	p. 80, Apr 79
Inductance or capacitance, a method for measuring (HN)	
W2CHO	p. 68, Jul 80
Instant balun (letter)	
W8MQW	p. 6, Aug 81
KWM 380 external control circuit (HN)	
W4ZRUD	p. 96, Dec 83
Light-emitting diodes: theory and application	
WB6AFT	p. 12, Aug 80
Linear-amplifier cost efficiency	
W8MFL	p. 60, Jul 80
Linear tuning, a fresh look at (HN)	
W2OLU	p. 74, Aug 80
Low cost linear design and construction	
W4MB	p. 12, Dec 82
Multiplexing, the how and why of	
KH6N	p. 60, Sep 81

Mysterious spur on 160 (Tech. forum)	
N3BEK	p. 73, May 83
Comments, K0KL, N3BEJ	p. 95, Nov 83
Navigational aid for small-boat operators	
W5TRS	p. 46, Sep 80
Ni-cad battery charging (letter)	
W6NRM	p. 6, Jul 80
Operation upgrade: part 1	
W6BNB	p. 12, Sep 81
Operation upgrade: part 2	
W6BNB	p. 28, Oct 81
Optimum pi-network design	
DL9LX	p. 50, Sep 80
Passive lumped constant 90-degree phase-difference networks	
K6ZV	p. 70, Mar 79
PCB "threat" (letter)	
VE5UK	p. 66, Sep 80
Phase-shift network, 90-degree, offers 2:1 bandwidth	
K6ZV	p. 66, Feb 80
Photovoltaic cells: a progress report	
WDBAHO	p. 52, Dec 83
Plasma-diode experiments	
Stockman	p. 62, Feb 80
Q systems	
W1IUZ	p. 6, Nov 80
Quartz crystals	
WB2EGZ	p. 37, Feb 79
Relay, inexpensive automatic send/receive	
W0PBV	p. 40, May 82
Repeater controller, microprocessor-based	
K80CY	p. 12, Mar 82
Rf exposure	
WA2UMY	p. 26, Sep 79
Rf radiation, environmental aspects of	
K6YB	p. 24, Dec 79
Rf power distributor, the	
W3BYM	p. 46, Dec 81
Rfi cures: avoiding side effects	
WB9TQG	p. 52, Sep 81
Comments WB75YB, WB9TQG, VE2QO	p. 6, Dec 81
Rotary-dial mechanism for digitally tuned transceivers	
K3CU	p. 14, Jul 80
Semiconductor curve tracing simplified	
W6HPH	p. 34, Aug 80
Signal-strength, measuring	
W2YE	p. 20, Aug 80
Solid-state amplifier switching (HN)	
WB2HTH	p. 75, Aug 80
Sorting and inventory of standard resistor values, computer program for	
W46SWR	p. 66, Jun 81
Speed of light (letter)	
KL6WU	p. 67, Sep 80
Speed of light (letter)	
WB2AOT	p. 6, Apr 80
Speed of light (letter)	
W4MLM	p. 6, Aug 80
Speed of light, observations on, through the metric system	
W7ITB	p. 62, Jan 80
Super beep circuit for repeaters	
KP4AQI	p. 48, Jul 81
Synthesizer system, simple (HN)	
AA7M	p. 78, Jul 79
Talking clock (letter)	
N9KV	p. 75, Feb 80
Talking digital readout for amateur transceivers	
N9KV	p. 58, Jun 79
Talking digital readout (letter)	
N5AF	p. 6, May 80
T coupler, the (HN)	
K3NXU	p. 78, Nov 80
Timer, electronic (HN)	
W9EBT	p. 65, Mar 82
Tubes, surplus (letter)	
W2JTP	p. 6, Aug 80
Tubes, surplus (letter)	
Seljat	p. 66, Sep 80
Varactor tuning tips (HN)	
N3GN	p. 67, Feb 81
Variable-inductance variable frequency oscillators	
W0YBF	p. 50, Jul 80
VLF dip meter, no-adjust bias for (HN)	
WB3IDJ	p. 69, Jul 80
VMOS on 1750 meters	
K1RGO	p. 71, Oct 83
Wideband amplifier summary	
DJ2LR	p. 34, Nov 79

microprocessors, computers and calculators

An RS-232 to TTL interface	
WD4KGI	p. 70, Nov 82
Calculator or computer — which to buy?	
W4MB	p. 86, Nov 82
Computer rfi (letter)	
KA5HJI	p. 8, Jun 81
Computer, satellite, for under \$150	
WB6POU	p. 12, Mar 80
CW keyboard using the APPLE II computer	
W6WR	p. 60, Oct 80
CW trainer/keyer using a single-chip microcomputer	
N6TY	p. 16, Aug 79
Data retrieval program using the APPLE II computer (HN)	
WB6YHS	p. 75, Oct 81
Frequency counters, CMOS timing circuit for (HN)	
Bevel, David H.	p. 72, Jul 82
Ham gear controller: part 1	
N3CA	p. 12, Oct 82
Ham gear controller: part 2	
N3CA	p. 25, Nov 82
Microcomputer-based contest keyer	
K9CW	p. 36, Jan 81
Microprocessor repeater controller	
K85F	p. 56, Apr 83
Radio Shack ASCII keyboard encoder for microprocessor-controlled CW keyboard using the (HN)	
VE7ZV	p. 72, Oct 80

**GEM-QUAD FIBRE-GLASS
ANTENNA FOR 10, 15, and 20 METERS**

Two Elements \$235.00
Extra Elements \$164.00
Price is F.O.B. Transcona
**INCLUDES U.S. Customs
Duty**

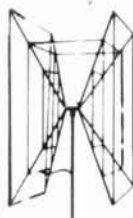

KIT COMPLETE WITH
*SPIDER
*ARMS
*WIRE
*BALUN KIT
*BOOM WHERE
NEEDED

WINNER OF MANITOBA
DESIGN INSTITUTE
AWARD OF EXCELLENCE

Buy two elements now — a third and fourth
may be added later with little effort.

Enjoy up to 8 db forward gain on DX, with a
25 db back to front ratio and excellent side
discrimination.

Ask for our new 2m Quad Kit when you order
your Gem Quad. It's FREE for the asking!

Get maximum structural strength with low
weight, using our "Tridetic" arms. Please in-
quire directly to:

GEM QUAD PRODUCTS LTD.

Box 53
Transcona Manitoba
Canada R2C 2Z5
Tel. (204) 866-3338

**10GHz GUNNPLEXER
transceiver**



TR10GA

- Complete ready to use 10 GHz fm voice/cw transceiver
- 10 mW power output
- Typical frequency coverage 10.235-10.295 GHz
- Full duplex operation
- Internal Gunnplexer for portable operation
- Gunnplexer removable for tower mounting in fixed location service — three shielded cables required for interconnection
- Powered by 13 volts dc nominal at 250 mA
- 30 MHz i-f
- 10-turn potentiometer controlled VCO tuning
- 220 kHz ceramic i-f filter
- Extra diode switched filter position for optional filter
- Rugged two-tone grey enclosure
- Full one year warranty
- \$389.95 with 10 mW Gunnplexer
- \$269.95 without Gunnplexer

**Advanced
Receiver
Research**

Postpaid for U.S. and Canada. CT Residents
add 7-1/2% sales tax. C.O.D. orders add \$2.00.
Air mail to foreign countries add 10%

Box 1242 • Burlington CT 06013 • 203 582-9409



QUALITY MICROWAVE TV ANTENNAS

1.9 to 2.6 GHz
Frequency Range
Complete System (Pictured)



20" Parabolic Dish
Pre-Assembled Probe with Down
Converter, Power Supply and
Tuner Switch 63' of RG-59/U
Coax with Connector, Trans-
former for 75 to 300 Ohms. All
Mounting Hardware for Fast and
Easy Installation

S&W ELECTRONICS
145 North Main
Bountiful, UT 84010
(801) 295-1166

Dealers Wanted - COD'S

Suggested Retail \$259.00
Special \$74.95

2 Year Warranty



OVER 70 BRANDS IN STOCK
LAND-MOBILE RADIO
Full Service Shop • Spectrum Analysis • Antennas
New and Used Equipment • CW-SSB-FM, Etc. • Towers
FCC Study Guides • Code Tapes • Books • Accessories

AMATEUR RADIO
SHORTWAVE
SCANNERS

SPECTRONICS

Specialists in Amateur Radio,
Short-Wave Listening
And Contemporary
Electronic Gear.

HOURS
MON, TUES, WED.:
9:30-6:00 PM
THURS, FRI.:
9:30-8:00 PM
SAT.: 9:30-3:00 PM

CLOSED SUNDAYS, HOLIDAYS

BEARCAT • MORGAIN • MANY MORE...

SPECTRONICS, INC. (312) 848-6777
1009 GARFIELD ST. OAK PARK, IL. 60304

GROTH-Type

**COUNTS & DISPLAYS
YOUR TURNS**

- 99.99 Turns
- One Hole Panel Mount
- Handy Logging Area
- Spinner Handle Available

Case: 2x4"; shaft 1/4"x3"

TC2 \$12.50

TC3 \$13.50

Spinner Handle

Add.....\$1.50

Prices include UPS or Parcel Post in US

Model TC2: Skirt 2-1/8";
Knob 1-5/8"

Model TC3: Skirt 3";
Knob 2-3/8"

R. H. BAUMAN SALES

P.O. Box 122, Itasca, Ill. 60143



4 console displayed

MICA COMMUNICATIONS CONSOLES

4'-6'-8' Wide — 1' to 8' wide optional
"L" & "U" & Circular set up's — with optional corner table
Replaceable Front Panel — for station changes
Precisely cut panel holes — by computerized wood cutter
High station density — because no shelves are used!!
Hidden accessory shelf — for power supplies, dummy load
Puppets of all your equipment — for easy station layout

OPTIONAL ITEMS:

Drawer/Bookshelf combination — hangs under desk
1000 Mica's to select from — to match your decor
Desk recessed for keyboard — optimum 26" typing height
Desk top extensions: into panel — for apple computer or storage
Matching dolly for floor amp's — with concealed casters
Shelf under desk, quick access — for headphones, Key, Mic.
Exhaust cooling fan system — thermostatically controlled
Wire duct, wire labels, etc...

**Break
Communications
Systems, Inc.**

5817 S.W. 21st Street, Dept. HRM • Hollywood, Florida 33023
Phone (305) 989-2371

Wilkinson hybrids
WA2EWT p. 12, Jan 82

novice reading

Novice playground (letter)
WA5MUF p. 8, Jan 82
Novice roundup (letter)
KA9AZY p. 8, Jun 81
Operation upgrade: part 1
W6BNB p. 12, Sep 81
Operation upgrade: part 2
W6BNB p. 28, Oct 81

operating

Amateur band intruders (letter)
W5SAD p. 6, Oct 80
Amateur radio, 1933 (ham radio techniques)
W6SAI p. 41, Jun 81
Amateur radio, 1941 (ham radio techniques)
W6SAI p. 30, Aug 81
Battlefield, the (letter)
W0WL p. 8, Jun 83
Best best regards regards (letter)
W6BQD p. 8, Jan 82
Comments, N4AGS p. 8, Apr 82
Comments, KA6NFD p. 8, May 82
Comments, KA2AGZ p. 8, Sep 82
Blind ham (letter)
Gerrey, Bill p. 8, Sep 82
Burglar alarm RFI (letter)
WB2YVY p. 8, Mar 82
Card from Frenchy (letter)
W2LPV p. 8, Apr 82
CATV (letter)
WB4NMA p. 10, Aug 83
County awards (letter)
KB7SB p. 8, Jul 81
CW anyone?
W7JWJ p. 44, Mar 81
CW memory, simple (weekender)
K4DHC p. 46, Nov 80
CW nets (letter)
N4EVS p. 8, Jun 82
CW zero-beat indicator for transceivers (weekender)
W6KVD p. 88, Mar 83
DX and QRP (letter)
W6QJL p. 8, Oct 82
DXer's diary
W9KNI p. 18, Mar 81
DXer's diary
W9KNI p. 26, Apr 81
Comments p. 6, Sep 81
DXer's diary
W9KNI p. 22, Jun 81
DX Forecaster
K0RYW p. 76, Nov 81
DX Forecaster
K0RYW p. 78, Dec 81
EI2W six-meter report (letter)
EI2W p. 12, Jul 80
EME, 70-CM, requirements and recommendations
W1JR p. 12, Jun 82
Short circuit p. 79, Oct 82
FCC actions (letter)
W1ZI p. 6, Apr 80
FCC actions (letter)
N8ADA p. 6, Apr 80
Great-circle maps
N5KR p. 24, Feb 79
Ham radio techniques
W6SAI p. 53, Jan 82
Ham radio techniques
W6SAI p. 60, Feb 82
Ham radio techniques
W6SAI p. 26, Mar 82
Ham radio techniques
W6SAI p. 26, Apr 82

Ham radio techniques: the crystal ball
W6SAI p. 68, May 82
Ham radio techniques
W6SAI p. 76, Jun 82
Ham radio techniques
W6SAI p. 42, Jul 82
Ham radio techniques
W6SAI p. 42, Aug 82
Ham radio techniques
W6SAI p. 40, Sep 82
Ham radio techniques
W6SAI p. 20, Oct 82
Ham radio techniques
W6SAI p. 46, Nov 82
Ham radio techniques
W6SAI p. 58, Dec 82
Ham radio techniques
W6SAI p. 66, Jan 83
Ham radio techniques
W6SAI p. 65, Nov 83
Ham radio techniques
W6SAI p. 81, Dec 83
Hamvention slide show (letter)
N8ADA p. 8, Jan 82
Homebrew linears: treat or trap? (HN)
VK4LR p. 77, Nov 82
IC-255A switching circuit (HN)
WB6IQV p. 70, Jan 83
Comments, WA4MZZ p. 8, Jun 83
Intruder watch (letter)
ZL6IW/ZL1BAD p. 6, Aug 81
Is it stolen?
W8AP p. 84, Dec 82
Lifeline SAR (letter)
WB9PFZ p. 8, Apr 82
Listening in on 10 fm
W8FX p. 62, Jan 82
Monitor, tone alert
W4KRT p. 24, Aug 80
Mysterious spur on 160 (Tech. forum)
N3BEK p. 73, May 83
No-code license (letters)
WB4SKP, W9ZMR, W2LX,
W2JTP, W1BL, K4JW p. 8, Jan 83
No code (letter)
W6SN p. 10, Aug 83
On-air tune-up (letter)
K3EQ p. 36, Mar 82
Operation upgrade: part 3
W6BNB p. 30, Jan 82
Operation upgrade: part 4
W6BNB p. 32, Feb 82
Operation upgrade: part 5
W6BNB p. 56, Mar 82
Operation upgrade: part 6
W6BNB p. 56, Apr 82
Operation upgrade: part 7
W6BNB p. 54, Jun 82
Operation upgrade: part 8
W6BNB p. 56, Jul 82
Operation upgrade: part 9
W6BNB p. 58, Sep 82
Operation upgrade: part 10
W6BNB p. 60, Oct 82
Operation upgrade: part 11
W6BNB p. 58, Nov 82
Other guy (letter)
KA2GXS p. 8, May 82
Pacemakers and rfi (Tech. forum)
K4CN p. 98, Jun 83
Comments, K1RGO p. 76, Oct 83
Comments, K4CN p. 77, Oct 83
Pacemakers and RFI: safety first (Tech. forum)
K3EAS, K3FOW p. 76, Oct 83
Propagation of radio waves
W1GV/4 p. 26, Aug 82
Protecting amateur radio (letter)
K2JIY p. 8, Jul 81
QRP (letter)
W5QJM p. 8, Nov 82
Repeater etiquette (letter)
W1OLP p. 8, Oct 83
RST feedback (letter)
W4OVO p. 6, Dec 80
RST feedback (letter)
W0NN p. 6, Dec 80
RST (letter)
W0UCK p. 6, Feb 81
Selfish attitudes (letter)
K2OZ p. 6, Nov 80
Ten-meter band (ham radio techniques)

W6SAI p. 38, Apr 81
Ten-meter beacon (Tech. forum)
WA1IOB p. 46, Apr 83
Ten-meter beacons (letter)
KA1YE p. 13, Sep 83
Ten-second call swaps (letter)
WB1FJE p. 6, Aug 81
Transceiver tuning (letter)
N6TO p. 8, Jun 82
True north for antenna orientation, how to determine
K4DE p. 38, Oct 80
Tune-up method, low duty-cycle for transmitters (HN)
K4KI p. 62, Aug 83
Wearing cans (letter)
WB9FRV p. 8, Jul 81
Who pays the jammer (letter)
W3MEO p. 8, Oct 82
Working W5LFL from space
K6DUE p. 81, Sep 83
2 meters outlawed (letter)
AA6C p. 8, Aug 82
160-meter band (ham radio techniques)
W6SAI p. 46, May 81

oscillators

AFC circuit for VFOs
K6EHV p. 19, Jun 79
Crystal oscillator, low-frequency (HN)
W6XM p. 66, Mar 82
Short circuit p. 79, Oct 82
CW BFO crystal for the 75S-3 (HN)
N1FB p. 80, Feb 82
Phantom-coil VXO
W3MT p. 66, Jan 82
Comments, W3MT p. 8, Jul 82
RF synthesizers for hf communications, part 1
WA6OAA p. 12, Aug 83
RF synthesizers for hf communications, part 2
WA6OAA p. 48, Sep 83
RF synthesizers for hf communications, part 3
WA6OAA p. 17, Oct 83
UHF local-oscillator chain
N6TX p. 27, Jul 79
VFOs tuned by cylinder and disc
W0YBF p. 58, Feb 83
Voltage-tuned mosfet oscillator
WA9HUV p. 26, Mar 79
1-MHz oscillator, new approach
WA2SPI p. 46, Mar 79
10 GHz oscillator, ultra stable
K8UR p. 57, Jun 83

power supplies

AC converter, DC to 400-Hz (HN)
WB2YVY p. 58, Mar 83
Adjustable 5-ampere supply
N1JR p. 50, Jan 79
Battery charging (letter)
Carlson p. 6, Nov 80
Bench power supply (weekender)
WB6AFT p. 50, Feb 80
Diesel generator repair (Tech. forum)
Richardson, Wayne p. 46, Apr 83
Drake R-4C receiver improved power supply
W3RJ p. 28, Feb 82
Dual voltage power supply
WD4SKH p. 32, Mar 83
Comments, WB2UAQ p. 12, Jul 83
Short circuit p. 80, Jul 83
Dual voltage surge-protection for high-voltage power supplies (weekender)
K8VIR p. 42, Aug 81
Electrolytic capacitors (letter)
WB8MKU p. 6, Jun 81

ANNUAL LAS VEGAS PRESTIGE CONVENTION

SAROC™



HACIENDA RESORT HOTEL Las Vegas, Nevada

JANUARY 12-13-14-15, 1984

Cocktail Party hosted by **hamradio** MAGAZINE Friday evening for all **SAROC** exhibitors and **SAROC** Advance or Regular paid registered guests. Ladies' Program on Saturday included with **SAROC** Advance or Regular paid registration at no additional charge for ladies who register. Two HACIENDA RESORT HOTEL Breakfasts or Brunches in the Sunburst room are included with each Advance or Regular paid registration; one on Saturday and one on Sunday. Technical sessions, EXHIBITS, and SWAP TABLES open on Friday and Saturday to all **SAROC** paid registered guests. One SWAP TABLE available free to **SAROC** non-commercial guests holding Advance or Regular paid registration. **SAROC** is hosted by Southern Nevada Amateur Radio Club. **SAROC** Advance registration is only \$17.00 per person, if postmarked before January 1, 1984. After January 1, 1984, **SAROC** Regular registration is only \$19.00 per person.

SAROC fee of \$2.00 per person for those who want to attend only **SAROC** technical sessions, visit EXHIBIT and SWAP TABLE area. No admission to any function without a **SAROC** paid registration and wearing the **SAROC** registration badge in plain view. **SAROC** coupon book and cellophane badge holder may be picked up at **SAROC** registration desk. Send check or money order to **SAROC**, P.O. Box 945, Boulder City, NV 89005-0945. Refunds will be made after **SAROC** is over to those requesting same in writing and postmarked before January 12, 1984. Special **SAROC** HACIENDA RESORT HOTEL room rate is \$35.00 (plus .50 for telephone and room tax), per night, single or double occupancy. HACIENDA RESORT HOTEL accommodations request via mail to HACIENDA RESORT HOTEL, P.O. Box 15566, Las Vegas, NV 89114 or call toll free 1 (800) 634-6713. Either way they request a FIRST NIGHT'S DEPOSIT TO BE ASSURED A RESERVATION. **SAROC** 1985 scheduled Jan. 10-13.

-----Clip and mail ASAP to **SAROC**, P.O. Box 945, Boulder City, NV 89005-0945.-----

Enclosed is \$_____ check or money order (no cash) for _____ **SAROC** Advance Registration(s) @ \$17.00 each: after Jan. 1, 1984 **SAROC** Regular Registration is \$19.00 each.

OM _____ Call _____ License Class _____
Please type or print

YL _____ Call _____ License Class _____
Please type or print

Address _____ City _____
Please type or print

State _____ Zip _____ Telephone No./AC _____

Yes, I want a SWAP Table space (limit one free table per registered guest for Friday and Saturday).

I have attended **SAROC** _____ times. Yes, I plan to attend Ham Radio Magazine Cocktail Party.

I am interested in Antenna, ARRL, Cocktail Party, Computers, CW, DX, FCC, MARS, RTTY, TV, other _____

I receive: CQ, Ham Radio Magazine, QST, QCWA, RTTY, 73, Westlink, Worldradio, other _____

SAROC™

P.O. BOX 945, BOULDER CITY, NEVADA 89005-0945

Forget memory (Ni-Cd discussion) K0OV	p. 62, Jan 83
High-current regulated dc supply N8AKS	p. 50, Aug 79
Low-voltage dc power supplies — Repair K4IPV	p. 38, Oct 79
Ni-cad charger, any-state WA6TBC	p. 66, Dec 79
Nickel-cadmium batteries, time-current charging W1OLP	p. 32, Feb 79
Power supply, amplifier WA2GFP	p. 32, Sep 83
Power supply for the big amplifier W6YUY	p. 64, Jun 82
Protection for your solid-state devices W1OOP	p. 52, Mar 81
Regulator problem solved (HN) W6XM	p. 97, Dec 83
Safe power for your low-noise GaAs FET amplifier WA9HUV	p. 18, Nov 82
Squirrel-cage motors make field-day power supplies (HN) K6DZY	p. 74, Aug 81
Trans-global power supply (HN) W9CGI	p. 76, Nov 82
Two-way power for the IC2AT 2-meter handheld WB3JJF	p. 57, Feb 82
Comments WB4MNV, WB3JJF	p. 8, Jul 82
Vacuum tube substitution W2YE	p. 58, Oct 83
Variable high-voltage supply W1OLP	p. 62, Dec 79
VHF transceivers, regulated power supply for WA8RXU	p. 58, Sep 80

DX forecaster K0RYW	p. 82, Oct 82
DX forecaster K0RYW	p. 84, Nov 82
DX forecaster K0RYW	p. 80, Dec 82
DX forecaster K0RYW	p. 74, Jan 83
DX forecaster K0RYW	p. 56, Feb 83
DX forecaster K0RYW	p. 84, Mar 83
DX forecaster K0RYW	p. 94, Apr 83
DX forecaster K0RYW	p. 74, May 83
DX forecaster K0RYW	p. 65, Jun 83
DX forecaster K0RYW	p. 82, Jul 83
DX forecaster K0RYW	p. 66, Aug 83
DX forecaster K0RYW	p. 84, Sep 83
DX forecaster K0RYW	p. 87, Oct 83
DX forecaster K0RYW	p. 90, Nov 83
DX forecaster K0RYW	p. 92, Dec 83
New band propagation KK2XJM (W4MB)	p. 12, Jan 83
Radio signals, radiation of W1GV4	p. 26, Jun 82

Low-noise preamplifiers with good impedance match W1OOP	p. 36, Nov 82
Measuring receiver dynamic range: an addendum (HN) WB6CTW	p. 86, Apr 81
Multiple receivers on one antenna (Two for one) (HN) W2OZY	p. 72, Jun 80
Noise Blanker W5QJR	p. 54, Feb 79
Noise figure relationships (HN) W6WX	p. 70, Apr 80
Panoramic adaptor/spectrum analyzer design notes WA6NCX/1	p. 26, Feb 83
Comments, K2C8Y	p. 12, Sep 83
Short circuit	p. 70, Oct 83
Phaselocked up-converter W7GHH	p. 26, Nov 79
Power-line noise K4TWJ	p. 60, Feb 79
Receiver dynamic range W3JZO	p. 77, Dec 82
Receiver dynamic range (letter) AA6PZ	p. 7, Aug 80
Remote-site receivers and repeater operation K9EID	p. 36, Jan 83
Rotary dial and encoder for digital tuning N3CA	p. 30, Dec 82
Signal-strength, measuring W2YE	p. 20, Aug 80
Talking clock (letter) N9KV	p. 75, Feb 80
Talking digital readout (letter) N5AF	p. 6, May 80
Short circuit	p. 73, Dec 79
Wideband amplifier summary DJ2LR	p. 34, Nov 79

propagation

Calculator-aided propagation predictions N4UH	p. 26, Apr 79
Comments	p. 6, Sep 79
Digital ionosondes K2RR	p. 14, Dec 83
DX forecaster K0RYW	p. 76, Jan 81
DX forecaster K0RYW	p. 92, Feb 81
DX forecaster K0RYW	p. 78, Mar 81
DX forecaster K0RYW	p. 52, Apr 81
DX forecaster K0RYW	p. 76, May 81
DX forecaster K0RYW	p. 52, Jun 81
DX forecaster K0RYW	p. 56, Jul 81
DX forecaster K0RYW	p. 46, Aug 81
DX forecaster K0RYW	p. 48, Sep 81
DX forecaster K0RYW	p. 46, Oct 81
DX forecaster K0RYW	p. 76, Nov 81
DX forecaster K0RYW	p. 78, Dec 81
DX forecaster K0RYW	p. 74, Jan 82
DX forecaster K0RYW	p. 74, Feb 82
DX forecaster K0RYW	p. 82, Mar 82
DX forecaster K0RYW	p. 70, Apr 82
DX forecaster K0RYW	p. 50, May 82
DX forecaster K0RYW	p. 42, Jun 82
DX forecaster K0RYW	p. 78, Jul 82
DX forecaster K0RYW	p. 80, Aug 82
DX forecaster K0RYW	p. 82, Sep 82

receivers and converters

general

Active mixers, performance capability: part 1 DJ2LR	p. 30, Mar 82
Active mixers, performance capability: part 2 DJ2LR	p. 38, Apr 82
Audio processor, communications, for reception W6NRW	p. 71, Jan 80
Automatic repeater/receiver sensitivity (HN) VE7ABK	p. 81, Jan 82
Auto-product detection of double-sideband K4UD	p. 58, Mar 80
Letter G3JIP	p. 6, Oct 80
Bandsreading techniques (letter) Anderson, Leonard H.	p. 6, Jan 79
Bragg-cell receiver WB3JZO	p. 42, Feb 83
Broadband <i>ijet</i> amplifiers N6DX	p. 12, Nov 79
Communications receiver K2BLA	p. 12, Jul 82
Communications receivers, calculating the cascade intercept point of WA7TDB	p. 50, Aug 80
Crystal ladder filters, systematic design of N7WD	p. 40, Feb 82
CW filter, high performance W3NQN	p. 18, Apr 81
Comments W3NQN	p. 6, Nov 81
Detector, logarithmic with post-injection marker generator W1ERW	p. 36, Mar 80
Digital display N3FG	p. 40, Mar 79
Comments	p. 6, Jul 79
Diversity reception K4KJ	p. 48, Nov 79
Dynamic range, measuring WB6CTW	p. 56, Nov 79
I-F transformers, problems and cures (weekender) K4IPV	p. 56, Mar 79
LF converter, fixed-tuned K1RGO	p. 19, Jan 83

high-frequency receivers

Blanking the Woodpecker: part 1 VK1DN	p. 20, Jan 82
Blanking the Woodpecker, part 2: a practical circuit VK1DN	p. 18, Feb 82
Comments, NP4B	p. 8, Jul 82
Blanking the Woodpecker, part 3: an audio blanker VK1DN	p. 22, Mar 82
CB to 10 fm transceiver conversion VE3FIT, VE3AQN	p. 16, Feb 83
Communications receivers, high frequency, recent developments in circuits and techniques for DJ2LR	p. 20, Apr 80
Communications receivers for the year 2000: part 1 DJ2LR	p. 12, Nov 81
Communications receivers for the year 2000: part 2 DJ2LR	p. 36, Dec 81
Compact SSB receiver K1BQT	p. 10, Nov 83
CW regenerator for Amateur receivers W3BYM	p. 64, Oct 80
Designing a modern receiver WB3JZO	p. 23, Nov 83
Diversity receiver, high-frequency, from the 1930s K4KJ	p. 34, Apr 80
Drake R-4C product detector, improving (HN) W3CVS	p. 64, Mar 80
Improved stability and dial calibration for the Heathkit HW-8 (HN) W3HVK	p. 103, Nov 83
Inexpensive CW filter (HN) WB1AFQ	p. 80, Jan 82
Radio interference to shortwave receivers (HN) W6XM	p. 68, Jul 81
Shortwave converter, portable PY2PE1C	p. 64, Apr 81
Shortwave receiver, portable monoband, with electronic digital frequency readout PY2PE1C	p. 42, Jan 80
Simple 40-meter receiver (weekender) W6XM	p. 64, Sep 80
Simple shortwave broadcast receiver (weekender) W6XM	p. 83, Nov 83

If you need QUARTZ CRYSTALS

—one or hundreds—

YOU NEED JAN

- high stability
- prompt service
- cost savings

- General Communication
- Industry
- Marine VHF
- Scanners
- Amateur Bands
- CB Standard
- CB Special
- Microprocessor

Call or Write
JAN CRYSTALS

P.O. Box 06017
Ft. Myers, Fl. 33906-6017
All Phones (813) 936-2397

**JAN
CRYSTALS**

✓ 162

TUNE IN THE WORLD OF HAM-TV!

Amateur Radio operators in the 1980's are discovering the fascinating "World of Amateur Television". Be it Fast Scan TV (FSTV), Slow Scan TV (SSTV), Facsimile (FAX) or somewhere in between, Video communications modes are growing at an exciting pace!

New advancements are taking place in High-Resolution/Color SSTV and the use of personal computers for ATV graphics, SSTV—FAX—RTTY communications. Interest is even growing in MICROWAVE and TVRO applications.

A5 ATV MAGAZINE™ has supported these modes of Amateur Specialized Communications since 1967 — over 17 years! And now, under guidance of the UNITED STATES ATV SOCIETY, HAM-TV will continue to grow rapidly. Interested?

Send SASE for "free" information brochures today!

Special six month TRIAL
subscription only... \$10.00
One year subscription (12 issues)
of the "USATVS Journal" \$20.00
Sample issue available for... \$2.50 ppd.

A5 ATV MAGAZINE™

P.O. BOX H
LOWDEN, IOWA 52255

A DIVISION OF QCD PUBLICATIONS, INC.

✓ 116



**SAY YOU SAW IT
IN
HAM RADIO**

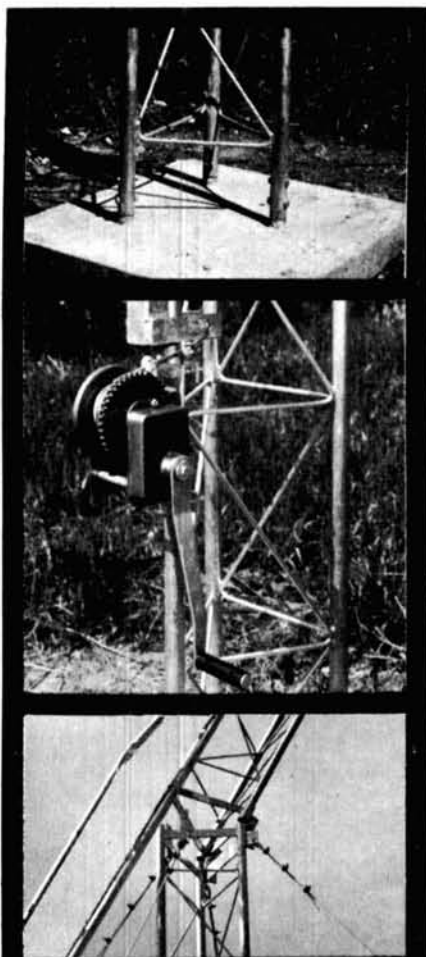

ROHN "FOLD-OVER" TOWERS

■ **EASE OF INSTALLATION**
ROHN "Fold-Over" Towers are quickly and easily installed. The "Fold-Over" is safe and easy to service.

■ **ADAPTABILITY**
ROHN has several sizes to fit your applications or you can purchase the "Fold-Over" components to convert your ROHN tower into a "Fold-Over".

■ **HOT DIP GALVANIZED**
All ROHN towers are hot dip galvanized after fabrication.

■ **REPUTATION**
ROHN is one of the leading tower manufacturers, with over 25 years of experience.

Write today for complete details.

QUALITY STEEL PRODUCTS BY

ROHN

Box 2000 • Peoria, Illinois 61656
U.S.A.

✓ 208

**BUY
HIGH QUALITY
CUTTERS & PLIERS**

**DIRECT FROM
MANUFACTURER!**

LOW PRICES—SEND FOR CATALOG!
Use this magazine's "reader service" card and we will enclose an extra 10% DISCOUNT CERTIFICATE.

SCANDEX INC.
87 Crescent Rd.
Needham, MA 02194
(617) 449-1550

✓ 198

**NEW! MULTI-CHANNEL
MICROWAVE**

Complete Antenna Systems from \$69⁹⁵

Full 800 Mhz Range
Tune 1.9-2.7 Ghz
Includes all
ITFS Channels

DEALERS WANTED

COD's and Credit Card
Orders call TOLL FREE
1-800-247-1151

**GALAXY
ELECTRONICS**
6009 N. 61 Avenue
Glendale, AZ 85301
1-602-247-1151

✓ 146

GO MOBILE WITH YOUR H.T.!

Model I—Icom IC-2A/T, Etc.
Model K-1 for TR-2500
—slides on bottom of radio

Guaranteed!

Model K—TR 2400;
—powered thru battery plug
Model N—FT-208R
Model T—Simple mod for Tempo
and all Santec

NOW FOR FT-208R & TR-2500

Model Y—FT-207R, Wilson
—fits into battery compartment

"A unique battery eliminator"
HANDI-TEK Regulator allows
constant hand-held operation
from auto DC or base supply
with no nicad drain and
WITHOUT RADIO MODIFICA-
TION! \$24.95 PPD in USA.
Calif. add \$1.50 Sales Tax.

✓ 156
HANDI-TEK
P.O. BOX 2205, LA PUENTE, CA 91746

Synthesizer, high resolution hf (letter)	
DJ2LR	p. 6, Jan 79
Ten-Tec Omni-D, improved CW agc for (HN)	
W6QA	p. 88, Jan 80
Transceiver, 40-meter, for low-power operation	
WB5DJE	p. 12, Apr 80
Two-band receiver, modular	
WA3TFS	p. 53, Jul 83
Understanding performance data of high-frequency receivers	
K6FM	p. 30, Nov 81
Comments KL7HT, K6FM	p. 8, Aug 82
Up-conversion receiver for the high-frequency bands: part 1	
W2VJN	p. 54, Nov 81
Up-conversion receiver for the high-frequency bands: part 2	
W2VJN	p. 20, Dec 81
Woodpecker noise blanker	
DJ2LR	p. 18, Jun 80
15-meter sideband transceiver	
WA4ZXF	p. 12, Mar 83
Short circuit	p. 80, Jul 83
80-meter receiver for the experimenter	
W6XM	p. 24, Feb 81
Comments	p. 6, Jun 81
7-MHz receiver	
K6SDX	p. 12, Apr 79
432-MHz converter	
N9KD	p. 74, Apr 79

vhf receivers and converters

Cavity bandpass filters	
W4FXE	p. 46, Mar 80
Communications receivers for the year 2000: part 1	
DJ2LR	p. 12, Nov 81
Communications receivers for the year 2000: part 2	
DJ2LR	p. 36, Dec 81
Interesting preamplifier for 144 MHz (HN)	
WA2GFP	p. 50, Nov 81
K9LHA 2-meter synthesizer, extending the range of (HN)	
K9LHA	p. 52, Dec 81
Optical fm receiver	
Poon and Pleper	p. 53, Nov 83
Synthesized 2-meter mobile stations, automation for	
W9CGI	p. 20, Jun 80
144-432 MHz GaAs fet preamp	
JH1BRY	p. 38, Nov 79

RTTY

Active bandpass filter for RTTY	
W4AYV	p. 46, Apr 79
AFSK generator, an accurate and practical	
K0SFU	p. 56, Aug 80
Baudot, a vote for (letter)	
W6NRM	p. 8, Mar 82
CW and RTTY digital audio filter	
W1OER	p. 60, Aug 83
Duplex audio-frequency generator with AFSK features	
WB6AFT	p. 66, Sep 79
Hellschreiber, a rediscovery	
PA0CX	p. 28, Dec 79
Hellschreiber (letter)	
K6KA	p. 6, Mar 80
Comment, G5XB	p. 6, Sep 80
Hellschreiber (letter)	
W6DKZ	p. 6, Mar 80

LED tuning indicator for RTTY	
WA0ELA	p. 50, Mar 80
Phase-coherent RTTY modulator	
K5PA	p. 26, Feb 79
RTTY and Atari™ computer	
K5VUV	p. 36, Jul 83
RTTY tuning indicator, a free (HN)	
N1AW	p. 74, Oct 81
RTTY zero-beat indicator (HN)	
W2QLI	p. 78, Oct 83
Slow ASCII	
W3FVC	p. 6, Jun 81
SSB transmitters, FSK adapter for	
WA3PLC	p. 12, Jul 81
Comments N1AL, WA3PLC	p. 8, Mar 82
Comments WB5DPZ, N1AL	p. 8, Oct 82
TRS-80 color computer for RTTY	
W1OER	p. 62, Jun 83
XK2C AFSK generator, the	
W3HVK	p. 58, Nov 80

satellites

Antenna accuracy in satellite tracking systems	
N5KR	p. 24, Jun 79
Geostationary satellite bearings with the TI-58/59 programmable calculator (HN)	
WA6BKC	p. 87, Apr 81
Geostationary satellites, locating	
W2TQK	p. 66, Oct 81
Comments W1DHX	p. 8, Jan 82
Comments W2TI	p. 8, Feb 82
Short circuits	p. 89, Jan 82
Graphic azimuth and elevation calculator	
WB0VGI	p. 25, Jan 83
Locate orbiting satellites	
W0ZWW	p. 72, Sep 83
Phase III spacecraft orbits, geometry of	
W8MQW	p. 68, Oct 80
Satellite communications on 10 meters (letter)	
G3IOR	p. 12, Dec 79
Tracking satellites in elliptical orbits	
WA6VJR	p. 46, Mar 81

semiconductors

Amplifiers, biasing Class-A bipolar transistor	
KQ7B	p. 32, Aug 82
GaAs FET performance and preamplifier application	
K8UR	p. 38, Mar 83
Comments, KC0W	p. 12, Jul 83
Predicting close encounters: OSCAR 7 and OSCAR 8	
K2UBC	p. 62, Jul 79
Solid-state replacements (Tech. forum)	
AK7N	p. 46, Apr 83

single sideband

Early single-sideband transmitter (ham radio techniques)	
W6SAI	p. 30, Dec 81
Linear amplifier design	
W6SAI	
Part 1	p. 12, Jun 79
Part 2	p. 34, Jul 79
Part 3	p. 58, Aug 79

Linear amplifier, modular, for the high-frequency	
Amateur bands	
K8RA	p. 12, Jan 81
Comments K1THP	p. 6, Mar 81
Speech processor, split-band	
N7WS	p. 12, Sep 79

software

TI58/TI59 (HN)	
K3VGX	p. 65, Mar 82

television

Console, video, for ATV	
WB8LGA	p. 12, Jan 80
CRT character enhancer	
W9CGI	p. 66, Aug 82
Display SSTV pictures on a fast-scan TV	
K6AEP	p. 12, Jul 79
Medium-scan television	
W9NTP	p. 54, Dec 81
SSTV, applying microcomputers to	
G3ZCZ/4X	p. 20, Jun 82

transmitters and power amplifiers

general

Air pressure measurements across transmitting tubes (HN)	
W4PSJ	p. 73, Dec 79
A-m/fm converter for facsimile transmission, an	
SM6FJB	p. 12, Dec 81
CQer, automatic, for RTTY	
W4AYV	p. 18, Nov 80
Eimac 5CX1500A power pentode, notes on	
K9XI	p. 60, Aug 80
Linear power amplifiers (letter)	
KB5EY, W8SAI	p. 6, Dec 79
Lowpass filters, elliptic, for transistor amplifiers	
W3NQN	p. 20, Jan 81
Quartz crystals (letter)	
WB2EGV	p. 12, Dec 79
Single-conversion transceivers, digital frequency display for	
K6YHK	p. 28, Mar 81
Talking clock (letter)	
N9KV	p. 75, Feb 80
Talking digital readout (letter)	
N5AF	p. 6, May 80
VMOS on 1750 meters	
K1RGO	p. 71, Oct 83
6-meter amplifier	
W2GN	p. 72, Apr 83
Short circuit	p. 97, Aug 83
40-meter transmitter-receiver	
W6XM	p. 43, Dec 82
5CX1500 screen protection (HN)	
VE3AIA	p. 58, Mar 83
XK2C AFSK generator, the	
W3HVK	p. 58, Nov 80

flea market



RATES Noncommercial ads 10¢ per word; commercial ads 60¢ per word **both payable in advance.** No cash discounts or agency commissions allowed.

HAMFESTS Sponsored by non-profit organizations receive one free Flea Market ad (subject to our editing) on a space available basis only. Repeat insertions of hamfest ads pay the non-commercial rate.

COPY No special layout or arrangements available. Material should be typewritten or clearly printed (not all capitals) and must include full name and address. We reserve the right to reject unsuitable copy. **Ham Radio** cannot check each advertiser and thus cannot be held responsible for claims made. Liability for correctness of material limited to corrected ad in next available issue.

DEADLINE 15th of second preceding month.

SEND MATERIAL TO: Flea Market, Ham Radio, Greenville, N. H. 03048.

QSL CARDS

QSLs & RUBBER STAMPS — Top Quality! Card Samples and Stamp info — 50¢ — Ebbert Graphics 5R, Box 70, Westerville, Ohio 43081.

TRAVEL-PAK QSL KIT — Converts post cards, photos to QSLs. Stamp brings circular. Samco, Box 203-c, Wyanntskill, New York 12198.

FOR SALE: Two only Westinghouse 4-125-A factory sealed carton. Both for \$100.00. No C.O.D. O.H. Uhrbrock, Sr., W5GYP, 712 Alameda, San Juan, TX. (512) 787-6414.

NEED TO CONTACT James Navarchi concerning Yaesu gear. C.T. Huth, 146 Schonhardt St., Tiffin, OH 44883.

PROFESSIONAL QUALITY circuit boards at ham prices. Catalog \$1.50. Dynacraft Industries, Box 296, Meadowlands, PA 15347.

CHASSIS and cabinet kits. SASE K3IWK.

Foreign Subscription Agents for Ham Radio Magazine

Ham Radio Austria
Karin Ueber
Postfach 2454
D-7850 Loerrach
West Germany

Ham Radio Belgium
Sterehouse
Brusselsesteenweg 416
B-9218 Gent
Belgium

Ham Radio Canada
Box 400, Goderich
Ontario, Canada N7A 4C7

Ham Radio Europe
Box 2084
S-194 02 Upplands Vasby
Sweden

Ham Radio France
SM Electronic
20 bis, Ave des Clarions
F-89000 Auxerre
France

Ham Radio Germany
Karin Ueber
Postfach 2454
D-7850 Loerrach
West Germany

Ham Radio Holland
Postbus 413
NL-7800 Ar Emmen
Holland

Ham Radio Italy
Via Pordenone 17
I-20132 Milano
Italy

Ham Radio Switzerland
Karin Ueber
Postfach 2454
D-7850 Loerrach
West Germany

Ham Radio UK
P.O. Box 63, Harrow
Middlesex HA3 6HS
England

Holland Radio
143 Greenway
Greenside, Johannesburg
Republic of South Africa

KW RF AMPLIFIER, consisting of chassis, socket, chimney, plate choke, all caps with two good PL172/8295 tubes, blower, BW850A, 350 pf 4.5 KV cap, 2000 pf cap, trade for Loran-C receiver or 2 meter programmable hand-held. Tom Johnson, N6BP, 6533 60A N.W., Oak Harbor, WA 98277. (206) 675-8670.

VLF-LF preamps, coupler, Loran-C boards. SASE. Burhans Electronics, 161 Grosvenor St., Athens, Ohio 45701.

HELP! In dire need of schematic for Hamtronics CA-144 VHF Converter 28 MHz I.F. Have the kit but lost the schematic. Box is stamped 8010 which means Oct. 1980. Rev A is NOT one I need. Will pay. Stephen Bach, Rt. 2, Box 89, Scottsville, VA 24590. (804) 286-3466. Thanks.

ELECTRON TUBES: Receiving, transmitting, microwave . . . all types available. Large stock. Next day delivery most cases. Daily Electronics, 14126 Willow Lane, Westminster, CA 92683. (714) 894-1368.

FOR SALE: Eico; 242 Fet-TVOM \$90.00; 150 signal tracer \$80.00; 330 RF signal generator \$90.00; 944 Flyback transformer + yoke tester \$50.00; Butler National Corp. 40 MHz frequency counter \$110.00. All units in excellent condition. Ask for Craig. (316) 792-1552.

WANTED: Kenwood TS-700SP transceiver and MARS-7600 adapter. C.T. Huth, 146 Schonhardt, Tiffin, OH 44883.

AUTODIALER BOARD, Ham Radio, August 1982. \$8.00 + \$1.50 shipping/handling. Catalog \$1.50. Dynacraft Industries, Box 296, Meadowlands, PA 15347.

TRANSMITTER, Hallicrafter BC-610-1, 2-18 MHz, 400W, good condition \$225 or best offer. Glenn, 3748 Yosemite, San Diego, CA 92109. (619) 272-7538.

RECLAIM SILVER from electronics scrap. Write RALTEC, 25884F Highland, Cleveland, OH 44143.

MOBILE IGNITION SHIELDING. Estes Engineering, 930 Marine Dr., Port Angeles, WA 98362.

DISKS CONTROL-DATA 5-1/4" SSDD \$22.00 plus s&h 3%, minimum \$3.00; checks — allow clearing time; Mastercard/Visa include number & expiration date; mainland U.S. only via UPS; no APO/FPO/COD's; NJ residents add 6% tax; prices subject to change without notice; OUT-PRINT, 44 Forrest Road, Randolph, NJ 07869.

CABLE CONVERTERS, decoders. Catalog \$1 refundable. APS, POB 263 HR, Newport, RI 02840.

GALAXY V Mk2, P.S., manual. Needs work but CW, RX working. Price negotiable. Also Drake 2C, manual. Good \$125.00. Bernard Pollock, 1330 SE Walnut, Hillsboro, OR 97123. (503) 648-1857.

RTTY-EXCLUSIVELY for the Amateur Teleprinter. One year \$7.00. Beginners RTTY Handbook \$8.00 includes journal index. P.O. Box RY, Cardiff, CA 92007.

SELL QST 1926-1978 less 4 issues 1930; all 1931, August 1946, November 1958 — \$500. Drake R4B with 10 auxiliary crystals — \$250. TR-4, RV-4, AC-4 — \$350. Professionally built 3-1000Z G-G amplifier with power supply, less than 50 hours use — \$500. New 4-250A — \$50. Pair new Penta 4D-21's — \$50 each. You pick up. Frank Wilson, W5DML, PO 1924, Gonzales, TX 78629. (512) 672-3961.

"KT5B" MULTI-BAND Antenna 160-10m \$59.95, SO239/PL259 weather boot kit \$5.95, 2m DDDR mobile antenna \$39.95, 2KW roller inductor 28mh \$47.50 plus more! Kilo-Tec, P.O. Box 1001, Oakview, CA 93022. Tel: 805-646-9645.

IRMA — International Mission Radio Assn. helps missionaries — equipment loaned; weekday net, 14.280 MHz, 2-3 PM Eastern. Br. Frey, 1 Pryer Manor Rd., Larchmont, NY 10538.

HAM HOLIDAY Sri Lanka. Write to Spangles Travels, 84 Templers Road, Mount Lavinia, Sri Lanka. Enclose 5 IRCs.

TENNAEST — Antenna noise bridge — out-performs others, accurate, costs less, satisfaction guaranteed. Send stamp for details, W8URR, 1025A Wildwood Road, Quincy, MI 49082.

HALLICRAFTERS \$\$\$ Serious collector needs Hallicrafter and other Ham equipment manufactured before 1940 for restoration and eventual museum exhibit. Need Hallicrafters, National, Hammarlund, Patterson, RCA, RME, Grebe, etc. Condition not important. Also need QST mags Vols. I & II and old tubes. All letters answered. Write Dave Medley, WA5YXA, 6621 Duffield Drive, Dallas, Texas 75248.

PRECISION PROCESSING



The E-CLIPS Model III

Provides total dynamic range control with very low distortion

- Selectable processing modes—envelope compression or peak limiting
- Variable high and low frequency response equalization
- Five segment LED display
- Easy to install and use with any transmitter/transceiver

Introductory price—\$189.95 ppd.

For brochure with complete technical specifications, contact:

ANALOG TECHNOLOGY

P.O. Box 8964 • Fort Collins, CO 80525

113

BASIC PROGRAM MANUAL FOR AMATEURS

Programs Design: Quads, beams, trap dipoles, antenna wind load, filters, pads, striplines, op amps, microwave, RF coils, calc. Ohms law, L. C. power, log QSO's, global distances and much more.

All for \$9.95 (INCLUDES SHIPPING AND HANDLING)

ATTENTION YAESU FT-207R OWNERS



AUTOMATIC SCAN MODULE
15 minutes to install; scan restarts when carrier drops off; busy switch controls automatic scan on-off; includes module and instructions.

Model AS-1 \$25.00

BATTERY SAVER KIT

Model BS-1 \$14.95

- No more dead batteries due to memory backup
- 30% less power drain when squelched
- Simple to install, step-by-step instructions and parts included
- 4 mA memory backup reduced to 500 µA
- 45 mA receiver drain reduced to 30 mA
- Improved audio fidelity and loudness

140

ENGINEERING CONSULTING

P.O. BOX 216 DEPT. H
BREA, CALIFORNIA 92621

DX TOUR

- Australia
- New Zealand
- Fiji
- Hawaii

THREE WEEKS
OCTOBER 11 thru 31, 1984

Departs from Los Angeles

For Hams, Spouses and Friends
Meet and greet your ham friends in their own countries. Welcoming events by local hams and clubs.

Tour directors: Jean (WA6AKP) and Bill (W6UFS) Thompson

Write for brochure:

DX TOURS

81 Fashion Island
Newport Beach, CA 92663

or
Call Jean (714) 640-0821

SPACE LIMITED — RESERVE EARLY

137
VK-ZL-3D2-KH6-VK-ZL-3D2-KH6-VK-ZL-3D2-KH6-VK-ZL

high-frequency transmitters

- Air pressure, measuring across transmitting tubes (HN)
W4PSJ p. 89, Jan 80
- ALC circuits, an analysis of
K4JW p. 19, Aug 81
- CB to 10 fm transceiver conversion
VE3FIT, VE3AQN p. 16, Feb 83
- Improved stability and dial calibration for the Heathkit HW-8 (HN)
W3HVK p. 103, Nov 83
- Kilowatt mobile for DX
K5DUT p. 43, Dec 80
- Linear-amplifier cost efficiency
W8MFL p. 60, Jul 80
- Linear amplifier design
W6SAI
Part 1 p. 12, Jun 79
Part 2 p. 34, Jul 79
Part 3 p. 58, Aug 79
- Linear amplifier, modular, for the high-frequency
Amateur bands
K8RA p. 12, Jan 81
Comments K1THP p. 6, Mar 81
- Lowpass filters, elliptic, for transistor amplifiers
W3NQN p. 20, Jan 81
- Remote control hf operation
K5QY p. 32, Apr 83
Short circuit p. 97, Aug 83
- 15-meter sideband transceiver
WA4ZXF p. 12, Mar 83
Short circuit p. 80, Jul 83

vhf and uhf transmitters

- Converter, dc-dc, increases Gunnplexer frequency swing (HN)
W1XZ p. 70, Apr 80
- Synthesized 2-meter mobile stations, automation for
W9CGI p. 20, Jun 80
- 220-MHz kilowatt linear
W6PO p. 12, Jun 80

troubleshooting

- I-f transformers, problems and cures (weekender)
K4IPV p. 56, Mar 79

vhf and microwave

general

- Battery-voltage monitor for HTs (weekender)
K2MWU p. 78, Sep 82
- Cavity filters, surplus, how to modify for 144 MHz
W4FXE p. 42, Feb 80
- Diplexer mods (HN)
K5PFE p. 89, Apr 83
- Earth-moon-earth (ham radio techniques)
W6SAI p. 40, Feb 81
- Efficient matching (Tech. forum)
VE7BS p. 83, Sep 83
- EI2W six-meter report (letter)
EI2W p. 12, Jul 80
- Frequency synthesizer (letter)
WA3AXS p. 12, Jul 80
- F-237/GRC surplus cavity filter, conversion versatility using the
W4FXE p. 22, Dec 80
- Gunn oscillator design for the 10-GHz band
WB2ZKW p. 6, Sep 80

- Handheld transceiver mount (a 2-way ashtray for your car) (weekender)
KB2XM p. 64, Jul 81
- Helical antenna matching (Tech. forum)
Belliveau, John p. 73, May 83
- Instant balun (letter)
W8MQW p. 6, Aug 81
- K9LHA 2-meter synthesizer, extending the range of (HN)
K9LHA p. 52, Dec 81
- L-band local oscillators
N6TX p. 40, Dec 79
- Microwave-frequency converter for vhf counters
KA9BYI p. 40, Jul 80
- Microwave network for multimode communications
K4TWJ p. 36, Aug 82
- Microwave systems, first building blocks for
WA2GFP p. 52, Dec 80
- Monitor, tone alert
W4KRT p. 24, Aug 80
- More about moonbounce (ham radio techniques)
W6SAI p. 34, Mar 81
- Multipurpose uhf oscillator, simplifying the
WA9HYV p. 26, Sep 81
- Plasma-diode experiments
Stockman, Harry p. 62, Feb 80
- Power supply, amplifier
WA2GFP p. 32, Sep 83
- Radio telescope antenna requirement (Tech. forum)
Landecker, Tom p. 44, Mar 83
- Repeater security
WA5FRF p. 52, Feb 81
- Super deep circuit for repeaters
K4AQI p. 48, Jul 81
- Synthesized time identifier for your repeater
WA4GUA p. 42, Nov 82
- Tone decoder, the ultimate
WD9EIA, WB9HGZ p. 33, Sep 82
Comment, WD9EIA p. 8, Feb 83
- Touchtone auto-dialer, portable
K2MWU p. 12, Aug 82
Comments, K2MWU p. 8, Feb 83
- Two-meter autopatches, tone-encoder for
WB0VSZ p. 51, Jun 80
- Varactor tuning tips (HN)
N3GN p. 69, Dec 80
- Voltage-tuned UHF oscillator, multipurpose
WA9HUV p. 12, Dec 80
- VHF techniques
W6NBI p. 62, Jul 80
- VHF transceivers, regulated power supply for
WA8RXU p. 58, Sep 80
- Weather radar, 10-GHz
K4TWJ p. 61, Sep 83
- Wireless 220-MHz to 2-meter converter (weekender)
W3RW p. 36, Jan 82
- X-band calibrator
WA6EJO p. 44, Apr 81
- X-band mixer, low noise (Tech. forum)
N5AX p. 22, Jan 83
- 10-GHz cross-guide coupler
WB2ZKW p. 66, Oct 79
- 10-GHz Gunnplexer transceivers, construction and practice
Comments, W6OAL p. 26, Jan 79
p. 6, Sep 79
- 10-GHz oscillator, ultra stable
K8UR p. 57, Jun 83
- 40-meter transmitter-receiver
W6XM p. 43, Dec 82
- 144-MHz frequency synthesizer, CMOS
K9LHA p. 14, Dec 79
Short circuit p. 81, Apr 80
- 440-MHz bandpass filter
WA8YBT p. 62, Nov 79

vhf and microwave antennas

- Antenna-performance measurements using celestial sources
W5CQ/W4RXY p. 75, May 79
- Cylindrical feedhorns, second-generation
WA9HUV p. 31, May 82
- Fresnel-zone plate for 10.4 GHz
WB6YVK p. 44, May 82
Comments, KB9O, WB6YVK p. 8, Nov 82
- Inexpensive five-eighth wave groundplane (HN)
W7CSD p. 84, Mar 81

- Matching 432 MHz helical antennas (Tech. forum)
WB4GCS p. 44, Mar 83
- Re-entrant cavity antenna for the vhf bands
W4FXE p. 12, May 81
- True north, how to determine for antenna orientation
K4DE p. 38, Oct 80
Comments, N6QX, K4DE p. 7, Mar 81
- Using a 2-meter quarter-wave whip on 450 MHz (HN)
K1ZJH p. 92, May 81
- Weathering the elements at 10.4 GHz
WB6YVK p. 74, Aug 82

vhf and microwave receivers and converters

- Add fm to your receiver (weekender)
K3NXU p. 74, Mar 81
- Cavity filters, surplus, how to modify for 144 MHz
W4FXE p. 42, Feb 80
- Crystal-controlled vhf receivers, tuning aid for (HN)
WA1FHB p. 69, Jul 80
- Fm transceiver, remote synthesized for 2 meters
WB4UPC p. 28, Jan 80
- GaAs FET performance and preamplifier application
K8UR p. 38, Mar 83
Comments, KC0W p. 12, Jul 83
- Kenscan 74
WB7QYB p. 50, Jan 81
Short circuit p. 89, Jan 82
- Modification of K9LHA 2-meter synthesizer for 144-148 MHz coverage (HN)
K9LHA p. 93, May 81
- Preamplifier design, UHF, computer-aided
KB0O p. 28, Oct 82
- Preamplifiers, vhf low-noise
WA2GFP p. 50, Dec 79
- Synthesizer, genesis of a
VE3FIT p. 38, Mar 81
- Uhf local-oscillator chain
N6TX p. 27, Jul 79
- 2-meter synthesizer, frequency modulator for
K9LHA p. 68, Apr 81
- 2-meter transverter
W6HPH p. 24, Jan 82
- 2-meter weather converter (weekender)
WA3EEC p. 87, Dec 83
- 10-80 MHz preamp, low-noise, low-cost
WA2GFP p. 65, May 81
- 144-432 MHz GaAs fet preamp
JH1BRY p. 38, Nov 79
- 432-MHz converter
N9KD p. 74, Apr 79
- 2304-MHz preamplifier, low-noise
WA2GFP p. 12, Feb 83

vhf and microwave transmitters

- Amplifier, 2 meter, 40 watt
WB4GCS p. 50, Oct 83
- ANUPX-6 cavities, converting surplus
W6NBI p. 12, Mar 81
- CMOS 2-meter synthesizer
K9LHA p. 14, Dec 79
Short circuit p. 89, Jan 82
- Fm transceiver, remote synthesized for 2 meters
WB4UPC p. 28, Jan 80
- Linear amplifiers, solid-state vhf
AFBZ p. 48, Jan 80
- Modification of K9LHA 2-meter synthesizer for 144-148 MHz coverage (HN)
K9LHA p. 93, May 81
- Solid-state power for 1296 MHz
N6JH p. 30, Feb 81
- Synthesizer, genesis of a
VE3FIT p. 38, Mar 81
- 2-meter synthesizer, frequency modulator for
K9LHA p. 68, Apr 81
- 6-meter amplifier
W2GN p. 72, Apr 83
Short circuit p. 97, Aug 83
- 50-MHz SSB exciter
K1LOG p. 12, Oct 79
- 144-MHz 10/80-watt amplifier
WB9RMA p. 12, Feb 79

UHF/VHF BOOK SPECIAL OFFER

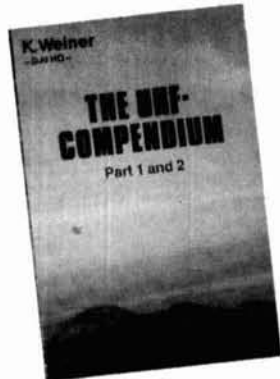

THE UHF COMPENDIUM by K. Weiner, DJ9HO

This 413 page book is an absolute must for every VHF and UHF enthusiast. Special emphasis has been placed on state-of-the-art techniques. Author Weiner fully describes test equipment, alignment tools, power measuring equipment and other handy gadgets. All of the projects and designs have been tested and proven and are not engineer's pipe dreams. Antennas are also fully covered with a number of easy-to-build designs as well as large mega-element arrays. ©1980.

KW-UHF Softbound \$23.75



VHF-UHF MANUAL

by G.R. Jessop, G6JP

This new, revised 4th edition is jam-packed with circuits, antennas, converters, cavity amplifiers and much, much more. Practical theory and construction projects cover from 70 MHz to 24 GHz. The chapter on Microwaves has been expanded to 83 state-of-the-art pages. Receiver and transmitters for all VHF and UHF bands are covered in 181 pages. The balance of this book contains information on propagation, tuned circuits, space communications, filters, test equipment, antennas, plus a handy easy-to-use data section. Equipment designed for the British 4 meter band can be adapted fairly easily to the U.S. 6 meter allocation. ©1983, 512 pages, 4th edition.

RS-VH Hardbound \$17.50

VHF/UHF BOOK SPECIAL OFFER

Buy 'em separately \$41.45

SPECIAL PRICE \$35.95

SAVE \$5.50

Please add \$2.50 for shipping

HAM RADIO'S BOOKSTORE
Greenville, NH 03048

flea market

WANTED, MILITARY SURPLUS RADIOS. We need Collins 618T, ARC-72, ARC-94, ARC-102, RT-712/ARC-105, ARC-114, ARC-115, ARC-116, RT-823/ARC-131, or FM-622, RT-857/ARC-134 or Wilcox 807A, RT-743/ARC-51A, ARC-159, RT-1167 or RT-1168/ARC-164, ARC-186, RT-1022/ARN-84, ARN118, RT-859/APX-72, RT-868/APX-76, APN-153, APN-155, APN-171, 718F-1/2, RT-618/URC, AM-3007A/URT, Collins antenna couplers type 490T-1, 490T-2, 490T-9, CU-1658A/ARC, CU-1669/GRC, 490B-1, 690D-1, CU-1239/ARC-105. Top dollar paid or trade for new amateur gear. Write or phone Bill Slep 704-524-7519, Slep Electronics Co., Hwy. 441, Otto, N. C. 28763.

WANTED: Cash paid for used Speed Radar equipment. Write or call: Brian R. Esterman, P.O. Box 8141, Northfield, Illinois 60093. (312) 251-8901.

WANTED: Old RCA, Western Electric tubes. (713) 728-4343. Maury Corb, 11122 Atwell, Houston, Texas 77096.

PARABOLIC ANTENNA, spun aluminum, 6 ft. with mount \$325.00. 408-730-2500. Norman, 2225 Sharon Rd., #224, Menlo Park, CA 94025. (415) 854-0266.

WANTED: Early Hallicrafter "Skyriders" and "Super Skyriders" with silver panels, also "Skyrider Commercial", early transmitters such as HT-1, HT-2, HT-8, and other Hallicrafter gear, parts, accessories, manuals. Chuck Dachis, WD5EOG, The Hallicrafter Collector, 4500 Russell Drive, Austin, Texas 78745.

WANTED: Boonton/HP type 250B RX meter also service manual for ex USN receiver type R1051B/URR. Write: Gill, 72 Elgin Street, Gordon, 2072, Australia.

RADIO WEST! High quality coverage communications receivers with Collins filters and other DX modifications! Catalog 50¢ (refundable). Radio West, 3417 Purer Rd., Dept. HR, Escondido, CA 92025. (619) 741-2891.

VERY in-ter-est-ing! Next 4 issues \$2. Ham Trader "Yellow Sheets", POB356, Wheaton, IL 60189.

ANNIE'S EASY. Analyze dipoles, slopers, verticals, inverted-vees and arrays; any orientation, position, phasing, weight or combination with Annie Antenna Analysis Software. Include REAL GROUND (conductivity, dielectric constant). Superb hi-res plotting. Annie's incredibly friendly and with 100% machine language, she's FAST! For Apple II+ (language card required) or Ile, DOS3.3, \$49.95 + \$2.00 postage, NY add sales tax. Include full name and call. S.A.S.E. for info. Commercial, library, etc., call for quote (315) 622-3641. Sonnet Software, Dept. HR, 4397 Luna Course, Liverpool, NY 10388.

Coming Events ACTIVITIES "Places to go..."

WISCONSIN: The West Allis Radio Amateur Club's 12th annual Midwinter Swapfest, Saturday, January 7, Waukesha County Expo Center Forum. Starting time 8 AM. Admission \$2.00 advance; \$3.00 at door. Reserved tables \$3.00 until 11 AM or \$4.00 at the door. Delicious food. For tickets or information SASE to WARAC, PO Box 1072, Milwaukee, WI 53201.

South Bend, INDIANA: Hamfest Swap & Shop, January 8, first Sunday after New Year's Day at Century Center downtown on U.S. 33 Oneway North between St. Joseph Bank Building and river. Industrial history Museum in same building. Carpeted half acre room. Tables \$3 each. Four lane highways to door from all directions. Talk in freq: 52-52, 99-39, 93-33, 78-18, 69-09, 145.43, 145.29.

OPERATING EVENTS "Things to do..."

DECEMBER 16 AND 17: The Triple States Radio Amateur Club will operate WD8DDL/8 from Bethlehem, West Virginia, 1400 to 0200 UTC daily. Frequencies: 7.275, 14.325, 21.425 and 28.550 MHz on SSB. 7.110, 14.075, 21.110 and 28.110 MHz on CW and 14.095 MHz on RTTY. A special holiday certificate will be sent to all those contacted who send a SASE to TSRAC, 26 Maple Lane, Bethlehem, Wheeling, WV 26003.

DECEMBER 17: The Burn family will operate B-N8EVE, U-KD8EO, R-N8EVF, N-KD8EV during Seasons Greetings from "The Little Town of Thompson, Ohio," from 1400-2000 UTC and December 18 from 1400-2000 UTC on 40 meters in General class band. You must work all four hams to receive your certificate. Please send SASE and QSL to 6215 Clay Street, Thompson, OH 44086 for 8 1/2" x 11" certificate.

DRAKE R-4/T-4X OWNERS AVOID OBSOLESCENCE

PLUG-IN SOLID STATE TUBES!
Get state-of-the-art performance.
Most types available

INSTALL KITS TO UPGRADE PERFORMANCE!
Basic Improvement, Audio Low Pass Filter, Audio IC Amplifier

TUBES \$23 PPD KITS \$25 PPD

OVERSEAS AIR \$7

TEXANS TAX 5%

SARTORI ASSOCIATES, W5DA

BOX 2085

RICHARDSON, TX 75080

214-494-3093

✓ 196

THE 1ST

2300 MHz A5 Transmitter and Accessories

Now you can actually transmit Fast Scan TV on the 2300 MHz Ham Band. Gizmo's 25 mw exciter is the first commercially manufactured transmitter for this band.

All units preassembled, tested and have a 30-day money back guarantee.

- 2300 MHz 25 milliwatt exciter \$49.95
- 4.5 MHz subcarrier generator \$19.95
- AM Video Modulator \$19.95

Buy all three and save \$5

Regularly \$89.95 Just \$84.85

Gizmo also has a 70 MHz 50 milliwatt upconverter for \$149.95

Please allow enough for shipping. ✓ 147
Any excess will be refunded.

GIZMO ELECTRONICS

PO Box 1205

Pittsburgh, KS 66762

(316) 231-8171

Kansas residents add 3.5% sales tax.

KATSUMI! No. 1! Electronic Keyers, etc.



4 Memory channels 256 bits ea. or 1 1024 bit message; squeeze or std. keying; auto or semi-auto keying; paddle, monitor, etc.

MK-1024 \$180 PPD

EK-150 same as 1024 except no message memory channels.

EK-150 \$110 PPD



Chromed; non skid base; dust cover. Silver contacts.

HK-706 \$27.00 PPD

100% Money-back Guarantee.

Dealers Wanted.

Free info., other products.

GLOBALMAN PRODUCTS

P.O. Box 400H, El Toro, Calif. 92630

(714) 533-4400

✓ 148

HAM MART

Ham Radio's guide to help you find your local

California

C & A ROBERTS, INC.
18511 HAWTHORN BLVD.
TORRANCE, CA 90504
213-370-7451
24 Hour: 213-834-5868
Not The Biggest, But The Best —
Since 1962.

FONTANA ELECTRONICS
8628 SIERRA AVENUE
FONTANA, CA 92335
714-822-7710
714-822-7725
The Largest Electronics Dealer in San
Bernardino County.

JUN'S ELECTRONICS
3919 SEPULVEDA BLVD.
CULVER CITY, CA 90230
213-390-8003
619-463-1886 San Diego
800-882-1343 Trades

— Parts at Cost — Full Service.
Habla Espanol

SHAVER RADIO, INC.
1378 S. BASCOM AVENUE
SAN JOSE, CA 95128
408-998-1103
Azden, Icom, Kenwood, Tempo,
Ten-Tec, Yaesu and many more.

Connecticut

HATRY ELECTRONICS
500 LEDYARD ST. (SOUTH)
HARTFORD, CT 06114
203-527-1881
Call today. Friendly one-stop shop-
ping at prices you can afford.

Delaware

DELAWARE AMATEUR SUPPLY
71 MEADOW ROAD
NEW CASTLE, DE 19720
302-328-7728
800-441-7008
Icom, Ten-Tec, Microlog, Yaesu,
Azden, Santec, KDK, and more.
One mile off I-95, no sales tax.

Florida

AMATEUR ELECTRONIC SUPPLY
1898 DREW STREET
CLEARWATER, FL 33575
813-461-4267
Clearwater Branch
West Coast's only full service
Amateur Radio Store.

AMATEUR ELECTRONIC SUPPLY
621 COMMONWEALTH AVE.
ORLANDO, FL 32803
305-894-3238
Fla. Wats: 1 (800) 432-9424
Outside Fla: 1 (800) 327-1917

AMATEUR RADIO CENTER, INC.
2805 N.E. 2ND AVENUE
MIAMI, FL 33137
305-573-8383
The place for great dependable
names in Ham Radio.

RAY'S AMATEUR RADIO
1590 US HIGHWAY 19 SO.
CLEARWATER, FL 33516
813-535-1416
Your complete Amateur Radio and
Computer Store.

Illinois

ERICKSON COMMUNICATIONS, INC.
5456 N. MILWAUKEE AVE.
CHICAGO, IL 60630
312-631-5181
Hours: 9:30-5:30 Mon, Tu, Wed & Fri;
9:30-8:00 Thurs; 9:00-3:00 Sat.

Indiana

THE HAM SHACK
808 NORTH MAIN STREET
EVANSVILLE, IN 47710
812-422-0231
Discount prices on Ten-Tec, Cubic,
Hy-Gain, MFJ, Azden, Kantronics,
Santec and others.

Kansas

ASSOCIATED RADIO
8012 CONSER, P. O. BOX 4327
OVERLAND PARK, KS 66204
913-381-5900
America's No. 1 Real Amateur Radio
Store. Trade — Sell — Buy.

Kentucky

L & S RADIO
307 McLEAN AVENUE
HOPKINSVILLE, KY 42240
502-885-8071
Ten-Tec, Azden, Ameritron Sales and
Service.

Maryland

THE COMM CENTER, INC.
LAUREL PLAZA, RT. 198
LAUREL, MD 20707
800-638-4486
Kenwood, Drake, Icom, Ten-Tec,
Tempo, Microlog, AEA, Ameritron.

Massachusetts

TEL-COM, INC.
675 GREAT ROAD, RTE. 119
LITTLETON, MA 01460
617-486-3040
617-486-3400 (this is new)
The Ham Store of New England
You Can Rely On.

Michigan

ENCON PHOTOVOLTAICS
Complete Photovoltaic Systems
27600 Schoolcraft Rd.
Livonia, Michigan 48150
313-523-1850
Amateur Radio, Repeaters, Satellite,
Computer applications.
Call Paul WD8AHO

Minnesota

MIDWEST AMATEUR RADIO SUPPLY
3452 FREMONT AVE. NO.
MINNEAPOLIS, MN 55412
612-521-4662
It's service after the sale that counts.

Nevada

AMATEUR ELECTRONIC SUPPLY
1072 N. RANCHO DRIVE
LAS VEGAS, NV 89106
702-647-3114
Dale Porray "Squeak," AD7K
Outside Nev: 1 (800) 634-6227

JUN'S ELECTRONICS
460 E. PLUMB LANE — 107
RENO, NV 89502
702-827-5732
Outside Nev: 1 (800) 648-3962
Icom — Yaesu Dealer

New Hampshire

POLCARI'S ELECTRONICS CENTER
61 LOWELL ROAD
HUDSON, NH 03051
603-883-5005
Southern New Hampshire's only Ham
Store. Call today for quotes.

New Jersey

RADIOS UNLIMITED
P. O. BOX 347
1760 EASTON AVENUE
SOMERSET, NJ 08873
201-469-4599
800-526-0903
New Jersey's only factory authorized
Yaesu and Icom distributor. New and
used equipment. Full service shop.

Dealers: *YOU SHOULD BE HERE TOO!*
Contact Ham Radio now for complete details.

Amateur Radio Dealer

ROUTE ELECTRONICS 46
225 ROUTE 46 WEST
TOTOWA, NJ 07512
201-256-8555

ROUTE ELECTRONICS 17
777 ROUTE 17 SOUTH
PARAMUS, NJ 07625
201-444-8717
Drake, Cubic, DenTron, Hy-Gain,
Cushcraft, Hustler, Larsen, MFJ,
Butternut, Fluke & Beckman
Instruments, etc.

New York

BARRY ELECTRONICS
512 BROADWAY
NEW YORK, NY 10012
212-925-7000
New York City's Largest Full Service
Ham and Commercial Radio Store.

GRAND CENTRAL RADIO
155 EAST 45 STREET
NEW YORK, NY 10017
212-682-3869
Drake, Kenwood, Yaesu,
Ten-Tec, DenTron, Hy-Gain,
in stock.

RADIO WORLD
ONEIDA COUNTY AIRPORT
TERMINAL BLDG.
ORISKANY, NY 13424
TOLL FREE 1 (800) 448-9338
NY Res. 1 (315) 337-0203
Authorized Dealer — ALL major
Amateur Brands.
We service *everything* we sell!
Warren K2IXN or Bob WA2MSH.

VHF COMMUNICATIONS
915 NORTH MAIN STREET
JAMESTOWN, NY 14701
716-664-6345
Call after 7 PM and save! Supplying
all of your Amateur needs. Featuring
ICOM "The World System." Western
New York's finest Amateur dealer.

Ohio

AMATEUR ELECTRONIC SUPPLY
28940 EUCLID AVE.
WICKLIFFE, OH (CLEVELAND AREA)
44092
216-585-7388
Ohio Wats: 1 (800) 362-0290
Outside Ohio: 1 (800) 321-3594

UNIVERSAL AMATEUR RADIO, INC.
1280 AIDA DRIVE
REYNOLDSBURG (COLUMBUS), OH
43068
614-866-4267
Featuring Kenwood and all other
Ham gear. Authorized sales and ser-
vice. Shortwave headquarters. Near
I-270 and airport.

Pennsylvania

HAMTRONICS,
DIV. OF TREVOSE ELECTRONICS
4033 BROWNSVILLE ROAD
TREVOSE, PA 19047
215-357-1400
Same Location for 30 Years.

LaRUE ELECTRONICS
1112 GRANDVIEW STREET
SCRANTON, PENNSYLVANIA 18509
717-343-2124
Icom, Bird, Cushcraft, Beckman,
Larsen, Hustler, Belden, Antenna
Specialists, W2AU/W2VS, AEA, B&W,
Amphenol, Saxton, J.W. Miller/Daiwa,
Vibroplex

THE VHF SHOP
BOX 349 RD 4
MOUNTAINTOP, PA 18707
717-868-6565
Lunar, Microwave Modules, ARCOS,
Astron, KLM, Tama, Tonna-F9FT,
UHF Units/Parabolic, Santec, Tokyo
Hy-Power, Dentron, Mirage,
Amphenol, Belden

Texas

MADISON ELECTRONICS SUPPLY
1508 MCKINNEY
HOUSTON, TX 77010
713-658-0268
Christmas?? Now??

Virginia

ELECTRONIC EQUIPMENT BANK
516 MILL STREET, N.E.
VIENNA, VA 22180
703-938-3350
Metropolitan D.C.'s One Stop
Amateur Store. Largest Warehousing
of Surplus Electronics.

Wisconsin

AMATEUR ELECTRONIC SUPPLY
4828 W. FOND DU LAC AVE.
MILWAUKEE, WI 53216
414-442-4200
Wisc. Wats: 1 (800) 242-5195
Outside Wisc: 1 (800) 558-0411
M-F 9-5:30
Sat 9-3

2 for 1
Performance
from
MIRAGE

Dual-purpose power
amplifiers for
HT and XCVR!



- 1-10 Watts Input
- All-mode operation
- 5 year warranty

model:

B1016 (2 meters)

1W In = 35W Out

2W In = 90W Out

10W In = 160W Out

with RX preamp!

\$279.95

C106 (220 MHz)

1W In = 15W Out

2W In = 30W Out

10W In = 60W Out

with RX preamp!

\$199.95

D1010 (430-450 MHz)

1W In = 20W Out

2W In = 45W Out

10W In = 100W Out

\$319.95

There's more, and
WATT/SWR Meters, too!
See your nearest Dealer

MIRAGE
MIRAGE
MIRAGE
COMMUNICATIONS EQUIPMENT, INC.
P.O. Box 1393
Gilroy, CA 95020
(408) 847-1857
made in U.S.A.

Call Long's for all the Hams on your Christmas list!

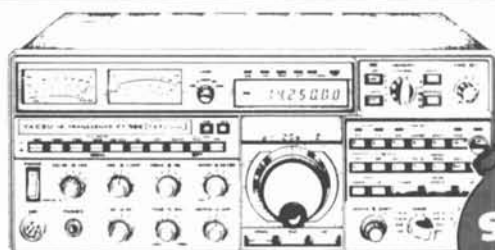

SAVE \$149!

YAESU FT-980 HF transceiver

Yaesu's new ultimate xcvr. 160-10 meter operation, plus general coverage receive. All mode operation. AC powered.

1349.10

List 1499.00 I.N. YAEFT980
Add 9.99 shipping & handling



SAVE \$210!

KENWOOD TS-530S HF transceiver

Covers 160-10 meters including WARC with 220W PEP/180W DC on all bands. IF shift tuning, built-in speech processor. AC powered.

589.00

List 799.95 I.N. KENTS530S
Add 7.44 shipping & handling



SAVE \$50!

ICOM IC-2AT handheld FM transceiver

Fully synthesized tuning with 144-148 MHz coverage and 1.5 or .15W output. TouchTone pad for autopatch operations. Complete with NiCad pack, wall charger, antenna and belt clip.

219.00

List 269.50 I.N. IC02AT/NICD
Add 1.98 shipping & handling

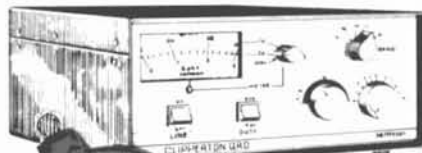

SAVE \$200!

DENTRON QR07 linear amplifier

Built-in power supply with forced air cooling. 160-15 meter coverage and full 2KW PEP on SSB. 117 or 234V AC.

599.00

List 799.00 I.N. DENQR07
Add 9.98 shipping & handling

NEW! HYGAIN Explorer 14 20/15/10 meter beam

Easily loads solid state rigs without antenna tuner. Excellent broadband performance on 20, 15 and 10 meters with 8 dB maximum gain and 27 dB F/B ratio. Boom length: 14' 1/2". Stainless steel hardware.



319.95

List 399.94 I.N. HYGEX14
Add 10.95 shipping & handling

SAVE \$80!



CALL FOR QUOTE!

COMMODORE 64 home computer

Features 64K memory, full-size full-stroke typewriter keyboard and built-in BASIC language. Call toll free today for quote!

List 595.00 I.N. COM64 Add 3.74 shipping & handling

Long's Electronics



Seasons Greetings on amateur gear!

Call
Toll Free



BEARCAT BC-100 handheld scanner

Synthesized tuning with LCD display. Covers 30-50, 138-174 and 406-512 MHz. Carry case, NiCad pack, and charger included.

299.95

List 449.95 I.N. BEABC100
Add 1.98 shipping & handling

SAVE
\$150!

SAVE
\$50!



UNIDEN CR-201 world band radio

Portable communications receiver covers 0.15 to 30 MHz. plus standard FM. Synthesized tuning, LCD frequency display.

249.95

List 299.95 I.N. UNICR201
Add 2.37 shipping & handling



NEW!

ARRL U.S. Amateur Radio Call Directory

New 1983-1984 directory from ARRL lists all U.S. amateurs, plus 32-page club supplement.

15.75

Item No. ARRL18
Add 2.18 shipping & handling



KENWOOD TR-8400 mobile UHF transceiver

FM mobile transceiver with 440-450 MHz coverage, twin VFO's and synthesized tuning. Power requirement: 13.8V DC.

299.95

List 499.95 I.N. KENTR8400
Add 9.00 shipping & handling

SAVE
\$200!



KENWOOD SW-2000 SWR/power meter

Separate SWR and power meters with 1.8-450 MHz range. Through-type detector included. Jacks provided for 2 additional detectors. Requires 12V DC.

98.95

List 109.95 I.N. KENSW2000
Add 1.98 shipping & handling

SAVE
\$11!



KENWOOD HC-10 digital world clock

Dual digital displays indicate local time and time from 10 major world cities. Two additional times can be programmed.

93.55

List 103.95 I.N. KENHC10
Add 1.98 shipping & handling

SAVE
\$10!

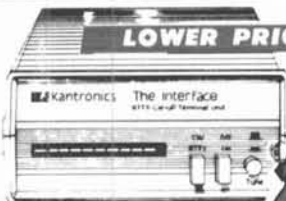

KANTRONICS The Interface

Complete CW/RTTY terminal. Connects between your transceiver and home computer. Decodes CW, RTTY and ASCII.

139.95

List 189.95 I.N. KANINTERFACE
Add 1.79 shipping & handling

SAVE
\$14!

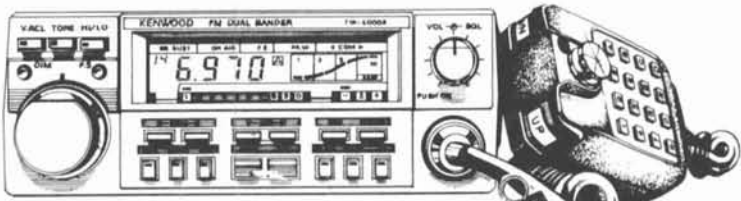

KENWOOD TW-4000A mobile 2m/70 cm FM transceiver

Features 25 watts of power, twin digital VFO's and covers 142-148.995 MHz plus 400-499.995 MHz. Scannable 10-channel memory and programmable band scan. Complete with autopatch up/down mic and mobile mounting bracket. Requires 13.8V DC.

539.95

List 599.95 I.N. KENTW4000A
Add 2.96 shipping & handling

SAVE
\$60!

Call
Toll Free **1-800-633-3410**

IN ALABAMA CALL 1-800-292-8668 9 AM TIL 5:30 PM CST, MONDAY THRU FRIDAY

Clean up the radio/computer clutter.

For less than \$250 you can make your investment in yourself pay off!

Chances are you have spent a couple thousand dollars on setting up a computer system that gets a lot of your work done. But sometimes it gets to be work to work at it.

I know that when I have to move two program manuals and a pencil holder to boot up the disk drive, it is work. When there is an unlabeled floppy (that I am going to identify some day) on top of the monitor and the business check-book is on top of the printer . . . and I will remember (I hope) before the next "report" comes through . . . that is work.

I found the annoyance of my own "computer clutter" was even worse than the extra work the disorder created. And that is when I started looking for some practical furniture for my computer set up. Since I had already spent a lot of money on the system itself, I was really dismayed when I found out how much it would cost to get a decent-looking desk or even a data table for my equipment. \$400 . . . \$500 . . . even more for a sleazy unit that looked like junk! In fact, it was junk! And it took a long time for me to find something that was really worth the money . . . and more.

A lot of my working day is spent with my computer, and I will bet a lot of your time is too. So I figure a "home" for my system—a housing that is good looking as well as efficient to work at—will pay off two ways:

1. Less work: an efficient and orderly layout will save me time and energy.
2. Personal satisfaction: good quality furnishings look better; they just plain feel better to work at too.

So imagine how good I felt to find the "Micro-Office" Work Center! These are fine pieces of computer system furniture that make my office-at-home as pleasant a place to work as it ought to be. And the



MICRO-OFFICE WORK CENTER

biggest and best surprise is the low, low price for such good quality.

Here is what you get—all for only \$249.50 plus shipping.

- Mar-resistant work surface. Your choice of oak or walnut grained. Work surface height is adjustable to your keyboard, your chair, your height.
- Two shelves plus work surface extender. Both shelves tilt to lock in position so that monitor faces you—in a position that does away with screen glare squinting and neck craning forever. Retainer bar keeps equipment from sliding off shelf. Snap-in bookends hold reference manuals and programs.
- Strong, sturdy and steady. All-steel welded frame construction is concealed by top-quality wood grain surfaces with finished trim. Adjustable floor levelers included. The work center is really a piece of fine furniture.
- There is no risk in buying from us either. We will make a full refund of purchase

price plus shipping charges if you return the workcenter within 30 days for any reason whatsoever. In addition, the product is warranted for any defects in materials or construction for a full year from date of purchase. This is a no-risk investment in your own productivity and work efficiency that will pay off for years to come—even if you do not yet have a microcomputer of your own.

- Take your choice for your own work center decor:

Order 48-inch unit in walnut, #2KPO-945, or in oak, #2KPO-947. Only \$249.50 for each unit plus \$20.00 shipping charge. On orders for two or more units at the same time, shipping charge applies to only the first unit ordered. Shipment made UPS, so we cannot ship to post office box. Illinois residents please add \$15 per unit sales tax. Please allow 10 extra days for personal checks to clear. Sorry—at these special offer prices we cannot ship c.o.d. or bill direct.

CALL TOLL FREE TODAY WHILE SUPPLIES LAST: 1-800/323-8064.

In Illinois call 1-312/251-5699. Or mail check with order to:

Micro-Mart Distributors

Dept. HR • 1131 Central Street • Wilmette, IL 60091

1296 & PHASE III

MAKI UTV 1200 - \$499⁹⁵
2M or 6M I.F. / 3 WATTS

MICROWAVE MODULES
432 / PHASE III UNITS
\$269.95

J-BEAM / LOOP YAGIS
AND ACCESSORIES

SEE US IN HOUSTON

SPECTRUM WEST

5717 NE 56th, SEATTLE, WA
206-382-2132 ✓ 200 98105

NEW EGBERT II

RTTY — CW

for

THE APPLE COMPUTER SOFTWARE ONLY

NO TU REQUIRED

Many Standard and UNIQUE FEATURES
(ALL ON ONE DISK)
any MARK and SPACE frequency 500 Hz to
3000 Hz

TRANSMIT OR RECEIVE

ALSO ACCEPTS TTL INPUT TO GAME I/O
C.W. VERSION AVAILABLE

PRICES: RTTY or CW Disk \$39.95
Back-Ups each \$ 7.50
RTTY with CW \$59.95
*Shipping \$ 2.50

Foreign Shipping = \$6.00

(Calif. Residents add 6% tax) ✓ 179

WRITE FOR DETAILS OR ORDER FROM:

W.H. NAIL COMPANY

275 Lodgeview Drive

Oroville, Ca. 95965

(916) 589-2043

CABLE CONVERTER SALE

MAGNAVOX FV-25 - 26 CHANNEL WITH
REMOTE CONTROL - VHF-MIDBAND-
SUPERBAND - REG \$59.95 - NOW **\$49.95**

JERROLD JSX-3DIC - 36 CHANNEL
WITH IN BAND GATED SYNC
DECODER - REG \$209.95 - NOW **\$149.95**

JERROLD SB-3 - IN BAND GATED
GATED SYNC DECODER - USE WITH
ANY CONVERTER WITH OUTPUT ON
CHANNEL 3 - REG \$149.95 - NOW **\$99.95**

UHF BLOCK CONVERTER - CONVERTS
MIDBAND AND SUPERBAND
TO UHF - REG \$39.95 - NOW **\$26.95**

SEND \$1.00 (REFUNDABLE) FOR CATALOG

ADD \$4.25 SHIPPING/HANDLING
FOR EACH UNIT ORDERED

NYS ADD SALES TAX -C.O.D.'S OK

24 HOUR ORDER LINE
(607) 962-7313

ORDER DIRECT FROM -

TAYCO COMMUNICATIONS
R3-146A NARROWS CREEK ROAD
CORNING, NEW YORK 14830 ✓ 205

THE AFFORDABLE REPEATER

FROM THE MANUFACTURER OF COMMERCIAL &
MILITARY EQUIPMENT MADE IN USA AT OUR
MIAMI, FLORIDA PLANT

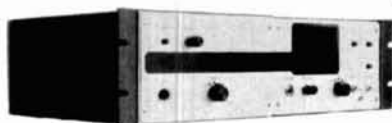

\$699.*

Basic Price

FEATURES:

- Several Frequency Ranges
30-50 MHZ, 132-172 MHZ,
200-240 MHZ, 380-480 MHZ.
- Sensitivity .3 Microvolt 12 DB S/N
- Power Output 30 Watts.
- Four Pole IF Filter.
- Complete separate transmitter
and Receiver
- 13.6 VDC or 115/220 UAC
Power Supply.
- 19" Rack Mounting.

OPTIONS

- Helical Filter Installed \$65.00.
- 8 Pole Filter Installed \$20.00.
- Cooling Fan Installed \$30.00.
- Duplexer
- Deluxe Cabinets
- Timer
- Tone Panel

OTHER PRODUCTS

- Simplex and Full Duplex
- VHF/UHF Mobiles and Bases
- Rural Radio Telephone
- Auto Patch
- HF SSB Transceiver
- Catalogues available upon request

DEALER INQUIRIES INVITED

ITS International Telecommunications Systems Florida Inc.

8416 N.W. 61 ST. / MIAMI, FLORIDA 33166
TEL: (305) 593-0214 / TELEX: 525834

✓ 151

WARNING

SAVE YOUR LIFE OR AN INJURY

Base plates, flat roof mounts, hinged bases, hinged sections, etc., are not intended to support the weight of a single man. Accidents have occurred because individuals assume situations are safe when they are not.

Installation and dismantling of towers is dangerous and temporary guys of sufficient strength and size should be used at all times when individuals are climbing towers during all types of installations or dismantlings. Temporary guys should be used on the first 10' or tower during erection or dismantling. Dismantling can even be more dangerous since the condition of the tower, guys, and/or roof in many cases is unknown.

The dismantling of some towers should be done with the use of a crane in order to minimize the possibility of member, guy wire, anchor, or base failures. **Used towers in many cases are not as inexpensive as you may think if you are injured or killed.**

Get professional, experienced help and read your Rohn catalog or other tower manufacturers' catalogs before erecting or dismantling any tower. A consultation with your local, professional tower erector would be very inexpensive insurance.

**Paid
for by
the following:**



UNR-Rohn
Division of UNR, Inc.
6718 West Plank Road
Peoria, Illinois 61601
USA

Advertisers check-off

... for literature, in a hurry — we'll rush your name to the companies whose names you "check-off"

Place your check mark in the space between name and number. Ex: Ham Radio 234

Ace Comm. 101	Heil 304
ADI 102	Icom 158, 308
ACC 103	I. C. M. 159
AEA 104	Int. Union 160
ARR 105	I. T. S. 161
AEMC 312	Jan Crystals 162
Alden Elec. 106	K and S 163
All Elec. 107	KLM Elec. 164
Alpha Delta 108	Kantronics 165, 166
AEE 109	Kenpro 167
Aluma 110	Kenwood *
Amateur-Wholesale 111	Kilo-Tec 309
ARRL 112	Larsen 168
Analog Tech. 113	Long's 169
AD&M 114	Lunar Elec. 170, 171
Astron 115	MCM Comm. 311
ATV Magazine 116	MFJ 172
Barker & Williamson 117	Macrotronics 173
Barry *	Madison 174
Bauman Sales 118	Memphis Amateur Elec. 175
Bowick 119	Meshna 176
Break Comm. *	Micro-Mart *
Buckmaster 120, 121	Mirage 177
Butternut *	Morning 178, 301
C & A Roberts 122	Mosley 216
Calvert Elec. 123	W. H. Nail 179
Calvert Instr. 303, 124	Nampa 180
Cambridge Tech. 306	Nemal Elec. 181, 182
Caywood 125	Nuts & Volts 183
Ceco 126, 127	P. B. Radio 184
Centurion 128	P. C. Elec. 185
Communications *	Paramount Comm. 186
Comm. Concepts 129	Proham Elec. 187
Comm. Spec. 130	Pro-Search 188
Computer Products and Peripherals 131	RF Products 189
Comp. Trader 132	Callbook 190
Connect Sys. 133	Ramsey 191
Contact East 134	Random Access 192
Direct Video 135	Regency 310
Doppler 136	S & T Elec. 193
DX Tours 137	S & W Elec. 194
Electra 138	SAROC *
Encomm 139	Sartori 196
Eng. Consulting 140	Satellite TV Mag. 197
Flesher 141	Scandex 198
Fluke Mfg. 302, 142	Spectronics *
Fox-Tango 143	Spectrum Comm. 305
GBC TV 144	Spectrum Inter. 199
GLB Elec. 145	Spectrum
Galaxy Elec. 146	West 200
Gem Quad *	Spi-Ro Dist. 201
Gizmo Elec. 147	Sultronics 202
Globalman 148	TE Systems 203
Hal-Tronix 149	Talmage Eng. 204
Ham Industries 313	Tayco Comm. 205
Ham MasterTapes 150	Telex *
H. R. B. 151	Transleteronic 206
H. R. Magazine 152	Tri-Ex 207
Ham Shack 153	UNR-Rohn 208
Hamtronics, N.Y. 154	Vanguard 209
Hamtronics, PA 155	Varian 210
Handi-Tek 156	Viewstar 211
Hatry Elec. 157	Webster Comm. 212
Henry 307	Western Elec. 213
	Yaesu 214
	Young 215

*Please contact this advertiser directly.

Limit 15 inquiries per request.

December 1983

Please use before January 31, 1984

Tear off and mail to

HAM RADIO MAGAZINE — "check off"

Greenville, N. H. 03048-0498

NAME

CALL

STREET

CITY

STATE ZIP

BUTTERNUT ELECTRONICS COMPANY



THE WINNERS

Model HF6V — Completely automatic bandswitching 80 through 10 plus 30 meters. Outperforms all 4- and 5-band "trap" verticals of comparable size. Thousands in use worldwide since December '81! 160 meter option available now. retrofit kits for remaining WARC bands coming soon. Height: 26 ft/7.8 meters, guying not required in most installations.

Model 2MVC "Trombone" — omnidirectional collinear gain vertical for 2 meters having the same gain as "double-A" types, but the patented "trombone" phasing section allows the radiator to remain unbroken by insulators for maximum strength in high winds. No coils "plumber's delight" construction and adjustable gamma match for complete D.C. grounding and lowest possible SWR. Height: 9.8 ft/2.98 meters.

Model 2MVC-5 "Super-Trombone" — Same advanced features as the basic 2MVC but a full wavelength taller with additional gain. Height: 15.75 ft/4.8 meters.

NEW

All BUTTERNUT ANTENNAS use stainless steel hardware and are guaranteed for a full year. For further information on these and other BUTTERNUT products write for our FREE CATALOG!

BUTTERNUT ELECTRONICS

405 E. MARKET STREET
LOCKHART, TX 78644

Advertisers iNdex

Ace Communications	103
Acquis Data, Inc.	86
Advanced Computer Controls	110
Advanced Electronic Applications	41
Advanced Receiver Research	119
All Electronics	56
Alpha Delta Communications	66, 89
Alternative Energy Engineering	106
Aluma Tower Co.	86
Amateur-Wholesale Electronics	72
American Radio Relay League	135
Analog Technology	125
Antenna Development & Manufacturing Co.	54
Astron Corp.	95
ATV Magazine	123
Barker & Williamson	84
Barry Electronics	99
Bauman Sales, R. H.	119
Chris Bowick	102
Break Communications Systems, Inc.	119
Buckmaster Publishing	105, 107
Butternut Electronics	134
C & A Roberts, Inc.	85
Calvert Electronics	20
Calvert Instruments Co.	65
Caywood Electronics, Inc.	105
Ceco Communications	91, 110
Centurion International Communications	11
Communications Concepts, Inc.	104
Communications Specialists	99
Computer Products and Peripherals Unlimited	136
Computer Trader	30
Connect Systems	102
Contact East	35
Direct Video Sales	102
Doppler Systems	107
DX Tours	100
Electra	125
Encomm, Inc.	7
Engineering Consulting	28
Flesher Corp.	125
John Fluke Manufacturing Co., Inc.	38
Fox Tango Corp.	1
GBC TV Corp.	102
GLB Electronics	117
Galaxy Electronics	88
Gem Quad Products	123
Gizmo Electronics	119
Globalman Products	127
Hal-Tronix	127
Ham MasterTapes	26
Ham Radio's Bookstore	71
Ham Radio Magazine	26, 51, 70, 88
The Ham Shack	49
Hamtronics, N.Y.	107
Hamtronics, PA	12, 13
Handi-Tek	56, 57
Hatry Electronics	123
Icom America, Inc.	38
International Crystal Manufacturing, Inc.	Cover II
International Telecommunications Systems	94
International Union Corp.	133
Jan Crystals	103
K and S Electronics	123
KLM Electronics	40
Kantronics, Inc.	101
Kenpro	66, 67
Kenwood Communications	94
Larsen Electronics	2, Cover IV
Long's Electronics	44
Lunar Electronics	130, 131
MFJ Enterprises	30, 107
Macrotronics	5
Madison Electronic Supply	94
Memphis Amateur Electronics	79
John J. Meshna, Jr. Co., Inc.	30
Micro-Mart Distributors	76
Mirage Communications	132
Morning Distributing	129
Mosley Electronics	86
W. H. Nail Co.	108
Nampa Satellite Receiver Systems	133
Nemal Electronics	115
Nuts & Volts	80, 88
P. B. Radio	106
P. C. Electronics	100
Paramount Communications	97
Proham Electronics, Inc.	58
Pro-Search Electronics	38
RF Products	100
Radio Amateur Callbook	83
Ramsey Electronics	8, 9
Random Access, Inc.	26
S & T Electronics	98
S & W Electronics	119
SAROC	121
Sartori Associates	127
Satellite TV Magazine	58
Scandex, Inc.	123
Spectronics	119
Spectrum International	78
Spectrum West	133
Spi-Ro Distributing	106
Sultronics	117
TE Systems	105
Talmage Engineering	102
Tayco Communications	133
Telex Communications	27
Transleteronic, Inc.	106
Tri-Ex Tower Corp.	80
UNR-Rohn	123, 133
Vanguard Labs	86
Varian/Ermac	29
Viewstar, Inc.	37
Webster Communications	117
Western Electronics	86
Yaesu Electronics	Cover III
Phil Young	102

NEW



ORDER TODAY!

1984 HANDBOOK

Another super edition of the standard manual of rf communication! Each year, *The Handbook* is revised to reflect changes in the state-of-the-art and this 61st edition is no exception. The chapter on Specialized Communications Systems has been completely revised with new material on Packet Radio, AMTOR, Spread Spectrum, etc. The Interference chapter has been reorganized and updated and you will find a new and better index. There are new tables for low and high pass filters, updated section on amplifier operation, a new kilowatt amplifier for 160, 80, and 40 meters, a 4-1000 amplifier for 6 meters and a refined version of the Deluxe Audio Filter. In 640 pages and 23 chapters, *The Handbook* presents everything from electrical laws and circuits to sophisticated communications techniques including packet radio and spread spectrum. Order your copy today! Paper edition: \$12 in the U.S., \$13 in Canada, and \$14.50 elsewhere. Cloth edition: \$17.75 in the U.S. and \$20 elsewhere. Payment must be in U.S. funds.



**GET YOUR COPY
TODAY!**

ANTENNA BOOK

14th
EDITION

Here is the most comprehensive and up-to-date antenna book available. It's chock-full of theory and practical information and includes proven designs for: Yagis, quads, wires, verticals or the more specialized designs: Beverage, curtain arrays and fish-bone antennas. It also has a chapter that covers UHF and VHF antenna design. You'll find antennas for any kind of real estate from the apartment dweller to the true antenna farm. *The Antenna Book* covers in complete, easy-to-understand language, antenna and transmission line theory and includes the most complete explanation available of the SMITH CHART®. Finally there is a thorough discussion of the phenomena of radio wave propagation. 328 pages 14th edition. Softbound Price \$8.00 in the US. Elsewhere \$8.50. Clothbound \$12.50, US; \$13.50 elsewhere. (US FUNDS). Available from your local dealer or direct from ARRL.

Please include \$1.00 per title for shipping and handling.

THE AMERICAN RADIO RELAY LEAGUE, INC.

**225 MAIN STREET
NEWINGTON, CT 06111**





Stuck with a problem?

Our TE-12P Encoder might be just the solution to pull you out of a sticky situation. Need a different CTCSS tone for each channel in a multi-channel Public Safety System? How about customer access to multiple repeater sites on the same channel? Or use it to generate any of the twelve tones for EMS use. Also, it can be used to access Amateur repeaters or just as a piece of versatile test equipment. Any of the CTCSS tones may be accessed with the TE-12PA, any of the audible frequencies with the TE-12PB. Just set a dip switch, no test equipment is required. As usual, we're a stickler for 1 day delivery with a full 1 year warranty.

- Output level flat to within 1.5db over entire range selected.
- Immune to RF.
- Powered by 6-30vdc, unregulated at 8 ma.
- Low impedance, low distortion, adjustable sinewave output, 5v peak-to-peak.
- Instant start-up.



TE-12PA

67.0 XZ	85.4 YA	103.5 1A	127.3 3A	156.7 5A	192.8 7A
71.9 XA	88.5 YB	107.2 1B	131.8 3B	162.2 5B	203.5 M1
74.4 WA	91.5 ZZ	110.9 2Z	136.5 4Z	167.9 6Z	
77.0 XB	94.8 ZA	114.8 2A	141.3 4A	173.8 6A	
79.7 SP	97.4 ZB	118.8 2B	146.2 4B	179.9 6B	
82.5 YZ	100.0 1Z	123.0 3Z	151.4 5Z	186.2 7Z	

- Frequency accuracy, ± 1 Hz maximum -40°C to $+85^{\circ}\text{C}$
- Frequencies to 250 Hz available on special order.
- Continuous tone

TE-12PB

TEST-TONES:	TOUCH-TONES:	BURST TONES:
600	697 1209	1600 1850 2150 2400
1000	770 1336	1650 1900 2200 2450
1500	852 1477	1700 1950 2250 2500
2175	941 1633	1750 2000 2300 2550
2805		1800 2100 2350

- Frequency accuracy, ± 1 Hz maximum -40°C to $+85^{\circ}\text{C}$
- Tone length approximately 300 ms. May be lengthened, shortened or eliminated by changing value of resistor

\$89.95

✓ 130

COMMUNICATIONS SPECIALISTS

426 West Taft Avenue, Orange, California 92667
(800) 854-0547/California: (714) 998-3021





MEET THE NEW YAESU FT-102



The FT-102 is factory equipped for operation on all present and proposed Amateur HF bands. An extra AUX band position is available for special applications. Equipped for SSB, CW, and AM (RX), the FT-102 may be activated on FM and AM (TX) via the optional AM/FM-102 Module.

The all-new receiver front end utilizes a low-distortion RF preamplifier that may be bypassed via a front panel switch when not needed. Maximum receiver performance is yours with this impressive lineup of standard features: IF Notch Filter, Audio Peak Filter, Variable IF Bandwidth Control, IF Shift, Variable Pulse Width Noise Blanking, Independent SSB and CW Audio Channels with Optimized Audio Bandwidth, and Front Panel Audio Tone Control. Wide/Narrow filter selection is independent of the Mode switch.

The celebrated transmitter section is powered by three 6146B final tubes, for more consistent power output and very low distortion. An RF Speech Processor, Mic Amp Audio Tone Control, VOX, and an IF Monitor round out the transmitter lineup.

Futuristic panel design and careful human engineering are the hallmarks of the FT-102. Convenient pop-out controls below the meters may be retracted when not in use, thus avoiding inadvertent mistuning. Abundant relay contacts, rear panel phono jacks for PTT, microphone/patch input, and other essential interface connections make the FT-102 extremely simple to incorporate into your station.

SPECIFICATIONS

TRANSMITTER

Power Input: (1.8-25 MHz) (28-29.9 MHz)	
SSB, CW	240W DC 160W DC
AM	80W DC 80W DC
FM	160W DC

RECEIVER

Image Rejection:
Better than 70dB from 1.8-21.5 MHz
Better than 50dB from 24.5-29.9 MHz

IF rejection:
Better than 70 dB

Selectivity (-6 dB/ -60 dB):
SSB, CW, AM; 2.7/4.8 kHz (with no optional filters)
Width adjusts continuously from 2.7 kHz to 500 Hz (-6 dB)

Spurious Radiation: Better than -40 dB



SP-102
The SP-102 External Speaker/Audio Filter features a large, high-fidelity speaker with selectable low- and high-cut audio filters. The front panel A-B switch allows selection of two receiver inputs for maximum versatility. Also available is the SP-102P Speaker/Patch.

See your Authorized Yaesu Dealer today for a hands-on demonstration of the rig that everybody's talking about. It's the FT-102, The Transceiver of Champions!

FV-102DM
The FV-102DM Synthesized External VFO tunes in 10 Hz steps. Keyboard entry of frequencies, UP/DOWN scanning, and 12 memories make the FV-102DM a "must" for serious DX or contest work.

FC-102
The FC-102 Antenna Coupler is capable of handling 1.2KW of transmitter power, with an in-line wattmeter, separate SWR meter, and A-B input/output selection expanding your station's capability. The optional FAS-1-4R allows remote selection of up to four antennas via one coaxial cable connected to the FC-102.

Price And Specifications Subject To Change Without Notice or Obligation 1082R 214

"Comm-packed."

**BIG performance...
small size...
smaller price!!!**

TR-2500

The TR-2500 is a compact 2 meter FM handheld transceiver featuring an LCD readout, 10 channel memory, lithium battery memory back-up, memory scan, programmable automatic band-scan, Hi/Lo power switch and built-in sub-tone encoder.

TR-2500 FEATURES:

- **Extremely compact size and light weight**
Measures 66 (2-5/8) W x 168 (6-5/8) H x 40 (1-5/8) D, mm (inches). Weighs 540 grams (1.2 lbs) with Ni-Cd pack.
- **LCD digital frequency readout**
Shows frequencies and memory channels, four "Arrow" indicators.
- **Ten channel memory**
Nine memories for simplex or ± 600 kHz offset. "M0" memory for non-standard split frequency repeaters.
- **Lithium battery memory back-up**
(Estimated 5 year life.) Maintains memory when Ni-Cd pack is fully discharged or removed.



- **HI/LOW power selection**
2.5 watts or 300 mw.
- **Memory scan**
Scans only channels in which frequency data is stored.
- **Programmable automatic band scan**
Upper and lower frequency limits and scan steps of 5-kHz and larger.
- **UP/DOWN manual scan**
- **Built-in tuneable sub-tone encoder**
Tuneable (variable resistor) to desired CTCSS tone.
- **Built-in 16-key autopatch encoder**
- **"SLIDE-LOC" battery pack**
- **Repeater reverse switch**
- **Keyboard frequency selection**
- **Extended frequency coverage**
Covers 143.900 to 148.995 MHz in 5-kHz steps.
- **Optional power source**
Using optional MS-1 mobile or ST-2 AC charger/power supply, radio may be operated while charging. (Automatic drop-in connections.)



Actual size

- **High impact plastic case**
- **Battery status indicator**
- **Two lock switches**
Prevent accidental frequency change and accidental transmission.

Standard accessories include:

- Flexible antenna with BNC connector
- 400 mA Ni-Cd battery pack
- AC charger

Optional accessories:

- ST-2 Base station power supply/charger (approx. 1 hr.)
- MS-1 13.8 VDC mobile stand/charger/power supply



TR-3500

70 CM FM Handheld

- 440-449.995 MHz in 5-kHz steps
- TX OFFSET switch keyboard programmable ± 5 kHz to ± 9.995 MHz
- 1.5 W/300 mW HI/LOW power switch
- Auto. squelch position on squelch control
- Tone switch for TU-35B optional programmable CTCSS encoder
- Other features include 10 memories, lithium battery memory back-up, programmable automatic band scan, memory scan, UP/DOWN manual scan, repeater reverse, 16-key autopatch, keyboard frequency selection, slide-lock battery.

- VB-2530 2-M 25 W RF power amp., w/cables, mtg. brkt. (TR-2500 only)
- TU-1 Programmable CTCSS encoder (TR-2500 only)
- TU-35B Programmable CTCSS encoder (mounts inside TR-3500 only)
- PB-25 Extra 400 mA Ni-Cd battery
- PB-25H Heavy-duty 490 mA Ni-Cd battery
- DC-25 13.8 VDC adapter.
- BT-1 Battery case for manganese/alkaline AA cells
- SMC-25 Speaker-microphone
- LH-2 Deluxe leather case
- BH-2A Belt hook
- RA-3 m 3/8" telescoping antenna (for TR-2500).
- WS-1 Wrist strap
- EP-1 Earphone

More information on the TR-2500 and TR-3500 is available from all authorized dealers of Trio-Kenwood Communications, 1111 West Walnut Street, Compton, California 90220.

KENWOOD

...pacesetter in amateur radio

Specifications and prices are subject to change without notice or obligation