

# HRT

**Incorporating  
SCANNERS**

## HAM RADIO TODAY

MAY 1993 £1.70

**Pye M296 PMR  
Conversion to  
70cm FM**

**YAESU  
FRG-100  
REVIEWED**



**Pictures  
from  
Space**



**via  
Weather  
Satellites**

05  
9 770269 826031  
**Argus** SPECIALIST PUBLICATION **BEST VALUE**

**NOVICE • PACKET • REVIEWS • PROJECTS • SATELLITES**



DON'T BE SEDUCED BY  
ITS GOOD LOOKS.

BE SEDUCED BY ITS  
PERFORMANCE.



If someone can make a dual-band transceiver as small and feature-packed as this, who cares about its looks? Especially if it's also so sturdy that it shrugs off the knocks and shocks of a lifetime's use. And especially if it has a host of product features, from built-in DTSS and paging functions to alphanumeric

memory, simultaneous dual-frequency receive and message paging. We'll tell you who cares. Kenwood cares.

Which is why the TH78E isn't just the neatest dual-band transceiver you can buy, it's also the best designed. Right down to thoughtful touches like the sliding keypad cover.

So visit your nearest Kenwood approved dealer, pick up the TH78E and admire its ergonomic curves at close quarters. Or simply take in the wonders of its specification.

Either way, it's love at first sight.

*Kenwood TH78E is part of a range of hand portables from £240 to £430.*

**KENWOOD**

HOME AUDIO, CAR AUDIO, COMMUNICATIONS EQUIPMENT, TEST AND MEASURING INSTRUMENTS, TELECOMMUNICATIONS

# HRT

# CONTENTS

## HAM RADIO TODAY

VOLUME II NO.5 MAY 1993

### REGULAR COLUMNS

<b>FROM MY NOTEBOOK</b> .....	36
Geoff Arnold G3GSR explains the mysteries of SSB and CW mixing and filtering	
<b>SATELLITE RENDEZVOUS</b> .....	40
Richard Limebear G3RWL with this month's collation of AMSAT-UK news	
<b>PACKET RADIO ROUNDUP</b> .....	42
Chris Lorek G4HCL reviews the latest DRSI Terminal Node Controller	
<b>VHF/UHF MESSAGE</b> .....	44
Geoff Brown GJ4ICD with a few tips on how to spot Spradic E	
<b>HF HAPPENINGS</b> .....	46
Don field G3XTT gives a few tips on 160m DX aerial systems, and has a tale of aerial tower woe	
<b>QRP CORNER</b> .....	48
Dick Pascoe G0BPS mourns the possible death of QRP kits for EC amateurs	
<b>FREE READERS ADS</b> .....	54
Helplines, For Sale, Exchange and Wanted. Published free.	

### PROJECT

<b>PORTABLE 2M GROUND PLANE AERIAL</b> .....	26
Peter Cole DA1PE shows how to build a simple ground plane to boost your /P signals	

### NEWS AND VIEWS

<b>CQ de G8IYA EDITORIAL</b> .....	5
Where can you become a licensed amateur without paying through the nose?	
<b>LETTERS</b> .....	6
HRT readers have their say!	
<b>RADIO TODAY</b> .....	8
RA Novice Licence improvements, and much more	
<b>CLUB NEWS</b> .....	49
Dynamic go-ahead clubs and local RAE course contact details. Is your club listed? If not, why not?	
<b>RALLIES</b> .....	52
Spring rallies to meet your mates at!	
<b>HRT SUBSCRIPTION OFFER</b> .....	53
Make sure you get your copy each month	
<b>CLASSIFIED ADVERTISEMENTS</b> .....	57
Your local dealers, component and kit suppliers, and RAE courses	

### REVIEW

<b>YAESU FRG-100 REVIEWED</b> .....	14
Chris Lorek looks at the latest 'hot newcomer' in the HF receiver field	

### FEATURES

<b>PYE M296 EX-PMR CONVERSION</b> .....	22
G4HCL continues with the M290 series by featuring a compact 6W/25W rig for 70cm	
<b>SCANNERS</b> .....	29
LA320 Loop Aerial Mini-Review, plus Starting on Weather Satellites	
<b>GETTING READY FOR VHF CONTESTS</b> .....	39
Dick G0BPS gives a beginner's guide to 2m contesting	

**Pye M296 Ex-PMR Conversion to 70cm**

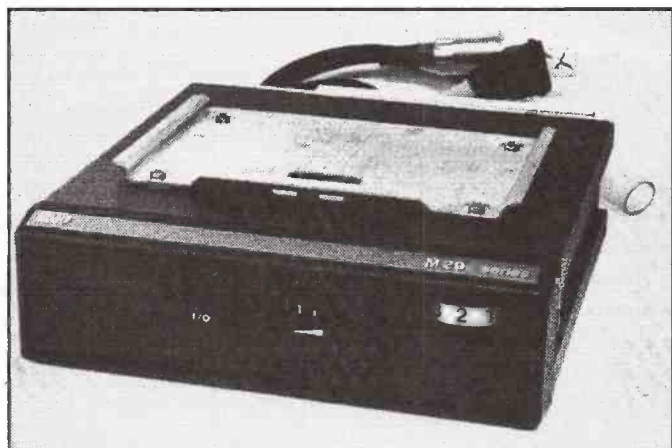

**Project - Portable 2m Ground Plane**

  
 SUBSCRIPTION  
 & BACK ISSUES  
**HOTLINE**  
 0737 768611

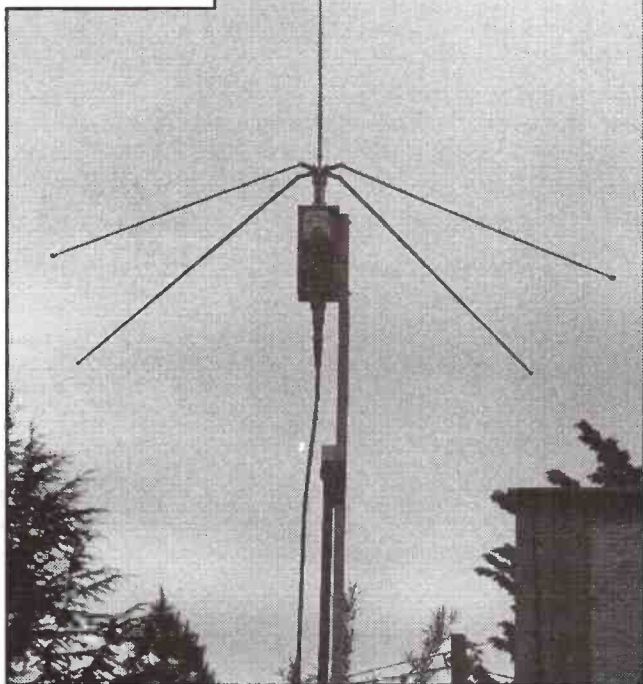



## KENWOOD APPROVED DEALERS

### AVON

AMDAT, 4 Northville Road, Northville,  
Bristol. Tel: 0272 699352

Lowe Electronics, 79 Gloucester Road,  
Patchway, Bristol. Tel: 0272 771770

### BERKSHIRE

Lowe Electronics, 6 Cherwell Close,  
Langley. Tel: 0753 545255

### BUCKINGHAMSHIRE

Photo Acoustics, 58 High Street,  
Newport Pagnell. Tel: 0908 610625

### CAMBRIDGESHIRE

Lowe Electronics, 162 High Street,  
Chesterton, Cambridge.  
Tel: 0223 311230

### DERBYSHIRE

Lowe Electronics, Chesterfield Road,  
Matlock. Tel: 0629 580800

South Midlands Communications,  
102 High Street, New Whittington,  
Chesterfield. Tel: 0246 453340

### DEVON

Reg Ward & Co, 1 Western Parade,  
Axminster. Tel: 0297 34918

### DORSET

Lowe Electronics, 27 Gillam Road,  
Northbourne, Bournemouth.  
Tel: 0202 577760

### ESSEX

Coastal Communications, 19 Cambridge  
Road, Clacton. Tel: 0255 474292

Waters & Stanton, 22 Main Road,  
Hockley. Tel: 0702 206835

Waters & Stanton, 12 North Street,  
Hornchurch. Tel: 0708 444765

### EIRE

Intronic Ltd, Windsor Hall, Glounthaune,  
Cork. Tel: 010353 2135 4422

### HAMPSHIRE

Nevada, 189 London Road, North End,  
Portsmouth. Tel: 0705 662145

South Midlands Communications,  
S M House, School Close, Chandlers  
Ford Industrial Estate, Eastleigh.  
Tel: 0703 255111

### HUMBERSIDE

Peter Rodmell, Field Head House,  
Leconfield. Tel: 0964 550921

### KENT

ICOM UK, Sea Street, Herne Bay.  
Tel: 0227 741741

Lowe Electronics, "The Corner House",  
Chatham Road, Sandling.  
Tel: 0622 692773

### LONDON

A R E, 6 Royal Parade, Hanger Lane  
W5A. Tel: 081 997 4476

Radio Hamstore, 11 Watford Way  
NW4. Tel: 081 202 0073

Martin Lynch, 286 Northfield Avenue  
W5. Tel: 081 566 1120

### MERSEYSIDE

Amateur Radio Communications,  
38 Bridge Street, Newton le Willows.  
Tel: 0925 229881

### MIDDLESEX

Haydon Communications, 132 High  
Street, Edgware. Tel: 081 951 5782

Lowe Electronics, 223 Field End Road,  
Eastcote. Tel: 081 429 3256

### NORFOLK

Eastern Communications, Cavendish  
House, Happisburgh. Tel: 0692 650077

### NORTHUMBERLAND

Lowe Electronics, Newcastle Airport,  
Woolsington. Tel: 0661 860418

### NORTHERN IRELAND

GM Electronics, 1 Evelyn Avenue,  
Belfast. Tel: 0232 671876

Tyrone Amateur Electronics,  
44 High Street, Omagh, County  
Tyrone. Tel: 0662 242043

### NOTTINGHAMSHIRE

R A S Nottingham, 3 Farndon Green,  
Wollaton Park. Tel: 0602 280267

### SCOTLAND

Lowe Electronics, Cumbernauld Airport,  
Cumbernauld, Strathclyde.  
Tel: 0236 721004

Jaycee Electronics, 20 Woodside Way,  
Glenrothes, Fife. Tel: 0592 756962

### WEST MIDLANDS

Dewsbury Electronics, 176 Lower High  
Street, Stourbridge. Tel: 0384 390063

Radio Hamstore, 963 Wolverhampton  
Road, Oldbury. Tel: 021 552 0073

South Midlands Communications,  
504 Alum Rock Road, Birmingham.  
Tel: 021 327 1497

Ward Electronics, 422 Bromford Lane,  
Birmingham. Tel: 021 328 6070

### WEST SUSSEX

Bredhurst Electronics, High Street,  
Hand Cross. Tel: 0444 400786

### YORKSHIRE

Lowe Electronics, 34 New Briggate,  
Leeds. Tel: 0532 452657

South Midlands Communications,  
Nowell Lane Industrial Estate, Nowell  
Lane, Leeds. Tel: 0532 350606

Alan Hooker, 42 Nether Hall Road,  
Doncaster. Tel: 0302 325690

### WALES

P M R Limited, Industrial Estate,  
Gwaelod-y-Garth, Cardiff, South  
Glamorgan. Tel: 0222 810999

# KENWOOD

HOME AUDIO, CAR AUDIO, COMMUNICATIONS EQUIPMENT, TEST AND MEASURING INSTRUMENTS, TELECOMMUNICATIONS

# CQ de G8IYA

*Where can you become a licensed amateur without paying through the nose?*



It all started in our local area, where there was no local novice course. Chris G4HCL and I found that aspiring youngsters would have to travel over 30 miles and pay over £100 each to attend their nearest course. So we took the bull by the horns and set ourselves up as instructors, and with lessons held in a local school classroom, guided four of the school's students together with their Craft, Design, and Technology teacher, through the novice training course. Through the kind help of Anchor Surplus in Nottingham, they were even presented with an ex-PMR 70cm handheld each, which they tuned up themselves in the classroom, ready for the hopeful coming of their 2E1 callsigns.

Then came the problem of finding where they could sit the NRAE (Novice Radio Amateur Examination). The venue was little problem, but what it would eventually cost them to do so was. I won't go into figures here, but it was many weeks of pocket-money saving. The CDT teacher enquired of the City and Guilds about establishing the school as the exam venue, but he found this was fraught with problems. Eventually they shelled out, with the exception of the CDT teacher who decided to go on for the 'full' RAE (and hopefully in time even take over most of the future Novice teaching). Fortu-

nately, all the students passed, and we now have four new 2E1 callsigns in our area, active on 70cm voice and packet, one is now also joining his teacher in going on for the full RAE. But at a price. Fortunately, our students just had to find the cost of minor bits and pieces, such as the crystals for their transceivers, the course notes, books, folders etc. were provided to them free of charge, the classes were held at lunchtimes and just after school so the students didn't need to find any further bus fares. We also know of other such courses where prospective amateurs are voluntarily helped by their instructors in every way possible, without them seeking recompense for their own gain. One such example is the subject of a worthy nomination we received for the HRT 'Amateur of the Year' award. But not all prospective amateurs are as fortunate.

A local lad, recently left college, contacted us with a plea, asking where he could take the RAE. 'Simple' we thought. The City and Guilds provided a list of exam centres for the RAE, however when he contacted those around his home near Southampton (a large city complete with international airport and international shipping port), not one would accept him for the exam. Why? They wanted to make money out of him by insisting he took their RAE course, at a charge, before they would allow him to sit the RAE. No negotiation, no increased exam or 'centre' fee for non-course members. Just a simple 'go away', if you don't pay us the money for the course, you can't sit the exam here. He's now found the nearest exam centre that will take him is in Newbury, 40 miles away, he's sitting it there shortly.

The problem isn't just around our city. Fortunately, our Senior Novice Instructor for Hampshire has now arranged for novice students to take the NRAE, at very low cost, at his course centre at the St. John's Ambulance hall. He's arranged for this to become a registered NRAE centre with the City and Guilds. How about some radio clubs taking his lead and doing likewise? Maybe for the RAE also? Clubs need new members, i.e., amateurs and prospective amateurs, to keep going, and they won't be getting as many as they

could at this rate.

Maybe this could be what's heard from a 14 year old visiting his local club; 'How much does it cost to be a radio amateur?', 'Well, the RA charge nothing each year for the novice licence, an ex-PMR rig will cost you a few pounds, and around £5-6 for a pair of crystals, an aerial you can make for a pound or two, and the course, exam and so on will cost around two or three hundred pounds'. 'Oh, OK, thank you, I'll try and find a cheaper hobby to get into, like the latest video games'.

## Are we going full circle?

How did you find out about our hobby? In days gone by, many casual listeners picked up amateurs on 'top band' (160m) AM whilst tuning around for broadcast or shipping stations. With the wide availability of scanners, many 'current-day' casual listeners could similarly come across amateur signals, on 2m and 70cm FM for example. But now, many 'upmarket' scanners, and particularly the majority of those recently featured in reviews within these pages, have HF reception facilities and even the addition of a BFO for SSB demodulation. These tend to be purchased by the 'dedicated' enthusiast, maybe one who's interested in 'extending his horizons' somewhat after possibly 'cutting his teeth' on a low cost scanner. He'll listen into HF broadcast stations, to utility stations, and to radio amateurs around the world communicating with each other. All on a top-pocket set (see the review of the VT-7100 for example in last month's issue).

Eventually, this 'wide world' of communications could start adding significantly to the more 'boring' stuff on VHF/UHF. Like listening into the various HF amateur nets, like coupling up to computers for HF weather fax as well as weather satellite reception. The interested casual listener then becomes a radio communications enthusiast, he starts putting up better aerial systems, reads up on propagation theory, maybe even thinks about becoming a radio amateur, and 'swots up' by reading the RAE manual. All he needs do now is save up to take the RAE, and find somewhere that'll allow him to take it. Just like the local teenager who contacted us, after he'd become introduced to amateur radio and subsequently began a career in radio equipment design, after winning an all mode base scanner for his 'student of the year' prize at college. Fortunately, the 'Go away, we won't let you take the RAE here' comments didn't dissuade him. But how many others have had the same cold shoulder?



# LETTERS

## Letter of the month

Dear HRT,

May I make a suggestion to you that would be of great benefit to all your readers, by taking a leaf out of your sister magazine ETI. I notice that they supply a free PCB for one of their projects each month, so why not give HRT readers the benefit of this also.

At present I work only part time and therefore have a restricted income and cannot afford some of the prices charged through your PCB service from Argus. I must stress though I still think your prices are reasonable, although I must think twice before purchasing a PCB. So why not supply one free with your magazine each month for one of the many projects you publish. You could call it 'weekender' or a name similar to this. Obviously you may need to make an increase in the price of your magazine, but surely this will be overshadowed by the benefits this service will bring to us all!

Perhaps other readers should write in and tell you what they think of this idea. Keep up the good work in your excellent magazine HRT.  
Lee Greaves, G0RSZ

**Editorial comment:**

**Yes this does sound like a good idea Lee, and we've already had discussions with cover mounted items such as this in mind. Argus Specialist Publications publish a range of magazines as well as HRT for radio and electronic interests, such as ETI Electronics Today International (for the constructor/student), CB Citizens Band (for the 'public communications' enthusiast), RCME Radio Model Control Engineer (for the radio control hobbyist) and so on. ETI, being mainly circuit oriented, is of course very suitable as a medium for small 'giveaway' circuit PCBs. As you correctly say, nothing is 'free', but 'mass manufacturing' of a given item is very much cheaper than making them in smaller quantities for individual needs, and may even possibly be able to be 'absorbed' within the selling price, especially if they're just an occasional item. What would other readers like to see on the cover of HRT? PCBs, maybe trimming tools for those ex-PMR projects, reference cards, PC disks with radio shareware? Let us know!**

Lastly, after my letter in question was published, I received many telephone messages of support along with three or four others opposing my views. Two further messages left on my answerphone displayed the ever popular tactics of those devoid of intelligent thought!

Ray Howes, G4OWY

**Editorial comment:**

**The RA have told us, for publication, that they're willing to listen to suggestions from readers on the subject of any possible 'higher level' amateur licence, which could be possible as long as funds are there to put it into place. In other words, whatever's necessary to get it, whether this be manpower, station inspection, examinations, or whatever, if it's paid for from the licence and/or application fee it looks like it could be OK. But only if UK amateurs want it. They're not going to force it down our throats. You can write with your views to the Radiocommunications Agency, Amateur Licensing Division, Waterloo Bridge House, Waterloo Road, London, SE1 8UA. Alternatively, we'll be happy to pass on letters from readers, so please share your thoughts with our readers, you could get a tenner in the post from me for a constructive letter. The RSGB are also looking at the possibility of incentive licensing (their details are in 'Club News' every month), it looks like my photocopier is going to be kept busy again!**

Dear HRT,

Well, at least someone somewhere supports my views and concerns regarding 'incentive licensing', and is prepared to put their argument in writing. I guess I should be thankful for small mercies, even though this support emanates from the pen of an American amateur radio enthusiast, W4WFL (March 93 letters column).

I have two reasons for labouring the controversy of incentive licensing, or for that matter 'Advanced Licenses'. Firstly, this proposal in my view, rests on the premise that the majority of UK radio amateurs presumably want the introduction of such 'futuristic' changes to their current modus operandi? Being involved in the retailing side of amateur radio, I try to solicit my clients' comments as to the pros and cons of the above. A high percentage of them either don't care one way or the other (a

classic example of British reserve/apathy raising its ugly head I suppose), the rest perceives it as yet another attempt to form a 'clique mentality'. Their words, not mine!

Many also voice the opinion that those who wish to flex their 'cranium muscle', would be far better employed in guarding the door to amateur radio's vulnerable flanks. Included here is increasing public awareness of our hobby and, (which is diabolical) as we approach the 21st century, consolidate its role for future generations, instead of reinventing the wheel and emulating the crass mistakes condoned by an organization that parallels the RSGB across the pond. Secondly, if the foregoing is a true representative viewpoint, how come incentive licensing enjoys such a populist ideal? And does this scenario, smack of a hidden agenda?

Dear HRT,

Ham radio's only excuse for using valuable frequencies is that it provides some benefit to the country. But does it encourage the right kind of sole training in 1993?

What do we need to keep the UK safe, secure, and competitive into the next century? Computer experts? Electronic engineers? Multi lingual salesmen? CW operators? Ham radio has much to offer the country, but will not give of its best if it remains in the past.

Perhaps we should encourage those with an interest in languages or computers to join the ranks, and provide

## £10 for the Letter of the Month

Do you have something constructive to say on the state of amateur radio today? Perhaps you'd like to put your viewpoint to the readers, get some discussion going, or give an answer to one of the issues raised? We'll pay £10 for the best letter we publish each month. So write in with your views, to Letters Column, P.O. Box 73, Eastleigh, Hants SO5 5WG.



# "TONE" BURST

by G6MEN



some commercially useful self training. Over to you.

Harry Leeming, G3LLL

## Editorial comment:

The HRT Consultant Tech Ed recently attended a Military/Commercial liaison organisation lecture (with unclassified content, so we can tell you about it) entitled 'Packet Data on the Battlefield'. In trials, a Royal Signals squadron were deployed around an area, communicating with and through their 25 individual portable packet nodes connected to their simplex Clansman 353 radios. Another Royal Signals squadron armed with electronic countermeasure equipment tried to 'jam' their communications. They couldn't. They said the soldiers 'loved it', they could get through every time when their other communication modes were having difficulty. They were using (Tempest hardened) laptop PCs for this 'get through when everything else failed' communication. Maybe the designers and users of these types of communications systems are the people our country needs to be safe, secure, and competitive into the next century? Over to you.

Dear HRT,

Paul, G6MEN did me a very nice QSL card, and I am sorry to have to offer some qualification to March's 'Tone Burst'. Hard cases can make bad law, and a modern plague is interference with other people, proclaimed of course to be for the common good and not at all for the gratification of the interferer.

Just look at the new RA EMC Leaflet, with a little figuring it turns out that under not at all far-fetched circumstances you could be descended upon and required to cut power to something like 6.5 watts. Probably to you and certainly to me it would mean effectively shutting down, which of course is what a lot of neighbours want, they are not interested in filters, and that's only to do with EMC. Look at the earlier fuss about overhead lines for instance, then magnetic fields. It seems to me it might only want some deluded person to imagine

your radio is damaging him (a very common sort of delusion), kick up a fuss invoking the dread word 'radiation', get picked up by a tabloid, and there could be all sorts of trouble.

I'm not sure what should be done. I once tried to suggest to the RSGB a common front of beleaguered groups, but from the lack of response I could not tell whether they thought the problem was imaginary or impossible to handle. If the first, I hope they are right, because I don't fancy no radio either.

Alex Dick, GM0IRZ

## Editorial comment:

To give a similar example, there used to be such radiation and magnetic field 'scares' from VDUs. The new EC Display Screen regulations (e.g. HSE Guidance on Regulations L26 from the HMSO) have effectively put paid to the 'scaremongers' who thought 'radiation' damaged people - the effects of seat height and so on appear far, far more important! If some scaremongers start, maybe we should tell them to stop sitting in a comfy chair watching their TV VDUs and do something else instead like go out for a walk! Regulations are supposed to be for the good of everyone, and we must at least feel a little happier in similar regulations now forcing manufacturers to make their equipment immune from radio transmission breakthrough, rather than 'wide open' as in the past.

Dear HRT,

I have today received HRT with thanks and have just been reading the letters, in particular the one from Evelyn G00ZI regarding the callsign when calling and the use of the oblique stroke.

I am basically a CW operator and belong to the G-QRP Club, FISTS Club, and RAFARS. When calling I use my call sign G0KCA and when using QRP I just leave a real space after G0KCA and send QRP, as an oblique stroke should not be used. If good Morse is sent and proper spacing applied there should be no problems. When calling CQ QRP or CQ RAFARS or FISTS the correct spacing should suffice.

On the subject of CW, I had a QSO yesterday with a station who was calling VE1ST/NA14. It would appear that the oblique stroke NA14 should not appear with the callsign. Presumably the /NA14 should appear in the QTH, of course the NA14 is an island or one of the new Brunswick South Province Islands.

John Walder-Davis, G0KCA

## Editorial comment:

As far as I can see there should be no problem whatsoever in leaving such a space after your callsign, although whoever you initially call may be a little debatable - it's your callsign you need to identify correctly to keep within the UK licence conditions, not the other person's! Even so, many 'senior' operators I used to hear some time back consistently dropped the 'G' from their callsign when in phone QSO with other Gs, as well as garbling their callsign. I wonder how SWLs get on with this? But common sense often prevails to save mass confusion, in the same way as stations call CQ DX rather than CQ/DX.

Dear HRT,

I am an avid SWL with a Trio 9R59DS, using a G5RV and a 120ft end fed long wire. I've been reading HRT for over two years and find a lot of useful information and interesting articles, keep up the good work. The editorial comment re. Mr. D. Barr, Tyne and Wear, in March's issue is just about right. Only a week ago I enquired about how to get into amateur radio and all I received was "I'm too busy to talk to you", basically a polite 'go away'. This particular amateur was rather rude, and (like Mr Barr) I also do have a skinhead appearance (I'm going bald, so by keeping my hair short I won't miss it when it's gone).

Mark Chapman.

## Editorial comment:

Looks aren't everything!

# RADIO TODAY

## RA Novice Licence improvements

The Radio Communications Agency have announced the review of the novice licence scheme for radio amateurs. They tell us that all at the review meeting agreed that the scheme was proving a success and meeting the desired objectives.

A number of improvements (especially to examination questions) have already taken place. More recently an addendum to the NRAE syllabus has been agreed, and will take effect for preparations for the exams planned for June 1993 onwards.

The Agency tell us they have varied the schedule to the Novice Amateur Radio Licence to improve the facilities available without losing the incentive nature of the licence. The allocations to novices in the 3.5MHz and 28MHz bands have been increased to enable use of accepted lower power frequencies. Also increased are the 50MHz allocation allowing novices the use of Morse and telephony as well as data, and the 430 to 440MHz allocation to allow novices the use of SSB telephony, slow scan TV and fast scan TV. The RA say these changes will give novices better access to frequencies used by other amateurs and improve the opportunity for contacts with them.

From 1st February 1993, the schedule to the 'Terms, Provisions and Limitations Booklet BR 68 a/N' will have been amended as follows;

In column 1, delete 3.565 and substitute 3.560.

In column 1, delete 28.100 and substitute 28.060.

In column 1, delete '50.620 - 50.760' and substitute '50.0 - 51.0' in column 5 against this frequency add 'Morse, Telephony' before 'Data'.

In column 1, delete '51.250 - 51.750' and substitute '51.0 - 52.0'.

In column 1, delete '433' and substitute '432'.

In column 1, add new entry '435.0 - 440.0' and in column 5 against this frequency band insert 'Morse, Telephony, Data, SSTV and FSTV'.

## CJ3RCL on World Red Cross Day

The London (Ontario, Canada) Amateur Radio Club in conjunction with the London Middlesex Red Cross will be operating a special event station, in support of World Red Cross Day, May 8th 1993. The station call sign will be CJ3RCL the original call is VE3RCL. Although some of the frequencies in use (40m and 80m) aren't available to European amateurs, those on the higher bands (20m, 15m and 10m) are. At 0000 UTC on May 8th operation will begin on 75 metres around 3.810MHz and change bands every two hours. The event will end at 2400 UTC on May 9th. The frequencies are as follows; 3.810, 7.210, 14.270, 21.270, and 28.270MHz plus or minus QRM. The London Middlesex Red Cross has prepared a certificate of appreciation for amateurs, or SWLs who QSL with a recommended donation of \$4. Please QSL direct to; Canadian Red Cross, 840

Commissioners Rd. East, London Ontario, Canada, N6C 2V5, marked for the attention of Joyce.

## Novice Course

We recently received the following press notice; Communicate free world-wide using your computer via packet radio. Get a novice amateur radio licence. For details please send an SAE to G3ZHI, 52 Hollytree Ave, Maltby, Rotherham, Yorkshire S66 8DY, Tel. 0709 799911. It looks like someone else out there is also trying to stir interest on an individual basis as well as nationally, why not a few more!

## Novice Instructors needed

Mr. Alan Gibbson, G0RCI has been in touch to say that he has recently been made the Senior Novice Instructor for the Lincolnshire area. He desperately needs more Instructors in this area. If you can spare the time and are interested in helping newcomers into the hobby, please contact him at 1 Oakleigh Rd, Grantham, Lincolnshire NG31 7NN, Tel 0476 66701 for details.

## 1993 RA Young Amateur Of The Year Award

The Radiocommunications Agency in conjunction with the Radio Society of Great Britain, have announced the Young Amateur of the Year Award for 1993. The award, which is for the most outstanding achievement by a young amateur radio enthusiast, is open to anyone under 18 who has an interest in radio. They do not necessarily need to be a licence holder to apply. When applying, applicants may like to consider the following areas of activity; DIY radio construction, operation of radio, community service (e.g., helping in emergency communications or helping the disabled), encouraging others (e.g., through the novice licence scheme), international communication, and school projects.

The idea behind the scheme is to generate interest in amateur radio and to encourage people to become involved themselves. The prize for the most outstanding achievement between 1st August 1992 and 31st July 1993, will be awarded by the Radiocommunications Agency at the RSGB's HF Convention, which is now from the 8th to the 10th of October. The winner will receive a £250 cash prize donated by the agency, and both winner and runner-up will also be invited to visit the Agency's Radio Monitoring Station at Baldock, Hertfordshire. The radiocommunications industry has also in the past been very supportive of this award, and has provided additional prizes for both the winner and runner-up (see HRT December 1992).

Last year's winner Martin G7JCJ (left), and runner up Neil G7NGM, with their collection of prizes and awards.





The closing date for applications is 31st July 1993. The award is open to any resident of the UK, Channel Islands, or the Isle of Man, who has not reached his or her 18th birthday by the closing date. Entrants can enter themselves or be nominated by an adult sponsor. Applications should be sent to; Young Amateur of the Year 1993, RSGB, Lambda House, Cranborne Road, Potters Bar, Herts EN6 3JE, Tel. 0707 659015

### **GB2RN Easter Activity Week**

The Royal Naval Amateur Radio Society have told us that they are holding an Easter Activity week commencing on Saturday the 10th April until Sunday 18th April. The callsign will be GB2RN, located in the bridge wireless office on H. M. S. Belfast in the upper pool of London, between London

and Tower Bridge. We're told activity will be on the frequencies 1.970, 3.660, 3.740, 7.090, 14.190, 21.360, and 29.933MHz on HF, CW, and Phone, plus or minus QRM. They also tell us that operation will also be on 2m FM and SSB, 2m packet, bulletin board will be GB7HSN, and that they also have 70cm, and 6m available. QSL via Bob G0FEK with SAE please, or via the RSGB bureau.

### **International Marconi Day**

The Cornish Amateur Radio Club have been in touch to tell us that the arrangements for the 1993 International Marconi Day are now well in hand. We understand that 20 stations are taking part this year. To claim the Marconi Certificate, stations must work 12 of the IMD stations which are;

- GB4IMD – Truro, Cornwall.
- GB4MID – Poldhu Marconi Site, Cornwall.
- GB0IMD – Isle of Wight Marconi Centre.
- GB2IMD – Rathlin Island Marconi Site, N. Ireland.
- GB2MDI – Marconi site on Salisbury plain.
- GB0SFL – South Foreland Lighthouse Marconi Centre.
- CT1TGM – Tertula Radioamadoristica Gugleimo Marconi, Coimbra.
- EI2IMD – Crookhaven, Eire, Marconi Site.
- EI4IMD – Galway, Eire, Marconi Site.
- DA0IMD – Borkum Island Marconi Site.
- IY0TCI – Civitavecchia.
- IY1TTM – Sestri Levante.
- IY4FGM – Villa Grifone, Pontecchio.
- IY0GA – Golfo Arancchi, Sardinia.
- ZS6IMD – Johannesburg.
- VO1IMD – St Johns, Newfoundland.
- VE1IMD – Glace Bay, Nova Scotia.
- K1VV/IMD – Cape Cod, Mass., Marconi Site.
- N2FCZ/IMD – Babylon, New York Marconi Memorial Site.
- KK6H/IMD – Marshall, California Marconi Park.

We're told award applications should be made through P. O. Box 100, Truro TR1 1RX, UK, and as previously the club will be pleased to act as clearing centre for QSL cards. The SWL award is also available on the same basis, that is to hear and log 12 of the stations. The cost of the award this year is £3.50 or \$8 (US), or 12 IRCs, and for the SWL section the costs are £2.50, \$5, or 8 IRCs.

### **The 9th Yeovil QRP Convention**

This year's Yeovil QRP Convention is on Sunday 9th May at The Preston Centre, Monks Dale, Yeovil, Somerset. The main features of the convention will be; Three QRP related lectures (with subjects ranging from extremely low

power long distance radio wave propagation, to a QRP transceiver project), prominent displays of home made QRP equipment, on air QRP stations using the callsign GB2LOW, trade stands orientated to QRP components etc., and a display of working vintage radio with technical commentary.

As a preamble to the convention there will be the usual friendly QRP Contest on 80 and 40 metres during the evenings of the previous week. This event is known as the QRP Funrun. Further information and copies of the rules are obtainable from P. Burrige G3CQR, 9 Quarr Drive, Sherborne, Dorset DT9 4HZ, Tel. 0935 813054

### **Two special event stations**

The Royal Air Force Finningley Amateur Radio Club in Doncaster, S. Yorks, tell us they are staging two special event stations in the near future. The first of these is GB2AMN on the 25th April to mark Newark Air Museum's 20th year. The operators will be operating from the inside of a Varsity and a 'Shack'elton aircraft on the ground at the museum. The second station is for the 16th to 19th May and will mark the 50th anniversary of 617 (Dambusters) squadron. The QTH for this is the east tower

of the Derwent Dam and the callsign to look out for is GB617SQN. For further details call either Walter G7GHI, Tel. 0302 867441 or Vic G1IND, Tel. 0302 531927.

### **1993 International HF Convention**

Since we told you of this forthcoming event last month, we have received information from the RSGB, that the dates for this have been changed, it is now from the 8th to the 10th October and not in September as originally planned.

### **Radio Spectrum Review Seminar**

The RA will be holding a seminar on the 8th July to discuss the radio spectrum review covering the frequency range 28-470MHz. They tell us this is one of the most intensively used parts of the radio spectrum, and demand for access is increasing. It does, of course, cover the 10m, 6m, 4m, 2m, and 70cm bands in the UK. The aim of the review is to examine existing and planned use of the 28-470MHz range, and make recommendations on that use in the light of national and international developments in radiocommunications.

Members of the independent Spectrum Review Committee will be presenting their findings based on the evidence submitted by users (i.e., **you**), manufacturers, business interests and Government departments with key roles in spectrum management and use. They tell us an 'open forum' will take place which will provide an ideal opportunity to discuss key issues with the committee.

The seminar will cover the major issues within the review range, i.e., Mobile Radio; Digital Audio Broadcasting; Defence and Emergency use of Radio; Services ancillary to broadcasting; Scanning Telemetry and International Issues.

Users of radio with an interest in this range, i.e., amateurs such as us, as well as members of the radiocommunication industry, are invited to attend. The space is limited to 250 delegates, and you can get full details from Mr. Don Pennell, Radio Spectrum Review Secretariat, Room 505, Radiocommunications Agency, Waterloo Bridge House, Waterloo Road, London SE1 8UA, Tel: 071 215 2157.

# NEW PRODUCTS AT RA

## RADIO HAMSTORES

**GIVE US A**

### ICOM IC-737

- All band, all mode transceiver. •General call
- Memo pad to store accumulated DX stations
- function. •101 memory channels. •Variable
- and ATX functions. •Speech compressor. •3

### YUPITERU MVT-7100

- Continuous coverage 530kHz-1650MHz. •Switchable AM, FM, WBFM, LSB & USB. •1000 memory channels! •Battery-saver circuitry.
- 13 tuning steps down to 50Hz.
- 10 user-definable search patterns.
- Memory search and priority scan. •Ideal choice for data communications. •Supplied complete with Nicad batteries & charger.



### KENWOOD TS-50S

- Ultra-compact HF transceiver, 69 x 180W x 270D mm •500kHz to 30MHz general coverage receiver
- High-efficiency cooling design and special heat-sink enables 100 watt output despite small size.
- Comprehensive interference reduction. •Menu system for easy function adjustment. •DDS with fuzzy control enables smooth tuning



## RADIO HAMSTORES AER AUTHORIZED DEALERS AND SERVICE CENTRES!

We also stock items by AEA, AKD, Alinco, AOR, Barenco, Comet, Cushcraft, Davis, Dee Comm, Diamond, Icom, JRC, Kenwood, Lowe, MFJ, Microset, RSGB Publications, Toyo, Yaesu, Yupiteru etc. Second-hand and ex-demo equipment is always available.

Payment by Access, Visa and Switch. Part-exchanges welcome, finance arranged (subject to status). Interest free credit on selected new ICOM products. If you cannot visit an ICOM HAMSTORE in person, use our efficient Mail Order Service. Stock items normally dispatched within 24Hrs.

As always we offer full warranty on c from the many authorized dealers within UK. It be replaced if the fault is deemed beyond s Any ICOM equipment purchased from an unc by ICOM warranty.

Gordon G3LEQ & John G8VIQ at Birm Bay and Doug G0LUH & Paul G7MNI in our ne to seeing you soon.

### LONDON

11 Watford Way, Hendon,  
London NW4 3JL.  
Tel: 081 202 0073  
Fax: 081 202 8873

### HERNE BAY

Unit 8, Herne Bay West Industrial Estate,  
Sea Street, Herne Bay, Kent CT6 8LD.  
Tel: 0227 741555  
Fax: 0227 741742

### BIRMI

Intern  
963 Wolverha  
West Mic  
Tel: 021 552 007

ALL STORES OPEN TUESDAYS TO FRIDAYS 09:00 - 17:00 & 09:00 - 16:00 SATURDAYS. N.B. Herne Bay cl



# DIO HAMSTORES NOW

## VISIT AND SEE FOR YOURSELF

### YAESU FRG-100

verage receiver. •Automatic antenna selector and tuner.  
 •Double band stacking register (DBSR). •Quick-split  
 tuning steps. •PBT, notch and CW full break-in. •RIT  
 types of scanning functions. •Electronic keyer.

- Frequency range 50kHz-30MHz.
- USB, LSB, CW, AM and optional FM.
- 50 fully tuneable memories.
- Adjustable BFO and SSB carrier offset.
- Instant broadcast band selection from 16 pre-programmed memories.
- Back-lit LCD with frequency read out down to 10Hz.
- 1.5 watt power output into 4 ohms.
- Dimensions: 238W x 93H x 243D mm.
- Multi-function scanning.
- Twin 12/24 hour programmable clocks and timers.
- CAT system to provide direct link to CPU.

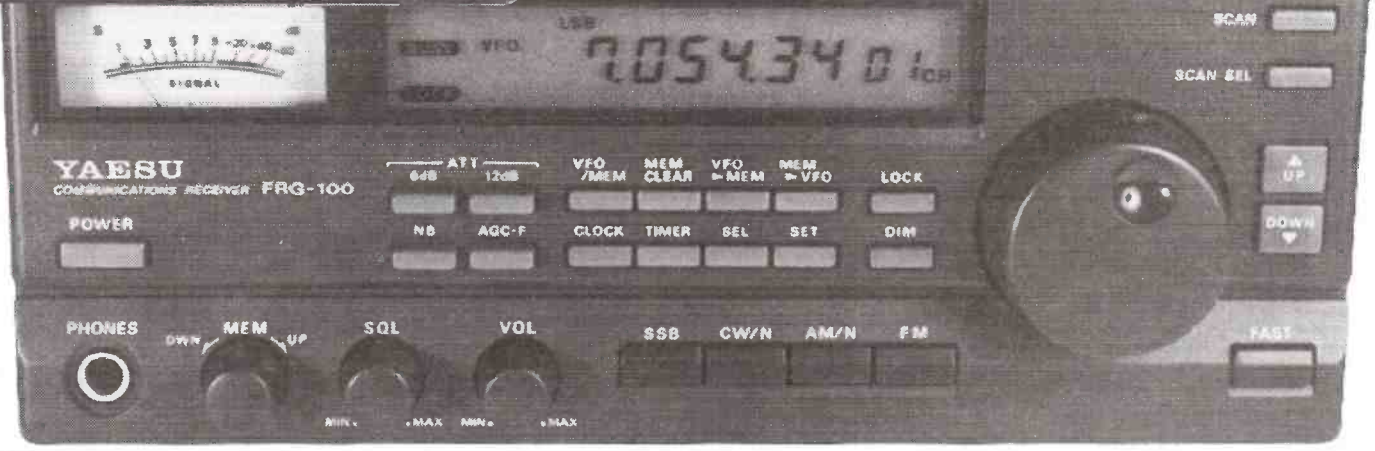

**FOR KENWOOD**  
 all ICOM equipment purchased  
 some cases the equipment will  
 speedy and satisfactory repair.  
 uthorized dealer is not covered

ingham, Chris G8GKC at Herne  
 v London shop, all look forward

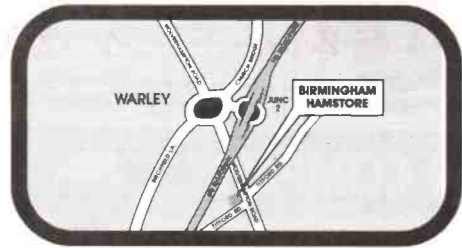
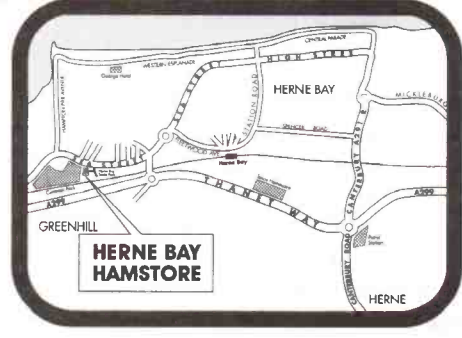

**NGHAM**  
 tional House,  
 mpton Rd. Oldbury,  
 lands B69 4RJ  
 73 Fax: 021 552 0051

osed for lunch 1300-1400

# NEVADA

# EVER



## YAESU RADIO

**Yaesu FT747GX** - Still an unbelievable performer across the H.F. bands and one of the top 5 in budget H.F. Transceivers. Top Band to Ten, you won't be disappointed...**£775**

**Yaesu FT-890** - Recent reviews answer all your questions. Based on a winning combination, available with or without auto A.T.U...**£1199**

**Yaesu FT-530** - A Twin Band Handheld and a host of features including Dual In-Band RX, CTCSS DTMF all fitted. Wideband coverage plus optional speaker mic with LCD display. Guaranteed to be the next No. 1...**£449.95**

**Yaesu FT-1000** - You will never want another H.F. Transceiver! The FT-1000 does it all. This has to be the ultimate word in H.F. communications. Full brochure available...**£3299**

**FULL YAESU RANGE NOW IN - CALL FOR DETAILS**

## DRAKE

**Drake R8E** - Number one in the U.S. since 1943. Drake is known right across the globe for its technology and above all, reliability - remember the "B" line separates (mine are still going!). Wide frequency coverage, excellent dynamic range Superb filtering In fact it's simply the best shortwave clarity you'll find. Outperforming many other receivers costing much more. Whatever your interests - Drakes' R8E can handle it!!!



- Fully filtered with AMS as standard
- 99 programmable memories with Scan
- Computer control option
- I.F. Pass-band offset facility

### Options

R8E Matching Speaker .....	<b>£49.95</b>
VHF Conv. (35-54 & 108-174MHz) .....	<b>£225.00</b>
P.C Computer Drive Software .....	<b>£59.95</b>
Full Technical W/Shop Manual .....	<b>£29.95</b>

**£1145**

## SCANNING RECEIVERS



### NEW - MVT-7100,

Set to be THE handheld of 1993. This radio must be heard to be believed. It provides effortless reception of SSB and CW signals using TRUE carrier injection with 50Hz resolution. It can even (with accessories) be hooked up for FAX and DATA reception.

- 100kHz-1650MHz
- 1000 memory channels
- All mode reception (incl. SSB & CW)

Each set is supplied with all accessories including: UK Charger, NiCad Batteries, Earphone, Telescopic Antenna, Original Yupiteru English Manual.....**PRICE £499**



### YUPITERU MVT 7000 HANDHELD

- Receives 8 to 1300 MHz
- 100kHz-1300MHz (at reduced sensitivity)
- 200 Memory channels
- Rotary or keypad freq. control
- AM/FM/NFM
- Large display with strength meter

Each set is supplied complete with:-

Full set of high power NiCads, AC charger. DC power lead and carry strap.....**£369**

**MVT-8000** - Mobile version of the 7000 c/w mains adaptor. Especially sensitive @ UHF. Recommended.....**£389.00**

**AR2800** - Desk top, all mode scanning receiver. 500kHz-600MHz and 800MHz-1300MHz. Fitted BFO for SSB reception, excellent results. Come and try one!!!.....**£449.00**

**AR3000A** - The latest in multimode scanners, offering continuous coverage from 100kHz-2036MHz. Modes:- USB/LSB/CW/AM/FM/WFM. Computer control available via ACEPAC-3 Software (for PC/Clones).....**£899.00**



**HP2000 - SUPPLIED WITH FREE UK SCANNING DIRECTORY VALUE £14.95**

**HP2000** - Still our most popular handheld scanner.

- 500kHz-1300MHz
- 1000 Memory channels
- AM/FM/WFM Modes
- Sensitive Receiver
- Supplied with all accessories & UK charger.....**£299**

## KENWOOD RADIO

**Kenwood R-5000** - Tried and tested in all corners of the world. This receiver keeps going and going. 150kHz-30MHz. All made with many options - what more could you want!...**£949**



**Kenwood TS450/690S** - Two superb H.F. Transceivers capable of delivering the "punch" when necessary. 100W O/P, optional Auto A.T.U. plus general coverage receive...**TS450 - £1149 690S - £1399**

**TH28/48/78E's** - The family of 3 "designer-type" handhelds that feel comfortable in the hand whether Two Meters, 70 Cms (ideal novice band) or 2/70 Twin Bander is what you're after - take a serious look at the "TH" range...**£Call**

**Kenwood TS850S** - Another sure winner from Kenwood! Designed with the serious operator in mind and built to last ..... why not consider upgrading or part-exchanging your old TS830???.**£1599.99**



**NEW**

## EXTENDAMAST 10 METRE RETRACTABLE MAST

Suitable for: Dipoles, Long Wires, VHF/UHF Beams, G5RV and many other antennas.

A new and inexpensive aluminium 10 metre retractable mast that may be used at home or for portable use. Easy to erect in minutes - your antennas can now be independent of trees, buildings and other make shift fixing points! The steel guying rings are corrosion protected to provide years of useful life. Because individual requirements vary guy wires are not included. A base fixing plate is available as an extra.

**Introductory Price £69 Plus £8 Carriage**



## FRG-100 H.F. RECEIVER

Call now and be one of the first to own this brand new general coverage receiver. Don't forget our generous part-exchange schemes.

Call the Hotline for Immediate response:  
**£559**

## SONY "PYXIS" G.P.S. RECEIVER

A new portable global positioning satellite receiver that gives -

- ★ Position in Latitude/Longitude and Altitude, accurate to 30-100 metres
- ★ Distance and direction to dest.
- ★ Current speed and heading
- ★ Time incl. estimated time of arrival



**PRICE £599**

## THIS MONTH'S BEST BUY

### NEVADA MS1000 BASE/MOBILE SCANNER

MOBILE VERSION OF THE HP2000 HANDHELD BUT WITH SEVERAL ADDITIONS:-

- ★ Switchable audio squelch
- ★ Tape recorder output socket
- ★ Automatic - signal operated tape recorder switching
- ★ All metal case for improved EMC compatibility
- ★ Receives: 500kHz - 600MHz, 805 - 1300MHz. Supplied with mains power supply.



**SAVE £50**

**£229**

**THE FASTEST MAIL ORDER COMPANY**



**USE YOUR CREDIT CARDS FOR SAME DAY DESPATCH**



# EVERYTHING FOR THE RADIO ENTHUSIAST

## HUGE STOCKS - FAST DELIVERY - PERSONAL SERVICE

NEVADA COMMUNICATIONS, 189 LONDON ROAD, PORTSMOUTH PO2 9AE  
 TELEPHONE HOTLINE: (0705) 662145 FAX: (0705) 690626

### ICOM RADIO

**icom IC-737** - A new full coverage HF transceiver with Auto ATU, Electronic Keyer, good receiver on a host of extras ..... **£1350**



**icom IC-728** - If you like Icom, you'll like the 728 HF Transceiver. As expected, built to a high standard. Full coverage, 100W o/p, many accessories .... **£Under 1000**

**icom IC-735** - This is more than just another transceiver - well designed & stylish in looks with an enviable performance. All the usual features and still ..... **£1095**

**icom IC-W21E** - Twin band handie with full duplex "Whisper" mode. C/W NiCad and charger ..... **£425**

**icom R-100** - The mobile monitoring station. 500kHz to 1.8GHz. What more is out there? 100 mems, AM, FM & WFM modes ..... **£475 incl. free antenna**

**icom R-7100** - An affordable - professional grade receiver. Hosting 25-2000MHz coverage & a whole 900 memories to play with! Full colour brochure available ..... **£1095 incl. free discone**

**icom R-72** - Lets not forget all the S.W.L's - Icom haven't with this general coverage H.F receiver 100kHz-30MHz. All mode (FM optional) with 99 mems for favourite frequencies ..... **£649 incl. free antenna**

### KENPRO RADIO

**KT-44** - 70 cms handheld. Thumb wheel frequency control. Full 10MHz! Ideal novice or repeater user. c/w NiCad, beltclip & charger ..... **£159.00**

**KT-22** - Popular 2M version of the KT-44 with simple NO FUSS operation. Ideal standby handheld or for use on Packet ..... **£149.00**

**KT-220** - A 2M handheld with direct keypad entry and LCD display. 10 memories & CTCSS fitted. Ext. 12V DC socket. Up to 5 watts output SPECIAL ..... **£169.95**

### NEW HAND-HELDS

**ALAN CT-145** - Fully featured 2M handheld with options for DTMF & CTCSS Paging. 5 watts output is available when powered from external 12V DC supply. Now with extended receive - 130-169MHz. Excellent reliability & performance ..... **£199.00**

**ALAN CT-450** - 70 cms version of the CT-145. This model will be a proven winner amongst the new novices and seasoned users alike. Full 10MHz coverage, 430-440MHz. 5 watts available when powered via 1.2V DC. This model comes highly recommended! ..... **£220**

### SONY SHORTWAVE

As a Sony Shortwave centre, we stock a complete range of Sony Shortwave product. Here is a selection of our best sellers -

**SW77** - One of the best new editions to the Sony range. The SW77 covers 150kHz-30MHz plus an additional 76-108MHz. With a rotary tuning dial, 125 scan memories, the reception of AM/FM/USB/LSB and CW modes is a breeze. Fitted tape record facility finishes this superb all round receiver. **£349.95**

**SW1E** - Pocket Shortwave plus VHF Commercial radio. Each unit is supplied with headphones, case and shortwave guide. This model will not hurt your pocket. **£139.95 this month only**

**SW7600** - One of Sony's most popular VHF and Shortwave medium sized receivers. Frequency coverage:- 76-108MHz FM, 150kHz-30MHz Shortwave, on AM/FM/SSB. Well rated ..... **£149.95 this month only**

**NEW PORTABLE SONY SW55** - Technically the best that Sony have come up with yet! Stable enough for fax reception, yet easy enough to tune on SSB. A dual conversion receiver produces excellent results on all the bands - the SW55 is a real winner.

- 150kHz - 30MHz, 76-108MHz, all mode inc. SSB.
- 125 multi-function memories inc. world time clock/alarm.
- 4 way digital inc. scan/manual/direct access ..... **£P/X Special**

### NEW VECTRONICS AMP

Vector 500. "Canadian Punch!" A full 1000 Watts PEP on SSB enables you to beat the pile ups. Now available here in the U.K. Top band to 10 from only 60-80 Watts input. Call now for your brochure!



- 4x811A Low Cost Tubes
- 600W C.W. 1000W PEP
- Compact 24lb weight

**£865**

### TRADING POST

We buy as well as sell new and used radio equipment, please feel free to call Paul or John on our Hotline for an instant quote on either P/X or Buy-Ins.

- Yaesu FT200** HF Rig, slight fault on 10m ..... **£195**
- Kenwood T5930** Matching Speaker, reasonable condition ..... **£75**
- Yaesu FRG9600** Desktop Scanning Receiver, av. cond ..... **£365**
- Kenwood T5440S** C/W Matching Speaker, excellent cond. .... **£845**
- Yaesu FT102** Mains Powered HF Transceiver, av. cond. .... **£525**
- Wetlz SWR** Meter Model SP400 ..... **£59**
- Mirage B1016** 2m Amp 150W ..... **£150**
- Trio JR500/S** Shortwave Receiver, good for beginners ..... **£149**
- Trio R1000** Digital RX, 0-30MHz (choice of two) ..... **£265**
- Datong Speech Processor**, Boxed ..... **£50**
- Yaesu FT707** 12V HF Transceiver, excellent cond ..... **£425**
- Kenwood R5000** Top of the Range model, exc. cond ..... **£650**
- Yaesu FT290** Mk I, 2m Multimode, NiCads & Charger ..... **£345**
- Standard C5800** 2m. Mobile, reasonable condition ..... **£345**
- MM33/LS** 2m. Amp ..... **£59**
- Tokyo HP**, HC200 ATU, 80m thru 10m ..... **£99**
- ERA Microreader**, boxed, v.g.c. .... **£1220**
- Yaesu FT220** 2m. M/M Bose ..... **£275**
- VC300LP ATU**, boxed ..... **£110**
- Trio TS700G** 2m. Base av. cond. .... **£375**

Call us now - even if we haven't listed your radio, for what we know to be unbeatable P/X deals.

### EARTALKER

**Eartalker** - A completely new concept in microphone technology. The Eartalker is a combination of earphone and microphone which is worn within the ear. It provides outstanding transmitted audio quality and is suitable for all leading brands of handheld (Call for details on your particular model). Separate volume, PTT switch and control box ..... **£39**

### MICRO-READER

**ERA Microreader** - Data Communications decoder - decodes RTTY, CW, AMTOR (A) & SITOR (B). 16 character LCD display needing only connection to receiver extension speaker socket. Shortly to become available will be the large 4-line LCD display with built-in parallel printer driver part. Variable in-built Morse tutor. (Call and reserve your optional display now) ..... **£169.00**



### SCANNING ANTENNAS

**WB1300** Discone - (25-1300MHz) Stainless steel top of the range "N" type connector. Complete with short mounting pole and clamps. 8 elements with vertical whip. Suitable for transmit on 6m, 2m, 70cm, 32cm, and 23cm bands. Length 1.7 mtrs ..... **£49.95**

**Nevada Scanmaster** - (500kHz - 1500MHz). New high quality wide-band receiving antenna uses fibre glass/stainless steel with 4 small radials. "N" type connector. Length 1.1 metres ..... **£39.95**



**Micro-Scan** - (180-1300MHz). New low cost budget ground plane antenna ..... **£12**

**Skyband** - (25-1300MHz). Our most popular stainless steel economy wideband discone. Recommended. Bargain Price ONLY ..... **£27.95**

### SONY ACTIVE ANTENNAS

**AN1** - An external active antenna with built-in pre-amp, covers 150kHz-30MHz. Fully portable with easy to mount fixing brackets. **£57.95**

**AN3** - Active antenna for Aircraft and VHF reception, suitable for Sony Air 7 plus many others ..... **£54.00**

### ALINCO & STANDARD

**Alinco DJ-580** - Fast becoming the top selling Twin Band handheld here in the U.K. Complete with all "mod-cons" including AM Airband RX. Comes ready to go just plug-in and charge - the perfect way to operate 2M & 70 Cms ..... **£399**

**Alinco DJ-F1E** - Don't take my word for it but my customers agree that this is the perfect companion when considering a 2M handheld. Full coverage and again offered with Airband receive ..... **£249**

**Alinco DR-599E** - Replacing the 590E - This little unit has an impressive 50W on each band, automatic remote repeater function (ideal raynet exercises) and a host of extra facilities including ext. RX. Full colour brochure available - call us now! **£599.95 incl. free duplexer**

**Standard C528** - This Twinband handheld is the model the others were based on! Still a popular choice with many features including remote cloning and repeater talk-thru! ..... **£365**

**Alinco DJ-F4E** - A popular novice band radio on 70cms. Simple to operate handheld with 40 memories and 5 Watts output ..... **£269**

### LOW LOSS CABLE

Superb Japanese low loss cable with aluminium foil and braid double earth screening, tough weather resistant yet flexible. Fantastic low loss - suitable for high power and frequencies up to 3GHz.



- 5D-FB** (8.1mm - 0.055dB/mtr) ..... **£0.65/mtr**
  - 8D-FB** (11.1mm - 0.039dB/mtr) ..... **£1.65/mtr**
  - 10D-FB** (13.1mm - 0.031dB/mtr) ..... **£2.42/mtr**
- Losses quoted at 100MHz
- CONNECTORS** (for above)
- "N" Types ..... **£3.56**
  - BNC ..... **£3.75**
  - PL259 ..... **£1.50**

### VECTRONICS

Vectronics - Canadian based - producing High Quality affordable Amateur accessories including:

- ANTENNA TUNING UNITS**
- VC300** - 300 Watt ATU with X pointer metering of FWD/REV/SWR readings. Select 2 coax antennas plus balanced line (4:1 balun included) ..... **£139.00**
- VC300DLP** - As above but with built-in Dummy Load ..... **£149.00**
- VC300DL** - As above but with built-in Dummy Load ..... **£169.00**
- VC300D** - Deluxe model with peak reading bar graph ..... **£399**
- HFT1500** - 3KW ATU with built-in 4:1 balun. Peak reading bar graph, X pointer meter matches just about anything! ..... **£89**
- PM-30** - 3KW Power/SWR meter covers 1.8-60MHz ..... **£39**
- LP30** - Low pass filter rated 1.5KW ..... **£39**

### NEVADA ATU COMPONENTS

- VARIABLE CAPACITORS** ..... **£19.95**
- Either** - 150pF, 170pF or 250pF variables (7.8KV rating) ..... **£28.00**
- 500pF** variable (2 x 250pF ganged) ..... **£15.95**
- TC48** - 48 turn mechanical turns counter 1 count/rev ..... **£3.57**
- Control Knobs** - large graduated 1-9 indicator knobs

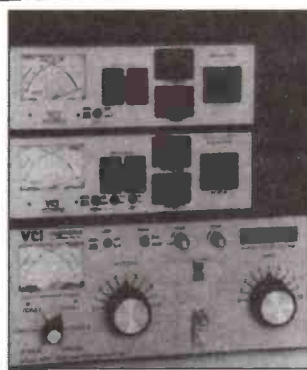

# Yaesu FRG-100 Review

*Chris Lorek G4HCL looks at the latest 'hot newcomer' in the HF receiver field*



**A sensibly laid-out front panel**

New models of HF amateur band transceivers seems to appear on the market quite regularly, however similarly specified HF receivers seem to be rather 'thin on the ground' by comparison. Which is surprising, as there must, no doubt, be many listeners who'd also want good performance, without spending vast amounts of money on almost 'professional quality' receivers.

## Competition

In the 'earlier days', the Trio 9R59D and Yaesu FRG-7 could have been said to have started the ball rolling as such receivers, being hotly followed as the years went by with a veritable selection of different offerings. Manufacturers have obviously been keeping their eyes open, and the new Yaesu FRG-100 already seems to have captivated the interest of quite a few people. Priced at around the mid-£500s, it isn't a 'bare bones' receiver, neither is it a 'top of the range' model. For example, it doesn't have any keypad entry facility for the receive frequency, even as an option, which it's 'big brother' the FRG-8000 has as standard, nor the facility of allowing an internal VHF receive option. Operating from 12V DC, neither does it have a mains supply built in, the power supply being provided as an external unit. However, this makes it light, reasonably small but without a 'minute'

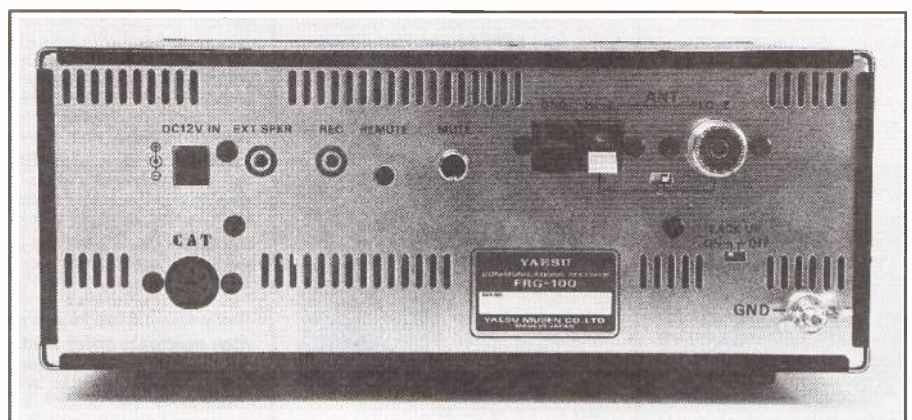

**Rear Panel connections for aerials, tape recorder, and computer interface**

front panel which could make operation difficult, and possibly most importantly, not quite as expensive as its 'big brother'.

## What Do You Get?

So what do you get for your money? You get a 50kHz-30MHz receiver, with selectable CW, LSB, USB, and AM, optional FM, together with lots of memories, clocks, remote control functions and other 'bells and whistles' to make it very flexible. But along with these facilities, I'm told it was designed to *perform*, and *perform well*.

## Tuning

The large 'Up/Down' buttons step the frequency in 100kHz or 1MHz steps, and the rotary knob lets you move around in 10Hz steps in 'normal' mode, plus any step you want between 100Hz and 100kHz in 'fast' mode, on a mode-by-mode basis. For broadcast band listeners, the 'Up/Down' buttons can be programmed to switch between HF broadcast bands instead of 100kHz/1MHz steps, or for amateur band use you can use the memories to switch between bands and modes. The 50 memory channels provided can store frequency, mode, and narrow/wide receiver bandwidth, and you can tune away from any of these after you've selected them simply by giving the tuning knob a twist.

Three filter bandwidths come with the set, these being 2.7kHz for SSB/CW use, 4kHz for 'narrow AM', and 6kHz for 'normal AM'. CW devotees can add an optional 500Hz or 250Hz filter, and any bandwidth can be selected as the 'default' for the reception mode you select. The FM option uses a fixed 15kHz bandwidth for reception.

## Connectors

The set comes equipped for either low impedance (i.e., dipole) or high impedance (i.e., long wire) aerials, as well as having connections for a tape recorder, with a variety of inbuilt timers and clocks, to allow automatically timed recordings. With the use of computers growing day by day, the FRG-100 can



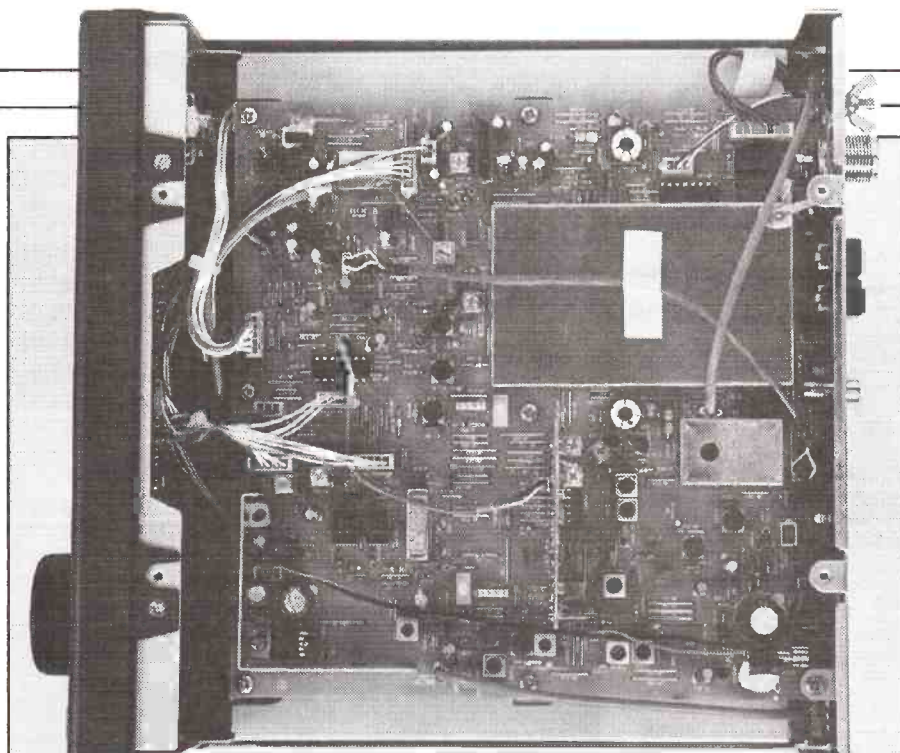

Inside the set

also be controlled from your computer's serial port using an in-line interface, and several pages in the manual are devoted to details of this and how to set the frequency, mode, memories and the like, thus 'opening up' the flexibility somewhat. An external mains power supply comes with the set, and you can also operate it from 12V with a DC lead which is also supplied.

A well-written manual gives details on the many things the set can do, as well as giving several pages of advice on aerials and HF propagation.

### Personalization

The set has quite a range of things you can 'personalize, to match your own operating tastes as well as the various tuning steps. The receiver uses a flexible DDS (Direct Digital Synthesizer) for local frequency generation, and together with the set's microprocessor a whole range of things can be programmed in. For example, the CW beat note can be altered over 400Hz-700Hz with the receiver altering its BIO injection frequency to correspond, it can be shifted to either USB or LSB offset, and switched to be either below or above the receive frequency for QRM rejection. Even the volume and tone frequency of the 'button press' beeps can be altered to suit your personal tastes.

### On the Air

On reading through the manual, I was almost bewildered by the various 'start-up' modes the set had to offer, i.e., by pressing various buttons while

these, or if I pressed the 'scan' button the set would cycle between these, halting for either 5 seconds on each one or just whenever the carrier squelch (the level being set by the front panel control) raises. Further upper/lower frequency memories were present, which the set could search between, which could be useful for, say, listening out for 10m DX activity.

I started off by listening around on the amateur bands. One of my favourite activities is low band DXing, which of course really puts the capability of most receivers to test! I found the dynamic range of the set was excellent, even on 40m just as the 'grey line' was disappearing, i.e., with DX signals getting weaker and weaker and QRM signals getting stronger and stronger, the set held its own - I rarely needed to switch in the 6dB/12dB attenuators. I also found it handy to be able to program LSB (rather than USB) injection

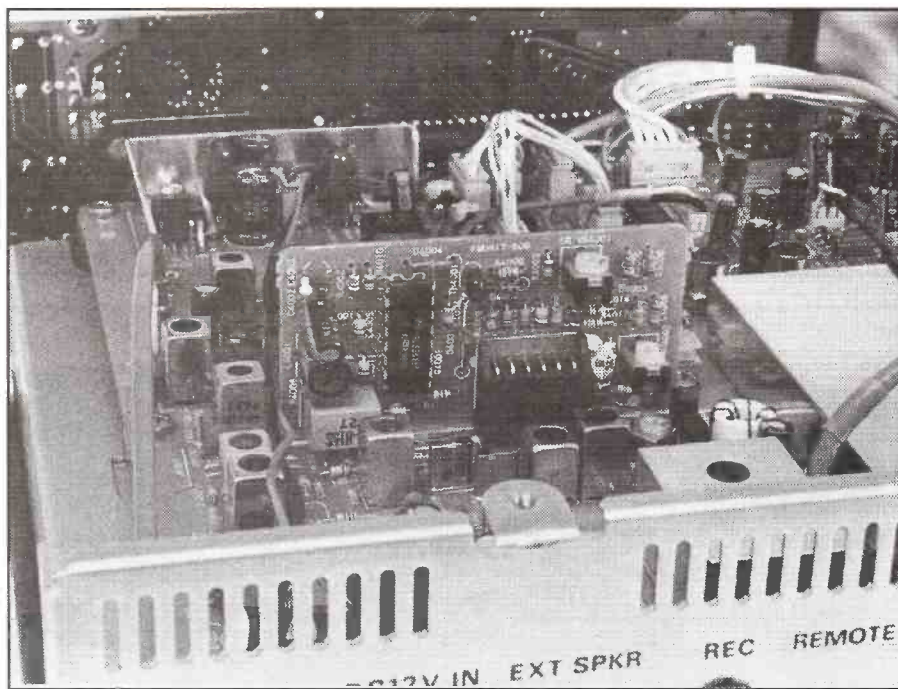

The FM Board

switching on, for example, the default memory and filter settings, SSB offset, time display and so on, could be changed. So, being a confirmed 'gadget freak', I started by having a short 'play', including programming the memories in a logical format, before getting down to some serious tuning around.

The 50 memories could also be used in 5 'groups' of ten channels each. I found I could program these for, say, different amateur bands and switch between them, or, say, a number of different frequencies used by a given HF broadcast station or even amateur HF DX 'net' frequencies. A twist of the memory knob then switched between

for CW, this way as I switched between LSB and CW, I didn't need to retune to find that weak signal I'd just come across! I found that the 2.7kHz SSB filter bandwidth was too wide for my liking although it did provide more 'hi-fi' SSB quality if you could call it that. But I missed the facility to 'narrow' this somewhat for, say, data reception, although the optional 500Hz CW filter coupled with appropriate offset programming could be used here for, say, narrower bandwidth RTTY or other utility reception in SSB mode.

The good signal handling capability of the set also showed up while I was tuning around the broadcast bands,

# SCANNERS AND TRANCEIVERS

## YUPITERU

AIR POWER AT YOUR FINGERTIPS

VT-125 II .....	£159.95
MVT-7000 .....	£319.95
VT-225 .....	£239.95
VT7100 .....	£369.95

## PANASONIC

RF-B10 World band receiver - pocket size .....	£59.95
RF-B65 S/pro multi band digital radio - memories present .....	£169.95
RF-B45 Digital M/f band radio .....	£129.95

## ICOM

SCANNERS/TRANCEIVERS	
IC-W2E .....	£429.95
IC-R115-1300 MHz 100 memories .....	only £349.95
ICP-2ET .....	£274.95
ICR-7100 .....	£1199

FULL RANGE STOCKED



GOVT. AND LOCAL AUTHORITY ORDERS ARE WELCOME, TAX-FREE EXPORT! MAIL ORDER IMMEDIATE DESPATCH

## PHILIPS

D2345	
* Portable Radio • LW/MW/FM/2 x SW • Fine Tuning Control • Mains/battery supply .....	
£24.95	
D1875	
* Compact 12-band Portable Radio • LW/MW/FM/9 shortwave • Large tuning control • Tuning LED indicator	
* Telescopic and ferroceptor aerial • DC supply connection	
* Earphone connection • Wrist strap • Attractive pouch .....	
£49.95	

## YUPITERU

VT-150	
142-170MHz FM marine monitor .....	
£159.95	
MVT-8000	
200kHz-1300MHz base scanner .....	
£319.95	
MVT-6000	
25-550/800 - 1300MHz scanner .....	
£5249.95	

## ALINCO

DJ-S1E .....	£199.95
DJ-F1E .....	£239.95
DJ-180E .....	£199.95
DJ-580E Dual band .....	£379.95
DR-599E	
Dual band 2m/70cm - 50 watt mobile .....	
£569.00	
DR-112E 2m FM 45w mobile transceiver .....	£269.00
DJX1D 100kHz-1300MHz - no gaps .....	£259.00
NEW ALAN TRANSCEIVER CT145 .....	£199.00

## AOR

AOR 1500 EX	£319.95
AOR 2800 .....	£409.00
AOR 2000 .....	£279.95
AOR 3000A .....	£859.95

HAND-HELD CB's

from £49

MOBILE CB's

from £79.95

BASE STATION

from £169

## ROBERTS

RC818 .....	£179.95
R727 5 bands - FM/MW/SW/LW/SW1-4 .....	£79.95
R747 3 bands .....	£92.95
RF-M3 Tiny .....	£59.95
RP-26 FM/MW/LW .....	£81.95
RP-14 Cassette radio 4 FM's .....	£60.95
RC-35 mono cassette radio .....	£56.95
R808 .....	£99.95

## GRUNDIG

SATELLIT 700 .....	£349.00
YACHT BOY 222 .....	£56.99
YACHT BOY 230 .....	£73.00
CONCERT BOY 230 .....	£36.70

New full range antennas, base stations, CB mobiles, etc



Call: 071-637-0353

# ASK

ELECTRONICS LTD

248 Tottenham Court Road, London, W1P 9AD Tel: 071-637-0353/0590 Fax: 071-637-2690



with the various 'monster' signals present in amongst weaker DX stations. Here I could easily switch between 'narrow' and 'wide' AM modes, although I found this didn't make as much difference in practice as I'd thought. One 'funny' was that I couldn't seem to switch in fast AGC decay on AM for tuning, although this operated OK on SSB, maybe this was one of the hidden 'switch on' functions. The set had quite a flexible 'timer' facility, with two digital clocks and various remote on/off

functions, so automatic recording of programs I'd otherwise have missed was no problem. I was pleased to see the set went right down to 50kHz, and using my HF trap dipole I found Rugby on 60kHz came through at good strength.

As well as the good performance, I found the set was very, very easy to operate, I didn't have to keep referring to the instruction manual! A nice touch also was a pull-out 'Reference Guide' from the bottom of the receiver, giving

a reminder of what the various buttons did, the reverse of this having a world time zone map on it. However, one thing that almost drove me mad at the beginning, before I'd taken the time to actually read through all of the instruction manual, was a 'time signal' of two short bleeps followed by a long bleep, every hour, coming from somewhere near my computer. This even happened when all the radio and computer gear on my 'shack table' was switched off! Eventually I found that I'd inadvertently enabled the 'Hourly Time Annunciator' of the FRG-100, - well, this was described towards the back of the manual!

## Technicalities

The set uses a double conversion superheterodyne circuit, with IFs of 47.21MHz and 455kHz. The main selectivity is carried out at 455kHz, with a roofing filter at the first IF. A pair of direct digital synthesizers are used to generate the various carrier signals, and the 'main' local oscillator signal in combination with a crystal mixer. A central processing unit IC handles all the various 'housekeeping' functions of the set, including frequency management and the various readouts, filter selections and so on.



## LABORATORY RESULTS:

### RECEIVER;

All measurements carried out in standard bandwidth for mode in use, with attenuator out, unless stated.

#### Sensitivity;

Input level in  $\mu V$  pd required to give 12dB SINAD, SSB/CW carrier, AM 60% mod, FM 3kHz dev;

Freq. MHz	SSB/CW	AM	FM
1.8	0.17	0.49	0.36
3.5	0.16	0.44	0.35
7.0	0.15	0.40	0.31
10.1	0.14	0.38	0.31
14.0	0.17	0.48	0.36
18.1	0.17	0.45	0.40
21.0	0.18	0.48	0.42
24.9	0.25	0.51	0.45
28.5	0.27	0.56	0.49
29.5	0.28	0.56	0.50

#### Blocking;

Measured on 21.4MHz as increase over 12dB SINAD level of interfering signal, unmodulated carrier, causing 6dB degradation in 12dB SINAD on-channel signal;

+/-50kHz;	96.0dB
+/-100kHz;	102.9dB
+/-200kHz;	108.9dB

#### 3rd Order Intermodulation Rejection;

Increase over 12dB SINAD level of two interfering signals giving identical 12dB SINAD on-channel 3rd order intermodulation product, measured at 21.4MHz;

50/100kHz spacing;	91.8dB
100/200kHz spacing;	93.1dB

#### Image Rejection;

Increase in level of signals at the first IF image frequency, and the first IF itself, over level of on-channel signal to give identical 12dB SINAD signals;

Freq. MHz	Image Rej.	IF Rej.
1.8	70.3dB	90.2dB
3.5	72.8dB	87.6dB
7.0	70.2dB	80.5dB
10.1	74.9dB	96.9dB
14.0	72.1dB	94.1dB
18.1	86.9dB	87.8dB
21.0	85.8dB	86.8dB
24.9	82.2dB	84.3dB
28.5	81.1dB	83.3dB
29.5	80.6dB	83.2dB

#### S-Meter Linearity

Measured at 14.25MHz;

Indication	Sig. Level	Rel. Level
S1	1.43 $\mu V$ pd	-34.9dB
S2	1.71 $\mu V$ pd	-33.4dB
S3	2.22 $\mu V$ pd	-31.1dB
S4	3.04 $\mu V$ pd	-28.5dB
S5	5.02 $\mu V$ pd	-24.1dB
S6	8.78 $\mu V$ pd	-19.2dB
S7	17.1 $\mu V$ pd	-13.4dB
S8	36.6 $\mu V$ pd	- 6.8dB
S9	80.7 $\mu V$ pd	0dB ref.
S9+20dB	1.08mV pd	+22.6dB
S9+40dB	7.90mV pd	+39.9dB
S9+60dB	54.5mV pd	+56.7dB

#### Selectivity;

	SSB/CW	AM(N)	AM
-3dB	1.98kHz	5.8kHz	7.0kHz
-6dB	2.63kHz	6.9kHz	8.2kHz
-20dB	3.17kHz	8.8kHz	10.5kHz
-40dB	3.53kHz	10.6kHz	12.4kHz
-60dB	5.03kHz	14.5kHz	15.6kHz

#### S-Meter S9 Level;

Freq. MHz	Sig. Level
1.8	64.7 $\mu V$ pd
3.5	61.6 $\mu V$ pd
7.0	62.6 $\mu V$ pd
10.1	58.7 $\mu V$ pd
14.0	75.6 $\mu V$ pd
18.1	84.6 $\mu V$ pd
21.0	97.2 $\mu V$ pd
24.9	100.4 $\mu V$ pd
28.5	104.6 $\mu V$ pd
29.5	107.1 $\mu V$ pd

The accompanying lab results showed that the strong signal handling capability of the set was very good, although I found the IF filter 'skirts' started to widen out a bit towards the -60dB mark. The blocking and intermodulation rejection was excellent, explaining the lack of problems I had from strong 41m broadcast stations whilst tuning around the 40m amateur band.

### Conclusion

The FRG-100 should be quite a popular HF receiver, I found it easy to use on the air, with a very good on-air performance that belied its plastic front panel and tuning knob. Although its AM performance is more than adequate especially for crowded band use, I feel it may not be the 'ultimate' for serious broadcast band reception due to the lack of a synchronous AM option. On the other hand its facilities for serious amateur and utility reception are very good, the capability of computer interfacing being an added bonus for such listeners. A receiver giving a combination of the 'best of everything' would be rather more expensive than the FRG-100, and it won't replace such a 'top of the range' set, but for a general purpose receiver I found it gave a good deal of versatility and flexibility.

*My thanks go to South Midlands Communications Ltd. for the loan of the review set.*

# SMMC

## FT530 DUALBANDER

- VHF/UHF Handheld
- Dual Reception on same or different bands
- RX Frequency Coverage: 110-180, 300-500, 800-950MHz
- AM Capability
- Built in CTCSS & DTMF Encode/Decode



- Full Duplex Cross Band Operation
- Built In Vox for Hands Free Operation
- Programmable Clock with Timer/Alarm Functions
- Enhanced Save Function for Extended Nicad Life

## Dualband Mobile



## FT1500

- Dual Reception on the same or different Bands
- 50W on 2m, 35W on 70cms
- Built In Antenna Duplexer
- Dualband CTCSS Option available
- Smaller than a Car Radio
- List of Options available



- MH29A2B Speaker Microphone c/w LCD Frequency Display and most used Keypad Function Buttons
- Supplied with Nicad, FNB28, and Charger

**Try one today –  
We know you'll  
like it !!!**

Leeds (0532) 350606 Axminster (0297) 34918 Southampton (0703) 255111



# S.M.C

South Midlands Communications Ltd, S.M. House, School Close, Chandlers Ford Ind. Est., Eastleigh, Hants SO5 3BY

## FT530 DUALBAND HANDHELD



- VHF/UHF Handheld
- Dual reception on same or different bands
- Rx Frequency coverage: 144-146, 430-440 MHz Expandable to 110-180, 300-500, 800-950 MHz
- AM Capability
- Built-in CTCSS & DTMF Encode/Decode
- Full Duplex Crossband operation
- Built in VOX for "Hands Free" operation
- Programmable clock with TIMER/ALARM functions
- Enhanced save function for extended NiCad life
- MH29A2B Speaker/Microphone c/w LCD frequency display and most used keypad function buttons.
- Supplied with FNB28 NiCad & charger.

**TRY ONE TODAY -  
WE KNOW YOU'LL LIKE IT !!!**

## SECONDHAND SELECTION

### HF EQUIPMENT

FT102	HF transceiver	£425.00	AX
IC726	HF transceiver	£699.00	AX
IC735	HF transceiver	£750.00	AX
IC2KL	HF linear	£1099.00	AX
FT757GX	HF transceiver	3 from £595.00	AX/PX
FT901DE	HF transceiver	£439.00	AX
FT902DM	HF transceiver	£549.00	RX
FT980	HF transceiver	£895.00	CX
FTONE	HF transceiver	2 from £850.00	CX/RX
TS120S	HF transceiver	£299.00	AX
TS120S	HF transceiver + Ext VFO	£340.00	AX
TS140S	HF transceiver	£650.00	CX
TS450SAT	HF transceiver	£1099.00	AX
TS680S	HF + 6m	£799.00	AX
TS940S	HF transceiver	£1495.00	PX
FT101ZD	HF transceiver 2 from	£450.00	RX
FT102	HF transceiver 5 from	£495.00	RX
FT650	24/28/50MHz c/w PSU	£1295.00	RX
CORSAIR	HF transceiver	£725.00	RX
TS440S	HF transceiver	£750.00	RX
TS450SAT	HF transceiver	£1095.00	RX
TS530S	HF transceiver	£525.00	RX
TS930	HF transceiver	£895.00	RX
TS930S	HF transceiver	£895.00	RX
TS940S	HF transceiver	£1350.00	AX
FT101Z	HF transceiver	£449.00	PX
FT107M	HF transceiver 12VD	£475.00	PX
FT980	HF transceiver	5 from £895.00	PX
FTONE	HF transceiver	£895.00	PX
HL2K	HF linear	£1450.00	PX
HT120	20m transceiver	£289.00	PX
HT180	80m transceiver	£289.00	PX

### VHF/UHF EQUIPMENT

ALR222	Transceiver	£160.00	AX
FT208R	Handheld	£130.00	AX
FT736R	Transceiver 2/70 + 6m	£1299.00	PX
FT736R	Transceiver + 6m	£1395.00	AX
IC2SRE	Transceiver handheld	£299.00	AX
IC2GE	Transceiver handheld	£169.00	AX
KT44	Handheld	£125.00	AX
TR9500	Transceiver	£325.00	AX
C5608D	Transceiver	£500.00	AX
FT290R	2m multimode	£310.00	LX
FT703R (3)	70cms handheld 2.5w	£135.00	LX
FT727	2/70 handheld	£260.00	RX
FT727	2/70 handheld	£276.00	CX
FT73R	70cms handheld	£175.00	AX
FT790R	70cms handheld	£269.00	AX
IC211E	2m Base station 10W	£349.00	AX
IC271E	2m Base station 25W	£395.00	CX
IC271H	2m Base station 100W	£650.00	AX
TH205E	2m handheld	£175.00	CX
TS790E	2/70 multimode	£1250.00	LX
TS811E	70cms Base station	£650.00	AX
FT690R2	6m multimode	£389.00	BX
C500	2m/70cm handheld	£150.00	RX
FT203R	2m handheld	£145.00	RX
IC25E	2m mobile	£155.00	RX
FT211RH	2m mobile	£299.00	PX
FT290R2	2m multimode	£239.00	PX
FT790R2	70cms multimode	£425.00	PX
FT811	70cms handheld	£239.00	PX
FT203R	2m handheld	£110.00	AX

### RECEIVERS/SCANNERS

MX7000	Scanner	£149.00	AX
PRO2005	Scanner	£100.00	AX
PRO2006	Scanner	£299.00	AX
PRO37	Scanner	£115.00	AX
PRO80	Receiver/Scanner	£158.63	AX
R2000	Receiver	£369.00	AX
R532	Receiver	£125.00	AX
SW1E	Receiver	£115.00	AX
AR1500E	Scanner	£249.00	AX
AR2001	Scanner	£125.00	AX
200XLT	Scanner	£99.99	AX
AR2002	Scanner	£275.00	RX
ICR7100	Receiver + HF	£999.00	AX
FR101	Receiver Ham Band + 2m + 6m	£160.00	PX
FRG7700	HF Receiver	£299.00	AX
FRG8800	HF Receiver	£439.00	AX
HF225	HF Receiver	£279.00	BX
SRG8600SDX	HF Receiver	£325.00	AX
ICR100	Scanner	£380.00	LX
2C	Amateur Band Rx	£135.00	RX
D2999	Multiband Rx	£195.00	AX
AIR 7	HF + VHF RX	£140.00	RX
FRG7000	HF Receiver	£155.00	RX
ICF2001D	Receiver	£179.00	AX
ICF7600	Receiver	£119.00	AX
PRO80	Handheld Receiver	£220.00	RX
ICR1	Handheld Scanner	£255.00	RX
R2000	HF Rx + VHF Converter	£475.00	RX
AIR7	Airband + B/cast RX	£169.00	PX
AR3000	Scanner	£599.00	RX
FRG9600	Scanner	£439.00	PX
HF225	Receiver	£389.00	PX
HX850E	Scanner	£99.95	PX
AR2001	Base Scanner	£175.00	RX

AX = ARE, LONDON BX = SMC, BIRMINGHAM CX = SMC, CHESTERFIELD LX = SMC, LEEDS PX = SMC, SOUTHAMPTON (HQ) RX = REG WARD, AXMINSTER

- Prices and availability subject to change without prior notice. ■ Carriage charged on all items as indicated or by quotation.
- Free Finance on selected items, subject to status. Details available on request. ■ Yaesu Distributor Warranty, 12 months parts and labour.
- Up to £1000 instant credit, a quotation in writing is available on request, subject to status. ■ Same day despatch wherever possible.

**HQ & Mail Order Southampton (0703) 255111 Leeds (0532) 350606**  
**Birmingham 021-327 1497 Axminster (0297) 34918 Chesterfield (0246) 453340**

## SECONDHAND Amateur Radio Equipment

Hygain TH7 antenna £300  
 Hygain Tailtwister Rotator £200  
 BBC B with D/D RTTY SSTV CW ETC £160  
 100ft 4 Sec mast complete with electric winch  
 £1500  
 Buyer dismantles above  
 Tel: 0724 764 390 - Home  
 0724 - 85 4424 - Business

**S. Dunsmore 33, Church St,  
 Messingham DN17 3SB.**

**G6XBH    GIRAS    G8UUS**

### Visit your Local Emporium

Large selection of New/Used Equipment on Show

AGENTS FOR:

YAESU • AZDEN • ICOM • KENWOOD • ALINCO

ACCESSORIES:

Wetz Range, Adonis Mics, Mutek Pre-Amps, Barenco Mast Supports,  
 DRAE Products, BNOS Linears & PSU's, ERA Microreader & BP 34  
 Filter, SEM Products

Full range of scanning receivers

AERIALS, Tonna. Full Range of Mobile Ants, Jaybeam

JUST GIVE US A RING

### Radio Amateur Supplies

3 Farndon Green, Wollaton Park, Nottingham NG8 1DU  
 Off Ring Rd., between A52 (Derby Road) & A609 (Ilkeston Road)  
 Monday: CLOSED Tuesday-Saturday: 10.00 a.m. to 5.00 p.m.

Tel: 0602 280267

R.A.S. (Nottingham)

R.A.S. (Nottingham)



## SPECIAL DEALS

*Putting Communications into Perspective*

### MAXON UHF mobiles • New Boxed!

- \*\* Ideal for 70cm FM voice or packet
- \*\* 4 Channel UHF downband (445Mhz TX/445Mhz RX)
- \*\* 25 Watt output
- \*\* Including information sheet for crystalizing and tuning.
- \*\* Not including microphone

**£46.99**

### MAXON VHF mobiles • New Boxed

16ch. synthesised £139.99

### Motorola Low Band Mobiles

convertible to 4 FM £29.99

### Surplus Philips MCR40 Cellular Telephone

£29.99

CRYSTALING and TUNING SERVICE ★

+

NEW, USED and SURPLUS EQUIPMENT AVAILABLE

## MAIL ORDER WELCOME

Contact us now to arrange the servicing and repair of  
 your radio equipment.



Tel. 0604 26283



SALES SHOWROOM, Victoria Chambers, 1 Victoria Rd, Northampton NN1 5EB



## THE COMMUNICATIONS PEOPLE

PRIVATE MOBILE RADIO LIMITED

These are just a part of our stock, phone me  
 for the best prices.  
 Phil GW4 REX

### YAESU

FT 990	General coverage RX & ATU & PSU
FT 890	Compact HF Base/Mobile
FT 747	Budget HF Rig
FT 530	Yaesu Dual Band Handheld

### ICOM

IC 735	Still one of Icom's best HF rigs
IC 728	Fully featured, budget price
IC 729	The '728' with 6 metres
IC W21E	Easy to operate dual band handheld
IC 2ie	Surely the smallest 2 metre handheld

### KENWOOD

TS 950 SDX	Top of the range
TS 50S	The truly 'mobile' mobile HF
TS 742	Latest Tri Bander
TH78/48/28	Kenwood's handportable family

### SCANNERS

AOR 3000A	The best desk top receiver with SSB
AOR 1500E	500KHz to 1500MHz lots of extras
YUPITERU MTV 7000	One of the best handhelds
YUPITERU MTV 7100	The 7000 with SSB
YUPITERU VT 225	Air band & Marine
YUPITERU VT 125	Dedicated air band at attractive price
Fairmate HP 2000	One of the best selling handhelds

We also have base & mobile aerials by Maldol, Diamond, Comet & Jaybeam plus a wide range of accessories.

### PRIVATE MOBILE RADIO LTD

INDUSTRIAL ESTATE,  
 GWAELOD-Y-GARTH,  
 CARDIFF  
 SOUTH GLAMORGAN  
 CF4 8JN. UK.

Come and see us Monday  
 to Saturday 9.00am -  
 5.00pm

TELEPHONE: 0222 810999  
 FAX: 0222 813369

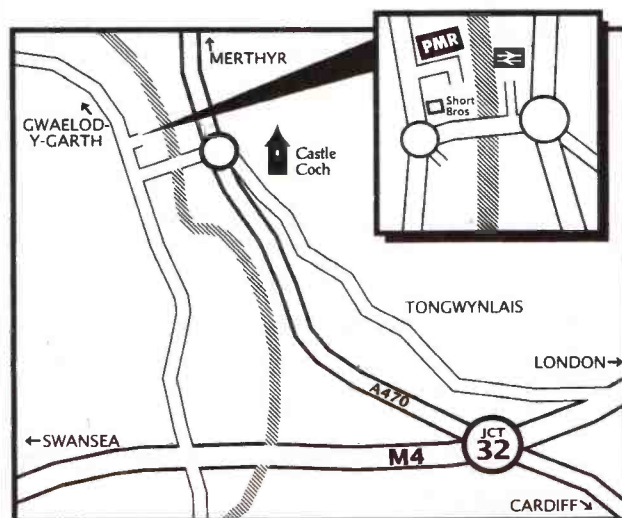



# 'RadCom' comes FREE!

Radio Communication is internationally recognised as one of the world's leading journals for the radio amateur and short-wave listener. Published monthly by the Radio Society of Great Britain, it is circulated exclusively to members of the Society and carries wide ranging and authoritative articles, technical reviews and data essential to those seeking to keep themselves briefed on the most up to date developments in the hobby. Regular columns cater for HF, VHF/UHF, microwaves, satellite, data transmission and QRP enthusiasts. Regular constructional articles are supported by a PCB service.



## JOIN THE RSGB TODAY

Membership services include a QSL Bureau, advice on planning permission for aerials and EMC problems, discounts on books and much, much more!

### FOR YOUR FREE 'RadCom'

(published end of March)

and a membership pack, post the coupon today, or

**CALL 0707 659015**

PLEASE SEND YOUR PUBLICITY PACK

Name .....

Call Sign .....

Address .....

.....

..... HRT

To RADIO SOCIETY OF GREAT BRITAIN  
Lambda House, Cranborne Road  
Potters Bar, Herts EN6 3JE



# Scanning Receivers

## MVT 7000

- 100kHz to 1300MHz, continuous coverage
- 200 programmable channels
- Search and scan facilities
- AM, FM and WBFM modes
- 10 programmable bands
- Excellent sensitivity
- LC display with signal strength meter
- Supplied with ni-cad batteries, mains charger/adaptor, telescopic aerial, carry strap, belt clip, 12Vdc lead and manual.

**£319.00**  
40-17000



## HP2000

- Continuous tuning from 500kHz to 1300MHz
- 1000 programmable channels
- Search and scan facilities
- AM, FM and WBFM modes
- 10 programmable bands
- Supplied with telescopic, UHF and VHF antennae, ni-cad batteries, carrying case, dc cable, mains charger/adaptor and manual.

**£279.00**  
40-31001

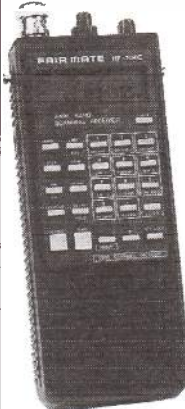

## VT225

- Civil and military airband receiver
- Covers 108 to 391MHz in 3 bands
- AM and FM modes
- 100 programmable channels
- Scan and search facilities
- LC display with signal meter
- Supplied with ni-cad batteries, mains charger/power supply, rubber duck antenna, carry strap, belt clip, 12Vdc lead and manual.

**£249.00**  
40-00225



## VT125UK

- VHF, AM Airband receiver
- Covers 108 to 142MHz
- 30 programmable channels
- LC display with signal meter
- Supplied with ni-cad batteries, mains charger/power supply, rubber duck antenna, carry strap, 12Vdc lead and manual

**£169.00**  
40-00125



Full details of all the above are included in our comprehensive catalogue, £1.70 (plus 30p p&p)  
All the above are currently in stock and available for immediate delivery. Standard p&p £1.40, next day delivery £4.60 (UK Mainland).

All prices include VAT (at 17.5%)

# Cirkit



**CIRKIT DISTRIBUTION LTD**  
Park Lane · Broxbourne · Hertfordshire · EN10 7NQ  
Telephone (0992) 444111 · Fax (0992) 464457

# Pye M296 Conversion to 70cm FM

*G4HCL continues with the M290 series by featuring a compact 6W/25W rig for 70cm*

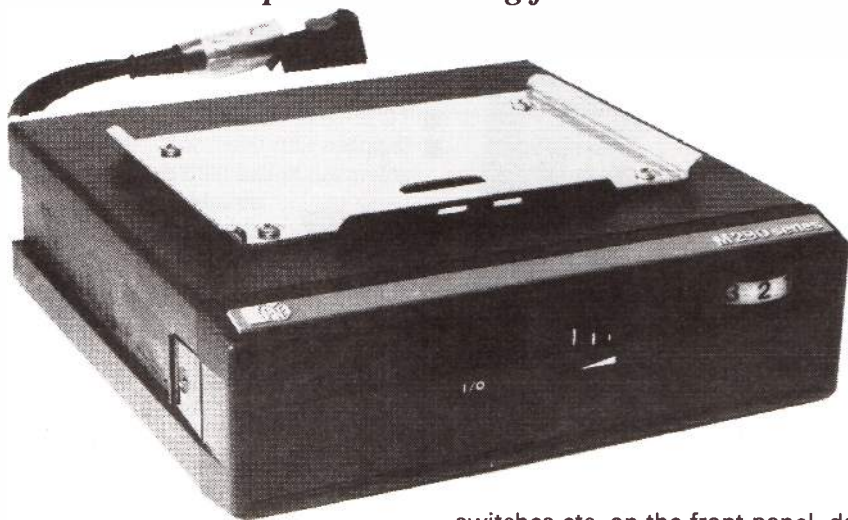

**The M290 Series, they all look the same!**

I gave an introduction to M290 series in the January 1993 issue of HRT, this series covering a range of VHF AM/FM and UHF FM car radio-sized transceivers, and giving details for the M294 A, B, and E band models for 2m and 4m use. This time I'm covering the M296, suitable for use on 70cm, and there's also a HRT article 'lined up' by Pete G7DXV on converting the M band M294 to 2m, which you'll see in these pages shortly.

## Part of a Series

From the Jan 93 article (if you missed it, back issues *are* available!) you'll see this set is part of a *series*, which all look identical from the outside. So take a look at the bolted-on serial number plate on the rear panel, if you see 'M296' on this then you're in business for 70cm! The set comes in either single or six channel versions, if it has a mechanical 6-way channel switch on the front it's multichannel, if it has a blanking plate instead it's single channel, simple as that. You may also see various selective calling indicators,

switches etc. on the front panel, don't worry about these, (see the earlier article for details), we'll get your M296 operating 'normally' without these.

The set's transmitter comes in either a 6W or 25W power output versions, the difference being an additional power amplifier PCB which is bolted to the inside rear panel of the set. Take a look inside by undoing the four screws on the rear panel and sliding the set out, if you see such a board with its prominent CD4442 transistor fitted, you've got a 25W model, if there's an empty space it's the more common 6W version.

The transceiver was originally manufactured to cover either the 405-440MHz range (T band) or the 440-470MHz range (U band), either will operate on 70cm, but ensure you obtain the correct crystals using the formula

shown here. Don't be 'fobbed off' by the supplier saying "Yours is a U band set so you need receive crystals to the U band formula", as this uses negative side carrier injection and you may end up with lower receive sensitivity when you try to tune the multiplier stages down to operate on 70cm. If he wants to argue the point, say 'goodbye' and purchase them from someone else instead!

## Crystals

The formula you need is;

$$\text{TX Crystal Freq.} = \frac{\text{TX Freq}}{32}$$

$$\text{RX Crystal Freq.} = \frac{\text{RX Freq} + 21.4\text{MHz}}{8}$$

You'll need a pair of crystals for each channel, i.e., one for transmit and one for receive. The crystals are plug-in HC25u types, remember to quote the crystal frequency rather than the transceiver operating frequency when you order these, stating they're for the M296 transceiver. Although I'd advise ordering just 'amateur spec' crystals to save money, the commercial specification reference for these are T92RX for both the TX and RX crystals, which may be useful to give to your supplier for information.

## Getting it Going

The first thing to do is to slide the set out from its case (just remove the four rear screws, you don't need to remove the front panel), lift the crystal compartment lid and plug your crystals into their respective positions. Now take a look inside the case you've just removed the set from, and see if any 'electronics' remain in the shape of selective calling units. These slide into the set in the same way as the RF board you've just removed, but out of the front of the set rather than the rear. This circuitry may cause your set to either keep its receive audio muted until it

**Look at the rear panel to find the model number**

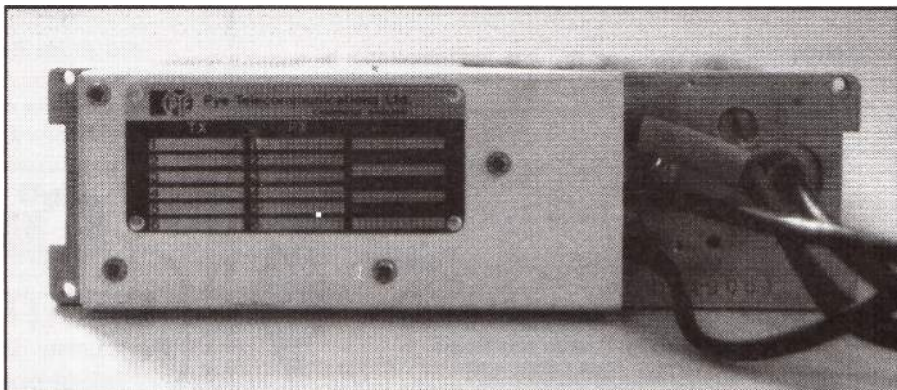



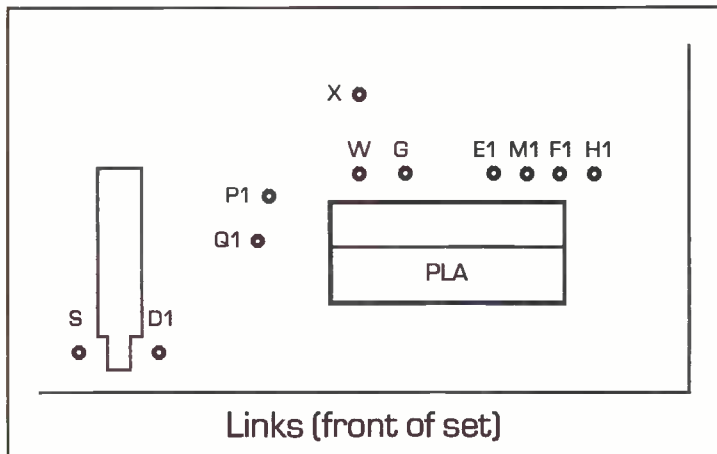

Links (front of set)

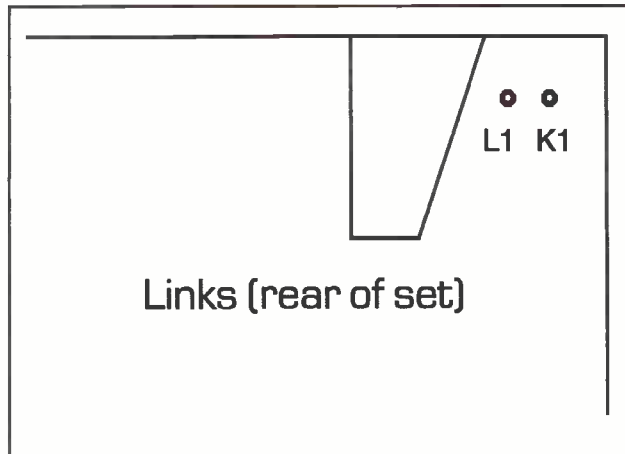

Links (rear of set)

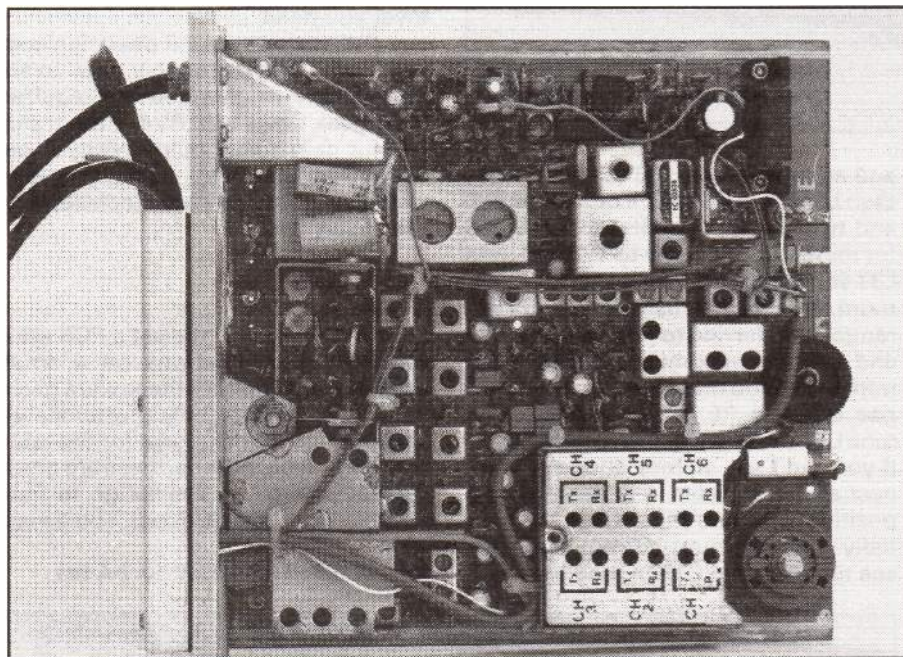

Here's what's inside the M296

receives the correct off-air tone(s), or transmit various 'funnies' you possibly might not wish it to! If you find a selective call module present, I'd recommend you entirely remove the electronics of this from the set, just retaining the plastic front panel for use with the set. If so, then check the linking details on the radio section PCB, you need to have pin F1 linked to pin S, rather than G1 linked to S as may be fitted if the option provides RX audio switching. Likewise on transmit, the lead

from pin 3 of the mic socket should go to pin L1, rather than to pin K1 if automatic selective call signalling is used on transmit.

The red and black wires are the DC 12V positive and negative, and the remaining pair are for the external loud-speaker connection, you should use a 3-8Ω impedance speaker here. The TX PTT needs +10V for switching, this is provided on pin 5, see the previous article for details of packet TNC interfacing.

### Receiver Alignment

Let's start with the receiver. Connect your 12V power supply, set the receiver volume control to about a third of its maximum travel, and rotate the squelch potentiometer, RV3, fully anticlockwise to make sure you hear squelch noise from your speaker - if not then check your connections and links. You'll need a non-metallic trimming tool for alignment, and the use of a multimeter, and towards the end an off-air signal to align the front end with.

Starting with the multiplier stages, connect your multimeter negative lead to the DC negative supply, which is also the rear panel chassis, and set your meter to its 2.5V DC range. Connect the meter positive lead to test point TP1, and with your channel switch in the correct position use your non-metallic trimming tool (*don't, ever, use a jeweller's screwdriver!*) tune the cores of L15 and L16 for maximum reading, peaking both for absolute maximum, then adjust L17 for minimum reading. Remove your multimeter positive lead, switch the meter to the 10V DC range, then connect the positive lead to TP2 and tune L18 and L19 both for minimum reading. Transfer the lead to TP3, switch back to the 2.5V DC range, and tune L20, L21, L18 and L19 for maximum, then retune L20 and L21 again for absolute maximum. That's it for the multiplier alignment.

Now for the front end. If you con-

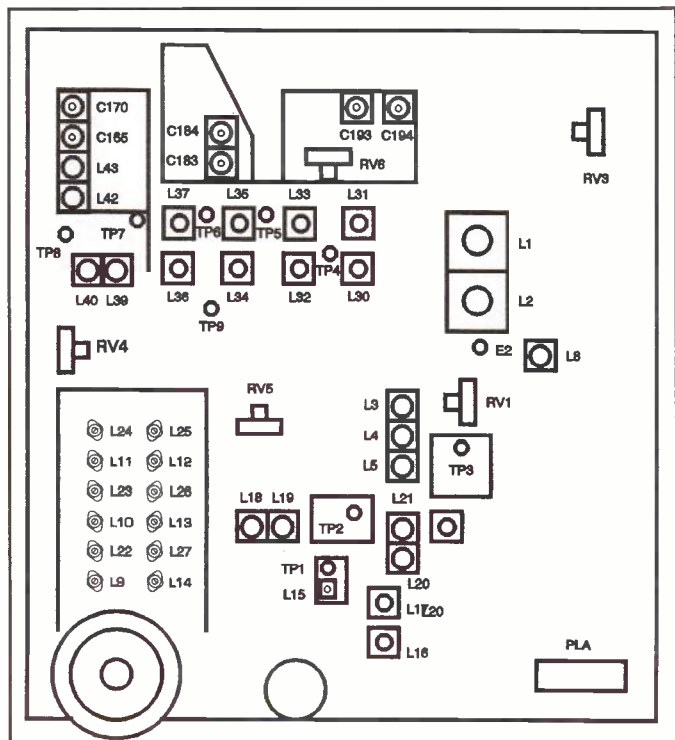

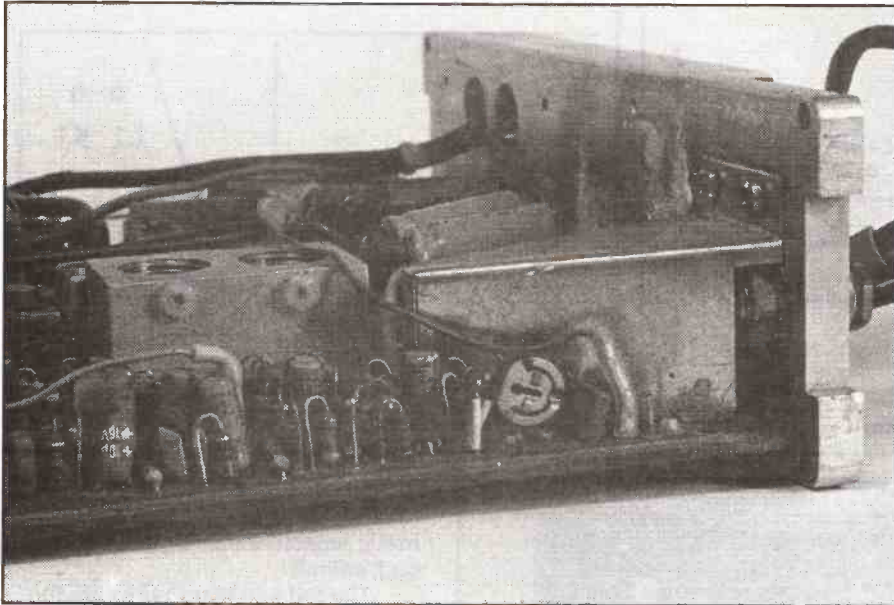

### RV3, the RX squelch control

nect an aerial (or a signal generator if you're fortunate enough to have access to one), you may be able to hear any strong off-air signals on your frequency already. You'll need to find some form of signal on your channel frequency to align onto (local amateurs can be useful here), and start by adjusting your receiver crystal trimmer for distortion-free reception. Then, tune L1, L2, L3, L4 and L5 for best quieting, reducing the level of the off-air signal as needed for accurate adjustment, and retune all these until you can't get it any better. Then, a final re-set of the crystal trimmer, followed by your squelch preset, and that's it, you should have a fully operational receiver.

### Transmitter Alignment

For this you'll need a 50Ω dummy load connected to your aerial socket, capable of handling 6W or 25W as applicable, with some form of RF power level detection in line such as a power meter or an absorption wavemeter. Remember to keep your PTT (Push-To-Talk) keyed when making adjustments, by shorting pins 3 and 5 on the microphone connector, but keep this keyed for only the length of time it takes for you to adjust each stage, to prevent overheating or damage to the PA.

To begin with, set the RF power preset, RV6, fully anticlockwise, you can get access to this with your trimmer through the small hole in the screen in front of it. Set your multimeter to its 10V DC range, and connect the meter positive lead to TP4. With the PTT keyed, adjust L30 and L31 for maximum reading. Transfer your meter positive lead to TP5, set now to its 2.5V DC range,

and adjust L32 and L33 for maximum, then L34 for minimum. Transfer to TP6 and tune L35 for maximum, then L36 for minimum. Transfer to TP7 and tune L37 for maximum, then L39 for minimum. Now switch back to the 10V DC range, transferring to TP8, and tune L39 and L40 for maximum, then L42 for minimum. You may by now see a slight rise on your RF power indicator, so tune L43 and C165 for maximum power. If you can't see an indication yet, connect a DC ammeter in series with the positive supply to the set and tune initially for maximum current until you see the RF appear, then tune for maxi-

imum RF output. Carry on by tuning C170 again for maximum, and then tune C183 and C184 as a 'pair' for maximum, then C193 and C194 again as a 'pair' again for maximum - i.e., tune one of the pair slightly, then the other of the pair, then back again and so on, then onto the next pair. If you have a 25W PA unit fitted, you'll need to also peak the trimmer capacitor, C306, on this PCB for maximum output. As a 'final touch', readjust L39 and L40 for absolute maximum power. You can, now, if you wish adjust RV6 to reduce the power output to the level you need, if so you should readjust C193 (and C306 if fitted) for maximum power again, then readjust RV6 again for the level you need.

RV5 is the transmit deviation control, which you'll probably need to adjust slightly to give you the required 5kHz peak deviation. RV4 is the transmit mic gain (this should already be set to appropriate level) which you may wish to adjust after you've correctly set the deviation.

### Interfacing

On the front of the set's PCB are a number of connections on a small socket. The details for these were given in the earlier article, but unfortunately a 'gremlin' got in the works for the table of the pin designations, these are given correctly here, my thanks go to Pete G7DXV for pointing this out. You'll need

**This is where the 25W TX PA fits**

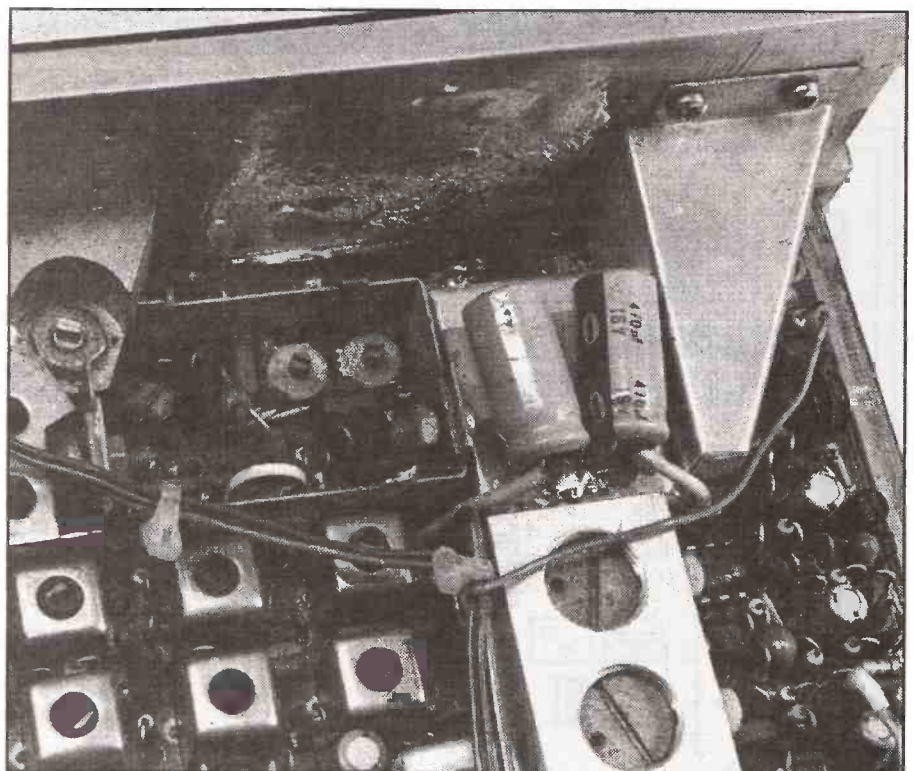



**Table 1 - Mic Connections**

1	Mic live
2	Ground
3	10V PTT line
4	RX low level audio
5	10V output

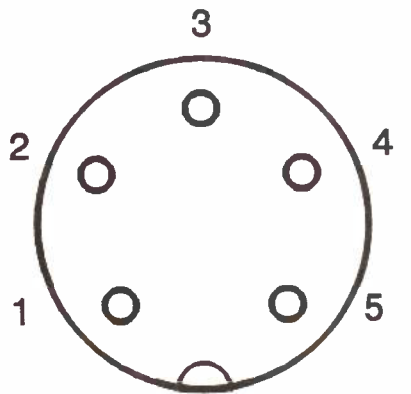

**Microphone Connections**

a link between pins D1 and D2 if you want to add TX sub-tone (CTCSS) encode. If you'd like to add a 'busy' indicator, you'll find that pin P2 goes to 0V

**Table 2 - Facility Module Connections (correction from Jan 93 article)**

A	-ve	J	TX 10V
B	Mic preamp gating	K	10V via TX PTT
C	In band TX encode	L	TX relay coil
D	Sub audio TX encode	M	Undedicated
E	RX audio for decoders	N	13.2V
F	RX squelched audio	P	Undedicated
G	Undedicated	Q	Undedicated
H	10V		

Q P G K L E M F



D N J C B A A H

**Facility plug connections (viewed from front of set)**

when the squelch raises (you may sometimes find this is linked to pin M1, which is in turn connected to pin M on the PCB facility connector), so you can add an LED/resistor combination or an

indicator lamp here if you wish. You may also find it handy to bring the squelch potentiometer connections out to a front panel mounted control, you'll need to use a 10k linear potentiometer for this.

**Final Final**

That's it. If you've used a jeweller's screwdriver on the cores and broken them, don't cry to me for help (you were warned!), but if you find you are having problems and need a copy of the circuit diagram of the set, send an SAE, marked 'M296 circuit' in the top left hand corner, to the HRT Editorial Office, P. O. Box 73, Eastleigh, Hants. SO5 5WG, and you'll have one by return of post. Happy 70cm operating!

**WISE BUY  BARGAINS!**

- DYMAR 2000 mobile radios synthesised, 100ch 15w r/f o/p, supplied with mod info, eproms, componentsetc. To make useful 2m radio £60
- PYE M294 "A" band for 2m. 6ch with mic etc £75
- PYE MX294 "A" band synthesised with mic etc £100
- PYE MF5FM "A" band for 2m. 3ch with mic and circuit £29
- PYE MF5U "U" band for 70cms with mic £36
- NOLTON NOVA 242 small 10ch mobile for 4m am/fm +info £26
- RACAL MA685 30-76 MHz wire dipole kits with 4 antenna elements in satchel 50w power handling BNC connector £12
- MOTOROLA PSU Mains in 130VA 13.6V out £35
- PYE W15FM "A" band boot mount 25Khz, ch sep, 6ch with gear £26
- PYE AC15PU 13.5V mains psu for W15 etc £30
- PYE M293 "A" band + mic + l/s £40
- PYE MX293 "E" band synthesised + mic + l/s £45
- PYE L9U UHF o.k. 70cms wall mount base, 12V £26

We now accept ACCESS/VISA orders on the telephone. SAE for mail-list or enquiries please. Ex PMR radios are sold "as is" but are checked for completeness before despatch.

BARGAINS FOR CALLERS. SURPLUS AND SECOND-USER EQUIPMENT ALWAYS WANTED

**G.W.M. RADIO LTD**

40/42 PORTLAND ROAD, WORTHING, SUSSEX BN11 1QN  
TELEPHONE: 0903 234897 Fax: 0903 239050



# THE FLYING SHOP

BIGGIN HILL AIRPORT



**YUPITERU MVT-7000**

1MHz-1300MHz  
• AM-NBFM-WBFM • Multiple steps  
• Better than 0.5uV • 200 memories • Rotary dial • S-meter • Fast scan speed • Lockout/priority • Ni-cads • Charger/AC PSU • 12V lead

The MVT-7000 from Yupiteru provides unbroken coverage throughout the spectrum. Each one is carefully tested by us and supplied with a unique power supply that will not only recharge the ni-cads, but also run the set directly from the mains. It's beautifully styled lines and superb engineering make it the best buy for the customer who wants the widest frequency range possible. **£299 incl V.A.T.**

**THE NEW!!!**  
**YUPITERU MVT-7100**

- 1000 Channels
- All Mode AM/FM/MW/LSB/USB
- 500kHz-1650MHz
- SSB tuning in 10Hz steps

**LOWEST PRICE £369**

**YUPITERU VT-225**  
**£199 incl V.A.T.**

---

**YUPITERU VT-125 MkII**

- Excellent reception • 108-142MHz
- 30 memory channels
- Illuminated LCD display! 25, 150 or 100KHz steps
- Search scan or direct frequency entry
- Keylock • Keyboard beep tone • LCD signal meter

**£160 incl V.A.T.**

*Complete with 3 AA size ni-cad batteries, 240V mains adaptor. 12V d.c. cigar plug & carry strap.*

**24 hour delivery £7.50**  
**48 hour delivery £5.00**

*The Flying Shop, Biggin Hill Airport,*  
Westerham, Kent TN16 3BN  
Tel: (0959) 576370 0900 - 18.00 (Mon-Sun)  
(0959) 572352 0700-0900 & 1800-2000  
Fax: (0959) 576711 24 Hour.



# A Portable Ground Plane for 2m

*Peter Cole DAIPE shows how to build a simple ground plane to boost your /P signals*

A 2m ground plane is an easily built aerial system, ideal for short range working to repeater and mobile stations where an omni-directional, vertically polarized radiator is needed. Although its use in base stations has decreased in favour of designs giving worthwhile amounts of gain, because of its small size, the basic ground plane is still very useful as a temporary or back-up aerial for portable or emergency use.

The aerial described here was built to replace the very inefficient flexible rubber aerial supplied with many portable rigs, in the hope of getting better results when working from a poor location such as an hotel bedroom. Because of this, it was designed as a compact aerial that could be collapsed easily for packing but could be re-assembled quickly when required.

plane aerial shown in Fig 1a consists of a quarter wavelength long vertical radiator mounted above four equally spaced quarter wavelength long horizontal radials. These radials effectively isolate the vertical radiator from the coaxial feeder, as the opposite radials induce opposing currents into the feed line which cancel each other out providing the aerial and feeder are properly installed.

The feedpoint impedance of a VHF type ground plane mounted in the clear is of the order of 20 ohms. This can be transformed to a higher value in a number of ways, but one of the simplest is by sloping the radials downward to form the 'drooping ground plane' shown in Fig 1b. Here the feedpoint impedance is a function of the angle of tilt and 50 ohms is obtained when this angle is about 30-45 degrees.

is built from transistor radio type telescopic whip aerials mounted onto a square SO-239 type UHF coax socket. The vertical element is a straight telescopic whip with a length of M3 threaded brass rod screwed into the bottom end. This is joined to the centre pin of the SO-239 socket with a brass coupler and the whole lot soldered together. Finally, for extra strength, the lower end of the radiator may be potted in an epoxy resin compound after testing is complete.

For the radials, four telescopic whips are needed. These should be of the same size and type, and must have some form of universal 'tilt and swivel' joint like the one shown in the drawings. This is necessary to allow the radial elements to be adjusted and positioned for operation, or collapsed and folded for transportation.

## Testing and Tuning

Tuning and adjustment of the aerial can best be carried out with the help of a low power transmitter and an SWR bridge, ideally the latter should be an instrument designed for VHF/UHF

## The Ground Plane Aerial

In its simplest form the ground

## Construction

Fig. 2 shows how the ground plane

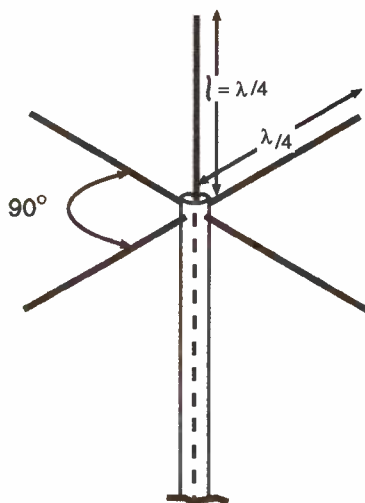

FIG.1a: THE BASIC GROUND PLANE AERIAL

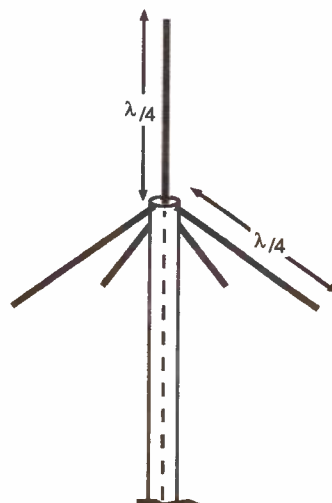

FIG.1b: THE DROOPING GROUND PLANE AERIAL



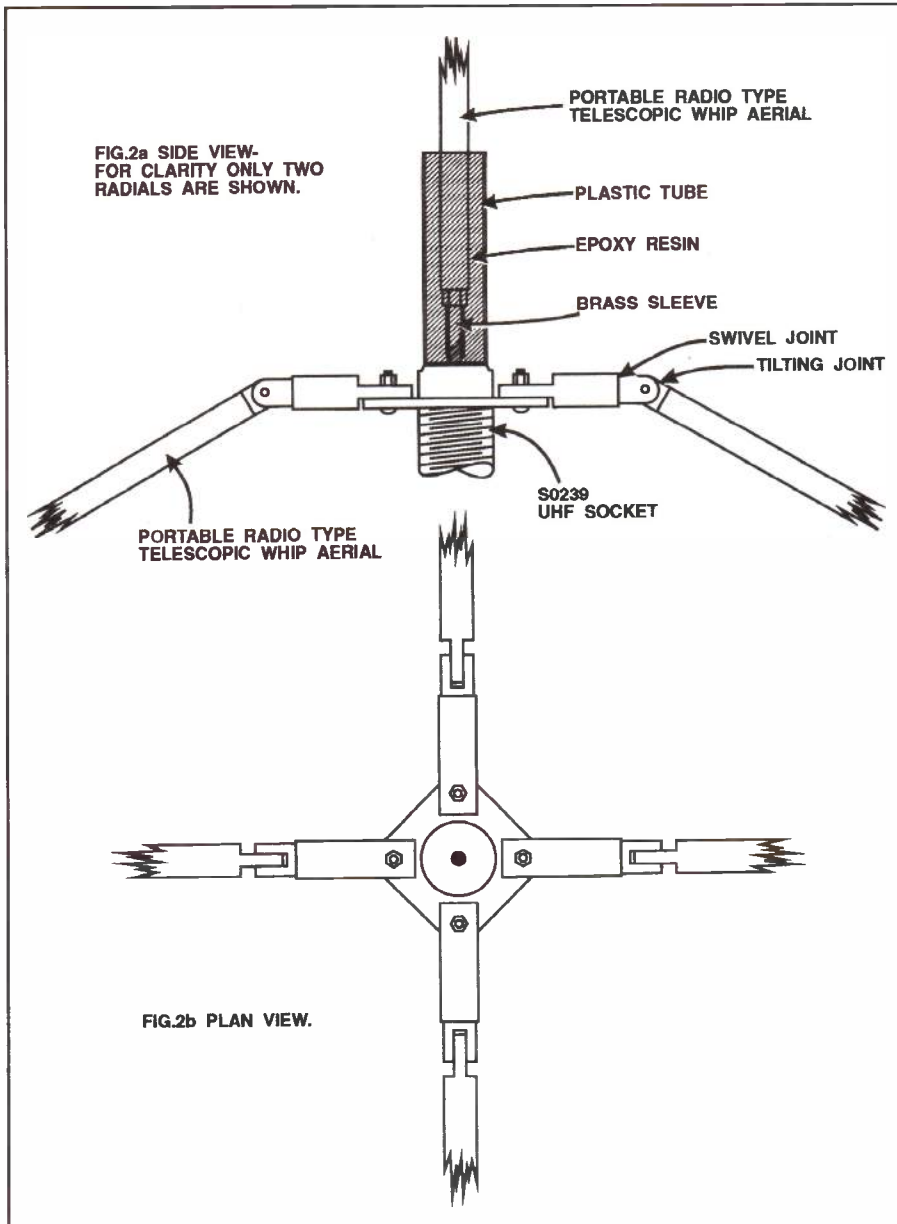

FIG.2a SIDE VIEW-  
FOR CLARITY ONLY TWO  
RADIALS ARE SHOWN.

FIG.2b PLAN VIEW.

measurements, although I managed to use a HF type after a few internal modifications. For convenience during testing, I mounted the aerial directly on top of the SWR meter, this being fastened to a temporary wooden mast.

With the radials horizontal and all of the elements set to 500mm in length carry out the following procedure:

1) On a clear channel near 145MHz, calibrate the SWR meter (if required) using the lowest possible transmitted power.

2) Set the SWR meter to read reverse power and adjust the vertical element in small steps to obtain the lowest reading. When doing this, a) unkey the TX before touching any of the elements, and b) use a long keying lead so that you can stand well back from the aerial when the transmitter is turned on. (these are safety measures, b) is

however also important to reduce detuning of the aerial by body capacity).

3) Change the length of the radials, tilting them as necessary, and repeat the above to get the best match. By doing this it should be possible to get a

near 1:1 SWR at 145MHz, and this should stay within acceptable limits over the whole of the band.

4) Note the element lengths and the tilt angle of the radials for future use. A small cardboard template would be helpful for resetting the radial tilt.

Based on the standard formula for aerial lengths the elements should be about 490mm long at 145MHz. This will vary depending on the method of construction, materials and siting but it is a good indication of what to expect. Also, with tilted radials the aerial does seem to work better if they are made slightly longer than the vertical element. The final measurements for my aerial were 510mm for the radiator, and 540mm for the radials with a 40 degrees tilt.

## Aerial Mounting

When folded the aerial fits neatly inside a 250mm long section cut from a 90mm diameter postal tube. For indoor portable operation, this tube serves also as a short 'mast'. With the tube stood upright on one end, the radials sit in four notches cut at the other end. The feeder passes down through the tube and out of a hole in its side to the transceiver, which should be placed well below the aerial.

This aerial is not sufficiently weathertproof or strong enough for permanent outdoor use. However it is fine for temporary portable working and in this case I'd suggest you use a non-metallic mast. This could be fastened to the SO-239 socket by a small metal bracket.

## Results

The constructed ground plane gave a big improvement over the short aerial it was designed to replace. Signals were generally at least 2 'S' points better, and this was often enough to allow good contacts which otherwise could not have been made. This design is therefore well worth consideration by other operators who are disappointed with the performance of their portable or handheld rigs.

### Parts List

- 1 x Straight portable radio type telescopic whip aerial, extending to about 670mm
- 4 x Telescopic whips as above with tilt and swivel joints
- 1 x SO-239 square UHF socket
- 1 x Brass coupler (terminal from a screw type terminal block)
- 50 ohm coaxial cable terminated with suitable plugs
- M3 screws and nuts for assembly
- Epoxy resin potting compound.



# "Nearly New" stock offers substantial savings

Occasionally we are able to offer "Nearly New" equipment with full 12 months' AOR warranty at attractive prices. There can be many reasons for this stock, but most important for 'you' is that we can offer substantial savings from Suggested Retail Price. All equipment is thoroughly tested before despatch to ensure full conformity to specification. Typical examples of "Nearly New" equipment include:

1. Brand new arrivals from Japan with slight cosmetic damage, possibly a small scratch or soiled packaging.
2. Dead on arrival (or near-arrival) which has been refurbished - often in the Japanese factory. Be rest assured, any faults in the early days tend to be of a minor nature, of course any such faults are cleared and the equipment fully tested prior to placement into "Nearly New" stock.
3. Equipment returned subject to a re-stocking charge within a few days. This is most unusual and would only be the subject of an unwanted Christmas or Birthday present etc. Equipment is sold subject to the company's current terms and conditions, a copy of which is available upon request. *This offer is only available directly from AOR (UK) and subject to availability. (Carriage £6.00 extra).*

MODEL	DESCRIPTION	Suggested Retail Price	"Nearly New" Price	Saving
AR3000A	The ultimate. Unique all mode extremely wide band base-mobile receiver. Coverage is from 100 kHz - 2036 MHz with no gaps. Fitted with RS232 computer port.	949.00	799.00	150.00
AR1500e	Compact all mode hand-held receiver. Receive coverage 500 kHz ~ 1300 MHz... AM/NFM/WFM & SSB using BFO. <b>Enhanced model.</b>	Was 299.00	250.00	49.00
AR1500EX	Compact all mode hand-held receiver. Receive coverage 500 kHz ~ 1300 MHz... AM/NFM/WFM & SSB using BFO. <b>Latest model.</b>	349.00	299.00	50.00
AR2800	Competitively priced full featured base - mobile scanning receiver. All mode operation AM/NFM/WFM & SSB using a BFO. Coverage is 500 kHz ~ 600 MHz & 800 ~ 1300 MHz. Includes internal NiCad.	449.00	375.00	74.00
AR2500	Base - mobile receiver 5 - 550 MHz & 800 - 1300 MHz fitted with BFO. Has an RS232 computer port.	Was 419.00	325.00	94.00
AR2000	Hand-held receiver 500 kHz - 1300 MHz without gaps. AM/NFM/WFM	309.00	250.00	59.00

*"Nearly New" equipment is truly supplied as-new and is not the result of worn out used equipment through trade-in deals etc.*

New...  
 ARI500EX ~ Latest enhanced model  
 out now £349.00 inc. VAT.  
 Phone for full details



**AOR (UK) Ltd.** Adam Bede High Tech Centre,  
 Derby Road, Wirksworth, Derbys. DE4 4BG.  
 Tel: 0629 - 825926 Fax: 0629 - 825927  
 A subsidiary of AOR Ltd Japan E&OE



## SPECIALIST ANTENNA SYSTEM LTD

present the finest range of DX antennas and accessories

See you at the  
**LONDON**  
 AMATEUR RADIO  
 EXHIBITION

### cushcraft

- 40-2CD ..... 40m 2 element Beam
- 20-4CD ..... 20m 4 element Beam
- 20-3CD ..... 20m 3 element Beam
- 15-3CD ..... 15m 3 element Beam
- 10-4CD ..... 10m 4 element Beam
- TEN-3 ..... 10m 3 element Beam
- A4S ..... 20-15-10m 4 element Beam
- A3S ..... 20-15-10m 3 element Beam
- A3WS ..... 17-12m 3 element Beam
- D40 ..... 40m Rotary Dipole
- D4 ..... 40-20-15-10m Dipole
- D3 ..... 20-15-10m Dipole
- D3W ..... 30-17-12m Dipole
- R7 ..... 40-10m H/W Vertical
- R5 ..... 20-10m H/W Vertical
- AP8 ..... 80-10m Vertical
- AV5 ..... 8 Band HF Vertical
- AV3 ..... 20-15-10m Vertical
- A50-6S ..... 6m 6 element Beam
- A50-5S ..... 6m 5 element Beam
- A50-3S ..... 6m 3 element Beam
- AR-6 ..... 6m Ringo Vertical
- 17B2 ..... 2m 17 element Beam
- 13B2 ..... 2m 13 element Beam
- 124WB ..... 2m 4 element Beam
- A144-7 ..... 2m 7 element Beam
- A144-11 ..... 2m 11 element Beam
- A144-20T ..... 2m 10 element X Oscar
- AR-2 ..... 2m Ringo Vertical
- ARX-2B ..... 2m Ringo Ranger II
- AR-270 ..... 2m/70cm Vertical
- 424-B ..... 70cm 24 element Beam
- A430-11 ..... 70cm 11 element Beam
- 416TB ..... 70cm 8 element X Oscar
- ARX450B ..... 70cm Ringo Ranger II



### MIRAGE/KLM

COMMUNICATIONS EQUIPMENT

- 40M-2 ..... 40m 2 element Beam
- 20M-4 ..... 20m 4 element Beam
- 15M-4 ..... 15m 4 element Beam
- 10M-4 ..... 10m 4 element Beam
- KT34-A ..... 20-15-10m 4 element Beam
- KT34-XA ..... 20-15-10m 6 element Beam
- 6M-7LD ..... 6m 7 element Beam
- 6M-5 ..... 6m 5 element Beam
- 2M-20LBX ..... 2m 20 element Beam
- 2M-16LBX ..... 2m 16 element Beam
- 2M-13LBA ..... 2m 13 element Beam
- 2M-22C ..... 2m 11 element X Oscar
- 2M-14C ..... 2m 7 element X Oscar
- 432-30LBX ..... 70cm 30 element Beam
- 432-20LBX ..... 70cm 20 element Beam
- 435-40CX ..... 70cm 20 element X Oscar
- 435-18C ..... 70cm 9 element X Oscar

#### LINEAR AMPLIFIERS

- A1015G ..... 6m 10-150w g/f rx
- B3030G ..... 2m 30-300w g/f rx
- B3016G ..... 2m 30-160w g/f rx
- B1016G ..... 2m 10-160w g/f rx
- B108G ..... 2m 10-80w g/f rx
- B215G ..... 2m 2-150w g/f rx
- D3030N ..... 70cm 30w-100w
- D1010N ..... 70cm 10w-100w
- D15N ..... 70cm 2w-20w

#### GASFET PRE-AMPLIFIERS

- KP-1/2M ..... 2m Indoor unit
- KP-1/70 ..... 70cm Indoor unit
- KP-2/2M ..... 2m Masthead unit
- KP-2/70 ..... 70cm Masthead unit

### TELEX hy-gain

- 7-2 ..... 40m 2 element Beam
- 7-1 ..... 40m Rotatable Dipole
- 205CA ..... 20m 5 element Beam
- 204BAS ..... 20m 4 element Beam
- 203BAS ..... 20m 3 element Beam
- 155CA ..... 15m 5 element Beam
- 153BAS ..... 15m 3 element Beam
- 105BAS ..... 10m 5 element Beam
- 103BAS ..... 10m 3 element Beam
- TH7DXS ..... 20-15-10m 7 element Beam
- TH5MK2S ..... 20-15-10m 5 element Beam
- EXP14 ..... 20-15-10m 4 element Beam
- TH3JRS ..... 20-15-10m 3 element Beam
- TH2MK3S ..... 20-15-10m 2 element Beam
- DX88 ..... 8 Band HF Vertical
- 12AVQS ..... 20-15-10m Vertical
- 14AVQ ..... 40-10m Vertical
- 18VS ..... 80-10m Vertical
- 66DX ..... 6m 6 element Beam
- 64DX ..... 6m 4 element Beam
- 215DX ..... 2m 15 element Beam
- 216SAT ..... 2m 8 element X Oscar
- 7031DX ..... 70cm 31 element Beam
- 7030SAT ..... 70cm 15 element X Oscar

#### ROTATORS

- T2X ..... Windload 1.9m<sup>2</sup>
- HAM IV ..... Windload 1.4m<sup>2</sup>
- CD45 II ..... Windload 0.79m<sup>2</sup>
- AR40 ..... Windload 0.28m<sup>2</sup>

**WE NOW HAVE  
 GEM QUAD PRODUCTS**  
 PLEASE ASK FOR DETAILS

LIGHTNING ARRESTERS AND FULL RANGE OF COMMERCIAL ANTENNAS ALSO AVAILABLE. PLEASE ASK FOR FULL DETAILS

Trefonen, Oswestry, Shropshire SY10 9DJ  
 Phone 0691 670440 Fax 0691 670282  
 CALLERS WELCOME - PLEASE NOTE OUR NEW ADDRESS

OPENING HOURS  
 Mon-Fri 8.30-5.30  
 Saturday 9.00-1.00



# SCANNERS

## LA320

## INTERNATIONAL

### Mini-Review

Chris Lorek tests AOR's new range of active loop aerials for HF use

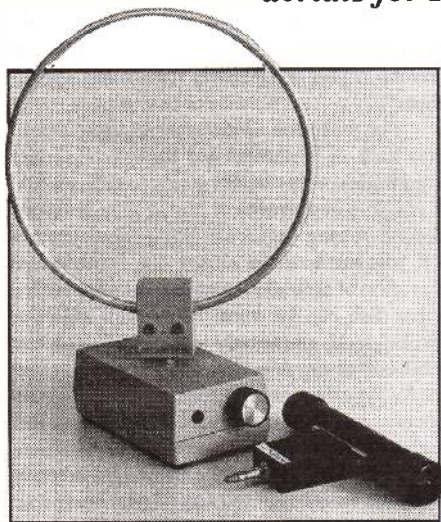

Together with the significant number of dedicated HF receivers, an ever-increasing of scanners now also have HF (High Frequency, or 'short wave') coverage, some even having SSB reception facilities. A short length of wire used as an aerial can often give you disappointing results on the 'lower' HF ranges, but not everyone has the facility of being able to connect a long wire outdoor aerial with its associated aerial tuner, or a dedicated resonant aerials, for this. Another problem which many of us face in this 'electronic age' is that of electrical 'hash' from our neighbour's computers, TVs and so on. A directional aerial helps here, but such an animal for, say, the 41m broadcast band tends to be a bit large at around 20m long, rotatable!

With this in mind, AOR have complemented their wideband aerial range with the LA320. This is an ultra-compact loop aerial, specifically designed to improve reception when located indoors. As supplied it comes with two plug-in elements, a black shrouded ferrite loop for 1.6MHz-5MHz, and a metal shrouded loop for 5-15MHz. Each of these plug into a plastic base unit, which houses a varicap tuning circuit and RF amplifier arrangement, powered from a PP3 sized 9V battery fitted within the base. Optional plug-in elements are also available for 0.2-0.54 and 0.54-1.6MHz.

#### In Use

Everything, including the coax patch lead to your receiver and even the 9V battery, are supplied, so all you need to do is simply connect up. The large black knob on the base unit acts as an on/off and tuning control, this being adjusted for maximum signal strength at whatever frequency you're listening to at the time. After doing this, I found that by placing the aerial on a window sill, I could get very good performance and effectively 'null out' virtually all the noise from my computer system located within the house, but possibly more importantly I could also 'peak up' on weak broadcast signals whilst reducing the level of an unwanted adjacent broadcaster from a different direction - superb!

I often found there was rather too much 'gain' from the aerial due to its internal preamp, even my outdoor (33m long) HF trap dipole yielded considerably less signal level than the LA320 provided, and I normally had to keep my receiver's attenuator switched fully in to prevent overloading. Although many dedicated HF receivers will cope with this, as did the FRG-100 I tested the LA-320 with, some handheld scanner receivers would undoubtedly just 'curl up'.

#### Medium Wave DXing

AOR (UK) kindly also sent me the optional LF loops. These really came into their own for semi-serious MW/LW broadcast band 'DXing', especially at night when the directional advantage of the LA320 would nicely

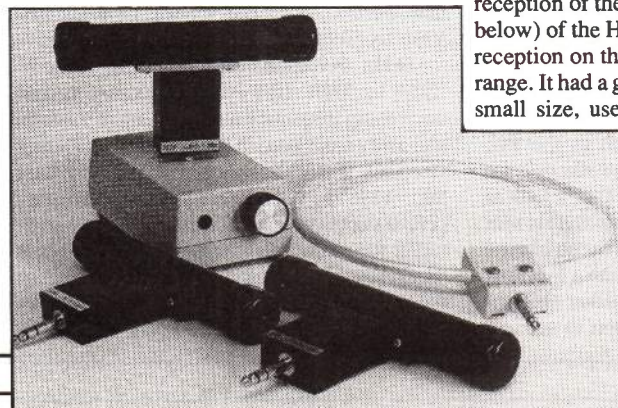

## From the Editor's Desk

### When is a scanner not a scanner?

When it's called the incredible multiband "Pocket Scanning Radio Receiver" from Development Products! (see our 'exposé' of this in the July 91 issue) and in response to our readers requests to "take them to the cleaners" we at Scanners helped to prove it. On the 24th February, Mr. Martin Fisher trading as Development Products was found guilty by Medway Magistrates Court, of being in contravention of the Trade Descriptions Act 1968 after action was taken against him by the County Trading Standards Office of Kent County Council. Acting as the technical authority, our *Scanners* Technical Editor provided a statement after having examined the radio and the associated advertisement, saying that it was not a scanner, and that it could not receive what the defendant claimed it could in the advertisement. As Mr. Fisher did not turn up at court, sentencing will be carried out at a later date, we'll let you know what happens.

'null out' one or more of the many stations on the same frequency, almost like a large frame aerial but a fraction of the size.

In all, I found the LA320 system should be very useful in those cases where either a long outdoor wire aerial would be difficult for reception of the 'lower half' (i.e. 15MHz and below) of the HF spectrum, as well as for DX reception on the lower part of this frequency range. It had a good directional capability in a small size, useful for nulling out unwanted signals, but make sure your receiver has a switchable attenuator otherwise you could have problems with overloading.

My thanks go to AOR (UK), Tel. 0629 825926, for the loan of the aerial.



# Starting on Weather Satellites

Bill Robertson gives a beginner's introduction to this fascinating hobby

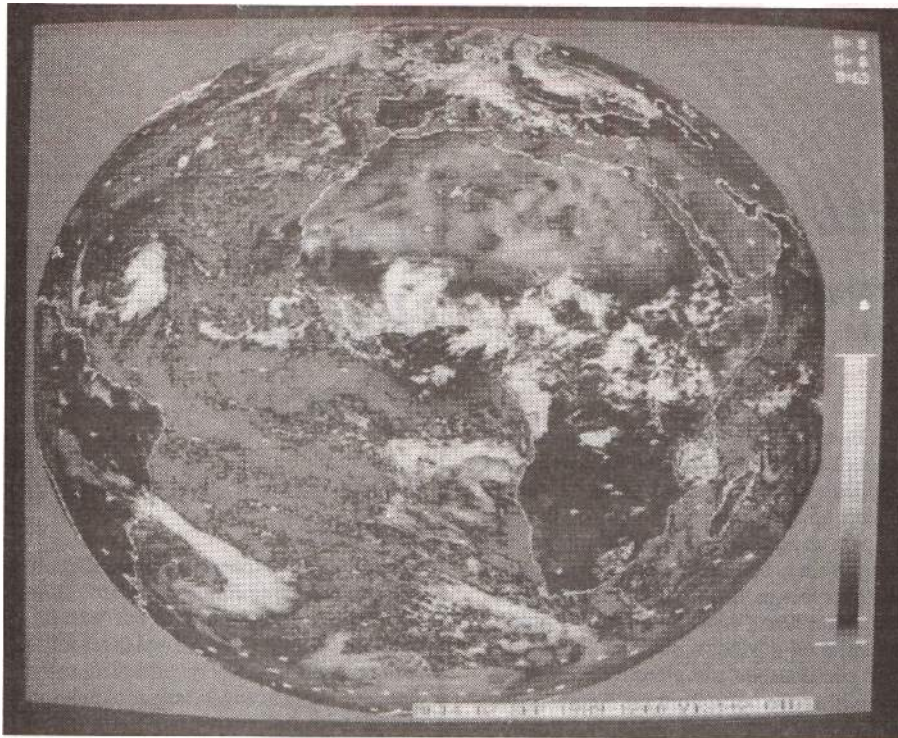

Meteosat Whole Earth Disc

Above us at this very moment, a network of satellites are beaming signals to us, pictures of our country, our continent, and even the entire globe, as seen from their 'eye' in outer space. Some of these satellites orbit the Earth a few hundred years above us, sending us 'close-up' images. Others stay around 23,000 miles above us in geostationary orbit, transmitting images of their entire visible 'disc' as well as various sectionalized areas.

Try setting your scanner to search across 137-138MHz one afternoon with your aerial having a clear 'view' of the sky above. Even with just a set-top whip, you'll soon hear the mysterious sounding bleeps from one of the NOAA (US) or Cosmos/Meteor (CIS) low-earth orbiting satellites as they pass otherwise silently above you.

## Equipment

So what do you need to decode these bleeps, and transform them into visual images? If you have a computer as well as your scanner you already have most of what you need. There are several software packages available for a variety of machines, such as the PC, BBC, Atari and so on, which normally operate with a simple plug-in interface. Take a look at Peter Rouse's review of the Amgiasat system in the June 92 issue of Scanners for an idea of what you'll be able to receive with a low cost system. Alternatively, you can either build or buy a dedicated 'frame store' unit to act as a

display memory for your monitor.

## But isn't it all too easy?

Well, yes and no. Many beginners start by receiving the 'low earth' orbiting satellites. You can, if you wish, simply take 'pot luck' and see what you can receive at any time, using a simple fixed aerial system such as crossed dipoles. You can add an elaborate system for storage and animation of received images from both orbiting and geostationary satellites. You can also run a satellite pass prediction program on your computer to tell you exactly which satellite is coming over and when, and even automatically steer an azimuth/elevation rotator system for a beam aerial to track the orbiting satellites if you wish.

## Receivers

Although your scanner can give you a 'start', weather satellites use higher deviation than 'normal' terrestrial two-way radio signals. Your receiver needs to be able to cope with +/- 18kHz deviation, plus up to +/-3kHz of 'Doppler Shift' (the effect of increasing and decreasing frequency with movement towards and away from you) in the case of the orbiting satellites. If you have a sensitive receiver, then the 'Wide' FM mode on your scanner may give acceptable results, although this is often rather too wide. Another problem with this is breakthrough of paging signal interference in the UK, from high power transmitters operating in the adjacent paging band. The 'best'

way is to either replace the IF filters in your receiver to provide a 50kHz total bandwidth, or of course use a dedicated receiver for such, these are readily available for both the 137MHz and 1691MHz ranges.

## Aerials

For reception of the orbiting 137MHz satellites, a vertical whip or discone will work but it won't give you the best results. A pair of crossed dipoles, phased for circular polarisation, are ideal, and you can improve the gain by using a pair of reflector elements beneath these, or of course by adding a masthead preamp if you don't suffer from other strong signals.

For reception of the geostationary satellites such as Meteosat over Europe (at 0 deg Longitude) or the GOES series over the USA if you live in that area, a higher gain aerial is needed. A long yagi is a popular choice, in the UK this needs to be aimed due south at an elevation of around 30 degrees. Alternatively, a 1m dish can be used, fitted with either a 'probe' feed, commonly home made inside a large coffee tin, or a simple dipole element at the focal point. Larger dishes give greater gain of course, and are suitable for reception of the high quality 'Primary User Data' transmitted (see later). An aerial-mounted preamp is almost essential to overcome coax feeder losses at these frequencies.

## Decoding

Both 'visible' and 'infra red' images are transmitted by the satellites as well as other types, but don't confuse 'weather fax' decoding (from HF signals) with 'weather satellite' decoding (from VHF/UHF signals), the two are different. If, however, you already have weather fax receive capability, for example a multimode TNC, the APT-1 module from Technical Software can be used as a 'converter'. The best quality, undoubtedly, comes from a dedicated system, and there are plenty available, such as the MET-2a from ICS Ltd., the PROSAT2 from Timestep Weather Systems, and PC-GOES from PC Maritime Ltd., all for the PC. Some systems even allow you to artificially 'colour' the images, to replicate blue sea and green land for example. For non-computer use, the YU3UMV frame store is a popular choice, available from a number of suppliers in kit and ready-built form.

For orbiting satellite pass prediction, again plenty of software is available, including some as 'shareware'. For accuracy these require you to enter up-to-date Keplerian elements to allow for minor changes in the satellites' orbits, these are freely available from various sources including BBSS. If you'd like a printed copy of the latest elements for all current weather



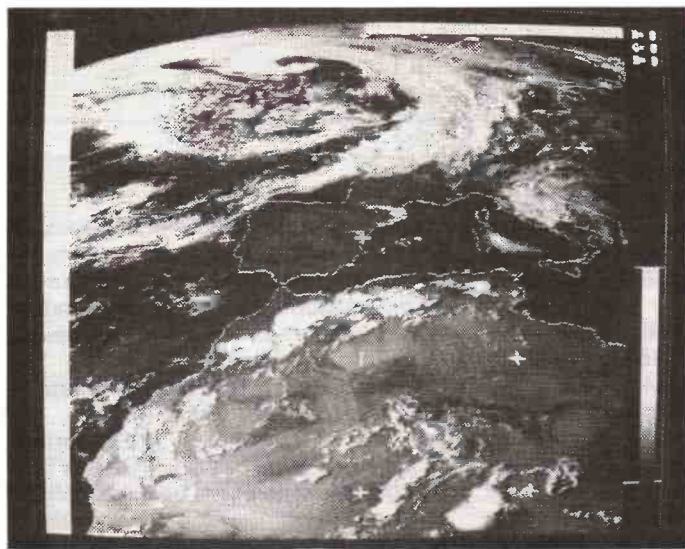

### Europe and North Africa from Space

satellites, send an SAE marked 'Weather Sat Keplers' to Scanners, P. O. Box 73, Eastleigh, Hants. SO5 5WG.

All the weather satellites use APT, Automatic Picture Transmission, which varies the amplitude of a 2400Hz tone which is then transmitted using FM. Hence you can use the same decoder for either orbiting or geostationary satellite decoding, although most software has a number of 'preset modes' to cater for the slight differences in the format of these.

HRPT, High Resolution Picture Transmission, and PDUS, Primary Data User System, formats are also transmitted in digital form. These were once limited to professional users, but 'end user' systems for the reception of these are now available for keen devotees who'd like to receive high resolution images from the satellites.

The Meteosat images you receive on APT are processed images from a ground station, with country contours added to help identification. Images of the whole of Europe are transmitted every half hour, plus four visible close-ups of Europe every hour during daylight hours, the entire visible 'disc' sixteen times a day, plus other sections at intervals including infra-red retransmissions taken from the GOES satellite over the USA

### What Next?

If your appetite has been 'whetted' by this, there's a very wide range of further information available for the asking. The 'Weather Satellite Handbook', for example, is from AMSAT-UK at £17.46 (£14.55 to AMSAT-UK Members), this voluntary organisation can also supply a great deal of tracking software, send them a large SAE for details. Another organisation well worth contacting is the Remote Imaging Group, who again are a voluntary organisation and cater for the needs of electronic weather watchers.

You'll see further information on weathersats in future issues of Scanners, including reviews of weather satellite equipment (the Editor already has one lined up), so watch this space!

### Useful contacts;

AMSAT-UK, 94 Herongate Rd, London



### The ICS MET-2a is a 'plug-in and go' Meteosat system for your PC

*Timestep Weather Systems*, Wickhambrook, Newmarket, CB8 8QA, Tel. 0440 820040 (complete systems).

### Frequency Finder

NOAA 9	137.62MHz
NOAA 10	137.50MHz
NOAA 11	137.62MHz
NOAA 12	137.50MHz
METEOR 3-3, 3-4, 3-5	137.30MHz
	and 137.40MHz
	and 137.85MHz
METEOSAT	1691.00MHz
	and 1694.5MHz

### The Weather Satellite Handbook gives plenty of information

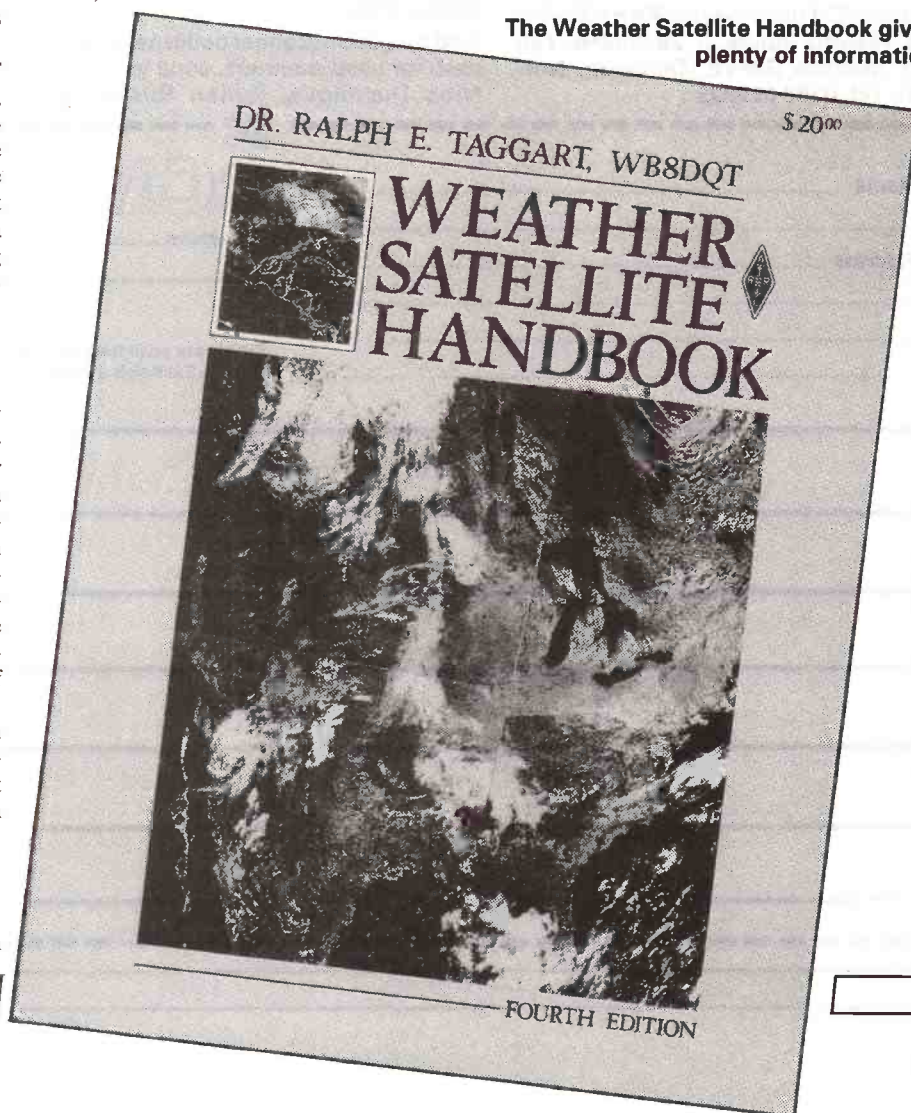

# ScanAds

Want a scanner or receiver, or have you got one to sell? Do you need some accessories, or simply want to advertise your local scanner/airband club? Then advertise free in our 'ScanAds' page! This is a free service for reader's privately-owned scanner-related products and for non-profit enthusiast groups (for other equipment please use the 'main' magazine ads - thanks). Commercial or private ads may also be placed in the pre-paid classified ads section - call 0442 66551 for details.

Send your free reader's ad to; ScanAds, Scanners International, P. O. Box 73, Eastleigh. SO5 5WG, or you can fax your coupon to us directly on 0703 263429.

## FOR SALE

**Yupiteru MVT-7000** complete, plus leatherette case, extra aerial RH701, six months old, boxed, mint condition, £230 plus p/p. (Mid Glamorgan). Tel. 0222 892425

**Fairmate HP2000** scanner, boxed as new, bought 8/12/92, complete with two aerials, instruction manual, UK scanner dict, AC adapter/charger, carry case, under guarantee, unwanted gift, was £283.95, now £250 ono. Contact Ted Meechan, Tel. 0450 370725

**Yupiteru MVT-6000** AM/FM scanner, mains or 12V, boxed, as new, £210 ono. Datong VC-1 upconverter 90kHz-30MHz and 144MHz inputs, IF 28-30MHz, £50 ono. Maurice G0FVE (Dereham, Norfolk), Tel. 0362 696993

**Realistic PRO-2005**, one owner, good condition, 25-520MHz, 760- 1300MHz, manual, with discone and cable plus brackets and 6ft pole, £200. (Barnsley). Tel. 0226 293679

**Sony Air-7** scanner, PSB, Air, FM, AM, 9 months old, boxed, £150 (Wivelsfield Green, Sussex). Tel. 044484 538

**Realistic PRO-37** 3 months old, boxed, health forces sale, books, ext speaker, £160 (Preesall), Derek, Tel. 0253 811765

**Azden PCS-3000** 2 metre scanner complete with remote cable kit, mounting brackets, manual, mike etc. Requires nicad. Stored 12 months. Illness cause of sale, going QRT, £85. B. J. R. Powell G4DZN, 'Suncot', Chapel Street, Taliesin, Machynlleth, Powys, SY20 8JH

**Realistic PRO43** handheld scanner, one week old, still in the box, £220 or exchange for an AR-2000 handheld scanner or home base. (Telford). Tel. 0952 223017

**Diamond D-130** super discone receiving aerial in mint condition with free VHF/UHF frequency list book and coax plugs, £50 post paid (Ormskirk). Tel. 0704 892088

**Realistic PRO-34** scanner, mains adapter and scanner book, £140 the lot, or will swap for AR-2000 or Bearcat 760XLT or similar, will pay price difference. Dave (London), Tel. 071 328 2559

## WANTED

**First Bulgarian** scanner outlet pays good cash for used scanners, send yours to; Nina Dushilova, Svilen Rusev 43,

Plovdiv, Bulgaria

**Wanted** by private collector, all types of scanner and CB equipment, scanners, aerials, rigs, power supplies etc. to add to my collection. Must be reasonably priced as I am on dole. Contact David Spalding, Tel. 0501 51372

**Scanner frequencies** for a 10 channel scanner for York area. Thanks, all letters to Neil McManus, 11 Swinerton Ave, Leeman Road, York. YO21 4YT.

**DA3000 Discone** aerial or MA500 VHF/UHF mobile whip aerial or Skyscan desk top 1300 or V1300 discone aerils, cash, (Finchley), Tel. 081 346 3297

## EXCHANGE

**Two 2W** Motorola handheld transceivers, complete with charger unit, harnesses, carrying cases and personal LS/microphones, model MT700, £110 or exchange for desktop/handheld scanner. Eric Allen, 44 Tweed St, Berwick-upon-Tweed, Northumberland. TD15 1NG

**Uniden Bearcat 200XLT**, cost £220, will exchange for CB equipments, aerials, power packs, what have you? Uniden 6 months old, sell £200, bargain, charger, case, and boxed. Gareth Davies, 15 Bron Y Berth, Penrhos, Pwllheli, Gwynedd, LL53 7HL, Tel. 0758 614446

**Canonvision VME1** video camera, mint condition, many extras, will exchange for AR3000A or AR2800. Please contact Mick, (Dawlish, South Devon) Tel. 0626 862719

Name .....

Address .....



**SCANNERS** Free Readers Advertisements

Signature .....

Date .....

Enter your ad in the boxes below and send to ScanAds, PO Box 73, Eastleigh, Hants SO5 5WG



# Timestep



**Weather Satellite**  
**Live images from space**  
**400 different images a day**  
**No running costs**  
**Automatic animation**  
**3D and image processing**  
**Temperature calibration**  
**Complete systems available**  
**The only supplier of APT, HRPT & PDUS**

**Phone or write for a colour brochure**

**Timestep Electronics Ltd Wickhambrook Newmarket CB8 8QA**  
**Tel. 0440 820040 Fax. 0440 820281**



TALK IN ON 2 MTRS

**Dunstable Downs Radio Club**  
PRESENT THE 10th NATIONAL AMATEUR RADIO



## CAR BOOT SALE

**SUNDAY 16th MAY 1993 FROM 10am until 5pm**  
**CAR PARKING £2 ....INCLUDES FREE ADMISSION TO**  
**THE MOSSMAN COLLECTION OF HORSE DRAWN VEHICLES**  
**AND ENVIRONMENTAL OPEN DAY**

**LUTON**  
M1 JUNCT 10



**FARLEY HILL ENTRANCE**  
Near M1 Junct 10

# STOCKWOOD PARK

**A GREAT DAY OUT FOR THE WHOLE FAMILY**

**BARGAINS**  
**FOR EVERYONE**  
**OR**  
**HAVE YOUR OWN STALL !!**

**COMPUTERS**  
**COMPONENTS**  
**TRANSMITTERS**  
**RECEIVERS**  
**MICROWAVE**  
**SATELLITE TV.**

**CRAFT MUSEUM WORKSHOP**  
**FLORAL GARDENS**  
**FALCONRY DISPLAYS**  
**RARE BREEDS EXHIBITION**

**CARRIAGE RIDES**  
**AMUSEMENTS & SIDESTALLS**  
**MUSIC & ENTERTAINMENT**

**COST OF PLOTS PRIVATE.. £7 IN ADVANCE. £9 ON THE DAY. TRADE .. £20 LARGE PLOT.**

**SEND CHEQUES MADE PAYABLE TO DDRC TO....**

**ALL OTHER ENQUIRIES TEL 0582 - 451057**

**DDRC**  
c/o 125, TELSCOMBE WAY  
LUTON LU2 8QP

**PLEASE ENCLOSE A S.A.E. NO PERSONAL CALLERS**

**HAM RADIO TODAY MAY1993**



## THE UK SCANNING DIRECTORY

The success and popularity of this book has demanded a second edition to accommodate the wealth of new information. Now over 7000 spot frequencies are listed in the 30MHz to 1GHz range, filling in the parts that other books leave blank. As well as covering the popular VHF Maritime Service and Civil & Military Aviation, "The UK Scanning Directory" also includes the new military frequencies,

Emergency Services, Army, Royal Navy, RAF ground services, Eye-in-the-Sky Links, Personal Paging Systems, News Networks, Taxi Services, Courier Services, details of call signs, duplex frequency splits and channel numbers, and much, much more.

Available at leading radio shops throughout the U.K.

## INTERPRODUCTS

H43, 8 Abbot Street, Perth PH2 0EB, Scotland

**NEW**  
**2nd EDITION**



## ATTENTION ALL NORTH AMERICAN READERS!

**Did you know that you can order an annual subscription to this magazine direct from our official U.S. subscription representative?**

**For more information and rates contact:**  
**Wise Owl Worldwide Publications,**  
**4314 West 238th Street,**  
**Torrance, CA 90505**  
**Tel: (213) 375 6258**

*please mention HRT when replying to advertisements*



# 18th Sandown Park Model Exhibition & Display



**SANDOWN EXHIBITION CENTRE,**  
**Esher, Surrey**  
**on 15th & 16th May 1993**

*Calling all model enthusiasts and families –*

**Enjoy a day out at Sandown Park.**

Watch \* Continuous Flying Displays \* Novelties on the Boat Pool  
\* Model Car Racing \* Railway Display

Admission: Adults £5 Senior Citizens £3.50 Children £2  
Family Tickets £12 (2 Adults & up to 4 children)  
Advance & Group tickets available on request: Adults £4.50  
Senior Citizens £3.00 Children £2

*Further details available from:*

**Argus Specialist Exhibitions**  
**Argus House,**  
**Boundary Way,**  
**Hemel Hempstead,**  
**Herts.**  
**Tel: 0442 66551**

**WANDER ROUND THE**  
**NUMEROUS TRADE STANDS**  
**YOU WILL FIND EVERYTHING AT SANDOWN**

**Radio control equipment • Aircraft • Car and marine engines • Helicopters • IC and electric cars • Boats and yachts • Railway layouts and engineering products.**

Please look out for new parking arrangements, traffic control and directional signs



# SANDOWN PARK MODEL SYMPOSIUM EXHIBITION & DISPLAY

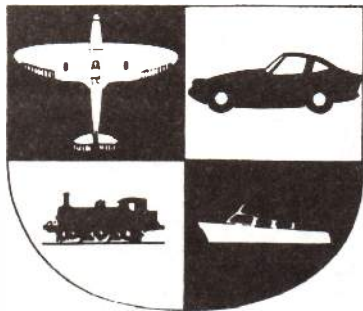

## 15th & 16th May 1993

Sandown Park Racecourse, Esher, Surrey

### ADVANCE BOOKING INFORMATION

ADULTS	£4.50	NO .....	£ .....
SENIOR CITIZENS	£3.00	NO .....	£ .....
CHILD	£2.00	NO .....	£ .....
FAMILY (2 adults & up to 4 children)	£12.00	NO .....	£ .....

#### GROUPS 10-20 PERSONS

ADULT	£4.00	NO .....	£ .....
SENIOR CITIZENS	£2.80	NO .....	£ .....
CHILD	£1.80	NO .....	£ .....

#### GROUPS 21 and MORE PERSONS

ADULT	£3.80	NO .....	£ .....
SENIOR CITIZENS	£2.60	NO .....	£ .....
CHILD	£1.70	NO .....	£ .....

(Coach Drivers Free of Charge)

TOTAL ENCLOSED £ .....

Please complete and return the enclosed form with your cheque/P.O. made payable to Argus Specialist Exhibitions, Argus House, Boundary Way, Hemel Hempstead, Herts. HP2 7ST.

Name .....

Address .....

Name of coach operator .....

Signed ..... Date .....

CLOSING DATE - 26TH APRIL 1993

ORGANISED BY  
ARGUS SPECIALIST EXHIBITIONS  
IN ASSOCIATION WITH  
THE ELMBRIDGE MODEL CLUB

# SANDOWN PARK MODEL SYMPOSIUM EXHIBITION & DISPLAY

## 15th & 16th May 1993

AN **Argus**  
SPECIALIST EXHIBITION

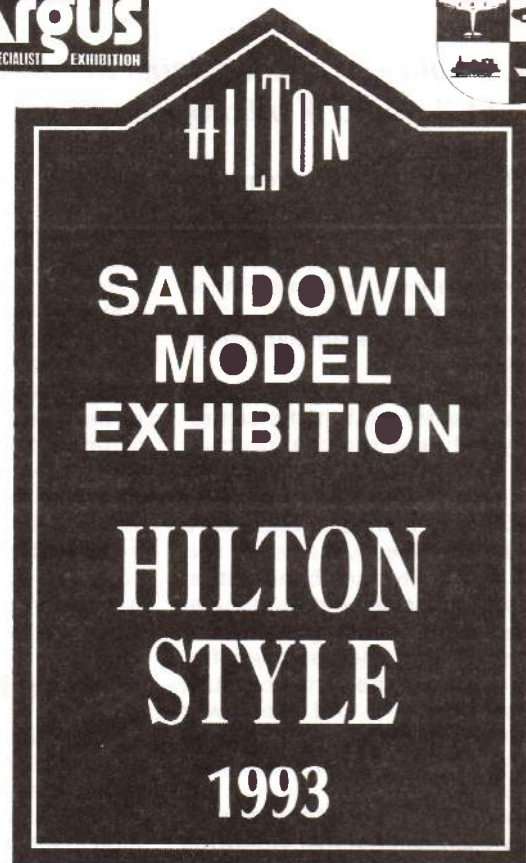

Argus Specialist Exhibitions offer you yet another great deal with Hilton Hotels. If you require accommodation when visiting the Model Exhibition this year or simply just fancy a weekend break, why not stay at The Hilton National, Cobham, which is about 10 minutes drive away from Sandown Park. The hotel has free car parking so you can leave your car at the hotel and take the courtesy coach to the Model Exhibition, commencing at 9.30am and returning you at 1pm or 6pm.

This beautiful country retreat is in the heart of Surrey, and the Terrace Restaurant offers a fine and varied cuisine. For leisure: enjoy the all-weather tennis courts, squash courts, exercise room, indoor swimming pool and steam bath.

#### THE PRICE:

£36.80 each guest each night (Twin/Double room) including full English breakfast and VAT. £16.00 single room supplement. Add £5 per person to the price if you require the courtesy coach for transfer to and from Sandown Park.

#### HOW TO BOOK:

Call Heidi Ross, Hilton Reservations today quoting Argus Specialist Exhibitions on 0923 238877 (Monday-Friday 8.30am-6.30pm and Saturday 8.30am-4.30pm). £10 deposit is required and you can give us your credit card number an expiry date.

## ENJOY A MODEL STAY

# From My Notebook

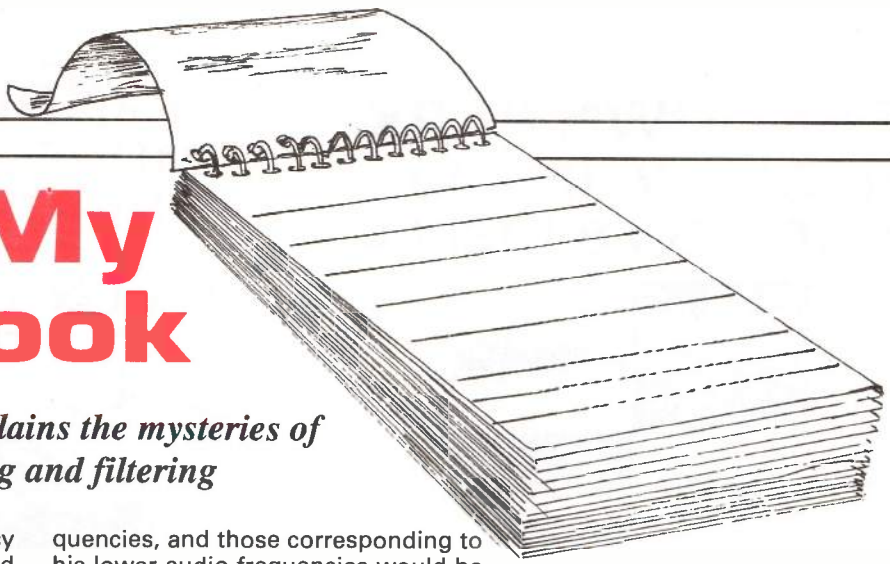

*Geoff Arnold G3GSR explains the mysteries of SSB and CW mixing and filtering*

Last month, I talked about the frequency relationships of sidebands, carriers and beat-frequency or carrier-insertion oscillators in 'straight' (TRF) receivers and in simple superhets. I also mentioned the term 'assigned frequency' as an alternative to the more familiar 'carrier frequency'.

So what is an assigned frequency? In the simplest terms, it is the centre-frequency of the chunk of the spectrum occupied by any radio signal. For a CW (Morse) signal, the carrier and assigned frequencies are identical, because a CW signal comprises just a keyed carrier, with very limited sidebands either side. For a double-sideband, amplitude-modulated signal carrying speech or music, the carrier and assigned frequencies are again the same, because the upper sideband and the lower sideband each extend similar distances on either side of the carrier – or at least they should do!

The same applies to a conventional frequency-modulated signal, where the upward and downward frequency excursions should be identical in a properly adjusted transmitter.

When we come to single-sideband, amplitude-modulated signals, things are very different. A typical amateur station in the 20m band might be using a carrier frequency of 14.200MHz, with upper sideband modulation by a speech signal having a frequency range of 300Hz to 2700Hz (2.7kHz). The carrier would be suppressed typically by better than 40dB. The radiated RF signal will occupy a chunk of the spectrum stretching from 14,200.3 to 14,202.7kHz. A simple calculation will show that this radiated signal is centred on 14,201.5kHz, and this would be the assigned frequency for this transmission.

If a second amateur came on the band, having switched his transmitter to LSB by mistake, and tuned up so that his suppressed carrier frequency was 14,203kHz, his lower sideband signal would occupy an identical part of the spectrum to the first, because his assigned frequency would be 14,201.5kHz too. His sideband would be inverted, of course, so that the RF components corresponding to his higher audio frequencies would be at the lower fre-

quencies, and those corresponding to his lower audio frequencies would be at the higher frequencies, but the space occupied would be the same (assuming his modulating audio bandwidth was also 300 to 2700Hz).

In the commercial bands, where specific channels and modes are allocated for use by each station, this idea of assigned frequencies is important. In the amateur bands, where apart from the observance of band plans it's more of a 'free-for-all', it is a bit academic. The idea does come in useful, however, in the understanding of the frequency-conversion and signal-processing organisation inside a receiver, transmitter or transceiver.

## Keep It Simple!

In order to introduce you as gently as possible to the principles involved, I shall use as an example a simple, VFO-tuned transceiver having a 9MHz IF filter in the transmit and receive signal-processing chains. By doing so, I hope to give a basic understanding which you can then apply to studying the technical description of a state-of-the-art, synthesised, up-conversion rig.

To further reduce the need for mental gymnastics at this stage of things, I shall be making a couple of assumptions which are not actually true in practice. I will sort these out next month, by which time, hopefully, you will be better able to cope!

The block diagram of Fig. 1 shows the outline of the transmitter. The audio frequencies (which I shall here assume to be in the range 0-3000Hz) from the microphone and a signal from the carrier oscillator are mixed in Balanced

Mixer 1. Its output will consist of two sidebands, one equal to the carrier frequency *plus* the modulating frequencies, and the other the carrier frequency *minus* the modulating frequencies – the original modulating audio and the carrier will both have been largely suppressed.

At this point in the circuit, the term 'carrier frequency' does not mean the frequency of the final radiated carrier, which will be arrived at later. It simply means a radio frequency on which the audio information is modulated – it 'carries' the information, hence the name.

The 9MHz IF filter will have a bandwidth just wide enough to accommodate one full speech sideband – around 3kHz. The figure of 9MHz corresponds to the centre-frequency of the filter, and also the centre-frequency of the modulated signal that will pass through it. But isn't that very like the definition of 'assigned frequency' which I gave earlier? It certainly is, and that's why the idea of assigned frequency is useful in understanding SSB transceivers, where we can consider the IF to be the assigned frequency, with the carrier frequency either above or below it.

If the sideband is centred on 9MHz, the carrier frequency will either be above 9MHz if lower sideband transmission is wanted, or below 9MHz for upper sideband. In my simple SSB transceiver, the two carrier frequencies are 8998.5 and 9001.5kHz respectively, coming from crystal oscillators selected by the 'Mode' switch.

When the carrier frequency is

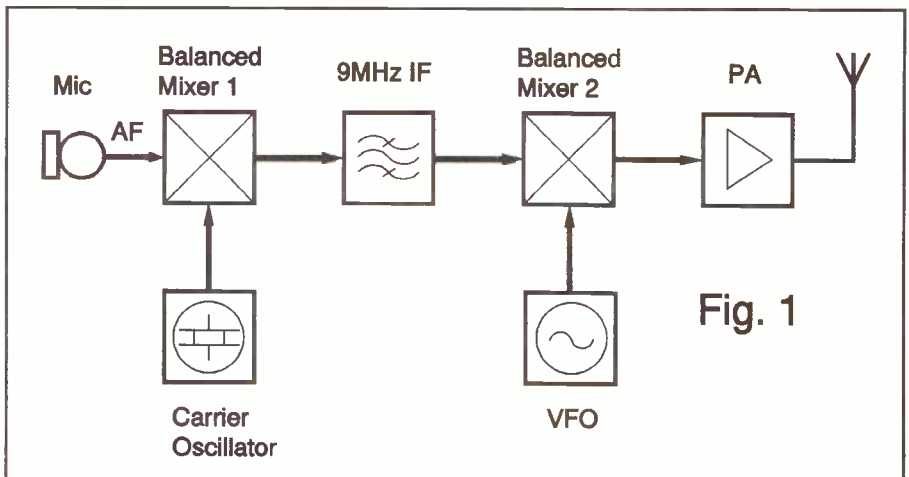

Fig. 1



8998.5, the output of the balanced mixer will consist of one sideband running from 8995.5 to 8998.5kHz, and another sideband from 8998.5 to 9001.5kHz. The lower of these two sidebands will be outside the passband of the 9MHz filter, and will therefore be very much attenuated by it. The upper sideband falls neatly into the filter passband, and will be passed on to Balanced Mixer 2.

If an LSB signal was required, the 9001.5kHz carrier oscillator would be used, and the two sidebands at the output of the balanced mixer would run from 8998.5 to 9001.5kHz and 9001.5 to 9004.5kHz. This time, the upper sideband would fall outside the filter passband and be removed.

Older SSB rigs using LC tuned circuits to provide IF selectivity would have a crystal notch filter between the balanced mixer and the IF stages, to get rid of any of the carrier which may have crept through (or around) the mixer. Modern 'block' IF filters usually have a deep notch in the response on either side of the passband, and these notches are engineered to coincide with the carrier frequency, providing extra attenuation.

Having produced our single-sideband, suppressed-carrier signal at 9MHz, it is necessary to transpose it to the desired radiated frequency, and this is done by mixing the 9MHz signal with the signal from a VFO in Balanced Mixer 2. I shall be returning to this area later, but for the moment, I want to consider what happens when the rig is switched to CW.

For CW (Morse code) communications, we need a keyed carrier, without audio modulation. If the same frequency-generating chain is to be used as was provided for SSB, the keyed carrier must lie within the passband of the 9MHz filter, rather than immediately outside. There are different ways in which this can be done, but in my simple rig, a third crystal-controlled carrier oscillator running at 8999.3kHz is used. This frequency is just 700Hz below the centre-frequency of the 9MHz filter, and well within its passband. The balanced modulator must either be bypassed, or else deliberately unbalanced by applying a DC bias to it, so that it passes the carrier signal. Sometimes it is this bias which is keyed to generate the Morse symbols. The audio modulation amplifier is disabled when on CW.

An alternative technique, which might be termed 'pseudo-CW', is to use a keyed audio oscillator whose output is fed to the balanced mixer in place of the microphone signal. If the carrier oscillator and balanced mixer set-up already described for USB is used, and the keyed audio oscillator runs at 800Hz,

the output of the balanced mixer will be indistinguishable from a keyed 8999.3kHz oscillator. This method is a variation of that used for practice Morse code contacts on 2m FM, where keyed tone is applied to the microphone circuit of the FM transmitter.

## Reception

When switched to receive, instead of modulating audio signals from a microphone onto a carrier (albeit one that is not at the final radiated frequency, and which has been removed in the modulation process), we need to recover audio signals which were originally put onto a carrier at a distant transmitter. Assuming that we have tuned our receiver correctly, the sideband carrying the intelligence which we want to extract will have been mixed and translated in frequency to place it within the passband of our 9MHz IF filter (Fig. 2).

At the output of the filter, whose connections are swapped around as part of the transmit-receive changeover switching process, the single-sideband signal is applied to a balanced mixer similar to that used in the transmit chain. The other input to the mixer comes from a carrier-insertion oscillator (CIO), actually one of the same carrier oscillators that were used on the transmit side. If it is a lower sideband signal being received, then fairly obviously the 9001.5kHz oscillator is used (carrier above sideband), but if it is an upper-sideband signal, the 8998.5kHz oscillator is required (carrier below sideband). The output of the balanced mixer will be the recovered version of the audio modulation at the distant station.

All that is fairly straightforward, but where life begins to get complicated is when we consider what happens in receiving a CW signal. The best way I know of approaching the problem, is to forget the frequency translation to and from an amateur band and to imagine that the entire radio link between you and the distant station runs at the 9MHz IF.

To help a little bit more, I'm going to assume for the moment that the distant station is using a separate transmitter and receiver, rather than an integrated transceiver. The time-honoured method for the distant operator to put his transmitter on exactly the same frequency as yours, was to tune his receiver to zero-beat with your transmission, then 'net' his transmitter

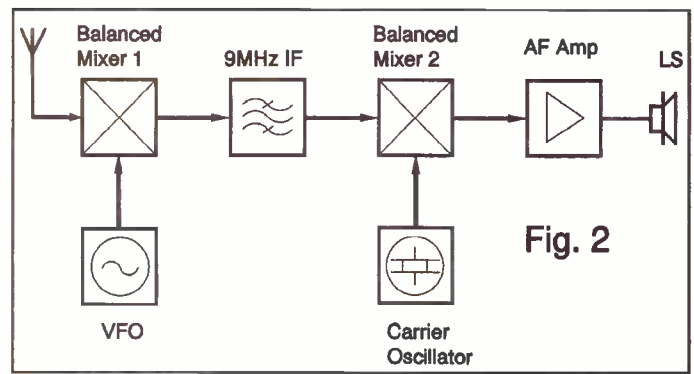

Fig. 2

by running at low power and tuning it also to zero beat. He would then re-tune his receiver to produce a comfortable beat-note from your signals in his headphones.

Having done that, his transmitted carrier (remembering our mythical 9MHz radio link) would have been on 8999.3kHz, just like ours, and well within our filter passband. To receive his Morse signals, we now need to inject a beat-frequency oscillator (BFO) signal at a suitable frequency to produce an audio beat-note in our headphones. It's no good using the same carrier oscillator as we use for transmitting on CW, because it's on an identical frequency to the incoming signal. But wait a moment, one of our carrier oscillators runs at 8998.5kHz, and if you mix that with 8999.3kHz the result is a nice 800Hz beat-note. The send-receive switching of the rig is arranged to do the required switching between the two carrier oscillators.

If the distant station is using a transceiver, instead of separate TX and RX, he will have instead to tune his rig to give a comfortable beat-note. Whether his transmitter will end up on exactly the same frequency as ours will depend on various factors, including his selection of beat-note, the setting-up of the various oscillators in his rig, and whether he remembered to zero or switch off his RIT (receiver incremental tune) before listening around the band!

## Radiated Frequency

As previously mentioned, translating the transmitted signal from the IF to the radiated frequency is done by mixing the modulated 9MHz signal with the output from a variable frequency oscillator. Unless it is a single-band rig, this will involve switching the VFO to cover different frequency ranges for each band, or more likely, mixing the VFO with another oscillator to provide an output in the required range. The same applies to the process of translating a received signal to the 9MHz IF.

The arrangements for doing this are not entirely straightforward, but for now I shall leave you to digest the description of what happens in the audio and IF stages. The process of converting to and from the radiated frequency will be explored next month.

## SANGEAN ATS 803A

(Direct key-in world receiver with quartz alarm clock timer)

**Tunable BFO SSB/CW!**

### Specifications and features

★ 150-29.999 continuous tuning with no gaps. Phase locked loop-double conversion Superheterodyne ★ Full shortwave/AM/SSB 150-29999kHz no gaps! + FM87.5-108 mono/stereo ★ Five tuning functions: Direct press button frequency input auto scanning, manual scanning memory recall and manual tuning knob



★ Built-in clock and alarm. Radio turns on automatically at preset time and frequency. ★ Large digital frequency display. ★ Fourteen memories – nine memory channels for your favourite station frequencies. Last setting of mode and waveband stored in five memories. ★ Direct press-button access to all 12 shortwave broadcast bands. ★ Two power

sources – battery or AC mains adaptor. ★ General coverage of all AM bands in LW/MW/SW (dedicated broadcast band coverage on all versions), plus of course the FM band for quality sound broadcasts in headphone stereo. ★ SLEEP function turns the radio on or off after an adjustable time of 10-90 minutes. ★ Separate BASS and TREBLE controls for maximum listening pleasure. ★ External antenna jack for better reception. ★ Adjustable RF GAIN control to prevent overloading when listening close to other strong stations or if there is interference. ★ New improved wide/narrow filter (6/2.7kHz) ★ BFO control (Beat Frequency Oscillator) enables reception of SSB/USB/LSWB (single side band) and CW (Morse Code) transmissions. ★ Illuminated display to facilitate night-time use. ★ Designed for both portable and desk top use. ★ Five dot LED signal strength indicator.

DIMENSIONS: 29.2cm x 16.0cm (11.5in x 6.3in x 2.36in). OUTPUT: 1200mW (10%THD) WEIGHT: 1.7kg (3.75lbs) without batteries. Wide/narrow filter switch.

£119.95 + £5 check, test and p&p

## SKY SCAN

### Desk Top Antenna Model Desk 1300

Built and designed for use with scanners. Coverage: 25 to 1300MHz. Total height – 36ins – 9ins at widest point. Comes complete with 4 metres of RG58 coax cable and BNC connector fitted. Ideal indoor – high performance antenna and can also be used as a car antenna when your car is static. REMEMBER YOUR SCANNER IS ONLY AS GOOD AS YOUR ANTENNA SYSTEM!

£49.00 + £3.00 p&p



## SKY SCAN

### V1300 Antenna

Most discons only have horizontal elements and this is the reason that they are not ideal for use with a scanner. Most of the transmissions that you are likely to receive on your scanner are transmitted from vertically mounted antennas. The Sky Scan V1300 discone has both vertical and horizontal elements for maximum reception. The V1300 is constructed from best quality stainless steel and aluminium and comes complete with mounting pole. Designed and built for use with scanners.

£49.95 + £3.00 p&p

## SKY SCAN

### Magmount MKII

For improved performance, wide band reception, 25 to 1300MHz. Comes complete with protective rubber base, 4m RG.58 coax cable and BNC connector. Built and designed for use with scanners.

£24.95 + £3.00 p&p



## SANGEAN Portable SW Antenna

### ANT 60

- Greatly improve reception power of portable shortwave receiver
- Easy hookup to snap onto telescoping rod antenna or plug into radio's external AM antenna jack extends to 7 metres (23 feet).
- Portable for indoors and outdoors.
- Suitable for all kinds of shortwave radios.

£14.99 FREE POST & PACKING WITH THIS ISSUE ONLY



## YUPITERU

### MVT 7000 HANDHELD

PROBABLY THE UK'S MOST POPULAR HANDHELD SCANNER!

- ★ Receives 8 to 1300 MHz 100kHz-1300MHz (at reduced sensitivity)
- ★ 200 Memory channels
- ★ Rotary or keypad freq. control
- ★ AM/FM/NFM
- ★ Large display with signal strength ...mete

### May Special Offer - £PHONE

Full set of high power NiCads, AC charger, DC power lead and carry strap

### MVT 8000 MOBILE/BASE

This new model is the mobile version of the popular MVT 7000 Handheld above.

★ Receives 8 to 1300MHz, 100kHz to 1300MHz (at reduced sensitivity)

THIS RADIO IS ESPECIALLY SENSITIVE AT UHF FREQS. Set is supplied with mains power unit

### May Special Offer - £PHONE

## AIRBAND RADIOS

This month we are pleased to introduce

### THE WORLDS FIRST DEDICATED CIVIL/MILITARY AIRBAND RECEIVER, THE VT225.

A powerful pocket scanner that leaves the competition standing. ★ A super sensitive set designed for optimum performance on the Civil/MilitaryAirbands.

- ★ Receives 108-142 MHz Civil Airband 222-391MHz Military Airband 149.5-160MHz Marine Band
- ★ 100 Memory channels
- ★ AM/FM on VHF
- ★ Priority channel function

EACH SET IS SUPPLIED COMPLETE WITH:- NiCads, earphone, carrying strap and mains charger

### May Special Offer - £PHONE

### VT-125 UK CIVIL AIRBAND RECEIVER

Using the same technology as the VT-225, this set covers the full Civil Airband - hearing distant signals that are inaudible on some other scanners.

- ★ Covers 108-142MHz
- ★ 30 Direct entry memories
- ★ Search steps 25, 50, 100kHz SUPPLIED COMPLETE WITH NICADS AND UK CHARGER

### May Special Offer - £PHONE



## FAIRMATE

### HP2000

STILL ONE OF THE MOST POPULAR HANDHELD SCANNERS ON THE MARKET.

Over the last year the HP2000 has outsold almost all other models.

- ★ Continuous coverage from 500kHz to 1300MHz
- ★ 1000 channels of memory
- ★ Keypad or rotary control
- ★ AM, FM and WIDE FM modes
- ★ Search steps from 5 to 995kHz

### EVERY SET COMES COMPLETE WITH:-

Full set of high power NiCads, 2 antennas, carrying case, earphone, DC cable, belt clip and strap, UK charger

### May Special Offer - £PHONE



## MS1000 BASE/MOBILE SCANNER

MOBILE VERSION OF THE HP2000 HANDHELD BUT WITH SEVERAL ADDITIONS:-

- ★ Switchable audio squelch
- ★ Tape recorder output socket
- ★ Automatic - signal operated tape recorder switching
- ★ All metal case for improved EMC compatibility
- ★ Receives: 500kHz - 600MHz, 805 - 1300MHz. Supplied with mains power supply

### May Special Offer - £PHONE



## AOR SCANNERS

### AR1500 HANDHELD

Covers 500kHz to 1300MHz receiving NFM, WFM, AM, and SSB. Supplied with a large selection of accessories including:-

- ★ Charger
- ★ Dry cell battery case
- ★ 5 mtr LW antenna
- ★ Ear piece
- ★ Soft case

### NOW IN STOCK

### May Special Offer - £PHONE



### AR2002 /BASE/MOBILE

Receives 25 - 550MHz, 800 - 1300MHz, AM, FM, WFM. Super-sensitive receiver

### May Special Offer - £PHONE

## SKY SCAN 204 HAND HELD SCANNER

FULL VHF CIVIL AIR BAND FULL UHF MILITARY AIR BAND Marine/Cellular Telephones/Amateur Radio/and lots more!

NEW FOR 1993 LOW PRICE HI PERFORMANCE

- Frequency coverage:
- 68-88 MHz (in 5 kHz Steps)
  - 118-136.975 MHz (in 225 kHz Steps)
  - 137-174 MHz (in 5 kHz Steps)
  - 220-225 MHz (in 5 kHz Steps)
  - 225.0125-400 MHz (in 12.5 kHz Steps)
  - 400.0125-512 MHz (in 12.5 kHz Steps)
  - 806-999.9875 MHz (in 12.5 kHz Steps)

Channels of operation: Any 200 Channels in any Band Combinations (20 Channels, 10 Banks) and 10 Monitor Channels



SRP Trading, Unit 20, Nash Works, Forge Lane, Belbroughton, Nr. Stourbridge, Worcs.

Tel: (0562) 730672. Fax: (0562) 731002



# Getting Ready for VHF Contests

*Dick Pascoe G0BPS gives a beginners guide to 2m contesting*

Love them, or hate them, they do take place throughout the year. Hardened VHF contest operators can turn the page, but for the newly licensed the following may be of interest. For the beginner, 2m is usually the first step, and to turn on the rig somewhere in the SSB end of the band when a contest is in full swing will make the new operator stagger back from the QRM and the huge number of stations and wonderful DX being heard.

## CQ CQ Contest

If you're a new operator and you hear a contest in operation, the first thing to do is *listen* for at least 30 minutes. Tune around the band, find out what is happening, *listen* carefully and *learn*. By doing this you can ascertain what information is required to be passed, and will ensure that when you do fire up, you operate in a smooth and clear manner to avoid clogging up a serious contesters' frequency. All amateurs are willing to assist newcomers, but the middle of a contest is not the place to start!

The very basic QSO will be... 'CQ CQ CQ Contest, Golf Eight Yankee Mike Delta over'. 'Golf Eight Yankee Mike Delta, this is Golf One Delta Golf Oscar'. 'Golf One Delta Golf Oscar, you are five nine, three, five, six in Juliett November Zero Three Bravo Kilo, over'. 'Roger, Roger, you are five seven, zero zero one in Juliett Oscar Zero One Alpha Alpha, QSL?'. 'Roger Roger, good luck, QRZ QRZ contest Golf Eight Yankee Mike Delta listening'.

If we look at what has happened.... G8YMD is calling for contacts, G1DGO answers quickly and succinctly, G8YMD gives the report 59, his serial number (356) and his Maidenhead locator as JO 03 BK. G1DGO then replies with his report, here he gives 57, serial number of 001 and his locator as JO 01 AA.

The report given is the usual one of readability and signal strength, the next number given (here 356) is the serial number. Each station starts at zero and adds one for each contact, so we can see that the station G8YMD has 356 contacts up until this time. The number given by G1DGO is 001, so this is his first contact of the contest.

Remember too that if the station you are in contact with is 5-9 plus lots, it's not necessary to repeat your information or to give your callsign phonetically. Just speak clearly and slowly, if the other station misses any of the information they will ask for it again.

If we assume that you have heard these wonderful stations calling and working real DX that you can't hear, don't despair, your 2W into a HB9CV will get through eventually. Just wait for a gap and jump in, don't rush the exchange but do be brief. You may not stand too much of a chance of winning the contest, but certificates are sometimes awarded to the highest scoring station in each square. One of these sits proudly on my shelf after my first solo entry from JO square. There are several types of contest and some of the larger ones are subdivided into smaller sections. This enables the smaller station to stand a chance of winning a section, even if the 'big guns' are operating.

All serious entrants to the contest will, of course, stay with it right through, but it is not necessary for everyone to do so. It is quite permissible for a station to take part for a few minutes, work a few stations and leave, come back an hour or so later and have another go. The only important point of doing this is that you must keep your serial numbers going, don't start at one again even if the contest is a two day one, and you operate on both days.

## Your gear

What is required to take part? Well any rig will do as long as it covers the parts of the band in use. Your beam should be on a mast and be able to be rotated from wherever you operate. Most of the big contest stations nowadays use multi-element arrays (in some cases up to 100 elements), and also use large amplifiers (2 x 8877) which are designed to 'tick over' at 400W out! These are mostly situated on top of the highest mountain in the area, or on a site suitably close to the sea. The small station can't hope to win these open contests, but he can have a go at some of the QRP contests and do well. Most of the QRP contests specify an output of not more than 3W from the rig, and

the famous FT-290R fits the bill well.

Aerials are funny things when it comes to contests. For a small station you may consider that a single 19 element is perfect. But the chap with perhaps two eight or ten elements with the same or slightly less gain will, in fact do slightly better under identical conditions. If this seems strange, look at the beamwidth of an average long yagi and compare it with the beamwidth of a shorter beam. The shorter beam has a wider beamwidth (less gain), thus stacking two or more short yagis will still show a greater beamwidth than the single 19 ele. Now if that weak station is in the null of the long yagi he may not be heard, but with the shorter one he could be. It also calls for less turning of the aerial, and permits the operator to concentrate more on the station calling him.

## Logging

Get a clipboard and several sheets of lined paper, and rule off six columns, head them with time, station called, report given, report received, locator, and of course power used. If the contest requires other information then additional columns will be required. It may also help to make a remarks column to make notes on band conditions etc. Keep a close check on your log sheet, and at the end of the day give thanks if nothing has fallen down, shorted out, or just plain given up on you.

When the contest is over there is still work to be done if you intend to enter the contest. Those in the UK are usually (but not always) organised by the RSGB, and although only members may enter for awards for these, any licensed amateur may take part.

For entrants, the proper entry form must be completed, but 'check logs' from non-entrants are always welcomed by the adjudicators and these should also include all the relevant information.

So get in there and have a go. One big benefit of contests is that so many groups try to open the unusual squares, and if you need a few more squares or countries for your awards then off you go. A polite request 'QSL please' often brings results. Best of luck....QRZ QRZ de....G0BPS.

# Satellite Rendezvous

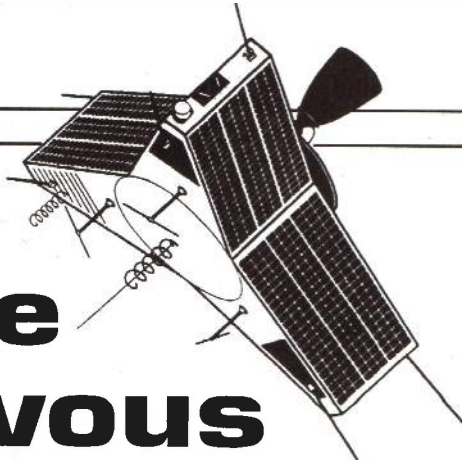

*Richard Limebear G3RWL with this month's collation of AMSAT-UK news including this month's planned ARSENE launch*

## ARSENE Transponder Frequencies

Uplink 1:	435.050MHz	
Uplink 2:	435.100MHz	←
Uplink 3:	435.150MHz	
		Mode S Combination (CW/SSB)
Downlink 1:	145.975MHz	
Downlink 2:	2446.500MHz	←

At the present time the planned launch date for *ARSENE* is scheduled for 20th April 1993, and it will fly aboard an ARIANE-4 rocket launcher along with the geostationary television satellite ASTRA-1C. Right after launch there will be two stations in place at La Reunion Island prepared to copy telemetry from *ARSENE* immediately after it separates from the rocket booster. These two stations will gather telemetry and send it to Toulouse, France where the satellite ground control station will analyze the satellite's condition during the first critical hours of its life. For those who would like to collect and analyze the telemetry yourself, you can copy the telemetry on the 2m downlink frequency of 145.975MHz using a standard packet radio TNC.

On the fourth orbit, *ARSENE*'s kick motor will be fired in order to place it into the proper orbit. It will burn for 12 seconds and give a velocity change of 1200 metres/sec that will raise the perigee from 200km up to 20,000km. The final orbit will have an apogee of 36,000km, a perigee of 20,000km, an orbital inclination of zero degrees, and an orbital period of seventeen and a half hours! This orbit will allow stations located between latitudes of 60 degrees north and south to see and use *ARSENE* for at least 50% of its period! *ARSENE*'s transponder frequencies are shown in the accompanying table.

*ARSENE* will be a packet radio 'relay' satellite, a digipeater, it will not have a bulletin board system capability. All three uplink link frequencies will only accept AX.25 1200 baud FSK packet. However, when *ARSENE* is in Mode S,

you can transmit on 435.100MHz and listen to your downlink on 2446.500MHz. During Mode S, one can use this 'analogue' transponder for CW or SSB, the downlink passband on Mode S is 16kHz wide.

On launch day, there will be a 'launch-net' to help keep amateurs around the world informed of the progress of *ARSENE*, especially in the first critical orbits. Immediately after the launch of *ARSENE*, all amateurs are invited to decode and analyze the telemetry from the 2m beacon located on 145.975MHz. Using a 'standard' AX.25 1200 baud FSK TNC, one will be able to copy this all of this telemetry quite easily, the 2m telemetry beacon will have an output power of 15W! The *ARSENE* packet beacon will transmit 30 analogue telemetry channels, providing information about the condition and function of the different on-board modules on the satellite.

## Russian Satellites

AO-21 is back in full operation with transponder, voice beacon, music, and 1200 baud packet. Some of the packet is apparently non-ASCII data. As a reminder, the frequencies for the FM transponder are Uplink on 435.016MHz and downlink on 145.987MHz.

AO-21 was planned to change mode to the RM-2 transponder sometime in February to provide for G4CUO's organised Double Hop trans-satellite link up tests. Here, it was hoped to link to RS-10 in mode A who's uplink is 145.860-145.900MHz and downlink 29.360-29.400MHz, the participants at

the time of writing being G4CUO, G6HMS, G3CAG, G0NKA and G7MUB.

GM4IHJ reports from NM7M a possible explanation for the long DX non-ionized sub-horizon polar path QSOs made by G3IOR via RS-12 Mode K. This is possibly due to Drifting F region Electron Density Structures in and above both the Arctic and Antarctic polar regions when certain conditions apply in the Interplanetary Magnetic Field. The time to try for RS-12 super-sub-horizon DX is around local magnetic noon -2 to + 4 hours when passes are suitable. If the MUF rises, it is worth looking now. South Pole again seems possible in mid-Summer!

## New Service for MIR QSLs

A lot of complaints are being made to the Cosmonauts, to RV3DR, as well as to UA3CR, about bad QSL service for MIR QSOs. It has been decided that a new service will be opened for this purpose, the general manager now being RV3DR. All mail, except South America, will be forwarded by him in return for an SAE with enclosed QSL, full data of the QSO, and one or two IRCs (or a dollar bill). His address is; *S.Samburov, prospect Kosmonavtov, d.36, kw.96 Kaliningrad City Moscow 141070 Russia*

The recent MIR operations were very regular, packet and speech, but there's a crew change going on at the moment. Normally, they tell us of interest and training sessions, but, with things as they are in the CIS for "profitable commercial MIR use only" further operations are unclear.

The PROGRESS-M15 cargo supply ship will undock from MIR on the 5th of February and stay in orbit until at least 10th February. After undocking M15 will deploy a 24 sq.metre sheet of aluminized mylar to test the concept of a space mirror to reflect sunlight to illuminate an area tens of kilometers in diameter with the equivalent light of several full moons. The experiment is to test the concept of artificial illumination of territories suffering from disasters. The experiment will have taken place from 5th to 10th February, and UK readers may well have seen this from dawn minus 2 hours to dawn -15 minutes. The crew will try to aim the beam on Vienna, but attempts will be made over other places also.

## KitSat

The Kitsat BBS is at last open. Kaist announced that it would be open from 15th January but they forgot to make a software change which would give everyone access for several days after-



wards. Though the on-board software is unstable at times, they hope KO-23 can relieve some of the load from the other PACSATs. The Earth imaging system has started to take pictures again recently and they are hoping to explore some more of its capability with the high resolution camera. With the general opening of the BBS, KAIST have stressed their special thanks to Prof. M. Sweeting and Jeff Ward in the UoS who helped KO-23 construction and launching, and also many thanks to Mr. Harold Price in the USA who originally designed the OBC186 kernel system.

## UoSats

UoS have loaded new software into UO-22 recently and software crashes are to be expected. They've tried the new software several times in the past months without success, and this time the controllers wanted to fully understand the source of the fault, so when the computer crashes they'll be debugging. UoSAT controllers apologize for any inconvenience the disruption of service may cause many users worldwide.

Apparently some questions have been raised recently concerning the observation of some stations that they have not been able to use the 145.900MHz uploading channel. UoS say that they are studying the problem but, personally, I tried this channel after they said the above and have found no problems with it.

Finally, Jeff Ward G0/K8KA has got an English callsign at last; G0SUL. Congratulations Jeff.

## MicroSats

Amsat-NA announced early this year that AO-16's spin rate has slowed to about 0.07 RPM, or one *revolution* every 14 minutes. Since then, the spin rate has increased slightly. The AO-16 command team will be looking at the spin rate over the next several weeks, but these activities should *not* impact the normal operation of the spacecraft.

The cause of the slowed spin and wobble is presently unknown, but probably related to normal deterioration of the white paint on the antenna blades, and perhaps seasonal illumination changes.

## Satellite Band Sharing?

In view of pending changes in UHF and EHF amateur radio bands (from WARC-92), several countries are reviewing band plans in these bands. Also sharing amateur satellite bands with other modes like ATV, DX, FM Repeaters, etc.... is considered. Pro-

posals are already being prepared for submission at coming IARU conferences.

In order to be prepared to give advice in these matters, ON6UG is currently collecting information about this subject. Although all amateur Societies have a say in IARU band planning, comments are welcome in answer to the following questions; 1) Is sharing possible in satellite bands? 2) If so, can we share with: a) DX terrestrial communications (SSB/CW), b) ATV/Wide Band FM, c) FM repeaters, etc.

We know that sharing would be impossible on 145MHz but it may be possible or needed on 2.4GHz if these bands are reduced. Experience in the past and present with ATV on 70cm show possible conflicts. There are FM repeaters operating in the 435MHz satellite band in some countries. Any comments especially experience with conflicts are welcome, please forward these to; IARU Satellite Coordinator Freddy de Guchteneire, Olmstraat 18B, 9030 Mariakerke, Belgium.

## AMSAT-UK Phase-3D Fund

The ESA have changed the specification of the launcher interface for Phase-3D; this is the place where the satellite physically bolts onto the rocket. This change put Amsat-DL on the spot since plans were well advanced for the old interface (which is a different shape

and size). Amsat-DL appealed to Amsat-UK for DM 75000 (about £31,000) to help them out because of this. Amsat-UK committee meeting on 30th January *agreed to pay this*. While the Amsat-UK coffers exist for this sort of support, and we can afford it, it would be very much appreciated if amateurs would help us to refill them ready for whatever needs support next. Contributions to the Amsat-UK Phase-3D fund are solicited, its *your* money that we put to these sort of uses. (Note that all of G3RWL's fee for this column is also always put into the Phase-3D fund, who's target is a million pounds - Ed).

A copy of the latest Keplers for a various satellites is available on packet radio (HF/VHF) from me if anyone wants it; my packet mailbox is GB7HSN. When asking for Keplers please say which satellites; *all* means about 140 satellites. ('All amateur sats' is adequate if that's what you want); requests on packet will get 2-line elements unless AMSAT format is specified.

Remember that date for your diaries; the AMSAT-UK Colloquium from Thursday 29th July to Sunday 2nd August, to be held as usual at the University of Surrey.

For further information on AMSAT UK, who are the Radio Amateur Satellite Organisation of the UK, send a large SAE to; AMSAT-UK, c/o Ron Broadbent G3AAJ, 94 Herongate Road, Wanstead Park, London E12 5EQ, licenced amateurs and SWLs are equally welcome.

## AO-13 Transponder Schedule, Mar 08 - May 10 1993

Mode-B : MA 0 to MA 120 |  
 Mode-S : MA 120 to MA 130 | <- S transponder; B trsp. is off!  
 Mode-LS : MA 130 to MA 135 | <- S beacon + L transponder  
 Mode-JL : MA 135 to MA 150 | Alon/Alat 180/0  
 Mode-B : MA 150 to MA 256 |  
 Omnis : MA 230 to MA 40 | Move to attitude 180/0, Mar 08

Please don't uplink to B, MA 120-130, it interferes with mode S. Continuous up-to-date information about AO-13 operations is always available on the beacons, 145.812MHz, 435.658MHz and 2400.646MHz in CW, RTTY and 400 bps PSK.

KEPLERS							
SAT:	OSCAR 10	UoSSat 2	AO-13	PACSAT	DO-17	WO-18	LO-19
EPOC:	93028.75266335	93026.61330566	93027.82104774	93027.89579257	93025.24935489	93026.19666309	93027.74668344
INCL:	27.0250	97.8258	57.4307	98.6319	98.6317	98.6316	98.6329
RAAN:	42.4582	59.1865	335.9809	114.2555	112.0023	112.9760	114.6644
ECCN:	0.6021897	0.0013273	0.7314574	0.0010471	0.0010893	0.0011363	0.0011788
ARGP:	53.0203	88.3358	306.0019	236.1106	246.6645	242.6622	237.9593
MA:	348.4093	271.9366	6.5580	123.9088	114.3400	117.3404	122.0447
MM:	2.05877420	14.68839657	2.09724338	14.29789670	14.29921748	14.29906618	14.29993852
DECY:	3E-08	5.46E-06	-1.75E-06	1.16E-06	1.61E-06	1.44E-06	1.32E-06
REVN:	4442	47593	391	15736	15702	15716	15739
SAT:	FO-20	AO21	UO-22	KO-23	RS-10/11	RS-12/13	Mir
EPOC:	93007.71700293	93028.86641036	93021.72455628	93027.07879705	93028.31353610	93021.53387052	93029.37748586
INCL:	99.0620	82.9435	98.4886	66.0815	82.9260	82.9216	51.6206
RAAN:	254.1158	155.9261	100.1074	259.6358	341.9945	30.8715	196.4888
ECCN:	0.0541753	0.0036753	0.0008391	0.0012178	0.0012253	0.0030840	0.0002509
ARGP:	90.0675	50.4436	19.7776	224.4774	353.0964	91.5322	322.4995
MA:	276.2479	309.9944	340.3734	135.5268	7.0018	268.9367	37.6623
MM:	12.83215823	13.74508078	14.36767856	12.86276722	13.72307113	13.74012300	15.58314179
DECY:	8E-08	1.01E-06	2.04E-06	-1E-08	9.7E-07	3.1E-07	8.678E-05
REVN:	13673	10030	7963	2169	28066	9838	39748

# Packet Radio

## -Roundup-



*Chris Lorek G4HCL reviews the latest DRSI Terminal Node Controller*

I'll kick off this month with a short apology to those amateurs who sent me messages over the network and have had to wait a while for a reply. The reason for this is that my local BBS went 'down' for a couple of weeks for a computer upgrade. I *always* try to reply within a day or two of receiving all mail, however all messages I've received have now been responded to, thanks for your patience!

### NOSintro

As well as the subsequent 'flood' of messages, I also seem to have had a small 'flood' of mail and even parcels for this column. One of these was a copy of Ian G3NRW's new book, *NOSintro - TCP/IP Over Packet Radio*. In my opinion this gives the best, and the most comprehensive, 'hands-on' introduction to the KA9Q Network Operating System that I've come across.

TCP/IP often appears as an 'esoteric art' to many packet operators, indeed the system is very, very powerful. The

emphasis in Ian's well-written book is extremely practical, and within its 356 pages it shows you exactly how to install NOS on your PC, how to set up the control files, check basic operations, and of course how to use NOS for transferring files, logging into systems, setting up a NOS BBS or just sending mail, and so on. Diagrams, screen displays and so on make reading of what is, essentially, a 'heavy' subject with matters such as SMTP mail forwarding quite light going, even for me! I would certainly recommend the book to both 'old hands' in TCP/IP as well as advanced beginners who'd like to go 'one further' than what is often regarded as the 'common' type of packet radio.

Ian's book is available from Dowermain Ltd., 7 Daubeney Close, Harlington, Dunstable, Beds, LU5 6NF, UK, at £11.50 plus p/p (£1.35 UK, £2.92 rest of Europe, £5.23 Americas/Africa, £5.84 rest of World), or over the counter at the PC Bookshop at Southampton Row, London (Tel. 071 831 0022)

### DRSI DPK-2 TNC

After much asking and waiting, a sample of this new TNC for review appeared unexpectedly on my doorstep! You'll have seen it mentioned and pictured before in HRT, now we can see what it's made of and how it performed on air.

The unit comes in a painted metal (and thus RF screened) case, and is

compatible with the TNC-2, i.e., you can plug in any 'standard' TNC-2 EPROM for subsequent upgrading or for use as a TheNet node and the like. It comes with version 1.1.8 EPROM-based firmware, this giving the 'usual' TNC-2 command set for familiarity's sake, plus a Personal Mailbox and selectable 'host mode'. Measuring 127mm (W) x 33mm (H) x 167mm (D), it uses CMOS circuitry and draws a low 45mA at 12V DC - good for remote use. As well as the instruction manual, a handy A5 sized fold-out card comes with the TNC which gives you a one-line 'reminder' of each of the many commands - something I found quite useful (what is the ANSWRORA command anyway?).

ATCM3105 modem is used - so for on air use I found that I could add a plug-in 'Software DCD' board for 'open squelch' use - very useful for when I was on 4m or 6m packet with a degree of local 'hash' from neighbouring electronic equipment.

The TNC has a battery backed PMS, and when I'd 'enabled' this the command prompt from the TNC changed from *cmd:* to *pms:*. Unfortunately, I found that I had to remember to keep changing to this each time I'd finished 'live' operating for the day, as the PMS used the same callsign as MYcall - I couldn't enter, say, a different SSID for the PMS for other stations to connect to. This caused a few problems when a local BBS tried to automatically for-

### The DRSI DPK-2 TNC

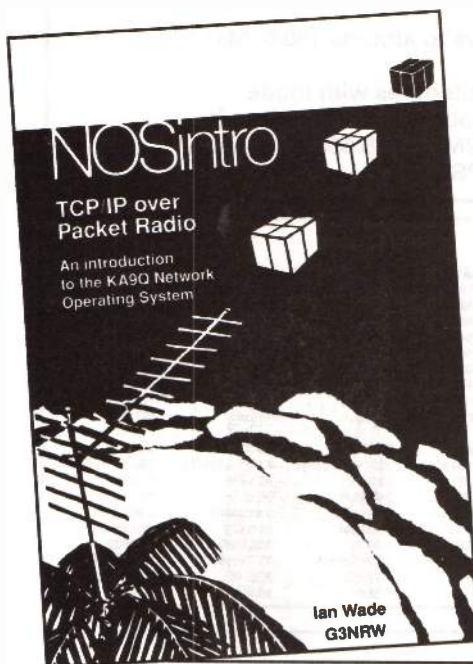



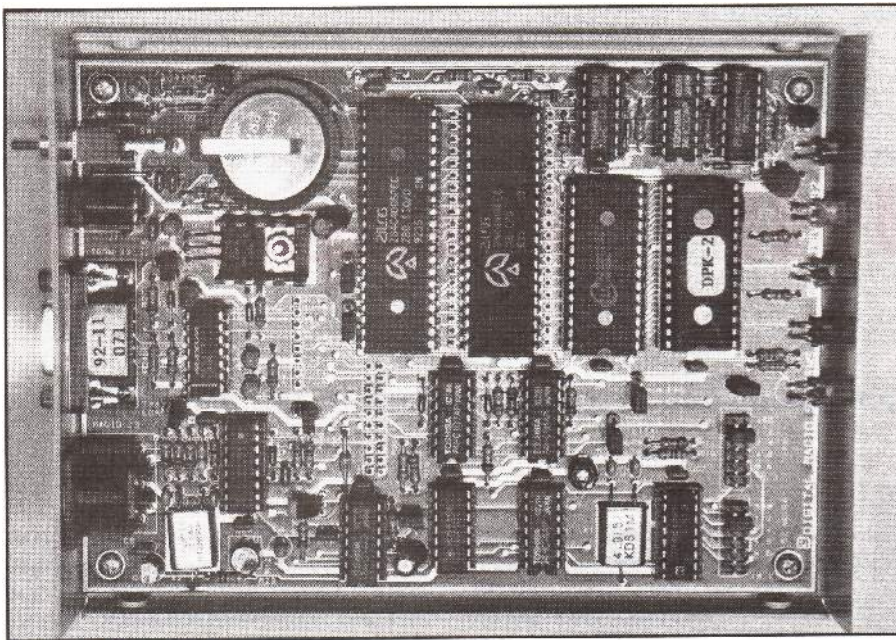

CMOS circuitry gives low current consumption

Rear Panel connectors



ward my mail onto me when I was 'live' at the keyboard! The PMS did seem a little 'limited' compared with other Firmware I'd used, for example the PMS commands available were rather limited, likewise the message listing, and it didn't have the 'reverse forwarding' capability I'd have expected from modern firmware.

Having said that, I found a couple of the firmware's features could certainly be useful, such as the *QRA ping* facility. A 'QRA ping' will 'poll' all other TNCs within range, and each will transmit its ID packet within 1 to 16 seconds (assuming it supports this of course). This way, you can see exactly which other TNCs and Digis you can reach from your station - very useful! 'Prioritized Acknowledgement' is also supported - this lets ACKs get priority access to the channel so that time isn't wasted in retry packets that have already been copied correctly by a remote TNC, the resultant channel congestion just making matters worse for everyone. In normal AX25 packet, the ACK often isn't received within the time limit set by the FRACK protocol timer.

A 236 page A5 size manual comes with the TNC, and yes, I know it's too long for most users! But at the beginning of this it does give useful information on 'getting going', with the remainder giving details for the more enthusiastic packeteers amongst us.

The DPK-2 is currently priced at around £110, and my thanks go to the UK distributors Amdat Ltd. (0272 699352) for the loan of the review model.

### Four TNCs, One Radio!

If you're a confirmed packet 'freak' but haven't got enough transceivers and associated aeriols to go round, the new RM-2 Radio Multiplier from NX2P Electronics might be the answer! With this you can use up to four different TNCs with one transceiver, the unit handling different baud rates, callsigns etc. (e.g. 1200 and 9600 baud from different TNCs) automatically, including cross-connection between the TNCs (e.g. between your 'user' TNC and, say, a TheNet node TNC). It isn't cheap, but you can get further details and prices from the UK Distributors Siskin Electronics (0703 207155).

### New 1200 baud FM Packet Satellite

Readers of 'Satellite Rendezvous' will know that ARSENE is planned for launch on the 20th April. This will use 'normal' 1200 baud AX25 that you'll be able to receive on 145.975MHz, with one of three 70cm uplinks (novice licensees take note!). This of course, is only one of many amateur satellites designed for packet, and Richard G3RWL has been in touch to say that the use of satellite gateways for international packet forwarding is causing some frustration amongst satellite users because of the congestion it is causing. I'm sure that many readers can appreciate the problem where amateurs who get such a satellite up

with money from their own pockets, find they then can't use it because of all the BBS forwarding going on!

A frequently voiced argument is that the (non-satellite) packet users should help to contribute to the amateur satellites that pass their mail. It could possibly be unfair to charge the (unknowing) users of this system, but if you are sending international mail, then do you realise it's likely going by an Amsat-provided resource? This voluntary group would gratefully accept some small donation from such users towards supporting this resource, sent to; Amsat-UK, 94 Herongate Rd, London E12 5EQ. If you're a member of your local packet group, how about lobbying them to dip into their funds also?

### CTRL-Z, End of Message

Joe G3VYA kindly sent me the latest issue of *Digicom*, the newsletter of *Maxpak*, the Midlands AX25 packet group. It's good to see the group are alive and kicking and active as ever, recent improvements they've been doing include a 23cm BBS forwarding link between GB7MAX and GB7SAM, plus tests on 23cm linking to Fourpak at Malvern. You can get membership details from Richard G1NZZ @ GB7MAX, or phone him on 0384 373682 between 20.00 and 21.00.

The *Sunpac* (Southern Users Packet Network) group seem to be going from strength to strength, with the addition of a number of trunk interlinks to free 'user channels' from congestion on 4m, 2m and 70cm. They meet around every two months, and do an excellent job in area network coordination. You can get details on the group from Martin G7JCJ @ GB7BNM or John G8OQN @ GB7HJP.

A letter from Ian GW1MVL @ GB7WXM tells HRT readers that the Wrexham area BBS, GB7WXM, is now operational and is providing a much needed service between GB7CRG, GB7SAM and GB7PMB. The Sysop is Malcolm GW8HBP, and operates on 144.650MHz and 432.675MHz for user access, with forwarding on 70.4875MHz. What makes GB7WXM unique is that it holds a quantity of GIF files, Lunar, and star images, taken by an ST4 CCD camera, with files regularly updated from the Starbase 4 landline BBS.

That's all there's room for this time. Next month for Baycom software owners I'll be taking a look at the Ramsey Kits modem offering, which I have sitting here just waiting for it to be assembled (maybe I'll get Sheila G8IYA to get her soldering iron out again). Until then, 73 from Chris G4HCL @ GB7XJZ.



# VHF/UHF Message

*Geoff Brown GJ4ICD with a few tips on how to spot Sporadic E on 6m, 4m and 70cm.*

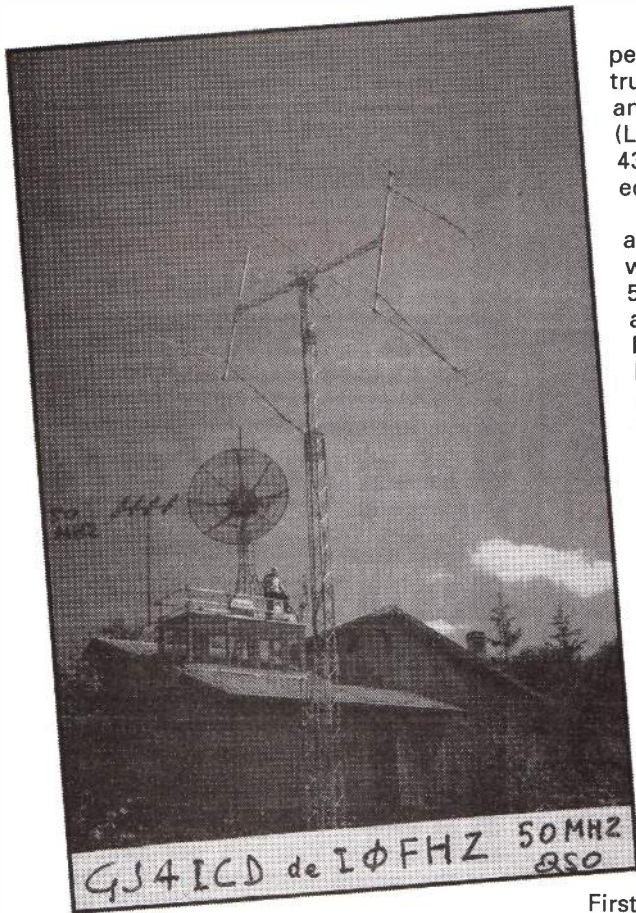

**The impressive EME array belonging to Bob WB5LBT**

Just as I finished the column last month there was a fantastic opening on all of the VHF/UHF/SHF bands. Unfortunately no space was left to report on the opening and so this month we will start off with details of the opening.

High pressure had dominated the scene for the festive season bringing a few openings on the higher bands, but January 2nd was really spectacular. On switch-on early in the morning 433MHz repeaters were everywhere at S9+, even the FM simplex section was alive as Andrew GJ7JHF reports, who, with only his handy (5 watts) was working G, GW and via the repeaters up to the Scottish border!

Mike GU8IRF (Guernsey) was worked via GB3CN (the Northants re-

peater on 1297.125MHz) by yours truly which was a very big shock, and an old friend Jack G5UM (Leicester) was also contacted on 433.4MHz FM at S7 who was equally surprised.

Six metres was also open, as Roger G6HMF in Bedfordshire was heard in Jersey at S7 on 50.530MHz FM, using a vertical aerial (at last, some life on six!). Many calls were put out for Novices but no contacts resulted. The Buxton beacon GB3BUX on 50.000MHz was S9+ via tropo on the south coast and even into northern France, and that is very rare.

As the day progressed, conditions became better, with OZ5BZ being heard on 1296.190MHz in GJ plus very strong signals from around the UK on all VHF/UHF/SHF bands. But, the anti-cyclone that produced the nice DX decided to move and next day we were back into the normal 'dead' conditions.

## 144MHz Reports

Firstly Terek CN8ST, well known for his 50MHz activity, is now QRV from Morocco on meteor scatter, strings of Europeans have been queuing up to try tests with him. Terek can be found on the VHF net on 14.345MHz, he is also QRV on 144MHz EME, and his qsl manager is K8EFS.

Speaking of EME, I received a letter from Bob WB5LBT who has a massive aerial system, take a look at the accompanying photo. Bob is looking for skeds off the moon, and can be contacted at 10715, Waverland Drive, Barton Rouge, LA 70815, USA.

## New Countries and DXpeditions

For those DX fiends, OK (Czechoslovakia) has from the 1st January 1993 become two separate countries. Their callsigns will be OK1 or OK2 and OM (OK3CM will now be OM3CM), the old

OK callsign is now deleted from DXCC.

Famous in the past for his enthusiasm on 50MHz, Mike UL7GCC has now changed his callsign to UL8GC. He still shows great enthusiasm for six but he also has no propagation.

Poland gained its full 50MHz allocation from the 15th January 1993, but the bad news is that in order to gain an extension to the existing licence, the licensee must pay the equivalent of one months salary!

On 28.885MHz, information was passed on that HB9 (Switzerland) stations gained 24 hour use of 50MHz from January. Well, I'm sorry to say that this was not so, Swiss stations have had an extension for the use of 50MHz for 1993, but *not* 24 hour use.

Angelo I2ADN hopes to be QRV from rare squares JM88, JM87 and possibly even C30 (Andorra) if he can get a permit. However this seems unlikely, as only residents of Andorra are permitted to operate amateur radio.

HV4NAC (North American College, Vatican City) is now QRV on 50MHz. QSLs go via I0CUT, remember this is a separate country for RSGB and DXCC.

Pierre ON4PS is trying to obtain a special 70MHz permit from the Belgium PTT to carry out tests with UK stations. Pierre is also trying for a power increase for 50MHz, but tells us that the Antwerp TV transmitter on Band I is still operational.

## Beacon Updates

Please update your December beacon listing with the following: FX3UHB 432.935MHz (IN78VC), GB3MCB 432.970MHz (IO70), GB3DUN 1296.890MHz (ZL08E), GB3FRS 1296.848MHz (locator unknown), FX1UHY 1296.853MHz (JN18). Also, please delete GB3WHA on 432.810MHz and UA9C in the 432MHz listing, at a later date a complete revised listing will be published. A new proposed 50MHz beacon is 7Q7SIX (KH64?) located at the lower end of Lake Malawi, the keepers are Ron 7Q7RM and John 7Q7JL, the proposed frequency is 50.003MHz. Please also amend Z21SIX new proposed frequency to 50.052MHz instead of 50.060MHz.





# AMDAT

4 Northville Road, Northville, Bristol, BS7 0RG 0272 699352  
The Leading Amateur Radio Retailer for Bristol and South Wales



## The return of **AFFORDABLE** Packet Radio

### FEATURES

- Version 1.1.8 Firmware ● Personal Message System
- CW Identification ● TNC-2 Code Compatible
- Modem Disconnect Header ● 32k CMOS Battery-Backed RAM
- Weighs only 430g ● Draws only 45mA at 12v DC

### OPTIONS

- Open Squelch DCD
  - 10MHz CPU dock for network nodes
- Price includes VAT at 17.5%

### DPK-2 Packet Radio TNC

The DPK-2 is a compact, low-power, All CMOS Packet Radio TNC which is 100% firmware compatibility with the TAPR TNC-2 and will run NET/ROM as well. The DPK-2 comes with version 1.1.8 firmware enhanced with the DRSI Personal message system (PMS). To meet UK licence conditions CW Identification can be sent. The crystal controlled modem is always right on frequency for 1200 band VHF and UHF operation. Full CMOS construction reduces power requirements making the DPK-2 the best choice for briefcase and portable systems.

The Modem Disconnect Header supports any of the wide range of external modems including G3RUH and satellite PSK. All this in a case just 1.25" x 5" x 6.25"

The DPK-2 comes with a 2.1mm power plug, a 5 pin DIN connector. Quickstart guide and a comprehensive technical reference manual covering all areas of the hardware and software. Just add 12V DC, a serial cable to the computer and a connection to the radio.

**All this for ONLY £119**

Post + Package £4.50

Prices subject to change

## Sporadic 'E' Season

Well, we are now into the Summer 'ES' season and here are a few tips to help you monitor and work the DX on 50MHz, 70MHz and 144MHz.

One of the best tips for monitoring 50MHz 'ES', if you have a HF receiver, is to watch the 28MHz beacon band, this is usually the best 'first' indicator. Then as the MUF (Maximum Usable Frequency) rises a Band I VHF 625 line TV receiver will display the many countries still transmitting on these frequencies (48.250MHz to 49.750MHz) within Europe and even Russia, in fact there are at least twenty countries still active on Band I TV.

Sporadic 'E' can last for many hours on 50MHz but on 144MHz openings can be very brief. So, keep the overs short but with precise information. 144MHz openings are usually 'tipped off' by hearing continental FM broadcast stations in the 88 to 108MHz VHF radio band, but there is a better indicator and that is the use of Europe's VOR beacons. These beacons, usually located at airfields, are one of the best propagation indicators for 144MHz sporadic 'E'. Their frequencies fall between 108MHz and 116MHz, and lists appear from time to time in the German VHF/UHF/SHF publication *Dubus*, or see your local friendly pilot! Speaking of *Dubus*, if any one is interested in this publication which is purely dedicated towards VHF/UHF/SHF then you can contact the UK distributor; Ken Hatton, G4IZW, Hamilton House, Boat Rd., Bellingham, Hexam, Northumberland.

Also, remember there are going to be lots of confusing new call signs such as 9A, S57, S59, OM and 4N4. When you do hear these exotic prefixes, don't panic or hesitate just get in and work them! With that little note, good luck and good DX during the 'ES'.

### Activity

News from Dave Ackrill G0DJA (W

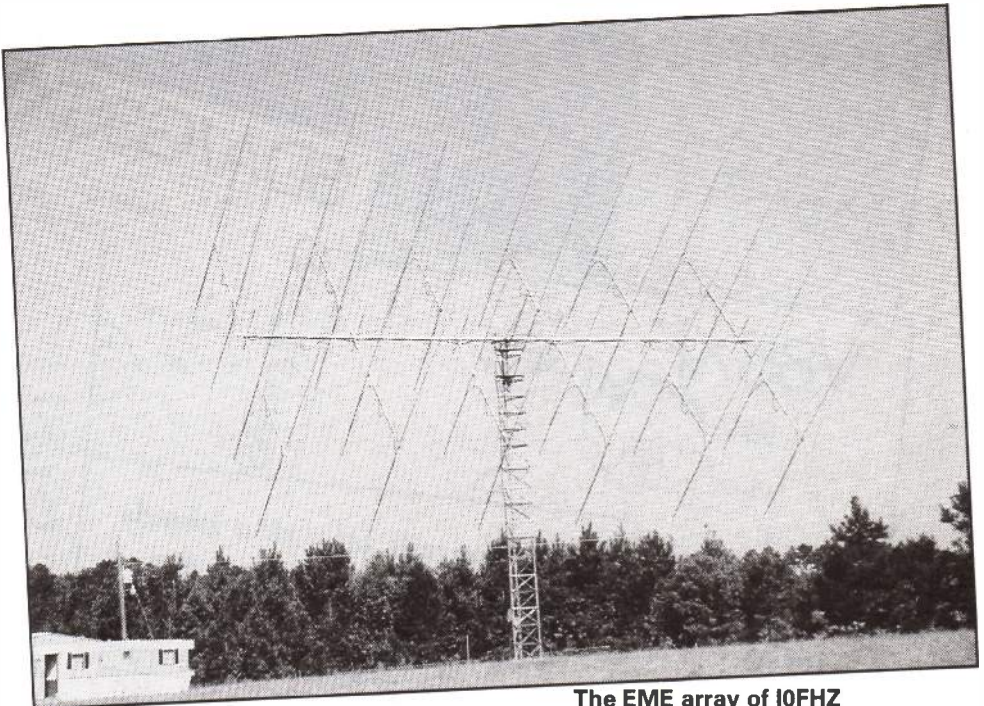

The EME array of 10FHZ

Yorks) is that he is now QRV on 50MHz after becoming the new owner of an Icom 726. Dave got straight into 6m by catching the Aurora on December 28th and worked a few new Scottish stations. Then in early January, Dave had a nice tropo path to PA3EHP and ON4AQB, these are nice distances for QRP and just shows that tropo *does* exist on 50MHz. Dave also asks if the good old VHF net on 14.345MHz still exists. Well the answer to that one is yes it does, but from what I have heard of it just recently it tends to have become more orientated towards EME.

Neil G0JHC reports good sporadic 'E' openings on 50MHz on the 16th/17th of January with the new 'OK' and 'OM' countries added, while Lawrence GJ3RAX worked Sweden at the same time, putting the ionised layer somewhere over northern Holland.

Chris GM3WOJ reported a weak aurora on 1/2/93 as the 'K' had risen to 4, on the 2nd/3rd/4th of February high

pressure ruled the scene with many beacons being reported, stations in Wales reported FX3UHF in IN94 on 1296.950 at S9+ but no activity was heard (sounds familiar!).

Ela G6HKM (Essex) wrote in saying things have been hectic at her end with family visits and no time for the DX if there had been any! Also just received by Ela was a QSL from EA8/DJ3OS for 50MHz, she asks if it is a valid card. Well, sorry to all who worked this one but EA8/DJ3OS has no permit for 50MHz and neither the RSGB or ARRL will accept this card for an award.

Well that's it for another month, and next month we take a quick look at 2m on the island of Crete with Chris G6XPJ, and the results of the UK Six Metre Group EME tests with the USA. So 73 for now and send any news please by the 6th of the month to: Geoff Brown, GJ4ICD, TV Shop, Belmont Rd, St Helier, Jersey C.I. JE2 4SA.

# HF Happenings

*Don Field G3XTT gives a few tips on 160m DX aerial systems, and has a tale of aerial tower woe*

much again on the surface of the lawn. Laying earth wires is tedious, but at least it doesn't require planning permission and works wonders if you are using some sort of vertical aerial. It's pretty well essential for DX working on topband and 80m, as it is well nigh impossible to get a horizontal aerial which is a half wave high. Any lower, of course, and most of the radiation will go upwards, which won't help you work the DX. Incidentally, I have never had a TV interference problem as a result of my topband transmissions, even running

**G4SMC/8RI**  
THE CLUB STATION OF  
SOUTH MIDLAND  
COMMUNICATIONS LTD  
ENGLAND

**NU2L/VE8**  
IGLOOLIK ISLAND - N.W.T. IOTA - NA174

**V85XF**  
BRUNEI

**3DA/G3SXW**  
SWAZILAND

**FP/G3TKN**  
St. Pierre & Miquelon Islands

TO RADIO	DATE	GMT	MODE	MHz	RST
G3XTT	9/18/92	1450	CW	18	599

**ZC4FOC**  
DHEKELIA CYPRUS  
EASTERN SOVEREIGN BASE

Band conditions now seem to be starting to reflect the decline in the sunspot numbers. During the AH1A Baker and Howland Island DXpedition in January and February, propagation on the higher bands was relatively poor, whereas the low bands were much more reliable. UK stations were able to contact AH1A on 80, 40, 30, 20 and 17 metres. Even more remarkable, some extremely exotic DX was worked from the UK on topband (160m) during the same period. This included KH6CC (Hawaii) and FK8CP (New Caledonia) as well as 9F2CW/A (Eritrea), 9K2ZZ (Kuwait), HZ1AB (Saudi Arabia), 5U7M (Niger) and lots of Caribbean stations like KP2A (US Virgin Isles), 8P9DX

(Barbados), P40PI (Aruba), CO6CG (Cuba), WP4IIV (Puerto Rico), and T11C (Costa Rica). VR6BB on Pitcairn Island was heard but not worked from the UK.

If all this seems out of your reach, perhaps it's time you revisited 160m. The power limit is now 400W, at least between 1830 and 1850kHz, and elaborate aerial systems are neither feasible nor essential. In the CQWW 160 contest at the end of January, my folded inverted-L antenna was only about 12m high at its highest point, but I was able to work most of the African, Middle Eastern and Caribbean stations listed above. A major part of the secret lies in the earth system. I have over 300m of buried earth wires, and during the winter season lay probably twice as

maximum legal power, whereas all the other bands have given me problems from time to time.

## A Different Perspective

You will probably recall reading in the February edition of this column a write-up by Chris Burger, ZS6EZ, of his Penguin Island and Lesotho DXpeditions. Chris is also an avid contest and one of the most consistent signals out of southern Africa on all bands. I was delighted, therefore, finally to meet Chris in person when he made a business trip to the UK in mid-February. We get so used to how the bands sound day by day that we forget how different things can be from other perspectives. Chris was astonished to listen to the LF bands from my shack and to hear them full of S9+ signals. On topband in particular he has never heard any stations much above the ambient noise level. He was telling me that only five South African stations have ever achieved 5-band DXCC (he is one of them), the LF bands proving so difficult from there. Working DX on any band



can be difficult, too. While DXpeditions will turn their aerials to Europe, North America and Japan, as a matter of course, other parts of the world often get neglected. The other side of the coin is that contesting from there, provided you have a potent signal, is usually a recipe for a good score. Most major population areas are roughly north, so there is no need to be constantly moving the aerial, and serious contesters will search you out for a needed country and zone multiplier. The weather is also more conducive to aerial work! Chris enjoyed his visit to the UK, but told me he couldn't live with our cold, damp winter weather for more than a few days at a time!

### Aerial Woes

Talking of aerials, I have a sorry tale to tell. Fortunately my aerial system survived the very strong winds of mid-January (and, yes, I do know of some that bit the dust – reminiscent of the old adage that if your aerial didn't fall down last winter it was not big enough). However, after the weekend of the CQWW 160 contest I tried to lower my tower (it is a 17m telescopic mast, with a TH5 triband beam on the top) and found that I couldn't! The winch cable, which is stainless steel, had frayed and some of it must have jammed inside the bottom section, preventing the second section from retracting. With some invaluable help from G3WGV I was able to lower the remaining two sections, so I am now left with my beam at about 9m and no obvious way of getting the tower down and dismantling it. All the weight – three sections and the beam – is high up, so that the bending moment if I tried to luff the tower over would be tremendous. As mine is a tubular, rather than a lattice, mast, there is no way of getting at the problem area. If any HRT readers have any bright ideas I would be delighted to hear them! Otherwise watch this space for the next exciting instalment!

### North Korea

A message from JA1BK, copied on the PacketCluster system, reported that the P5RS7 operation from North Korea had made a total of more than 36,000 contacts in just over two weeks of operation. There were five operators, all Russian, and they operated from a site close to the Russian border. Wire aeri-als were used, and two stations were operational, one with and one without a linear amplifier. Apparently the logs were inspected by the authorities in Pyongyang before the team left. There is no word yet on whether this one will count for DXCC.

### Ghana

As I write this, there is news that a group of Dutch amateurs has received an official invitation to operate from Ghana (where amateur radio has been banned for some years) in connection with a project to raise funds for a hospital there. The Dutch have argued that an amateur radio operation would increase international goodwill in connection with the fund raising project. The operation should have taken place in late March, so hopefully you will all have it in the log by the time this appears in print.

### Bhutan

DX News Sheet also reports that progress continues towards the re-introduction of amateur radio to Bhutan. I certainly hope so, as Bhutan is the only country I still haven't worked. This remote Himalayan kingdom discourages contact with the modern world, except for allowing a very limited amount of tourism in order to bring in some external funds. Jim Smith, VK9NS, who managed a brief operation from Bhutan a couple of years ago, has been the main driving force behind recent negotiations; let's hope he pulls it off.

### Ascension Island

Andy, G4ZVJ, is now back on Ascension Island, and using his ZD8VJ callsign. He will be there for a year. ZD8LII also continues to be very active, and Jim Neiger, N6TJ, is a regular visitor, signing ZD8Z, so no excuses for missing out on an Ascension island contact.

### DXCC News

The ARRL has announced that the start date for the 5-band DXCC award has been amended, so that it is now 15 November 1945, in line with other DXCC awards. Presumably this is to make their job easier. Dates will not have to be checked, and all cards credited to you on the DXCC database will count automatically towards the day that you finally qualify for 5BDXCC. In fact the computer system at ARRL HQ now seems to be working reasonably well, although my latest update took about four months to be returned from the US. I hope those of you who chase DXCC are having some success in getting QSL cards for the newly created countries resulting from the break-up of the former Yugoslavia. I have cards for Croatia, but still need them for Slovenia and Bosnia-Hercegovina. Mail appears to be sporadic and the QSL bureaux in those countries don't seem

to be working properly yet, perhaps not surprisingly as the folk there obviously have a million more important things on their minds.

### Eat Your Heart Out

DX News Sheet has recently been publishing snippets received about some of the mega-stations which US and other amateurs have put together. Just to give you a flavour, some of the recent ones include;

N2KK who has 46m and 15m towers with 6-element beams for 10/15/20, a 7-element for 10m, and quarter-wave square vertical arrays for 40, 80 and 160. The 80m set-up consists of four 41m masts in a square, with two miles of above ground radials!

Carlos, TI2CF, in Costa Rica, has four 51m and 72m towers spaced 100m apart in a square configuration supporting the following: a 2-element quad for 160m at 66m high, with a reference dipole at 49m; on 80m, 4-element quads at 49m plus a 3-element Yagi at 73m; on 40m, a 4-element Yagi at 52m; on 20m a 6-element Yagi at 52m; on 15m a 6-element Yagi at 53m; on 10m, a 6-element Yagi at 52m and another at 30m. And your XYL thought your G5RV dipole at 12m was over the top!

N6DX in California runs a 4-element vertical Yagi on 160m, consisting of a 53m tower with 7.3m top-hat for the driven element, plus three 43m parasitics switchable as directors/reflectors giving 6dB gain and a 25dB front-to-back ratio. He also has 305m Beverage aeri-als for receiving. Darrell say "It really plays", and I can but agree, as he is the only Californian station I have heard on 160m on SSB.

### Software

Finally, EI5DI, a review of whose contesting software appeared in the March issue of HRT, has let me have the most recent copy of his program. Paul now supports additional contests including the RSGB Commonwealth Contest, and has put right some of the minor bugs which I had identified in the review. Paul has also written a version of his program to support the RSGB Islands on the Air contest, to be held on 24/25th July, and is making this available to anyone anticipating making an entry for the cost of postage, which can't be bad. Send 2 IRCs and a 3.5in disk, or 4 IRCs without a disk, to Paul O'Kane, 36 Coolkill, Sandyford, Dublin 18, Ireland.

And as a final, final (!), don't be fooled by the exotic call signs on the QSL cards which illustrate this month's column. These are all from recent operations by British amateurs.

# QRP CORNER

*Dick Pascoe G0BPS mourns the possible death of QRP kits for EC amateurs*



I'm sorry about the lack of the QRP column last month, but the anticipated move of home failed at the last minute and then leapt upon us a month later. We had to pack and leave our home of 17 years in just 6 days! So please note the new address at the foot of the column and do please drop me a line about your latest QRP activities.

## The End of an Era

There's both good and bad news for QRP operators this month. The latest news about the EMC rules for commercial equipment may be beneficial to the 'black box' brigade but it may well mean the death knell of the UK kit manufacturing companies.

The new legislation which comes into effect after the 31st December 1995 means that all kits sold on a commercial basis will have to be EC approved. As this is a costly affair, sometimes as much as several thousand pounds and a suggested minimum of £200 per kit, I cannot see the smaller kit manufacturers staying in business after this date selling only test equipment and non transmitting / transceiving equipment.

What this means for us all is that all transmitting equipment sold commercially in the EEC will have to comply with this legislation. Note the 'commercial', if you as an avid builder wish to make your own transmitter then this will be OK, second hand equipment is exempt too.

There is some good news in amongst all this though. Kit purchasers will know that their purchase in 'benign' However the cost of the kit will have rocketed because of the cost of obtaining the coveted EC stamp of approval.

## A 'Funk' Book

An offering from Germany dropped on my desk the other day from a well known German publishing company. They offer many books and even a couple of magazines to the German speaking world.

This book is entitled *QRP Mit kleiner leistung rund um die welt* by Mathias Rauhut. I managed to translate the heading with my very limited German to mean (in the region of) *Around the world with low power*.

'What has this got to do with me?', you may ask. 'Everything', I reply, because much to my amazement only one of the circuits shown in the book was by a German. All the rest were from England, most of which had appeared in the QRP Club magazine *Sprat*. Circuits from G3ZOM, GM3OXX (of course), G4RAW, G3MY, G3RJV and many more.

The list of suppliers in the back of the book looks like a list of Who's who in the UK kit manufacturing industry with only six of the listed thirteen being non British.

You don't have to speak or read German to appreciate the book either, with chapter titles such as "QRPP Was ist das?" being totally understandable even if the text wasn't, even my one term at night school doing conversational German didn't prepare me for all this.

I enjoyed browsing through the book just looking at the pictures and the circuit diagrams which are all self explanatory. It will join the many other books on low power operating on the book shelf in the shack.

Other books in their range should also make delightful reading, how about.. Funk und Computer, Packet Radio, Englisch fur CB-Funker, RTTY und AMTOR and several others.

Should you be interested then drop a line to: Funk Technik Berater, Fachbuchservice, Postfach 11 28, 7570 Baden-Baden 1, Germany. I regret I do not have a price for the book. The ISBN is 3-88180-317-3.

## QRP Winter Sports

Several reports have come in about the activities during the winter sports, even entries for the HRT competition. Activity was high with many long QSOs taking place. Needless to say my HF rig

was in a cardboard box and the aerials wound up and also packed. I did manage to listen around though on a friends rig, suffering from withdrawal symptoms I could only listen.

In my last column I mentioned the OK club, I have since found out that the newsworthy split in the country hasn't affected the club at all. The club magazine is full of information about activities in the country and is of interest to many UK operators too. The good news here is that their club magazine is in both languages. Anyone interested in the club can drop me a line and I will pass on the details.

UK amateurs within the QRP fraternity have long had an affinity with our friends in Czechoslovakia and it was almost sad to hear of the split. For those who haven't heard the Czech part will be OK1 and OK2 and the Slovakian part as OK3.

It is understood also that OK as a country has now been deleted from the DXCC listings and the two countries will be re-entered when things settle down and they have their own call signs issued.

## Novel Morse Award

I heard of an unusual CW award recently where the number in the prefix defines the score, I should be in great demand if this takes off as the highest score for a single contact is for the prefix with a zero, thus my G0BPS would score ten points with G3\*\*\* scoring only 3 points, WA9\*\*\* 9 points LA2\*\*\* only 2. The difficulty of making a contact with a rare DX station is removed so making the award easier to obtain.

Sounds strange doesn't it? But if I tell you it is the Russian CW clubs idea it may be a little clearer. Any contact after 1st January 1991 counts and to gain the award you must collect 200 points. At least 10 U-CW club members are obligatory which may be more difficult to find. If you fancy a go then the award costs \$5 US or 8 IRCs. Send a registered letter to: Vladimir Stepanenko, UB5RR, PO Box 28, CHERNIGOV Post Office 250000 Ukraine.

That's it for this month, news, views and comments to me at HRT Editorial (P. O. Box 73, Eastleigh, Hants, SO5 5WG), via GB7ZAA, or at Seaview House, Crete Road East, Folkestone CT18 7EG. 72.... de Dick



# Club News

**Aberdeen ARS** meet every Friday, 7.30pm, at 35 Thistle Lane, Aberdeen (just off Rose St.). Visitors and anyone interested in radio or electronics will be made most welcome. Planned club events/talks;

Apr 2nd Junk sale.

Further details can be obtained from John GM1TDU, Tel. 0224 706619

**Action, Brentford & Chiswick RC** meet at 7.30pm on the third Tuesday of each month, at the Chiswick Town Hall, Turnham Green, Chiswick, London W4. New members welcome. Club event/talk;

Apr 20th Practical problems in EMC, by G3IGM.

Further details from Colm Mulvany G0JRY, Tel. 081 749 9972.

**Aylesbury Vale RS** meet on Wednesday evenings in the Village Hall in Hardwick, located off the A413 between Aylesbury and Buckingham. Club events/talks;

Apr 7th Cellular telephones.

Apr 21st Slide show of members' shacks, G3KLT.

May 5th Talk – The Bletchley Park Trust.

May 19th Surplus equipment auction.

For more details and meeting times, contact Martin G4XZJ, Tel. 0296 81097 or Roger G3MEH, Tel. 044282 6651

**Basingstoke ARC** meet on the first Monday of each month, 7.30pm, at the Forest Ring Community Centre, Sycamore Way, Winklebury, Basingstoke, Hants. Planned club events/talks;

Apr 5th Magnetic loop aerials, Len G3MAO.

Apr 25th 2m direction finding competition.

May 3rd Junk sale and natter night.

May 23rd 2m direction finding competition.

For further details Tel. 0256 25517

**Bridlington and District ARS** meet every other Thursday, 7.30pm, in the Combined Cadet Building, Bridlington Upper School, Yorkshire, all visitors welcome. Planned club events/talks;

Apr 1st Emergency services, by Mike Norrie.

May 13th Microwaves, by Dave G3ZTR.

Further details can be obtained from Norman G4NJP, 44 Hilderthorpe Rd, Bridlington, Yorks YO15 3BG.

**Bristol (North) ARC** meet at 7.00pm every Friday at SHE 7, Braemar Crescent, Northville, Bristol. Courses are run for the RAE and Morse test. Planned club events/talks;

Apr 9th Kits, Bits, and PCBs, John Badger.

Apr 16th Home brew competition.

Apr 23rd An insight into QRP.

May 14th Rig maintenance and repairs, Castle Electronics.

Further details from Dave Coxon, Tel. 0275 855123

**Bristol (South) ARC** meet every Wednesday at the Whitchurch Folkhouse Association, Bridge Farm House, East Dundry Road, Whitchurch, Bristol. Club diary of events/talks;

Apr 7th Training for a private pilot's licence.

Apr 14th 2m activity evening.

Apr 21st Stress management.

Apr 28th Simple computer programming.

For more information and meeting times, telephone Whitchurch 832222 on a Wednesday evening.

**City of Bristol Group** meet on the last Monday in the month, 7.00pm for 7.30pm, at The Small Lecture Theatre, Queens Building, University of Bristol. Club diary of events/talks;

Apr 26th Home winemaking, with free samples!, G7GHB.

May 24th Half yearly general meeting.

Further details can be obtained from Dave Coxon G0GHH, Tel. 0275 855123

**Bromley and District ARC** meet on the 3rd Tuesday of each month, 7.30pm for 8.00pm at the Victory Social Club, Kechill Gardens, Hayes, Kent. Club events/talks;

Apr 20th Death Valley by bicycle, Dave G0OBL.

May 18th TV principles, Ian Daniels.

Further details from Mr. Geoffrey Milne G3UMI, 142 Hayes Lane, Hayes, Kent, BR2 9EL, Tel. 081 462 2689.



**Bromsgrove ARC** meet on the 2nd and 4th Tuesday of the month at Lickey End Working Men's Club, Burcot, Bromsgrove. Club diary of events/talks;

Apr 13th Aerial construction (2m).

Apr 27th Birthday party! 10 years!

May 11th AGM.

May 25th Technical topics.

Further details from Mr. D. Edwards G4TUI, Tel. 0527 546075

**Bromsgrove and District ARC** meet every Friday night for on-air, construction, and natter nights. On the second Friday of each month at 8.00pm they have a talk/lecture at Wasely Country Park. Planned club talks/events;

Apr 9th Constructors competition.

For further details contact Joe Poolle G3MRC, Wasely Country Park, Gannow Green Lane, Rubery B45 9AT, Tel. 0562 710010

**Buxton ARC** meet at the Lee Wood Hotel, Buxton, at 8.00pm on the 2nd and 4th Tuesdays each month. Club diary of events/talks;

Apr 13th Quiz night, plus live Morse.

Apr 27th Walking fox hunt.

May 11th Explanation of packet BBS network.

May 25th SWL, an enjoyable hobby.

For further information contact Derek Carson G4IHO, Tel. 0298 25506

**Carrickfergus ARC** meet every Tuesday, 7pm, in Downshire Community School, Downshire Road, Carrickfergus. Planned club talk;

Apr 6th Computer speech, G4IRW.

For further details contact Gavin G10GMG, Tel. 0232 835650

**Charnwood AR Contest Club** meet every first and third Sunday in the month, at The Albion, on the canal bank, Loughborough. The club are grouping together interested amateurs to form an AM operators' clan in their area and elsewhere, hoping to experiment in long range propagation. If you are interested please contact Mike G0LBP, 25 Rivington Drive, Loughborough, Leics LE11 0EJ. The club will be 'AM active' on 11th July on 144.5625MHz, horizontal beaming north and south. Club events;

Apr 4th 80m QRP night on air at Albion.

Apr 11th Club field day HF.

Apr 18th 40m QRP night on air.

May 2nd 20m QRP night on air.

Further details from Phil G4RVW, 2 Alan Moss Road, Loughborough, Leics LE11 0LX, Tel. 0509 232927

**Mid Cheshire ARS** meet each Wednesday, 8.00pm, at the Cotebrook Village Hall, Cotebrook, Cheshire. Planned club events/talks;

Apr 7th Theatre in POW camp, Len Moss.

Apr 14th Talk by Castle Electronics.

Apr 21st On air night.

Apr 28th History of computing, by G4XFD.

May 5th Theatre make-up, Len Moss.

May 12th On air night.

May 19th Setting up an HF station, G4XUV, G0IRA, and G4CAX.

May 26th Identifying components, by G0IRA.

Further details from M. Baguley G7LQD, 21 Sovereign Close, Northwich CW9 7XN

**Chichester and District ARC** at 7.30pm on the first and third Tuesday each month at St. Pancras Hall, St. Pancras, Chichester. Planned club events/talks;

Apr 6th AGM.

Further details from D. Clear G0KNU, 1 Milestone Cottages, Fishbourne, Chichester, West Sussex, PO18 8AU. Tel. Chichester 573541

**Dacorum AR and TS** meet on the first (informal) and third (formal) Tuesdays, 8.00pm, at the Heath Park, Cotterells, Hemel Hempstead. Club talk/event;

Apr 20th Being an RLO for the RSGB, by Roy G4UNL.

May 18th Talk by Mr. Armstrong of AKD.

For further details contact Dennis Boast G1AKX, Tel. 0442 259620

**Dereham ARC** meet at the St. Johns Ambulance Hall, Yaxham Road, Dereham, at 8.00pm. Planned club talks;

Apr 8th SWL, Chris G4LPW.

May 13th Use of test equipment, Mark G0LGJ.

For further details contact Mark Taylor G0LGJ, Tel. 0362 691099 or G0LGJ @ GB7TLH packet.

**Dragon ARC** meet on the first and third Mondays of each month at the Fourcrosses Hotel, Menai Bridge. Club diary of events/talks;

Apr 5th Using a camcorder, GW0PZS and GW0ABL.

Apr 19th 'The grand debate', when we hope to challenge the Conwy Valley Club.



May 3rd Bank holiday surplus sale.  
May 17th Talk by Dr. David Last GW3MZY.  
Further details from the Secretary Tony Rees GW0FMQ, Tel. 0248 600963

**Echelford ARS** meet on the second and fourth Thursday each month, 7.30pm, at the Community Hall, St. Martin's Court, Kingston Crescent, Ashford, Middx. Planned club talks/events;  
Apr 8th AGM.  
Apr 22nd Contest operating, Justin G4TSH.  
May 13th Natter night.  
May 27th Surplus equipment auction.  
Further details from P. Townshend, Tel. 0344 843472

**Exeter ARS** meet on the second Monday each month, 8.00pm, at the Community Centre, St. Davids Hill, Exeter. Planned club events/talks;  
Apr 19th Inter club quiz.  
May 10th Surplus sale.  
Further details from B. L. Bolt, Tel. 0392 214204

**North Ferriby United ARS** meet at 8.00pm on Fridays at the North Ferriby Utd. FC Social Club, Church Road, North Ferriby. Planned club events/talks;  
Apr 16th My importing and exporting experiences, G4NJP.  
Apr 30th The new phasing transceiver, talk and demo.  
May 14th Surplus sale.  
Further details from Frank Lee G3YCC, Tel. 0482 650410

**Grantham Radio Club** meet on the first and third Tuesdays of each month at the Kontak sports and social club, Barrowby Road, Grantham, starting at 8.00pm. Everyone welcome. Planned club talks/events;  
Apr 6th Visit to the County Emergency Centre, Lincoln.  
Apr 20th Oscilloscopes, Steve G6IPW.  
May 4th Club quiz.  
May 18th HF Aerials, Mike G3PJR  
Further details from John Kirton G8WWJ, Tel. 0476 65743

**Halifax and District ARS** meet at 7.30pm on the first and third Tuesdays each month. The first Tuesdays are informal 'Noggin and Natter' nights, other planned club events/talks;  
Apr 20th Search and rescue dogs, Neville Sharp.  
May 18th Visit to police headquarters.  
Further details can be obtained from Mr. D. Moss G0DLM, Beechwood Lodge, Lightcliffe, Halifax HX3 8NU, Tel. 0422 202306

**Hastings Electronics and RC** meet every Friday, 7.30pm at Ashdown Farm C.C., Downey Close, Hastings, for a social evening, and every third Wednesday of each month for their main meeting, at West Hill Community Centre. They run RAE and Novice courses. Planned club events;  
Apr 21st Junk sale.  
May 19th Police forensic techniques, by Barry G7GHP.  
For further details contact Reg Kemp G3YYF, Tel. 0424 83454

**Hoddesdon Radio Club** meet alternate Thursdays at the Conservative Club, Rye Road, Hoddesdon from 8.00pm. Club diary of talks/events;  
Apr 1st Hints and tips, Don G3JNJ.  
Apr 15th The post office tower, by George Morley.  
For more information contact Roy G4UNL, Tel. 081 804 5643.



**Hordean and District ARC** meet on the first Thursday of each month at Hordean Community School, Barton Cross (off Catherington Lane), Hordean, Hants. Club diary;  
May 6th Visit by Peter Chadwick, 1993 RSGB President.  
Further details can be obtained from Stuart Swain, Tel. 0705 472846

**Keighley ARS meet at the Cricket Club**, Ingrow, near Keighley every Thursday at 8.00pm. Most club meetings are 'Natter nights', other events/talks include;  
Apr 8th Junk sale.  
Apr 15th Night on the air GX0KRS, GX7KRC.  
Apr 29th QRP construction, Rev. G. Dobbs.  
May 13th Horse racing/natter night.  
Further details from Kathy Conlon G1IGH on 0274 496222

**South East Kent (YMCA) ARC** meet at the Dover YMCA in Leyburne Road, Dover, every Wednesday at 7.30pm. The club is actively involved with manning the permanent special event station at the South Foreland Lighthouse, and also runs Morse and Novice classes. Planned club talks/events;  
Apr 7th Evening for Novices.  
Apr 14th RSGB video – amateur satellites.

Apr 21st Construction contest.  
Apr 28th AGM.  
For further details about the club and courses contact Eileen G7HXJ, Tel. 0304 372656.

**Kettering ARS** meet every Tuesday at 7.30pm at The Electricity Sports and Social Club, Eksdale St, Kettering. Club diary of events/talks;  
Apr 20th AGM.  
Apr 27th Repeaters, G. Dover G4AFG.  
May 15/16th Special event station at Rockingham Castle.  
May 25th Amateur radio direction finding, G3TFA.  
Further details from Len G0RDV (was G7EHM), Tel. 0536 514544

**Liverpool and District ARS** meet at 8.00pm every Tuesday evening at The Churchill Club, Church Rd, Wavertree, Liverpool. Planned club events/talks;  
Apr 6th Contest preparation.  
Apr 13th Activity night.  
Apr 20th Quiz.  
Apr 27th Surplus sale.  
For further details contact Ian Mant G4WWX, Tel. 051 722 1178.

**Loughton and District ARS** meet 7.45pm, in Room 12, Loughton Hall, Rectory Lane, Loughton, Essex. Planned club events/talks;  
Apr 2nd Annual General Meeting.  
Apr 16th Video night, the latest videos from the RSGB and other sources.  
Further details can be obtained from Ray Pedley G0LWF, Tel. 081 500 2811

**Mansfield ARC** meet on the first Thursday every month, 7.30pm, at The Polish Catholic Club, Off Windmill Lane, Woodhouse Road, Mansfield. Planned club diary of events/talks;  
Apr 1st Junk sale.  
May 6th AGM.  
For further details contact Mary G0NZA, Tel. 0623 755288

**Norfolk ARC** meet every Wednesday at 'The Norfolk Dumpling', The Livestock Market, Harford, Norwich, 7.30 for 8.00pm start. Club diary of events/talks;  
Apr 7th AGM.  
Apr 14th Prehistoric elephant of West Runton.  
Apr 21st Real radio evening, constructing a DF aerial.  
May 5th Radio Bygones update by Tim Christianson.  
May 12th GB3NB repeater AGM.  
May 16th Club trip to RSGB Exhibition at NEC.  
May 19th Real radio practical.  
Further details can be obtained from Sheila Snelling G0KPW, Tel. 0603 618810.

**Northern Heights ARS** meet on the first and third Wednesdays every month, 8.00pm, at the Broadshaw Tavern, near Queensbury, between Bradford and Halifax. Forthcoming club event;  
Apr 7th AGM.  
Further details can be obtained from Stan Catton G1HYR/G0IYR, Tel. 0274 673116.



**Nottingham ARC** meet every Thursday, 7.30pm, in the Sherwood Community Centre, Mansfield Road, Nottingham. Visitors interested in amateur radio, whether as a transmitting amateur or SWL, are most welcome. Forthcoming events/talks include;  
Apr 1st Construction/activity/on the air.  
Apr 8th AGM.  
Apr 15th Forum.  
Apr 22nd Fox hunt No. 1/activity.  
Apr 29th Junk sale.  
May 6th Talk on WAB Awards, Kate G0FEZ.  
May 20th Foxhunt No. 2.  
May 27th Construction evening.  
Further details from Ian Miller G4JAE, Tel. 0602 232604



**Reading and District ARC** meet on the 2nd and 4th Thursdays, 8.00pm, at The Woodley Pavilion, Woodford Park, Haddon Drive, Woodley, Reading, Berks. The club Christmas dinner will be in December, contact Nick for details. The club diary of events/talks;  
Apr 8th WW2 radio equipment part 2, G8ORE and Charles.  
Apr 22nd The optimised doublet aerial, G4JTR.  
Apr 24th Help with Scouts fox hunt evening.  
May 13th HF NFD planning.  
May 28th Construction and alignment evening.  
Further details can be obtained from Nick Challacombe, Tel. 0734 722489

**Rochdale and District ARS** meet every Monday, 8.00pm, at the Cemetary Hotel,



470 Bury Road, Rochdale, Lancs. New members are welcome, please ask for any committee member on arrival. Planned club events/talks;  
 Apr 12th Five million volts, talk.  
 May 10th Five million volts – aftermath.  
 Further details from Dave G0PUD, Tel. 0706 32502 or Brian G0GNR, Tel. 061 653 8316

**Shefford and District ARS** meet every Thursday, 7.45pm, at The Church Hall, Amphil Road, Shefford, Beds. All newcomers are welcome. Planned club events/talks;  
 Apr 8th Bring your vintage amateur radio kit, with books and other by-gones.  
 Apr 15th ARIANE, the rocket and the launch site.  
 May 6th Modern 10GHz operation.  
 May 20th Balloons and hot air, demo.  
 For further details contact Paul Bradfield, Tel. 0462 700618

**Southgate ARC** meet on the second and last Thursdays of each month at the Winchmore Hill Cricket Club Pavilion, Firs Lane, Winchmore Hill, London N21. Forthcoming club events/talks;  
 Apr 8th Surplus equipment sale.  
 May 13th Early radar, by Stan Wood.  
 May 27th DF workshop, equipment and technique explained.  
 For further details contact Brian Shelton G0MEE, Tel. 081 360 2453.



**Stevenage and District ARS** meet every Tuesday, 7.30pm, at Cottswood House, Ridgemoor Park, Telford Ave, Stevenage, Herts. Morse practice available on club nights. Planned club events/talks;  
 Apr 6th Novice update, progress on 70cm PMR gear.  
 Apr 13th Practical night.  
 Apr 20th QRP operating skills, Ron G4DDX.  
 Apr 27th Practical night, HF/VHF night on air.  
 Further details from Peter Good G7HCL, Tel. 0438 724509

**Stockport ARS** meet on the second and fourth Wednesdays each month, for details of their meeting place contact Club Secretary Jim G3KAF, Tel. 061 439 4952. Planned club events/talks;  
 Apr 28th Solar activity, J. Tottle G4SSN.  
 May 13th Introduction to packet radio, Dave Wood G4UJD.  
 May 27th Clinic evening.

**Stratford upon Avon & District RS** meet at the Home Guard Club, Main Road, Tiddington, Stratford upon Avon, at 7.30pm. Club events/talks include;  
 Apr 26th AGM.  
 May 10th Preparing for 2m DF foxhunt.  
 May 24th 2m DF foxhunt.  
 Details from A. Beasley G0CXJ, Tel. 060 882 495.



**Sudbury and District RA (SAnDRA)** meet on the first Tuesday of each month, 8.00pm, at The Five Bells Inn, Great Cornard, Sudbury, Suffolk. Forthcoming talks/events;  
 Apr 6th G4GGC compares the data modes of packet and AMTOR.  
 May 4th Natter'n'Nogging night, with raffle.  
 Further details from Colin Muddimer G0PAO, Tel. 0787 77004.

**Surrey Radio Contact Club** meet on the first Monday of each month at TS 'Terra Nova', The Waldrons, Waddon, Croydon, Surrey. Planned club talks/events;  
 Apr 5th AGM.  
 May 3rd Construction contest.  
 For further details contact Bernard Wynn G8TB, Tel. 081 660 7517

**Sutton and Cheam RS** meet on the 3rd Thursdays each month, 7.30pm for 8.00pm at Sutton United Football Club, The Borough Sports Ground, Gander Green Lane, Sutton, Surrey. Natter nights are on the first Thursday of each month, and they have a club net on Monday at 20.30 on 70.3875MHz, and Tuesday at 10.30 on 3.760MHz. Club talks;  
 Apr 15th Junk sale.  
 May 4th Visit to Didcot power station, Oxfordshire.  
 May 20th AGM.  
 For further details, Tel. 081 644 9945



**Torbay ARS** meet every Friday at the ECC Social Club, Highweek, Newton Abbot at 7.30pm. They have informal meetings most Fridays with a talk/event once a month, details as follows;  
 Apr 23th Trains 'n Things, by Peter G4VFG  
 May 21st Junk sale.  
 Further details can be obtained from Walt G3HTX, Tel. 0803 526762 or Andy G4VPM, Tel. 0803 329055



**Trowbridge and District ARC** meet at Southwick Village Hall, Southwick, Trowbridge, Wiltshire for a main meeting every 1st Wednesday of the month, and a natter night every 3rd Wednesday. Planned club events/talks;  
 Apr 7th CW operating practice and procedures, G3BPE.  
 May 5th Data mode symposium.  
 For further information please contact Ian G0GRI, Tel. 0225 864698 evenings.

**Verulam ARC** meet on the 2nd and 4th Tuesdays each month, 7.30 for 8.00pm, at the RAF Association Headquarters, New Kent Road (off Marlborough Road), St. Albans. Club diary of events/talks;  
 Apr 27th Aerial Modelling Software, by Ian White G3SEK  
 May 25th Antiques road show.  
 For further details contact Walter Craine G3PMF, Tel. 0923 262180

**Wakefield and District ARS** meet every Tuesday at 8.00pm, in the first floor rooms, Ossett Community Centre, Prospect Road, Ossett, W. Yorkshire. Club events;  
 Apr 6th The G3TDZ phasing transceiver, by G3TDZ.  
 Apr 13th Computers in amateur radio, Bob G3WWF.  
 Apr 20th AGM.  
 May 4th Construction evening.  
 May 11th Repeater logic, John G0PRF.  
 Further details from Dave Ackrill G0DJA, Tel. 0924 240577

**Widness and Runcorn ARC** meet at 8.00pm every other Tuesday evening at the Halton Scout Hut, Castle Road, Halton Castle, Runcorn, Cheshire. The club is currently running RAE and Novice courses. Planned club events;  
 Apr 13th Construction night.  
 Apr 25th Treasure hunt.  
 Apr 27th Activity night.  
 Further details from Dave Wilson G7OBW, Tel. 0270 761608

**Wimbledon and District ARS** meet on the second and last Friday of each month in St. Andrews Church Hall, Herbert Road, Wimbledon SW19. Planned club events/talks;  
 Apr 30th 'I followed Rommel', Joan Nicholls.  
 Further details available from Chris Frost G0KEB, Tel. 081 397 0427.

**Wrexham ARS** meet at Maesgwyn Road Community Centre, Wrexham (behind the Wrexham Maelor Hospital Maternity Unit). Forthcoming events/talks;  
 Apr 6th Test equipment – talk.  
 Apr 20th Quiz.  
 May 4th Talk by Whittington Astronomical Society.  
 May 18th Annual constructors contest.  
 For further details and meeting times contact D. Ian Wright GW1MVL, Tel. 0978 845858

**Yeovil ARC** meet every Thursday, at the Red Cross Centre, Grove Avenue, Yeovil, Somerset. Club events/talks;  
 Apr 8th Adjudication of constructors contest.  
 Apr 15th Video. Melbourne Radio Club 1992.  
 Apr 22nd 47th AGM.  
 Further details can be obtained from Cedric White, Tel. 0258 73845

#### National and International

**British Amateur Radio Teledata Group (BARTG)** have a quarterly magazine, hold two contests and a rally each year. The membership officer is Peter Adams, G6LZB, Tel. 0923 220774 for details of joining the BARTG, for other information the group's Secretary is Ian Brothwell G4EAN, 56 Arnot Hill Road, Arnold, Nottingham NG5 6LQ, Tel. 0602 262360, or via packet G4EAN @ GB7BAD.



**G-QRP Club** publish a quarterly magazine devoted to low power communication, and hold regular get-togethers. Their secretary is Rev. G. Dobbs, St. Aiden's Vicarage, 498 Manchester Road, Rochdale, Lancs. OL11 3HE. Tel. 0706 31812.



**International Short Wave League** who as well as running an International QSL bureau for amateurs and SWLs, have a monthly newsletter and regular get-togethers at their rally stands plus several on-air nets on HF and VHF. See their feature in the June 92 issue of HRT. For more details send an A4 sized SAE to; ISWL HQ, 10 Clyde Crescent, Wharton, Winsford, Cheshire. CW7 3LA



**The Irish Radio Transmitters Society** send out regular newsletters giving details of local activities. The society's annual dinner and AGM will be held at The Royal Hotel, Bray, on 24/25th April, and their 2m Counties Contest is on the 13th April. The contact man for this is Dave Moore EI4BZ, 12 Castle Ave, Carrigtwohill, Co Cork. Tel. (Eire) 021 883555



**ARE YOU MISSING OUT EVERY MONTH?**

Are you having trouble getting a copy of your favourite HRT magazine every month? Are you missing out on the great news, views and features that we pack in these pages? Are you losing the race to grab the new issues? Do you want to help yourself or a friend keep in touch? If the answer to any of those questions is yes then simply fill in your name and address on this coupon and hand it to your local newsagent and he will order or save a copy just for you!



Dear newsagent,

Please deliver/save me a copy of Ham Radio Today Magazine every month.

Name .....

Address .....

Ham Radio Today is available from SM Distribution

**TOP QUALITY BINDERS**

TO TREASURE YOUR COLLECTION OF



12 copies of your magazine kept in pristine condition in these classic, sturdy binders

Please supply ..... binder/s at only £6.95 each, including postage & packing (UK only, Overseas please add £1.50).

I enclose my cheque M/O for £ ..... made payable to ASP or please debit my Access/Visa ..... Expiry .....

.....

Signature .....

**PLEASE FILL IN THE FOLLOWING IN BLOCK CAPITALS:**

Name .....

Address .....

..... Post Code .....

Send this coupon and payment to: ASP HRT Binders Offers, Argus House, Boundary Way, Hemel Hempstead, Herts HP2 7ST.  
Or why not order by phone? Call us on (0442) 66551  
You may receive further information which may be of interest to you.  
Please allow 28 days for delivery

Radio Society of Great Britain are based at Lambda House, Cranbourne Road, Potters Bar, Herts. EN6 3JE, Tel. 0707 659015. They have a unique blend of full-time staff at Potters Bar coupled with many volunteer officials around the country. See their 'open day' feature in the July 92 issue of HRT.

To include your club, or rally, in this feature, make sure you send us your events details early. We only list active clubs, i.e., those who send us their diary of planned talks/events, so if they're not listed here they're obviously not very dynamic! Is your club listed - if not then either give your Secretary a boot or get some activities going! Dates to be included in the issue published on the first Friday in June must reach us by the 15th April, addressed to 'HRT Club News', P. O. Box 73, Eastleigh, Hants, SO5 5WG, or faxed to us on 0703 263429.

**Rallies**

**April 4th**

**Launceston 7th Amateur Radio Rally** will be held at Launceston College. Two large halls with bring and buy, well known traders, official Morse tests (application through usual channels), and hot snacks. Doors open 10.30am, talk-in on S22. Further details from Maggie Caldwell, Tel. 0566 777027 or Rodney and Joy, Tel. 0566 775167.

**April 18th**

**Cambridgeshire Repeater Group Amateur Radio Rally** will be held at the Philips Telecom Catering Centre, St Andrews Road, Chesterton, Cambridge. Doors open at 10.30am, trade stands, bring and buy auction, plus hot food and drinks. Further details from Mike G6COQ, Tel. 0223 358985 ext. 3310

**Lough Erne ARC 12th Annual Mobile Rally** will be held in the Killyhevin Hotel, Enniskillen, Co. Fermanagh. Talk-in on S22. Further details from Alwyn G10BFD, Tel. 0365 323802

**Marske-by-the-Sea Radio Rally** will be held in the Marske Leisure Centre, High St, Marske-by-the-Sea, near Saltburn. Doors open 11.00am, all the usual traders in attendance, plus bring and buy and refreshments. Talk-in on S22. Further details from Mic G7ION, Tel. 0287 610030

**May 2nd**

**The British Amateur Television Club Rally** will be at Harlaxton Manor, near Grantham, just off the A1 (signposted). Usual traders, bring and buy, bar and refreshments, lecture programme, talk-in, demonstrations and flea market, family venue. Further details from Paul G8MJW, Tel. 0522 703348

**May 3rd**

**Dartmoor RC Rally** (new larger venue - parking for 600 cars) Yelverton War Memorial Village Hall, Meavy Lane, Yelverton, Devon. Doors open at 10.30am, talk-in S22. Further details from Ron G7LLG, Tel. 0822 852586

**May 9th**

**The 9th Yeovil QRP Convention** will be at The Preston Centre, Monks Dale, Yeovil, Somerset. Trade stands, QRP related lectures, displays of home made QRP equipment, working vintage radio with technical commentary, on-air QRP stations using the callsign GB2LOW. Further details from G3CQR, Tel. 0935 813054

**May 16th**

**The 1993 RSGB Exhibition** at the NEC in Birmingham, a one-day event this year. Further details from Norman Miller, Tel. 0277 225563

**The Parkanaur Rally** will be held at The Silverwood Hotel, Lurgan, Co. Armagh. Doors open at 12 noon, admission £1. Plenty of parking, all usual traders, refreshments available. All proceeds of the rally will go to the Stanley Eakins Memorial Fund. Further details from W. A. Hutchman, 35 Carlingford Park, Newry, Co. Down, N. Ireland BT34 2NY

**May 30th**

**Plymouth RC Rally** at Plymstock School, Plymstock, Devon. Doors open at 10.30am, car parking, many traders, bring and buy, talk-in, raffle and refreshments. Further details from Dereck Foster G7ESZ, Tel. 0752 787181



# Free Readers Ads!

## HELPLINES

**Help wanted** to get my UHF Pye Olympic ex-PMR rig going on 70cm, will travel up to approx 30 miles radius of Scunthorpe, South Humberside. Alan Batho (Scunthorpe), Tel. 0724 845735 evenings only.

**Circuit info** for Heathkit IM2410 counter (kit) ex-Maplins. Also circuit info for Realistic PRO-2004, and info for fitting 'S' meter and other mods, expenses repaid. Please write first as I have done more common mods, i.e., speed and channel expansion. John Powell, 30 Grosvenor Rd, Bassaleg, Newport, Gwent.

**Book - free** to good home, i.e., beginner, UB40, novice or unpaid instructor; 'HF Antennas For All Locations' by Les Moxon G6XN, 1st edition, hardback, full of useful info. Chris G4HCL, Tel. 0703 262105 6.30-8.30pm Mon-Sat.

**Design help** required for a QRP HF SSB transceiver. I require a 1 to 30MHz broadband synthesizer design or kit, can someone please help. Mr. P. Cadenet G4ZOW, 22 Beeching Close, Harpenden, Herts AL5 4LZ, Tel. 0850 876292 daytime.

**Manual for Realistic DX160** wanted, purchase loan or gift, all expenses reimbursed. Dave Power (London), Tel. 081 469 2504 anytime.

**Service manuals and circuit data** wanted for Pye SG3V signal generator, and Burndept Dymar 2080 transceiver. Where can good reliable servicing be obtained for the Pye AM/FM signal generator above? Mr. Stan Green, 45 Bleakhouse Road, Oldbury, Warley, West Midlands B68 9DS, Tel. 021 422 3654

**Circuit diagram** and layout wanted for Spectrum Communications 2m to 6m transverter, will pay postage and any photocopying fees, thanks. Steve Collier (Chorley, Lancs), Tel. 0772 853683 (work).

**Wanted, have** anyone got a spare tuning film for an R210 HF receiver or does anyone know where I could obtain one, also any info on fitting the film. Might consider exchanging R210 for similar receiver. (Bedworth), Tel. 0203 315080

**Can 'Bill'** who sold me an FRV7700 please contact me, lost address, been ill in hospital, £15 I owe. John Redmond, 38

Ochilview, Devonside, Tillilcoultry, Clacks FK13 6JD, Scotland.

**Starting Off** in radios, learner, looking for old radio books, seeking help. Please send old books or leaflets or handbooks. Dermot O'Neill, 50 St. Olivers Pk, Kitsaran, Castlebelingham, Co. Lough, Ireland.

**Any Info**, circuit etc. for receiver R103A manufactured by M.R.O (no other info available). John Armstrong G4VPU, Whitley Bay, Tyne and Wear, Tel. 091 252 2304 after 7.00pm.

**Has anyone** got a service manual for a Yaesu FT-980 receiver, goes for three quarters of an hour and cuts out. M. J. Seaward, 7 St. Olafs Road, Stratton, Bude, Cornwall, EX23 9AF

## FOR SALE

**Sony CRF-320** very high standard classical digital 32 band receiver, excellent performance on SSB and broadcast bands, cost over £800, bargain £350. Grundig 650, excellent, £230. Grundig 700 new, save £100, sale £250. Panasonic RF3100 M. L. FM 1.6-30MHz digital, very good radio, £110. (Southall), tel. 081 813 9193

**AOR AR-2002** base mobile scanner, 25MHz to 1300MHz, £275 ono. (Lincoln), Tel. 0522 690732

**Two Metre** (136-175MHz) professional repeater station units, all made 1989, with N connectors, RF amplifier, 8-15W input. 13.8V DC, 45W output £15, another 90W output, £25. Duplexer cavity filters, £10; LP filter, £5. Test units here, pay cash, and collect (Egham). Tel. 0784 434947

**Trio TS-120S** HF transceiver, 100W, five bands, PS30 PSU, AT120 ATC, MC50 desk mic, GWO, boxed with manuals, £425 ono. Trio TR2500 2m FM handheld, many accessories, boxed with manual, good condition, 25W linear amp, £175 ono. G4BLT (Wakefield), Tel. 0924 25515

**AR88D Receiver** £50. CR100 receiver £25. Both good condition and with photostat manuals. Buyer collects. Eric Bettles (Southampton), Tel. 0703 466506

**PFX UHF** synthesized handheld TX/RX, converted to 70cm amateur with 90+ channels, 1.2W output, complete with aerial and nicad, ideal for Novice and better, £110 inc. 1st p/p. Tony (York),

Tel. 0904 792208 answerphone. **Isoloop 14/30MHz**, only used indoors, £150. Yaesu FP-8 PSU, unused, £50. Cordless soldering iron, £20. Welz SP-220 SWR/Power meter, £40. Palomar R-X noise bridge, 340. PF3 pocketphone with xtals for RB0, 2, 4, 11 and SU8. Alan Williams (IoW), Tel. 0983 565551 **Yaesu YC7B** digital readout for FT-7B, £50 ono. Scopex scope good condition single beam 6MHz DC small solid state, £70 ono. GODOE (Chessington), Tel. 081 391 0514, or 07842 59149

**Yaesu Transceiver** FT-211RH, perfect condition, owner CW DX person, sale of this helps to purchase later HF transceiver, offers invited, no reasonable offer ignored. Also, surplus to requirements, SMC power SWR meter, Azden external speaker. G4HGX (Keelby, Lincs), Tel. 0469 60026, or daytime 0652 652620

**Shack Sale** house move, FT-736R 2m + 70cm + Sat, £850. HF TS-450AT, as new, £950. 4m RN transverter, £145, 10mIF. FT-9600 scanner, HF video board fitted, £450. Tilt over Versatower four sections also KR rotator, 3 ele triband Jaybeam TB3MkII, £650. (Birmingham), Tel. 021 420 1837 **Matsui MR4099** RX, vgc, £45. Computer monitor 9in b/w PV901D, £40. Supra TV./monitor STV660 PAL/Secam sound 5.0-6.5 vgc, £90. Must be collector. Howard (Enfield), Tel. 081 363 3093

**BNOS Electronics** LPM50 linear amplifier, 10W in, 100W out, as new condition, in original box, still under guarantee, £135. (Solihull), Tel. 021 704 2393

**FT-757 with** FC-757 ATU and FD-757HD PSU, good condition, £750. (Plymouth), Tel. 0752 893367 between 5.00pm and 7.00pm

**Yaesu FRG-9600MkII**, 60MHz-950MHz, AM, FM, SSB receiver, mint condition, £295. Yaesu FRG-7700 100kHz-30MHz, AM, FM, SSB receiver, good condition, £225. Gary (Solihull, W. Midlands), Tel. 021 711 1553

**Hustler 5BTV** trap vertical 10, 15, 20, 40 + 80m bands, boxed, as new, can be seen working, £120 ono. Tim (New Milton, Hants), Tel. 0425 628105

**PC EPROM** programmer interface card, socket block (6), software, £45. Daiwa DK electronic keyer unit £45. Tokyo Hypower HL140 180W 2m linear, 180W out 3/10W in, perfect, £160.

Welz 3-15V metered PSU £38. Kenwood MC40S handmic (new) £19. Paul (Crawley), Tel. 0293 515201

**2m/70cm dual band** mobile, Standard C5200 transceiver, attractive modern slimline rig, hardly used, comes with dual band mobile aerial and diplexer, owner gone QRT, bargain £300 for quick sale. No offers. Ian Evans G4URC (Bristol), Tel. 0454 327429.

**PMR Radio** converted for 2m 144.500 to 145.975 FM 25kHz channel steps, fully synthesized, includes repeaters, reverse repeaters, simplex, satellites, 10W, toneburst board, bracket, microphone, £70. GODOE/GOPUR (Chessington), Tel. 081 391 0514, or 07842 59149

**Icom 271E** 2m multimode base station, excellent condition, £375. 6m SSB/CW mobile radio, excellent condition, £200. 2m linear 10W in, 60W out, £50. Peter (Telford), Tel. 0952 613080 or 0952 610764

**ERA Microreader** £85. Trio receiver JR-60, £40. Kenwood SP70 speaker, £10. Receiver ATU, £15. Apricot computer PC twin drives, monito, lots software, £200. Will exchange anything for good oscilloscope or what have you. Roger GOPYL (Nuneaton), Tel. 0203 327647.

**FT-726R VHF/UHF** all mode tribander for 2m and 70cm, as new with manual, £550. 2m linear HL-62V, £100. 70cm linear HL-36U, £100. The lot, £700. (Chesterfield), Tel. 0246 236496.

**ORO power** supply, 13.8 volts at 30 amps continuous current, £120. Duncan GM1SZH (West Lothian), Tel. 0506 56429

**Kenwood TS-940S**, including YG-455CN-1, IF10B, SP940, SM220 station monitor, AT230 ATU, and AEA PK232MBX. Everything in excellent condition. P. Leicester (Ripley, Notts), Tel. 0773 862860 **Sony PRO80**, hardly used, boxed with accessories and instructions, mint condition, £175. Dave Baldock (Suffolk), Tel. 0502 586594

**Yaesu FT-101ZD** MkIII, 9 band (WARC), fan, CW filter, AF filters, DC converter, and mic. Lightly used and immaculate, boxed with manuals and circuits, £425 ono. Rick G4BLT (Wakefield), Tel. 0924 255515

**HF QRP** Shimuzu SS105S low all mode transceiver, £175. Belcom 10ZLS RA authorised, £150. Kenwood TL-120 linear, 3.5 to

28MHz, £75. Jim G4PFR (Aylesbury), Tel. 0296 623802 evenings or weekends

**Mizuho/JIM MX-14S** 20m hand held with extra crystal, carrying case, nicads, compatible external PSU, and ZA14 end fed zepp (no ATU required). Ideal set-up for DXpedition and already been to 579, £220 ono. Robert (Kilmarnock), Tel. 0563 40048

**BBC B computer**, disc drive 40T, green screen, RTTY, Packet Eproms fitted, VGC, £170. Sam Grannon (Hull), Tel. 0482 814912

**Realistic PRO37** handheld 200 channel scanner, two weeks old and still in box with manual, £120 ono. Mr. M. Deavall (Warrington), Tel. 092575 5150

**Icom IC-2AT** 2m handheld, complete with Icom HM46 speaker mic and battery charger, £110 ono. Yaesu YS60 SWR power meter, brand new and unused, cost £95, sell for £70 ono or exchange for a mobile 2m linear. Clive Harrison (West Glam.), Tel. 0639 638339

**Amstrad 1512** 640k, 5.25 and 3.5in disk drives, colour monitor, 32 Meg hard drive, £250 ono, buyer collects. G. Pomroy (Cambridge), Tel. 0223 860667

**PK232, software**, manual, updates, leads, VGC, £230. J. Barber (Carlisle), Tel. 0228 26436

**Kenwood TM431E** 70cm mobile transceiver, little used, mint condition, standard mic, all boxed with manual and mobile fixing bracket, £225. Michael Miller (Southend), Tel. 0702 512814

**Icom IC-R100** SSB, for sale or exchange for HF receiver Trio R1000, Yaesu 8800 WHY? Wanted - manual for Trio JR310 RX. Martin Butland (Devon), Tel. 0837 87438 after 6pm.

**Yaesu FRG7700** communications receiver, £295. Kenwood Trio 9R-590, mint condition, £150. Eagle RX60, £95. R. Benham-Holman (Tiverton), Tel. 03986 215 anytime.

**286AT PC** Clone, 12MHz motherboard MS DOS V.5 small tower 200W 2 Meg fast RAM, 1 serial, 1 parallel, 2 games ports, floppies 5.25 360k, 3.5 720k, Western Digital 42 MB hard card, Panasonic EGA C/W T/S base, all excellent condition, £345 ono. John Whitfield (London area), Tel. 081 857 8096

**Rotator, Kenpro 400RC**, good condition, complete with cable, £50. Power supply 15 to 20 amp 13.8 volts, never used, only £50. Jason Eccles (Colchester), Tel. 0206 761015

**Yaesu FRG 8800** receiver, VHF converter fitted, as new condition, £480 ono. Mr. M. Clancy (Halifax), Tel. 0422 363856

**Fax-1 facsimile** and RTTY receiver terminal unit. Stands alone between receiver and printer,

excellent performer, latest version, £200 no offers. May exchange for interesting receiver. W. Johnston (Bournemouth), Tel. 0202 422273 after 6.30pm.

**Trio TH77E** 70cm and 2m handheld transceiver, hardly used, charged three times, VOX head set, mobile boot mount, quarter wave dual band aerial, soft case, complete, £250 ono. James Marston (Walsall), Tel. 0922 25770 after 6.00pm.

**Autophon PA3-1DDRF** amplifier, 2 metre, FM mode, 3-15W input, 60-100W output, 13.8V DC, has MRT224 transistors, manufactured 1989, will demonstrate, £25. Airtech MR256 6 cavity filter duplexer, £10. AFL LP filter, 0-154MHz, £5. All above have N- female connectors. Mr. R. Everson (Egham, Surrey) Tel. 0784 434947

**AR2002 communications** receiver, continuous coverage 25MHz to 1300MHz, brand new condition, boxed, instruction book, indoor aerial, outdoor aerial Welz Diamond D.130, used very little, cost new receiver and aerial £660, will sell lot for £360. Donald Wicks (Doncaster) Tel. 0302 882942

**TH6DXX HF** aerial, 3 band, good condition, also FB53 HF aerial, 3 band, plus 40/30 meter extension, serious offers please, possible delivery in local area. Mike Parker (Harrogate, N. Yorks), Tel. 0423 500600 ext. 3352 (Mon-Fri, 8.00am to 4.30pm)

**FT-290R**, new unused with muTek kit (not fitted) for front end, plus AKD wavemeter and dipole aerial with cable, £240. F. J. Latter (North Shropshire), Tel. 0691 830614

**Receiver, Racal 17L-C12** in good working order, rack mounting type, 0 to 30MHz, no manual, £90 ono. Jim GONDU (Cheltenham), Tel. 0242 224384

**ICF-SW55, unwanted** Christmas present, £200. Also Bird 43 thruline UHF VHF elements, best reasonable price accepted. IC-R1 with case, £225. Andrew Paton (Warley), Tel. 021 565 0070 after 6.45pm

**CTE BS25W** docking booster for VHF handhelds, Kenpro, Icom etc., £50. 3 amp PSU, £12. SWR meter, £15. Spectrum 48k+, £40. RAMS IV decoder program, £18. RAMS filter, £25. Modem plus Spectrum interface, £35. All good working order, postage extra. Robert Connolly (Co. Down), Tel. 06937 62166

**Decoder, Pocom AFR2010/V4** multi RTTY/CW output to monitor or printer, auto to decode on all modes, swiss made, no computer needed, Baudot, AMTOR, ASCII, FEC, ARQ, original cost £845, receive only, plugs into audio out of receiver, 12V. For sale or

exchange. Wanted - R5/R7, WHY, offers, AM updating via computer. H. Harmsworth (Scarborough), Tel. 0723 584475

**Kenwood TH-215E** 2m handheld with speaker mic, immaculate, £150 or exchange for HF FT7B or 2m synth mobile. Mike GW4WVE (Swansea), Tel. 0792 579242 evenings.

**Yaesu FT-211RH** 2m mobile with mic, £190. FT-23R 2m handheld with speaker mic, £100. FT-73R 70cm handheld with mobile bracket, £120. All with CTCSS tone boards and scanning. Also NC29 and 2m colinear. T. Parr (Derby), Tel. 0332 781069

**Racal RA17** general coverage receiver, very good condition with manual and leads, £140. Also Amstrad 1512 PC with 30Mb hard drive, floppy drive, mouse, software, and books, £150. Dave G4DWP (Reading), Tel. 0734 483486

**Kenwood TS-530SP**, as new, original box, manual, mic, and spare set of PA valves, all excellent, £500 ono. T. Hartshorn (Chesterfield), Tel. 0246 236496

**Alinco DJ-F1** miniature 2m transceiver complete with charger, spare battery, case, super rod and mic, all as new, £180. Tel. Lee (Broadstone) on 0202 697892

**Icom IC-740**, FM fitted plus SP3, £550. Heathkit SB200 linear, 1200W output, £325. FT-690 MkII, linear, vertical aerial, £365. Kenwood TH-75E 2m/70cm handheld, accessories, £265. MC85 base mic, £60. SP102 speaker, £45. G4MH minibeam, £55. All in first class condition. Patrick Chapman (Dereham, Norfolk), Tel. 0362 821125

**FT-480R** 2m multimode transceiver, good condition, new PA module fitted, 10W plus output, £250. Terry G4OXD (Hitchin), Tel. 0462 435248 after 6.00pm.

**Yaesu FT-107M** HF transceiver, 160 to 10m including WARC, built-in PSU, speech processor, memory unit, all solid state, 100W output, full Yaesu workshop manual, extension speaker, £525. Heathkit SB200 linear, 1200W PEP, recent valves, £300. Dave White (Sheffield), Tel. 0742 520177 weekdays, or 0246 414995 evenings.

**Complete course** material for RAE, this helped me to pass with two credits! £60 or any GWO radio related equipment considered in exchange. Mr. S. Gandy (N. Yorks), Tel. 0845 577526 after 5.00pm, or leave details on answerphone.

**Icom ICR-7000**, boxed, excellent condition, with instructions, £625 or exchange for transistor PA HF rig. Doug Green 2E0ADC or John

G0HQK (Telford), Tel. 0952 596147 or 0952 200280

**Yaesu FT-736** with fully modded 9600 satellite circuits fitted, full duplex, VGC, £950 ono. BV131 linear amplifier, £50. TM transmatch ATU, £45. A. B. Stanley (Appleby, Cumbria), Tel. 07683 61262

**Racal receiver** with single sideband converter, buyer collects, £185. Brian Twiby (Pontefract), Tel. 0977 617226

**Shure mic**, offers around £10. Realistic Hyproscan, 3 months old, present, boxed, £230. Old valve books with conversions 1930. Wanted - Kenwood 140S transceiver. T. Johnston (Derby), Tel. 0283 221872

**Grundig Satellite INT 500** plus 10m band, mint and boxed with booklets, 6 months old, new £350 sell for £195. Also I have three portables, £40, £25, and £25. Charles Haynes (Beccles), Tel. 0502 711880

**Racal RA17** and RA37 LF convertor in table top steel cabinet, with manuals, £200 ono. Kenwood BS5 bandscope unit for SM220, £30. Kenwood MC-35S microphone, £15. Three 6146B GE valves, one new, two used but OK, £15. Robin (Blackpool), Tel. 0253 395764

**Tequipment oscilloscope** D1011, dual channel 10MHz, £100. B/W TV camera, remote control, x 10 zoom, with homemade control box, £35 plus P&P. ARRL Handbooks 1948 and 1978, offers. E. L. Simpson G3GRX, 'Everdene', Fell Lane, Penrith, Cumbria CA118AW, Tel. 0768 64890

**Two Tektronix 547** oscilloscopes, bandwidth DC-50MHz, uses Hybrid circuitry (valve and transistor) Circa mid 1960s, with assorted plug-in units such as quad channel, spectrum analyser, 1GHz sampling units, some manuals available as well, any reasonable offer accepted. Danny Rafferty (East London), Tel. 081 471 0669

**Yupiteru MVT-6000** AM/FM scanner, mains or 12V, boxed as new, £210 ono. Datong VC-1 upconverter, 90kHz to 30MHz and 144MHz inputs, IF 28 to 30MHz, £50 ono. Maurice G0FVE (Dereham, Norfolk), Tel. 0362 696993

**Vicon model VM409** black and white monitor, VGC, £50. Centronics printer switches 2-way, £10, 3-way, £12. RS232 printer/data switch 2-way, £10. All plus postage. P. G. Lawrence (Warwick), Tel. 0926 498388

**Alinco DJ-180** 2m handheld, with charger, soft case, speaker mic, 2 dry cell cases, 13.8V DC adapter, manual, boxed as new, 4 months old, £175. Steve Zarczynski (Rotherham), Tel. 0709 378403







**FAX decoding** system for BBC printer or to disc and on screen, cost £70 new, make me an offer or WHY. R. Wassell, Tel. Nottingham 399556

**Sony CRF320** 32 band digital world band receiver, excellent condition, USB, LSB, CW, clock, and timer, cost £1000, sell for £350. Eddystone 1837/2 digital general coverage, 5 filters, excellent performance, VGC, £300. Grundig 650 International, first class receiver, £250. Exchange radio. Mr. Rai (Southall, Middx), Tel. 081 813 9193

**Radio Amateurs** correspondence course for City and Guilds, passed both parts so no longer required, cost £120, sell for £40. Rob Hatch (Blackpool), Tel. 0253 767775

**R216 receiver**, original PSU, spare homemade PSU, original leads including aerial lead, excellent condition, £150. Electronic insulation tester (Megger), as new, used twice, £70 new accept £45. Valve tester CT160, working order, complete with manual and charts, £30. Mr. J. Barnes G4DVH (Ulverston, Cumbria), Tel. 0229 54466

**Yaesu FT-767GX**, mint condition, new in 1992, boxed with manuals, auto ATU, inbuilt power supply, monitoring facility, memories etc, ability to cover 0.7, 2, and 6m (no modules included), £1125. Mr. R. Collett (Birmingham), Tel. 021 458 2596

**Yaesu FT-757GX**, excellent condition, owned from new, very little used, with fan cooled FP-707 PSU, also in excellent condition, £625 or part exchange for good FT-290 Mkl plus cash adjustment. Steve Collier (Chorley, Lancs), Tel. 0772 853683 (work), or 0257 452447 (home).

**Sony Air-7** airband, FM, AM receiver, £90. Stan Gooch

(Basingstoke), Tel. 0256 24969  
**Magnetic loop** 150 loop, 10 to 30MHz, as new, 6 months old, internal use only, boxed, ideal for restricted locations, £249. R. Burdess G4OFU (Sidcup, Kent), Tel. 081 309 5013

**Drake TR7**, PS7, RV7 remote VFO, 7077 matching microphone, extra SSB and CW filters fitted, best offers please. Kenwood TS-530S, little used, mint condition, with microphone and manual, £450. Yaesu FR-101, FL-101 separates, will transceive, £425. L. Huntley G4LW (Trowbridge, Wilts), Tel. 0225 753166

**Solartron scope** CD814, 2 to 11MHz, single beam, good working order with manual, £30. Fax telecopier RX400 with manual and paper, £20. Tony Leeming (Oxfordshire), Tel. 0608 811102 evenings and weekends.  
**Yaesu FT-708R** 70cm handheld with NC8 base charger PSU, speaker mic, spare nicad, manual, VGC, bargain £140. KW Vanguard, 10 to 160m, CW, AM transmitter, GWO, VGC, £65. Collectors item Eddystone round die cast aluminium speaker, VGC, offers. Geoff Duffin (Redditch, Worcs), Tel. 0527 546048

**Datong active** aerial AD270, 200kHz to 30MHz, up to 6dB gain, £40 ono. Philip Elwood (Lincoln), Tel. 0522 751323

**WANTED**

**Two Novices** need 70cm gear, handheld, mobile, Kenpro KT-44S perfect but anything considered (inc. ex-PMR) if within budget. Have well specified Amstrad 1512 PC to part exchange (1640 spec.) if you're interested. Any help much appreciated. Jim Izzard (Bexhill-on-Sea), Tel. 0424 731834

**Yaesu FT-707** workshop manual wanted. For sale - Yaesu FT-757 and 767 workshop manual. Mr. D. Parry, P. O. Box 32, Eastleigh, Hants SO5 5WY

**Yaesu 747**, 757, Uniden 2830, must be good condition. Also AOR-2002 base/mobile scanner, 25 to 1300MHz for sale, £250 or exchange for one of above transceivers. A. Lane (Lincoln), Tel. 0522 690732

**Service manual** for FT-980, scanner beam 100 to 130MHz, 4-way Daiwa coaxial switches, SO239 external speaker, 14 AVG vertical. Please send details to; M. J. Seaward, 7 St. Olafs Road, Stratton, Nr. Bude, Cornwall EX23 9AF

**FC-102 ATU**, must be in good condition to match my FT-102, cash waiting. Mr. P. Griffiths (Brookwood, Surrey), Tel. 0483 481358 anytime.

**AC power** supply for KW2000B in working order, price negotiable. Trev Griffiths (Swansea), Tel. 0792 643427

**Wartime Philips**, Pye receivers PCR and variants, Eddystone EC10, 870, 870A, 960, etc., for cash. Can possibly collect. Please telephone Peter Lepino (Surrey), 0374 128170 anytime, thank you.

**Yaesu FT-736**, preferably in midlands or north of England, pound notes waiting for good bargain. Tony Briggs G0JND (Buxton, Derbyshire), Tel. 0298 26800 daytime or evenings.

**E-Z Match** by SEM or KW, KW107, KW207, or KW109, cash settlement. Richard Benham-Holman (Tiverton, Devon), Tel. 03986 215 anytime.

**Heathkit HW16**, working or not. Also working Codar AT5 with 250S AC PU. Please send details of condition and price required to R. Marris, 35 Kingswood

House, Farnham Road, Slough, Berks SL2 1DA

**Mini Beam** for 10, 15, 20m, scanning beams 105 to 1300MHz, SSTV RX. M. J. Seaward, 7 St. Olafs Road, Stratton, Bude, Cornwall, EX23 9AF

**EXCHANGE**

**Alinco DJ560** dual band handheld, boxed, manual, VGC. Also 2 element triband aerial. Exchange both for HF tranceiver, TS-120, FT-707, TenTec Argosy or similar. Robert GW0MOH (Rhyl), Tel. 0745 338197 thanks.

**Drake TR7** with all filters, DR7 general coverage board, AUX7 board, NB7 noise blanker, FA7 fan, PS7 PSU, MS7 speaker, RV7 external VFO, 7077 mic, workshop manual, set edge extenders, excellent condition. Exchange for Drake R7/4 receiver, WHY. B. Pollard (Fulham), Tel. 071 736 6581

**Eddystone 990S** UHF receiver, exchange for 2m or 70cm handheld, or 12V 20A PSU. Bill Symes (Merseyside), Tel. 051 644 9897

**FT-101** transceiver and FDK-750XX 2m rig. Swop for good receiver or good coverage scanner. Ian G1WEV (Northumberland), Tel. 0670 760132 after 6pm.

**Going QRT** on VHF, hence will exchange FT-208 and FT-703, both as new with diplexer, dual band base and mobile aerials, 5-ele beam and rotator plus extras. Wanted - TS-520, KW2000 or similar. Peter (Pontefract area), Tel. 0977 620973 evenings only.

**Collins TCSRX** in good condition, internal mains PSU, classic valve RX, for realistic DX302 or Lowe SRX30 RX. (Tyne and Wear). Tel. 0207 544342 after 6.00pm

**Subscriptions and back issues:**

Argus Subscription Services,  
Ham Radio Today, Queensway House,  
2 Queensway, Redhill, Surrey  
Tel: (0737) 768611

**Subscription rates:**

UK £20.40, Europe £28.80, Sterling  
Overseas £28.90, US Dollars  
Overseas \$52. Airmail rates available  
on request. Cheques payable to ASP.

**USA Subscription Agent:**

Wise Owl Worldwide Publications,  
4314 West 238th Street,  
Torrance CA90505  
Tel: (310) 375 6258

**USA Visa/Mastercard orders:**

Phone: (213) 375-6258 Pacific  
Time: 6pm-9pm weekdays,  
10am-6pm weekends.

**Editor:**  
Sheila Lorek, G8IYA

**Consultant Technical Editor:**  
Chris Lorek BSc (Hons) AMIEE, G4HCL

**Technical Illustrator:**  
Tony Burlinson

**Creative:**  
**Design Manager:** Peter Kirby  
**Photographer:** Manny Cefai

**Advertising:**  
**Advertisement Sales:** Amanda Spray  
**Classified Sales:** Helen Taylor  
**Advertisement Copy Control:**  
Marie Quilter

**Management:**  
**Managing Director:** Terry Pattison  
**Circulation Manager:** Debra Stuppel  
**Production Manager:** Tony Dowdeswell

**Group Editor:** Stuart Cooke  
**Group Advertising Manager:**  
Claire Jenkinson

**HRT Address:**  
Ham Radio Today, ASP, Argus House, Boundary  
Way, Hemel Hempstead, Herts HP2 7ST  
Tel: 0442 66551  
Fax: 0442 66998

**Editorial Queries:**  
Tel: 0703 262105  
Fax: 0703 263429 (24 hrs)

**HRT Photocopies:**  
Photocopies of articles older than 12 months can usually be obtained. Please write to: ASP Photocopy Service, Argus House, Boundary Way, Hemel Hempstead, stating article title, HRT magazine, and issue it appeared in. The cost is £2 per article (multiple parts count as separate articles). Cheques payable to ASP.

Printed in Great Britain by  
Wiltshire Ltd, Bristol



Member of the  
Audit Bureau  
of Circulation



Ham Radio Today is normally published on the first Friday of the month preceding cover date. The contents of HRT including all articles, designs, plans and photographs and all copyright and other intellectual property rights therein belong to Argus Specialist Publications. All rights conferred by the Law of Copyright and other intellectual property rights and by virtue of international copyright conventions are specifically reserved to Argus Specialist Publications and any reproduction requires the consent of the Company ©1993 Argus Specialist Publications. All reasonable care is taken in the preparation of the magazine contents, but the publishers cannot be held legally responsible for errors. Where mistakes do occur, a correction will normally be published as soon as possible afterwards. All prices and data contained in advertisements are accepted by us in good faith as correct at the time of going to press. Neither the advertisers nor the publishers can be held responsible, however, for any variations affecting price or availability, which may occur after the publication has closed for press.



# RETAIL NETWORK

## AVON

Open Mon-Sat 9.30AM - 5.00PM  
 Bristol & Avon Independent Retailer  
**ICOM - YAESU - ALINCO - AOR**  
 Packet Radio Equipment Satellite Tracking Equipment  
 Sole Agents for DRSI Packet PC cards/L.L. Grace DSP-12  
 Junghans MSF Controlled Clocks  
 Accessories - Books - Magazines

**AMDAT** 4 Northville Road, Northville,  
 Bristol BS7 0RG  
 Tel: (0272) 699352 Fax: (0272) 236088

## BIRMINGHAM

**HEWARD'S HOME STORES LTD.**  
 (Est. 1963)  
 822/4 Kingstanding Rd., Birmingham  
 B44 9RT  
 Tel: 021-354 2083  
 G4RJM with over 41 years in The Radio Trade  
 Ham Equipment urgently wanted!  
**Open: Mon-Sat 9-6**

## CORNWALL

**SKYWAVE** CORNWALL 24hrs, 7 Days a Week  
**RADIO AMATEUR & MARINE COMMUNICATIONS SERVICES**  
 ICOM, YAESU, NAVICO JAYBEAM, Etc

SLADES ROAD, ST. AUSTELL,  
 CORNWALL PL25 4HG  
 Tel: 0726 70220  
 Voice Bank 0426 961909

## LANCASHIRE

**AMATEUR ELECTRONICS/HOLDINGS G3LLL.**  
 YAESU, JAYBEAM, DRAE, DATONG, BLACK STAR COUNTERS,  
 ETC. FT 101 EXPERTS  
 6JS6C 6146B 12BY7A Original type approved  
 valves & our own Double Balanced Mixer and  
 new band WARC Kits for original FT101 MK1-E,  
 S.A.E. List. Full Yaesu range. 15 mins Junction  
 31 M6. Free parking. Call and consult G3LLL  
 without obligation. Holidays? Phone, check we  
 are open before calling. Lunch 12-1.30pm.  
 45 JOHNSON STREET, BLACKBURN BB2 1EF.  
 (0254) 59595. CLOSED THURSDAY.

## HAMPSHIRE

**SMC**  
 The Communicators

**South Midlands Communications Ltd**  
 S. M. HOUSE, SCHOOL CLOSE, CHANDLERS FORD, INDUSTRIAL ESTATE.  
 EASTLEIGH, HAMPSHIRE SO5 3BY. TELEPHONE: [+44] (0)703 255111  
 FAX: [+44] (0)703 263507 SMC FX TELEX: 477351 SMCMM G

**THE OFFICIAL UK YAESU IMPORTER**  
 OFFICIAL DISTRIBUTORS FOR: COMET • DAIWA • TERELEADER • TOKYO • HY POWER • HOKUSHIN

## LONDON

**ARE COMMUNICATIONS**  
 TEL 081 997 4476

- ★ Well stocked with YAESU, ICOM, KENWOOD, STANDARD, AOR ETC.
- ★ We buy and sell secondhand equipment
- ★ Equipment servicing available
- ★ Friendly and helpful staff!

6 Royal Parade, Hangar Lane, Ealing,  
 London W5A 1ET  
 Mon-Fri: 9am-6pm Sat: 9am-3pm

## N. HUMBERSIDE

**HEATHERLITE MICROPHONES**  
 75 ST. CATHERINES DRIVE, LECONFIELD, NORTH  
 HUMBERSIDE HU17 7NY

**HANDS FREE MICROPHONES**  
 Selection of hands free microphones and control  
 boxes manufactured to suit individual operators and  
 transmitters.  
 (Amateur, CB, Coach, truck phone taxis etc.)  
 Telephone 0964 550577 for further information

## OXFORDSHIRE

**SERVICE MANUALS**  
 Available for Most Equipment  
 TV, Video, PMR, Military, Amateur, Test  
 etc. Any Age, Make or Model.  
 Write or Phone for Quotation.  
**MAURITRON (HRT)**  
 8 Cherry Tree Road, Chinnor,  
 Oxon, OX9 4QY  
 Tel:- (0844) 51694. Fax:- (0844) 52554.

## WEST SUSSEX

**BREDHURST ELECTRONICS LTD.**  
 HIGH ST., HANDCROSS,  
 WEST SUSSEX.  
 TEL: (0444) 400786  
 FAX: (0444) 400604

Situated at the Southern end of M23. Easy access to M25  
 and South London. Open Mon-Fri. 9am-5.30pm,  
 Sat. 9.30am-4pm.

ICOM KENWOOD YAESU  
 MAIL ORDER RETAIL

## TYNE & WEAR

**SUPERTECH**  
 Communication Specialists

YUPITERU AOR PAMA SONY.

- ★ Official Nevada and Kernow Stockists
- ★ Full range of CB's, Scanners and Accessories in stock.
- ★ Branches throughout the North East
- ★ Mail order available

32 Russell Way, Gateshead Metro  
 Centre, Tyne & Wear, NE11 9YZ  
 Open: Mon-Fri 10am-8pm Sat 9am-7pm  
 Thurs late night 10am-9pm  
 Tel: (091) 4932316  
 Near the UCI Cinema)

MAIL ORDER AVAILABLE

## YORKSHIRE

**AVIATION ENTHUSIASTS AVIATORS — LISTENERS**  
 AIR TRAFFIC CONTROLLERS — on hand to help 'Guide' you towards an  
 interesting & rewarding pastime.  
 AIR BAND RADIOS — SCANNERS etc. Over 20 to choose from: AERIALS &  
 ACCESSORIES, MAPS — BOOKS, CHARTS, CAA PUBLICATIONS:  
 POSTCARDS, MODELS, TIE PINS & BADGES, AIRBAND TRANSCEIVERS:  
 PHOTOS; PILOTS' PRODUCTS

Information pack only 50p.

 **AIR SUPPLY**  
 83b High Street, Yeading,  
 Leeds LS19 7TA. Tel: 0532 509581  
 Opening times: 10.00am - 1.00pm and 2.00pm - 5.30pm  
 Shop just two minutes from Leeds Bradford Airport. (Closed Wednesday & Sunday)

## SCOTLAND

**JAYCEE ELECTRONICS LTD**  
 20 Woodside Way Glenrothes  
 Fife KY7 5DF  
 Tel: 0592 756962 (Day or Night)

Open: Tuesday-Friday 9-5; Saturday 9-4  
 Good range Kenwood, Yaesu & Icom etc,  
 plus quality secondhand equipment

## SOUTH WALES

**ELECTRO MART**  
 Receivers, Scanners, Howes, ERA, CB, Marine  
 radio etc. part exchange welcome  
**FULL SERVICE AND REPAIR  
 FACILITIES**  
 96 High St, Clydach, Swansea  
 Tel: 0792 842135

## NORTH WALES

**T.M.P COMMUNICATIONS**  
 UNIT 27, PINFOLD INDUSTRIAL ESTATE  
 PINFOLD LANE, BUCKLEY, CLWYD  
 NORTH WALES 0244 549563

ICOM YAESU

KENWOOD, ALINCO, STANDARD, DIAMOND,  
 REVEX, JAYBEAM, AOR, LOWE, etc

AMATEUR • MARINE • AIR • PMR • SWL  
 SCANNERS etc

Large stock of secondhand equipment in stock  
 (changing daily) equipment also wanted

OPEN THROUGH THE WEEK 11am-7pm  
 except Tuesdays and Sundays





TEL 081 997 4476  
 FAX 081 991 2565



# ARE COMMUNICATIONS '92



**FT890/AT**



**FT990  
 FT990/DC**



**FT1000**



**TS450S**



**TS850S**



**TS950SDX**

These are what can only be described as the 6 most popular HF transceivers at present. They have everything you require or not require whatever the case may be. Phone us now and we will tell you why as well as the all-important question – *No prizes for guessing.*



**TH78E**



**ICW21E/ICW2E**



**FT530**



**DJ580E**

Just look at the choice that is open to you, they all do the same we hear you say. Not true, there is one which has just that bit extra, which one will it be for you?



**TM732E**



**FT5100**



**IC3230**



**TM741E**

Yet again all four of these mobiles are packed with features from 2m, 70cm, 6m in one rig, remote head facility, wideband receive, dual receive, auto repeater, AM facility. It just goes on and on.



**FT26/76**



**DJF1/F4**



**TH28/48**



**P2E/4E**

If a dual band hand held is not for you then just take a look at these 2m and 70cm handies. From the basic FT26 to the sophisticated TH28E. The thing is all of these hand helds are good, it's just a question of your taste.

## Rich Man Poor Man



**NRD535G**

Why bother with any other shortwave receivers, these are the only two that fit the bill. The basic FRG100 which is winning awards left right and centre for performance and price and the NRD535G which can only be the best for the most serious listener.



**FRG100**

**After Hours  
 0836 550899**

Don't forget, we want your good secondhand equipment.

**ARE COMMUNICATIONS '92**  
 6 Royal Parade, Hanger Lane, Ealing, London W5A 1ET  
 Easy parking at the rear of the shop. Part exchange and equipment purchases welcomed! Credit facilities available subject to status APR from 37.8%. Located next to Hanger Lane tube station (Central Line) and on the junction of the A406 and A40.  
 Open Monday – Friday 9:30 – 5:30 Saturday 9:30 – 3:00  
**Don't delay phone or fax today!**  
 Tel: 081 997 4476  
 Fax: 081 991 2565

# YAESU

UK Sole Distributor  
South Midlands Communications Ltd, S.M. House,  
School Close, Chandlers Ford Industrial Estate,  
Eastleigh, Hants SO5 3BY.  
Tel: (0703) 255111.

# Top of the Range

To be a truly world-class competitor, you have to have a truly world-class rig. And it's here now. The versatile FT-1000 from Yaesu.

The FT-1000 will blow away your competition with a spectacular combination of power and operation flexibility. There will be no contest.

Just superb performance...yours and your FT-1000



## FT-1000 HF All-Mode Transceiver

- ✓ **Direct Digital Synthesis (DDS):**  
Two ten-bit DDS plus three eight-bit DDS
- ✓ **High RF Power Output:**  
Up to 200 Watts.
- ✓ **Dual Receiver:**  
Two tuning knobs.
- ✓ **Automatic Antenna Tuner:**  
Built-in with 39 memories.
- ✓ **Built-In Vox.**
- ✓ **100 Memories:**  
Independent ATU and mode/IF Filter memory.
- ✓ **CW Audio Peaking Filter:**  
Additional selectivity on CW for weak signal work.
- ✓ **CW Spot:**  
Provides audible tone for alignment.
- ✓ **High Dynamic Range:**  
108dB (Typical).
- ✓ **Multimode Selection on Packet/RTTY:**  
Switchable FSK tone, RTTY shift and CW pitch.
- ✓ **Front Panel RX Antenna Selection:**  
Allows quick switching.
- ✓ **Digital Voice Storage:**  
Option provides instant playback.
- ✓ **BPF-1 Module Option:**  
Allows crossband dual receive.

### SPECIFICATIONS:

Receiver Range:	100kHz-30MHz.
Transmit Range:	160-10 Meters.
Power Output:	Adjustable Up To 200 Watts (50 Watts AM Carrier).
Emission Types:	LSB/USB (J3E), CW (A1A), FSK (J1D/J2D), AM (A3E), FM (F3E).
Antenna Impedance:	16.5-150 Ohms Nominal.
Power Consumption:	95 VA (Receiver). 1050 VA (Transmit).
Sensitivity:	SSB/CW <math>-0.25V</math> For 10dB S/N, 1.8-30MHz..
Dynamic Range (Typical):	108dB @ 500Hz BW, (Preamp off).
Maximum Audio Power Output:	2 Watts Into 4 Ohms with <math><10\%</math> THD.
Audio Output Impedance:	4-8 Ohms.
Weight:	56.2 lbs. Standard Version:

*Performance without compromise*