

RAADIO

TODAY

**HF DXing from
your back garden –
Work 100 countries
on all bands
80-10m like
G3ZPF**

**Boost your 70cm
handheld with our
IOW PA**

**The Mystery of the
Missing G7 Call Signs**

**Long
Distances
From Small Spaces**

REVIEWS REVIEWS REVIEWS REVIEWS
We scrutinise the Yaesu FRG9600
VHF/UHF scanning receiver
and the Timestep weather
satellite reception system



**Win a unique Welz
PEP/RMS/VSWR power meter
Details inside...**

Amcomm of London

CALL NOW FOR THE LATEST PRICES

2 YEAR GUARANTEE on MANY PRODUCTS

01-422 9585 FOR FAST DELIVERY

Why own a 1st Class Radio with a 2nd Class Sound? May we suggest an answer?



Now for the first time, a new ingenious compact sound system allows you to hear weak signals like never before, sort out the rare ones and listen to quality like you have never heard from your receiver, hand talkie or scanner. Usually, accessory speakers are no more than 50 pence speakers in fifty pound boxes. Their efficiency, frequency response and distortion levels are minimal and since most of all of the new transceivers have less than one watt of audio, our ability to understand becomes very difficult.



The new SS-2 Heil Sound System contains two five watt amplifiers, a 3.5" woofer with a half pound magnet a 1.5" tweeter with a 12 dB per octave passive crossover network. The tweeter is crossed over at 1500 hz, right where the response of the human ear starts to fall off and the huge woofer fills out the mid-range and low frequency response. No single cheap speaker can begin to give you this type of response.



The second five watt amplifier can be used to drive a second speaker enclosure and will be used in a dual diversity system using the Heil parametric equalization system which will be introduced very soon.

When most receivers are running at a comfortable listening level, their little one half watt amplifiers are being pushed into extreme distortion levels. The extended response, the added efficiency and additional output power of the SS2 will lower your noise floor, reduce noise and allow you to copy signals that formerly were impossible to hear.

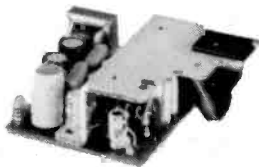

Mobile optional with the new Heil Sound System is unbelievable. The 5 watts of output and the tweeter system really adds to the articulation factor making signals so much easier to copy. The system makes Hand Held receivers come alive!

The SS-2 measures 3 3/4" x 5" x 3 3/4". It weighs 2 lbs. and is housed in a high impact silver beige case. Power requirements are 12-13.8 volts D.C. at 400 M.A. A red L.E.D. is mounted on the front panel for power up indication. All input/output connections to the amplifier is made through a 5 pin DIN plug.

You can own this great new addition to your station for only £65.00 inclusive of VAT and carriage. We suggest that you hurry as there is probably someone calling you right now that your present speaker isn't truly reproducing. Discover the world of high quality audio today!

SS-2 Sound System £65.00

THE MICROPHONE HEIL HM-5

Radio amateurs have historically used microphones designed for something else: industrial paging, public address, tape recording, etc. "Matching" microphones for new equipment usually means it's the same colour as the radio! None of these microphones has the correct response we so desperately need for maximum speech articulation. The engineers at Heil, Ltd., went far beyond traditional mic design. They spent thousands of hours analyzing complex SSB voice patterns... allowing them to determine precisely what was really necessary for your communications microphones. The results are enhanced intelligibility, maximum articulation and clean, natural audio for the signal that will always be "on top".

The HM-5 uses the famous Heil HC-3 "Key Element" mounted in a quality goose neck which is set into a steel die cast base - not plastic like most of the industrial paging mics. A large push-to-talk bar with locking switch allows for smooth P.T.T. operation. The cartridge is connected straight through, so that proper vox operation is possible without the necessity for any external switching.

The HM-5 is a stunning addition to any station and it will be the answer to getting those signals "on top". The HM-5 is the preferred microphone for many leading contest and DX stations.

Sensitivity: -70 DB
Response: 300 HZ - 4,000 HZ.
With a very defined rise at 2100 HZ.

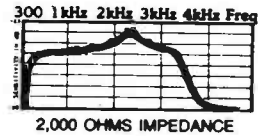

The element works very well into a 600 ohm load, but it may need a matching transformer when using high impedance outputs.
Polar Pattern: Cardioid pattern forward.

HC-3 Key Element £22.95 inc VAT & P&P
HM-5 Microphone £59.95 inc VAT & P&P

LOOK! BEAT THE PILE UP WITH NO HANDS AND THE HEIL BM10

A NEW and UNIQUE NO HANDS Headset/Boom Microphone weighing in at a super light 8oz.

The Heil BM10 is a VERY SPECIAL unit designed to a specification from some of the WORLD'S LEADING contest and DX operators.

The microphone *element is the SPECTACULAR Heil HC4 with a specially TAILORED RESPONSE to help you push through the pile up. The headpieces are soft, comfortable and have a high "CLOSE OUT" of external noises. The whole unit is HIGHLY VERSATILE allowing removal or adjustment of the headpieces or microphone to suit the OPERATOR'S NEEDS yet it remains ROBUST enough to meet the RIGOROUS demands of PROLONGED use.

The Heil BM10 CAN DO MUCH FOR YOU, TRY IT, HANDS OFF STYLE, RELAX, SIT RIGHT BACK, CUT THROUGH THE PILE UP AND WATCH YOUR CONTEST SCORE SOAR.



PRICE HEIL BM10 £65:00 inc VAT & Carr.

*Adaptor required for Icom equipment.

Goods will be despatched by return



Amcomm

SERVICES LTD., 194 NORTHOLT ROAD, SOUTH HARROW, MIDDX.
HA2 0EN, ENGLAND. (Opp. South Harrow Underground Station)

TEL: 01-422 9585. TELEX: 24263



HAM RADIO CONTENTS

TODAY

VOLUME THREE NO. 10 OCTOBER 1985

Consultant Editor
Steve Ireland, G3ZZD
Editor
Dave Bradshaw, G1HRT
Assistant Editor
Julie Darby, G1CKF
Advertisement Manager
Dave Gadsden, G4NXV
Classified Sales Executive
Caroline Faulkner
Publishing Director
Peter Welham

 Design by

MM DESIGN

Published by:

Argus Specialist Publications Ltd.,
1, Golden Square,
London W1R 3AB.
Telephone: 01-437 0626

Distributed by:

SM Distribution Ltd.

Printed by:

The Garden City Press Ltd.

Subscription Rate

UK £17.00

O/Seas Sur: £18.50

USA Sur: \$25.00

O/Seas Air: £33.50

Ham Radio Today,

Subscriptions Dept,

Infonet Ltd,

Times House,

179 The Marlowes,

Hemel Hempstead,

Herts HP1 1BB

Tel: (0442) 48432



Ham Radio Today is normally published on the first Friday in the month preceding cover date. The contents of this publication including all articles, designs, plans, drawings and programs and all copyright and other intellectual property rights therein belong to Argus Specialist Publications Limited. All rights conferred by the Law of Copyright and other intellectual property rights and by virtue of international copyright conventions are specifically reserved to Argus Specialist Publications Limited and any reproduction requires the prior written consent of the Company. © 1985 Argus Specialist Publications Ltd. All reasonable care is taken in the preparation of the magazine contents, but the publishers cannot be held legally responsible for errors. Where mistakes do occur, a correction will normally be published as soon as possible afterwards. All prices and data contained in advertisements are accepted by us in good faith as correct at time of going to press. Neither the advertisers nor the publishers can be held responsible, however, for any variation affecting price or availability which may occur after the publication has closed for press.

REGULAR COLUMNS

LETTERS.....	6
RADIO TODAY.....	10
RADIO TOMORROW.....	24
MICRO' NET.....	28
STOP PRESS.....	58

CONSTRUCTION

10W POWER AMPLIFIER FOR 70cm HANDHELDS.....	14
---	----

Increase your output power with this Cirkit design.

PROJECT OMEGA ALL MODE TRANSCEIVER.....	38
---	----

Finishing off the accessory PCB, G3WPO and G4JST add a couple of mods.

FEATURES

MYSTERY OF THE MISSING G7s.....	18
---------------------------------	----

Andy Emmerson, G8PTH, goes in search of G7 and G9 callsigns.

HF DXing FROM SMALL SPACES.....	44
---------------------------------	----

Have a small garden or live in a flat? David Reynolds, G3ZPF, offers a variety of antenna ideas and a glimmer of hope...

REVIEWS

WEATHER SATELLITE PICTURES.....	20
---------------------------------	----

Ken Michaelson, G3RDG, reviews the Timestep Electronics system.

REVIEW: FRG9600.....	33
----------------------	----

Yaesu's latest receiver is put through its paces by Tony Bailey.

COMPETITION - WIN A WELZ POWER METER!.....	8
--	---

NEXT MONTH IN HRT.....	42
------------------------	----

FREE READERS ADS.....	52
-----------------------	----

Sorry it's a bit short this month.

CLASSIFIED.....	54
-----------------	----

EMPORIUM GUIDE.....	56
---------------------	----

ADVERTISEMENT INDEX.....	58
--------------------------	----

We have had to hold over this month's Metrewave but hope to run it next month.

Thanet Electronics

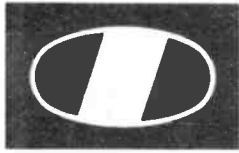

ICOM

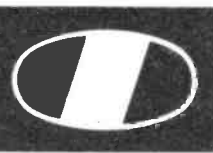

ICOM

IC-735, The Complete HF Radio



This new HF transceiver from ICOM is compact enough to make mobile or portable use a possibility. The IC-735 covers all Amateur frequencies from 1.8MHz to 30MHz including the three new bands 10, 18 and 24MHz. Modes include SSB, CW, AM and FM, all circuits are solid-state and output is approximately 100 watts.

Tuning ranges from 100kHz to 30MHz, made continuous by using a high-side IF and a CPU control system. RTTY operation is also possible. Dynamic range is 105dB with a 70.451 MHz first IF circuit. The direct feed mixer rejects spurious response and gives higher sensitivity and wider dynamic range. Pass-band tuning and a sharp IF notch filter provide clear reception even under duress. Preamp is 10dB and attenuator 20dB.

The new IC-735 from ICOM is easy to operate and versatile, it has various scanning functions, comprehensive LCD and 12 memories. Computer remote control is possible via the RS-232C jack.

Options include: the AT-150 automatic antenna tuner and shown here the PS-55 AC power supply and SM-8 desk mic.

Please contact Thanet Electronics or your local ICOM dealer for even more information on this latest HF transceiver – the IC-735.



IC-290D/290E Mobile



290D is the state of the art 2 meter mobile, it has 5 memories and VFO's to store your favourite repeaters and a priority channel to check your most important frequency automatically. Programmable offsets are included for odd repeater splits, tuning is 5KHz or 1KHz.

The squelch on SSB silently scans for signals, while 2 VFO's with equalising capability mark your signal frequency with the touch of a button. Other features include: RIT, 1 KHz or 100Hz tuning/CW sidetone, AGC slow or fast in SSB and CW, Noise blanker to suppress pulse type noises on SSB/CW.

You can scan the whole band between VFO's/scan memories and VFO's. Adjustable scan rate 144 to 146 MHz, remote tuning with IC-HM10 and HM11 microphones. Digital frequency display, Hi/Low power switch. Optional Nicad battery system allows retention of memory.

Thanet ICOM Thanet ICOM Thanet ICOM Thanet ICOM Thanet ICOM Thanet ICOM Thanet ICOM Thanet ICOM

Electronics

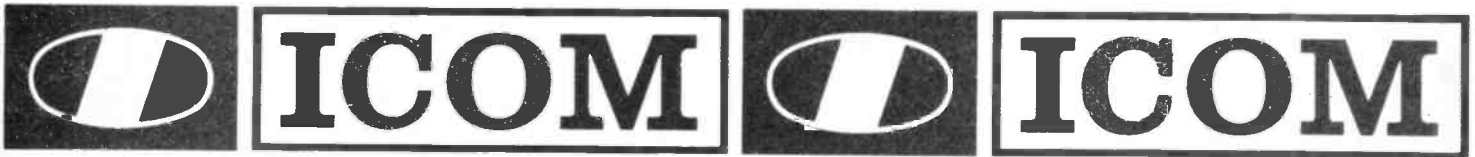

IC-02E, IC-04E Handheld

The direct entry microprocessor controlled IC-02E is a 2 meter handheld, features include: scanning, 10 memories, duplex offset storage in memory and odd offsets also stored in memory. Internal Lithium battery backup and repeater tone are included. Keyboard entry is made through the 16 button pad allowing easy access to frequencies, duplex, memories, memory scan and priority.

The IC-02E has an LCD readout indicating frequency, memory channel, signal strength, transmitter output and scanning functions.

HS-10 Headset also available, with earphone and boom microphone, which operates with either of the following: - HS 10-SB Switch box with pre-amplifier giving biased toggle on, off and continuous transmit. HS 10-SA Voice operated switch box, with pre-amplifier, mic gain, vox gain and delay. The IC-2E and 4E continue to be available.



IC-27E Mobile

You can get what you want just by picking up the telephone. Our mail-order dept. offers you: free, same-day despatch whenever possible, instant credit, interest-free H.P., telephone Barclaycard and Access facility and a 24 hour answering service.

Please note that we have a retail branch at 95, Mortimer Street, Herne Bay, Kent. Tel: 369464. Give it a visit, BCNU.



This must be the smallest, 2M, FM mobile available today, measuring only 38mm H x 144mm W x 177mm D. It has all the features that you probably require included in this microprocessor controlled unit. In addition, if you feel lonely and can't find anybody on the band, just press "speech" and the optional built in speech synthesizer will tell you the frequency you are tuned to. This is a boon to the blind operator or to those that tuck their rigs out of sight.

Brief features: - 25/1 Watt output, green LED readout, scanning (memories and programmable limit band scan), priority scan, programmable duplex splits, 25 and 5Khz tuning steps, 10 memory channels with lithium back up cell, normal and reverse repeater switch, dual VFO, internal speaker and optional speech synthesizer. Just ask for a leaflet and we'll be glad to send you one.

Authorised ICOM dealers in the UK

Alyntronics, Newcastle, 0632-761002.
Amateur Radio Exchange, London (Ealing), 01-992 5765.
Amcomm, London (S. Harrow), 01-422 9585.
A.R.E. Comms. Earlstown, Merseyside, 0952-29881.
Arrow Electronics Ltd., Chelmsford, Essex, 0245-381673/26.
Beamrite, Cardiff, 0222-486884.
Booth Holding (Bath) Ltd., Bristol, 02217-2402.
Bredhurst Electronics Ltd., W. Sussex, 0444-400786.
Dressler (UK) Ltd., London (Leyton), 01-558 0854.
D.W. Electronics, Widnes, Cheshire, 051-420 2559.
Hobbytronics, Knutsford, Cheshire, 0565-4040. Until 10pm daily.
Photo Acoustics Ltd., Buckinghamshire, 0908-610625.
Radcomm Electronics, Co. Cork, Ireland, 01035321-632725.
Radio Shack Ltd., London NW6, 01-624 7174.
Ray Withers Comms. Warley, West Midlands, 021-421 8201.
Scotcomms, Edinburgh, 031-657 2430.
Tyrone Amateur Electronics, Co. Tyrone, N. Ireland, 0662-2043.
Reg Ward & Co. Ltd., S.W. England, 0279-34918.
Waters & Stanton Electronics, Hockley, Essex, 0702-206835.

Listed here are authorised dealers who can demonstrate ICOM equipment all year round. This list covers most areas of the U.K., but if you have difficulty finding a dealer near you, contact Thanet Electronics and we will be able to help you.

**STOP PRESS» Contact us regarding
50MHz equipment for new issued band!**

Thanet ICOM
Thanet ICOM
Thanet ICOM
Thanet ICOM
Thanet ICOM
Thanet ICOM
Thanet ICOM
Thanet ICOM
Thanet ICOM
Thanet ICOM
Thanet Electronics
Dept H.R., Herne Bay, Kent.
Tel: (0227) 363859

LETTERS

RIGHT OF REPLY

Sir, In your July issue you published a feature on "Correspondence Courses — can they help you pass the RAE?" I am not sure whether your reviewer, Sharon Metcalfe, saw our whole course when conducting her review, but her comments appear to concentrate on one of the four booklets in the course and thereby give your readers a misleading impression of the overall course.

She says, "There appear to be four short lines on FM" and while this is certainly the case in the booklet she was looking at she has overlooked the fact that in the next booklet there are some six pages on the principles of frequency modulation. Similarly, she mentions there is nothing on superhet principles and again there are in fact three pages on this in the booklet that deals with FM.

It is very much a matter of opinion how much material to include in a course for the RAE. Certainly valves are not included in the City & Guilds syllabus, but many radio amateurs would argue that knowledge of valves is still essential and for this reason it appears in our course. More emphasis is in fact given to transistors in the third booklet in the course and most of the diagrams in this particular booklet deal with transistors rather than valves. Another important point that Sharon Metcalfe has not mentioned is that we provide two introductory booklets, one for maths and one for physics covering the basic principles required in these subjects by those studying for the examination.

Whilst accepting that our course could be open to criticism in that the tests do not give enough practice on multiple choice questions it is not in fact correct as your reviewer states that "even the final revision papers are of the old style RAE exam". Our final booklet in the course comprises a multiple choice test of 100 questions to give students practice in this format.

Finally, may I say that over the last few years we have had many hundreds of successful students for the RAE who have been very satisfied with our course and the tutorial service that we provide. Currently we are preparing a revised course to cover

the new City & Guilds syllabus and this will be available from October of this year. This will be tailored more strictly to the syllabus and as a consequence will feature tests in the multiple choice format only and will have very much reduced emphasis on valves. I would be happy to send you a copy of this new course as soon as it is available so that you may review it.

Andrew Young BA FCA
Principal, Rapid Results College

Firstly, we must point out that we did initially request the lessons on semiconductor theory and on radio receivers: if we were not sent the parts dealing with these topics, we cannot really be blamed for jumping to conclusions! That said, we still feel that most of our (we hope, constructive) criticisms of the lessons we saw are still applicable. We look forward to receiving the revised courses and we will be pleased to look them over and publish our comments in these pages.

'OPEN SOCIETY' — FOR . . .

Sir, I read the letter from G3ZHI with interest and feel that a more detailed explanation is called for. I agree that Ian Abel should join but the Council will not let him. A very serious situation has developed within the RSGB. The Society is now dominated by a few members of the Council. All attempts to get any changes made within the Society are blocked by every means available. The election of the 1985 President has been done in a very questionable manner and the reports of the Council meetings severely edited to hide this.

At the 1984 AGM I proposed a vote of no confidence in the General Manager and the Council. I did this because of the very questionable way in which the 1985 President was elected. Despite repeated attempts to get this matter discussed under any other business the President refused to allow any discussion at all. This was in clear contravention of the various Companies Acts and the normal practice at meetings. After the meeting was suspended in uproar, the

General Manager agreed that the situation was unsatisfactory and he agreed to look into the matter and publish guidance to members as to how items could be raised. He agreed to publish this in the April or May Radcom. The solicitors were consulted and a report made to Council at their January meeting. Nothing further has been published. The minutes will not be published until October in an attempt to prevent any motions being put in time for the 1985 AGM. This is typical of the underhanded way in which the Society's affairs are conducted.

If one investigates further it is easy to see that most of the Society's sub committees are dominated by a small number of Council members who force their views on the membership as a whole. Also note who is on the editorial board. A proposal will soon be put to members that the President be elected for three years instead of one. No doubt this will be forced through by hundreds of proxy votes held by the members of Council. The time has come when the Society must be made much more open and allow an infusion of new committee and Council members to revitalise the Society before it is too late. If you are in favour of an open Society then I suggest that you start taking the lid off it!

P L Crosland, G6 JNS.

. . . AND AGAINST

Sir, I would like to make comments about Ian Abel's letter "Open Society", (HRT, August '85). As a long time member of the RSGB, I have received the monthly journal in its many forms over the years from when it was the 'Bull' up to the present 'Rad Com' and I have always thought that the Society gave a good balance of contents in each issue. If the complete details of Council minutes and meetings were to be published, each journal would be full of nothing else, leaving little room for other articles. It is common practice nowadays, is it not, to publish a synopsis of whatever goes on at such meetings. I for one am sufficiently satisfied with the Society's support and aims and ambitions without wishing to know so

much about what goes on behind closed doors, after all, it's what matters in the end, the conclusion is what really matters and affects us.

I cannot help but notice that whenever Ian Abel's letters appear in any of the magazines or journals, they have a distinct apathetic and completely anti-establishment air about them. I think he delights in trying to 'nit-pick' at any likely snippet of potentially harmful publicity and revels in blowing it up out of all proportions to fan the flames of his own contorted views. His comments about the membership of the RSGB falling — so what if they are? Why should he be bothered? He isn't even a member, and I for one think he doesn't deserve ever to become one again. I really suspect that support for his ill fated Amateur Radio Novice Licence Campaign is falling much more rapidly.

As a footnote, I notice that he has even tried to take some of the credit for the draft proposal sent by the RSGB Council to the DTI on the subject of an Intermediate Amateur Licence. My own thoughts are that if everyone ignores Ian Abel, as well they should he might just go away.

John Smith

Sir, I was interested to read in the

letter from Ian Abel (August issue) that RSGB membership is falling. I say this because in his report for the financial year ending on 30th June 1984, the Society's Secretary stated that there had been an increase of 6.73% compared with 5.13% during the previous year, and also that this increase was more than maintained during the first few months of the current financial year.

Since the figures for the current year ending in two day's time will not be published until nearer the end of the year, many of us would like to know what grounds Mr Abel has for making such a remark. Has he some 'inside information' concerning some sudden reversal of fortune? Is he suggesting that the Society deliberately issues false figures, or is this just another case of "empty vessels"?

I trust that your correspondent and also the RSGB will be asked for their further comments.

Denis O'Neill.

The above letters on the 'Open Society' question were all received before the September edition of HRT was published, with the Opinion piece 'RSGB — an Open Society' from Geoff Smith, G4AJJ. As a magazine, we do

not yet have enough undisputed evidence to come to our own opinion on this topic, so we see our role as to give room to all sides of opinion.

CHEERS 'N' PERRIER?

Sir, Further to D B Slack's letter in the August issue of HRT. May I suggest that the first step in divorcing radio from alcohol should be the phasing out of "Cheers 'n' Beers"! I'm TT, and most of my friends have learned to wish me "Cheers 'n' Perrier" already.

Paul Thompson, G6 MEN.

Sir, What a shame Mr Slack, G3GFE, is missing out on the good, clean, booze-free Radio Club meetings that are around. If only he were to look further than the fantasies in his over active imagination, he could well find the majority of clubs are tee-total. I am a lady operator whose club meets in a school classroom and serves only tea and coffee or hot chocolate to young and old alike.

Mrs C J Critchley, G1 GUN.

No 'hic!' response needed!

Please address correspondence to:
Ham Radio Today,
1 Golden Square,
LONDON W1R 3AB.

WATERS & STANTON ELECTRONICS

WELZ PUT "PEP" INTO VSWR METERS



SP220(S)	1.8-200 MHz	2/20/200w	£59.00
SP420(S)	140-525 MHz	4/20/200w	£69.00
SP122(S)	1.8-60 MHz	20/200/2kw	£79.00
SP225(D)	1.8-180 MHz	5/15/150w	£99.00
SP425(D)	140-525 MHz	5/15/150w	£99.00

S = single meter D = dual meter

For a long time it's been impossible for the amateur to measure his pep output without recourse to an oscilloscope which is not the cheapest of items these days. This means that most SSB operators can never be sure exactly what power their rigs are generating. In these days of high technology rigs, that seems somewhat tropical. Welz have changed all that. Their new range of meters will read either RMS or PEP and yet the prices are incredibly cheap. The pep circuitry requires an external 12v DC supply and this also powers LED's and the back lighted meters. A rather nice touch is the removable sensor at the rear so that the meter may be used several feet from the coaxial line. A VSWR is really a once only purchase so don't accept second best when for a very reasonable figure you can have the best.

SECONDHAND SAVER

It's getting pretty well known that we carry good stocks of second-hand equipment for the radio amateur. Very often equipment is no more than a year old and all items are thoroughly tested and realigned where necessary. We also give a 3 month warranty on these items so you really stand a chance of making a big saving without the risk of buying privately. We don't publish lists of secondhand items because our stocks are forever changing. However if you want to check on our latest bargains then give Mark G1NFU a call on the telephone on (0702) 204965 and he'll tell you all the latest goodies he has got.

Main agents for all leading amateur equipment



Serving amateurs and listeners from London and the East of England

It really is amazing how many people invest large amounts of money in purchasing a sophisticated transceiver and then use a low grade microphone with it. Let's be honest, the microphones supplied with most rigs are O.K. but they are really not capable of doing full justice to the transceivers. Experienced operators know this and they will have probably invested money in a purpose-designed microphone. Today's all purpose microphone is the Adonis AM303 and 503. Superbly built the quality of these microphones will make you proud to be on the air. They will match any impedance (without any change in frequency response) and have adjustable output levels. They also have switched responses for SSB & FM. The smooth touch ptt and latching controls make operating a joy and there are up/down frequency control buttons for rigs fitted with this facility. The AM503 has the addition of a switchable audio compressor that gives that little bit of extra punch when required. Finally, if you have more than one rig you can purchase additional plug-in mic. leads that make for instant changeover from one rig to another.

CAN YOU BE PROUD OF ... YOUR SIGNAL?

ADONIS

"The microphone that makes your signal head and shoulders above the rest."

AM303G £39.95

AM503G £52.95



UK LISTENERS

Just published this new frequency list is a must for the serious short wave listener. It provides a comprehensive list of stations throughout the HF spectrum including Aircraft, Shipping, Military, Embassy, etc. Details of models ie SSB, CW, RTTY, etc are given together with call signs. In addition a complete list of the worlds major short wave broadcast sections are given together with frequencies and time.s Much other information is also given and it really is a bargain. We are offering limited quantities at an offer price of £4.95 + 50p p&p. So don't miss out. Send today.

£1000 instant credit
Details upon request



18/20 Main Rd, Hockley, Essex.
Tel: (0702) 206835-204965

12 North St, Hornchurch, Essex.
Tel: (04024) 44765

MON-SAT 9-5. E/C WEDNESDAY

COMPETITION

Win a Welz RF Power Meter



Whether you are QRO or QRP, an accurate SWR/power meter is a necessity. In this month's competition, we have two of the latest devices from Welz, as marketed by Waters and Stanton of Hockley, Essex. The SP420 retails at £69 and the SP220 at £59. The prizes measure PEP as well as SWR and RMS power — so you can be sure of your SSB output whilst transmitting!

What do you know about RF power measurement!

- If a CW transmitter is measured by an RF ammeter and found to be putting 0.5A into a 50 ohm dummy load, what is the mean output power?
(a) 12.5W (b) 25W (c) 50W
- What is the maximum power recognised as QRP by the G-QRP Club?
(d) 5W (e) 8W (f) 10W
- On what technical development is the operation of an SWR meter based?
(g) Absorption wavemeter (h) Wobbulator (i) Wheatstone bridge
- If 62.5W produces an S7 signal report, what will reducing power down to 1W give, if the receiving station's 'S' meter is accurate?
(j) S2 (k) S3 (l) S4
- Under what conditions will an RF ammeter enable the calculation of true power in a transmission line?
(m) under any conditions (n) when the line is correctly matched
(o) when the line is terminated
- When using a two-tone test signal into an SSB transmitter, 400W PEP is equivalent to a mean RF power of how much?
(p) 150W (q) 200W (r) 230W

<p>Welz SP220 and SP420 features:</p> <ul style="list-style-type: none"> ★ cover 1.8 to 200MHz and 140 to 525MHz respectively with a flat frequency response. ★ scale is selectable from 2, 20 or 200W for the 220 	<p>and 4, 20 or 200 for the 420.</p> <ul style="list-style-type: none"> ★ remote RF sensor enables meter to be positioned for maximum operator convenience. ★ 12V DC operation with illuminated meter.
--	--

Complete fully and carefully. If you are the winner, this will act as a label for your prize. Post to Waters and Stanton Meter Competition, Ham Radio Today, No. 1 Golden Square, LONDON W1R 3AB. Closing date: first post, 1st October, 1985. Don't forget to follow the advice in the How To Enter section, including writing your choice of the answers on the back of the envelope!

How To Enter

Look at the questions nearby which are intended to test your knowledge of RF power measurement. Each question has a number of possible answers. Choose which you think are the correct answers and write them in sequence on the coupon below. For example, if you think the answer to question 1 is B and question 2 is D, your sequence will begin B, D...

IMPORTANT: write your choice of the order on the back of your envelope in addition to the coupon. Send your entry to Waters and Stanton Meter Competition, Ham Radio Today, No. 1 Golden Square, LONDON W1R 3AB. Closing date is first post on 1st October, '85.

Complete the coupon fully and clearly — if you are the winner, this will be used as a label. All correct entries will be placed in the HRT competition hat box and the winning entry drawn by the lovely (?) Julie. You may enter as many times as you like, but each entry must be on an official coupon — not a copy — and sealed in a separate envelope.

The Rules

Entries will not be accepted from employees of Argus Specialist Publications, Waters and Stanton Electronics Ltd. or Garden City Press. This restriction also applies to employees' families and agents of the companies. The 'How To Enter' section forms part of the rules. We will try to ensure the two prize winners receive their stated preference of model.

Name

Address

post code

Your choice of question answers ie B, D, N etc.

Please tick the box for the model you would prefer.

SP220

SP420

R WITHERS

584 HAGLEY ROAD WEST, OLDBURY,
QUINTON, B68 0BS BIRMINGHAM.

M5
JUNCT
3



BIRMINGHAM
MAJOR INDEPENDENT
SERVING THE UK

JUST LOOK AT THESE

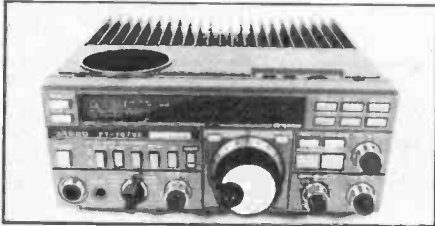

FT757GX £739.00

Including FREE Raycom mod board unit that eliminates 'tune glitch' and increases tuning speed. Value £39.50. Fully Fitted and tested.

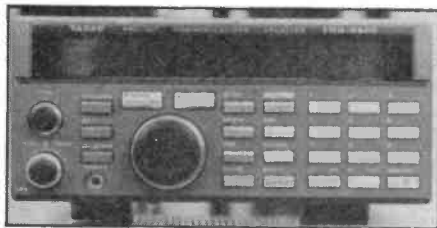

FRG 9600 UHF/VHF RX. £449.00

Includes FREE Airband frequency list.



**FT203R
FT703R**
2mtr or 70cms
hand held.

**FT203R £192.00
FT703R £238.00**
includes battery
pack.

**FT209R
FT709R**
keyboard entry
hand held

**FT209R £242
FT709R £262**
Includes
battery pack

**FT2700RH
2mtr/70cms
MOBILE
£489.00**

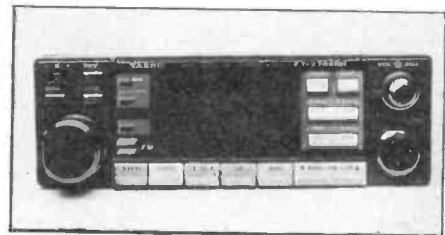

Includes FREE SE $\frac{7}{8}$ antenna with gutter mount/cable assembly.

**FT290R
PORTABLE
2mtr multimode
£315.00**



or choose any one of these packages
290+ PSU 0-15v. 3A. **£335**
290+ Linear amp V35L **£372.50**
290+ nicade/charger **£335.00**

**FREE TRAVELLING JIM ANTENNA WITH ALL
2m/70cms rigs, worth over £6.00**

WE OFFER THE AMATEUR THAT LITTLE XTRA VALUE FOR HIS/HER MONEY

NEW PRODUCTS EXCLUSIVE TO R.W.C.

RAYCOM MODULAR RF AMPLIFIERS

A complete range of linear and fm amplifiers for use with VHF hand portables and multimode portables such as the YAESU FT290R. Power output from 15W to 45W depending on model. (eight are available). All units feature Mitsubishi or Toshiba power modules as used in the majority of mobile and base radio transceivers. Two versions are also available for business radio applications.

PRICE from £39.50 for the 15W vhf model + £2.00 post



VHF UNITS (144-149MHz)	ORDER CODE	PRICE
45 FM/CW	V45F	£62.30
35 FM/CW/SSB/AM	V35L	£59.50
25 FM/CW	V25F	£48.50
15 FM/CW/SSB/AM	V15L	£49.50
15 FM/CW	V15F	£39.50

Raycom Limited

A.R.M. MULTI P6 ANTENNA
Probably the most versatile
Antenna ever designed

PRICE £39.25
+ £2.50 carriage

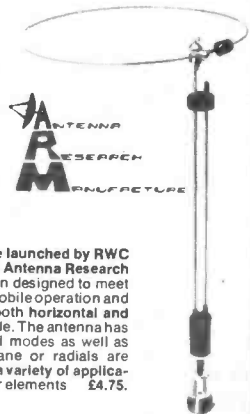

This is one of the most exciting new products to be launched by RWC and is the result of many months of development by Antenna Research Manufacture based in Devon. The antenna has been designed to meet the growing popularity in multimode portable and mobile operation and is capable of being used on both vhf and uhf in both horizontal and vertical polarization modes, both portable and mobile. The antenna has the facility of being used as both omni-directional modes as well as having capability of DF function. No ground-plane or radials are required and the antenna can therefore be used in a variety of applications on frequencies between 140-450 mhz. Colinear elements £4.75.
* SEE THE REVIEWS * or SAE LEAFLETS

**£1000.00 instant credit available
for licensed amateurs. Details upon
request. Call now!**

We also sell and service Cellular Radio, and PMR (Business) radio equipment.

Tel: 021 421 8201 (24hr answerphone)

Telex: 334303 G TXAGWM



HP/PERSONAL
LOANS AVAILABLE
(written details upon request)
RWC CREDITCARD

RADIO TODAY

The WINNER of our competition for a Dewsbury Electronics Starmaster key is Peter Robinson of Cambridge, whose choice was A, F, G, L, O, S. Congratulations!

Straight Key Evening - The Results

Were you on 80m CW on 30th May? If not, you missed out on an evening of spring madness using the oldest implement in the history of wireless telegraphy.

GB4HRT was there with an FT101E running at 100W into a 30m long wire from the QTH of the Milton Keynes DARS. Many thanks to the club for their superb hospitality. Various members of the club could be heard using the call to give a rather weary G3ZZD a rest. GB4HRT had been on the air all day on 80m and 2m and the strain was beginning to tell, not least on the quality of his CW. The station key, a GW Morse key, was put into good use until 2230 when we had to close down.

The event was an unqualified success with some stations going strong till well after



midnight. All ages were represented with superb CW coming from both ends of the call-sign spectrum - G4WLG and G6TQ were G3MCK's votes for the best fist. Also given honourable mention by G3MCK, who used a valve crystal oscillator/power amplifier transmitter at 35W, was Julia, G4UOW.

QRP was well represented by Les, G3UI, and Brian, GM4XQJ, both using 3W, the former with a Project Omega transceiver. Equipment was a mixture of homebrewed and commercial, the contacts made by GB4HRT being about 60/40 in favour of the

latter.

As regards the activity level, the only way GB4HRT could have worked all the stations calling would have been to descend to contest style operation, a sentiment shared by others including SKE supreme and originator G3SJE of the Edware DARS.

Many thanks to all those who took part and I have the pleasure of rewarding the GW Morse key to G3EFR, the station with the most best 'fist' mentions in participating stations letters. See you next year?

G3ZZD

Lundy DXpedition

As part of their tenth anniversary, members of Newport ARS, GW4EZW, will be visiting Lundy Island in the Bristol Channel from 21st to 28th September. 13 operators will be going and will be on all bands 160m to 70cm. They hope to be on the air throughout the period so as to obtain as many awards as possible. WAB contacts are particularly welcome as five operators are members. DX-CC and 4-2-70 awards will also be attempted.

The callsign to listen out for is GB4LIE — Lundy Island Expedition — and the equipment to be used for HF is an FT77, FT707, TS520S, for 2m an FT480 plus a linear and an Icom 290H and for 70cm an FT790 and a linear. A 60 foot tower is being transported by boat for the HF beams.

Skeds and any other information can be arranged and obtained before their departure, via PO box 33, Gwent, or telephone (02912) 6867. Special QSL cards will be available through the RSGB bureau or direct to the PO box.

This may be one of the last opportunities for working Lundy Island as the helicopter service is being discontinued from the end of September. After then, the only means of getting across to the island will be via the boats.

● The Civil Service ARS intend operating two special event stations under the callsign GBOCSR on 7th and 8th September. The first day will be from the Central Ordnance Depot, Chilwell, and on Sunday from the Civil Service Sports Ground in Nottingham. The station will be operating on HF 80 to 10m and hopefully 2m.

The CEPT Common Licence

As revealed in last month's HRT, an agreement has been reached between fourteen of the CEPT member countries on a common amateur radio licence. Although administrative details have not been finalised, what this will mean in practice is that reciprocal licences will become a thing of the past: your ordinary amateur radio licence will be valid in any of the participating countries.

There will be two classes of international licence, Class 1 and Class 2. Class 1 will correspond to the UK Class A licence and Class 2 to the VHF-only

licence (UK Class B). Intermediate licence holders will be restricted to Class 2 privileges when operating outside their own country. When operating in another country which belongs to the agreement, the format of your call sign will be country prefix/home call (eg OE/G4IJF or F/G1HRT). However, the agreement will apply to mobile and portable operation only, but that the definition of portable will include operation from temporary premises as well as from a temporary location.

Hans Berg, DJ6TJ, International Liaison Officer of the DARC, estimates that it will take about twelve months for the final details to be worked out, as there is still

considerable paperwork to be completed between the various national administrations. It is also not quite clear at this stage as to what form the actual licence will take, and whether the participating countries will issue amateur radio licences in a common format or not. If not, then we will need to have some kind of 'International Amateur Radio Licence Document', possibly issued by the IARU member societies.

This historic agreement is a landmark in amateur radio, and reflects the considerable effort put in by Dr John Allaway, G3FKM, and his co-workers in IARU Region 1, and they deserve our warmest congratulations at their achievement.



New Linears From BNOS

Following the recent announcement of a six meter allocation for amateurs in the UK, BNOS have introduced a new six meter power amplifier. Capable of running

a 100 watts for 10 watts drive, this new unit is available priced at £172.50.

Also from the BNOS stable, and recently introduced, is a new four meter power amplifier. Like its six meter partner, the amplifier runs 100 watts and costs £172.50.

Permanent Flea Market

We all get enjoyment rummaging through the flea market stalls at exhibitions and rallies, for that surplus equipment, components and bits and pieces and digging up the odd bargain. Well, Ray Withers of R Withers Communications has just opened up new premises a couple of doors away from the Birmingham emporium with

just that in mind. Called Technical Surplus, the shop will provide the best of both worlds for the amateur/constructor.

If you want further details of what is on offer, contact Ray at Technical Surplus on 021 421 8201 and the shop can be found at 576 Hagley Road West, Quinton, Warley.

New Book For The RAE

A new book called Towards the RAE has just been published which claims to fully meet the requirements of the City and Guilds Institute new syllabus. The author, Mr J Bowyer, G4KGS, has summarised all the basic material and relevant theory in 26 topics. There are worked calculations throughout and a series of graded multiple choice items which are answered with the worked solutions and explanations — something many prospective RAE candidates have complained about in the past. The book claims to take the student to examination standard and in some cases beyond as "a valuable boost to confidence".

The book is published by Stam Press of Amersham and costs £3.95. Further information can be obtained from Stam Press 02403 28595.

Paying For Interference?

Mr Geoffrey Pattie, Minister of Information Technology, stated in Parliament on 26th July that more resources will be devoted to dealing with pollution of the radio spectrum by those who operate without licences and those who abuse their licence conditions. This statement is the first tangible result of a review of the Radio Interference Service's functions and procedures, commissioned by the DTI soon after taking responsibility for the service.

In the past much of the work of the RIS has been devoted to the eradication of interference to domestic broadcast reception but this

is now to take a back seat. More resources will be spent on a 'policing' role. With intermediate effect, anyone requiring the services of the RIS for the purposes of TVI investigation will be required to pay a £21 call out fee before receiving a visit. Visits will not be made to those who have not fitted an external aerial or who have not completed a log of the interference. As from 1/1/87, these reports will need to be combined with a written report from a dealer stating that he has been unable to effect a remedy.

The current minimum standard for TV immunity,

BS905, is to become legally enforceable and from 1st Jan '88, the RIS will deal with reception problems only if the set meets this standard. All business and service users are to be charged a 'commercial rate' for the RIS' services except where these relate to the RIS enforcement role. Finally, as a means of helping the public to diagnose the cause of domestic interference the DTI proposes to publish a comprehensive booklet. This booklet, which is expected to be available from Post Offices will also contain a technical section for TV dealers. The RIS will organise training sessions to the trade on TV and radio reception problems if there is sufficient demand.

Where On Earth Part 2

Following on from last month's article, Martin Atherton would like to clarify the situation with regard to Mount Athos in Greece. It is still possible to operate from

Greece if you have a Greek licence. But the Council of Abbots, the governing body on Mount Athos are refusing to issue any more visas to radio amateurs wishing to set up a station.

It may be that individual Abbots may give special permission

though whether the documentation will be acceptable for the various awards is unknown.

Finally, W9KNI was mentioned as having a QSO with a Clipperton Island DXpedition. Apparently, this was unfortunately just a good tale!

Satellite Decoding With Astrid

Astrid, which actually stands for Automatic Satellite Telemetry Receiver and Information Decoder, is a complete and ready to use satellite receiving system with a built in decoder. It receives signals from the UoSAT satellites and with the aid of software

available from AMSAT-UK, displays it on a home computer monitor. The data Astrid receives is automatically recorded onto a standard cassette tape recorder. Astrid costs £144 complete and is available from MM Microwave Ltd, Satellite Group, Thornton Road Industrial Estate, Pickering, N Yorkshire (phone 0751 75455).



● The recently redesigned Meteosat system is now available from the Liverpool factory of Microwave Modules. Delivery is quoted as being within 28 days and the complete installation is priced at £1,738.00 excluding

VAT and delivery. We have been advised by the factory that if correct crystals are plugged into the receiver many of the weather satellites, including the NOAA series and the Russian satellites can be received on this system.

Ham Radio Convention, Friedrichshafen

Most people have heard about the Dayton Hamvention, the largest radio convention in the world. Europe's largest convention, however, is hardly ever mentioned in Britain, despite the fact that it is a truly international event attracting visitors and exhibitors from all over Europe and even some visitors from other continents. It is much more accessible than faraway Dayton, and is almost as easy to get to as is the NEC, for those of us who live outside the West Midlands.

The convention, which takes place in Friedrichshafen is officially known as *Ham Radio*, though it is universally referred to simply as Friedrichshafen. (The picturesque town of Friedrichshafen is in Southern Germany not as stated in last month's Stop Press.) Ham Radio is organised by the German national society, DARC, and radio amateurs from all over Europe, and even further afield, attend



what is the highlight of the European amateur radio calendar. During the three days of the 1985 convention 34 different country prefixes were spotted on the callsign badges of the visitors, which is a good way towards 'eyeball' DXCC!

There were representatives of most of the IARU Region 1 Societies, including RSGB president Joan Heathershaw, G4CHH. Dr. John Allaway, G3FKM, IARU Region 1 Secretary, said that he had been to every Ham Radio since the first, ten years ago, and that he had every intention of continuing to go every year.

The convention itself is much more than a radio rally with a few lectures thrown in. It is a weekend packed with events and activities. There

are, of course, the normal trade stands, where prices of new gear are much lower than UK prices, and the dealers more than happy to talk about special export deals. There are also stands set up by special interest groups, such as DARC committees. This included a large YL stand, paid for by the DARC, where coffee was dispensed to all and sundry. The radio regulatory authorities (Post Offices) of Germany, Austria, and Switzerland also had stands where reciprocal licences were issued on the spot and free of charge. The Austrian official who issued mine remarked that he hoped that they wouldn't have to be attending next year, due to the introduction of the CEPT licence.

The stands take up one of

the three halls, plus the foyer of the lecture hall. The second hall is taken up by a giant flea-market where anyone may grab a table free of charge and sell unwanted equipment or junk. The other hall is converted to provide youth-hostel type accommodation for students and young people visiting the convention. Other facilities include a temporary camping and caravan site and free crèche for children under 7. There is a full programme of talks and lectures, plus all sorts of fun activities and entertainment, such as competitions, DF hunts, and a hamfeast or party on the Saturday night, which is open to all holders of 3 day tickets. It's not surprising, therefore, that the majority of visitors come for the entire weekend, and make a family holiday of it.

Next year's Friedrichshafen Convention takes place between July 4th and 6th, and if there is enough interest National Travel will be organising an all-in package specially for the convention. For further details write to PO Box 49, Colchester, CO4 3SF.

HF Enthusiasts Big Day!

The RSGB HF Convention will take place on Sunday 29th September at the Belfry Hotel on the A40 just outside of Oxford. The entry fee is £2 and the doors open at 10am.

There will be lectures on subjects as diverse as planning permission, QRP operation, propagation, the sunspot cycle, ATUs, contesting and DXpeditions. The organisers have also arranged for forums, displays, stands and a 'testing' booth plus a car boot sale. Morse tests can be taken at the convention by arrange-

ment with Gavin Williams at the BTI radio station, Worston Lane, Highbridge, TA9 3JY. A talk-in station run by Mid Thames RAYNET will operate on 160m, 10m FM, 4 and 2m and 70cm.

● Gavin Williams will also be going round several of the rallies and conventions providing morse test facilities at Telford on the 8th Sept. Blackwood – the Welsh National Convention – on the 6th Oct. and at the Leicester show on 25th and 26th Oct. Please apply to him at the above address beforehand and all enquiries should be directed to him.

No Pain in The Arras

Members of West of Scotland ARS have just finished converting a former curtain factory into new clubrooms. The curtain is due to be raised (groan) formally on the club rooms on Friday 20th September (8pm) by RSGB President Joan Heathershaw.

The new club rooms include a sizeable meeting hall, a shack equipped for HF and VHF, a room for morse classes and construction work, a lounge, kitchen and cloakrooms. All of this makes the new place at 154 Ingram Street far more congenial

than the old club rooms in Robertson Street.

West of Scotland ARS welcomes all new members and meets every Friday at 7.30pm and has a fortnightly lecture programme starting in September. Ian McGarvie, GM4JDU, can provide further information on 050 581 2708.

R.S.G.B. MEMBER? Can You Answer These Questions?

Whilst visiting the recently held Scarborough rally, G1CKF met Geoff Smith, G4AJJ, who wrote the Opinion in last month's HRT. During an interesting conversation, she was provided with a leaflet part of which is shown above. Apparently,

this leaflet is being distributed around the country "in the best interests of amateur radio". The rally, itself, was a well attended affair in the delightful surroundings of the Spa and the Ass Ed was relieved to see that the bar closed at 2pm (hic).

Did You Know...

● 6000 notices of variation have been issued so far for the Class 'B' morse code experiment.

● In the first quarter of 1985, 242 people were convicted of illicitly using wireless telegraphy apparatus. The total for last year (1984) was 1281 which was a reduction of 225 from the previous year.

So You Want To Study For The RAE II

Paddington College, London W2 are offering an RAE course with something special. It covers the RAE syllabus and enables students to carry out practical experiments in the electrical engineering department. However, no previous knowledge is expected and the college has an active club station (G4UWU) run by the course tutors, G4KKM and G6MFR. The course is run two evenings a week and starts 24th Sept. Enrolment is 9/10/11th Sept 1-4pm and 6-8pm. More details are available from David Peace on 01-402 6221 ext 54.

Reddish Vale Evening Centre, Reddish Road, Stockport have an evening RAE course on Mondays from 7 till 9pm designed to prepare students for the May 1986 exam, although facilities are available for taking it in December. The centre is also running a morse code class on Thursdays (7-9pm) for two terms. Enrolment is 16/17/19th Sept. from 7pm. Phone

the centre on 061 477 3544 during school hours if you have any enquiries.

NE Hants Adult Education Institute are starting an RAE course at Wavell School, Lynchford Road, Farnborough on Thursday 26th Sept. For details of enrolment, telephone 0252 518305 or 0252 540084.

Amateur radio classes aiming for both December and May exams are being offered at **Barr Beacon Community School**, Old Hall Lane, Aldridge, Walsall. Enrol on Thursday 5th Sept. at 6.30pm, and if you are interested in forming a club for amateur radio enthusiasts, there will be a meeting after enrolment. The 12 week course starts on 12th at 7pm and the course fees are £10.20 with reductions for the unemployed etc. Further details can be obtained from the Community Director on 021 325 0466 or the course tutor, Frank on Aldridge 52706.

The Islington Institute is

again running an RAE class on Mondays between 6.30 and 9.30pm; also starting on 16th Sept. Enrolment commences one week earlier. The course lecturer is Brian Bond, G3ZKE. For more details telephone 01-485 7065.

Three courses are being run at the **Bradford and Ilkley Community College** in Great Horton Road, Bradford. The first course is a preparation for the RAE, the second for the morse test and the third is entitled 'Construction for the Radio Amateur' and is project based. Enrolment starts on 10th Sept.

Kingston College of Further Education are hoping to run an evening class for the RAE, subject to sufficient attendance. The course will run on Mondays between 7 and 9pm, starting on the 16th. The fee is £24 and you can enrol on 9/10th Sept. between 6.30 and 8.30pm. Further information may be obtained from Mr Harris at KCFE in Kingston Hall Road, Kingston upon Thames or Dave Chambers, G4SYT, QTHR.

De Havilland College,

Elstree Way, Borehamwood are running a course to be taught by Mr Benbow, G3HB, on Tuesdays between 7 and 9pm. The class starts on 17th Sept. and enrolment is the 9/10th between 2 and 8pm. Contact the college on 01-953 6024 for more details.

Stamford College of Further Education have an RAE course to start in Sept. at Stamford. Details can be obtained from the college or the course tutor, Mr Parker on 0778 425224.

Both parts of the RAE will be taught on Wednesday and Thursday evenings, 6.30-9.30pm at **Grantham College of Further Education**, Stonebridge Road, Grantham and more details can be obtained from the college.

De Beauvoir Evening Institute, London N1 have an RAE class starting 25th Sept. The lecturer will again be Tom Clark, G4BZW, who had a 100% pass rate in 1984 and was hoping for equal success in the 1985 results. Enrolment is the week previous and Tom can be contacted on 01-249 1843 for more information.

THE LEICESTER AMATEUR RADIO SHOW COMMITTEE

EXTEND AN INVITATION TO
THE NATIONAL

AMATEUR RADIO AND ELECTRONICS EXHIBITION

AT THE
**GRANBY HALLS,
LEICESTER**

ON FRIDAY AND SATURDAY
OCTOBER 25th-26th 1985

10.00a.m. — 6.00 p.m.

ENQUIRIES TO FRANK G4PDZ: (0533-553293)

B
R
I
N
G
A
N
D
B
U
Y

S
T
A
R
R
A
F
F
L
E

10W Power Amplifier for 70cm Handhelds

The current generation of UHF handheld synthesised transceivers have almost all the facilities found in mobile/base rigs; the only major limitation being their output power. For handheld operation 1W or so is adequate, but for mobile to mobile and for use with higher power repeaters, the additional power provided by this amplifier increases the range considerably. This is especially noticeable when on the edge of a repeater's service area.

Want to improve the output of your 70cm handheld? Then try this 10W PA design from Cirkit.

This 70cm power amp will boost the output power of your handheld transceiver up to 12W. It has automatic relay switching between the transmitter and receiver which is provided by the RF sense circuitry. The box provides sufficient heat sinking whilst retaining its small but tough look.

Circuit Description

The amplifier is provided by Q1 which is biased for class C operation, so that the transistor takes zero current with no signal – the

applied drive providing the base bias. Class C operation is inherently non linear, which means that doubling the applied drive power will not necessarily double the output power. Also, the output will be zero until sufficient drive has been applied to supply the base-emitter bias. For CW or FM this does not present major problems and, in fact, provides higher efficiency. With a single frequency drive signal, the only spurious signals generated are harmonics and these are readily suppressed in the matching networks and output filter. The amplifier takes a lower DC supply current for a given power output and therefore runs cooler as less power is being dissipated in the heatsink.

The input is matched to Q1 by the network comprising C1, C2,

Z1, C3, C4. The output from the collector is matched to 50R by Z2, C5 and C6. DC power is supplied via the collector choke, L2. This is decoupled by C12, 13 and 14 and the RC network, C15 and R4. L3 is present for further supply filtering. A two section low pass filter is formed by C6, C7, C8, Z3 and Z4. The cut off frequency of this filter is approximately 490MHz. The stripline inductors Z1, Z2, Z3 and Z4 are printed tracks on the PCB.

The switching circuit operates by applying some RF, via C18, to the voltage doubler, D1, D2, C9, C10. The base current to Q2 is limited by R1 which, in conjunction with C11, smooths the transients (ie the spikes) which are present during switching. The relay current is switched by Q3. D4 provides some reverse polarity protection.

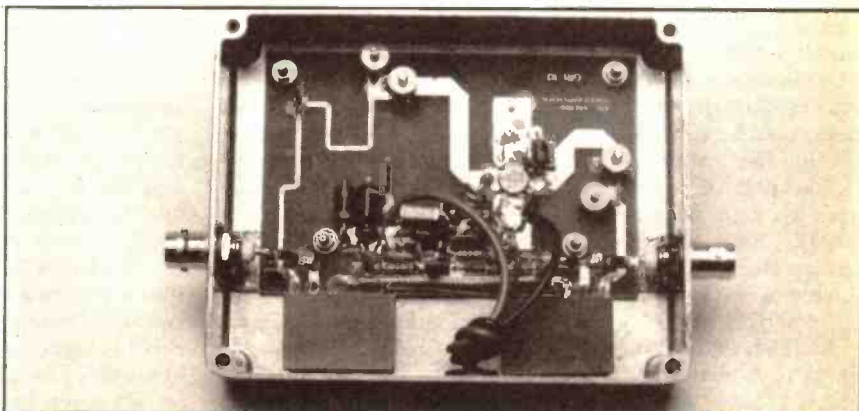
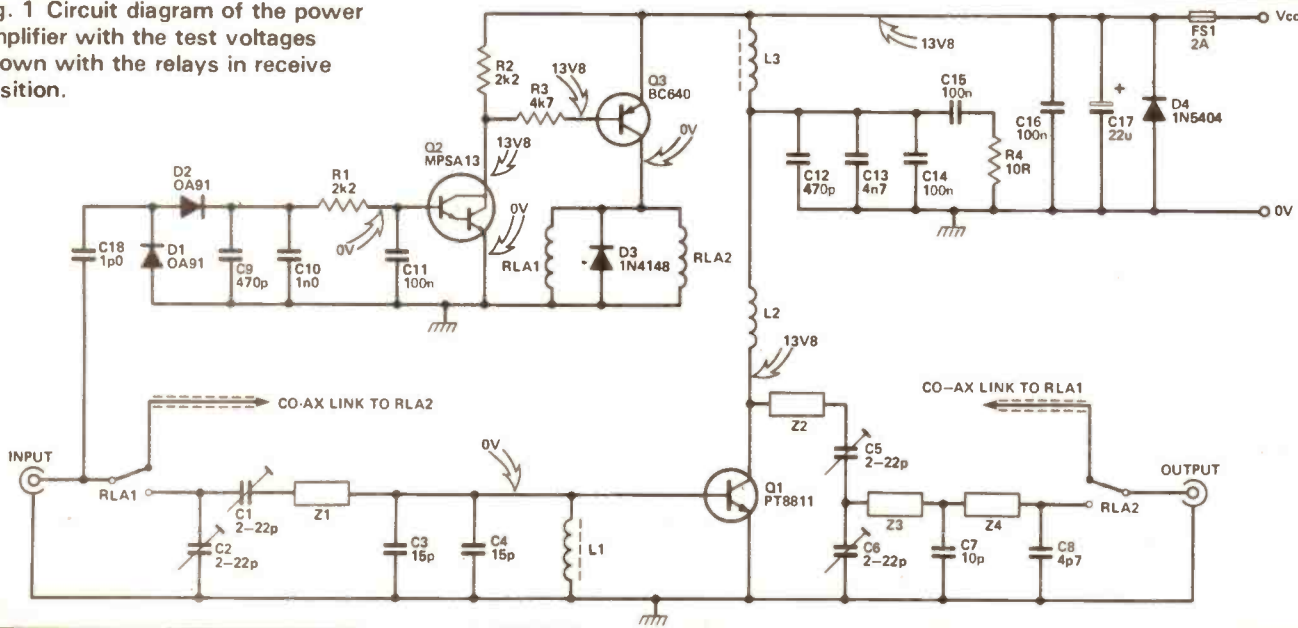

Fig. 1 Circuit diagram of the power amplifier with the test voltages shown with the relays in receive position.



Construction

A double sided PCB is used to provide good electrical stability and simplicity of construction. Components that require an earth connection (which are not connected to the emitter pads) are soldered to the earth plane in the underside of the PCB. Components that are connected to the track have their leads soldered directly to the top of the PCB, as illustrated in Fig. 2. As in

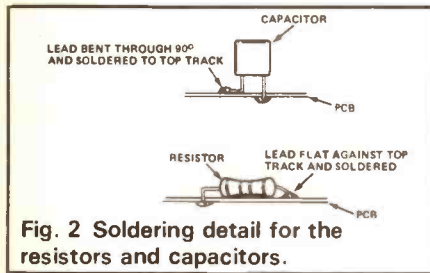

Fig. 2 Soldering detail for the resistors and capacitors.

all RF circuits it is important to keep all component leads as short as possible; lay resistors directly on the board, keep capacitor leads to a minimum and mount transistors Q2 and Q3 with lead lengths 3-4 mm.

The suggested order of construction is as follows:

1. Fit and solder the through board links around the emitter leads. Form two pieces of brass strip around the PCB inside the transistor hole to connect the emitter leads of Q1 to earth see Fig. 3. Solder these to the PCB making certain that they are not likely to raise the emitter leads.

2. Wind L1 and L3 and solder in position.

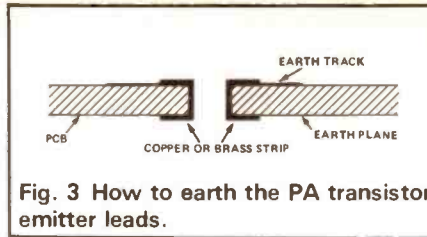

Fig. 3 How to earth the PA transistor emitter leads.

3. Fit the other components with the exception of Q1, RL1, RL2, C3, C4, L2 and the coax link, taking note of the orientation of the transistors, diodes and C17.

4. Cut the coax to the dimensions shown in Fig. 4 and fit to the PCB.
5. Cut two pieces of brass strip approximately 1.5 x 3 cm and solder about 5 mm to the underside of the board by the input and output points.

6. Insert the PCB assembly in the case, bending the two pieces of strip to the shape of the case. Score the shape of the socket holes on the strip and, using tin shears, cut them to form earth tags.

7. Bolt the PCB loosely into the box as shown in Fig. 5.

8. Trim the base and collector leads of the Q1 to 8 mm. (Warning: the PT8811 contains berillium oxide,

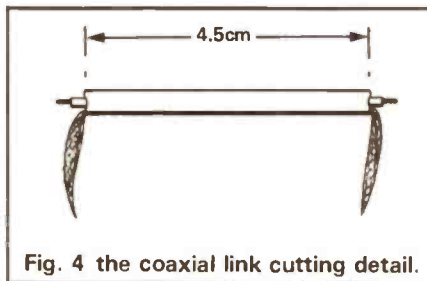

Fig. 4 the coaxial link cutting detail.

C2 for about 1 amp of supply current and peak C5 and C6 for maximum output power. Increase the supply voltage to 13.8V and adjust C1, C2, C5 and C6 for maximum output power. Keep the transmit time as short as possible whilst adjusting.

Check that the stud of Q1 (PT8811) does not get excessively hot (greater than 70°C); if it does, the almost certain cause is that it is not secured tightly enough to the case. In normal use, you can expect the amplifier and case to get quite warm — 40°C or so — but this is perfectly safe, so long as Q1 is not very much hotter than the case. If the amplifier is to be used in a confined space with little ventila-

tion, a heat sink may be bolted to the box to improve dissipation. Prototypes have been run continuously at 12 watts output for two hours or more.

9. Tighten up the fixing screws and the transistor nut. Solder C3 and C4 in position keeping their leads as short as possible.

10. Carefully wind the coil L2, using a former of the correct diameter (5 mm drill bit etc.) and solder it in position on the board.

11. Solder the relays in position on

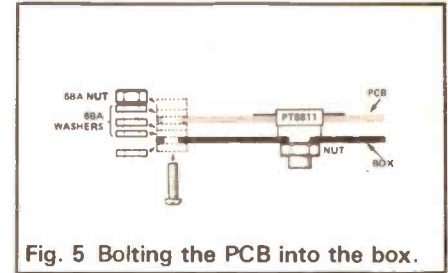

Fig. 5 Bolting the PCB into the box.

the edge of the PCB and connect the upper tags of both the relay coils to earth. Some silicon rubber compound between the relays and the case will provide extra mechanical stability for mobile applications.

12. Fit the BNC sockets making sure that the earth tags make a good connection.

13. Solder two pieces of brass strip approx 20 cm x 0.5 cm to form the input and output connections from the PCB to the BNC sockets.

14. Fit the power leads and include an in-line fuseholder on the positive side.

Testing

Before applying any power, thoroughly check the amplifier for solder bridges, incorrect components etc.

With no DC power applied check that the RF power loss through the amplifier is not more than 1 dB (it should be less than 200 mW in 1 watt). Connect a dummy load and a DC power supply set to 12V. Monitor the output power and the DC input current which, at this stage, should be negligible. Set the trimmer capacitor to mid position and switch on the transmitter. The relays should operate and the current drawn increase. Adjust C1 and

tion, a heat sink may be bolted to the box to improve dissipation. Prototypes have been run continuously at 12 watts output for two hours or more.

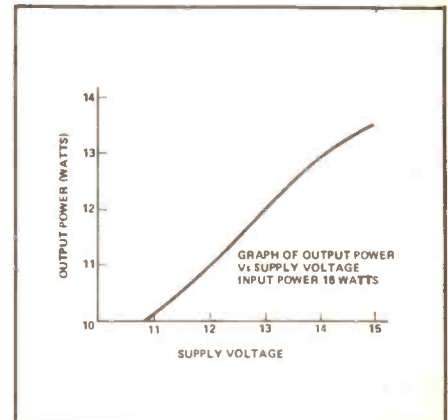

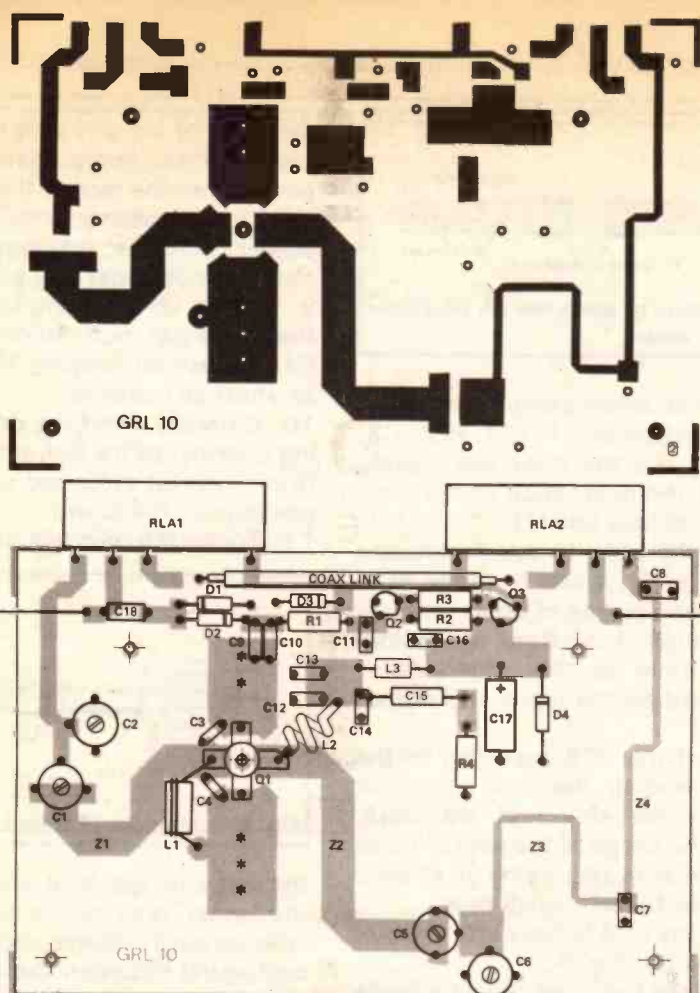

Fig. 6 Top: PCB foil pattern. Bottom: the component overlay.

COMPONENTS LISTING

RESISTORS

R1, 2	2k2
R3	4k7
R4	10R

all 0.25W 5% carbon film.

CAPACITORS

C1, 2, 5, 6	2-22p foil trimmer
C3, 4	15p
C7	10p
C8	4p7
C9, 12	470p
C10	1n0
C11, 14, 16	100n mono
C13	4n7
C15	100n polycarbonate
C17	22u 16V electro. axial
C18	1p0

INDUCTORS

L1	2 turns, 33swg (0.25mm) en. copper on FX1242.
L2	2 turns, 5mm dia, 18swg, (1.2mm) tinned copper, spaced at 1 wire dia.
L3	18swg (1.2mm) tinned copper wire through FX1242.

SEMICONDUCTORS

Q1	PT8811
Q2	MPSA13
Q3	BC640
D1, 2	0A91/0A90/0A47
D3	1N4148
D4	1N5404

MISCELLANEOUS

2 OM1 relays (RL1, 2); 2 BNC sockets; 2 FX1242 ferrite beads; 4 6BA 1/2" screws; 4 6BA nuts; 16 6BA plain washers; 1" x 4 1/2" brass strip; a grommet; 10cm LR95; 15cm 18swg tinned copper wire; 10cm 33 swg en. copper wire; 1m of black 16/0.2mm, 1m or red 16/0.2mm; an in line fuse holder; and a 1 1/4" 2A QA fuse; a die cast box and a PCB.

Specification

Power gain(2W1/P)	7.2dB
Output power (13.8V) 2W input	10W(min)
Saturated power output	14W
Supply voltage	10-16V(13.8V nom)
Input/Output impedance	50R
Bandwidth	430-440MHz
Supply current	2 amps at 12W
Dimensions	119 x 94 x 34mm

In Use

The input power should not be greater than 2.5 watts and the output power must not be allowed to be above 14 watts for more than a short period.

The RF switching operates from an input level of about 0.5W upwards so if your transceiver has a low power position then you may find this will not switch the amplifier.

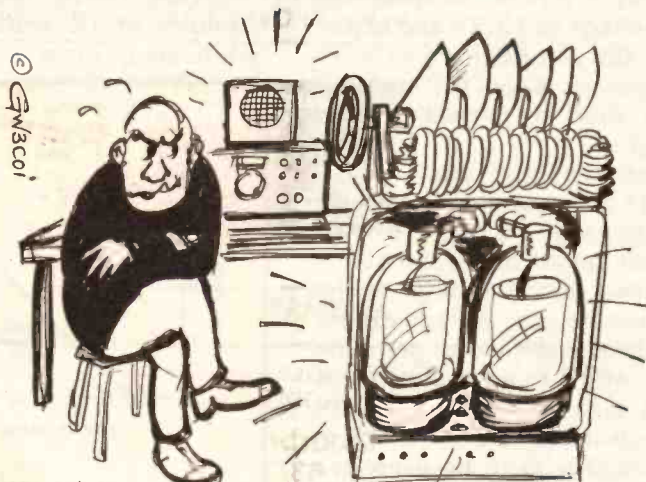

MPSA13



BC640

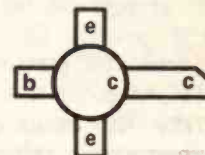

PT8811 (FROM TOP)

Fig. 7 Base connections of the transistors.

DEWSBURY

G4CLX

ELECTRONICS



FRG 8800 £559



TRIO R600 £299



NRD 515 £965

NEW PRODUCT NEWS

IF YOU'RE THINKING ABOUT C/W YOU MUST READ THIS!

- ★ Iambic Keyer ★ Dash/Dot Memory
 - ★ Keying Speed 1 — 55 wpm
 - ★ Built In Side Tone Oscillator And Speaker ★ Headphone Socket
 - ★ Variable Weight Control ★ Side Tone Volume And Pitch Control
 - ★ Switchable Automatic/Semi Automatic Keying/Tune Control ★ Operation From Internal Batteries Or 9 — 15v. External Supply ★ Low Current Drain
 - ★ British Made ☼
 - ★ Selectable Positives or Negative Keying
- 5 YEAR GUARANTEE**
Only £49.95 + £3.00 P&P To Include External Power Leads And Plugs.

APPROVED
TRIO
DEALER

APPROVED
TRIO
DEALER

IF IT'S TRIO IT MUST BE DEWSBURY

A FULL RANGE ALWAYS IN STOCK



TRIO R2000 £479



IC - R 71E £699



POCOMOTOR AFR2000 RTTY ALL MODE DECODER
AFR8000 with built-in display now available. Write for details.

(Now with CW option) From £425



STAR MASTER — KEYER

Stockists of DAIWA — MET ANTENNAS — MUTEK — WOOD & DOUGLAS — TASCOS TELEREADERS — MICROWAVE MODULES — ICs AMTOR — AEA PRODUCTS — DRAE

Dewsbury Electronics, 176 Lower High Street, Stourbridge, West Midlands.

Telephone: Stourbridge (0384) 390063/371228

Telex: 337675 TELPES G



Instant finance available subject to status. Written details on request.



The Mystery of the Missing G7s

This is the tale of a quest to discover the gaps in our callsign series: it started with a chance hearing and gradually took on the fascination of an archaeological 'dig'...

four letters followed by a single figure (other than 0 or 1) in the case of other mobile stations; (f) one or two letters and a single figure (other than 0 or 1) followed by a group of not more than three

Have you ever wondered why you never hear G7 or G9 callsigns on the air? Well, Andy Emmerson, G8PTH, explains the mystery.

In 'What's In A Callsign' (March '83 HRT), I set out the number and letter series used for British amateur callsigns, so I won't repeat that information here. Suffice to say that numbers 1, 7, 9 and 0 were not used in the past for amateur calls, or at least not generally. The exceptions will be explained later in this article. Of course, radio amateurs do not have a monopoly of callsigns and of all the radio calls in use, only the so-called international callsigns need conform to a pattern. Calls used locally by taxi firms and armed forces (to quote just two examples) can take any convenient form. But for international recognition, the calls take specified forms, as explained in an old GPO Handbook for Wireless Operators.

"The calls consist of: (a) three letters in the case of land stations; (b) three letters, or three letters followed by a single figure (other than 0 or 1), in the case of fixed stations; (c) four letters in the case of ship stations; (d) five letters in the case of aircraft stations; (e)

letters in the case of private experimental stations, amateur stations and private radiocommunication stations; the prohibition of the use of the figure 0 and 1, however, does not apply to amateur stations.

The nationality of a station is indicated by the first letter or letters of the callsign."

Presumably the figures 1 and 0 were capable of confusion with the letters I and O. With the solitary exceptions of GB1RS soon after the last war and GB1IARU in 1981, the British licensing authorities avoided their use until recently. This just leaves us with the G7 and G9 series.

G9 = Private Experimental

The G9 calls are not very mysterious in fact; they come in the 'private experimental station' category mentioned above. More commonly known as Test and Development calls, they are assigned to organisations who design or repair equipment and need to test this on the air. I have not traced any

pre-war G9 calls; one of the oldest was G9AED, the pilot Band III transmitter used by independent television from 1955 onwards.

Nowadays G9 calls are issued only where speech is involved, not for video or data transmission. The series has recently passed G9BZE, so they are not issued very fast! A number of amateur radio dealers hold G9 calls, so they are occasionally heard on our bands. In fact it was hearing one of these dealers using a G9 call that caught my attention originally.

G7?

The callsigns beginning G7 were more difficult to track down, because the Radio Regulatory Department told me there are no G7s in force at the moment. Furthermore they had no record of any previous use (though the series is due for re-use shortly). The earliest recorded use was during the last war, as noted by Mike Ockenden in his article 'Bitte QRX Krieg' (Short Wave Magazine, June 1981). Eight British stations, G7FA-G7FH, contacted German and Swiss stations in 1945, while the war was still on. This was unusual to say the least — we were still at war with Germany and amateur transmitting was officially banned.

It is also understood that calls in the G7A plus one letter series were issued just before the end of the war by the Radio Security Service (RSS) to 'voluntary interceptor' operators. These amateurs were allowed to work 7MHz from home, presumably to make contact with stations operating as pirates inside Europe. This would enable the RSS to get bearings on these clandestine operators. Considerable doubt still surrounds these wartime activities and if nobody comes forward soon, the questions may remain unanswered forever.

After this, G7 calls were allocated to maritime colleges for training stations. These colleges have replica ships' wireless stations — operating into dummy loads — and used to have callsigns such as G7TM in Southampton. I'd be pleased to hear of other examples, especially if still in use. Apart from this, a non-directional beacon was heard transmitting a G7-plus-two call in MCW just

above the top of the long-wave broadcast band in the Chelmsford area a couple of years ago, so the series may have been used for general test and development purposes too.

Balloon Mobile

The most recent use of the G7 series was for rather more exotic purposes and did involve amateurs, though not for amateur communication. Two events figure in our story and both concerned expeditions, though not of the DX kind. The first, in 1958, was described as 'the Kon Tiki of the Air'. Codenamed 'Small World' the intention was to fly a para-balloon across the south Atlantic from Tenerife to somewhere in South America.

A request was made to the RSGB for short-wave (14 MHz) communication between the balloon and volunteer operators in 'the old country'. However, since there were no amateurs on board the balloon, this looked problematic until the GPO Radio Branch generously allowed nominated

amateurs to receive messages 'of a scientific and personal nature'. Accordingly, the balloon was assigned the call G7AA and the nominated base stations were G7AB (G6UT), G7AC (G3AAE), G7AD (G2FUX) and G7AE (G8KS). Although the balloon did fly, no radio contact was ever made; a thermal brought the balloon down and the transmitter was jetisoned into the sea. The balloon was cast off and the gondola eventually drifted across the Atlantic to Barbados¹.

The call G7AE was issued again ten years later, in connection with the British Transarctic Expedition. The explorers operated outside amateur bands from a drifting ice floe and a number of amateurs in the UK were licensed to communicate with the relay station: these were G2BVN, G2FLB, G8FC, G8KW and G8PB. Full details can be found in the June 1968 issue of Radio Communication.

And The Others?

So far, the story has concerned only regular 'G' type stations. One or two more unusual calls have

been used in connection with special event stations on the Kennedy Memorial Site at Runnymede. This is now American soil, and the callsigns used reflected this. WG1-JFK was organised in 1976 by G8AUU to commemorate the US bicentennial and in 1984 GK1JFK was arranged by G3KMA for the Los Angeles Olympics.

Other 'unusual' calls heard on the bands are generally not amateurs: there are, for instance, the army and sea cadet nets. Operation from home QTH is allowed on occasion and QSL cards are issued; amateurs should not attempt to join these nets without authorisation, however. Additionally, in the late '40s and '50s boy scout stations operated with G3R or S plus two letter calls, and suffixed hyphen 1, 2 or 3 to indicate the patrol.

In describing these 'unusual' callsigns I am sure I have only scratched the surface and if any readers can add information I shall be pleased to hear from them.

Reference

1. RSGB Bulletin, December 1958.

Tune in With Cirkit

70 cm 10 W POWER AMP

As featured in this issue of HRT, the Cirkit 70 cm PA is designed to boost the power output of hand held FM transceivers by up to 12 watts from a 2 watt input.

Auto relay switching between TX and RX is provided via the RF sense circuitry and the finished amplifier is mounted in a tough pre-drilled die-cast box.

SPECIFICATION

Power Gain (min)	7.2 dB
Output power (min)	
2 w I/P (13.8 v)	10w
Saturated power output	14 w
Supply voltage	10-16 v
(13.8 v nom)	
I/P O/P impedance	50 R
Bandwidth	430-440 MHz
Supply current (12 w O/P) 2A @ 13.8 v	
Dimensions	119 x 94 x 34mm
41-01505	£38.00

WEATHER SATELLITE

RX

6 channel, VHF weather satellite RX for the 136-138 MHz band. Low noise MOSFET front-end, PLL detector and audio amp.

40-02300 £42.52

FET DIP OSCILLATOR

The ever popular dip oscillator from G3WPO. Covering 1.6-215 MHz in 5 ranges with wavemeter, audio output and meter indication. Complete kit with punched case.

40-16215 £21.60

23 cm CONVERTER

Low noise converter for the 23 cm converter with IF output at either 2 m or 10 m.

10 m 40-23038 £21.20

2 m 40-23144 £21.20

70 cm CONVERTER

Low noise 435-144 MHz amateur band converter.

41-01405 £23.00

2 m PRE AMP

Miniature low-noise MOSFET pre-amp for the 2 m amateur band.

41-01307 £4.13

2m CONVERTER

Low nose 144 MHz-28 MHz amateur band covnerter.

41-01306 £19.26

70 cm PREAMP

Low noise, miniature pre-amp for the 70 cm amateur band.

41-01506 £4.78

These are just a few of over 100 kits we hold in stock.

Please add 15% VAT to all advertised prices and 60p post and packing. Please call in to one of our shops or send for our catalogue to see the complete range of kits and complements.

200 North Service Road
BRENTWOOD
Essex
CM14 4SG

CIRKIT DISTRIBUTION, Park Lane, Broxbourne, Herts, EN10 7NQ
Telephone: (0992) 444111 Telex: 22478

53 Burrfields Road
PORTSMOUTH
Hampshire
PO3 5EB

Park Lane
BROXBORNE
Herts
EN10 7NQ

NEW AUTUMN '85
CATALOGUE
OUT NOW
£1.15

Weather Satellite Pictures:

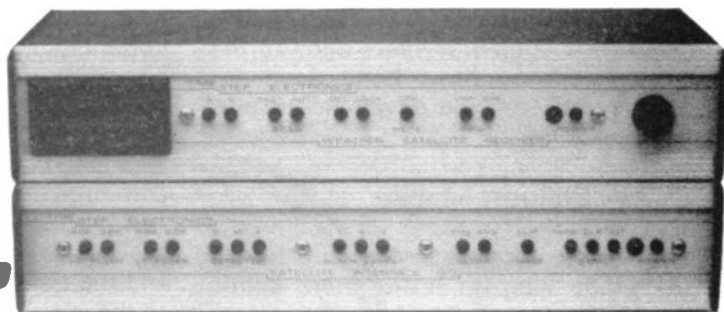

Timestep Electronics System

For the past ten years, I have been interested in weather forecasting having started out decoding the five figure weather codes transmitted from Bracknell. The only bother with this method is that the codes require decoding, into so many tenths cloud or so many kilometres per hour for the wind, etc — all very in-

teresting but rather time consuming. So when I went to the National Exhibition Centre for the RSGB exhibition this year and saw the stand run by Timestep Electronics Ltd, I thought to myself, this is for me!

satellite's data to pictures is called 'Slow Scan Imaging'. There are three satellites in orbit at the moment sent up by USA in the frequency range of 137-138MHz, called NOAA 6, NOAA 8 and NOAA 9. (The letters 'NOAA' stand for National Oceanic and Atmosphere Administration). There are also a number of Russian satellites which transmit pictures. They all use the same type of equipment, APT, which stands for automatic picture transmission. So a single receiver can accept signals from them all.

switched off and NOAA 8 being activated. The failure of NOAA 6 was due to an internal oscillator problem which prevented proper operation of the attitude controls. Because the failure was intermittent, the back-up oscillator would not switch on. However, the primary oscillator has now ceased operation completely, allowing the back-up to be activated. At present both NOAA 6 and NOAA 8 operate on a frequency of 137.50MHz and NOAA 9 on 137.62MHz.

Having become interested in weather satellites, the next step is the receiving equipment. Ken Michaelson, G3RDG, evaluates one system, from Timestep Electronics Ltd, which runs with a BBC 'B' micro computer.

I understand at the time of going to press that NOAA 6 is being

JUNE 1985 NOAA 9		Heading
Listen for Sat.		
1 June 1985		
120		67
200		29
420		7
620		3-1
1240		117
1420		104
1600		207
2 June 1985		
110		73
240		36
420		10
610		3-7
1290		111
1410		157
1500		208
3 June 1985		
230		43
410		11
600		342
1220		104
1400		150
1510		177

Fig. 1 Where you would have found NOAA9 in June.

interesting but rather time consuming. So when I went to the National Exhibition Centre for the RSGB exhibition this year and saw the stand run by Timestep Electronics Ltd, I thought to myself, this is for me!

Timestep Electronics market a complete system for the reception of weather satellite data with the exception of the BBC computer. The pictures on Timestep's stand showed the sort of thing one used to see on BBC 1 TV before the weather forecasting went over to the latest method.

The conversion of the

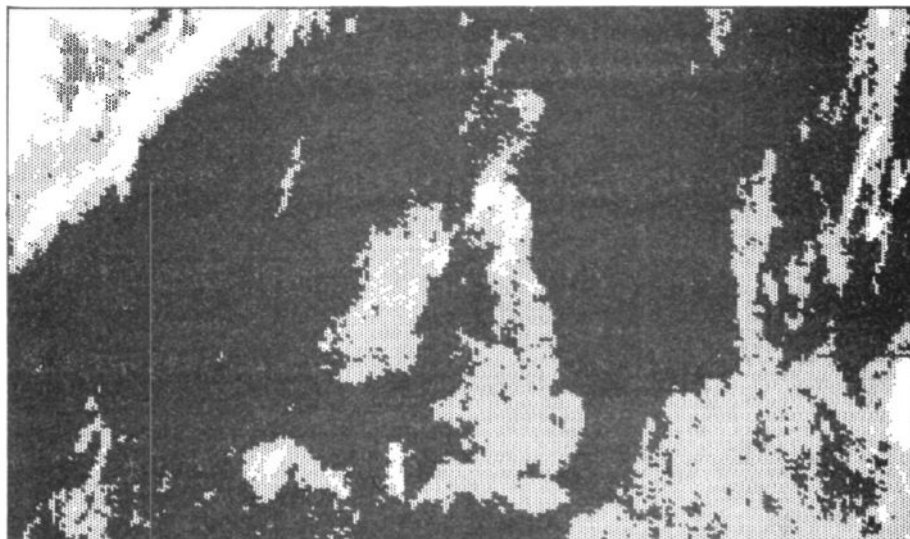

Fig. 2 A print out of a picture of the UK received from NOAA9.



The necessary 'in door' equipment — the AR4200 receiver, a BBC 'B' micro and the interface.

Taking The Plunge

After due consideration, I bought the equipment. The goods duly arrived, with a number of sheets of paper describing the various parts of the equipment. One of these instruction/description sheets was very aptly entitled 'Now I've got it all what do I do with it?' This was very necessary sheet, as it was my first venture into the world of satellites.

I first had to decide whether I wanted a 'live' system or one with a stereo cassette recorder: if one buys the interface boxed, a relay is installed for the remote switching of a stereo tape recorder to capture the signal when you are not there. The first snag I came up against was that my cassette recorder, normally used with the computer is mono. The cassette recorder has to have stereo because it records the signal on one track and the output from the 'clock' (a timing pulse generated inside the interface unit) on the other. However, Timestep Electronics have managed to overcome this problem, and all future units will be modified so that they can work with a mono cassette recorder.

At this point, I must stress that not all mono cassette recorders are suitable. The cheaper versions will not function, giving an unstable picture. The more expensive recorders work correctly, although the picture reproduced from them does not compare with one produced using a stereo cassette recorder — the 'clock' signal on the second channel ensures perfect stability. I tried using my mono cassette recorder, only to find that it reproduced rather inferior pictures.

Making The Connection

Eventually I chose to connect it

up as a live system. This was quite straightforward. Antenna to pre-amp; pre-amp to receiver; audio from receiver to interface and finally, two multi-way ribbon cables, one 20 way and the other 26 way, to be connected to the Beeb. The 20 way went to the user port and the 26 way to the printer port. The final job, of course, was to plug in the ROM, written by Peter Clappison and M J Atkinson.

I typed '* HELP' and the ROM's name 'SATPIC' appeared together with the other ROMs available. (Each ROM has the owner's name and address embedded in it, so as to discourage copying. When the menu is displayed, the words 'The property of _____' also appears on the screen). Satpic is called either by typing '* SATPIC' or simply '* S'. It then goes straight into default mode, assuming the parameters for receiving Meteosat 2, the geostationary satellite.

The menu is displayed by pressing 'Escape', during which time the picture is preserved but not updated with any further data

until 'Escape' is pressed again, when picture mode restored. While in the menu mode, you are offered a number of different options. One of which is the 'colour palette' in which there are ten colour choices, although the screen displays only four choices at any time. The 'viewing window' on the colour monitor can be moved using the cursor keys and the current colour set (such as mode 1 — black, red, yellow and white) flashing as they are displayed.

There is a zoom facility for close-ups of say the UK, although this can only be used when receiving signals from Meteosat 2. This satellite transmits on 1.69GHz in the 'S' band and therefore, I needed a converter from 1.69GHz to 137-138MHz (the NOAA frequencies) and a dish antenna. Timestep provide a memory prompter which gives the number of facilities available with this very sophisticated ROM and which can be inserted under the plastic cover above the function keys of the Beeb. It will be seen that there are eight variations, but not all of which can be employed with the equipment I have at the moment.

To begin with, the receiver I used, the WSAT, was crystal controlled and only one satellite could be received, that being NOAA 9. This was not a drawback, since the whole idea and operation in this frequency range was new to me and had to be taken slowly. I have since been using a scanning receiver, model AR4200. This is based on a Japanese scanner but has been heavily modified by Timestep so

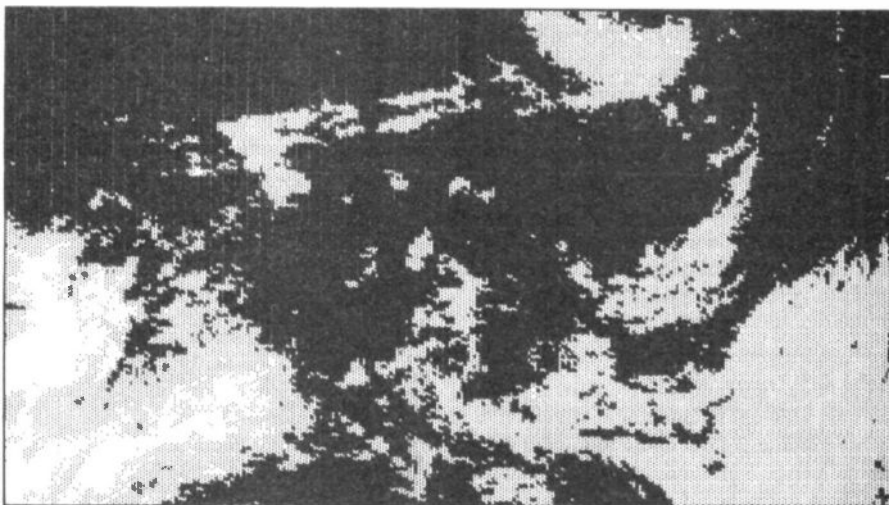

Fig. 3 Print out of a picture received from a Russian weather satellite. Most Russian satellites remain something of a mystery because they are supplied with very little information.

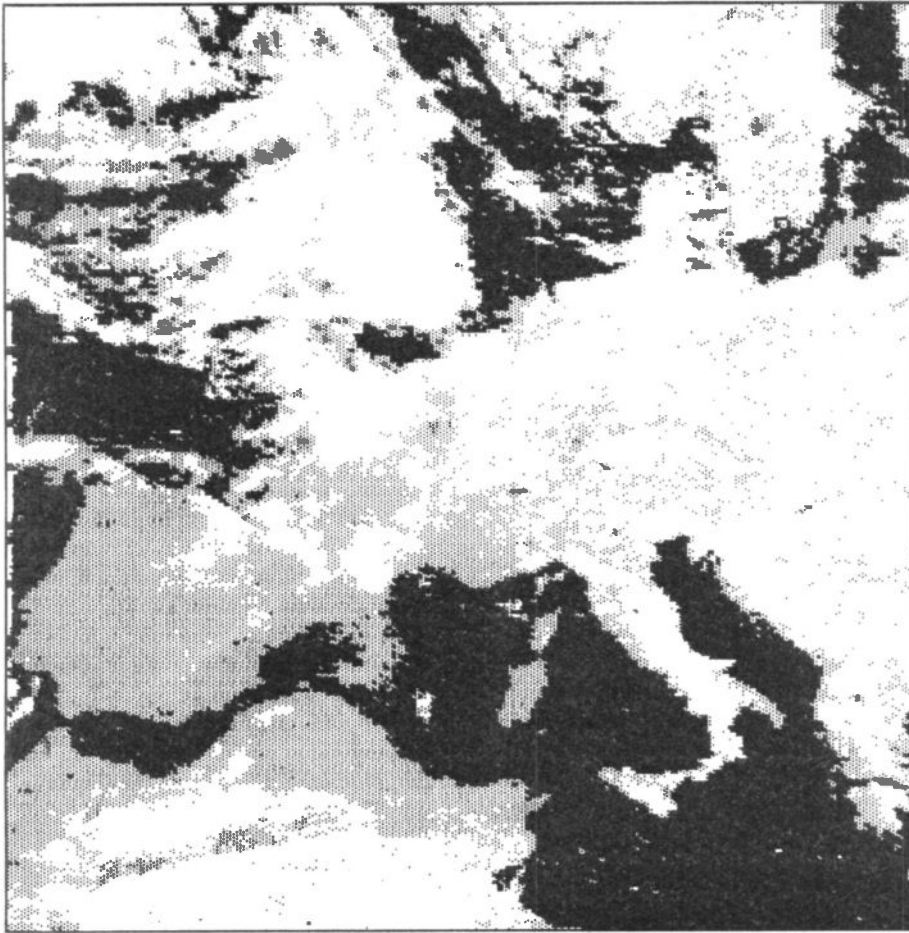

Fig. 4 Western Europe as seen by NOAA9. Britain as usual covered in cloud!

that it has the correct bandwidth capable of scanning all VHF weather satellites channels as well as UOSAT 1 and 2.

Provided in all the paperwork was a list of the orbital times and headings of NOAA 9. There are six passes each 24 hours; because I was using a non-directional antenna, only two or perhaps three were copyable, the other three being too far out to give a reasonable signal. The usable headings lie roughly between 100 and 200 degrees latitude, and for June, the times are between 1130 and 1530 hours local time. So the next thing to do was to wait for the specified time.

I switched on the receiver and the interface, keyed '* S RETURN' and 'Escape' to display the menu. Referring to the 'memory prompter' which was above the function keys, pressed 'F1' which gave me 'NOAA infra red/visible' and pressed 'Escape' to return to the picture. By this time, I could faintly hear the 'ping ping' of the clock on the satellite. The various switches on the interface now had to be set, full instructions for which are given in the leaflet supplied. In the mean-

time the 'ping ping' was getting louder and the screen was showing a jumble of shapes in colour building up from the bottom. The screen was cleared by pressing the space bar, and the picture started to build up again, this time looking something like an image.

First Pictures

In fact, I was getting my first ever picture from a satellite! This was displayed on the screen in four colours and appeared a bit of a muddle to start with. It was quite obvious that there was a bar going

down the middle, and the pictures were different either side. This was because 'F1' gives pictures of both the infra red and visible light. By pressing 'Escape' followed by 'F2', I was in the picture mode but this time the picture could be scrolled to the right using the 'slip' button on the interface — giving a whole screen display of either infra red or visible light. I carefully did this, watching the screen, until I thought it need go no further, then pressed the space bar to give me a clear screen.

Another facility on the ROM enables you to retain the picture: when the picture is completed, just press 'F0'. The whole contents of the screen is transferred to disc and a new file called 'PICA' (the software checks that the title has not been used before; the filename would otherwise be 'PICB').

The results of my efforts are shown nearby, together with one or two other selections. If the weather is cloudy, naturally one is not able to see the ground beneath, which makes it a bit difficult to know what one is looking at! I made a tracing of Europe, including North Africa which when placed over the picture gave me the outlines of the various countries.

One of the most interesting facilities of the whole set-up is the ability to print the picture as it were on hard copy with shades of grey and, of course, white where necessary. The extra hardware requirements for this is either an Epson FX80 or RX80 printer and the 'Printmaster' ROM from Computer Concepts. With the picture stored on disc, the interface disconnected and the printer reconnected to the printer port, the following program will load the picture on to the screen and the printer will commence printing it.

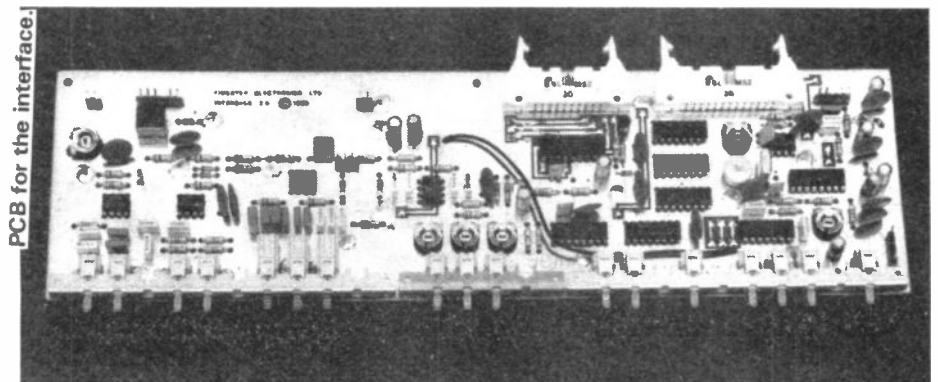

10 MODE 1
 20 * FX 6,0
 30 * LOAD PICA
 40 * GDUMP 0,2
 50 * INIT.
 RUN

Additional Equipment

I have now made two additions to the initial equipment. I obtained a special Jaybeam crossed dipole assembly, designed to resonate at 137 to 138 MHz, and fitted to this the preamplifier unit designed by Timothy Edwards (reviewed in the January 1983 issue of HRT). The preamp, which is not much bigger than half a match-box, has to be mounted within five metres of the antenna; using a plastic 35mm film holder to house the amplifier (wrapped in some sponge-type plastic), I connected it to the antenna with a 1' length of URM76 50ohm cable terminated in a 'N'-type plug (a hot soldering iron can be used to make reasonably neat holes at either end of the film holder). I used low-loss coax to connect the preamp to the receiver, with an extra single-core wire for the 12V power supply, these two leads emerging from the lid end of

the box. To finish off, I covered the whole assembly, including the plug, with stretched self-amalgamating tape, and taped the coax and the 12V feed to the mast to avoid stress being applied to the preamp terminals.

The difference this made was quite amazing. With the 2 metre dipole that I had been using, the time that was available to obtain a picture was perhaps 15 minutes. With the new antenna, its reflector and pre-amp, I appeared to have reception over the whole time the satellite goes from one horizon to the other, about half an hour! I can recommend that anyone interested gets the antenna which is designed for the job.

The second change which I have made is to use the AR4200 scanning receiver. With this not only can I receive NOAA9, but I seem to be able to receive some satellite or other at most times of the day, including a number of Russian ones and NOAA 8. Of course, the scanning receiver picks up numerous transmissions of interest on other frequencies within its range. Well worth the extra, I thought, for the additional facilities it gives.

All in all, I have found myself an absorbing interest. It seems to take precedence over actual transmitting, at least for the moment — every available moment I pop into the shack 'to see what's on'! The next step is to obtain a dish in order to receive Meteosat on 1.69GHz.

The quality of workmanship of the assembled units, the crystal controlled receiver WSAT Rx, the interface, (IF 2.0) and the pre-amp, WS-pre, I found to be excellent. Timestep Electronics themselves are very helpful in answering queries from an absolute greenhorn in this subject. I can thoroughly recommend receiving weather satellites for any amateur who wants a 'change of scenery'.

The crystal controlled receiver, WSAT Rx, costs £79.95, and the scanning receiver, AR4200 is £269. The interface unit IF.20 costs £88.50 and the Matthew Atkinson EPROM, EPROM WS 2.0 is £37.50, the WS-pre pre-amp £10.95 and J beam's crossed dipole with reflectors (2X-WS) £34.50. Timestep Electronics Ltd, are based at Wickhambrook, Newmarket, Suffolk (phone 0440 820040).

HALBAR

NOAA WEATHER SATELLITE IMAGING STATION

On a BBC microcomputer, Halbar's weather satellite station will display and store on disc European weather maps which are broadcast from the polar orbiting NOAA series satellites. Meteosat signals can also be processed.

The Station will be of value to individuals or education institutions who wish to display weather maps for forecasting, geological mapping or to expand their Information Technology programme.

The station comprises:

- DIGITIZER (interfaces APT signals to a BBC micro)
- RECEIVER (6 channel 50kHz bandwidth. NOAA9 crystal fitted)
- AERIAL (double inverted turnstile I.T. aerial)
- SOFTWARE on disc to drive micro. User friendly by menu options
- TEST signals on tape and sample pictures on disc.
- DOCUMENTATION plus all necessary connecting leads.

Price £200. plus VAT. P&P £7. Further details SAE and £1. Redeemable on purchase.

Units are available separately: Digitizer including software, cassette and documentation £105 plus VAT. Receiver £85 plus VAT. P&P £5. Aerial £17 plus VAT P&P £2.50. Documentation (User Guide) £3.

HALBAR Unit 1 Bury Walk Bedford MK41 0DU. (0234) 44720
 Halbar aerial products SAE.

Suppliers to MoD Industry and Educational Authorities.

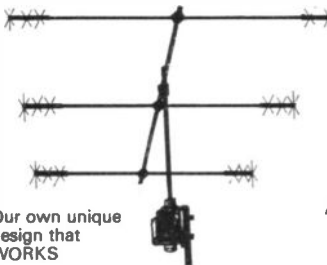



**COMPACT
 Spacesaver
 ANTENNAS**

AQ6 20, 2 Ele and 3 Ele
4 BAND, 6, 10, 15, 20 M
 AQ40, 2 Ele, 40M! **NEW**

Our own unique design that WORKS

CLOSE COUPLED—HI 'Q'—CAPACITY HAT LOADED YAGI
Special features:

- Unique Altron fully sealed coils for max stability
- Resonant length elements for improved VSWR (1-1)
- Selectively detuned for optimum performance and gain (no gimmick quad needed)
- Easy trim spokes with lock nuts and spares
- Minimized wind load and weight
- Double insulated elements

Typical performance



Antenna model	AQ-20/2E	AQ6-20/3E	AQ40/2E
Forward Gain Dbd	3.8 to 4.8	5.5 to 7.5	3.8
Front to Back Db	13 to 15	16 to 18	12
Side Null Db	25	25	20
VSWR (typical)	1.1:1	1.1:1	1.1:1
Weight	7.5lb	12lb	12lb
Wind load	2ft ² 0.18M ²	3ft ² 0.27M ²	3ft ² 0.27M ²
Turning radius	76"/1930mm	96"/2438mm	114"/2895mm

PRICE + p&p £114.50 (4.50) £169.00 (7.00) £149.50 (7.00)
 PRICES ARE INCLUSIVE OF VAT. TERMS. CWO. ACCESS. VISA
WE DESIGN—WE MAKE—WE SELL DIRECT. You get best value

Callers welcome.
 Open Mon-Fri 9am-5
 Sat 9am-12.15pm

ALLWELD ENGINEERING
 Unit 6, 232 Selsdon Road
 S Croydon CP2 6PL
 Telephone: 01-680 2995 (24 hr) 01-681 6734

STOCK ITEMS NORMALLY DESPATCHED WITHIN 7 DAYS

RADIO Tomorrow

Your at-a-glance guide to what's happening around the clubs, on the air and in general radio-wise.

- | | |
|---|---|
| <p>2 Sept Horndean DARC: junk sale.
Basingstoke ARC: <i>Direction Finding</i> by G6AGE.
Alyn and Deeside ARS: contest arrangements.
Worcester DARC: club publicity evening.
Todmorden DARS: <i>Talk</i> by Harry Leeming, G3LLL.
Wolverhampton ARS: visit to Police Radio Control Centre, Bourneville.</p> <p>3 Sept E Lancashire ARC: surplus equipment sale.
Reading DARC: <i>Packet Radio talk and demonstration</i> by G6CCA.
Worksop ARS: evening visit to the Scunthorpe club.
Wolverhampton ARS: meeting.
Bury RS: informal.
Fylde ARS: visit to the control tower at Blackpool Airport.</p> <p>4 Sept Three Counties ARC: <i>Computer Decoded Morse</i> by G6VMA.
Wirral ARS: Quiz.
Brighton DARS: meeting.
Cheshunt DARC: club project with G4ZCX.
Hornsea ARC: SSB field day preparation.
Fareham DARC: natter night on the air.
Havering DARC: informal.
Telford DARS: rally group final meeting.
Wirral DARC: Inter club quiz vs Wirral ARS.
Mirfield RC: meets every Wednesday at the club room; Mirfield Community Centre, Yockleton Road, Lea Village, Birmingham. All visitors welcome starting from 7pm.</p> <p>5 Sept N Wakefield RC: AGM.
Meirion ARS: video or film.
Abergavenny and Nevill Hall ARC: meets every Thursday at the Pen-y-Fal hospital (above male ward 2), starting at 7.30pm.
Sheffield DARS: technical topics with G6PVS.</p> <p>6 Sept W Kent ARS: open evening.
Coventry ARS: night on the air/project launch.
Radio Society of Harrow: construction contest.
S Manchester RC: contest preparation for SSB field day and 2m event.</p> <p>7-8 Sept RSGB 144 MHz Trophy contest, 1400-1400 GMT.
GB0CSR operated by the Civil Service ARS on HF (80-10m) and 2m from the Central Ordinance Dept in Chilwell, Notts on Saturday and on Sunday from the Civil Service Sports ground in Nottingham.</p> <p>8 Sept Galashiels DARS: open day with trade stands, raffle, bring and buy much more. The venue is</p> | <p>9 Sept Alyn and Deeside ARS: drink and waffle.
Swale ARC: <i>Kent Repeaters</i> by G4RVV and G3TIS at the Ivy Leaf Club, Sittingbourne.
S Cheshire ARS: <i>Mast Construction</i> by G1JAT at the Victoria Club, Gatefield Street, Crewe starting at 8pm.</p> <p>10 Sept Chester DRS: <i>Lowe Electronics display their latest</i>.
Newbury DARS: junk sale.
Dartford Heath DFC: pre hunt meeting.
Wolverhampton ARS: club project discussion.
Bury RS: <i>Propagation</i> by G3LEQ.</p> <p>11 Sept Exmouth ARX: meeting.
Cheshunt DARC: natter nite.
Fareham DARC: <i>70cm 1kW linear amplifier with G6XHR</i>.
Havering DARC: DF hunt.
Telford DARS: natter nite.
Hornsea ARC: <i>Vintage and Veteran Radio</i> by G4IGY.</p> <p>12 Sept N Wakefield RC: junk sale.
Preston ARS: <i>Atomic Structure</i> by G4DBU.
Sheffield DRS: <i>Repeaters Past and Present</i> by G8HVV.</p> <p>13 Sept Bromsgrove DARC: surplus sale.
Dunstable Downs RC: <i>Airport '85 - A Pilot's View</i> by G4ZJF.
Coventry ARS: Ill fated mini lectures.
Radio Society of Harrow: activity night on 10m.
S Manchester RC: HF activity night.</p> <p>14-15 Sept International ATV contest on bands, 432, 1260 and 10 000 MHz from 1800 Sat to 1200 Sun (GMT).</p> <p>15 Sept Peterborough Mobile Rally at the Werrina Sports Stadium, Bishops Road, Peterborough.
Dartford Heath DFC: DF hunt.
Wolverhampton ARS: 144MHz DF hunt.</p> <p>16 Sept Alyn and Deeside ARS: <i>Computers in Data Comms - A professional View</i> by Roy Honeyman.
Todmorden DARS: informal chat night.</p> <p>17 Sept Chester DRS: inter club quiz with Ellesmere Port ARS at Chester.
Midland ARS: homebrew contest.
Reading DARC: <i>an exhibition of latest equipment and kits from Wood and Douglas</i>.
Worksop ARS: <i>Lightning Protection</i>.</p> |
|---|---|

	Bury RS: informal. Biggin Hill ARC: <i>Space Shuttle video and Richard Todd from BT Cellular Radio starting at 8.30pm at St Marks Church Hall, Biggin Hill.</i> Flyde ARS: <i>QRP Is Fun by George Dobbs, G3RJV.</i>	3 Oct	Abergavenny and Nevill Hall ARC: meets every Thursday. Shefford DARS: <i>Understanding SWR Measurements by G3WRJ.</i>
18 Sept	Three Counties ARC: <i>Smith Charts Simplified by G3EGX;</i> Brighton DARS: meeting. Cheshunt DARC: video 'Amateur Radio's Newest Frontiers' and an introduction to amateur radio for new members. Fareham DARC: natter nite on the air. Havering DARC: informal. Telford DARS: <i>What We Did On Our Holidays by G3UKV and Co. in GM land.</i> Braintree ARS: meeting.	4 Oct	W Kent ARS: meeting. Coventry ARS: AGM. Radio Society of Harrow: <i>G2UV prize 'talk challenge'.</i>
19 Sept	Shefford DARS: junk sale.	5 Oct	Meirion ARS: <i>Talk by G3CSG.</i>
20 Sept	The Second National Amateur Car Boot Sale at the Old Warden Aerodrome, Beds.	7 Oct	Hornsea DARC: AGM. Basingstoke ARC: AGM. Alyn and Deeside ARS: drink and waffle. Worcester DARC: <i>Dewsbury Electronics visit.</i> Todmorden DARS: construction tips at the start of the construction contest.
22 Sept	Harlow Mobile Rally at the Sports Centre, Harlow, beginning at 10.30am with ample free parking, refreshments, bring and buy and book stall. Talk in on S22. RSGB 70 MHz Trophy contest 0900-1600 GMT.	8 Oct	Bury RS: <i>club construction contest and George Dobbs, G3RJV on QRP Operation.</i> Wolverhampton ARS: discussion night.
23 Sept	Alyn and Deeside ARS: drink and waffle.	9 Oct	Exmouth ARC: meeting. Cheshunt DARC: natter nite. Fareham DARC: <i>Davtrend talk and demonstration.</i> Havering DARC: informal. Telford DARS: video/film night. Hornsea ARC: open meeting. Preston ARS: <i>Worked All Britain with G4PLB.</i> Shefford DARS: <i>Interference Forum chaired by G3UFB. from RSGB EMC committee.</i>
24 Sept	Chester DRS: informal. Wolverhampton ARS: night on the air. Bury RS: informal.	10 Oct	Bromsgrove DARC: main meeting. Coventry ARS: night on the air. Radio Society of Harrow: activity night on 80m. Dunstable Downs RC: open evening and demonstrations.
25 Sept	Exmouth ARC: meeting. Cheshunt DARC: natter nite. Fareham DARC: <i>2m Rhombic Aerials by G6MVL.</i> Havering DARC: surplus equipment and junk sale. Telford DARS: Doctors Surgery — failed projects welcome. Hornsea ARC: <i>23cms by G6BCC.</i>	11 Oct	RSGB 21 and 28 MHz telephony contest from 0700 to 1900 GMT. Alyn and Deeside ARS: talk, demonstration and members workshop with G8OJQ.
26 Sept	Preston ARS: test your rig night with G3SYA. Greater Peterborough ARC: <i>The New 50MHz Band by G3FDW.</i> Shefford DARS: <i>Weather Satellites by G8LOK.</i>	13 Oct	Midland ARS: AGM. Dartford Heath DFC: pre hunt meeting. Reading DARC: junk sale. Bury RS: informal. Fylde ARS: <i>Further Thoughts on Propagation.</i> Wolverhampton ARS: <i>Clandestine Radio as a POW by G3BA.</i>
27 Sept	Bromsgrove DARC: construction meeting. Coventry ARS: project construction. Radio Society of Harrow: activity night on 15m. S Manchester RC: visit by John Nelson, G4FRX.	14 Oct	Three Counties ARC: <i>Interference by G4JXO.</i> Wirral ARS: AGM. Fareham DARC: natter nite on the air. Havering DARC: constructors cup competition. Telford DARS: <i>SSB Generation by G4AZV.</i> Braintree ARS: club construction meeting. Hornsea ARC: ELHOEX '85 preparation.
30 Sept	Alyn and Deeside ARS: <i>RAYNET talk and demonstration by G8RXB.</i> Worcester DARC: AGM.	15 Oct	Shefford DARS: <i>Amateur Radio Computer Programs.</i> Sutton and Cheam RS: <i>Propagation by G2FKZ.</i> Worksop ARS: club quiz vs Maltby club. W Kent ARS: meeting. Coventry ARS: quiz. Radio Society of Harrow: <i>Making Electricity with CEGB.</i>
1 Oct	E Lancashire ARC: <i>The Welshpool and Llanfair Light Railway.</i> Reading DARC: <i>Improving Your DX on 2m by Ken Willis, G8VR.</i> Worksop ARS: Space Shuttle video. Wolverhampton ARS: AGM. Bury RS: informal. Fylde ARS: <i>Propagation — Principles And Factors.</i>	16 Oct	Dartford Heath DFC: DF hunt. ELHOEX '85 organised by Hornsea ARC and other clubs at the Floral Hall, Hornsea. Further details from G4NIP on 0262 673635. RSGB 21 MHz CW only contest 0700-1900 GMT.
2 Oct	Three Counties ARC: <i>VHF Repeaters by Farnham VHF Group.</i> Wirral ARS: surplus equipment sale. Cheshunt DARC: <i>Lightning Protection by Peter Tingey.</i> Fareham DARC: natter nite on the air. Havering DARC: business meeting. Telford DARS: natter night. Mirfield RC: meets every Wednesday. Braintree ARS: meeting. Hornsea ARC: The RSGB video show.	17 Oct	Alyn and Deeside ARS: drink and waffle. Todmorden DARS: surplus equipment sale. Bury RS: informal. Wolverhampton ARS: members slide and film show.
		18 Oct	Exmouth ARC: meeting.
		20 Oct	
		21 Oct	
		22 Oct	
		23 Oct	

Fareham DARC: *A Better Way with End Fed Aerials by G3CCB*
 Havering DARC: informal.
 Worcester DARC: informal.
 Telford DARS: HF activity night.
 Hornsea ARC: ELHOEX '85 post mortem.
24 Oct Preston ARS: Secret Listeners video.
 Greater Peterborough ARC: *The Sharp End of Broadcasting by G4HPE.*
 Shefford DARS: *Satellite TV by G8AFN.*
25-26 Oct Leicester Amateur Radio Show at the Granby Halls, Leicester. Further details can be obtained from Frank, G4PDZ on 0533 553293.
25 Oct Coventry ARS: night on the air.
 Radio Society of Harrow: activity night on 20m.
 Dunstable Downs RC: *Improving your DX on 2m by G8VR.*
 Hornsea ARC: AGM.
27 Oct Wolverhampton ARS: DF hunt.
 RSGB 70MHz fixed station contest 1000-1500 GMT.
28 Oct Alyn and Deeside ARS: meeting.
29 Oct E Lancashire ARC: informal.

Reading DARC: *24cm TV Repeaters by G3VZV of BATC and RMG.*
 Worksoop ARS: return visit and quiz vs Maltby club.
 Bury RS: informal.
 Wolverhampton ARS: night on the air and discussion
30 Oct Three Counties ARC: HF and VHF stations on the air.
 Fareham DARC: natter nite on the air.
 Havering DARC: *Oscar Satellites by G3RWL.*
 Telford DARS: natter nite.
31 Oct Shefford DARS: *Getting Going on 10GHz by G8OFA.*
1 Nov W Kent ARS: club expedition video and slide show.
 Coventry ARS: film show.
 Radio Society of Harrow: *Astronomy for Amateurs by G4ZES.*

Will club secretaries please note that the deadline for the December segment of Radio Tomorrow (covering radio activities from 1st November to 1st January) is 20th September.

Contacts

Abergavenny & NH ARC	GW4XQH	0873 4655	Loughton DARS	G6FWT	01-508 7190
Alyn and Deeside ARS	GW4RKX	0244 660066	Maidenhead DARC	John	0628 28463
Barking RES	R. Woodberry	01 594 4009	Maltby ARS	Ian Abel	0709 814911
Bath DARC	G4UMN	Frome 63939	Medway ARTS	Tony	0634 578647
Basingstoke ARC	Dave	07356 5185	Midland ARS	G8BHE	021382 0086
Biggin Hill ARC	G0AMP	0689 57848	Mid Sussex ARS	G1FRF	0791 82937
Braintree RS	J. Robegy	1597 44857	Mid Ulster ARC	DF Campbell	0762 42620
Brighton DARS	Peter	0273 607737	Mid Warwickshire ARS	G4TIL	Southam 4765
Bristol ARC	G4YOC	Bitton 4116	N. Cornwall RS	J. West	0288 4916
Bury RS	Bryan	0282 24254	N. Staffs ARS	G6MLI	0782 332657
Cambridge DARC	D. Wilcox	0954 50597	N. Wakefield RC	S. Thompson	0532 536633
Cheshunt DARC	Roger Frisby	0992 464795	Newbury DARS	G3VOW	0635 43048
Chester DRS	Alan	0244 40055	Nunsfield HCA ARG	G4PZY	Derby 767994
Chichester DARC	C. Bryan	0243 789587	Preston ARS	George	0772 718175
Clifton ARS	Mr Hilton	01 301 1864	Oswestry DARC	Brian	0691 831023
Coventry ARS	R. Tew	0203 73999	Reading DARC	Chris	Reading 471761
Dartford Heath DFC	Pete	0322 844467	Rhyl DARC	GW1AKT	Nantglyn 469
Denby Dale DARC	G3SDY	0484 602905	Shefford DRS	G4PSO	Hitchin 57946
Donegal ARC	EI3BOB	074 57155	S. Bristol ARS	Len Baker	0272 834282
Droitwich DARC	G4HFP	0299 33818	S. Lakeland ARS	Dave	0229 54982
Dudley ARC	John	0384 278300	S. Manchester ARC	Dave Holland	061 973 1837
Dunstable Downs RC	Phill Morris	0582 607623	Southdown ARS	P. Henly	0323 763123
East Kent RS	Stuart	0227 68913	Stockton DARS	John Walker	0642 582578
East Lancashire ARC	Stuart	0254 887385	Stowmarket DARS	M. Goodrum	0449 676288
Edgware DARS	John	01 306 4342	St. Helens DARC	A. Riley	051 430 9227
Exeter ARS	Roger Tipper	0392 68065	Swale ARC	B. Hancock	0795 873147
Fareham DARC	Brian	0329 234904	Telford DARS	Tom Crosbie	0952 597506
Farnborough DRS	Mr Taylor	0252 837581	Three Counties ARC	R. Hodgson	0428 77368
Fylde RS	PRO	0253 737680	Tiverton (SW) RC	G. Draper	03634 235
Galashiels DARS	GM3DAR	0896 56027	Todmorden DARS	Mr Gamble	070 681 2494
G. Peterborough ARC	Frank	0733 231848	V White Horse ARS	Ian White	Abingdon 31559
Halifax DARS	D Moss	0422 202306	Verulam ARC	Secretary	St Albans 59318
Harrow RS	Dave Atkins	0923 779942	Wakefield DRS	G8PBE	0924 378727
Hastings ERC	Dave Shirley	0424 420608	Welland Valley ARS	J. Day	0858 32109
Haverhill DARS	Rob Proctor	0787 281359	Welwyn Hatfield ARC	Dave	07073 26138
Hazelrigg ARC	G1HDV	274 2413	West Kent ARS	PRO	0892 32877
Hornsea ARC	Norman	0262 73635	Westmorland RS	G. Chapman	0539 28491
Horsham ARC	Pete Head	0403 64580	Willenhall ARS	G4LWI	0902 782036
Inverness ARC	Brian	0463 242463	Wirral ARS	Cedric	051 625 7311
Kidderminster DARS	Tony	0562 751584	Wirral DARC	Gerry Scott	051 630 1393
Leighton Linlade RC	Pete Brazier	052 523 270	Wolverhampton ARS	Keith	0902 24870
Loughborough ARC	Philip	0509 412043	Worcester DARC	D. Batchelor	0905 641733
			Worksoop ARS	G4ZUN	Worksoop 486614
			Worthing DARC	Roy	0903 690415
			308 ARC (Surbiton)	Dave Davis	01 399 5487

WEATHER SATELLITES

Fed up with space invaders?

Then join the elite and watch live satellites on your BBC B micro.

Switch on the TV in the early evening and you are bound to see one of those magnificent satellite pictures the weather men are so fond of. These are taken by satellites continuously orbiting the earth to help meteorologists study the world's climate and predict our weather. The equipment they use costs an arm and a leg but now for the first time a complete package of hardware and software is available at a realistic price, both in kit form for the adventurous, and ready built for those short of time. The vast cost reductions are due to the superiority of the BBC with its interface capabilities and graphics combined with the use of our innovative software.

Timestep who have been making satellite systems for British Telecom for years, have now acquired the exciting new 2.0 version software from Matthew Atkinson, which in conjunction with the new WSAT receiver enables anybody to beat the weathermen. Schools and farmers will find this project particularly interesting.

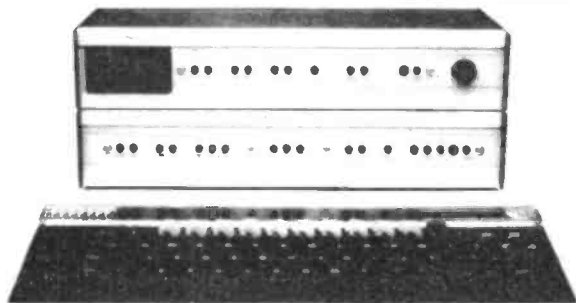

Aerial £34.50
 Pre-amp Kit £4.95 Built £10.95
 Receiver Kit £37.50 Built £48.50 Boxed £79.95
 Interface Kit £49.50 Built £67.50 Boxed £94.50
 Software on EPROM £37.50
 Full Data on system 50p

UoSAT SATELLITES

At last everything you need to receive and display UoSAT data on your BBC computer. Our custom designed software is the first on the open market to decode the data and display it in an easily understood format on the screen. Each channel is identified and labelled with a full description. Using an inbuilt printer dump routine eliminates the need for a printer rom. Written by Tony Ferneyhough this new improved software is rapidly becoming the standard for schools and enthusiasts. A review of the previous version is featured in May R&EW.

Proving our ability to lead the forefronts of RF Technology we have already sold over 2,000 of the receivers and pre amps that this system is based on. Tracking of the aerial and receiver is not needed for any of the satellite passes. For the ultimate the optional data correlator designed by James Miller can be used. Using advanced correlation detection techniques and a matched filter this unit provides stable data under most signal conditions. The correlator is suitable for both UoSAT 1 and 2.

For satellites in education talk to the experts, Timestep Electronics

★	Aerial	£18.50	★
	Aerial cable	30p metre	
	Pre amp kit	£4.95	
	Built module	£10.95	
★	Receiver (MK2) kit	£37.50	★
	Built module	£48.50	
	Software on disc UoSAT 1 or 2	£12.95	
	Data correlator kit	£42.00	
	Built module	£56.50	
★	Receiver and correlator built and boxed	£138.50	★
	Full data	50p	

All prices include postage and VAT.

Mail order only. Please allow up to 28 days for delivery.

TIMESTEP ELECTRONICS LTD, WICKHAMBROOK, NEWMARKET, SUFFOLK.

TELEPHONE NO. 0440 820040 (TECHNICAL ENQUIRIES 3.00 TO 4.00 PM ONLY) TELEX 817015 TIMEST G



MICRO' NET

As Micro' Net is approaching it's first anniversary in print, it seems appropriate to look back at the developments over the past year in the field of amateur radio and data communications over the past year. Perhaps the two most significant developments have been the growing range of specialist computer packages catering for the radio user and the tre-

welcome whether they are old, young or somewhere in-between!

Amateur Radio Software Index

A few brief notes concerning the Software Index are needed to clarify one or two points. All the prices shown include both VAT and Postage & Pack-

best be described as 'support' programs require no interfacing as they are designed to work on a 'stand alone' basis. Examples of these are morse tutors, log books, QRA locators and the 'Global View' Grey Line DX program featured in last month's HRT. Most of the other packages require electrical connection to a transceiver in order to decode off-air signals and the interfacing requirements depend largely upon a) the facilities provided by the host micro and b) the sophistication of the interface used. In the latter case, interfaces can range from simple single transistor connections between rig and micro to advanced filter and PLL type tuning units. Obviously, it would be unreasonable for anyone to expect to get similar performance from a BC108 than from one or two hundred pounds worth of LSI technology!

Some packages are sold with a simple interface included in the price whereas others offer the option of an interface (of varying complexity) for more money. Other programs are marketed on their own leaving the purchaser to supply a suitable interface of their own choosing. Overall people who are new to data comms would probably opt for a cheap route so as to 'test the water'. whereas more established operators would probably have a suitable tuning unit already and would only need the software. With regard to the capabilities of the micro itself, the only thing to watch here is that your machine has sufficient RAM for the application in question. When a program requires that a minimum amount of RAM is present this has been indicated in the Index.

A final point is that the computer industry (be it on a giant industrial or cottage scale) tends to be rather volatile, so it is wise to check on availability and cost before placing an order. Again, if readers find that a software source has either ceased trading or has expanded their range I would be appreciate hearing about it so that the Software Index can be updated.

Celebrating Micro' Net's first birthday, Dave Bobbett, G4IRQ, provides the most comprehensive and up to date index of amateur radio software.

mendous upsurge of interest in this particular area of the hobby.

One problem which faces newcomers to the field these days is not so much lack of software but how to go about ploughing through all the ads in order to locate the package they are interested in. So in the wake of a number of enquiries for such information, we thought that Micro' Net should celebrate its first birthday by publishing a complete and up to date index of all the radio-related software which is currently on offer.

Before embarking upon that mammoth task however, I would like to thank all those readers who have sent in QSL cards for inclusion in the Micro' Net Data Users List. If you've not got around to dropping us a line yet, you'll find the details on p.23 August HRT. All we would like is a card showing the bands, modes and types of data comms which interest you. Eventually we hope to publish a list of participating stations so that people can get in contact with each other.

Still on the August edition, a *trying horrer* crept in somewhere along the line which resulted in the Fareham based AMRAC data comms group being described as a group of 'youngsters'. This should have read 'amateurs', the club's membership covers a broad age range and of course new members are always

ing, because it makes cost comparison much more convenient. There's nothing more irritating than having to multiply everything by 1.15 before you know the *real* cost of an item. Whilst the Index is fairly exhaustive, packages which have been advertised without a price have been omitted, as have packages which are said to be 'available soon'. I subscribe to the maxim that "if it isn't on the shelf then it doesn't exist"! No doubt there will be one or two programs which have evaded the eagle eye and I would be glad to incorporate such products in future issues of the Software Index if readers or sellers drop me a line with the relevant details.

Interfacing

A fairly large number of what can

CALLSIGN	COUNTY	BANDS	SYSTEM
		HF	AMTEXT
		VHF	AMTDR
		UHF	AX.25 PACKET
			B CODE
			CAMBRIDGE
			RTTY
			Others.....
Please send to:- MICRO'NET, PO BOX 48, COLCHESTER, ESSEX			

Fig. 1 Format for the Micro' Net data information card.

MICRO' NET

A complete buyers guide to radio related computer software and peripherals.
Please let the advertisers know you saw them in HRT.

73s

David M. Gadsden
G4NXV.

For Spectrum/QL/BBC:- WD Morse Tutor (cassette £4, microdrive/£5.25" disc £6)

From absolute beginner to beyond RYA and Amateur Radio receiving. Adjust pitch. Set speed to your test level (4-18 wpm). Learn from single characters, via groups with wide spaces to random sentences; decrease spacing to normal. Write down what you hear, then CHECK on Screen or Printer (or speech for Spectrum fitted with Currah Micro-speech). Also own message, random figures, letters or mixed. Punctuation in own message or single characters. Discs may be 40 or 80-track (SPDOS for Spectrum. Price includes postage in Europe, £1 extra outside.
WD Software, Hilltop, St Mary, Jersey.
Tel: (0534) 81392

MORSE (SPECTRUM 48K)

Randomly generated letters and/or numbers at users requested speeds spacing visual and audible presentation, £5.50 cassette or SAE for details:

Educational Software
20 Beaufront Rd.
Camberley GU15 1NF

(G3WHO) BBC RTTY

and AMTOR (as reviewed in Ham August) Software.

SAE or phone for details to:

10 Appleby Close, Gt Alne,
Alcester, Warks, B49 6HJ.
Tel: (078) 981 377.

BBC MICRO SOFTWARE

RTTY/CW Transceive. Send/Receive Morse tutor. Super locator. Sun/Moon Prediction. Multifile. Disc menu/Catalogue. Utilities. TV info.

Please send two SAE/IRC for details:

BLT SOFTWARE
1 Wavel Garth, Sandal Magna,
Wakefield WF2 6JP

AMPROM

The ultimate amateur Radio Communications ROM for the BBC Micro. This ROM is BEEBCOM compatible (Micronet May 1985) with many NEW features, including error-free disk file transfers over air. EMPROM £18.

SAE for details. STAZ callsign with order.

CTP Software
107A Shacklwell Lane
London E8 2EB

DRAGON/TRS80C

A range of high quality radio software available on tape or ROM cartridge.
RTTY Tape £12. Morse Tutor £8.50
CW Transceive £10.75

ROM Cartridge for RTTY, ASCII CW and AMTOR £59

CBM64 - RTTY - Tape £11, Disk £14

CBM64 - CW Tx/Rx Tape £10, Disk £12

ATOM - RTTY - UTILITY ROM £18

All programs feature split-screen, type-ahead operation. State callsign (if any).

SAE for details:

GROSVENDOR SOFTWARE (HRT)
2 Beacon Close, Seaford, Sussex BN25 2JZ Tel: (0323) 893378

MORSE
AMTOR
RTTY
SATELLITE

RTTY and CW TRANSCIVE with NO TERMINAL UNIT

No expensive terminal unit is needed with our program, just a very simple interface. All the right features: split screen, type ahead, 26 saveable memories. auto CR/LF, autotrack CW to 250 wpm, QSO review and more. If you already have a TU, it will give you, too, the same superb features.

For CBM64, BBC-B, VIC20 (+ at least 8k), Tape £20. Interface Kit £5, ready-made £20 Inc all connections (state rig) CW-only version for SPECTRUM (no hardware needed) £12.

And these superb programs CBM64, VIC20, BBC-B ELECTRON, SPECTRUM MORSE TUTOR Britain's best. Absolute beginner to over 40 wpm. Easy, effective, with full learning guide. Tape £6. For ZX81-16k also.

LOCATOR QTH or Maidenhead locator or lat/long. Distances, headings, contest points, converts between locator and lat/long. Tape £7.

LOGBOOK Date, band, mode, call and remarks. Instant callsign search. Screen/printer output. VIC20 needs expansion. Tape £8.

RAE MATHS All the practice and testing you need. With comprehensive reference sheet. Tape £9. For ZX81-16k also.

Any CBM64 or VIC20 program on disk at £2 extra. BBC: please ask.

Prices include VAT and p&p by return 1st class inland, airmail overseas.

Channel Islands, Eire, BFPO Europe deduct 13%.

BBC
COMM 64
SPECTRUM
DRAGON
TANDY
VIC 20

technical software (HRT)

Fron, Upper Llandwrog, Caernarfon, Gwynedd LL54 7RF. Tel: 0286 881886

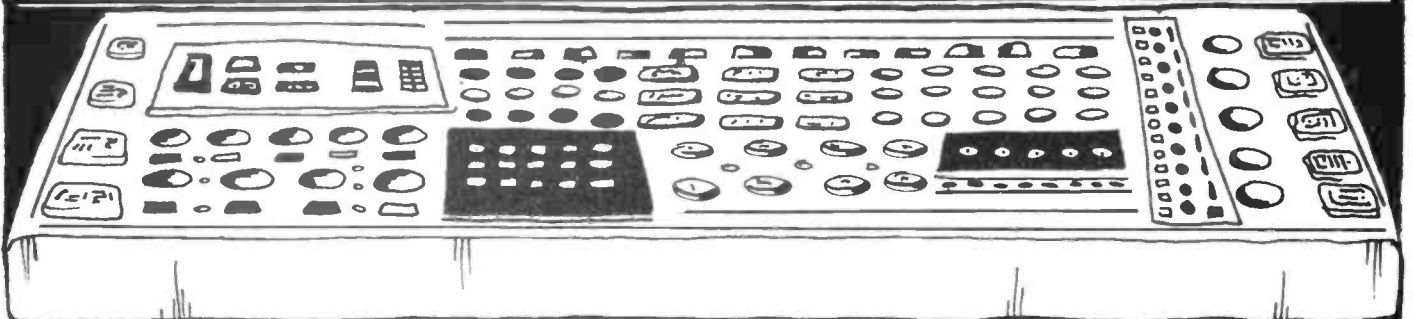

Amateur Radio Software Index

Micro/Program	Interface	Price	Supplier	Micro/Program	Interface	Price	Supplier
Amstrad CPC464				RTTY/CW Tx/Rx (8k+)	Inc I/F	£20.00	T TE
Morse Tutor	N/A	£6.90	T PN	QRA Locator	N/A	£6.00	T TE
Morse Reader	None	£6.00	T JE	Logbook	N/A	£6.00	T TE
Morse Reader	I/F	£2.50	BT JE	Contest Log	N/A	£6.00	T TE
RTTY Tx/Rx	None	£10.50	T WE	RAE Maths (3k+)	N/A	£8.00	T TE
RTTY Tx/Rx	None	£11.00	T SC				
RTTY Tx/Rx	Inc I/F	£78.00	T SC	CBM Pet			
				RTTY Tx/Rx	None	£9.00	T SC
				RTTY Tx/Rx	Inc I/F	£76.00	T SC
Atari 600/800XL							
Morse Reader	N/A	£6.00	T JE	Colour Genie			
Morse Reader	I/F	£2.50	BT JE	RTTY/CW Tx/Rx	Inc I/F	£40.00	T UP
Acorn Atom				Dragon			
RTTY Tx/Rx	None	£12.00	T GR	Morse Tutor	N/A	£5.00	T SC
RTTY Tx/Rx	None	£16.00	R GR	Morse Tutor	N/A	£6.50	T GR
				Morse Reader	Inc I/F	£6.00	T JE
				Morse Tx/Rx	None	£12.36	T PN
Acorn Electron				Morse Tx/Rx	Inc I/F	£32.48	T PN
Morse Tutor	N/A	£6.50	T SC	Morse Tx/Rx	None	£10.75	T GR
QTH Locator	N/A	£7.50	T SC	Morse Tx/Rx	None	£14.00	D GR
Grey Line DX	N/A	£4.00	T AB	Morse Tx/Rx	None	£10.75	C GR
Grey Line DX	N/A	£6.00	D AB	RTTY Tx/Rx	None	£13.80	T PN
				RTTY Tx/Rx	Inc I/F	£58.65	T PN
				RTTY Tx/Rx	No I/F needed	£12.00	T GR
BBC Micro				RTTY Tx/Rx	No I/F needed	£15.00	D GR
Morse Tutor	N/A	£6.00	T TE	RTTY Tx/Rx	No I/F needed	£22.00	C GR
Morse Tutor	N/A	£4.00	T WD	RTTY/CW Tx/Rx	None	£35.00	C GR
Morse Tutor	N/A	£6.00	D WD	AMTOR/RTTY Tx/Rx	None	£59.00	C GR
Morse Tutor	N/A	£4.95	T DB	AMTOR/RTTY/CW Tx/Rx	None	£69.00	C GR
Morse Tutor	N/A	£6.00	T PJ	AMTOR Tx/Rx	None	£44.85	T PN
Morse Tutor	N/A	£6.50	T GO	AMTOR Tx/Rx	Inc I/F	£65.55	T PN
Morse Tutor	N/A	£6.50	T SC	AMTOR Tx/Rx	None	£39.00	C GR
Morse Reader	Inc I/F	£6.00	T JE	AMTOR Tx/Rx	None	£44.00	D GR
Morse Sender	None	£5.00	T SC	AMTOR Tx/Rx	None	£49.00	C GR
Morse Sender	None	£9.00	T SC	Satellite Predictor	N/A	£5.50	T GM
Morse Tx/Rx	None	£8.50	T PA	Satellite Predictor	N/A	£8.50	D GM
RTTY Tx/Rx	None	£7.50	T PJ				
RTTY Tx/Rx	None	£9.50	D PJ	Sinclair ZX-81			
RTTY Tx/Rx	None	£20.00	R PJ	Morse Tutor (16k)	N/A	£6.00	T TE
RTTY Tx/Rx	None	£9.00	T SC	Morse Reader	No I/F needed	£6.00	T JE
RTTY Tx/Rx	Inc I/F	£76.00	T SC	RTTY Tx/Rx	None	£9.75	T SC
RTTY & CW Tx/Rx	Inc I/F	£20.00	T TE	RTTY Tx/Rx	Inc I/F PCB	£13.45	T SC
SSTV Tx/Rx	Inc I/F PCB	£17.50	T SC	RTTY Tx/Rx	Inc I/F PCB & parts	£25.10	T/KT SC
SSTV Tx/Rx	Inc I/F PCB	£19.50	D SC	RTTY Tx/Rx	Inc BT PCB	£30.00	T/BT SC
SSTV Tx/Rx	Inc I/F PCB & parts	£68.50	T/KT SC	QRA Locator	N/A	£3.40	T SC
SSTV Tx/Rx	Inc I/F PCB & parts	£70.50	D/KT SC	Propagation Predictor	N/A	£4.75	T DS
SSTV Tx/Rx	Inc I/F PCB & parts	£79.95	T/BT SC	RAE Maths (16k)	N/A	£8.00	T TE
SSTV Tx/Rx	Inc I/F PCB & parts	£81.95	D/BT SC				
Cambridge Packet Radio	No I/F needed	£2.50	T RA	Sinclair Spectrum			
AMTEXT Packet Radio	No I/F needed	£2.50	T RA	Morse Tutor	N/A	£4.00	T WD
QRA Locator	N/A	£6.00	T TE	Morse Tutor	N/A	£6.00	D WD
QRA Locator	N/A	£7.50	T GO	Morse Tutor	N/A	£6.00	M WD
QRA Locator	N/A	£7.50	T PA	Morse Tutor	N/A	£6.00	T TE
QRA Locator	N/A	£7.50	T SC	Morse Tutor (48k)	N/A	£5.50	T ED
LogBook	N/A	£6.00	T TE	Morse Tutor	N/A	£5.00	T SC
Contest Log	N/A	£6.00	T TE	Morse Reader	No I/F needed	£6.00	T JE
RF Propagation Predictor	N/A	£8.50	T PA	Morse Tx/Rx	Inc I/F	£10.00	T TE
RAE Maths	N/A	£8.00	T TE	Morse Tx/Rx (48k)	None	£9.00	T SC
Grey Line DX	N/A	£4.00	T AB	Morse Tx/Rx (48k)	Inc I/F PCB	£15.00	T SC
Grey Line DX	N/A	£6.00	D AB	Morse Tx/Rx (48k)	Inc I/F PCB & parts	£31.50	T/KT SC
				Morse Tx/Rx (48k)	Inc BT PCB	£37.50	T/BT SC
Commodore CBM64				Morse Tx/Rx (48k)	Inc I/F PCB	£15.00	T SC
Morse Tutor	N/A	£6.00	T TE	RTTY Tx/Rx (16k)	Inc I/F PCB	£17.50	T SC
Morse Tutor	N/A	£5.00	T SC	RTTY Tx/Rx (48k)	Inc I/F PCB & parts	£29.00	T/KT SC
Morse Tutor	N/A	£6.00	T JE	RTTY Tx/Rx (48k)	Inc I/F PCB & parts	£31.50	T/KT SC
Morse Tutor	Inc I/F	£6.00	T JE	RTTY Tx/Rx (16k)	Inc BT PCB	£35.00	T/BT SC
Morse Reader	N/A	£10.00	T GR	RTTY Tx/Rx (48k)	Inc BT PCB	£37.50	T/BT SC
Morse Reader	N/A	£12.00	D GR	RTTY Tx/Rx (48k)	Inc I/F	£41.50	T AM
RTTY Tx/Rx	None	£10.50	T SC	RTTY Tx/Rx (16/48k)	None	£9.00	T G4
RTTY Tx/Rx	None	£78.00	T SC	RTTY Tx/Rx	No I/F needed	£10.00	T BJ
RTTY Tx/Rx	None	£11.00	T GR	RTTY/CW Tx/Rx	Inc I/F	£40.00	T UP
RTTY Tx/Rx	None	£14.00	D GR	QRA Locator	N/A	£6.00	T TE
RTTY/CW Tx/Rx	Inc I/F	£20.00	T TE	QRA Locator	N/A	£5.00	T SC
RTTY/CW/SSTV Tx/Rx	Inc I/F	£110.50	C ZE	Logbook (48k)	N/A	£5.00	T SC
+ Word Proc				Logbook	N/A	£6.00	T TE
QRA Locator	N/A	£5.00	T SC	World Prefix Map (48k)	N/A	£6.25	T SC
QRA Locator	N/A	£6.00	T JE	RAE Maths	N/A	£8.00	T TE
QRA Locator	N/A	£6.00	T TE				
Logbook	N/A	£6.00	T TE	Sinclair QL			
Contest Log	N/A	£6.00	T TE	Morse Tutor	N/A	£4.00	T WD
RAE Maths	N/A	£8.00	T TE	Morse Tutor	N/A	£6.00	D WD
				Morse Tutor	N/A	£6.00	M WD
Vic-20							
Morse Tutor	N/A	£6.00	T TE	TRS80			
Morse Reader	Inc I/F	£6.00	T JE	RTTY/CW Tx/Rx	Inc I/F	£40.00	T UP
RTTY Tx/Rx	None	£9.00	T SC	Morse Tx/Rx	None	£10.75	T GR
RTTY Tx/Rx	None	£76.00	T SC	Morse Tx/Rx	None	£19.75	C GR
RTTY Tx/Rx	None	£10.00	T GR				

Micro/Program	Interface	Price	Supplier
RTTY Tx/Rx	No I/F needed	£12.00 T	GR
RTTY Tx/Rx	No I/F needed	£22.00 C	GR
RTTY/CW Tx/Rx	None	£35.00 C	GR
AMTOR/RTTY/CW Tx/Rx	None	£59.00 C	GR
AMTOR Tx/Rx	None	£39.00 C	GR
AMTOR Tx/Rx	None	£29.00 T	GR

Video Genie	Interface	Price	Supplier
RTTY/CW Tx/Rx	Inc I/F	£40.00 T	UP

Notes

- All prices quoted include both VAT and postage and packing within the UK.
- Software sources which do not quote prices in their adverts have been omitted.
- Although the information given was correct as of August 1985, readers are advised to check prices before ordering.

Key to Abbreviations

Software Format

T = Tape
D = Disc
R = ROM
C = Cartridge
M = Microdrive

Others

N/A = Not Applicable
I/F = Interface
BT = Ready built
KT = In kit form
(16k) = Minimum RAM needed

Key to Suppliers Addresses

AB	'Global View Offer', A&B Computing Editorial, No. 1 Golden Square, LONDON. W1R 3AB
AM	AMTEC Electronics, 25 Wychwood Ave., LUTON, Bedfordshire. LU2 7HT
BJ	B & J Telecommunications, 9 Queens Walk, THORNBURY, Nr Bristol Tel: (0454) 416381

DB	D Brandon, 1 Woodlands Rd., CHESTER. CH4 8LB
DS	D Sumner, 20 Woodlands Way, SOUTHWATER, W Sussex.
ED	Educational Software, 20 Beaufront Road, CAMBERLEY Surrey GU15 1NF
GO	GOC Software Ltd, 'CQ Cottage', Longhill Lane, AUDLEM, Cheshire. CW3 0HU
GM	GMT Software, 4 Werneth Close, DENTON, Manchester.
GR	Grosvenor Software, 22 Grosvenor Rd., SEAFORD, East Sussex BN25 2BS Tel: (0323) 893378
G4	G4IDE Micro Systems, 79 South Parade, BOSTON, Lincs. PE21 7PN Tel: (0205) 63454
JE	J E Price, 4, Houseman Walk, KIDDERMINSTER
PA	PAEAN Systems, Little Bealings, WOODBRIDGE, Suffolk. IP13 6TL Tel: (0473) 623757
PJ	P J Harris, 10 Appleby Close, GREAT ALNE, Alcester, Warks. B49 6HJ. Tel: (078981) 377
PN	PNP Communications, 62 Lawes Ave., NEWHAVEN, East Sussex. BN9 9SB. Tel: (0273) 514465
RA	RAMTOP, Great Billing Rectory, NORTHAMPTON. NN3 4ED
TE	Technical Software, Fron, Upper Llandwrog, Caernarfon. LL54 7RF. Tel: (0286) 881886
SC	Scarab Systems, 39 Stafford St., GILLINGHAM, Kent. ME7 5EN Tel: (0634) 570441
UP	Update Computer Systems, 83 Nora Street, High Barnes, Sunderland. SR4 7QN Tel: (0783) 288598
WD	WD Software, Hilltop, St Mary, JERSEY. Tel: (0534) 81392
WE	Ward Electronics, 422 Bromford Lane, Ward End, Birmingham. B8 2RX Tel: (021328) 6070
ZE	ZERO Electronics, 149 King Street, Great Yarmouth. NR30 2PA Tel: (0493) 842023

HI-TEC WORLWIDE

Specialist Communications Distributors



A SIGN OF TECHNICAL EXCELLENCE

ARE YOU PAYING TOO MUCH?

If you're looking for a handheld chances are you will want to be sure that you're buying quality. For long reliable service you will probably have grave doubts about cheapy's and rightly so, but the regular makes are so expensive. **WELL AT LAST** there is a high quality alternative, the **KENPRO KT200EE/KT400EE**. **KENPRO's** uncompromising quality is already well known in the UK and now we are the appointed distributors for **KENPRO** transceivers with full service back-up reinforced by direct factory contact, so if you don't want to risk quality, **KENPRO** has the answers and for a limited period its on offer at a special introductory price and with a **FREE CHARGER**.

KT200EE VHF Transceiver - 140-150MHz
— £169 + £5.00 p&p
KT400EE UHF Transceiver - 430-440MHz
— £189 + £5.00 p&p
Standard accessories, nicad pack — flexible antenna — ear phone — hand strap-belt suspender.
Full UK specification, tone-repeater shift — etc.

Optional accessories

KTSMI speaker mic. £19.50
KTBMC mobile charger lead £4.50
KTLC leather case £5.50
KTBP(H) Hi-power ni-cad pack (3w) £33.00

Brochures etc on request, instant finance available, written details upon application.

TRADE ENQUIRIES
WELCOME



584 HAGLEY RD WEST, OLDBURY, QUINTON, BIRMINGHAM B68 0BS.
TEL: 021-421-6001 TELEX: 334303G-TXAGWM

dressler

191 FRANCIS ROAD
LEYTON · E10

OPEN: MON - SAT 9AM - 5.30PM

HP FACILITIES AVAILABLE

PROMPT MAIL ORDER

JUST ARRIVED
The very latest in HF receivers.
Phillips D2999
call in for a test drive

TEL. 01-558 0854 / 01-556 1415



TELEX 8953609 LEXTON G



ICOM
IC2E 2MTR ● IC02E
IC4E 70CMS ● IC04E
+ ALL ICOM
ACCESSORIES



TRIO
KENWOOD
TH-21
TH-41





YAESU
FT
209



YAESU
FT
203R

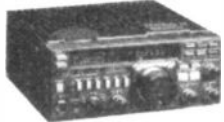

<p>AOR 2001 £330</p>  <p>25-550MHz</p>	<p>YAESU FRG-9600 "see this months review"</p>  <p>60-905MHz AM · FM · SSB</p>	<p>HX 4000</p>  <p>60-89, 118-174, 380-495, 800-950MHz. 5-10-12-5 25KC steps complete with mount, NiCad charger and antenna £320.00</p>	<p>ICOM R71</p>  <p>100KC-30MHz AM FM SSB CW GEN. COV.</p>	<p>YAESU FRG 8800</p>  <p>+ OPTIONAL FRV8800 CONVERTOR GEN. COV.</p>
<p>HX 2000E An excellent hand-held scanner</p>  <p>60- 80MHz 118-136MHz 138-174MHz 436-490MHz 490-525MHz AM/FM 5-10-12½Kc steps</p>	<p>TRIO-KENWOOD R600</p>  <p>TRIO-KENWOOD R2000</p> 	<p>ICOM IC-751</p>  <p>ALSO AVAILABLE IC-745</p>	<p>YAESU FT-757GX</p>  <p>+ FP757 HD PSU + FC757 ATU</p>	<p>TRIO-KENWOOD TS-940</p>  <p>£1,695 inc. auto internal a.t.u.</p>

ANTENNAS AVAILABLE 3 & 5 ELEMENT MOBILE WHIPS
VERTICALS RX & TX

50 MHz IS COMING!!



50MHz MAST-HEAD PRE-AMP AVAILABLE SOON

IC505

IN STOCK YAESU 50MHz/726 MODULE IN STOCK

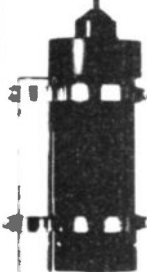

dressler - ara 30 - active antenna
200 kHz . . . 40 MHz

Professional electronic circuitry with very wide dynamic range. Meets professional demands both in electronics and mechanical ruggedness. 120 cm long glassfibre rod. Circuit is built into waterproof 2.5 mm thick aluminium tube. Ideal for commercial and swl-receiving systems. £90
See Review in August Issue p.15

AVAILABLE SOON
ARA 500 ACTIVE ANTENNA 50-500MHz

DIAWA ROTATORS IN STOCK

VHF POWER AMPS.

D200 2MTR. 300w F.M. 550w SSB £699
D200S 2MTR. 400-500w 1Kw. D.C. in £799
D70 70cms 325w F.M. 500w SSB £799
NEW MODEL DUE SOON
1296 MHz. 1w-in-10w-out.

* NEW *

DRESSLER

1296 Masthead Amps
EVV 1296 - EVV 1296C
EVV 1296S



ANTENNAS JAYBEAM

TONNA · TET

DRESSLER FULL RANGE STOCKED MAST HEAD PRE-AMPS

GAAS FET

POWER HANDLING UP TO 1KW
-7 to -9dB NOISE 15 to 19dB GAIN
0-2dB INSERTION LOSS

EVV200 GAAS 2MTR. 750W SSB Through power £80
EVV2000 GAAS 2MTR 1KW SSB Through power £90
EVVPS receive 2MTR only £50
EVVPS receive 70cm £50
EVV700 GAAS 70cm. 500W SSB £90
EVV70 GAAS 70cm 100W £60
EVV2 GAAS 2MTR 100W £85
VY200V0X GAAS 2MTR 250W SSB £21
INTERFACE
DRESSLER ASA12 Mast Head Coaxial 2 in 1 out Switch with 'N' Connector 1Hz-1GHz 1KW. PEP 0.15dB Insertion Loss £45

PHONE THE REST . . . THEN PHONE US FOR THE BEST PRICES

Review: Yaesu



FRG 9600

Scanning receivers pack more and more facilities into less and less space. This latest offering from Yaesu appeared in the advertisements to be about the normal size or a receiver, but, actually measuring 180 x 80 x 220mm, it is a lot smaller than I expected!

Despite the sophistication of the facilities, when you actually look inside the receiver, there isn't a lot there! The reason is simple: the use of the latest technology, especially liberal use of chip resistors and capacitors on the underside of the PCB's, leaving only the inductors, ICs and other larger components on the top. The resultant saving in space leaves a lot of air in the case — the determining factor for size really being the front panel and display. I suspect it could have been made a lot smaller, but then one would have run into the usual problem of very closely spaced buttons and consequent operator inconvenience.

Before starting in earnest, I should mention that the normal licences you may hold only cover you for reception of broadcast and licensed amateur stations. Listening to anything else is illegal; although that doesn't seem to stop anyone listening to the police, air traffic, ambulance, PMR, radio-telephones etc.

Is this just another scanning receiver from Japan, or has it something more to offer?
Tony Bailey, G3WPO,
finds out...

The FRG9600 is a VHF/UHF scanning receiver with full coverage from 60 — 905MHz. It has the added facility of SSB and CW as well as the usual narrow and wide band FM and AM plus an optional video interface for output to a monitor. The manual claims that the SSB facility only extends as far as 460MHz but it appeared to work up to 900MHz in practice. However, I couldn't find any SSB stations above 460MHz, so it is almost certainly a question of stability above this frequency.

Basic Requirements

In an earlier article on scanning receivers (August 1984), I laid down the following basic requirements for a good scanning receiver.

1. Coverage of all desired frequencies in one receiver.
2. Minimum number of antennas needed for the frequencies covered.

3. Adequate sensitivity, bearing in mind the frequencies you need to receive and type of antennas to be used.

4. Lack of image response when wide spectrum coverages are planned.

5. Choice of scanning rates and steps — suitable for the frequencies and mode/channel spacings in use.

6. Selectable facilities for either continuously staying on a signal once found, or automatically continuing to scan after a predetermined period.

7. Choice of continuous frequency coverage, or programmable set of individual frequencies.

8. 12V operation for mobile or portable use (plus emergencies) with memory back up.

The first requirement is pretty well covered by the FRG 9600, with 60MHz being a bit higher than say the AOR2001 (it's a pity it doesn't cover our new 50MHz allocation!) and 905MHz well up on many including the AOR2001 which only goes to 550MHz. This extra UHF coverage is more of interest to the TV enthusiast, and (unfortunately) doesn't quite reach the 934MHz CB allocation. The optional video IF unit allows reception of NTSC format pictures on a video monitor. You can of course listen to TV sound without any problems (but do you need a TV licence for this?).

Antennas for this receiver, as per requirement 2, are a little more difficult. The ideal arrangement is a bank of switched beams for the spectrum, but I doubt that many listeners could run to this! The cheaper alternative is to use a wideband discone type of system which are obtainable from many of the distributors. A home made version was used for this review.

Sensitivity is good across the whole frequency range, with better than 1.0uV for 10dB S+N/N available in most modes. Squelch is provided for all modes, but was found to be poor on AM with perfectly readable signals refusing to open it at minimum threshold.

The image response is

reasonable for a receiver of this wide spectrum coverage (quoted at -50dB up to 460MHz and -40dB above) and will be helped by resonant aerials if these are used. During operation, some air traffic was found within the 2 metre amateur band (my QTH is fairly close to Gatwick and under Amber One air route) and the odd taxi popped up where it shouldn't. This is a difficult problem to overcome unless banks of switched preselector filters are used which increases the cost a lot.

Signals From Within . . .

There are a number of sproggies within the coverage, as one might expect, although they were not mentioned in the specification. There are quite a lot of weak ones not worth detailing, but also some very strong ones which will cause problems if you monitor near them. In particular, 70.103, 70.112 and 70.119 have S9+ spurii nearby. These are associated with the second harmonic of one of the conversion crystals on 35.06MHz. Likewise, higher harmonics give rise to more on 105.18, 140.24 etc, these two also being S9. Again, the 10.245MHz conversion crystal (the IF's are 45.754, 10.7 and 455kHz) gives audible harmonics from the 6th upwards but at very low levels.

Frequency Control

The scanning and general frequency control facilities are comprehensive and include the ability to computer-interface the rig using the Yaesu CAT system to a home computer. This does open a lot of possibilities looked at later.

Basic frequency control is via an optional encoder/front panel tuning knob and a keypad - the latter appears a bit more durable than some offerings. Rotating the tuning knob produces changes in frequency by increments depending on both the mode and the step rate selected via a front panel button. For AM wide and FM narrow, the step rates are 5, 10, 12.5 and 25kHz - these are shown on the digital display at the right hand side. With SSB (USB or LSB) and AM narrow, the step rate reduces to 100Hz or 1kHz, again selectable but this time not indicated by the

display. Finally, for FM wide, the only step rate is 100kHz.

The Display

The 9600 uses a green fluorescent type of display, easily readable under any lighting conditions, showing the frequency in the form '200.101.2' (ie to 100Hz). In addition there are various annunciators for mode and frequency step rate, plus the memory channel which when used displays two digits, such as '45'. It also incorporates the 'S' meter, a bargraph-type display with the colour changing to red when over S9.

The initial dial frequency can be entered in several ways. The usual one will be via the keypad and is a simple operation; you punch in the full frequency required (adding a preceding '0' if under 100MHz), then press 'dial'. Error entries get a double beep, while correct ones are marked by a single beep (you can't kill the beep if it annoys you!). You can then tune around from that entered frequency. The alternative is to recall a start frequency from memory by punching in the two figure memory channel, then pressing 'M-D' (memory to dial). All keypad entries can be cancelled via the CE button.

100 Memories

In all, the FRG9600 has 100 memory channels available (101, if you include the dial setting), each of which will hold the frequency *and* mode for that channel. Inputting to a memory is quite simple if you have a frequency on dial which you wish to store, say in memory channel 03, then you punch in '03', followed by the 'D-M' button. The receiver stays in the dial state. To recall a memory there are two options: you can punch in the two digit memory number followed by the 'MR' (memory recall) button. The memory channel number is then displayed to the right of the main frequency display, together with the memory frequency. Alternatively just press 'MR', in which case the receiver goes to the last selected memory.

Once a memory channel is on display, there are several options as to how you move around. Rotating the main tuning knob will step through all memory channels which

have something stored in them. If you have information stored only in channels 01, 05, 13, 56, 78 and 99 then it will ignore all the others and just show these in a continuous rotating sequence.

The other methods illustrate one limitation of the rig, which is that the memories are not continuous but split into ten banks of ten memories numbered 00-09, 10-19, 20-29 etc. The main tuning dial is the only method (other than computer control) by which all the memories can be continuously checked. If you opt to scan the memories, you are limited to scanning one memory 'block' at a time. This is itself is not a major problem with such a wide frequency spectrum available it means you are not forced to scan every channel if you don't want to. However, the option to scan all 100 memories is not available (again, except by computer control when you can have thousands of memory channels if you want to). Looking through one bank of memories can either be accomplished manually by using the 'up' and 'down' buttons (these also step the frequency when in dial mode); or, by pressing one of these two buttons for about half a second.

The scan rate is about 2 channels per second with options on how the scan is stopped. Option 1 uses the squelch and stops as soon as this is opened by a signal. While stopped, each digit in the display is flashed briefly over a period of 8 seconds, and at the end of this time the scanning resumes. Also, every time the scan halts, you get a beep which will drive you round the bend after a while.

Option 2 is designed to overcome the 'dead carrier' syndrome where the receiver spends a lot of time on plain carriers (or even the sproggies . . .). Another button, the AF scan, will only allow the scan to stop if there is modulation on the carrier, irrespective of the squelch setting. This is fine as an idea, but suffers on AM from the same problem as the squelch. You still tend to need a strongish carrier to stop the scan for some reason.

Once you have a memory frequency up on the dial, you cannot immediately tune away from it, or change the mode it is associated with. However, if you press 'M-D' the memory transfers to the dial

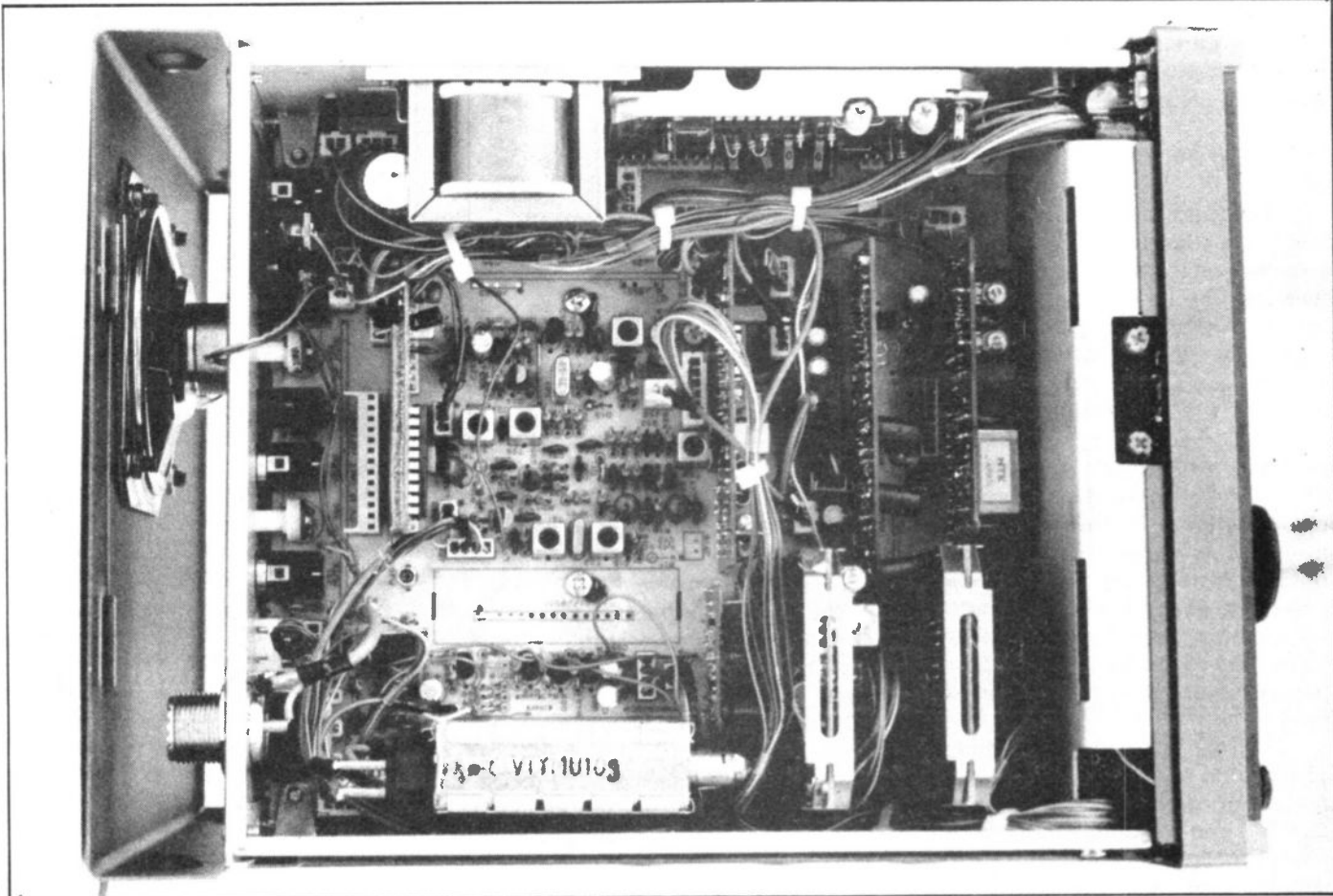

mode and off you go. This facility is extremely useful and does save a lot of keypad punching.

All memory frequencies (and the last dial frequency) are supplied by a Lithium back-up battery so you can de-power the rig and not lose this information. Once or twice I did lose individual banks of memories for some reason; it appeared to be connected with the way the receiver was switched off and seemed to happen if you removed power direct from the 9600 without switching it off on the front panel first.

One of the reasons for having banks of ten memories is quite sensible. Over such a wide coverage, there are bound to be individual segments where a number of individual channels are of interest. For instance, if you are into WBFM DX, you will want to store a number of frequencies around 88 – 108MHz and be able to scan these without listening elsewhere at the same time. Again, you may have all the 2 metre repeaters of interest in another block.

It is possible to only scan selected parts of the spectrum by using any two adjacent memory

channels as frequency limits. Say you have 145.000MHz in channel 13 and 145.750MHz in channel 14. If you transfer memory channel 14 to the dial (14 followed by M-D), then start the scan, the rig will scan from 145.750 down to 145.000 in steps selected, then start over again. It is important that the lower frequency limit is in the lower of the two memory channels; if you had 600MHz in channel 13, the rig would scan from 145.750MHz, down to 60MHz, then jump to 905MHz then down to 600MHz before starting again – this can lead to some funny scans if you are not careful. If the scan is stopped, tuning with the main dial is still limited to this preset band, which can be useful. To escape from this preset band, another frequency has to be keyed into the dial.

Another feature common to many scanners, even the simple ones, is priority channel monitoring, where a specific frequency can be checked every 6 seconds while listening somewhere else. This only works for one dial frequency and the selected memory, and not, for instance, during scan mode.

There is one use for this receiver which will be of particular interest to DX fans and propagation watchers, especially if you have the computer interface and an A-D converter for the 'S' meter output. It is possible to monitor a bank of channels spread over the whole spectrum and continuously watch for appearance of DX signals (broadcast stations, beacons and such like). These can appear on a print out, together with time, frequency, strength etc and could be very useful in being first at the DX when it appears on, say, 50, 70, 144 or 432MHz.

Timing

Also incorporated in the receiver is a digital clock, selectable to appear on the display rather than the frequency. Although it doesn't affect the receiver reception, it disables further operations. The initial time is entered via the keypad in a similar manner to the frequency (24 hour format). Once in, it can be used simply as a clock, or with a bit more keypad operation, as an on/off timer and 'snooze' facility. Note that the battery back-up does

SOUTH MIDLANDS COMMUNICATIONS



COVER THE SPECTRUM...

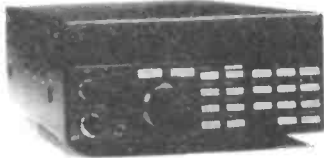

FRG 9600 £499
60-905MHz Continuous. NBFM, WBFM, AM(W+N) & SSB*
100 Memory Channels. 7(W) X 3(H) X 8½(D) Ins. * SSB up to 460MHz

Both Yaesu receivers feature keyboard frequency entry and spin tune VFO as standard and optional computer control



FRG 880 £475
0.15-30MHz (118-174MHz)*. AM/W, AM/N, SSB, CW/W, CW/N
NBFM Standard (WBFM Option). 12 Memory Channels. * Optional Unit.

COVER THE WORLD...

NRD 515 £998 MS 8400A £219 SX 7000 £399



SEND LARGE SAE FOR DETAILS
SM HOUSE, RUMBRIDGE ST, TOTTON
SOUTHAMPTON SO4 4DP. ENGLAND. TEL: (0703) 867333

KW TEN-TEC CORSAIR II

NO FRILLS, "GIMMICKS", OR UNUSED FACILITIES — FOR THE SERIOUS PHONE/CW OPERATOR WHO WANTS THE LOWEST NOISE, CLEANEST AND MOST SELECTIVE AMATEUR hf TRANSCEIVER ON THE WORLD MARKET.



Other KW-TEN TEC winners

The ARGOSY II phone/cw transceiver
The CENTURY 22 cw only transceiver

WRITE OR PHONE FOR DETAILS

KW TEN-TEC LTD

Vanguard Works, Jenkins Dale, Chatham, Kent, ME4 5RT
Tel: 0634 815173

BECOME A RADIO AMATEUR

Train now for the Radio Amateur Licence examination. No previous knowledge needed, only a few hours per week of home study for 3 to 6 months. Post coupon now for details or tel. 062 67 6114(24 hr service)

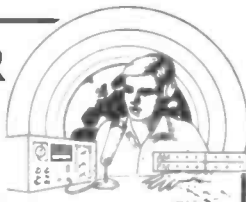

British National Radio & Electronics School, P.O. Box 7, Teignmouth, Devon, TQ14 0HS



FREE brochure without obligation from:—
British National Radio & Electronics School
P.O. Box 7, TEIGNMOUTH, DEVON, TQ14 0HS

Name

Address

HRT10

BLOCK CAPS PLEASE

RAINBOW COMMUNICATIONS

HOME

G5RVs
½ size £9.50
F/S £12.50
½ wave verticals
for 10m £11.90
Centre loaded
mobile whips
from £8.95
25 watt linears
from £20
Repairs & Service

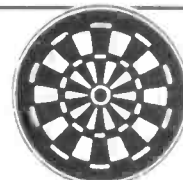

AWAY

MET
AKD
SUN
ALTRON
JAYBEAM
LCL + DNT
CBs with 10FM
conversion kits
or ready
converted.

TEL: 01-640-1904

ASK FOR HOWARD
(G4VWR) OR WIN

OPEN TILL 8pm MON - SAT
MAIL ORDER WELCOME

68 Gorringe Park Ave.,
Mitcham, Surrey

SOUTH LONDON'S BUSIEST EMPORIUM

FARNBOROUGH COMMUNICATIONS

FOR ALL YOUR AMATEUR REQUIREMENTS



Call and bargain with MICK G4MPW
DRAE ● MICROWAVE MODULES ● J.BEAM
SHURE MICS ● ADONIS MICS ● WELZ ●
OSKERBLOCK ● BENCHER ● TVI FILTERS
● CABLES ● MIRAGE AMPS
● RSGB PUBLICATIONS ●
AND SO MUCH MORE

Call Mick
G4MPW
for best
bargains.

Instant HP
Terms. Ask
for details!



97 - Osbourne Road, North Camp
Farnborough. Tel: 0252 518009
Mon-Sat 10-6



AMATEUR ELECTRONICS UK

G6XBH



R.A.S. (Nottingham)
Radio Amateur Supplies
Tel: 0602 280267

G8UUS



Visit your Local Emporium

Large Selection of New/Used Equipment on Show

AGENTS FOR: ICOM F.D.K. Barenco Mast Supports
YAESU AZDEN DRAE PSU and Wave Meters
FORTOP ATV Microwave Modules

ACCESSORIES: Welz Range Adonis Mics Mutek Pre-Amps

AERIAL: Tonna, Halbar, New Diamond Range of Mobile Whips

PLUS OWN

'Special' Q.R.P. GW5 HF5 Band Beams
JUST GIVE US A RING

Monday: CLOSED Tuesday-Saturday: 10.00am to 5.00pm

3 Farndon Green, Wollaton Park, Nottingham
Off Ring Rd. between A52 (Derby Rd.) & A609 (Ilkeston Rd.)

ALL MODE TRANSCEIVER

The accessory circuits, with the exception of the actual thermal sensor, are built on one single sided PCB, which is mounted on the rear panel of the Omega case behind the repositioned QRP PA. The board is split into two — the current transformer circuit and the remainder of the detection and metering circuit. A brass or tinplate screen separates the two halves on the top the PCB.

The PCB assembly is not particularly difficult. Please note however, that in the April part of Omega, the CAL SWR control is referred to on p56 as VR1 when it should be RV1.

1. Insert and solder the 1mm PCB connection pins at the points shown with larger black circles on the overlay. Note that the centre conductor connections from the current transformer primary are made direct to the PCB holes and not via pins.

2. Insert and solder all the components in the metering section of the board. Note that both C10 and C6 are mounted on the track side of the board and are soldered, with short leads, directly between the IC pin and earth (pin 4).

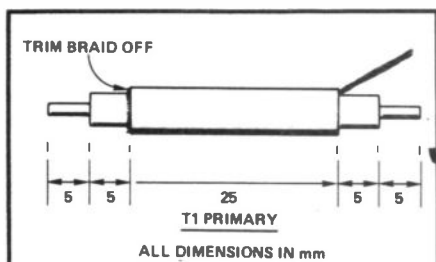
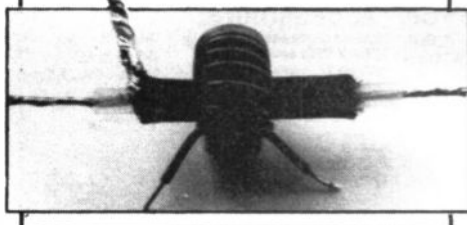

Fig. 1 Detail of the T1 primary.



PROJECT



Part 12

*Tony Bailey, G3WPO,
and Frank Ogden, G4JST,
continue with the
construction, alignment
and mounting of the
accessory PCB.*

3. Next insert and solder all the components except T1, in the RF section. TC1 should be inserted with the 'shoulder' end at earth potential to avoid the 'screwdriver effect' when adjusting.

4. Cut a 45mm length of 1/4" coaxial cable and trim as shown in Fig. 1. Pigtail the braid remaining at one end. The secondary of T1 is wound using 40cm length of 0.56mm dia. enamelled copper wire for 15 turns. Trim the ends to 10mm and slide over the coaxial cable. Insert the ends of the secondary in the appropriate holes and then solder the coaxial cable ends into place, followed by the secondary windings.

5. Solder the centre screen into place.

Alignment

Some of the functions can be tested before wiring the whole unit into place; although some further minor adjustments will be required afterwards, to take out the resistance of the logic switch meter changeover circuit. This can be avoided if the meter connections to the unit are made via the appropriate terminals on the logic boards (see Omega parts in Nov '83 and April '85 issues) and all adjustments made in transmit mode. The following steps assume that the above connection is made and that the front panel meter is replaced with the scale shown in Fig. 2.

1. Adjust all presets to mid-travel. Connect an earth and a source of +12V to the PCB. Put a flying lead from the meter's +ve terminal (pin M on the logic switch) to pin N on the accessory PCB. The -ve terminal of the meter (pin R on the logic switch) should be connected to earth.

2. Apply power and adjust VR5 so that the meter reading is the same as the power supply voltage being used.

3. Change the meter connections so that the meter +ve terminal is to pin G and the -ve terminal to earth. Set VR4 so that the meter reads FSD.

4. Temporarily connect up the temperature sensor across pins H and J (it has no polarity) and an LED (cathode to pin K, anode to +12V). *Very carefully* hold your soldering iron bit near to the sensor tab *but do not touch it*. After a while, the LED should illuminate and the resistance of the collector of Q3, measured with respect to earth, should decrease — thus showing that the sensor is working.

The next stage requires that the accessory board be mounted on the

Fig. 2 The replacement scale for the front panel meter (actual size).

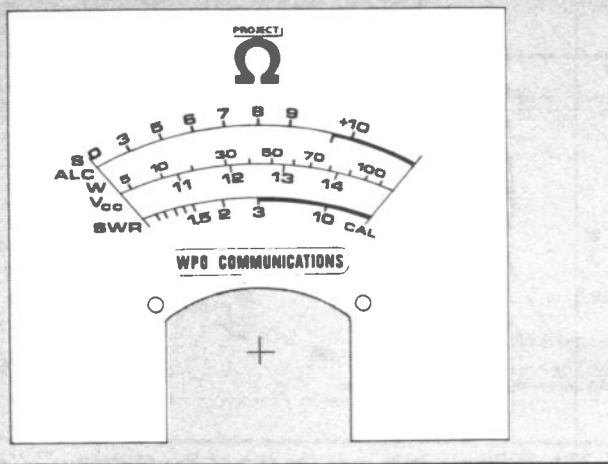

rear panel and connected up to the PA (or another source of power RF). It is mounted using a 6 BA bolt and nuts already in place from constructing the PA, and two further 6 BA 12mm long 6 BA bolt/nut combinations. The output from the low pass filters goes to the input of the accessory PCB — the lead being taken through the side of the internal screen via a grommet which is mounted in one of the holes originally intended for a feedthrough. The output from the PCB then goes back to the SO239 panel socket via another grommet in the remaining feedthrough hole.

For accurate setting up of the power metering function, you will require another power meter with known calibration and a 100W dummy load. The accuracy of the Omega metering circuit should be $\pm 15\%$, or better, after calibration — depending on the meter it is calibrated against.

It will assist working on the PCB if the various leads between the PCB and the PA compartment, are long enough to allow the rear panel to be laid flat on the bench. A temporary heavy earth lead should be connected between the rear panel and the main case chassis.

1. Connect the +ve terminal of the meter to pin C on the PCB, and the -ve terminal via RV1 front panel control (100k — CAL SWR) to earth — set this control to about $\frac{1}{2}$ travel. Apply power and run about 50W of RF into the dummy load on 28MHz. Carefully adjust TC1 for minimum reading on the meter, adjusting the front panel control as necessary for a measurable reading. Then reconnect the meter +ve to pin D, and set RV1 front panel control so that the meter

reads exactly FSD.

2. Without changing the RF power output, or adjusting any controls, change the coaxial input connection of the accessory PCB over to the output, and vice versa. Reapply power and adjust preset VR1 on the PCB so that the meter reads exactly FSD. This calibrates the SWR function. Replace the coaxial leads in their correct positions!

3. The power scale can be

calibrated if a suitable power meter is to hand. Set up on 14MHz and connect the meter +ve terminal to pin E, with -ve to earth. Using an RF power output that will give approximately mid-scale reading on the Omega power meter, and that will correspond with a calibration point on the external meter, set preset VR2 so that the meters agree.

4. The ALC function is set up as follows. Connect pin F to the slider of the drive control, pin G to the meter +ve, and meter -ve to earth. You will need to know which of the bands on your transceiver is the most inefficient i.e. which band requires most current to the PA for a given power output. Once you have established this, set the PA output for exactly 100W on this band, then adjust VR3 so that the ALC meter indication just starts to drop from FSD.

In use, never allow the ALC meter to drop past the indicated safety zone of $\frac{1}{4}$ FSD in any mode.

5. Thermal trip. The sensor mounts

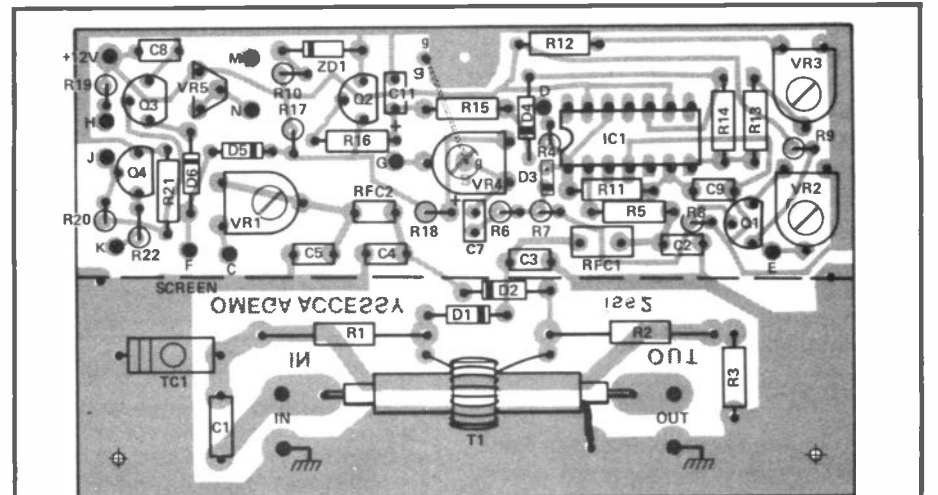

Top: overlay diagram of the Omega accessory board.

NOTE: LINK 9-9 ON UNDERSIDE
C6 & C10 ARE MOUNTED ON UNDERSIDE

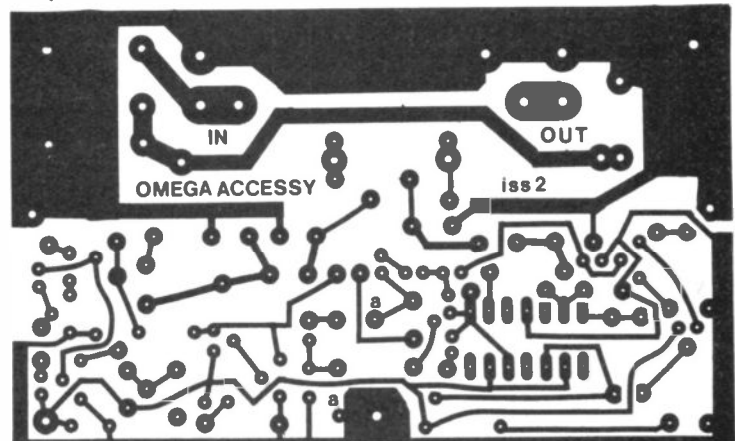

Bottom: Foil pattern, etched area shown in white.

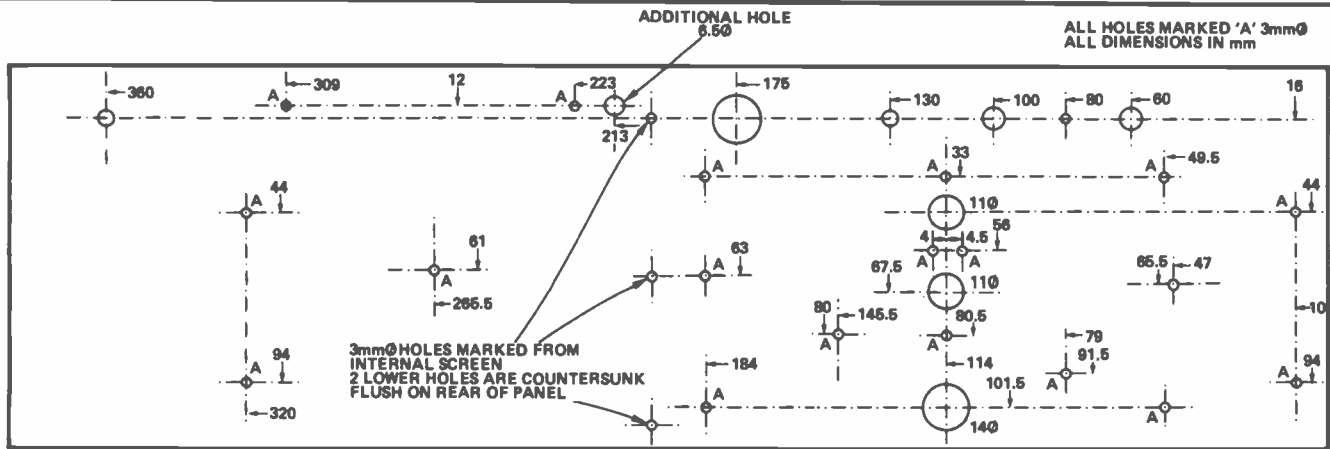

Fig.3 The QRP PA rear panel drilling detail. The additional hole is at the top of the diagram.

on the rear of the interface plate, behind the head of the bolt immediately above the top PA transistor. This bolt should be removed, the sensor tab mounted with a very small amount of heatsink compound and then replaced, with its pins facing upwards.

Bend the sensor pins back away from the interface plate. Use a length of twisted pair insulated wire to link the pins of the sensor (use sleeving at the solder junctions to avoid shorts) along the top of the interface plate and back in through the grommeted hole to the right of the SO239 socket with pins J & H on the accessory PCB. The twisted pair can be run in a length of sleeving to improve the appearance if required. Note: the grommeted hole referred to appears to be missing from the drilling diagrams published so far — its position is shown as the additional hole X in Fig.3.

Finishing Wiring

The permanent wiring may now be made, using the diagram given on p56 of the April '85 issue. +12V to the PCB comes from the feedthrough on the side of the PA screen. Run the PCB wiring that goes to the front panel switch/controls as a multiple twisted pair, dropping straight down from the PCB, between the VCO and screen and thence along the base of the chassis to the front panel controls.

The sensor LED indication uses the spare LED provided on the front panel which originally had no allocation.

More Omega

The final part of the Omega series will be the AM/FM adaptor,

Component Listing

Resistors		C7	10n ceramic disc
R1,2	27R1W	C11	47uF Lo-Leak electrolytic
R3	2k2	TC1	1uf tantalum bead
R4,5,6,11,15	10k	Semiconductors	140pF mica trimmer
R7,16	1M2	Q1 - Q4	BC238 or BC239
R8,14	2M2	ICI	CA3240-E
R9	470R	D1,2,6	OA91
R10	1k	D3,4,5	1N4148
R12,18	33k	ZD1	10v 400mW Zener
R13	68k	TS1	75 deg sensor
R17	39k	RFC1,2	RS type 307-935
R19	5k6	T1	100uH Toko choke (coded 101)
R20	150R		See text. Wound on Fair-Rite core type 59-61001101 or 59-61001102
R21	390R		
R22	820R		
All resistors are carbon film, 0.25W 5% unless otherwise stated.			
RV1	100k Alps pot		
VR1,3	47k or 50k hor 10mm preset		
VR2	100k hor 10mm preset		
VR4	10k hor 10mm preset		
VR5	100k vert 10mm preset		
Capacitors			
C1	2p2 silver mica		
C2,3,4,5,6,8,9,10			

A kit of parts for this board including PCB, sensor and all components is available from WPO Communications for £19.45 with boards alone at £5.25, both inc post. The sensor is available separately for £4.38 inc.

Notes On Project Omega

1. **Interstage wiring** — a number of people have reported various degrees of 'clicking' on CW when all the modules are in place, and also strange feedback problems on SSB, especially when the QRO PA is in use, although this can occur with only the QRP PA in use. These problems are connected with voltage drops introduced into the CIFPU +12V supply by the method of wiring. It can be demonstrated that even a small voltage drop on the CIFPU +12V feed will introduce clicks (sometimes violent) as the rig is keyed, originating in the areas around the product detector and noise blanker stages by the small DC shift introduced.

The cure is to make sure that +12V to the CIFPU is taken direct from the feedthrough on the internal screen, and *not* via a point which may have several feet of wiring ahead of it! Likewise, as the QRP PA itself takes an appreciable current when in operation (300mA bias + drive), the wire used to connect +12V to this should be taken direct from the feedthrough using a short length of heavy gauge wire, with no further +12V connections taken from the PA +12V pin itself.

It is important that the muting voltage connected to point AA is in operation *both* on CW and SSB ie the connection is taken from a point *before* the mode switch. Otherwise SSB will be heard via the audio stages on transmit.

Another source of clicks is from the QRP PA which can oscillate at VHF if incorrectly built, while apparently working normally otherwise. The usual cause is an inadvertent partial short in the input transformers, or possibly in the trifilar output transformer.

2. **Digital Display** — the existing display connections are prone to the display being affected by harmonics from the VFO stage affecting the reading (giving the impression that the VFO is unlocking). The cure is to use a 470R resistor in series with a 10n capacitor as the interconnection rather than the single low-value capacitor used at present. These two components can be soldered directly behind the display output socket on the VCO box.

3. **AM/FM Adaptor** — This is currently under development with a revised circuit and will be published later. It will also be usable with other 10.7MHz if modules such as the G4CLF and G3ZVC designs.

providing both these functions in one unit, including a both modes squelch circuit. It features its own IF strips and filters, and diode switching where diode switching is required.

We had originally intended producing an RF processor and VHF adaptors, but neither of these generated enough interest to warrant the considerable work involved in the preparation of the article or the supply of kits.

Modification of the Audio: a number of people have found the audio output to be lower than they would like. This can easily be remedied by changing R6 on the active filter unit to 15k.

Noisy Keying: problems involving noisy changeover that only occur when the QRP PA is connected in circuit, are almost certainly due to parasitic oscillation of the PA due to incorrect assembly. To check this, key the transceiver with the bias line disconnected from the QRP PA and no drive. If the clicks disappear but return when the bias is reconnected, then you have this problem.

Newsletter: please note that from now on, the Omega Newsletter will only be sent to active constructors of Omega who have built at least the CIFPU and VFO units. If you are on the mailing list but a non-

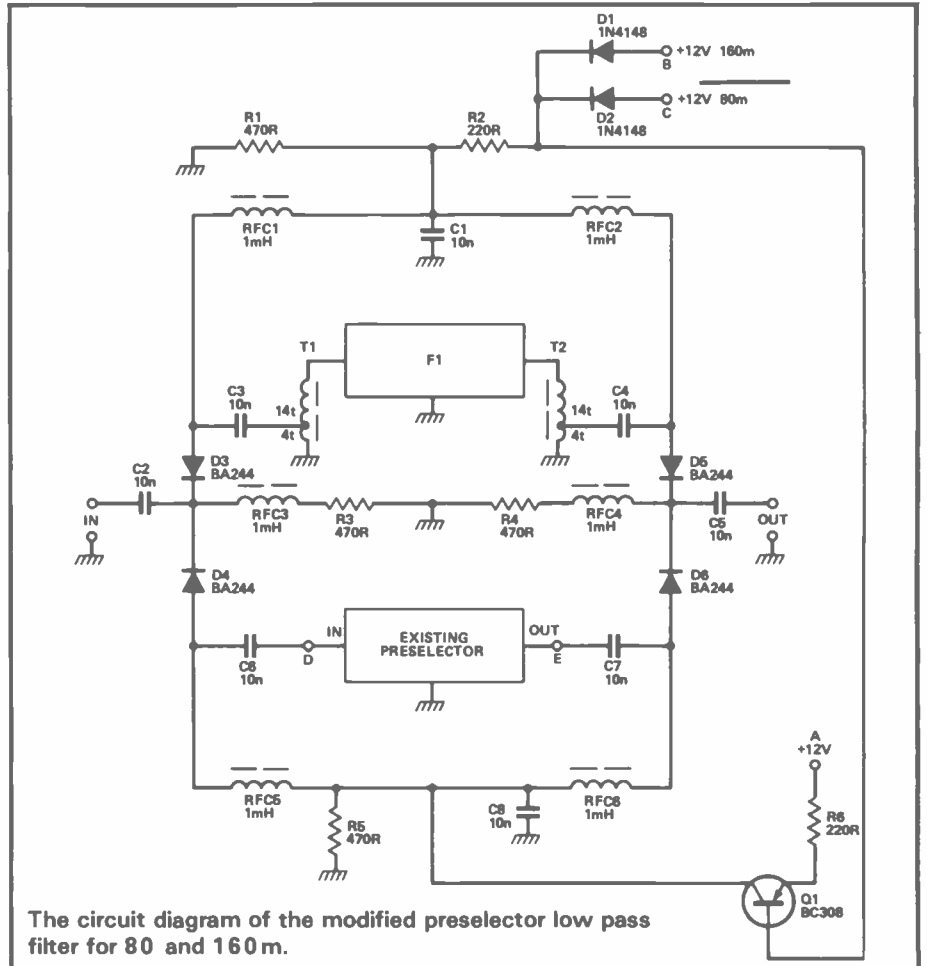

The circuit diagram of the modified preselector low pass filter for 80 and 160m.

constructor and wish to remain on it, please inform WPO Communications as soon as possible by sending them two SAE's (13p stamp)

marked ML in the top left hand corner.

Modifying The Preselector

As reported in earlier articles, the existing preselector module for Project Omega suffers from an increasing signal loss below 5MHz. While this is mostly not a problem on receive mode, it does mean that the QRP PA can be difficult to drive fully on 80 and, especially, 160m.

The easiest way to overcome this loss is to provide an additional single switched low pass filter network on these two bands, which replaces the existing preselector on 160 and 80m. Rather than devise a discrete circuit which would probably require some alignment, a pre-aligned network has been used from the Toko Video filter range which exhibits ideal characteristics for this application. It has a -3dB cut-off at 4.5MHz rapidly increasing to 63dB at 10MHz and requires no alignment. The new filter, together with the necessary diode switching is built on a small PCB, connected across the input/output terminals of the existing pre-

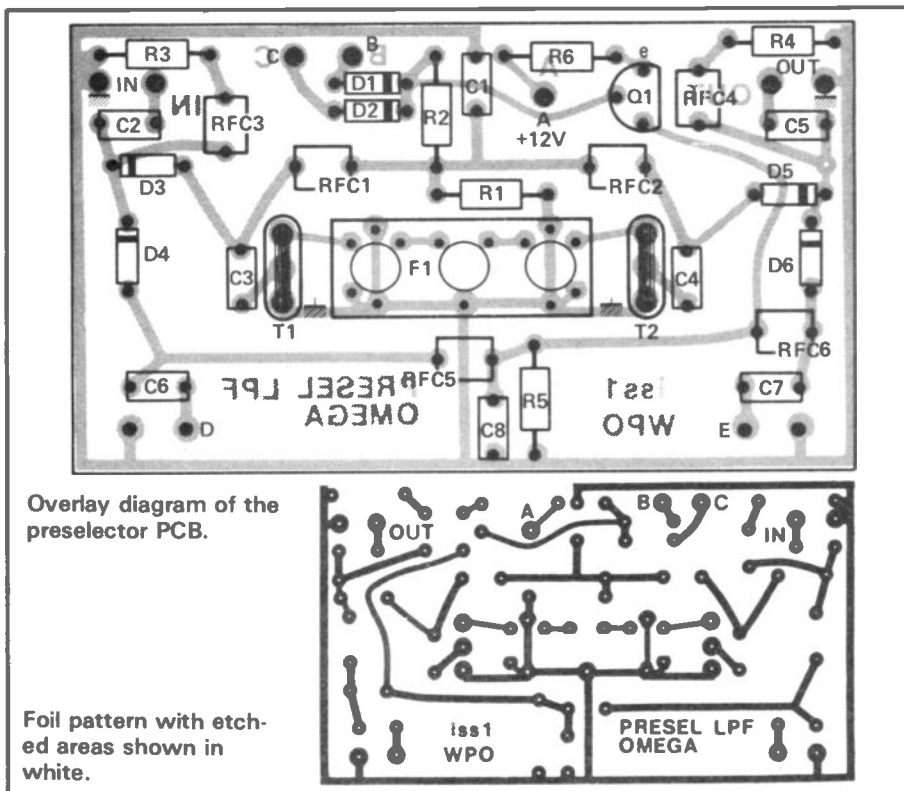

Overlay diagram of the preselector PCB.

Foil pattern with etched areas shown in white.

selector.

The input/output impedance of the low pass filter is 1k ohm and therefore requires matching to 50 ohms for this application. From the circuit diagram, input signals are applied to the IN terminals of the new board — when bands other than 160 or 80m are in use, Q1, a BC308, is conducting and PIN diodes D4 and D6 are biased into conduction via the RF blocking chokes. Signals can then pass in either direction through the existing preselector which functions as normal.

When 160 or 80m are in use, +12V, switched via the band switch, is applied via blocking diodes D1 or D2 — this turns Q1 off and allows D3 and D5 to conduct (with D4 and D6 reverse biased), switching signals through the new networks in either direction. T1 is wound as a step-up transformer to transform the 50 ohm input to around the 1k ohm required by the low pass filter block, while T2 transforms this back down again. In use, the existing preselector is tuned normally on all bands above 80m, but on 160 and

80m the new low pass filter requires no adjustment.

Construction

A small single sided PCB accommodates all the new circuitry. Construction is simple, requiring all components to be soldered into place, with T1 and T2 wound and inserted last. The latter are wound using a total of 18 turns each, tapped at 4 turns from the earthy end. They are wound on small 'Fair-Rite' two-hole Balun cores, as previously used, with 38swg enamelled copper wire — the 4 turn part requiring 9cm of wire and the 14 turns 29cm. Some care in winding these transformers is required, as the wire is fragile and the insulation easily stripped. The layout diagram shows the location of the earthy ends of the transformers.

When built, the new PCB is attached to the preselector board with the components *facing* the preselector. Short lengths of bare wire are used to link the *input* pins of the preselector to the new board at point D, and the *output* at point E. The existing coaxial connections

to the original board are then attached to the new PCB IN/OUT pins. The other connections are +12V to point A, and connections from the bandswitch to pins B and C.

Kits

A kit of components for this module are available from WPO Communications for £9.28 inc VAT & post. The PCB alone is £3.90 inc.

Component Listing

R1,3,4,5	470R carbon film 5% 0.25W
R2,6	220R carbon film
C1,2,3,4,5,6,7,8	10n ceramic disc
Q1	BC308
D1,2	IN4148
D3,4,5,6	BA482 or BA244
F1	Toko 237 LVS-1110
T1,2	Wound on Fair-Rite core type 28-43002402. 18 turns 38swg enamelled copper wire tapped at 4 turns from earthy end.
RFC1,2,3,4,5,6	Toko 7BA or BS 1mH (102)

HAM

RADIO TODAY

NEXT MONTH

50MHz FROM THE SPARES BOX

Jack Hum, G5UM, describes a simple transmitter for 6m.

TR9000 2m MULTIMODE REVISITED

Not many transceivers have been through so much and still worked!

Hugh Allison, G3XSE, illustrates why this is a good second hand rig to buy.

REVIEWS

TS830S Hybrid HF TRANSCEIVER

Used by top contesters - so what makes it the ultimate in selectivity?

BNOS 2m LINEAR

- put through its paces by Chris Lorek, G4HCL.

CIRKIT AUTUMN CATALOGUE

OUT NOW

- ★ No cover price increase
- ★ 16 extra pages and many new products including ...
 - ★ 25 new radio communication kits and projects
 - ★ New Epson compatible NLQ dot matrix printer for under £200 - including VAT, p&p
 - ★ Acoustic MODEM and interface for Amstrad CPC464/664, supporting Prestel, terminal emulation (BT Gold, glass teletype etc) and data transfer. All this for just £26.00.
 - ★ A new selection of soldering irons and accessories from Weller plus many new hand tools.
 - ★ Test equipment from Black Star and Altai.
 - ★ New range of memory and MODEM ICs
 - ★ Full range of Electrolube aerosols and service aids.

The Autumn catalogue is on sale at your newsagent, or direct from our sales counters in Broxbourne, Herts, Brentwood, Essex and in Portsmouth.

CIRKIT - BIGGER STOCK, BETTER SERVICE

Park Lane, Broxbourne, Herts, EN10 7NQ - 0992-444111



Amateur Electronics UK
AJH ELECTRONICS (G8AQN)
Est. since 1967



A professional service to amateurs and S.W.L.s from the East Midlands Emporium.

Stockists for: Yaesu, Tokyo Inlars, Sun antennas, HI Mound Keys, RSGB books, Tokyo Power/SWR meter. Specialist components for the radio amateur. Xtal filters, capacitors etc. Send for FREE list.

Cellular and PMR sales and service. Vodaphone authorised dealer. Answer phone sales for the business and private user. B.T. approved phone sales. 27 and 934 CB equipment. Full after sales service/workshops. P.X. welcome on amateur equipment. Retail shop now open. 9.30-5.30 Tues-Sat.

151a Bilton Rd., Rugby CV22 7AJ. Tel: (0788) 76473

SPECTRUM COMMUNICATIONS

MANUFACTURERS OF RADIO EQUIPMENT & KITS

RECEIVE PREAMPS, 2, 4, 6, & 10 metres, unswitched, gain over 14dB, NF less than 2.5dB, suitable for 50 or 75 ohm systems. Protected against static and transients at the input and against supply reversal. 10-18V negative earth operation, unboxed for internal fitting into equipment. 2 & 4 metre versions measure 23 x 50 x 14mm, 6 & 10 metre types measure 25 x 60 x 14mm.

Types RP2, RP4, RP6, RP10, Kit £5.50, Built £7.00.

RECEIVE PREAMPS, 2, 3, 6, & 10 metres, switched, 100W rated, gain over 20dB, noise figures 1dB on 2M, 1.5dB on 4 & 10M, and 2.5dB on 10M. Panel mounted smooth gain control 0-20dB+. Input and output matched to 50 ohms. Protected against static and transients at input and output and against overvoltage and supply reversal. Relay hang prevents relay chatter on SSb. Board size 69 x 47 x 30mm, boxed unit 79 x 74 x 39. Types RP25, RP45, RP65, RP105.

PCB Kit £10.25, Board Kit £18.75, Built £24.75.
VAT & P&P INCLUSIVE PRICES

Delivery within 14 days subject to availability. 24hr answering. Plus a large range of other kits and modules. SEND SAE FOR LIST.



UNIT B6 MARABOUT INDUSTRIAL ESTATE
DORCHESTER, DORSET. TEL 0305 62250





TOWARDS THE RAE 1986

This new book is prepared specifically for the City and Guilds of London Institute's new RAE Syllabus 1986. In 26 topics it summarises the basic material and relevant theory for City and Guilds subject 765.

Author: John Bowyer (G4KGS) Principal Lecturer in Electrical Engineering at Polytechnic, Huddersfield.

Advisor and Editor: David Pratt (G4DMP) member of the City and Guilds Advisory Committee and Examiner for the RAE.

Price: £3.95 non nett ISBN 0 85973 036 0

Available via Bookshops or direct from Publishers:
STAM PRESS LTD.,
Raans Road, Amersham, Bucks, HP6 6JJ
Phone 024 03 28595/6

If an advertisement is wrong we're here to put it right.

If you see an advertisement in the press, in print, on posters or in the cinema which you find unacceptable, write to us at the address below.

The Advertising Standards Authority. ✓

ASA Ltd. Dept 3 Brook House, Torrington Place, London WC1E 7HN

HF DXing From Small Spaces

In recent years, CW has undergone something of a revival with large numbers of radio amateurs taking, and passing, the morse test to get to the bands. However, it never ceases to amaze me that the dozens of class A licensees that I know of within a 3 mile radius of me very rarely surface on anything other than 2m. TVI must account for some of them not being too keen to fire up their expensive HF rigs, but that does not seem to be the real problem. A brief period of high activity follows the acquisition of the coveted class A ticket, then a deep rooted belief sets in that unless a monster tower and beam can be erected, no DX contacts can possibly be made.

Want to work HF DX but only have a small garden? Well, David Reynolds, G3ZPF, has some ideas for effective 'limited space' antennas for newcomers (and perhaps old-timers) to the HF bands.

Their initial lack of success in DX chasing is invariably put down to having to make do with wire aerials, but in reality may have more to do with lack of HF operating experience than the aerial limitations. At VHF/UHF frequencies, the dimensional accuracies required in the construction of aerials inevitably means that almost all arrays are commercially manufactured. This seems to instil the belief that no aerial can be any good unless (a) it is made of aluminium tubing, and (b) it is made in a factory. On transferring their activities to HF, many amateurs seem to bring this belief with them — often spending considerable amounts of money on commercial limited space

aerials only to be disappointed with the results.

I am particularly interested in DX chasing but my location dictates that this be done with low wire aerials: I have, in recent years, been asked to give talks at the local radio club. In these talks, I attempted to explain that at HF it is quite possible to 'roll your own' aerials at minimal expense; and although a tower and a beam certainly make things easier, it is still possible to chase DX even on indoor aerials.

In reproducing the gist of those talks I hope to inspire others to reconsider what they had previously thought to be an 'impossible' QTH. As I have no professional involvement with the electronics

industry, the descriptions given do not go beyond that required for the RAE course. The only 'qualification' that I can claim to have, that relate to the topic, are the achievement of working over 100 countries on *each* of the 80 to 10m bands (pre WARC) and 15 years worth of experience. Of the latter, it can only be said that if we learn by our mistakes then I've had one hell of an education!

Reference Books

I have read quite a number of books over the years, but have yet to find an aerial in any of them that would fit into my garden exactly as it was described. The general im-

pression I gained from the books was that the aerials would not work at all unless constructed exactly as described. Yet I have found it possible to take great liberties with the layout of HF wire aerials and still get them to perform very well. Doubtless, the real purists would be able to get an extra dB or so out of them, but then they probably have far more room and height than I have ever had.

I would strongly advise borrowing copies of the various aerial books from the public library before deciding to buy any, and although personal preference will obviously vary, my own favourite is "HF Antennas For All Locations" by Les Moxon G6XN. This covers both the practical construction of wire aerials for limited spaces and also goes into the theory for those who like to delve deeper.

Initial Considerations

The first decision you must make is which bands to operate on. For many newcomers nowadays this is no simple matter. When I first got my licence, it was usual for an 'apprenticeship' to have been served as an SWL before coming on the air. This now seems to be the exception rather than the rule. Those that have come over from CB activities will find the channelised life at VHF/UHF vaguely familiar, but the vast majority of those new to our ranks share a general lack of background knowledge about the hobby in general.

To those who think themselves in such a position I would recommend the "Amateur Radio Operating

Manual", published by the RSGB, which is a goldmine of information. One of its many chapters contains a summary of the type of contacts likely to be made on each band at various stages of the sunspot cycle, at each season of the year. This should help the complete beginner decide which bands are likely to be of interest.

Initially, most people want to get going on all bands; but where space is at a premium, better results may be obtained by restricting operation to one or two bands to begin with. For those readers who cannot decide which bands will suit them, or for those who simply have to have a go at all of them, the words of the late Jim Fisk (W1HR) are good advice. "There is no doubt that the most efficient and simplest multiband aerial is a halfwave dipole cut for the lowest frequency of operation, and centre fed with open wire feeders via an ATU."

Dipoles

One of the simplest aerials to get started with is the half wave dipole, Fig. 1. The lengths for each band are given in the table beneath. Unless the aerial is totally in the clear, some adjustment will need to be made to the lengths to bring it to resonance. The proximity of buildings or the ground tend to lower the resonant frequency somewhat. The fact that the resonant frequency reduces is convenient since it is far easier to cut pieces off an aerial than to solder extra lengths on.

The table shows how much the resonant frequency shifts for a given adjustment, but note that the amounts indicated need to be removed from *each* end of the dipole. Generally, dipoles fed with

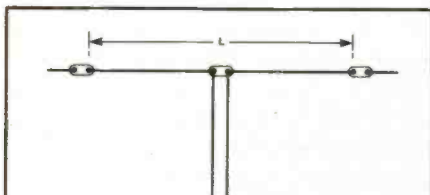

Fig. 1 The simple 1/2 wave dipole with a 'cutting' chart for each HF band.

FREQUENCY (MHz)	LENGTH "L" (m)	TRIM EACH END PER 100kHz (mm)
1.800	83.333	2193
3.500	42.857	595
7.000	21.428	150
10.100	14.851	72
14.000	10.714	37
18.068	8.302	22
21.000	7.143	17
24.890	6.027	12
28.000	5.357	9

coax or twinlead are essentially single band devices, with the exception of a 40m dipole which will also operate satisfactorily on 15m. Whilst the previous sentence can be found in any aerial textbook, the additional fact that I have only ever seen quoted in one of them is that on 15m a 40m dipole has a rather higher feed impedance,

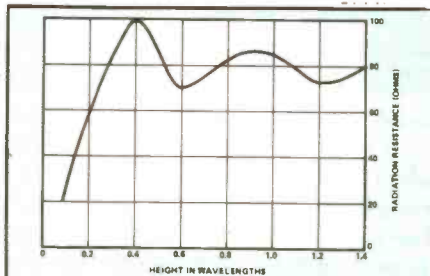

Fig. 2 Variation of feed impedance of a horizontal 1/2 wave dipole with height.

resulting in a minimum VSWR of around 1.7:1 on that band. This is low enough to be matched by rigs with valve PAs, but owners of modern solid state rigs may well find their output greatly reduced on 15m unless an ATU is used.

Many textbooks quote the feed impedance of a half wave dipole as 50 to 75 ohms and treat that as a constant. Unfortunately, life is not that simple, as Fig.2 shows, the feedpoint impedance varies considerably with height. It is easy to see that particularly on the LF bands, a resonant dipole will have some residual VSWR, even though it is common to hear operators on the bands claiming "perfect" 1:1 VSWR. This is undoubtedly what their VSWR meter is telling them, but the situation is arrived at by the way the aerial has been adjusted.

The easy way to adjust an aerial — and hence the method most commonly used — is to snip gleefully away at the ends until the VSWR falls to an impressively low figure. Under these circumstances the aerial is not really resonant quite where you think it is, but the reactive components present with the resistive impedance "fool" the VSWR bridge. The correct way to adjust an aerial is with a GDO or noise bridge either at the feedpoint (hardly convenient), or at a multiple of electrical half wavelengths down the feeder being used. The mechanics of the latter method are fully explained in the various handbooks so I'll not regurgitate them here. If you want to get an aerial set up in a hurry, the first method ac-

tually works quite well *providing* that the aerial is a full sized one and not 'compressed' in any way by loading cells or whatever.

Whenever I've experimented with physically short aerials, it has always proved essential to get the aerial truly resonant and live with the resulting feed impedance, 'fudging' to get the VSWR looking good produces disappointing results. I think this is because the resonant frequency in such cases is considerably removed from that being used, whereas with a full sized aerial the shift is far less and the resulting losses are seldom noticed in practice.

Using Baluns

Obviously a dipole is a balanced aerial, but the output of all modern — and many not so modern — transceivers is unbalanced, as is coaxial cable. To be correct a balun (balance-to-unbalance) transformer should be used at the feedpoint. Otherwise, there could be radiation from the feedline which (when it is inside the house) can cause BCI/TVI by getting into the mains wiring. The fact that not using a balun will also distort the radiation pattern of the aerial, will not affect amateurs whose aerials are either very low or even indoors, as the proximity of the ground and buildings will distort the radiation pattern anyway.

Amateurs seem to be firmly divided into two camps on the subject of baluns with one side swearing by them and the other side at them. Whilst I number myself among the latter, it is a choice which readers must decide for themselves, based on their own experiences and QTH. Perhaps I have been unfortunate with the baluns I have either made or bought; but with a balun at the feedpoint I have always found it difficult to check the resonant frequency of an aerial with my GDO. This is because most baluns are wound on a ferrite core which always seem to give a number of spurious resonances on my GDO. Even when finally the balun is set up correctly, there are no noticeable benefits.

I hasten to add that my aerials have always been quite low and the results may well be different for aerials well in the clear. However, I have always felt that the currents

on the outer of the coax — because the feeder does not come away from the aerial at right angles for some distance — (ie RF pickup) is the real bugbear for aerials at low heights. A balun at the feedpoint cannot do much for that.

My preferred method of overcoming RF pickup is to wrap the coax around a ferrite ring just inside the house in the same way you

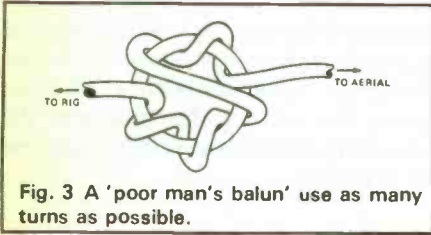

Fig. 3 A 'poor man's balun' use as many turns as possible.

would deal with RF on the outer of a TV aerial feedline (Fig. 3). This seems to cure any problems without any of the side effects of ferrite baluns. Where the feeder enters the house, put in an in-line spark gap which will earth the outer braid at that point and not only stops current coming down the outer but also provides some protection against lightning too, as shown in Fig. 4.

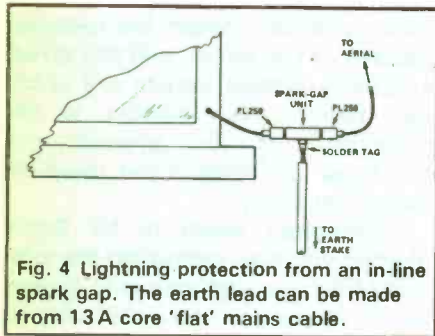

Fig. 4 Lightning protection from an in-line spark gap. The earth lead can be made from 13A core 'flat' mains cable.

Parallel Dipoles

A simple way to get a multi band dipole is to put two, or more, in parallel on the same feeder (Fig. 5). The general idea for the case of a 20, 15 and 10m dipole is shown, but any other combination will

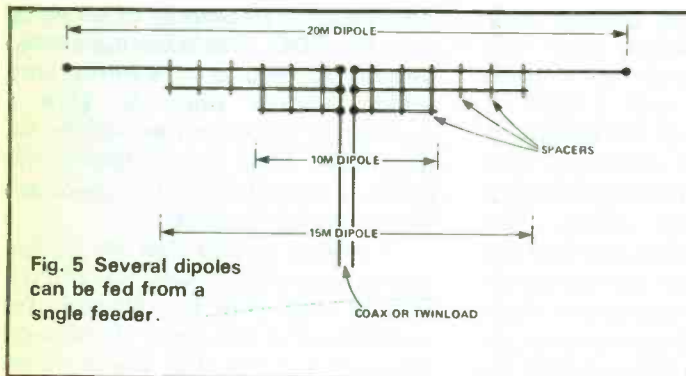

Fig. 5 Several dipoles can be fed from a single feeder.

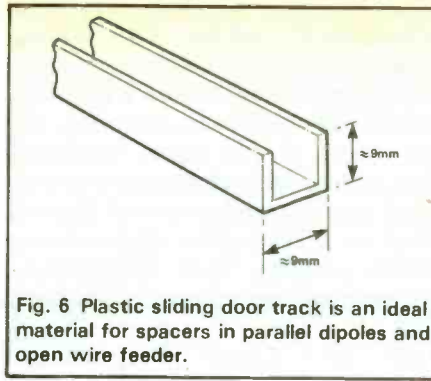

Fig. 6 Plastic sliding door track is an ideal material for spacers in parallel dipoles and open wire feeder.

work in much the same way. Initially, I spent a great deal of time and effort setting up parallel dipole arrangements, but over the years, I have evolved a systematic approach which cuts down on the time taken quite considerably.

Being inherently idle, the first time I ever made parallel dipoles I used 300 ohm ribbon cable so that I would be spared the task of constructing suitable spacers. This proved unsatisfactory on two counts: the first being that the wire broke repeatedly in the wind. The main problem though was that the VSWR on each band changed considerably whenever it rained, a now well known characteristic of 300 ohm ribbon. Having found out that "well known fact" the hard way, it seems as well to point out that in recent years a version of 300 ohm ribbon with slots in the insulation has become available which is supposed to change its properties far less in the wet. Since it seems to be more substantial too, it should not break so easily and might well be worth trying.

Even so, I came to the conclusion that a minimum of 100mm spacing between each pair of dipoles was needed, if reliable results were to be obtained. I also came to realise that there was no need to tension up all of the dipoles, just let the lower ones hang on the spacers underneath

the longest one. If stiff wire is used for the lower dipoles this stops them flapping about in a gale, as does a maximum of 300mm between each spacer.

The spacers can be made of any insulating material, but after trying strips cut from perspex sheet and bakelite rods I opted for plastic sliding door track as shown in Fig. 6. This is readily available at reasonable prices and can be cut easily with a kitchen knife. It also has the highly desirable feature of not rolling away from you when you try to cut it. The soft plastic does not seem to go brittle on exposure to sunlight and the "U" section is quite rigid. It is also ideal for the spacers in open wire feeder. Furthermore, the thinner coaxes available are a push fit inbetween the legs of the "U". So fixing a length to the shack wall with the legs sticking out is an ideal way of restraining coax runs and is advantageous when replacing the coax. Readers using the larger diameter coaxes could use plastic cable trunking found in computer rooms — although this is rather expensive.

Having got the parallel dipoles into the air it then remains to resonate them all. Hopefully they will all initially be too long since they do tend to 'load' one another. The important thing is to firstly adjust the *shortest* dipole, with this done, it will have shifted the resonance of the others slightly higher. Now adjust the next longest dipole, the 15m one in my example, which will again shift the resonance of the 20m dipole, but not that of the 10m dipole since you have been trimming beyond its ends. Finally adjust the 20m dipole and the arrangement is set up for three band operation.

There must be some readers who are wondering how 3 dipoles

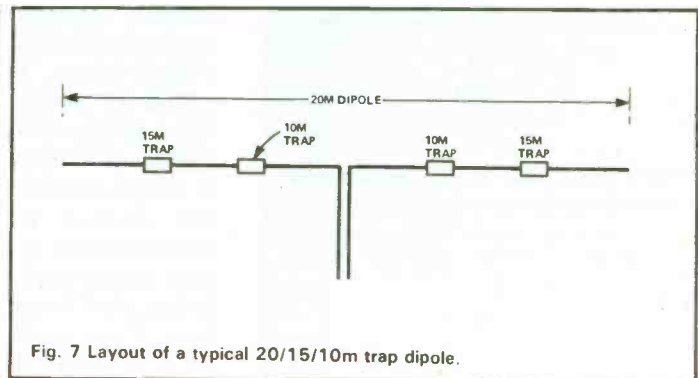

Fig. 7 Layout of a typical 20/15/10m trap dipole.

can be fed in parallel without altering the feed impedance, but remember that any of the three bands, two of the dipoles will have a very high impedance and only one will have a low impedance. The result of these in parallel is to lower the feed impedance only very slightly.

Trap Dipoles

Another way of making a dipole function on more than one band is by the use of traps. A trap is no more than a parallel tuned circuit which, as readers may recall from their RAE class, appears as an open circuit at the frequency of resonance. Fig. 7 shows the layout of a 20/15/10m trap dipole although, as with the previous example, any other combination works equally well. On 10m, the first set of traps appear as an open circuit so only the centre part of the

bandwidth being reduced, and on the lower frequencies this might be important.

There is no reason why one dipole could not have traps for each of the amateur bands, and thus give all-band operation. Unfortunately this approach has some snags. Firstly, given traps with a very high Q coil, there will be some slight loss. The lower frequency bands would suffer as the RF has to travel through several sets of traps, each adding its own slight loss. The loading effects of the traps, means that an all-band aerial would be considerably shorter on the lowest

because it is *apparently* possible to get a reasonable match on all the 80 to 10m pre WARC bands by carefully selecting the L/C ratio of the 7MHz traps. The word *apparently* was chosen deliberately because personally I have never managed to achieve it at my QTH. It probably comes down to being able to get the aerial up in the clear.

This trap dipole gives a very good account of itself on the 80 and 40 metre bands, but because the aerial is shortened by the traps on 80m, it will only cover most of that band not the whole of it. The VSWR rises slowly enough though for a simple ATU to be used for the band edges if needs be. The aerial is commonly referred to as a 'KW trap dipole', an 'Isle of Wight trap dipole', or a 'W3DZZ'.

Another aerial for the 80 and 40m bands is often referred to as a 'compressed' trap dipole. The principle is the same except a large L/C

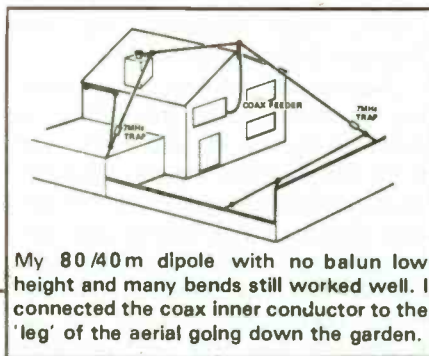

My 80/40m dipole with no balun low height and many bends still worked well. I connected the coax inner conductor to the 'leg' of the aerial going down the garden.

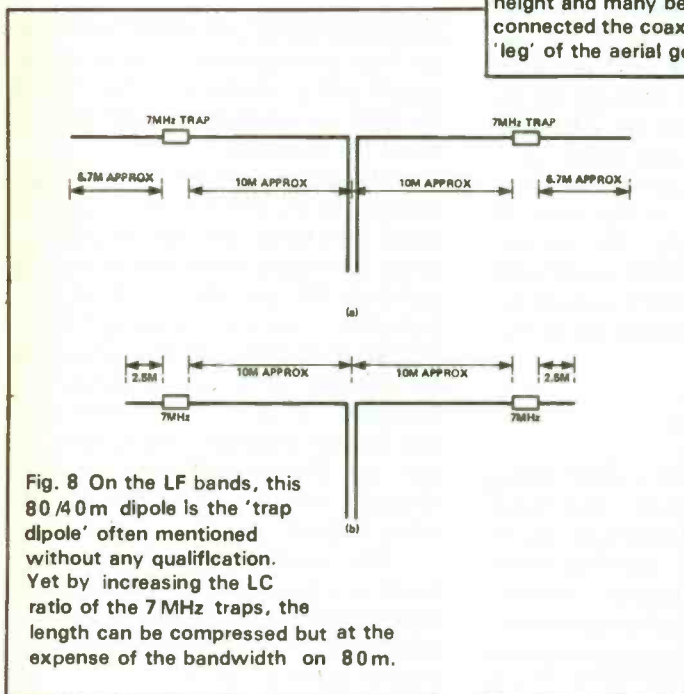

Fig. 8 On the LF bands, this 80/40m dipole is the 'trap dipole' often mentioned without any qualification. Yet by increasing the LC ratio of the 7 MHz traps, the length can be compressed but at the expense of the bandwidth on 80m.

aerial is used. On 15m, the RF passes through the 10m traps and the next section of the aerial comes into use. The whole of the length of the aerial is used on 20m, remember though that trap dipoles will be somewhat shorter than their single band counterparts because the coils in the traps act as loading coils on the lower frequencies in use. In most cases, the shortening will not be too great; but with traps having a high L/C ratio it could be significant. Note that any shortening of an aerial results in its usable

frequencies used and the resultant narrowing of the bandwidth may mean the aerial can only be used over part of a band with low VSWR.

Although trap dipoles can be made to operate on any combination of frequencies, 80 and 40 metre operators often refer to their aerial as a trap dipole without qualifying the term any further. What is generally inferred in such cases is an aerial of the type shown in Fig. 8a which is basically a two band aerial for 80/40m. I say basically

ratio is used in the traps. This results in a somewhat shorter length (Fig. 8b) at the expense of a much reduced bandwidth on 80m, with only about 75kHz between the 2:1 VSWR points. At least two companies manufacture an 80/40m compressed dipole of the dimensions shown, and the 40m section allows 15m operation albeit with some VSWR.

Open Wire Feeders

Dipoles can be made to cover a

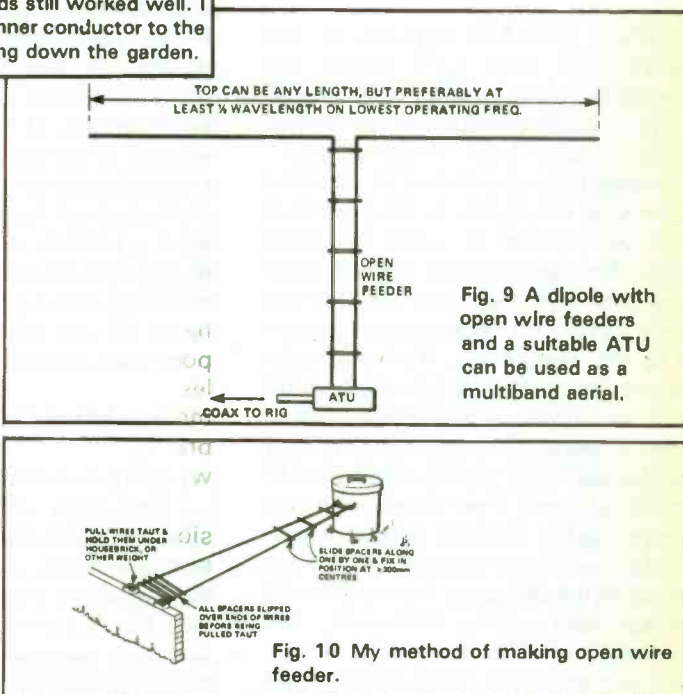

Fig. 9 A dipole with open wire feeders and a suitable ATU can be used as a multiband aerial.

Fig. 10 My method of making open wire feeder.

range of frequencies by operating with open wire feeders as Fig. 9 illustrates. The price to be paid for multi-band operation is the necessity of using an ATU, which needs to be capable of providing a balanced output. The vast majority of commercially available ATUs only have unbalanced outputs, and only match a limited range of impedances. They are intended primarily to be used in coaxial lines with solid state transceivers in the same way as the 'load' and 'tune' controls on a valve PA.

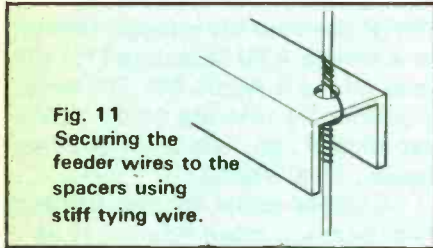

Fig. 11 Securing the feeder wires to the spacers using stiff tying wire.

Those that can cope with balanced outputs are often referred to as a 'Z match' ATU. The circuit of the Z matches appears in the handbooks and can easily be homebrewed providing a source of surplus components can be found. Roller coaster coils and wide spaced capacitors used to be in plentiful supply on rally stalls in the past, but they are harder to come by these days. Recognising the gap at least one UK firm has started making them again, and advertises regularly in the magazines. To be strictly correct they do sell complete units too, achieving a balanced output from a basically unbalanced circuit by the use of a ferrite balun inside the ATU itself. I've never been too happy using baluns where there could be large amounts of reactance flying about as the cores tend to saturate easily. However, the reviews of ATUs using the technique are generally favourable — so perhaps its just me. . .

The exact spacing of the wires is not critical and I generally use about 100mm simply because it looks about right. A suitable method of making spacers has already been described but as with the parallel dipole arrangement a good deal of time and effort can be saved by going about construction in the right way. I found the trick was to stretch the wires between two convenient points in the garden, a dustbin handle and a wall in my case, with the wires at roughly the right spacing, and with

all of the spacers slipped over one end (see Fig. 10). Using a ruler to get equal centres between the spacers, they can now be fixed in position with tying wire (as in Fig. 11). Since the feeder wires are taut, the whole assembly will still look shipshape when hung up in the air.

According to textbooks, aerials and feeders should be constructed from hard drawn copper wire, but I generally use plastic covered stranded wire with no ill effects. GPO telephone cable is obviously ideal if you come across any surplus, but they tend to get funny if you start shinning up the telegraph poles to get some.

If an aerial is a half wavelength long at the lowest frequency of operation then it should work well on all frequencies above that frequency, although it will start to get more directive the higher you go. That statement, plus the polar plots to go with it, can be found in most of the textbooks; but in my experience it depends on the aerial being horizontal and straight for its whole length. If there are a goodly number of bends in the aerial, or it is predominantly in an inverted vee configuration then, in the case of (say) an 80m dipole, the performance on 15m and 10m could well be disappointing, and it would be better to use a separate aerial for those two bands.

Inverted Vees

I must confess to a great liking for this type of aerial, and have used little else for some time. In its simplest form, it is nothing more than a single band dipole mounted as in Fig. 12 and is quite commonly

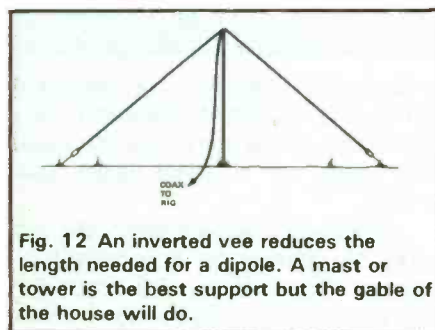

Fig. 12 An inverted vee reduces the length needed for a dipole. A mast or tower is the best support but the gable of the house will do.

used on 80m and 40m. It does not require such a long garden as would a horizontal dipole and only requires one high support. For those lucky enough to have a tower, an ideal centre support is

already available. In either case, it has the advantage that since the ends are relatively low it can be adjusted for resonance without having to lower the whole thing down each time an adjustment has to be made.

A multiband version can be formed by using open wire feeders, but I found that having a 25.6 metre (84ft) top produced the best length for 80 to 10m coverage. Any longer and the 10m performance was dramatically reduced and in spite of being rather short for 80m, I managed to work into ZL on

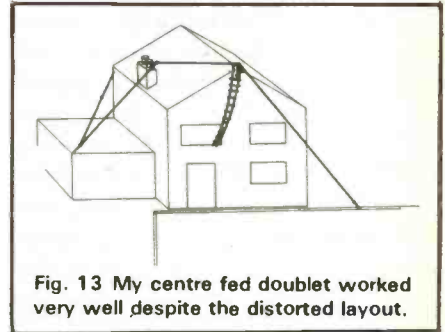
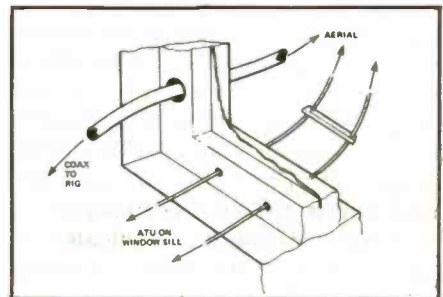

Fig. 13 My centre fed doublet worked very well despite the distorted layout.

such an arrangement. The best top length will probably vary from QTH to QTH so readers should experiment for themselves.

The big advantage of open wire feeders to my mind is that once the aerial has been erected, all adjustment is then carried out from the comfort of the shack. With the parallel dipole arrangement repeated raising and lowering will be needed until adjustments are finalised. Given the variability of the British weather, being able to put up the aerial and then go straight back indoors has an obvious appeal.

Yet open wire feeders do not seem popular in spite of their being considerably cheaper than coaxial cable. An often quoted problem is that of getting the feeders through a window. To me, there seems little difference in drilling two small



holes through a wooden frame than a large one for a coaxial cable entry. Another way of getting open

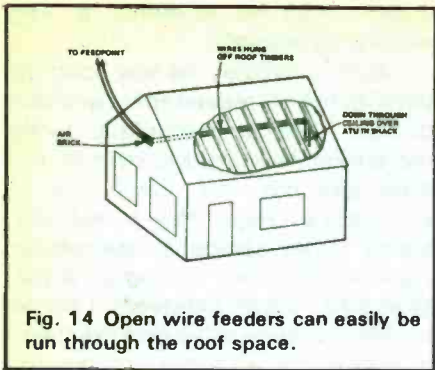

Fig. 14 Open wire feeders can easily be run through the roof space.

wire feeders into the house is to bring them through the brickwork via an airbrick, which can easily be fitted if not already present. Once inside the roofspace the feeders can be suspended from the truss-beams and then brought down through the plasterboard ceiling as detailed in Fig. 14.

Verticals

Surprising as it may seem, I have never really made much use of vertical aerials since the garden layouts were never conducive to getting down really good radial mats. As verticals have a lower angle of radiation than horizontal dipoles, they are a very popular

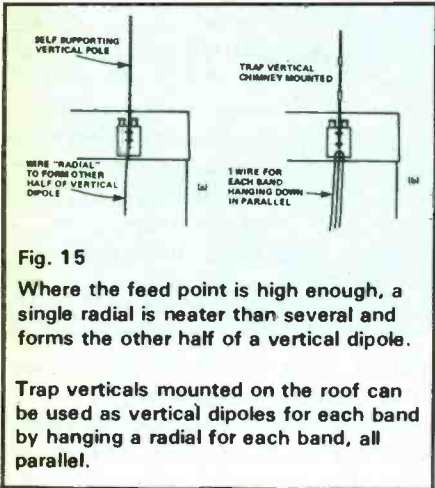

Fig. 15 Where the feed point is high enough, a single radial is neater than several and forms the other half of a vertical dipole.

Trap verticals mounted on the roof can be used as vertical dipoles for each band by hanging a radial for each band, all parallel.

choice for a simple but effective DX aerial — particularly at the higher frequencies where full sized quarter waves or more become a practical consideration. Vertical dipoles seem to be used only very rarely, and yet would seem to be a far neater arrangement where the feedpoint is elevated sufficiently.

If ground mounted verticals are used, then it is essential to have a very good earth otherwise the results will be disappointing even though the VSWR will look impressive (Fig. 16). For the lower

Indoor Aerials

All of the aerials so far described have been used by me in a garden only 12 metres long, far shorter than any I have ever seen mentioned in other aerial articles. Whilst that will possibly give renewed hope to many, there will inevitably be some poor soul who cannot put up outside aerials at all. In such cases, the roof space is the next best thing. Although the radiated signal will be slightly down

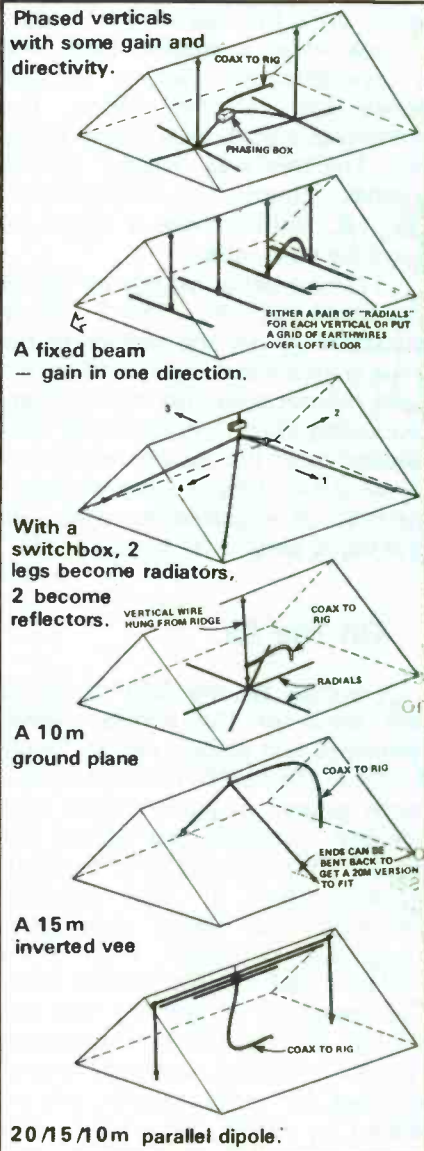

on an outdoor aerial at similar height, worthwhile results can still be obtained given a little thought. In most attics, a 10m ground plane will be quite practical, even if the top has to be bent over a little. Or how about a 15m inverted vee? There is no reason why the ends cannot be bent back of course, and a 20m version then becomes possible without loading coils. A pair of

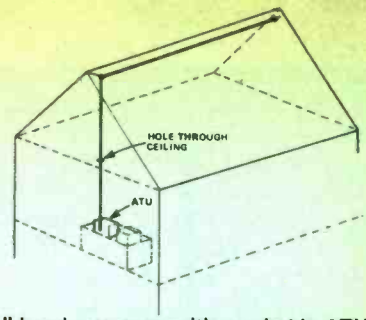

All band coverage with a suitable ATU and an inverted 'L'.

phased verticals can give a fixed vertical beam, assuming the alignment of the house is suitable — although arrays with all elements driven rather than parasitic elements are said to work better indoors. For those who simply have to spray RF in all directions, how about the pyramid beam with four switchable directions.

Lower frequencies tend to be more of a problem for those using roof space antennas. A full sized inverted L aerial should be possible for at least 40m and with a suitable

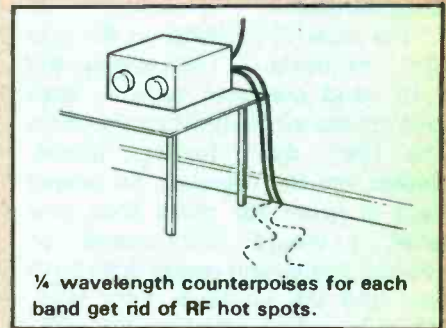

ATU can be used on a number of bands. With end fed aerials there is always the possibility of RF hot spots appearing on the rig. These can be cured by adding a quarter wave counterpoise for each band.

For a temporary QTH the mobile whip could even be pressed into use as a loft aerial or mounted on the balcony rail in a block of flats. Where no balcony exists, a

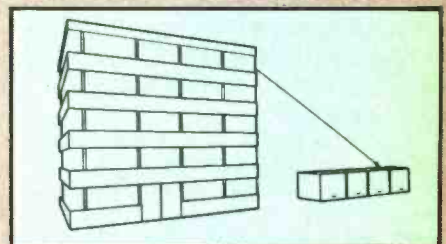

whip aerial can be fixed to the window frame and I have even worked one chap who uses a thin gauge wire hung down from his flat window as an "invisible" aerial with the lower end fixed to a block of garages. Providing the lower end is above arms reach nobody will ever notice it, but it can radiate quite an effective signal.

Using Trees As Aerials

Back in the early 1970s, the US army experimented with the use of trees as vertical radiators. The results were reported in the technical press and claimed up to 20dB advantage over a tuned whip in tropical rain forests in the 4 to 10MHz range. Before everyone gets too excited remember that the tuned whip in question was probably one of those very short ones fitted to a manpack type radio, so 20dB up on that could still be well down on a full size dipole. Nevertheless where a suitably large tree is available and where outside aerials are definitely taboo, the technique could well have some use. The tree was 'loaded' with a 'Hemac' coupler, as illustrated in Fig. 18, formed from a length of large diameter coax.

I remember an article by G8PG appeared in the Short Wave Magazine giving the results of his trials with a homebrew version. He used his portable QRP transceiver, producing about 2W, but was very pleased with the results he obtained on 20m. I have seen no other mention of experiments with this technique since that time.

On The Air

I would be the first to admit that none of the simple aerials described will enable you to "burn a hole in the band" no matter how much power is used. When first licensed, I initially ran almost the legal limit but found it to be more trouble than it was worth. Although the signal was only marginally stronger than with 100W I had terrible trouble with high levels of RF getting into the mains wiring with inevitable results. Given limited aerial facilities far more benefit will be gained by using some nous, and lady luck smiles far more often than many give her credit for.

With the present state of the sunspot cycle, 20m seems the highest band capable of producing consistent DX during daylight hours. If working in the shack monitor 15m and 10m; you may find a DX station on an otherwise dead band before the 'hordes' do. On the odd occasion that this pays off, the resulting smug feeling as

others start to squabble is very satisfying indeed!

One benefit of the low solar activity is the increased effectiveness of the LF bands, particularly during the winter months. My own love is 40m CW but this would not be everyone's choice due to the problems with adjacent commercial signals at very strong signal strengths. Most amateurs I speak to refer to 40m after dark as "wall to wall noise" but this is often due to the receiver's front end suffering under vast amounts of RF — switching in the 20dB attenuator

Fig. 16 A single radial is insufficient for a ground mounted vertical even though the VSWR may look good.

frequencies, verticals are generally loaded, often with traps for multi band operation in the case of commercial units. Of course, there are losses inherent in even high quality traps; but one fact I have only rarely seen mentioned is that if the vertical is not *physically* one quarter wavelength or more, then the angle of radiation goes up, as well as the useable bandwidth being reduced.

For inter-G working on 80 and 40m, verticals — especially the multi band compact type — give poor results although they do come into their own further afield. Dipoles are the opposite so unless there is room for more than one aerial, I would recommend an inverted vee which copes with both local and DX contacts very well. Naturally when chasing the DX, receiving close-in signals is a disadvantage. That is the price to be paid for making do with one aerial. As with horizontal aerials, it is possible to get multiband operation from inverted vees with traps or parallel elements as well as open wire feeders — for example see Fig. 17.

Fig. 17 Using open wire feeder, an inverted vee will be a multiband aerial, the aerial legs could be guys for the mast.

For coaxial lines, traps or parallel dipoles can be used or even a combination of the two.

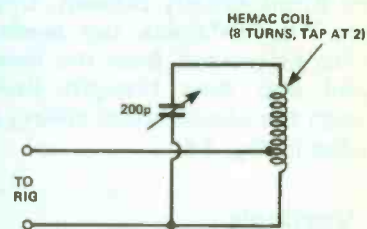
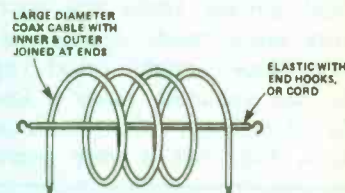
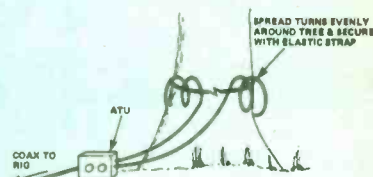

Fig.18 Circuit diagram of G8 PG's 'minimal ATU'.



The Hemac coil.



The Hemac coupler in position.

results in a world of difference. There is still rather a lot of noise, yes, but signals can now be heard in it. My own favourite time is the hour after midnight, when a goodly number of the commercial stations seem to disappear and the band generally seems quieter. I have an inverted vee up 9m and if I call CQ and don't get a stateside station come back then it's a sure sign that conditions are not up to much. This is on CW I hasten to add, which will be a necessity in the small hours if an indoor shack is used with the keying gap fairly close and the headphones on.

Using CW

Considering all of the time and

effort that goes into learning the morse code it is not too surprising that many take a rest from CW when they first get licensed, although the vast majority do return to the mode later. In my case it was an extreme case of laryngitis which caused my return to the key, after a few days continuous usage I was hooked again. Over the years I have found myself using the mode far more than SSB and have found that one thing that increases enjoyment out of all recognition is fitting a CW filter.

On the crowded HF bands listening to CW through an SSB filter can be very tiresome as you try and sort out which one of the signals you are supposed to be listening to. When I finally fitted a filter in my rig I was staggered at the difference, which was comforting as it cost rather a lot, and invited some of the locals around for a look. None of them had ever heard a CW filter in use before, but afterwards they all went out and bought one for their rigs too.

However, I recently listened to a very modern synthesised "miniature" transceiver, and was

rather disappointed with the CW filter. Although the nose selectivity was quite good, the skirt rejection was rather poor which had the effect of only attenuating adjacent signals somewhat, instead of removing them altogether. It may also be due to signals "sneaking around" the filter because to its small size and the very dense component layout on the PCB. It would seem advisable to listen before you buy.

Audio CW filters are quite popular, especially as they are far cheaper than commercial crystal CW filters. They suffer from the slight drawback that all signals that pass through the SSB filter can affect the AGC response of the receiver, even though most of them will be inaudible through the AF filter. This can cause some confusing effects occasionally, but they are still a very useful device.

And Finally . . .

That about winds up my mental meanderings and hopefully one or two readers might be spurred into

giving HF operating a more serious attempt. The problem of radiating RF from confined spaces are so varied that it is unlikely that readers will find specific solutions here, but that was not the intention. What was intended was to point out just some of the ways that HF aerials can be manipulated from their intended shapes and yet still prove to be effective. Once that has been realised, it should be possible to re-appraise the situation and put up an aerial at virtually zero cost. That way if it turns out not to be so hot then no money has been lost, but some experience has been gained.

There will undoubtedly be those who disagree, possibly strongly with some of my findings or opinions on technical grounds, but they represent what happened to me in practice rather than any attempt to refute existing texts. It all comes down to the fact that no two QTHs are ever the same, especially where confined space is a problem, and it is up to each individual to experiment and find out what works best for them. Given some patience and a modicum of common sense the results will be well worthwhile.

Build yourself a micron transceiver at a price you can afford

£241 FOR 6 BANDS/INTERNAL ATU/DIGITAL DISPLAY AND CASE

OUR LATEST TRANSCEIVER KIT setting new standards in QRP performance. The MICRON is a 6 band CW only 8/10W output rig covering 80,40,30, 20,15 & 10 metres (bottom 200kHz of each). A 0.25uV sensitivity receiver with AGC, S Meter, very stable VFO with IRT, LW AF o/p to speaker and 3 position LC filter + selectable attenuator. Silent solid-state Rx/Tx switching with fast semi break-in + sidetone. Fully variable RF power o/p + optional SWR metering. + 12v required.

PLUS fully finished smart CUSTOM CASE and hardware with UNIQUE facility for optional internal TRANSMATCH ATU and Full Frequency DIGITAL DISPLAY. The MICRON uses a high grade solder masked/screen printed pcb with comprehensive instructions using a step-by-step assembly manual designed for the relative newcomer. Mostly prewound coils and minimal test equipment needed for alignment.

See review of the MICRON in the latest issue of SPRAT

PRICES: FULL KIT with all options including Case/Hardware/ATU/Metering/Digital display at an all-in £241. Or, 6-band pcb kit complete at £145 or with case is £182.50 and the options of INTERNAL ATU at £37, and DISPLAY at £38.50.

QRP for under £40?

ONLY NEEDS +12v, SPEAKER + KEY/MIC TO BE ON THE AIR!

FOR THE LESS AMBITIOUS, why not try our DSB80 kit? A 2W + DSB or CW VFO controlled TRANSCEIVER kit for either 80 or 160m at a ridiculous £39.95 for a complete pcb kit - over 1000 sold to date! It has a very sensitive receiver and is ideal for beginners. Punched aluminium CASE and HARDWARE for the DSB80 at £25.95, and digital display at £29.50 - all three kits for £85.00.



NEW! The MICRON MATCH ATU Kit, developed from the MICRON ATU, with its own case, connectors, etc. Suitable for SWL or QRP (15W) from 1.8-30Mhz. With air spaced capacitors for only £39.95 inc.

2M FM UNDER £70?

We also make a popular 2M FM T*/RX kit - 8 channel crystal control at 1W RF o/p. Receiver at £39.50 and Tx at £34.50 ex crystals - both for £89.95. Optional PLL VFO available at £38.50.

OTHER KITS: DSB2 - enhanced version of the DSB80 for any single band 160 - 15m, DSB/CW 2W+ at £69.50 basic kit. SPEECH PROCESSOR - very popular kit at £14.65 to help get the DXI ALPHA - our 50W monoband SSB/CW Transceiver with case and display at £179.95. - Available for 160m or 20m.

Why not join the ranks of satisfied customers building our Projects? All of our kits come with copious instructions, all components, pcb, wire, pots, etc, and many are designed for beginners. Our Products are used world wide and can help YOU get on the air. KITS are sent in 7-10 days but please allow up to 28 days for popular items. All prices include VAT and Post. OVERSEAS - Europe use UK prices and Rest of World UK + 5% for carriage, etc. CREDIT CARD orders can be left on our 24hr Answering Service. For our 40+ page CATALOGUE please send 50p in stamps. Kit Debug service available.

WPO COMMUNICATIONS



UK
DESIGN
AND
MANUFACTURE

20 FARNHAM AVENUE, HASSOCKS G3WPO
WEST SUSSEX BN6 8NS MAIL ORDER ONLY
24hr Anaphone 07918 6149

Free Readers' ADS!

WANTED

WANTED for Icom 215 IC20L IC-3PS and charger unit BC20 and IC202S IC402 plus any accessories for above rigs. Phone Mike G6PVA 021-476 7300.

WANTED for aged receiver in need of valve transplant W81, X81, N77, DH81, D63 buy or trade. Tel: G4MNB Swindon (0793) 826325 after 7pm.

WANTED TI-99/4A manuals (loan for photocopying?) also any new games cartridges or peripherals — such as peripheral expansion unit, RS232 exp. memory expansion or disk system. Also cassette recorder cable. Call with details and price phone daytime 0793 696704. Evenings 0285 2036.

WANTED Mobile 2 metre T/R multi mode preferred must be vgc. Tel: Jack G1CMH Gloucester (0452) 423908.

WANTED three pointer knobs for canadian reception set. VRL also required one heterodyne switch and one filter switch for R1155RX. CM Duncan, Roadside Cottage, Hoswick, Sandwick Shetland ZE2 9HL. Telephone: (09505) 405.

WANTED Service manual or circuit diagram of Eddystone 870A receiver. Mr Beech, 66 Newpool Road, Knypersley, Staffs ST8 6NS.

WANTED Codar AT5 transmitter with AC power unit — please send price and condition to Marris, 35 Kingswood House, Farnham Road, Slough, Berks SL2 1DA.

WANTED Yaesu FC102 ATV in FB condition please. Selling/exchange sun 80-200 mm zoom lens, contax fitting, new £70, and minux compact 35mm, model 35GT £100. Case, superb quality G3MIN. Shoreham, Sussex (07917) 3552.

WANTED old radio books, magazines, catalogues, callbooks, QSL-cards, circuit diagrams, service-sheets. Douglas Byrne, G3KPO, 52 West Hill Road, Ryde, I.O.W.

PO33 1LN. Tel: Ryde (0983) 67665.

WANTED Prop pitch motor complete, preferably unmodified, please note this is not a cowl gill motor. Also any Osborne 1 software for Ham Radio. Call reverse charge, G3AAG 0730 892143.

WANTED Belcom LS102L urgent cash waiting, also NATO 2000 mark three if possible. Phone 0283 221870. Also for sale Amtec 300 ATU £35. Phone 0283 221870.

WANTED Plustron TVR5D 5 inch dual standard DX-TV in good working order. Phone Ruislip (08956) 32999.

WANTED Yaesu FT902DM also any available information for Sphynx SSB transmitter and 70cm conversion details for Pye pocket phones. Phone 01-733 0665, aks for Paul or leave a message on 021 772 2677.

WANTED spares boards for Liner 2 and FT2FB reasonable. Exchange Lansing Bagnall battery charger 50/61V 25amp also motor 1ph 1hp cap/st and starter for any good 2MT multimode transceiver. Chris Matthews, G6JGI, 160 Unicorn Road, Oswestry, Shropshire SY11 2ND. Tel:0961 653728.

WANTED I will pay £200 for a Drake HF ATU MN2700 (1KW) in mint or near mint condition definitely not mods complete with baluns and instruction manual. Phone Glover G4KPB, Farnworth 75345, Lancashire.

WANTED Yaesu FT1012D FM FC902 SP901P would consider FT757GX. Require manual for Heathkit HW32A, buy/loan. Phone George G3RCZ 0524 54388.

WANTED Mizuho SB-2X 2 meter TCVR complete with original accessories. Phone Tiverton 820027.

WANTED Commodore computer 64 without extras. Tel 0734 342565.

WANTED circuitry and information on National NC 100A RX and assistance much appreciated, can I help you on

HROs? Mr Simmons, Oxford, Mill Road, Banham, Norfolk NR16 2HU.

WANTED Yaesu FTV901R transvertor must be in mint condition with all leads manual two metre module top price paid, G3BRD Seaford 0323 897313.

WANTED Codar PR30 preselector G3JMO, 42 Runswick Ave, Redcar (0642) 486155.

WANTED Datong converter VC1 or PC1. Tel: Tony Leeming 0608 811102.

WANTED World Radio and TV Handbook 1982 £10. Phone George (0582) 421617 Luton.

WANTED FC700 ATU also FV-700DM VFO. Phone Peter 0538 702208, G4YYO QTHR.

WANTED Avanti PDLII in good working order, secondhand or new. Declan Farnan, 104 Monivea Park, Galway, Ireland.

WANTED valves "R" type to KT88, any quantity, output triodes specially wanted, all valve audio, communications, wireless equipment and crystal sets, early quality hi-fi amplifiers using large output valves, tuners, turntables, speakers, units, pickups and heads, pre 1950 radiograms etc. Compact transportable military receivers, transmitters, American midget radios, Ekco, Phillips, Philco etc. Bakerlite radio's and speakers. Please write or telephone John Baker, 57, Birkenhead Street, London WC1H 8HH 01-833 3008.

EXCHANGE

EXCHANGE Trio 72006 2M mobile tcvr 10watt for IC2E or similar. Ideal set for newly qualified. Would consider SSB mobile. Phone Granville G1 FGA 0254 394177

EXCHANGE Heron cartop sailing dinghy (hull requires renovation) for 70cms transceiver. G8GZC QTHR or 04606 4376.

EXCHANGE 48K Spectrum microdrive/Kempston interface etc will exchange for

CW SW/SSB HF rig KW2000 /Heathkit etc considered but must be GWO QRP OK. Phone (0632) 562908 evenings.

WANTED Yaesu FT102 transceiver, preferably with AM/FM board fitted, in FB condition, in direct exchange, cash adjustment if required, for Contax 139 Quartz camera F1.7 planar, case, plus zoom lenses, Tokina-ATX 28-85mm, Sun 80-200mm, all absolutely mint, boxed, Shoreham (07917) 3552.

HAVE Yaesu FC707 aerial tuner, dummy load, Sankyo 400S Super 8 sound camera, Sanyo SHV2000 portably super 8 8mm sound projector with built in screen. Exchange for HF linear 70cms base station, computer or WHY. G4NJP QTHR phone 0262 673635.

EXCHANGE Webley Vulcan air-rifle hunters combination, scope, silencer extras worth £150 with cash adjustment for either Trio R600 or Yaesu FRG 7000 communication receivers. Interested? Ring Paul on Studley (052 785) 2252 during evenings. PS selection of photographic darkroom equipment also available.

EXCHANGE FT208R 2m hand held, PA3 car adapter, NC8C PWR/quick charger. TM 24A speaker/mic ¼ wave whip for FT290R in good condition. G6CJL QTHR Halifax (0422) 54635.

FT7 plus £250 for your Icom IC720A or FT757GX or similar, FT7 has VOX mod fitted. Phone Les G4JNW Scarborough (0723) 366360.

SWAP Olympus OM10 and case and computer flash, all boxed as new. Exchange for a 144MHz valve mains linear 3 watt drive 100W out(min). Phone Gerry 01 890 9733 evenings.

EXCHANGE classical guitar Alhambra model 9C with carrying case, music and foot stool. Wanted Commodore 64 or BBC computer, or WHY Telephone 01 363 3363

Lineage:

35p per word (minimum 15 words)

Semi Display: (minimum 2 cms)

£7.00 per single column centimetre

Ring for information on series bookings/discounts:

All advertisements in this section must be prepaid.

Advertisements are accepted subject to the terms and

conditions printed on the advertisement rate card (available on request)

01-437 0669

EXT 323

Send your requirements to:

Caroline Faulkner

ASP Ltd.,

1 Golden Square,

London W1

EQUIPMENT

USED AMATEUR EQUIPMENT?



I BUY, SELL & EXCHANGE!

SELLING? I pay the BEST POSSIBLE PRICES for clean used equipment!!

BUYING? I have the BEST SELECTION of TOP QUALITY USED EQUIPMENT AVAILABLE!!

Whether buying or selling phone Dave, anytime, for a deal you've been looking for on

HORNCHURCH (040 24) 57722 ANYTIME,

or send SAE for latest list to:

G4TNY AMATEUR RADIO

132 Albany Road, Hornchurch, Essex RN12 4AQ.

AKD

Armstrong
Kirkwood
Developments

The name for
wavemeters, pre-amps
and rf filters

VHF/UHF ABSORPTION WAVEMETER

Covers 120-450 MHz. Extremely sensitive. Low profile. Requires PP3 battery Only £24.95



2MTR PRE-AMP

18db of gain. Fail safe circuit. Min. 25 watts through power. S0239 connectors

..... Only £24.95

Both products carry a

2 year no quibble guarantee.

ALSO AVAILABLE FROM MOST LEADING AMATEUR RADIO DEALERS
Prices include VAT, postage & packing.

(Prop.) J.W. ARMSTRONG

10 Wilow Green, Graham Park Estate, London, NW9. Tel: 01-205 4704

AMATEUR RADIO EQUIPMENT bought, sold, exchanged. List of available items sent on request. Ring R&S Radio 0305-786930.

COURSES

COURSES - RADIO AMATEURS EXAMINATION City & Guilds. Pass this important examination and obtain your licence, with any RRC Home Study Course. For details of this and other courses (GCE, professional examination, etc.) write or phone — THE RAPID RESULTS COLLEGE, Dept JN4, Tulton House, London SW19 4DS. Tel: 01-947 7272 (9am-5pm) or use our 24 hr Recordacall Service 01-946 1102 quoting Dept. JN4.

ALPHA KEY

ALPHA GOLD

Precision engineered keys for the connoisseur. Twin paddle, Single paddle, and the new Straight Key. Now even better value.

CAVITY WAVEMETERS

One Wavemeter to cover 144MHz to over 2500MHz. Now with improved pickup and frequency readout.

10 GHz WAVEMETER KITS

A pre machined cavity block to make a 10 GHz wavemeter using your own micrometer.

Send large SAE for full information to:

Paul Sergent
6 Gurney Close, Costessey
Norwich (0603) 747762

CARDS/STICKERS

QSL CARDS. Many designs, reasonably priced. Free samples, please state if S.W.L. DEROGA PRINTING, Whitewell Rd., Sparham, Norwich NR9 5PN.

HIGH CLASS QSL CARDS. Competitive prices, free artwork. SAE for samples stating ham or breaker to: J.S. Coates, 57 Worrall Street, Morley, Leeds LS27 0PJ.

PLASTIC / MEMBERSHIP / CARDS, laminated cards, lapel badges, all made to your specification. KARDLINE, P.O. BOX 206, Wootton Bassett SN4 7EZ. Tel: 0793 853406.

QSL CARDS. Gloss or tinted cards. SAE for samples to TWROG Press, Dept HRT. Penypont, Gillylydan, Blaenau, Ffestiniog, Gwynedd, LL41 4EP.

MISCELLANEOUS

HEATHKIT U.K. spares and service centre. CEDAR ELECTRONICS, Unit 12, Station Drive, Bredon, Tewkesbury, Glos. Tel: 0684 73127.

PERSONALISED LEATHER BELTS
HAND MADE
YOUR CALL SIGN
LEATHER BELTS
in top quality cowhide with solid brass buckle
£7.50 +50p p&p (colours brown, tan, black)
Other personalised leather goods made to order
Crawton Leather Co
Lampton, Sandness
Shetland Isles
Tel: Sandness 296

WANTED

TURN YOUR SURPLUS transistors, IC's etc into cash. Contact Coles Harding & Co., 103 South Brink, Wisbech, Cambs. Tel: 0945 584188. Immediate settlement.

ALARMS

BURGLAR Alarm Equipment Please visit our 2,000 sq. ft showrooms or write or phone for your free catalogue. C.W.A.S. Ltd, 100 Rooley Avenue, Bradford BD6 1DB. Telephone 0274 731532.

KITES



KITES for portable aeriels. Hand-made of ripstop-nylon. Many signs from £9.95. S.A.E. for catalogue. D.I. KITES, 20 Embay Rd., Lower Stanwick, Southampton. Tel: 04895 3026.

RIG DOCTOR

POWER SUPPLY REPAIRS

We offer a fast repair service on most makes of D.C. power supplies in the 1 to 30 amp range, crowbar circuits, etc. also fitted.

For full details please ring
0536 743496

HOLIDAYS

SELF-CATERING CHALETs. Explore by day, DX by night. My aeriels, your rig £15-£120 per chalet per week. Green, Goats, 'Chylean' Tintagel, Cornwall PL34 0HH. Tel: (0840 212262).

RTTY

RTTY - CW - AMTOR Now on the Dragon Complete set of Programs & Hardware

to convert your DRAGON 32/64 into a complete communications terminal.

Morse transceiver
Program (Cassette) £10.75
Interface (Module) £17.50

RTTY
Program (Cassette) £12.00
Terminal unit of
modules £39.00

AMTOR
Program (Cassette) £39.00
Clock/Switch
Module £18.00

Programs also available in Cartridge.
Hardware available in kit or fully
boxed form.

For full details send 2x 17p stamps
to:-

PNP Communications (HT)
62 Lawes Avenue, Newhaven
East Sussex BN9 9SB
Tel: (0273) 514465
Prices include postage but not VAT

ANTENNAS

G2VF DIY loop Antennas for H.F.
long and medium wave bands.
SAE for details: Rylands, HRT, 39,
Parkside Ave., Southampton
SO1 9AF.

VINTAGE REPAIRS/SERVICE

VINTAGE RADIOS repaired —
restored — over 200 Radios
Stocked! 1922-1960. RADIO VIN-
TAGE, 250 Seabrook Rd., Sea-
brook, Hythe, Kent CT21 5RQ.

COMPONENTS

RESISTORS, CAPACITORS.
1,000 mixed carbon film 1/8W, 1/4W,
1/2W, 2%, 5%, 10% resistors £2.95
+ 50p P&P. SAE for details to: D.J.
Hooker, Romney Marsh, Elec-
tronics, Clark Road, Greatstone,
New Romney, Kent TN28 8PB.

R.F. Transistors. Specialist Com-
ponents for Transmitters. Unelco Capa-
citors. Sprague Mica Trimmers (500V).
Sole Agent for solid state Microwave
R.F. Transistors supplied to full specifi-
cation. Full 12N range supplied. Special
SD range 1W-100WATT output 1 to 100
MHz. Preamplifiers for 2 meters and
70cms. Power Amplifiers with and without
switching. Aligned and ready for use. Due
to exchange fluctuations we cannot price.
*Send S.A.E. for full lists.

Phone: (0243) 823803. Modular Elec-
tronics, 1 Coniston Close, Felpham,
Bognor Regis, Sussex.

KITS

TRUTONE MODULES
For serious repeater users
Toneburst and timer module combined on one
board. For operating a transceiver with any 2
metre F.M. repeater in the UK. Accurately times
transmission providing both visible and audible
warnings at end of pre-determined period when
user is about to time-out through repeater. SAE
for details. Price £12.50. Timeout or toneburst
board supplied separately at £7.50 each. All
prices inc P&P.
**TRUTONE MODULES, 58 Norman Rd., Saltford,
Bristol BS10 3BH.**

FOR SALE

PRE-WAR RADIOS 1930-40.
Contents of old radio shop. Ring
for details: 051-521-4942.

COMPUTER LOG

**SINCLAIR (48K + 16K) Spectrum
ZX81 (16K). Logger designed for
amateur radio operator. Holds
720 logs (48K). All the legal
requirements and niceties, full
search and update. Price on
cassette £5.50 each, cheques and
P.O.'s to: Martello Computer Ser-
vices, "Freepost Reading RG6
1BR".**

BUSINESS OPPORTUNITIES

MULTIPLY your income/profits
working for yourself with the
breakthrough **ENTREPRENEUR
ASSOCIATION**, part-time or full-
time. Send SAE for valuable free
details: Atlantic Press, Dept P6(1),
9 Cork Street, Mayfair, London
W1.

BOOKS AND PUBLICATIONS

SERVICE MANUALS

Ham Concorde 2, Ham multi-
mode 2, Ham Jumbo 2, Ham
Viking, Ham Puma, Cobra 148
GTL DX, PC 879 and PB010.
Coit 1600 DX, Tristar 777,
York 863, York 861.

All above at **£6.00 + £1.00 p&p**
each.

Other, rigs and spare parts
available.

10m conversion for FMCB rigs
£30 + £1.50 p&p
Details on request.

CBT

1 Prince of Wales Road,
Swansea. (Tel: (0792) 463821.

ANTENNAS

TIGER ANTENNAS FORGET THE REST BUY THE BEST

To Radio users both amateur and professional Tiger antennas represents an excellent range of antennas on the market today.

We use high quality (high strength materials produced to our own specifications. All our products are designed and engineered to give maximum performance both electrically and mechanically. Special attention has been given to reducing wind loading and still maintaining a very strong and durable antenna. We guarantee Tiger and silver 70 range against electrical and mechanical defect for 2 years.

	Model	Gain	Price inc VAT. £s
Tiger	144 Colinear	8dB Gain	33.95
Tiger	LY13 LONG YAGI	15dB Gain	39.50
Tiger	LY10 LONG YAGI	13dB Gain	32.00
Tiger	LY9 LONG YAGI	12dB Gain	24.80
Tiger	LY8 LONG YAGI	9dB Gain	15.50
Tiger	LY4 LONG YAGI	7dB Gain	11.70
Tiger	LY13 LONG YAGI	15dB Gain	39.50
Tiger	SUPER SLIM JIM 144 or 432 MHz		7.50
Tiger	Diecone 500 wideband Antenna		5.95
SILVER 70	BEAM 14EL	16dB Gain	31.50
TIGER LY9/ HF BALUM	432 BEAM TRANSFORMER	1dB Gain 500W1-30 MHz	15.95 17.00

**SPECIAL
OFFER**

A POWER SPLITTER FREE WITH ANY PAIR OF LY9/10/A 870's.
UK P&P Securicor £8.60. Allow 14 days for delivery

UK STOCKISTS

APW Electronics
Cleveland 0842 870434
Barnsley Aerial Centre
Barnsley 0226 245520
J Birkett
Lincoln 0522 20767
Alyntronics
Newcastle Upon Tyne
0632 781002
Stephens James
Lancashire 0842 878790
RW Pollock & Co
Bradford 0274 729223
Robinsons TV
Leeds 0532 633838

RAS
Nottingham 0802 280267
Ward Electronics
Birmingham 021-328 6070
Erver Ltd
Maldon, Essex 0621 891755
Cian Communications
Glasgow 0475 41376
Alan Hooker
Doncaster 0302 25690
Hessle Communications
Hessle (Hull) 0482 648602

Frank Godfrey
Workop Notts 0909 472829
Glenbond Ltd
Cheshire 061-941 3057
Castle Electronics
Nottingham 0802 808999/812523
Collins Communication
Cambridge 022386041
MGR Services
Berkenhead 051-863-3457
DX Amateur Radio
Warwickshire 0928 312421

OVERSEAS DISTRIBUTION (SOLE EUROPEAN AGENT) WITRONICS,
NANOVESTRAAT 153, B.1890, OPWIJK, BELGIUM. TEL: 052357226
P.O. Box 118, Scunthorpe, South Humberside DN15 8EQ. Tel: (0724) 851975

FOR ALL
YOUR RADIO
NEEDS...



USE
HRT
CLASSIFIEDS!

EMPORIUM GUIDE

W. MIDLANDS

HEWARD'S HOME STORES LTD. (Est. 1963)
822/4 Kingstanding Rd., Birmingham
B44 9RT. Tel: 021-354 2083
G4RJM with 38 years in The Radio Trade
Ham Equipment urgently wanted!
Open: Mon-Sat 9-6

WARD ELECTRONICS

DIAWA LOWE PRODUCTS COMMODORE COMPUTERS
HOKUSHIN I.C.S. AMTOR/RTTY EQUIPMENT RSGB BOOKS
G3LIV PCB'S FOR SSTV/RTTY FOR RADIO ENTHUSIASTS
422 Bromford Lane, Ward End
Birmingham B8 2RX
Tel: 021-328 6070 (Closed Monday)

R. WITHERS COMMUNICATIONS

584 Hagley Road West
Oldbury, Warley B68 0BS
(Quinton B'Ham) Tel: 021-421 8201/2/3
Opening hours 9.00-5.30pm. Late nights Thurs-Fri.
For all your communication requirements send SAE for latest used list and latest info.

TAR AERIALS AND COMMUNICATIONS

Specialists in Aerial Components, Lashings & Masts
Dealers in Jaybeam, Icom, Yaesu and others. Visit the
THE COMMUNICATIONS CENTRE
KING WILLIAM STREET, AMBLECOTE
STOURBRIDGE, WEST MIDLANDS, DY4 4CY
TEL: 0384 390944

CENTRE ELECTRONICS

354 Stockfield Road, Yardley, Birmingham B25 8JP
Specialist in the sale and service of Ex Government and Vintage Radio and Test Equipment.
(Many spares in stock).

Telephone enquiries to 0676 32560

Special delivery service Shop open Thursdays, Fridays and Saturdays

DEWSBURY ELECTRONICS

RXs, from YAESU, JRC, ICOM.
Stockists of microwave modules, B.N.O.S., M.E.T.,
GAMMA, DATONG, ICS, TASCOS.

Open Mon-Sat, 9.30-5.15

176 Lower High Street
Stourbridge (0384) 390063

YORKSHIRE

••RADIO AMATEURS AND 'C.B.' PEOPLE TALK TO••

34 NEW BRIGGATE LEEDS LS1 6NU
COMMUNICATIONS CENTRE

ELECTRONIC COMPONENTS - TELEPHONES
VIDEO - AUDIO LEADS - STYL!
LEEDS 452657 THE PROFESSIONALS!

TRIO ICOM YAESU
LARGE RANGE OF ACCESSORIES

LONDON

PROTEL AERIALS AND COMMUNICATIONS

Manufacturers and suppliers of aerials and accessories, DXTV equipment and aerials also other specialist aerials. Large range of bracketry and masts also available.
295-297 Ballards Lane, N12. Tel: 01-445 4441
TRADE ENQUIRIES WELCOME

Details on request.

DRESSLER UK LTD

191 Francis Rd, Leyton, E10
Open 9-5.30pm Monday-Friday 10-5 Saturday
Authorised dealers for:
Dressler, Yaesu, Icom, Standard, Trio/Kenwood,
Datong, SCM, Microwave Modules, Tonna
Tel: 01-558 0845/558-1415 Telex: 8653609

BONEX LTD

RF component specialists Toko
coil & inductors "available at show"
102 Churchfield Road
London W3 6DH
Tel: 01-992 7748

CHESHIRE

GLENBOND (VIDEOTEL) LTD

25, Stamford Street, Altrincham, Cheshire, WA14 1EX
Tel: 061-941 3057 Telex: 666387
Standard 2m and 70cm - Jaybeam - Ant Antennae
- Antiference - Weltz - Sinclair Computer Spares
- Revco

Collin G1 1ZD Gavin G1 1ZL
YOUR RADIO SOLD ON COMMISSION BASIS

DW ELECTRONICS G3 XCF

Amateur Radio Supplies
71 Victoria Rd, Widnes
Tel: 051-420 2559

Open Mon-Sat 9.30-6 (closed all day Thurs)
We supply YAESU, ICOM, Tonna, Jaybeam,
Microwave Modules, Datongs etc

LEICESTERSHIRE

ELLIOTT ELECTRONICS

FOR THE RADIO ENTHUSIAST
26-28 BRAUNSTON GATE,
LEICESTER. TEL: 563283
Open: Mon-Sat 9.00am to 5.30pm

KENT

Thanet ELECTRONICS

95 Mortimer St, Herne Bay
Tel: (0227) 369464

Open Mon-Sat 9-5.30pm
except Thursday 9-1pm

SCARAB SYSTEMS AMATEUR RADIO SOFTWARE

STOCKISTS
38 Stafford Street, Gillingham 0634-570441
please see main advertisement

SURREY

GUILDFORD COMMUNICATIONS

34 Aldershot Rd., Guildford
Open Mon-Fri 8am-6.30pm
Sat 8am-5.30pm
Secondhand wanted
ASDEN TOTSUKO
0483-574434

TYNE & WEAR

Approved Dealer
ALYNARONICS
ICOM

129 Chillingham Rd, Newcastle-upon-Tyne
Tel: 091-276 1002
Open: Tues-Sat 10am-6pm

AVON

Booth Holdings Bath

6 GOLF CLUB LANE,
SALTFORD,
BRISTOL

Tel: 02217 2402
Open: Tues-Sat 9am-9pm
Close Mondays

NORFOLK

D.P. HOBBS (Norwich) Ltd
13 St. Benedicts Street, Norwich
Tel: 615788

Open Mon-Sat 9-5.30
Closed Thurs
Stockists of: ICOM
YAESU, FDK, ICOM, JAYBEAM
& Electronic Component Specialists

STOP PRESS

Shuttle Success On Slow Scan TV

During the recent Space Shuttle 'Challenger' flight, astronaut Dr Tony England, WOORE successfully transmitted slow scan TV pictures to earth. Despite the problems at the start of the mission, some very good pictures were received.

S22 or 145.550MHz was kept fairly quiet by the 'policemen' during the Shuttle passes so most of the country had good reception. The pictures were transmitted using the three slow scan systems: 36 second line sequential colour, 24 second colour and 8 second black and white. Five different pictures were seen at the G4TVC QTH, either direct on an 8s system or QSP'd from Roddy, G3CDK. By far the best picture seen was of WOORE sitting (or floating) on the right of the frame. The badges on his shirt were quite visible. This was a good colour picture using the 36s system. The final picture was an outside view looking over the tail of 'Challenger' with the cloud formations on earth showing up well.

Although some of the experiments on Challenger were a bit of a flop, the amateur SSTV transmissions were very successful and we hope NASA will continue these amateur radio exploits.

Jack Darby.

HAM RADIO TODAY — OCTOBER 1985 ADVERTISERS INDEX

AJH Electronics.....	43	Microwave Modules	I.B.C.
Allweld Engineering.....	23	Rainbow Communications	37
Amcomm Services.....	23	RAS Nottingham	37
Arrow Electronics	O.B.C	R. Withers Communications	9
BNR&ES.....	37	Radio Related Software.....	29
Cirkit Holdings	19 & 43	South Midlands Communications.....	37
Dewsbury Electronics.....	17	Spectrum Communications	43
Dressler U.K.	32	Stam Press.....	43
Farnborough Communications.....	37	Technical Software	29
Halbar Aerials.....	23	Thanet Electronics	4/5
Hi-Tec Worldwide	31	Timestep Electronics	27
K.W. Ten-Tec.....	37	Waters & Stanton Electronics	7
Leicester Amateur Radio Show	13	WPO Communications	51

Don't forget, when calling an advertiser,
mention Ham Radio Today — it helps them and us.

73's Dave Gadsden, G4NXV, Advertisement Manager



MICROWAVE MODULES LTD

Microwave Modules Ltd. Is a full time professional organisation, established over **16 years** ago in **1969**, and currently employs over **30 full time**, on site staff based in our two modern, purpose built factories. In addition, a similar number of 'Outworkers' are involved in assembly and mechanical operations.

OUR EXTENSIVE RANGE . . .

Our product range now exceeds **50 Individual Items** in total and is the widest range available from any one manufacturing company. Our technical resources have enabled us to not only become **the largest and most successful** designer and manufacturer of R F Products, such as **Linear Amplifiers** and transverters, but also designers and manufacturers of **innovative** microprocessor and digital products such as **The Morsetalker**, MMSI, and the RTTY to TV decoder, MM2001.

ALL BRITISH . . .

Every product in our range is designed and manufactured in the UK by our own employees, and wherever possible British Components are utilised.

GUARANTEED . . .

All Microwave Modules Products are **Fully Guaranteed for 12 months**. This includes all semi-conductors and **PA Transistors**. We have built our reputation around our customer service and back-up and it is second to one.

OUR RANGE OF LINEAR AMPLIFIERS . . .



MML144/30-LS

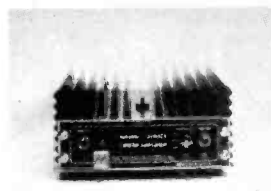

MML144/50-S

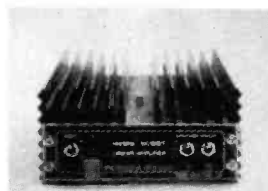

MML144/100-LS

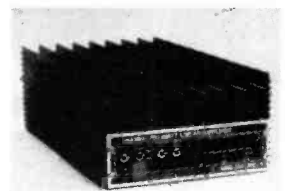

MML144/200-S

PRODUCT	INPUT POWER	OUTPUT POWER	MODES OF OPERATION	Pre Amplifier		POWER REQUIREMENTS	RF * VOX	PRICE INC VAT
				GAIN	NF			
MML144/30-LS	1 or 3W	30W	SSB,	12dB	<1.5dB	13.8V @ 4A	✓	£82.90 (p&p £3.50)
MML144/50-S	10W	50W	FM,			13.8V @ 6A	✓	£92.00 (p&p £3.50)
MML144/100-S	10W	100W	AM,			13.8V @ 12A	✓	£149.95 (p&p £4.00)
MML144/100-HS	25W	100W	CW,			13.8V @ 12A	✓	£149.95 (p&p £4.00)
MML144/100-LS	1 or 3W	100W				13.8V @ 14A	✓	£169.95 (p&p £4.00)
MML144/200-S	3, 10 or 25W	200W				13.8V @ 30A	✓	£299.00 (p&p £5.25)

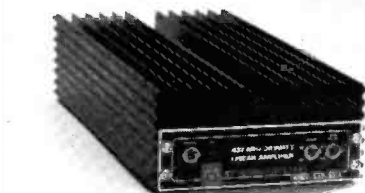

MML432/30-L

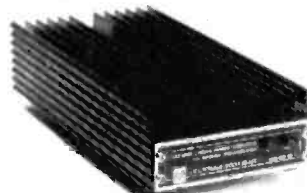

MML432/50



MML432/100

PRODUCT	INPUT POWER	OUTPUT POWER	MODES OF OPERATION	PRE AMPLIFIER		POWER REQUIREMENTS	RF* VOX	PRICE inc VAT
				GAIN	NF			
MML432/30-L	1 or 3W	30W	SSB,	12dB	2dB	13.8V @ 6A	✓	£145.00 (p&p £4.00)
MML432/50	10W	50W	FM,	12dB	2dB	13.8V @ 8A	✓	£129.95 (p&p £4.00)
MML432/100	10W	100W	ATV, CW,	—	—	13.8V @ 20A	✓	£299.00 (p&p £5.25)

*THE RF VOX CAN BE OVERRIDDEN AND HARDWIRED.

CONNECTORS . . .

144MHz Products — Our standard connector on these products is SO239. We use a high quality PTFE socket of superior quality, but we are able to supply the choice of BNC or 'N' type at no extra charge. Please specify

432 MHz Products — The MML 432/30-L's fitted with BNC connectors, 'N' type available, please specify. The MML432/50 and MML432/100 both have BNC input sockets and 'N' type output sockets. If this is not to your preference please specify when ordering.

DATA SHEETS . . .

A full printed data sheet is available on each product, and is free on request.

CATALOGUE . . .

A copy of our latest catalogue can be obtained free of charge on request.

AVAILABILITY . . .

Our products are normally available from stock, either direct from ourselves or any of our 75 UK outlets.



WELCOME

MICROWAVE MODULES Ltd

BROOKFIELD DRIVE, AINTREE, LIVERPOOL L9 7AN, ENGLAND
Telephone: 051-523 4011. Telex: 628608 MICRO G
CALLERS ARE WELCOME, PLEASE TELEPHONE FIRST

HOURS:
MONDAY-FRIDAY
9-12.30, 1-5.00
E & O.E.

YOUR ONE SOURCE FOR RADIO

ARROW

ELECTRONICS
LIMITED
5, The Street,
Hatfield Peverel,
Chelmsford, Essex

FOR IMMEDIATE DESPATCH

phone with your Access, Eurocard,
Mastercharge or Visa number to

0245 (Chelmsford) 381673 or 381626.
Telex 995801 (ref: A5)

OVER
500
LINES AT
UNBEATABLE
PRICES

IT WILL
PAY YOU
TO PAY
US A
VISIT!

THE NAME YOU CAN TRUST FOR PRICE & AFTER SALES SERVICE

INTEREST FREE FINANCE

Yes, you really can spread the cost of your new rig over 6, 9 or 12 months and ARROW pays the interest charges for you. Three schemes: 20% deposit, balance over 6 monthly payments. 1/3rd deposit, balance over 9 monthly payments. 50% deposit, balance over 12 monthly payments. And remember, you pay no more than the normal RR price!! Just call us and we will send agreement for your new gear same day!!!



One of the country's largest Yaesu stockists you can see all the new models at ARROW plus get the very best deals - take advantage of our Interest Free Credit or call us for a really keen price - Nobody does it better!!!

DAIWA produce a marvellous range of PSUs - see the variable volt PS300 or the Cross needle SWR bridges. New 2M RTU/SWR meter. And some of the best HF tuning units around.

"Bencher" Paddles stocked and "Vibroplex", Hi-Mound see and try a key or paddle at the ARROW shops. BNOS make some of the finest British made PSUs we have seen and the Linears are superb with 5 year warranty

APPROVED
TRIO
DEALER

YES! It's true ARROW became fully franchised dealers for TRIO in December and are now fully stocked with all the latest models



AR2001 Receiver
25/500MHz

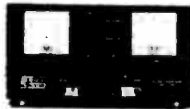

IC751, IC745, R71, R70, IC271E, IC471E, IC2E, IC4E, IC02E, IC04E, all stocked with accessory ranges - Call us for price

AUTHORISED
ICOM
DEALER

Rotators stocked include the new Daiwa multi-torque with up to 4 motors possible. Also the full Daiwa range at competitive prices, Kenpro from KR2000RC to KR250 inc KR500 Elevation type



Send us an SAE for details of the new TET beams with 40 metre band 11 & the minibeams with the same gain as fullsize



WELZ full range stocked

Come and see the new Trix-tower at Chelmsford, 30 or 40ft folds down really low, tilt or wall mounted. Keen prices

Our normal despatch is one or two days (as thousands of satisfied customers will tell you). Subject to manufacturers supplies being available. CARRIAGE FREE on all orders of £300 value and over (UK Mainland only)

Access and Barclaycard accepted. Save time - phone over your order with your Access or Barclaycard number. Express delivery can be arranged on all items for a total charge of £7.50. Please phone for details. This offer applies to UK Mainland only. N.B. The F.O.C. carriage offer does not apply when Express Delivery is requested.

THIS MONTH'S SPECIALS

The Cost Cutters

TRIO
TS430s
HF TRANSCEIVER
£719.95

TRIO
MINI-HANDHELD
2M. FM.
£169.95
Incl. Charger

FT757GX
YAESU HF
TRANSCEIVER
£729.00

FRG 9600
YAESU'S NEW
VHF/UHF SCANNER
£425

FT209R
YAESU 2M. FM
KEYBOARD HANDY
£209.00

TRIO
TS940S
NEW FANTASTIC
HF TRANSCEIVER

FT2700RH
25 watts FM
ON 2M + 70CMS
£479.00

MT20E
DAIWA. NEW
MINI THUMBWHEEL
2M. FM HANDY
ONLY £159



All mail orders to
ARROW ELECTRONICS LTD
5 The Street, Hatfield Peverel, Chelmsford, Essex

Hatfield Peverel showrooms which are just off the A12 trunk road, are open 9-5pm Mon, Tues, Weds, Fri, Sat. Closed all day Thursdays. Approach by road via M25 & A12. By rail to BR Hatfield Peverel (3 mins from shop). We will taxi you back to rail station with heavy equipment. Buses from Chelmsford and Colchester pass the door. Free parking in our own car park. Local repeater GB3DA R5.

Scottish customers welcome at ARROW ELECTRONICS (SCOTLAND) 51 Hyndland Street, Partick, Glasgow. Tel: 041-339 6445 ask for Bill GM0ARO. Parking free outside the shop, which is near the Clyde Tunnel and Kelvin Museum. Open six days (closed Sunday) 9-5.30

At ARROW ELECTRONICS (MIDLANDS) Tel: 0858 62827 you will find Alan G4TZY who will be pleased to assist you. Alan lives at 33 Fairway, Market Harborough, Leics, but please telephone first.

At ARROW ELECTRONICS (WALES) John Lewis GW8UZL waits to talk to you in English or Welsh! John is an expert on Satellite work & knows all the wrinkles on FT726R etc. Tel: 0248 714657 14 Carreg-y-gad Llanfair-p-g Anglesey N. Wales