

# HAM

AN ARGUS SPECIALIST PUBLICATION

AUGUST 1985 £1.20

# RADIO

## Receiving Weather Satellites

# TODAY

A practical guide to this fast growing pastime by Mike Christieson, G8FCD

Project to Build Combined 2m SWR bridge and wavemeter

Shed to Shack Thinking of turning the garden shed into a radio room?

Meteosat view of Europe and North Africa



**The Multimite keyer**  
Customised and programmable iambic keyer/keyboard sender/morse trainer

Win the Dewsbury Electronics 'Star Master' keyer reviewed inside . . .

# R WITHERS

584 HAGLEY ROAD WEST, OLDBURY,  
QUINTON, B68 0BS BIRMINGHAM.

M5  
JUNCT  
3



BIRMINGHAM  
MAJOR INDEPENDENT  
SERVING THE UK



AN HF BEST  
SELLER  
FT757GX

- \* 100 Watt multimode \* AM, FM, CW, SSB.
- \* Gen. coverage RX \* Computer compatible.

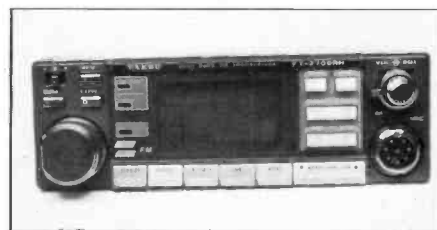

THE ULTIMATE  
2mtr/70cms  
MOBILE  
FT2700RH

- \* Full duplex \* A big 25 watts on VHF/UHF.
- \* 10 channel memory \* Scanning \* LCD display/'S' meter.

NEW PRODUCTS EXCLUSIVE TO R.W.C.

## RAYCOM MODULAR RF AMPLIFIERS

A complete range of linear and fm amplifiers for use with both VHF and UHF hand portables and multimode portables such as the YAESU FT290R and FT790R. Power output from 15W to 45W depending on model. (eight are available). All units feature Mitsubishi or Toshiba power modules as used in the majority of mobile and base radio transceivers. Two versions are also available for business radio applications.

PRICE from £39.50 for the 15W vhf model + £2.00 post

### UHF UNITS (430-440MHz)

	ORDER CODE	PRICE
25W FM/CW	U25F	£79.50
15W FM/CW/SSB/AM	U15L	£69.50
15W FM/CW	U15F	£59.50

### VHF UNITS (144-149MHz)

	ORDER CODE	PRICE
45 FM/CW	V45F	£62.30
35 FM/CW/SSB/AM	V35L	£59.50
25 FM/CW	V25F	£48.50
15 FM/CW/SSB/AM	V15L	£49.50
15 FM/CW	V15F	£39.50

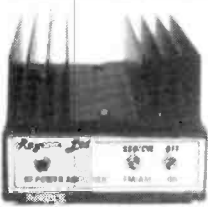

## 10 Mtr MOD BOARD

PRICE  
£22.50

+ £1.00 post free  
packing. Kit now  
available at £17.50

This is a complete modification board designed to fit all CB radios that incorporate the SANYO LC7137 series of synthesizer chip, the unit comprises of a small pcb with six microchips and fits almost all current legal (CB 27/81) radios, the unit is supplied with full fitting instructions and can be fitted easily by most enthusiasts, with the current upsurge in interest in this band demand has been high as this means that over 90% of current CB radios can now be used on 10 mtr amateur band. See other ads for more information. Over 300 sold in 2 months. Complete radios available & other kits.

We also sell and service Cellular Radio, and PMR (Business) radio equipment.

Tel: 021 421 8201 (24hr answerphone)

Telex: 334303 G TXAGWM



NEW EXCITING  
DUAL BANDER

IC3200E



- \* Simplified front panel \* Simplex/Duplex memory
- \* Built in duplexer \* Smallest in its class.



THE HIGH-TECH  
ALL BAND  
HF TRANSCEIVER

IC745



- \* 16 tunable memories \* Gen. coverage RX
- \* Scanning \* Deep IF notch filter \*

Raycom Limited



## A.R.M. MULTI P6 ANTENNA

Probably the most versatile  
Antenna ever designed

PRICE £39.25  
+ £2.50 carriage

This is one of the most exciting new products to be launched by RWC and is the result of many months of development by Antenna Research Manufacture based in Devon. The antenna has been designed to meet the growing popularity in multimode portable and mobile operation and is capable of being used on both vhf and uhf in both horizontal and vertical polarization modes, both portable and mobile. The antenna has the facility of being used as both omnidirectional modes as well as having capability of DF function. No ground-plane or radials are required and the antenna can therefore be used in a variety of applications on frequencies between 140-450 mhz. Colinear elements £4.75.

\* SEE THE REVIEWS \* or SAE LEAFLETS

## ANNOUNCING THE SUPER YAESU FT757GX — MOD BOARD UNIT from Raycom

- The modification serves two major purposes
- (1) to improve VFO tuning and eliminate 'TUNING GLITCH'
- (2) to increase tuning speed from 5khz per dial revolution to 50khz per dial revolution (selectable on the 500khz step switch)
- UK price is £29.50 for the built and tested pcb with complete fitting instructions and £39.50 plus carriage for a unit factory fitted and tested. Instant fitting service available. Phone now.

£1000.00 instant credit available  
for licensed amateurs. Details upon  
request. Call now!



HP/PERSONAL  
LOANS AVAILABLE  
(written details upon request)

RWC CREDITCARD

# HAM RADIO CONTENTS

## TODAY

VOLUME THREE NO.8 AUGUST 1985

**Editor**  
Steve Ireland, G3ZZD  
**Editorial Assistant**  
Julie Darby, G1CKF  
**Group Editor**  
Dave Bradshaw, G1HRT  
**Advertisement Manager**  
Dave Gadsden, G4NXV  
**Classified Sales Executive**  
Caroline Faulkner  
**Publisher**  
Peter Welham  
**Chairman**  
Jim Connell



Design by

MM DESIGN

Published by:

Argus Specialist Publications Ltd.,  
1, Golden Square,  
London W1R 3AB.  
Telephone: 01-437 0626

Distributed by:

SM Distribution Ltd.

Printed by:

The Garden City Press Ltd.

Subscription Rate

UK £17.00

O/Seas Sur: £18.50

USA Sur: \$25.00

O/Seas Air: £33.50

Ham Radio Today,  
Subscriptions Dept,  
Infonet Ltd,  
Times House,  
179 The Marlowes,  
Hemel Hempstead,  
Herts HP1 1BB  
Tel: (0442) 48432



Ham Radio Today is normally published on the first Friday in the month preceding cover date. The contents of this publication including all articles, designs, plans, drawings and programs and all copyright and other intellectual property rights therein belong to Argus Specialist Publications Limited. All rights conferred by the Law of Copyright and other intellectual property rights and by virtue of international copyright conventions are specifically reserved to Argus Specialist Publications Limited and any reproduction requires the prior written consent of the Company. © 1985 Argus Specialist Publications Ltd. All reasonable care is taken in the preparation of the magazine contents, but the publishers cannot be held legally responsible for errors. Where mistakes do occur, a correction will normally be published as soon as possible afterwards. All prices and data contained in advertisements are accepted by us in good faith as correct at time of going to press. Neither the advertisers nor the publishers can be held responsible, however, for any variation affecting price or availability which may occur after the publication has closed for press.

## REGULAR COLUMNS

LETTERS .....	4
RADIO TODAY special report from Dayton Hamvention, USA ...	8
MICRO' NET .....	23
RADIO TOMORROW .....	47

## CONSTRUCTION

COMBINED SWR BRIDGE AND WAVEMETER FOR 2m.....	18
<i>Just got a G1 or new to 2m? This simple project is ideal for you!</i>	
THE MULTIMATE KEYS .....	30
<i>Superb keyboard sender, iambic keyer and morse tutor. Design by Mike Bedford, G4AEE.</i>	
MEET THE MICRON .....	40
<i>Final alignment and operating information from G4JST and G3WPO.</i>	

## FEATURES

RECEIVING WEATHER SATELLITES .....	12
<i>A practical guide to this fascinating and fast growing pastime.</i>	
FROM SHED TO SHACK .....	26
<i>"You too can make the garden shed into a radio room", says Trevor Butler, G6LPZ</i>	
LOOP IN A LOFT .....	38
<i>No room for outside antennas and want to work HF DX? Read on!</i>	
BOOKEND .....	46
<i>Julie Darby, goes undercover to survey some of the better and more unusual frequency listings.</i>	

## REVIEWS

SQUEEZE KEYS SUPREME? .....	22
<i>The editor takes Dewsbury's Star Masterkey to National Field Day.</i>	
YAESU FT270RH MINIATURE 2m FM TRANSCEIVER .....	43
<i>Tony Bailey, G3WPO, found a new Japanese driving companion...</i>	
COMPETITION! WIN A DEWSBURY 'STAR MASTERKEY' .....	6
ADDENDUM .....	11
STOP PRESS! .....	42
Free Readers Ads .....	51
Emporium Guide .....	55
Classified .....	57
NEXT MONTH IN HRT .....	56
ADVERTISEMENT INDEX .....	56

Due to lack of space, we regret that 'A Look at the BBC Outside Broadcasts' part 2 has had to be held over.

# LETTERS

## PROVIDING PCBs

Sir, firstly, I have regularly obtained your excellent magazine since its inception during 1983, and must compliment you on a compact, well written, easily understood publication, which must stand at the fore-front of those available to the hobbyist today.

I have only one criticism to make relating to your magazine; unlike many of the other publications within the field of electronics, you do not offer a "Printed Circuit Board Supply Service", to enable readers to construct projects as published in your magazine.

Whilst it might be argued that the hobbyist should produce his own PCB's, this being an integral part of the hobby. There are those amongst us however, who for one reason or another, fight shy of the problem of producing the basic artwork form, on the copperclad board.

Thinking about this problem, I feel that I might have a solution. The idea is that, rather than your publication holding stocks of space and money consuming PCBs, you could however from your original artwork, via a vis foil-pattern(s) as published in the various articles, produce, sheets of etch-resist rub-down transfers of the circuit. These as previously stated would cost your magazine far less than actual PCB's, and encourage hobbyists to etch their own ones, perhaps even eventually instilling in the hobbyist the desire to ultimately produce his own artwork.

Well, how about it HRTI Can you now prove that you really are the leading magazine in the field today, by accepting what is really a very simple to implement idea.

Raymond Michael Fox

*Your idea of the etch resist 'rub down' transfers sounded very interesting and I mentioned this idea to my Group Editor. He informed me that 'Electronics Today International' had used this very idea in the past. Apparently, the cost of producing the transfers was relatively high and after initial interest from readers, the amount of transfers sold steadily declined. This was deduced to be partly because of the price and partly*

*because of difficulties of implementation by readers. When the transfers were rubbed down, there was a tendency for them to distort or, in extreme cases, disintegrate. The service was thus discontinued, leaving ETI with a large number of these transfers, and a service providing etched boards instituted in its place.*

*You will be pleased to hear that we hope to offer an etched PCB service in the fairly near future.*

## OPEN SOCIETY?

Sir, anyone reading the RSGB's 'Radio Communication' (April edition, minutes of the Council Proceedings held on the 19th January '85) cannot fail to get the message when the President emphasised the confidentiality of Council meetings and minutes.

What are the published 'Council Proceedings', a thoroughly vetted version of events? There has to be something fundamentally wrong when the Society has to be obsessed with secrecy. Do the members really want this secrecy, or do they want and have a right to know, what is really going on?

One member stands up and lets the world know what is really going on and most of the other Council members attack him. What was the release of information about — the election of the 1985 President Joan Heathershaw . . . ?

All does not look well for the future, especially with the RSGB membership falling.

Ian Abel

*As a member, I would certainly like a more open society myself. The best way of changing things is from inside — when are you going to join the society, Ian? At the moment you can just be dismissed with 'He's not even a member, we must take account of the wishes of our members first. After all, they have put their money where their mouth's are!'* . . .

## CRYSTAL CLEAR?

Sir, I have built the diode detector short wave receiver as detailed in the May '85 issue of Ham Radio Today.

Unfortunately, I can only pick up

Radio Manchester on 1458kHz! The amplifier section works OK (after I disconnected the earth side of the 10k volume control) so it would appear that the tuning circuit is at fault although it has been built according to the article. Any help would be appreciated.

Ken Murgatroyd

*The problem that you are experiencing with the diode detector short wave receiver is a common problem with simpler receivers of this kind without any selectivity at RF apart from the main tuning circuit. The strength of the Radio Manchester transmitter is probably such that with no RF stage and an untuned aerial, the receiver detector cannot cope with this.*

*Some months ago, whilst evaluating a simple TRF shortwave receiver I suffered a similar problem, living only a few miles distant from a BBC medium wave transmitter. The inclusion of a simple L-match aerial tuning unit produced almost complete rejection of the BBC 'breakthrough'!*

*I would suggest that you construct an ATU of this kind and also insert a parallel tuned circuit in the aerial lead, tuned to 1458kHz. The combination of these should cure your problem and may be useful on other shortwave receivers you have. A 1000pf capacitor connected between pin 14 of the IC and earth (the right hand side of the IC was incorrectly numbered and pin 14 is shown as pin 8) may also help the situation.*

*Finally, regarding the volume control, this is a strange one. You could try earthing pin 7 of the LM380 and then put the earth back on the 10k potentiometer.*

## BEER AND HAM?

Sir, I am very concerned about what seems to be the close association between amateur radio and drinking. So what, some will say. Persons are free to make their own choice. If only it was so simple!

There is a national problem regarding drink. To quote this week's Radio Times "HELPLINES. Teenage tots. Wednesday's QED (programme) 'Another Little Drink Won't Do Us Any Harm' looks at how society accepts

LOOK OUT FOR THESE TWO MEN



HUW

REPRESENTING

MICROWAVE  
MODULES LTD

AT MOBILE RALLIES THROUGHOUT THE YEAR.  
ORDER NOW TO AVOID DISAPPOINTMENT.  
FOR DETAILS AND AVAILABILITY

PHONE: 0403-730767



MICK

excessive alcohol consumption even among the young. Professor Maynard of the Centre for Health Economics at York University has recently produced a report which suggests that there has been a marked increase in drinking

since 1960 and that the cost to society of alcohol related problems is around £1.6 thousand million each year."

In fact there is freedom if you are a drinker — but not if you are a non-

drinker! There are many and subtle pressures (and some which are not so subtle), to persuade people to drink alcohol. Right there in the vanguard is amateur radio.

In our ranks we have, and we encourage, young people — the very people at risk to subtle pressure. Yet where do many clubs hold their meetings? At pubs! In articles about amateur radio activities, there is inevitably the mandatory plug about pubs/drinking/boozing. In fact I often wonder where ham radio comes in. We do not have many articles from lady hams but they seem the worst of all. My mind boggles at the picture these ladies present.

Is it too much to hope that amateur radio can change the image it presents and from now on present a picture of itself as being in the forefront of moderation. I hope so, because then I could encourage my own children in the hobby.

DB Slack, G3GFE

*Keeping your children away from amateur radio isn't going to stop them drinking — or drinking to excess for that matter. Ham radio clubs usually have members from a wide range of age groups and there is always someone to keep a benign, fatherly (or motherly) eye on us youngsters. Wouldn't you rather have your children having a drink for the first time — of home made beer, suitably watered down with lemonade — in the healthy and open environment of National Field Day, rather than secretly with no one else around?*

*Finally, you seem to have a pretty poor picture of your fellow enthusiasts, particularly those of the opposite sex. Poisonally, I never drink and neither does Julie (hic)...*



'ITS A BIT NOISY IN HERE THESE DAYS!'

Please address correspondence to:  
Ham Radio Today,  
1, Golden Square,  
LONDON W1R 3AB.

# COMPETITION

## Win a Dewsbury 'Star Master' Squeeze Keyer!

So you think you know all about CW? Get really keyed up (drive yourself 'dotty'?) with this month's whacky competition for the latest 'squeeze' keyer on the market!



So you think you know all about CW?

- When was the inventor of the Code, Samuel Finlay Breeze Morse born?  
(a) 1791 (b) 1799 (c) 1807
- What was the original meaning of the telegraphy abbreviation '73'?  
(d) fraternal greetings (e) best wishes (f) my love to you

- The number 0 is often abbreviated in CW contests. Is the abbreviation  
(g) T (h) M (i) O (j) S
- Who was the manufacturer of the semi-automatic key that came to be referred to as a 'bug'?  
(k) McElroy (j) Marconi Company (l) Vibroplex
- Squeeze keyers are often referred to as being iambic. Is this term derived from

- Medicine (o) Greek Poetry  
(p) Shakespeare (q) Samuel Morse
- Many of today's solid state transmitters are keyed by switching a positive voltage, whereas most valve type transceivers are keyed by switching a negative voltage. The method used in the TS530, TS820, TS830 and FT101 etc is usually known as  
(r) cathode keying (s) grid block keying (t) screen grid keying

### Dewsbury 'Star Master' squeeze keyer features

- Variable speed from 1-55 wpm with dash/dot memories.
- Automatic or semi-automatic operation. Even a 'straight' key can be used!
- Built-in sidetone with
- variable volume and pitch control for maximum operator comfort.
- Selectable 'positive' and 'negative' keying to suit semiconductor and valve PA rigs.
- Runs off a PP9 and is British made!

Complete fully and carefully. If you are the winner, this will act as a label for your prize. Post to Dewsbury 'Star Master' Competition, Ham Radio Today, No.1 Golden Square, LONDON W1R 3AB. Closing date: first post, 2nd August '85. Don't forget to follow the advice in the How To Enter section, including writing your choice of the answers on the back of the envelope!

Name .....

Address .....

.....

.....

..... postcode .....

Your choice of question answers ie C,D,I etc .....

.....

### How To Enter

Look at the list of questions nearby, designed to test out your knowledge of 10m FM operation. Each question has a number of possible answers. Choose which you think are the correct answers and write them in sequence on the coupon below. For example, if you think the answer to question 1 is B and question 2 is D, your sequence will begin B,D... **IMPORTANT:** write your choice of the order on the back of your envelope in addition to the coupon. Send your entry to Dewsbury 'Star Master' Competition, Ham Radio Today, No.1 Golden Square, LONDON W1R 3AB. Closing date is first post on 2nd August '85.

Complete the coupon fully and clearly — if you are the winner this will be used as a label. All correct entries will be placed in the HRT competition hat (size 14) and the winning entry drawn by the editor himself. You may enter as many times as you like, but each entry must be on an official coupon — not a copy — and sealed in a separate envelope.

### The Rules

Entries will not be accepted from employees of Argus Specialist Publications, Dewsbury Electronics or Garden City Press. This restriction also applies to employees' families and agents of the companies. The 'How To Enter' section forms part of the rules.

# dressler

(UK) LTD

191 FRANCIS RD  
LEYTON E10.  
Tel: 01-558-0854  
01-556-1415

## EAST LONDON'S HAM STORE



FRG-9600

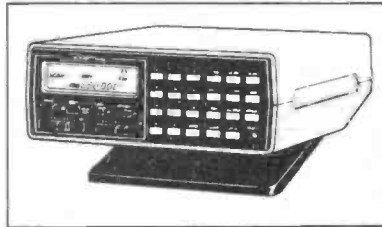

MX 4000

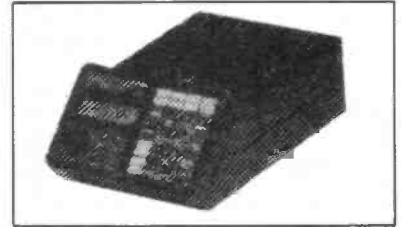

AR 2001

HF  
LF

**SUMMERTIME ANTENNA SPECIALS**

VHF  
UHF

## MET — TONNA — ETC

Rotators from £49.00 — £350.00. Poles & lashing kits.  
Bearings, Cables, Towers, Preamps, Connectors etc.

*Erection service available!!!*

And when you've got all that up. What about a new rig?



FT757GX



FT726R

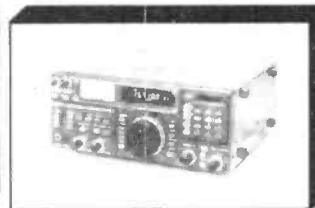

ICR71

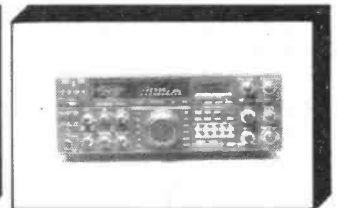

TS-940S

Full range of accessories for all makes

## HOW ABOUT A HANDHELD?



IC02E IC04E



TH41 TH21

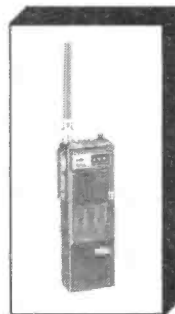

MT-20

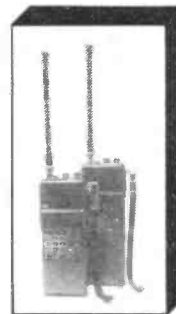

FT-209R FT-709R

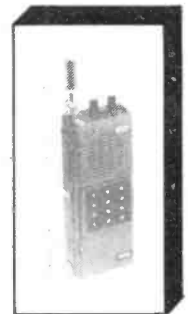

IC-2E



HP FACILITIES  
AVAILABLE

PROMPT MAIL  
ORDER

OPEN: MON - SAT  
9AM - 5.30PM

# RADIO TODAY

The WINNER of our competition for a Spectrum Communications boxed 10-2 m kit was L. Case, G8BJQ, of Widnes whose choice was B,C,F,I,L,N

**Congratulations!**

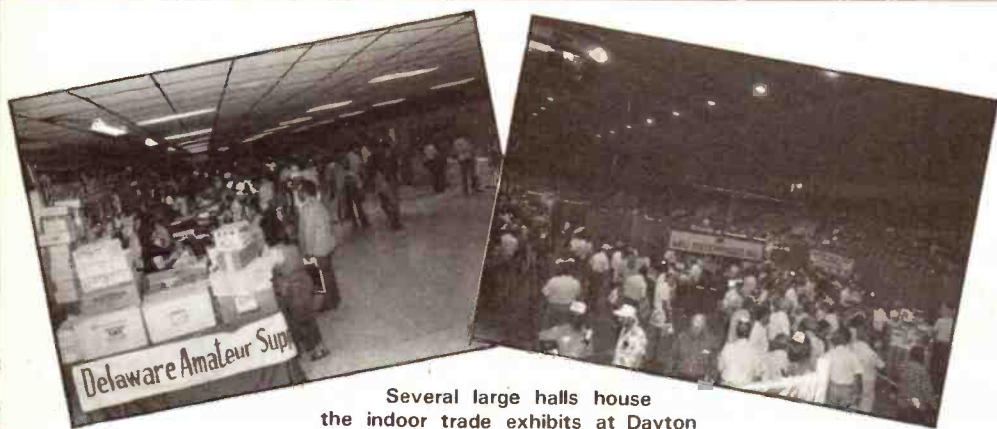

Several large halls house the indoor trade exhibits at Dayton

## Dayton USA: The World's Largest 'Hamfest'

Take the RSGB's NEC, multiply the floor area by three, add a ten acre outside flea market, multiply the number of attendees by three or four, add a multi-stream amateur radio conference programme covering everything from moonbounce to HF contesting and you will have an idea of the dimensions of the world's largest Amateur Radio gathering: the Dayton Hamvention in Ohio, USA. Nigel Hawthorne, G3TXF, attended this year's event.

The three day Dayton Hamvention attracted over 30,000 visitors from all over the US as well as overseas. Overseas Amateurs planning to visit the US on business or vacation often try to time their visit to coincide with Dayton. As well as a number of European amateurs, several VKs, ZLs and IAs were seen to be wandering around Dayton this year.

Apart from the enormity, an important difference between Dayton and the NEC is that Dayton is run just by one local club — not by the national society. The Dayton

Hamvention is organised and managed by a team of amateurs from the Dayton Amateur Radio Association. The ARRL, the national amateur radio society of the US, are in attendance at Dayton, but do not take part in organising it.

### Flea Market

"If you can't find it at Dayton, you'll never find it!" is the way the Dayton organisers describe the world's largest amateur flea market. From Collins 30S1 1kW linear amplifiers to QRP components, everything and anything that a radio amateur needs can be found at the Dayton flea-market. Even with the high Dollar, there are still amazing bargains to be found and for overseas visitors the real problem is 'excess baggage' on the journey home!

The best bargains in the flea market go early. And 'early' in the US means early. The Dayton flea-market opens at 6am. Bargain hunters flock to the flea market just as the gates open soon after sunrise. The flea market is just one of

the many attractions at the Dayton Hamvention.

### Full Programme

Starting at noon on the Friday, Dayton runs for three days through until Sunday evening. Dayton is not only a daytime event but there is also a full programme of entertainments and activities in the evenings too.

On Saturday evenings there is a vast banquet at which several thousand amateurs, wives and friends sit down to a huge dinner and a programme of speeches and entertainment from prominent amateurs in the US. As well as the formal evening dinner, there are also a whole range of much less formal entertainment: the aptly named 'hospitality suites'.

Hospitality suites are organised by clubs and groups with specialist interests in order to receive and entertain visiting amateurs of similar dispositions. One hotel in Dayton houses the hospitality suites run by the DX and Contest clubs. Other hotels have hospitality suites for QRPers, VHFers, Amateur TV

enthusiasts and many other interests. In true American style, bathtubs are filled with cans of beer and ice. 'Fisherman's tales' of DXing are exchanged well into the early hours at all the DX Club hospitality suites.

With the flea market opening at dawn, it is not unknown for Dayton hamfesters to roll out after an all night session in the hospitality suites straight into the flea market!

### Forum

The programme of lectures organised for the 'forums' is formidable. There are three days of lecture programmes covering subjects such as packet radio, AMSAT, 10 metres, contests, DX, VHF/UHF, RTTY, SSTV/ATV, amateur radio and the law, weather satellites, photovoltaic power, 2200MHz SWL, QRP, antique amateur radio, handicapped and amateur radio, repeater frequency coordination and the ARRL to mention but a few. Under each of these headings there was a full programme of lectures. At the contest forum for instance, there were about a dozen lectures in a three hour programme, covering everything from contesting on 160 metres to contesting in the USSR. Many different lecture streams are running in parallel.

Trying to attend all the lectures that are of interest; searching the flea market for that super bargain; and staying awake after the late night sessions at the hospitality suites makes Dayton not only a most memorable amateur radio event, but also an extremely tiring three days!



## New Products in Brief...

● Interested in a DIY CB to 10m conversion? Raycom Ltd (Ray Withers Comms) are now offering their popular conversion PCB for CB sets with LC7137 PLL chips as a kit, with full instructions for £17.50. Further details on 021 421 8203.

● Armstrong Kirkwood Developments (AKD), well known for their VHF/UHF wavemeters also market a useful and wide range of filters for both the amateur and professional markets.

In the former category is a standard UHF high pass filter (model HPF1) providing filtering for both inner and outer braid of a UHF TV coax downlead and suitable for interference from HF transmissions. For stubborn cases of interference, where this occurs during operation on a particular band, tuned filters, providing a 'notch' on both inner and outer of the TV coax are available for 20(TNF20), 15(TNF15)m 10(TNF10) and 2m. Also available, providing a 'notch' on the inner of the TV coax, is a tuned filter for 70cm(RBF1).

AKD have also recently

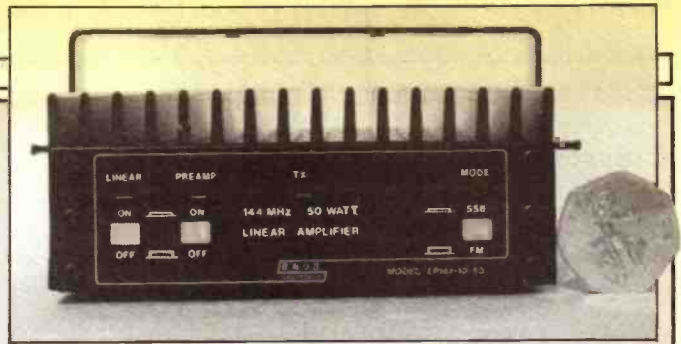

BNOS LPM144-10-50

developed a new 2m pre-amplifier, the GPA1. The preamp will give 18dB of gain and is RF switched, capable of handling up to a maximum of 25W. John Armstrong reports excellent results on test with an FT290R and further details of all the above are obtainable from him on 01-205-4704.

LP144-10-50 (10W for TR9000, FT480 etc) retail at £108 inc. VAT.

● Not exactly a new product but...by the time you read this, Dewsbury Electronics will have doubled their size sideways. Actually, they have taken over the entire ground floor of their present premises in 176 Lower High Street, Stourbridge, West Midlands. Tony Dewsbury, G4CLX, has recently launched the first of a range of their own products in the shape of the 'Star Master' keyer which they will be retailing along with Trio, ICS, Microwave Modules, Wood and Douglas, MET etc. Sounds as though they need the space!

● BNOS have recently announced two very compact additions to their range of linear amplifiers. Both models give 50W RMS output, incorporate BNOS's well known switchable low noise preamplifier and have PTT and VOX switching. The LP144-3-50 (3W input for FT290 etc) and



AKD GPA1

## Starting On Satellites?

We were unable to obtain both the current membership details and prices of the Orbital Prediction Calendar at the time of going to press on the recent series 'Getting Started On Amateur Satellites'. Ron Broadbent, G3AAJ, Hon. Sec./Treasurer of AMSAT UK, recently supplied us with the following information:

"AMSAT-UK, the Amateur Satellite Organisation of the United Kingdom, is open for membership to any person or persons interested in the reception or transmission to the current amateur satellites. Information on membership can be obtained from Ron Broadbent G3AAJ, AMSAT-UK, LONDON E12 5EQ for the courtesy of a stamped self

addressed enveloped. A sample copy of Oscar News and the current copy of the Orbital Prediction Calendar can be obtained by the addition of £1.30 by cheque or postage stamps to cover publication costs. Non-members of AMSAT-UK may obtain the current orbital calendar which is produced every two months by sending £1.15 on the 1st June or 1st August, the publication dates. There is also available a publication called The Sheffield Project, a primer for newcomers to UOSAT which guides the reader gently through the problems of obtaining a receiver, an antenna system, and the collection and collation of data from our newest British satellite. This is priced at £2.75 including postage and packing."

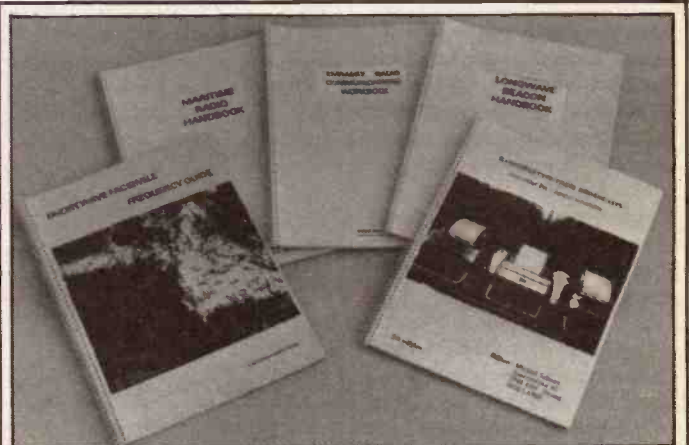

## Be A Shortwave 'Spy'

A new company, Interbooks Ltd, has been recently formed to deal solely with the importation and marketing of books from Europe and the USA for the radio amateur. These include such interesting tomes as 'Confidential Frequency List', an index of 10,000 'unusual' radio stations/frequencies including embassies and FAX, and 'Clandestine Confidential' "devoted exclusively to the subject of clandestine broadcasting on a

largely current basis" on the shortwaves and apparently includes a chapter on the Falklands crisis.

Other interesting books include 'Radioteletype Press Broadcasts', 'Embassy Radio Communications Workbook' and 'Longwave Beacon Handbook' (looking at longwave navigational beacons, a rather novel facet of DX listening). Further details on 073882 575.

## Did You Know?

★ The RSGB had a wartime magazine known as the 'Tar Bulletin'. In December 1941, a fund was started by British members to send parcels of cigarettes, tobacco and books to POWs in Germany and Italy. In the same issue there was a report concerning Denise, G2DTB,

whose fiancée was imprisoned in Norway by the occupying forces. Norwegian amateurs were able to get a message to the UK by radio, to say that he was well. By the end of the war, monies raised by the Bulletin appeal totalled £1,358.19s 96d.

★ Dr Alex Comfort, author of the best selling book 'The Joy of Sex', is a radio amateur living in Santa Barbara, California.

★ 88 was used by telegraph operators from well before the turn of the century although it never received official recognition. During the first world war, 88 was used by the US Signal

Corps in unofficial communications(!) and with the cessation of hostilities, achieved 'official' status among amateur's terminology as 'love and kisses'.

## Welsh 934 MHz Transceiver

Uniace Telecommunications Ltd recently announced the availability of their new Uniace 400 Personal Mobile Transceiver for the 934MHz leisure band. All British made using state of the art design and surface mounted component techniques, the transceiver performance equals or exceeds the basic DTI specifications. Using micro-processor control and an integrated VCO, the frequency stability is ensured by the use of a 'TXCO' type reference oscillator giving a tolerance of +/- 1PPM over a temperature range of 0°-60°C.

The Rx is a dual conversion superhet with IF's

at 21.4MHz and 100kHz. Selectivity is ensured by the use of 'Gigafil' pre-tuned cavity filters as well as the more conventional crystal filtering. Double-balanced Schottky diode mixers are used for frequency mixing. A bi-polar transistor pre-amp in the Rx front end gives low noise and excellent sensitivity, at about 0.5uV for 20dB quieting, which Uniace claim matches "any other 934MHz equipment on the British market".

On the transmit side, a VOGAD IC takes care of the audio, providing automatic speech processing. Filtering by 'Gigafils' in the Tx line makes for a nice clean RF signal to the PA module, which gives a full 8W transmitted power.

Finally, at the present



time, the Uniace 400 is supplied tuned to the 20 channels as allocated by the DTI, but provision has been made for easy conversion to 40 channels, as and when these are available. There is an Rx signal strength meter, a transmit indicator LED, and the usual LED channel number display. The supply voltage should be 13.4V at 3A

and the antenna socket is a low-loss BNC type for ease of mobile installation.

The Uniace 400 is available from leading distributors or direct from Uniace Telecommunications Ltd, Unit 8 Conway Road Industrial Estate, Llandudno Junction, Gwynedd, North Wales (0492 61 3232) for £355 inc. VAT.

## VHF-HF Okay!

In the past, crossband operation from VHF-HF between a class 'B' amateur and a class 'A' amateur has been deemed illegal. Indeed, the editor and a G8 friend were rapped over the knuckles by the GPO for doing this back in the 1970's.

Ian Abel, G3ZHI, recently received the following communication from the DTI with regard to the current position...

"There has been a lot of confusion over whether a class 'B' licensee can work crossband VHF-HF, and you will be interested to know that a press release is shortly to be issued which clarifies the position. Essentially, it is perfectly in order for a class 'B' licensee to receive an HF transmission from another licensed amateur station and to respond by transmitting on frequencies for which he/she is licensed to transmit."

The DTI have also clarified the position as to when class 'B' licensees can work on HF... "When a class 'B' licensee operates the station of a class 'A' licensee under his direct supervision, then the terms and conditions of the class 'A' licence prevail. It therefore follows that the class 'B' licensee can send Morse code from the class 'A' licensee's station (using the class 'A' callsign).



The Straight Key Evening/activity day on 30th May was quite a success with over 230 contacts made by GB4 HRT from the Milton Keynes DARS QTH. Pictured L-R are Doris, G3ZZD, G1CKF and G1GOF.

## ARE to Become AE UK — But Only In London!

An announcement made recently by Amateur Radio Exchange and Amateur Electronics Limited confirms that Amateur Electronics Limited of Birmingham has purchased the lease and Goodwill of the shop occupied by Amateur Radio Exchange of London. Amateur Radio Exchange of London will continue to operate under the ownership of Amateur Electronics Limited of Birmingham, but both Bernie and Brenda will be available to Amateur Electronics Limited on a consultancy basis for continuity of the London

business for a limited period.

Customers who frequent the London shop can be assured that Amateur Electronics Limited will continue to offer the same policies adopted by the previous owners, offering good service and a friendly welcome to all callers.

This sale, of lease and Goodwill, is for the London shop only and the Northern branch of ARE will still continue under the ownership of both Bernie and Brenda as before, managed by Peter Roberts, G4KKN, and trade as ARE Communications. Under this banner they will continue to exhibit at rallies and exhibitions throughout the UK, and both Bernie and Brenda will attend as many as possible.

## Software Saves The Day!

Recently, radio amateurs with Technical Software's RTTY/CW transceive program may have been having problems when using the Commodore 64 home computer. Yet these only seemed to have been happening on some 64s and not others...

The problem was found to be with the computers themselves and not 'bugs' in the program. Now Technical Software have overcome the 64's inability to transmit CW and RTTY with the program, by rewriting it to avoid the computer fault. All programs now being sent out are capable of running correctly on all Commodore 64s. Contact Technical Software on 0286 88 1886 for further details.

● The Radio Society of Great Britain awarded its annual Wortley Talbot trophy to Paul Elliot, G4MOS, partner with his father, Frank Elliot, G4PDZ, in Elliot Electronics in Leicester. Paul won the award for his work developing GB3GV (24cm) the first ATV repeater to come on-air in the country. The trophy was presented to Paul at the AGM for the most outstanding experimental achievement during the year". He accepted the trophy on behalf of the Leicestershire Repeater Group under whose aegis the repeater was initiated and funded.

# Addendum

## AN RF NOISE BRIDGE FROM A-Z (June '85)

The transistors used in the bridge should have been listed as BF194 - not the BF184. Apologies from HRT and Duncan Walters.

Some readers have had difficulty in obtaining the Amidon T-50-2 toroid core. This can be obtained from Cirkit Holdings, Park Lane, Broxbourne, Herts EN10 7NQ for 87p including postage.

# HALBAR

AERIAL MANUFACTURER

UNIT 1 BURY WALK  
BEDFORD MK41 0DU  
(0234)44720

## QUALITY SATELLITE AERIALS FOR UoSAT AND TIROS/NOAA SIGNALS

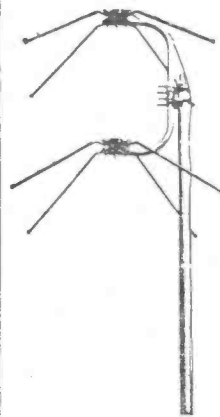

There are two versions of the I.T aerial. The I.T/u is designed to receive left-hand polarized signals from UoSAT. The I.T/tn aerial will receive right-hand polarized signals from TIROS/NOAA. State requirement on order.  
Supplied with mast clamp.

SAE please for further information.

**PRICE COMPLETE AS  
ILLUSTRATED**

**£19.50 INCL. VAT**

**P&P £2.50**

We produce a range of 2 metre, 70cm and 23cm aerials for the amateur bands. SAE please for lists.



ALL GOODS DESPATCHED WITHIN 24 HOURS

# VHF Weather Satellite Receiver

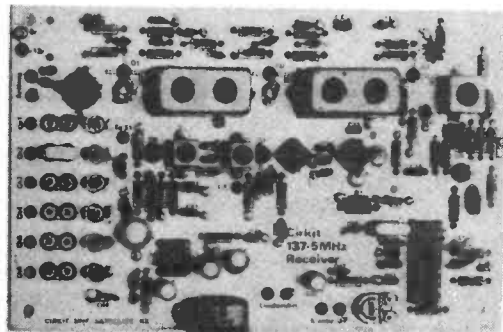

Stock no.  
40-02300

Price  
**£42.52**  
+ VAT  
+ 60p p&p



- ★ High Sensitivity
- ★ Large Image rejection
- ★ Crystal Controlled
- ★ 6 Channel
- ★ PLL Detector
- ★ On Board Audio Amp

## Cirkit Distribution

Park Lane, Broxbourne, Herts  
Tel: (0992) 444111

Please send SAE for full details

## The Cirkit Kit

The receiver is built on a double-sided PCB (134 x 87mm) to give stable and repeatable results, all RF coils are pre-wound and full construction and alignment details are supplied with the kit. A complete kit of parts is supplied which includes the following: Double sided fibre glass PCB; All resistors, capacitors, semiconductors and filters; All coils, all TOKO pre-wound types; Pot, switch and sockets; Loudspeaker; Xtal for 137.5MHz; Construction and alignment details.

# Receiving WEATHER SATELLITES

Contrary to popular amateur belief there is a whole world of VHF radio outside the amateur frequency allocations. Almost everybody is aware of the broadcasting band from 88 to 100MHz and many are aware of the aircraft

to experts, the weather satellites send pictures which can be appreciated by the layman (or woman!) without specialized meteorological training.

How easy is it to receive and print out these pictures? The

a step-by-step look at the transmission formats and the equipment required to cope with them.

## Receiving the Signal

The APT signal is quite easy to receive since the transmitter power is 5W and the height only 500 miles. The bandwidth is 50kHz and so the requirements are similar to a 2 metre amateur station. For maximum reception time, ie from horizon to horizon, a small steerable directional antenna with right hand circular polarization is usually used, such as a cross yagi or a helix. If slightly less coverage is acceptable, eg 10 degrees minimum elevation, a fixed antenna firing upwards such as a turnstile (crossed dipole) or a small helix can be used. Many professional installations use fixed antennas. A low noise preamplifier should be mounted as near to the antenna as possible, which should have a noise figure better than 2dB although no worthwhile improvement will be gained by one with less than 1dB. A pre-amp using dual gate MOSFETs should be satisfactory. Due to the proximity to the aircraft and 2m band, some front end selectivity is desirable, centred on 137.5MHz.

Frequency modulation is employed with a deviation of +17kHz. This is quite wide by amateur standards and a sufficient IF bandwidth should be used in the receiver; there is at least one kit on

*In the last twelve months, interest in weather satellite reception has really taken off, with the commercial availability of both micro computer assisted and 'stand alone' systems/building blocks. How easy is it to receive these pictures from space? According to Mike Christieson, G8FCD, 'not as difficult as it might seem'...*

transmission between 108 and 136MHz. Few know about the space communication band of 136-138MHz. Almost any time of the day or night a casual band-scan will reveal a selection of peculiar whining and buzzing sounds, particularly between 137 and 138MHz. Many of these are digital data streams from the hundreds of satellites in various orbits around the earth. One of the strongest signals, with a quite distinctive sound, comes from the American and Russian series of weather satellites in polar orbit. From an altitude of a few hundred miles, they transmit a continuous stream of cloud pictures, used by over 1,000 stations every day.

Another series of weather satellites, located in geosynchronous orbit (ie in such an orbit that the satellites are each stationary with respect to a geographical area of the Earth) 22,000 miles above the equator, transmit pictures of a complete hemisphere on a daily broadcast schedule. These transmissions are at microwave frequencies, in the so-called 'S' band (1.55 - 5.20GHz) because of the lower background noise.

While many satellites send scientific data which is only useful

answer is 'not as difficult as it might seem'. In the early days of weather satellites (TIROS 1 was launched 25 years ago last April) the transmission parameters were chosen to make reception as easy as possible for low cost ground stations. Since then, the basic format has remained unchanged in order to maintain compatibility with the large numbers of existing ground stations. Originally all transmissions were in analogue form; later digital transmissions were added but the low resolution analogue format was retained. It is these analogue pictures which are the easiest for the amateur to receive. They are referred to as APT (Automatic Picture Transmission) from the polar orbiting satellites and WEFAX (Weather Facsimile) from geostationary satellites. Let's take

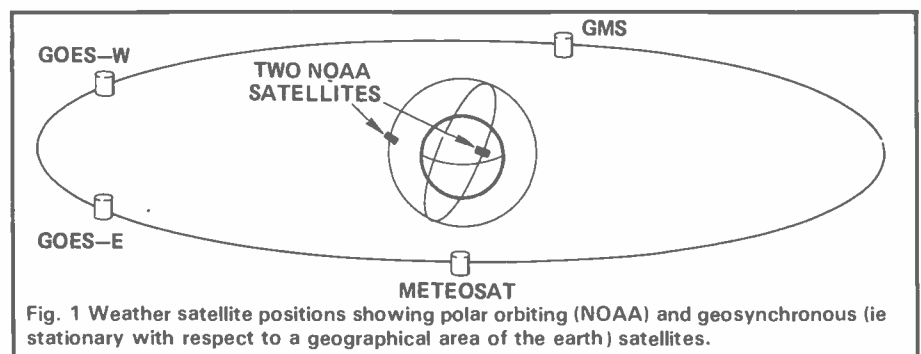

Fig. 1 Weather satellite positions showing polar orbiting (NOAA) and geosynchronous (ie stationary with respect to a geographical area of the earth) satellites.



Reasonably sharp satellite pictures can be obtained by using a micro with high resolution graphics as a frame store. Polar orbiting NOAA9, received on a Cirkit VHF satellite receiver, is shown above 'resolved' by a BBC 'B' micro using software by Clappison and Atkinson, available from Timestep.

the market for a suitable unit (see appendix). The exact transmission frequencies in use at present are:

Russian Satellites: 137.3, 137.4, 137.85MHz.

American Satellites: 137.5, 137.62MHz.

Any FM detector may be used but best results are obtained with a phase lock loop, particularly at low signal levels.

The analogue data is transmitted as an amplitude modulated sub-carrier of 2400Hz, ie the FM detector output is a 2400Hz sine wave, the instantaneous amplitude of which represents the brightness of the picture. The video bandwidth is about 1.1kHz so the post detection filter should have 3dB points of about 1.3kHz and 3.5kHz.

Some of the foregoing probably sounds rather technical, but do not let this put you off. As an experiment in order to wet your appetite, simply retune an ordinary FM broadcast receiver to 137.5MHz and connect a simple dipole, poked out of the nearest window or in the loft, and listen. Sometime between 1200 and 1500 or 0600 and 0900 or 1700 and 1900 (GMT) you should hear one of the satellites go over. The 2400Hz sub carrier with a 2Hz 'throb' on it should be easily recognisable.

An alternative and perhaps simpler method is to retune a 2 metre converter and listen 6.5MHz below the IF frequency for 144MHz. *In fact, most converters are wide enough to hear something without retuning although the sensitivity may be poor.* Remember the

signal will be distorted on a receive system with a narrow band FM detector.

### S Band Reception

The pictures from the geostationary satellites hold a particular fascination because, being geostationary (ie effectively stationary with respect to the Earth) they can provide data, and thus pictures, virtually continuously. Also, unlike the polar satellites, which transmit only the narrow strip of earth immediately below them, those in the more distant geostationary orbits transmit *global* pictures, where the Earth is seen as a disc hanging in space. The greater distance

View of Europe from 'Meteosat' geostationary satellite. Note the dotted coastlines which are added when the signal undergoes processing by the satellite's ground station (see section 'Satellite Orbits and Pictures').

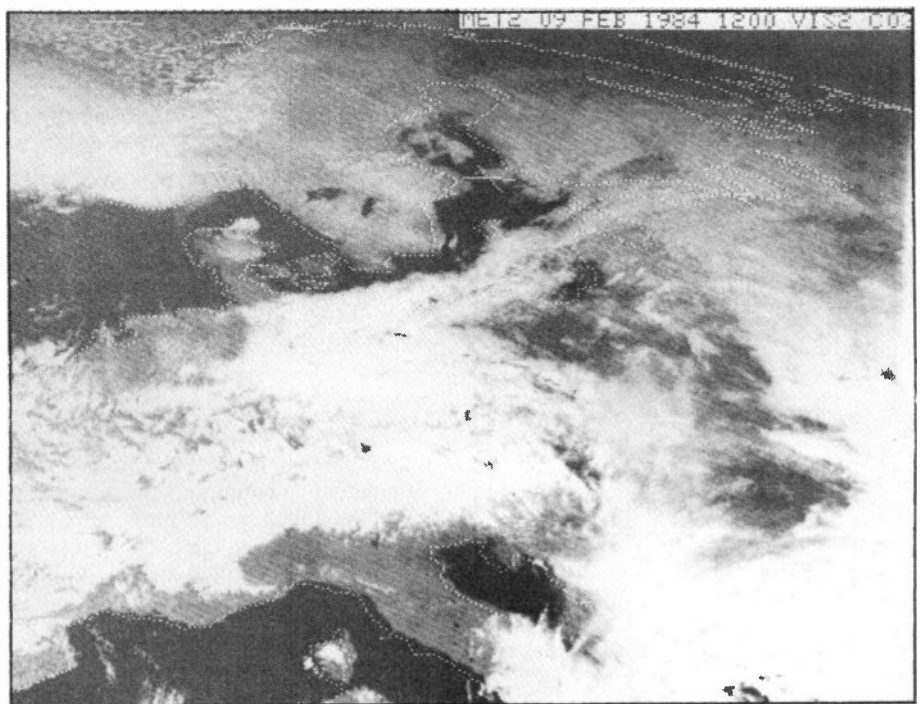

(remember, they are 22,300 miles away!) creates problems for low cost reception because, even though the transmitted power is about 80W ERP, the received signal strength is very low.

All transmissions take place near to 1700MHz, where the background noise is an order of magnitude lower than VHF. There is an advantage though; because the satellite is always at the same point in the sky, a highly directional antenna may be used without the need for tracking. Also, at this higher frequency directional and hence high gain antennas are of manageable proportions. Another advantage of geostationary satellites is that they are transmitting almost continuously and test and line-up problems are this considerably eased. The European satellite operates on two frequencies, 1691.0MHz and 1694.5MHz

The commonest form of antenna is the front fed parabolic dish. How big the dish needs to be depends on the quality of the preamplifier which of course must be located at the antenna or very close to it. Using a good gallium arsenide (GaAs) FET amplifier with a noise figure of less than 1.5dB, excellent reception is possible using a 1 metre dish. If a 2 metre dish is available, a very inexpensive preamplifier may be used.

After amplification, the most

practical thing to do is convert the signal to a lower frequency. The first IF needs to be in the VHF band and 137MHz is often chosen so the converter output may plug directly into an existing APT receiver. The format of the signal is very similar to APT (the frequency deviation is  $\pm 9\text{kHz}$ ) and so the same IF amplifier and detector may be used. There have been many designs for preamplifiers and converters published and there are several reasonably low cost commercial units designed for amateur use (again, see appendix). The techniques are closely allied to those used on 1296MHz, the 23cm amateur band.

### Subcarrier Demodulation and Picture Printing

Once a suitable antenna and receiving system is working, the problem arises how to convert this amplitude modulated 2400Hz tone into pictures. The APT signal has a line rate of 2 lines per second, each line consisting of infra-red for half a line and visible for half a line. The transmission from the spacecraft is continuous (even though an individual station will only pick it up for a short time) and line sync information is included on

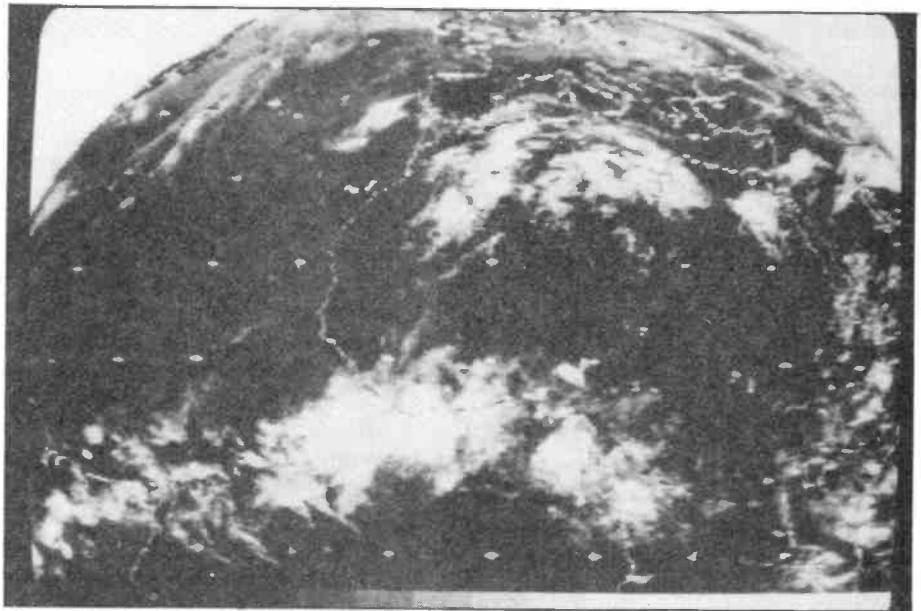
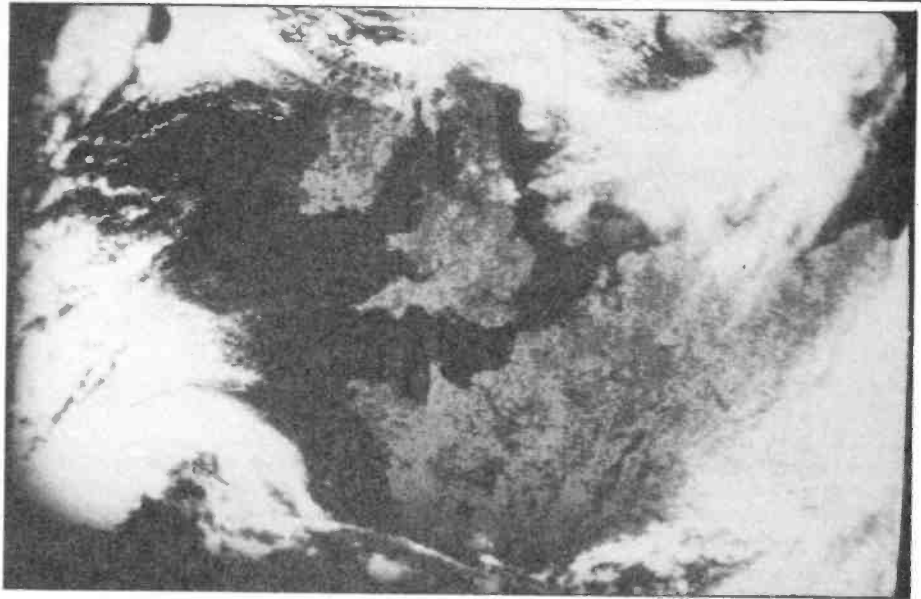

Top: polar orbiter NOAA9 passing over western Europe. Bottom: 'Meteosat' satellite view of the northern hemisphere in infra-red. Both pictures resolved using purpose built semiconductor digital frame store.

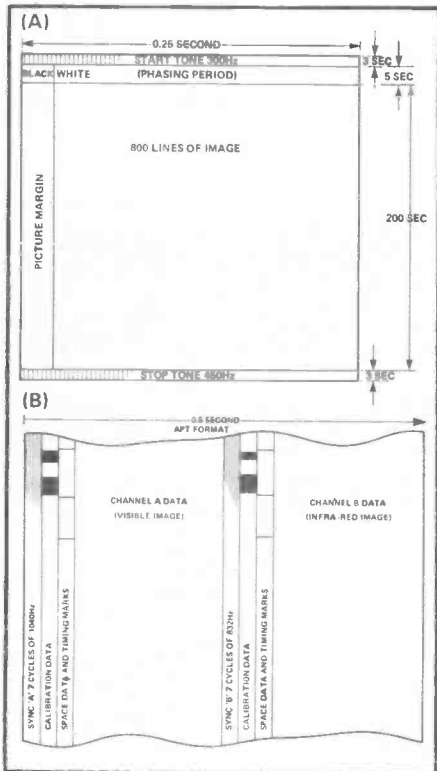

Fig. 2 The picture format used by the polar orbiters (A) is referred to as APT (Automatic Picture Transmission) and from the geostationary satellites (B) WEFAX (Weather Facsimile).

every line. It is normal however to use it only once, when acquiring the signal. The exact format is shown in Fig. 2. The WEFAX signal is slightly different because each image is separate; they therefore have a start and finish and contain only either visible or infra-red data. The WEFAX format is also shown in Fig. 2. The line rate is 4 per second.

Up to a few years ago, the conventional method for display was a facsimile recorder using either photographic or chemical paper. These machines can still be obtained on the second-hand market and provide an easy method for printing high quality images. Some were specifically designed for satellite use and contain the subcarrier

demodulator, sync, and start/stop detection. Many only contain the demodulator and a number were designed for other purposes like 'wire-photo' (ie a photograph transmitted by radio, often used by newspapers) and have different characteristics such as line rate, line scan direction and index of cooperation. (IOC is a measure of aspect ratio). The mechanical modification of a facsimile recorder is not easy and often beyond an amateur without machine-shop facilities. The running costs can also be appreciable, particularly for those which use photographic paper. Even the electrochemical ones, which use wet paper, cost about 15p per picture to run. Nevertheless, this type of display

still provides the cheapest method for hard-copy.

Now that semiconductor memory is relatively inexpensive, digitising the signal and storing it in a 'frame store' is becoming very popular, both in the amateur field and commercially. One ready made source of frame stores is those microcomputers with reasonably high resolution graphics. The minimum resolution for commercial grade picture is 256 pixels by 256 lines and 16 grey levels (4-bit storage). This is not normally obtainable on a microcomputer and so special frame stores are often built. However, many amateurs have obtained quite acceptable results using computers such as the BBC model 'B'. Of course special software has to be written, some of it in assembler (a program which translates assembly language into machine code) in order to operate fast enough, and a number of schemes for this have been published. The interface between the receiver and computer is quite important and can mean the difference between very poor and acceptable results.

There is at least one way of combining sub-carrier detection and digitization in one circuit, but the most straightforward method is to amplitude demodulate the sub-carrier first. Since the sub-carrier frequency, 2400Hz, and the maximum video bandwidth, 1.1kHz, are quite close, a simple half wave rectifier and filter is unsuitable. Full wave rectification or synchronous demodulation is required, followed by a multipole post detection filter. The resulting video has a bandwidth from 0 to 1.1kHz. It may then be digitised at a rate chosen by the user, although clearly a rate above about 3kHz is fairly pointless. The number of bits is again up to the user; commercial systems have up to 8 bits but it depends on the number of grey levels that can be stored or displayed.

As many of the microcomputers have colour displays, a careful choice of colour representing each grey level must be made or the resulting image will be very difficult to recognise.

## Sync Detection

Software sync. detection has



Global view from a more distant geostationary 'Meteosat' satellite, received on the Microwave Modules MMS1690 system.

### Sources of commercial weather satellite reception equipment

**Microwave Modules** Their MMS1690 'Meteosat' receiver system is the 'Rolls Royce' of the bunch. The complete system is intended for very high quality 'Meteosat' (S band) reception. A 32 segment antenna with phased array reflector (£270) feeds a GaAsFET pre-amplifier with a noise figure of 1.2dB, which in turn feeds a 'S band' to VHF satellite band (APT) converter (£126). This feeds a 137MHz 6 channel (£345) which, with an appropriate aerial could also be used to receive the APT satellites. The signal is then treated by a combined scan converter/digital frame store, offering colour and monochrome outputs and very high resolution of 256 lines, each of 256 pixels, obtained with 64 grey levels (£650). The complete system works out at £1738 plus VAT. Further details on 051 523 4011

**Timestep Electronics** Intended for the APT format polar satellites (NOAA-8 and NOAA-9). Timestep also supply a complete package which is based around a BBC 'B' computer. Jaybeam have apparently been "commissioned to make a special aerial" for Timestep (£34.50) and this feeds a pre-amp (£10.95 built) which feed a 137MHz receiver with a claimed performance of 0.5uV for 12dB SINAD (£59.95 boxed). An interface, containing several switchable op-amp filters and giving claimed enhanced pictures from weak signals (£68.50), feeds the signal to the BBC 'B', also allowing low frequency FAX data to be demodulated. An E-PROM program (£37.50) fitted to the BBC 'B', written by Peter Clappison and Mathew Atkinson, allows the signal to be resolved as a monochrome picture with 320x 256 pixels and 4 grey levels (white, light grey, dark grey and black). To quote a recent article on this, "while the resolution is reasonable, the grey scale is somewhat restricted". In costing this system, you must take into account (obviously) that a BBC 'B' computer and a monitor is also needed. Much of the above is also available in kit form. Further details on 0440 820040.

**Circuit Holdings** Currently in the process of launching a system for the APT format polar satellites. A 6 channel crystal controlled receiver kit (1 crystal supplied), offering a claimed 0.4uV for 12dB SINAD is currently available (£48.90) and their popular 2m pre-amp can be simply retuned for 137.5MHz.

Muirhead FAX machines can sometimes be found in surplus stores or at rallies, and can often be used to display polar and geostationary satellite pictures after some modifications: although no source of these could be found as we went to press.

been used quite successfully but the preferred method is an op-amp tuned circuit to pick off the tone bursts on the side of the APT data. The start and stop tones may also be detected by analogue means and the edge of the WEFAX data located from the phasing period. These signals, after conversion to logic levels, can be applied to the computer via another port.

In the initial stages of building a station it is possible to operate without automatic sync, the operator standing by to centre the picture.

## Satellite Orbits and Pictures

The two types of orbit are shown in the diagram. Since the APT pictures are taken from relatively near to the ground, little processing is required before they reach individual users and in fact these images are transmitted in near real-time. Let me explain further. As the satellite passes over the ground, it scans the earth at right angles to its track and sends the picture line by line. By the time it has completed one orbit, about 102 minutes, the earth has turned and the satellite scans an adjacent strip. 12 hours later, it again passes over the station, this time in the opposite direction. The American satellites have their orbits arranged so they keep a constant angle to the sun, so overhead passes occur at roughly the same time every day. There are normally two satellites covering each station with their orbit planes set 90 degrees apart, hence local coverage is every six hours. There are no geographical reference points on the pictures from the polar satellites.

From their distant position, the geostationary satellites take pictures that require considerable processing before they are useful. It is not sensible to put this on board the satellites and so they transmit the

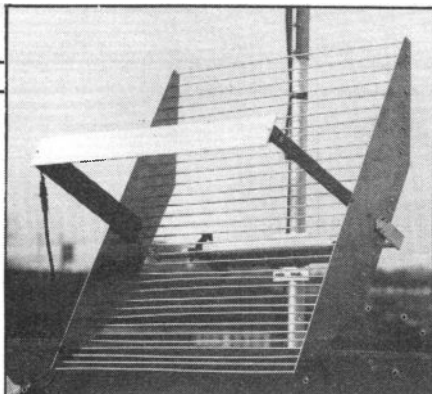

Microwave Modules 32 segment antenna for 'Meteosat' S-band reception. The antenna has a claimed gain of 25dB.

'raw' images to a main ground station. Here processing takes place. The processed images are then relayed to users via the same satellite, using on-board transponding facilities. One particularly useful feature is the addition of coastal outlines and latitude/longitude marks, both which make picture identification very easy.

Of course, one geostationary satellite only sees one side of the earth so there have to be several for global coverage. The satellite available in Europe is **Meteosat** located at 0° longitude. There are normally two over the USA, called GOES-east (75°W) and GOES-west (135°W). The Japanese operate one at 140°E which has slightly different characteristics. A Russian satellite will shortly be operating at 70°E.

## Locating Geostationary Satellites

A number of software programs have been written for this but for the UK, **Meteosat** is almost due south at about 30° elevation above the horizon. GOES east is 'visible' from the western Britain but the elevation is only a degree or so. Once a receiver is working, the simplest method is to swing the antenna around by degrees until the signal is heard.

## Tracking Polar Satellites

The polar satellites at present in

orbit are NOAA-9 (south to north during the afternoon, 137.62MHz) and NOAA-6 (south to north during the evening and north to south during the morning, 137.5MHz). The orbit is very similar to some of the OSCAR satellites with approximate parameters as shown in Table 1.

Many of the programs written for the OSCAR series will work with the NOAA series with suitable modifications.

The reception of weather satellites is a fascinating facet of radio and can provide the enthusiast with years of experimental fun, of gradually refining a satellite picture from almost unrecognisable smudges to images better than many commercial ones. Do not be daunted by the apparent complexity of the operation, a step-by-step procedure will yield very rewarding results.

### List of Useful Publications

The TIROS/NOAA A-G Satellite Series (NESS-95)

(published by NOAA).

Guide to Designing RF Ground Receiving Stations for TIROS-N (NESS-75)

(published by NOAA).

Data Extraction and Calibration of the TIROS/NOAA Radiometers (NESS-107)

(published by NOAA).

TIROS-N Series Direct Readout Users Guide

(published by NOAA).

Meteosat WEFAX

(published by ESA).

Meteosat Schedule

(published periodically by ESA).

The Satellite Experimenters Handbook (published by ARRL). Available from RSGB Books, priced at £10.11.

Satellite Tracking Software for the Radio Amateur

(published by AMSAT-UK). Available from RSGB Books, priced at £4.47.

### List of Useful Addresses

NOAA (National Oceanic and Atmospheric Administration)

Satellite Program Specialist

NOAA/NESDIS

E/ER2 Room 3306

FB4

Washington DC 20233

USA

ESA (European Space Agency)

European Space Operation Centre

MDMD

Robert-Bosch-Strasse 5

D-6100 Darmstadt

West Germany

Table. 1 Parameters of Polar Satellites

	NOAA-6	NOAA-9
period	101.2 mins	102.1 mins
inclination	98.5°	98.9°
height	830km	850km
typical pass duration	13 minutes	13 minutes



# UoSAT 2 SATELLITE

At last everything you need to receive and display UoSAT 2 data on your BBC computer. Our custom designed software is the first on the open market to decode the data and display it in an easily understood format on the screen. Each channel is identified and labelled with a full description. Using an inbuilt printer dump routine eliminates the need for a printer rom. Written by Tony Ferneyhough this new improved software is rapidly becoming the standard for schools and enthusiasts. A review of the previous version is featured in May R&EW.

Proving our ability to lead the forefronts of RF Technology we have already sold over 2,000 of the receivers and pre amps that this system is based on. Tracking of the aerial and receiver is not needed for any of the satellite passes. For the ultimate the optional data correlator designed by James Miller can be used. Using advanced correlation detection techniques and a matched filter this unit provides stable data under most signal conditions. The correlator is suitable for both UoSAT 1 and 2.

**For satellites in education talk to the experts, Timestep Electronics.**

★	Aerial .....	£18.50	★
	Aerial cable .....	20p metre	
	Pre amp kit .....	£4.95	
	Built module .....	£10.95	
★	Receiver (MK2) kit .....	£37.50	★
	Built module .....	£48.50	
	Software on disc .....	£12.95	
	Data correlator kit .....	£42.00	
	Built module .....	£56.50	
★	Receiver and correlator built and boxed .....	£138.50	★
	Full data .....	35p	

All prices include VAT and postage and packing.

Allow up to 28 days for delivery.

**Timestep Electronics Ltd Wickhambrook Newmarket Suffolk CB8 8QA**  
**Tel 0440 820040 Telex 817015 TIMEST G**



# WEATHER SATELLITES

We are able to supply the complete weather satellite reception package. Everything you need has been designed around the superb new ROM from Peter Clappison and Mathew Atkinson. We have commissioned Jaybeam to make a special aerial for us that doesn't need to be moved or turned when it is used with our pre-amp and receiver, it gives good predictable pictures. Our receiver will give 12dB SINAD with only 0.15µV which is considerably better than any of our competitors. The interface unit has several switchable op-amp filters giving enhanced pictures from weak signals and also allows low frequency FAX data to be demodulated. The BBC EPROM has been designed to be used with our interface and will also decode the HF and VLF data from our interface.

<b>Aerial</b>	<b>£34.50</b>	<b>Interface</b>	<b>Kit £39.50</b>
			<b>Built £58.00</b>
			<b>Boxed £88.50</b>
<b>Pre-amp</b>	<b>Kit £4.95</b>		
	<b>Built £10.95</b>		
		<b>Software</b>	<b>Eprom £37.50</b>
<b>Receiver</b>	<b>Kit £37.50</b>		<b>Full data £0.50</b>
	<b>Built £48.50</b>		
	<b>Boxed £79.95</b>		

**UoSAT systems send SAE**

Mail order only. Allow up to 28 days for delivery



**TIMESTEP ELECTRONICS LTD**  
**Wickhambrook, Newmarket, Suffolk CB8 8QA**  
**Tel: 0440 820040 Telex: 817015 TIMEST-G**

# Combined SWR Bridge and Wavemeter for 2m

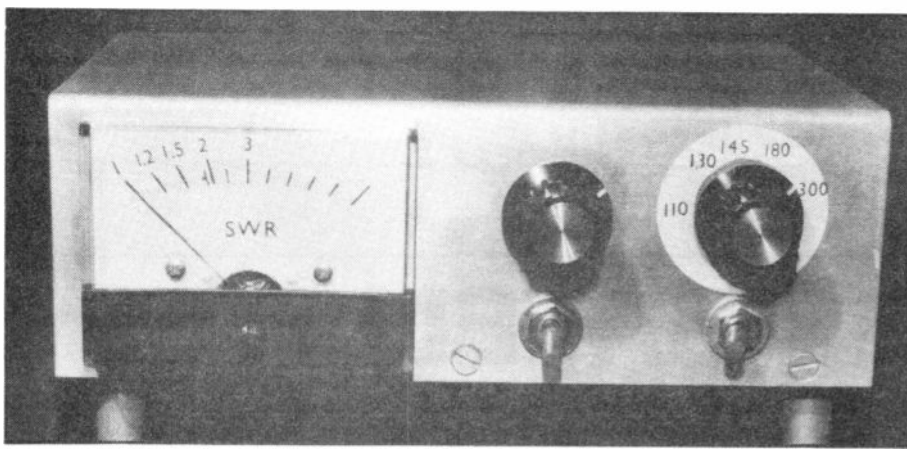

*For the newly licensed class 'B' amateur, the two most useful pieces of ancillary equipment are an SWR bridge and an absorption wavemeter. Tony Smith, G4FAI, shows how to build a simple combined unit to provide both personal satisfaction and good performance.*

The amateur radio licence requires that "Equipment shall be provided capable of verifying that the sending apparatus comprised in the Station is operating with emissions within the authorised frequency bands". This includes the ability to detect any emissions outside the bands. A simple device which will perform both functions is the absorption wavemeter, provided, as stated in the notes attached to the licence, the frequency coverage of this extends to *at least* the second

harmonic of the radiated frequency.

An SWR bridge is often left connected in the antenna feeder line of an amateur station and a wavemeter could conveniently be incorporated in the same unit. This would enable regular tests for the radiation of harmonics and other spurious emissions to be made without any special setting up of equipment. Often absorption wavemeters tend to spend their time in cupboards and out of sight

is out of mind. Both circuits have appeared in various versions over the years, and the novelty of this article is merely in the way they are brought together.

**SWR bridge.** This is the well known "Monimatch", a simply constructed circuit which samples RF from a feeder to provide a relative indication of forward and reflected power. The sampling line is terminated by a resistor, R1, of approximately the same impedance as the transmission line, at one end, and by a diode, D1, at the other. Rectified current from the diode activates the meter from which readings are taken. A switch, SW1, effectively reverses the positions of resistor and diode on the sampling line, permitting either forward or reflected SWR readings to be made.

**Absorption wavemeter.** This consists of a calibrated tuned circuit loosely coupled to the sampling line of the SWR bridge. The circuit absorbs power from the line when it is tuned to the *same frequency* at that passing through the coaxial feeder line hence the name. SW2 routes the power absorbed to the meter of the SWR bridge, via

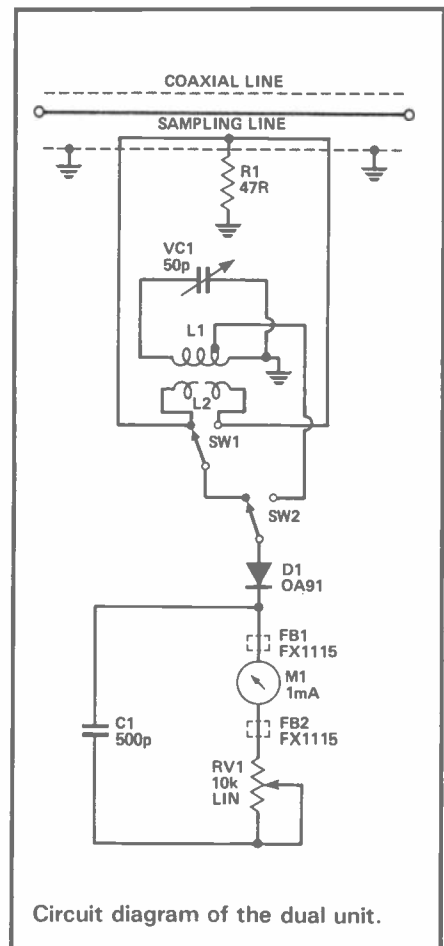

Circuit diagram of the dual unit.

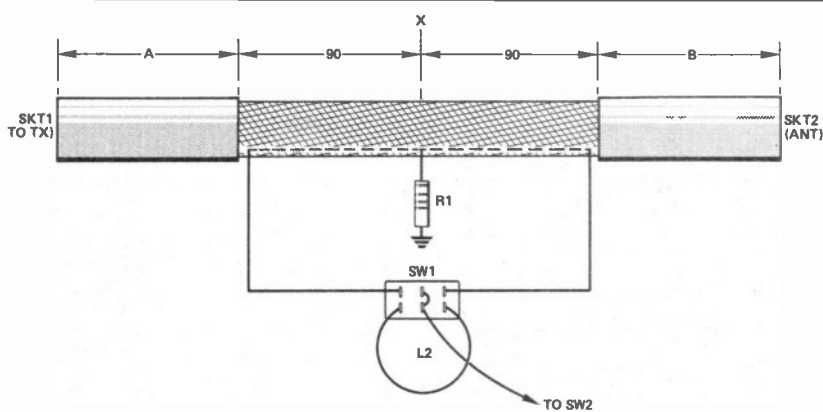

**SAMPLING LINE ASSEMBLY.** Lengths A & B are those necessary to connect the cable to the two sockets. The coaxial lead to the transmitter should be one or more half wavelengths, including the distance from point X to socket 1. A half wavelength at 145MHz, assuming 0.66 velocity factor, is approx. 882mm, suitable for all frequencies in the 2 metre band.

Sampling line assembly. Note that this is fabricated from a single piece of coaxial cable.

the diode, and maximum deflection of the meter indicates the point of resonance of the tuned circuit coinciding with the frequency of the RF power sampled.

This type of instrument is not especially accurate for frequency measurement, but fulfills the licence requirement by registering the presence of either wanted or unwanted emissions at approximate frequencies sufficient to indicate the need, or otherwise, for further investigations. The device has the advantage that it responds *only* to the frequency of the RF energy to which it is tuned, not to the frequency of the circuit in which the energy is present, and not to any other harmonic frequency, until it is tuned to that harmonic.

This version tunes from approximately 110 to 300 MHz, and covers the second harmonic of the highest frequency in the 144MHz band ( $2 \times 146\text{MHz}$ ) ie 292MHz.

### Construction

The heart of the unit is the sampling line, which comprises two lengths of single strand plastic covered wire, such as telephone type wire, threaded between the braid and the dielectric of a short length of coaxial cable of the same impedance as the main station feeder.

A 180mm length of outer covering is stripped away, care being taken not to cut the braid. Three holes are made and enlarged in the braid, one at each end of the stripped section and one in the centre of

this, again without cutting the strands. By careful bunching of the braid it is now possible to insert one of the wires at each end of the stripped section, both to emerge through the centre holes. The braid

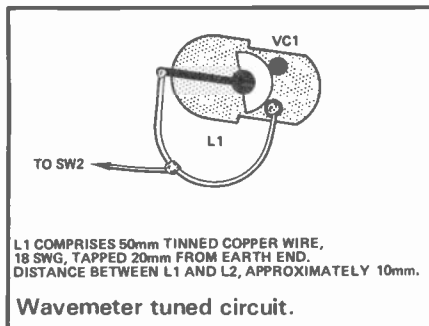

L1 COMPRISES 50mm TINNED COPPER WIRE, 18 SWG, TAPPED 20mm FROM EARTH END. DISTANCE BETWEEN L1 AND L2, APPROXIMATELY 10mm.

Wavemeter tuned circuit.

is then smoothed back to its original length.

The single turn radiating coil, L2, for the wavemeter has no specific dimensions, and is constructed so that it runs parallel to the tuned coil, L1, linked to it, depending on the position of SW1

L2 (at centre) the link coil, is mounted on the back of SW1 and above and parallel to the tuning coil, L1.

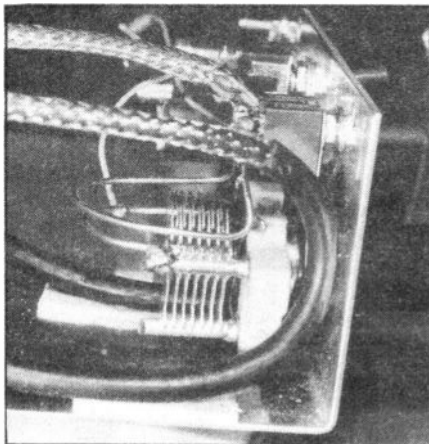

on which it is mounted for its size (see the photo nearby).

The sampling line assembly should be as symmetrical as possible and, for use with medium to high powers, should be screened from the other components. The layout of components is not particularly critical and can be adjusted to suit the size and shape of the metal case used, if different to that shown here.

D1 is a germanium type to avoid misleading results with *low* levels of reflected power, since these start to conduct at a lower voltage than silicon types.

The SWR bridge described will indicate 'full scale' at a minimum power of about 1.5 watts, and lower powers can be accommodated by using a more sensitive meter. The upper power limit is determined by the rating of the resistor, R1, in the sampling line. The 0.5W suggested is sufficient for most powers, but a 1W resistor might be preferable if high power (greater than 30W) is used regularly.

### Calibration

**SWR.** This type of bridge does not provide a highly accurate measurement of standing wave ratio. It does however provide sufficient accuracy to enable the effect of small adjustments to an antenna to be monitored adequately. The actual calibration of the meter in SWR can be simply and conveniently obtained. For instance, if the meter scale is already marked in tenths of full scale deflection, as are the majority of meters, these markings can be converted to SWR indications by use of the formula:

$$F + R/F - R$$

where  $F = 100\%$  full scale, and  $R =$  the % intermediate point to be calibrated

$$\text{eg for } 10\% \text{ deflection} = \frac{100 + 10}{100 - 10}$$

$= 1.2:1$  SWR approx.

similarly,  $30\% = 1.85:1$ , and  $50\% = 3:1$ .

An adequate scale would be markings at 1.2 (10%); 1.5 (20%); 2.0 (33%); and 3.0 (50%).

**Wavemeter.** Calibration is made initially with the instrument in-line between the transmitter and the antenna (or dummy load). A low power transmission of RF at

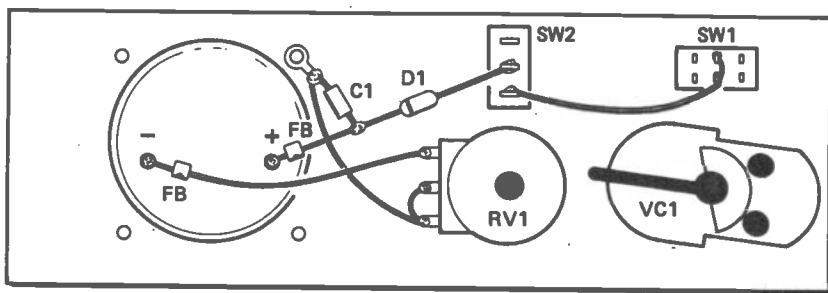

Brief wiring detail viewed from upside down for purpose of clarity. Construction of L1, L2 and sample line shown separately.

approximately 145 MHz should cause the meter to register when the tuning capacitor, VC1, is rotated, and the front panel of the instrument should be marked with the position of VC1 when maximum meter deflection is obtained.

Provided the transmitter has no unwanted spurious, rotation clockwise from this point may produce one further, very small, deflection of the meter, representing the second harmonic of the transmitted frequency, which can also be marked on the panel.

An alternative method of calibration is to use a friend's grid-dip oscillator. With the cover of the dual unit removed, the coil of the GDO is placed close to the tuned coil of the wavemeter. Set the GDO, in the oscillator mode, to the

calibration frequency required, and then tune the wavemeter for maximum deflection as before. This method will, of course, enable intermediate frequencies to be calibrated apart from the fundamental and its second harmonic.

### Operation

The unit can now be left permanently in-line. The coaxial cable connecting the transmitter to the instrument should be one or more multiples of half-wavelength at the most commonly used frequency, taking into account the velocity factor of the cable used. This ensures that the bridge "sees", as near as possible, the same electrical conditions as that at the transmitter output socket.

SW2 selects SWR or wavemeter operation. When using the SWR bridge, VC1 should be detuned from the frequency of the transmission to avoid upsetting the balance of the bridge.

SW1 selects SWR FORWARD or REFLECTED readings and, initially, in the FORWARD mode, the sensitivity control, VR1, should be adjusted for meter FSD. Reversal of SW1 then indicates SWR. This should not normally exceed 3 : 1, and ideally should be less than 1.5 : 1.

When using the wavemeter, SW1 should be in the FORWARD position to provide best sensitivity. Spurious frequencies, or an unusually high second harmonic can easily be detected by rotating VC1 and observing the meter — and appropriate steps then taken to correct the malfunction! Every time the wavemeter is used, an entry can be made in the station log book as required by the licence regulations. As shown, the unit works well with powers of up to about 30 watts.

Construction shown from above.

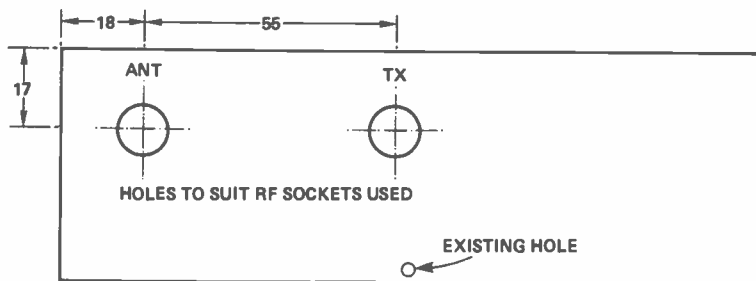
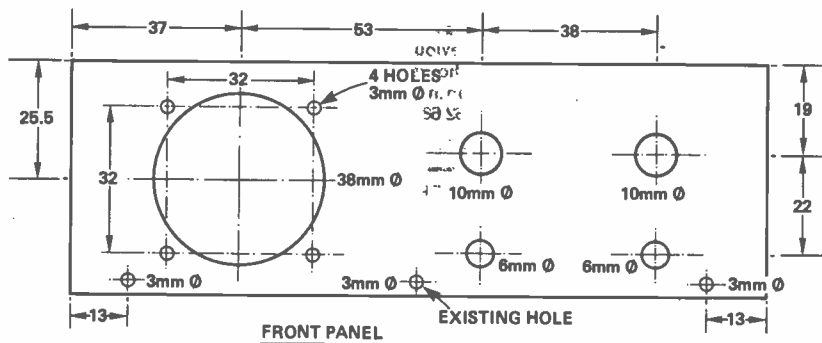
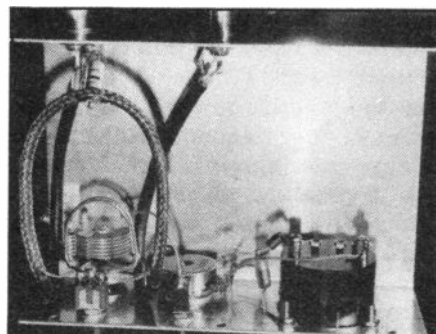

Drilling detail of the case.

### COMPONENTS LISTING

#### Resistors

R1 47R, 0.5W  
VR1 10k lin.

#### Capacitors

C1 500pF, Polystyrene  
VC1 50pF, eg. Jackson C804

#### Semiconductor

D1 OA91 or similar, germanium

#### Inductors

L1,2 see text

Aluminium box, (Maplin AB13) 6 × 4 × 2";  
Ferrite beads (2) FX1115, Double-Pole  
Switch, Min. Toggle; Single-Pole Switch,  
Min. Toggle; Milliammeter, 1 mA; RF  
sockets (2) of choice, eg. SO-239, BNC.  
Knobs (2), for VR1, VC1; Rubber feet (4), to  
choice; Tinned copper wire, 18 swg; Solder  
tags; C/sunk self-tap screws.

# Build yourself a micron transceiver at a price you can afford



**£241 FOR 6 BANDS/INTERNAL ATU/DIGITAL DISPLAY AND CASE**

OUR LATEST TRANSCEIVER KIT setting new standards in QRP performance. The MICRON is a 6 band CW only 8/10W output rig covering 80,40,30, 20,15 & 10 metres (bottom 200kHz of each). A 0.25uV sensitivity receiver with AGC, S Meter, very stable VFO with IRT, I/W AF o/p to speaker and 3 position LC filter + selectable attenuator. Silent solid-state Rx/Tx switching with fast semi break-in + sidetone. Fully variable RF power o/p + optional SWR metering. + 12v required.

PLUS fully finished smart CUSTOM CASE and hardware with UNIQUE facility for optional internal TRANSMATCH ATU and Full Frequency DIGITAL DISPLAY. The MICRON uses a high grade solder masked/screen printed pcb with comprehensive Instructions using a step-by-step assembly manual designed for the relative newcomer. Mostly prewound coils and minimal test equipment needed for alignment.

**EXPORT A PLEASURE!**

PRICES: FULL KIT with all options including Case/Hardware/ATU/Metering/Digital display at an all-in £241. Or, 6-band pcb kit complete at £145 or with case is £182.50 and the options of INTERNAL ATU at £37, and DISPLAY at £38.50.

## QRP for under £40?

ONLY NEEDS +12v, SPEAKER + KEY/MIC TO BE ON THE AIR!

FOR THE LESS AMBITIOUS, why not try our DSB80 kit? A 2W + DSB or CW VFO controlled TRANSCEIVER kit for either 80 or 160m at a ridiculous £39.95 for a complete pcb kit - over 1000 sold to date! It has a very sensitive receiver and is ideal for beginners. Punched aluminium CASE and HARDWARE for the DSB80 at £25.95, and digital display at £29.50 - all three kits for £85.00.

NEW! The MICRON MATCH ATU Kit, developed from the MICRON ATU, with its own case, connectors, etc. Suitable for SWL or QRP (15W) from 1.8 - 30Mhz. With air spaced capacitors for only £39.95 inc.

## 2M FM UNDER £70?

We also make a popular 2M FM Tx/RX kit - 6 channel crystal control at 1W RF o/p. Receiver at £39.50 and Tx at £34.50 ex crystals - both for £69.95. Optional PLL VFO available at £38.50.

OTHER KITS: DSB2 - enhanced version of the DSB80 for any single band 160 - 15m, DSB/CW 2W+ at £69.50 basic kit. SPEECH PROCESSOR - very popular kit at £14.65 to help get the DXI ALPHA - our 50W monoband SSB/CW Transceiver with case and display at £179.95. OMEGA - 9 band 100W multimode for the specialist constructor - write for details.

Why not join the ranks of satisfied customers building our Projects? All of our kits come with copious instructions, all components, pcb, wire, pots, etc, and many are designed for beginners. Our Products are used world wide and can help YOU get on the air. KITS are sent in 7-10 days but please allow up to 28 days for popular items. All prices include VAT and Post. OVERSEAS - Europe use UK prices and Rest of World UK + 5% for carriage, etc. CREDIT CARD orders can be left on our 24hr Answering Service. For our 40+ page CATALOGUE please send 50p in stamps. Kit Debug service available.

**WPO COMMUNICATIONS**



UK DESIGN AND MANUFACTURE

20 FARNHAM AVENUE, HASSOCKS G3WPO  
WEST SUSSEX BN6 8NS MAIL ORDER ONLY  
24hr Ansaphone 07918 6149

**AKD** Armstrong Kirkwood Developments

The name for wavemeters, pre-amps and rf filters

## VHF/UHF ABSORPTION WAVEMETER

Covers 120-450 MHz. Extremely sensitive. Low profile. Requires PP3 battery ..... Only £24.95

## 2MTR PRE-AMP

18db of gain. Fail safe circuit. Min. 25 watts through power. S0239 connectors

..... Only £24.95  
Both products carry a 2 year no quibble guarantee.



ALSO AVAILABLE FROM MOST LEADING AMATEUR RADIO DEALERS  
Prices incl. VAT, postage & packing.

(Prop.) J.W. ARMSTRONG  
10 Willow Green, Graham Park Estate, London, NW9. Tel: 01-205 4704

## BECOME A RADIO AMATEUR

Train now for the Radio Amateur Licence examination. No previous knowledge needed, only a few hours per week of home study for 3 to 6 months. Post coupon now for details or tel. 062 687 2598 (24 hr service)



British National Radio & Electronics School P.O.Box 7, Teignmouth, Devon, TQ14 OHS



FREE brochure without obligation from:-  
**British National Radio & Electronics School**  
P.O. Box 7, TEIGNMOUTH, DEVON, TQ14 OHS

Name .....

Address .....

HRT/8 .....

BLOCK CAPS PLEASE



Amateur Electronics UK  
**AJH ELECTRONICS (G8AQN)**  
Est. since 1967



A professional service to amateurs and S.W.L.s from the East Midlands Emporium.

Stockists for: Yaeusu, Tokyo linears, Sun antennas, Hi Mound Keys, RSGB books, Tokyo Power/SWR meter. Specialist components for the radio amateur. Xtal filters, capacitors etc. Send for FREE list. Cellular and PMR sales and service. Vodaphone authorised dealer. Answer phone sales for the business and private user. B.T. approved phone sales. 27 and 934 CB equipment. Full after sales service/workshops. P.X. welcome on amateur equipment. Retail shop now open. 9.30-5.30 Mon-Sat. 1/2 day Wed.

151a Bilton Rd., Rugby CV22 7AJ. Tel: (0788) 76473

## GENERAL COVERAGE RECEIVER KIT FCR 130

Model FCR 130 Receiver kit

For Constructors and SWLs

- ★ 30: 1 Geared analogue tuning
- ★ 3 Band switch with spare position
- ★ Tape record socket
- ★ Headphone socket
- ★ Signal Meter
- ★ Internal Speaker + On/Off sw.
- ★ A.F. Gain and Tone Control
- ★ C.W. A.M. SSB.

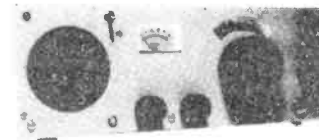

This is a kit designed as an introduction to the hobby of Radio and Short Wave Listening. It has been designed with beginners in mind and does not require any test equipment to align. It comes complete with easy to understand instructions and notes. The pleasure does not finish with the building as there are many hours of enjoyment using it afterwards. Ideal for those who want to learn the basics of radio and have something to actually use afterwards. Enter the world of SWLs and listen to the WORLD! 'New York Weather'... ANKARA... Sidebanders on 6.5MHz... and according to one of our customers... ZK2RS Nive Island, Pacific Ocean. Send for details.

## COMMUTECH (Devon) LTD

12 Edgecumbe Way, St. Anns Chapel, Gunnislake, Cornwall PL18 9HJ  
Tel: (0822) 832787

# Squeeze Keyer Supreme?

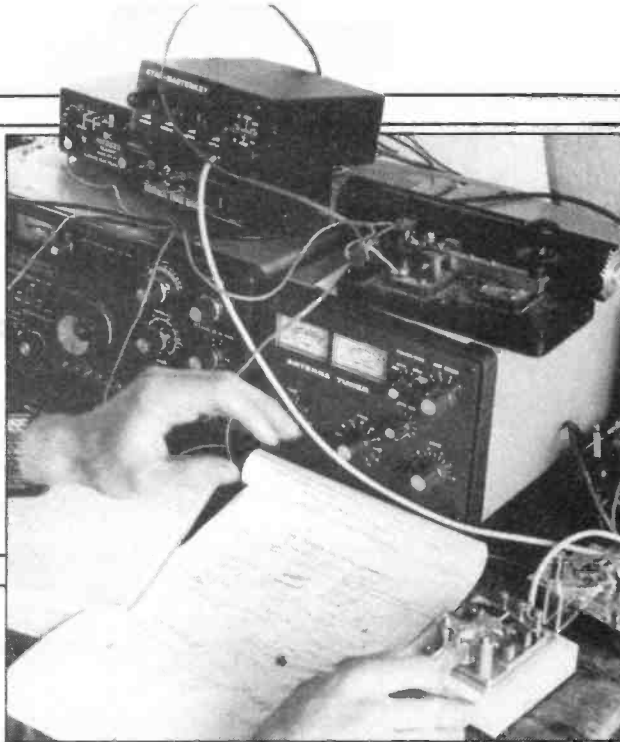

*National Field Day is a perfect time to test out a new keyer. Steve Ireland, G3ZZD, and the West Kent Amateur Radio Society took the Dewsbury Star Masterkey into the field — literally!*

The first thing I should say about this article is that it is a users review, rather than the opinions of one person. National Field Day at the West Kent Amateur Radio Society is a time of reunion and a social occasion par excellence, in addition to it being the CW contest event of the year. Consequently there is quite a high attendance, many people coming from considerable distances, all keen to try their fist, even though some may not have been on the air in the previous twelve months. This latter is not to say that the operator's are not skilled — their pedigree on the contrary is long and *most* distinguished — but, because of where they are currently living or working, regular operation is impossible.

The result of this situation is when these people (myself included) are confronted with National Field Day, their latent CW tendencies rise violently to the surface and they become positively *enthusiastic* (manic?) and *very* critical. Any equipment that is thought to be below par is torn off the operating bench and (almost) thrown aside, regardless of the feelings of the owner.

## Technicalities

Circuit information is limited. The keyer comes complete with a four sided leaflet, giving fairly comprehensive operating instructions but no circuit diagram. A look inside the unit revealed a total of seven ICs and seven transistors, the former being CMOS Motorola 1400 series — 14001, 14011, 14025, 14015 and 14071. No relays of any kind are used in the keyer, the switching being entirely 'solid state'.

The unit is designed to run from 9-18V; either a PP6 battery may be mounted internally or powered externally via a miniature jack plug, supplied with

the unit. Sidetone is provided by the keyer, variable in both level and pitch on the front panel, and a miniature speaker is mounted at the rear of the unit, although a socket is also provided for an external speaker. There are three basic controls for the actual keyer; two potentiometers, one controlling 'speed' — very slow up to about 55wpm — and the other, 'weight', or the dot-to-dash ratio of the unit. This is fixed at 3:1 in the majority of keyers. Having a facility of this kind is not essential but does allow the operator to adjust the ratio to their own taste.

A miniature 3 position toggle switch selects either 'automatic' (iambic/el bug), or 'semi automatic' (sideswiper bug) or 'tune' (short circuit) at the keyer output. The keyer may also be used with a straight key for keying relatively(!) high current sources.

An external paddle is needed with the keyer.

## In The Arena

On arrival at the NFD site, a space was first cleared for the keyer among the debris and other key(ers) (two pump handles, one 'el-bug' and one iambic) and the keyer plugged into the rig for the first session. Confusion initially resulted when I tried to plug the Hi-Mound paddle into the external speaker socket at the rear of the unit. Some labelling on the back panel in the form of small sticky pads would have helped here, especially as the only thing not labelled on the front panel is the paddle socket. Yes, it does tell you all this in the leaflet.

The unit was powered up via a small power unit (batteries are *not* a good idea in contests for obvious reasons) and away we went — or so I thought. The keyer was making all the right noises but the transmitter, an old

FT101ZD with valve PAs, was not being keyed. Now, the Star Masterkey is designed for both 'positive' and 'negative' keying — ie the solid state switching will key either positive or negative voltages — to suit both solid state or valve type PA rigs, such as the FT101 series etc. Having valve PAs and 'grid block' type keying, negative keying was needed and the keyer was currently set to positive. A removal of the keyer lid and the repositioning of a small 'spade' terminal quickly corrected this.

## Conclusions

The silence of the keying was appreciated by a number of operators, particularly myself. Many older type keyers with relays produce quite loud clicking, which can grate on the nerves after hours of contest operation. The sidetone is loud and clear, although slightly 'belchy' at some settings of the pitch control, and could be heard above all the constant din in the tent ('Where's that \*\*\*\*\* check log!', 'How's old Bill, haven't seen him for ages'... etc). The ability to change the pitch of the sidetone to suit your own personal preference also eased operator fatigue.

Comments on the keyer ranged from "How much is that, I think I'm going to buy one", through "the weighting facility is a good idea but adjustment is rather sharp" to "so *this* is an iambic key" (from an old straight key diehard). The keyer survived the contest without a hiccup and was used by all the squeeze/el-bug operators present, without being put aside once in preference to their own personal keyers.

The Dewsbury Star Masterkey costs £49.95 plus £3.00 p&p and is available from Dewsbury Electronics, 176 Lower High Street, Stourbridge, West Midlands. See the competition in this issue if you would like to win one!

# MICRO' NET

Now that summer is/should be (delete as applicable!) more or less upon us, quite a few of the more recently active radiophiles will be experiencing a rather odd phenomenon which was not touch-

indeed they have kindly allowed *Ham Radio Today* to reproduce these from time to time in the past. If you happen to be a member of one of these groups there is a good chance that you can find someone

in this area or who would *like* to be active but cannot find a compatible station to work with, to send us a card showing details of their station and its facilities. Once we have a reasonable number of stations registered, we can then put together a list which will show, on a county-by-county basis, the callsigns of 'data stations', the types of data they are able to handle and the bands which they use. By doing this, we can not only get local contacts going (after all, it's not *too* difficult to drop subtle hints like "Anywun wanna data QSO" through a local repeater) but perhaps encourage people further afield to get in on the act. Depending on the size of the list compiled, this will either be published or available from the editorial offices on receipt of an SAE.

***Dave Bobbett, G4IRQ, tells how to interface your micro' to a transmitter without generating harmonics and launches our very own data communications register for licensed amateurs and SWLs.***

ed upon in the RAE syllabus. Characterising the summer months, this can be seen as a polar opposite to 'anomolous propagation' (where signals are heard when they shouldn't be). The appearance of the sun for any reasonable length of time results in signals which should be able to be heard being notable by their absence. I suppose you could call it 'anonymous propagation' or 'operator QSB'! For the fact is that ham activity often fades away as summer holidays, gardening and decorating take their tragic toll of the amateur community. Now I'm not going to try and persuade errant operators to get back to the rig and start taking advantage of the gradually improving conditions on the HF bands as we climb out of the sunspot minimum — but I am going to try and prise some information out of microphiles which may be useful to others once being indoors is a more attractive proposition than being outdoors.

with common interests not too far away, but if you are new to ham radio or experimenting with micros and radio for the first time, then there are quite a few problems facing you. How do you go about trying to find out who, if anyone, is 'into' data comms in your area; and having done that, there is the question of knowing which systems and which bands are likely to be used by them?

To try and help like-minded operators get in touch with one another (and based upon the fact that any good idea is worth copying!) Micro'Net is launching its own list of people who are interested in data communications and which, with a bit of luck, will be ready in time for the mass exodus back to the radio at the first hint of winter.

The general idea is that we are asking all operators who are active

What we would like *you* to do is fill out a post-card or a QSL card using Fig. 1 as a guide and include the following information:

- 1) Your Callsign
- 2) Your County
- 3) The band you use for data, ie 14MHz, 144MHz or 432MHz
- 4) The data system you use:
  - i) Amtext
  - ii) Amtor
  - iii) AX.25 Packet system
  - iv) Basicode
  - v) Cambridge Packet
  - vi) RTTY
  - vii) Others

But *please, please, please* don't send it to the editorial offices in London, instead send it to:

Micro'Net  
PO Box 49  
COLCHESTER  
Essex

Naturally, if you are a short-wave listener with an interest in data,

## Put Yourself On Our List!

A number of specialist micro-radio groups have had a lot of success with putting together lists of those who are interested in the various forms of data comms, and

Fig. 1 Format for the Micro' Net data information card.

CALLSIGN	COUNTY	BANDS	SYSTEM
		HF	AMTEXT
		VHF	AMTOR
		UHF	AX.25 PACKET
			B.CODE
			CAMBRIDGE
			RTTY
			OTHER.....

Please send to: MICRO'NET, PO BOX 49, COLCHESTER, ESSEX

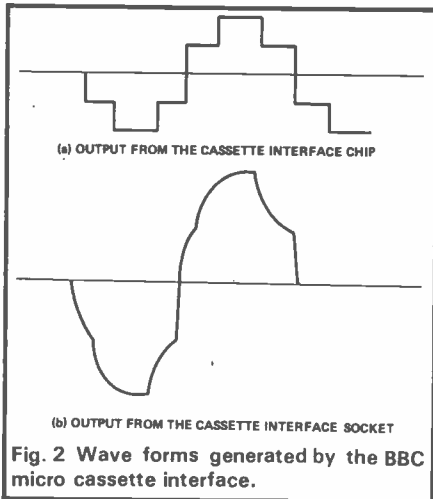

Fig. 2 Wave forms generated by the BBC micro cassette interface.

then we are keen to hear from you, too. Include your BRS No. if you have one and give us the name of your town so that experimenters can get an idea of whether or not their test transmissions are likely to be intercepted by you or others.

I know that there are a number of local clubs springing up which are specifically aimed at data comms enthusiasts. If club secretaries would like to get in touch (as one or two already have) then we can also put their names (and maybe even the numbers) on the register and also get the clubs a little publicity through a mention in Micro'Net. The list should help newcomers to assess which data system is the most popular in their area and also help us to put together a picture of what is happening data comms wise over the country.

### Around The Pubs and Clubs

Before we leave the subject of lists and clubs, I would like to briefly mention a letter which I've received from Trevor Tugwell, Secretary to the newly formed 'AMRAC' club in Fareham, Hants. AMRAC aims to encourage the use of computers in radio and although a remarkable 19 out of 22

youngsters present at a recent meeting were BBC Micro users, the club intends to cater for all makes of machine. Data communications activity seems to centre around a program written by club member Mark Johnson, G4ZRT, at the moment, and 'activity' seems to be the key word here. Since the club was formed, the data frequency of 144.675 has become so crowded that 144.525 and 144.550 have had to be used so as to accomodate everybody. Who says data will never catch on!

At the moment the club meets bi-monthly and will be going over to a monthly schedule in the autumn; the venue is the Crown Public House, Bishops Waltham, Hants and further details can be obtained from Trevor at the address shown nearby.

### Smoothing Micro Inputs

Regular readers of Micro'Net will know that I have previously referred to the problem of square-wave audio inputs to transceivers and the resultant interference risk caused by the inherently high harmonic content of a square wave signal. Up until recently, I had been led to believe that I was one of the lucky ones in so far as the BBC Micro *allegedly* put out a sine wave from its cassette port. I decided to take a look and see how it was done...

First of all, I decided to take a look at the output from the special ULA chip which takes care of cassette interfacing on the Beeb. Fig. 2a shows the resulting trace (taken from IC7, pin 27 if you want to try it yourself) and Fig. 2b illustrates the same wave-form after it has been passed through a shaping network. As you can see, the wave-shape is far from sinusoidal to start off with and, even after shaping, there are quite a few unpleasant 'corners' still remaining. To be fair, I should say that

Fig.2B was traced when there was no cassette recorder connected. However, as there is no guarantee that the micro will always see a perfect load, it is clear that a filter or shaper is needed for radio work, even if a certain amount of shaping is done inside the computer itself.

A solution to this problem was finally found on page 10.11 of the *Radio Communication Handbook* and takes the form of a very simple two-transistor circuit which is reproduced in Fig. 3.

Any square wave, or other wave-form possessing the sharp edge-transitions which are characteristic of harmonically rich signals, can be fed into the circuit and emerge with these features removed, ready for feeding to a transceiver. The circuit itself is so simple that it would seem to be a worthwhile exercise just to knock one together for use as a form of 'insurance' — at least that way, regardless of whatever may go wrong 'upwind' of the device, you'll know that indescribable nasties will not be emanating from your PA stage!

### That's All Folks!

That about rounds it up for this month, Micro'Net will be back again next month with something very special for HF aficionados in the shape of a 'grey line' prediction program and guide which will make this type of DXing both more exciting and easier than before. Watch this space!

#### ADDRESS BOX

Further details concerning the AMRAC club can be obtained from:

AMRAC  
Trevor Tugwell  
50 Maybridge  
FAREHAM  
Hants  
PO14 4QP

Tel: 04895 81032

An SAE would no doubt be appreciated.

Please send your data station cards, comments, letters and details of micro/radio clubs for inclusion in Micro'Net to:

Micro'Net  
PO Box 49  
COLCHESTER  
Essex

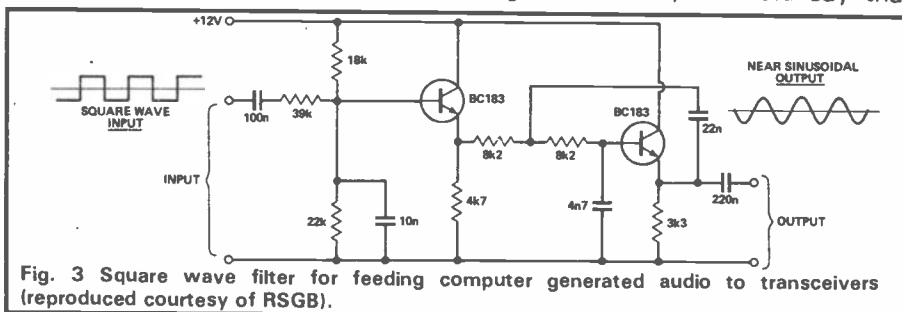

Fig. 3 Square wave filter for feeding computer generated audio to transceivers (reproduced courtesy of RSGB).



**STOP PRESS!**

# 1st Amstrad RTTY

The first RTTY transceiver package for Amstrad CPC464 is now available.

The computer is connected to the radio via a terminal unit such as the MPTU-1. 5 screens include Rx/Tx window, type ahead window, menu and status report areas. 10 memories with total storage capability of 10K. QSO is stored in a buffer which can be recaptured or saved and loaded from tape. **Program cassette £10.50, With MPTU-1 £78.**

**BBC SSTV.** Slow Scan Rx/Tx package is now available for the BBC. There are three Rx modes — Line or Frame sync. and Browse. Up to 99 screens can be saved for later recall and transmission. Onboard PTT circuitry. Requires +12v -12v and 5v external power supply. A circuit diagram can be obtained for home build or a ready assembled unit is available.

**Program, PCB and demonstration tape £17.50.**

**As above plus component kit £68.50 Complete, ready assembled and tested £79.95 Please add £2 if Disk option is preferred.**



Prices include VAT and are correct at time of going to press. Trade enquiries welcome.

Scarab Systems produce many other top-quality programs and equipment for the radio amateur. Use the coupon now for details.



## SCARAB SYSTEMS

39 Stafford Street, Gillingham, Kent ME7 5EN.  
Tel: (0634) 570441

Please send me

- |   |   |
|---|---|
| <input type="checkbox"/> Amstrad RTTY £10.50- 50p postage                       | <input type="checkbox"/> BBC SSTV plus component kit £68.50 inc. postage. |
| <input type="checkbox"/> Amstrad RTTY with MPTU-1 £78 inc. postage.             | <input type="checkbox"/> BBC SSTV ready assembled £79.95 inc. postage.    |
| <input type="checkbox"/> BBC TV program, PCB and demo tape £17.50 inc. postage. | <input type="checkbox"/> Free details of other equipment and programs.    |

I enclose a cheque/postal order for.....

I wish to use my Access/Visa Card No.

Name.....

Address.....

Telephone No.....

Signature.....

I understand that if I am not fully satisfied I can return the equipment within 21 days for full reimbursement. 14 days delivery HRT



### RAINBOW COMMUNICATIONS

#### MENU

1. 1/2 wave verticals for 10m £11.90
2. Centre-loaded mobile whips from £7.00
3. 25 watt linear amps from £17.00
4. P.S.Us from £14.00
5. Repairs
6. 10m FM Conversions

**WANTED URGENTLY!**  
2nd hand VHF+HF equipment, part X welcome

**BNOS. AKD. SUN. ALTRON. JAYBEAM.**

### EVERYTHING FOR 10 FM

68 Goringe Park Ave  
Mitcham Surrey  
Ask for  
Howard (G4VWR)  
or WIN (xxxxxx)  
01-640 1904

**OPEN TILL 8PM MON-SAT  
SOUTH LONDON'S BUSIEST EMPORIUM**

### RTTY and CW TRANSCEIVE with NO TERMINAL UNIT

This fantastic program interfaces direct to your rig, slashing the cost of previous systems. Split screen, type ahead, all the usual features and more. Tape and kit for the very simple interface for only £20. Ready-made interfaces available. For CBM64. VIC20 (+ at least 8k), BBC-B. CW-only version for SPECTRUM £10.

And four superb programs for CBM64, VIC20, BBC-B, SPECTRUM

**LOCATOR** QTH or Maidenhead locator or lat/long. Distances, headings, contest points, converts between locator and lat/long. Tape £6.  
**LOGBOOK** Date, band, mode, call and remarks. Superfast callsign search. Easy, fast updating of files. Screen/printer output. Tape £6. VIC20 needs at least 8k expansion.  
**MORSE TUTOR** Britain's best. Learn fast in easy stages from absolute beginner to over 40 wpm. Join the hundreds who have succeeded with this program. Tape and full learning guide £6. For ZX-16k also.

All programs are very easy to use and come with full instructions. Prices include p&p 1st Class by return. Add £1 per tape if outside UK or Ireland.

UK orders: add 15% VAT

**technical software (HRT)**

Fron, Upper Llandwrog, Caernarfon, Gwynedd LL54 7RF. Tel: 0286 881886

### AMATEUR ELECTRONICS UK

G6XBH



**R.A.S. (Nottingham)**  
Radio Amateur Supplies  
Tel: 0602 280267

G8UUS



#### Visit your Local Emporium

Large Selection of New/Used Equipment on Show

#### AGENTS FOR:

ICOM F.D.K.  
YAESU AZDEN  
FORTOP ATV

#### ACCESSORIES:

Barenco Mast Supports  
DRAE PSU and  
Wave Meters  
Microwave Modules

Welz Range  
Adonis Mics  
Mutek Pre-Amps

AERIAL: Tonna, Halbar, New Diamond Range of Mobile Whips

#### PLUS OWN

'Special' Q.R.P. GW5 HF5 Band Beams  
JUST GIVE US A RING

Monday: CLOSED Tuesday-Saturday. 10.00am to 5.00pm

3 Farndon Green, Wollaton Park, Nottingham  
Off Ring Rd. between A52 (Derby Rd.) & A609 (Ilkeston Rd.)

### FARNBOROUGH COMMUNICATIONS

FOR ALL YOUR AMATEUR REQUIREMENTS



Call Mick G4MPW for best bargains

Call and bargain with MICK G4MPW

DRAE ● MICROWAVE MODULES ● J.BEAM  
SHURE MICS ● ADONIS MICS ● WELZ ●  
OSKERBLOCK ● BENCHER ● TVI FILTERS  
● CABLES ● MIRAGE AMPS  
● RSGB PUBLICATIONS ●  
AND SO MUCH MORE

Instant HP Terms. Ask for details!



97 - Osbourne Road, North Camp  
Farnborough. Tel: 0252 518009  
Mon-Sat 10-6



# From Shed

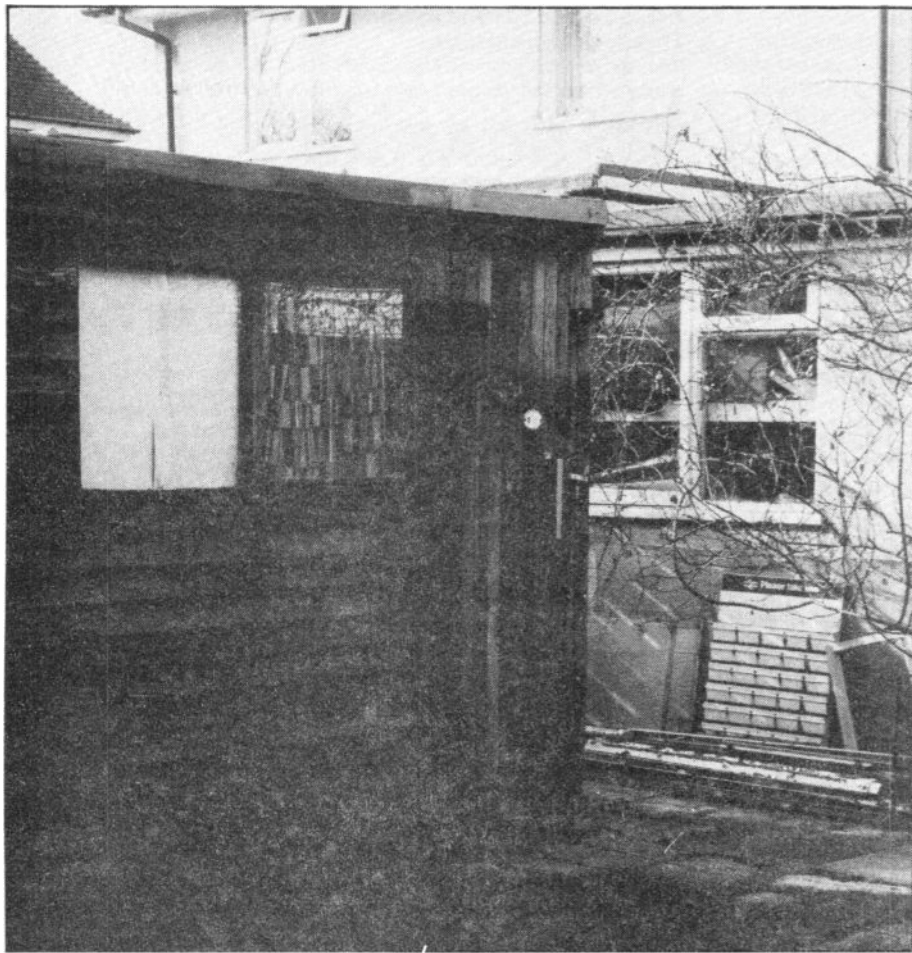

## to Shack

I sometimes wonder how many other budding radio enthusiasts or indeed people with a similar noisy hobby find themselves in the same predicament that I was in some time ago. The basic problem was

was never popular at the best of times, let alone at three in the morning when the HB9's were five and nine on 2m!

Frustrated at often not being able to make the most of good con-

---

***Does your nocturnal activity keep the family awake?  
Well, if these are radio related(!), Trevor Butler,  
G6LPZ, has some advice for you...***

---

that DX conditions often seemed to occur at the most unsociable of hours. Whether one is a parent afraid of waking the young family, or, as I was, living at home and frightened of disturbing the rest of the household, the fact still remains that DX conditions often seemed although trying to contact it will inevitably involve noise; my Creed 7B

ditions when they arose "out of hours", I searched for a solution. My first thoughts were of the roof-space, having heard in many a QSO that this allows for short feeder lengths if the antenna is mounted on the roof. My problem was that the loft was immediately above the main bedrooms!

Looking further afield, I spent

some time measuring the concrete garage. This seemed a distinct possibility, complete with power and lighting and (almost) waterproof. I couldn't, though, persuade the car owner in the household that his much loved and cared for vehicle would be just as happy parked in the driveway, because certainly there wasn't room for car and radio gear.

The whole subject was becoming a problem until, one morning, a handyman arrived to replace the felting in the potting-shed roof. This rather small, certainly dingy and very dirty structure (the shed, not the roofing man) lay at the bottom of the garden, full only with a selection of seed-trays during the planting season, at other times stuffed with odd garden tools which rarely saw daylight and some deck-chairs and three lawnmowers. Indeed, during the colder months icicles had been seen hanging from the inside of the roof. Hardly an ideal location to base one's radio operation and not a place to leave what amounted to about a thousand pounds worth of electronic equipment.

### First Steps

The odd-job-man departed and at least the roof should be weather-tight, I thought. If only I could lay on some electricity and ensure a warm and damp-free atmosphere, there was the remotest possibility that this would make a shack, and even perhaps a workshop for those home construction projects one is always trying to assemble on the kitchen table. I certainly couldn't afford to be sociable, though, for there would be room for only one person, due to the small nature of the hut.

Having cleared out all the old garden equipment, a thorough clean-out was called for and a new coat of wood preservative. Whilst looking through a Consumer Association publication to try and decide what sort of treatment to use, I came across a chapter on "outhouses". The book suggested that for insulation the walls of structures be lined with hardboard, with a layer of loft Fibreglass material sandwiched between this and the walls for even better results. Two layers of old, but clean carpet were recommended for the

floor, and all gaps and cracks in the walls should be sealed with a good filler. Another old dodge I discovered later is to use crumpled up newspaper between the wall and the hardboard but this apparently does encourage insects.

### Putting It Together

My most costly exercise was to run the mains supply out to my new "den". Having a friend, who's an electrician helped, for although he didn't actually do the work, I was able to ask him to check everything before the final connection to the mains was made, something which really should be done for safety's sake. He recommended mineral type cable for the run between the house and the shed, which is very expensive but hard wearing and suitable for long runs out-of-doors.

After first fitting a new distribution board in the shed, I then installed four double wall-sockets. These all have to be in metal boxes to comply with regulations (IEE 15th edition, usually known as 'the regs'), and of course this adds to the cost.

My first thoughts were to install a fluorescent tube type light fitting, but, remembering the amount of interference generated by my teleprinters alone and the fact that 'fluorescents' are reknowned for electrical noise, I went instead for three bulk-head lights, each with a

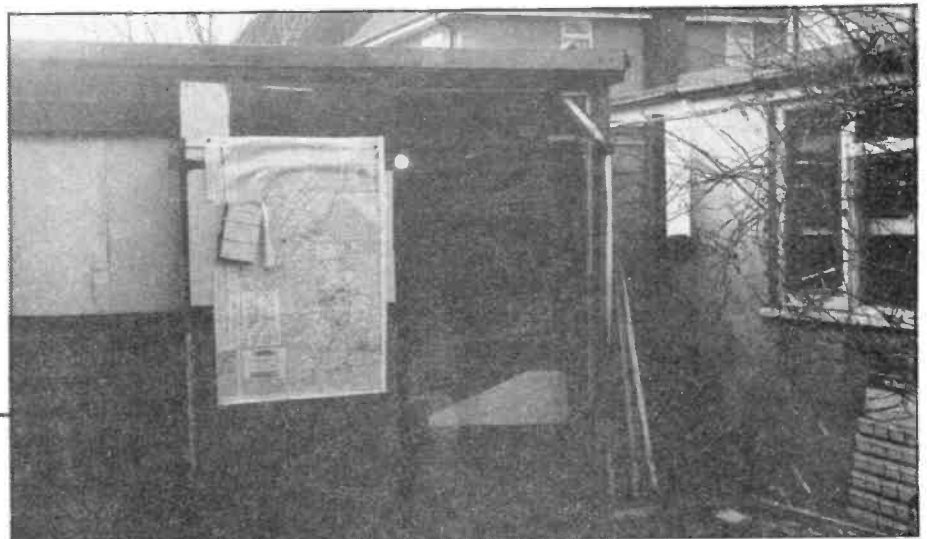
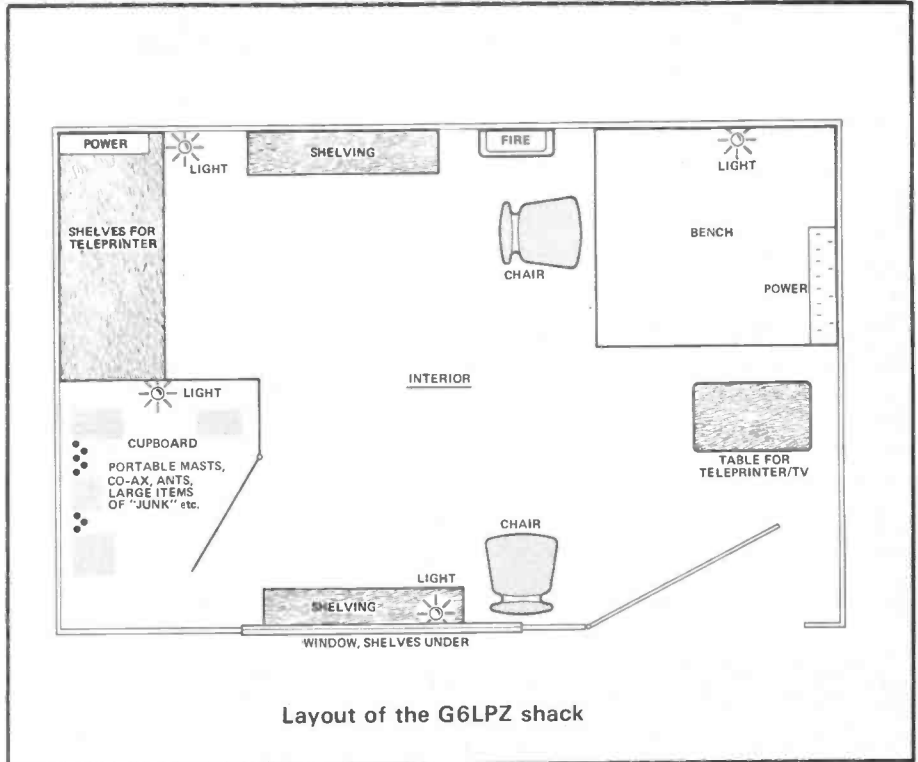

Entrance to shack with large scale map of Great Britain on door. Teleprinter table and one of the bulkhead lights can be glimpsed inside.



100 watt bulb, one of which was directly over where I intended to install a work-bench.

Now carpentry is not my strong point, indeed I failed my woodwork at school and prefer working with more durable substances like steel and aluminium. A visit to the local DIY was thus extremely valuable; the advice I gained there was certainly more than I had been able to extract from a nearby home-superstore establishment, even if their prices were lower, as they

claimed. I purchased a large amount of hardboard for the lining and some laminated chipboard for the bench and other hardwood for shelving (don't buy chipboard for this, it tends to bow badly under even moderate loading), together with brackets, screws and some wood-filler. These were actually delivered free of charge by the DIY shop.

Having settled this account, the project was becoming rather expensive, so I knuckled down and did all of the measuring, sawing and fixing myself, despite my dislike of woodworking. . . I put in

one main workbench and two made-to-measure for the teleprinters, and shelves just about everywhere else I could in order to accommodate all the 'junk' that we amateurs seem to accumulate (I was working on the premise that I would also probably acquire more as the years went on).

Strength was all-important, for I had seen other people's shelves in garages and outhouses bowing in the centre and in extreme cases, even from the wall altogether under the extreme weight to which they were subjected. I employed the strongest brackets I could find and

As can be seen, the G6LPZ operating space doubles as a workbench. The shelves are made from hardwood rather than chipboard, which tends to bow even under moderate loads. Note the surplus telephone used as an intercom.



Storage systems like the above can be either obtained from local hardware stores or brought as single drawer units and assembled to suit your own requirements from Maplin Electronics.

fixed them to the structural pillars of the shed. If you intend to line the shed walls before putting the shelf brackets up, be careful to mark the position of the supporting pillars on the lining so you can find them to put the brackets on. . . I didn't.

Some floor covering was essential if I was to prevent rising draughts, for I had a wooden floor. Anyone with a concrete floor would be advised to seal it from the damp with one of the proprietary sealants available. Try your DIY shop again.

I went in search of some carpet, old but not threadbare; I began by visiting jumble sales but, alas, all that was on offer was amounts to cover complete rooms and enough for my new shack three or four times over. My next sortie was more successful. A casual visit to a local and friendly carpet shop brought forth the promise from the staff to save me some odds and ends. Two weeks later I collected a number of useful sized pieces from their fitter and was able to patch these together to cover the floor. The pieces were of the foam-backed variety so I used a layer of old-fashioned under-felt for extra warmth. After all, it's no use spending pounds fitting up and heating the shack, only to find that half the heat is lost through lack of insulation and the place is uninhabitable in mid winter as well as costing a fortune to heat the rest of the time.

## Re-locating

Having made my home-from-home alternative operating area, I had to transfer my VHF/UHF antenna feeder cables. In my case, this was simply a matter of removing the feeders from a window-frame and re-trailing them from the mast in the garden. In fact I was able to reduce their length somewhat, which must be to the good of received and transmitted signals.

Deciding that the plain hard-board walls were certainly less than attractive and seemed to absorb most of the light emitted from the bulkhead lights, I fixed up some maps and charts and stuck up all but my most prized QSL cards, and the whole effect was quite cheerful. As is the nature of things, the eight power points proved to be insufficient and I ended up installing some multi-way trailing outlets, (Currys is a good and cheap source of these), and settled down to wait for the DX to arrive. Even with the teleprinters running and two rigs turned on, only a slight rumbling noise could be heard outside, although I think the neighbours are quite tolerant, for now I was nearer other dwellings, although certainly out of sound and sight of my own.

This isolation proved inconvenient, for I had no idea when I was required indoors — ie when to col-

**An advantage of having a shack in a garden shed is that masts with VHF/UHF antennas may be erected nearby and conveniently rotated by hand.**

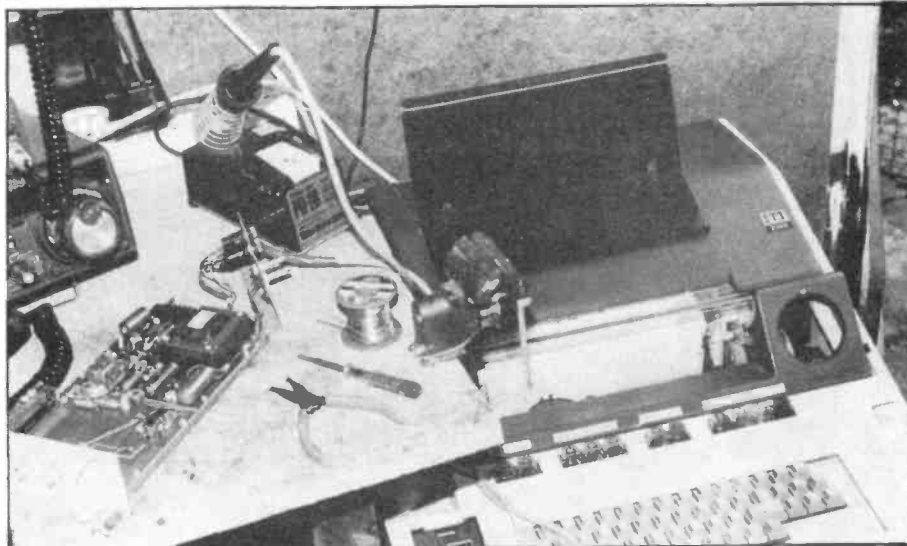

**Remember if you are building workbenches to consider carefully what height you require them. Unless a chair of variable height, such as a typist's chair, is available, this is essential to ensure comfortable operation and particularly important in the case of RTTY and CW.**



**A large amount of space for cables, masts and general junk is essential, preferable in the shape of a cupboard as in the case of G6LPZ's shack.**

lect meals, etc. The solution was to run an intercom to the kitchen. An old 'baby alarm' could be used for this. Now that BT have lost their monopoly on secondary instruments, though, I may run a telephone out as well. (*Not permitted on domestic premises. Ed.*)

## Taking Out Insurance

Another hazard that the seclusion brought was the security risk, something that my insurance company was not happy with. Two seven-lever padlocks were required to make them content, and as an added precaution I fixed a door magnet switch with a buzzer and hung a large bell, previously acquired at a local junk sale for fifty

pence, on the exterior of the shed.

All in all, the project was both successful and undoubtably cheaper than my earlier idea of a loft-space conversion, which would have required flooring, power and lighting, and some sort of loft ladder. I would recommend anyone thinking of 'moving out' to utilize the garden shed, although to actually buy a structure from new would probably make the cost four-fold.

After all this effort, I have recently moved into a self-contained flat in West London with little provision for antennas... although I'm working on it. There's a flat roof outside my kitchen window; now I wonder if I could stand a shed on it...

# The Multimate



# Keyer

It could be argued that the most efficient morse code keyer is a keyboard sender, since any character may be sent by a *single* key stroke compared to as many as 4 for some characters on some

issue and that for a *single* keyer unit to achieve universal acclaim, this would require both a double paddle unit *and* a keyboard!

The keyboard presented here, however, is more than just a

***Ideal for club or individual use, the Multimate is a combined Iambic keyer with programmable memories — suitable for meteor scatter to contest working — keyboard sender and morse tutor, with built-in checking facilities to boot. In short, the Multimate is the ultimate in CW flexibility. Design by Mike Bedford, G4AEE.***

other types of automatic keyer. Although the recent increase in popularity of keyboard senders goes some way to supporting this point of view, it is significant that the 'squeeze' keyer still remains the most popular type of morse sender within amateur circles. Admittedly financial considerations play a part in restricting the use of keyboard senders, but it also has to be said that many amateurs prefer to use double paddled keyers. It is therefore clear that the choice of a keyer is very much of a subjective

keyboard sender and a squeeze keyer, with memory facilities, sharing common electronics. The 'Multimate' is a piece of equipment in which these two devices can be used *in conjunction* with each other. For example, a user who prefers to use a conventional squeeze keyer may well find it preferable to use a keyboard for programming up memories. It is envisaged that such a keyer will be especially attractive in a club environment, in contest operation, where it is likely to be used by a

number of people with different keying preferences, and in the Multimate's additional role as a morse tutor. To further allow its customisation to individual requirements, various characteristics may be altered from the keyboard. For example, as an alternative to iambic operation, the key may be configured for semi-automatic or 'bug-key' operation and, additionally, auto inter-character spacing may be turned on or off. When in the 'tutor' mode, either 12 groups of 5 figures or 20 groups of 5 letters may be sent at random, and subsequently either repeated or checked.

The keyer is based on a minimally populated and slightly modified Microtanic Computer Systems single board controller using a 6809 processor. Since this card is available as a bare PCB and thus populated as required, this can result in a very attractively priced unit. Despite the impressive specification, the Multimate may

Fig.1 Modifications to Microtanic PCB to enable 6821s to be used in place of 6522s.

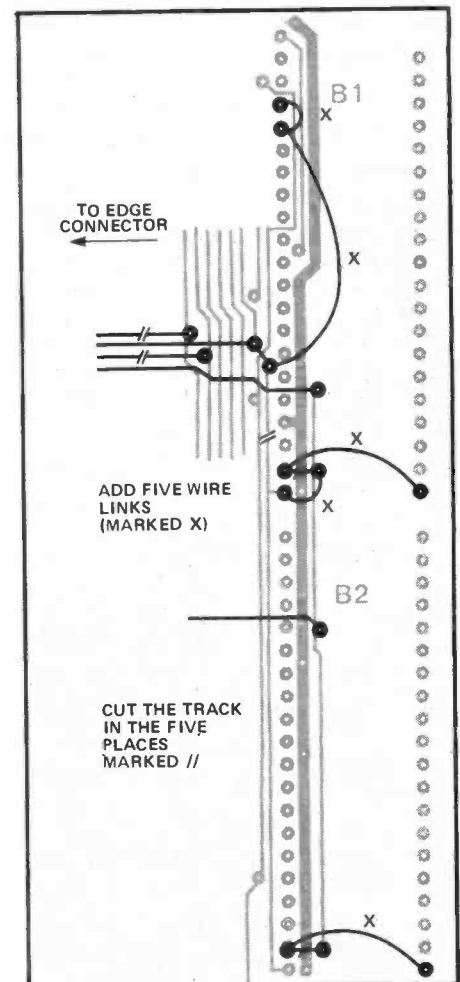

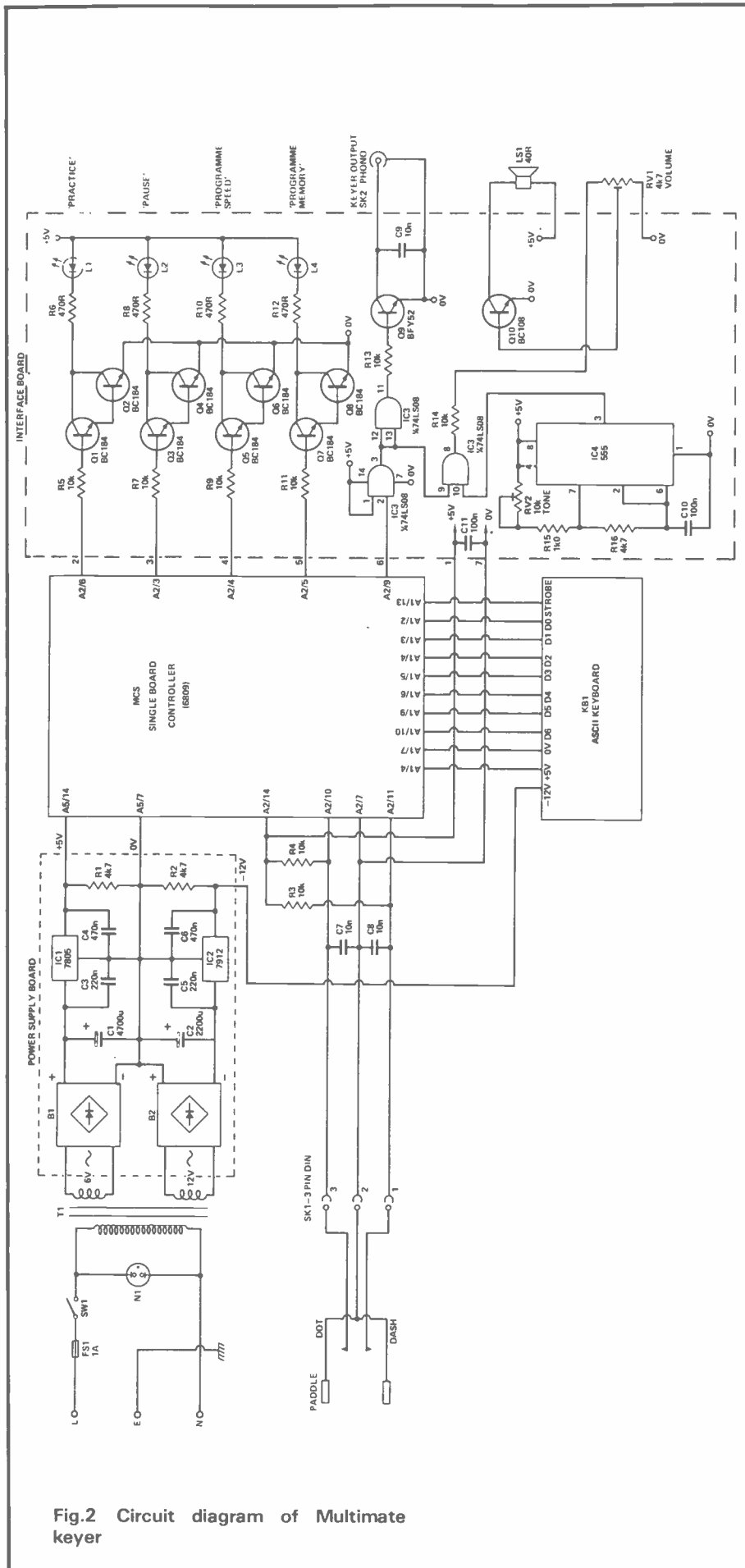

Fig.2 Circuit diagram of Multimate keyer

be constructed for a cost comparable to that of a commercially available squeeze keyer with memories.

### Construction

As mentioned previously, the controller board used in this project is a stripped down and slightly modified version of the Microtanic Computer Systems single board controller. The first task in constructing this board is therefore to carry out the few modifications to the actual PCB which are needed to enable the replacement of the 6522s with cheaper 6821s. This modification consists of making 5 cuts to PCB tracks and making 5 wire links as illustrated in Fig.1. This being complete, the board can now be built up using only those components specified in the parts list and thus leaving a number of unfilled positions on the board.

It is suggested that DIL type sockets are used for the 6809, 6821, RAM and 2716. DIL sockets will also require fitting in positions A1, A2 and A5, the first two for making connections to the PIAs and A5 for connecting the power supply.

The address buffers E2 and E3 are replaced by wire links as shown in Fig.3 and the memory mapping PROM (N3) is replaced by the configuration shown in Fig.4, which can be wired to a DIL header (dummy plug) and plugged into the socket. The standard controller board options are link selectable and the following link configurations are required for this application: LK1-A, LK2-A, LK4, LK7, LK9, LK13, LK15 x to b, LK18 x to c, LK20, LK21-A, LK22-A, LK24-A, LK25. If a pre-programmed EPROM is not used, the 'hex dump' given in Table 1 will require entering into an EPROM programmer (subject to changing the individual requirements of callsign and default speed) and (then) programmed into a 2716. The would-be programmer is warned that typing in long hex dumps is very prone to errors, and even assuming 99% accuracy on each hex digit, the 2K program would contain 40 errors! Readers may be comforted to know that a pre-programmed E-PROM with your callsign and chosen 'default' speed is available from the author (see Buylines).

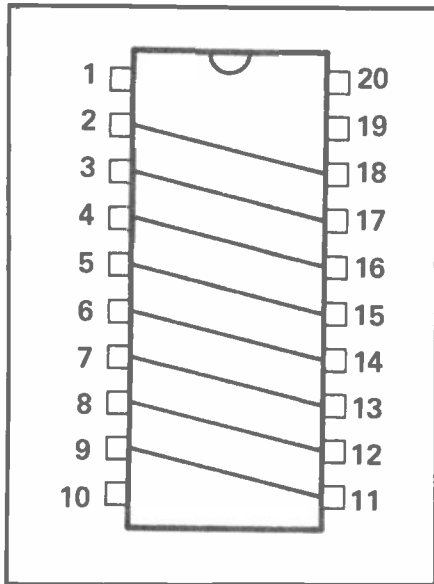

Fig.3 Wire link replacement for E2 and E3 - wire to 20 pin DIL 'headers'.

The interface board has been designed as a single sided PCB for which the artwork is given. Alternatively this could be built up on a piece of Vero-board, in which case care should be taken to ensure that the LEDs are spaced at .75", the spacing between keyboard keys, necessary to ensure that the LEDs line up with the appropriate keys. Apart from this comment, no special instructions are required to produce the interface board. The PCB foil and component overlay are shown nearby in Fig.5.

The circuit given has an 'open collector' NPN output transistor, meaning that it can key transmitters with a positive keying voltage. The transistor specified will cope with voltages up to 20V and a switching current of up to 1A, adequate for most modern transmitters. For those cases with a greater voltage or current is required, a different transistor with a similar gain may be used. If it is required to key a transmitter with a -ve voltage, a further PNP transistor may be

driven via a resistor from the standard keyer output.

The power supply with the exception of the transformer, mains switch, neon and fuse is also built up on a small single sided PCB, a foil pattern for which is given. Once again Vero-board can be used if preferred. The transformer is bolted to the base of the case, the mains switch and neon to the top surface and the mains fuse to the rear panel. The PCB artwork and component overlay are shown in Fig.6.

### Customising The Keyboard

Since the keyboard is dedicated to the morse keyer, unlike the situation of running a program on a home computer, the keyboard can be customised to this application. The special function keys on the top row, ie shifted 1,2,3 etc can be labelled on the top surface of the case immediately above these keys. In those cases where a LED indicates the mode, the labelling also applies to the LED.

For the other function keys eg speed up/down, CQ, DE etc it is suggested that the keys in question are re-labelled. This can be achieved by respraying and then applying new legends, either by engraving or 'letraset', followed by a coat of clear varnish. Rather than attempt to match the colours of the other keys, it is probably preferable to use a completely different colour for these special function keys. For the Q-codes, which are generated by control keys, it is suggested that the codes are labelled on the front surfaces of the keys in question.

Fig.1, the circuit diagram, identifies the interconnections required between the various modules and Fig.7, together with the various photographs, illustrate the mechanical construction. It is

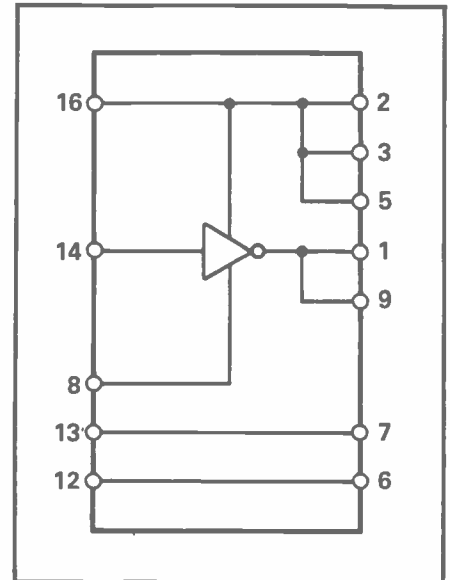

Fig.4 Replacement for N3 - wire to a 16 pin DIL 'header'

suggested that ribbon cable is used for the inter board connections and signal connections are made to the processor board by use of DIL headers (dummy plugs) plugged into the appropriate DIL sockets.

It may be seen from the circuit diagram that a few components are not fitted onto the various circuit boards. Some of these are connected with the power supply and have already been mentioned. The remaining such components are R3, R4, C7 and C8, these four all being wired onto the DIL header which plugs into socket A2 in the processor card.

### Mechanical Matters

As regards the mechanical construction, a few points are worth bearing in mind. If the suggested instrument case is used, the only mechanical work which needs carrying out is to make a cutout for the keyboard, holes for the LEDs, mains neon and switch and a few small holes for the speaker in the lid

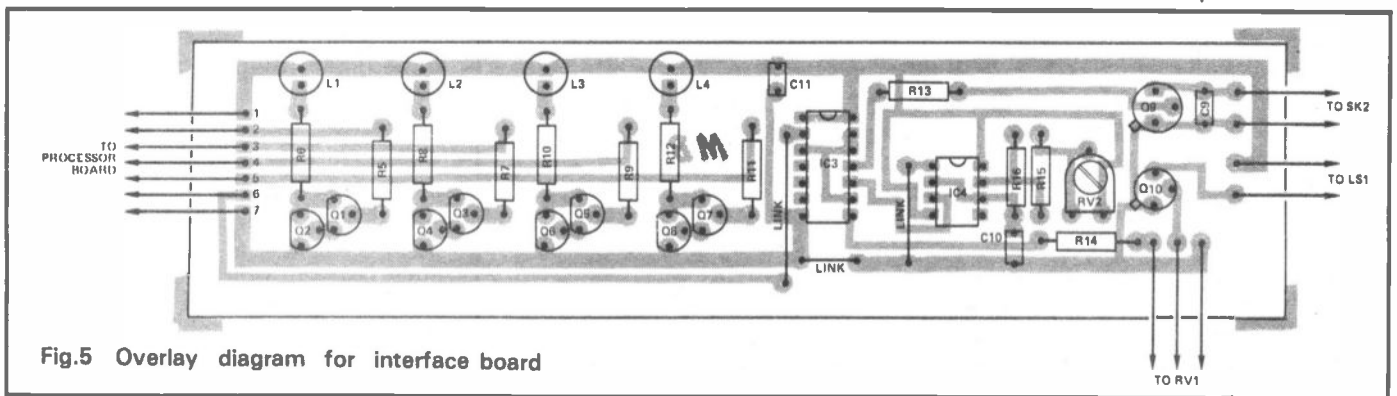

Fig.5 Overlay diagram for interface board



## Basic Hardware

The design is built around a Microtanic Computer Systems Ltd single board controller. This is a processor board intended as the heart of a Tangerine computer system, which may be configured to use either the 6502 or 6809 processors. Whereas a fully populated board would provide much more comprehensive facilities than are required for a morse keyer and the price would be prohibitive, using a bare PCB and populating as required provides a very effective solution to this project.

A recent article by the author in *Electronics Today International* describes the single board controller in detail and outlines a number of modifications which can be made to get rid of some of the more expensive components, which are not required in control applications. These modifications in-

clude a). Simplifying the memory map by replacing the mapping PROM by wire links and a single inverter wired to a DIL header. b). Replacing the 6522 VIAs by the less expensive 6821 PIAs (these are 'peripheral interface adaptors'(!) and provide selective buffering for the microprocessor inputs and outputs). c). Linking across the address buffers which are not required in our 'minimal' system and d). Omitting those components connected with the RS232 port and cassette interface. The board as configured for this project uses the 6809 processor running at 1 MHz, 1 6821 PIA providing interface for the keyboard, paddle, LEDs, sidetone and keying circuitry, 2K bytes of RAM and a 2716 EPROM.

The remainder of the keyer consists of an interface board, a power supply and a keyboard.

The interface board consists of 4 'darlington' drivers, which are driven from one of the PIA ports, and drives 4 LEDs indicating

keyer status, an oscillator and amplifier for sidetone and the keying circuit which has been made 'solid state' to avoid all the problems associated with keying relays, such as noise, arcing etc.

The power supply is of a standard design and provides +5V and -12V. The -12V supply is required on some types of keyboard but if a +5V only keyboard is used, the -12V part of the power supply circuit may be omitted.

No design is given here for a keyboard but the requirements are not particularly critical and suitable keyboards are available at a modest cost from various sources. The keyboard should provide 7-bit parallel data with a positive going strobe, all signal levels being TTL.

### References

1. Single Board Controller; Mike Bedford; *Electronics Today International*, March '85, p.35.

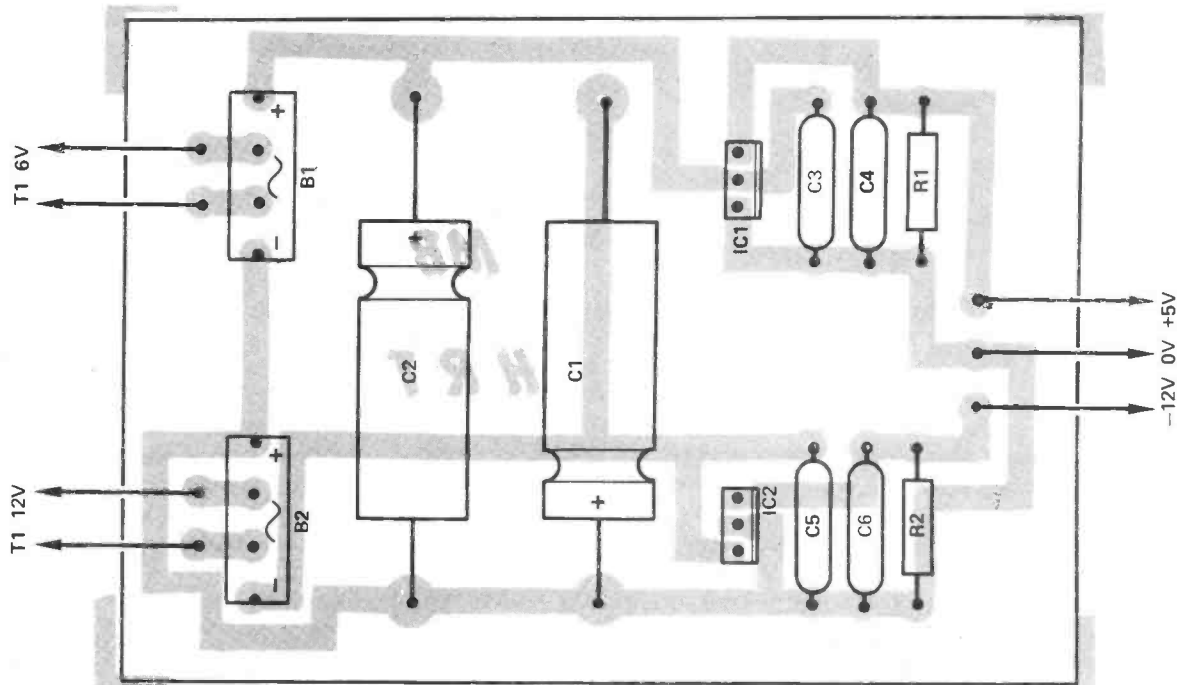

Fig.6 Overlay diagram of power supply board

in addition to those holes clearly identified in the mechanical drawing. The processor board and power supply boards are mounted flat in the case and, accordingly, stand off insulators will be required for their mounting.

The keyboard is mounted above the processor board and long bolts, or pillars, will be required to raise it to the height required for the keys to protrude through the cut-out in the lid. The mounting method will clearly depend on the physical characteristics of the particular keyboard used, but I suggested that more than 4 fixing screws are used, or, alternatively, some other means of support is used to prevent

it bending under the pressure of use.

The easiest way to mount the interface board is to bolt it to the keyboard as shown in Fig.7. This will ensure that the LEDs will line up with the holes in the lid when the keyboard is in position. If this approach is adopted, care should be taken to ensure that bolt holes do not damage tracks on the keyboard.

## Operating The Multimite

On first switching on the multi-keyer, it can be used from either a keyboard or a double padded 'key'. When operating from the paddle

key, the initial conditions will include iambic operation with auto inter-character spacing turned on. The built-in sidetone oscillator will also be (and is always) active. Since a rear panel volume control is provided, this can be turned down to zero if the facility is not required.

Turning to the keyboard, the letter A-Z, figures 0-9 and various punctuations (!/? ) all give the expected results and letters may be entered either as upper case or lower case. In order to give the correct inter-character spacing, the keyboard input is buffered as it is entered, which means that the actual morse being sent may be ac-

tually keyed a few seconds earlier. This buffering necessitates the use of the space bar, which increases the inter-character space to an inter-word space.

Buffering can potentially be a problem in that stopping keying does not necessarily cause the keyer to stop sending. Two keys are available to help overcome this. The pause key will cause the keyer to suspend output of characters, whereas subsequently pressing any standard key will cause keying from the buffer to be resumed. Pause mode is indicated by the LED situated above the pause key. It should also be noted that the keyer goes into 'pause mode' whenever the paddles are operated, thereby allowing the operator to break-in on the buffered keying. If the operator wishes to not only suspend buffered keying, but also clear out the buffer, then the DELETE key may be used.

A number of keys are provided to allow commonly used words or special morse characters to be sent by a single key depression. The special characters are as follows and the keys used to send them are listed in Table 1: (.....), (-.-.-), (-.-.-) and (...-.-). The keys in the category of commonly used words are CQ, DE, Callsign and CQ call. The CQ call key causes a message of the following form to be sent: CQ CQ CQ DE Callsign Callsign. If the recommendation of re-labelling various keys with their specific functions is adhered to, clearly the use of these keys does not involve remembering key positions.

A further category of commonly used words is the Q-codes. All the commonly used codes are

**Inside the Multimater**



0 - 9	FIGURES		
A - Z	LETTERS		
.	...		
^ or /	...		
:	...		
/ or	.....		
-	...		
/	...		
?	...		
!	MEMORY 1		
-	MEMORY 2		
E	MEMORY 3		
S	MEMORY 4		
%	CALLSIGN		
Et	PROGRAMME MEMORY		
'	PROGRAMME SPEED		
(	PAUSE		
)	PRACTICE MODE		
.	CQ CALL		
DELETE	CLEAR BUFFER		
	CQ		
	DE		
@ or .	TUNE		
ESC A	AUTOMATIC (IAMBIC) MODE		
ESC B	BUG (SEMI-AUTOMATIC) MODE		
ESC C	AUTO INTER CHARACTER SPACING ON		
ESC D	AUTO INTER CHARACTER SPACING OFF		
ESC M	METEOR SCATTER MODE ON		
ESC N	METEOR SCATTER MODE OFF		
CTRL A	QSA	CTRL Q	QRQ
CTRL B	QSB	CTRL R	QRR
CTRL C	QSD	CTRL S	QRS
CTRL G	QSG	CTRL T	QRT
CTRL H	QTH	CTRL U	QRU
CTRL I	QRI	CTRL V	QRV
CTRL K	QRK	CTRL W	QRW
CTRL L	QSL	CTRL X	QRX
CTRL M	QRM	CTRL Y	QSY
CTRL N	QRN	CTRL Z	QRZ
CTRL O	QSO	CTRL /	QRO
CTRL P	QSP	CTRL _	QRP

**Table 1 Summary of keyboard commands**

available as single key depressions. If the subset of Q-codes commonly used on amateur circles is analysed, with a couple of exceptions they have unique final letters. In other words, if QRZ is in general use then neither of the other two possibilities (ie QSZ and QTZ) are commonly encountered. This being the case, (almost) any Q-code is generated by pressing the key for its last letter in conjunction with the CTRL key. The two exceptions are O and P as QSO/QRO and QSP/QRP are all in common use. In this case CTRL O and CTRL P generated QSO and QSP respectively, whereas

QRO and QRP are generated by CTRL / and CTRL \_ respectively.

The callsign mentioned under the CQ call is in fact a special case of the programmable memories of which the keyer has 5. Memories 1-4 each allow a string of 126 characters, whereas the callsign memory has a capacity of 15 characters. Unlike the others, this latter memory is initialised to a default value at switch-on.

Pressing the program memory key initiates 'program memory mode', which is indicated by the LED above this key. The 2nd key to be pressed should be one of the keys 1-5 (5 being 'callsign') to indicate the memory to be programmed. Following this, the required message up to the maximum length for the particular memory should be entered, terminating with program memory again. In addition to letters and figures, memories may be programmed to include all the special characters, words, Q-codes etc. and even other memories — although it would not normally be required(!), it is quite feasible for a memory to include itself, or to include a second memory which in turn includes the first. Cases such as these would clearly cause the memory to loop forever. Since this is undesirable, the keyer is able to detect this situation and stop sending once it has looped for 30 or so times. Memory programming is not buffered but takes place immediately.

The keyer automatically sets itself to a particular speed when switched on (referred to as the 'default' speed), but various means are available for varying this speed. As for memory programming, all speed change command are executed immediately rather than being buffered. Program speed mode is entered by pressing the 'programme speed' key and is indicated by the LED above this key. Once in this mode, 1 or 2 figures representing the speed in wpm should be entered, terminating with programme speed again. For small changes in speed, the 'speed up' and 'speed down' keys may be used for decreasing or increasing the speed by 1 wpm per depression. When shifted, these keys have a similar effect but in steps of 5 wpm. It should be noted that this speed is common to keying with either the keyboard or the paddles.

## Buylines

The processor board is available as a bare PCB from Microtanic Computer Systems Ltd at 102, Lordship Lane, Dulwich, LONDON SE22. The components for the single board controller, interface and power supply boards are readily available from any major component supplier. If problems are encountered with the mains transformer, two separate transformers may be used to give the 6V and 12V. Alternatively, with care, it is possible to modify the secondary wings of a transformer to customise it to the requirements.

The keyboard should be readily available. Prices for this component will vary very much from one source to another so it

is worthwhile shopping around. Surplus keyboards are often available at rallies but the potential builder is encouraged to ensure that it is an *ASCII encoded version with a TTL level parallel output*. The strobe should be positive going but, by the addition of a single TTL inverter, use could be made of a keyboard with a negative going pulse.

A suitable and reasonably priced case was obtained from Cirkit Holdings PLC, (0992 444111) where it is referred to as the SX2 case. The firmware may either be programmed into a 2716 EPROM from the hex dump given or alternatively a pre-programmed EPROM may be obtained from the author at 19, Selborne Grove, Keighley, West Yorks BD21 1HP at a cost of £8.50 including recorded delivery (please state callsign and 'default' speed required).

## Mode Selection

Some further functions are available as 'escape' sequences. These are mode changing commands, and since mode changing is carried out relatively infrequently, it was not considered that the use of 2 characters would be too inconvenient. Escape sequences consist of the ESCAPE key followed by one other letter. For example, semi-automatic or 'bug-key' operation is selected by ESC B and cancelled in favour of iambic operation by ESC A. You should note that when in iambic operation, the keyer brings into play dot and dash memories, both of which are edge triggered, hence avoiding sending extra dots

or dashes at the end of a squeeze operation.

ESC C turns on auto inter-character spacing for paddle keying, whereas ESC D turns this feature off. ESC M selects 'meteor scatter mode' in which the speed is increased to about 250 wpm.

Although direct keyboard entry and the squeeze key are not prohibited in meteor mode, they are clearly of little use and the mode will normally be used in conjunction with the programmable memory facility. In this mode, the increase/decrease speed keys have no effect, nor can programme speed mode be entered. ESC N turns off meteor mode, restoring the previously selected speed.

Pressing the tune key short circuits the keyer output to provide a 'tune' function for use on transmitters without this facility. Depressing the key again open circuits the keyer output. It should be noted that the above function also puts the keyer into pause mode.

It should be pointed out that the keyer is to some extent 'multi-tasking' or in other words, *more than one operation may be carried out at the same time*. For example, if the keyer is sending from the buffer or a memory (hence not requiring keyboard depressions) or is being used as a squeeze keyer, other operations can be carried out *in parallel* from the keyboard. In the case of the latter, this would of course necessitate an extra pair of hands. Such operations include speed changing, programming memories or mode changing by escape sequence.

## Using As A Tutor

Turning from using the unit as a keyer to its use as a morse tutor, this mode is selected by pressing the 'practice' key. Practice mode is indicated by the LED situated above this key. Once the mode has been selected, a key should be pressed to indicate the type of practice required. Pressing any let-

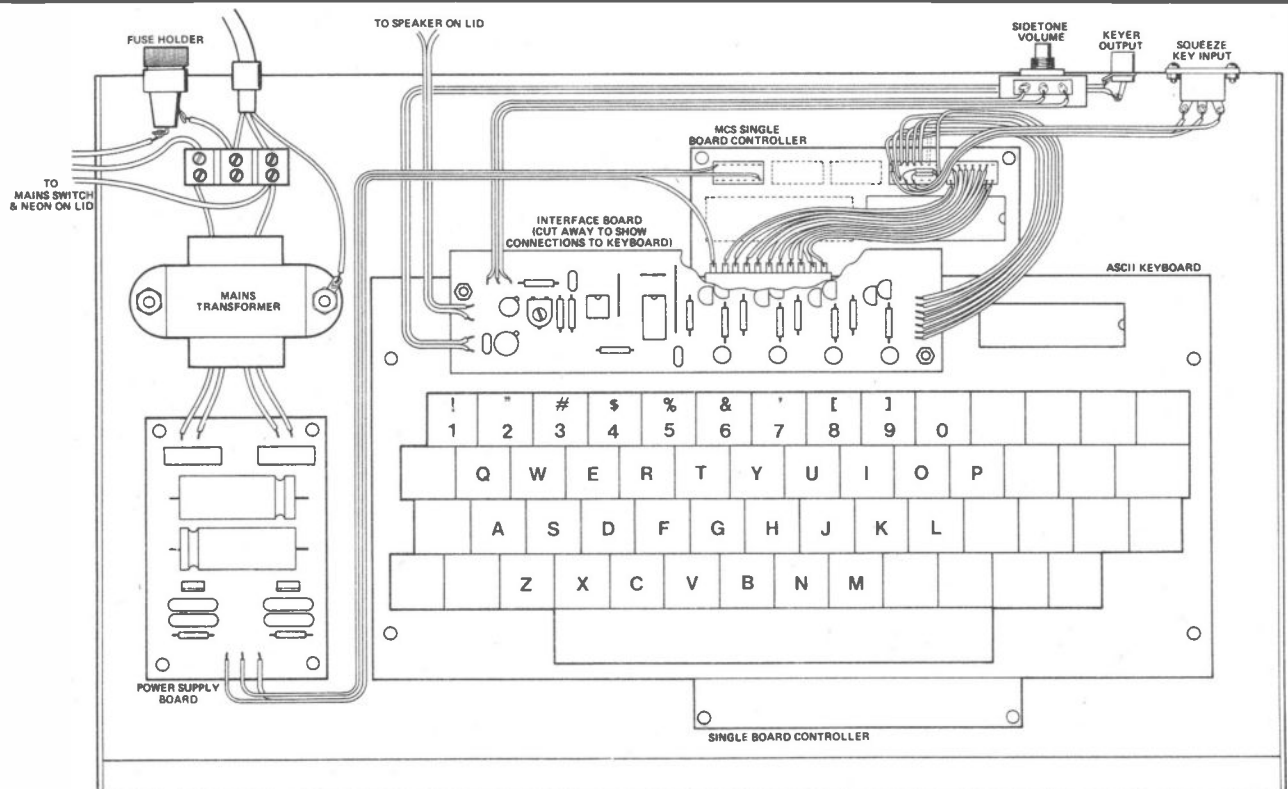
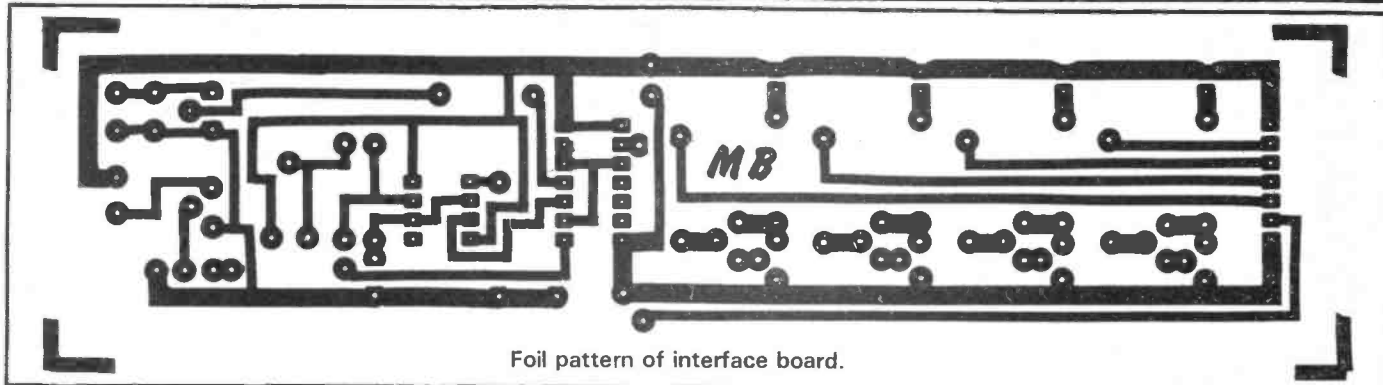

Fig.7 Mechanical layout of Multimater keyer



Foil pattern of interface board.

ter key will cause 20 5 letter groups to be sent, whereas pressing any figure key will cause 12 5 figure groups to be sent. There will be a short delay from pressing this key to the actual start of the sending.

During the sending of these groups, the speed may be increased or decreased, as described earlier for keying. Once the groups have been sent, a number of options are available. Pressing a further letter or figure will cause more groups to be sent, but it should be noted that even if letters or numbers are requested twice in succession, *different* random groups will be generated in both cases. Pressing the RETURN key, however, will cause the previously sent series of groups to be repeated.

Pressing the ? key will put the keyer into a checking mode. In check mode, the keyer will send the K character, after which the

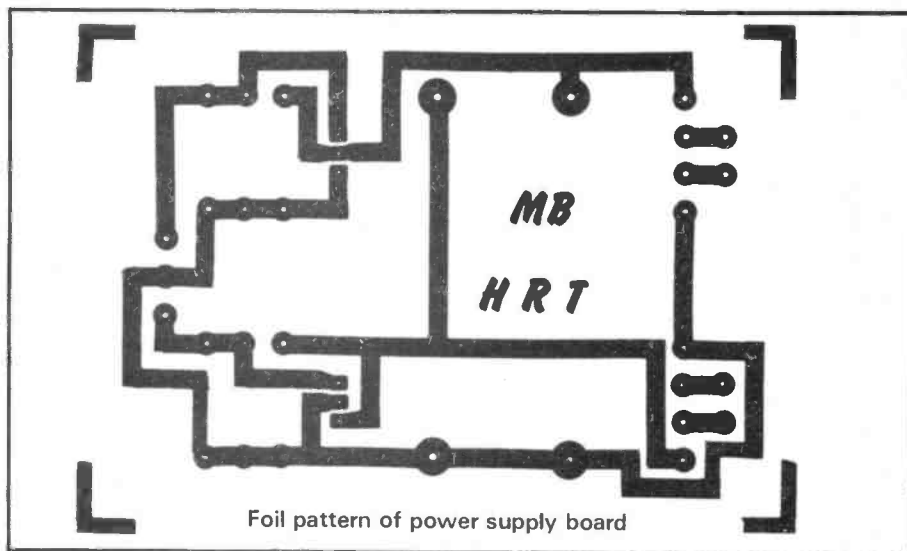

Foil pattern of power supply board

characters actually received during the previous practice session should be entered by the pupil. If the character is correct, a single short beep will be 'echoed' whereas three short beeps would result from entering a wrong character. After all the characters

have been checked, the keyer will send a R and the check mode will be automatically terminated. Practice mode is terminated by pressing the practice key a second time — as long as the keyer is not in the middle of sending or checking a set of groups.

### Components Listing

#### RESISTORS

R1,2,16	4 k7
R3,4,5,7,9,11,13,14	10k
R6,8,10,12	470R
R15	1k
RV1	4K7 log panel mounting
RV2	10K lin PCB mount min. horiz preset
All resistors 0.125W 5% carbon film	

#### CAPACITORS

C1	4700u 10V axial electro
C2	2200u 25V axial electro
C3,5	220n ceramic
C4,6	470n ceramic
C7,8,9	10n ceramic
C10,11	100n ceramic

#### SEMICONDUCTORS

B1,2	1 A bridge rectifier
IC1	7805 1A
IC2	7912 1A
Q1,2,3,4,5,6,7,8	BC184
Q9	BFY52
Q10	BC108
L1,2,3,4	standard red LEDs

#### MISCELLANEOUS

T1	6VA mains transformer 6V, 12V
----	-------------------------------

F1	1A fuse in panel mounting holder
SW1	mains switch
N1	mains neon
SK1	3 pin DIN socket
SK2	2 pin phono socket
LS1	35R min. louspeaker

PCBs for power supply and interface boards; ASCII encoded parallel keyboard with +ve strobe; instrument case (eg SX2 from Cirkit Holdings); 3-way terminal block; wire for PCB interconnections and cable ties etc.

#### MCS SINGLE BOARD CONTROLLER (WITH SLIGHT TRACK MODS AS DESCRIBED IN TEXT) POPULATED AS FOLLOWS:

#### RESISTORS

R5,11,12,14	4 k7
R13	470R
RP1	4 k7 SIL pack (7 commoned)
RP3	1 k0 SIL pack (4 separate resistors)
RP4	1 k0 SIL pack (7 commoned)

#### CAPACITORS

C1,7-14	100n ceramic
C2,15	10n ceramic

C3	100p
C5	100u electrolytic

#### DISCRETE SEMICONDUCTORS

D2,3	1N4001
Xtal 1	8.0 MHz

#### INTEGRATED CIRCUITS

B1	6821
C1	74LS393
C2	74LS04
D2	6809
F3	74LS139
G3	74LS00
H3	74LS266
J3	74LS12
K3	74LS10
L3	74LS08
M3	74LS138
K1	2k static RAM (eg 6116, 2016)
L1	2716 with firmware

#### MISCELLANEOUS

N3	PROM replacement wired on DIL 'header' as described in text
E2,E3	Wire links on DIL 'header' as described in text
A1,A2,A5	14 pin DIL sockets

```

0000 F6 1F C0 C4 7F C1 60 2D 02 CO 20 F7 C4 37 7D C4
0010 35 26 55 7D C3 16 27 05 17 00 EA 20 4B 7D C3 15
0020 24 07 17 02 24 20 41 7D C3 18 27 05 17 02 AD 20
0030 37 7D C3 1B 27 05 17 00 5B 20 2D 8E F8 6B 6D 84
0040 2B 0F E1 80 26 07 AE 84 17 05 2F 20 1B 30 02 20
0050 ED 1F 98 8E C3 23 F6 C4 23 3A A7 84 7C A4 23 7C
0060 C4 25 7F C3 22 7F C3 17 1C EF 3B 1B F8 8D 26 FA
0070 34 27 F8 EB 28 F9 E6 29 FA C4 40 FA B7 5F F9 EA
0080 3E F9 FA 2E FA 01 3C FA 17 2C FA 1E FF 7F C3 1B
0090 73 C3 1B 39 8E F8 AE 6D 84 2B OF E1 80 26 07 AE
00A0 84 17 04 D6 20 04 30 02 20 ED 7F C3 1B 39 41 F8
00B0 C1 42 F8 C5 43 F8 DO 44 F8 CC 4D F8 DE 4E F8 D7
00C0 FF 7F C3 1C 39 7F C3 1C 73 C3 1C 39 7F C3 1D 39
00D0 7F C3 1D 7C C3 1D 39 7F C4 39 17 00 63 39 7F C4
00E0 39 73 C4 39 CC 00 32 17 00 61 39 7D C4 39 26 14
00F0 F6 1F C8 CA 04 F7 1F C8 7F C3 16 73 C3 16 7F C4
0100 2D 7F C4 2E 39 C1 27 27 15 C1 30 2D 27 C1 39 2E
0110 23 C0 30 B6 C4 2E B7 C4 2D F7 C4 2E 20 21 B6 C4
0120 2D C6 OA 3D FB C4 2E C1 01 2D 14 C1 46 2E 10 F7
0130 C4 26 8D OC F6 1F C8 C4 FB F7 1F C8 7F C3 16 39
0140 F6 C4 26 5A 8E F9 5A 3A 3A EC 84 FD C4 27 58 49
0150 FD C4 29 F3 C4 27 FD C4 2B 39 31 88 18 C4 10 84
0160 OC 62 09 E8 08 42 07 14 06 2C 05 81 04 F4 04 82
0170 04 21 03 D0 03 8C 03 4D 03 19 02 EA 02 C1 02 9C
0180 02 7A 02 5C 02 40 02 27 02 10 01 FB 01 E8 01 D6
0190 01 C5 01 B6 01 A7 01 98 01 8C 01 81 01 75 01 6A
01A0 01 61 01 57 01 4E 01 45 01 3D 01 35 01 2E 01 27
01B0 01 20 01 19 01 14 01 0E 01 09 01 03 00 FE 00 F9
01C0 00 F4 00 F0 00 EB 00 E7 00 E2 00 DF 00 DA 00 D7
01D0 00 D3 00 D0 00 CC 00 CA 00 C6 00 C3 00 C0 00 BD
01E0 00 BA 00 B8 00 B5 73 C3 17 39 7F C4 25 7F C4 23
01F0 7F C4 24 7F C3 22 73 C3 22 39 B6 C4 26 8B 05 20
0200 04 B6 C4 26 4C 7D C4 39 26 OC 81 46 2F 02 86 46
0210 B7 C4 26 17 FF 2A 39 B6 C4 26 80 05 20 04 B6 C4
0220 26 4A 7D C4 39 26 OC 81 01 2C 02 86 01 B7 C4 26
0230 17 FF OD 39 F6 1F C8 CA 08 F7 1F C8 7F C3 15 73
0240 C3 15 7F C1 01 73 C1 01 39 B6 C1 01 81 FF 26 2C
0250 C1 31 2D 04 C0 31 20 04 CQ 21 2D 4F C1 05 2E 4B
0260 7F C1 01 C1 05 27 OD 86 80 3D 8E C1 05 30 8B BF
0270 C1 02 20 42 8E C3 05 BF C1 02 20 3A C1 26 27 23
0280 1F 98 F6 C1 01 BE C1 02 3A A7 84 7C C1 01 F6 C1
0290 01 BE C1 02 8C C3 05 27 06 C1 7F 26 19 20 04 C1
02A0 0F 26 13 BE C1 02 F6 C1 01 E7 1F F6 1F C8 C4 F7
02B0 F7 1F C8 7F C3 15 39 73 C3 17 27 04 17 02 2D 39
02C0 17 02 36 39 7F C3 19 7F C4 36 7F C4 35 7F C3 18
02D0 73 C3 18 F6 1F C8 CA 10 F7 1F C8 39 C1 27 10 27
02E0 FE 09 C1 3E 10 27 FF 12 C1 2E 10 27 FF 13 C1 3C
02F0 10 27 FF 23 C1 2C 10 27 FF 24 7D C3 19 26 55 C1
0300 29 26 OD 7F C3 18 F6 1F C8 C4 EF F7 1F C8 20 44
0310 C1 3F 26 13 7D C4 36 27 3B 7F C4 35 73 C4 35 FC
0320 C4 31 FD C4 2F 20 2D C1 OD 26 08 FC C4 31 FD C4
0330 2F 20 1B C1 30 2D 1D C1 39 2E 08 7F C3 1A 73 C3
0340 1A 20 OB C1 41 2D OD C1 5A 2E 09 7F C3 1A 7F C3
0350 19 73 C3 19 39 10 CE C1 00 7F C4 25 7F C4 23 7F
0360 C4 24 7F 1F C4 7F 1F C0 86 07 B7 1F C4 7F 1F CC
0370 86 3F B7 1F C8 86 04 B7 1F CC 86 C0 B7 1F C8 7F
0380 C3 15 7F C3 16 7F C3 17 7F C3 18 7F C3 1C 7F C4
0390 39 7F C3 1B 7F C3 1D 73 C3 1D 7F C3 1E 7F C3 1F
03A0 B6 FF 8D B7 C4 26 17 FD 97 7F C1 04 7F C1 84 7F
03B0 C2 04 7F C2 84 8E FF 8E 10 8E C3 05 4F E6 80 E7
03C0 A0 4C C1 04 26 F7 4A B7 C3 04 1C EF 7F C4 34 73
03D0 C4 34 17 00 85 17 01 48 7C C4 30 24 03 7C C4 2F
03E0 7D C3 18 10 26 02 DE F6 1F C8 C5 80 27 OF 7D C3
03F0 1F 27 OD 7D C3 21 27 05 7F C3 1F 20 03 17 00 B4
0400 F6 1F C8 C5 40 27 OF 7D C3 1E 27 OF 7D C3 20 27
0410 05 7F C3 1E 20 05 17 00 78 20 BA 7D C3 17 27 1A
0420 7D C3 1D 27 A7 7D C4 33 27 AE 7D C4 33 26 9D 17
0430 00 DA 7F C4 33 73 C4 34 30 92 7D C4 25 10 27 FF
0440 8B 1A 20 8E C3 23 F6 C4 24 3A E6 84 7A C4 25 7C
0450 C4 24 1C EF 17 00 DB 16 FF 72 B6 1F C8 85 80 26
0460 OE 7F C3 17 73 C3 17 7F C3 1F 73 C3 1F 20 02 8D
0470 15 85 40 26 OE 7F C3 17 73 C3 17 7F C3 1E 73 C3
0480 1E 20 02 8D 01 39 21 FE 21 FC 21 FA 21 F8 21 F6
0490 39 34 02 7F C4 33 7F C4 34 7F C3 21 B6 1F C8 85
04A0 80 26 03 73 C3 21 8D 44 8D 5C 8D 4D 8D 58 35 02
04B0 7F C3 1E 39 34 02 7F C4 33 7F C4 34 7F C3 20 B6
04C0 1F C8 85 40 26 03 73 C3 20 8D 21 7D C3 1C 27 10
04D0 7D C3 17 27 0B B6 1F C8 85 80 27 F9 8D 1B 20 06
04E0 8D 30 8D 15 8D 20 35 02 7F C3 1F 39 34 04 F6 1F
04F0 C8 CA 20 F7 1F C8 35 04 39 34 04 F6 1F C8 C4 DF
0500 F7 1F C8 35 04 39 10 BE C4 27 20 OA 10 BE C4 29
0510 20 04 10 BE C4 2B 17 FF 41 31 3F 26 F9 8D 01 39
0520 B6 1F C8 7D C3 17 27 04 8A 02 20 02 84 FD B7 1F
0530 C8 39 11.8C C0 OA 22 07 10 CE C1 00 16 FE 8D 34
0540 16 C1 20 2C 05 17 00 C6 20 2D 8E FD 7C CO 20 3A
0550 3A A6 80 27 17 2B 20 E6 84 59 24 05 17 FF 55 20
0560 03 17 FF 2D 4A 26 F2 17 FF A2 20 0B E6 84 8E FD
0570 FC 3A 3A AE 84 8D 03 35 16 39 1F 15 00 00 00 01
0580 00 02 00 03 00 04 00 05 FF 00 FF 00 FF 00 FF 00
0590 00 06 FF 00 FF 00 05 88 FF 00 05 90 05 F8 05 78
05A0 05 38 05 18 05 08 05 00 05 80 05 C0 05 E0 05 F0
05B0 05 50 05 A8 FF 00 FF 00 FF 00 06 30 FF 00 02 40
05C0 04 80 04 A0 03 80 01 00 04 20 03 CO 04 00 02 00
05D0 04 70 03 A0 04 02 CO 02 80 03 EO 04 60 04 DO
05E0 03 40 03 00 01 80 03 20 04 10 03 60 04 90 04 BO
05F0 04 C0 00 07 08 00 00 0F 06 14 05 88 FE 5B FE 89
0600 FE 91 FE 99 FE A1 FE 70 FE 7A FE 62 FE 69 8E FE
0610 3B 3A A6 84 27 24 34 04 C6 51 17 FF 15 1F 89 17
0620 FF 10 35 04 CB 40 C1 5F 26 04 C6 50 20 06 C1 5E
0630 26 02 C6 4F 17 FE FB 17 00 21 39 00 53 53 00 53
0640 00 00 52 54 52 00 52 53 52 52 53 53 52 54 52 52
0650 52 52 52 52 53 52 00 00 00 52 52 17 FE B4 17 FE
0660 A5 39 8E FE BF 86 02 20 40 8E FE C2 86 02 20 39
0670 8E C3 05 B6 C3 04 8D 31 20 E1 8D E6 8D E4 8D E2
0680 8D E7 8D EC 8D EA 8D E8 39 8E C1 05 B6 C1 04 20
0690 18 8E C1 85 B6 C1 84 20 10 8E C2 05 B6 C2 04 20
06A0 08 8E C2 85 B6 C2 84 20 00 4D 27 12 7D C3 17 26
06B0 OD 7D C3 22 26 08 E6 80 17 FE 77 4A 20 EB 39 43
06C0 51 20 44 45 20 7D C3 18 10 27 FD 00 7D C3 19 26
06D0 1A 7D C4 35 27 EF F6 C4 26 F7 C4 38 C6 28 F7 C4
06E0 26 17 FA 5C C6 4B 17 FE 49 20 07 10 8E 4E 20 17
06F0 FE 24 FC C4 2F FD C4 31 86 OC 7D C3 1A 26 02 86
0700 14 34 02 C6 05 34 04 8D 52 7D C4 35 27 13 7F C4
0710 37 7D C4 37 27 FB F1 C4 37 27 04 C6 53 20 02 C6
0720 45 17 FE OE 35 04 5A 26 DC 7D C4 35 26 03 17 FF
0730 2A 35 02 4A 26 CB 7D C4 35 27 11 17 FF 1D C6 52
0740 17 FD EF F6 C4 38 F7 C4 26 17 F9 F4 7F C3 19 7F
0750 C4 35 7F C4 36 73 C4 36 16 FF 6A FC C4 2F 58 49
0760 58 49 58 49 58 49 58 49 58 49 B3 C4 2F C3 00 03
0770 FD C4 2F 1F 89 54 54 CB 30 7D C3 1A 27 06 C1 39
0780 2F OA 20 D7 C1 41 2D D3 C1 5A 2E CF 39 OF 47 34
0790 41 45 45 04
07F0 FB 55 FB 55 FB 55 FB 55 F8 00 FB 55 FB 55 FB 55

```

Table 2 'Hex dump' of Multimate E-PROM

The above listing is a hexadecimal dump of the firmware. For those not familiar with hex dumps a few words of explanation will be appropriate. The column on the left is the address in hexadecimal of the first byte on that line. It will be noticed that these addresses (which are relative to the start of the EPROM) are separated by 10 (hex) (16 decimal) which means that each line contains the data for 16 bytes. Each such byte is represented by a 2 digit hexadecimal number.

Two items of information in the firmware listing will require modifying to suit the individual user, these being the default callsign and speed. The speed is at address 078D (hex) and occupies a single byte. This byte should be changed to the required default speed in hex and must be in the range 1-70 wpm. The following table shows the hex equivalent of various likely speeds.

10 - OA	25 - 19	0 - 30	I - 49
11 - OB	26 - 1A	1 - 31	J - 4A
12 - OC	27 - 1B	2 - 32	K - 4B
13 - OD	28 - 1C	3 - 33	L - 4C
14 - OE	29 - 1D	4 - 34	M - 4D
15 - OF	30 - 1E	5 - 35	N - 4E
16 - 10	31 - 1F	6 - 36	O - 4F
17 - 11	32 - 20	7 - 37	P - 50
18 - 12	33 - 21	8 - 38	Q - 51
19 - 13	34 - 22	9 - 39	R - 52
20 - 14	35 - 23	/ - 2F	S - 53
21 - 15	36 - 24	A - 41	T - 54
22 - 16	37 - 25	B - 42	U - 55
23 - 17	38 - 26	C - 43	V - 56
24 - 18	39 - 27	D - 44	W - 57
		E - 45	X - 58
		F - 46	Y - 59
		G - 47	Z - 5A
		H - 48	

The default callsign starts at address 078E (hex) or in other words immediately after the default speed. It may consist of up to 15 characters which are represented in hexadecimal ASCII, followed by the hex value 04 which acts as a terminator, marking the end of the callsign. The table below shows the hex ASCII values of all characters which could be used in a callsign.

From the above information it will be clear that in the dump given, that of the prototype keyer, the default speed is 15 wpm and the default callsign is G4AEE.

# Loop in a Loft

Having enjoyed the amenities of a Hygain TH3 atop a Westower 3HD in the heart of Aberdeen for over five years, it was particularly frustrating to be refused planning

permission with supportive signatures. At the time I did not realise until it was too late that a strong objector, in the form of a councillor (!) had made it their business to visit near-

ly able to pin you down! (You will note how easily I have developed a persecution complex?). Under cover you are able to arrange the layout easily and make any adjustments that may subsequently be necessary almost immediately. Whatever feed point or aerial wire you use, you have the satisfaction of knowing it will not be subject to the effects of the weather. No masts are required; you have an average height of some 25' as a starter!

## *Can't put up an outside antenna but would like to work some DX? A full wave loop in the loft was the answer for Stan Crabtree, G3OXC.*

permission after a move south. I had chosen my new QTH with care. It was a derelict cottage on an elevated site and with the rolling Cleveland Hills of North Yorkshire just to the south of me and theorist friends had proclaimed a better-than-average take off in all directions that mattered. The siting of the mast was to be such that even my immediate neighbours would not normally see it and would not be seen from the roadway at all. The rear 150' garden was next to a large recreation ground and the antenna would be some 200' from the nearest spectator's view.

Looking back I realise I was too complacent. I should have taken more time in preparing my applica-

tion by residents and urge them to object. Although some were reluctant to do this (and subsequently signed a petition supporting my appeal) the powers that be came up with a decided NO to my application and appeal.

A chance article I read got me thinking about a loft antenna. To inhabitants of housing estates where the authorities maintain restrictive policies with regard to external antennas, an indoor aerial of one sort or another is often the only chance to get on the air. VHF stalwarts can probably manage a small outside array without notice but, from ten metres down, even a humble vertical can arouse interest — especially if a 'busy body' is on the look-out.

I started to consider the facts. My QTH was a detached Georgian house with a roof of clay pantiles and the attic had been floored with chipboard and the only appreciable amount of conductive material was the copper hot water tank and the piping.

### The Raison D'etre

After further thought, I decided on single band operation and not to get involved with loading coils and earth systems. Simplicity was to be the prime aim. I did not want to spend too much time in exploratory work and subsequently find out all my efforts had been wasted.

To ensure the outward appearance of the house complied with the original period, two lengths of metal guttering ran along the front and back. At first I considered trying to incorporate these as either a director or reflector.

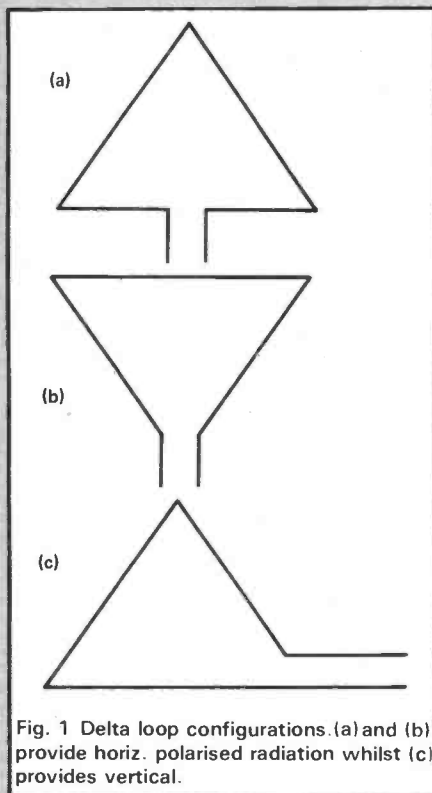

Fig. 1 Delta loop configurations. (a) and (b) provide horiz. polarised radiation whilst (c) provides vertical.

### Pros And Cons

I pondered with the idea of trying an aerial in my attic and the more I considered this, the more attractive it became. In fact the advantages soon seemed to outweigh the disadvantages. On the negative side, the screening effects of roofing materials limit radiation to a large extent so that an indoor antenna can never perform as well as an external array of comparable height. Space is usually confined and the actual layout of the antenna must take into account electrical wiring, water tanks, plumbing etc.

But consider the advantages. Virtual secrecy. No one need know you are in operation at all. I am not suggesting illegal operation but this factor could be very useful in the event of you causing TVI. At least you would have time to investigate any problem on your own set before an irate neighbour was final-

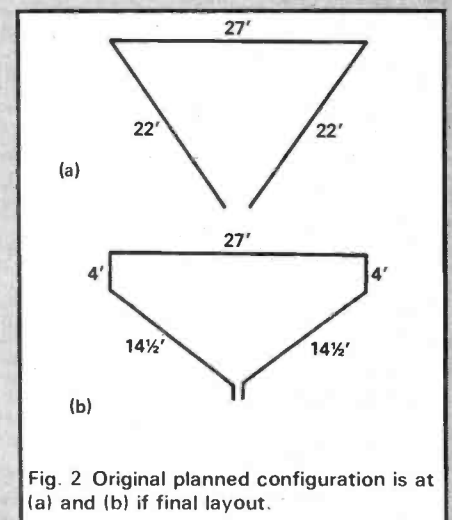

Fig. 2 Original planned configuration is at (a) and (b) if final layout.

However, the separation between them of approximately 22' did not compute too well with the chosen band of 20 metres. The house runs virtually North/South which for a simple dipole meant bi-directional radiation of a fashion to the Caribbean and Northern Europe — not ideal!

A single quad element was unfortunately out of the question as the required 16' sides could not be accommodated in the vertical plane. There seemed only one variety of antenna left - the delta loop.

Using the formula  $1005/F(\text{MHz})$  the overall length for 14025kHz would be 71 feet. Now there are a number of possible feed configurations for a delta loop and depending upon the type chosen, the antenna will (theoretically) radiate in either a horizontally or vertically polarised fashion (Fig.1). After some thought, the configuration in Fig.1 b was chosen as a starting point.

To fit in the two 'vertical' sides a compromise was necessary. The top section was moved away from the apex to a point 4' above the loft floor. This was also conveniently further away from the plumbing system. The feed point was then laid out at the centre of the extreme western side of the roof space area. The above meant the plane of the antenna was more nearer the horizontal than the vertical and so what exactly the polarisation of the antenna radiation would be was anyone's guess...At the feedpoint I used a small die-cast box with a SO239 co-axial socket and two audio type sockets for the antenna connection. The aerial wire was supported as necessary from wooden rafters by electrical plastic cable clips. I planned to replace these, if the system worked, with nylon fishline later. The down leg of the loop passing nearest to the water system was classed as the 'earth' side and this wire was plugged into the socket on the box that was also connected to the screen of the 50 ohm co-axial feeder. Cheap insulated flex was used for the antenna.

When I came to the stage of connecting the aerial wire to the connection box, I realised the vertical-ish sections of the antenna were too long to fit in the run direct and had to 'square off' the points

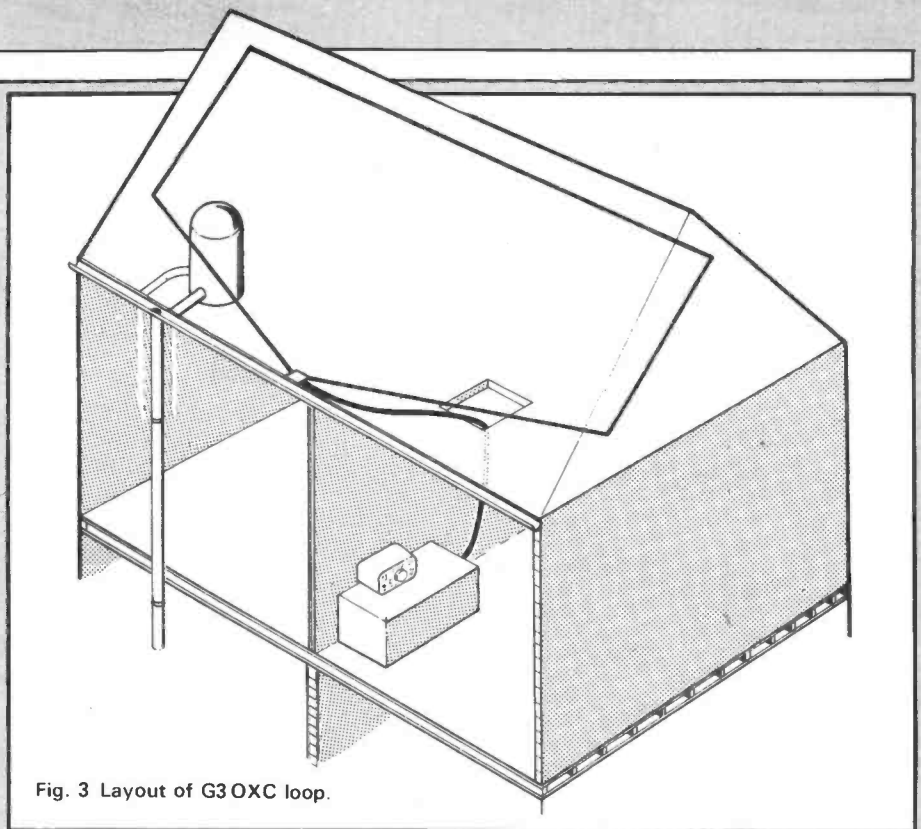

Fig. 3 Layout of G3 OXC loop.

they left the top section of the loop in order to use up the wire. The installation took less than half an hour.

### In Operation

After firing up I was disappointed to see the SWR was very high. I wanted to get this right down because I intended to drive the antenna direct from a transceiver with a solid state output. After checking the resonant frequency with a GDO at the feed point, I was surprised to find it around 13MHz. Theoretically this meant the antenna was far too long and I commenced pruning one of the legs. I had finally to dispense with 7 feet off one side section to end up with a total aerial length of 64'. But the result was worth it. An SWR meter showed less than 1:1.5 *right across the band!* (*The antenna's resonant frequency was probably affected by house wiring etc — Ed.*)

An air test was approached with some trepidation. I

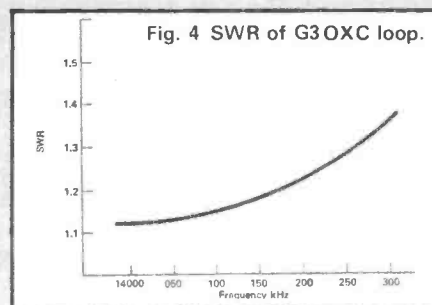

Fig. 4 SWR of G3 OXC loop.

remembered once spending half a day coaxing a low SWR from a tower ostensibly serving as a mast type radiator. I ended up with a 'text-book' SWR — but never worked anyone!

At 1600gmt there was not a lot on the band. A few UA3's and some very weak W's. I tail-ended a QSO and managed to contact an old friend W8VSK who gave me 559 but said there was little coming out of Europe anyway. My next opportunity came on New Year's Day when HA8, UC1 and a string of other Eastern Europeans gave me 599! Although this is almost routine during radio competitive sports nowadays, this wasn't a contest. Later OH6YJ also gave me 599 and I was finally convinced.

I am not of course able to say this spate of flattering reports continued but the antenna performance has certainly more than come up to expectations. Since its installation I have worked W1, W4, JA, UA and PY during limited operation. Admittedly one report was 429 but I worked him! I have now got to the stage where I call a distant station and often forget I have an indoor antenna.

If you are in a modern housing estate check the construction at joist floor level. Occasionally, metallic material is used as sheet insulation and this will of course make any attempted aerial system futile.

# Meet the MICRON!

## Part 4



### Final Alignment

The final stage is to check the operation of the transmit strip. There is no alignment involved as the strip is broadband. This test can only be done with heatsinks fitted

down as far as it will go and standing vertically, then solder the emitter (right) lead to the top foil, and the three leads on the underside. Finally remove excess lead lengths.

around the 3mm hole on the lower right hand side of the rear panel. Place the small rectangular insulating washer over the latter hole with the main area of the washer facing downwards.

***In Part 4, Tony Bailey, G3WPO, and Frank Ogden, G4JST, complete the alignment and describe the switched attenuator.***

Carefully drop the PCB down over the bolts taking care not to disturb the insulating washer. Insert a 6BAx6mm thread length - countersunk screw through the hole from the rear. Slide the small plastic bush supplied over the screw and seat it into the transistor tab. Then place a 6BA lockwasher over the screw and tighten up loosely with a 6BA nut.

14. Temporarily place 6BA nuts over the outside four screws only on the PCB and tighten down, then tighten up the PA transistor nut.

15. As with Q49, smear a small amount of heatsink compound over the rear of Q39 (TIP34A), and over the area to be occupied by the tab (hole above the PA transistor). Place the remaining insulating washer over the hole with the main area of the washer projecting downwards. Carefully bend the leads of Q39 up at right angles to

to Q39 and the PA transistor. If you are using the *Micron* case, then the basic PCB will have to be fitted to this to carry out the next tests. Alternatively, if you are to use your own case, it will be necessary to make up a suitable heatsink. The testing can be carried out using a piece of 18 swg aluminium sheet, the length of the PCB, bent into an L shape so that the PCB can be mounted on it via spacers. The two transistors then mount against the rear vertical part of this sheet using the insulating washers and bushes supplied. See the next section for more details.

11. Insert Q49 (2SC1969) into position with the metal tab facing the rear of the PCB. Make sure it is

12. You will now require the chassis part of the case and some of the fittings to continue the construction.

Insert a 12mmx6BA round head bolt through each of the holes on the base of the chassis, from the underside, ignoring the three holes along the front - as you insert the bolts, place a small piece of masking or insulating tape over the head of each to stop it falling out when you let go! Drop a 6mm long round nickel plated spacer over each bolt on the inside of the chassis.

13. Smear a *small* amount of the heatsink compound supplied evenly over the rear of Q49, and a further small amount over the area to be occupied by the tab of Q49



the body. Then insert a 6BAx6mm thread *countersunk* screw through the hole and washer from the rear, place Q39 over the screw and slide on the remaining insulating bush until it is seated inside the tab. Fix in place with a 6BA lockwasher and nut. *Note: providing the transceiver is not keyed continuously in the following tests for more than 5 seconds at a time, the additional external heatsink supplied is not required.*

16. Before carrying on, make sure that all leads and controls coming from the board are clear of the metal chassis and not shorting. Attach a 50 ohm dummy load capable of dissipating 10W or more to the antenna pins on the PCB, preferably via a power meter or SWR bridge so that you can check the power output. Remember, most of the inexpensive SWR/power meters only measure *relative power*, and cannot be used for *absolute power* measurements unless you have previously calibrated them against a calibrated 'power meter' at the frequency being used (their response *usually* varies with frequency).

17. Apply power — the PSU should be capable of delivering up to 2.5/3A at 13.8V DC. Keying the transceiver should result in a power output of not less than 8W on all bands except for 10m, where the minimum of 6W can be expected. The Drive control should vary the power smoothly from virtually zero to full output.

Lack of output on all bands would indicate a fault somewhere in the PA strip. If this happens, the services of an oscilloscope are invaluable for tracing the fault. Detailed and specific fault finding details are not practical for this stage of *Micron* unless instrumentation is available. If you find that the PA transistor gets very hot but no power is delivered, suspect the winding of T5 or T6. Lack of output on a single band would indicate a fault in the switching of low pass filters.

18. Using a 25cm length of coaxial cable, stripped as before, link point AW (below left of IC6) to the antenna pins (which are already connected to the power meter). The Tx power metering should then

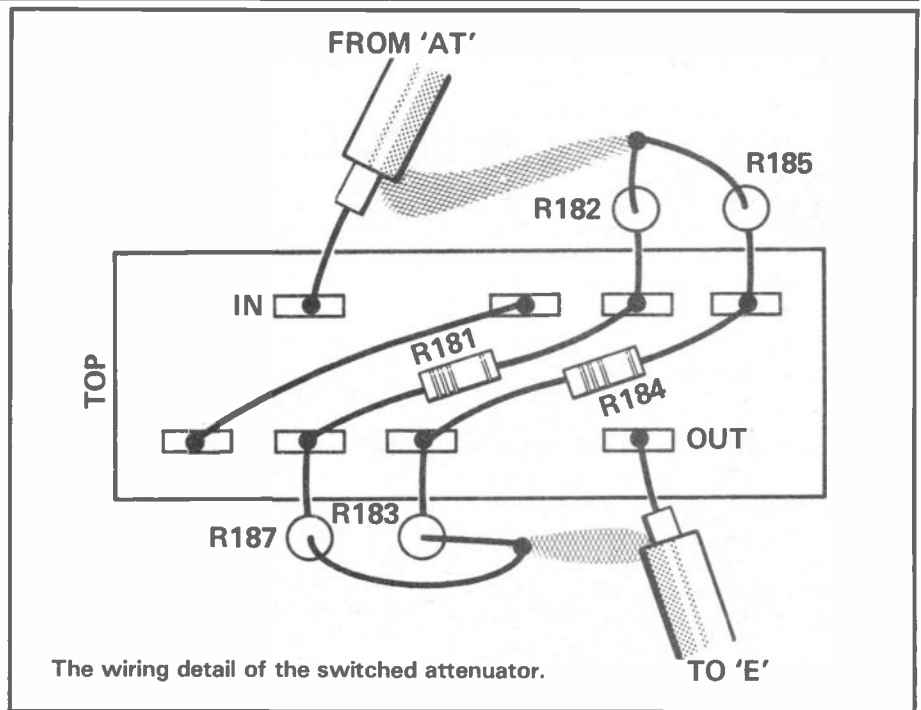

The wiring detail of the switched attenuator.

be set with RV8 so that the meter indicates one division from full scale at maximum power output.

If you are using the *Micron* case, and all tests have been successful, all 8 of the mounting screws should now be fitted with lockwashers and nuts, and tightened. +12V to the digital display module is taken from the marked position just left of RV5 at the front of the PCB.

### Switched Attenuator

The switched attenuator is constructed directly on the 2 pole, 3 way slide switch supplied with the *Micron* case kit (you may use any similar slide or rotary switch for your own case). The drawing gives details. Keep all leads as short as possible when building this item.

Start by soldering the resistors directly to the switch as shown. When you have done this, remove the coax link to point E (left to S1c) and connect the coax to the input of the attenuator as shown. Then use a further 12cm length of coax to link the output of the attenuator back to point E.

You will find the attenuator useful when dealing with very high strength local signals, or when operating on 40m at night where very high levels of adjacent broadcast station signals are present which may overload the receiver. The effect of the attenuator is to reduce or remove this overload, but

with far less effect on the wanted in-band signals.

An LED may be used to indicate transmit mode on the front panel. Connect the anode (usually the longer lead) of the LED to point AP using insulated wire, and the other lead of the LED to earth (in front of VFO enclosure).

The 'S' meter may be illuminated by connecting one end of one bulb tag to the +12V supply, and the other bulb tag to earth. Bulb life can be prolonged by reducing the applied voltage using a series dropping resistor (82R 0.5W recommended).

### Tidying Up

Once the main wiring is complete, you should neatly tie the wiring together in the area behind the VFO enclosure so that the various cables are as high up and as near to the top of the enclosure as possible. If certain of the wires are close to the audio pre-amplifier stages, you may experience some audio feedback at high volume levels — some experimentation with the position of the wires will cure this. Also avoid running cables directly over the top of the VCO coils as this may induce 'synthesiser buzz' into the received signals.

### Finishing Touches

1. The Tx IRT preset, RV1, should be reset after installation in the

case so that the received frequency with the RIT control knob indicator line vertical (control at mid-position) is the same as when the spot button is pressed. The wiring of the spot button is shown in the wiring diagram in these instructions. When this is complete, the VCO lid should be fitted — place it on top of the enclosure and solder a short piece of wire at each end of the two longer sides to link the lid to the sides of the enclosure.

2. If you are using your own case, it is important that all 8 of the mounting holes on the PCB are used to provide a good earth from the board to the chassis. Failure to do this may result in poor quality transmissions due to earth loops. If you wish to purchase any of the switches used on our case for your own, please contact us. The filter switch may be any type of 1 pole — 3 position slide or rotary switch, which should be connected as illustrated.

#### Coming Next

The next parts of this series will deal with the frequency display, the internal ATU and the case assembly.

### USING THE MICRON

The *Micron* operates like most other CW transceivers with the advantage of a semi break-in operation. As with all direct conversion transceivers, or superhet designs such as the HW-9 which use a wide roofing filter rather than a narrow band filter, you will be able to copy a CW signal by tuning both sides of its nominal carrier frequency. With most superior DC or superhet transceivers, a fixed transmit offset is used so that when you tune on receive to the 800Hz note that most operators prefer, going to transmit offsets the Tx frequency by 800Hz — this results in the other station also hearing a 800Hz beat note. This does mean that you must *always* tune to the same 'side' of the received signal — ie always tune from the high end of the low end of the band when looking for a station. If you do it the other way, you will be transmitting up to 2kHz off the other stations' frequency and they will not hear you.

We have opted to provide a 'spot' button to overcome this. In use, having found a station to work, you leave the IRT control at mid setting, press the 'spot' button to zero beat the received station using the main tuning knob. Having done this, you then re-tune in the sta-

tion you decide to work, using the IRT control, for a comfortable beat note, on either side of the carrier (whichever is the more free of interference). You can therefore adjust the IRT control as much as you like without affecting the transmitted frequency.

The rear panel mounted Balance control will only require adjustment if you suffer from direct broadcast station demodulation. This is likely only to occur on 80 or 40m, where there are adjacent high level broadcast bands. Simply adjust the control until the interference is removed or considerably reduced. The control may require re-adjustment when changing bands.

### IMPORTANT

In common with any other rig with a 'solid state' broadband PA, the *Micron* requires a well matched antenna close to 50 ohms for best performance, both on receive and transmit. You should not operate at full power into a high VSWR — this will result in low output power and possible damage to the PA transistor. The correct procedure is to use an Antenna Matching Unit, either the optional internal *Micron* unit, or an external matching unit of your own choice.

# STOP PRESS

## Psst! Have You Worked Rockall?

Tom Maclean, the ex-Transatlantic oarsman, currently living on Rockall, the 70' rock outcrop some 250 miles W off the Hebrides and claimed by Britain, Denmark and Iceland, has been active

on the amateur bands.

Using the callsigns GM1TM and GR1TM, Tom has been active on 14MHz and is known to have contacted a number of UK stations, included one who allowed the contact to be filmed for ITN's News At Ten! Strong rumour

has it that he is operating illegally and that the DTI will be paying him a visit when he returns to the UK.

Personally, the editor would not fancy their chances of making a prosecution without looking somewhat humourless and getting a lot of adverse publicity...

## New Intermediate Licence Category To Be Introduced?

Draft proposals for a new category of amateur radio licence have recently been submitted to the DTI by Council of the RSGB. This 'licence' would permit the holder of a class 'B' licence or an RAE certificate to operate CW on 3 HF bands after passing a test of 5wpm, with a power limit of 9dBW.

David Evans, general manager of the RSGB, when interviewed, stressed that the proposals had been submitted as a basis for discussion and could be revised or rejected by the DTI. Information received from Ian Abel, secretary of the

Amateur Radio Novice Licence Campaign, had indicated that the proposal submitted were for a 'novice' licence. David Evans firmly denied this claiming that a licence category with a lower technical standard than the present RAE neither accorded with the wishes of the members of the Society or the DTI and that the introduction of such a licence would only serve to devalue the technical credibility of amateur radio. The notion was "to pitch a licence category which was somewhat easier than a full class 'A' licence and would give an HF capability but without the full privileges of a class 'A' and which would act as an incentive."

The 'limited' licence would thus allow the holder to experience the wide

range of HF propagation and techniques whilst minimising any chance of interference.

David Evans put forward the view that because most people take the RAE before attempting the morse test, the natural reaction is to take out a class 'B' licence just so as to get on the air. Once on VHF/UHF, many then look no further, a situation which is depriving them of a very different and fascinating facet of radio.

The above proposals dovetail in with the recent granting of permission for class 'B's to operate CW on VHF/UHF and seem to be an excellent idea. Proposed bands are presently 28, 21 and 1.8MHz - all of which could do with some extra occupancy at present!

# REVIEW:

## Yaesu FT270RH miniature 2m FM mobile

At one time, a few watts mobile on 2 metres would have meant a large box, probably in the boot, almost certainly an ex-PMR rig, lots of valves getting hot, and several amps of current on receive alone! Today there is no shortage of 2m rigs — the problem is what to choose from the vast range, most of which are of the 'all-singing-dancing' type.

The subject of this review is one of the latest 'mini-rigs' available from the Orient, all the more impressive as it runs all of 45W output from a box 5.5" wide, 6.5" deep and only 1.5" high, together with all the facilities we have come to accept lately in 2m mobile rigs. The FT270RH is the 'high power' version and the 'low power' version runs 25W.

The first thing you notice on unpacking it is that the miniaturisation means that the usual rear panel antenna and power connectors have had to be relegated to flying leads as there is no longer room for them in standard form! The power lead has a pair of short non-reversible leads which plug into the normal mobile fused lead, while the antenna socket is a flying SO239 socket.

You may wonder how on earth 45W can be got out of a box this size? Or rather, how you get rid of the heat! The answer is a specially designed 'duct-flow' diecast chassis, with the heatsink running from the back to the front of the case, plus a small extruded heatsink on the back *plus* a miniature blower! The latter jumps into action as required by means of a thermal sensor. In the low power position (5W) it did occasionally come on when the car was warm, but was on most of the time at 45W with any extended QSO (I should say at this point that the 25W version doesn't have the fan).

Depending on the cir-



*The undisputably most popular band for mobile operation is 2m, with a plethora of commercial rigs available. These seem to be continually getting smaller, yet offer even more facilities and higher RF output. 'Where will it end?', mused Tony Bailey, G3WPO, as he took the new Yaesu FT270RH for a drive...*



cumstances, the fan can be regarded as noisy — under mobile conditions this tends to get lost in all the other car noise (you might find it distracting in a Rolls though!) but in the shack it is a different matter. The first time it came on I leapt up wondering what on earth the noise was, thinking that something was about to explode in my power supply. As the fan is only about 1.5" square it is bound to make a fair amount of noise at high speed and this can be distracting in a quiet shack. Several people commented on the noise in the background.

All the usual extras are there — memories, memory scanning, 'priority', band scanning, toneburst, repeater shift, reverse shift, and two VFOs with 12.5/25kHz VFO steps. An optional Tone Encoder is available, as is a 'speech synthesizer', giving a 'talk-out' of your operating frequency. This is either on all the time, or on

request via a microphone button. For the blind operator this is obviously a 'godsend' and possibly for the sighted operator as well.

### Small Affects

I make the latter remark because one of the effects of miniaturisation is that you get smaller and smaller control buttons. In the environment of a car, where your concentration is (hopefully) devoted to the lunatics round you, attempting to press a very small button, close to other very small buttons, when you want to change something can be a hit-and-miss affair. A persistent example of this I found was the VFO/memory buttons — these are side-by-side and it was easy to hit the wrong one and find that you were not where you thought you

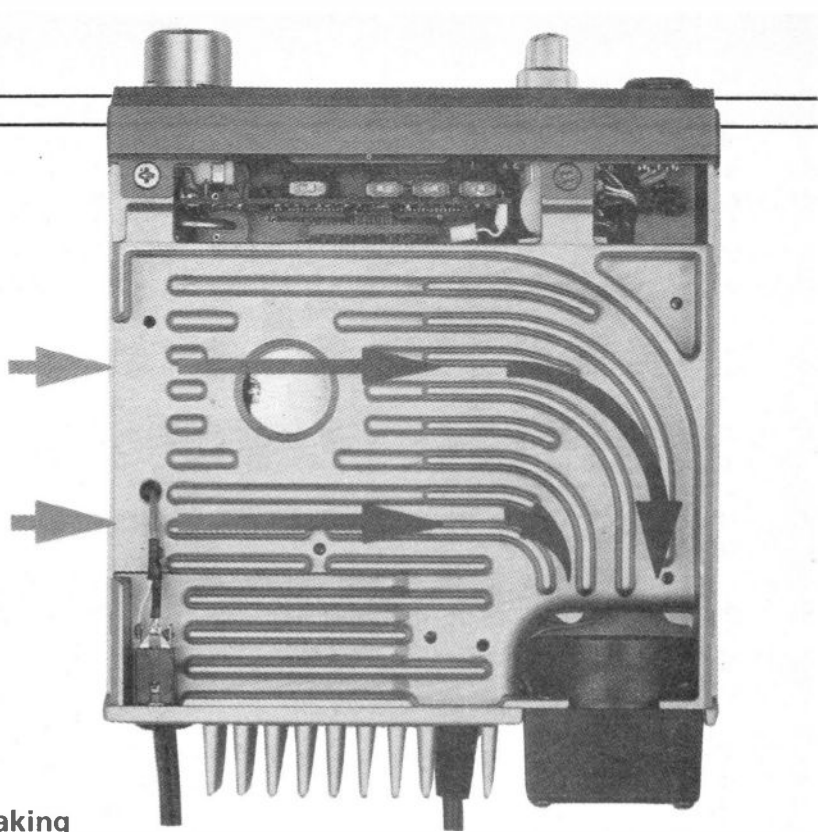
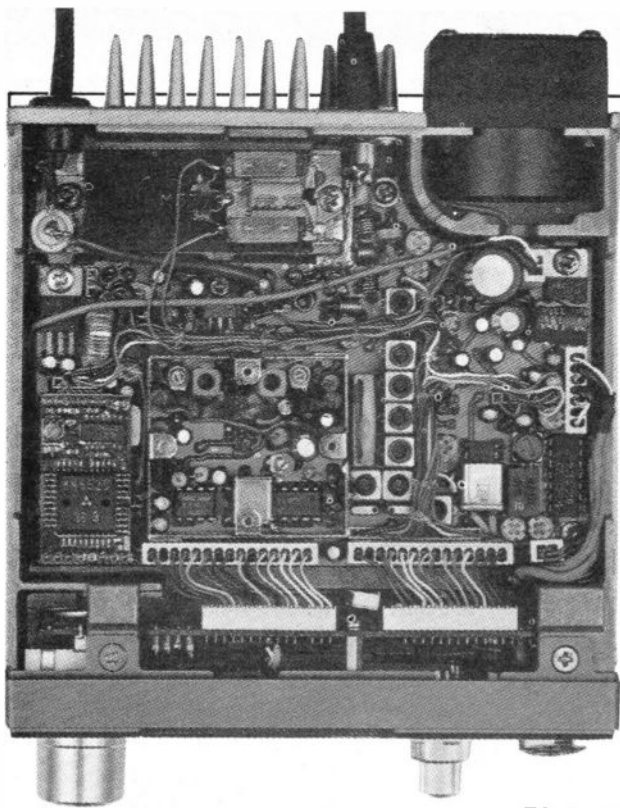

### Plain Speaking

were. Not a problem in the shack where you tend to look at what you are pressing. In fact, I did find that a lot of the time whilst 'mobile' I felt compelled to glance at the display to check that the right operation had been carried out, a side effect of this.

The display has a pleasant green background and differs from many LCD readouts in that it can be viewed from very wide angles in *any* direction — you don't have to be right in front of it to see the frequency. Also shown on the display, by means of small annunciators, are the actual facilities in use, including memory channel, priority, scan, VFO A or B, and, if you foul up the button pressing, the diminutive Err to indicate an error.

The S Meter is of the 'lemons and cherries' type (LED bargraph to the uninitiated) and sits underneath the LCD display. This also functions as the power output monitor, showing about half scale for low power.

There is a 'beep' function which is activated when you press any button involving a change of function, plus a double-beep when an error condition exists. Unfortunately you can't get rid of this if you want to. When in scan mode this fires off every time the scanner stops — every 6 seconds or so if the band is busy. Possibly an 'invalidate-the-guarantee' piece of surgery might get over this, but there was insufficient information on the circuit diagram to evaluate this.

Fancy your own Japanese lady in the car? Well, Yaesu will oblige for a small sum but limit themselves to providing her voice only! The optional voice synthesiser comes on a very small pre-aligned PCB which is very easy to fit and allows you to be told where you are, rather than having to look. The synthesiser will work 'continuously', speaking every time the frequency is changed, or on 'demand', via a button on the microphone.

The first thing to be announced is which VFO is in operation, say(ing) 'VFO A', followed by 'V' for VHF, then the frequency, missing out the first two numbers. So, the 'talk-out' for 144.525 on VFO B would be 'VFO B, V, Four point five two five'. The VFO and V indications are only omitted if you are in 'programmed memory scan' mode and select a frequency manually while it is *not* scanning.

### Memory Matters

There are 10 standard memory channels, and each can hold a different transmit frequency to that of receive if required. You can scan these for either 'busy' or 'vacant' operation, with a 6 second stop on a busy channel. To stay on a channel you just push the PTT switch once. Also, a memory channel can be 'masked' from the scan routine temporarily, if desired.

In addition to being normal memory channels, memory chan-

### Top and bottom of the FT270 RH

nels 9 and 0 hold the limit frequencies for the programmed scan. In this, the rig scans between the two frequencies stored, either up or down — a very useful facility for just monitoring the FM portion of the band, or perhaps the simplex or repeater sections.

You can scan the whole 2MHz if needed by selecting scan mode on either of the VFOs. If you have the voice synthesiser running, this will tell you which VFO is in use every time the scan returns to 144.000MHz; this also changes the VFO statement to 'MEMORY' plus the memory number when a memory channel is selected manually.

The other scan/memory function is 'priority' — this flips back to a selected memory channel every 6 seconds from the operating frequency and will stay there if it is busy. This mode cannot be used while actually scanning, only in conjunction with a static VFO frequency.

The remaining front panel controls are firstly the main tuning knob (optical encoder type) which steps a channel at a time — either 25kHz or 12.5kHz, depending on the setting of the 'step' switch. You can also move a whole MHz at a time, either up or down, with another button — this also doubles as a memory channel selector. The only annoying thing

about this switch is that if you go from, say, 144.8 to 145.8 then pressing this again, you don't get 144.8 back, but 144MHz, with the VFO resetting itself to the nearest whole MHz.

A slide switch allows selection of standard repeater shifts, either + or - 600kHz, with another button giving the 'reverse repeater' shift at a touch. If you need a non-standard shift, this can be achieved via the memory facility with the transmit storage programmed for the frequency required.

Two buttons which are somewhat superfluous in this country, are those associated with the optional tone encoder. The rig does have an internal toneburst which can either be fired up from the front panel as required, or on continuously, via a small switch on the underside of the case. The panel button would have been much better placed on the microphone — you have to reach for the rig when mobile to bring up a repeater.

Other than the audio and squelch controls (dual concentric knobs are quite small) this only leaves the mic. socket which is of the 8-pin type.

## Manual Situation

The manual for the rig is in A5 format and runs to 28 pages, plus a pull-out circuit diagram. It is to the usual comprehensive Yaesu standards and they even appear to have used someone with a good grasp of English to write it for a change! For the technically minded, there is, unfortunately, absolutely no circuit description (other than a brief introductory overview) or guide to servicing. There is probably a separate Service Manual available if you want it, but with an abundance of dedicated chips on rig, most people will be very limited in what they could do and would have to seek dealer back-up should the need arise. This is a good reason for ensuring that you purchase from an Approved Stockist.

The receive side uses the ubiquitous MC3357 for the main FM processing functions, running with a 21.6MHz first IF and 455kHz second IF in a standard superhet configuration. The RF stage is MOSFET followed by a comprehensive band-pass filter, plus solid state antenna

changeover switch. On the transmit side, the PA is one of the block module type, found in almost all such rigs these days, but expensive to replace when they go pop! The FT270 series are micro-processor controlled, using two 4-bit CPU's.

The output power was measured at 47W (spec 45W), and receive sensitivity at 0.14uV for 12dB SINAD (spec 0.2uV/12dB SINAD).

## In Use

The rig was used for many weeks, both as a base station and mobile, the latter running into either a helical 5/8th wave, or standard 7/8 whip. As a base station it functioned admirably, albeit with noisy help from the internal fan when at high power. The audio was quite pleasant from the internal speaker (which is mounted on the bottom of the case but has a grill outlet on the top). There is some considerable distortion at full volume, caused by the rather small speaker.

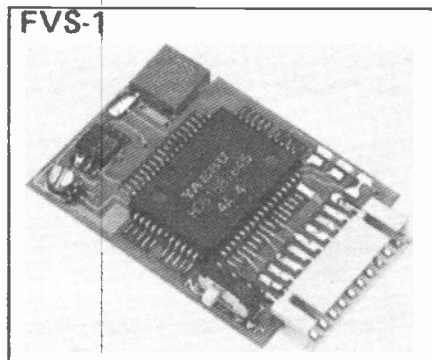

**FVS-1**  
Voice synthesiser

One of the most noticeable things about the performance of the FT270RH was that you didn't have to ask what the audio quality was like — most stations commented on the excellent response without being asked. The transmission bandwidth appeared to be controlled within a fairly tight limit and no adverse reports were received from locals on adjacent channels — likewise, no trouble was experienced on receive from strong adjacent channel locals at 25kHz spacing. Although the rig is capable of 12.5kHz spacing operation, you will get trouble when using this with another strong station 12.5kHz away, as the ceramic IF filter is too wide for such spacing,

being suited for 25kHz channels and having a 14kHz bandwidth at -6dB.

As mentioned earlier, the cramped front panel made mobile operation awkward to say the least, and several times a stop had to be made to sort out buttons pressed in error when QSY'ing. For reasons which I am unable to duplicate, I twice lost the memory transmit frequencies while mobile, being presented with an 'ERR' condition on pressing the PTT. The most useful facility I found was the programmed scan between two frequency limits, used for listening between the bottom end of the FM simplex section and the top end of the repeater frequencies, whilst mobile.

When using a repeater that requires a tone, you have to make up your mind before you leave on your journey as to whether to dive for the tone call button whilst driving, or leave the burst switched on permanently.

## Conclusions

Overall, allowing for the ergonomically poor controls, dictated by trying to get a lot of functions into a small area, I liked the FT270RH a lot. It has all the facilities one could possibly want in a very small box and combines high output power with good sensitivity/performance. The modern small car needs a compact rig, one that can be easily removed when the car is left unattended and this fits the bill. The small speaker and case size does mean that an external speaker is really needed when mobile, but this is true of many other 2m mobiles.

As a base station for a small shack it is again ideal, but I would like to have seen a means of disabling the 'Beep' tone and a quieter fan. One final amusing point, the voice synthesiser appears to suffer from the Japanese problem of pronouncing 'R's and 'L's — 'Error' comes out near to sounding like 'Ellor'...

*Thanks to SMC Limited for the loan of the rig and its voice synthesiser. The price at the time of writing is £380 for the /RH version, and £325 for the /R (25W) model. The FVS-1 voice synthesiser costs an additional £21.45.*

# BOOKEND

## DIALSEARCH (3rd edition),

By George Wilcox, 9 Thurrock Close, Eastbourne, East Sussex. BN20 9NF.

This is a very useful booklet for the uninitiated short wave listener and is updated every two years, the next edition coming out in early 1986. The author has set out to provide a 'Listeners Checklist and Guide to European Broadcasting' but has, in fact, given the absolute beginner all the essential information on how to actually get started in this area, what to listen for and when.

The booklet includes two maps one of which gives all the major broadcasting stations in Europe. The second map is of the British Isles and is part of the full and thorough 'package' on how to gain the best from a simple portable radio receiver.

The listings of stations to be heard are grouped into short, medium and long wave and are listed by frequency, with notes on language, time, transmitter power and programme content. The major European programme networks are listed by the language of the transmission and some brief programming details are also given. Mr Wilcox has also managed to accumulate information on foreign stations that transmit in English and has listed the time that they transmit classical music and jazz. Also, amusingly, for the musically minded, there are the music 'scripts' of all the major world broadcast stations' signature tunes.

The booklet is available from George Wilcox at the above address for £2.50 plus 50p postage.

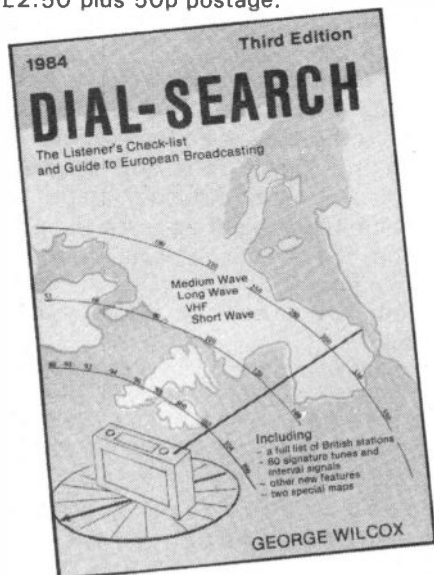

Short wave listening seems to cover a wide range of specialised areas, and has subsequently spawned a number of guides and books on these areas, as well as some general guides. Recent 'listening' books have covered the world press frequencies, European and world broadcast stations and secret governmental (and anti-governmental!) transmissions. These books come in a variety of shapes, sizes and prices, from the cheap pamphlet to the expensive tome. A selection of better and more unusual short wave listening books are reviewed here.

## WORLD RADIO TV HANDBOOK (39th edition)

Published by Billboard, Distributed in the UK by Pitman Publishing Ltd, 128 Long Acre, London WC2E 9AN

This tome is claimed by its editors, and many radio enthusiasts, to be *the* comprehensive guide to listening around the world. However, WRTV Handbook not only gives about the most thorough listing country-by-country of what can be heard on the airwaves anywhere but also has some very interesting articles by famous and authoritative radio enthusiasts.

The section that will be most useful to the majority of SWLs, is the listing by country of all the known broadcasting stations in the world. These are grouped by country and region. Each regional breakdown is preceded by a map of the region abbreviated details of the stations are given, ie times of operation, frequencies and language(s) used. This list is followed by one of the standard frequency (ie WWV) and time signal stations, which for the amateur listener are useful for checking the accuracy of the shack clock, receiver calibration and propagation conditions. Later in the handbook, the reader will find a useful cross reference listing, headed by band frequency and detailing the countries which have stations operating on that band, their power output and location.

The title of the handbook does include television, however, the actual section on TV is rather limited, since the editors have merely aimed to give an "accurate impression of the state of development of TV services in each country". They go on to explain that

reception of 'foreign' TV is often difficult because of the various different systems of transmission, (ie PAL, SECAM) antenna polarisations and colour standard (PAL, NTSC). These are given in the country-by-country listing of TV services. One failing of the book, that the editors are considering remedying, is the lack of information on satellite TV and cable services.

The book includes some reasonably useful tables concerning *propagation*, in particular the one covering the most suitable shortwave bands reception for certain areas from transmission from the various regions at different times of the year. One of the last tables in the book is vital in this sort of listing book. Although all the book times are in UTC (ie GMT), having a table of local time around the world can be of assistance.

The articles in this handbook, as I have mentioned earlier, are by well known participants in the hobby and are generally well written and interesting. They cover the future of the wave bands, solar activity — which is rather short and obvious — an insight into Radio Nederland's new transmitter station, what to expect in the way of HF broadcasting in 1985, a history of Swiss Radio International and a description of tropical band DXing. There is a list of national and international DX clubs which is quite informative — giving details of their membership, specialist interests and present activities.

The final section of the handbook is given over to reviews of some of the newest receivers (about half a dozen) and various signal boosting accessories — the latest in pre-amplifiers and active antennas. These reviews are comparative and although not all the equipment reviewed is available in this country, the reviews should be useful. On the whole the WRTH, as it often refers to itself, is interesting and probably very useful to the serious shortwave listener/DXer. Apart from the lack of information on the TV front I think I can safely say it is comprehensive. The tables are reasonably easy to read, without having to wade through the lists of abbreviations first. The book is well laid out and the main listings easy to find. My only other criticism concerns the lack of an index of contents at the back of the book and a contents page that I found less than informative. The book costs £17.95 and is available at most bookshops and radio emporia.

## CLANDESTINE CONFIDENTIAL

By G L Dexter,

Supplied by Interbook Ltd, Lynton,  
Stanley, Perth PH1 4QQ

This book sets out to show the short wave listener another side to shortwave broadcasting — that of illegal, anti-government and government 'propaganda' stations. Mr Dexter seems to have considerable experience, from around the world, of playing 'detective' and searching out these stations. Firstly, of course, the author defines what he means by a 'clandestine' station, why it (apparently) broadcasts and how to identify them. The book is then divided into three main sections, the first describing a few past 'famous' stations, the second those that are still presently broadcasting and the final section the future prospects — where to look for clandestine stations and that they are what they seem to be!

Past 'clandestine' stations include the suspected CIA backed 'Radio Swan', that broadcast to Cuba until quite recently. The stations that broadcast from the Falklands during the Argentine occupation provides a topical and interesting dimension to that particular conflict. These examples, being fairly well known, have more documentary evidence. Many other stations

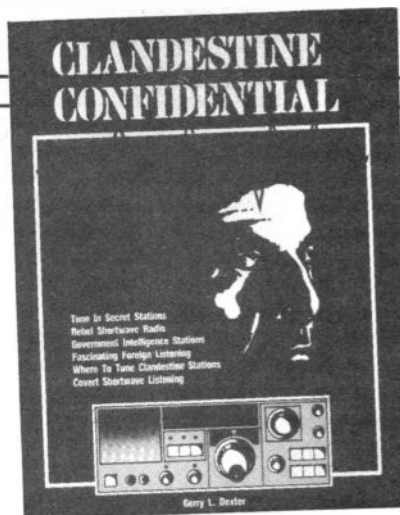

mentioned later in the book present more of a challenge to the listener.

The presently operating clandestine stations are listed by country, with some having as many as ten different stations. Interesting countries to listen out for include Nicaragua, Cuba and South and North Korea — the latter two seem to have broken a mutual agreement to 'stop verbal hostilities via radio'. Once you've spotted a clandestine station, the main problem may well be understanding the language, although some do use a smattering of English.

Mr Dexter has made every effort to assist the would-be clandestine listener by giving times, frequencies and occasionally the languages used. He also

provides a brief synopsis of the organisation behind the station and the country's recent past history. He illustrates the articles on the various stations with copies of verification letters and a few 'clandestine' photos. There is only very limited information on the sort of equipment used on these stations, despite some obvious big backers!

The final section looks to areas where future clandestine operations may arise. The Caribbean seems to be a prime target, particularly for Cuban/Russian radio activities (*don't forget the author is an American!* — Ed). Other 'hot' spots are also highlighted for possible listening success. And once you've 'caught' your clandestine, the next step is to get it verified. This, it seems, is the hardest part — trying to get an address for QSLing, let alone a reply! However, this is apparently half the fun of being a listening 'detective'.

On the whole, the book is written in a very familiar and readable style. It does not sink into the quagmire of politics and is rather humorous in places — something quite rare in most of these books. On the bad side, the type seems a bit too large and the illustrations and heading take up more space than is necessary.

The book is available from Interbooks Ltd., and costs £6.80 inc p+p.

# RADIO Tomorrow

*Your at-a-glance guide to what's happening around the clubs, on the air and in general radio-wise.*

- |  |  |
|--|--|
| <p>1 July</p> <p>Horndean DARC: <i>Working CW</i> by G4DFG.<br/>Hazelrigg ARC: meets every Monday at the Community Centre, Hazelrigg.<br/>Basingstoke ARC: VHF NFD arrangements.<br/>Alyn and Deeside ARS: NFD arrangements.<br/>N Staffs ARS: informal meeting.<br/>Wolverhampton ARS: meeting.<br/>Todmorden DARS: natter night.<br/>Worcester DARC: natter night.<br/>Southdown ARS: barbeque.</p> <p>2 July</p> <p>Fylde ARS: equipment construction contest.<br/>E Lancashire ARC: fox hunt.<br/>Bury RS: surplus equipment sale.<br/>Chichester DARC: club meeting in the Long Room.</p> | <p>3 July</p> <p>Wolverhampton ARS: <i>visit to Central Telephone Exchange.</i><br/>Reading DARC: VHF NFD finalisations.<br/>Wirral ARS: surplus equipment sale.<br/>Worthing DARC: meets every Wednesday at the Parish Hall, South St, Lancing at 7.30pm.<br/>Cheshunt DARC: natter nite.<br/>Fareham DARC: <i>AMTOR operation</i> by G4FJO, G4CJO and G4EMR.<br/>Exmouth ARC: meets at the Scout Hut, Marpool Hill.<br/>Denby Dale DARS: <i>noggin n' natter.</i><br/>Hornsea ARC: preparing for VHF NFD.<br/>Wirral DARC: annual barbeque on Heswall shore.</p> |
|--|--|

	Brighton DARS: meeting. Note change to first and third Wednesdays of the month. Venue and time unchanged.	16 July	Chester DRS: treasure hunt. Maidenhead DARC: preparing for the McMichael rally. Fylde ARS: <i>visit to County Police HQ Control and Communications dept.</i> Wolverhampton ARS: <i>Demonstration of RTTY and AMTOR by G1DIL.</i> Bury RS: informal. Midland ARS: meeting.
4 July	N Wakefield RC: on the air night. Inverness ARC: meets every Thursday, 7.30pm, Cameron Youth Club, Planefield Road, Inverness. Horsham ARC: pre VHF field day natter. Maidenhead DARC: lecture. Preston ARS: preparing for VHF NFD and natter night.	17 July	Wirral ARS: problems night. Fareham DARC: meeting. Exmouth ARC: meeting. Denby Dale DARS: noggin n' natter. Wirral DARC: The Lighthouse, Wallasey D and W. Brighton DARC: meeting. Cheshunt DARC: natter nite. Preston ARS: informal meeting. Greater Peterborough ARC: junk sale. Chichester DARC: club meeting, Green Room.
5-7 July	<b>GB4CSB — 75 years of scouting in Chester — on HF and VHF from Eaton Hall, Chester.</b>	18 July	Sutton and Cheam RS: <i>Amateur Radio in the Early Days by G2MI.</i> Clifton ARS: meeting. Coventry ARS: open night. Maltby ARS: DF hunt. Dunstable Downs RC: <i>Awash in Norfolk by GOALB.</i>
5 July	S Manchester RC: preparing for VHF NFD. Nunsfield Hse CA ARG: final preparations for VHF NFD. Clifton ARS: meeting. Coventry ARS: treasure hunt and barbeque. Maltby ARS: treasure hunt.	19 July	Anglian mobile rally at Colchester. <b>McMichael ARS mobile rally at Stoke Poges.</b> Wolverhampton ARS: 144MHz DF hunt starting at 11am from Tettenhall Park. <b>Low Power Field Day 0900gmt — 1200gmt between 3.520 and 3.570MHz and 1300gmt — 1600gmt 7.01-7.04MHz.</b> Alyn and Deeside ARS: <i>Contest arrangements and the Use of Computers in Radio by G3VQT.</i> N Staffs ARS: VHF night on the air.
6-7 July	<b>VHF National Field Day — 70, 144, 432 and 1296MHz; portable operation only from 1400gmt to 1400gmt Sun.</b>	21 July	Chester DRS: <i>DX Trip to the Orkneys.</i> Wolverhampton ARS: night on the air and discussion night. Workshop ARS: <i>A Ham Holiday in Scotland, G3XXN.</i> Bury RS: informal. Kidderminster DARS: meeting. Dartford Heath DFC: pre hunt meeting at the Horse and Groom. Verulam ARC: <i>Radio Test Equipment by Marconi Instruments Ltd.</i> Reading DARC: final preparations for a sponsored special event station.
8 July	Alyn and Deeside ARS: DF hunt. N Staffs ARS: natter night plus special event station GB4SOT.	22 July	Three Counties ARC: <i>QRP and Home Construction by G4BCY.</i> Fareham DARC: <i>ATV Again by Popular Demand by G8VOI.</i> Stroud ARS: meeting. Denby Dale DARS: holiday special. Farnborough DRS: <i>RTTY by G8WMM.</i> Maidenhead DARC: <i>visit to satellite earth tracking station.</i> Cheshunt DARC: 2m portable on Bass Hill Common, Broxbourne.
9-13 July	<b>Chichester DARC operating GB2CHI in the afternoons, for the Chichester 910 Festival.</b>	23 July	N Wakefield RC: monthly meeting. Clifton ARS: meeting. Bromsgrove DARC: construction meeting. Coventry ARS: open night. Maltby ARS: <i>The Early Days of Amateur Radio by G3ZHI.</i>
9 July	Mid Warwickshire ARS: fox hunt Workshop ARS: Convert Your Radio from MW to top band. Chester DRS: surplus equipment sale. Westmorland RS: meeting. Wolverhampton ARS: <i>What's So Bad About CB Anyway? a discussion chaired by G8YFA.</i> Bury RS: informal. Newbury DARS: <i>From Berkshire to Box 88 — an illustrated talk at Newbury Technical College.</i> Reading DARC: <i>Receiver Front End Parameters and their Measurement.</i>	24 July	<b>GBORAR operated by the Reading DARC will be on all HF bands plus 2m and 70cm. The station will be 'sponsored' for the number of contacts it makes, the proceeds going to help</b>
10 July	Three Counties ARC: <i>Aerial Topics with Practical Wireless (who?).</i> Fareham DARC: natter nite on the air. Stroud ARS: meeting. Denby Dale DARS: <i>The IARU by G3PSM.</i> Hornsea ARC: natter nite. Wirral DARC: <i>Raynet by G4EFP and G8RXB.</i> Farnborough DRS: <i>HF Antennas by G5RV.</i> Cheshunt DARC: equipment evening, test gear available on demand.		
11 July	N Wakefield RC: <i>AMTOR by G3PSM.</i> Abergavenny and Nevill Hall ARC: meets every Thursday at the Pen-y-Fal Hospital, 7.30pm start.		
12 July	Clifton ARS: meeting. Bromsgrove DARC: main meeting. Coventry ARS: open night. Maltby ARS: <i>Cheap QRP HF Transceiver by G4BVV.</i>		
13-14 July	<b>Cray Valley RS: operating GB0DAN on HF, VHF-TV, and SHF-TV, at the Danson Park Show.</b>		
14 July	Wirral DARC: DF hunt <b>Droitwich Mobile Rally in Droitwich High Street. Further details from Brian G8ASO.</b> <b>Sussex Mobile Rally at Brighton Raceground.</b>	25 July 26 July	
15 July	Alyn and Deeside ARS: D and W. N Staffs ARS: construction help night. Todmorden DARS: informal natter. Worcester DARC: informal.	27-28 July	
16-20 July	<b>GB2CHI operated by Chichester DARC, afternoons only.</b>		



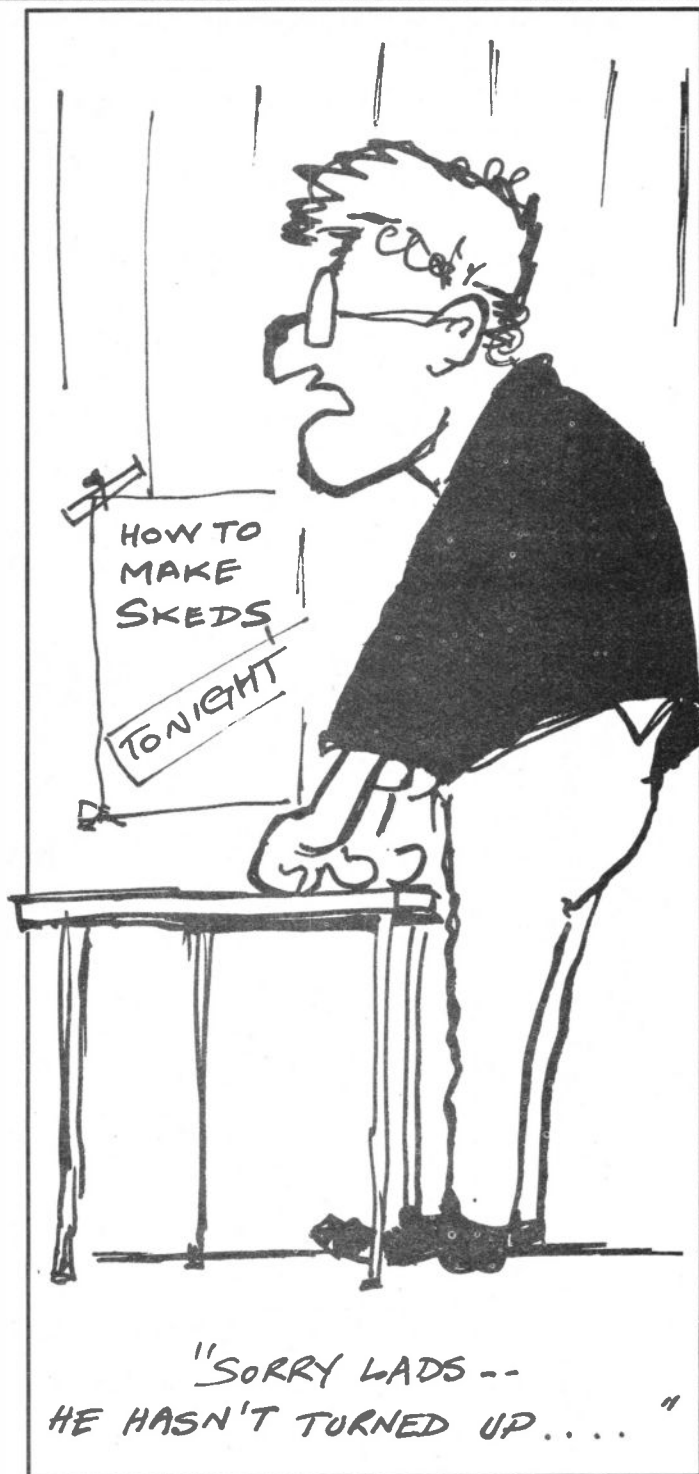

- the suffering in N Africa. There will also be a display of many different aspects of the hobby at the Shire Hall, J11 off the M4.
- 27 July RSGB 432MHz Low Power Contest from 1700gmt to 2300gmt.
  - 28 July Scarborough Rally.  
Dartford Heath DFC: DF hunt.  
RSGB 144MHz Low Power Contest from 0900gmt to 1700gmt.
  - 29 July N Staffs ARS: informal night.
  - 30 July Chester DRS: rig on the air.  
Wolverhampton ARS: committee meeting.  
E Lancashire ARC: informal.  
Bury TS: informal.
  - 31 July Fareham DARC: planning for summer portable operation.

- Exmouth ARC: meeting.
- Denby Dale DARS: holiday special.
- Wirral DARC: Revenge DF hunt for the G8PMF Rose Bowl.
- Cheshunt DARC: natter nite.
- 1 Aug N Wakefield RC: on the air night.
- Preston ARS: informal meeting.
- 2 Aug Maidenhead DARC: evening out.
- Coventry ARS: 2m DF contest.
- Maltby ARS: *three lectures in a row (!?)*
- Clifton ARS: meeting at New Cross.
- Dunstable Downs RC: *Radio Controlled Models.*
- 5 Aug Horndean DARC: *Salvage of the SS Great Britain.*
- Basingstoke ARC: natter night.
- Worcester DARC: *Contesting by G4ERP.*
- 6 Aug E Lancashire ARC: *visit to British Nuclear Fuels at Salwick.*
- Bury RS: informal.
- Fylde ARS: *visit to Lytham CAA radar station.*
- Kidderminster DARS: meeting.
- Chichester DARC: club meeting in the Long Room.
- Wolverhampton ARS: *visit to Police motorway control centre.*
- Dartford Heath DFC: pre hunt meeting at the Horse and Groom.
- Worksop ARS: fox hunt.
- Reading DARC: discussion of contest arrangements.
- 7 Aug Three Counties ARC: film night.
- Wirral ARS: meeting.
- Denby Dale DARS: noggin n' natter.
- Brighton DARS: meeting.
- Cheshunt DARC: junk sale.
- Fareham DARC: portable operation.
- 8 Aug N Wakefield RC: natter night.
- 9 Aug Bromsgrove DARC: main meeting.
- Coventry ARS: night on the air.
- Maltby ARS: junk sale.
- Clifton ARS: meeting.
- 11 Aug Dartford Heath DFC: DF hunt.
- Derby Mobile rally at Lower Bemrose School, St Albans Rd, Derby. Talk in GB3ERD.**
- Hamfeast '85 organised by RAIBC and Flight Refuelling ARS. Contact Elaine Howard on 0202 671191 for further details.**
- 13 Aug Wolverhampton RS: meeting
- Newbury DARS: informal at the Spotted Dog.
- Wolverhampton ARS: club project discussion.
- Reading DARC: *canal boat trip.*
- 14 Aug Exmouth ARC: meets at the Scout Hut, Marpool.
- Denby Dale DARS: Chairman's evening — G3YWI.
- Farnborough DRS: Field Day post mortem!
- Cheshunt DARC: natter nite.
- 15 Aug Fareham DARC: portable equipment.
- N Wakefield RC: lecture/visit.
- Preston ARS: final preparations for the rally.
- Chichester DARC: club meeting — Green Room.
- 16 Aug Maltby ARS: *Getting on 2m SSB Cheaply by G1CAQ.*
- Clifton ARS: meeting.
- Dunstable Downs RC: *Improving your DX on 2m by G8VR.*
- 17-18 Aug **Special event station GB2TC run by Tamworth ARC to celebrate 500th anniversary of Henry Tudor's visit to Tamworth prior to the**

**18 Aug** Battle of Bosworth. Operations on 3.5 and 144MHz from 10-8 Sat and 10-5 Sun from Tamworth castle.  
Wolverhampton ARS: 144MHz DF hunt.  
**RSGB 1296/2320MHz contest, 0700 – 1300gmt.**  
West Manchester RC Red Rose Rally at Haydock Park, Newton le Willows. Talk-in on S22 and GB2RRR from 10am.

**19 Aug** Worcester DARC: informal.

**20 Aug** Kidderminster DARS: meeting.  
Maidenhead DARC: video show.  
Midland ARS: *Amateur TV by G8GWN.*  
Wolverhampton ARS: *Fire Prevention and Fire Fighting by an officer of WM Fire Service.*  
Reading DARC: *RAYNET by G4KWT.*  
Fylde ARS: top band fox hunt.  
Workshop ARS: junk sale.

**21 Aug** Three Counties ARC: *2m DX by G3VXM.*  
Wirral ARS: meeting.  
Denby Dale DARS: noggin n' natter.  
Brighton DARS: meeting.  
Cheshunt DARC: 2m portable station.  
Fareham DARC: portable operation.

**22 Aug** Greater Peterborough ARC: informal social.

**23 Aug** Bromsgrove DARC: construction meeting.  
Maltby ARS: Spitewinter.  
Clifton ARS: meeting.

**24-31 Aug** GB8SDX and GB6SDX will be operational on 2m and 70cm from IO97 locator square, organised by City and Brunel Universities ARS using SSB, ATV, RTTY and Packet Radio modes.

**25 Aug** Preston Annual Rally at Lancaster University. Talk-in on 2m FM, entry 50p, open from 11am. Details G3DWQ.

**27 Aug** BARTG Rally at Sandown Park, Esher.  
Chester DRS: Pre SSB HF field day contest meeting.  
E Lancashire ARC: informal.  
Wolverhampton ARS: night on the air and discussion group.

**28 Aug** Exmouth ARC: meeting.  
Denby Dale DARS: rally wind down meeting.  
Cheshunt DARC: natter nite.  
Fareham DARC: portable operation.

**29 Aug** N Wakefield RC: monthly meeting.  
Preston ARS: *Audio visual evening by G3UEC.*  
Clifton ARS: meeting.

**30 Aug** **1 Sept** Cambridge Amateur Radio Rally at the Kelsey Kerridge Sports Hall, Gonville Place, Cambridge. Open from 10.30am.

**Will club secretaries please note that the deadline for the October segment of Radio Tomorrow (covering radio activities from 1st September to 1st November) is 26th July.**

### Contacts

Abergavenny & NH ARC	GW4XQH	0873 4655
Alyn and Deeside ARS	GW4RKX	0244 660066
Axe Vale ARC	Roger Jones	040 486 468
Barking RES	R. Woodberry	01 594 4009
Bath DARC	G4UMN	Frome 63939
Basingstoke ARC	Dave	07356 5185
Braintree RS	J. Roberts	0376 44857
Brighton DARS	Peter	0273 607737
Bristol ARC	G4YOC	Bitton 4116
Bury RS	Bryan	0282 24254
Cambridge DARC	D. Wilcox	0954 50597
Cheshunt DARC	Roger Frisby	0992 464795
Chester DRS	Alan	0244 40055
Chichester DARC	C. Bryan	0243 789587
Clifton ARS	Mr Hinton	01 301 1864
Coventry ARS	R. Tew	0203 73999
Dartford Heath DFC	Pete	0322 844467
Denby Dale DARS	G3SDY	0484 602905
Donegal ARC	EI3BOB	074 57155
Droitwich DARC	G4HFP	0299 33818
Dudley ARC	John	0384 278300
Dunstable Downs RC	Phill Morris	0582 607623
East Kent RS	Stuart	0227 68913
East Lancashire ARC	Stuart	0254 887385
Edgware DARS	John	01 306 4342
Exeter ARS	Roger Tipper	0392 68065
Fareham DARC	Brian	0329 234904
Farnborough DRS	Mr Taylor	0252 837581
Fylde RS	PRO	0253 737680
G. Peterborough ARC	Frank	0733 231848
Halifax DARS	DL Moss	0422 202306
Harrow RS	Dave Atkins	0923 779942
Hastings ERC	Dave Shirley	0424 420608
Haverhill DARS	Rob Proctor	0787 281359
Hazelrigg ARC	G1HDV	274 2413
Hornsea ARC	Norman	0262 73635
Horsham ARC	Pete Head	0403 64580
Inverness ARC	Brian	0463 242463
Kidderminster DARS	Tony	0562 751584
Leighton Linlade RC	Pete Brazier	052 523 270
Maidenhead DARC	John	0628 28463

Maltby ARS	Ian Abel	0709 814911
Medway ARTS	Andy Wallis	0634 363960
Midland ARS	G8BHE	021382 0086
Mid Sussex ARS	G1FRF	0791 82937
Mid Ulster ARC	DF Campbell	0762 42620
Mid-Warwickshire ARS	G4TIL	Southam 4765
N. Cornwall RS	J. West	0288 4916
N. Staffs ARS	G6MLI	0782 332657
N. Wakefield RC	S. Thompson	0532 536633
Nunsfield HCA ARG	G4PZY	Derby 767994
Preston ARS	George	0772 718175
Oswestry DARC	Brian	0691 831023
Reading DARC	Chris	Reading 471761
Rhyl DARC	GW1AKT	Nantglyn 469
Shefford DRS	G4PSO	Hitchin 57949
S. Bristol ARS	Len Baker	0272 834282
S. Lakeland ARS	Dave	0229 54982
S. Manchester ARC	Dave Holland	061 973 1837
Southdown ARS	P. Henly	0323 763123
Stockton DARS	John Walker	0642 582578
Stowmarket DARS	M. Goodrum	0449 676288
St. Helens DARC	A. Riley	051 430 9227
Swale ARC	B. Hancock	0795 873147
Telford DARS	Tom Crosbie	0952 597506
Three Counties ARC	R. Hodgson	0428 77368
Tiverton (SW) RC	G. Draper	03634 235
Todmorden DARS	Mr Gamble	070 681 2494
V White Horse ARS	Ian White	Abingdon 31559
Verulam ARC	Secretary	St Albans 59318
WACRAL	G4NPM	0795 873147
Wakefield DRS	G8PBE	0924 378727
Welland Valley ARS	J. Day	0858 32109
Welwyn Hatfield ARC	Dave	07073 26138
West Kent ARS	J. Green	0892 32877
Westmorland RS	G. Chapman	0539 28491
Willenhall ARS	G4LWI	0902 782036
Wirral ARS	Cedric	051 625 7311
Wirral DARC	Gerry Scott	051 630 1393
Wolverhampton ARS	Keith	0902 24870
Worcester DARC	D. Batchelor	0905 641733
Workshop ARS	G4ZUN	Workshop 486614
Worthing DARC	Jim Hicks	0903 690415
308 ARC (Surbiton)	Dave Davis	01 399 5487

# Free Readers' ADS!

## FOR SALE

**SALE/SWAP FISHING TACKLE** carbon float, sigma wand rods and two others ABU601, D.A.M. clipper reels tackle-box, landing and keep nets, banksticks etc. Swap for FT290R, FRG7700, WHY. Cash adjustment both ways money offers considered, inspection. Phone Michael Radlett 4172.

**TRIO TS130S** little used, SWR/Power meter, mic, 5 band G-whip antenna, £420 ono. Or p/ex 2m portable. Tel Leigh (0942) 729516.

**YAESU FT290R** plus NiCads, charger and 30W linear amplifier, all in v.g.c. £300, or will exchange for HF rig plus or minus cash balance. Phone 0953 607068.

**SALE OR SWAP** complete 2m station Trio 9000 multimode. Matching B09, SP120, PS20. Mobile mount, 7/8 whip, gutter clip, base 3 x 3/8 colinear, rotator, beam. v.g.c. £475 or swap for FT77, TenTec Argosy or similar. WHY? Tel Seaford (0323) 898515.

**FOR SALE** Pye 19" 6-channel video monitor £50. ICL 14" green screen video monitor £50. Phone Wokingham 782236.

**QRP/QRO TEN-TEC** Argosy analogue, 500Hz xtl filter AF filters PSU., Icom 751 plus CW filter Drake R4C NB 250Hz filter, Trio VFO120 Icom 215 2m portable NiCads charger, Ian G3YRQ (0942) 679948 moving QTH.

**YAESU FT290R** for sale. Also FL2010 10W amplifier and mobile mount bracket complete with carrying case, NiCads and charger, and mobile antenna £280 the lot. Contact Wayne on 01-423 6870 after 6pm (Harrow).

**GEN BOOK** 75A1 S38 to S43 various national NC183 HR07 RME 45 84 various aircraft + marine circuits £2.50 (0434) 603085.

**Yaesu FT290R** unmodified with NiCads charger and carrying case. All in v.g.c. £210. G4RRH QTHR Tel Felixstowe (0394) 272045.

**COMPLETE STATION** Trio 9000 multimode, scanning mike, mobile mount, matching B09 Sp120, PS20. Mobile 7/8 whip, gutter clip and calbe. Base 3 x 3/8 colinear, rotator with control box, cable 8 ele Yagi. £475. No offers. Seen working. Seaford (0323) 898515.

**100 WATT** audio amp including transformer, no case £35. 3A, 12V Farnell PSU £15. Phone Collin (85) 77075 or write Simon, 8 Ripon row, Halton Lodge, Runcorn, Cheshire. WA7 5YT. Plus Rad coms PW's etc. Inquire for prices. Buyer collects.

**KW2000A TRANSCEIVER** complete with matching power unit and manual in good condition £100. To inspect and collect telephone Aubrey Leeds 0532 674766. G4OOD QTH.

**COMMUNICATIONS RECEIVERS**, trio Lafatette, both complete with 2m converters £65 each. Rotator AR1002 new, still boxed £30. Buyer collects. Phone John 0705 261399.

**TRIO 830M** as S model but with AM as well. 2 years old, excellent condition, superb audio quality includes mobile supply unit. New price £830 first £550 secures. Manchester area ring Brian 061-904 9853.

**VHF UHF FDK750E** and 430 expander. 2m and 70CMs mobile multimode, LO/HI power, dual VFO's, repeater shifts, auto toneburst. Boxed as new with handbook. Sold complete with Diplexer and dual band mobile antenna £350. Bought TS780 G1EJE Burntwood (05436) 72275.

**PET 2001**, fully expanded twin discs, mint. Also complete BBC B set up approx 1 year old. Offers. Or will swap or px for station equipment, transceiver etc. Phone John 051-420 3628.

**HEWLETT PACKARD 180** dual beam 50MHz scope £150 or exchange for FT290R multimode or similar. 0376 29089, Henry.

**FDK 750E** 2m multimode

trans. £250, or will swap for FRG7700 or a good general coverage rx. Ask for Rick, 0302 26080.

**FT290R** new NiCads carrying case, never used. Charger etc four months old £225 or p/x for older HF rig. Must have CW and be in good order, prefer FT7B, TS120 QRP or FTDX501 similar or why. Telephone 0293 515711.

**PS430 POWER SUPPLY**, 20A 13.8V, suits most HF rigs or 2m rig + 100W linear: £90. 2m transverter module fits any Yaesu transverter frame £85. Wanted FT902dm, possible p/x on any of above. Buyers collect. Phone 0625 527250. (Manchester Area).

**FOR SALE** Yaesu FT480R only used as base station. Offers around £320. Kenpro KR400 rotator only used 4 months, 10 element J-beam no rot, 5/7 amp PSU all open to offers. QRM forces sale. No time wasters please. Tel Hennesford 77648.

**HEWLETT PACKARD 140A** scope with 1400A differential amp and 1422 timebase plugins £150 ono. Would consider p/x for smaller. D/B scope. Metrosound ST20 stereo amp £20. ICE 680R multimeter £20 ono. tel 031 333 2610 after 6pm.

**35MSLR CAMERA** Konica FS-1 motorwind autoloader. 35-70 autozoom. X2 converter. Semi-Fisheye/Macro dedicated flash. Slave flash tripod etc. Excellent value £260+. Exchange 934 setup/Gencover RX AOR2001 WHY. Cash either way. Phone Frank weekday/evenings Ipswich 682678.

**PRINTER** Commodore CBM 2023 suit PET £50. Wanted HF bands VFO and ATU. Non workers considered. Telephone Caterham (Surrey) 42829 evenings.

**TRIO TS711E** 2M base station transceiver, fitted with VS1 speech synthesiser, in perfect condition. Under Lowe agents guarantee. £750. No offers, prefer buyer inspects and collects. Ring FH Watts QTHR. Newent (Glos) 820960.

**TANDY CB** handheld cost £130, with extension microphone, accept £65. 44MHz crystals for two metres £1.50 each. SWR meter and extension speaker for CB £5 both mike, 2 Woodside, Wimbledon, London SW19. Tel 01-946 2967 and ask for Jane.

**SSTV MONITOR** venus SS2 self contained factory built £125. Pne Romford 47998 G4FQF QTHR.

**BARGAIN** complete SWL station cost £1,080, sell for £900. Includes HF/VHF, SSB/CW, RTTY reception aerials for VHF/HF receiver R2000 in mint condition. Ask for details. Will split but would prefer not all items. Boxed. 0436 71262.

**CO DE MASTER CWR 600** CW and RTTY reader v.g.c. £110. Phone Andy, Southampton 782545.

**YAESU FT480R** very good condition, proven receiver. Box and manual mobile mount microphone etc. £295 ono. Telephone Wellinboro' (0933) 677573. Has worked 27 countries in two years!

**JIL SX200N** scanning receiver 26 to 514 MHz £160. Plus Disccone antenna £15. Phone Cowes 0938 297084.

**SALE** VHF valves also obsolete types pre-war, post-war. Books, periodicals, manuals, service infor, meters, crystals, transformers, large SAE for lists. Wanted any Ten-Tec gear. Trowell, 'Hamlyn', Saxon Avenue, Minster, Sheerness, Kent ME12 2RP.

**FOR SALE** FRG7700 & FRT7700 no mods £250 or swap for KW2000B or HW101 or similar HF gear. Telephone (0406) 362610 Les G4ZID QTHR.

**KENWOOD TS 430HF** transceiver, Kenwood AT200 ATV power supply, dummy load, MC 60 mike, SP 930. All as new, cost new £1500 plus, offers. 0705 376008. No time wasters please.

**TS 711E** 2m base all mode stn, 40 memories, speech processor, voice synthesiser if shift, mains powered 2-30w output etc. £675. FT480R

mobile multimode £275. Wanted TS780, 471k, 451, 221R/225RD, FT780R. Phone Reading (0734) 596495 after 9pm or week-ends.

**JAYBEAM D5/2M** £15. Pye Vanguard modified for 2m FM, S18 and S20, £20. Teletype KSR33 with stand, vgc, £35. Two army 19 sets, £10 each. Rotator Hirschman RO250 with cable £30. All ono. Wanted Shimizu 105S. G4SXH Tel 0242 571223.

**ICOM IC-251E** with mutek front end used very little, also IC-R70 receiver with FM. Tested but never used. Both rigs in superb condition, £450 each or £850 for both. Tel Ian, G6NKB QTHR 0509 502989 after 6pm.

**TRIO TR9000** multimode 2 meter mint £285. Tokyo 85 watt linear with preamp £85. Dummy load 120-450 MHz 150 watt £15. HF 100 watt Solid state wideband linear 3.5-30MHz 5-20w input with preamp £85. Tony G4XBY. Tel Markfield 243248.

**YAESU FT790R** 70cm multimode as new condition £280 ono telephone Glasgow 641 7203.

**TWO CREED 75RR ZX81** offers or exchange for anything of interest. Chris, 188 Low Derw, Trehafrew, Newtown, Powys.

**TRIO TS120V QRP** HF transceiver 20 watts input £275. Matching TL-120 100 watt linear amplifier £125. Both items are boxed and in good clean condition. Complete with workshop manual, mike, leads etc, postage paid. Phone Graham G4VOE 061-740 4126 any time.

**YAESU FR-101** receiver 160, 80,60,40,31,25,20,19,-16,15,13,11,10,6,2 meter bands instruction manual in perfect working order £225 ono. Ring Michael 01-958 8516 G11DN.

**SINCLAIR SPECTRUM 48K** plus cassette recorder, Scarab RTTY CW (unused) CW decoder (new) many books, programs both amateur data games £150 ono WHY? HF vertical (surplus) £40. Martyn Bolt (G4SUI) 112 Leeds Road, Murfield, West Yorks WF14 0JE tele 0924 495916.

**MILITARY SPEC** general coverage receiver covers VLF - 32MHz all modes, good

filters, solid state, compact size, for full specs and photo send SAE new £4000 selling £???. Martyn Bolt, 112 Leeds Road, Murfield, West Yorks WF14 0JE tele 0924 495916.

**FOR SALE** Swan 100MX tcvr 80-10m £275. Trio TM-20IA 3m 25w fm, boxed £200. Heathkit RF-IU sig gen £20. G4AFY QTHR Kidderminster. (0562) 753358.

**ELBEX 906** monochrome surveillance video camera with wall mount, mains PSU, 'zoom' lens/'pan' function, good condition £55 ono. 23cms brass PA cavity (single 2C39) £55 ono. 23cms inter digital filter, good £25 ono. Phone Paul G4XHF Crawley (0293) 515201.

**PRESIDENT "GRANT"** transceiver AM-SSB converted 29MHz, perfect £65. Collectors item, Marconi key, type 365A, all brass, with brass base, as new £35. Japanese mech., bug key, new £18. Telephone 0274 728219.

**FT707** £300; **FC707** £50; **FT101E** £275; **FDK multi 2700** £225; **Trio 9R/590S** £40; **Tono 9000** £350; **VDU** £25; **Sinclair Spectrum 48K** £50; **Scarab RTTY** £50; 6ft mobile Moonraker £25. Phone Tunbridge Wells 30819 or Crowborough 62790.

**COMPLETE RTTY/CW station.** TRS 80 level II, plus VDU. Still boxed, dedicated Macrotronics terminal, software interface and manuals. Multiple band, ASCII, CW, 300 words per minute. Complete £250 or will separate. Exchange for other radio equipment considered. Telephone Bob GM1LYT 0563 35738.

**FOR SALE** FT243 crystals 3530, 7005, 7010, 7015, 7020, £3 each. Also Codar PR-40 preselector £8. Wanted very low frequency VLF receiver. Write Marris, 35 Kingswood House, Farnham Road, Slough, Berks SL2 1DA.

**COMPLETE RTTY** receiving station Sait receiver VLF-HF, all modes, Tono 550 decoder, green monitor £800. Hammarlund receiver SX400 valve type, beautiful ex-Cunarder £200. Mains PSU 300 VDC 140mA +6.3V £30. Marine fixed frequency Tx/Rx 'Call Buoy' £125. 01-660 0794.

**COMPLETE 2 METRE** setup

**FT290R (LOI)**, NiCads, charger, case, portable whip, rubber duck, mobile mount, mobile antenna, 12W linear, MM100/30 linear/preamp, 10dB beam antenna, manual, diagrams £350. Telephone 01-551 2169 (Dave) Ilford, Essex.

**YAESU** communications receiver FRG-7000, excellent condition £190. Lea-Valley 761965.

**TRIO TS700S** multimode transceiver no mods vg condition. Dual bander forces reluctant sale. Rig covers 2 metres all modes. £385. Tele: Disley (std 06632) 4840.

**FOR SALE** Belcom LS102L 26-29MHz £185 as new little used Nato 2000 £100 Turner 500 mic 75 watt Bremi £37. Phone 0283 221870.

**FOR SALE** AOR 240A two meter handheld transceiver with, helical charger, beltclip, earphone 144 to 149 MHz £80 or nearest offer for this great little rig. Contact Roberts 40 Partridge Way, Duffryn, Newport, Gwent NP1 9WN.

**TR2400** as new 144-148, charger, leather case £140. **SX200N** scanner 26-514 MHz with SSB adaptor £230. **FRG7700M** £260. **FT101** workshop manual £17.

Polaroid 350, £55. Record-a-call answering machine, remote 80a; £100. Telephone Hants 0730 892143 Mr May. **YAESU FT790R** UHF multimode includes up/down mic, case, strap, Ni-Cads and helical whip mint condition, only a few weeks old, £265 ovno. Carriage at cost. Graeme, G6CSY, Orpington, (0689) 29230 evenings.

**TS7730 2 METRE** FM tcvr scanning, mic, memories, 25 watts, manual, £180. MC50 desk mic, £20. HK708 Hy-Mound morse hand key £10. Sinclair Spectrum, 48K, PSU manual £60. G4KWA, 01-777-9061.

**COMMODORE 64** with 1541 disk, MPS801 printer, cassette and RS232 I/F, Basic, Pascal and Assembler compilers on disk. As new £450. Contact Stuart G4MIB QTHR 01-675 0280.

**AMT-2** AMTOR, RTTY and CW terminal unit £145. Roland MB121A 12" amber monitor £75. T432 144-432MHz power SWR meter £25. Lowe FX1 GDO £15. All as new. Contact

Stuart G4MIB QTHR 01-675 0280.

**SX-200 SCANNER** covers 26-57.995MHz 58-88MHz 108-180MHz 380-514MHz AM FM plus new Disone antenna £185. Also pair Celestion Ditton 22 hi fi speakers handling cap 80 watts including stands quality sound £65. All items excellent condition. Telephone Runcorn 711393. Cheshire.

**KENWOOD TR7730** scanning FM transceiver 25 watt output, good condition £190. Or p/x adjustment if necessary. Sentinel auto HF pre-amplifier £10. Microwave modules MML/100HS linear amplifier with pre-amp 10 or 25 watt drive 100 watt output FM/SSB as new £150 ono. Martin Wills G3ZZS, 21 Woodford Road, Glenholt, Plymouth PL6 7HX.

**SALE OR EXCHANGE** FT707 as new still in original packing for FT101ZD or similar. Phone Dave on Northampton 36914.

**YAESU FGR7** HR Rx with timestep DFC and FM detector. Handbook included. All in perfect working order. £80 G6WJZ QTHR 0527 77963.

**FOR SALE** SB102 Tx/Rx 180w DC input ham bands, spkr, p/supply £180. SX62AU Hallicrafters gen/cov 500kHz to 108MHz £70. SX71 Rx 500kHz-54MHz £75. All good con-DX. WW2 mine detector, complete and working! £50 ono want FR101 Rx digital readout. 0908 314095.

**TOP OF RANGE** Bearcat 300 scanner covers 30MHz 512MHz in 5kHz steps, 50 ch memory. 11 preset channels, fire, air, ham 220 and 12V. £250 ono. Contact Colin Grellis, 8 Dreadnought, Bridport, Dorset. Tel 0308 24340 for complete details.

**YAESU FT-290R** virtually unused, as new, boxed, 8 months old. Also NiCads charger and carry case. £250 the lot. Telephone Norman on Medway (0634) 715209.

**FT290R** new £300, FT102+FM, mint £565, FT230R £230, TS120S £430, TR2300 £110. C58 £240, FT7B digital £335, KDK2030 £190, all mint. Tel 0792 401058. Wanted: P40 tower.

**FOR SALE** Cobra 148 mk3, 26.065-28.300 and also alpha's. President Grant 5A

26.515-28.500 plus power supplies plus President Grant AM & sidebands 40 channel & mid. Offers to (0463) Inverness 236491.

**FOR SALE Yaesu FT-757GX** 0.5-30MHz Tx/Rx little used 4 months old. Boxed with hand microphone, operating and technical manuals, £650 ono. Tele 01-471 0669 after 5pm.

**RADIO YESTERDAY** for sale wartime type 311 portable transmitting/receiving equipment 1.6m, PA grid 3-16, crystal 3-8, with powerpack 90/250V or 6V battery, "spares box" and manual in 2 watertight 13" x 11" x 6" containers — best offer circa £140. Phone Mitchell (Cornwall) 221.

**TRIO TR9130** 2m multimode, memories, 25W RF, complete with mobile mount, 5 ele X Yagi and mic. Excellent condition, used only as base station. £330. Ten Tec Argonaut 509 5W CW/SSB HF transceiver. Superb QRP rig. Full break in, excellent condition £220. Ireland 01-348-9780 (on holiday till 10th July).

**LAFAYETTE 1200FM Tx/Rx.** 26.515-27.855MHz. Very good condition. Will convert to 28MHz easily. Sell £45 or exchange fully regulate 13.8V PSU, rated 15 amps or more. 021 355 3173.

**FT301 CW250HZ** xtal filter, would exchange for 500Hz or offer. 036283 8142 John G4BYV QTHR.

**YAESU FT301** 100 watts HF transceiver with all filters fitted complete with Psu £300 ono. Phone G3KLV 0604 48091 after 6pm.

**TRIO R1000** £180. UL1000 RF amplifier/preselector, 1.8-30MHz, £25. LAR VHF omni-match £20. LAR linear omni-match £10. Buyer inspects and collects. Wanted HF band transceiver and 144MHz valve linear. Tel (0772) Preston 635560. Mike G3TSL.

**YAESU FT902DM** all modes, CW filter, DC-DC power unit, blower, mic, Yaesu FC902 ATU, excellent unit. Yaesu FV901DM, synthesised VFO, with 40 memory channels, normal tuning, fast/slow auto/man scan. All equipment complimentary and mint

condition. Can be tested in my shack. First £600 secures the lot. Ring Mr Jones on 0934 28563.

**FOR SALE Icom IC202** all crystals, NiCads, charger £100 ovno. G8ZCC QTHR. FDK 2m transceiver 1-25 watts, variable FM only, ideal mobile rig. Complete with accessories. As new £160. Tel Alan on Wrexham (0978) 840473 after 5.30pm or write to Gernant, 39 Brynglas, Rhos, Wrexham, Clwyd, North Wales LL14 2EA.

**SALE OR SWOP** video — Genie EG3003 computer £85. Metx 402 flashgun with NiCad and charger £55, or exchange for HF gear, WHY G1DGO, 3 Limes Road, Folkstone, Kent. **FOR SALE Trio 9130** 2m multimode, transc. 40W box/packing etc, mint cond used little. £350 Bearcat 220FB VHF/UHF scanner. Mains 12V OPE £150 G4FQF QTHR. Phone Peter, Romford 47998. **DISC DRIVE**, 400K 80 track, double sided, Shugart. For BBC or Shugart compatible computer. As new, £150. Telephone Nottingham 503312.

**SX-200N** VHF scanning receiver 26-514MHz with discone antenna £220. Yaesu FT-202R handheld transceiver one watt 2 metres R1 R2 R7 S-20 S-21 S-22 with rechargeable batteries £80. Mike De-Wynter, 2 Woodside, Wimbledon, London SW19. Telephone 01 946 2967 and ask for Jane.

**TS500 Tx/Rx, TS500 PSU** and external VFO 80-10 mtrs, including spare valves. Excellent for beginner, £120 ono. Tel: 0442 212891 extn 236 office hours only.

**COMMODORE MPS 801** printer with box of paper in vgc would exchange for FRG7700 or FRG7 in good working order. Or sell £140. G1HYU Tel King's Lynn 766018 ask for Ken.

**FT101ZD FM MK3, FC902 SP901P**, 1Kw dummy load, all excellent condition £600. Buyer must collect. Andrew, Clitheroe (0200) 24716.

**FILTER CW 250Hz** for TS530S FT Special 8830.7kHz. Cost \$60, unused £20 for sale. GM3DOD QTHR or phone Greenock (0475) 23742.

**SPACEMARK ETM-3** electronic squeeze keyer, 8 to 50

wpm no need to switch off — idling 1uA takes 4 size AA batteries (built-in) battery holder. First offer of £50 secures. Telephone 0698 424347 after 6pm.

**TOWER 30'** high, tilt over base. All alloy construction. Base 15" square tapering to 6" square at bearing plate. Breaks down into 3, 10' sections. Custom built at a cost of £380. Will accept £195. Tel Ian Brooks, Blackpool (0253) 890003.

**G2DYM CUSTOM** built '8 trap' dipole, covers 10,15,20, 40,80,160 metres and WARC bands, 1000W power rating. Was £133 good. £50 ono. Also GP27 aerial (3 radials) £10. Phone Accrington (0254) 392072. Also Stolle antenna rotator new, packed with switch £30.

**STANDARD C5F00** 2m multi mode 25/1W as new, original packing, mobile mount, six months old, still under guarantee £320. G6OCH QTHR 01 647 6334. Wanted FT230R or TR7800.

**NEW 250 VA** mains isolating toroid £15. RS mains isolating transformer 500VA £10. G4CLF board 9MHz version £40. Pye UHF base F460 will convert 70cms £40. G8HUA 0274 875066 after 6.

**2 METRE FM monitor** 144-146MHz VFO plus 11 xtal controlled channels (3 xtals fitted — R0 R3 and R6) ideal fixed/mobile. 12 volt stand/mobile mount, instructions. £45. Tel Bristol 776891 evenings/weekends.

### EXCHANGE

**EXCHANGE FLDX500 Tx FRDX500 Rx** for QRP rig or sell £200 plus carriage. Sale IC22 2m FM low, 14 channels crystallised, £70 ono plus postage. Lucas FM Tx/Rx 10m £25 ono plus postage. Mr McAllister, 2/11 Dunphail Road, Brucefield Park, Glasgow G34 0BX.

**SUFFOLK Super Colt** lawn mower exchange for communication receiver value £80. If more cash adjustment G1IQM QTHR Church Stretton 722131 any time.

**RADIO CONTROLLED yacht**, 3 sets sails plus sail winch. Radio controlled "off-road" racing car with Enya 21CX, new, never used. Will sell or px for Yaesu 757 or FT290 or WHY. Tel Shrewsbury 0743 67087. **EXCHANGE** Yamaha outboard

3.5HP for Yaesu FRG7 cash adjustment if required Tadley 2476.

**EXCHANGE Trio 9R59DS** general coverage receiver 0.15MHz plus cash straight swop for FT7B or FT7 after 6pm, Tony 051 260 9723.

**WANTED** 70cms multimode or ATV gear WHY, in exchange for bedroom fitments including continental headboard. Telephone G6XMY on 0773 604965 for full details.

**COLT EXCALIBUR SSB** 1600DX AM FM LSB USB 4 band covers 26.515MHz to 28.305MHz mint condition exchange, for general coverage receiver preferably with VHF converter must be in excellent condition, possible cash adjustment. Phone Ron (05097) 3901.

**EXCHANGE FT290R** with 20 watt amp & preamp, NiCads etc, for FT480R. Phone Peter 0328 51781.

**EXCHANGE** new Webley Omega 177 air rifle, complete with sling and case. Total value £150. For 144/28 2m transverter with AM and SSB. Contact Brian GM1IUX 041 472 3968.

### WANTED

**WANTED** power supply unit for a Yaesu FT200 SSB transceiver (grey). MJ Goodall, 1 Sheinton Road, Cressage, Nr Shrewsbury SY5 6DH. Tel Cressage 596.

**PEN FRIEND** — 14 years old, I will write to a girl or boy — I collect pictures from hit songs. I like reading and swimming. I will write soon, preferably to England. Mike Odighauser, 9043 KarlMarxStad, Johann-Richster Str 1, East Germany.

**INFORMATION** signal generator CT218 105/16780 valve voltmeter A/S by CR LTD, Edinburgh. I have info, lots steam radios and TV. Initially call reverse charge after 6pm. Jim 051 336 1907. Will defray expenses or send valves components.

**WANTED** any info, c/ diagrams or spares for HR0600 or someone to sort out fault on mine it is solid state. For sale Senith 7000 portable 12 bands LW to 30megs & SSB & 88 to 174 megs this cost a fortune new, £220 or WHY Brian 736 6581.

**WANTED** Hallicrafters SX-42 Rx any condition, set for rebuild. Also SX-88 SX-101 Rx or manuals why. G4AFY QTHR Kidderminster.

# Free Readers' ADS!

*Buy, sell or exchange your gear through our free service to readers*

## CONDITIONS

1. These advertisements are offered as a free service to readers who are not engaged in buying or selling the same equipment or services on a commercial basis. Readers who are should contact our advertising department who will be pleased to help.

2. Advertisements will be inserted as and when space becomes available.

3. The insertion of advertisements will be on a first-come, first-served basis, subject to condition (2). As a result, it will not be possible to guarantee the insertion of a particular advertisement into any particular issue of the magazine.

4. Readers should either write out their advertisement in BLOCK CAPITALS or type it, underlining any words that are to appear in bold.

5. The magazine cannot accept any responsibility for printers' errors in the advertisements; however, we will do our best to ensure that legibly written advertisements are reproduced correctly. In the event of a gross error, at the Editor's discretion, a corrected version of the advertisement will be printed (at the advertiser's request) at the earliest issue in which space is available.

6. The magazine or its publishers will not accept responsibility for the contents of the advertisements, and by acceptance of these conditions,

the advertiser undertakes to indemnify the publisher against any legal action arising out of the contents of the advertisement.

7. The magazine reserves the right to refuse to accept or to delete sections of advertisements where this is judged necessary.

8. Advertisements are accepted in good faith; however, the publisher cannot be held responsible for any untruths or misrepresentations in the advertisement, nor for the activities of advertisers or respondents.

9. Advertisers must fill in their names, addresses and (if available) telephone number in the space provided, and sign the form to indicate acceptance of these conditions (forms returned without a signature will not be used).

10. All that is to be reproduced in the advertisement should be entered into the space provided on the form printed in the magazine – note that a photocopy is not acceptable. All advertisements must give either a telephone number and/or address for respondents to contact, and this must be included in the wording of the advertisement.

11. Advertisements must be 40 words or less in length (telephone numbers normally count as two words, exchange or exchange code plus number).

Name .....

Address .....

.....

.....

I accept the conditions above.

Signature .....

Send this form to: Free Readers Ads, Ham Radio Today,  
1 Golden Square, London, W1R 3AB

**ENTER YOUR ADVERTISEMENT HERE:**

# EMPORIUM GUIDE

## LEICESTERSHIRE

**ELLIOTT ELECTRONICS**  
FOR THE RADIO ENTHUSIAST

28-28 BRAUNSTON GATE,  
LEICESTER. TEL: 553283  
Open: Mon-Sat 9.00am to 5.30pm



## TYNE & WEAR

Approved Dealer  
**ALYNTRONICS**  
**ICOM**

129 Chillingham Rd, Newcastle-upon-Tyne  
Tel: 091-276 1002  
Open: Tues-Sat 10am-6pm



## NORFOLK

**D.P. HOBBS (Norwich) Ltd**  
13 St. Benedicts Street, Norwich  
Tel: 615786



Open Mon-Sat 9-5.30  
Closed Thurs  
Stockists of **ICOM**  
YAESU, FDK, ICOM, JAYBEAM  
& Electronic Component Specialists

## W. MIDLANDS

**DEWSBURY ELECTRONICS**

RXs from YAESU, JRC, ICOM  
Stockists of microwave modules, B.N.O.S. M.L.T.,  
HAMMA, DATONG, ICS, TASCOS

Open Mon-Sat, 9-30-5.15  
176 Lower High Street  
Stourbridge (0384) 390063



## LANCASHIRE

**AMATEUR ELECTRONICS U.K./HOLDINGS**



Yaesu, Tel, Jaybeam, Frequency  
Counters, Drae, Datong, FT101  
Experts. Repairs, G3SBC, 12BY7 A,  
6KD6, RF Clipper, Double Balanced  
Mixer, Warc Kit etc. S.A.E. List 15  
min. Junc. 31 M6. Free parking.  
45 Johnston Street  
Blackburn BB2 1EF  
(0284) 89595  
CLOSED THURSDAYS

## EIRE

**RADCOMM ELECTRONICS**

25 Riversfield, Co. Cork, Eire  
SUPPLIERS OF YAESU, ICOM,  
DATONG, SEM, JAYBEAM, BNOS,  
RHF CABLES, CONNECTORS,  
ROTATORS, MOBILE ANTENNA  
AND LOTS MORE!



RING (021) 632725 anytime for details.

**HEWARD'S HOME STORES LTD.** (Est. 1963)

822/4 Kingstanding Rd., Birmingham  
B44 9RT. Tel. 021-354 2083  
G4RJM with 38 years in The Radio Trade  
Ham Equipment urgently wanted!  
Open: Mon-Sat 9-6

## LONDON

**DRESSLER UK LTD**

191 Francis Rd, Leyton, E10  
Open 9-5.30pm Monday-Friday 10-5 Saturday

Authorised dealers for:  
Dressler, Yaesu, Icom, Standard, Trio/Kenwood,  
Datong, SCM, Microwave Modules, Tonna  
Tel: 01-558 0845/556-1415 Telex: 8953609

## WALES

**WARD ELECTRONICS**

DIAWA  
LOWE PRODUCTS  
CC/M/MODORE  
COMPUTERS



HOKUSHIN  
ICS AMTOR,  
RTTY EQUIPMENT  
RSGB BOOKS

G3LIV PCB'S FOR SSVT/RTTY  
FOR RADIO ENTHUSIASTS

422 Bromford Lane, Ward End  
Birmingham B9 2RX  
Tel: 021-328 6070 (Closed Monday)

**PROTEL AERIALS AND COMMUNICATIONS**

Manufacturers and suppliers of aerials and accessories, DXTV  
equipment and aerials also other specialist aerials. Large range of  
bracketry and masts also available.

29-297 Ballards Lane, N12. Tel: 01-455 4441  
TRADE ENQUIRIES WELCOME

10m conversion for FMCB rigs £30 + £1.50 p&p  
Details on request.

**BEAMRITE**

Amateur Radio and CB stockists,  
TV aerials, telephone and computer  
accessories

Open 9-1.00pm Mon-Sat 2-5.30pm

Weds closed after 1.00pm

19 Broadway Roath, Cardiff

Tel: (0222) 486884 or 460266



**R. WITHERS COMMUNICATIONS**

584 Hagley Road West  
Oldbury, Warley B68 0BS

(Quinton B'Ham) Tel: 021-421 8201/2/3

Opening hours 9.00-5.30pm. Late nights Thurs-Fri.

For all your communication requirements send SAE for  
latest used list and latest info.



## SCOTLAND

**JAYCEE ELECTRONICS**

JOHN GM30PW  
20 Woodside Way, Gelsenrothes, Fife KY7 5DF

Tel: 0592 756962  
Open: Tues-Sat 9-5



Quality secondhand equipment in stock. Full range of  
TRIO goodies. Jaybeam - Microwave Modules - LAR.

## AVON

**Booth Holdings Bath**

6 GOLF CLUB  
LANE,  
SALTFOORD,  
BRISTOL

Tel: 02217 2402

Open Tues-Sat 9am-9pm  
Close Mondays

## SURREY

**GUILDFORD COMMUNICATIONS**

34 Aldershot Rd., Guildford

Open Mon-Fri 8am-6.30pm  
Sat 8am-5.30pm

Secondhand wanted



ASDEN  
TOTSUKO



0483-574434

**ICOM**

**SCOTCOMMS**

OPEN TUES-FRIDAY 10am-12.30pm. 2pm-5pm

SA1 9am-1pm. 2pm-4pm. CLOSED MONDAY

25 Morton Street, Edinburgh 15

Tel: 031-657-2430



Radio Communications  
Amateur P.M.R. Member

**UPPINGTON**  
Tele-Radio Ltd

12-14 PENNYWELL ROAD, BRISTOL, BS5 0TJ

KENT

**Thanet**  
ELECTRONICS  
95 Mortimer St, Herne Bay  
Tel: (0227) 369464  
Open Mon-Sat 9-5.30pm  
except Thursday 9-1pm

MIDDLESEX

**AMCOMM**  
Authorised Icom dealer  
OPEN 10am - 5.30pm TUES-SAT. CLOSED MONDAY  
NORTHOLT RD., S. HARROW  
MIDDLESEX  
TEL: 01-422 0985

YORKSHIRE

• RADIO AMATEURS' AND 'C.B.' PEOPLE TALK TO •  
34 NEW BRIGGATE LEEDS LS1 6NU  
**LAF** COMMUNICATIONS CENTRE  
ELECTRONIC COMPONENTS - TELEPHONES  
VIDEO - AUDIO LEADS - STYL  
LEEDS LS2 6ST the PROFESSIONALS!  
**UNICE** TELECOMMUNICATIONS  
**TRIO ICOM YAESU**  
LARGE RANGE OF ACCESSORIES

NOTTINGHAM

**SCARAB SYSTEMS**  
AMATEUR RADIO SOFTWARE  
STOCKISTS  
39 Stafford Street, Gillingham 0634-570441  
please see main advertisement

**R.A.S. (NOTTINGHAM)**  
P. Owen G8UUS  
3 FARNDON GREEN; WOLLATON PARK  
NOTTINGHAM: TEL: 0602 280267  
Open: Tues-Fri 10-5.30. Sat 9-5  
YAESU: FDK: ICOM: TONNA  
HALBAR: WELZ: ANTENNAS & OWN GW5 H.F.

4 Cross Church St, Huddersfield Tel: 0484 20774  
Open: 6 days 9-5.30  
Closed Weds. Thurs 9am-8pm  
G4MH Mini Beam, Trio & Yaesu  
Always a good selection of new & 2nd hand equipment in stock  
**Amateur Radio Shop**

**DON'T LEAVE IT TO CHANCE!**  
— GIVE YOUR BUSINESS A BOOST  
BY ADVERTISING IN HRT  
PHONE 01-437 0699 FOR DETAILS

**HAM RADIO TODAY** **NEXT MONTH**

**COMPUTA DX**  
*Graphically display and predict 'grey line' HF openings on a BBC 'B' to get ahead with DX!*

**2m OMNI**  
*Build our high gain antenna and save money!*

**TESTING! TESTING!**  
*Companion test equipment for your oscilloscope - dual beam capability - 'in circuit' component tester*

**A FRESH LOOK AT THE FT401**  
*Modifications and servicing advice from G3LLL*

**HAM RADIO TODAY, AUGUST 1985 ADVERTISERS INDEX**

- Aerial Systems .....5
- A.K.D. Ltd .....21
- A.J.H. Electronics .....21
- BNR&ES .....21
- Cirkit Distribution ..... 11
- Commutech Ltd .....21
- Dressler (UK) Ltd .....7
- Dewsbury Electronics.....O.B.C.
- Farnborough Communications.....25
- RAS Nottingham .....25
- Scarab Systems .....25
- Technical Software .....25
- Timestep Electronics.....17
- WPO Communications .....21

*Don't forget, when calling an advertiser, mention Ham Radio Today — It helps them and us.*

**73's Dave Gadsden, G4NXV, Advertisement Manager**



## Lineage:

35p per word (minimum 15 words)

**Semi Display: (minimum 2 cms)**

£7.00 per single column centimetre

Ring for information on series bookings/discounts

All advertisements in this section must be prepaid.

Advertisements are accepted subject to the terms and conditions printed on the advertisement rate card (available on request)

01-437 0669

EXT 323

Send your requirements to:

Caroline Faulkner

ASP Ltd.,

1 Golden Square,

London W1

## EQUIPMENT

### USED AMATEUR EQUIPMENT?



## I BUY, SELL & EXCHANGE!

**SELLING?** I pay the BEST POSSIBLE PRICES for clean used equipment!!

**BUYING?** I have the BEST SELECTION of TOP QUALITY USED EQUIPMENT AVAILABLE!!

Whether buying or selling phone Dave, anytime, for a deal you've been looking for on

HORNCHURCH (040 24) 57722 ANYTIME, or send SAE for latest list to:

## G4TNY AMATEUR RADIO

132 Albany Road, Hornchurch, Essex RN12 4AQ.

## BOOKS AND PUBLICATIONS

### SERVICE MANUALS

Ham Concorde 2, Ham multi-mode 2, Ham Jumbo 2, Ham Viking, Ham Puma, Cobra 148 GTL DX, PC 879 and PB010. Colt 1600 DX, Tristar 777, York 863, York 861.

All above at **£6.00 + £1.00 p&p** each.

Other, rigs and spare parts available.

10m conversion for FMCB rigs **£30 + £1.50 p&p**  
Details on request.

### CBT

1 Prince of Wales Road, Swansea. (Tel: (0792) 463821.

## HOLIDAYS

**SELF-CATERING CHALETs.** Explore by day, DX by night. My aerials, your rig £15-£120 per chalet per week. Green, Goats, 'Chylean' Tintagel, Cornwall PL34 0HH. Tel: (0840 212262).

## RTTY

### RTTY - CW - AMTOR

Now on the Dragon

### Complete set of Programs & Hardware

to convert your DRAGON 32/64 into a complete communications terminal.

**Morse transceiver**  
Program (Cassette) **£10.75**  
Interface (Module) **£17.50**

**RTTY**  
Program (Cassette) **£12.00**  
Terminal unit of modules **£39.00**

**AMTOR**  
Program (Cassette) **£39.00**  
Clock/Switch Module **£18.00**

Programs also available in Cartridge. Hardware available in kit or fully boxed form.

For full details send 2x 17p stamps to:-

**PNP Communications (HT)**  
62 Lawes Avenue, Newhaven  
East Sussex BN9 9SB  
Tel: (0273) 514465  
Prices include postage but not VAT

## COURSES

**COURSES - RADIO AMATEURS EXAMINATION** City & Guilds. Pass this important examination and obtain your licence, with any RRC Home Study Course. For details of this and other courses (GCE, professional examination, etc.) write or phone — THE RAPID RESULTS COLLEGE, Dept JN2, Tuition House, London SW19 4DS. Tel: 01-947 7272 (9am-5pm) or use our 24 hr Recordacall Service: 01-946 1102 quoting Dept JN2.

## CARDS/STICKERS

**PLASTIC / MEMBERSHIP / CARDS**, laminated cards, lapel badges, all made to your specification. **KARDLINE**, P.O. BOX 206, Wootton Bassett SN4 7EZ. Tel: 0793 853406.

**QSL CARDS.** Many designs, reasonably priced. Free samples, please state if S.W.L. **DEROGA PRINTING**, Whitewell Rd., Sparham, Norwich NR9 5PN.

**HIGH CLASS QSL CARDS.** Competitive prices, free artwork. SAE for samples stating ham or breaker to: J.S. Coates, 57 Worrall Street, Morley, Leeds LS27 0PJ.

**QSL CARDS.** Gloss or tinted cards. SAE for samples to **TWROG Press**, Dept HRT, Penpont, Gillilydan, Blaenau Ffestiniog, Gwynedd.

## KITES



**KITES** for portable aerials. Hand-made of ripstop-nylon. Many signs from £9.95. S.A.E. for catalogue. **D.I. KITES**, 20 Embay Rd., Lower Stanwick, Southampton. Tel: 04895 3026.

## MISCELLANEOUS

### PERSONALISED LEATHER BELTS HAND MADE

**LEATHER BELTS**  
in-top quality cowhide with solid brass buckle

**£7.50 +50p p&p** (colours brown, tan, black)

Other personalised leather goods made to order

**Crawton Leather Co**  
Lampton, Sandness  
Shetland Isles  
Tel: Sandness 286

## ALARMS

**BURGLAR Alarm Equipment.** Please visit our 2,000 sq. ft. showrooms or write or phone for your free catalogue. **C.W.A.S. Ltd.**, 100 Rooley Avenue, Bradford BD6 1DB. Telephone 0274 731532.

## ANTENNAS

**G2VF DIY loop Antennas** for H.F. long and medium wave bands. SAE for details: Rylands, HRT, 39, Parkside Ave., Southampton SO1 9AF.

## KITS

### TRUTONE MODULES

For serious repeater users  
Toneburst and timer module combined on one board. For operating a transceiver with any 2 metre F.M. repeater in the UK. Accurately times transmission providing both visible and audible warnings at end of pre-determined period when user is about to time-out through repeater. SAE for details. Price £12.50. Timeout or toneburst board supplied separately at £7.50 each. All prices inc P&P.  
**TRUTONE MODULES**, 56 Norman Rd., Saltford, Bristol BS18 3BH.

## BUSINESS OPPORTUNITIES

**MULTIPLY** your income/profits working for yourself with the breakthrough **ENTREPRENEUR ASSOCIATION**, part-time or full-time. Send SAE for valuable free details: Atlantic Press, Dept P6(1), 9 Cork Stret, Mayfair, London W1.

## SERVICE MANUALS

**SERVICE MANUALS.** Amateur Radio Test, Audio, Television, Video etc. S.A.E. enquiries, **Mauritron (HRT)**, 8 Cherrytree Road, Chinnor, Oxfordshire.



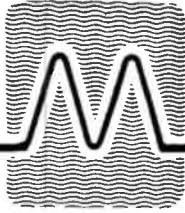

# MICROWAVE MODULES LTD

Microwave Modules Ltd. Is a full time professional organisation, established over **16 years** ago in **1969**, and currently employs over **30 full time**, on site staff based in our two modern, purpose built factories. In addition, a similar number of 'Outworkers' are involved in assembly and mechanical operations.

## OUR EXTENSIVE RANGE . . .

Our product range now exceeds **50 individual items** in total and is the widest range available from any one manufacturing company. Our technical resources have enabled us to not only become **the largest and most successful** designer and manufacturer of R F Products, such as **Linear Amplifiers** and transverters, but also designers and manufacturers of **innovative** microprocessor and digital products such as **The Morsetalker**, MMSI, and the RTTY to TV decoder, MM2001.

## ALL BRITISH . . .

Every product in our range is designed and manufactured in the UK by our own employees, and wherever possible British Components are utilised.

## GUARANTEED . . .

All Microwave Modules Products are **Fully Guaranteed for 12 months**. This includes all semi-conductors and **PA Transistors**. We have built our reputation around our customer service and back-up and it is second to one.

## OUR RANGE OF LINEAR AMPLIFIERS . . .

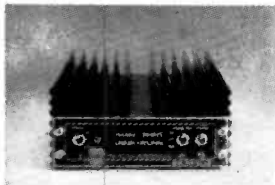

MML144/30-LS

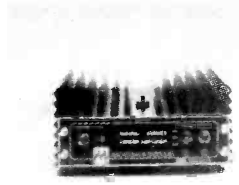

MML144/50-S

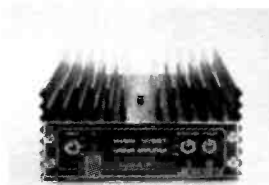

MML144/100-LS

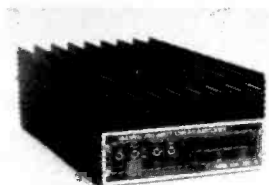

MML144/200-S

PRODUCT	INPUT POWER	OUTPUT POWER	MODES OF OPERATION	Pre Amplifier		POWER REQUIREMENTS	RF * VOX	PRICE INC VAT
				GAIN	NF			
MML144/30-LS	1 or 3W	30W	SSB.	12dB	<1.5dB	13.8V @ 4A	✓	£82.90 (p&p £3.50)
MML144/50-S	10W	50W	FM.			✓	£92.00 (p&p £3.50)	
MML144/100-S	10W	100W	AM.			✓	£149.95 (p&p £4.00)	
MML144/100-HS	25W	100W	CW.			✓	£149.95 (p&p £4.00)	
MML144/100-LS	1 or 3W	100W				✓	£169.95 (p&p £4.00)	
MML144/200-S	3, 10 or 25W	200W			✓	£299.00 (p&p £5.25)		

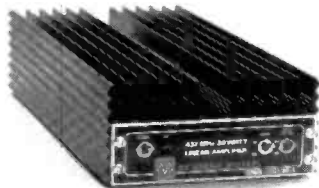

MML432/30-L

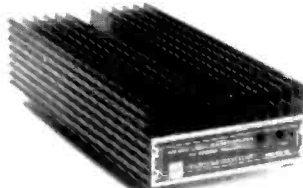

MML432/50

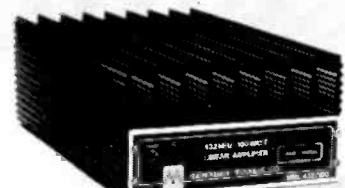

MML432/100

PRODUCT	INPUT POWER	OUTPUT POWER	MODES OF OPERATION	PRE AMPLIFIER		POWER REQUIREMENTS	RF*	PRICE inc VAT
				GAIN	NF			
MML432/30-L	1 or 3W	30W	SSB.	12dB	2dB	13.8V @ 6A	✓	£145.00 (p&p £4.00)
MML432/50	10W	50W	FM.	12dB	2dB	13.8V @ 8A	✓	£129.95 (p&p £4.00)
MML432/100	10W	100W	ATV. CW.	—	—	13.8V @ 20A	✓	£299.00 (p&p £5.25)

\*THE RF VOX CAN BE OVERRIDDEN AND HARDWIRED.

## CONNECTORS . . .

144MHz Products — Our standard connector on these products is SO239. We use a high quality PTFE socket of superior quality, but we are able to supply the choice of BNC or 'N' type at no extra charge. Please specify

432 MHz Products — The MML 432/30-L's fitted with BNC connectors, 'N' type available, please specify. The MML432/50 and MML432/100 both have BNC input sockets and 'N' type output sockets. If this is not to your preference please specify when ordering.

## DATA SHEETS . . .

A full printed data sheet is available on each product, and is free on request.

## CATALOGUE . . .

A copy of our latest catalogue can be obtained free of charge on request.

## AVAILABILITY . . .

Our products are normally available from stock, either direct from ourselves or any of our 75 UK outlets.



VISA

WELCOME

## MICROWAVE MODULES Ltd

BROOKFIELD DRIVE, AINTREE, LIVERPOOL L9 7AN, ENGLAND  
Telephone: 051-523 4011. Telex. 628608 MICRO.G  
CALLERS ARE WELCOME, PLEASE TELEPHONE FIRST

HOURS:  
MONDAY-FRIDAY  
9-12.30, 1-5.00  
E & O.E.

# DEWSBURY



# ELECTRONICS



FRG 8800 £559



TRIO R600 £299



NRD 515 £965

## NEW PRODUCT NEWS

**IF YOU'RE THINKING ABOUT C/W YOU MUST READ THIS!**

- ★ Iambic Keyer ★ Dash/Dot Memory
  - ★ Keying Speed 1 — 55 wpm
  - ★ Built In Side Tone Oscillator And Speaker ★ Headphone Socket
  - ★ Variable Weight Control ★ Side Tone Volume And Pitch Control
  - ★ Switchable Automatic/Semi Automatic Keying/Tune Control ★ Operation From Internal Batteries Or 9 — 15v. External Supply ★ Low Current Drain
  - ★ British Made ☼
  - ★ Selectable Positives or Negative Keying
- 5 YEAR GUARANTEE**  
 Only £49.95 + £3.00 P&P To Include External Power Leads And Plugs.

APPROVED  
**TRIO**  
DEALER

APPROVED  
**TRIO**  
DEALER

## IF IT'S TRIO IT MUST BE DEWSBURY

A FULL RANGE ALWAYS IN STOCK



TRIO R2000 £479



IC — R 71E £699



**POCOMOTOR AFR2000 RTTY ALL MODE DECODER**  
AFR8000 with built-in display now available. Write for details.

(Now with CW option) From £425



**STAR MASTER — KEYER**

SEE REVIEW IN THIS ISSUE

Stockists of DAIWA — MET ANTENNAS — MUTEK — WOOD & DOUGLAS — TASCO TELEREADERS — MICROWAVE MODULES — ICs AMTOR — AEA PRODUCTS — DRAE

**Dewsbury Electronics, 176 Lower High Street, Stourbridge, West Midlands.**

Telephone: Stourbridge (0384) 390063/371228

Telex: 337675 TELPES G



Instant finance available subject to status. Written details on request.

