

# HAM

AN ARGUS SPECIALIST PUBLICATION

JANUARY 1985

# RADIO

99p

## GOING 'MOBILE!'

## TODAY

Constructing  
Mobile  
Antennas  
for the HF  
and LF  
Bands

Diplexers and  
Dual Band  
Antennas  
for 2m and  
70cm

**PLUS**

Microwaves from a Mustard Tin

PROJECT OMEGA 100W  
RF Amplifier



ATV — G8PTH looks  
at the latest from  
Wood and Douglas



# HAM RADIO CONTENTS

VOLUME THREE NO.1 JANUARY 1985

**Acting Editor**  
Steve Ireland, G3ZZD  
**Editorial Assistant**  
Julie Darby, G1CKF  
**Group Editor**  
Dave Bradshaw, G1HRT  
**Advertisement Manager**  
Dave Gadsden, G4NXV  
**Classified Sales Executive**  
Jason Inskip  
**Chairman**  
Jim Connell

**Designed by:**  
MM Design & Print

**Published by:**  
Argus Specialist Publications Ltd.,  
1, Golden Square,  
London W1R 3AB.  
Telephone: 01-437 0626

**Distributed by:**  
SM Distribution Ltd.

**Printed by:**  
The Garden City Press Ltd.

**Subscription Rate**  
UK £14.50

O/Seas Sur: £16.00

USA Sur: \$21.00

O/Seas Air: £31.00

Ham Radio Today,  
Subscriptions Dept.,  
Infonet Ltd,  
Times House,  
179 The Marlowes,  
Hemel Hempstead,  
Herts HP1 1BB  
Tel: (0442) 48432



Ham Radio Today is normally published on the first Friday in the month preceding cover date. The contents of this publication including all articles, designs, plans, drawings and programs and all copyright and other intellectual property rights therein belong to Argus Specialist Publications Limited. All rights conferred by the Law of Copyright and other intellectual property rights and by virtue of international copyright conventions are specifically reserved to Argus Specialist Publications Limited and any reproduction requires the prior written consent of the Company. © 1983 Argus Specialist Publications Ltd. All reasonable care is taken in the preparation of the magazine contents, but the publishers cannot be held legally responsible for errors. Where mistakes do occur, a correction will normally be published as soon as possible afterwards. All prices and data contained in advertisements are accepted by us in good faith as correct at time of going to press. Neither the advertisers nor the publishers can be held responsible, however, for any variation affecting price or availability which may occur after the publication has closed for press.

## TODAY

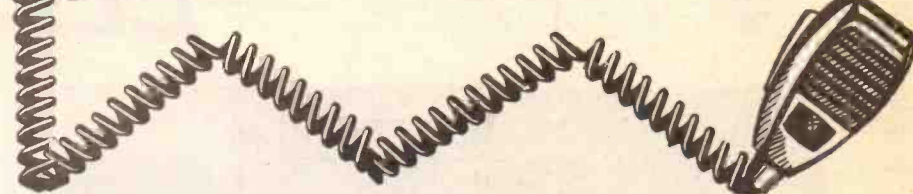

## REGULAR COLUMNS

LETTERS .....	.4
RADIO TODAY .....	.6
PRACTICALITIES .....	.32
METREWAVE .....	.52
RADIO TOMORROW .....	.56

## CONSTRUCTION

MICROWAVES FROM A MUSTARD TIN .....	16
<i>A cheap, entertaining and educational project from Frank Ogden.</i>	
MOBILE 'WHIPS' FOR HF .....	36
<i>Here are the in-depth constructional details you can't find in books.</i>	
PROJECT OMEGA ALL MODE TRANSCEIVER .....	44
<i>In Part 9 G3WPO and G4JST describe the construction of the QRO PA.</i>	
ANTENNA DISCHARGER .....	55
<i>Protect your transmitter or receiver from lightning and static discharges.</i>	

## FEATURES

PLANTING A TOWER .....	20
<i>Do a little spadework with Nigel Cawthorne, G3TXF.</i>	
DIPLEXERS AND DUAL BAND ANTENNAS .....	24
<i>Use 2m and 70cm? You could be in for a shock...</i>	
FAULT FINDING FOR RADIO AMATEURS .....	28
<i>In the final part G14FFL looks at methodology and individual component testing.</i>	

## REVIEWS

ATV AND THE WOOD & DOUGLAS FM DOWNCONVERTER ....	12
<i>Andy Emmerson looks at 24cm ATV and the latest product for the band.</i>	
ADDENDUM .....	12
NEXT MONTH IN HRT .....	54
Free Readers Ads .....	59
Emporium Guide .....	63
Classified .....	65
ADVERTISEMENT INDEX .....	66



- FACTORY APPOINTED IMPORTED
- FREE SECURICOR ON MAJOR ITEMS

# AMATEUR ELECTRONICS



## THE FT2700R 2M and 70cms FM DUAL BAND MOBILE

(Full details and prices available shortly)

**YAESU'S LATEST TECHNOLOGY, AVAILABLE SOON**

## THE FT270R THE VERY LATEST IN YAESU'S MOBILE FM TECHNOLOGY

(Full details and prices available shortly)



### AGENTS

**WALES & WEST**  
ROSSCLARE GW3NWS  
0632 880146

**SHROPSHIRE**  
SYD POOLE G3IMP  
0952 812834

**NORTH STAFFS**  
BOB AINGE G4XEK  
0528 754553

### BRANCHES

**NORTHERN**  
AMATEUR ELECTRONICS UK/HOLDINGS,  
45 JOHNSTON ST., BLACKBURN  
0254-59595

**YORKSHIRE**  
AMATEUR ELECTRONICS UK/HOOKER  
42 NETHER HALL RD., DONCASTER. 0302 25690

**INSTANT HP AVAILABLE**  
WRITTEN DETAILS ON REQUEST



**504-516 ALUM ROCK RD.,**  
TEL: 021-327-1497 or 021-327-6313.

# AE LIMITED

- FACTORY BACKED EQUIPMENT
- FREEPOST — MAIL ORDER ENQUIRIES.



**FT209R**



• **FT709R**  
70cms version of the 209R. 430-440 coverage.

**FT203R**



• **FT703R**  
70cms version of the 203R. 430-440 coverage.

## YAESU'S HANDY PORT- ABLES

(Full colour brochure and specifications upon request).

**STOP PRESS**

## FRG8800. THE NEW STATE OF THE ART FULLY COMPATIBLE COMMUNICATIONS RECEIVER

- LCD. ■ MULTICOLOURED S/SINPO "BAR GRAPH" INDICATOR.
  - YAESU CAT SYSTEM. ■ 12 MEMORIES. ■ COMPATIBLE WITH MOST PERSONAL COMPUTERS.
  - 21 BUTTON KEYPAD. ■ 8 BIT CPU. ■ 24 HOUR CLOCK.
  - SCANNING FACILITY. ■ ALL MODE SQUELCH. ■ IFs. 47.005MHZ. AND 455 KHZ.
  - COVERAGE 150KHZ to 29.999MHZ. ■ MODES.
- AM (WIDE/NARROW). SSB. (USB/LSB). CW (WIDE AND NARROW 800HZ).  
FM (NARROW) FM WIDE (OPTION). *CONTACT US NOW FOR FURTHER DETAILS.*

**EAST ANGLIA**  
AMATEUR ELECTRONICS UK/  
31 CATTLE MARKET ST.,  
NORWICH. 0603-667189

**SOUTH WEST**  
AMATEUR ELECTRONICS UK/UPPINGTON  
12-14 PENNYWELL RD., BRISTOL. 0272-557732

**EAST MIDLANDS**  
AMATEUR ELECTRONICS UK/RAS NOTTS  
3 FARNDON GREEN, WOLLATON PARK,  
NOTTINGHAM. 0602-280267

**S.E. MIDLANDS**  
AMATEUR ELECTRONICS UK/AJH  
151a, BILTON RD.,  
RUGBY, WARWICKS.  
0788 76478

FREEPOST —  
MAIL ORDER  
ENQUIRES



AMATEUR ELECTRONICS LTD  
FREEPOST  
BIRMINGHAM B8 1B6

**BIRMINGHAM 8.**

OPEN 9.30 - 5.30 TUES-SAT. CLOSED MONDAYS.

• AKD • BNOS • DATONG • MUTEK • MICROWAVE MODULES • TONNA • HI MOUND • TET • JAYBEAM

# RADIO TODAY

Further details of Doctor DX are available from ICS Electronics, on 024365 590.

## Software 'Refresh'

### Space Invaders For Radio Hams . . . !

People who want to develop their CW contest operating skills may be interested in a new computer game from the USA. Called the 'Doctor DX', a small module plugs into the back of your Commodore 64 and enables you to participate in a presumably life-like reconstruction of a worldwide DX CW contest.

A transceiver appears on your TV screen and can be manipulated by touching the function keys on the computer. The program emits the Morse transmissions — including QRM — through the computer loudspeaker. By entering your position and time of day, the conditions become appropriate to your location in a sunspot maximum period. All 304 countries are represented and weighted according to their amateur population.

The real test of your skill as an

operator comes when you plug your Morse key in and attempt some contacts. If you are good — according to the module — the station you have called will reply. This enables you to score points — as in the real thing. There are slower Morse stations on the upper section of each band and faster stations towards the bottom of it.

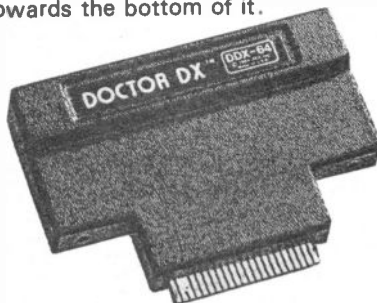

Currently attracting rave reviews in the US, Doctor DX is supposed to help to improve your contest operating ability without "embarrassing" yourself, or having to wait for a contest to come along. But at a cost of £96.95, plus £1.50 p and p, it will be a lot cheaper to swallow your pride and enter a contest, after all, everyone has to start somewhere! G1CKF

This month the new releases fall into two main categories. The largest of these is that of 'Morse Tutor' type programmes. First up is a Morse tutor for the Amstrad CPC464, a fairly new and economic machine which has received some good reviews in the computer world.

The program which is available on cassette takes "a structured approach to the problem of gaining proficiency in the sending and receiving of morse code." Five modes of operation are possible:-

- (1). Structured tutor.
- (2). Specify letters to be practiced.
- (3). Select random words from internal library.
- (4). Type in text to be coded.
- (5). Load text from data cassette.

Over two hundred words are available in the standard internal library and they have apparently been chosen "to cover a wide range of letter combinations". Further words or text can be loaded into the program from a previously prepared data cassette. This feature is useful in setting up a dummy-run of the morse test.

A separate program is supplied on the tutor cassette for the preparation of data tapes. The speed range is from 4 to 24 words per minute and has been timed using the standard 'PARIS' test word.

Figures are included as a separate section in the structured tutor and can be intermixed with letters in the "text" modes. Punctuation characters may also be mixed with text and figures in the "text" mode.

The program is available on cassette price £6.90 including VAT and post and packing from: PNP COMMUNICATIONS, 62 Lawes Avenue, NEWHAVEN East Sussex. BN9 9SB (0273) 514465.

Next up is a Morse tutor for the Spectrum 48K, one of an ever increasing number of tutors for this machine, and is intended "for the complete beginner." Using as much colour as possible, this tutor is entertaining as well as educative. Eight separate programs can be chosen from the menu and the Morse speed is variable upwards from about 3wpm. One of the programs goes continually through the Morse alphabet, with an accompanying display to drum the alphabet in. An unusual feature is that of 'Rest' which takes the form of an interval and takes

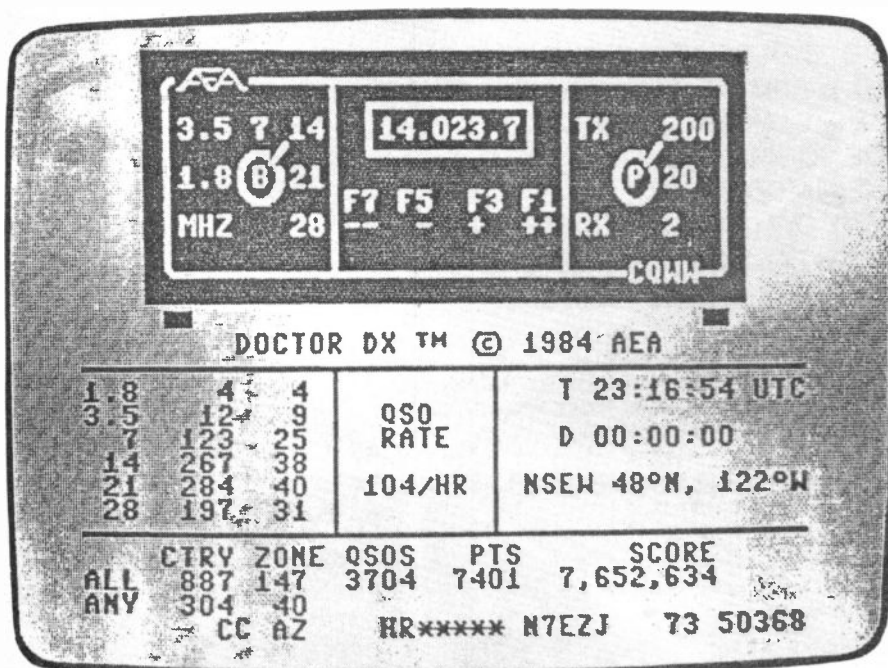

the stress out of learning Morse.

The tape is available from Harold Bentley, "Sixty-One", Vale Crescent South Ainsley Estate, Nottingham NG8 3PQ.

Also for the Spectrum 48K is an

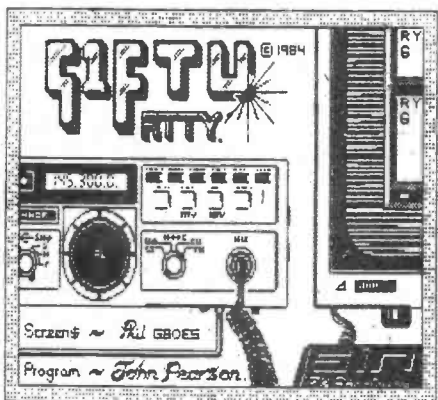

RTTY Tx/Rx program from Pearsons Computing written by G1FTU. This allows the 48K Spectrum computer to transmit and receive RTTY with *no* interface or terminal unit. The user simply connects the EAR and MIC sockets on the Spectrum to the external speaker and audio input (or MIC) of his or her transceiver.

The program features split-screen operation with full type-ahead during receive and transmit, and the user has his or her own personalised CQ memory and eight other memories, of up to 255 characters each, which may be saved on cassette.

Other features include baud rate variable between 45 and 110 baud, variable transmit tones, on-screen tuning indicator, unshift-on-space, and the program has the capability to receive reversed 'mark' and 'space' tones.

The program also provides the user with a unique 'clarifier' facility for tuning accurately to FM RTTY tones.

Pearsons Computing claim that the program "will run correctly on *all* issues of the 48K Spectrum, including those fitted with microdrives, printer, joystick interface, etc" — so that you don't have to dismantle the system in order to use the program — as with some of the amateur radio and other software on the market today.

The program costs £10 inclusive and orders from licenced amateurs should be accompanied by a callsign for

the CQ memory. Non-amateurs will apparently be allocated a 'dummy' callsign.

Further details may be obtained from John Pearson at 42 Chesterfield Road, Barlborough, CHESTERFIELD, Derbys (0246) 810652.

Finally, we have a Morse transmit and receive program for the Oric-1 or Atmos Computers. This is of French origin and is retailed by a company called "No Man's Land".

The claimed main features are: complete decoding of Morse alphabet; automatic speed adjustment; direct input to low level source or loudspeaker output without interface; audio frequency selection by programme; filtering of short duration interferences; memory of 10240 characters; possibility of saving screen and memory on cassette; simultaneous or delayed impression on decoding; monitoring function enabling user to hear the signal 'filtered by the Oric.

Full, if a little confusing, instructions of how to connect your Oric-1/Atmos to your receiver/receive section are given. The instructions connecting your computer to a transmitter are rather sketchy and would be inadequate for the novice, I feel. That being said, at a quick glance the program itself seems very good and I am not aware of a program of this kind for Oric computers being available from another source.

Further details may be obtained from "No Man's Land, 110 bis, Avenue du General Leclerc, 93500 Pantin, France.

## Up, Up and Away

Access Equipment Ltd. have come up with a versatile 'Zip Up' aluminium scaffolding for building radio masts. These masts can be up to 300ft high if you have the planning permission — and are made up of 'Zip-Up' stairway sections of heavy gauge tube and built-in platforms. The ease of construction is apparently enhanced by the lightness of the frame and the easy clip-on structure.

Recently, Access Equipment supplied a 300ft radio mast to the RAF at

North Luffenham. The special rigging team of 8 RAF personnel, who were accustomed to 'Zip-Up' equipment, managed to erect the complete tower in 2 days.

However, if you are considering this sort of tower for your garden, the price for a 6ft platform, 19ft 10" high is £1127.30 exclusive of VAT.

Further information can be obtained from the company on 0442 60101.

'Zip-Up' Tower — 300' in two days!

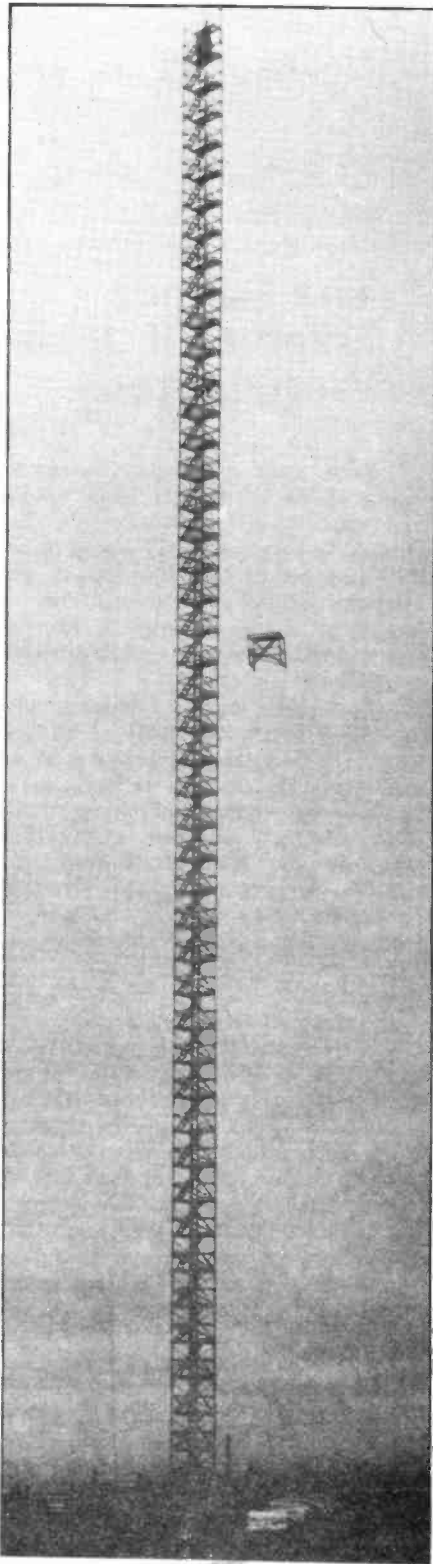

Yaesu's new  
FRG8800  
(see  
'FRG8800  
Out Now!')



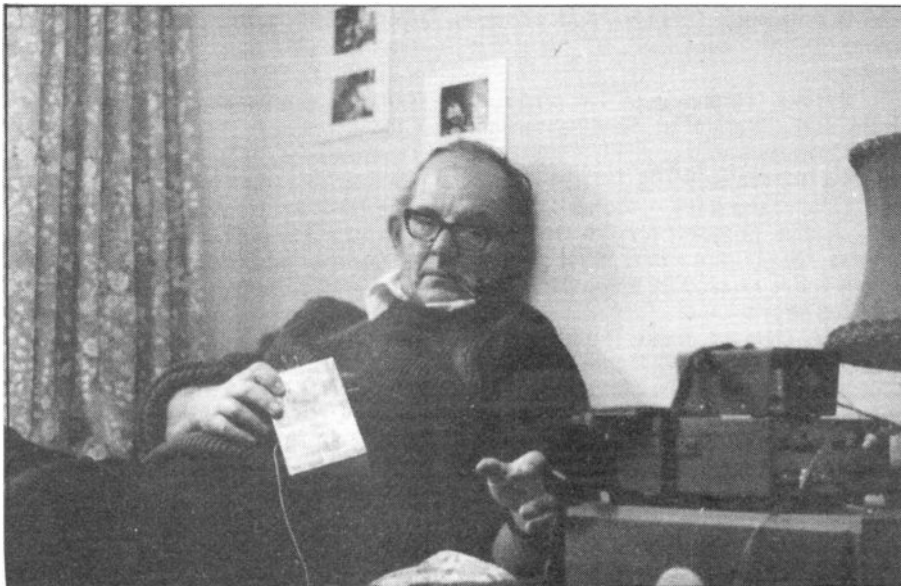

John Worthington, keyer in hand, relaxing on 80m with an FT7.

## The Curious Enigma Of John Worthington

Every now and again the Editor gets a phone call from a reader who is curious about HRT cartoonist GW3COI, alias John Worthington. He has to admit that he knows little about this strangely elusive man, except that he has been drawing cartoons for the amateur radio press for well over twenty years.

Occasional reports surface of him appearing at the CW ends of 80 and 40m. The only tangible evidence of his existence apart from his cartoons lies in the monthly invoice submitted to the HRT offices headed somewhat enigmatically "Piano Tuning and Repairs, John Worthington". That is, until the photo shown nearby and the following text arrived in the office. . .

"Dear Ed,  
 Photograph shows a rare picture of GW3COI working A/ in a fairly 'safe house'. He is of course using CW and the equipment is a borrowed FT7 and home brew iambic keyer. The operator is in a semi-recumbent posture, enabling him to assume an appearance of slumber fairly rapidly should he hear the approaching footsteps of the xyl with instructions for some urgent household chore. At the time of the photograph all hell was being let loose on the low end of eighty metres as it was the Annual Worked All Cherished Veteran Car Registration Numbers under which conditions a gentle ragchew at 18 wpm is quite an achievement, as can be seen from the clenched face of the emigrated Englishman. (He found later he had bitten through another pipe stem — and this without his teeth).

There is little doubt that ten watts to a random wire on such occasions is about as useful as a rubber duck in a lead mine and soon 'COI had no need to mime slumber. Look out for further pictorial evidence of his wide spectrum of activities. 73 'COI'

Well, we're waiting. . .

## Multi Standard Terminal Unit from PNP Comms

PNP Communications have announced that their new multi-standard "matched-filter" type RTTY/CW receive only terminal unit is now available.

PNP seem to have aimed this unit at the serious SWL who has the necessary home computer and can interface their communications receiver to it. The matched filter-rectifier-integrator design appears also to make the unit suitable for demodulating morse from 'CW reader' type programs.

The terminal unit is made up of 2 active filter chains: one fixed at 1275Hz for "space", the other can be switched to one of three frequency shift positions:-

1445Hz for 170Hz shift, 1700Hz for 425Hz shift. 2125Hz for 850Hz shift (used for Morse reception). It also has an ALC to compensate for signal fading and a "bar-graph" indicator for accurate tuning. It can receive signals above 200 bauds, including AMTOR and commercial TOR transmissions. Compatible TTLs are used for normal and inverted signals.

At present it is supplied ready built

for £32.50 plus VAT, but kits, we are assured, will be available soon. For further details contact PNP Communications on 0273 514465.

## Low Cost 'Radio Modem' From ICS

The Sussex based firm of ICS Electronics have been extremely busy of late. Seldom a month has gone by of late without a press release of a new product appearing on the Editor's desk.

Previously known for their slightly expensive but very high quality AMTOR and RTTY terminal units, ICS have recently introduced a new, versatile low cost terminal unit for the beginner, experimenter or VHF operator.

Requiring 12 Volt DC input at 150mA, the RM-1 connects to a home computer via either TTL or RS232 level interfaces (both are supplied as standard). It can be used to send and receive RTTY or AMTOR at up to 100 Bauds with 170Hz shift. Also available are CW send and receive and wide band ASCII communications at up to 1200 Bauds. European IARU tone standards are supported and the wide band receive mode can be used for receiving commercial 425, 850Hz shift RTTY, as well as data transmissions from the UoSat series satellites.

A range of software and cable packages for the RM-1 is available from ICS for many of the more popular home micro computers. Most other RTTY software on the market can also be used with the RM-1. It is also plug compatible with other ICS terminal units.

Packaged in an attractive screen printed enclosure, with a comprehensive manual, ICS claim that the RM-1 "lacks the extensive filtering of ICS's more expensive terminal units, but is ideal for most medium to strong signal applications." The RM-1 is available for £70.50 inc VAT and postage from ICS at P O Box 2, ARUNDEL, West Sussex BN18 0NX.

## FRG-8800 Out Now!

In December, 1984 the FRG-8800 will supplant the world renowned FRG-7700 as the latest Yaesu general coverage communications receiver, bringing the newest advances in technology to the famous Yaesu receiver line that began with the FRG-7.





The Merseyside Special Event Group who recently activated GB0 and GB8BCL at the 'Beatle City' museum in Liverpool. From L-R, G4UVB, G4SYW, G1DFQ, G4KIN, G4YPD, G6ICR, QSL mgr G4VKV, G4HSF, and G6ZPW.

Featuring a large liquid crystal display with 100Hz frequency resolution and including a unique multi-coloured S/SINPO "bar graph" type indicator, the FRG-8800 also incorporates the Yaesu CAT System. This allows remote power control, mode and frequency selection and signal strength measurement for processing from the operator's personal computer when used with one of the Yaesu FIF-series CAT Interface Units. The CAT System allows the user to program his computer for the type of receiver operation that he desires, including such functions as unlimited additional memories (the FRG-8800 includes 12 itself as standard) and automatic tuning by station callsign (for broadcast stations) and time, unlimited choice of scanning systems and even voting reception modes to automatically select the clearest frequency of multi-frequency broadcasts. The user can literally build his own receiver functions using almost any personal computer and BASIC or any other language.

The FRG-8800 includes a 21-button keypad for frequency and memory control via the internal 8-bit cpu. Additional button switches are provided for mode and wide/narrow IF filter selection, AGC release time, noise blanker, display brightness, tuning rate selection and settling of the 24 hour dual (local/UTC) clock/timer. The 12 internal memories can be selected by either the keypad or a rotary switch. Three scanning modes are available through the keypad, by which either all or only pre-programmed memories can be scanned, or all frequencies between two memories. Squelch is all mode, and knob tuning rates of either 6.25 or 125

kHz/rotation are selectable, with steps of 25 or 500 Hz, respectively. The dual clock/timer includes power on/off and "sleep" functions.

The FRV-8800 VHF converter, which mounts inside the FRG-8800, is available as an option to add the range of 118 to 173.99 MHz to the receiver. The FRV-7700 Converters, FRA-7700 Active Antenna, FRT-7700 Antenna Tuner and FF-5 Lowpass Filter originally designed for the FRG-7700 are fully compatible with the FRG-8800.

Frequency coverage: 150 kHz to 29.999 MHz

(150 kHz to 25.999 MHz and 2 MHz to 29.999 MHz versions will also be available).

Modes:

AM (wide & narrow)  
SSB (USB, LSB)  
Cw (wide & 800 Hz narrow)  
FM (narrow)  
FM wide to be available as option

Intermediate frequencies: 47.055 MHz and 455 kHz.

The FRG-8800 hopefully will be available from authorised Yaesu importers SMC and Amateur Electronics UK and other Yaesu dealers about the time of publication of this issue.

## Aussie Special Event

A special commemorative callsign,

VI3WI, can be heard on the DX bands (conditions permitting) until 30th April, 1985 (perhaps longer if sufficient volunteers). The callsign celebrates 150 years of European settlement in Victoria, Australia, and is being organised by the Wireless Institute of Australia and its affiliated clubs.

The volunteers hope to work all DX bands and all modes and will send a special commemorative QSL directly or via the VK3 OSL bureau for any confirmed contact.

A special award certificate is available for anyone making a radio contact (SWLs log) with one station in VK3 (Victoria) between November and April. The organisers ask for Aus\$2 or equivalent and the QSL to be sent to Victoria 150 Award, Wireless Institute of Australia, 412 Brunswick Street, Fitzroy, 3056, Victoria.

## Biggest Cat' Yet From Electrovalue

Electrovalue have recently published their latest catalogue which is usually updated and issued three times a year, available free on demand at Electrovalue shops or mail order service. This is the largest to date in terms of items stocked and each item is individually priced.

The catalogue is available from Electrovalue Ltd, 28 St. Jude's Road, Englefield Green, Egham, Surrey TW20 0HB.

# LETTERS

## BEFORE CQ

Sir, quotations (HRT 2/10 Oct 84 p6)  
Caption: "Norman... delicate final adjustments..."

Text: Col 2 "... people will no longer regard amateurs as eccentric..."; para 1 "... something you've built yourself..."; para 1 "... not having yet grasped the constructional side..."; para 2 "... give a new insight..."; para 4 "... fairly serious analysis..." para 4.

Col 3: "... it is funny..."; "... the Morse is a bit ropey..."; para 4.

Please: "serious?"; "funny"?; with a dirty great "dumpy" screwdriver: in that fashion?? Ha Ha Ha Ha Ha He He He He He He He He. Oh dear! Excuse me while I find a tissue: my eyes are streaming, Not with sorrow!!! 'OO was this Ancock? There was once a Norman who was funny.

Yours in pain,  
JW Short.  
P.S. I don't feel very well!

*The picture of 'Norman', the radio amateur in Channel 4's 'CQ', used in October '84 HRT, was a promotional shot, not a still from the actual play.*

*The technical adviser, G3 YXZ, ensured that the technical presentation of amateur radio in the course of the actual filming was very fair and in no way is Norman portrayed as a technical buffoon in mine or Julie's opinion — an impression the shot should give.*

*I found CQ both serious and funny — as was Tony Hancock's 'The Radio Ham'. You might find watching 'CQ' a little uneasy — but not too painful, I hope.*

## AFTER CQ

Sir, I am afraid that I must have a moan about Channel 4's television Programme 'CQ' shown this evening.

If, in Julie Darby's (G1 CKF) report on the programme, it gave the amateur publicity, I believe it was very bad publicity.

G4 ESB has some super equipment — if only someone had given him a little more than basics on how to use it!

He broke just about every regulation on the licence and I quote:

Part 1 (6.5) Signals not being sent in secret code or cypher.

Part 5 The licensee shall not permit any unauthorised person to operate the station or have access to apparatus.

Part 8 (para 1) recorded messages should only be retransmitted to originating station.

Part 9 (para 2) The callsign shall be sent at beginning and end of each transmission. Yes, it was sent at the start but only once at the end right through the programme.

As for his attitude towards his neighbours TVI problem and the falsification of his logbook it certainly isn't a very good impression of a radio amateur for anyone, is it?

Maybe a good CBer would be proud of this programme but never an amateur or should I say a good amateur! And you certainly weren't kidding about the CW being ropey. I have not yet taken my Morse test, but am studying at the moment and certainly can do better than this so-called G4 on the prog.

Thank you for listening to my moan, feeling better getting it off my chest.

Janice, GM1 KHV

*Regarding your list of Norman's misdemeanours, I think you're being a bit hard on him. For instance, while he was often lax about giving his callsign at the end of each transmission he was having a rather exciting time — how many of us have not been guilty of similar misdemeanours when working a rather choice piece of DX?*

*'CQ' seemed to me to use amateur radio as a framework to investigate questions like "how far will a person go in order to obtain fame" and "who deserves to be famous?" Norman is a (fallible) man first and a radio amateur second. I'm glad I've got this off my chest, too.*

## GEOGRAPHICAL BANDPLANNING

Sir, referring to the 'Metrowave' article in HRT in November 1984, may I suggest that G5UM should check on this statement that the concept of geographical bandplanning emerged from the fertile brain of the late G6FO. He will find that the idea was first outlined in a letter published in 'Short Wave Magazine', sometime in the early to mid 1950's, written by Ian Paul, G3CYY.

The scheme was endorsed by G6FO, the editor of SWM, and, if my



memory serves me right, was slightly modified as a result of some debate in the columns of SWM before being more or less universally adopted.

Unfortunately, I no longer have the large pile of SWM's from the late forties and early fifties, given to me some years ago, which would allow me to verify this, and the dates.

T G Lambert, G8EZL.

### MORE SPARRING

Sir, J G Peel's letter ('Peaceful RAYNET' Nov HRT) surely avoids the main point which is that SPARS (Society for the Preservation of Amateur Radio Standards) objects to RAYNET's involvement in exercises called by the CEPO (or a substitute) which are directly linked to political/military strategy, particularly when such exercises are performed on the Amateur Bands. The final straw was the exercise on March 10th (INTEX '84), previous to which SPARS did not exist although a number of concerned individuals had been increasingly alarmed at the changing complexion of the RAYNET hierarchy and its apparent enthusiasm to be associated with activities having a political/military flavour.

RAYNET came into being after the 1953 East Coast floods and though, fortunately, only occasionally has there been a real need for their services since that time, no-one has seriously objected to them assisting with marathons, county shows and so forth, which permits them to practice message-handling in preparation for a natural, peace-time disaster.

That sir, is rather different from planning the aftermath of a nuclear war, which, as the recent TV programme 'Threads' portrayed, was not something we should be preparing for but instead should be doing all we can to prevent. The true spirit of amateur radio internationally has done, and can still do, much to prevent conflict, having been, hitherto, traditionally concerned with international friendship and goodwill — not sectarian politics. Hence the need to restore standards to their former level!

Of course, Mr Peel is right to proclaim the virtue of activities that are not self-orientated. Where he is wrong is in misjudging the issue.

D J Smith, G3PZG.

Sir, it was heartening to read the letter of G4NFL stating "... in no way that we as a group will be used for any of the purposes complained of by Mr. Frisby ..."

Even so, Mr Peel seems to criticise 'SPARS' for what he has

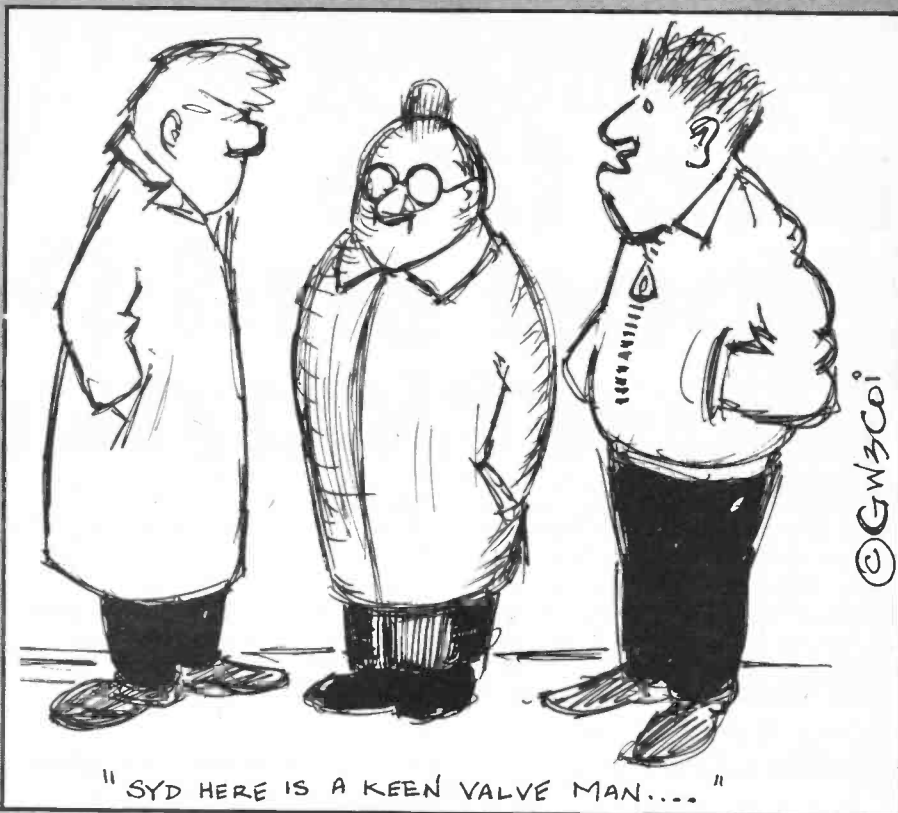

taken to be an anti-Raynet stance, which is not the factual case. Many of our members are active RAYNET members and supporters, and are fully aware of the active and socially valuable work that members have performed, particularly in this area of potential sea-flooding. It is because we actively support vital work of this type that we oppose the diversion from essential functions to the attempts of involvement into "civil defence" that is of propaganda value only, being impracticable, ineffective and unworkable.

That entire policy is mono-political, and based upon the pretence that both people and equipment would survive a nuclear holocaust, which tends to purport that the aftermath would be survivable, hence more tolerable, hence making such a catastrophe appear practically acceptable.

All radio-amateurs have to be seen to steer well clear of political intrigues and dogma, as there are some of the few people who are able to act as 'ambassadors' between people of all countries and bring peace and understanding in this World.

By international friendship in their communications, and by applying their time and expertise to the continuation of socially useful functions that have won so much recognition, not to mention technical achievement, Amateur-Radio operators can actively help to improve this World. They will not achieve this if they permit their talents and humanitarian ideals to be

prostituted by those anxious to divert these energies to political opportunism and administrative delusion.

If Radio-Amateurs feel that they must play "war-games" then there are plenty of frequencies available for numerous military organisations, and there is no excuse for polluting the impartial amateur-bands with such activities, which do not credit to our movement in general, and RAYNET in particular.

Pat Gowen, G3UOR

### DO YOU USE SSTV?

Sir, although many 'G' stations are active on SSTV on 14230 kHz, there appears to be very little local activity on the LF Bands.

For some months now, GD4HOX, EI6EU and EI3CZ have been very active on 80m and would welcome others to join them. They can be found on 3730kHz most Saturdays at 2.30pm, Sundays 10.15am and often during the week at 1.15pm.

Ted Brooks, GD4HOX

*Hopefully the recent development of cheap computer assisted reception will serve to regenerate SSTV in the near future (see Ken Michaelson's review of the G3LIV/G8UEE SSTV interface on the BBC 'B' in the next issue).*

Please address correspondence to:  
Ham Radio Today,  
1, Golden Square,  
LONDON W1R 3AB.

# 24cm ATV and the Wood and Douglas 'Downconverter'



Ideas for articles can happen in strange ways — your editor says "How about a review on Wood & Douglas's new FM TV bits if I get hold of them for you?" To which I

cm equipment can be used for ATV transmission and reception, and domestic TVs can be used for viewing the transmissions. Increasing pressure on the space of 'seventy'

ing that you'll make more contacts immediately than on 'Seventy', though — 24 is still essentially a band for people with a pioneering spirit.

*As 70cm becomes more crowded, many TV enthusiasts are moving to the next band up. Aerial systems are very compact, repeaters are planned for many parts of the country and there is DX to be had. Andy Emmerson, G8PTH, surveys the current 24cm scene and looks at the latest in equipment from Wood and Douglas.*

had to reply "But I'm ahead of you — I'm already using them!" So was born this review of W&D's new 24cm ATV receiver, and for good measure an update on the TV repeater scene.

Wood & Douglas are not a bad lot really — for instance, they have helped out the Worthing TV repeater group with advance samples of their products (good idea for in-the-field product testing). When W&D recently brought out their new tunable downconverter they made sure that several people had 'samples' to evaluate. On the basis that a good product sells itself by word of mouth, particularly true in the world of amateur radio which, after all, is essentially concerned with communication(!), this is a good philosophy and I am pleased to say their new baby is a winner. But before we take it to bits, so to speak, let's look at the current situation with regard to 24 cm ATV.

## 24 — The Next Band Up

Traditionally amateur television (ATV) has been on seventy centimetres, just below the UHF broadcast TV band. A lot of normal 70

cm equipment can be used for ATV transmission and reception, and domestic TVs can be used for viewing the transmissions. Increasing pressure on the space of 'seventy' and the desire to try something new has led a growing number of ATVers to try the next band up. Commonly known as 23 cm this stretches from 1240 to 1325 MHz, though not all the band is used for TV. "We" use mainly the bottom and middle of the band, which is why ATVers call this ATV area more correctly 24 cm. Activity is both simplex and through repeaters, and in both AM and FM. AM or 'Ancient Modulation' was the original ATV mode but is now all but extinct, and the future I believe lies entirely with FM, which allows much simpler signal generation and power amplification. (See the Wood & Douglas catalogue for an even more convincing explanation of this!).

Since 24 cm is our lowest microwave band, people not already up there may be forgiven for thinking that working on 24 is a bit 'hairy' and is only suitable for short distances. Not so; you have to construct your whole station carefully (but really you need to do that on all bands) and propagation is very comparable with 'seventy'. Under lift conditions, '24' actually can be better, and 'openings' to relatively distant parts seem to happen more frequently. I am not say-

## Making A Start

Having read my rosy description of the potential of 24cm TV you may wish to make a start on the band by receiving the local activity. Even with a converter, a normal TV receiver will not make a very good job of displaying local-ish FM transmissions; it will work but not efficiently. And this is where the new W&D products come in: the 1250DC50 tunable 'downconverter' and VIDIF FM demodulator. Together they take an FM TV signal anywhere in the 23/24 cm band and bring it down to baseband video, which can be displayed on a normal monitor (or put into a channel 36 modulator for viewing on your domestic TV set).

The downconverter comes in a sturdy tinfoil box 5" x 3.75" x 1.25". The video IF board also fits into the same box, which is available separately. I put my IF board in this box and would recommend you do likewise; the combination will then fit nicely into the standard no. 202 Verobox (see photo nearby).

Both items are available ready assembled, and the VIDIF can also be purchased as a kit. The downconverter is not available in kit form, however, and the manufacturer's explanation for this makes technical sense to me. "The complexity of the circuitry demands a high level of instrumentation to allow correct alignment, and minor variations in assembly

technique could not be tolerated at such a high frequency." In other words, assembly must not only be exact but a rather larger amount of test gear than the average amateur possesses is necessary to make it tick!

With this in mind, I had to take the lid off and see the standard of their construction; it is exemplary, with separate compartments for the RF sections. Looking at the PCB, and one can see the signal entering a bandpass filter, gain-matching it for the GaAsFET and then out through another filter to the ring mixer. There is an NE219 as VCO, controlled by two BB221 varactors and a BFR91 following a VCO. A standard Plessey SL560 amplifier leads to the output of the downconverter. The overall noise figure is not quoted but from a subjective point of view seems very adequate. (Many 23cm stations tend to use low noise masthead preamplifiers to minimise feeder losses, enabling the use of reasonably priced feeder cable such as H100 — providing the feeder run is not too long — and making the noise factor of the actual Rx front end much less important — Ed). The AFC seemed unnecessary for FM to a colleague; the phase-locked loop in the VIDIF ought to be able to track the incoming signal without too much difficulty. This minor quibble to one side, my impression as an ATV enthusiast for a fair number of years, is that a lot of thought has gone into the design and this looks very professionally executed as well.

### Looking At The Video IF

After all this hi-tech, the VIDIF

The lid off!

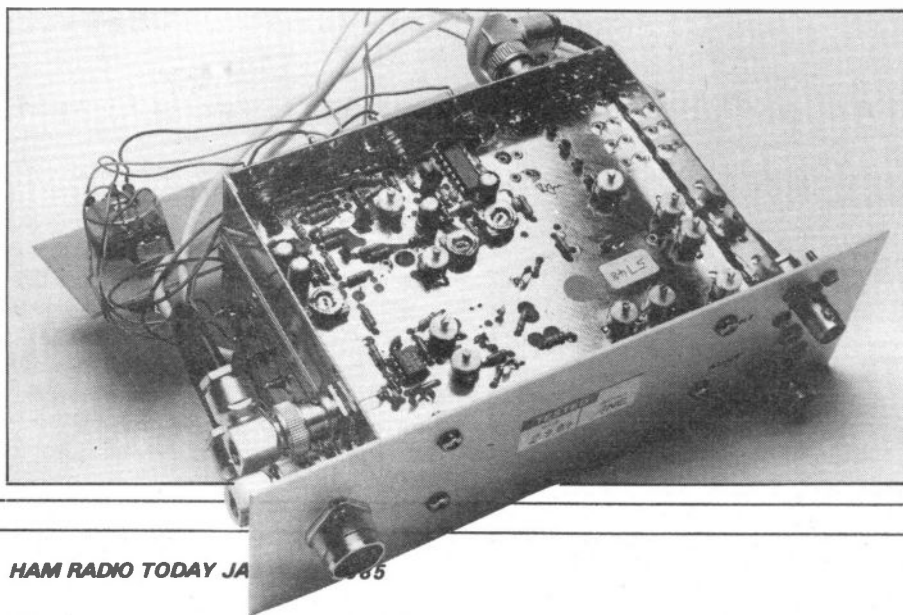

board seems quite tame! No problem though, it is a workmanlike product. You get a circuit diagram in this case which helps you follow the signal past an OM335 level booster to limiting and demodulation (NE564 PLL). A positive or negative signal can be selected: all amateur FM signals are positive sense, though my board came somewhat mysteriously with the link set to negative. Anyway, it's no trouble to change this. Twin 1 volt video outputs are supplied, also a 6 MHz audio signal for external direction and AFC (for front end tracking) and AGC voltage (for an 'S' meter).

Connecting the two boards is a simple matter; the cabinet of your choice will need to be provided with a modulation sense switch and a 'tuning' potentiometer. A volume control and loudspeaker are optional extras.

### Best Buy?

I do have two other manufacturers' (who shall be nameless) converters in use in the G8PTH shack, but after trying these two W & D units over a period of a fortnight I decided to buy them. This is a recommendation then: I find their performance very satisfactory and in some respects better than the opposition.

Good points to note are the first rate rejection of radar signals (pointing to good limiting) and no spurious oscillators of any kind. The modulation sense is absolute: you cannot mistake a signal with the wrong sense as you can with a rival product. The units are not a 'plug-in and turn-on' job though: you still have to build the case and

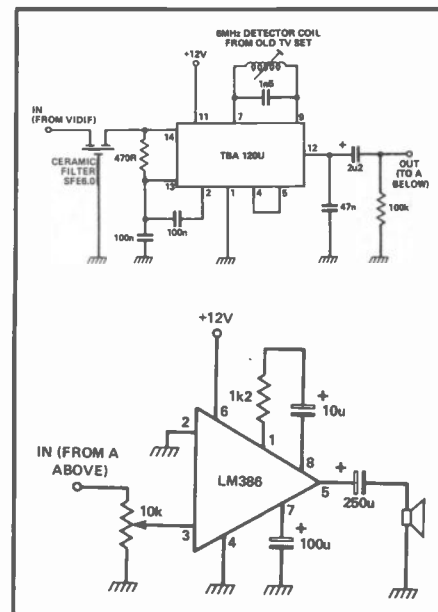

Fig.1. Sound demodulator and output stage suitable for the unit.

peripheral circuitry. For many people this is not only more fun but is an advantage — the converter can be cased and switched to suit your particular set-up.

My sole real complaint is that the tuning spreads way above the top of the band; if there is to be an overspill why not have it at both ends as some French stations still use 1227 MHz. It is a pity that the sound demodulator is not yet ready, but you can easily build your own audio output stage (see Fig.1). The packing of the bare VIDIF boards does need to be improved, though; mishandling in the post caused the coils to poke through the jiffy bag and... crunch!

A custom-designed audio board is planned and may be reviewed here in due course. Wood & Douglas also make some modules for the construction of an FM TV transmitter; I recommend you get hold of their catalogue and check these out.

### Where The Activity Is

Without a doubt the TV repeaters have given 24cm TV a terrific boost, and for this reason most of the activity is centred around the places where repeaters have been opened. There are five repeaters in Phase 1, of which two (Worthing and Dunstable) were in full operation at the time of writing. Of the others Leicester (the very first) was in beacon mode, and the other two (Bath and Stoke-On-Trent) are still under construction.

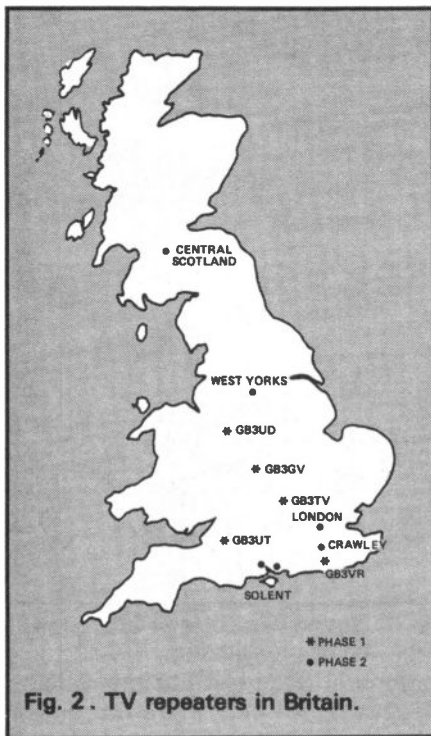

Fig. 2. TV repeaters in Britain.

As the Phase 1 repeaters are more 'experimental' than those which will follow, there are two distinct systems in use. GB3GV (Leicester) and GB3UT (Bath) accept either AM or FM input signals but radiate in AM only. The remainder, GB3TV (Dunstable), GB3VR (Worthing) and GB3UD (Stoke) are FM machines, and all the known repeaters planned for Phase 2 will be FM too. (FM is the rule in most other European countries where the 24 cm band is exploited).

### More Repeaters Soon?

From the start of planning a

repeater to the eventual licencing can take a long time, even if everything goes to plan. I am not aware of an official timetable for Phase 2 TV repeaters but there is no harm in mentioning those planned which are fairly well advanced. From A-Z we have:

**CENTRAL SCOTLAND.** Still at initial planning stage.

**CRAWLEY, GB3CT.** Site in ZL80H, 325 feet above sea level. Power 20W erp from an Alford Slot. Field trials show good average of North Sussex and Surrey.

**SOLENT REGION.** The proposal is for one or two machines, to serve firstly, Poole and Bournemouth and secondly, Southampton.

**WEST YORKSHIRE.** The site has been agreed — the top of Emley Moor TV mast!

I have also hear rumours of plans for machines in the Thames Valley, west of London, and also in Central London (co-sited with GB3LW). In addition, I was associated with a plan for a repeater on the Isle of Sheppey to serve parts of Kent, Essex and London. An excellent site was found and although the plans never came to fruition the opportunity is still there for enthusiasts in this area.

### Simplex And Relay Working Too

Not everyone lives within reach

of a TV repeater and there are pockets of keen simplex activity, especially in the Thames Valley, Midlands and Solent areas. All in all, there are some forty transmitting stations on 24cm in England now and many more 'eyewigs'. Simplex also gives you the opportunity to work a bit of DX: the Sussex Coast mob regularly have contacts across the Channel, and stations in the Midlands have had visual QSOs with France and Holland.

Relay working is also a possibility: signals can be picked up on 70 cm and transmitted further on 24 (and vice versa). With proper filtering and a wide spread between Rx and Tx frequencies, in-band relays are also a possibility.

### Frequencies And Standards

Although in theory you can operate on any frequency you choose, commonsense dictates that you follow the established patterns of activity to maximise your chances of a QSO. Simplex activity is generally low in the band. 1255 MHz is the standard frequency in France and Belgium, and is becoming the rule here as well. Many Continental stations have crystal-controlled receive converters, so 1255 makes sense. The FM repeater frequencies are 1249.0 MHz input and 1318.5 MHz output. For the AM boxes, the figures are 1276.5 MHz in and 1311.5 MHz out.

FM signals are limited to a deviation of +/- 6.5 MHz, and the audio subcarrier is the same in both systems, namely 6 MHz (but 5.5 MHz abroad). Aerial polarisation is horizontal or circular.

Further technical information can be found in a six part series on 24 cm in "Amateur Radio", (*What's that — Ed.*) February to July 1984 and in the BATC Amateur TV Handbook, available from the RSGB, so why not get cracking now?

WOOD & DOUGLAS, Unit 13, Young's Industrial Estate, Paices Hill, Aldermaston, Berks., RG7 4PQ. (Telephone 07356-71444).

1250DC50 Downconverter, £69.95. assembled. VIDIF board, £38.95 kit or £54.25 assembled. Custom box for above, £5.50. Postage 75p extra on all above items.

Table 1 — SPECIFICATIONS

#### 1250DC50

Input frequency range	1240-1325 MHz
Intermediate frequency	50 MHz nominal
Conversion gain	25 dB minimum, 30 dB typical
First RF stage	MGF1100 GaAsFET
Mixer type	discrete Schottky ring
Post mixer processing	SL560c amplifier
Operating voltage	11.5-14.0 volts
Operating current	80 mA nominal
Internal stabilisation	8.5, 5.5V rails
External connections	AFC input, supply input, tuning voltage input, 8.5V output
RF connections	BNC

#### VIDIF

Input signal range	40-55 MHz
Supply voltage	12V (with internal stabilisation for PLL supply)
External connections	AGC output, AFC output, IF input, twin video outputs, 6 MHz audio output, supply voltage.

# WOOD & DOUGLAS



Despite the threat of BIG BROTHER hanging over us, 1984 has been a happy and busy year for the W & D team. We would like to take this opportunity to thank all our customers for making it so, and to wish everyone a Happy Christmas and prosperous New Year.

JUNE • MIKE • CHERYL • MIKE • DI • MIKE • DAVE • ROSE • ALAN

### Package Prices

1. 500mW TV Transmit	(70FM05T4 + TVM1 + BPF433)	35.00	Kit
2. 500mW TV Transceiver	(As 1 above plus TVUP2 + PSI 433)	60.00	
3. 10W TV Transmit	(As 1 above plus 70FM10 + BD335)	65.00	
4. 10W TV Transceiver	(As 2 above plus 70FM10 + BD335)	90.00	
5. 70cms 500mW FM Transceiver	(70T4 + 70R5 + SSR1 + BPF)	75.00	
6. 70cms 10W FM Transceiver	(As 5 above plus 70FM10)	105.00	
7. 2M Linear/Pre-amp 10W	(144PA4/S + 144LIN10B)	40.00	
8. 2M Linear/Pre-amp 25W	(144PA4/S + 144LIN25B)	42.00	
9. 70cms Synthesised 10W Transceiver	(R5+SY+AX+MOD+SSR+70FM10)	150.00	
10. 2M Synthesised 10W Transceiver	(R5+SY+SY2T+SSR+144FM10A)	120.00	
11. 2M Crystal Controlled 10W Transceiver	(R5+T3+BPF+144FM10+SSR)	85.00	
12. 70cms Linear/pre-amp	(70LIN10+70PA2/S)	45.00	

### 70cms EQUIPMENT

	CODE	ASSEMBLED	KIT
<b>Transceiver Kits and Accessories</b>			
FM Transmitter (0.5W)	70FM0514	48.00	28.75
FM Receiver (with PIN RF c/o)	70FM05R5	65.40	45.80
Transmitter 6 Channel Adaptor	70MCO6T	21.30	14.25
Receiver 6 Channel Adaptor	70MCO6R	25.20	17.90
Synthesiser (2 PCBs)	70SY25B	88.00	62.25
Synthesiser Transmitter Amp	A-X3U-06F	34.15	22.10
Synthesiser Modulator	MOD 1	8.95	5.50
Bandpass Filter	BPF 433	6.50	3.30
PIN RF Switch	PSI 433	7.55	5.35
Converter (2M or 10M if.)	70RX2/2	27.10	20.10

### TV Products

Receiver Converter (Ch 36 Output)	TVUP2	27.50	22.80
Pattern Generator (Mains PSU)	TVPG1	42.25	36.50
TV Modulator (For Transmission)	TVM1	9.85	5.75
Ch 36 Modulator (For TV Injection)	TVMOD1	9.80	5.50

### Power Amplifiers (FM/CW Use)

50mW to 500mW	70FM1	18.45	12.80
500mW to 3W	70FM3	23.45	17.80
500mW to 10W	70FM10	41.45	33.45
3W to 10W	70FM3/10	23.95	18.30
10W to 40W	70FM40	65.10	52.35

### Combined Power Amp/Pre-Amp (Auto Changeover)

70PA/FM10	56.60	40.15
-----------	-------	-------

### Linears

500mW to 3W (Straight amp, no changeover)	70LIN3/LT	27.90	19.90
3W to 10W (Auto Changeover)	70LIN3/10E	41.05	30.15
1W to 7W (Auto Changeover)	70LIN10	44.25	32.50

### Pre-Amplifiers

Bipolar Miniature (13dB)	70PA2	8.10	6.50
MOSFET Miniature (14dB)	70PA3	9.65	7.50
RF Switched (30W)	70PA2/S	24.25	15.25
GaAs FET (16dB)	70PA5	20.10	12.80

### 6M EQUIPMENT

Converter (2M if.)	6RX2	28.40	20.80
--------------------	------	-------	-------

### 2M EQUIPMENT

<b>Transceiver Kits and Accessories</b>			
FM Transmitter (1.5W)	144FM2T3	39.35	26.30
FM Receiver (with PIN RF Changeover)	144FM2R5	65.50	47.20
Synthesiser (2 PCBs)	144SY25B	78.75	60.05
Synthesiser Multi/Amp (1.5W O/P)	SY2T	27.90	20.65
Bandpass Filter	BPF 144	6.50	3.30
PIN RF Switch	PSI 144	7.55	5.35

### Power Amplifiers (FM/CW Use)

1.5W to 10W (No Changeover)	144FM10A	24.15	18.50
1.5W to 10W (Auto-Changeover)	144FM10B	36.11	26.25

### Linears

1.5W to 10W (SSB/FM) (Auto Changeover)	144LIN10B	38.40	28.50
2.5W to 25W (SSB/FM) (Auto Changeover)	144LIN25B	40.25	29.95
1.0W to 25W (SSB/FM) (Auto Changeover)	144LIN25C	44.25	32.95

### Pre-Amplifiers

Low Noise, Miniature	144PA3	8.60	7.40
Low Noise, Improved Performance	144PA4	12.86	8.40
Low Noise, RF Switched, Full Changeover	144PA4/S	24.30	15.30

### GENERAL ACCESSORIES

Toneburst	TB2	6.70	4.25
Piptone	PT3	7.50	4.45
Kaytone	PTK3	8.75	6.05
Relayed Kaytone	PTK4R	12.70	8.20
Regulator (12V, low differential)	REG1	6.95	4.40
Solid State Supply Switch	SSR1	5.85	3.70
Microphone Pre-Amplifier	MPA2	6.10	3.50
Reflectometer	SWR1	6.35	5.35
CW Filter	CFW1	8.55	5.80
TVI Filter (Boxed)	HFP1	5.95	—

### FM TV MODULES

50mW 420MHz Source (Video Input)	UFM01	26.95	19.80
50MHz If. Processor	VIDIF	54.25	38.95
Varactor Multiplier (Boxed)	WDV400/	63.95	—
1250MHz Downconverter	1250DC50	69.95	—

Further details on our product range will gladly be forwarded on receipt of an A5 size SAE. Technical help is available by phone (NEW NUMBER) during normal office hours. Kits are usually available by return of post but please allow 28 days for unforeseen delays. Please add 75 pence to your total order for postage and handling. Credit card orders are gladly accepted, please give us a call.

ANYONE CAN SELL A KIT . . . REPUTATION SELLS OURS

UNIT 13, YOUNGS INDUSTRIAL ESTATE  
ALDERMASTON, READING RG7 4PQ  
Tel: 07356 71444 Tx: 848702

## GREAT OFFERS FROM SCARAB SYSTEMS

Choose from this professionally produced equipment from UK's leading radio software house.

### BBC Super QTH location finder

This large program comprises two parts and you can 'toggle' between them at any time. The first includes a point to point distance locator, radial ring score and outgoing and return bearings plus the Maidenhead Universal Locator system. The second part is a scoring log. £7.50 (HF and VHF/UHF).

### MPTU-1 tone encoder/decoder

This phase lock loop circuit is 100% reliable and extremely sensitive. £69.70 (all plugs supplied).

### BBC Super morse code Tutor

This very sophisticated program includes many special features such as variable sending speeds and a 750 word vocabulary and enables your computer to test your ability to receive and SEND good clean morse. £6.50 (cassette or disc).



## SCARAB SYSTEMS

39 Stafford St, Gillingham, Kent ME8 5EN Tel: (0634) 570441

Please send me:

- Super QTH Locator Cassette £7.50  
 BBC Super Morse Tutor Cassette £6.50  
 MPTU-Rtty/Amtor Terminal unit £69.70  
 Free details of other equipment and programs

I enclose a cheque/postal order for.....

I wish to use my Access/Visa

Name.....

Address.....

Telephone.....

Signature.....

I understand that, if I am not fully satisfied, I can return the equipment with full reimbursement.



## REG WARD & CO LTD AXMINSTER DEVON

## SOUTH WESTS LARGEST AMATEUR RADIO DEALER



Official Agents Yaesu Trio Icom FDK.

: Complete range stocked :

: Full demonstration facilities :

: Barclaycard, Access, Instant Credit :

Ancillary equipment by: Microwave Modules; Mutek, Drae, BNOS, Himond.

Kempro, Welz, Hansen, Tono, Datong.

Aerials by: Jaybeam, TET, G. Whip, Miniproducts, Tonno.



1 Western Parade,  
West Street,  
Axminster,  
Devon EX13 5NY



\*Opening hours:  
Tues - Sat  
9 - 5.30.  
Closed  
Mondays.

Christmas holiday closing 24 Dec - 2nd Jan  
\*Note revised opening times from January '85.

Telephone  
(0297)  
34918

### RAINBOW MENU

- 10M FM Conversions
- S/H HF/2M Equipment
- Repairs
- Modifications
- Antennas
- Accessories

### COMMUNICATIONS CHEF'S SPECIALE

SOUP OF THE DAY  
Lucas 10M FM Radio

**HAPPY NEW YEAR  
TO ALL OUR CUSTOMERS**

68  
Gorrings Park Ave  
Mitcham Surrey  
Ask for  
Howard (G4VWR)  
or WIN (xxxxxx)  
01-640 1904

# MICROWAVES with a Mustard Tin

Sitting down at my bench and looking at an empty Colman's mustard tin it occurred to me that the tin with its lid off looked rather like a waveguide which had been blanked off at one end. Could it be that it

blown, presumably due to static. The Gunn source still functioned OK but I had nothing which received efficiently at the operating frequency. I had three choices: cancel the lecture; find something

*The microwaves are an area in which amusing and informative experiments on how radio waves are propagated can be carried out. You too can feel like Marconi! Our very own Guglielmo, Frank Ogden, G4JST, describes the construction of a simple transmitter and receiver for 9cm and hints at the art of using a wok as a waveguide.*

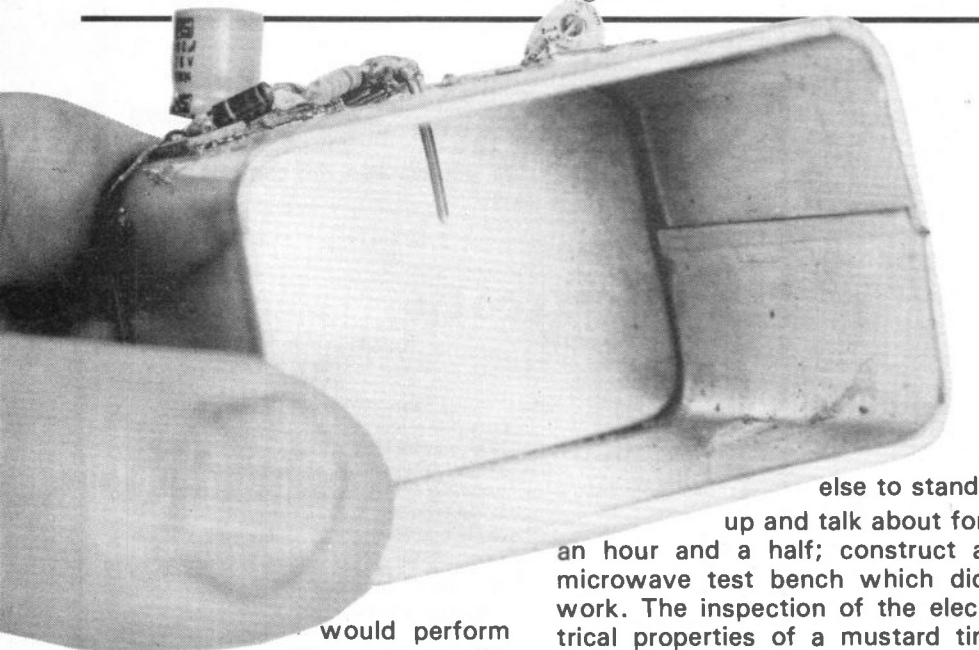

would perform like a waveguide resonator? I set about finding out.

I had been asked by a local radio club to give a lecture — subject of my choice — with the request coming at fairly short notice. I decided that a microwave demonstration would be interesting — I could show how radio waves could be bent, reflected, polarised and focussed — all in the space of two village hall trestle tables.

With two days to go before the lecture I pulled out my old 10GHz Gunn oscillator and fired it up to make sure it worked. I lined up the detector, connected up the meter and . . . nothing. With rising panic I discovered that the fragile barrier diode in the detector assembly had

else to stand up and talk about for an hour and a half; construct a microwave test bench which did work. The inspection of the electrical properties of a mustard tin followed course three!

I say all this to put the design which I offer into perspective. The total time taken to design, build, de-bug and evaluate the transmitter and receiver was approximately five hours. What follows is surely nowhere near optimum, but provides a good starting point for readers' own experiments. *Furthermore, we would like to hear about the results of these mustard tin microwave links at Ham Radio Today.* Since the entire project should cost under a fiver, there is no excuse for not building one!

## Details Of The Link

The link comprises a single

transistor oscillator producing around 50mW at 3400MHz (8.8cm wavelength) coupled into the mustard tin waveguide by a capacitive probe. The link uses amplitude modulation produced by applying audio to the base of the oscillator transistor. In its simplest form, the transmitter aerial is simply the open end of the mustard tin radiating into free space.

The receiver comprises a UHF Schottky mixer diode connected to the centre of a broadband 'butterfly' dipole. The diode, which is biased into conduction by a very small DC current feeds the demodulated signal into a very sensitive audio amplifier. Needless to say, the gain of the overall link (and thus its range) can be increased considerably by focussing both the transmitting and receiving radiators with dustbin lids, frying pans, Chinese woks (the author's personal preference) and other bits of metal.

The range of the link is not quite up to Marconi's experiments from Poldhu, Cornwall but is demonstrably a lot better than Hertz's. The first attempt with my experiment produced ranges of several hundred feet. Superior aerial arrangements would improve this considerably.

## The Transmitter

Fig.1 shows the schematic of the sender unit. The single transistor oscillates by feeding RF from the tuned collector to the emitter via the internal capacitance of the device, a BFT95 'T' package transistor. Please note that this is a PNP type and thus requires a negative supply for its collector circuit. This type of transistor was intended as a low noise, high current RF pre-amp for TV tuner service. Its high  $f_T$  of around 5GHz makes it eminently suitable for this type of oscillator.

Construction of the sender unit is essentially a mix of solder and super glue. The collector circuit,



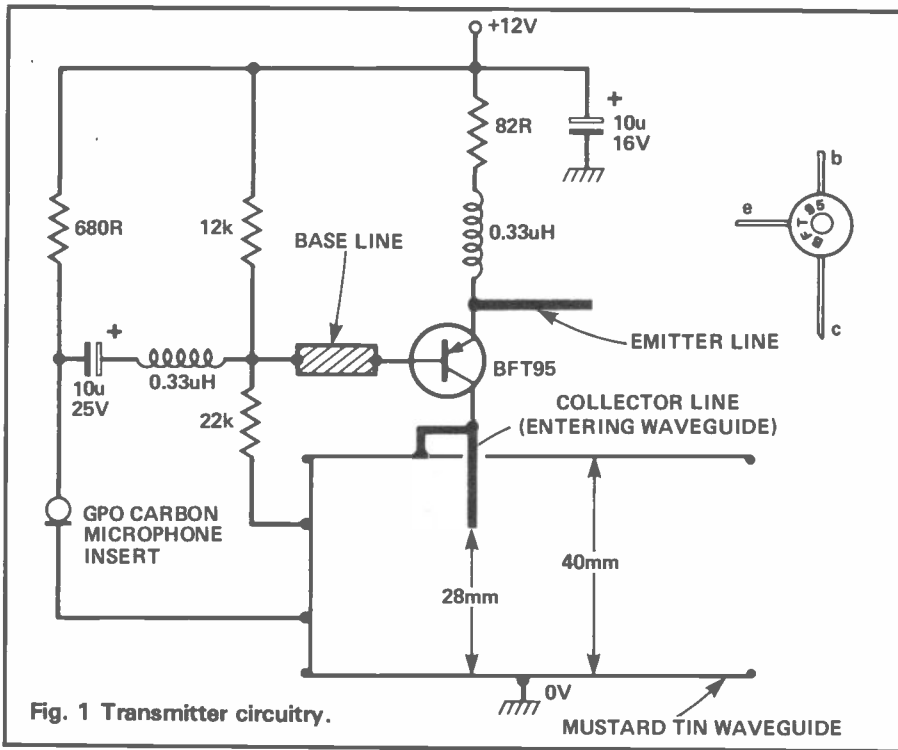

Fig. 1 Transmitter circuitry.

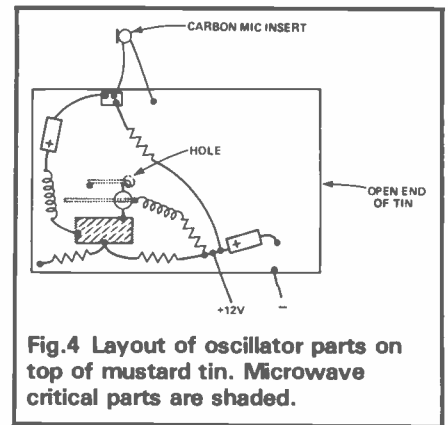

Fig. 4 Layout of oscillator parts on top of mustard tin. Microwave critical parts are shaded.

'pads' — bits of PCB material held on with super glue — can be made at the convenience of the builder.

Note that Fig. 4 also shows a base line, a low impedance quarter-wave stub to ground the transistor base at the operating frequency, and an emitter line, a short bit of wire hung onto the emitter connection. Although not essential to oscillator function, this last addition was found to boost efficiency of the circuit substantially.

The base line is essential. This is a super glued piece of circuit board with the dimensions shown in Fig. 5. The output frequency of the oscillator is determined by the length of the collector line. More about this later.

The circuit (Fig. 1) shows a number of low value RF chokes scattered around various parts of the circuit. The prototype used 0.33 microhenry commercial sub-miniature units but five turns of 22 SWG wire wound as a 3mm airspaced coil (use a drill bit to wind these on) would do equally well.

### The Receiver

The microwave part of the receiver is apparently just a simple broadband dipole mounted on a miniature ceramic tag strip. The Schottky mixer diode is mounted directly across the dipole with a

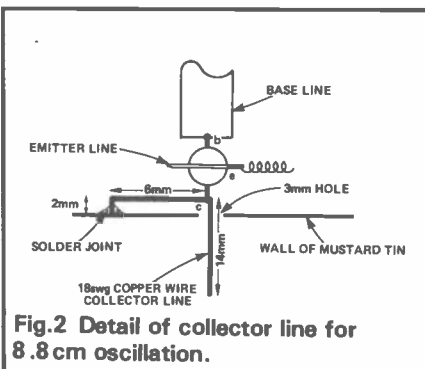

Fig. 2 Detail of collector line for 8.8 cm oscillation.

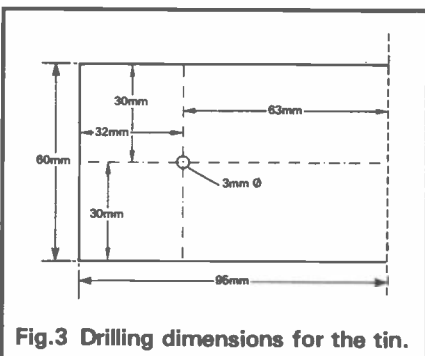

Fig. 3 Drilling dimensions for the tin.

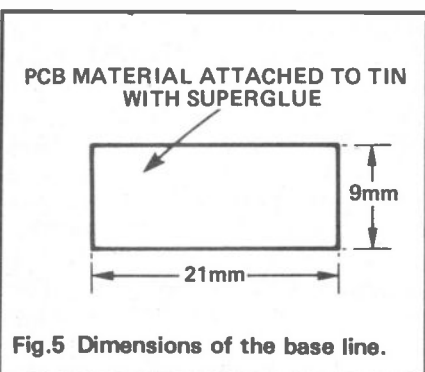
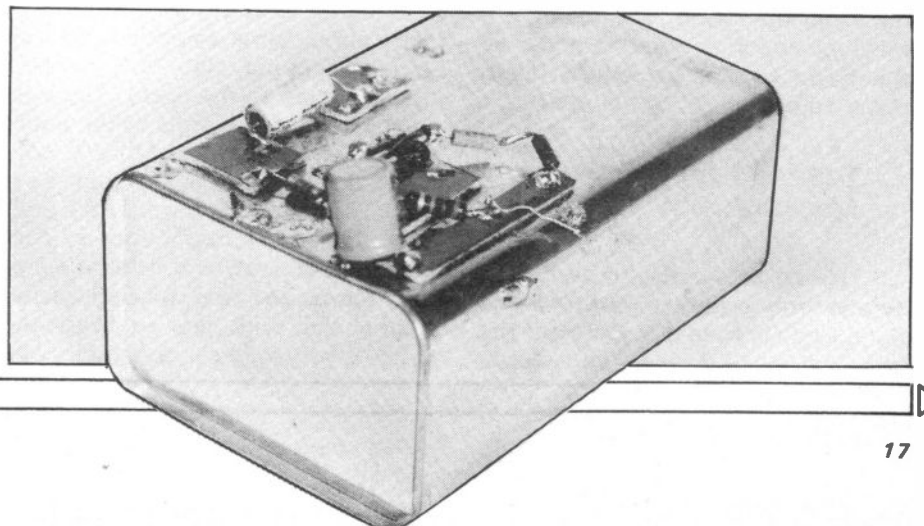

Fig. 5 Dimensions of the base line.

electrically a quarterwave line grounded at one end, is a right angle of 18 SWG bare copper wire of total length 22mm. The 'hot' end passes through a hole drilled into the mustard tin waveguide. The 'cold' end has its last couple of millimeters bent into a small foot which is then soldered directly to the outside of the tin. The collector of the transistor (the long tab) is soldered directly to the collector line about 6mm from the earthy end (ie the cold end that is now soldered to the tin). The device should be soldered with the tab so short that the collector line is hard up against the transistor case. *Care should be taken during this operation that the transistor isn't cooked.* Fig. 2 shows the detail of the collector line; Fig. 3 gives the drilling details of the mustard tin while Fig. 4 shows the plan view of critical components which are active at microwave frequencies. Placement of other connector



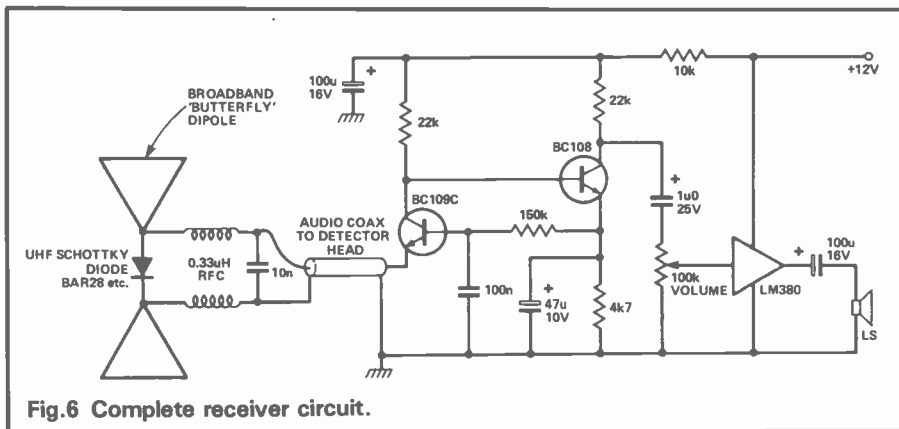

Fig.6 Complete receiver circuit.

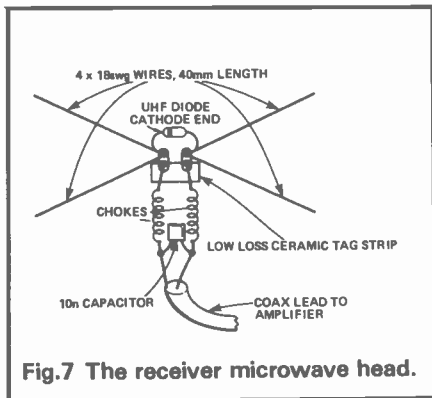

Fig.7 The receiver microwave head.

pair of small chokes taking the rectified signal to a piece of audio coax. The overall receiver circuit is shown in Fig.6. The details of the receiver microwave head are shown in Fig.7. The 10nF capacitor connected across the cold end of the RF chokes is essential to prevent broadcast interference breakthrough.

The prototype audio amplifier was built on an off-cut of veroboard. There is nothing special about construction except that the audio loudspeaker output should be kept away from the amplifier input.

The first stage of the preamp performs two functions: it provides around 50 microamps of current to bias the detector diode to maximum sensitivity while the emitter input configuration provides a good impedance match to the audio output from the diode. The result is a receiver which is much superior to the basic crystal set which it appears to be.

### Testing And Frequency Measurement

Having soldered and stuck the sender unit together, the obvious thing to do is to test it. Connect the unit to a 12V low impedance

supply. The current drawn should be in the region of 30 to 40mA. A finger placed on the collector line should alter the current reading or stop oscillation altogether. The current should drop to around 5mA in the latter case. Placing a hand across the mustard tin waveguide mouth should also reduce the current. The transistor runs quite hot even under normal conditions.

The prototype could light a small bulb (1.2V 100mA) quite brightly by placing the bulb with a couple of 'dipole aerial' leads attached (20mm each) inside the waveguide. *There is clearly quite a bit of microwave power about and the waveguide exit should be kept away from the head and — particularly — eyes.*

### Decouple Well

Working near its upper frequency limit, the transistor presents a negative resistance to the supply. Low frequency RF oscillations can result unless the supply is well decoupled. This same effect makes it quite difficult to obtain deep amplitude modulation with a simple carbon microphone connected as shown. This part of the circuit would doubtless benefit from further circuit development.

Crude but effective frequency measurement may be made by stretching a length of bare copper wire about 2mm above a large surface of copper clad PCB material (copper side to the wire). The wire is soldered to the edge of the board at one end while the other is connected to a UHF diode such as a BAR28 or a germanium OA91 unit. A sensitive microammeter is connected between the other end of the diode and the ground plane. When the wire line is irradiated with RF from the waveguide, the

meter will show a deflection due to rectified RF.

A shorting bar slid along the wire and PCB ground plane will produce a series of peaks and troughs in the meter reading. Physically measure the distance between nulls on the wire and multiply by two to give you the operating wavelength.

The receiver when working correctly should produce masses of white noise with or without an incident signal on the detector head. In any case, the detector should produce a large reading when connected to a microammeter rather than the amplifier for initial checking with the microwave source in close proximity. Please note that the amplifier circuit will not function without the detector head being connected. Incident microwave energy does not quieten the white noise but doppler effects, microphony of waveguide, etc should at once be evident.

### A Few Experiments

The first thing to note about the RF coming out of the mustard tin is that it is vertically polarised when the mustard tin is on its 'flat' side. The receive butterfly aerial must therefore be parallel to waveguide probe axis ie vertical. As well as radiotelephony using the carbon mic (why not build two links for true two-way QSOs?) the receiver and sender placed close together act as a dual cavity doppler module, as in the typical intruder alarm. Interferometer experiments can also be carried out. For instance, some types of wrist watch placed in the beam will reflect incident RF off the internal moving parts back to the receiver head. This mixes with directly received RF to produce an audible result similar to an 'X ray' microphone ie a very loud tick tock! Classic distance and wavelength experiments can also be done.

A miniature aerial testing range could also be made but this is something that I haven't tried (*G6CJ's famous 'aerial circus' works along those lines — Ed.*). The possibilities are endless. Speaking from a purely personal point, this is one of the most interesting projects that I've carried out for a long time. I am sure that those who build it will have at least an equal amount of fun.

# ATTENTION ALL WRITERS . . .

... or just those of you who sometimes think "I could do better than that!"

## We want to hear from you!

The magazine you hold in your hand is part of ASP's electronics group of titles. These include *ETI*, *Ham Radio Today*, *Digital and Micro Electronics*, and our new magazine, *Electronics*. All these magazines are looking for new authors, so if you've designed something for yourself that you think may be of interest to others, or if you've a subject you'd like to write a feature article on, then drop us a line with an outline of what you have in mind.

### We particularly need:

- Projects for the Commodore Vic 20 and 64, the Amstrad, the BBC A and B, and the Electron computers;
- Simple projects that do something useful, perhaps in a novel or instructive way;
- Radio projects (not necessarily for radio amateurs);
- Features on amateur satellite radio.

If you're interested in writing for us, send an outline of your proposed article to: Dave Bradshaw, Group Editor (Electronics), Argus Specialist Publications, 1 Golden Square, London W1R 3AB.

Please note that while we take ever care, we cannot be held responsible for the loss of unsolicited manuscripts. We advise all authors to keep a photocopy or carbon copy of any article they send us.

## R. WITHERS communications

### TRANSCEIVERS YAESU

FT757GX	£719.00
FT726R <i>(inc. 2mtr option)</i>	£775.00
FT209R/FNB3	£239.00
FT209R/FNB4	£249.00
FT203R/FNB3	£175.00
FT203R/FNB4	£185.00
NC15 Charger	£49.95
NC8 Charger	£54.95

### THE FULL YAESU RANGE KEPT IN STOCK

Always in stock ICOM  
FDK, Kenwood, Mutek,  
Welz, Hi, Mound, D.N.T./  
LCL 10 metre FM

Transceivers and of course  
our now very famous mod  
kit for the above rigs.

RWC wish all old and new  
customers alike a Very  
Happy Xmas & New Year.

### SPECIAL OFFERS

FT790R inc. Ni-Cads and Charger, plus FREE HB9CV 70cms.	£279.00
FT708R inc. free Ni-Cad Case & Charger, plus FREE HB9CV.	£199.00
FTV707 + 2mtr module, complete usable on most Yaesu HF Transceivers.	£159.00
FT730R or FT230R. Great Little Mobiles. Free Gutter Mount & Cable Assembly.	£249.00
FT730R RWC Price	£249.00
FT230R	£269.00

With all H.F. Transceivers  
purchased up to Dec. 31 st  
FREE ½ size G5RV and  
FREE Comm Headphones!

That's RWC Value!

### ANTENNAS ACCESSORIES

Hoxin 7/8 2 mtr	£15.95
SMC 2m/70cm Colinear	
Base Station aerial	£32.95
SMC 3 x 5/8 70cm	£18.95
Hoxin ½ Wave 2 metre DC ground mobile comp. with cable & plug RWC.	£12.95
Sun 3 x 5/8 2mtr Base Co- linear	£28.95
RWC G5RV ½ size	£12.95
G8KW/W3DZZ Traps. The pair	£9.50
A.J.H. 25 watt linear amp 3 watts input kit	£29.95
Case & Heatsink	£6.00

Complete range of Revco  
Coils/Whips & Bases now  
in stock.

Also Tonna/Jaybeam/  
R.W.C. HB9CV

### SCANNERS & RECEIVERS

Revco RS2000 Scanner V.H.F.-U.H.F. Air, Marine, Pair FM-AM 70 Memories, Gasfet Model	£259.00
Extended Coverage (60-179 MHz)(380-520MHz)	£279.00
Century 21D Gen Coverage Receiver	£199.00
The fabulous SX400 now here, ask for RWC Price! Special offer on the terrific Revco Discone Antenna only	£28.99

Always wanted, used  
equipment working or not.  
Ask about selling your old  
rig on our Special  
Commission Sale  
Agreement! PX Welcome.  
The AOR 2001 continuous  
coverage scanner in stock.  
26-550MHz £339.00  
All above inc. VAT + Carr.



MON, SAT 8.30-5.30 LATE NIGHT THURS/FRI 584 HAGLEY ROAD WEST, OLDBURY, WARLEY B68 0BS  
Secondhand lists available/part exchanges welcome Carriage At Cost (QUINTON, BIRMINGHAM)  
STOCK ITEMS NORMALLY DELIVERED WITHIN 7 DAYS Tel: 021-421 8201/2 (24 HR ANSWERPHONE)  
Overseas customers welcome, we speak German and Japanese S.A.E. with all enquiries please.  
Telex: 334303 TXAGWM/G

# Planting a Tower

To have a tower in the garden, whether it be for HF or VHF antennas, is the dream of every radio amateur. For some lucky ones this dream comes true; I have been

characteristics that are the most helpful with obtaining planning permission.

Thankfully, I had no difficulties obtaining planning permission

---

*Putting up a tower looks easy, but Nigel Cawthorne, G3TXF, explains that there is a lot of hard graft involved.*

---

lucky enough to have had a tower up at two different QTHs. This article describes some of my experiences and lessons learned of 'digging in' and 'rooting up' towers.

## Planning Permission

Assuming for the moment that he/she has already crossed the hurdles of gardener and bank manager opposition, the next one to be encountered by the would-be tower user is obtaining planning permission.

There seems to be a mathematical formula linking height of tower, quantity of near neighbours and your chances of obtaining planning permission: the larger the number of neighbours, the higher the tower, the greater the problems of getting permission.

I do not propose to go into the 'ins and outs' of getting planning permission, but the RSGB provide an excellent support service especially the booklet covering this subject. (See the article in the July issue of HRT by Steve Voy). A letter of support from the RSGB attached to your application will increase your chances of success. Diplomacy, common sense and tenacity are probably the three

because I was fortunate enough on both occasions to have very few direct neighbours and was successful on the first attempt.

As part of the procedures that the local authorities went through, my direct neighbours were each sent a questionnaire after my application had gone in. Before anyone was contacted, I mentioned what I was doing to everyone likely to receive a questionnaire; and had made a point of inviting each of the more immediate neighbours in for a visit to the shack and a demonstration QSO. Good public relations are very important at these delicate times!

As a part of these PR operations, I have found displaying and highlighting my QSL from JY1 (King Hussein) does wonders for the image of amateur radio with the neighbours!

Where there are large numbers of neighbours involved, the PR operation might have to be on a bigger scale, and the chances of finding among them an "I'm going to object on principle" type increases dramatically!

Having got over the hurdle of planning permission you can become the proud owner of a tower. All you have to do now is put it up.

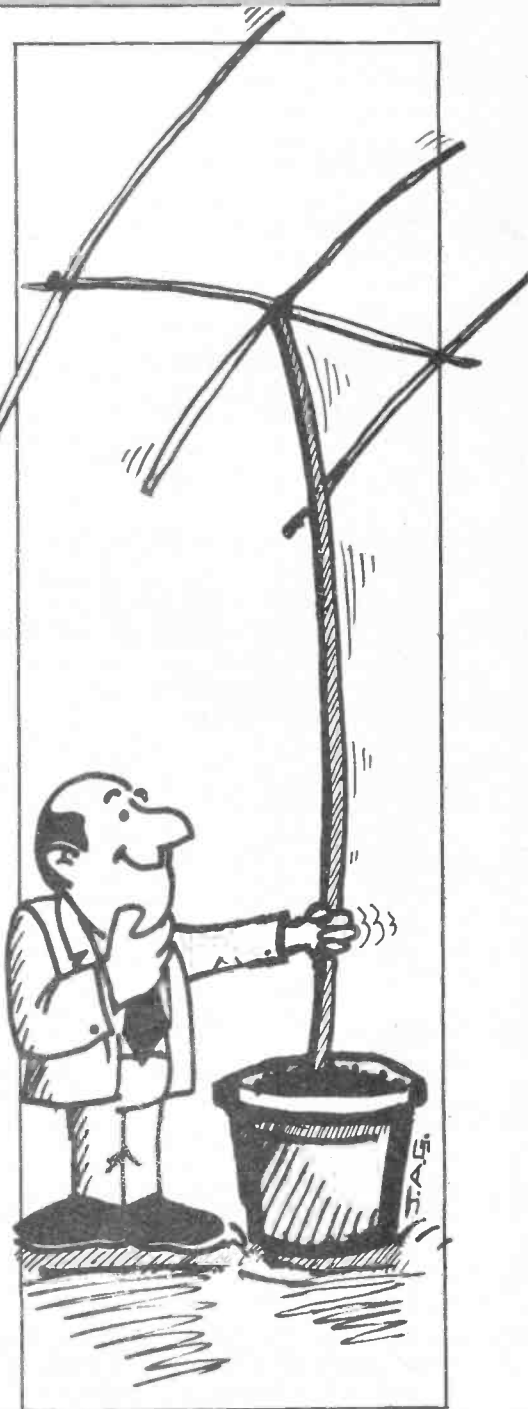

## Positioning The Tower

Great care must be taken in positioning the tower. If it is the tilt-over type, (mine is a Versatower P60, 60 foot post mounted type) calculations should be made of where the tower will be when it tilts over, especially where the antennas will 'land' as the tower tilts over.

The practical advantages of a tilt-over tower can be soon lost if the antennas get stuck in a tree as the tower is lowered. If the tower is being put up in the winter time when the trees are bare remember to allow sufficient clearance for clearance as spring approaches. Plan carefully where the tower is to go, although, of course, in smaller gardens, there may well be no choice in the matter.

Having planned in detail where the tower is to be positioned and its orientation, the next part is the worst bit of all — digging the hole!

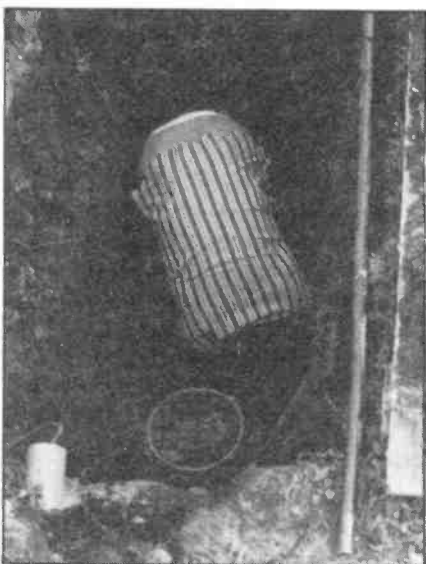

G3TXF completes the hardest task of digging the hole.

## The Spade Work

The most common type of tilt-over towers that use a base post require a six foot hole, which has to be about 1 foot square at the bottom. The amount of physical effort this requires comes as quite a shock to many. But the thought of all those QSO's that you are going to make keeps you going as you dig further down the hole. It may take two inexperienced diggers a full afternoon's work to achieve the required hole for the base post. But



John, G8IQQ, helps with inserting the base post.

don't worry, the ensuing backache is soon to be compensated for by that big signal which will be there just as soon as the tower and antennas are complete!

## Pouring the Concrete

Where a base post mounted, tilt-over tower is to be installed, great care must be used in setting the base post vertically into the ground. Half of an inch off true at the level of the base post will produce a Tower of Pisa effect on a 60ft tower. So the base post should be firmly held in true vertical position by boards or ropes. It must not budge as the concrete is poured around it.

With the tower on the base post, G3TXF examines progress so far.

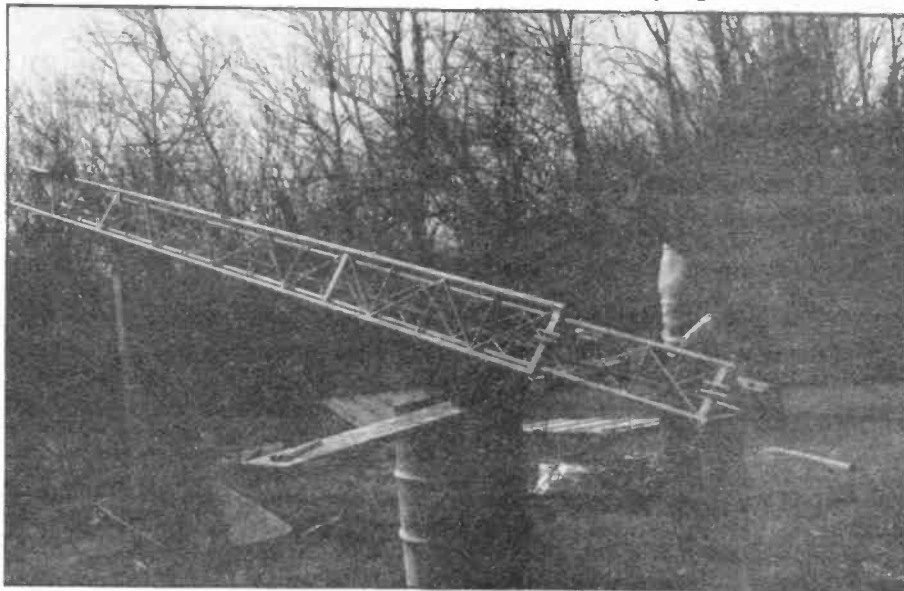

## The Non-Stick Base Post

Even while you are digging your tower base into the ground, it is worth remembering that one day you may be moving house, and that you will not want to have to leave a costly base post behind just because it is set in concrete. A useful technique for keeping the base post clean when it is in concrete, is to fix a layer of silver foil all over the part of the base post that is to be in contact with the concrete.

Unless you are in a very exposed and windy location, it is probably unnecessary encasing the whole length of the base post in concrete. Usually a 'collar' of concrete around the upper two feet of the base post is adequate. It is this upper two feet that is covered with silver foil, held on with tape. This keeps the concrete away from the surface of the base post.

When it is time to move house, and the tower has to be dug up, the concrete collar can be dug free. With a sledge hammer the concrete collar can be broken off, leaving the tower base post in a good clean condition all ready for removal to the new QTH.

The removal of a tower from one QTH to another can add a heavy burden of work to the already onerous task of moving house! My tower is already at it's third QTH, sadly a QTH far too small and cramped for a tower. However with a fourth QTH already in view where there will probably be more space and it will soon be back to the hole digging again!

## Leaving The Concrete To Set

With the concrete poured around the base post, adequate time should be allowed for it to harden before lifting the main body of the tower onto the base post. For a three section 60ft tower lifting the tower up onto the base post can be a problem. Not only is it

cranking it up to see what it looks like and to get a feel of how the cranking system works. It is not unknown for amateurs to crank up their new tower to full height at this stage and then to take a gentle walk around the neighbourhood just to see how far away they can see it! It's like an artist stepping back from his canvas to admire his work. Quite understandable!

you're going to start off with a misaligned antenna rotator system!

## The First QSO

New tower, and possibly new antennas too, it won't be long before you're on the bands looking for that first QSO. If you've just installed a HF antenna on top of the tower, a CQ call will hopefully produce an encouraging reply. A nice run of JAs on 21 MHz perhaps, just to show that the antenna is working.

The first day that it is all up and working you will probably be too tired to spend much time on the air testing out the new system. After all that digging, concrete mixing and lifting you may be on your back already!

With the tower up and with the antennas working, the bands will seem somewhat different. A CQ call produced not just one caller, or perhaps silence, but several callers at once. DX-stations come back on the first call. Pile-ups that previously were impossible to break, are now easy. The DXCC score starts to climb. Your signal becomes competitive in contests and you no longer have to wait at the bottom of the heap to make that DX QSO. No more agony of being the only station replying to a DX station's CQ call on a clear frequency; only to hear the DX station start calling CQ again because he can't hear you (even with no QRM!) But now, with your new tower up, they all come back first time! Well, almost.

**The end result, well worth the effort!**

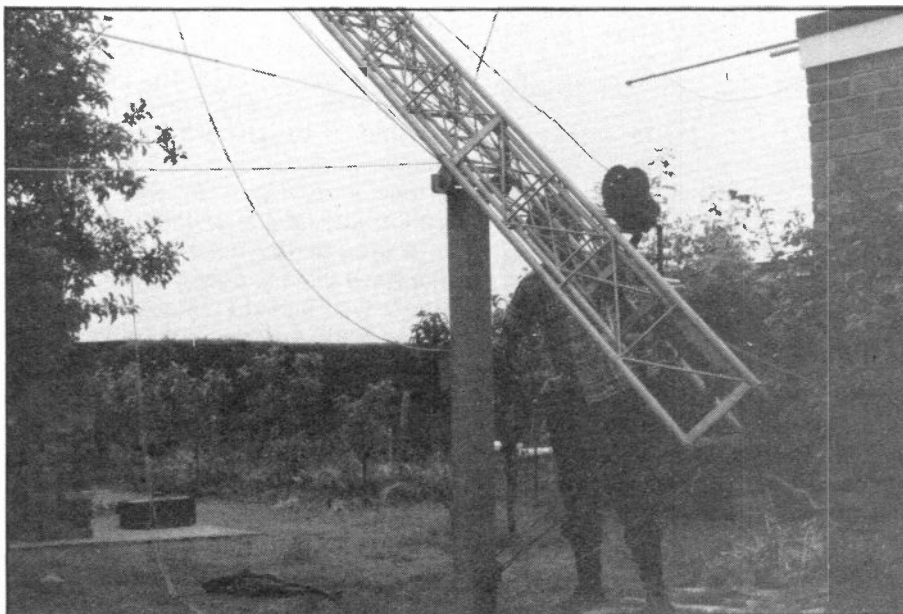

Cranking up the tower, the moment of truth.

very heavy, but it has to be lifted about six feet above ground level. This is a case for "many hands make light work."

## Get The Neighbours In

Getting the neighbours in to actually assist you with putting up the tower is a very useful ruse. It is probably too much to expect neighbours to help dig the hole for you, but they might be able to help you with lifting the tower onto the base post. Make a party of it! Invite them all in for tea (something a little stronger may be necessary for some!). After this get them all lined up on either side of the tower and heave! With about eight people lifting, you'll wonder what all the fuss was about!

There is nothing like it for your own good PR with the neighbours. Once the neighbours have been directly involved in putting up your tower with you, it leaves them without a leg to stand on if they want to complain about it at a later date!

Before putting any antennas onto the new tower, it is worth just

## Installing The Antennas

Rotators and antennas should all be checked before they are fitted to the head section of the tower. Rotators can be mounted either inside the head section or just on top of a small length of tubing fitted into the head section.

Don't be tempted to try and guild the lily by putting too much extra tubing on top of the tower. It is better to be safe than sorry. Settle for a beam directly above the head section at 60ft, which survives all gales, rather than a beam on top of a 10ft pole, itself on top of the head section, that buckles and crashes down in the first gale. Seek the tower manufacturers' advice if in any doubt. Whatever you do, do not overload the tower.

Allow adequate cable for antenna rotation. There should be an adequate loop of coax between the head section and the antenna above the rotator.

Check the alignment of the rotator before you fix it to the tower. If you are using a compass to set the heading, stand away from the tower itself, otherwise



**ALTRON**

**TOWERS, MASTS, AERIALS**  
**AQ6-20 4 BAND (2EL + 3EL)**  
**\* SPACE SAVER \***  
**6M to 20M**

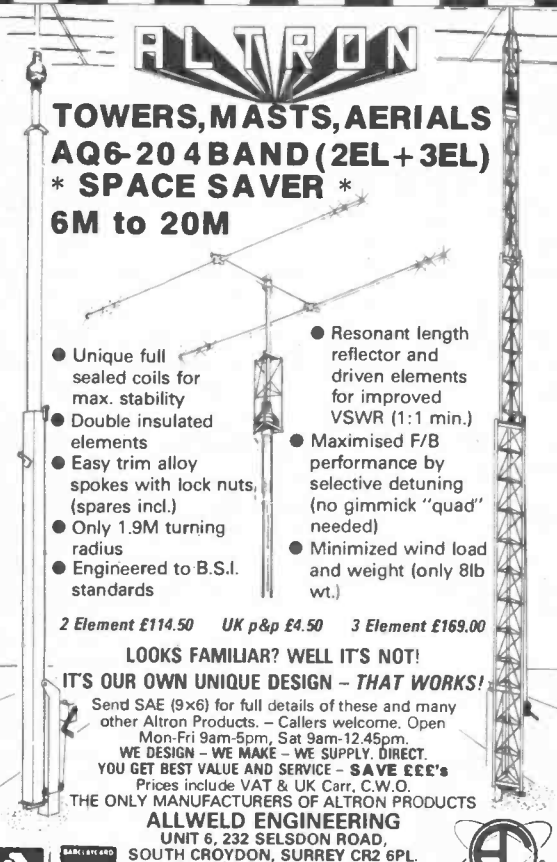

- Unique full sealed coils for max. stability
- Double insulated elements
- Easy trim alloy spokes with lock nuts. (spares incl.)
- Only 1.9M turning radius
- Engineered to B.S.I. standards
- Resonant length reflector and driven elements for improved VSWR (1:1 min.)
- Maximised F/B performance by selective detuning (no gimmick "quad" needed)
- Minimized wind load and weight (only 8lb wt.)

2 Element £114.50 UK p&p £4.50 3 Element £169.00

**LOOKS FAMILIAR? WELL IT'S NOT!**  
**IT'S OUR OWN UNIQUE DESIGN - THAT WORKS!**

Send SAE (9x6) for full details of these and many other Altron Products. - Callers welcome. Open Mon-Fri 9am-5pm, Sat 9am-12.45pm.  
**WE DESIGN - WE MAKE - WE SUPPLY. DIRECT.**  
**YOU GET BEST VALUE AND SERVICE - SAVE \$\$\$'s**  
 Prices include VAT & UK Carr. C.W.O.  
**THE ONLY MANUFACTURERS OF ALTRON PRODUCTS**  
**ALLWELD ENGINEERING**  
 UNIT 6, 232 SELSDON ROAD,  
 SOUTH CROYDON, SURREY CR2 6PL.  
 Telephone: 01-680 2995 (24hr) 01-681 6734  
 Normally despatched within 7 days

**PARTNERSHIP MICROSYSTEMS**  
 . . . Things for the VHF man.

**THE G3WZT 2m GaAsFET mast head pre-amp.**



PCB 41601 £14; S3030 £8.65; BF256A 55p  
 N-type connector (rear cable entry) £4  
 Misc. Parts; comprings  
 2 off 100n cermaic monobloc C7, 18  
 2 off 1n5 chip C9, 11; 2 off 15n chip C10, 12  
 4 off 5082-2835 D1-4; 36" 18 swg silver plated wire  
 Copper foil for cable termination and input screen £3.25

Control units  
 PCB 41602 £9; PCB 41603 £6.50; 100n ceramic monobloc 10p  
 Relay DR 12V (Good for 50W at 144 MHz) £4  
 BA 379 PIN Diode £1  
 Chip capacitors 1n5 100V or 15n 50V 10 for £1

All above components are **EXACTLY** as used by G3WZT to build prototypes.  
 Complete pre-amp build, tested and aligned £88.25  
 Logbooks for the VHF man, with VHF countries and countries list — includes space for QTH/WAB locator £2  
 All prices include VAT. Post & packing 50p per order.

**PARTNERSHIP MICROSYSTEMS LTD**  
 Tardis House, Cowfold, West Sussex RH13 8DR  
 Telephone: 040386 227

**If an advertisement is wrong we're here to put it right.**

If you see an advertisement in the press, in print, on posters or in the cinema which you find unacceptable, write to us at the address below.

**The Advertising Standards Authority. ✓**

ASA Ltd, Dept 3 Brook House, Torrington Place, London WC1E 7HN

# Addendum

**Finding Your IARU Locator**

The two programs on P40 for changing latitude and longitude into the new locator and vice versa were incorrectly captioned - the captions should be transposed.

There is a mistake in the last but one sentence of the article (on P41) which seems to have caused some confusion. This should read 'To test the program, try converting IO92LD - the answer should be latitude = 52.1458, longitude = -1.04170.' Both programs have been checked on an Apple 2 computer.

**BECOME A RADIO AMATEUR**

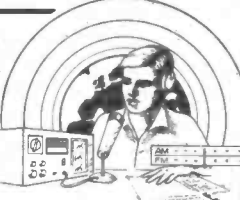

Train now for the Radio Amateur Licence examination. No previous knowledge needed, only a few hours per week of home study for 3 to 6 months. Post coupon now for details or tel. 0734 51515 (24 hr service)

British National Radio & Electronics School Reading, Berks. RG1 1BR

FREE brochure without obligation from:—  
**British National Radio & Electronics School**  
 READING, BERKS. RG1 1BR

Name .....

Address .....

HRT/1 BLOCK CAPS PLEASE

# DIPLLEXERS and Dual Band Antennas

The author used to run four aerials on his car, to get, he hoped, the best performance possible on each band he used. This had the usual effect of eyes being turned by

on 70cm, and a loaded  $\frac{3}{8}$  or  $\frac{1}{2}$  wave radiator on 2m. Gain specifications for a variety of commercial antennas for both 2m and 70cm (all made by the same

nas could then be changed prior to travelling if required, whilst still allowing operation on a previously selected band, by a switch. The reason for this switch was due to my disappointment with the quoted specifications for commercially available diplexers enabling true dual-band operation, (ie one feeder to two aerials), typically 0.5dB loss and only 30 dB isolation between ports.

*More and more people are operating on both 2m and 70cm from the car. Chris Lorek, BSc(Hons), G4HCL, tells how to maximise your results with a minimum of aerials and reveals some home truths about dual band operation.*

passers-by, CB microphones being waved by other motorists, and so on. It may also have something to do with his car being rammed in the back by other (distracted?) drivers three times in the first year of owning the car! The final straw came when the local City Council decided, in their infinite wisdom, to close the last remaining open-air car park in the city centre, meaning for me a dismantling job on the aerials every shopping trip on a hurried dinner-time in order to be able to use a multi-storey car park. Something *had* to be done. I now have aerials able to cover 2m, 70cm, 4m, 10m, my business radio, CB, broadcast FM, MW, and LW, and a further VHF test band. However, the sum total of metalwork now is one visible 3ft long aerial and a further electrically-controlled stainless steel telescopic aerial, top loaded, which pops up when needed!

My primary interest, mobile operational wise, lies in 70cm and 2m and close investigation was thus carried out on the range of 'dual band' aerials now available for these bands. These usually act as a  $\frac{1}{2}$  over  $\frac{3}{8}$  wavelength radiator

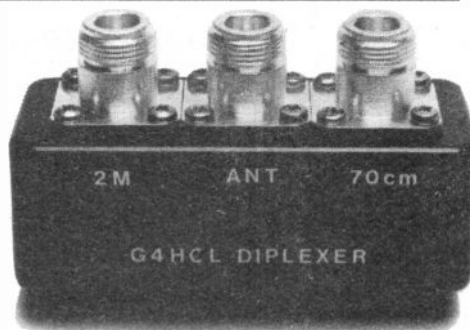

manufacturer — which suggest probably the same test methods are used for each gain measurement and therefore a reasonably accurate comparison of antenna gains is possible) are given in Table 1.

It was considered that the theoretical figures were not too promising with regard to the gains of the dual band aerial, particularly as the majority of my monitoring was done towards the fringe areas of activity. I decided my existing  $\frac{3}{8}$  wave 2m aerial and  $3 \times \frac{3}{8}$  wave 70cm aerial would be kept for general use, and a dual band aerial would be purchased and kept in the boot for use when a trip into the city centre was envisaged. The anten-

## Antenna Isolation

It was at this time that I decided to actually measure the typical isolation between a 2m  $\frac{3}{8}$  whip on one car gutter mount, and a 70cm  $3 \times \frac{3}{8}$  whip mounted on the opposite gutter. 50 watts of 2m power was fed into the  $\frac{3}{8}$ , and the resultant power measured coming from the 70cm whip, using a sensitive power meter. I was amazed to find a bare 17 dB isolation, ie *a full watt coming back down the coax, straight into the 70cm rig!* I wondered how my 70cm rig had survived for so long.

At this point I decided it would be a good idea to use a diplexer to at least alleviate this situation. With the generous help of two local amateur radio shops, the responses of two commercially available diplexers were measured using a calibrated spectrum analyser and tracking generator. The first, a Kenwood diplexer to be used with the Kenwood dual band aerial, showed a 2m to 70cm isolation of 62dB and a 70 to 2m isolation of 50.5dB. The insertion loss on 2m was 0.2dB and on 70cm, 0.55dB. The figures I felt showed good isolation but poor insertion loss with the diplexer, slightly higher than the quoted specification. Silver plated connectors with gold plated centre pins were used for the measurements. A further 0.1dB loss was found on 70cm when standard amateur type PL259 and 'N' connectors were used.

It can be seen from the

Table 1. Gain specifications for a (typical) range of commercial 2m and 70cm antennas.

5/8 wave whip, 2m:	Length 4ft 3ins;	Gain 3.0 dB rel.	1/4 wave
7/8 wave whip, 2m:	Length 5ft 7ins;	Gain 4.5 dB rel.	1/4 wave
2 x 5/8 whip, 70cm:	Length 3ft 1in;	Gain 5.5 dB rel.	1/4 wave
3 x 5/8 whip, 70cm:	Length 4ft 7ins;	Gain 6.3 dB rel.	1/4 wave
2m/70cm dual band whip,		Gain 2m, 2.7 dB rel.	1/4 wave
		70cm, 5.1 dB rel.	1/4 wave



response curves of the diplexers (Fig. 1a) that a low-pass and high-pass filter was used internal to the unit to separate the two ports.

A Hokushin diplexer was measured next, with the response as shown in Fig. 1b. This showed a resonant response, indicating that some form of tuned circuits were used in the unit. 2m to 70cm isolation was measured as 37dB, and 70cm to 2m, 30dB, just inside the specification. 2m loss was measured at 0.2dB, and 70cm loss at 0.4dB, within specification.

### Going Homebrew

Both diplexers have their merits, but it was thought that a home designed job, made to a specification rather than a price, using simple components, could possibly do the job better.

The eventual design is shown below (Fig. 2). This gives over 70dB isolation between 2m and

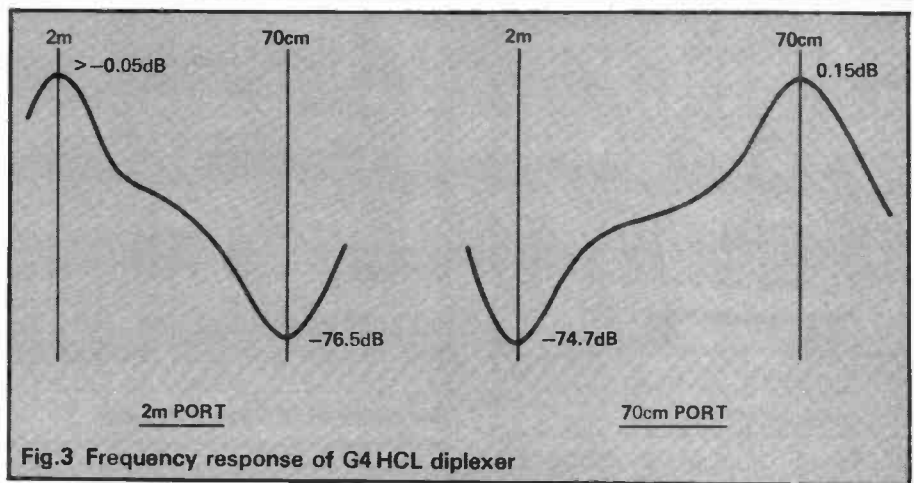

Fig. 3 Frequency response of G4 HCL diplexer

70cm, with 'unmeasurable' loss (ie less than 0.5dB) on 2m, and 0.15 dB loss on 70cm. It is built in an Edystone type diecast box, approx 1in x 1in x 3ins, with three 'N' connectors used for aerial connections. Apart from some 1.6mm dia. wire for the coils, the components listing consists simply of four good quality trimmer capacitors. The

total cost if a commercial manufacturer made this would probably be in the order of £40-£50, but by doing one's shopping at a typical radio rally it may be built for less than six or seven pounds.

All coils are wound on a ¼ inch former (you could use a drill bit), using 1.6mm diameter wire, preferably silver plated, diameter spaced between turns. The trimmer capacitors used in the prototype units were of the multi-turn variety, but one may use any mechanically stable type. *Note that high-Q silver-plated air-spaced types will give the best performance figures* — although these may prove more difficult to tune due to the sharper responses that would be achieved with them. The response of my prototype is shown in Fig. 3.

A tuned pass circuit resonant on 2m, comprising of C2 and L2, is used between the aerial port and the 2m port. Likewise a 70cm pass circuit comprising of C3 and L3, is used between the aerial port and the 70cm port. Between the 2m port and ground, a similar 70cm pass circuit, this time comprising of C1 and L1, is used to get rid of any residual 70cm energy. Similarly a 2m pass circuit is used between the 70cm port and ground comprising of C4 and L4.

Alignment by the user may consist of:

- 1) Connect 2m transceiver and 70cm transceiver to their relevant ports. Do *not* transmit yet. Tune to a moderately strong 2m signal and tune C2 for maximum received signal strength as indicated on the 2m rig S-meter. Then transfer to the 70cm rig and do likewise, this time tuning C3.

- 2) Then connect the 2m transceiver to the 70cm port, and

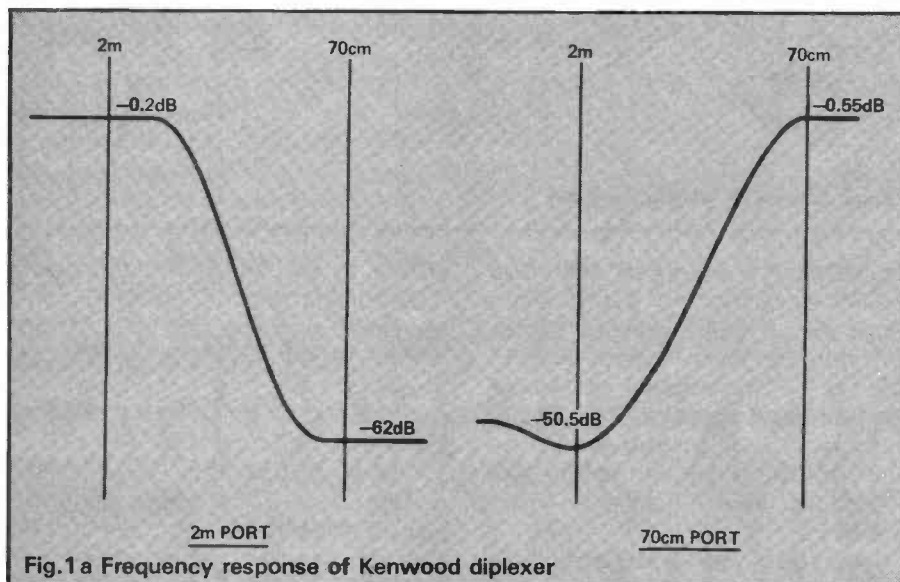

Fig. 1a Frequency response of Kenwood diplexer

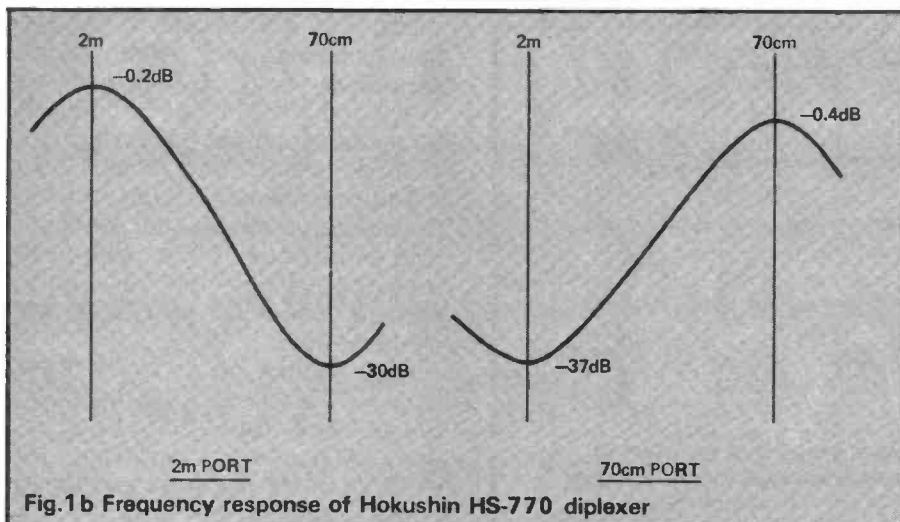
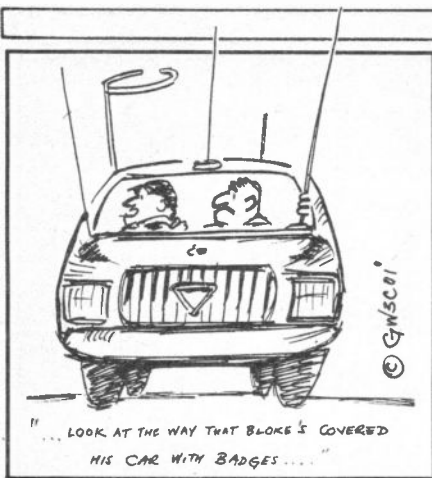

Fig. 1b Frequency response of Hokushin HS-770 diplexer



the 70cm transceiver to the 2m port. Once again, do *not* transmit, (you could disconnect your microphone as an added precaution). Tune to a very strong signal on the 2m rig, and adjust C4 for minimum 'S' meter reading. Then tune to a very strong signal on 70cm and adjust C1 for minimum 'S' meter reading.

3) Now connect as in 1). It is now safe to reconnect your microphones! Final trimming is performed by inserting a power meter in the aerial line, ie between the diplexer and aerial, and fine tuning C2 for maximum power with the 2m transmitter operated, and similarly tuning C3 for maximum power with the 70cm transmitter operated. This final operation should ensure the ultimate in performance.

At each stage, a check should be made to ensure that fitting of the diplexer box lid does not excessively affect the adjustment made, with a slight retune being undertaken if this occurs.

*The power rating of the diplexer is entirely dependent upon the individual types of components used by the constructor and the quality of soldering.* As a guide, the author's units easily stand in excess of 100 watts into each port simultaneously.

## Dual Band Vs Single Band

The dual band whip used, a Welz EL-770 was eventually found to outperform the 2m  $\frac{7}{8}$  whip, due to the bending effects of the longer whip at normal driving speeds (ie movement of the vertical plane and thus also coming into closer proximity with the car metalwork). On 70cm, in flat Fenland very slight

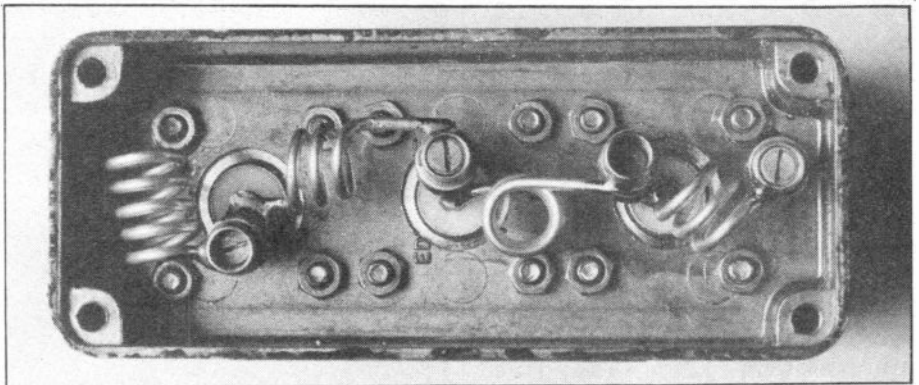

Construction of G4 HCL diplexer

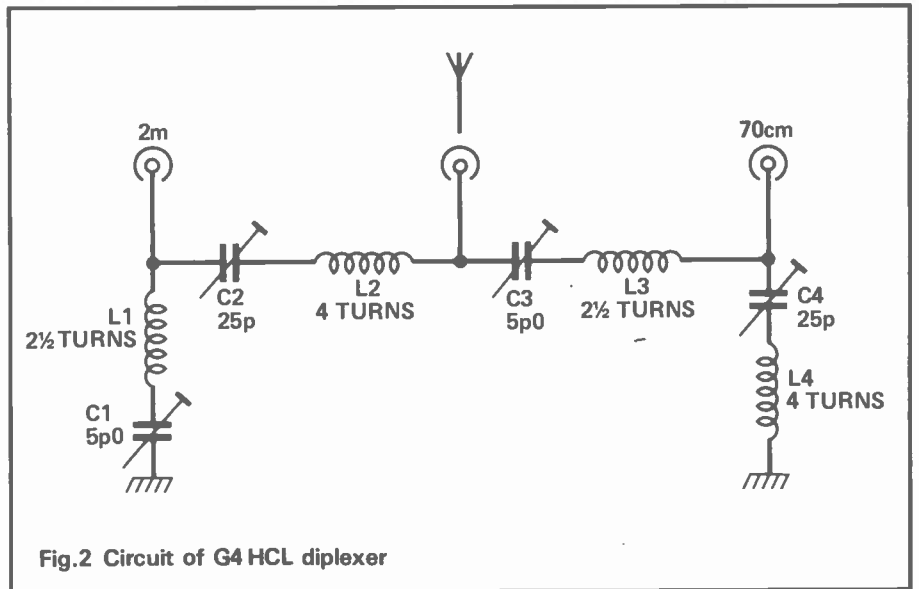

Fig.2 Circuit of G4 HCL diplexer

degradation was noted with the EL-770 as against my 3 x  $\frac{5}{8}$  wave whip, yet, in built-up areas, better performance was noted, due I believe, to the radiation pattern of the dual band antenna. This finally prompted the author to retain the dual-band whip for permanent use — and to swiftly sell his other aerials!

Accurate measurements are presently being carried out by the

author to test the gains and polar radiation patterns of several commercially available 2m and 70cm mobile whips, using a variety of ground planes, and it is hoped that the results of these tests will be featured in a future article in HRT.

Several diplexers have been constructed to the design described and all perform well. Their use is certainly not limited to mobile installations: a further typical use could be in a base station installation to replace two perhaps comparatively 'lossy' feeder runs on 70cm and 2m with *one* good quality feeder such as Heliac, with a diplexer at either end (Fig.4). Also if you use a scanner type receiver to monitor these bands, separate high gain 2m and 70cm aerials fed from the diplexer may be used in place of the usual wide band and low gain aerial.

My thanks go to Lowe Electronics, Chesterton High St, Cambridge, and Collins Communications, Milton Rd, Cambridge, for the loan of the diplexers evaluated in this article.

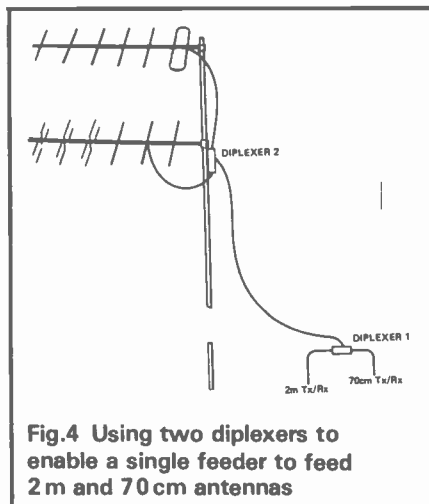
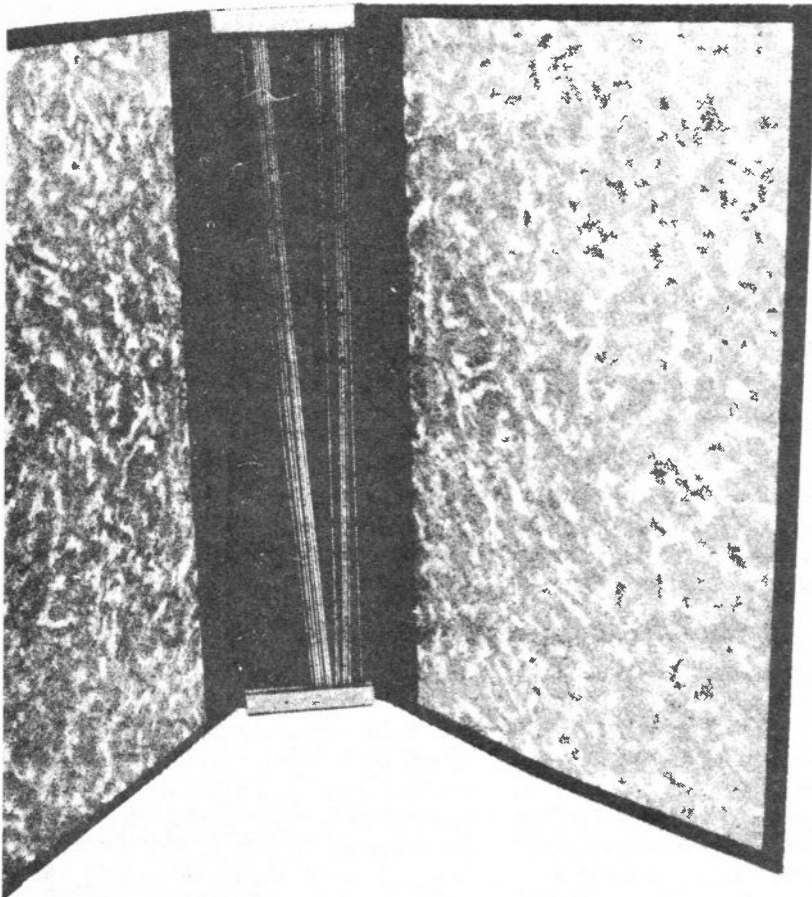

Fig.4 Using two diplexers to enable a single feeder to feed 2m and 70cm antennas

**SAVE £4.25 by receiving a FREE magazine binder when you subscribe to.....**



It's true, by subscribing to *Ham Radio Today* you will not only receive your personal copy direct to your door for a whole year but also have a superb magazine binder in which to keep your copies **AND IT'S FREE!**

All you have to do to receive your **FREE** binder is book a new subscription or renew an existing subscription to *Ham Radio Today*.

What could be simpler? Normally priced at £4.25, these attractive binders will hold approximately 12 issues of *Ham Radio Today*.

Not for you any longer the chore of having to track down dogeared copies of your favourite magazine, instead you will merely go to your bookshelf and they will be waiting for you in pristine condition. Don't miss out on this outstanding offer — subscribe today and receive your **FREE** binder within 14 days of your order being received.

**SPECIAL OFFER**

**SUBSCRIPTION ORDER FORM**

Cut out and send to.  
**HAM RADIO TODAY,**  
**INFONET LTD,**  
**TIMES HOUSE,**  
**179 THE MARLOWES,**  
**HEMEL HEMPSTEAD,**  
**HERTS HP1 1BB**

Please send my free binder and commence my personal subscription to **HAM RADIO TODAY** with the

*I am enclosing my (delete as necessary)  
 Cheque/Postal Order/International Money  
 Order for £.....  
 (made payable to ASP Ltd)  
 OR  
 Debit my Access/Barclaycard\*  
 (\*delete as necessary)  
 Insert card no.*



.....

Please use **BLOCK CAPITALS** and include post codes.

**NAME (Mr/Mrs/Miss)** .....  
(delete accordingly)

**ADDRESS** .....

.....  
**POSTCODE** .....

**Signature** .....

**Date** .....

<b>SUBSCRIPTION RATES</b> (tick as appropriate)	£14.50 for 12 issues UK <input type="checkbox"/>
	£16.00 for 12 issues overseas surface <input type="checkbox"/>
	£31.00 for 12 issues overseas Air Mail <input type="checkbox"/>

# FAULT FINDING TECHNIQUES for Radio Amateurs

Coming now to the method used in finding the faults on the equipment mentioned previously. There were first of all a number of practical points to be taken care of. Some of these included finding that,

blanker is working (at least as well as can be expected!) saves us a little time, since we can take it that a signal path must be present to the ceramic filter CF 301 and the NB IF amp (Q301) on the FM IF unit. This

ding that the supply is present, what next can be done to provide further information? We must check the voltages at the base, emitter and collector of the transistor or take it out of circuit and do the 'two diode junctions and wet finger test' on it with the test meter (see next stage). Nothing seems to be wrong here so, what next?

This is when the *experience* of a person doing the fault finding can prove crucial. From experience I have found that crystals can sometimes apparently die under normal temperature conditions but will work for a short time if sprayed with a little 'aerosol freezer'. Crystal XF301 was 'frozen' in circuit, the oscillator started working again and the set performed normally. Is this cause or effect, though? In practical terms, this can be difficult to determine; could something have altered in the oscillator circuit to prevent 'normal' oscillation? In this case, however, as seemed likely, a replacement crystal cured the problem and the rig has continued to work normally ever since.

Sometimes similar problems can be caused by other component failures, especially in older or valve sets where often resistors of 100K or more can become *very* high in resistance, sometimes virtually open circuit and capacitors can change value considerably outside their tolerance limits or even become 'leaky', particularly electrolytics. Despite the foregoing, I have seen some crystal oscillators continue to run correctly when virtually *all* the components were far from their nominal values!

## FT107M

In this set, we know that the 13.5V on Tx line in the AF unit has about 4 volts incorrectly sitting on it at all times, leading to RL5001

*In the final part of the series, James Finnegan, G14FFL, demonstrates a few of the problems that can arise when fault finding in a methodical fashion and gives some advice on testing individual components.*

although you knew what you wanted to do, you found yourself apparently confounded by the physical layout of the equipment, access to the test points you needed to reach being seemingly impossible, or that extended boards or jumper leads were at least required. Some ways round these kind of problems are mentioned in more detail in the final sections of the article.

## FT225RD

In this set, we have to determine why there is apparently a loss of signal between the O/P of the xtal filter XF102 at 10.7MHz and the I/P to the FM IF amp (Q306) at 455kHz. Knowing that the noise

leaves two filters, one mixer (Q305) and the 10.245MHz xtal oscillator providing injection to it. What can we measure here? Using the internal marker as a test signal, we could try to measure with an RF diode probe the level of the signal produced at the I/Ps of CF 301 and CF 302. We could also check with it that the O/P of Q309 is present at its emitter, and also at the junction of C312 and R314. On making these checks, we find that there is no signal injection present to the mixer and that the oscillator stage Q309 is not working. Why is this?

The first thing to do is confirm that the 8 volt supply is present to the oscillator — *it's unlikely that it isn't, but measure it to be sure!* Fin-

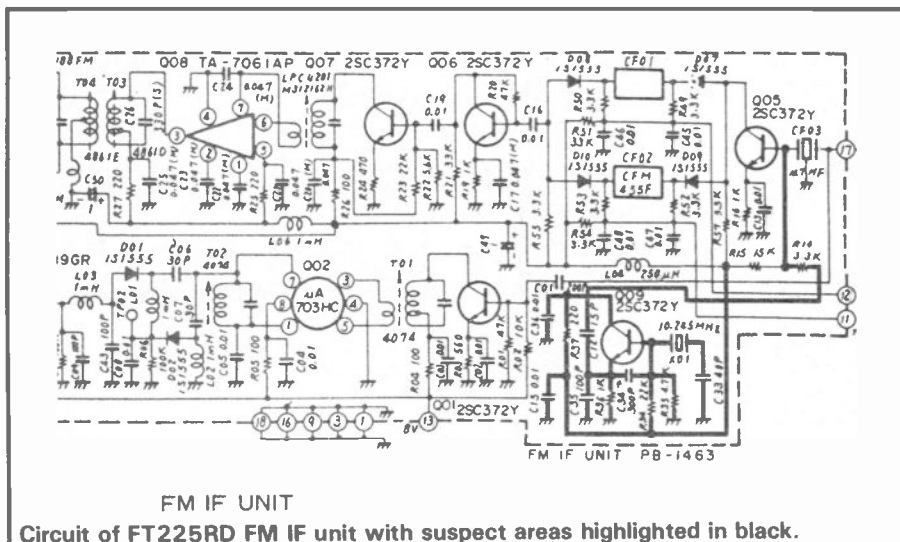

holding on after being correctly energised when the PTT is operated. Finding *where* this 'spurious' supply is coming from is the problem!

Looking at the interboard wiring diagram, we have to decide on a method to use for tracking this down. *Faced with this formidable looking circuit it's important not to panic and give up*, particularly since we are so close to the fault that a little time and patience will find it. *So what method shall we use?* Once more, we shall be logical in our attack and confirm that the fault is indeed external to the AF unit by isolating pin 23 (see diagram) at least before going on a chase through the rest of the set. Result — the spurious voltage is coming from somewhere external to this board — *but where?*

Our next step could be to remove all the other boards one-by-one to see if the voltage disappeared — I haven't tried it so I can't recommend it, but it doesn't strike me as a good procedure, especially since the fault may not even be on any of these boards! Once more, we must keep our heads and be calmly logical. Knowing that the unwanted voltage is *external* to the AF board means that we have to

trace and isolate *all* external connections to the Tx 13.5 volt line! However, by using our heads, *this is where we can make one step which can save us a lot of time*. As opposed to systematically working our way through the Tx 13.5V line from the AF unit to the other boards and junctions, we could isolate the Tx 13.5V line from the complete IF mother board at P15 and see what happens. By doing this, we find that the spurious voltage, as measured at the AF board, disappears, telling us that it was coming in on the Tx 13.5 volt line *completely external to the mother board*. Although this theoretically still leaves us with the rest of the set to worry about (!) this is not quite as bad as it seems, since we can do the same type of thing again *only this time with the RF mother board*, to further isolate stages and provide us with even more information. Reconnecting again the Tx 13.5V line at P15 IF mother board and then disconnecting it at pin 17 on the RF mother board, we find that the unwanted voltage on the A/F board disappears — thank goodness for that, we are lucky, since now we don't have to dig our way around the wiring harness!

The fault would seem to lie somewhere in the circuitry on the RF mother board and a few more logical steps should pin it down. Isolating the Tx 13.5V line from pin 16 on the local unit, we find that the spurious voltage is still present at the A/F unit, but disconnecting from pin 21 on the RF unit and it disappears — the Tx 13.5V line is being supplied with this unwanted voltage *from within the RF unit*.

Let's look at this in more detail using the individual circuit diagram. As can be seen, the Tx 13.5V line enters the board at the junction of R93 and R94/L24, and further circuit isolation at this point should lead us towards the source of the unwanted voltage. On lifting the supply side of R93, we find it disappears, so we pursue the fault along this line. Measuring at the junction of R93 and L23, we find that the voltage is still present, likewise at the junction of C124 and DO4. We are getting very close to the fault now. Either the diode or the capacitor may be short circuit, but in fact they are not. With both disconnected, after testing them, the unwanted voltage is still present at R93/L02. Measuring at DO2 anode, we find the voltage present there which we can see is

Partial circuit diagram of FT107M with suspect areas highlighted in black. The faulty DO2 is shown at lower centre.

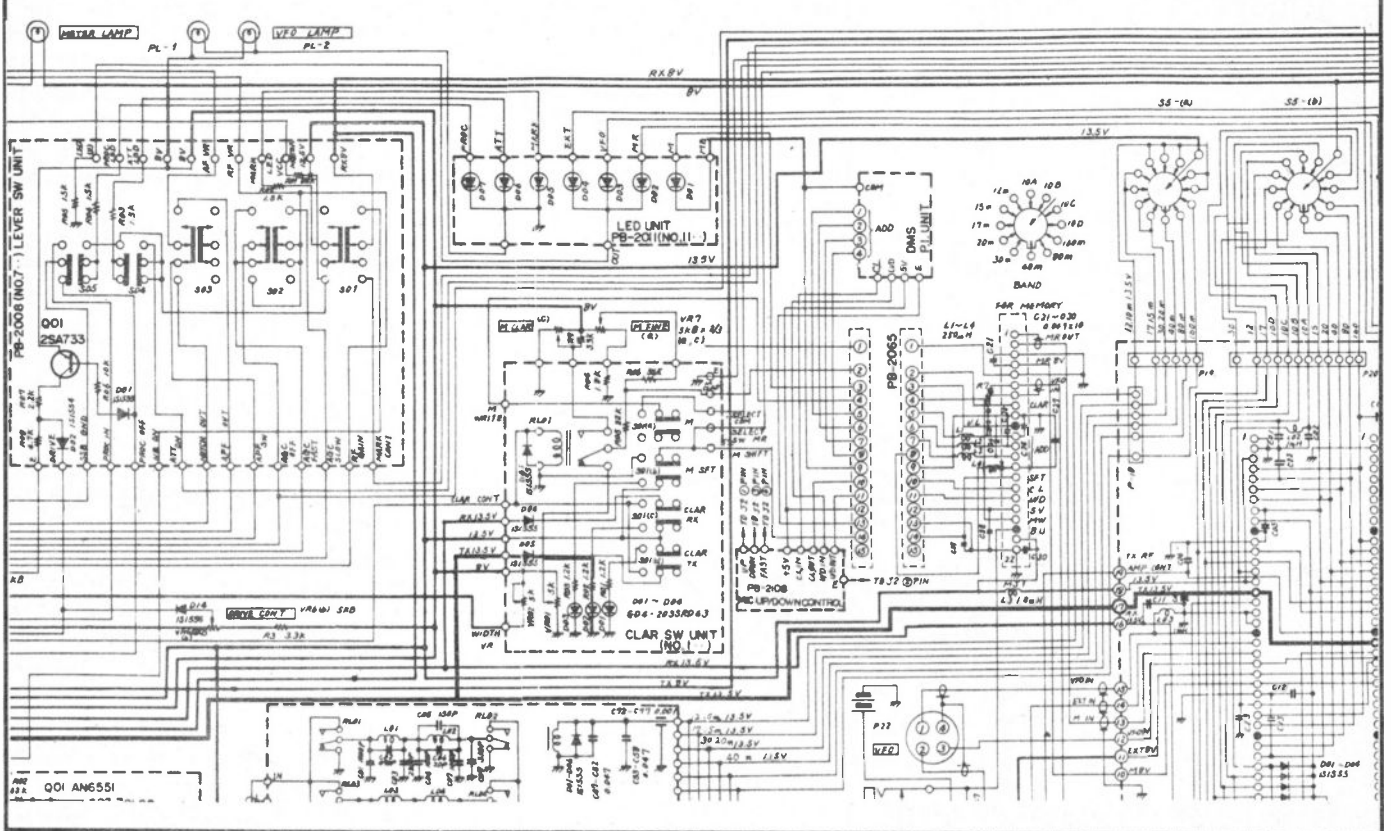

totally wrong! *Checking DO2, we find that it has gone short circuit!*

What was happening was that DO2 was completing a path of conduction along the route indicated on the circuit diagram nearby, placing an unwanted voltage on the Tx 13.5V line, thus causing all our problems! Replacing the diode soon had the rig working normally again.

Obviously, writing about something with the benefit of hindsight is always somewhat easier, and, in the examples given, some of the practicalities and pitfalls were not mentioned, but these and other general fault finding 'hints and tips' are covered in the following section:-

### Practicalities, Hints And Tips

If you have decided to work on your rig, good preparation is most important. If possible, try to work somewhere where you can leave the set undisturbed and come back to it again if things seem to be getting too much! Having lots of space available is helpful, as is adequate lighting since small densely packed PCBs can be hard to examine (a magnifying glass always handy for this).

An angle-poise lamp, or even an ordinary torch, shone through a removed PCB is invaluable in locating and tracing PCB 'tracks', especially on double sided types, as increasingly used in some equipment.

Before starting to remove the covers and gain access to the circuitry, it is a very good idea to have small containers available to hold the various assorted nuts, bolts and

screws which will soon start appearing in large and confusing numbers. Carefully labelling these will be of great help to you in putting the set back together again after repair and prevent you spending long periods of time on the floor looking for them — and maybe having some "left over"! Be warned, *some rigs can do very funny things if they are not cased up as they should be.*

At this stage make sure that your tools are adequate for the job, especially since you will find that the 'star head' screws encountered on most Japanese rigs will deform very easily if mistreated using a badly fitting screw driver (an unsuitable screwdriver could slip and put an unwanted scrape up the side of the paintwork) so do be careful. With the covers off the rig, pause and take a good look around to familiarise yourself with it and compare it to the photographs in the manual. This will also give you time to recover from the shock and maybe let you see something obvious, like loose plugs or sockets, for example. By this stage you should have a fair idea about what your *intentions* are and how you are going to go about it, but will most likely come up against some problem or other in trying to achieve them.

Most rigs will have a number of PCBs both top and bottom of the main chassis. Depending on the make of the rig, these will either be arranged vertically within screening (usually plugging into sockets, or onto a mother board, below) or horizontally, often with another board plugging in flush to it from above, or a combination of both. *This can make access to some*

*parts of the circuit very difficult.* To overcome this, the manufacturers use special extender boards and looms to elevate or remove the appropriate board from the set for repair or testing (these may be available to suit your rig and this is worth checking up on). Sometimes a home made substitute will enable you to do the same. For example, 0.15 inch pitch veroboard will fit some edge connectors and sockets. Carefully using this, with an identical socket to that of the PCB mounting soldered to the veroboard, will allow you to raise some boards to a clear position, thus providing you with access sufficient to make the necessary measurements. If this is not possible, another dodge is to remove the board, determine a test point and solder a small piece of insulated wire to it on which you can attach your test probe when the board is back in circuit. This can be a time consuming process but is necessary under some circumstances.

One point worth looking out for involves the removal of plug-in boards from their sockets. These can often be a tight fit, so take care that you don't snap the corners off them when trying to lever them out or that you don't damage the board by gripping them with a pair of pliers and squeezing too hard! Beware of some of the smaller plug and sockets which can have locking devices on them (So that you don't pull them to bits before finding this out!) Also, remove in-line phono plugs and sockets by gripping the connectors and *not* the wire to them, since some day the wire will break inside the device unknown to you and cause additional faults to the ones you are trying to clear.

Lastly, you will sometimes find that pin numbers on the circuit do not correspond to the numbering sequence on the edge connector or socket — this can be most confusing and misleading so don't presume that the two correspond — check it!

Having provided access to the appropriate circuit board so that tests can be made, it's important to have probes suitable for doing so. Very often these are not the ones supplied with the multimeter which can resemble knitting needles at the end of plastic holders and are

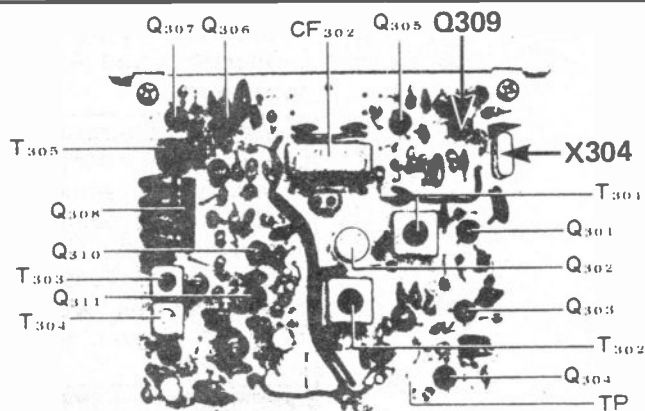

Most modern manuals give layout diagrams of individual circuit boards to aid component location. Shown above is the FT225RD FM IF PCB with the suspect components highlighted.

often a liability, since the chance of accidentally shorting out something with them is very high. It's best to use smaller, better designed self-gripping types for example as advertised by Cirkit and many other component companies. Also, always check which range the meter is switched to before taking measurements — some meters don't take too kindly to being connected to a 1200 volt supply when left on the OHMS range! (*The equipment you are fault finding on won't like this either — Ed.*)

Unfortunately, space does not permit a comprehensive description covering measurement and component testing, but the following is a very rough guide on using a multimeter on a resistance range covering up to 100K ohms to check components.

#### Diodes

Check forward and reverse bias. With most silicon types, this should be about 1000 ohms forward bias and at least 100 times higher the other way round — germanium types show lower forward reading and usually increased leakage reversed.

#### Transistors

Check for two diode junctions — base/emitter and base/collector. Also check that collector to emitter reading drops when base current is supplied by a damp finger placed across collector and base, forward biasing the device.

#### Junction Gate Fets

Check for a few hundred ohms resistance between drain/source and that the reading varies considerably, going high and then low again with a *dry* finger placed briefly on the gate (only). Also, check for diode junctions between gate/source and gate/drain.

#### Insulated Gate Fets

Check drain/source as before. Check insulation separately between each gate and source/drain, also between each gate. Checking gate insulation with the meter on higher resistance range may show the presence of gate protection (zener diodes are employed for this purpose between gate and source and the meter may indicate an apparent leakage as the result of this protection. These often break down at 10V, so don't use an 'AVO' on the highest resistance range — which gives 15V!) Check leakage of large electrolytic types.

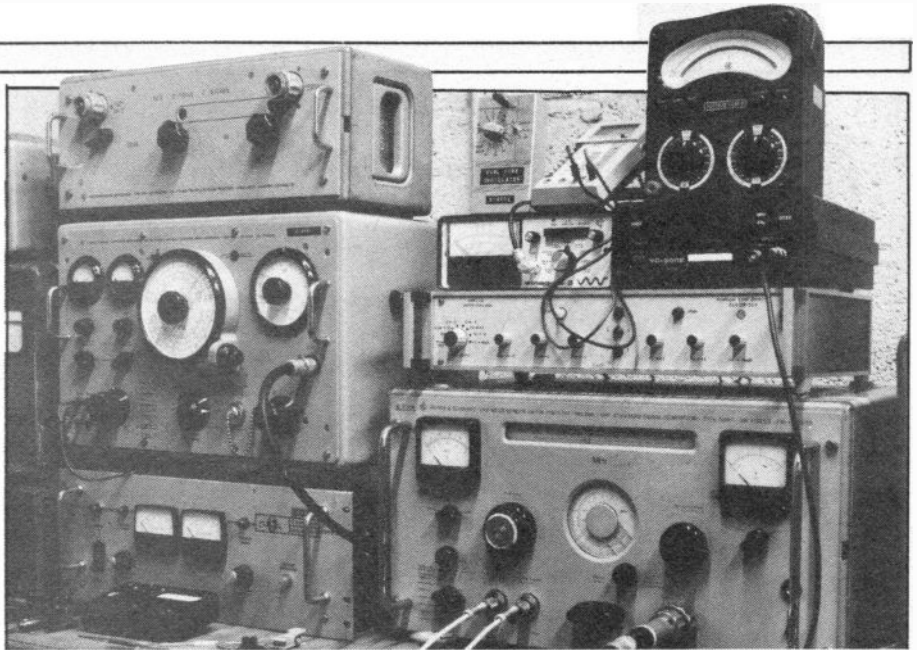

Whilst the purpose of James' article has been to show readers that even complex faults may be traced with simple test equipment and a logical approach to the problem, more sophisticated test gear is admittedly useful! The above picture shows some of the test gear at GI4FFL's QSK Electronics.

Larger capacitor values charge and discharge as indicated by rising and falling reading of meter — eventually indicating open circuit. Check smaller values show O/C — if doubtful, check by substitution.

#### Resistors

Should indicate within tolerance limits (*If your multimeter is calibrated accurately! — Ed.*) Older higher value types often become very high in value or go open circuit. Some very low value resistors, as often found in power supply stages, also have a tendency to go open circuit.

If you are fortunate, a component failure will show itself up by providing an indisputable reading on the ohms range of your testmeter (ie short circuit!), but sometimes the only way to prove one faulty is by substituting with a device known to be good. With most modern amateur rigs (and some not so new) spare parts can often be obtained quickly within the UK from the appropriate agents, or obtained from abroad by them as required. In the meantime, an amateur might try substituting the faulty semiconductor with another similar component or equivalent. Much data on equivalents is available from books such as:-

Towers, International Semiconductor Selector; Balls, Semiconductor Data Book; Solid State Design (ARRL); the Maplin and Cirkit Catalogues and, of course, from

the semiconductor manufacturers' catalogues and data books. On the subject of equivalents, it should be noted that in some parts of RF circuitry, particularly 'front ends' and mixers, the devices used are carefully chosen and a careless substitution could cause performance problems which may not be immediately apparent. Also, with any component found faulty, it is most important to consider what might have caused this to fail — this is especially so around receiver 'front ends' and mixers and also transistor RF PA stages.

It is hoped that readers who have persevered in reading this series will have acquired a better insight into the techniques involved in the repair of their equipment. That, by following the procedures I've described on the printed page, they will have seen that their equipment is not a "magic black box" to be merely feared when something goes wrong.

There was an error in the first part of Fault Finding for Radio Amateurs' (November '84 HRT) on P.23 14 lines below the heading 'Any Fireworks'. This should read "Most other types of fault are unlikely to get worse or cause damage with continued use during fault finding. . ."

Readers are reminded that any attempts to self-repair equipment whilst under guarantee will invalidate the latter.

# Practicalities

One aspect of amateur radio that never ceases to amaze me is the number of ways people have of solving problems, some of which are more scientific than others. Some years ago, I can remember working with another electronic engineer designing some video signal processing equipment. As you may imagine this had a wide band width which made it very prone to oscillation, which of course very often happened. I can remember this other engineer

## *Make your own open wire feeder, cable tips and a quick test for FETs from Ian Poole, G3YWX.*

investigating one 'spurious' and tracking it down in his own effective way or by poking his finger onto various parts of the circuit to see which stage was oscillating. I must add that the highest voltage around was about 10V. When he touched the offending stage, the oscillation would either drastically change or disappear. Then having quickly discovered the stage he would proceed to decouple the supply or other suitable points of the circuit. Hopefully, some of the ideas this month will you save you time, just as this idea saved me a lot of time.

### Shack Cable Entry Tip

One difficulty, which is encountered in many amateur 'shacks', is that of devising a suitable method of entry for the feeder through the wall. If care is not taken this can be a source of draughts, or window frames have to be drilled through etc. One rather neat method which I came across, was to use a section of 1 1/4 inch waste pipe to act as plastic conduit through the wall. The outside end should be terminated with a 90 degree bend pointing down as shown in Fig. 1 to prevent water entering. This will

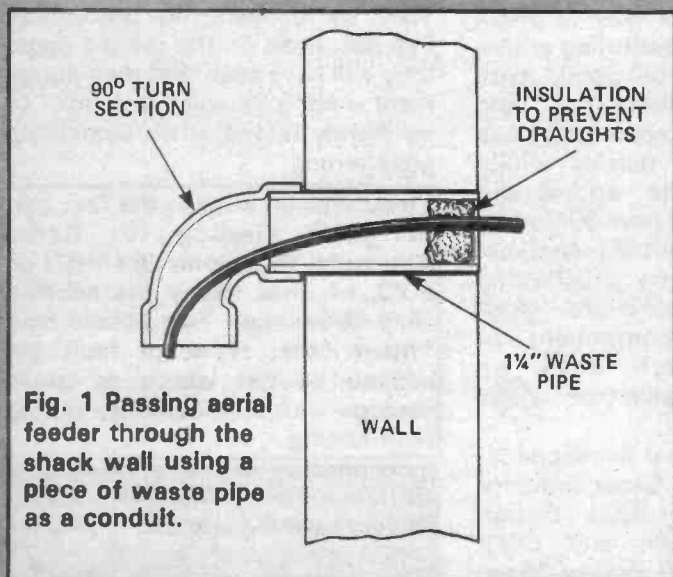

stop chaffing of the cable as it passes through the wall, and also enables new cables to be installed with a minimum of work. In addition to this, if the pipe is a source of draughts, it can easily be plugged with cotton wool or something similar.

### Open Wire Feeders

One fact which tends to be overlooked these days is how useful open wire feeders can be. Coax seems to have gained the dominant position on the amateur feeder market and for several good reasons.

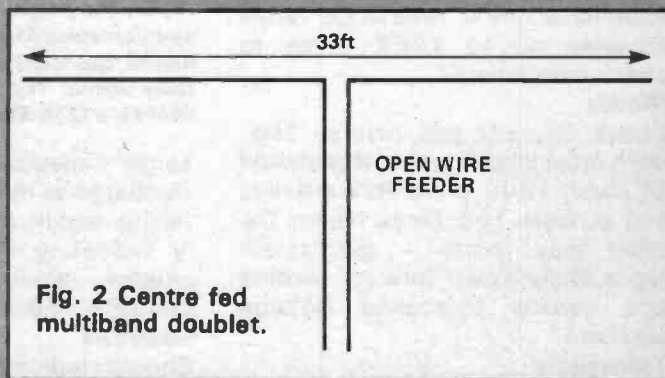

However, open wire feeders still have many advantages over coax, for a surprisingly large number of aerial systems and it should not be ignored. For example, it can operate with a high VSWR which will enable the aerial to be used over a large bandwidth, or on several different bands provided that a suitable ATU is available. The ATU should either have a balanced output, or if this is not the case a balun may be used. Using this type of system the aerial shown in Fig. 2 can be constructed and this has been used very successfully on 20, 15 and 10 metres, providing a very neat solution to a multiband aerial problem.

In addition to this, open wire feeders exhibit a much lower loss than normal coax, provided that nearby objects are kept to a minimum and the feeder remains balanced. In fact for feeder runs where coax would give losses of a few dBs at HF, a similar run using open wire feeder would produce a loss of a few tenths of a dB. It is most interesting to note that most commercial HF transmitting and receiving stations use open wire feeders as they must obviously find them superior to coax.

If open wire feeder is to be used, it should be made and the 300 ohm ribbon cable which is available in the shops, should be avoided. The reason for this is that the plastic insulation used to cover the wires and maintain their spacing absorbs water, introducing a loss into the system.

The feeder is surprisingly easy to make. It is also very tolerant with the materials used and the way in which it is constructed. Almost any wire can be





used, provided that its resistance over the total run is low. The spacers can be constructed out of any suitable insulating material to hand. One way of constructing spacers is to drill two holes, large enough for the feeder wires to pass through at the correct spacing and then anchor them by winding some thin wire tightly round the spacer and feeder wire, as shown in Fig. 3. Slippage of the spacer can be reduced still further by adding a small amount of a suitable glue as shown. Even the spacing of the wires is not critical and can be around 4 inches. With this

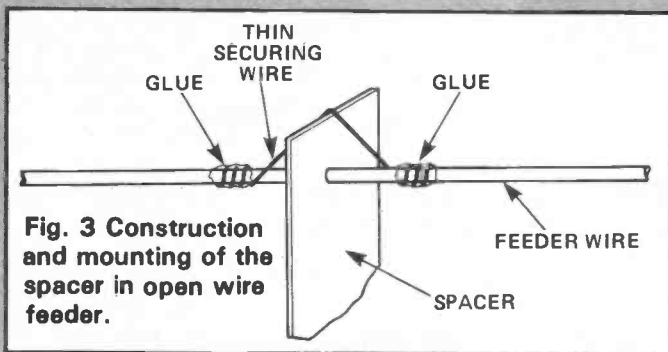

**Fig. 3 Construction and mounting of the spacer in open wire feeder.**

spacing the spacers should be about two or three feet apart, or more frequent if the symmetry is likely to be disturbed. However, if spacers are placed too frequently this will increase the losses slightly, especially during wet weather.

### A Quick Test For FETs

Some months back I outlined a quick and easy method of testing bipolar transistors, which I had found particularly useful over the past years. There is also an equivalent method for testing junction FETs like the popular 2N3819. Unfortunately MOSFETs, IGFETs etc cannot be tested using this method, as their gates are physically insulated from the channel by an oxide layer, even though it is very thin.

The test hinges round the equivalent circuit representation of the FET shown in Fig. 4. The

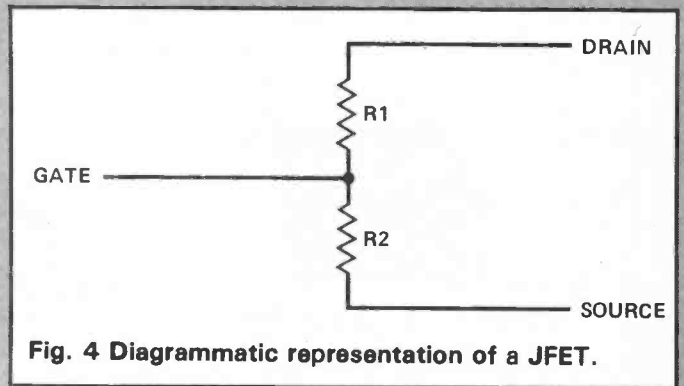

**Fig. 4 Diagrammatic representation of a JFET.**

resistance  $R1 + R2$  represents the channel resistance, and the diode  $D1$  represents the gate-channel junction. The first step is to ensure that the channel is intact by using a test meter to measure the resistance of the channel. The reading obtained should be the same in both directions and is normally about 200 ohms. Incidentally, this can be used to identify the drain source terminals. The next step is to find out whether the junction between the gate and channel is still functional, by measuring the resistance between the gate and either the drain or the source. If the FET is intact then the junction should conduct in only one direction.

Incidentally, this test can be used to identify whether the device is either n-channel or p-channel. If the FET is an n-channel variety then when the positive probe from the test meter is connected to gate, the gate-channel diode will conduct and show a low resistance. Conversely, for a p-channel FET, a low resistance will be indicated when the negative test meter terminal is connected to the gate.

Whilst this test is by no means a complete test of an FET it does give a very useful guide as to whether it has blown or not.



# South Midlands

★ FREE FINANCE · 2 YEAR GUARANTEE

Branches at: SOUTHAMPTON, LEEDS, CHESTERFIELD, BUCKLEY,

## CHRISTMAS SPECIAL OFFERS FROM S.M.C.

**FT902 LAST FEW**



'D' & 'DE' MODELS  
**ONLY £599inc**  
(free sec delivery)

**FT102 DEMO AND SHOP  
SOILED MODELS TO CLEAR**



**ONLY £599inc**  
(free sec. delivery)



**FT790R**



**NOW DISCONTINUED  
LAST FEW  
£299inc**  
(free post delivery)

**FTV107R**



**TRANSVERTER MAIN FRAME  
ONLY £30inc**  
(Sec del £5)

144TV 2m module      **£119 inc**  
432TV 70cm module    **£239 inc**

**FT102 ANTENNA TUNER**



**£159inc**  
(free delivery)

**160-10m  
1.2KW  
PEP**

**ORDER NOW  
TO AVOID  
DISAPPOINTMENT**

**FT730R      70cm  
10W FM  
MOBILE**



**ONLY £239inc**  
Compare this price with  
other manufacturers models  
(free post delivery)

SMC STOCK CARRYING AGENTS WITH DEMONSTRATION FACILITIES

John Doyle  
Transworld Comms

Neath (0639) 52374 Day  
(0639) 2942 Eve

SMC N. Ireland (0247) 464875

John Stringer, SMC N. Ireland (0247) 464875

**SMC SERVICE**  
Free Securicor delivery on major equipment.  
Access and Barclaycard over the phone.  
Biggest Branch agent and dealer network.  
Securicor 'B' Service contract at £5.00.  
Biggest stockist of amateur equipment.  
Same day despatch wherever possible.

★ **FREE FINANCE**  
On many regular priced items SMC offers  
Free Finance for invoice balance over £120.  
20% down and the balance over 6 months or  
50% down and the balance over a year.  
*You pay no more than the cash price!!*  
details of eligible items available on request.

**GUARANTEE**  
Importer warranty on Yaesu Musen products.  
Able staffed and equipped Service Department.  
Daily contact with the Yaesu Musen factory.  
Tens of thousands of spares and test equipment.  
Twenty-five years of professional experience.

● 2 Year warranty on regular priced Yaesu products.

# Communications Ltd.



MAIN DISTRIBUTOR FACTORY BACKED

STOKE, GRIMSBY, JERSEY, EDINBURGH, N. IRELAND.

## YAESU No1 FOR FACILITIES AND PERFORMANCE

FT209R



FT203R



FT290R



FT230R



AVAILABLE  
SOON!

NEW! FT703R  
NEW! FT709R  
(phone for details)

FT726R

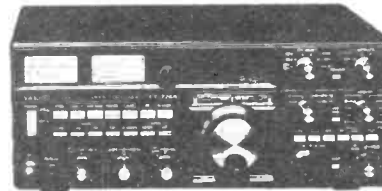

FT737GX

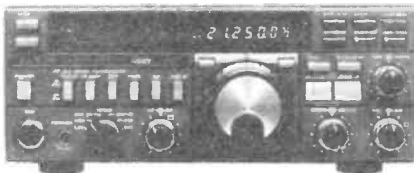

MULTIMODE UHF, VHF, HF



ALL MODES STANDARD  
'NO OPTIONS'

FT77



FT980



FT-ONE



FT680R



AVAILABLE SOON

NEW! FRG8800 HF RECEIVER  
NEW! FT2700R DUAL BAND FULL DUPLEX FM MOBILE  
NEW! FT270RH 45W FM 2M MOBILE

All models on this page  
Available or free Finance.

LEEDS  
SMC (Leeds)  
257 Otley Road  
Leeds 16, Yorkshire  
Leeds (0532) 782328  
9-5.30 Mon-Sat

CHESTERFIELD  
SMC (Jack Tweedy) Ltd  
102 High Street  
New Whittington, Chesterfield  
Chesterfield (0246) 453340  
9-5 Tues-Sat

BUCKLEY  
SMC (TMP)  
Unit 27, Pinfold Lane  
Buckley, Chryd  
Buckley (0244) 549583  
10-5 Tues-Fri  
10-4 Sat

STOKE  
SMC (Stoke)  
78 High Street  
Talks Pla, Stoke  
Kidsgrove (07816) 72644  
9-5.30 Mon-Sat

Southampton showroom open 9-5.30 Mon-Fri, 9-1pm Sat.

GRIMSBY  
SMC (Grimsby)  
247A Freeman Street  
Grimsby, Lincs  
Grimsby (0472) 59388  
9.30-5.30 Mon-Sat

JERSEY  
SMC (Jersey)  
1 Belmont Gardens  
St. Helier, Jersey  
Jersey (0534) 77067  
9-5 p.m. Mon-Sat  
Closed Wed

EDINBURGH  
SMC (Edinburgh)  
23 Morton Street  
Edinburgh EH15 2HM  
Tel: 051-857 2430  
10-5 Tues-Fri, 9-4 Sat

N. IRELAND  
SMC N. Ireland  
10 Ward Avenue  
Bangor  
County Down  
0247 464875

HEAD OFFICE S.M. HOUSE, RUMBRIDGE STREET, TOTTON, SOUTHAMPTON, SO4 4DP, ENGLAND,  
& MAIL ORDER Tel: (0703) 867333, Telex: 477351 SMCMM G, Telegram: "Aerial" Southampton

# MOBILE 'WHIPS'

Since the late 1950s when I first discovered Amateur Radio, I have had a fascination for mobile and car based portable operation. The motor vehicle makes an ideal base with a readily available power

readily available tube, rod and scrap tubular formers. Some lathe work was done in the course of construction but the resourceful could get by without this.

Over the last two years, the

*With the compact solid state HF transceivers available these days, all working from 12V supplies, operating HF 'mobile' is almost as easy as VHF. Although commercial antennas are readily available, great satisfaction and excellent results — plus a good saving of money — can be obtained from 'rolling your own'. Veteran mobileer Mike Grierson, G3TSO, tells how.*

supply (your 12V battery!) and a convenient mounting base for vertical antennas. While there are a number of commercial mobile antennas currently available for the HF and LF bands — costing from £20 for a single band model to over £100 for a multiband array — there are relatively few 'homebrew' antennas among the growing ranks of mobile operators. Twenty years ago, in the good old days of AM, the homebrew 160m mobile antenna was very commonplace.

Commercial antennas do not always produce the best results, or even use the best designs and are certainly no easier to use than a simple homemade mobile antenna. With fairly limited engineering resources, homemade antennas can be tailored to suit individual requirements using whatever materials come to hand. The antennas described were all made of

author has experimented with a number of mobile antenna designs and has produced a set of antenna parts enabling coverage of all 6 traditional amateur bands. The antennas have been compared with two commercial designs, the G-Whip and the Hustler. Total cost of construction of the six band set-up was less than the cost of a single band commercial antenna.

Both the RSGB and ARRL Handbooks have sections on mobile antennas but these sections have been reproduced without change in the handbooks for the last 30 years and are not a great deal of use to the would-be constructor who is in need of more practical data. The purpose of this article is to produce sufficient data to enable the home constructor to design and build his own mobile aerial system.

## Mobile Antenna Theory

Before contemplating the construction of a mobile antenna it is necessary to have some idea of how this works. The mobile vertical antenna is essentially a shortened quarter wave vertical that has 'evolved' to suit the problems of mobile operating — this is short enough so that it will not hit trees, bridges, overhead cables and is mechanically stable enough to stay attached to the vehicle and not endanger other road users. Whilst a quarter wave long antenna is a possibility on 10m, it most certainly isn't on any of the lower frequencies (!) and some means of reducing its length must be found. In

Fig. 1 The loaded vertical antenna.

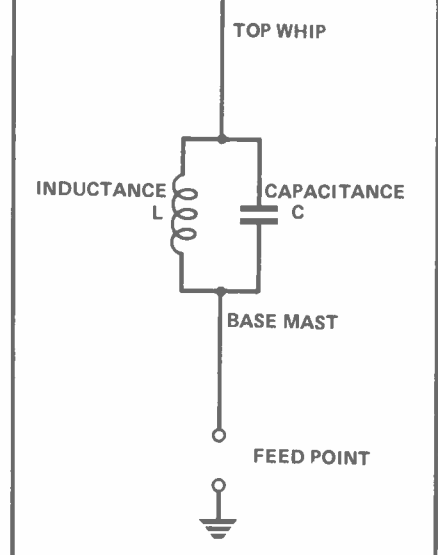

order to reduce the mechanical length of the antenna, we must introduce a form of electrical compensation or 'loading', as it is commonly called. The loading can be represented by a parallel tuned circuit inserted along the length of the antenna, as shown in Fig. 1, and comprises an inductive loading coil actually inserted in the antenna length. The capacitive element C is not as obvious and comprises of self capacitance in the coil and stray capacitance of earth (ie the car) of the various parts of the antenna system. The value of the loading inductance will vary depending upon the design of the antenna and relative position of the loading inductance in the antenna system.

Any transmitting antenna has a voltage node at the open end and of course zero current flow. In a true quarter wave system, the voltage and current will distribute themselves along the length of the antenna such that maximum current will occur at the feed point, which will also be the point of minimum voltage. In the shortened quarter wave antenna the purpose of the loading element is to maintain this distribution of voltage and current in the antenna. However, the distribution will vary considerably with the position of the loading element.



It is generally accepted that maximum radiation occurs from the part of the antenna which carries maximum current, whilst minimum radiation comes from the high voltage parts of the antenna. The position of the loading coil can, therefore, be an important factor in determining the overall efficiency of the antenna.

The current distribution in three, theoretical, loaded antennas is shown in Fig.2. The base loaded antenna in Fig.2a has the loading coil inserted at the very base of the antenna, an attractive mechanical consideration, but current distribution is confined to the coil with very little current in the antenna itself. Capacitance is high and consequently a relatively low value of inductance is required; the feed impedance is low, bandwidth is relatively high *but radiation resistance and efficiency are very low indeed.*

By raising the loading coil to the top of the antenna, Fig.2b, the antenna can be made to carry a maximum current and hence, improve the radiation resistance and efficiency. However, we seldom get something for nothing(!): with the coil high above ground, capacitance in the system is relatively low, which in turn means a bigger coil. Any small change in capacitance will have a significantly large effect on the resonant frequency and the bandwidth of the antenna will be very narrow. The mechanical problems inherent in such a design are considerable.

An ideal compromise, therefore, is to centre load as in Fig.2c. The base of the antenna carries the maximum current, as does much of the coil, whilst the top antenna section provides sufficient

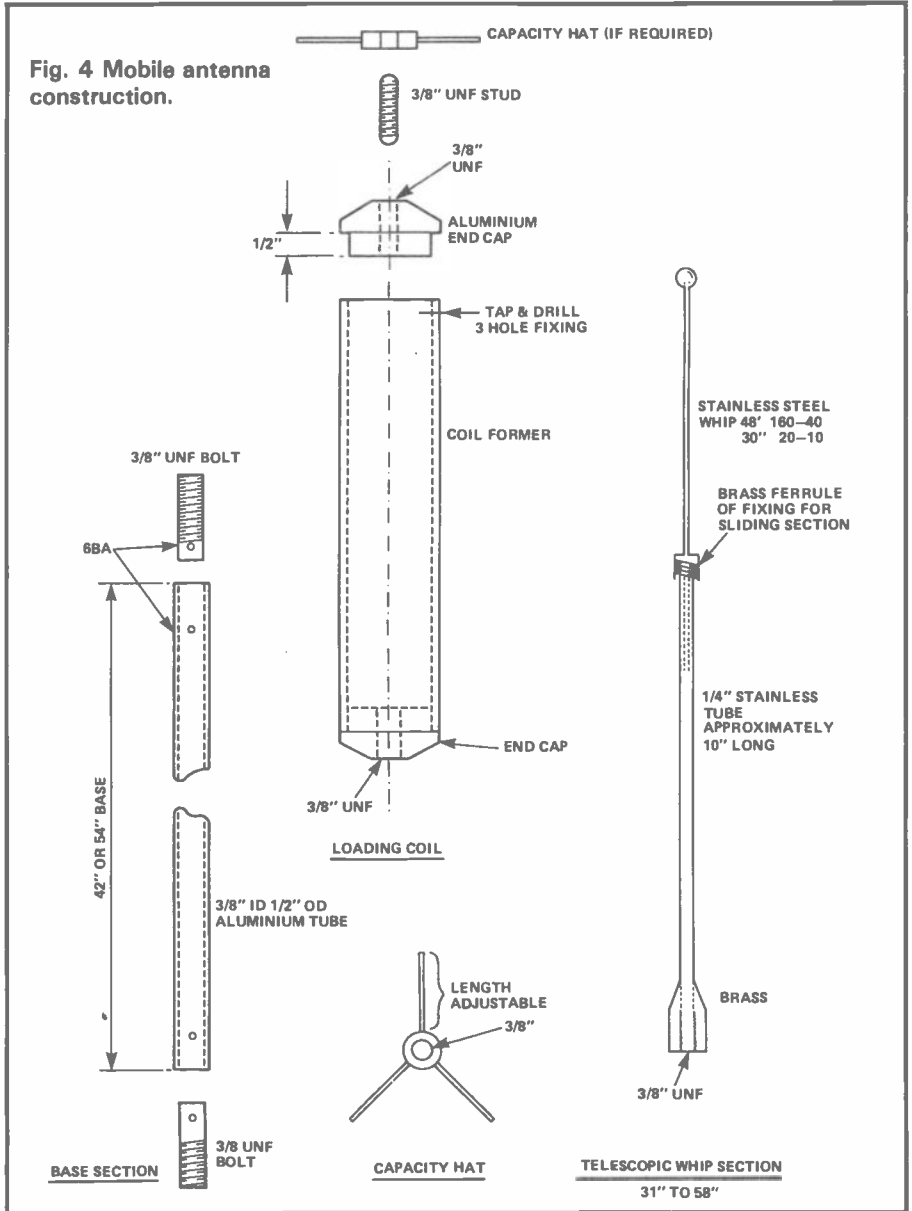

capacitance to provide a reasonable bandwidth. This also allows a smaller coil to be used than would be required for top loading, but still larger than that required for base loading.

Any antenna where the loading

element is the centre 50% of the antenna can be regarded as centre loaded. The value of inductance required to resonate a centre loaded antenna is approximately twice that required to base load the same total antenna length.

It is convenient to consider the centre loaded antenna as comprising of two parts, a base or mast section, up to but not including the loading coil, and the resonator comprising of the loading coil, top whip and capacity hat, if used. A resonator will operate on approximately the same frequency for a variety of different base mast lengths and can enable base extensions to be added for static operation. This is only recommended below 7MHz as the higher frequencies will require excessive adjustment to resonate. Often, adding a base extension on 20 or 15m will

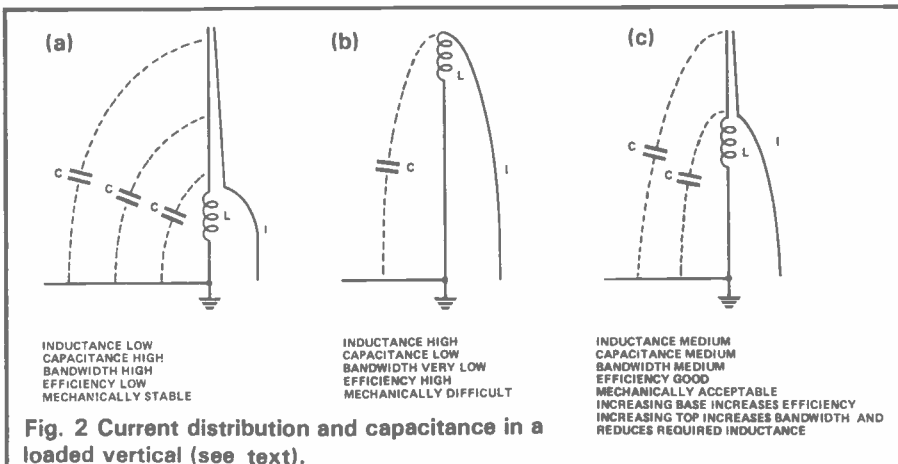

require increasing the top whip length, as the total value of capacitance in the system will have reduced. On 20 and 15m, a base extension will bring the physical length of the antenna much closer to a quarter wave and the coil inductance would need to be reduced for resonance, but the latter is not really a practical proposition when the antenna is in situ!

As with any quarter wave system, maximum current flow in the base of the antenna and an equal current must be able to flow in the earth or counterpoise (the car). Earthing the antenna base to the car is, therefore, of paramount importance — poor or long earths can result in inefficiency, difficulty in matching, RF associated interference at the transmitter and with car electrics and electronics, as well as changing the resonant frequency of the antenna.

## Designing The Antenna

The first consideration is whether mobile or portable operation is envisaged as this will determine the overall size, strength, weight and method of construction. All future considerations in this article are based on the ability to operate whilst actually mobile on any of the bands 160, 80, 40, 20, 15 and 10 metres. Coils would therefore have to be interchangeable. The maximum strength should not exceed 8' 6" and the whole structure must be strong and light, as well as mechanically stable at speeds of at least 70 mph. For portable operation only, construction techniques become less critical and dimensions can of course be increased significantly.

The antenna mounting position on a vehicle may be an important factor in deciding the overall length. There are essentially three main options, the front wing, the roof or gutter and the rear bumper or boot of the vehicle. The author favours the rear for the following reasons: a more substantial mounting point cannot be found; it is normally furthest from the engine; it does not distract the driver and good earthing to the vehicle chassis is normally possible. Despite the assurances of others that the roof offers better radiation

characteristics, my own experiments leave me totally unconvinced on the low frequency bands and I have worked sufficient DX on the HF bands with rear mounted antennas not to be bothered about trying elsewhere.

In order to standardise on the fitting together of components, I decided to use a standard thread of  $\frac{3}{8}$ " UNF with 24 turns per inch. This is the same thread used on the 'Hustler' commercial antenna and numerous CB antennas and base mountings. Unfortunately, the 'G-Whip' uses a coarser  $\frac{3}{8}$ " British Standard thread, but was fitted with an adapter during trials. The author uses a commercial Ball type



base unit, which has the ability to be swivelled to match a range of surface angles, as well as being readily available and reasonably strong. The antenna is fitted by means of a quick release bayonet fixing, all of which use the  $\frac{3}{8}$ " UNF thread for fixing.

The base mast should be of sufficient length to raise the loading coil well clear of the vehicle roof and reasonably strong and light. Two lengths have been used in experiments, 54" and 42" and comprise of  $\frac{3}{8}$ " inner diameter aluminium tube with a  $\frac{3}{8}$ " UNF bolt inserted into each end, after the head has been removed with a hacksaw. The bolts are held in position by drilling through and the tube and bolt in situ inserting a 6BA nut and bolt. The shorter length base section proved to be much more

stable under mobile conditions with no noticeable loss in performance over the larger one.

The top section of the antenna can comprise of an old telescopic car radio aerial, a stainless steel VHF whip or a variety of other pieces of tubing. Ideally, the length should be adjustable, 10 to 15 inches of adjustment will normally allow full coverage of 160 and 80 metres whilst only 2 or 3 inches will be needed on the higher frequencies.

If the top section is a fixed length, adjustment can be introduced by means of a 'capacity hat'. This can simply consist of a number of short horizontal wires or spokes radiating horizontally from above the loading coil. Their purpose is to increase the capacity of the top section of the aerial (hence 'hat') and so lower the frequency of the antenna. Adjusting the length of these spokes so as to set the resonant frequency in the centre of the band can easily give full band coverage on 40, 20 and 15m as the hat tends to broaden the bandwidth of the antenna considerably.

The top section used for the experiments consisted of a length of  $\frac{1}{8}$ " OD stainless tube (hydraulic pipe) fixed into a  $\frac{3}{8}$ " UNF nut with a brass ferrule attached to the upper end, to clutch a standard 2 metre stainless steel whip. The adjustable length was originally 22 inches but was reduced to 10 inches to reduce the weight. (Access to a lathe can greatly assist the production of these fittings).

An ideal top whip length of 48 inches on the three LF bands works well and can be reduced on the HF bands to around 30 inches, producing an antenna that never exceeds 8 feet 6 inches in height.

## The Loading Coil

When contemplating multiband antennas, the loading problem is a minimum at 28MHz (where no loading coil need be used) while it is at its most critical on 160 metres, where efficiency is of prime importance.

The early articles on mobile antennas extolled the virtues of the high 'Q' large diameter coils often seen on homebrew whips 20 years ago. The RSGB Handbook does show some reservations about the

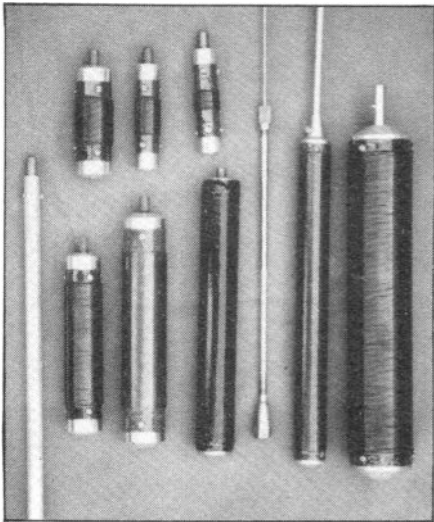

merits of such coils and suggests that long thin coils work curiously well. After experimenting on 160m with 1 inch diameter coils and 2 inch diameter coils my final conclusion was that the long thin coil definitely worked much better than the short fat coil! Work done by another local amateur confirmed these results and established an optimum coil length of around 16 inches. The author did not have a coil former longer than 10 inches so that had to do!

Coils can be wound on a variety of formers; fibreglass is ideal, as are some plastics; teleprinter paper roll formers are often suitable and the older brown composite materials such as 'bakelite' and resin bonded fabrics have been used successfully. Plastic drainpipe *may* be acceptable but tends to bend easily, whilst ceramic is too brittle and too heavy. All the author's formers were obtained as scrap or junk.

Mounting the coils can be achieved by fitting end plugs and drilling and tapping with a 3/8" UNF thread. This is where access to a lathe greatly simplifies the construction enabling the ends to be turned from aluminium rod. The ends can be fitted to the former with three screws at either end. The top of the coil can be fitted with a 3/8" UNF brass stud to accept the top whip section.

HF coils were wound with 18 SWG enamelled copper wire, though the gauge is not critical, the 80m coil with the 20 SWG and the 160m coil with 25 SWG — thinner wire than this should not be contemplated. Often the gauge of wire to be used will be dictated by the

size of former available. The DC resistance of the coil should be kept as low as possible and will determine the thinnest wire gauge to be used. 160m is the most critical, a 500uH coil of 25 SWG wire on a 1 inch diameter former had a DC resistance of 3 ohms, a figure that proved acceptable. (Note the G-Whip 160m coil is 10 ohms DC).

Coil winding should *not* begin over the end plugs but level with them. All coils have been close wound directly onto the former and once resonated, sealed with several coats of good quality yacht varnish. Heat shrink sleeving should only be used if totally sealed with varnish — otherwise problems with moisture may result.

A useful formula for calculating coil inductance is as follows:

$$L(\mu\text{H}) = a^2n^2(9a + 10b)$$

where: L = Inductance in microhenrys;

a = coil radius in inches;

b = coil winding length;

n = number of turns;

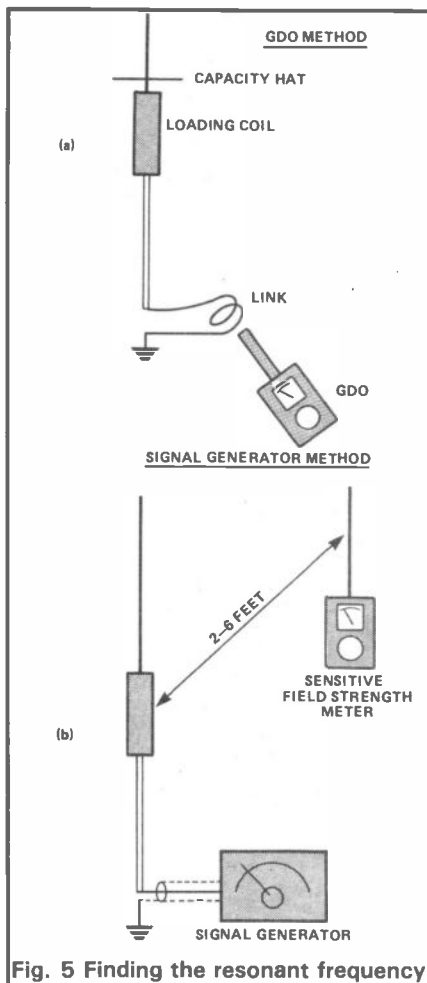

Fig. 5 Finding the resonant frequency.

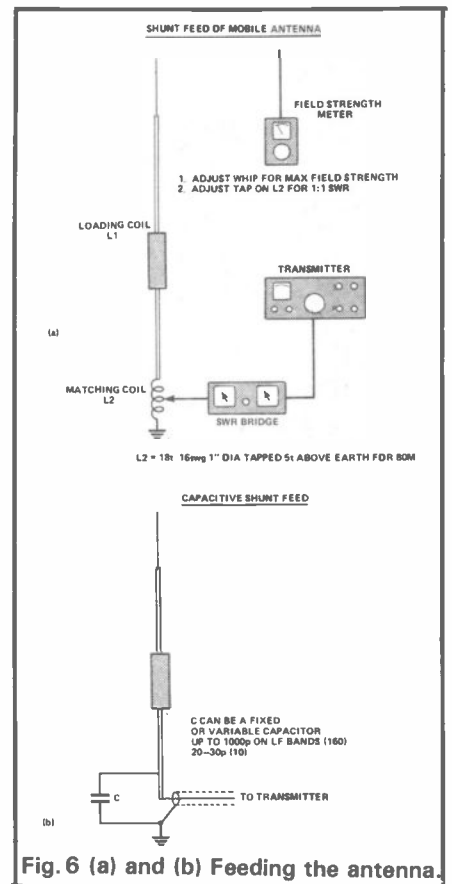

Fig. 6 (a) and (b) Feeding the antenna.

Simple rules to remember when winding coils are:

1. The larger the diameter the more inductance, therefore less length.
2. If there is sufficient inductance in the coil, rewind with thinner gauge wire.

## Resonating A Mobile Antenna

To the uninitiated, resonating a mobile whip may seem a little complex. It is often not realised just how sharp the tuning can be, in particular on 160 and 80 metres where typical bandwidths can be as low as 5kHz. Essential equipment comprises a grid dip oscillator (GDO) a sensitive field strength meter and an SWR bridge — though the latter can be a positive hindrance at times!

The antenna under test should be mounted on the vehicle in the intended operating position and a two turn link fitted between the feed point and earth. The GDO should be placed very close to the link and the unit adjusted to establish a dip. Do not couple the GDO too tightly or frequency 'pulling' will occur and more than one dip may be found. An ideal method

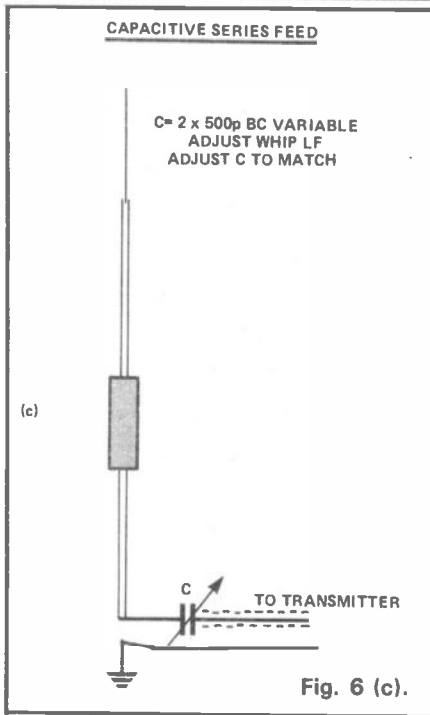

of finding the exact frequency of the dip is either by listening on a receiver to the oscillator signal or with a digital frequency meter. Once the frequency of the antenna is found it can be adjusted by either changing the top whip length, adjusting the capacity hat or changing the number of turns of the coil until it is resonant inside the required amateur band.

An alternative method is to feed a signal generator into the antenna under test and, using a very sensitive field strength meter, observe a peak on the meter at the resonant frequency as the generator is swept through it (Fig. 5b). If a noise bridge is available this can also be used to determine the resonant frequency. Once the antenna is resonant

within an amateur band, further testing can be conducted with the transmitter and receiver. A noticeable noise peak should be detectable on the receiver, particularly on the low frequencies.

Using the transmitter as a low power signal generator (ie with the power reduced as much as possible), it should be possible to sweep slowly across the band to establish a peak in output on the field strength meter. This is where the SWR bridge comes in useful, with only enough power to give half scale forward deflection (1-2 watts) look for a dip in reflected power somewhere close to the frequency where maximum field strength occurs. As the antenna is unlikely to present a 50 ohm match, the lowest SWR reading should not be regarded as indicating resonance — the peak reading on a field strength is much more reliable. Further adjustments to antenna length can be made until the desired operating frequency is achieved. If the SWR is acceptable at resonant frequency the transmitter may be fed directly to the antenna, but if it is high some form of matching must be used. I shall discuss this problem in a minute.

When adjusting the antenna, increasing the length of the top whip will lower the resonant frequency, as will adding a capacity hat or increasing the size of the whip. Increasing the length of the base mast will not excessively alter the resonant frequency but may require a longer top section as well to keep resonance as the overall capacity in the antenna will have been reduced as it is moved further from the ground. It is not recom-

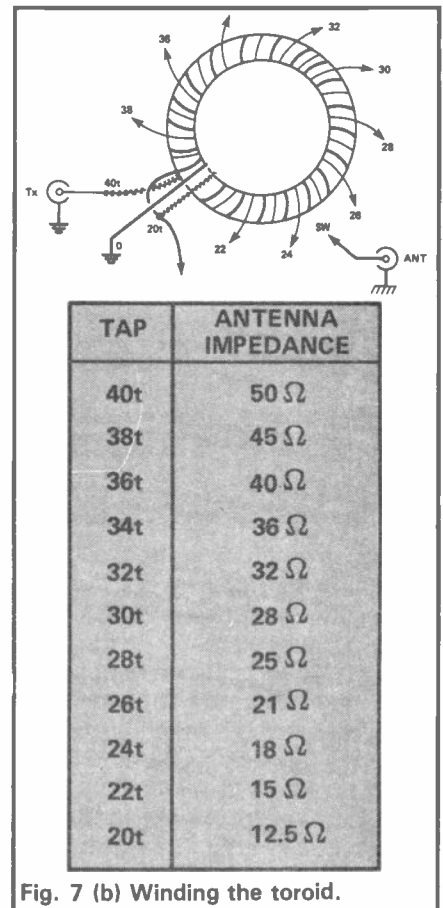

mended to raise the base mast on frequencies above 7MHz as it will have a significant effect on the antenna resonant frequency as I remarked earlier. The diameter of the top whip will also affect the length required — the thinner it is the longer it will need to be. A small metallic ball of the top is a useful means of reducing the top length by an inch or two.

### Matching Your Antenna

Centre loaded whips can exhibit feed impedances in the order of 20 to 30 ohms and this will vary considerably from band to band. That being said, often they can be fed directly from a transmitter with a 50 ohm antenna impedance with an acceptable SWR. High SWRs in mobile installations are usually only a problem to the transmitter itself (ie the PA protection circuitry!) and a variety of methods of improving the match exist. Shunt feeding, illustrated in Fig. 6a, is often used commercially and is particularly suitable for base loaded single band antennas but is a little tricky for multiband operation. Capacitive shunting of the antenna base is

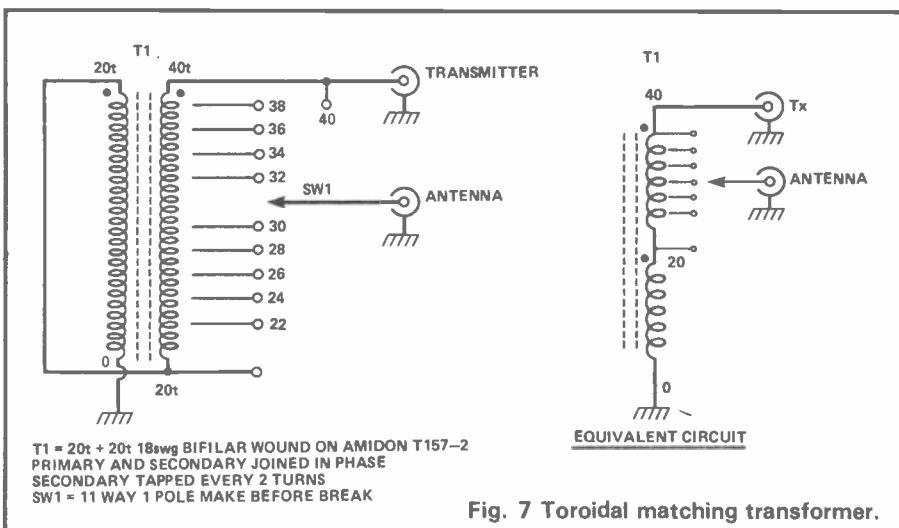



both simple and effective (Fig. 6b), either a fixed capacitor can be soldered across the aerial base for a particular band, or a number of capacitors can be arranged with a switch, or, alternatively, a broadcast type variable capacitor can be employed. Ideally, the capacitor should be at the base of the antenna, but it will also work at the transmitter end of the coax cable. Values in the order of 1000 pF are common on 160m, reducing to 20 or 30 pF on 28 MHz. A variable capacitor in series with the antenna, as shown in Fig. 6c, is another possibility.

A toroidal matching transformer (Fig. 7) permits the matching of a range of impedances from 50 down to 12.5 ohms. However the use of such a device can be a little tricky, particularly if the load is not purely resistive. This can often necessitate marked changes in whip length before an ideal match is found.

The miniature ATU (Fig. 7) permits the matching of a range of impedances from 50 down to 12.5 ohms. However the use of such a device can be a little tricky, particularly if the load is not purely resistive. This can often necessitate marked changes in whip length before an ideal match is found.

The miniature ATU (Fig. 8) will permit the matching of almost any type of mobile antenna that you are likely to use. It is very similar to some commercial designs and per-

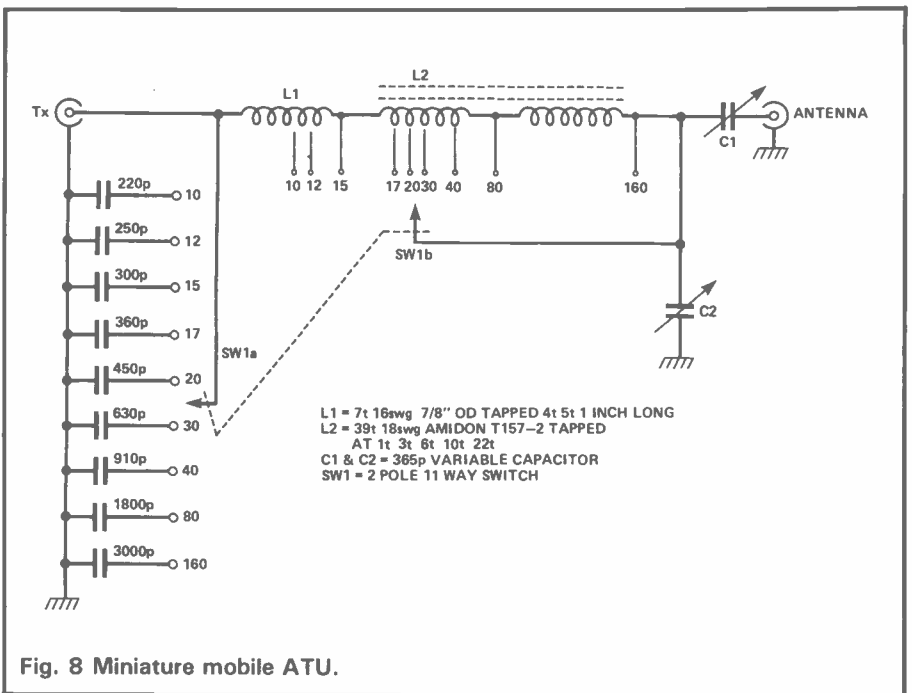
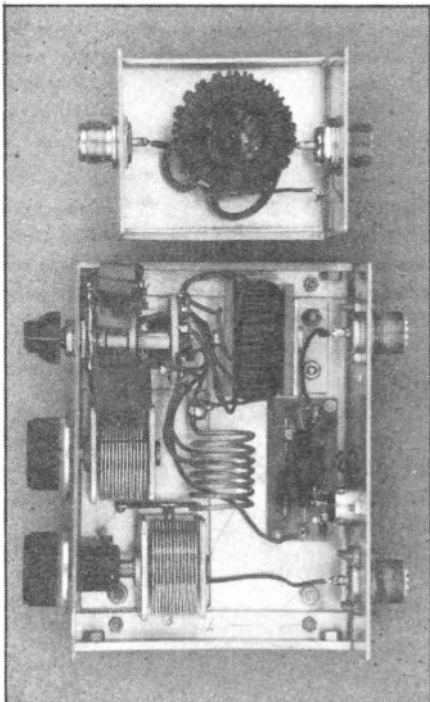

Fig. 8 Miniature mobile ATU.

mits considerable flexibility (25kHz) on the lower frequency bands. *The use of such an ATU does not mean that you can simply tune up any non-resonant mobile antenna.* The antenna must still be brought to resonance as previously described and the ATU then placed in circuit and adjusted for a good match to the transmitter. The field strength meter still remains the best indication of maximum output.

### Matching By Toroid

The toroidal step down transformer of Fig. 7 permits matching to a range of impedances from 50 down to 12.5 ohms. It is wound on an Amidon T157-2 iron dust core and comprises two bifilar windings of 20 turns. The windings are connected in series in phase and the transmitter is connected across both windings. The antenna is tapped down every two turns on the upper winding to get the best match. Winding the transformer with two different coloured wires, or one enamelled and one tinned makes it easier to locate the correct winding for tapping. The maximum step down of 2:1 represents an impedance ratio of 4:1.

A single pole, 11 or 12 way switch, with make-before-break contacts, is required and should have good size contacts. (100 watts into 12.5 ohms = 2.88 amps!). Constructional details of the Toroid ATU are shown in Fig. 7.

### A Miniature ATU

The miniature ATU, as shown in Fig. 8 bears a close resemblance to the pi-tank circuit of a valve transmitter, but the opposite way around. It is essentially a low pass filter with a fixed input impedance and an output impedance of 10 to 200 ohms. The capacitors used are 365pF single gang broadcast type units with fairly narrow spacing. They will handle 100 watts into low impedances with no problems but will flash over at higher impedances. Strangely, the only band where flash over has been encountered is 160m. The input capacitor is switched and should be a silver mica type. The value may be made up by one or more capacitors in parallel. L1 is an air wound coil whilst L2 is wound on an Amidon T157-2 iron-dust core.

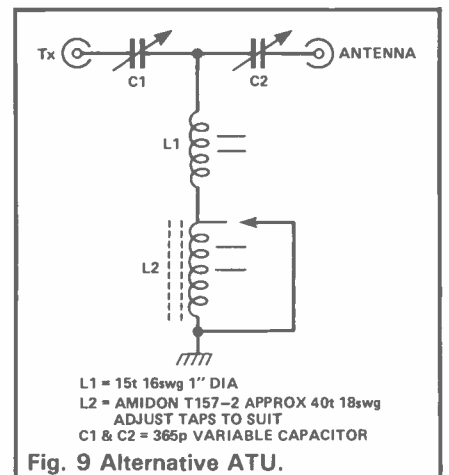

Fig. 9 Alternative ATU.

Table 1 Mobile Antenna Dimensions (G3TSO)

BAND	COIL WINDING DATA						Base Length (inches)	Top Whip Length (inches)	Freq (MHz)	Band Width (±KHz)	Remarks
	Length (inches)	Dia (ins)	Winding Length	Wire Gauge	Turns	Approx L(uH)					
160	10	1	9 ½	25	450	500	42	58	1.93	5	Base Z = 34 ohms Top 15 KHz/inch
	10	2	9 ½	18	187	335	54	94	1.93	10	"Jumbo Whip" Base Z = 21 ohms Portable use only
80	6 ½	1 ¾	5	20	130	142	54	44-58	3.8-3.5	7	Base Z = 15 ohms 50 KHz bandwidth with ATU Will match with 1000 pF Series C.
							42*	48-56	3.8-3.6		
40	4 ¾	1 ¾	4	18	70	34	54	50	7.05	40	Unable to match with Transformer. OK with ATU or 360 pF Series C
							42*	53	7.05		
20	2 ½	1 ¾	1 ½	18	26	10	54	32 ½	14.2	100	Base Z = 45 Ohms
							42*	35 ½	14.2	100	
15	2 ¼	¾	1 ¼	18	21	4	54	32 ½	21.2	150	Base Z = 45 ohms
							42*	39 ½		150	
10	No Loading Coil			18	10	2	54	48	28.5	500	Base Z = 45 ohms
	2 ¼	¾	¾				42*	32 ½	28.5	450	

\* Note: 54 inch base used with 28 inches of top adjustment and 30 inch ½" dia stainless whip  
42 inch base used with 10 inches of top adjustment. 48" stainless whip 160/80/40. 30" whip 20/15/10.

The alternative and simpler circuit (Fig. 9) can use the same capacitors, L1 can be an air wound coil of approximately 1" diameter with approximately 15 turns and L2 can be 35 to 40 turns on an Amidon T157-2 core. Tapping points will need to be found experimentally.

**Conclusion**

The antenna dimensions in Table 1 have been determined experimentally over a period of two years and represent the final figure for a set of mobile antennas covering 160 to 10 metres. No attempt has been made to include the three new (WARC) bands. These figures should be treated as a general guide and not as absolute dimensions as there are many variables in a mobile antenna.

Results have been compared with the G-Whip Triband Helical with LF coils and the Hustler 80 to 10 metre antennas. Hustler do not make a 160m resonator and the G-Whip is very inefficient on 160 — my smaller homemade antenna showed a 6dB improvement over the G-Whip for a length increase of

only 20 inches, a worthwhile improvement. The Jumbo 160 homemade (portable rather than mobile!) antenna showed a 12dB increase over the G-Whip. The homemade antennas were very comparable with the Hustler on all other bands and showed an improvement over the G-Whip on 80 to 10m of approximately 3dB to 6dB. (Up to an S point). Considerable improvements can be achieved on the LF bands by extending the base mast when working portable.

Homemade mobile antennas are a very viable proposition and can represent a significant saving of money over their commercial counterparts with no sacrifice in performance and can also be tailored to suit individual requirements. The best finish can only be achieved with some engineering resources, but effective antennas can still be made with very limited resources and a degree of imagination.

It is essential that the sharp frequency response of loaded antennas is understood and that logical steps are taken to bring an antenna to resonance if optimum perfor-

mance is to be realised. Once adjusted, the dimensions of the antenna on a particular frequency can be noted for future use and the construction of a graph or table of top whip length versus resonant frequency is a desirable aid to quick QSYing.

After 2 years experimentation the trusty G-Whip has now been permanently replaced with the homebrew antennas for both mobile and portable operation. The relatively narrow bandwidth of a mobile antenna on 160 and 80 metres (typically 10kHz) need not be a disadvantage; most fixed stations will leave you the channel if asked. Careful selection of the design frequency in the first instance will provide hours of operation without need to QSY.

The general principles outlined in this article do not need any great technical expertise to understand. The dimensions and details provided should give any practically minded amateur the basis for developing a mobile or portable antenna.

**Bibliography:**  
 RSGB Amateur Radio Handbook.  
 ARRL Amateur Radio Handbook.

**The reasons single people join Dateline are often very varied, but come down to one thing — they are simply not meeting the sort of people they would like to meet.**

Tim Stagg, a 31-year old engineer from Pangbourne, found that the break-up of his marriage two years previously and the ending of another relationship since, had left his confidence rather dented. 'So I thought I'd try Dateline because at least that gives you a starting point for meeting people.'

At first Tim could not bring himself to actually telephone any of the girls whose names he received through Dateline; instead he made the initial approach by letter. He was delighted when girls started to telephone him, after receiving his name on their lists. For Tim it made the whole thing a lot easier, and a series of pleasant dates soon saw the return of his confidence. Fortunately, because on his third list from Dateline appeared the name of Christine Terry.

**'Many of my colleagues were married'**

Tim and Chris agreed to meet at a point halfway between his home and Basingstoke, where Chris worked as a student midwife. Having just moved to Basingstoke, and working unsocial hours, Chris found it very difficult to meet people. 'Many of my colleagues were married and I was getting very low,' said Chris, an articulate 29-year old. 'I saw Dateline advertised and decided to give it a try.'

Chris had only been a member of Dateline for two weeks when Tim contacted her. Nevertheless, she managed to meet four people before that! But she was immediately taken with Tim when he phoned and was delighted when he suggested that they meet.

They agreed to meet in the car park of a pub and swapped car registration numbers as a means of identifying each other. Chris liked Tim immediately. 'Even seeing him sitting in his car, I thought 'We're going to get on!' Mind you, I thought that when he phoned up first of all. He was quite cheeky on the phone and I liked that.'

**'Time just flew by...'**

Tim was also very taken with Chris and their first evening was extremely successful. 'The time just flew by. It seemed we had only just met and then it was time to go again. I can't even remember what we talked about!'

They decided to meet again a week later ('or sooner if you prefer,' Tim had said, hopefully), and Chris went home to her parents for the weekend. She returned to Basingstoke rather earlier than anticipated on the Sunday and felt like seeing Tim again, so she phoned him and they met again at 'their' pub that evening. They've met nearly every night since!

Within two or three weeks, Chris



**'We are going to get on!'**

realised that she was falling in love with Tim and they were beginning to talk about the possibility of a future together. 'We went to London for a few days,' remembered Chris, 'and Tim said, 'Why don't we go to Hatton Garden and get a ring?!' So we did! It was a lovely day.'

Within three months of meeting each other, Chris and Tim were engaged and are planning a wedding in a year's time when Chris has qualified. Their families are very happy for them and Tim has found his friends very supportive. 'I thought they would laugh at me joining Dateline, but they didn't,' he said. 'After a while, especially after I met Chris, it made such a tremendous difference to me — I was so

much happier. I would definitely advise anyone to join Dateline. I enjoyed nearly all my dates and even at worst had a pleasant evening out each time. Dateline helped me get my confidence back and I enjoyed my membership.'

Even though Chris was a member for such a short time she met quite a few people before finding Tim. 'Even just getting correspondence and phone calls was nice,' she said. And what advice would she give people who join Dateline?

**'Give it time and you do meet the right people,' she said, smiling at Tim.**

*If you would like to be one of the many thousands of people nationwide who have been making friends and enjoying a new social life through Dateline, complete this simple questionnaire. We will send you confidentially and completely free, full details about Dateline and how it works, and details of just one of the Dateline members who are compatible with you. Send to: Dateline Computer Dating, 23 Abingdon Rd., London W8. Tel: 01-938-1011*

**CONFIDENTIAL**

**FREE: Computer Test to Find Your Ideal Partner.**

I am over seventeen and would like you to send me completely free and without obligation, a description of my ideal partner. Plus a free full colour brochure and lots more information about Dateline. I enclose two first class stamps.

**3** Your sex  M or  F Your Height  ft.  ins  
Your Age  yrs. Age you would like to meet Min.  Max.

Christian Name   
Surname   
Address

Nationality  Religion   
Occupation

Send today to:  
Dateline, Dept HMA  
23/25 Abingdon Rd.  
London W8.  
01-938 1011

**Dateline**

**1** **START HERE**  
Do you consider yourself:

<input type="checkbox"/> Shy	<input type="checkbox"/> Generous
<input type="checkbox"/> Extrovert	<input type="checkbox"/> Outdoor Type
<input type="checkbox"/> Adventurous	<input type="checkbox"/> Creative
<input type="checkbox"/> Family Type	<input type="checkbox"/> Practical
<input type="checkbox"/> Clothes-conscious	<input type="checkbox"/> Intellectual

**2** Indicate which activities and interests you enjoy by placing a '1' (one) in the appropriate box. If you dislike a particular activity, write a '0' (nought) in the box. If you have no preference, leave the column blank.

<input type="checkbox"/> Pop music	<input type="checkbox"/> Politics
<input type="checkbox"/> Fashion	<input type="checkbox"/> Classical music
<input type="checkbox"/> Pubs	<input type="checkbox"/> Art/Literature
<input type="checkbox"/> Sport	<input type="checkbox"/> 'Live' theatre
<input type="checkbox"/> Pets	<input type="checkbox"/> Science or technology
<input type="checkbox"/> Folk music	<input type="checkbox"/> Creative writing/painting
<input type="checkbox"/> Jazz	<input type="checkbox"/> Poetry
<input type="checkbox"/> Travelling	<input type="checkbox"/> Philosophy/Psychology/Sociology
<input type="checkbox"/> Cinema	<input type="checkbox"/> History/Archaeology
<input type="checkbox"/> Good food	<input type="checkbox"/> Conversation

# ALL MODE TRANSCEIVER

As most of you following Project Omega will be aware, we have experienced some problems in the development of the high power amplifier for the transceiver. On the face of it, this should have been a relatively simple part of the series, but it was not to be. Not only did the actual

are the results of our efforts over the past 10 months.

## Specification

The design allows output of 100W RF at 1.8-30MHz for a drive level of approximately 3W from the QRP PA at

DC overcurrent conditions.

This article describes the PA construction, and Part 10 next month will describe the alignment.

## PA Design

The successful design of high power HF amplifiers requires a somewhat different approach to that of amplifiers in the 1-10W region. At outputs approaching 100W, currents of around 20A are going to be involved at a supply of 13.8V. This means a lot of attention has to be paid to DC physical construction, safety aspects and dissipation of all the heat generated by the output devices. Large RF circulating currents are also going to be present increasing losses in 'normal' type components, and decoupling becomes of great importance.

## Heatsinks

Perhaps the biggest difference in construction against a low power amplifier is the degree of heatsinking required. It is generally true to say that as much power as is generated in RF output is going to have to be dissipated in heat. Hence we will be looking at getting rid of around 50/60W of heat from the two output devices as efficiently as possible, coupled with a means by which the PA heatsink can be monitored for excessive temperature rise and automatically cut the PA drive should this happen. This design uses a 1/4" aluminium interface block between the PA devices and three extruded heatsinks which dissipate the majority of the power.

## PA Devices

Our original attempts at the PA were using a pair of low-cost VHF devices — 2N6084's. While it was possible to get around 60/70W of output from these, the chances of their lasting very long were fairly remote — as we proved several times! The problem is (and it appears to be unreported with this type of device as far as we can see) that broadband operation requires large amounts of ferrite to be present in the output transformer to get the low frequency response. This can store prodigious amounts of RF energy which is

*The Omega 100W PA is here! Even if you haven't built any of the series, this article provides an excellent glimpse into the tears and fears of QRO transistor PA design. By Tony Bailey, G3WPO, and Frank Ogden, G4JST.*

amplifier refuse to function quite as expected, but the Logic Switch (published in Part 5 November 1983 HRT), although capable of handling at least 100W of pure harmonic free RF, proved unable to live long with 100W of harmonic rich energy direct from the PA output. This in itself took some time to overcome, and hence the reason for the delay in publication.

We should also explain that there is a difference in the requirements of publishing a design that you have just built as 'one-off' of, purely so that you can pass on the constructional details to other people, and publishing a design that you know will be built by the hundred, and that has to match up to a previously published series of high-performance companion modules. The amateur radio press is littered with designs that 'only had one built' as many people who have tried to build them will testify. The individual constructor can play and twiddle to his heart's delight to get something working, and then publish it, but will the next 10 to be built work?

On the basis of a one-off publication, we could have printed a suitable amplifier months ago! However, it would have been full of provisos such as dire warnings of disasters should you operate the rig into an SWR of greater than 3:1. And also lacking a number of refinements and the reproduceability it now possesses. We have probably been pedantic over certain aspects of the performance, but we did say that we would not publish *any* module until we were happy with its performance — development and fault tracking takes an inordinate number of hours, and a frequent wish to throw the latest design failure out of the window. Finally here



1.8-21MHz and 4W at 24-30MHz. At 3W input on 28MHz, the output is approximately 80/90W. The design is able to withstand all phase angle mismatches at full power output (this is not to say that you should run it like this!) and is rated continuously for CW/SSB use at full power output. In conjunction with the accessory PCB, it also features thermal protection sensing, ALC (automatic level control), SWR/power metering, and automatic reduction of drive if 'over current' conditions exist. Under all normal operating conditions it should be impossible to damage the output devices, providing the assembly and alignment instructions are followed closely, and the unit is used in conjunction with a suitable power supply unit capable of providing 22A at 13.8V DC. It is highly advisable that the PSU also has fast electronic 'trip' facilities as a protection against

normally discharged into the antenna system. If a fault develops, and the antenna develops a mismatch, much of this energy gets channelled back into the transistor itself, and coupled with transformer leakage inductance at higher frequencies, manifests itself as an RF overvoltage over and above the normal peak RF voltage present. In the case of 2N6084, the  $V_{cbo}$  (collector/base breakdown voltage) is 36V — this voltage was visibly observed to be exceeded with very little problem with probes.

Devices specified for HF broadband use have a much higher  $V_{cbo}$  rating; in the case of the TRW PT9784/A devices used in this design it is 50V, and this is more than adequate under all conditions. Unlike the 2N6084, *during development we have not lost a single device*, despite some pretty horrific things happening to them, including self-oscillation, full power/open/short circuit operation and other nasties. They are in fact rated to withstand mismatches at all phase angles under full power output conditions, and we are pleased to have proved this successfully!

### Valve vs Solid State PAs

Most valve PA amplifiers have resonant tank circuits, adjustable by the operator to cope with the various load conditions presented to them. Those of

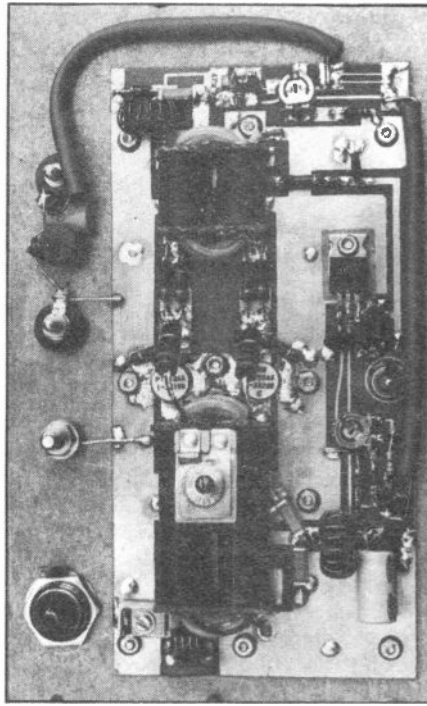

Omega PA viewed from above

you who have tuned up a valve linear will know that if the circuit is at resonance and the applied load very light, the power dissipated in the valves is quite small, as shown by the null which reduces the current taken almost to the level existing with no drive. Off-resonance, the current and therefore

the dissipation increases rapidly, and possible damage to the valve may result if this is not contained. However, there is a limit to the amount of current that you can draw from a valve cathode, and this will limit the current that can be drawn from the supply.

With solid state broadband amplifiers, when drive is applied without a load, there is nothing to limit the collector current and all the current taken has to be dissipated in the transistor. As the collector internal impedance is only a fraction of an ohm, very high currents can be drawn from the supply if it is not current limited, leading to rapid failure of the device.

Even under less violent mismatch conditions, problems can still arise. An SWR of 3:1 indicates that there is an impedance mismatch of three times. If our proper load is 50 ohms, under these conditions, a reflected load can vary from around 17 ohms to 150 ohms against a nominal 50 ohms. As transistors are constant current devices, dangerously high voltages may be developed across them if the mismatch is towards the large end of the range.

All this is meant to show you that solid-state amplifiers do not like looking at any other than their design load impedance, which in this case is 50 ohms, and that care should be taken to match the amplifier output to this figure via a matching unit before any appreciable

Circuit of the Omega 100W power amplifier

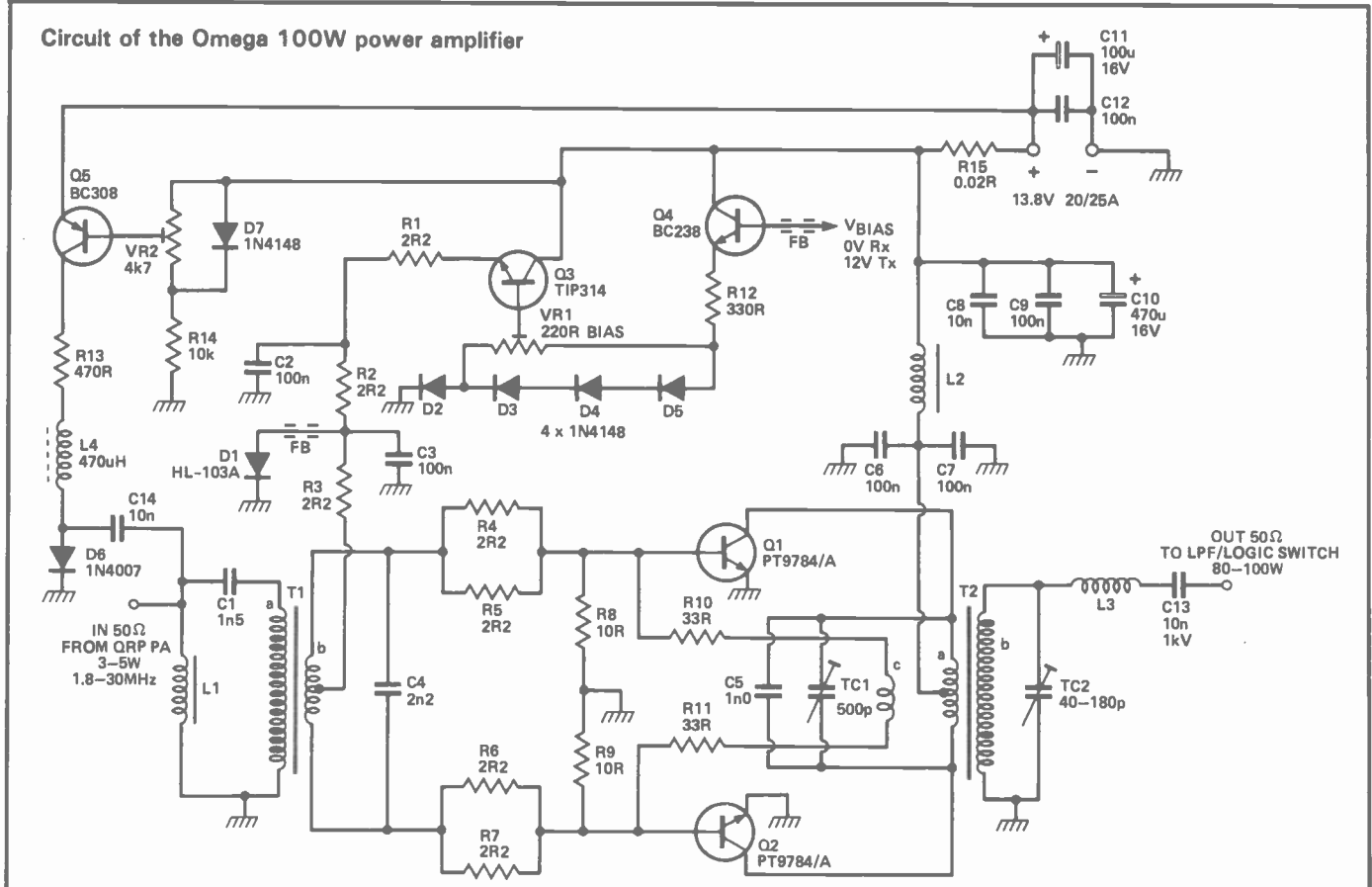

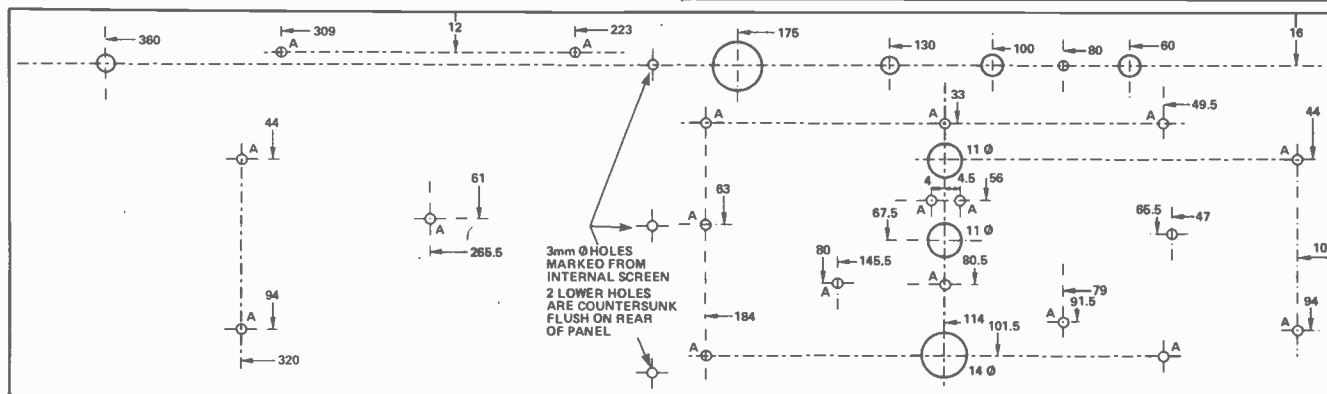

Omega QRO PA rear panel drilling detail

ALL HOLES MARKED 'A' 3mm Ø

power is applied to the antenna.

### Circuit

The final circuit is based on a TRW applications design, with various modifications we have found necessary for stability. Referring to the circuit diagram, shown in Fig.1, input power at the 3W level from the QRP PA is coupled into the input transformer, T1 via C1 and L1. The latter provide low-frequency compensation for the transformer. The combined input impedance of Q1 and Q2 is around 3 ohms, and the transformer therefore has to change the input impedance from 50 ohms to this figure. A turns ratio of 4:1 (impedance ratio of 16:1) will accomplish this, and in the process provides a simple transformer construction. As described in detail later, the transformer is of classical broadband construction, using a single turn low-impedance output winding made from brass tubing, with the high impedance four-turn winding threaded through the tubing. Ferrite cores are used to load the transformer for best low-frequency response.

Capacitor C4 and resistors R4/5/6/7/8/9 are for matching and stability purposes, helping to prevent unwanted LF and VHF parasitic oscillations.

Bias for Q1 and Q2 is obtained via Q2/3 and D1. The main controlling elements are Q3 and D1, with Q3 providing a low impedance source of bias current in its emitter follower configuration. Diodes D2 to D5 provide a stable voltage reference, with preset VR1 allowing this voltage to be varied over the 0.5-1.0V range. Diode D1 is an important part of the circuit and provides the temperature compensation for the bias circuit, by virtue of being in physical contact with the heatsink surface near to Q1/2. Without this, the transistor's bias current would increase as their case temperatures rose. This in turn means they generate more heat, increasing the current still further until a condition known as 'thermal runaway' is reached, leading to eventual destruction of the devices. D1 has a negative temperature coefficient, and as the temperature of the heatsink rises, so the bias current is decreased a little to compensate. We found that the original TRW bias circuit was of little use, with the standing current, nominally 200mA, rising to 5A after a few minutes. With this design, the bias stays relatively constant.

D1 is a power stud-mounting diode type HL-103A, which features the cathode connected directly to the stud and metal case. This allows convenient mounting directly against the heatsink,

without having to mess around with the uncertainty of trying to mount ordinary diodes in good thermal contact with the heatsink.

As Omega features full 'break-in' working on CW, switch Q4 is fed from the bias output on the logic switch, and thus the PA is only biased on when transmitting. Its output is then in a high impedance state and allows connection directly across the common path to the antenna and receiver on the logic switch unit.

The amplified output from Q1/2 now has to be transformed up to the 50 ohms required for convenience at the output. From the usual formula the collector load impedance needed is:

$$R_c = \frac{(V_{cc} - V_{sat})^2}{2P_o} = 1.1 \text{ ohms.}$$

In push-pull, the transformer matches  $2 \times Z_{out}$  to 50 ohms. This requires a voltage transformation ratio of 4.7, and the nearest obtainable to this using conventional techniques is 4, giving an output transformer similar in construction to the input one. The major difference is that the volume of ferrite required is much larger to cope with the higher power levels involved. In this

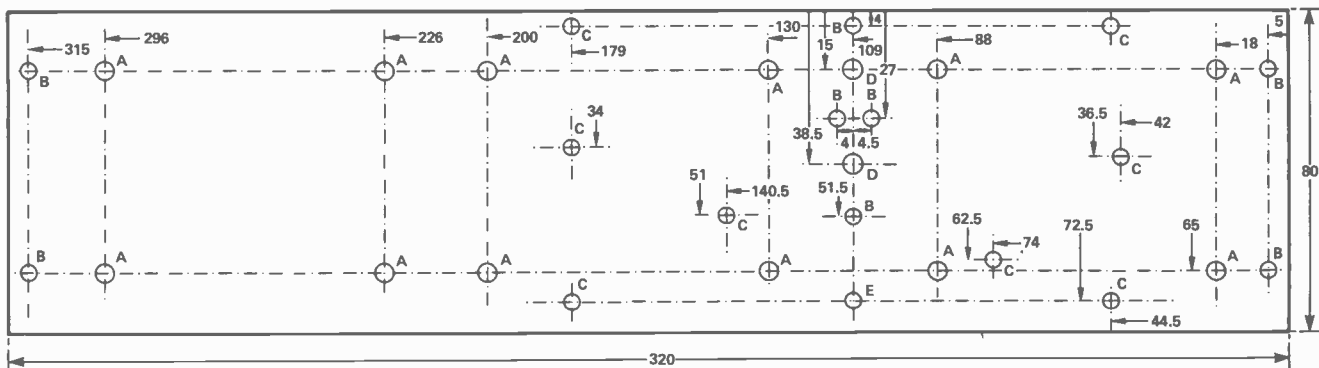

- 12 HOLES 'A' = M4 CLEAR COUNTERSUNK SUB-FLUSH FACING SIDE
- 8 HOLES 'B' = 3mm Ø
- 8 HOLES 'C' = 3mm Ø COUNTERSUNK SUB-FLUSH (FOR 6BA BOLT) REVERSE SIDE
- 2 HOLES 'D' = CLEAR FOR 8.32 NC 3A THREAD - PANEL MUST NOT HAVE BURRS EITHER SIDE OF HOLE
- 1 HOLE 'E' = CLEAR FOR 10.32 NC 2A THREAD - PANEL MUST NOT HAVE BURRS EITHER SIDE OF HOLE

MATERIAL; 1/4" ALUMINIUM PLATE  
BLACK ANODISED

Omega QRO PA heatsink interface panel

case, while the input one uses 6 ferrite cores, the output needs 14, with seven threaded on each brass tube comprising the primary single turn winding ('a' on the diagram). Similarly, the high impedance (output — winding 'b') section is again 4 turns. Due to the much higher voltages and currents involved, this secondary winding is made using 1.25mm enamelled copper wire, covered in a protective PTFE sleeving. To prevent possible shorts, the input transformer is also wound in a similar manner.

Capacitor C5 and trimmer CT1 on the primary winding, plus trimmer CT2 and inductor L3 on the secondary are for high frequency transformer compensation, together with C13 for low frequency compensation.

An additional single turn link winding ('c') on the output transformer provides negative feedback to the bases of the transistors via R10/11 for gain-slope compensation, reducing the 6dB/octave gain rise at lower frequencies to a more sensible level. It also has the advantage that the transistor bases do see a real resistance under all operating conditions, reducing the chances of unwanted oscillations to a minimum.

## Careful Matching

You must remember that unlike valve designs, the broadband output transformer network in solid-state designs is fixed in its tuning. Hence any reactive component in the load impedance presented to the output is transformed to the collector circuit. It is possible with certain types of reactance, especially inductive, for parasitic oscillations to arise, which, although not in themselves damaging to the devices (in the short term), may cause problems elsewhere (the logic switch particularly). Hence, although we have taken as much care as possible with suppression of such parasitics, some violent mis-matches can cause problems, and this is common to all similar designs. The answer is, of course, the use of a proper antenna matching unit, and the avoidance of setting this up at high output powers.

The 20 amps or so of collector current at 13.8V needed by Q1/2 is fed into T2 via a centre tap on the primary, with decoupling provided by L2 and associated capacitors. It is important that the capacitors on the T2 side of L2 are good quality polyester types — poor quality capacitors can give rise to losses and unwanted low frequency oscillations.

One of the main power transistor 'killers' is secondary breakdown. Although a current limited PSU is essential, some protection has been added against this problem on the PCB. Two of the likely causes of secondary breakdown are too

much drive, or a mismatch into a lower load than 50 ohms. Both of these can be overcome by automatically reducing the drive. The circuit of Q5 (BC308 — PNP) in conjunction with R15 (0.02 ohms) acts as a current monitor with VR2 being adjusted so that Q5 conducts when a current of 22A is exceeded. Positive bias is then applied to D6 which conducts and effectively limits the drive to T1 via C14. R15 is made up from several short lengths of Constantine resistance wire in parallel mounted on the PCB.

Note that this circuit will not protect against DC problems (ie getting +12V on the base of one of the transistors), hence the advised PSU protection should not be ignored. Also, once the circuit of Q5 is conducting, distortion will be present on the output signal as the collector supplies are being current limited.

## PCB Design

Although properly part of the construction side, the design of the PCB also plays an important part in the per-

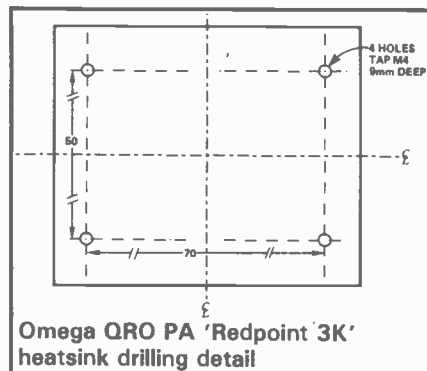

formance of the amplifier. In fact, far more than we originally thought, and it is here that some of the design problems were encountered. The PCB used is double sided, with islands on the 'track' side on which the components are mounted directly. The underside of the PCB is a common earth plane, linked through at various points to the earthy tracks on the topside. In conjunction with the wide foils used on the top side for all tracks carrying RF and high-current DC, the double sided construction is vital in the interests of electrical stability. The ground plane on one side and wide foils on the other help to prevent current loops which can cause instability, and act as small capacitors helping to prevent VHF and UHF oscillations. The copper coating on the PCB itself is heavier than would normally be used (2oz copper); as normal PCB material is barely adequate to carry the many amperes of circulating currents involved.

## Construction

Unlike the preceding Omega

modules, the PA is more of a metal-bashing and assembly exercise than electronics! This is decided by the level of heatsinking required to dissipate the heat generated. The photographs\* will give a good idea of how it all goes together. Basically, the PA assembly consists of 6 individual parts — a) the PCB and components mounted thereon, b) the rear panel of the Omega case (see Part 8 May '84 HRT) which holds the whole assembly, c) an interface plate made from 1/4" aluminium sheet stock, and d) three Redpoint 3K extruded heatsinks bolted to the interface plate which carry out the majority of the heat radiation.

If you are building the PA as part of another project not connected with Omega, the rear panel will not of course be available. It can be replaced by a sheet of 18g aluminium, the same size or slightly larger than the interface plate. This is needed to get the correct spacing between the leads on the power transistors and the inside face of the interface plate against which the transistors mount.

The first job is to get the interface and rear panels correctly drilled as per the drawings. The row of holes along the top of the rear panel is exactly as given in Part 8 of the series with two additional ones near the left, leaving the remainder to be marked and drilled. Care should be taken in marking and drilling this part as many of the holes have to line up with matching holes in the interface plate and the PCB — it is possible to make some of these oversize later on if things don't fit exactly.

Don't forget to countersink the rear (vinyl side) of the two lower holes used to mount the rear panel to the case internal screen and the central hole to the left — otherwise the interface plate will not seat correctly against the panel.

The interface plate itself is fairly easy to drill and countersink, but not to cut! If you are obtaining this yourself, your local metal stockist will probably cut this to size for you from bulk if you ask him nicely. It will pay dividends to be precise in the drilling, using small pilot holes initially, gradually increasing in size as required. All countersink holes are made sub-flush so that the heads of the bolts on both sides are just below the surface. There is one important point about this plate — the two holes where the transistors mount should only just be a clearance for the studs of the transistors. The mounting side of the plate (the side facing you in the drawing) must be absolutely flat where the transistors mount.

This means that no burrs are allowable on these holes, nor should you effectively countersink the holes to get rid of burrs. Any burr will prevent the flange of the transistor from making perfect contact with the plate, which can be fatal; and a countersink reduces the area of flange in contact with the

heatsink, again raising the device temperature.

The finished item should preferably be anodised to aid heat radiation, but this is not vital — all the prototypes used a plain finish, but anodised does perform better.

The PCB can be made by any of the usual techniques, although the basic stock material may be difficult to get hold of. As usual, this is available ready drilled and tinned, together with the transformer end plates used to construct T1 and T2.

When you have all three of these pieces made, they should be placed together the correct way round and 6 BA bolts placed through all the 3mm dia holes to check alignment. If any are incorrect, the best place to enlarge holes is the rear panel, or some of the holes may be slightly enlarged on the PCB using a small round file.

The heatsinks are available separately ready tapped as per the drawing.

## Assembly

The PA is built 'back-to-front' ie the mechanical assembly of the metalwork is made first, and the components assembled onto the PCB afterwards. We suggest you follow these instructions exactly, due to the fact that bolts go in both directions through the interface plate, it is easy to get in a situation where you cannot get one bolt in at the end!

The first job is the mounting of the heatsinks onto the interface plate (IP) together with some of the bolts whose heads are on the interface/heat sink side of the assembly. You will also require some heatsink compound, preferably the white type, or Vaseline may be used as a last resort, although this is not recommended.

Initially, smear a reasonable layer of compound across the plane side of one heatsink, and over the area it will mount on at the right hand side of the IP on the rear. Looking at the rear of the IP, place 6 BA x 12mm thread countersunk bolts at each of the four positions marked 'x' into the holes — check that all the heads are below the surface of the plate. Then place the heatsink approximately in the correct position, hold the assembly together and invert. Insert an M4 x 12mm thread countersunk bolt into one of the heatsink fixing holes and tighten up loosely. Then fix the other three bolts for that heatsink in place and tighten them all up firmly.

Repeat this process with the next heatsink, inserting 6 BA bolts at the four holes 'y', and finally screw on the last heatsink.

Take one of the transistors and drop it into its mounting hole. Press on the header and check visually that it is seated perfectly flat against the IP. If not, find the cause and remedy it!

Repeat with the other hole. Remove the transistors and place to one side. Now smear a light layer of heatsink compound on the IP around the areas of the two holes where the power transistors go — try to spread this evenly. Remember that too much can actually decrease the heat transfer between the flange of the transistor and the aluminium.

Next, place three 12mm long c/s 6 BA bolts through the two lower holes on the rear panel which connect the panel with the internal case screen, also the central hole to the left of these. Hold these in place on the vinyl side of the panel with small pieces of Sellotape. Now drop the panel over the IP assembly making sure that all the bolts go through the holes in the panel. Loosely fix the IP to the panel using 6 BA 12mm long round head bolts inserted from the rear through the two holes at each end of the IP. Use a plain washer on the bolt head side, and a lockwasher/nut on the inside of the rear panel.

## PCB

Next, the earth foils on the PCB need to be linked through. At each of the points marked with a circled cross on the layout, push a 1mm PCB link pin (supplied with the kit) through from the continuous foil side. Press these hard home so that the heads are as close to the foil as possible, and then solder on both sides of the PCB. Do not omit these — they are important for earthing continuity. Lightly file the foil side of the PCB around each of these pins to remove any solder projections etc.

Now drop the PCB onto the rear panel and check that it will lie flat against the panel. If necessary enlarge any of the PCB holes that do not align until the PCB drops flat.

Remove the PCB, and drop one 6 BA plain washer over each of the 6 BA bolts that go through the PCB and over the four 3mm dia holes (that do not yet have bolts in them) around the transistor mounting holes. Carefully replace the PCB without disturbing the centre washers. Then insert one 6 BA 12mm long round head bolt, with a plain washer under the head through each of the centre four holes (from the heatsink side) that you placed the washers on. Do this one at a time, and loosely fix in place with a 6 BA lock washer and nut. Then loosely place further lockwashers/nuts on all the other bolts protruding from the PCB except that marked X1 (where Q3 mounts).

When everything is in place, firmly tighten up the outside four nuts which secure the IP to the rear panel, and then all the remaining nuts.

## Mounting The Devices

It is necessary to reduce the length

of the leads on each transistor to 4mm so that they fit the PCB correctly. Do this *not forgetting to take a small amount off the corner of each transistor collector lead in order to identify it*. The collectors are also identified with a 'C' adjacent to the lead. Inspect the heat sink compound smeared on the rear of the IP through the PCB holes, and make sure nothing (swarf etc) has fallen onto it — if so, remove it! Drop one transistor into place with the collector facing in the right direction and twist it slightly to distribute the heat sink compound evenly. Screw on the nut from the underside and, making sure that the leads are orientated with the foils on the PCB, tighten up *finger tight*. You should then use a spanner, or what have you, to tighten up *just past this point and no further*. It is important *not* to overtighten the nut or the thread may strip. If you have a torque wrench, the correct setting is 10 in. pound (9kg.cm +/- 10%). Do not hold the transistor in place using the leads during this operation.

Repeat with the other transistor. Check that the emitter leads of the devices can be mounted flat against the PCB without being fouled by the nuts and solder all four leads of each transistor to the PCB. During this operation (which requires a fair amount of heat as the devices are in contact with the heat-sinking), the transistor headers should get barely warm, as all the heat should be going downwards! If one or both gets appreciably warm, you have a thermal contact problem with the flanges. It will then be necessary to remove the device and check for the cause before proceeding further.

Next, smear some heatsink compound on the underside of D1, drop it into place, and tighten up securely using the spring washer and nut supplied with it. Now smear some heatsink compound around the area occupied by the tap of Q3, place the appropriate insulating washer in place. Shorten Q3 leads to a total length of 7mm, smear some more heatsink compound on the metal contact side of the tab, and drop into place over the mounting bolt. Place an insulating bush onto the bolt and seat in the tab hole, then tighten up with a lockwasher and nut. Check with an ohmmeter that the tab is isolated from the heatsink. Solder the three leads to the foil tracks.

## Transformers

Next comes the construction of the input/output transformers. If you are making the end plates from the foil patterns, a single sided PCB is used, preferably with 2oz copper for the output version. The holes should be an interference fit over the thin wall brass tubing used, nominally 8mm OD (5/16"). Start with the input



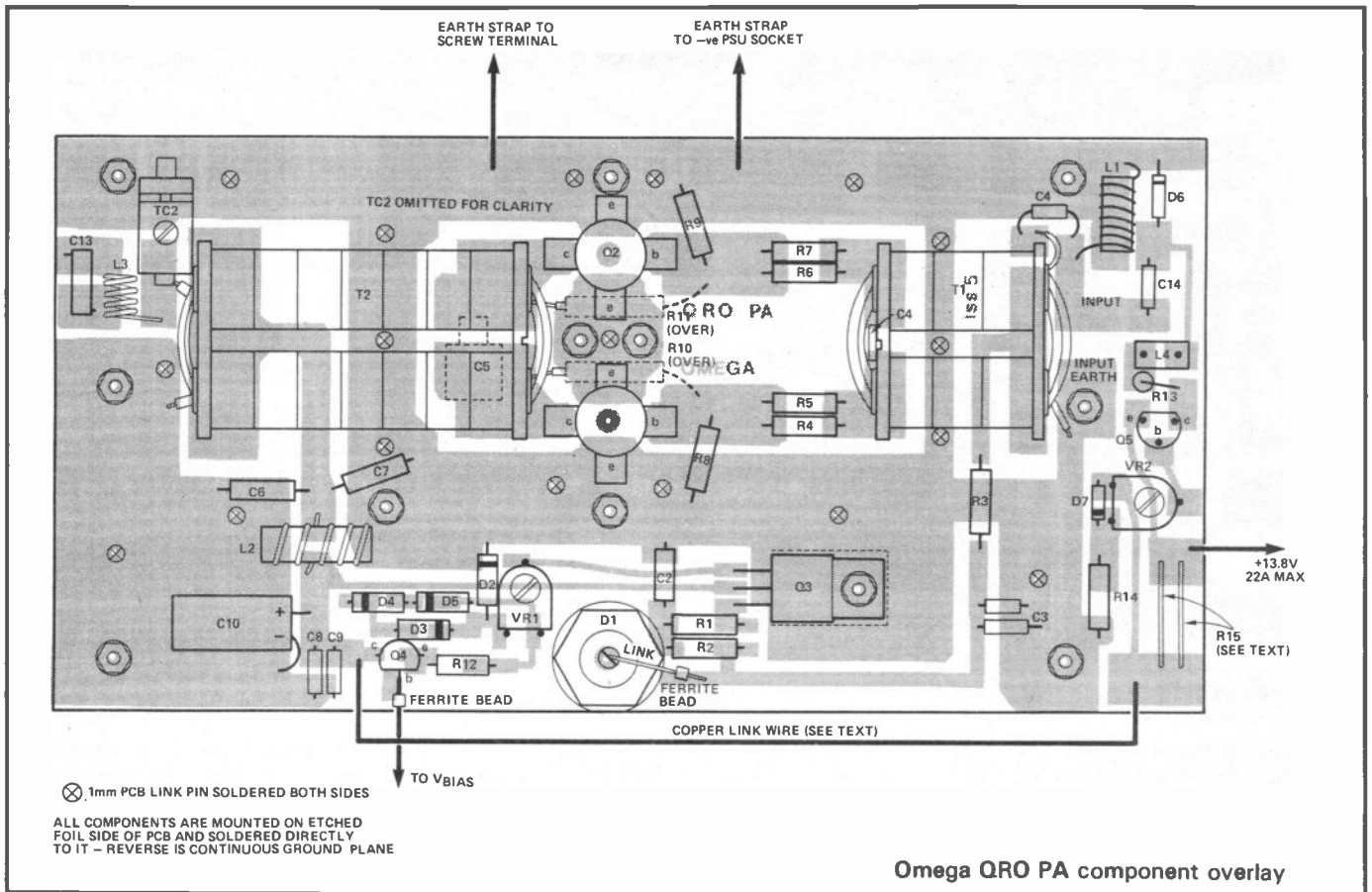

transformer, insert a length of brass tube 24mm long into each hole of one end plate. Holding these in place, thread three ferrite cores onto each tube, then place on the other end plate. Adjust the tubing so that an equal amount protrudes from each end of the plates. Lightly solder tack each end plate in place to the tube holding the end plates firmly against the ferrites. Then solder all round each tube in turn.

Repeat the procedure with the output transformer, using 50mm lengths of tube, and seven cores on each tube.

The high impedance windings are now added. For T1, take 35cm of 1.25mm dia enamelled copper wire and slide over it, an equal length of PTFE sleeving with an internal dia of 1.9mm. Four turns are now wound through the brass tubing, in such a manner that the two free ends emerge from the end of the transformer that has a continuous foil end plate. Insert the wire through one tube until about 15mm protrudes from one end. Carefully take the long end and thread it back through the other tube to make the first turn. Handling this wire is a little awkward and you should try to make a smooth bend where the wire returns through the tubing. Repeat three more times. Trim back the PTFE sleeving using a knife to within 5mm of the end plate. Clear off the insulation on each free end back to the sleeving.

The output transformer is made in a similar fashion, using 59 cm of

1.25mm en wire and sleeving, again four turns.

When you have made these, the 1000pF UNELCO wrapped mica capacitor is soldered into place on the PCB — do not substitute this with any other type as it will lead to high frequency losses and possible instability. The photo shows where this goes, underneath T2. Lay it on the PCB so that about 1mm of track is just visible outside of the body to the left of the PCB. Check that when T2 is put in its correct position, the end plate is clear of the capacitor. Solder the sides of the body in place, then the tab. Do not bend the tab — allow the solder to flow

Unelco mica capacitor in position at lower RHS

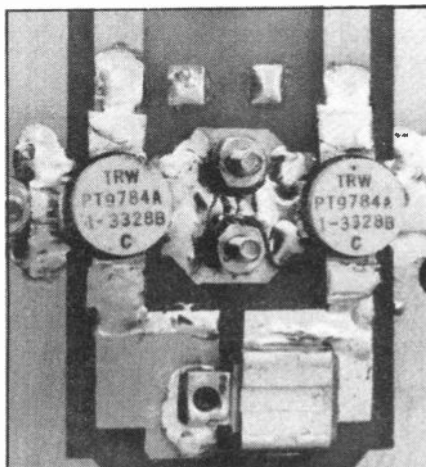

from the tab onto the PCB until a good joint is made. Mechanical stress on the tab may induce an RF short later.

Place T2 on the PCB so that an equal amount (about 1mm) of PCB track is showing outside of each end plate. Make sure it is squarely placed, then solder the end plates to the PCB with a continuous run of solder. Take care not to bridge the gap at the centre on the right hand side of the transformer. Follow by soldering T1 in to place similarly.

Next solder TC2 into place, after shortening the earthy end (tag nearest the raised portion) to 3mm long, doing the same with the other tag, then bend the tags slightly downwards. The trimmer fits with the earthy tag just at the edge of the PCB, between one of the nuts, and T2 end plate. Solder in place and check that the underside of the trimmer is not shorting against the PCB.

Bend the lead from T2 secondary nearest the trimmer down and trim it so that it just contacts the PCB against the trimmer tag. Solder into place firmly. Then solder the other lead to the earth plane immediately in front of the transformer.

Now wind L3. Take a 15cm length of 1mm dia en copper wire, and wind 4 turns round a 7mm dia drill or former. Reduce the leads to 3mm in length, strip and tin them, and bend both slightly downwards, but not at right angles to the coil. It then mounts as shown just up in front of T2 end

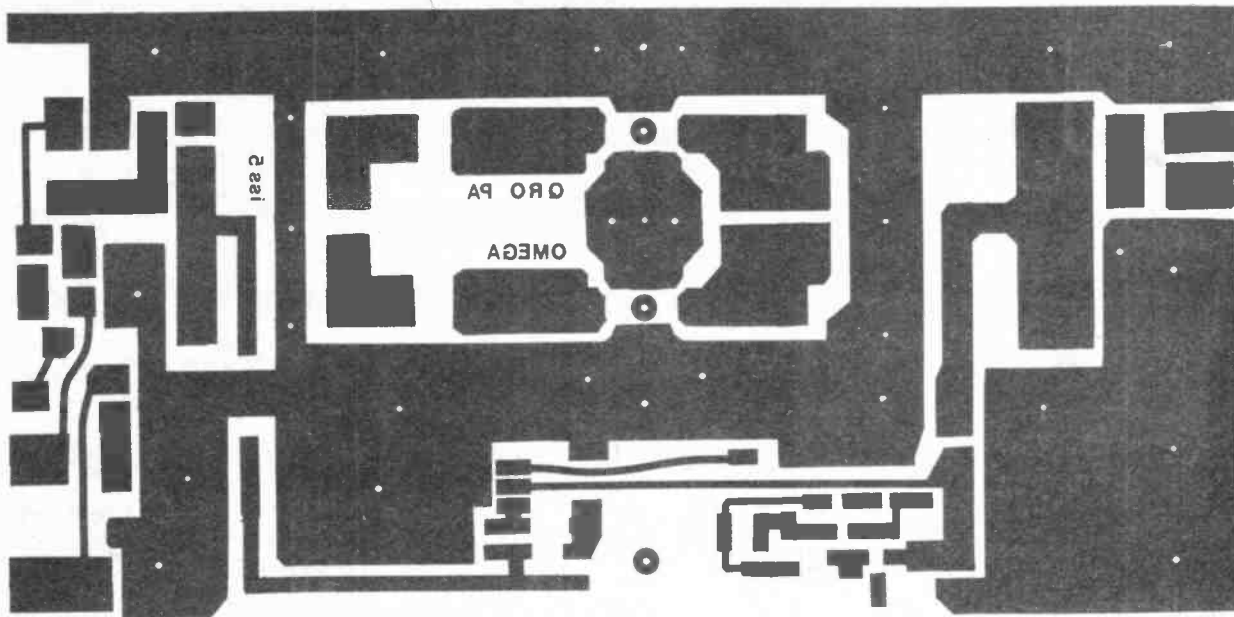

Foil pattern

plates. Solder into place.

Solder in C13, keeping the leads as short as possible. Then solder in C6 /C7 bending the leads out from the bodies first (care — they can break off easily) and soldering them close to the bodies.

Now wind L2. take a 27 cm length of 1mm wire, wind 10 turns onto the ferrite core (ie so that 9 turns of wire are visible on the outside), shorten the leads to 5mm, strip, tin, and solder to the PCB. Then solder in C8, C9 and C10, keeping the leads as short as possible.

Next solder in all the fixed resistors except R3, 10 and 11. The leads should be kept as short as possible, soldered close to the bodies, with the resistor bodies resting against the PCB. Then solder in the remainder of the fixed capacitors, again keeping leads as short as possible.

Bend both leads of TC2 down at right angles against the ceramic body. Then place against the inside top edge of T2 and solder to the end plate foils above the brass tube ends so that the bolt is just above the ferrite cores.

Now take a 14 cm length of 7/0.2 PTFE covered wire and strip off 10mm of insulation from each end with a sharp knife. Tin the leads. Thread one end through the windings in one tube of T2 so that both free ends will eventually project from the side facing the transformer. Then return the other end back through the other tube. This is not as easy as it sounds — the windings will almost certainly get in the way. Some patience plus the help of a pair of tweezers may be required. Take R10 and cut one lead down to 5mm in

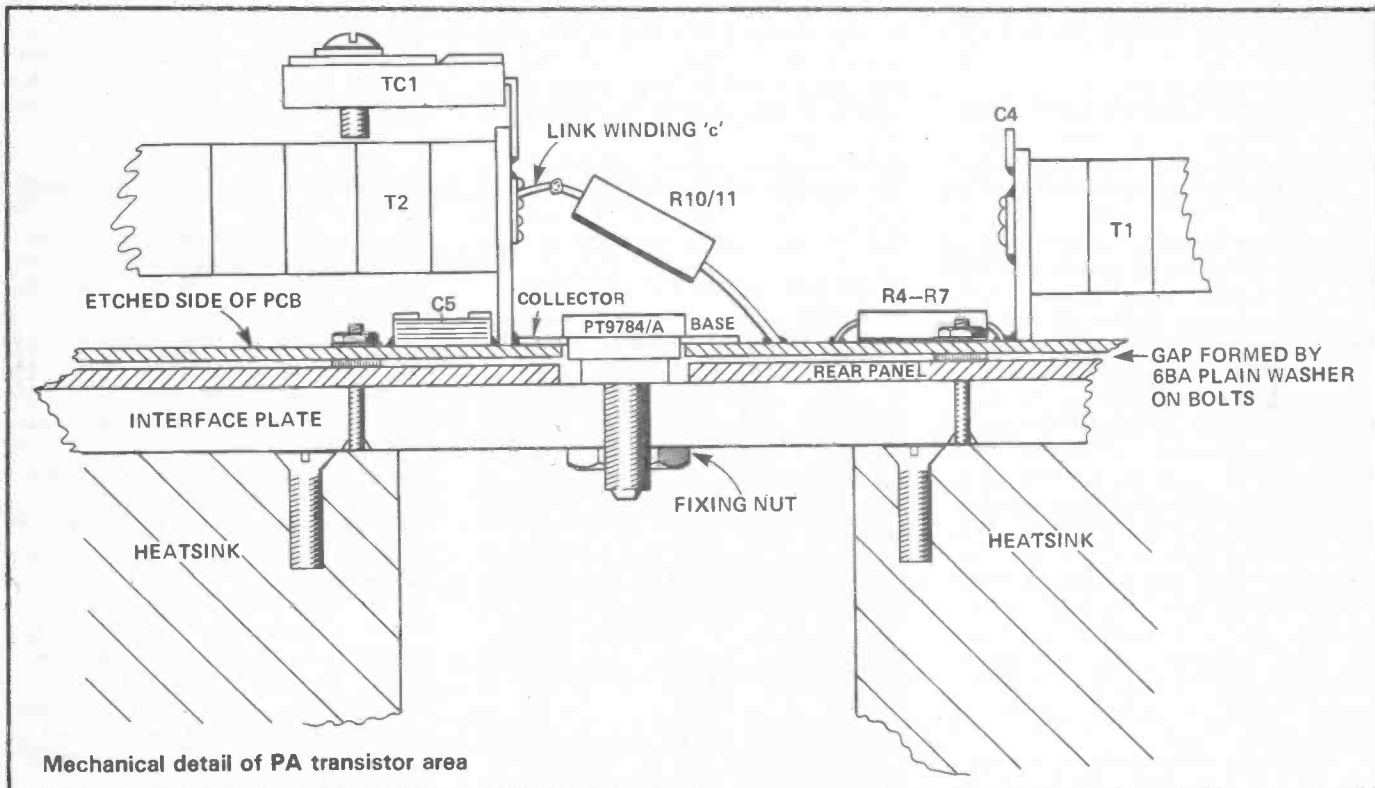

Mechanical detail of PA transistor area

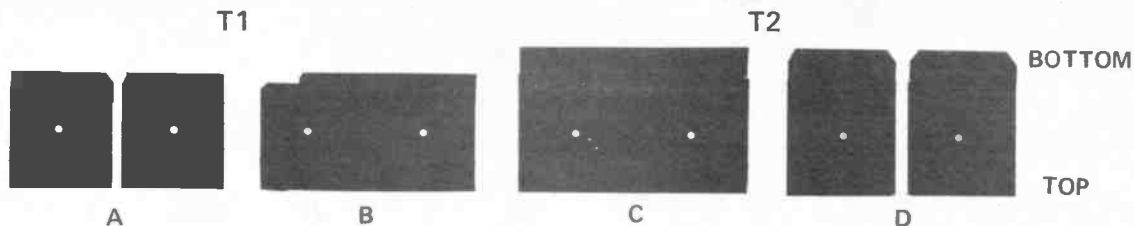

Transformer end plate patterns for T1 and T2. These are made from single sided copper clad 2oz PCB. Plates A and B are one piece of PCB with etched clearance at centre. The holes in the centre must be enlarged to clear 8mm inside dia brass tube.

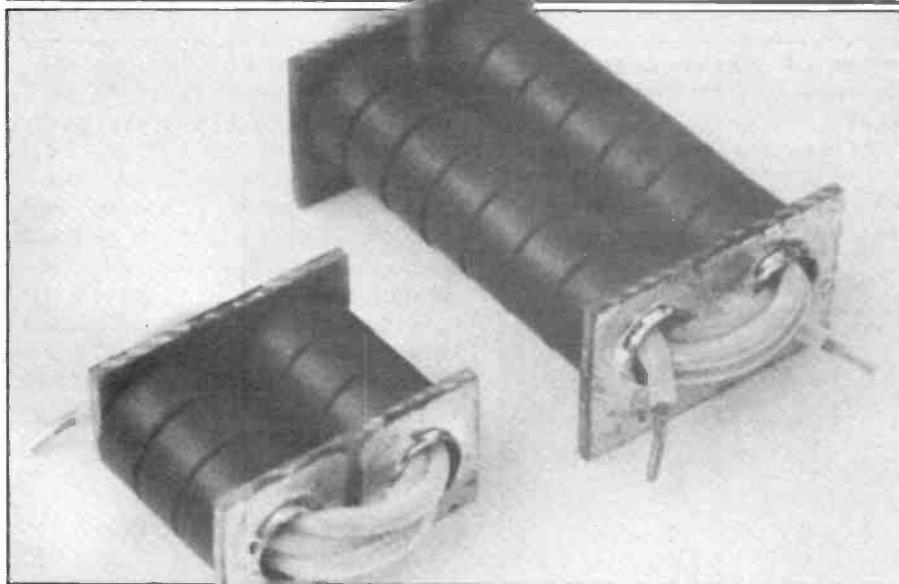

T1 and T2 after assembly

length. Firmly wind one of the free ends of the PTFE wire round the short end of R10 and solder. Then cut the other end of R10 to 10mm in length and bend down so that it can be soldered to the base lead of one of the transistors.

Repeat with the other resistor.

Next solder the earthy lead of T1 to the top foil where indicated. Then bend the other lead so that it can be soldered to the PCB foil in the correct place. Now wind L1. Take a 35 cm length of 0.56mm dia en copper wire, and wind 15 turns onto a ferrite core. Shorten the

leads to 5mm, strip, tin, and solder into place.

The last few operations are to solder the diodes D2-D4 to the PCB where shown (bodies resting against board) — take care they are the right way round! Then bend the last 4mm of Q4 leads out at right angles, with the centre lead projecting towards the flat end of the body. Solder into place, again making sure that the flat on the body is facing the right way. Then solder VR1 to the PCB, after bending the leads at right angles again. Using a short length of wire, solder one end to the tab of D1. Thread a ferrite bead over the lead and solder the other end to the track where shown.

Then add all the components associated with the current limiting circuit, Q5, keeping leads as short as possible, especially at the input to T1. L4 mounts vertically without bending its pins. R15 is made from two lengths of Constantine wire, each 18mm long. Solder them side by side a little way apart directly to the PCB where shown, right up to the edges of the foil at each end — this leaves exactly 1cm of each wire conducting.

You should now have all components in place with the exception of R3 which is added after checking the operation of the bias supply.

Using heavy gauge wire, connect earth straps from the PCB to the rear panel earth terminal, and the PSU input negative terminal. Then solder C11 and 12 across the PSU input terminals. Now solder a sleeved length of 1.25mm en copper wire as a link where shown along the lower edge of the PCB.

### Kits

A full kit of parts for this project including all components, drilled tinned 2oz copper PCB, transformer end plates and tubing, machined interface plate, tapped heat sinks and all wire/sleeving is available from WPO Communications for £149 inc carriage and VAT. PCB's/transformer end plate set only, cost £11.50 inc. Certain other parts are also available separately — please send an sae for details.

\* Due to lack of space some of these photographs have been held over to next month.

### Component Listing

#### Resistors

R1,2,3	2R2 0.5W carbon film
R4,5,6,7	2R2 0.5W carbon composition
R8,9	10R 0.5W carbon composition
R10,11	33R 1W carbon composition
R12	330R 0.25W carbon film
R13	470R 0.25W carbon film
R14	10k 0.25W carbon film
R15	.02R — made from two 1cm effective lengths of 28swg Constantine resistance wire in parallel

#### Capacitors

C1	1n5 ceramic disc
C2,3,9,12	100n ceramic disc
C4	2n2 ceramic disc
C5	1n wrapped mica
C6,7	100n block polyester
C8	10n ceramic disc
C10	470uF/16v radial electro
C11	100uF/16v radial electro
C13	10n 1kV ceramic disc
C14	10n block polyester

#### Semiconductors

D1	HL-103A stud mount
----	--------------------

D2-D5,7	1N4148
D6	1N4007
Q1,2	TRW PT9784/A (380-SOE)
Q3	TIP31A
Q4	BC238
Q5	BC308

#### Miscellaneous

L1	15 turns 0.56mm en Cu wire wound on Fair-Rite core type 59-61001101 ( $\mu=125$ )
L2	10 turns 1mm dia en Cu wire on core as L1
L3	4 turns air spaced 1mm en Cu wire on 7mm former
L4	TOKO 470uH choke
T1	Broadband Transformer (see text) using 6 x Fair-Rite cores as L1. Primary 4 turns 1.25mm dia en Cu wire in 2mm ID PTFE sleeving wound through secondary
T2	As T1 using 14 cores as L1 and 4 turn primary. Single turn feedback winding using PTFE covered 7/0.2 wire
VR1	220R horizontal preset
TC1	500pF max ceramic/mica compression trimmer
TC2	180pF max ceramic/mica compression trimmer

# Metre wave

"Please, please, not *another* look back on the year a-dying and a look ahead to the year about to open!" The reader may be excused the

number of people coming into amateur radio from Citizens' Band. 'ticket'.

At the same time the number of

*As 1984 goes out, Jack Hum, G5UM, dons grey beard and scythe to assess the last twelve months 'metre wave' wise.*

thought at a time when the media seem obsessed — as they always do at the turn of a year — with what has happened over the last twelvemonth and what is likely to happen in the next. Need we in 'Metre Wave' in *Ham Radio Today* follow the same trend? It will profit us to do so only if we can identify any definite landmarks that arose during 1984 on the metre-wave front and can perhaps derive some instruction from the dying year.

Any landmarks, then? Yes, assuredly. Reckoning that the metre-wave spectrum is the only one where any true progress in amateur radio can be discerned (for the HF bands have long since fallen into an unchanging mould — and if you think that to be a provocative utterance, you may challenge it in the HRT letters page!), there were in '84 two major developments that affected — and affect — the generality of metre-wave users, and two less major ones, having a minority interest but holding great technical potential for the future.

The major developments first, then...

One of them was that significant moment at the beginning of 1984 when the number of British amateurs holding the VHF-only Class B licence exceeded those holding the Class A one. At this cross-over point, there were 26,276 Class B licences and 24,359 Class A extant in the UK, a trend that accelerated as the year progressed, helped by the large

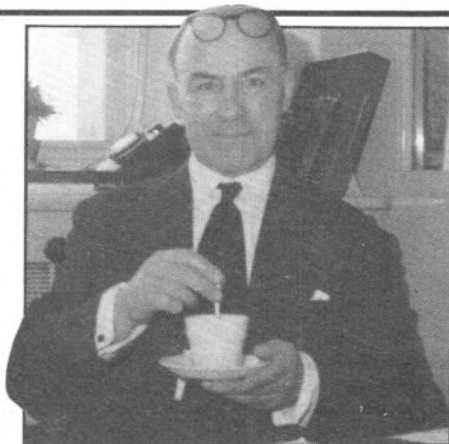

number of people coming into amateur radio from Citizens' Band. 'ticket'.

no fewer than 80,000 in a year. Clearly, not all of these 80,000 dropped out of CB because they intended to take 'ham tickets': most of them quit because CB lost its appeal and novelty value. But thousands *did* decide that amateur radio was for them and that they would take The Examination. Of the thousands who went on to pass it a majority opted for the Class B licence simply because operation on 2m promised to be in the style of communication with which they had had experience.

## Flight from 'Two'?

In parallel with this development occurred a noticeable flight from two metres by the older hands accompanied by cries that "Two is becoming like Citizens' Band", which was a derogatory viewpoint not to be reconciled with the hard fact that most of the ex-CB recruits were quick to learn, already had

## The Metre-Wave Operator's Ten-Point New Year Resolution

1. I will never use the wrong mode in the wrong place and to allow me not to do so, I will memorise the UK VHF/UHF Bandplan (and if I can't remember it, I'll keep a copy of it by the log).
2. To extend my range I will use the morse code to put my signal into ears which otherwise wouldn't read it — and if I don't know the morse code, I'll jolly well learn it before 1985 is much older.
3. When I use CW I'll go along at the speed of the other person — and I hope he/she has made a similar resolution to help *me* along in turn.
4. I will never from my home station use a repeater except to attract the *attention* of someone I want to talk to: if he/she is within simplex range we will QSY to a non-repeater frequency.
5. At all times I will use the lowest possible power to sustain communica-

tion.

6. I will always send a QSL when asked — but I will remember that if I send a QSL for a through-repeater contact the card has no validity for any metre-wave awards and logically should be posted to the repeater!
7. If I'm not in The Callbook I'll regularly announce my position.
8. If I haven't got a Callbook I'll buy one, knowing it's the VHF Person's Best Friend after "the rig" (No matter whether I'm in it or not. It's the other person's identity I want to know, not my own).
9. Whether I'm in The Callbook or not I'll always be at the start of a QSO saying where I am, remembering it's much more important than "the name".
10. I'll try never again to say "there" as a punctuation point.

I won't make any more resolutions. I might forget them. Anyway all of these have appeared in HRT during the last twelve months and I'll try to follow them."

microphone experience, and rapidly sloughed off such quirks as "the personal" or saying "Radio Five" when they meant "Readability Five" or "On this side" when the simple word "here" would suffice.

And how many of us are in the "we"? Probably 60,000 in the UK by the year end, with the implication that amateur radio has an overcrowding problem ahead of it (though hardly on the scale of some of 1984's doom mongers with their prognostications that poor old Mother Earth would need to sustain 8,000 million souls by the end of the century!). But more of this phenomenon later in this piece.

## Secondly, Repeaters

What now of the second major development remarked in Paragraph 2 above? It can be put in one word: Repeaters.

Just a year ago your present writer contributed two articles to HRT on the subject of repeaters which suggested that they represented the biggest collective technical and organisation effort ever to be extended by the British amateur radio movement. That effort continues to be directed towards the improvement of the current chain of repeaters and towards an extension of their numbers where gaps in coverage occur.

No excuse is offered in restating a few basics about Britain's repeater chain in spite of the fact that most of them were rehearsed here in those articles of a twelvemonth ago. To the many thousands of enthusiasts who have come into amateur radio since then and have added their numbers to the readership of *Ham Radio Today*, it may be news that repeaters are "not provided by authority" like the National Health, say, or your local bus service. They exist solely because dedicated groups have seen a need for them, have undertaken the lengthy process of stating this need to the national society and, through the RSGB, to the Licensing Authority; and, once given the go-ahead, have designed and built the hardware that makes a repeater a viable entity, and have obtained site clearance to allow the device to be advantageously installed.

Creating a repeater station is a

demanding job. For one thing, "the box" must give 24-hour-a-day unattended service. For another, it must be funded. These things happen if there is a solid technical and financial backing to each group undertaking such an enterprise. They don't if there isn't.

The newcomer, then, needs to be fully aware that the repeater they — sometimes quite casually — use is the product of the brains and the brass of his fellow hams. If he is one of its regular patrons he owes it to those fellow hams to join their group and, with his subscription, to help to keep it financially sound.

## Low Down — and High Up

Now for those minority interest developments of the past year (and likely to continue into the next) which are hinted at in my preamble. They represent amateur radio activity at opposite ends of the metre-wave spectrum.

At one end of it lies "the lowest very high", meaning the six metre band, an area denied to the British operator by the declining presence of 405-line television broadcasting. It was the advent of this same TV that put paid to "Six" back in 1949 at a time when special licenses for 50MHz were held by a pioneering band of metre-wave enthusiasts, sadly granted little time to explore the band before video took it over.

Three-and-a-half decades later with archaic "405" on VHF by now superseded by colour on UHF, the seeds for hope of renewed amateur activity at 6 metres were resown, even though they offered a hard row to hoe.

For one thing, "the viewer must be protected", even though on "405" there might be no more than half a dozen of them left in the remote parts of the land. For another, services other than the Amateur Service might cast covetous eyes for space at 50MHz when television eventually vacated it. But as the months of 1984 wore on, that germinal row seemed less hard to hoe: as the broadcasters announced the closure of station after station of the old 405-line tradition, there came from official circles on high distinct murmurings of sympathy towards the amateur case for space on "Six". Already,

before 1984 was very old, amateur activity on 50MHz had been authorized, admittedly by only a sprinkling of stations geographically placed to provide best experimental evidence of the band's capabilities, but at least it was a foot in the door of "Fifty". The limiting factor that transmission was forbidden within TV broadcasting hours and in no way restrained the enthusiasm and technical expertise of the lucky few.

A minority interest, perhaps: but if few can as yet transmit, many may receive. They were shown how — being retrospective again! — in another of HRT's articles of 1984, that in which the "Extrapolator" converter was described.

The other minority interest, burgeoning over many years and gathering a force in 1984 which will assuredly carry it with great momentum through 1985 and beyond is microwaves.

Here is an area of amateur radio where the do-it-yourself ethic is pre-dominant (as indeed it is on "Six" also). In spite of the increasing availability of commercial "black boxes" (a lot of them grey ones) for the 23cm band — with such an enhancement of performance that "23" now takes in many of the attributes of 70cm — it is still the case that to achieve results on the higher megahertz allocations you must be able to "do your own thing". You must be well versed in circuit design and construction using techniques comparatively unfamiliar to those used on the lower frequencies. You need much patience before you reach that magic moment when input from the home built transmitter is realised. And you need stamina and dedication to transport your microwavery to remote and inaccessible high spots where good DX will result.

## Finally, That Demography

So much for the metre-wave *landmarks* of our opening paragraph, four in number. The individual reader could no doubt identify many more of his own choice. What, now, of the *lessons* to be drawn from the experience of the passing year?

Here again each individual to his or her choice. You are learning

all the time when you inhabit the 'metre waves': there is so much new to do and to discover both in operating and building.

To this writer the major lesson to be learned from 1984 is a reminder that we have all got to do something about our ever increasing numbers, Metre-wave licensees are increasing at such a rate that something *must* be done if the movement is not to collapse under the weight of its own numbers and the enjoyment of amateur radio inhibited as a result.

Well, what *can* be done? In a metre-wave context quite a lot, as has been suggested here in previous articles in HRT. For example, it would abate the QRM problem enormously if the use of omnidirectional antennas were to be discontinued as being anti-social devices, radiating in all directions and not solely in the wanted one. They cause QRM where it need not be heard.

Coupled with this consideration is the tendency to use more power than is necessary for adequate communications. Power amplifiers hitched on to the end of transmit-

ters are an expensive means of "getting more e.r.p." when a cheap and cheerful five or eight element beam will do the job much more effectively — and much less anti socially because directionally.

Something else which has become increasingly obvious is the need to use more of the 2 metre band below 144.9MHz, a trend which thankfully has been gathering pace during the last year or two or three. Yet even with this resort "Two" seems likely to seen become so overfull at peak operating times that to find a clear spot will be almost impossible.

The answer? Go to the next band up, meaning 433MHz. The space it offers for pleasurable communication is vast, the antennas needed are small, and signal levels point-to-point for a given ERP little different from those experienced on "Two". If an augury is sought for 1985 you can spell it "Seventy Cems".

"I seem to have read some of this before". The longer term reader may be forgiven the thought. But today he has several thousand new companions who

have *not* read it all before, and to whom much of the foregoing may well be news. Some of it may (hopefully) direct their metre-wave intentions for 1985.

### That Two-Figure Phrase

Now it's time to say "73 to the retiring year of 1984" as it vanishes into history.

This valedictory signing-off term — just "73", not "seventy threes" or, worse, "seventy threeses" — was handed down into early wireless communication from the days of the American railroad telegraph.

When miles and miles of wire linked lone signal boxes across the prairies and batteries were the sole source of power, economy was essential: you sent the maximum information with the minimum of dots and dashes. Many two-letter groups came into (often unofficial) use: "73" was one of them. With just those two numerals, the lone signal boxmen would impart their best wishes to their unseen chums up and down the line. Just as we do today! 73.

# HAM

# RADIO TODAY

## NEXT MONTH

### SIMPLY THIS IS PACKET RADIO!

Dave Bobbett, G4IRQ, clarifies the situation with a 'Micro Net' special feature

### PLUS

### SOME MODIFICATIONS TO THE TOTSUKO TR 2100M

Upgrade this flexible and popular 2m SSB/CW Tx/Rx

### THE CASE FOR 'F' UNITS

### HOW TO START YOUR OWN NET

**SPECIAL REVIEW:** Angus McKenzie investigates the talking walking (!) Trio TS711E 2m multimode transceiver - *the state of the art?*

# An Antenna Discharger

Amateur radio stations employing open wire feeder for the antenna, will be very familiar with the use of 'stand-off' and 'feed-through' insulators. Fitting 'feed-through' in-

then earthed, a simple form of lightning, or static, spark-gap is provided at the same time (see Fig.1). Ideally, a gas-filled, sealed unit should be used since it is not

rod.

The plug gap can be adjusted by gently bending the side electrode in the usual manner and checking with feeler gauges. The actual gap size will depend upon the transmitter power and feeder system in use, but should be as small as permissible without sparking occurring on power peaks on any band under humid conditions. With low impedance feeders it will

*A useful, inexpensive idea for protecting your transceiver from lightning or static discharges when using open wire feeder, from Peter MacKrell, G3AEP.*

sulators, to provide entry of the feeder into the shack through a window does not require the detailed methods of drilling glass suggested in some of the earlier handbooks. These days, it is usually less work removing one small pane and replacing it with a piece of easily worked perspex or acetate sheet.

Should 'stand-offs' be required, a cheap and efficient substitute can be found lying in a corner of the average garage — the discarded sparking plug! Designed to withstand high ignition voltages, with low-leakage insulators, it is only necessary to forcibly screw them into holes of the required spacing in a piece of wood, or plastic, to form a base mounting. If the same form of construction is used with a metal base, which is

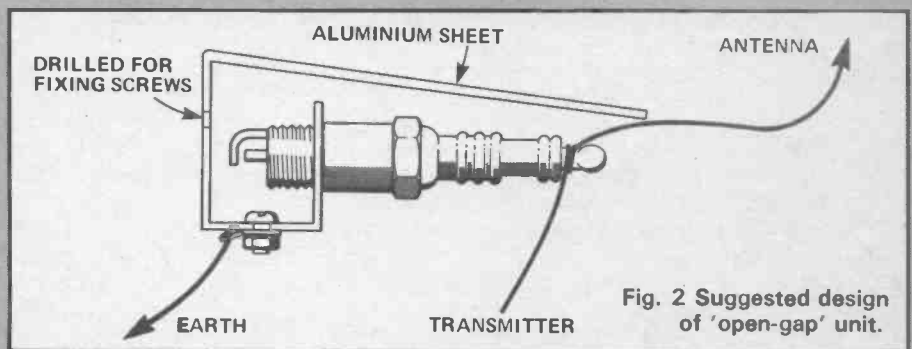

affected by varying conditions of humidity. However, the simple 'open gap' has been widely used for many years and were usually an integral part of those ceramic knife switches common to most window-sills, when domestic 'wireless sets' had external aerial/earth systems.

obviously be possible to maintain a smaller gap than with feed-lines having high standing waves and consequent large voltage peaks; it therefore follows, in the latter case, that the actual voltage applied to the gap can vary at different points along the feeder and from band to band. Sparking plugs are usually supplied with the electrodes set in the region of 25 thou., but in many stations it will be possible to halve this gap without difficulty.

With talk of E.M.P. (electromagnetic pulse) from nuclear sources to add to the natural hazards of lightning and static, it seems prudent — at negligible cost — to provide some measure of protection for expensive equipment.

## Construction

The actual construction is up to the individual, but the design shown was only a few minutes work. A piece of aluminium sheet, approximately 8 1/2" x 3 1/2", was bent as in Fig.2 (the extra length merely providing a 'roof' for the insulators). Two holes were drilled and filed to almost the size of the plugs, which were then used to tap their own threads. As these are not tapered, some pressure may be needed to get the thread started. Continue tapping, screwing the plugs home with a plug-spanner, or wrench. Further holes were drilled to take the two fixing screws and the nut and bolt for connecting the earth lead to the copper ground

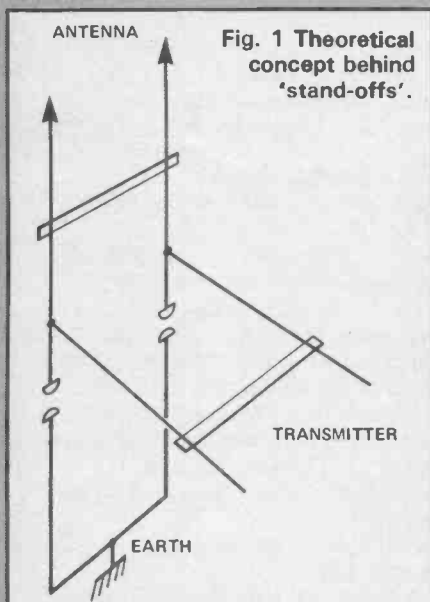
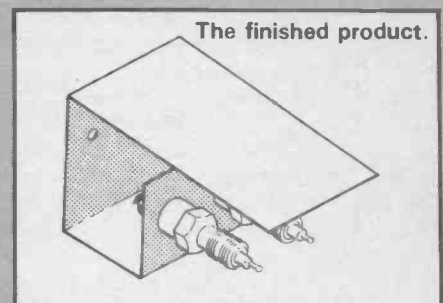

# RADIO Tomorrow

*Your at-a-glance guide to what's happening around the clubs, on the air and in general radio-wise.*

- |        |  |        |   |
|--------|--|--------|---|
| 1 Dec  | Bristol ARC: Christmas Fayre at YMCA, 6 Park Road, Kingswood, special event callsign <b>GB2 KCF</b> .<br>S Manchester RC: club dinner.   |        |   |
| 2 Dec  | <b>RSGB 144 MHz Fixed</b> .<br>Sutton and Cheam RS: Coulsdon club flea market.   | 11 Dec | venue The Victoria Club, Gatefield Street, Crewe starting at 8pm. Newcomers very welcome.<br>Exeter ARS: introduction to club construction project — a simple frequency marker.<br>Mid-Warwickshire ARS: Christmas celebrations.  |
| 3 Dec  | Stourdridge ARS: informal.<br>Stowmarket ARS: Christmas social.<br>Sutton and Cheam RS: natter night.<br>Todmorden DARS: social evening.<br>Worcester DARC: <i>The Spectrum Computer by G6CQK</i> at the Old Fellows Club.<br><b>BARTG Cumulative 2m/70cm RTTY contest final part</b> .  |        | Wakefield DRS: Christmas social evening.<br>Bury RS: AGM and cheese and wine.<br>Westmorland RS: <i>Talk about 10m by G3IZD</i> .<br>Bristol ARC: <i>Crime Prevention</i> .   |
| 4 Dec  | Chichester DARC: club meeting.<br>S Lakeland ARS: club meeting.<br>Dartford Heath DFC: pre-hunt meeting.<br>Fylde ARS: <i>Radio Astronomy by G3KEN</i> .<br>Bristol ARC: <i>Visit and talk by RSGB Regional Rep G3LP</i> .<br>Ealing DARC: <i>RTTY/AMTOR/ Packet Radio</i> .   | 12 Dec | Farnborough DRS: Christmas social evening.<br>Cheshunt DARC: natter nite.<br>S Bristol ARC: HF CW activity night, by <b>G4SQQ</b> .<br>Telford DARS: quiz night.<br>Chesham ARC: <i>RTTY/AMTOR/Packet Radio</i> .<br>Bath DARC: meeting 8pm at the Englishcombe Inn, Englishcombe Lane, Bath. Newcomers very welcome.   |
| 5 Dec  | Cheshunt DARC: <i>Remote Imaging by G8LOK</i> .<br>S Bristol ARC: <i>Test Equipment with G4KUQ and G4SDR</i> .<br>N Cornwall RC: Ring PRO.<br>Telford DARS: Telford Radio Rally Group AGM.<br>Wirral ARS: <i>Japanese Morse by G3CSG</i> .<br>Change of venue to Heswall Parish Church Hall, next to the bus station.  |        | Rugby ATS: Warwickshire Repeater Group on GB3YJ and GB3MW. Meeting commences at 7.30 pm at the Cricket Pavilion, BTI Station, 'B' Building entrance, A5 Trunk Road, Hillmorton, Rugby.<br>Crawley ARC: Skittles evening, at The Haycutter, Oxted. (I hope the next 25 years of CARC are as successful as the last. Congratulations!)  |
| 6 Dec  | Horsham ARC: AGM at The Queen's Head, Church Street, Horsham.<br>Sheffield DRS: junk sale.<br>Cray Valley RS: <i>G3RWL on 'OSCAR'</i> .<br>N Wakefield RC: natter night.   | 13 Dec | Southgate ARC: AGM.<br>Sheffield DRS: constructors contest.<br>Edgware DRS: junk sale.<br>N Wakefield RC: on-the-air night.<br>Cheshunt DARC: Christmas dinner, tickets from <b>G4UDZ</b> .   |
| 7 Dec  | Axe Vale ARC: annual dinner.<br>S Lakeland ARS: annual dinner.<br>W Kent ARS: informal.<br>Maltby ARS: <i>Using Test Equipment by G3XXN</i> .<br>Medway ARTS: junk sale.<br>Radio Society of Harrow: informal and practice.<br>N Wakefield RC: Christmas dinner at the Swallow Hotel.<br>Dunstable Downs RC: Christmas TV show.<br>S Manchester RC: <i>The Smith Chart by G8UQ</i> . | 14 Dec | W Kent ARS: annual dinner.<br>Maltby ARS: <i>Make It Work with G3ZVG</i> .<br>Medway ARTS: natter night.<br>Radio Society of Harrow: <i>'Spring Valley' Computers lecture and demonstration</i> .<br>Tiverton (South West) RC: club dinner. The club meets every Monday at the Queen's Head pub, Tiverton and has been able to set up a base station in the skittle alley with the club's callsign <b>G4TSW</b> . The Tiverton Ten award is available from the club when operators make contact with 10 Tiverton stations.<br>S Manchester RC: <i>Three Years of SSB Field Day by G3SVW</i> . |
| 8 Dec  | Three Counties ARC: Christmas party.   |        |   |
| 9 Dec  | Dartford Heath DFC: club hunt.   | 15 Dec | Horndean DARC: Christmas dance.   |
| 10 Dec | Milton Keynes DARS: <i>Fibre Optics</i> .<br>Sussex Repeater Group: AGM, Queen's Head, Horsham 8pm.<br>Sutton and Cheam RS: committee meeting.<br>South Cheshire ARS: club meeting at new  | 16 Dec | <b>RSGB 70 MHz CW</b> .<br>Glenrothes DARC: <i>Fire Safety Films by</i>   |



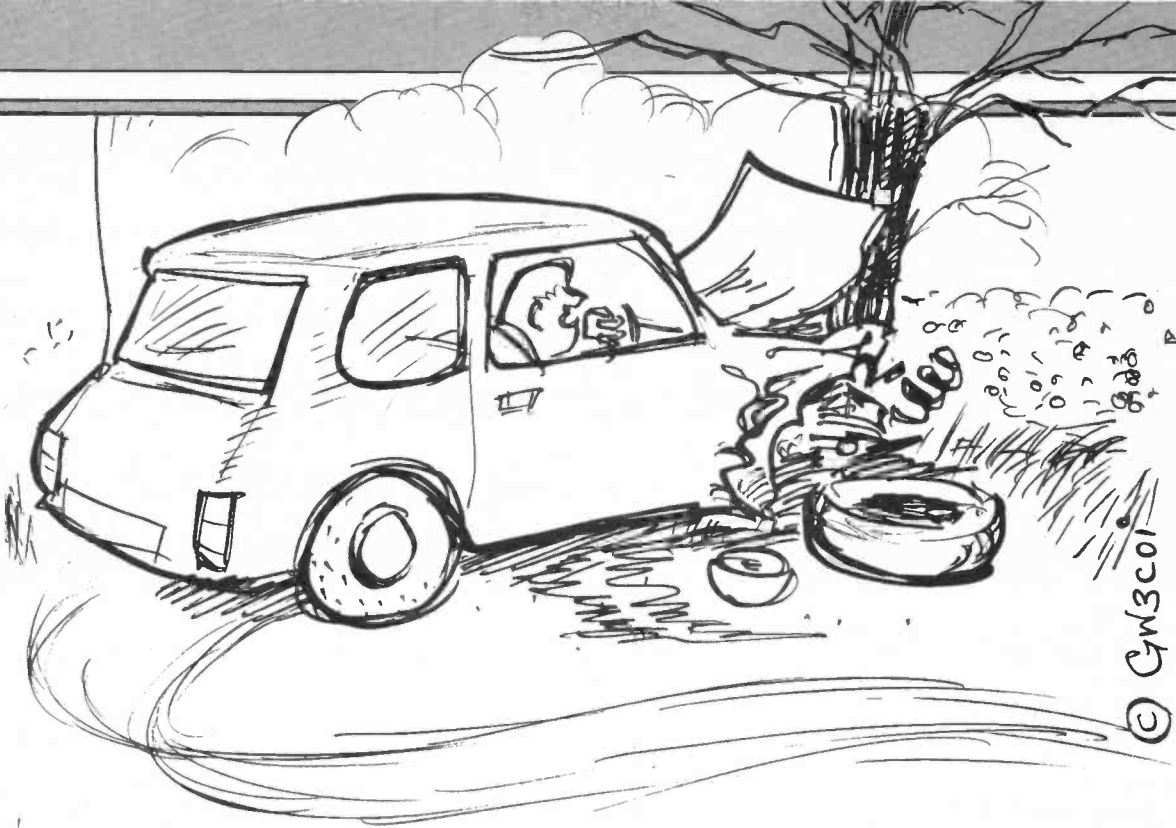

"... WELL I SUPPOSE YOU COULD SAY WE'RE STATIC MOBILE..."

- GM3YOR.**
- 17 Dec** Worcester DARC: skittles and social evening at the Old Pheasant.
- 18 Dec** Dartford Heath DFC: EGM.  
Fylde ARS: Christmas party.  
Bristol ARC: Christmas goodies or "It'll be all right on the night!"  
Verulam ARC: AGM, film show and seasonal refreshments, meet 7.30 for 8pm.
- 19 Dec** Cheshunt DARC: Christmas video show with G8NDR and G4OAA.  
Hastings ERC: Christmas social.  
S Bristol ARC: club families evening with G4YZR.  
Telford DARS: RSGB video films.  
Rugby ATS: informal, bring along your latest construction project for discussion, technical matters etc.
- 20 Dec** Cray Valley RS: natter night.  
Chichester DARC: Christmas social.  
S Lakeland ARS: club meeting.  
Shefford DRS: The Chairman's Mince Pie evening.  
N Wakefield RC: lecture/visit.
- 21 Dec** Sutton and Cheam RS: Christmas get together.  
Maltby ARS: Christmas junk sale.  
Medway ARTS: Christmas social.  
Radio Society of Harrow: grand Christmas party.  
Dunstable Downs RC: DDRC Christmas party.  
S Manchester RC: Christmas party.
- 28 Dec** W Kent ARS: Cheese and wine.  
Radio Society of Harrow: No(e)l meeting(?).
- 31 Dec** S Lakeland ARS: New Years party.
- 2 Jan** S Bristol ARC: *Discussion 'What's Legal' with G3OUK*  
Cheshunt DARC: natter night.
- 3 Jan** Cray Valley RS: *Assorted Panics by G3GJW.*  
N Wakefield RC: natter night.
- 4 Jan** Maltby ARS: *G8VHB Talk*  
Medway ARTS: natter night.  
Radio Society of Harrow: used equipment extravaganza.

- Dunstable Downs RC: junk sale.  
S Manchester RC: *Oscilloscope Design Development by G4AOK.*
- 5 Jan** Exeter ARS: annual Christmas dinner.
- 7 Jan** Sutton and Cheam RS: natter night in the Downs Bar.  
Horndean DARC: *Talk by G6NZ.* Visitors and potential members are very welcome. An active constructors section is aimed at those knowing little of radio techniques. The club is based at Merchistoun Hall, on the A27 near the Schooner Inn. Meetings start at 1930 for 2000.
- 8 Jan** Dartford Heath DFC: pre-hunt meeting.  
Bristol ARC: night on the air.  
Bury RS: to be announced.
- 9 Jan** Three Counties ARC: *Did Morse Get It Right? by G3CCB.*  
S Bristol ARC: SWL activity night.  
Cheshunt DARC: *The Morse Telegraphy with G4FAI.*  
Farnborough DRS: *G3AQC's Aerial Circus.*  
Rugby ATS: Are the voltages correct? Bring along your multi-meters and have their calibration checked!
- 10 Jan** Edgware DARS: AGM.  
N Wakefield: visit to Pontefract junk sale.
- 11 Jan** Maltby ARS: computer night.  
Medway ARTS: *'How Can I Work Meteor Scatter' by G8VR.*  
S Manchester RC: *Radio Analysis by G6EAO.*
- 13 Jan** Dartford Heath DFC: club hunt.
- 15 Jan** Fylde ARS: AGM, election of officers.  
Bristol ARC: 70cm dish redesign and construction.
- 16 Jan** Hastings ERC: *Compact Disc Demo by Sony (himself?)*  
S Bristol ARC: activity night with G4TSS.  
Cheshunt DARC: natter night.  
Rugby ATS: informal plus Christmas social details(?)
- 17 Jan** Cray Valley RS: natter night.
- 18 Jan** Maltby ARS: RSGB video.

Medway ARTS: natter night.  
 Sutton and Cheam RS: *QRP with G4BUE.*  
 S Manchester RC: *Microwaves by G3PFR.*  
 20 Jan Glenrothes DARC: *DXpeditions OY, TF, 9L, ZB and VP2M (Montserrat) by GM3YOR.*  
 22 Jan Bristol ARC: computer night — Z80 machine code in the beginning.  
 23 Jan Three Counties ARC: *Steam Railways by G3ZRM.*  
 S Bristol ARC: To be advised.  
 Cheshunt DARC: *The RSGB — questions and answers with Smudge Lundegard, G3GJW.*  
 Farnborough DRS: construction contest winner with G4JNT.  
 Rugby ATS: informal.  
 24 Jan Edgware DARS: informal.  
 N Wakefield RC: *Test Equipment by G8UYZ.*

25 Jan Maltby ARS: *Morse 'The Great Debate' with G6RIL and G3ZVG.*  
 Medway ARTS: video — 'Japan's Visit To China' or The Japanese visit to China.  
 S Manchester: *RTTY by G4NTY and G4MYB.*  
 30 Jan S Bristol ARC: to be advised.  
 Cheshunt DARC: natter night.  
 Rugby ATS: an amateur radio video (title to be announced).  
 31 Jan N Wakefield RC: monthly meeting.  
 1 Feb Medway ARTS: construction contest.  
 Dunstable Downs RC: *AMTOR, RTTY and packet radio by Ian Wade, G3NRW.*  
 S Manchester RC: club quiz.

Will Club Secretaries please note that the deadline for the March segment of Radio Tomorrow (covering radio activities from 1st February — 1st April '85) is 15th December.

### Contacts

Axe Vale ARC	Roger Jones	Uptonery 468
Barking RES	R. Woodberry	01 594 4009
Bath DARC	G4UMN	Frome 63939
Braintree RS	J. Roberts	0376 448678
Bristol ARC	T. Rowe	0272 559398
Bury RS	B. Tydesley	0282 24254
Cambridge DARC	D. Wilcock	0954 50597
Cheshunt DARC	Roger Frisby	0992 464975
Chichester DARC	C. Bryan	0243 789587
Donegal ARC	EI3BOB	074 57755
Droitwich	G4HFP	0299 33818
Dunstable Downs RC	Phill Morris	Dunstable 607623
East Kent RS	Stuart Alexander	0227 68913
Edgware DARS	John Cobley	30 64342
Exeter ARS	Roger Tipper	0392 68065
Farborough DRS	Mr Taylor	0252 837581
Fylde RS	PRO	Lytham 737680
Halifax DARS	DL Moss	0422 202306
Harrow RS	Dave Atkins	0923 779942
Hastings ERC	Dave Shirley	0424 420608
Haverhill DARS	Rob Proctor	0787 281359
Hornsea ARC	Norman Bedford	0262 73635
Horsham ARC	Pete Head	0403 64580
Leighton Linslade RC	Pete Brazier	052 523 270
Maltby ARS	Ian Abel	Rotherham 814911
Medway ARTS	Andy Wallis	0634 363960
Mid Ulster ARC	DF Campbell	0762 42620
N. Cornwall RS	J. West	0288 4916
N. Wakefield RC	S. Thompson	0532 536633
Preston ARS	George Earnshaw	0772 718175
Shefford DRS	G4PSO	Hitchin 57946
S. Bristol ARS	Len Baker	0272 834282
S. Lakeland ARS	Dave Warburton	Ulverston 54982
S. Manchester ARC	Dave Holland	061 973 1837
Southdown ARS	P. Henly	0323 763123
Stockton DARS	John Walker	0642 582578
Stowmarket DARS	M. Goodrum	0449 676288
Swale ARC	B. Hancock	0795 873147
Telford DARS	Tom Crosbie	0952 597506
Three Counties ARC	R. Hodgson	0428 77368
Tiverton (South West) RC	G. Draper	03634 235
Vale of White Horse ARS	Ian White	Abingdon 31559
Verulam ARC	H. Clayton Smith	St Albans 59318
WACRAL	G4NPM	0795 873147
Welland Valley ARS	J. Day	0858 32109
West Kent ARS	J. Green	0892 28275
Westmorland RS	G. Chapman	0539 28491
Wirral ARS	Cedric, G4KPY	625 7311
Wirral DARC	Gerry Scott	051 630 1393
Worcester DARC	D. Batchelor	Worcester 641733
Worthing DARC	Jim Hicks	0903 690415
308 ARC (Surbiton)	Dave Davis	01 399 5487

# Free Readers' ADS!

**CORSAIR** from K.W. ten-tec plus external VFO and ATU. All filters 150Hz, 500 Hz, 1.8kHz fitted. This rig is exceptional, see reviews. £895 no offers. Over £500 less than today's price? Telephone Dave G3RCQ 01-594 3495 9/5pm Hornchurch 55733 evening, weekends.

**STALKER S.S.B. U.S.B. L.S.B. AM** £30. Zetagi 200 W linear mains £30. K40 ant. £10. Magmount, Firestik £2. DV27 £2 Spare Mike £2. Mr. Higgins, 4A Ullet WaLK, Ullet Road, Liverpool, L17 IAR.

**YAESU FRG 7000** communications receiver, all amateur bands and general coverage, excellent condition, modern digital readout clock and timer etc. £165 datong indoor active aerial plus mains PSU, £45. Telephone Ruislip (71) 39111.

**DAIWA** search 9 receiver fitted 8 crystals plus VFO tuner 2m £32. Two 1155 power packs original £6 each. Faversham 538196.

**BRAND** new 4CX250B valves unused and in carton. £25 the pair 061 740 9630.

**TUNER FMT-51**, eagle products, LW/AM/FM. New, unused, battery operated. Requires amplifier and loudspeaker for complete radio £6 ono. N. Gundry 30 Newbridge Hill, Bath, Avon. Bath 21605.

**YAESU FRDX400** comm's receiver. 1.5-30MHz amateur bands, 10 MHz W.W.V., CB band, 4m, 2m. C.W. sharp, C.W. medium, SSB, AM wide, AM narrow, FM. 'S' meter. AVC slow, fast, off. Notch filter, clarifier. Excellent condition. £100. Buyer inspects and collects. Call G6XM 0425 73584.

**Twenty** dubus VHF UHF magazines and handbook £10. Daiwa CN520 SWR/power meter. Ranges 200W or 2kW £20. AMSAT - UK technical manual £6. Ring Dursley (0453) 811454 after 6 pm.

**FREE** Sony 405 video recorder, if you buy Sony video camera plus lens, 405 8" monitor, microphone and tapes. Recorder needs slight attention. £50. Buyer collects. Wanted Dynamotor DM28 for BC348 receiver. Phone Wickersley 541606. G3JDK Allendale Road, Rotherham, Yorks.

**YAESU FR50B** amateur band receiver 'Q' multiplier fitted, good order £70. Tel G4ORJ Rushden 314250 (Northants).

**YAESU FT77** HF transceiver with mobile bracket and mike, 3 months old used on Rx only £400 ono. Also Yaesu FC707 ATU £55. Contact Martin on Cheltenham 0242 517336 evenings.

**BARLOW** Wadley XCR2 receiver VGC with full service manual £50. Sommerkamp FL200 200W transmitter vgc with spare PA valves £50. Vintage CR100 receiver GWO with service data £30. Hastings 0424 753949 G3UFI.

**TRIO 2200GX** plus NiCads and charger £75, shure 444B base mic £25, pet computer 2001 32K series £120, Pye Cambridge single channel Tx. 4M AM, 70.26MHz. £15. Bob Canvey Island 697906.

**R107 RECEIVER.** 1.2-18MHz. 20,40,80,160m AM-SSB. Built in PSU 12V DC 240V AC GWO £25. M/M 100W 2m linear. Built in pre-amp RF changeover boxed, as new. £95. Wanted Trio 9500. 70cm multimode, cash waiting. G6BDY QTHR Kidderminster 755501 after 7 pm. please.

**SALE** unused HF600D 8 digit counter, reads up to 600MHz in 2 ranges £85. DFK Palm IV, 7 channels (0,2,4,6,8, 14, 20) boxed PSU £85. Both including P&P. Ring Winterslow 862489 after 1900. Bland, 11 Great Croft Firs Road, Winterslow, Salisbury, SP51SN.

**FOR SALE** Ham International Concorde 2 SSB rig AM FM USB LSB and CW, 120 channels £100 or nearest offer. Good working order and condition, or swap for HF receiver for beginner. S Wilson, 26 Watson Avenue, St. Andrew's, Fife, Scotland.

**STANDARD SRC146A ZW** portable external mike, leather case, base charger etc. Excellent condition £85. Also M.M. Converter 2m to 4-6MHz IF, £15, AEC dual power/SWR meter £8 ono. Call Steve 01-451 2276.

**FT757GX** HF transceiver, few months old £600. Would consider BBC micro or TS120S in part exchange. **GM4UJZ** QTHR or 031-331-2755.

**FT290R** 2 years old, very little use. With NiCads, charger, slim-Jim and 10M of R-G8 £220 ono. Phone Watford (0923) 27047.

**HRO 500** general coverage solid state Rx. 0.5-30MHz. plus LW CGC £300. Drake SPR-4. 23 crystals fitted. £150. Romsey 516841.

**AR88** communications receiver. Fully working fully serviced. Excellent condition. £75. Telephone Dartford 20388.

**UNIDEN** Uniace 100 legal CB mint condition, never used mobile, auto squelch fitted by Bury Electronics. Responds only to signals not noise! Standard Squelch still working normally plus realignment and performance report by local shop. £40 ono. Phone 01-247-6097 (daytime).

**FOR SALE** Trio R2000 communications receiver, mint condition, super radio with many facilities, must go to make way for HF-Tx set up. £325 ono. Phone Stan on (0602) 875413 after 6pm.

**YAESU FRG7700** general coverage receiver, little used, plus 5 band trap dipole, aerial

with matching unit £290 ono. Phone Taunton (0823) 433037.

**AVANTI PDL II** beam plus instructions £45; Zetagi BV131 linear £40; also Lafayette HA63A not working £10; the lot £90. Mr. Baker 0206 575036.

**SAGANT EL40X** compressed 80/40M dipole (80'), with balun and carry bag. Ideal for /P. Adjustable without cutting £19. Azimuth dual LCD clock. 12 and 24 hour display. Extra large digits, extruded aluminium case. £16. G3ZPF QTHR.

**G4MH** mini beam, 4 months old, good condition £75 ono G4WUU. Tel. Kings Langley 65823.

**FOR SALE.** Oscilloscopes EMI WM16 with trolley and cossor model 1035 mark 3. Also Phillips N1500 video recorder, new heads, many tapes. All items in working order and excellent condition. No reasonable offer refused. Buyer collects. Telephone 01-363-3766 (evening).

**HR 0.5T** general coverage Rx; Full set of 9 coils PSU and hardbook. Exchange for AR88 or similar O.W.H.Y. Sugden. Tele 0361 82714.

**FOR SALE.** FT209R with NiCads, charger, helical and mobile mount. £180. Telephone 01-994-8361.

**K202** communication receiver and matching speaker, 9 bands built in Q multiplier and notch filter, instruction manual, excellent condition. Would suit new SWL or as a second receiver for an established station. £125 G4YYV Southport 0704 79825.

**HAMMARLUND HQ170A** Receiver VGC with Manual, no Mods plus KW Antenna Traps, Phones, Speaker, etc. £120 Walton on Thames 243606.

**YAESU FT208R** 2M FM handheld — 2.5W out — 10 memories. With NiCads, carry case and strap, rubber duck and external microphone plug (worth £8). boxed, as new — 4 months old £145 or part exchange for FT290R. Telephone Chris G1CBC Darwen 771303.

**TRIO TR2200GX** fully crystallised NiCads charger, good worker £65, Edison phonographic 1905 wind up but incomplete no horn, offers please. Yaesu FT221R with YC221 display and mutek plus valve amp 300W output £600, no offers. Phone Alton (0420) 82693.

**FT101E** with remote VFO, 500 cycle CW filter, holdings mods for FM transmit and receive spare set, new valves. £350. Telephone Brighton 605704.

**PRINTER** keyboard, letter quality RS232 BBC £90; Tektronix 561A D/B scope £160; Solartron CD1016 D/B scope £15; Marconi video monitor £20; Marconi 6548 generator 4-12GHz £50; Intel 8086, 8087 £45; Yaesu YR901 CW/RTTY £150; Tel 07842 51409 after 8pm.

**MICROPATCH AEA** unwanted fit. New in box tested, £70 beam 4-element, six months old as new can be made 3 element 20-15-10 metres £145 Cheltenham 580959.

**KW2000A** manual stabilised PSU, various spare valves including new pas, spare crystals for 15M and shure 201 mic £160. Buyer collects or pays carriage. M. R. Davies, Laburnam House, Guilsfield, Welshpool, Powys. SY21 9PX Telephone 0938 75441.

**TRIO R600** general coverage receiver hardly used, in mint condition, still in original packing £160. Will pay delivery. Phone Northwich 782809.

**DRAKE TR7A** with PS7 power supply £850; Drake MN7 ATU £125; Drake SP75 speech processor £50; Trio TR9000 2M Multimode with PSU control unit and speaker £250; Dressler D200S 1Kw 2M linear £600. Tel 0742 666169 evenings.

**AR88D** Receiver, Diawa 2m receiver, home brew 20M receiver, plus Hi-Fi system, comprising realistic amplifier, tuner, sharp, belt driven deck, audiotronic front load cassette deck and realistic speakers. Price £160 ono. the lot. Good condition. Phone Derby (0332) 74115.

**DRAKE R4B** receiver £220 and Telford communications TC10 MK2 2M TX £80 Phone Steve 0572 56930 (evenings).

**COMMERCIAL** inverted Vee multi band antenna £22 NRD NDH515 24 channel memory unit for NRD515. £125 Racal dual diversity unit MA168B with handbook. £45 professional dual 10 band graphic equaliser. Cost £425 perfect. £195 All carriage extra. G3HWX Tel. 0704-840328.

**SHURE 444D** microphone (mint) £32; SSB Product NOAA etc weather satellite Rx £190; Microwave Modules 23cms/144MHz transverter (new model) £185; Tonna 23cms Yagis. £25 each; cushcraft (new) 70 cms cross Yagi; Teac F055E disk drive £145. Phone G4XHF Crawley (0293) 515201.

**IC 2025** £100, TR2300 £100, 6 elements 2M Quad £20 G8 TTI, QTHR, Chippenham (0249) 658109.

**YAESU FT200**, FP200, all 10M xtals, £195. Sem 100W 2M PA, £60. solid state modules 28/432, 10W transverter £50. Met 70cm, 17 ele Yagi, unused, £28. G8HCK, not QTHR, 01-802-7166, anytime.

**WELZ DIAMOND GH22** Antenna for sale as new £20. G3DRN QTHR 01-947-3914.

**Standard C5800** 2 multimode, 25W output, 144-148 MHz. Mint condition, little used £285 ono. Telephone G1CFY Folkstone (0303) 38849.

**SONY ICF 7600DF** portable FM/LW/MW/SW PLL synthesised receiver. Direct, scan or present tuning. Mains/battery, worldwide coverage, includes transformer, NiCads, manual, still boxed as brand new. Accept first £145. Sheffield (0246) 410545.

**EXCHANGE** or sell Trio TW4000A plus Jaybeam LW10/2m LW24/70cm Yagi's Hirshman remote rotator, all new cost £675, unwanted gift, accept £625. Or swap HF Transceiver, 9 bands plus FM FT101ZFM or FT102, etc or similar. 33 Hitchen, Merriott, or Crewkerne Somerset.

**SANGAMO Q550** range time switch. New in box £18. Labgear televorta £15, isolating transformer 240v in 25V out, pair crystals 4581.0 kHz offers. Wanted short wave Rx useful items 2m vertical ant omnimatch WHY swap for above. Aldridge. Phone 01-200 3825 Hendon.

**YAESU FT107m** ivory fitted, memory FM board, cw filter matching external PSU and speaker £395. FTV107 transverter fitted 2m £110. American 'Voman' split band processor £50. Drake R2B £75. Wanted Dentron MT3000, Tokyo HC2000 ATUs, medium rotator. Ring Bill G4EMG 01-534 3460.

**GRANDSTAND** CBFM base station immaculate £90. Rama speech processor, desk mike £20. Uniace 100 CBFM rig superb audio. Swap all above for 40A PSU or 40' lattice tower or computer or FRG7700 or WHY telephone 0652 34704 evenings or weekends.

**12AVQ** vertical trapped antenna. Swap for rotor GDO WHY — G3KEC phone Looe 3651..

**WANTED** Commodore 64 Spectrum TS530SP ATU AT230; selling TS520SE 10pF/100uF 10H/1mH 1ohm/10M ohm in 8 steps carriage to be arranged all in mint condition. Phone Jackson 0229 85669.

**SWAP** Have FDK T1200 handheld 143-149 MHz, complete with NiCads charger and case. Also manual. Would like 2M mobile cash adjustment if required. Tele Harlow (0279) 26647.

**EXCHANGE** 2m FM transceiver for Gumig 936 8mm Cine sound projector or ZX81 16K RAM PAK and Sanyo Slim 3A computer cassette recorder and taped

game. All as new. Contact L.T. Mannering, 135A Watling Street, Gillingham, Kent.

**EDDYSTONE 750** communication set 3.5 MHz - 80 MHz offer £55 ono. SX200N exchange for FT250 or FTB7 or sell £235 ono or 'cash difference. J Tarleton, 499 Burton Road, Midway, Nr Burton-on-Trent, Staffs.

**EXCHANGE** PCR2 valve Rx coverage LW/MW/SW for 2M beam or anything interesting. Tel Keith, Fakenham 3987 (Norfolk).

**SALE/SWAP** 48K Spectrum PSU, 2 games plus Scarab RTTY system £200. Or swap for 2m multimode mobile or portable not handheld also Hallicrafters Sky Champion S20R receiver 500kHz to 46MHz £125 ono. Will pay postage. Contact Mr Bolton, 10 Bowness Rd, Ciniston Park Estate, Timperley, Cheshire.

**GENUINE** Delta Sports ski boat and trailer. Requires inboard engine and underwater gear. Ideal DIY winter project. Will exchange for heavy duty rotator. Come and see it at Crown Farm Cottage, A52, Croft, Skegness, Lincs, PE24 4AP.

**SELL/SWAP** Old radio hard back books of the 1930's = "News Chronicle" Wireless Constructor's encyclopaedia by F.J. Camm, — The Book of Practical Radio by John Scott-Taggart — The Manual of Modern Radio by John Scott-Taggart — Admiralty Handbook of Wireless Telegraphy all in good condition sell or swap for Rx. Phone after 6pm 01-593-4439

**SELL/SWAP** 1 com IC25E 25wFM mobile 2VFO, 5 memories full scan, hardly used complete with box and manual. £275. Or swap for 2M synth multi contact. Ken G4UQN 0945 61029.

**SWAP FT 902DM** for 102 or 430S/PS 9 months old. Contact G4XNR Selby 702213 for a true base station.

**WANTED** for Shimizu Denishi SS-105S HF transceiver project, CW-F 0.5kHz C.W filterm SE-NB noiseblanker, SE-FMR

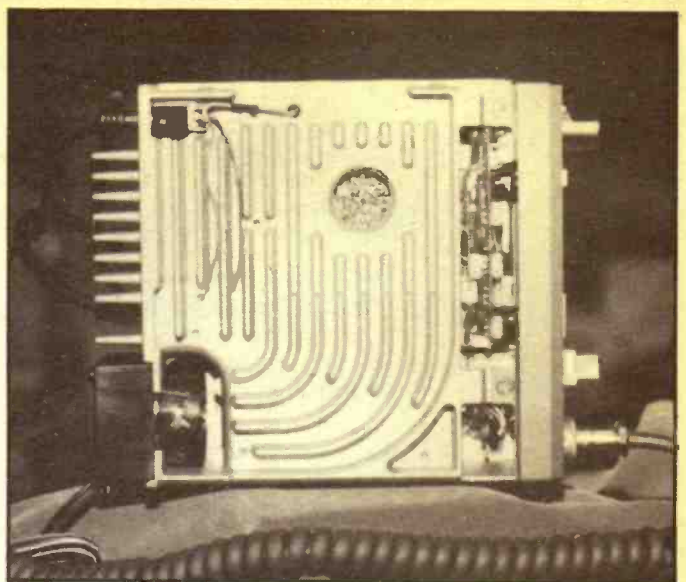

The new Yaesu FT270R CPU-controlled 2m FM transceiver has two particularly interesting features. One is an output of 45W (!) - without the rig getting too hot, achieved by a miniature blower and ducted heatsinking. The other is an optional voice synthesiser - with both English and Japanese languages!

FM demodulator SE-MK 25kHz marker oscillator. Anything considered either ready built or kit form. Tony Martin G4XBY not QTHR. Tel 0530 243248.

**HAVE** astronomical telescope and books - will swap for good general coverage receiver or AM. Willing to sell. Tel. Minster (0795) 875973 Mr Ogilvie.

**YAESU FT208R** 2m FM handheld, as new with charger and speaker mic. In makers box, offered in exchange for video recorder. Tom 01 749 7810.

**WANTED** air band Rx and marine band handheld Rx 40 etc. Phone 0274 676556 after 6pm.

**WANTED** IC251 or FT221(D) in good condition. Will pay cash, or have Sony ICF2001 to part exchange. Please contact Dave after 6pm on 0277 220428, or write P.O. Box 388, Brentwood, Essex. Thanks.

**WANTED** Yaesu FRG7 receiver please write with price required and telephone number to Crown Farm Cottage, Croft, Skegness, Lincs, PE24 4AP.

**WANTED** valve HF linear 3.5-28MHz. Must have own power supply 10W input 100W output. Also amateur radio software for Apple IIE. G4VJK. QTHR. Tel 02934 3556.

**WANTED** Electroniques QoLPAX (valved or transistorised) QP 166 RF front end, also Electroniques IFA 455/SSB Mk 3 amplifier module or any information on possible suppliers. T. Duffin, 16 Park Lane, Newcastle, Co. Down.

**WANTED** any old DX cards unwanted. Please send to 30 Devonshire Gardens, Tilehurst, Reading, Berks.

**WANTED** Drake ATU type MN2700 must be in mint condition ring G4OOK 0642 211685. QTHR.

**WANTED** UHF (220-400 MHz) receiver. Age immaterial, must be functional. Ring 0494 449524 eves and weekends.

**INEXPENSIVE HF CW (CW/SSB) transceiver** wanted for new licensee, anxious to get on the air. Can arrange collection. Please telephone 0723 863137 (Scarborough) after 6pm or weekends.

**WANTED** manual or photocopied manual for telequipment D31R oscilloscope. If you can help please phone Andy on Grimsby (0472) 814290 after 5pm.

**EXCITER LAMP** required for BTH sound projector G/22, 4V6A vertical filament SC PG Robins G8BSK 290 Priory

Road, St. Denys Southampton SO2 1LS.

**WANTED** to buy or borrow handbook and information on Hallicrafters SX24 Skyrider defiant receiver. All expenses paid. Mr Wiseman, 147 Oil Mills Road, Ramsey Mereside, Huntingdon, Cambs PE17 1UA. Telephone Mereside 403.

**WANTED** Kokushai mechanical filter MF45510AZ121 G5DH QTHR 040-928-342.

**WANTED** FC707 ATU reasonable price. Ring 01-672-3372 afternoons.

**WANTED** service manual for Lafayette HE80 to copy and return with costs. Bill Potter 32 Douglas Road, Clacton-on-Sea, Essex CO15 3JT Tel. 0255 429111.

**WANTED** handbook for Kenwood TR7500 will pay for photocopy. Tel Atherton (0742) 89004 or contact R.E. Rothwell, 15 Charleston Court, Tyldesley, Manchester M29 8JS.

**WANTED** manual for Heathkit GDO model GO-4; also additional plug-in coils model 341-U required. Short form oscilloscope catalogues and service scope booklets needed any year. Details to Paul Lockley, 52 Bunkers Hill Lane, Bilston, West Midlands. WV14 6JR.

**LARGE** private collection of service sheets for old valve wireless receivers and televisions. Copies £1.50 each. Write with details of requirements, make, model, age etc or SAE enquiries. Mr M Small, 8 Cherry Tree Road, Chinnor, Oxfordshire, OX9 4QY.

**WANTED** Yaesu FT780R 70cm multimode, no mods and in perfect working order Tel High Wycombe 446348 or 448939 works number. Please ask for Roy.

**WANTED** Argosy II Ten-Tec G4PKB. Telephone 0603 501939 evenings.

**WANTED** Yaesu FL60 Tx with manual and FV50 VFO if possible in good condition. Tomlins, 44 Newlands, Balcombe, Sussex. Balcombe 811793.

**WANTED** R1155 good price paid for working example. Sweet, 6 Springfield Close, Worcester WR5 3BQ.

**WANTED** for Racal RA117E black Bakelite Facal plate (cursor scape), 1 film strip (frequency readout), 2(c196) 0.5u paper 150V 20%, 2 (c197) 100u electrolytic 50V, (c217A) 0.01u silver ceramic 750V 20%. 2 (R124) 120ohm wire wound 6W 5%. Robin 0262 602278.

# Free Readers' ADS!

*Buy, sell or exchange your gear through our free service to readers*

## CONDITIONS

1. These advertisements are offered as a free service to readers who are not engaged in buying or selling the same equipment or services on a commercial basis. Readers who are should contact our advertising department who will be pleased to help.

2. Advertisements will be inserted as and when space becomes available.

3. The insertion of advertisements will be on a first-come, first-served basis, subject to condition (2). As a result, it will not be possible to guarantee the insertion of a particular advertisement into any particular issue of the magazine.

4. Readers should either write out their advertisement in BLOCK CAPITALS or type it, underlining any words that are to appear in bold.

5. The magazine cannot accept any responsibility for printers' errors in the advertisements; however, we will do our best to ensure that legibly written advertisements are reproduced correctly. In the event of a gross error, at the Editor's discretion, a corrected version of the advertisement will be printed (at the advertiser's request) at the earliest issue in which space is available.

6. The magazine or its publishers will not accept responsibility for the contents of the advertisements, and by acceptance of these conditions,

the advertiser undertakes to indemnify the publisher against any legal action arising out of the contents of the advertisement.

7. The magazine reserves the right to refuse to accept or to delete sections of advertisements where this is judged necessary.

8. Advertisements are accepted in good faith; however, the publisher cannot be held responsible for any untruths or misrepresentations in the advertisement, nor for the activities of advertisers or respondents.

9. Advertisers must fill in their names, addresses and (if available) telephone number in the space provided, and sign the form to indicate acceptance of these conditions (forms returned without a signature will not be used).

10. All that is to be reproduced in the advertisement should be entered into the space provided on the form printed in the magazine — note that a photocopy is not acceptable. All advertisements must give either a telephone number and/or address for respondents to contact, and this must be included in the wording of the advertisement.

11. Advertisements must be 40 words or less in length (telephone numbers normally count as two words, exchange or exchange code plus number).

Name .....

Address .....

.....

.....

**ENTER YOUR ADVERTISEMENT HERE:**

I accept the conditions above.

Signature .....

Send this form to: Free Readers' Ads, Ham Radio Today, 1 Golden Square, London WC2,

# EMPORIUM GUIDE

## AVON

**Booth Holdings Bath**

6 GOLF CLUB LANE, SALT FORD, BRISTOL  
Tel: 02217 2402

Open: Tues-Sat 9am - 9pm  
Close Mondays

RING 557732 BRISTOL

Radio Communications  
Amateur P.M.R. Marine

**UPPINGTON**  
Tele-Radio Bristol Ltd

12 14 PENNYWELL ROAD, BRISTOL, BS5 9TJ

## ESSEX

BARCLAYCARD  
VISA

**ARROW**  
Electronics Ltd

5 The Street, Hatfield, Peverel  
Nr. Chelmsford, Essex CM8 3YL  
Tel: 0245 381673/381626



Trio/Kenwood, Tonna, Welz, T.E.T.,  
K.D.K., Daiwa, Tono, Tasco

## HANTS

**FARNBOROUGH COMMUNICATIONS**

97 Osborne Rd, North Comp,  
Farnborough. Tel. 0252-518009

Open: 6 days 10-6

Yaesu, Icom, FDKs, Mosley aerials, Jaybeams,  
G Whips

## KENT

**THANET ELECTRONICS**

95 Mortimer St, Herne Bay  
Tel: (02273) 69464

Open Mon-Sat 9-5.30pm  
except Thursday 9-1pm

**AMTRONICS (TONBRIDGE) G4 SYZ**  
THE AMATEUR RADIO SPECIALISTS IN KENT

IT'S AMATEUR RADIO  
from AMTRONICS

8 Tollgate Buildings  
Hadlow Road, Tonbridge, Kent  
Tel: (0732) 361850

FDK, AZDEN, YAESU, JAYBEAM,  
FORTOP, DATONG, etc.

**SCARAB SYSTEMS**  
AMATEUR RADIO SOFTWARE

ICOM STOCKISTS

39 Stafford Street, Gillingham 0634-570441  
please see main advertisement

## LANCASHIRE

**AMATEUR ELECTRONICS U.K./HOLDINGS**



G3LLL

Yaesu, Tel, Jaybeam, Frequency  
Counters, Draa, Datong, FT101  
Experts, Repairs, GJ86C, 12BY7A  
8KDE, RF Clipper, Double Balanced  
Mixer, Warc Kit etc. S.A.E. List: 16  
min. Junc. 31 M8. Free parking.  
45 Johnston Street  
Blackburn BB2 1EP  
(0254) 56595  
CLOSED THURSDAYS

THE VIDEO HAM radio SHOP

141 Lancaster Rd, Morecombe, Lancs LA4 5QJ  
Tel: 0524-418873

27MHz, 934MHz, Ham radio, Shortwave radiol  
SALES (& Service on prem.)

24 years in the Trade

Open 9.30-4.30pm weekdays & Sat all day  
or phone anytime (P.S. Like our phone No!)

## LEICESTERSHIRE

**ELLIOTT ELECTRONICS**  
FOR THE RADIO ENTHUSIAST

28-28 BRAUNSTON GAT.  
LEICESTER. TEL: 663293

Open: Mon-Sat 9.00am to 5.30pm

## LONDON

**DRESSLER UK LTD**

181 Francis Rd, Leyton, E10

Open 9-5.30pm Monday-Friday 10-5 Saturday

Authorised dealers for:

Dressler, Yaesu, Icom, Standard, Trio/Kenwood,  
Datong, SCM, Microwave Modules, Tonna  
Tel: 01-558 0845/556-1415 Telex: 8953809

## W. MIDLANDS



**DEWSBURY ELECTRONICS**

RXs, from YAESU, JRC, ICOM.  
Stockists of microwave modules, B.N.O.S., M.E.T.,  
GAMMA, DATONG, ICS, TASCOS.

Open Mon-Sat 9-30-5.15

176 Lower High Street  
Stourbridge (0384) 39063

**HEWARD'S HOME STORES LTD.** (Est. 1983)

822/4 Kingstanding Rd., Birmingham  
B44 9RT. Tel. 021-354 2083

G4RJM with 38 years in The Radio Trade  
Ham Equipment urgently wanted!  
Open: Mon-Sat 9-6

Technical enquiries  
G4STG

**NEW IDEA LTD**  
133 Flaxley Road,  
Stechford, Birmingham

Stockists of Yaesu, Trio, Kenwood,  
Totsuko, Tonna Antennas, Bantex.  
Full servicing repairs on all makes of  
amateur radio. Open Mon-Sat, 10am-7pm,  
Sundays, 10am-1pm.  
Tel: 021-784 3129

SALES  
G4SOV

## W. MIDLANDS

**WARD ELECTRONICS**

DIAWA  
LOWE PRODUCTS  
COMMODORE  
COMPUTERS



HOKUSHIN  
I.C.S. AMTOR/  
RTTY EQUIPMENT  
RSGB BOOKS

GSLIV PCBs FOR SSTV/RTTY  
FOR RADIO ENTHUSIASTS

Soho House (1st Floor), 362-4 Soho Road  
Handsworth, Birmingham B21 9QL  
Tel: 021-554 0708 (Closed Mondays)

**R. Withers Communications**

584 Hagley Road West,  
Oldbury, Warley B68 0BS  
Tel: 021-421 8201/2 Tel: 021-550 9324

Opening hours: Mon-Sat 9.30-5.30pm  
Late night Thursday 8pm

For all your communication requirements.

## NORFOLK

**D.P. HOBBS (Norwich) Ltd**  
13 St. Benedicts Street, Norwich

Tel: 615786

Open Mon-Sat 9-5.30

Closed Thurs

Stockists of:

YAESU, FDK, ICOM, JAYBEAM  
& Electronic Component Specialists

**Eastern Communications**



31 Cattle Market Street  
NORWICH

OPEN: 9.30-  
5.30 Mon-Fri  
9.30-5 Sat

(0603) 667189

MAIL ORDER



ICOM  
ACCESS-BARCLAYCARD

Put your business  
on the map. Phone  
Jason on 01-437 0699

## NOTTINGHAM

**SP ELECTRONICS**

48 Limby Rd  
Huckhall, Nottingham

Tel: (0602) 640377

open Monday-Saturday  
8.30-5.30

# EMPORIUM GUIDE

## NOTTINGHAM

**AMATEUR ELECTRONICS UK**  
**R.A.S. (NOTTINGHAM)**  
 RADIO AMATEUR SUPPLIES  
 3 Farndon Green, Wollaton Park, N01 7M  
 Tel: 0602 280267





**Use the  
 Emporium Guide-**  
 Phone Jason on  
 01- 437 0699  
 for details

## SCOTLAND

**JAYCEE ELECTRONICS**  
 JOHN GM30PW  
 20 Woodside Way, Gelenrothes, Fife KY7 5DF  
 Tel: 0592 756962  
 Open: Tues-Sat 9-5  
 Quality secondhand equipment in stock. Full range of  
 TRIO goodies. Jaybeam - Microwave Modules - LAR.

**Use the HRT  
 Classified section to:**  
 sell/your product/service  
 either fill in the coupon or  
 phone 01 437 0699

## SURREY

**GUILDFORD COMMUNICATIONS**  
 34 Aldershot Rd., Guildford  
 Open Mon-Fri 8am-6.30pm  
 Sat 8am-5.30pm  
 Secondhand wanted  
     
 0483-574434

## TYNE & WEAR

Approved Dealer **ALYNRONICS**   
  
 129 Chillingham Rd, Newcastle-upon-Tyne  
 Tel: 091-276 1002  
 Open: Tues-Sat 10am-6pm

## WILTSHIRE

**PACE ELECTRONICS**  
 76 Victoria Road, Swindon  
 Tel: (0793) 46807

Yaesu equipment, BBC Computers + Software for the  
 Spectrum, Commodore 64 & Amtror.  
 Open 9-5 6 days a week  
 We do everything for the BBC

4 Cross Church St, Huddersfield Tel: 0484 20774  
 Open: 6 days 9-5.30.

Closed Weds, Thurs 9am-8pm  
**G4MH Mini Beam, Trio & Yaesu**

*'Always a good selection of new & 2nd hand equipment in stock'*

**Amateur Radio Shop**

## TELECOM

6 New Street, Barnsley  
 South Yorkshire  
 Tel (0226) 5031  
 Specialists in Yaesu, Icom  
 and So-Kamp

## EMPORIUM GUIDE — ORDER FORM

Advertise nationally in these columns to over 100,000 readers from £14.50 for 12 months. Simply print your message in the coupon and send with your cheque or postal order made payable to Argus Specialist Publications Ltd to:

CLASSIFIED DEPT., HAM RADIO TODAY  
 1 Golden Square, London W1R 3AB.

Tel: 01-437 0699

Please indicate classification required.

Name .....

Address .....

.....

.....

Tel.No.(Day) .....

Please place my advert in Ham Radio Today for \_\_\_\_\_ months. Please indicate number of insertions required.



Or Debit my Access/Barclaycard  
 (Delete as necessary)



--	--	--	--	--	--	--	--	--	--	--	--	--	--	--	--	--	--	--	--





## Lineage:

35p per word (minimum 15 words)

**Semi Display: (minimum 2 cms)**

£7.00 per single column centimetre

Ring for information on series bookings/discounts

All advertisements in this section must be prepaid.

Advertisements are accepted subject to the terms and

conditions printed on the advertisement rate card (available on request)

## COMPUTER SOFTWARE

### RTTY and CW TRANSCEIVE with NO TERMINAL UNIT

This fantastic program interfaces direct with your rig, slashing the cost of previous systems. Split screen, type ahead, all the usual features and more. Tape and kit for the very simple interface for only £17.50. Connectors and ready-made interfaces available. For CBM64 and VIC20 (+ at least 8k). BBC-B coming soon. CW-only version for SPECTRUM £10.

And four superb programs for CBM64, VIC20, BBC-B, SPECTRUM LOCATOR QTH or Maldenhead locator or lat/long. Distances, headings, contest points, converts between locator and lat/long. Tape £8.

LOGBOOK Date, band, mode, call and remarks. Superfast callsign search. Easy, fast updating of files. Screen/printer output. Tape £8.

MORSE TUTOR Britain's best. Learn fast in easy stages from absolute beginner to over 40 wpm. Join the hundreds who have succeeded with this program. Tape and full learning guide £8. For ZX81-16k also.

RAE MATHS All the practice and testing you need. Tape and comprehensive reference sheet detailing all you need to know £8. VIC20 needs expansion (any). For ZX81-16k also. Don't let maths make you fail. PASS with this program.

All programs are very easy to use and come with full instructions.

Prices include p&p 1st Class by return. Add £1 per tape if outside UK or Ireland.

**technical software (HRT)**

From, Upper Llandwrog, Carnarfon, Gwynedd LL54 7RF. Tel: 0286 881888

## MORSE SOFTWARE

### MORSE READING PROGS.

Work on clean signals without hardware interface.

**ZX81 1K UNEXPANDED MEMORY**  
Translated code with word and line spaces for easy reading. Automatic scroll action. £7 Incl.

**SPECTRUM 16/48K**  
Scroll action with 10-page scrolling memory, instantly accessible page by page. £8 Incl. All types variable speeds. Feed signal directed into EAR socket.

Pinehurst Data Studios  
69 Pinehurst Park, West Moors  
Wimborne, Dorset BH22 0BP

### MORSE TUTOR

£4.00 on cassette. £8.50 on microdrive for Sinclair Spectrum. 4 to 19 words per minute, variable spacing, variable groups of random letters, numbers, or mixed; Random sentences, own message, single characters and variable pitch. Feedback on screen, printer, or speech (Currah Microspeech 48K only) and repeat facility. 16K and 48K versions on one cassette 48K only on microdrive.

**WD SOFTWARE**

Hilltop, St. Mary, Jersey, C. Islands  
Telephone (0534) 81392

## COURSES

### COURSES - RADIO AMATEURS

EXAMINATION City & Guilds. Pass this important examination and obtain your licence, with any RRC Home Study Course. For details of this and other courses (GCE, professional examination, etc.) write or phone - THE RAPID RESULTS COLLEGE, Dept. JN2, Tuition House, London SW19 4DS. Tel: 01-947 7272 (9am-5pm) or use our 24 hr Recordacall Service: 01-946 1102 quoting Dept. JN2.

## COMPONENTS

R.F. Transistors. Specialist Components for Transmitters. Unico Capacitors. Sparague Mica Trimmers (500V). Sole Agent for solid state Microwave R.F. Transistors supplied to full specification. Full 2N range supplied. Special SD range 1W-100 WATT output 1 to 100 MHz. Pre-amplifiers for 2 meters and 70cms. Power Amplifiers with and without switching. Aligned and ready for use. Due to exchange fluctuations we cannot price. Send S.A.E. for full lists.

Phone: Selsey

(0243) 823603. Modular Electronics, 1 Coniston Close, Felpham, Bognor Regis, Sussex.

### NEW & USED Amateur Radio

equipment supplied, bought and exchanged. S.A.E. for list or call: Calbreso Ltd, 258 Fratton Road, Portsmouth. Tel: (0705) 735003.

## FOR SALE

R & S RADIO (G4 OWY)  
Tel. Weymouth (0305) 786930  
Amateur radio Equipment bought sold and exchanged list sent on request.

TWO METER SSB transceivers from £119. Full range including Icom, Trio, Yaesu, Asden etc. Credit facilities Guildford CB. 0483 574434.

### AMATEUR EQUIPMENT,

bought, sold, exchanged. Tel 040 24 57722; or send SAE for current list. G3RCQ Electronics, 132 Albany Road, Hornchurch, Essex.

## SOFTWARE APPLICATIONS

### Special prices on surplus equipment

Racal RA17 Receivers High grade communications receivers 500KHz-30MHz in 30 effective bands. From £195. Eddystone receiver 730/4 500KHz-30MHz in 5 bands £145. All in excellent condition. Carr £15.

**SANYO-RP6890 9 Bands Portable Communications Receiver £125.00. P/p**  
Westminster W15 Low band A.M. £30 p&p £2.50. 27 foot telescopic mast with guys, insulator, etc. £25 collected. High impedance headphones with boom mike new £7.50.

**Avo valve testers £35 p&p £4. New 28 range digital multimeters £40.25**

**PCR Receivers LW/MW/SW Untested less PSU £20 p&p £5. 10' Whip aeriels £4 p&p £1.50. Creed teleprinters £25. Various single and double beam oscilloscopes, signal generators, valve testers, output meters etc always in stock.**

**Surplus circuits Book** containing circuits and notes on many surplus receivers, transceivers etc. £7.50. **Send 50p for illustrated catalogue** includes £1 voucher. Over 500 sets in stock. **Avos amateur rigs WANTED for cash.**

**New shop open at 218 St Albans Road.**

**Come and see the bargains**

**WEIRMEAD LIMITED, 129, St Albans Road, Watford Herts**

Telephone Watford 49456

**Access/Visa cards welcome.**

## CARDS, STICKERS & BADGES

### LISTENER & QSL CARDS.

Quality printing on coloured & white Glass Card at competitive prices. S.A.E. for samples: S.M. Tatham, "Woodside", Orchard Way, Fontwell, Arundel, W. Sussex.

### PLASTIC BUSINESS AND MEMBERSHIP CARDS



### QSL CARDS

Distinctive QSLs for all budgets. Many designs at really competitive prices.

TRY US — send for FREE samples.

**DEROGA PRINTING**

Whitwell Road, Sparham  
Norwich NR9 5PN

## OSARIO TRACKING

### SATELLITE CALCULATION PROGRAM

### FOR DRAGON/TANDY COLOUR COMPUTER

This unique software package features predictions by the hour for beam headings, including Azimuth, Range, elevation, squint and range rate. Daily or monthly printouts to screen or printer, for your own location. This programme is easy to use and comes with full instructions.

Send £5.50 for cassettes or £8.50 for disc inc. P&P.

For full details send S.A.E. to:

**G.M.T. SOFTWARE (Dept. HRJ)**  
4 Werneth Close, Denton  
Manchester

## AERIALS

### AERIAL WIRES & ACCESSORIES

Hard drawn copper wire 140ft 14swg £7.90 50 metres 16swg £8.90 10 metres 12swg soft enamelled copper wire £3.50. 50 metres 1.4mm soft enamelled copper wire £5.75. G5RV Type Aerials. 1/2 size £12.00. Full size £13.95. 4mm Polypropylene Rope 50 metres £3.95. 4mm Nylon Guy Rope 50 metres £8.90. Ceramic Egg Insulators Large 50p. Small 40p. All items postage paid.

S.M. TATHAM, 1, Orchard Way  
Fontwell, Arundel, West Sussex

## ALARMS

**BURGLAR ALARM EQUIPMENT.** Please visit our 2,000 sq ft showrooms or write or phone for your free catalogue. C.W.A.S. Ltd, 100 Rooley Avenue, Bradford BD6 1DB. Telephone 0274 731532.

## RTTY

### RTTY - CW - AMTOR

*Now on the Dragon*

Complete set of Programs & Hardware

to convert your DRAGON 32/64 into a complete communications terminal.

**Morse transceive**  
Program (Cassette) £10.75  
Interface (Module) £17.50

**RTTY**  
Program (Cassette) £12.00  
Terminal unit of modules £39.00

**AMTOR**  
Program (Cassette) £39.00  
Clock/Switch Module £18.00

Programs also available in Cartridge. Hardware available in kit or fully boxed form.

For full details send 2x16p stamps to:-

**PNP Communications (HT)**  
62 Lawes Avenue, Newhaven  
East Sussex BN9 9SB  
Tel: (0273) 514465  
Prices include postage but not VAT



# WPO COMMUNICATIONS

20 FARNHAM AVENUE, HASSOCKS G3WPO  
WEST SUSSEX BN6 8NS MAIL ORDER ONLY

24hr  
Ansaphone

07918 6149



DSB/CW

DSB80

2W+

Our most popular kit ever. Simple 80m (also 160m version) Tx/Rx with suprbly sensitive receiver. VFO. Basic pcb kit (only needs psu/mic/key & Speaker) ONLY £37.45. Case (punched but plain finish)/hardware £24.45 and digital display option @ £24.10. All above for £79.00 inc. 12v operation.



**XMAS OFFER!!**  
£34 until 31st Dec

## UNIVERSAL MORSE MEMORY

Our unique design which works with Hand keys! 10-120 sec message length at any input/output speed. Memory back-up, sidetone, battery or external supply. SPECIAL MS VERSION now available with 1-15sec message length.



£49.50  
READY  
BUILT

See previous ads for more details.

## 2W + DSB CW DSB2 ANY SINGLE BAND 160-15m

QRP Transceiver with mini-PLL VFO. Semi Break-in CW, AF filter etc. **ANY SINGLE BAND 160-15M.** Digital display option. Basic pcb Kits (2) £68 only needs PSU (12v) mic + key/speaker. Kits with case (punched but unfinished) /hardware £89.50 or with case plus display £113 (160/80m) or £118 (40-15m).

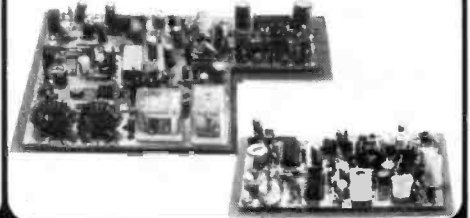

## ALPHA — SINGLE BAND SSB/CW 50W TRANSCEIVER KIT

160m or 20m



**XMAS OFFER until 31st DEC**  
£180 complete!!

Our latest Transceiver for mobile or base station use. Full kit with a painted custom case/bracket/digital display £199.50. Basic pcb kit with all components £149.50 (no display). 90dB+ dynamic range, excellent sensitivity, RF blanker, IF Gain.

WE SPECIALISE in kits for the home constructor. Why not try something from us soon? Many kits are suitable for beginners and come with comprehensive instructions, drilled tinned pcb and pots, wire etc. Our products are used worldwide and can help YOU get on the air to work the world or locals. Many other products under development — watch this space for details. Most kits have pcb's and instructions only available.

Our full Catalogue is available for 50p in stamps (no cheques etc) or short form for SAE. Kits are sent in 7-10 days, but allow up to 28 days for delivery of popular items if not ex-stock. EXPORT — Europe use UK prices, REST OF WORLD — UK + 5%. All prices include Post & VAT. Leave your Credit Card orders on our Ansaphone.

## OMEGA — 9 BAND MULTI-MODE TRANSCEIVER/FULL QSK CW

HF 160-10m 100W



Our most complex kit for the enthusiast constructor. High performance 90dB + dynamic range PLL synthesised design. Custom case and hardware available. Write for full details. Unique Mailing List/Newsletter service available for £1.00 stamps.



## 2M FM TRANSCEIVER

**BUILD AS PORTABLE OR BASE STATION**

Get on 2m FMI 6 channel max. 1W+ Tx and ideal for beginners. These are popular kits with Rx @£39.50 & Tx £32.90. Both kits for £68. Verocase (undrilled) to make portable rig £7.50.

**XMAS OFFER until 31st Dec**

£68  
£63



## VFO KITS

**MINISYNTH** As used in DSB2. 1 band PLL VFO, versions for 9 & 10.7MHz i.f.'s and for 160-10m (28-28.6). Full kit with tuning cap and crystal £29.70. Very stable — will drive SBL1.

**VHF MINISYNTH** our 2 metre version with continuous coverage of 144-146MHz. Direct output on 2m and options for up to 3 other bands i.e. 135-137 for Rx + 2 repeater shifts. Full kit with air tuning cap £38.50. Again, very stable — drives SBL1.

**OMEGA 9 band version** — all amateur bands with 1MHz coverage. Very stable and clean output PLL VFO. For 10.7MHz i.f.'s, the full kit with all crystals is £108. Drives SBL1 or similar.

**COAXIAL RELAYS** — New miniature coaxial relays, 50ohm pcb mounting, good to 900MHz (isolation typ. 65dB+ & 100dB+ @144MHz), 12v spco type, 15W RF handling. Size 26 x 21 x 10.5H — £6.50 ea. or 2 for £12.

## OTHER KITS

**G4JST SPEECH PROCESSOR** only £13.90 ATU KIT, SWL or QRP 5W 1-30MHz only £29.45. **ACTIVE AUDIO FILTER** for improving selectivity (low level input/output) 8 position SSB/CW for £16.65. **HF BROADBAND PREAMP** (1-30MHz) suitable for use with G3ZVC/G4CLF designs, 15dB gain — only £13.50. PIN switched.

We stock 1000pF Screw in Feedthroughs at 0.35 ea or £3.20/10.

Don't forget most of our OMEGA kits are suitable for use with G3ZVC/G4CLF designs to finally get them on the air.

**COMING SOON — The MICRON** — 6 band CW only transceiver with custom case, optional ATU/SWR. 8/10 waits or QRP, variable filtering. Our answer to the HW-7/9 etc. Write for details when available. 80-10m including 30m. RIT, Attenuator etc. Around £180 with case.

## QUARTZ CRYSTALS

STOCK CRYSTALS			MADE TO ORDER CRYSTALS		
CRYSTALS FOR 2 METRES			FUNDAMENTALS		
HC25 £2.15 FOR ONE CRYSTAL	£1.96 WHEN 2 OR MORE PURCHASED		FREQUENCY RANGE	PRICE	
HC6 £2.15 FOR ONE CRYSTAL	£2.05 WHEN 2 OR MORE PURCHASED		50 TO 150 KHZ	£21.00	3rd OVT
<b>TX CRYSTALS</b>	<b>RS CRYSTALS</b>	<b>CHANNELS IN STOCK</b>	150 TO 500 KHZ	£7.80	5th OVT
HC6/U 8MHZ 30PF	44 MHZ SERIES RES	RO TO R7, S11, S20 TO S23	160 TO 999 KHZ	£11.90	7th OVT
HC25/U 12MHZ 30 & 40PF	44 MHZ SERIES RES	RO TO R7 S8, TO S23 & S32	1 TO 1.5 MHZ	£10.75	
HC25/U 18 MHZ 25 & 20PF	14/15 MHZ 20 & 30 PF	RO TO R7 S8, TO S23 & S32	1.5 TO 2.0 MHZ	£5.10	
HC25	SCANNER XTLS (NOT SR9)	RO TO R7 S8, TO S23 & S32	2.0 TO 6.0 MHZ	£4.75	
	full list available on request please send SAE.		6 TO 21 MHZ	£4.55	
<b>4 METRE CRYSTALS FOR 70.26 IN HC6/U AT £2.40 each</b>			21 TO 25 MHZ	£6.50	
TX B.78250 RS 29.78000			25 TO 30 MHZ	£8.50	
<b>70CM CRYSTALS £5.00/pr or £2.50 each</b>					DELIVERY
For Pye PF1 PF2 & PF70 series Wood & Douglas and FDK MULTI U11					2.0 TO 175.0 MHZ
SUB(433.2) SU20 R80 R82 R84 R86 RB10 RB11 RB13 RB14 RB15.					2 TO 3 weeks
ALSO for MULTI U11 ONLY SU12 SU16 SU18					5 TO 999.9 KHZ
<b>CONVERTER CRYSTALS IN HC18/U AT £2.85 each.</b>					6 TO 8 weeks
22.000, 38.666, 70.000, 96.000, 116.000, 101.500, 116.000					1 TO 1.499 MHZ
<b>FREQUENCY STANDARDS £2.75 each</b>					3 TO 4 weeks
HC6/U 200kHz 1000kHz 3.50 MHz 5.00 MHz 10.000 MHz 10.700 MHz					
HC18/U 1000kHz 7.00 MHz 10.70 MHz 48.00 MHz 100.00 MHz					
Also HC6/U 200 kHz 455 kHz £3.25 each					
<b>TONEBURST, I.F. &amp; MPU CRYSTALS IN HC18 £2.25 EACH</b>					
7.168 MHz (For 1750 Hz Tone), 10.245 (for 10.7 I.F.),					
3.2768 5.0688 14.3180 15.00000					
<b>YAESU CRYSTALS FOR FT101's FT901 &amp; etc £4.00 each</b>					
Many available ex stock (A list is available on request please send SAE.)					



**QuartzLab**  
MARKETING LTD

P.O. Box 19  
Erith  
Kent DA8 1LH

ALL PRICES ARE  
EX VAT PLEASE ADD 15%

Telephone: 01-318 44119 24Hr Ansafone: Dartford (0322) 330830  
Telex: 8817271 GECOMSG (Attention QUARTSLAB)

# Cirkit. Making it bigger and better.

Cirkit stock all the components, accessories and tools and the kits you're looking for. Designed and selected to offer the best possible standards at the best possible price.

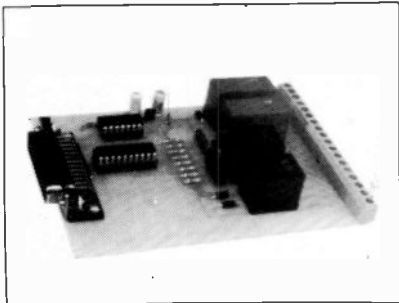

Centronics Interface

## Cirkit Kits

### CIRKIT ELECTRONICS TOOL KIT

Contains: 15W Soldering Iron 2 spare bits, heat shunt, solder, pliers, cutter, screwdriver 40-00007 15.56

### AUDIO FUNCTION GENERATOR

Versatile waveform generator with sine, triangular and square wave outputs. On board mains PSU 41-01302 27.00

### STEREO 40W AMPLIFIER

Single board 40W per channel stereo amplifier 41-01301 38.00

### STEREO VU METER

5 LED per channel stereo VU meter for use with stereo amplifiers 41-01401 11.50

### 5W AUDIO AMP

A very compact audio output stage for use in a wide range of equipment 41-01406 4.60

### UNIVERSAL AMP

A universal audio pre-amp with a gain of 10 41-01604 6.45

### MONO REVERBERATION UNIT

Single channel, spring line reverb unit to add echo effects to tape recording etc. 41-01602 10.00

### TONE GENERATOR AND DETECTOR

Very low distortion tone generator and signal detector for circuit fault finding 41-01603 10.45

### 10MHz DFM

8 Digit LED digital frequency meter and period measurement 41-01500 54.10

### 50MHz PRESCALER

Extend the range of the 10MHz DFM to 50MHz 41-01501 8.55

### 1.5MHz PRE AMP

Low frequency pre-amp and waveform shaper for the 10MHz DFM 41-01502 5.13

### 70cm PRE AMP

Low noise, miniature pre-amp for the 70cm amateur band 41-01506 4.78

### 70cm CONVERTER

70cm to 144MHz low noise converter featuring pre-aligned helical filter, schottky diode mixer and low noise transistors 41-01405 21.50

### 1-30V 1mA-2A PSU

Adjustable 1-30V Power supply with pre-settable current limit from 1mA-2A 41-01600 37.46

### 5-12V 1A PSU

Adjustable PSU from 5-12V with current protection, 1 amp max output 41-01504 6.45

### 1-30V 1.5A PSU

1-30 volt adjustable PSU with protected output up to 1.5 Amps 41-01402 10.45

### 3 DIGIT LED DVM

DVM to read up to 99.9 volts or configured as an ammeter to read up to 9.99 amps 41-01403 17.00

### INFRA RED LINK

Single channel IR Link with relay output 41-01300 9.60

### TEMPERATURE SENSOR

Thermistor based temperature sensor with relay output 41-01303 6.20

### LOCOMOTIVE SOUND GENERATOR

Realistic steam sound and whistle for model railways 41-01304 9.20

### LAMP DIMMER

Control lamps and drill speed 41-01305 5.70

### WATER LEVEL ALARM

Alarm to indicate high water level or flooding 41-01601 2.70

### 3 NOTE CHIME

Doorbell chime with adjustable tones 41-01503 7.00

### 2M PRE AMP

Miniature low-noise MOSFET pre-amp for the 2m amateur band 41-01307 3.91

### 2M CONVERTER

Low noise 144MHz-28MHz amateur band converter 41-01306 17.35

### 2M POWER AMP

20W - 10dB gain - power amplifier for the 2m band. Automatic TX switch over, RX pre-amp, robust construction 41-01404 32.87

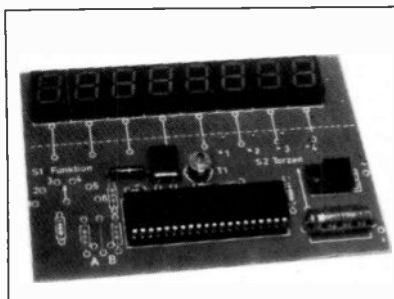

10MHz DFM

### CRYSTAL CALIBRATOR

Crystal reference calibrator for alignment of receivers, outputs at 4, 2, 1MHz, 100, 50 AND 10KHz 41-00801 4.32

### CB NOISE SQUELCH

Improves to mute performance of the majority of CB rigs 41-01605 5.40

### CENTRONICS INTERFACE

Connect your personal computer to the outside world via the Centronics printer output 41-01406 22.50

### 70cm PA

10W Power amp to boost the output of handheld and portable 70cm transceivers 41-01505 33.82

## Selected Lines

BBC to Centronics Connect Cable	03-10019	7.25
Dragon to Centronics Connect Cable	03-10017	7.25
C12 Computer Cassette Interface 84 multiplexed Ram Card	21-00012	0.55
Z80A industrial controller	40-84000	59.95
EPROM Eraser 84T	40-82000	54.95
6502 Micro Controller	40-82001	59.95
6802 Micro Controller	40-65020	54.95
PB2720 80dB Piezo Buzzer	40-68020	54.95
10M15A 10.7 Center Freq.	43-27201	0.55
10M08AA 10.695 Center Freq.	20-10152	2.10
FC177 LCD (Freq.)	20-11152	3.49
CM161 LCD Clock	39-17700	20.00
8 x 0.3" IC socket	40-80161	8.25
14 x 0.3" IC socket	28-00800	0.12
16 x 0.3" IC socket	28-14000	0.13
6V KUIT-A Relay	28-16000	0.13
9V KUIT-A Relay	46-80000	0.48
12V KUIT-A Relay	46-80001	0.48
CX120P COAX Relay	46-80002	0.48
CX520D COAX Relay	46-90120	11.96
CX540D COAX Relay (BNC)	46-90520	26.98
	46-90540	26.98

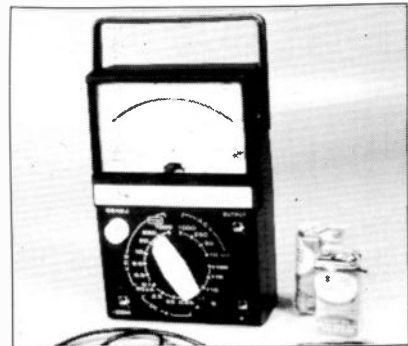

HT-320 Multimeter (20kΩ-V) 56-83201 14.00

Please add 15% VAT to all advertised prices and 60p post and packing. Minimum order value £5 please. We reserve the right to vary prices in accordance with market fluctuation.

Just send for our catalogue or visit one of our three outlets at:

200 North Service Road, Brentwood, Essex. CM14 4SG;  
53 Burrfields Road, Portsmouth, Hampshire. PO3 5EB;  
Park Lane, Broxbourne, Hertfordshire. EN10 7NQ.

To: Cirkit Holdings PLC, Park Lane, Broxbourne, Hertfordshire. EN10 7NQ.

I enclose 85p. Please send me your latest catalogue and 3 x £1 discount vouchers!

If you have any enquiries please telephone us on Hoddesdon (0992) 444111.

Name

Address

Telephone

Area of Special Interest

HRT 1/85

**Cirkit**  
Bigger Stock. Better Service.

NEW WINTER  
CATALOGUE  
OUT NOW!