

HAM

AN ARGUS SPECIALIST PUBLICATION

Morgen

July '84

RADIO TODAY

95p



This is
PY1ZFX/M...

PLUS

Single Channel
Transverter for
70cm

A Guide to
AMTOR



The Trio TS530SP – a good rig for the Common Man

WOOD & DOUGLAS

We are offering

Q.R.K.



in our new illustrated catalogue and price list.

Q.R.K.? Quality Radio Kit's of course, suitable for VHF, UHF, FM or Video techniques. If you can solder you can assemble our products. If they don't work first time apart from expressing surprise we will service and check your handiwork. We will also let you know where you went wrong.

INTERESTED? Then send an A5 stamped addressed envelope for your copy of this new product handbook. Our extensive range is held as stock whenever possible for immediate dispatch against you written or credit card order.

REMEMBER that apart from offering Q.R.K.'s we also service, back-up and believe in our products. TRY ONE

Unit 13
Youngs Industrial Estate
Aldermaston
Reading RG7 4PG
Tel: 07356 5324 Tx: 848 702



The Key Element

SSB clarity starts at the microphone...

Heil Sound, the company that pioneered proper audio equalization techniques for major performing groups and communicators, invites you to be part of one of the biggest advancements in Single Sideband transmission since the "Donald Duck" vs. AM days. If you are not satisfied with the "sound of your station" - it's no wonder - most "communications" microphones used today were designed for "public address" use, not for sophisticated SSB techniques.

No one microphone can be all things to Hams, so this new

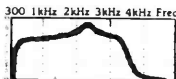

HC-3 element and HM-5 mic were developed *only* for maximum clarity on SSB transmissions. The response of this tiny ceramic element rolls off sharply under 350 Hz and above 3100 Hz with a peak at 2400 Hz for *high articulation* in the speech range. Hams who care about maximum results in getting over, around and through DX pile-ups now have another weapon in their arsenal... The Key Element! You can easily install this small, advanced HC-3 element, with its broad-range impedance-matching characteristics, into virtually any microphone case you own, or purchase the custom HM-5 with HC-3 installed.

All prices include VAT and Carriage, E. + OE. For further information, or to order the HC-3 cartridge element at £17.99, the HM-5 SSB microphone at £49.95 or the EQ-200 at £45.95 contact our Sole European Distributor, Amcomm Services Ltd., 194 Northolt Road, South Harrow, Middlesex or Telephone 01-422 9585.

"... Have not yet heard an FT-101 sound any better than when used with The Key Element..." - Paul, G5AWP

"... I now have a comfortable feeling that my audio is better than the rig was originally capable of..." - Ken, W9UBS

"... Thank you for the fine report, all reports to date have been excellent..." - Lee, W1SE

For those who desire the ultimate audio into and out of your transmitter/transceiver, consider the ideal combination of the Heil EQ 200 audio equalizer and HM-5 microphone.



Hearing Is Believing...

THE GAMMA TWIN

2 METRE FOLDED 1/2 WAVE ANTENNA

Copyright Gamma Aerial Products 1982



This antenna is based on the very popular and successful "SLIM JIM" design.

The GAMMA TWIN has the following unique features:

- ★ VERY LOW ANGLE OF RADIATION.
- ★ ADJUSTABLE RADIATOR. (140—150 MHz)
- ★ COMPLETELY WEATHERPROOF CONNECTING BOX
- ★ VERTICAL FIX DIRECTLY TO MAST



Available from your usual stockist or direct from the manufacturers

Gamma Aerial Products

MANUFACTURERS OF AMATEUR RADIO & CB ANTENNA

BALDS LANE, LYE, STOURBRIDGE
WEST MIDLANDS LYE 891132/891474
TRADE ENQUIRIES WELCOME

HAM RADIO TODAY CONTENTS

Acting Editor
Steve Ireland, G3ZZD
Consultant Editor
Dave Bradshaw

Advertisement Manager
David Gadsden, G4NXV
Classified Sales Executive
Debbie Miller

Managing Editor
Ron Harris
Chief Executive
T. J. Connell

VOLUME TWO NO.7 JULY '84

REGULAR COLUMNS

LETTERS	4
RADIO TODAY	6
RADIO TOMORROW	10
RADIO YESTERDAY	32
PRACTICALITIES	58

CONSTRUCTION

A SINGLE-CHANNEL TRANSVERTER FOR 70cm	21
<i>Hugh Allison, G3XSE, describes a cheap and crafty way of getting on the band</i>	
PLAIN MAN'S GUIDE TO 6m RECEPTION	47
<i>Step-by-step construction of a 6m converter with Jack Hum, G5UM</i>	

FEATURES

ANTENNA PLANNING	13
<i>Worried about the legalities? Steve Voy tells all</i>	
A GUIDE TO AMTOR	23
<i>Resident keyboard man, Ken Michaelson, G3RDG, tells how to do it</i>	
EARTH-MOON-EARTH WORKING – SIMPLY	27
<i>In part III, Charles Suckling, G3WGD, describes EME operating procedures</i>	
THIS IS PY1ZFX MOBILE	43
<i>Travel across South America with Roger Crofts, G3UPK, and Mary Carpenter</i>	
RADIO BUILDING BLOCKS	55
<i>Frank Ogden, G4JST, gets stuck into FM, in particular IF strips</i>	

REVIEWS

YAESU FT203R 2m HANDHELD TRANSCEIVER	18
<i>Steve Ireland, G3ZZD, investigates the latest fist-full of 2m</i>	
TRIO TS530SP HF TRANSCEIVER	36
<i>Eminently practical thought Angus McKenzie, G3OSS, and HRT</i>	
ADDENDUM	42
NEXT MONTH IN HRT	42
AD INDEX	59
Free Readers' Ads	60
Emporium	63
Classified	65

Published by:

Argus Specialist Publications Ltd.,
1, Golden Square,
London W1R 3AB.
Telephone: 01-437 0626

Distributed by:

SM Distribution Ltd.

Printed by:

The Garden City Press Ltd.

Subscription Rate:

UK £14.00
O/Seas Sur: £14.45
O/Seas Air: £27.00
Ham Radio Today,
Subscriptions Dept,
Infonet Ltd,
Times House,
179 The Marlowes,
Hemel Hempstead,
Herts HP1 1BB
Tel: (0442) 48432

ABC

Ham Radio Today is normally published on the first Friday in the month preceding cover date. The contents of this publication including all articles, designs, plans, drawings and programs and all copyright and other intellectual property rights therein belong to Argus Specialist Publications Limited. All rights conferred by the Law of Copyright and other intellectual property rights and by virtue of international copyright conventions are specifically reserved to Argus Specialist Publications Limited and any reproduction requires the prior written consent of the Company. © 1983 Argus Specialist Publications Ltd. All reasonable care is taken in the preparation of the magazine contents, but the publishers cannot be held legally responsible for errors. Where mistakes do occur, a correction will normally be published as soon as possible afterwards. All prices and data contained in advertisements are accepted by us in good faith as correct at time of going to press. Neither the advertisers nor the publishers can be held responsible, however, for any variation affecting price or availability which may occur after the publication has closed for press.

LETTERS

COMPONENT SHORTAGES

Sir, I am an avid homebrewer and take your magazine in part for the excellent construction articles. There is a positive approach in your magazine to encourage homebrewers. However, it should be brought to the notice of prospective builders of the availability of the parts required. My recent experiences certainly damp the enthusiasm to build. The latest project had a "out of stock" label to over half the parts required. The previous project held for six weeks pending supply of parts.

To the already high price of components is added not one lot of postal charges but possible two or three. To the suppliers who can boast adequate stocks and quick replenishment will go success and the others will drop out eventually.

My latest order has been sent labelled "All parts are required. If only PART available, CANCEL (this order).

George Clarkson, G3RHM

Obtaining components for radio projects has never been easy and has certainly got progressively more difficult in recent years. In general, components for projects in HRT can be obtained from Maplin, Ambit and Bi-pak — large suppliers with a substantial turnover — without too much difficulty. However the component business is not the most profitable of businesses and as you are probably aware, profitably is all in the present economic/political climate. . .

In order to circumvent this problem HRT tries to publish designs for which a kit of parts is available. When you count up the aggro, accumulated postal charges etc, the mark up on kits seems pretty reasonable — especially when the kit supplier has to cope with this aggro too!

FT102 PROBLEMS?

Sir, The reason for this letter is so that perhaps somewhere in your publication you could advise owners of FT102 Transceivers who may be experiencing the same as with my new purchase, namely poor selectivity, overloading and poor signal-to-noise level on all bands. Returning the equipment to the import agent has not been successful in clearing the fault. I have finally found

the fault myself and wish others to benefit from my experience.

If you are having the above symptoms, take a look at the IF PCB and alongside Test Point 10 which is on the output from T09 and feeds into the Gate of Q2010. Check if R84, a 100K resistor has been installed. R84 will be written on the topside of the board. R84 had been left out in my receiver; installation (of this) will cure the overloading, improve selectivity and signal-to-noise ratio.

The above is not an isolated instance as this seems to be common in the batch of transceivers between 2M071000 and 2M071100.

C.H. Castle, VK5KL

934 MHz CB

Sir, I am pleased to inform you that The 934 MHz Club UK has now been formed. We have a strong steering committee who have already met several times.

We are, of course, aware that it is virtually impossible for us to contact everyone using the band without the assistance of publications such as yourselves. I would therefore be grateful if you would publish details of the Club in your Magazine. Should any of your readers be interested in the Club or the

band generally they can contact me at The 934 MHz Club UK, PO Box 424, Chelmsford, Essex CM6 3UR.

We have received an excellent response from the initial mailing and new applications for memberships arrive every day. The Club now has a membership of over one hundred.

The QSL Bureau referred to in the initial letter is now operating successfully. We have a reliable QSL Manager who will ensure that QSL's received are forwarded to the members.

Lastly may I thank you in advance for any support that your Magazine will give to the Club.

Mrs Glenys Anthony, Secretary

NOT STAND-OFFISH

Sir, As a fairly new licensee may I make a few comments about Tom Wylies' (GM4FDM) letter in May HRT ("Where have all the Class B Licences gone"?)

First of all, up until I let my licence run out, I was quite happy to talk to anyone who happened to give out a general CQ call.

When I first appeared I was given every help and assistance and have made many new friends. Hopefully I will be able to make some more among the G1s who are appearing.

My temporary absence from the bands is due to my attempt at the morse test and the fact that I didn't want to pay

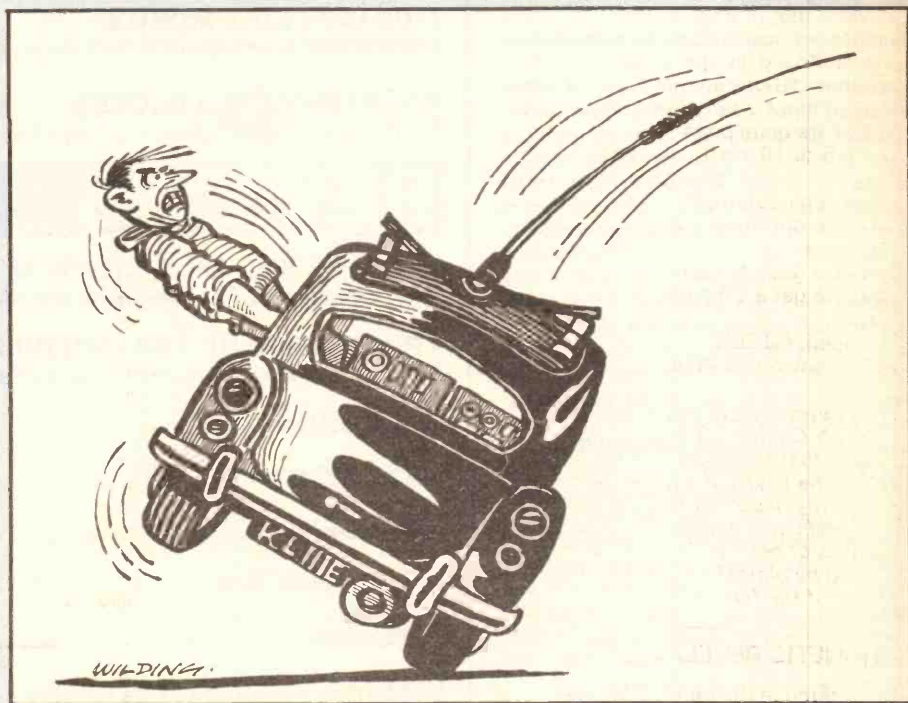

£12 twice (once to renew the VHF licence and another £12 for the HF when I finally pass the morse).

In doing the morse I do not want to 'escape' two metres nor do I want to attain the 'real standard', but at least when I have the HF licence I can use any mode on any band. I shall have to go back to 2m/70cm as that is all I have at the moment (I have an FT290R and a Pye Westminster).

As regards repeaters, there are several very good ones in my area and as I also do a lot of driving I tend to listen to one of them for ease of operating. This has meant that a) people know how to get hold of me, and b) there is someone to talk to the new G1s when no one else is around.

D. J. Ackrill, ex-G6 VMQ

PS I am looking forward to getting back on the bands with a new callsign.

Glad to hear that you will soon be back on 2m/70cm. Recently I had contact with a new G1 on 2m SSB who complained of an absence of replies to his CQ calls despite a fairly active band. He had a good signal with me despite his relative distance. Let me re-iterate Tom Wylie's plea: c'mon lads and lasses, when you hear a new callsign give them a call. Make friends, don't just monitor.

NOVICE LICENCE

Sir, I should be grateful if you would publish this letter. I realise that you will be inundated by replies but I believe that people like Mr Compton should be put right for once and all.

In reference to Mr Compton's letter, published in HRT May issue: obviously Mr Compton is sorely deluded if he thinks that the amateur radio fraternity needs a novice licence. Our hobby has prospered for years without a novice licence and it will continue to do so, provided people like Mr Compton are not let loose on our bands.

Mr Compton's idea does not stretch beyond that of a typical "CB-er". The novice licence suggested is just an excuse to legalise pirate SSB. The recommendations are pathetic. 250 watts max at night is very QRO, considering QSOs are quite possible world-wide using 5 or 10 watts. Besides, how many people will operate after 1 am — is Mr Compton nocturnal?

If Mr Compton does not like 27 MHz CB, we suggest he uses 93.4 MHz and leaves amateur radio alone because he is not going to get a CB paradise through our hobby.

P. Juden, G6 ZBN

P. Williamson G4 WUU

I have very little to add to my remarks after Mr Compton's letter in May HRT except that I think he is being hopeful rather than cynical. I would also like to repeat my assertion that the RAE tests the candidates application to radio rather than his or her intelligence and may be passed by almost any candidate with plenty of the former.

PHONETIC REVELATIONS

Sir, reference the item on Phonetics by



George Metcalfe, G6 VS (Letters, April '84 HRT).

He states it was not until 1938 that a full phonetic alphabet was introduced for Service Use. This is incorrect.

I am ex-army AIS County Regiment (Royal Signals trained). We were teaching full alphabet phonetics in 1929/30/31 etc.

These were:

Ack	Nuts
Beer	Orange
Charlie	Pip
Don	Queen
Edward	Robert
Freddie	Sugar
George	Toc
Harry	Uncle
Ink	Victor
Johnny	Willie
King	X-ray
London	Yorker
Monkey	Zebra

These come much easier to the mind than the present day ones.

Retired these days, but still playing with CB

Sir, With reference to previous correspondence on Phonetics I enclose a

copy of relevant sections of the Signal Training (All Arms) 1928 manual.

Referring to paragraph 6 ("To obtain uniformity by users of military telephones a card is affixed to every field telephone with the complete phonetic alphabet on it."), the card had, some time before 1938, been replaced with a black metal plate with the full phonetics embossed on it.

One explanation is that there may have been two training manuals, one, as quoted by the Curator of the R. Signals Museum, in G6 VS's letter, and the other as mentioned above, as issued to the Field units of the rest of the British Army.

The Royal Corps of Signals were rather more specialized than the rest and did not introduce the full phonetics until 1938 by which time it's usefulness had been assessed by Regimental Signallers. **M. Hughes, GW3 VFZ**

The phonetic alphabet in the manual quoted is the same as the alphabet above.

Please address correspondence to:
Ham Radio Today,
1, Golden Square,
LONDON W1R 3AB.

RADIO TODAY

Stop Press!

The winner of the Draw for all those who wisely bought subscriptions to HRT from our stand at the RSGB Amateur Radio Convention was Mr BL Chesworth of Wrexham, Clwyd. Mr Chesworth wins a 7 element 2m yagi kindly donated by MET antennas and the CQ Centre.

Interested in Microwaves?...

The MICROWAVE SOCIETY looks after the interests of all those operating on, or interested in, frequencies above 10 GHz.

Their well known DATAPACK (which includes all you need to know to build a complete system for under £40) has now been completely revised and is now in its 5th edition.

The societies newsletter "WAVEGUIDE" keeps member up to date with society affairs and also includes updates for the DATAPACK. This year sees the start of the societies awards and certificates scheme for achievements on the frequencies above 10 GHz. Some indication of the growth of interest in microwaves is the fact that nearly 200 new members joined the society during 1983.

The society looks forward to meeting as many microwave enthusiasts as possible on its stand at the NEC rally and at the large number of club talks undertaken in the course of the year. Full details from The Microwave Society, 81 Ringwood Highway, COVENTRY CV2 2GT.

Letter From America

In a recent editorial, Wayne Green, publisher of 73 magazine, claimed that the increase in American amateur radio licences over 1983 was 2.6% — which contrasts somewhat markedly

with the UK increase of 20%. Although the US have no equivalent to our Class B licence, they do have a novice licence (CW only), for which the annual growth was 9.4%, and their General class, very similar to our Class A in terms of structure, was down by 0.7%, according to Wayne. The crossover from CB to Amateur Radio is undoubtedly responsible for the large percentage increase in this country. Some RAE Instructor friends of the Editor report a small percentage decrease in the popularity of Examination classes for the first time in the last few years. Could the boom perhaps have reached its peak...

Wayne has also recently proposed to the FCC, American equivalent of the DTI, a change to the licence conditions whereby biennial re-testing of the radio amateurs' proficiency in Morse becomes mandatory. He has also proposed that amateurs be required to demonstrate a 5wpm increase in their morse ability to an ultimate figure of 35wpm at the end of each two year period. Amateurs failing the test would be given a period of 60 days to demonstrate the required rate or lose their licence!

Arrow Hit The Target!

It has probably not escaped the notice of HRT readers that Arrow Electronics

Dave Gadsden, G4NXV, at Arrow



have recently moved from their old premises in Brentwood to a rather nice showroom in 5 The Street, Hatfield Peverel, near Chelmsford. A crowd of around 50 enthusiastic amateurs, including HRT's Dave Gadsden, G4NXV, attended the Trade/Press Party on 30th March. The Editor was unable to attend owing to an importune attack of influenza, missing quite a good shindig... Dave was so enthusiastic that he actually made the first purchase, a 5/8 whip...

Arrow received flowers, homemade cakes and wine and many good wishes from their regulars and would like to extend a very big thank you for their support. Peter Clarke, G3LST, of Arrow reports over 500 customers on the first day at Hatfield Peverel!

BARTG Go DATACOM

The British Amateur Radio Teleprinter Group (BARTG) recently launched their new quarterly magazine called DATACOM. This replaces the BARTG Newsletter, and is sent free of charge to all members of the Group.

DATACOM is dedicated to all forms of data communication by conventional teleprinter and by computer, including RTTY, AMTOR, Packet Radio, FAX and so on. The first issue of DATACOM, dated Spring 1984, is 116 pages long, and is apparently the largest publication ever produced by BARTG. It contains a large number of technical articles of interest to teleprinter and computer enthusiasts, plus a number of special interest columns on emergency communication, FAX, clubs, etc.

There is a special feature on Packet Radio, with a tutorial article on the principles of Packet Radio for beginners, plus full details of a Packet Radio experiment being carried out in Cambridge, using BBC microcomputers. There is also a full-length article describing GB3PT, the RTTY repeater at Cambridge, with information on how to use it and details of plans for upgrading it to ASCII operation.

For full membership details, please contact Mr. John Beedie, G6MOK, 161 Tudor Road, Hayes, Middlesex UB3 2QG. (01-561 0010).

Amateur Radio And CB In Harmony

A group of radio amateurs and keen CB operators will be taking to the Sutherland Hills on the 2nd and 3rd of June 1984 in aid of the Highland Scanner Appeal. The amateur radio group

will be operating on the 20, 40, and 80 metre bands SSB/CW and also on 144.550MHz SSB. The CB STATION will be using 4 watts FM and hoping to work many CB enthusiasts far and wide. The Amateur Radio call sign will hopefully be GB2DOS (which stands for DUKE OF SUTHERLAND) and the location will be on the summit of Beinn A'Bhragaidh (XR10B) 1293 feet ASL and 1 1/2 miles North West of Golspie. "CB YL'S and XYL'S will be providing the Scottish Fare to keep 'the spirits high' during the two day event, as the 'Mountain Haggis' is out of season at this time of year!!" says the press release. Special QSL cards will be sent from both CB and Amateur Radio Stations.

New UHF GaAs FET

The new Mitsubishi low noise GaAs FET type MGF 1404 is now available from Aspen Electronics. This is a super low noise GaAs FET with a N-channel schottky gate which is designed for use in S to Ku band amplifiers. The hermetically sealed metal ceramic package "assures minimum parasitic losses and has a configuration suitable for microstrip circuits." Features include typical high maximum frequency of oscillation of 90 GHz; noise figure of 1.6 dB at 12 GHz; and a gain of 10.5 dB at 12 GHz.

Repeater Update — 29 MHz Repeaters?

There seems to be a growing interest in the possibility of 29MHz FM repeaters. There are presently six proposals with the Repeater Management Group; for Leicester, Daventry, London, Barnsley, Cornwall and Blackburn. The Leicester Group have recently drafted a complete technical specification for a repeater which is awaiting agreement from the HF committee.

A recent meeting was held to form a new repeater group for GB3NN (RB2), located 3 Km south of Wells Next The Sea in Norfolk (AM095F). Site approval and a franchise has been received, also licencing procedures are in progress within the DTI, and it is hoped to have the repeater operational at its new site by June/July 84. The repeater is a Pye 460 UHF unit converted to 70cm repeater use, the aeriels are 4 stacked J poles for Rx and 4 stacked dipoles for Tx, the site is 77 Mts ASL, with aeriels at 25m high and an ERP of 12 watts.

Donations from any prospective users of GB3NN would be gratefully ac-

cepted by the keeper, Bill Tuck G8KZP, "Whalebone Cottage", Wells Next The Sea, Norfolk, NR12 1EN, or the treasure Malcolm E. Amis G4VDC, "Arcantell", 5, Waveney Close, Wells Next The Sea, Norfolk, NR12 1HU.

The repeater support group of GB3BP have asked permission to change the callsign to GB3WS (West Sussex?) and this has apparently been approved. Some difficulties with the relocation of the long licensed GB3AE (Skipton, Yorks R5) has meant that it has not been operational.

The South West Hertfordshire UHF Group are responsible for providing and maintaining three UHF/SHF stations in this area. GB3HR is their 70cms FM Repeater Station located at Stanmore. This station was originally sited at Bushey Heath, however, due to financial and coverage problems, the new site at Stanmore was selected which gives a worthwhile advantage on both accounts. Regrettably they have found a couple of gremlins at the new site, which, up until recently, has meant reduced transmitter output power and reduced receiver performance. The transmitting aerial fault has now been rectified and users report good coverage to mobiles over the areas of St. Albans, Edgware, Harrow and Watford. They hope to have the receiver problem cured within the next month. GB3HR can be found on 70cms FM channel RB14 (433.350 MHz TX, 434.950 MHz RX). GB3SWH is SWH's 10 GHz (3cms) Beacon Station located at Bushey Heath. The device is horizontally polarised and provides a good source for checking propagation

Miss Yuka Nukina and Mr Hiroshi Shioguchi of Radio Japan, announcers of the 'DX Corner' programme



and alignment of 3 cms equipment. The station operates on 10.368 GHz with facilities for both wide and narrow band users, and is regularly heard in Suffolk and Hampshire. GB3BH is the proposed 1.3 GHz (23cms) FM Beacon/Repeater station, presently being constructed by members, to be located at Bushey Heath. This station is unusual as it will act both as a Beacon, and as a Repeater Station. Frequencies will be 1297.0 MHz TX and 1291.0 MHz RX. Horizontal polarisation will be used.

Contributions are always welcomed by the Group to pay for site rental and electricity charges and should be sent to Mr. Brian Greenaway G3THQ at 5 Lansdowne Grove, London NW10 1PL. Reception reports are also very welcome and should be sent to the Secretary, Mr. Trevor Groves G4KUJ, 62 The Crescent, Abbots Langley, Watford, WD5 ODS.

Members of the Group are available to Clubs for talks and demonstrations, for further information please contact the Secretary as above.

Radio Japan Expands Service To Europe

HRT's broadcast enthusiasts may be interested to hear that Radio Japan has expanded its overseas service to Europe and the Middle East by starting relay broadcasts on the 2nd April, from a high-powered transmitting station in Africa. The new relay broadcast will

provide listeners with greatly improved clarity of reception.

Listeners in these areas have so far found it difficult to receive clear broadcasts direct from Japan. Since October 1979, Radio Japan has been relaying broadcasts to Europe and the Middle East for one hour daily from Radio Trans-Europe in Sines, Portugal. Now from the Moyabi station in Gabon, West Africa, Radio Japan is offering relayed broadcasts on a 500 kw transmitter for six hours a day in English, Japanese, German, French, Italian, Swedish and Russian. The programmes are being sent from Tokyo via the Intelsat communication satellites over the Indian and the Atlantic Ocean.

The time schedule and frequencies of relay broadcast from Moyabi in English are as follows: *General Service* 0700-1800 GMT (English) 21.575 MHz, 1500-1600 GMT (English) 21.550 kHz. New regular features include: Science Today; reports on progress in science, medicine and high technology in Japan; and DX Corner; facts and news for short wave buffs on DX broadcasts around the world.

QTI Talking Newspaper

QTI Talking Newspaper for blind and partially sighted *radio amateurs* has been granted full charity status by the Charity Commission, (No. 326454). Donations and offers of financial support may be directed to: Mr. J. Feeley (G4MRB), Chairman QTITNA, 79 Narrow Lane, North Anston, Sheffield S31 7BJ. or Contact Dawn Tel: 0909 566301 between 10.00 am to 4.00 pm. Monday to Thursday.

Radio Amateur Micro User Group (RAMUG)

A new group has recently been formed for, as the heading shows, radio amateurs who use their microcomputers within the hobby. It is primarily for owners of the BBC MICRO, although other types of computer may be supported if demand is apparent.

They intend to hold meetings on a bi-monthly basis in East London but will unfortunately *Not* be running a 'Postal Club' as RAMUG feel that more can be achieved by practical use and demonstrations of various peripherals, hardware, software and also discussions 'on the air'. RAMUG propose to have a 'net' on 145.200 MHz (S8) on Friday evenings at 1930 hours local time.



Reg, G6XO, with the winning entry of the Chesham DARS Construction Contest, a 20/80m Trx by G4IWS

The first meeting and election of committee was held on March 20th, 1984 and was well supported.

Meetings are to be held at The Design Block, Eastlea School, Hilda Road, Canning Town, London E16 and will commence at 1930 hours until 2130 hours. The dates for future meetings in 1984 are: Tuesday, 8th May; Tuesday, 10th July; Tuesday, 11th September and Tuesday, 6th November.

On May 8th RAMUG will have a talk and demonstration of 'Radio Teletype (RTTY)' by Chris Fogarty (G4KBL) and on July 10th a demonstration and chat about 'Database and Log. Keeping in Amateur Radio' by John Hopkins (G60VL) and Rob Webb (G4KCS).

The cost of membership of the group will be £2.00 per annum and all enquiries should be sent, enclosing a stamped, addressed envelope to: The Secretary, RAMUG, c/o R.A. Webb, 39, Aldworth Road, Stratford, London E15 4DN.

Icom Microphone Matching

One of the problems radio amateurs have experienced with the latest Icom series of transceivers is the difficulty of using microphones other than those supplied by Icom. The reason for this is that all Icom microphones have small amplifiers built into the microphone housing and thus the input sensitivity of the transceiver is too low for normal microphone outputs.

A company represented in the UK

by Walters and Stanton, Adonis, have just announced their accessory AP-1 to overcome this problem. This is an 8 pin microphone plug fitted with an amplifier and drawing power from the existing DC point on the Icom 8 pin microphone transceiver socket. All that is necessary is to wire this plug onto any current microphone, thus enabling it to be used with all modern Icom transceivers. The price of this unit is £10.95 and they may be ordered direct from Waters and Stanton at 18/20 Main Road, Hockley, Essex SS5 4QS.

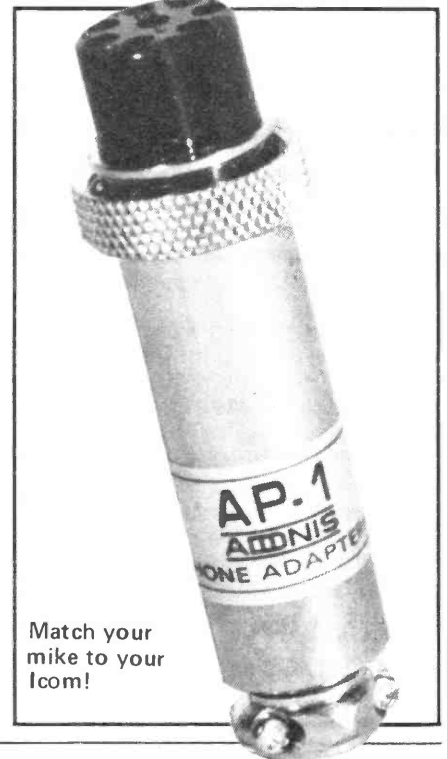

Match your mike to your Icom!

BI-PAK BARGAINS

MINIATURE TOOLS FOR HOBBYISTS

 Miniature round nose side cutters - insulated handles 4 1/2 inch length. Order No: Y043.

 Miniature long nose pliers - insulated handles 5 1/2 inch length. Order No: Y044.

 Miniature bend nose pliers - insulated handles 5 1/2 inch length. Order No: Y045.

 Miniature end nippers - insulated handles 4 1/2 inch length. Order No: Y046.

 Miniature snipe nose pliers with side cutter and serrated jaws - insulated handles 5 1/2 inch length. Order No: Y042.

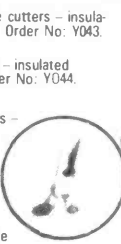

FLEXEY DRIVER

A flexible shaft screwdriver for those awkward to get at screws. Overall length 8 1/2 inch. Order No: FS-1 Flat blade 4mm FS-2 Cross point no. 1 £1.75 each.

GRIP-DRIVER

8 1/2 inch long screwdriver with spring loaded grip on end to hold screws in position while reaching into those difficult places. Order No: SD-1 Flat blade 4mm SD-2 Cross point no.0. £95p each.

ALL AT £1.25 each

13 PIECE TOOL KIT AND CASE

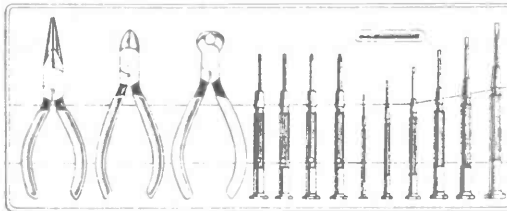

13-piece tool set housed in attractive moulded plastic case with clear sliding cover.
 • 1 off 5" snipe nose "radio" pliers with side cutters
 • 1 off 4 1/2" side cutters
 • 1 off 4 1/2" end cutters
 • 2 off hex "Allen" key drivers 2mm and 2.5mm
 • 2 off cross-point "Phillips" drivers No. 0 and No. 1 (with tommy bar)
 • 6 off precision screwdrivers. Sizes from 1mm to 3.5mm

ONLY £7.50 ORDER No. VP102

PRECISION JEWELLERS' TOOLS

Rustproof, Tempered Handles and Blades. Chrome Plated Handles. Swivel Heads for use on Precision Work.

5T21 SCREWDRIVER SET

6 precision screwdrivers in hinged plastic case. Sizes - 0.8, 1.4, 2, 2.4, 2.9 and 3.8mm £1.75

5T31 NUT DRIVER SET

5 precision nut drivers in hinged plastic case. With turning rod. Sizes - 3, 3.5, 4, 4.5 and 5mm £1.75

5T41 TOOL SET

5 precision instruments in hinged plastic case. Crosspoint (Phillips) screwdrivers - H0 and H1 Hex key wrenches. Sizes - 1.5, 2 and 2.5mm £1.75

5T51 WRENCH SET

5 precision wrenches in hinged plastic case. Sizes - 4, 4.5, 5, 5.5 and 6mm £1.75

MULTITESTER

1,000 opv including test leads & Battery

AC volts - 0-15-150-500-1,000

DC volts - 0-15-150-500-1,000

DC currents - 0-1ma-150ma

Resistance - 0-25 K ohms 100 K ohms

DC Voltage 0-200mV

0-2-20-200-1000V. Acc. 0.8%

AC Voltage 0-200-1000V

Acc. 1.2% DC Current 0-200uA

0-2-20-200mA, 0-10A. Acc. 1.2%

Resistance 0-2-20-200K ohms

0-2 Megohms. Acc. 1%

BI-PAK VERY LOWEST PRICE

£45.00 each

Leather Case for 188m £2.50 EACH

O/No. 1322 OUR PRICE £6.50 ONLY

SPEAKER PROTECTOR

Limits voltage to speaker or to the permissible max., by automatically introducing a resistor in series with speakers. When excessive voltage is reduced the unit resets itself. Electronic voltage-sensing relay circuit. Spring terminals. Cut-off level adjustable from 10W-120W. Full instructions included. Dims: 85 x 74 x 25mm. O/No. VP 118 £9.95



ANTENNA SWITCH 2 and 3 WAY

Co-axial switch for one transceiver to two antennae or one antenna to two transceivers. Dims: 86 x 55 x 32mm (Body). O/No. VP 113 £4.50

As above but 3-way. O/No. VP 114 £4.75

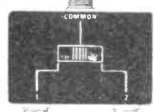

HIGH PASS FILTER/SUPPRESSOR

CB/TV. High pass filter. Reduces unwanted signals picked up by antenna. Dims: 45 x 25 x 17mm O/No. VP 115 45p

LOW PASS FILTER

Designed to reduce harmonics on the VHS and TV band. Cut-off frequency: 30MHz. V.S.W.R.: Less than 1.2 to 1. Insertion loss: -0.2dB @ 27MHz. Impedance: 50 ohms. Dims: 80 x 55 x 40mm O/No. VP116 £2.75



DC-DC POWER SUPPLY

DC to DC adaptor. Plugs into car cigar lighter aperture. Output 3, 4.5, 6, 7.5, 9, 12V @ 800mA. Has universal output spider plug, also 9V battery snap and polarity reversing facility. O/No. VP 119 £2.45

SIGNAL INJECTOR

Simple push button operation. Oscillates at 700 - 1k Hz with harmonics to 30MHz. 1.4V p/p output. Impedance 10kΩ. Ideal for trouble shooting with audio equipment. One "AA" penlight battery supplied. O/No VP96 £2.50

LOGIC PROBE

Automatic levelling. White LED indication. Minimum width of measuring pulse 30 milliseconds. Maximum input frequency 10M Hz. Input impedance: 100kΩ. Power consumption: 40mA maximum. Power supply: 4.5 - 18 V d.c. ORDER No. VP97 £10.50

CURRENT/POL CHECKER

Heavy duty test prods with built-in indicators for testing polarity; indicates whether a.c. or d.c. 3.5V to 400V. O/No. VP98 £2.50

TESTER

Universal tester with ceramic buzzer. Tests diodes, transistors, resistors, capacitors and continuity. One "AA" penlight battery included. Test current: Max 2μA. Test voltage: 12V. Response range: 100MΩ. Max voltage: 500V. Internal resistance: 390kΩ. Length: 135mm. O/No. VP99 £5.00

CIRCUIT TESTER

D.C. continuity tester for circuit checking on all low voltage equipment and components. Diode checking also possible. Takes two AA batteries. 90cm lead has crocodile clip. Body length 145mm. O/No. VP100 75p

ELECTRONIC SIREN 12v DC

Red plastic case with adjustable fixing bracket. Emits high-pitched wailing note of varying pitch - 100 cycles per minute. Dims: 90mm (dia) 60mm (depth). Power - 12v DC. O/P 90dBA 1m type. Our Price: £5.50 O/No. VP79

TAPE RECORDER SWITCH

Unit to control motor of tape recorder. 1.8m cord and 2.5mm plug attached. On/Off switch. Dims: 55 x 20 x 20mm. O/No. VP 127 £1.00

POWER SUPPLY OUR PRICE £4.25

Power supply fits directly into 13 amp socket. Fused for safety. Polarity reversing socket. Voltage switch. Lead with multi plug. Input - 240V AC 50Hz. Output - 3, 4, 5, 6, 7.5, 9 & 12V DC Rating - 300 ma VP109.

RATCHET SCREWDRIVER KIT

Comprises 2 standard screwdriver blades 5 & 7mm size. 2 cross point size 4 & 6. 1 Ratchet handle. 5-in-1 Kit. £1.45 each. O/No 329B

ELECT & PIEZO BUZZERS

PIEZO
Miniature round piezo-electronic buzzer. White plastic. Low consumption. Frequency: 4kHz approx. Output: 70dB (A) @ 1. typ. Power: 120mW @ 4mA. Dims: 22 (dia) x 11.5mm. Fixing Centres: 26.5mm. O/No. VP 107 95p

PIEZO
Piezo buzzer White plastic 50mm leads. For use on a.c. mains. Frequency: 3.5kHz approx. Output: 85dB (A) @ 1m typ. Power: 240V a.c. 5mA. Dims: 32 (dia) x 14mm. Fixing centres: 38mm. O/No. VP 108 £1.15

ELECTRONIC
Miniature electronic buzzers. Solid state. Ivory plastic. 150 leads. Frequency: 500 Hz approx. Dims: 22 x 16 x 15mm. Output: 82dB (A) @ 1m typ. Fixing centres: 26mm. 3V 25mA. O/No. VP 82 80p each. 6V 25mA. VP 83 12V 25mA. VP 86

SUB-BOX
A neat swivelling disc provides close tolerance substitution resistors of 36 preferred values from 50ohms to 10kohm. Simply fix clips into circuit and swivel until optimum result is achieved. O/No. VP 112 £4.75

MINIATURE VICE
Miniature plastic and metal vice with strong suction base for portability. Single action to secure or release suction. Plastic jaws with rubber pads 20mm wide, open out to 40mm. Dims: 85 x 65 x 60mm approx. FANTASY VALUE O/No. VP 95 ONLY £1.60

LEARN A LINGO! PILLow SPEAKER
Slim under pillow unit. 80hms 2" speaker. 1.5m lead with 3.5mm mono jack plug. Black. Dims: 65 (dia) x 17mm. O/No. VP 88 £1.25

METRIC & BRITISH MEASURES
Steel tapes in sturdy ABS plastic case. Silk wrist strap. These yellow coated convex tapes have inch and metric gradations. Automatic push-button return. 2m long x 13mm wide O/No. VP 89 £1.00. 3m long x 13mm wide O/No. VP 90 £1.50. 5m long x 16mm wide O/No. VP 91 £2.00

BATTERY TESTER
Tests all types of battery including standard NICAD Alkaline etc. Takes all standard sizes including 6V lantern batteries and 8V lantern and cells. Also tests fuses and lamps by means of internal 9V (PP3) battery. Can also be used to recharge NICAD batteries by means of external 3-12V d.c. power supply (not included). Full instructions provided. Dims: 185 x 103 x 30mm. O/No. VP 101 £7.00 (approx.)

FM MONITOR
FM monitor for 2 metre band. All metal. Attached earphone. PL259/SQ23 connectors. 144MHz. 10W maximum. Dims: (Body) 55 x 30 x 23mm. O/No. VP 120 £4.20

DUMMY LOAD
50 ohms 30W UHF co-axial plug fitting (PL259). O/No. VP 121 £5.20

PICK-UP COIL
Large telephone pick-up coil for high sensitivity. Suction pad to stick to telephone. 90cm lead to 3.5 jack plug. Connects direct to cassette recorder. Dims: 32 (dia) x 17mm (body) 36mm (dia) sucker. O/No. VP 87 £1.00

BI-PAK

Send your orders to Dept HRT7 BI-PAK PO BOX 6 WARE, HERTS SHOP AT 3 BALDOCK ST. WARE, HERTS. TERMS CASH WITH ORDER, SAME DAY DESPATCH, ACCESS, BARCLAYCARD ALSO ACCEPTED. TEL (0920) 3182, GIRO 388 7006 ADD 15% VAT AND 75p PER ORDER POSTAGE AND PACKING



Use your credit card. Ring us on Ware 3182 NOW and get your order even faster. Goods normally sent 2nd Class Mail. Remember you must add VAT at 15% to your Total order. Postage add 75p per Total order.

RADIO Tomorrow

Your at-a-glance to what's happening around the clubs, on-the-air and in general radio-wise.

1 Jun	West Kent ARS: Junk Sale Axe Vale ARC: <i>The Entertaining Electron</i> S. Manchester RC: <i>Modifications to the FT221R</i> by G4MYB Cambridge DARC: Junk Sale at Comberton Village Hall Sutton and Cheam DRS: <i>Receiver Measurements</i> (t.b.c.)	12 Jun	Mid-Warwickshire ARS: Fox Hunt and Barbeque Wakefield DRC now meet at Ossett Community Centre, Prospect Road. Tonight is an 'informal'.
2-3 Jun	HF NATIONAL FIELD DAY Welsh Amateur Radio Rally at Barry Leisure Centre, Greenwood Street, Barry, South Glamorgan. Trade stands, Bring and Buy, refreshments, bar and a swimming pool! Close to Barry Island Pleasure Park. Free Parking. Talk-in S22. Open 11-5pm. Info Reg Rowles 0222 565656 RSGB 70MHz Contest and SWL	13 Jun	S. Bristol ARC: Preparations for Longleat Rally Fareham DARC: On-air/natter night Farnborough (Hants) DRS: <i>Racal Equipment</i> by G3VCX Nene Valley RC: <i>RTTY and AMTOR</i> by G3NRW
4 Jun	Hornean DRC: <i>Matching Units</i> by G3GVC Leighton Linsdale RC: Quiz with Aylesbury Vale and Milton Keynes DRS Stourbridge ARS: ring PRO for details Dudley ARC: Natter Night	14 Jun	Edgeware DARS: <i>Electronic Music</i> by G4BZY Conwy Valley ARC: AGM at Green Lawns Hotel
5 Jun	Fylde ARS: Top Band Fox Hunting Arrangements Chichester DARC: ring PRO	15 Jun	S. Manchester RC: <i>160m DFing Today</i> by G3WFT Cambridge DARC: ring PRO for details Sutton and Cheam RS: <i>Maritime Radio</i> (t.b.c.) Harrow RS: Informal
6 Jun	Wolverhampton ARS: Junk Sale Three Counties ARC: <i>Gold and Silversmiths</i> S. Bristol ARC: Radio Interference Service Fareham DARC: Discussion on PSUs Wirral DARC: D & W at The Bassett Hound, Thingwall Nene Valley RC: Natter Nite	17 Jun	RNARS Mobile Rally at HMS Mercury, near Petersfield, Hants. Events for the whole family! Food. Talk-in on 2m and 70cm. GB4CSW at Casteldon School Fete, Bromfords Drive, Essex. Special QSL cards, operation on HF and 2m — and all the usual fete stands! Fylde RS: Top Band Fox Hunt Wirral DARC: DF Hunt Denby Dale Mobile Rally at Shelley School, Skelmanthorpe, Near Huddersfield. Opens 11am. Free parking and admission. Trade Stands, refreshments, bar plus family entertainment. Talk-in S22 and SU8. Details Jack Clegg 0484 862390
7 Jun	Three Counties ARC: ring PRO for details Preston ARS: Annual Quiz with G4DBU S. Manchester RC: Club Quiz Dunstable Downs RC: Summer Barbeque at Old Warden Medway ARTS: Junk Sale Cambridge DARC: Informal and Morse Class Southgate ARC: <i>Receiver Techniques</i> by G4AEZ Haverhill DARS: Talk on Radio 'Fox Hunts'	18 Jun	Leighton Linsdale RC: <i>Packet Radio</i> by G4ELA Stourbridge ARS: ring PRO for details Todmorden DARS: <i>Amateur Satellites</i> by G8UVE
9 Jun	Harrow RS: Constructing Antennas	19 Jun	Biggin Hill ARS: Junk Sale Fylde RS: Top Band Fox Hunt Post Mortem Halifax DARS: Surplus Equipment Sale Wolverhampton ARS: <i>Electronic Music</i> by R. Jeavons
10 Jun	RSGB 1296MHz Trophy RSGB 432MHz Trophy and SWL Elvaston Castle Mobile Rally at Elvaston County Park (5 miles SE of Derby on B5010). Opens 10am. Admission Free. Food. Talk-in. 80 Trade Stands. Bring and Buy. Flea Market. Helicopter rides and childrens entertainments. John Robson 0332 767994 308 ARC: Treasure Hunt	20 Jun	Three Counties ARC: <i>How A Broadcast Station Works</i> S. Bristol ARC: Final Preparation for Longleat Rally Fareham DARC: <i>2m DXing</i> by G3VXM Wirral DARC: D & W at The Lighthouse, Wallasey Nene Valley RC: Natter Nite
11 Jun	Exeter ARS: Inter Club Quiz Stratford Upon Avon DRC: On-air Dudley RC: <i>Data Transmissions</i> by G4JCP	21 Jun	Chichester DARC: Summer Social Preston ARS: Natter Night
		22 Jun	S. Manchester RC: 160m DF and Barbeque Dunstable Downs RC: VHF NFD Planning Medway ARTS: <i>The Worked All Britain Awards</i>

by *Adrian Keele*
 Cambridge DARC: Informal and Morse Class
 Haverhill DARS: Construction of DF Antennas
 for Hunt on 6th July.
 Harrow RS: *Special Event Stations*
 RSGB 1.8MHz Contest
 23-24 Jun Worked All Britain 2m/70cm Phone Contest
 24 Jun 1400-2200 UTC
 Downstable Downs RC: Car Boot Sale
 Longleat Mobile Rally at Longleat Park, near
 Warminster, Wilts. Trade Stands, Bring and
 Buy, Food and Drink, Camping Facilities, Talk-
 in. Enquiries G4FRG 0272 848140.
 Capital Radio Venture Day with Amateur Radio
 Show by Harrow RS at Battersea Park, Lon-
 don.
 Wordsley ARC at Wordsley Carnival
 (GB2WRA).
 25 Jun Stratford Upon Avon DRC: *Travels In Paradise*
 by G8KGJ
 Dudley ARC: *Radio and the Sun* by D. Harris
 26 Jun Mid-Warwickshire ARS: *QRP*
 Wakefield DRS: ring PRO for details
 Wolverhampton ARS: Informal
 Wakefield DRS: ring PRO
 27 Jun S. Bristol ARC: VHF FD Briefing
 Fareham DARC: On-air/natter night
 Wirral DARC: The Eileen Medley Challenge Cup
 DF Hunt
 Nene Valley RC: Lecture by The Microwave
 Society
 Farnborough (Hants) DRS: VHF FD Preview
 Colchester RA: *What Next In Space?* by Frank
 28 Jun Howe
 Greater Peterborough ARC: *QRP* by Rev.
 George Dobbs, G3RJV
 Edgeware DARS: VHF FD Briefing
 29 Jun S. Manchester RC: *Intro to 'Op Amps'* by
 G4HON
 Edgeware DARS: Informal and VHF FD Briefing
 Harrow RS: Informal
 30 Jun Three Counties ARC: Barbeque
 2 Jul Horndean DRC: *On-the-air cheaply* by G2DZT
 Leighton Linsdale RC: ring PRO for details
 Stourbridge ARS: Informal
 Todmorden DARS: Radio Treasure Hunt
 3 Jul Bury RS: Surplus Equipment Sale
 4 Jul S. Bristol ARC: Lecture by the RSGB
 Fareham DARC: *Brewing ATUs* by G4GBZ
 Wirral DARC: Barbeque at Heswall
 Fylde RS: Blackpool Airport Radio and Radar
 Cheshunt DARC: Equipment Evening
 6 Jul Axe Vale ARC: Visit to TV Transmitter at
 Stockland Hill
 S. Manchester RC: VHF NFD Preparations
 Sutton and Cheam RS: ring PRO for details
 Haverhill DARS: 2m Foxhunt
 Harrow RS: *Basic Microwaves*
 7-8 Jul VHF NFD and SWL Contest
 9 Jul Exeter ARS: Film Evening
 Stratford Upon Avon DRS: Homebrewing Tips
 Leighton Linsdale RC: Quiz at Milton Keynes
 DRC
 10 Jul Mid-Warwickshire ARS: St Johns Ambulance
 Wakefield DRS: 2m Foxhunt with Pontefract
 ARS
 Bury RS: Visit to Emley Moor IBA TV Transmit-
 ter
 11 Jul S. Bristol ARC: 70cms night with G4EIA
 Farnborough (Hants) DRS: Talk by G3IEE
 Cheshunt DARC: Natter Nite
 12 Jul Southgate ARC: To be arranged
 Edgeware DARS: Outside visit (t.b.a.)
 Bury RS: ring PRO
 13 Jul S. Manchester RC: *The Beginning of the*
Universe (I) by G4ROM
 14 Jul Harrow RS: Informal
 15 Jul RSGB Low Power Field Day
 Wirral DARC: DF Hunt
 16 Jul Leighton Linsdale RC: *Lightning and EMP Pro-*

tection by George Jessop, G6JP
 Stourbridge ARS: A Look at the Club's Ar-
 tifacts
 17 Jul Biggin Hill ARS: *QRP* by G4BUE
 Fylde ARS: Discussion of Blackpool Airport
 visit
 18 Jul S. Bristol ARC: *Computer Night* with G1DBH
 Fareham DARC: *QRP* from St Kilda by G3WLY
 Wirral DARC: D & W
 Cheshunt DARC: Visit — ring PRO
 20 Jul Sutton and Cheam RS: *German Wartime Radio*
 by G3IEE
 Haverhill DARS: *Club Aerials*
 Harrow RS: *Airborne Radio*
 21 Jul Radio and Electronics Fair held by West Kent
 ARS at Victoria Hall, Southborough, Kent (on
 the London Road between Tonbridge and Tun-
 bridge Wells). 40 + Trade Stands. Parking,
 Video games, computers and Special Event
 Station. Open 1030 — 1700. Info Dave Green
 0892 28275.
 22 Jul Anglian Mobile Rally at Stanway School, Col-
 chester. Open 1000 — 1700. Talk-in on 2m.
 Info G3YAJ 0206 393938
 Home Counties Mobile Rally at McMichael
 Sports and Social Club, Sefton Park, Bells Hill,
 Stoke Poges, Bucks. Doors open 1100. Trade
 Stands, flea market, demonstrations, including
 radio controlled models, and a real ale tent!
 Talk-in S22 and SU8
 23 Jul Stratford Upon Avon DRC: Constructional
 Evening
 24 Jul Mid-Warwickshire ARS: Fox Hunt and Barbeque



Wakefield DRS: Pitch and Putt at Holmfield Park
 25 Jul S. Bristol ARC: HF Night with G4TXW
 Fareham DARC: On-air/natter nite
 Wirral DARC: DF Hunt for G8PMF Award
 Farnborough (Hants) ARS: Club Station Work-in
 26 Jul Edgeware DARS: Informal

27 Jul Harrow RS: Informal
 1 Aug Wirral DARC: D & W

Will Club Secretaries please note that the deadline for the September segment of *Radio Tomorrow* (covering radio activities from 3rd August — 5th October '83) is 27th June.

Contacts

Axe Vale ARC	Alan Moore	0304 822738
Braintree RS	Roger Jones	Upottery 468
Bury RS	Bryan Tydesley	0282 24254
Cambridge DARC	David Wilcock	0954 50597
Chichester DARC	C. Bryan	0243 789587
Conwy Valley ARC	J. Wright	0492 823674
Cunningham DARC	N. Brown	05055 2052
Edgeware DARS	John Cobley	30 64342
Fylde RS	PRO	Lytham 737680
Halifax DARS	D L Moss	0422 202306
Haverhill DARS	Rob Proctor	0787 281359
Kent Repeater Grp	M W Stoneham	02273 69828
Leighton Linsdale RC	Pete Brazier	052 523 270
Medway ARTS	Andy Wallis	0634 363960
Mid Ulster ARC	D F Campbell	0762 42620
Preston ARS	George Earnshaw	0772 718175
S. Bristol ARS	Len Baker	0272 834282
S. Lakeland ARS	Dave Warburton	Ulverston 54982
Stourbridge ARS	Malcolm Davies	038482 4019
Southdown ARS	P. Henly	0323 763123
Three Counties ARC	Chris Forshaw	0428 713012
Vale of White Horse ARS	Ian White	Abingdon 31559
Veralum ARC	H. Clayton Smith	St Albans 59318
West Kent ARS	Peter Reeve	0892 24689
Wirral DARC	Gerry Scott	051 630 1393
Worthing DARC	Jim Hicks	0903 690415
308 ARC (Surbiton)	Dave Hicks	01 399 5487

G3WPO HASSOCKS (07918) 6149
 G4KEI
 20 FARNHAM AVENUE HASSOCKS
 WEST SUSSEX BN6 8NS



WPO COMMUNICATIONS

Home construction is on the increase! Or so it appears judging by the demand for our products. It really isn't that difficult once you have attempted that first project — as long as you can solder reasonably well, you are 99% of the way towards completing one of our projects. With comprehensive instructions (we believe the best on the market), clear layouts and high quality pcb's, WPO Communications aims at taking out all the uncertainties in building your own gear. All components needed to complete the project are normally supplied, including pcb's, pots and wire. Our speciality is HF equipment, but we are broadening our range to cover other aspects of the hobby, including some pretty unique projects which have never been offered before. Why don't you have a go at building something — QSO's are more interesting when you say "running a home brew rig here..." Design expertise from Tony G3WPO, Chris G4KEI and Frank G4JST. For HF, our most popular kits are the **DSB80/160 QRP Transceivers**, running 2 watts or more on either 80 or 160M, double sideband or CW and VFO controlled. The basic kit (£37.45) only needs an antenna, PSU (12v) and speaker/mic/key to get on the air, or we have a case (£23.35 inc hardware) and even a digital readout option (£24.10) if you want to go the whole hog! There are now over 500 of these scattered around the world with excellent results. Or, try the **UPGRADED DSB2** — with enhanced features such as semi-break in keying, active filter, and the ability to run on any single band from 160 through to 15M (£68 inc VFO — state band when ordering) — at the moment the most popular versions are for 80 and 20 metres, and for cw on 10MHz. This MKII version is driven by the **MINISYNTH PLL single band VFO**, itself available separately at £29.70. It covers any one band from 160 through 10M, with options for i.f.'s of 9 or 10.7 MHz (state which), direct conversion, or a 5-5.5MHz version, useful for second VFO etc. **Get that G4CLF/3ZVC board up and running at last.** Both the DSB2 and the MINISYNTH come with a polyvaricon capacitor to keep the cost down — for ultimate stability use an air spaced either from your own junk-box or add £7 to the prices for a top grade Jackson version. Other options are digital displays and a case — write for more details.

Still on HF, another very popular line is our **G4DHF TRANSVERTER** — unique kits which will put your 2 metre multimode rig on to 20/15/10 or 160/80/40 metres, both transmit and receive. You just operate the 2M rig as normal but you have HF transceiver operation instead of 2 metres! 2 watts min output will give you plenty of contacts on these bands, and only a 12v supply is needed. The kits have everything else included (except metalwork and the multimodel). Either version priced at £81 including the three conversion crystals needed. Cheaper than an HF Rig! Hear these working at the Rallies this year.

PROJECT OMEGA is now nearing completion. This is our top-of-the-line Kit for a 9 BAND HF SSB/CW Transceiver, engineered by G4JST for best performance without the frills. It isn't cheap but does work as many people can now testify. Professional appearance case available with anodised, screened and

New — HF SSB Transceiver 160 or 20m — phone for details.

punched panel plus hardware kit options. See our previous ads for more details, or ask to be included on our unique **OMEGA Mailing List** (£1 in stamps). Our newsletter will be sent at intervals (5 issued to date) and keeps you fully informed on the project, with all known mods, hints and corrections to the published articles. Some of the modules are suitable for use with other designs, in particular the **OMEGA PLL VFO** will suit 3ZVC/8CLF i.f. designs. It is low noise, highly stable and covers all Amateur bands in 1MHz segments and is priced at £108 inc all crystals (10.7MHz version). The **ACTIVE FILTER** can be used for any rig needing more selectivity and fits in the audio line at low level — 7 switched selectivity position (£16.65). **QRP PA (3W) suits 3ZVC/8CLF i.f. strips also** (£21.80). The **BROADBAND RF PREAMP** is very popular on its own and will live up any HF receiver, or can again be used with G4CLF type bidirectional signal designs as it uses pin diode Tx/Rx switching (£13.50).

Moving to VHF, our **2 METRE TALKBOX FM TRANSCEIVER** is proving another best seller kit. A cheap way to get on 2 metres, with our 6 channel receiver and transmitter designs. Both will work independently of the other, or mate them for Transceiver. Rx £39.50, and Tx £32.90, or both together for £68. Crystals not supplied but available from any of the usual suppliers — or go VFO with the new VHF Minisynth. Interested in 6 METRES? — then try our 6M to 28MHz i.f. converter design — complete pcb kit is only £14. Or, if your 2 metre rig is deaf, try our **2M PREAMP** (very small) at only £5, or the **70CM VERSION** for £6.50.

Have you a **FREQUENCY COUNTER** — then convert it to a **DIGITAL CAPACITANCE METER!** Another unique kit — if you can get at the gate pulse in your counter then try this design priced at £18.20, inc case. 1pF — 1000's uF's.

2 NEW ITEMS THIS MONTH! SPEECH PROCESSOR — simple but very efficient design by G4JST using VOGAD, variable clipping + filtering all the right places. Complete kit only £13.90. +12v operation, suitable for FM/AM/SSB, amateur/CB.

VHF MINISYNTH — by request, our **2 METRE PLL VFO KIT — 2MHz BAND COVERAGE** with options for 144, 133.3 or 135MHz or other outputs (up to 4 selectable 2MHz ranges on the pcb to allow for a repeater shift on Tx and Rx). **Works with our Talkbox for continuous 2M coverage**, and should go with almost any other rig that needs direct 2M injection on Tx, and either 9 or 10.7 MHz i.f. offset on receive (or Tx). Very stable and easily buildable. Complete pcb kit with air spaced VFO capacitor **ONLY £38.50**. Crystals are not supplied — 1 needed for each 2MHz range, full details on ordering rapidly are with instructions. Suitable SSB/CW/FM and can be modulated for latter. More details on request.

All prices include VAT and post. We are **MAIL ORDER**, or collection by arrangement (phone Chris between 10am-11am on Brighton 834478 before coming). Most items ex-stock or allow up to 28 days if not. Post Office COD over £30. Phone Mon-Fri 10-4pm. See you at the NEC (Stand E27), Woburn, Longleat and other Rallies. Access-24hour Answering phone 07918 6149.

ANTENNA PLANNING

a thinking man's guide

The idea of going through the municipal bureaucracy for permission to erect a HF or large VHF beam antenna is off-putting for many Amateurs. When considering the various forms, obscure questions and obligatory drawing up of plans, it is little wonder that many

that my XYL complained of feeling 'caged' whenever she went out to hang up the washing!

A few weeks later a letter arrived from the local Planning Authority. Very tactfully worded. It mentioned (almost casually) that an erection had been noted within my

fer I could not refuse, which resulted in a three section, heavy duty tower resting rather incongruously across my lawn.

I believe one of the difficulties when considering applying for planning permission is that there is really no certainty that you are going to get it. You may put in a lot of work and energy — all to no avail. You are at the mercy of a Committee who are unlikely to know very much about Amateur Radio or antennas. I had fortunately kept an excellent article in the Short Wave Magazine of a few years ago which pointed out that it was up to the applicant to make every effort to advance and substantiate his submission. Merely filling in the required forms could be leaving too much to providence.

A start was made on the form filling. In fact there was not too much to write in answer to the questions. I even exaggerated the 'area' of the 'proposed building' to 1.5 square metres, which was the extent of my proposed concrete base. Two sets of plans were drawn up. One, a street plan of the area and the second, at a scale of 1:240, showed the proposed site layout in the garden with a sketch of the future beam on top of the tower. The requirement called for four copies of the plans — one on linen or film. This condition was relaxed in my case, probably because no further construction or building work was involved. Photocopies were obtained at the local library for 10p each.

Want to put up a mast but not quite got the nerve? Steve Voy gives some encouraging advice on coping with the neighbours and the local authority

of us settle for an unobtrusive vertical. If we have an amenable neighbour, perhaps a 'Trap Dipole' with one leg on adjoining land may be permitted — always provided the neighbour on the OTHER side of the fence doesn't object. But for a beam or any other *obvious* antenna array, planning permission is a must.

Going Undercover

You can attempt an unauthorised erection. You may get away with it for a while. But there is always the fear that 'Authority' will suddenly present itself and ask some searching questions. I made an unauthorised attempt with two sections of an aluminium ladder strapped together with Jubilee Clips. This gave me a rather precarious 30 feet on top of which a length of 2" aluminium tubing supported a rotator and TA 33. Getting it up was quite a feat and needed the help of a few friends. Once up it was certainly a thing of beauty to me — especially when the sun caught the aluminium sections. The statement that you can keep a string of spaghetti upright if you guy it correctly was proved in my case. Unfortunately, the garden was thus literally covered in galvanised, steel guy wires — such

grounds for which it appeared no planning permission had been applied for! Stalling for time, I countered that the erection was in fact an aerial mast. I went on to say that it was only temporary and that it was not thought sanction would be necessary. Not so, came a reply shortly afterwards. I dismantled the support and packed away the beam elements in the garage.

A few months later a friend leaving the district made me an of-

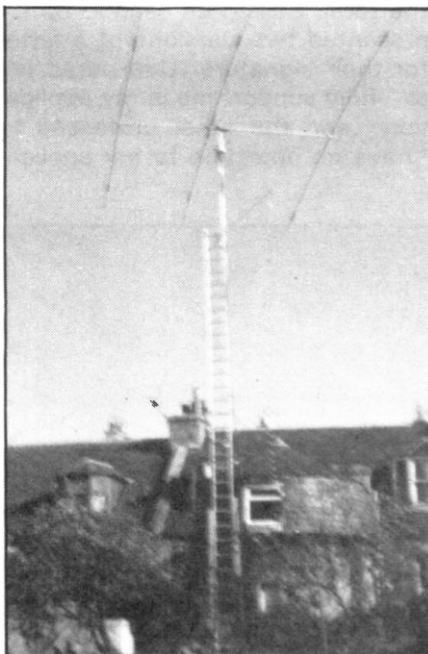

Steve's Ladder Mast

First Hurdle

A disadvantage I knew would be that I was living in a Category 'B' house of 'Special Architectural Interest'. I visited the Planning Of-

face to discuss my project and was told I could submit a letter to the Committee to elaborate on any points I felt may be relevant. I thought about this for a while and then came up with:

- a) The antenna would be used purely for Amateur Radio operations; no commercial interest was involved.
- b) The erected mast was to be in a semi-commercial area. Nearby telephone poles, power cables and three storey buildings by far overshadowed it in height.
- c) The rotating beam on top of the mast would be lower than practically all TV aerials in the vicinity.
- d) The supporting mast was telescopic in design. The antenna could well be lowered to around 10 feet (and thus out of general view) for much of the year.
- e) A GPO engineer had recently conducted tests on a similar aerial (my ladder mounted job) which proved that my equipment was free from spurious radiation out of the Amateur Bands. No complaints of interference to domestic radio or TV had been received.

All the above was admittedly of little significance to the dedicated conservationist on the Committee. But I thought it was plausible enough to sway any borderline cases in my favour. I purposely used the word 'mast' instead of 'tower' — why frighten the uninitiated?

Going Visiting

My next task was to visit neighbours extending to six houses

The present set-up viewed from afar

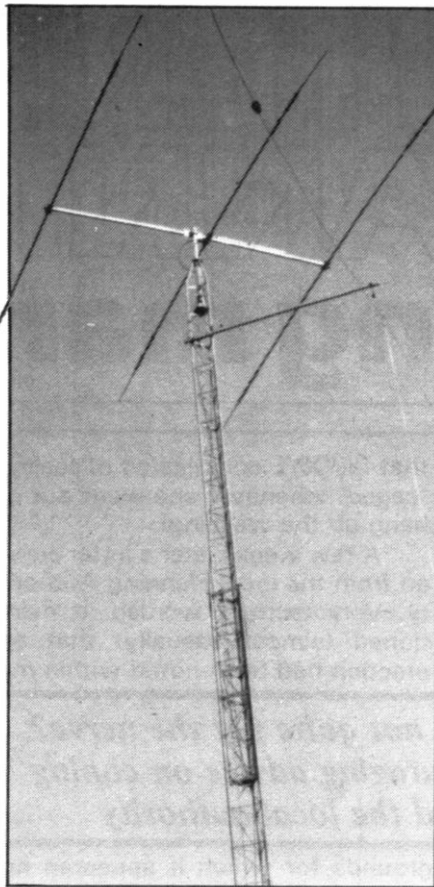
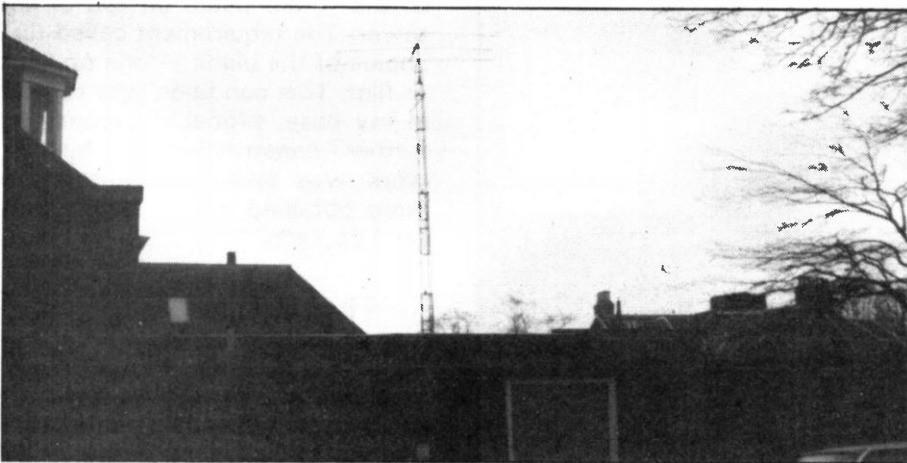

Voy antennas in close-up

on either side of me, about ten houses opposite me in the street and half a dozen buildings in the parallel street that overlooked my rear garden, which included a few Private Hotels. The occupants were a mixed bag, mainly business practices, consisting of Architects, Accountants, and Medical Specialists. A few private occupants made up the total. Calling on each in turn, I presented two versions of a letter for their signature. One purported to "fully support me in my application" and the other professed to "have no objection to my applica-

tion". The end result was around 60:40 in favour of supporting my application with two abstentions! Three young female students were in "full support" but a retired lady doctor had reservations and opted for the alternative. I lifted one dear little retired lady so that she could see over her garden wall to where my antenna would be. Full support. I had asked all if they remembered my previous ladder mast but none could recall it. The climax came when I had almost finished my canvassing and knocked on the door of one of my immediate neighbours.

"Hello," I beamed, in what I hoped was an engaging smile. "It's about my aerial. I wonder if you'd care to support"

"NO I WOULD NOT," he rasped and quickly shut the door.

Facing The Music

I realised I had a problem here. A next door neighbour must surely count for at least six more remotely sited residents. Undeterred I assembled my papers, plans and statements together and took them in person to the local Planning Authority.

A week later a Solicitor's letter arrived. It was quite courteous (they usually are) but stated they would be objecting (on behalf of the aforementioned irate neighbour) to the proposed antenna erection on the grounds of TV interference. I was furious. I phoned the advocates but no one would speak to me. I left a message saying that I strongly objected to the allegation and challenged them to provide dates/times and types of interference. I was convinced this was a red herring. I imagined the complainant visiting his solicitor and being comforted with, "Don't worry sir — we can always infer that he will interfere with your television." What really concerned me was that a similar letter would almost certainly have been sent for the attention of the Planning Committee.

I deliberated a bit. I did not want to get into a personal battle with my neighbour but felt I had to defend myself against what I was sure was a wild allegation. Eventually I sent a letter to the Committee stating I had reason to believe a complaint had been made as regards my causing interference to

TV. I was able to refer to my previous submission that no unwanted transmissions had been discerned by competent GPO Engineers. I said that if in fact he was suffering from TVI he had not reported it to the GPO (a wild guess on my part) and it certainly was not originating from my equipment.

A few days later I phoned the

Solicitors with the idea of extracting some reaction to my counter objections. I was informed that the person dealing with it was ill.

I contacted the Planning Office a few days after the meeting of the Committee and was told no decision had been made yet. My application had been discussed but deferred

The awaited letter finally came two weeks later. Success! Planning Permission had been granted for 2 years. The actual typewritten comment ended with the condition that "the said mast is removed on or before the expiration of two years . . ." This is not as ominous as it sounds. Just before the expiry date I simply reapply and ask for a further two years. So far the extension has always been granted.

Charge In Legislation

Legislation has since changed in that, nowadays, a form must be completed whereby you state you have *advised* your immediate neighbours of your intention. They do not have to agree; it is sufficient to make a declaration that you have made them aware of your plans. No doubt if they feel strongly enough about it the onus is on them to inspect your plans at the Municipal Offices and make any objections formally. I am now fortunate in having obliging neighbours who unanimously last time returned the form to me endorsed "OK with me."

The process is really quite straightforward. The initial forms seem rather overpowering but really it is the more involved 'Application for Building Warrant' — not normally necessary for a tower siting — where the procedure appears to become more complicated. Local Planning Authority staff were always most helpful. I suppose you could say it is their job to be so but their replies were always friendly and considerate — even if they perhaps thought they were dealing with a crank!

Should the application be disallowed, a reason is given — "conflicts with the amenity of the neighbourhood" is a good one! If the applicant feels strongly enough about it, he has recourse to appeal to the Secretary of State within six months.

I hope this narrative will give a little encouragement to any aspiring tower erectors. Don't assume the cards are automatically stacked against you. With a little thought and effort you may be able to steer your application along the right path — even if you know for certain you have at least one strong objector!



Cirkit. A new name

This year Ambit will stop being Ambit. And become Cirkit.

Cirkit is more than just a change of name. It means a better service for you. Faster delivery.

A bigger range of the best and latest products with well over 10,000 different items available.

Everything for the home and industrial user.

A whole new Cirkit range of constructional kits, graded for the student, expert and enthusiast.

Modules to build for everyone.

Cirkit is a go ahead company that believes in giving service to its customers.

There's a technically skilled staff to help you.

We keep in touch with the manufacturers and we know what's going on.

As soon as new products are available, Cirkit has them.

Cirkit means a bigger catalogue. A better company to deal with.

And a wider than ever range of products that's growing all the time.

For you, Cirkit means a bigger stock and better service.

For further information send for our latest catalogue or visit one of our three outlets at:
200 North Service Road, Brentwood, Essex, CM14 4SG; 53 Burrfields Road, Portsmouth, Hampshire, PO3 5EB; Park Lane, Broxbourne, Hertfordshire, EN10 7NQ.

To: Cirkit Holdings PLC, Park Lane, Broxbourne, Hertfordshire.
I enclose 80p. Please send me your latest catalogue and 3 x £1 discount vouchers!
If you have any enquiries please telephone us on Hoddesdon (0992) 444111.

Name _____

Address _____

Telephone _____

Area of Special Interest _____

Cirkit
Bigger Stock. Better Service.

HRT7

Computer Products

A complete range from Connectors to Board Level product

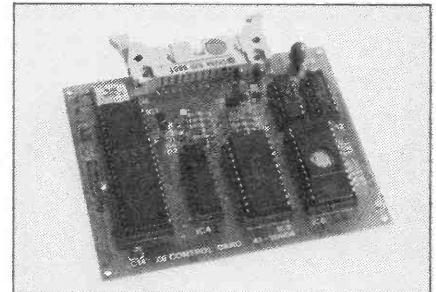

C12 Computer Cassette	21-00012	0.55
BBC to Centronics Printer	03-10019	7.25
BBC to 25 way D Male	03-10021	4.50
25 way D Socket	10-25200	1.90
25 way D Plug	10-25100	1.30
Cover for 25 way D	10-25322	0.93
20 up Eprom Eraser	40-82100	31.25
Z80 A Industrial Controller	40-82000	49.95
6802 Industrial Controller	40-68020	49.95
6502 Industrial Controller	40-65020	49.95
Z8 Basic/Debug Controller	41-00904	50.00

Nicad Batteries & Chargers

Minimum life 600 (300 PP3 size) full charge/discharge cycles. Batteries must be charged from a constant current source only. All batteries are supplied only with a residual charge and should be charged before used.

AA	1.2V	500mAH	01-12004	1.9	10.49
C	1.2V	2.2AH	01-12024	2.35	1.99
D	1.2V	4.0AH	01-12044	3.05	2.85
PP3	8.4V	110mAH	01-84054	3.70	3.50
CH1/22 PP3 Charger	11mA for 16 hours		01-00159	4.30	
CH8/RX Multi-purpose Charger			01-02204	9.40	

Will recharge AA, C, D and PP3 size cells with automatic voltage selection. Will recharge following combination: 6 x D, 6 x AA, 6 x C, 2 x PP3, 2 x D + 2 x C, 2 x D + 2 x AA, 2 x D + 1 x PP3, 2 x C + 2 x AA, 2 x C + 1 x PP3, 2 x AA + 1 x PP3.

Battery Adaptor 01-12001 0.96
Sold in pairs: one to convert AA size to C size and one to convert C to D size. Both may be used together to convert an AA to D size.

Semiconductors

Linear IC's

LM301AN	DIL version	61-03011	0.44
LM308CN	DIL version	61-03081	0.65
LM311CN	Popular comparator	61-00311	0.46
LM324	Low power quad op amp	61-03240	0.67
LM339N	Low power quad comparator	61-03390	0.68
LM346	Programmable quad op amp	61-00346	3.72
LF347	Quad Bi-FET op amp	61-00347	1.82
LM348	Quad 741 type op amp	61-03480	1.26
LF351	Bi-FET op amp	61-03510	0.49
LF353	Dual version of LF351	61-03530	0.76
LM380N	IW AF power amp	61-00380	1.00
NE555N	Multi-purpose low cost timer	61-05550	0.45

for a better service.

NE556N	Dual version of the 555	61-05560	0.50
uA741CN	DIL low cost op amp	61-07411	0.22
uA747CN	Dual 741 op amp	61-07470	0.70
uA748CN	741 with external frequency comp	61-04780	0.40
HA1388	18W PA from 14V	61-01388	2.75
TDA2002	8W into 2 ohms power amp	61-02002	1.25
ULN2283	1W max. 3-12V power amp	61-02283	1.00
MC3357	Low power NBFM IF system and detector	61-03357	2.85
ULN3859	Low current dual conversion NBFM IF and detector	61-03859	2.95
LM3900	Quad norton amp	61-39000	0.60
LM3909N	8-pin DIL LED flasher	61-39090	0.68
KB4445	Radio control 4 channel encoder and RF	61-04445	1.29
KB4446	Radio control 4 channel receiver and decoder	61-04446	2.75
ICM7555	Low power CMOS version of timer	61-75550	0.98
ICL8038CC	Versatile AF signal generator with sine/square/triangle OPs	61-08038	4.50
TK10170	5 channel version of KB4445	61-10170	1.87
HA12002	Protection monitor system for amps, PSUs, TXs etc	61-12002	1.22
HA12017	83dB S/N phono preamp 0.001% THD	61-12017	0.80
MC14412	300 baud MODEM controller (Eduro/US specs)	61-14412	6.85

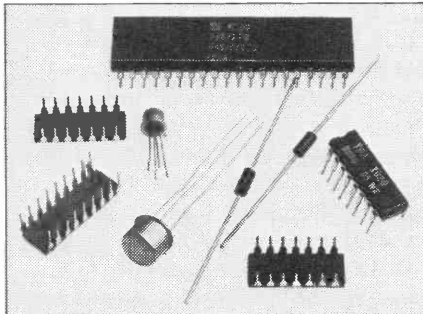

Microprocessor & Memories

Z80A	Popular and powerful 8-bit CPU	26-18400	3.40
Z80AP10	2 port parallel input/output	26-18420	2.95
Z80A CTC	4 channel counter/timer	26-18430	2.90
Z8671	Z8 Micro comp. and Basic	26-08671	17.50
6116-3	16K (2kx8) CMOS RAM 200nS	26-36116	6.68
Z6132-6	32K (4kx8) quasi RAM 350nS	26-06132	15.00
4116-2	16K (16kx1) 150nS	26-24116	1.59
2764	64K (8kx8) 450nS	26-02764	9.50
2732	32K (4kx8) 450nS	26-02732	5.70

Voltage Regulators

7805	5V 1A positive	27-78052	0.40
7812	12V 1A positive	27-78122	0.40
7815	15V 1A positive	27-78152	0.40
7905	5V 1A negative	27-79052	0.49
7912	12V 1A negative	27-79122	0.49
7915	15V 1A negative	27-79152	0.49

Transistors

BC182	General purpose	58-00182	0.10
BC212	General purpose	58-00212	0.10
BC237	Plastic BC107	58-00237	0.08
BC238	Plastic BC108	58-00238	0.08
BC239	Plastic BC109	58-00239	0.08
BC307	Complement to BC237	58-00307	0.08
BC308	Complement to BC238	58-00308	0.08

BC309	Complement to BC239	58-00309	0.08
BC327	Driver/power stage	58-00327	0.13
BC337	Driver/power stage	58-00337	0.13
MPSA13	NPN Darlington	58-04013	0.30
MPSA63	PNP Complement to MPSA13	58-04063	0.30
J310	JFET for HF-VHF	59-02310	0.69
J176	JFET analogue switch	59-02176	0.65
3SK51	Dual gate MOSFET-VHF amp	60-04051	0.60
3SK88	Dual gate MOSFET-Ultra lo noise	60-04088	0.99
TIP31A	Output stage	58-15031	0.35
TIP32A	Complement to TIP31A	58-15032	0.35
VN66AF	VMOS Power FET	60-02066	0.95
ZTX3866	E-line version 2N3866	58-03866	0.45
IN4001	Rectifier diode	12-40016	0.06
IN4002	Rectifier diode	12-40026	0.07
IN4148	General purpose silicon	12-41486	0.05

Silicon Controlled Rectifiers

BR555-100	100V .8A	52-55100	0.50
C106DI	400V 4.0A	52-00106	0.70
C122DI	400V 8.0A	52-00122	1.45

3mm Diameter LEDs

V178P	Red	15-01780	0.15
V179P	Green	15-01790	0.16
V180P	Yellow	15-01800	0.18

5mm Diameter LEDs

CQY40L	Red	15-10400	0.12
CQY72L	Green	15-10720	0.15
CQY74L	Yellow	15-10740	0.15

Infra-Red LEDs

CQY99	Emitter	15-10990	0.56
BPW41	Detector	15-30410	1.51

Tri Colour LED

V518	Orange-Green-Yellow	15-05180	0.60
------	---------------------	----------	------

Capacitors

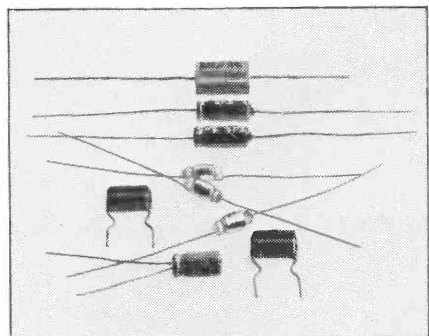

Aluminium Electrolytics Radial PCB Mounting

10u	16V	05-10606	0.24
47u	16V	05-47606	0.28
47u	25V	05-47607	0.28
470u	6.3V	05-47705	0.36
470u	16V	05-47706	0.48

Tantalum Beads

1uf	35V	05-10501	0.18
10uf	16V	05-10601	0.28
47uf	6.3V	05-47601	0.45
47uf	16V	05-47602	0.92

Monolithic Capacitors

1n	04-10204	0.39
10n	04-10304	0.42
100n	04-10404	0.45

Low Voltage Disc Cermaic

1n	04-10203	0.20
10n	04-10303	0.20

Polyester (C280)

10n	04-10305	0.18
47n	04-47305	0.24
100n	04-10405	0.24
470n	04-47405	0.51
1uF	04-10505	0.66

R F Components

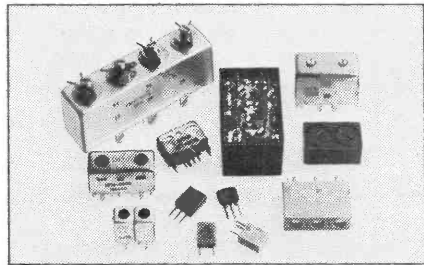

Filters

CFU/LFB CFW/LFH SERIES

Miniature 455kHz filters. I/P and O/P impedance 2K.

	-6dBW	-40dBW		
LFB6/CFU455H	6kHz	18kHz	16-45512	1.95
LFB12/CFU455F	12kHz	26kHz	16-45515	1.95
LFH6S/CFW455HT	6kHz	14kHz	16-45525	2.45
LFG12S/CFW455FT	12kHz	22kHz	16-45528	2.45
CFM2455A	Mechanical IF Filters for 455kHz		19-45530	0.77

Crystal Filters 2 Pole Types

10M15A	10.7 Centre Freq.	20-10152	2.10
10M08AA	10.695 Centre Freq.	20-11152	3.49

Inductors

We offer the complete Toko range of fixed and variable inductors. Over 500 coils from audio to V.H.F. See catalogue for details.

Soldering Irons (Antex)

CS240	Iron 240VAC 17 Watts	54-22300	5.20
XS-240	Iron 25W 240V High heat capacity	54-22500	5.40
SK6	Presentation pack of one XS-240 with ST4 stand	54-22510	7.20
MLXS	Handy 12V 15W soldering iron complete with crocodile clips and solder	54-20004	5.60

Please add 15% VAT to all advertised prices and 60p post and packing. Minimum order value £2 please. We reserve the right to vary prices in accordance with market fluctuation.

Have one handie... reviewing the Yaesu FT203R 2m Handheld

Currently priced at £169, the FT203R is Yaesu's new 'handie' 2m transceiver. Considerably smaller than the FT208R and with around the same power output (although the '203R will give 3.5W

the FT208R and 708R. Simplicity of operation is the watchword with the '203R. On the left hand side of the rig is the PTT control, and above this, the toneburst push control, both with dimpled surfaces

Thinking about a 2m handheld? Steve Ireland, G3ZZD, took Yaesu's new baby for a walk.

with the accessory FNB-4 12V NiCad pack), the FT203R offers straightforward FM simplex and repeater operation.

The frequency selection on the '203R is by thumb wheel switching, easier to manipulate on the move than the Keypad offered on

enabling slip-free operation. On the right hand side is a similar square button control for illuminating the miniature 'S'/RF Power output meter, which is mounted on the top of the transceiver. As well as the meter, the top panel carries a 'high/low button (which, when

Alison listening on S20 with the FT203R and YH2 headset



depressed, reduces the power output to some 0.3W), the BNC RF output socket, the three switch 'thumbnail' controls for squelch and audio volume (the volume control also doubling as the transceiver on/off switch), two miniature sockets for either the accessory headset/microphone (YH2) or the speaker microphone (MH-12A2b) and, finally, a small square push-button, which adds an additional 5kHz to the frequency selected by the thumbnail frequency selector. This control enables the election of odd channels, ie 144.775 as the thumbnail can only select to the nearest 10kHz. 144.775MHz is thus displayed as 577 — with this '+5kHz' button depressed. The necessity of a fourth thumbnail switch is thus avoided, which, after all, is only going to be set at either 5 or 0.

Set into the left hand corner of the top panel are two LEDs. The green LED indicates that the receiver squelch has opened: if the squelch is set very low — so that the ambient noise breaks squelch — the LED will light, in addition to lighting when a station is being received. The hand book says that this is useful when monitoring in a noisy environment as a 'busy channel' indicator — which is probably true. However, the author is moved to speculate that if the environment is that noisy, the operator will need at least to don the YH2 headset mic or move to a quieter environment before any operation can be done!

On the rear of the '203R, just above the unit belt clip, is a small square panel containing two

miniature three-position slide switches. One of these is for selecting repeater/reverse repeater/simplex operation, labelled '-600', 'SIMP' and '+600'. The lower switch selects VOX switching when using the YH2 headset/microphone: two settings are available, HI and LOW. The HI position is for quiet environments, providing maximum sensitivity of the VOX circuitry, whilst the LOW position desensitizes the circuitry in order to prevent 'triggering' from extraneous sounds (motor bikes, slamming doors etc) when operating in a noisy environment. Both of the switch levers are very low profile, in order to prevent the operator from inadvertently changing the switch selections, a nice touch.

Well Built?

With handheld transceivers rugged construction is a must. The battleship grey moulded-plastic case of the '203R looks as though it will stand a few hard knocks — although I was not moved to test this out! The transceiver PCB is surrounded by a U-shaped chassis, which should also help in this respect.

I have recently used the Yaesu FT708R, the 70cm portable transceiver and identical twin to the '208R, and the construction of the '203R seemed somewhat less solid than the aforementioned. However, the other consideration of construction with equipment of this kind is *weight* — and you are less likely to get a tired wrist with the '203R than the '208R, the latter being almost some 50% heavier than the former.

The circuit board of the '203R is well laid out without too much cramming of components and the quality of construction seems up to the usual Yaesu standard.

Operating The Beast

The FT203R fitted perfectly into the small but perfectly formed hands of the author. Even the most dainty of hands should not find this rig too much of a handful.

A number of contacts were initially made through the local repeater GB3NL — sitting at the kitchen table. Reports on the modulation were good, both using the in-



Top Panel

ternal mic and the YH2 headset. With many hand portables the audio quality and quantity is often noticeably better with an external mic, but the '203R proved itself a creditable exception in this case. No real difference was noticed between the YH2 and the internal mic by the stations I contacted, who all reported the audio quality as "good".

The FT203R was then taken on a prolonged hike, housed in the protective soft vinyl case supplied with the rig. Operation with the rig inside the case is possible but I did not like this, feeling that the PTT and toneburst buttons were difficult to 'feel' through the case. This was possibly due to my lack of familiarity with the '203R and was not felt to be a serious problem. Thus, most operation was done with the rig 'naked'. If you have large fingers and enjoy operating in a downpour, the FT203R might not be the rig for you. That being said, I don't know of any handheld transceiver which is too good in this latter respect.

Operation on the move was fairly easy and, with familiarity, the PTT and toneburst were easy to operate with a one/two movement of the fingers of the right hand, using the index finger to operate the toneburst. Despite my poor location, sprawled in a grassy hollow somewhere north of Edgware, Middlesex, with the transceiver beside me on the ground, most of the London repeaters were received at good strength.

If you are a night owl, the lamp inside the top mounted meter is useful for checking the power output (and, thus, your battery condition!). Unfortunately, the light thrown out doesn't quite reach the frequency selector and frequency checking requires a flashlight. Il-

lumination *on* the top panel rather than *in* the meter would have been better.

VOX operation was straightforward, both the 'high' and 'low' positions fulfilling the promises in the handbook. However, I did feel that the 'attack' of the VOX circuitry was slower than I would have liked, particularly on the low position, triggering often not occurring till well into the first syllable.

The Verdict

If you want a basic 2m lightweight FM 'handie', then this could be the rig for you. It lacks the scanning and memory facilities of its big brother, the FT208R. However, frankly, as far as I am concerned, this is really extra 'icing' and not particularly useful if you are to use the rig for the purpose of a sophisticated 'walkie-talkie' — which is what most 'handies' and 'portables' are intended for, and used as.

The lightness and compactness of the '203R mitigates against dropping the rig through not getting hold of it properly. People often forget to put their hands through the wrist straps of handies in the excitement of hearing someone coming through and wishing to reply quickly. Well, I do anyway and this can sometimes lead to near tragedy... By the way, the '203R has a good wrist strap.

Not dissimilar in size and specification to the Belcom LS20XE, the '203R packs rather a larger punch (2.5W against 1W) but costs some £40 more. However, with the optional FNB-4, the '203R will give 3.5W (!) — which can be useful as the small antenna on most 'handies' usually means that the transmit capability is often more restricted than the receive. On the other hand, the FNB-4 is another £36. Mind you, you really need NiCads anyway for regular portable operation — and that means shelling out a lot extra on *any* rig. And so on... and so on: You makes up your mind what you need from a portable, takes your choice and pays the money. As far as I am concerned, if you want a 'handie' this one is pretty OK. OK?

The author would like to thank SMC of Southampton for the review sample.

SAVE £4.25 by receiving a FREE magazine binder when you subscribe to.....

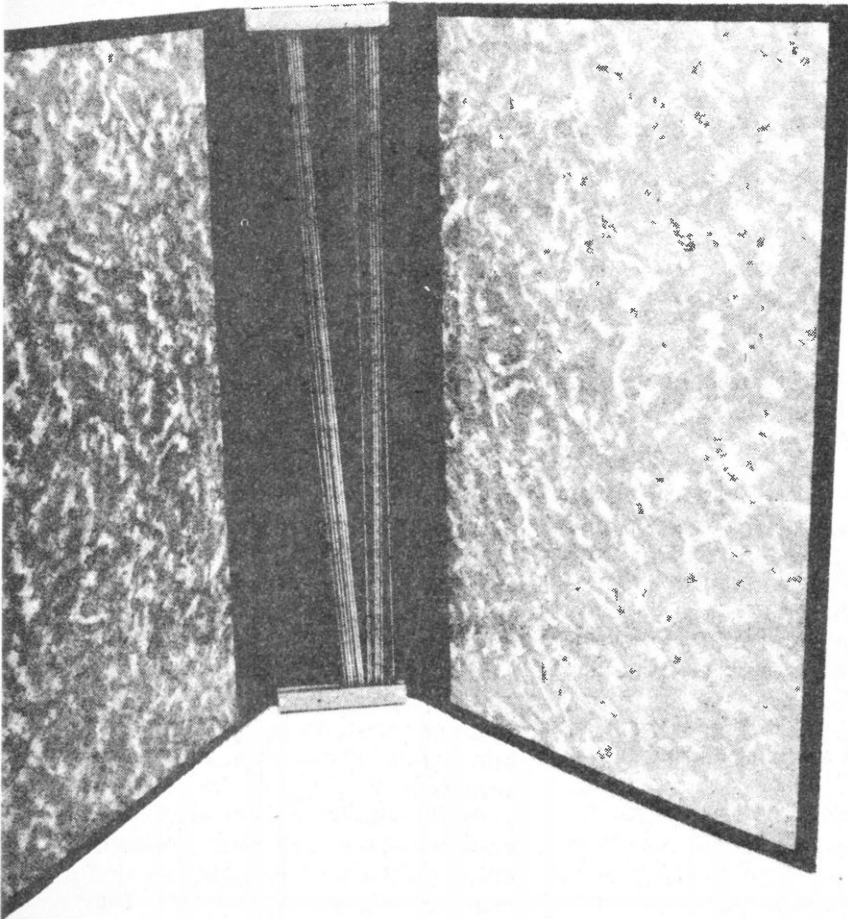

It's true, by subscribing to *Ham Radio Today* you will not only receive your personal copy direct to your door for a whole year but also have a superb magazine binder in which to keep your copies AND IT'S FREE!

All you have to do to receive your FREE binder is book a new subscription or renew an existing subscription to *Ham Radio Today*.

What could be simpler? Normally priced at £4.25, these attractive binders will hold approximately 12 issues of *Ham Radio Today*.

Not for you any longer the chore of having to track down dogeared copies of your favourite magazine, instead you will merely go to your bookshelf and they will be waiting for you in pristine condition. Don't miss out on this outstanding offer — subscribe today and receive your FREE binder within 14 days of your order being received.

SPECIAL OFFER

SUBSCRIPTION ORDER FORM

Cut out and send to:
HAM RADIO TODAY,
INFONET LTD,
TIMES HOUSE,
179 THE MARLOWES,
HEMEL HEMPSTEAD,
HERTS HP1 1BB

Please send my free binder and commence my personal subscription to **HAM RADIO TODAY** with the

..... issue

- | | | |
|--|--|--------------------------|
| SUBSCRIPTION RATES
(tick as appropriate) | £14.00 for 12 issues UK | <input type="checkbox"/> |
| | £14.45 for 12 issues Overseas Surface | <input type="checkbox"/> |
| | £27.00 for 12 issues Overseas Air Mail | <input type="checkbox"/> |
| | | |

I am enclosing my (delete as necessary)
 Cheque/Postal Order/International Money
 Order for £.....
 (made payable to ASP Ltd)
 OR
 Debit my Access/Barclaycard*
 (*delete as necessary)
 Insert card no.



.....

Please use **BLOCK CAPITALS** and include post codes.

NAME (Mr/Mrs/Miss)
 (delete accordingly)

ADDRESS

.....
 **POSTCODE**

Signature

Date

Single Channel Transverter for 70cm

Some time ago it was impossible to obtain power transistors that would work on the 70cm amateur band. As a result varactor diode

been lead without encountering these devices may be surprised to learn that quite a high efficiency can be obtained, typically ten watts

is 10 uV in on seventy producing 25 db quieting. This may seem lousy to your keen UHF type but is quite adequate for local repeater (or simplex) work. As a rough guide to someone who is contemplating this idea, a 'proper' 70cm receiver connected to the intended aerial should receive the intended repeater at about S7 for you to use the technique (ie if you can receive the repeater at S7 on purpose built 70cms equipment it should be perfectly copyable with the 'tripler').

Hugh Allison, G3XSE, describes a cheap and novel way to get going on 70cm.

'triplers' enjoyed a fair degree of popularity amongst the solid state enthusiasts. Although they still represent an easy way up onto the band on the transmit side, especially for FM, one is still left with the problem of obtaining a converter or receiver for listening. This article is dedicated to overcoming this little problem.

of 2m RF will yield six or seven watts of RF on 'seventy'. I digress, however. Why doesn't the tripler do anything on receive, you may well ask. Well, the tripler only triples due to the incoming RF energy on two metres, on receive there isn't any RF input so nothing happens. My idea was to inject some 288 MHz and see what happens, and it works; you get a crude receive converter.

Varactor Workings

Not many people know that a varactor 'triples' effectively by mixing. An idler circuit in a typical 'two' to 'seventy' tripler will be tuned to 288 MHz. The incoming two metre signal (144 MHz) mixes with 288 MHz to give resultant 432 MHz. People whose life has

Receiver Degradation

The normal two metre transceiver in my shack is a badly abused TRIO TR9000 which will give about 25 db of quieting for 1 uV of signal. The best I have managed to achieve with this idea

A Little Arithmetic

The first concept to be grasped is that mixing in a varactor does not produce a 'normal' transverter. Most transverters mix on receive and transmit, thus if you increase your frequency on 2m by 10KHz your receive and transmit frequencies on 70cm increase by 10KHz. Here your receive frequency will increase by 10 KHz but your transmit frequency will go up by 30KHz. That is why this is really a single channel device, although if you wade through the following mathematics you will be able to see that anyone with a two metre transceiver with a non-standard repeater mode can also work other channels.

In my area the local seventy repeater is GB3SV on RBO. This receives on 434.6 MHz and transmits on 433.0 MHz. Remember that is the repeater format; an accessing station does it round the other way round. We thus have to provide a transmit signal on 434.6 divide by three — which equals 144.866 MHz. Simple so far? Well, we are already up

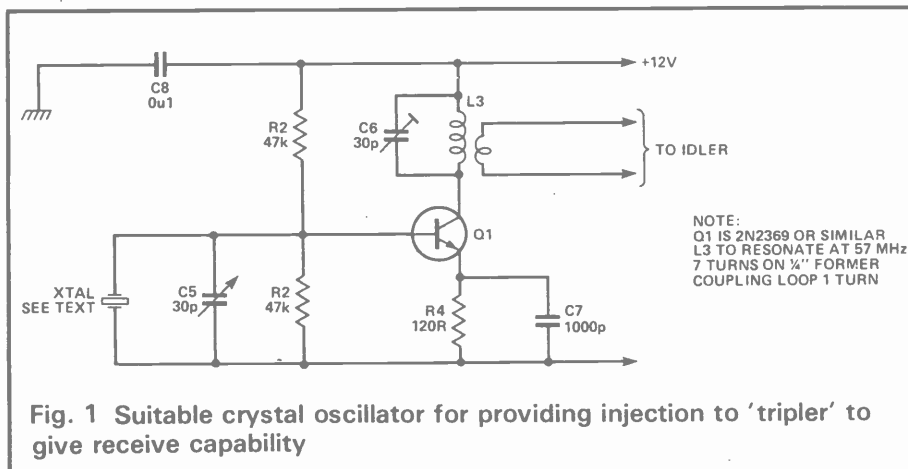

Fig. 1 Suitable crystal oscillator for providing injection to 'tripler' to give receive capability

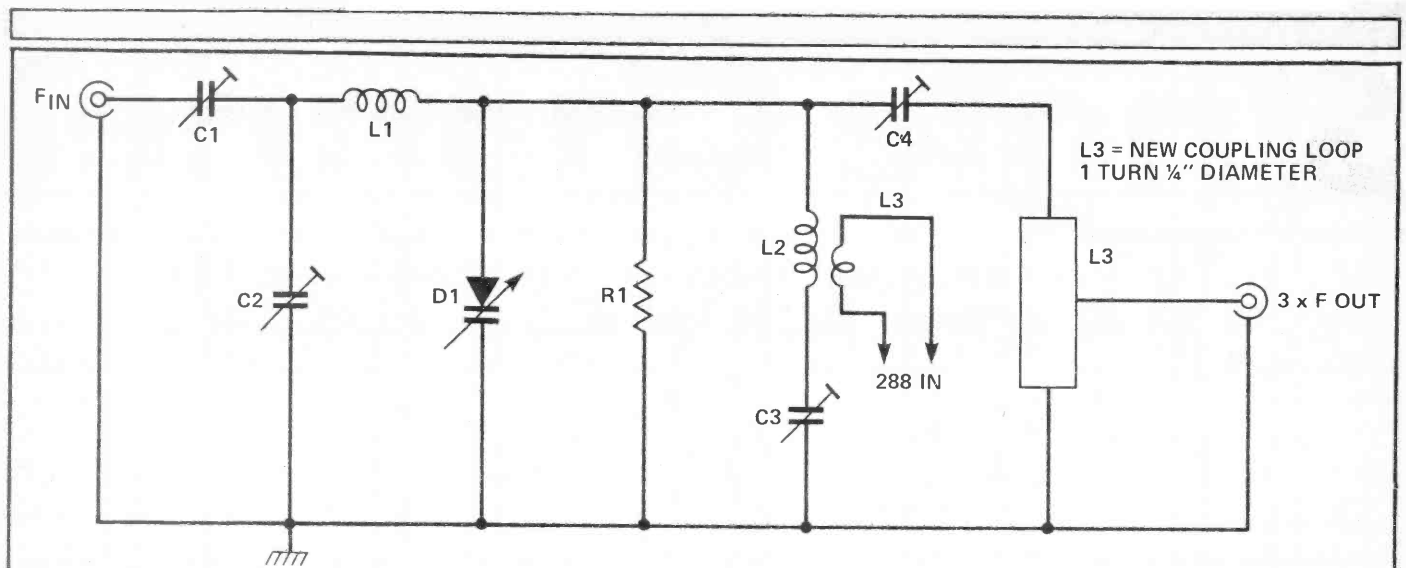

Fig. 2 Classic Varactor Tripler circuit. 'Triplers' may often be found in the secondhand columns of the radio magazines. If no luck there you could try asking around in your radio society. Someone somewhere will doubtless have one gathering dust. . .

against a snag; most rigs put up an accessing tone only when placed in the repeater mode — which means that you either dial up another 600 KHz (The 2m receive/transmit offset is receive 600 KHz higher at the accessing station; for 70cm the offset is *transmit* 1.6 MHz higher!) or you use a non-standard repeater shift of 0 KHz, ie transmit and receive on the same frequency. I shall only work this latter example since it will be of more interest to those owning a crystal controlled 2m rig.

So the 2m rig is set for 144.866 transmit and receive. Now let us consider the 70cm receive path. Here we want to listen to 433 MHz but are tuned to 144.866. Subtracting one from the other gives 288.134 MHz which is the frequency we have to inject into the idler circuit of the tripler.

Modifying the Tripler

It is not my intention in this article to give a step-by-step, hole-by-hole description of how to build a 70cm varactor tripler. Some people may well have one immediately to hand, either home made or one of the excellent Microwave Modules ones, which are often available second hand quite cheaply. The idea of this article is to resurrect an article many people have consigned to the junk box and of which there is a reasonably plentiful supply already in existence. For ease of identification the circuit diagram of the almost classic circuit that has

evolved over the years is shown in Fig.2. The coil of interest is L2, which fairly often runs from one side of the small diecast box, in which these triplers are normally constructed, to the other. It is normally a one turn loop of half or three quarter inch in diameter. Having identified the idler circuitry the decision has to be made as to whether the 'modification' (a source of 288.134 MHz) is going to be incorporated within the body of the tripler itself.

My original attempt to try out the idea was made using a free running oscillator to provide the necessary 288.134 MHz injection. The energy from the generator (A Hewlett Packard 608 giving about 700 mV into 50 ohms) was coupled via a quarter inch diameter one turn loop, the loop being pushed into place and then held there by simply replacing the lid of the box. If you want to make the unit self-contained the simple crystal oscillator of Fig.1 can be built-in, though take care not to place anything too close to any of the original components! Alternatively the oscillator could be mounted external to the box; it's up to you. Obviously the frequency of the crystal has to be worked out by the guidelines shown above, and a crystal of one fifth of the required frequency (about 57 MHz) should be obtained. The people with non-standard repeater shift rigs (*and good mathematics!* — Ed.) may be able to use a 'gash' crystal to hand by dialing up some odd receive frequencies.

Obviously a preamp could be used in front of the transverter, but the switching involved spoils the simplicity of the idea — and the attraction of essentially using the 2m rig normally, I think. There have, surprisingly, been no reports of any heterodynes being produced, which I had expected due to the two lots of 288 MHz at the diode when transmitting. This may well be due to the lower level of the receive 288 MHz compared to the transmit one.

I hope you have as much fun with the idea as I had. It's in the true spirit of amateur radio, getting something almost for nothing and making something work as it was never intended to!

Components Listing

Resistors

R2	47k ½W
R3	10k ½W
R4	120R ½W

Capacitors

C5,6	30p trimmer
C7	1000p disc
C8	0.1 u disc

Semiconductors

TR1	2N2369 or similar
-----	-------------------

Miscellaneous

L3 to resonate at 57MHz. 7 turns on ¼ inch former. Coupling loop 1 turn. Crystal (see text).

A Guide to AMTOR

Before beginning to discuss this method of communication let me tell you what the letters A, M, T, O, R mean. The first two stand for 'AMateur' and the 'TOR' indicates 'Telex Over Radio'. TOR was the name decided upon by Mr Van Duuren, a Dutch Posts and Telegraphs engineer, in the 1960s. He was endeavouring to find a means of improving the quality of copy on HF radio teleprinter circuits so that they could be connected directly into the international Telex network.

These errors then, are detected by encoding each of the 32 standard teleprinter characters as a pattern of 4 marks and 3 spaces. There are 35 possible combinations of 7 bits but the remaining 3 are used as special control characters. You may remember that in my first article on RTTY, (*Ham Radio Today*

Ken Michaelson, G3RDG, looks at AMTOR — the ultimate in keyboard communication.

I am sure that readers will appreciate that errors do occur when you have QSOs over the air using RTTY and very frustrating they can be too. The result is, of course, garbled copy, and this is not of great help when trying to discuss, for example, the subtleties of the rig you are using.

Mr Van Duuren recognised this problem and rather than try to improve the quality of the copy by conventional means, such as improvements to the antenna system or increasing the power of the transmitter etc, he decided on a scheme whereby the errors would be detected through a system of 'logic' after the demodulation process and then corrected by repetition. This 'logic' system is a system in which the values of the variables are simply restricted to two possible 'truth values'. These values may be represented by the digits '0' and '1' and therefore can be applied to the BINARY logic of computers. 'Mark' or 'Space', 'Plus' or 'Minus' volts etc can amount to the same thing. In this case it is 'Mark' as against 'Space'.

May 1983), I talked about the 'Baudot Code' or 'CCITT No 2 International Teleprinter Code'. That is a 5 unit code but in the first and best known version of the AMTOR system, called 'ARQ' (automatic request for repeat) or mode 'A', instead of 5 data bits, 7 are transmitted. Three bits are of one polarity and four of the other, making it in effect, a 7 bit code. Therefore, at the receiving end it is possible to detect whether a character is valid or not by counting the number of 'Mark' bits in it. If there are exactly 4 'mark' bits, then the character is treated as valid; if not, then it is rejected and signalled back to the transmitting station who then repeats the bad characters, several times if necessary, until the receiving station gets them correctly. This is not completely foolproof, of course, because it is possible for two or more bits to be corrupted and still leave a net result of 4 Mark bits giving the appearance of a valid character. This does sometimes happen, but it is much more likely that either a block of characters

gets received correctly or that it is corrupted beyond recognition. So in practice there are very few undetected errors.

This automatic request is achieved with the two stations working in an accurately synchronised quick-break mode. When operating in mode 'A' as described above, the transmitting station breaks the message down into blocks of three characters each and, after a block has been sent, the transmitting station switches to 'receive' and waits for a reply from the other end. If the receiver has copied the block correctly it responds with a single 'acknowledgement' character, and the transmitting station proceeds with the sending of the next block of three, and so on. If, however, the other end has not received the block correctly, it sends back a 'repeat' request, and the transmitting station sends the same block again. This procedure continues indefinitely until the particular block is copied by the receiving end, and then, and *only* then, does the transmitting station move to the next block of text.

In Synch'

It is the use in its circuitry, of

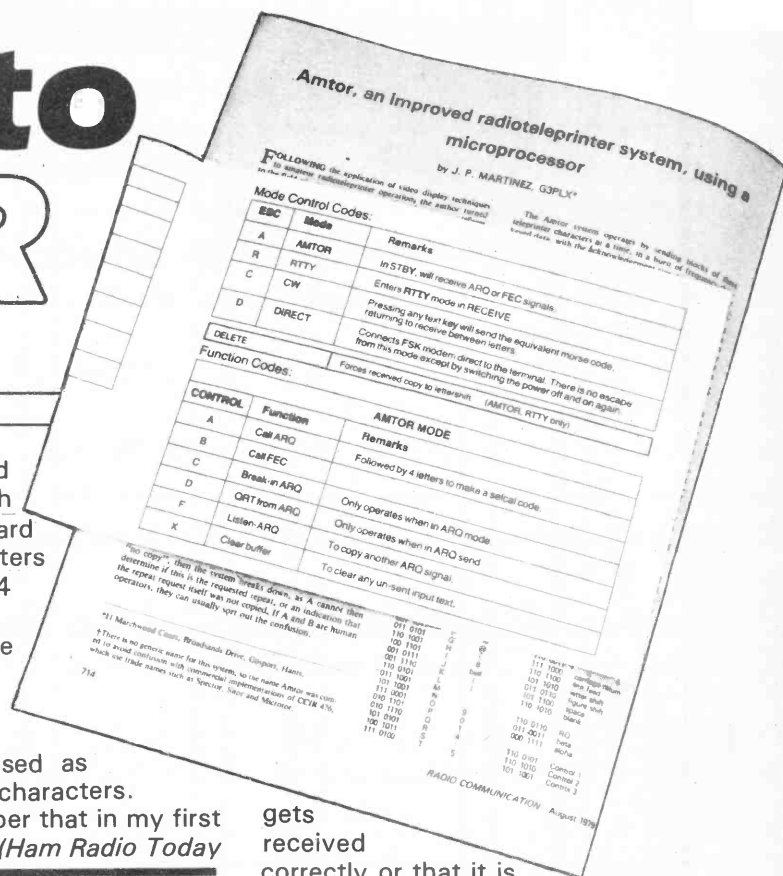

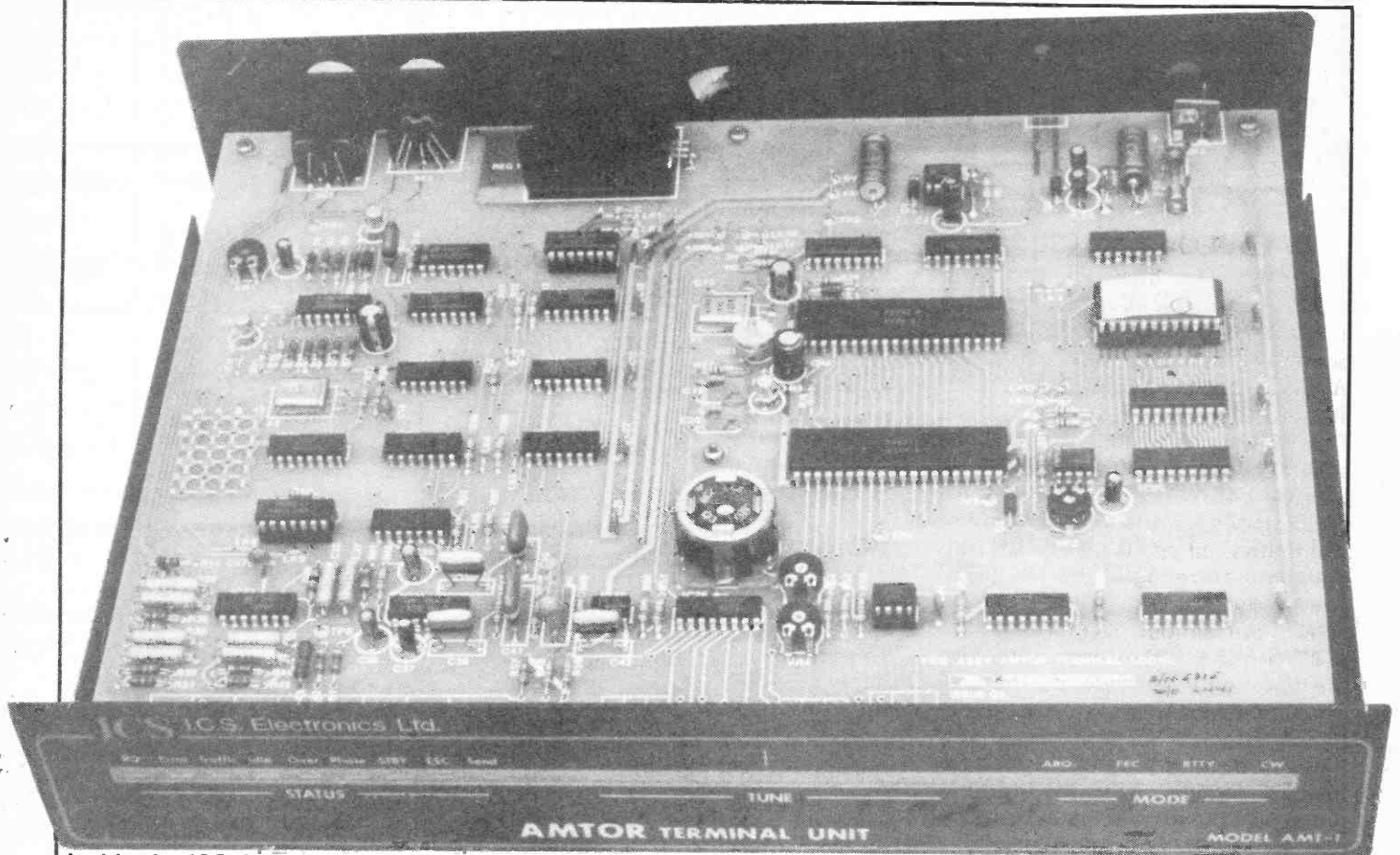

Inside the ICS AMT-1 purpose built AMTOR unit — used widely across the globe and manufactured in the UK to boot!

'synchronous' as against 'asynchronous', transmission of serial data which gives AMTOR 'A' such an advantage over conventional RTTY. Instead of a 'start' bit at the beginning of each character, as in normal RTTY, the receiving end is kept in sync' by the transmission of a 'start' code at the beginning of a transmission. In order that this method should work, the speeds at each end must be far more accurate than in an 'asynchronous' system and therefore it is necessary to use crystal oscillators rather than the mechanical governors which were described in my RTTY articles. At no time does the transmitting station send a continuous idle Mark or Space tone.

You might well ask how does the receiving station know when a character starts if there are no 'Start' bits. Well, the answer is that the receiver examines the incoming stream of bits looking for a particular pattern of consecutive bits which correspond to a known synchronisation character. When this pattern is recognised, the receiver knows that the next bit which follows is the first bit of the next

character. Clever, eh. In AMTOR, synchronisation is detected either by successfully receiving a known combination of IDLE characters, or by receiving a pre-determined four character Selective Call (Selcall) code. By using this method of sending messages, virtually error-free copy is obtained at the receiving end no matter how much QRM comes up on the frequency.

Mode 'B'

In the second version of the system, called 'FEC' (forward error correction) or Mode 'B', each 7 element character is transmitted twice, thus allowing the receiver to, as it were, get a second bite at the cherry if the first one was spoilt by interference. To reduce the possibility of a single burst of interference corrupting both copies of the character, the copies are separated in time by 350 mS, that is, 5 character times, therefore giving the receiver a greater chance of copying it. The speed is always 100 Bauds; that is, each bit time is 10 mS, so that it takes 70 mS to send a 7 bit character. There are no

Start or Stop bits, each character following immediately after the previous one. The transmitting station sends the repeat regardless, so no 'request for repeat' is sent back by the receiving station. This mode is most useful where it is not necessary to have a reverse link, such as when broadcasting. In fact, it is similar in use to normal RTTY in that it is 'simplex' operation. First station 'A' transmits and then passes the transmission over to station 'B', who, when he finishes his transmission, passes it back again to station 'A'. Its efficiency is not as high as ARQ, but nevertheless it is a considerable improvement over traditional RTTY, (sometimes to a factor of 10). A question which might occur to you at this point, is how does the receiver know which is the first copy of the character and which is the second. In mode 'B' two different Idle characters are used, one being transmitted in a 'time-slot' which would normally be used by the first copy of a message character, (time-slot No. 1 say), and the other being transmitted in a time-slot used by the second copy of the

character (time-slot No. 2). These Idle characters are transmitted when no message characters are being sent, and are also inserted at regular intervals, to give the receiving station a chance to get into 'sync'.

W1AW On AMTOR

It might also interest you to know that News Bulletins have been regularly broadcast from W1AW, the ARRL headquarters station, in RTTY, ASCII and AMTOR Mode 'B', and I have on several occasions observed the advantages of AMTOR over the other two modes. Under weak signal conditions, short extracts of the bulletin were recognisable in RTTY, practically nothing in 110 baud ASCII, but almost perfect copy in AMTOR mode 'B'. This was due in the main to the synchronous nature of AMTOR and to the fact that each character, as I described above, has two chances of getting through. Realising this, and appreciating the increasing interest in the mode, W1AW recently announced that the RTTY bulletins would be immediately followed by AMTOR, and finally in ASCII if time permitted.

For several years after the invention of TOR by Mr Van Duuren, the cost and complexity of the logic circuitry put this method well out of reach of amateurs, but the coming of the microprocessor age made the arranging of such a system a possibility, and AMTOR first came into existence in September 1978. Its very operation is due almost entirely to Peter Martinez, G3PLX, who told me one day at a BARTG rally that it was the now familiar 'chirp-chirp' of TOR that first attracted his attention to the mode when turning the dial on 80 meters one evening. He set out to find out about it, in due course discovered that it was TOR and determined to adapt it for amateur use. All praise must be given to his perseverance and foresight that, in a space of 5 years, AMTOR has become an established mode for amateurs on HF and VHF throughout the world.

Amateur Use

Initially experiments were made in the United Kingdom under a

clause permitting data transmissions on frequencies above 144 MHz, but in the following year with the help of the late Roy Stevens, G2BVN, permission was given by the authorities to use AMTOR on the HF bands. In 1980, the IARU Region 1 conference adopted a resolution urging all member countries to press for similar permission from their respective Posts and Telecommunications authorities.

In the beginning the only way to get on AMTOR was to write your own program to run on a microprocessor or 'home-brew' computer. This turned out to be very difficult, and the situation was really not made any easier when small computers initially became readily available, as the required programs could not be run in a high level language such as BASIC. However, Peter Martinez, G3PLX published two articles in *Radio Communication*, the monthly magazine of the Radio Society of Great Britain, (June/July 1980) that described a design for a code-converter board which allowed any conventional RTTY station to operate on AMTOR with the addition of a few level-shifting circuits. This became available in kit form and also as a made-up board, and was known as the Mk 1. I purchased one of these at the BARTG rally (British Amateur Radio Teletype Group) at Harpenden in July 1981, and after adding the necessary interfaces, (level shifting circuits mentioned above), to my ST 6 terminal unit, I commenced operation in the new mode. I do not exaggerate when I say that everything I had read about AMTOR was true, unbelievably so! This kit is now obsolete, being superseded by the Mk 2 which is available today from GPW Electronics of Ferndown, Dorset.

Call-up Facilities

One of the big attractions of the AMTOR mode 'A' is the availability of a 'SELCALL', that is, a 4 letter code which is uniquely yours. For example, my selcall code is 'GRDG', where my call is G3RDG. The selcall for GW3DZJ would be 'GDZJ', and so on. When on 'standby' the AMTOR system continuously monitors the incoming bit stream for this particular code, and only when your code is received

does the system spring into life. It is possible, therefore, to leave the receiver running for long periods without printing or displaying anything until someone calls you. This is a very different state of affairs to the working of 'Autostart' in conventional RTTY. I used to try Autostart in my RTTY set-up on 2 meters, and I must confess that it was not a great success. I suppose it was because of the fact that some operators use a speed of 45.45 bauds and others use 50 bauds, so that if you have set the gear to receive 45.45 bauds and someone comes up on the calling frequency at 50 bauds, you print a lot of rubbish!

Operating Procedures

When operating AMTOR, the first thing to do is to send 'CQ'. Normal practice is to send 'CQ' in mode 'B' giving your selcall in the transmission. eg: CQ CQ CQ DE G3RDG G3RDG G3RDG. SELCALL GRDG
CQ CQ CQ DE G3RDG G3RDG G3RDG. SELCALL GRDG PSE K K
This message can either be sent by hand keying, or, if you are operating with a computer, it can be put into the memory, and sent out by pressing one programmed key. When the message has been sent, the calling station reverts to 'Standby'. We will assume that a station answers my CQ, and calls me in mode 'A' by my selcall. (Remember that no one else can answer to it). The other station commences by typing 'GRDG' which activates my transmitter. He then perhaps, sends a few words such as 'de G3XYZ' followed by '+?'. Thus the transmission is passed back to me, and the QSO is under way. It carries on in the normal way, each end passing the transmission back and forth by means of the '+?' combination sent from the keyboard. However, there is a most interesting extra in the mode 'A' AMTOR operation. Either end can 'break-in' to the others transmission in order to raise a point or answer a question on the spur of the moment by pressing 'Control' and 'C' at the same time. This action forces the transmission back to the other end, and so the question or whatever can be answered followed by the usual '+?', passing the transmission

back to the originator. In this manner it is possible to have what amounts to a really good conversation — passing the transmission back and forth as if one were face to face with the other.

Amateur stations in many countries are active using AMTOR including Austria, Nigeria, Sudan, Zimbabwe, USA, Norway, Italy, Malaysia, Sweden, Switzerland and Japan to name but a few. In fact, there are over 25 countries active on this mode. There is also activity on 2 meters on AMTOR, at least, in the London area on a frequency of 144.590 MHz. The calling frequencies for the AMTOR mode on the HF bands are 3588 KHz, 14075 KHz, 21075 KHz and 28075 KHz. There is one African station who, at the time of going to press, maintains a standby watch at weekends on 21115 KHz.

Getting Started

As I mentioned previously, the easiest way to get on AMTOR is to purchase the Mk2 kit from GPW Electronics and tie it up with your existing RTTY gear, but a number of people, including yours truly, use the commercially manufactured 'AMT-1' from ICS of Arundel, West Sussex. This unit was reviewed by Tony Bailey, G3WPO, for the technical aspects of the unit, and yours truly (as a well satisfied user!) in this magazine in September 1983 so really I need

not add to this. There are other manufactured units appearing in the market place. HAL who are already well-known for their RTTY gear, have introduced their ARQ1000, which is a code converter unit and interfaces with their existing terminal unit and video display equipment. MICROLOG, another name well-known in the USA for their RTTY terminal, are introducing an add-on facility which should be an interesting proposition for existing operators. KANTRONICS in the USA is another name which comes to mind. They have just launched a range of programs to run AMTOR on the VIC20, CBM64 and Apple computers. These represent a low-cost introduction to AMTOR for those of you already owning the computers in question, and they offer facilities equivalent to the original Mk1 kit, using separate ARQ and FEC programs, and no RTTY or CW. *Unfortunately the European versions of the VIC20 and CBM64 will not run these programs because of differences in system timing.*

Commercial Feedback

Although AMTOR was originally 'acquired' from the commercial world, there is some evidence that a growing number of AMTOR units are filtering into commercial applications, mainly because of the much more expensive commercial equipment equivalent. At least two

scientific expeditions have used AMTOR units for HF communication back to base, and one maritime radio operator reports that he built an AMTOR kit while at sea and patched it into the ship's equipment, replacing the ageing commercial machine, with much improved results! Apart from the cheapness of AMTOR approach, another area where amateur techniques have shown the way is the use of transceivers for this mode. A comment in passing...Some of you might wonder whether the relays in a transceiver would stand up to the change from transmit to receive every 450 mS. Well, I can only tell you that I have been using my TRIO TS820S for the past two and a half years with more or less continuous AMTOR work, and no fault has developed in the relays yet!

Further Reading

I hope that the above has given you some idea of the working of this latest method of keyboard communication, and perhaps whetted your appetite for more information. In which case, I would recommend reading:-

a. 'AMTOR', an improved radioteletypewriter system, using a microprocessor by Peter Martinez, G3PLX. Radio Communication August 1979

b. 'AMTOR the easy way' by Peter Martinez, G3PLX. Radio Communication June/July 1980.

The ICS AMT-1 is controlled entirely by the operator's home computer 'terminal unit'. A number of LEDs behind the translucent front panel insert indicate the status and mode of the AMT-1, which can also be used as an interface for CW and RTTY.



EARTH-MOON-EARTH

with simple equipment

Part 3

3. Operating When to listen

The best way to learn about EME operating procedures is to spend some time listening before attempting to make contacts. This usually occurs anyway, as one is usually only too keen to try out the antenna and receiver as soon as these parts of the system are ready. The first question is, when to listen? Unfortunately EME activity levels are not yet high enough to guarantee that someone will be on whenever you want to listen. Activity

news'' newsletter published by K2UYH. There is a weekly net held on Saturdays and Sundays on 14345kHz between 1600 and 1700 GMT (for stations interested in 70cm and above), and 1700 onwards (for stations interested in 2m). The 70cm net begins with European traffic, and at 1645-1655 to 1700 there is a short period of international traffic, with W1JR acting as net controller. EME oriented stations are also to be found on Oscar 10, around 145.95MHz, or on Mode L. Both the

when the moon is close to perigee (to give the strongest signals). Since both of these phenomena have approximately 27 day cycles, sked weekends usually occur once every four weeks. The dates of the 70/23cm sked weekends for the remainder of 1984 are: May 12/13, June 9/10 or 23/24, July 21/22, August 18/19, September 15/16, October 13/14 or 20/21, November 17/18 and December 15/16. Activity levels on these dates should be high enough to enable some signals to be heard whenever the moon is up.

In the final part, Dr Charles Suckling, G3WDG, describes EME operating procedure.

tends to be concentrated on one weekend per month, referred to as the 'sked weekend'. This does not mean that all activity is in the form of skeds: indeed most activity during these weekends is 'random', ie non-prearranged. Skeds are arranged of course, either by personal arrangement or via the '432 and above EME

20m net and Oscar 10 are useful sources of information, and one can often hear skeds being arranged.

The dates for the sked weekends are chosen so that they occur when the moon has a high positive (northerly) declination (to give the maximum amount of operating time as well as the best windows), and if possible

Operating Frequencies

On number 2cm, 23cm, most EME occurs in the bottom 30kHz of the normal communication band. On 70cm, this means 432.000 to 432.030MHz. The 'newsletter'' sked frequencies are 432.000, 432.025 and 432.030MHz, and these frequencies should be left clear during sked weekends. Most of the random activity is concentrated into the segment 432.005 to 432.020MHz. 432.010MHz is the CW 'calling channel', and this tends to get rather busy during sked weekends, and weaker stations usually find it more productive to call CQ a few kHz either side of this frequency.

Operating Procedure

Because EME signals are very weak compared to signals normally found on the bands, special operating procedures have been devised to make contacts easier to achieve. With very few exceptions, strict time periods are used for skeds, CQ calls, replies to CQ calls and all subsequent traffic. On 2m two minute periods are used, and on 70cm 2.5 minute periods are used. During the early stages of a sked or QSO, the last 30 seconds of a period are reserved for reports only. The end of a period

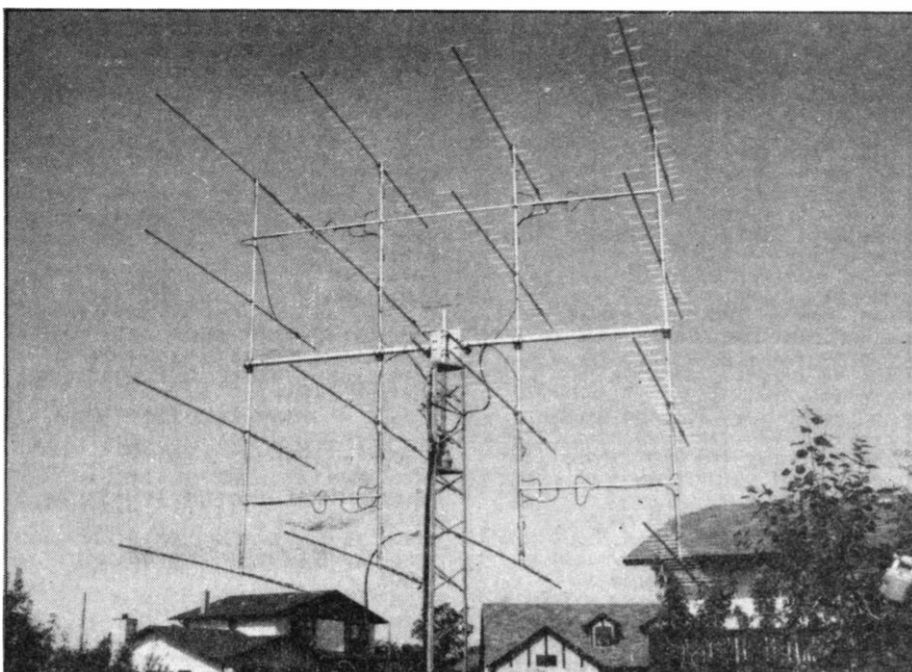

is terminated with a "K" and no callsigns. The rest of the period is used to send the callsigns, usually sent in three-by-three sequences.

The RST reporting system is only used when signals are good. Normally a different system is used, called the "TMO" system. In this, the letters T, M, or O are used as the report. They have the following meanings:

T: very weak, barely perceptible signals which are not strong enough to allow callsigns to be identified;

M: weak signals, but strong enough to allow callsigns to be positively identified;

O: good signals, strong enough to allow callsigns to be copied "in blocks" without too much difficulty.

On 70cm, M or O reports are good enough for the QSO to be valid, while on 2m the minimum is an O report. Of course, reports have to be acknowledged by the other station for the QSO to be complete, and on EME this is done by suffixing an R to the report being sent or by sending R on its own, as appropriate. M or O reports on 70cm, or an O report on 2m, *should only be sent when both callsigns have been positively identified*. This is different to meteor-scatter procedure, for example, where reports are sent before callsigns have been copied.

Worked Example

This procedure may seem a little complicated, and indeed some beginners do get confused! I hope that a short example will help to make things clearer. Suppose that two stations, W1JR and K2UYH have a sked on 70cm, with W1JR taking the first transmit period. If all goes according to the book, the QSO would proceed as follows:

1st period: W1JR sends K2UYH K2UYH K2UYH DE W1JR W1JR W1JR repeated for 2.5 minutes.

2nd period: K2UYH sends W1JR W1JR W1JR DE K2UYH K2UYH K2UYH, repeated for two minutes, then M M M M M repeated for 30 seconds (his report to W1JR).

3rd period: W1JR sends K2UYH K2UYH K2UYH DE W1JR W1JR W1JR repeated for 2 minutes then OR OR OR OR repeated for 30 seconds (his report to K2UYH, plus acknowledgement that he has copied his own report).

4th period: K2UYH sends W1JR W1JR W1JR DE K2UYH K2UYH K2UYH repeated for 2 minutes then R R R R R repeated for 30 seconds

```

95 REM MOON LOCATION PROGRAM
96 REM DEFINED CONSTANTS
100 P5 = 2.0000000000 *
3.1415926535
110 D5 = 360.000000000 / P5
120 R5 = P5 / 360.00000000
130 DEF FN A(X) = INT (X * D5 *
10 + .5) / 10
140 DEF FN B(X) = (X - INT (X))
* P5
145 REM DATA INPUT SECTION
150 INPUT "LATITUDE DEG,MIN?"
";L5,U5
160 INPUT "LONGITUDE DEG,MIN?"
";L6,U6
170 LA = L5 + INT ((U5 / 60) *
100) / 100
180 LO = L6 + INT ((U6 / 60) *
100) / 100
190 L5 = (L5 + U5 / 60) * R5
200 L6 = (L6 + U6 / 60) * R5
210 INPUT "INCREMENT IN MINUTES?"
";I
220 U5 = INT ((U5 / 60) * 100) /
100
230 U6 = INT ((U6 / 60) * 100) /
100
240 I6 = 100
250 GOTO 260
260 INPUT "DAY,MONTH,YEAR,TIME
START,TIME FINISH?" ;D,M,Y,B,E1
270 Y1 = Y - (INT (Y / 100) *
100)
280 PRINT
290 PRINT
300 NS$ = "N"
310 IF LA < 0 THEN NS$ = "S"
320 EW$ = "W"
330 IF LO < 0 THEN EW$ = "E"
340 PRINT "MOON
";D;"/";M;"/";Y1;" FROM LAT= ";LA
* SGN (LA);NS$;" LONG=" ;LO *
SGN (LO);EW$
350 F1 = 0
360 PRINT
370 I1 = 2
375 REM CALCULATION OF JULIAN
DATE
380 IF M > = 3 THEN 460
390 IF INT ((Y - 1853) / 4) < 11
THEN GOTO 420
400 C1 = - 1
410 GOTO 430
420 C1 = 0
430 J1 = 365 * (Y - 1853) + D + 30
* (M + 9) + INT ((M + 10) / 2)
440 J2 = INT ((Y - 1853) / 4) + 1
+ C1
450 GOTO 570
460 IF INT ((Y - 1852) / 4) < 11
THEN GOTO 490
470 C1 = - 1
480 GOTO 500
490 C1 = 0
500 IF M = 9 THEN 540
510 IF M = 11 THEN 540
520 C2 = 0
530 GOTO 550
540 C2 = 1
550 J1 = 365 * (Y - 1852) + D + 30
* (M - 3) + INT ((M - 2) / 2)
560 J2 = INT ((Y - 1852) / 4) +
C1 + C2
570 J = J1 + J2
580 T1 = J - 17472.5
585 REM CALCULATION OF DAYS
SINCE LAST PERIGEE AND AGE OF MOON
590 T9 = J + 2397547.5
600 T9 = T9 - 2444507.6
610 T7 = T9 - 14.6
620 T8 = INT (T7 / 29.5306)
630 T8 = T7 - T8 * 29.5306
640 Q = INT (T9 / 27.5545)
650 R = T9 - (27.5545 * Q)
660 S = 24 * R
665 REM START OF MAIN
CALCULATION LOOP
670 D9 = (B - INT (B / 100) *
100) + INT (B / 100) * 60
680 D6 = (E1 - INT (E1 / 100) *
100) + INT (E1 / 100) * 60
690 D7 = D9 - D6
700 D8 = D7 - I
710 IF D7 > = 0 THEN GOTO 730
720 GOTO 750
730 IF D8 > = 0 THEN GOTO 1840
740 B = E1
745 REM CALCULATION OF LUNAR
LAT AND LONG
750 T = (B - INT (B / 100) * 100)
/ 1440 + INT (B / 100) / 24
760 T5 = T1 + T
770 K1 = FN B(.751213 +
.036601102 * T5)
780 K2 = FN B(.822513 +
.03629116457 * T5)
790 K3 = FN B(.995766 +
.00273777825 * T5)
800 K4 = FN B(.974271 +
.0338631922 * T5)
810 K5 = FN B(.0312525 +
.0367481957 * T5)
820 LB = K1 + .658 * R5 * SIN (2
* K4) + 6.289 * R5 * SIN (K2)
830 LB = LB - 1.274 * R5 * SIN
(K2 - 2 * K4) - .186 * R5 * SIN
(K3)
840 LB = LB + .214 * R5 * SIN (2
* K2) - .114 * R5 * SIN (2 * K5)
850 LB = LB - .059 * R5 * SIN (2
* K2 - 2 * K4) - .057 * R5 * SIN
(K2 + K3 - 2 * K4)
860 K6 = K5 + .6593 * R5 * SIN (2
* K4) + 6.2303 * R5 * SIN (K2) -
1.272 * R5 * SIN (K2 - 2 * K4)
870 L7 = 5.144 * R5 * SIN (K6) -
.146 * R5 * SIN (K5 - 2 * K4)
875 REM CALCULATION OF LUNAR
RA AND DEC
880 D1 = COS (L7) * SIN (L8) *
.397821 + SIN (L7) * .917436
890 D1 = ATN (D1 / (SGN (1 - D1
^ 2)))
900 G1 = 50 + .5 + ((D1) / (.792))
* D5
910 G2 = 80 + ((D1) / (.808)) * D5
920 G3 = 141.5 - ((D1) * (.738) *
D5)
930 G4 = 170.5 - ((D1) * (.857) *
D5)
940 A2 = (COS (L7) * COS (L8)) /
COS (D1)
950 A1 = (COS (L7) * SIN (L8) *
.917436 - SIN (L7) * .397821) /
COS (D1)
960 A = ATN (A1 / A2)
970 GDSUB 1230
980 R1 = A
990 L1 = .065709822 * T1
1000 L = T * 24 * 1.002738 +
6.646055 + (L1 - INT (L1 / 24) *
24)
1010 L = (L - INT (L / 24) * 24)
1015 REM CALCULATION OF GHA
FROM LOCAL SIDERIAL TIME
1020 G = (L / 24) * P5 - R1
1030 IF G < P5 THEN GOTO 1060
1040 G = G - P5
1050 GOTO 1090
1060 IF G < 0 THEN GOTO 1080
1070 GOTO 1090
1080 G = G + P5
1085 REM CALCULATION OF LHA
FROM GHA
1090 H = L6 - G
1095 REM CALCULATION OF
ELEVATION
1100 E3 = COS (L5) * COS (H) *
COS (D1) + SIN (D1) * SIN (L5)
1110 E2 = SQR (1 - (E3 * E3))
1115 REM PARALLAX CORRECTION
FOR ELEVATION
1120 E = ATN ((E3 / E2) - (1 /
(61.33 * E2)))
1130 F = ATN (E3 / E2)
1135 REM JUMP TO TIME
INCREMENTING ROUTINE IF MOON IS
BELOW HORIZON
1140 IF E < 0 THEN GOTO 1770
1150 IF E > I6 * R5 THEN GOTO
1770
1155 REM CALCULATION OF
AZIMUTH
1160 A2 = SIN (D1) / (COS (L5) *

```

```

COS (F))
1170 A2 = A2 - ( SIN (L5) / COS
(L5)) * ( SIN (F) / COS (F))
1180 A1 = SIN (L5) * SIN (D1) +
COS (L5) * COS (D1) * COS (H)
1190 A1 = ( SIN (H) * COS (D1)) /
SQR (1 - A1 ^ 2)
1200 A = ATN (A1 / A2)
1210 GOSUB 1230
1220 GOTO 1370
1225 REM SUBROUTINE TO REMOVE
AMBIGUITIES ASSOCIATED WITH ATN
FUNCTION
1230 IF A = 0 THEN GOTO 1250
1240 GOTO 1280
1250 IF A2 < 0 THEN GOTO 1270
1260 GOTO 1360
1270 GOTO 1360
1280 IF A > 0 THEN GOTO 1340
1290 IF A2 < 0 THEN GOTO 1320
1300 A = P5 + A
1310 GOTO 1360
1320 A = P5 + (A - P5 / 2)
1330 GOTO 1360
1340 IF A2 = > 0 THEN GOTO 1360
1350 A = A + P5 / 2
1360 RETURN
1365 REM CALCULATION OF
DOPPLER SHIFT FOR ECHOES ON 432MHZ
1370 D7 = - .38 * ( SIN (.526 * S
/ 57.3))
1380 F = 432 * (D7 - (3.1 * COS
(D1) * COS (L5) * SIN (- 1 *
H)))
1390 F = INT (F)
1400 IF (T - I1) > (2 * I) / 1440
THEN GOTO 1420
1410 GOTO 1430
1420 PRINT
1430 IF INT (B + .5) > 9 THEN
GOTO 1460
1435 REM ROUTINE FOR PUTTING
LEADING ZEROS IN FRONT OF TIME
(B=TIME)
1440 S$ = "000"
1450 GOTO 1530
1460 IF INT (B + .5) > 99 THEN
GOTO 1490
1470 S$ = "00"
1480 GOTO 1530
1490 IF INT (B + .5) > 999 THEN
GOTO 1520
1500 S$ = "0"
1510 GOTO 1530
1520 S$ = ""
1530 Z1 = FN A(A)
1540 Z2 = FN A(E)
1550 Z3 = FN A(G)
1560 Z4 = FN A(D1)
1570 IF F1 = 1 THEN GOTO 1650
1580 R1 = INT (R)
1590 PRINT "DAYS SINCE PERIGEE="
";R1
1600 PRINT "AGE OF MOON=" ; INT
(T8 * 10) / 10;" DAYS"
1610 PRINT
1620 PRINT " GMT AZ EL
GHA DEC DOP"
1630 PRINT " --- -- --
--- ----"
1640 F1 = 1
1645 REM PRINTING OF FINAL
RESULTS (S$=LEADING ZEROS, STR$
CONVERTS TIME TO A STRING,
Z1=AZIMUTH, Z2=ELEVATION, Z3=GHA,
Z4=DECLINATION, F=DOPPLER SHIFT)
1650 PRINT S$; STR$ ( INT (B +
.5));
1660 HTAB 7
1670 PRINT Z1;
1680 HTAB 14
1690 PRINT Z2;
1700 HTAB 20
1710 PRINT Z3;
1720 HTAB 27
1730 PRINT Z4;
1740 HTAB 34
1750 PRINT F
1760 I1 = T
1765 REM TIME INCREMENTING
ROUTINE
1770 HR = INT (B / 100)
1780 MN = B - 100 * HR
1790 MN = MN + I
1800 B = 100 * (HR + INT (MN /
60))
1810 MN = MN - ( INT (MN / 60)) *
60
1820 B = B + MN
1825 REM LOOP BACK TO MAIN
CALCULATIONS
1830 GOTO 670
1840 PRINT
1850 PRINT "RE-RUN PROGRAM? (Y/N
";
1860 INPUT D$
1870 IF D$ = "Y" THEN GOTO 100
1880 END

```

BASIC program for determining the position of the moon.

(acknowledging that he has copied his report).

At this point, the QSO is complete, and pleasantries such as TNX, 73, GL etc are usually sent with no special procedure, except for time periods. Of course, things do not always work out as well as this, for example a station may not copy the report, and repeats are then necessary. The lack of an R from the other station will tell you that you have to send the report again. If you can hear your QSO partner, but not well enough to get both callsigns then use the T report, as it tells the other station that you are at least getting something. It is possible that as a result of this your partner might change the polarisation of the antenna and could be stronger on the next transmission. If you hear nothing at all from the other station, the strict procedure is to send nothing during the

30 second reporting period. Some stations do not do this, however, but continue sending callsigns for a full 2.5 minutes. The advantage of not sending anything is that it is a positive signal to the QSO partner that you are hearing nothing. Callsigns sent during a reporting period could be confused for reports.

When answering CQ calls, the same procedure should be followed as for skeds. You have the option of sending callsigns and a report, or just callsigns, in your reply. The advantage of sending callsigns and a report is that the contact can be completed more quickly — which might be desirable in a contest, but in EME working reduces the other stations "callsign deciphering" time by 20%. If the other station replies with QRZ?, then you should reply with callsigns only, as the other station is obviously not copying you very well.

One final point about procedure. Quite often stations do not stick to the 2 minutes of callsigns and 30 seconds of reports once they have copied a report from their QSO partner. Instead, they increase the time spent sending reports, since by that time they know that the other station has already copied the callsigns. Do not be surprised if this happens to you, but I would recommend that you stick to the formal procedure until you are fully familiar with EME procedure.

When you hear your first EME signals, do not be too surprised if you find them rather difficult to copy. Apart from the fact that the signals are weak, they are also subject to rapid fading (libration fading). The net result is that you only hear a certain percentage of what is being sent, almost on a character by character basis. With experience, the fading seems to become less of a problem. In a sked, you know in advance what the callsigns will be. When listening to the signals, try to pick out parts of the morse characters. This helps the brain to 'lock-in' to the sending speed. Sooner or later a complete letter will be heard. The brain can then anticipate what the next letter ought to be, and if part of it only is heard, you can still correlate it with what was sent. Of course, it is more difficult to identify callsigns when you have no idea beforehand who you are listening to, but with experience you build up a 'data base' of callsigns which you can try to fit to what you hear, until you get a positive identification. Taping signals is good idea, as one can go back to the tape afterwards and possibly copy more than you did at the time.

Moon Tracking

Finally, we come on to one very important aspect of EME operating — keeping the antenna pointed at the moon. If you have followed the suggestions above, you should now have an antenna with calibrated elevation and azimuth readouts. All you need to know is the elevation and azimuth of the moon at the time and you are in business. If your antenna is not equipped with calibrated readouts, then you have only yourself to blame when you have to miss that sked because it was cloudy and you could not see the moon!

There are a number of ways of working out the moon's position, but by far the most convenient is to use a

computer. The program reproduced here was written for an Apple II+ (as were all the programs in this series), but should run with little or no modification on most machines. It is based on an original program by WA1JXN, and I have added three useful features. In addition to printing out the elevation, azimuth and astronomical co-ordinates of the moon, the program also gives the number of days since perigee for the day in question, the age of the moon (the number of days since New moon) and the total Doppler shift (in Hertz) which you will find on your own echoes (on 70cm). The program can be easily modified to give the Doppler shift for other frequencies by changing the 432 in line 1380 to the frequency required. The one-way Doppler shift is half the number printed out, and by adding together the one-way Doppler shifts for your site and for your QSO partner's, the overall Doppler shift can be calculated. The number of days since perigee is useful to know, as it allows you to estimate the current EME path loss. Remember that there is a 2dB change in path loss as the moon goes from perigee to apogee. It takes about 27 days for the moon to go from one perigee to the next. The age of the moon is given, mainly so that you can be aware if the moon is close to New moon. At this point in the moon's orbit, it can happen that the sun and moon are close together in the sky, and your antenna could pick up some noise from the sun, which would degrade the receiver's performance.

Suppose that you want to run the program for 29 May, from 0000 to 2400GMT, at intervals of 60 minutes, from a site with a latitude of 51 deg 30min North, and a longitude of 1 deg 50min West. The program's prompts and appropriate entries are as follows:

```
LATITUDE DEG,MIN? 51,30
LONGITUDE DEG,MIN? 1,50
INCREMENT IN MINUTES? 60
DAY,MONTH,YEAR,TIME START,TIME FINISH?
29,5,1984,0000,2400
```

The program then outputs the following:

```
MOON 29/5/84 FROM LAT= 51.5N LONG= 1.83W
```

```
DAYS SINCE PERIGEE= 19
AGE OF MOON= 27.9 DAYS
```

GMT	AZ	EL	GHA	DEC	DOP
0400	69.9	4	259	16.3	926
0500	80.8	12.9	273.5	16.5	946
0600	91.9	22.1	288	16.6	913
0700	103.8	31.3	302.5	16.8	833
0800	117.4	39.9	317.1	17	708
0900	133.8	47.5	331.6	17.2	548
1000	154.1	53.1	346.1	17.4	362
1100	177.9	55.5	.6	17.5	163

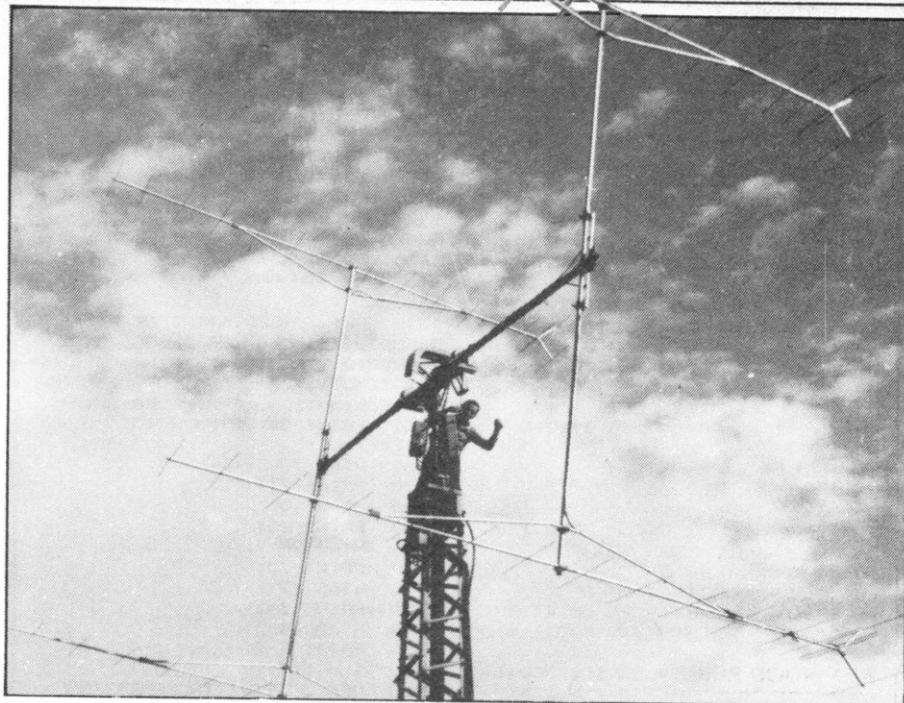

The 4 x 16 ele yagis of I2MBC provide an excellent signal on 2 m EME

1200	202.2	54.1	15.1	17.7	-36
1300	223.5	49.2	29.6	17.9	-224
1400	240.8	42.2	44.2	18.1	-387
1500	255.1	33.9	58.7	18.2	-516
1600	267.4	25	73.2	18.4	-603
1700	278.7	16.1	87.7	18.6	-642
1800	289.7	7.4	102.2	18.7	-630

As with the sun program, you must enter the latitude and longitude as negative numbers if your location is south of the equator, or east of Greenwich, respectively.

To track the moon, all you have to do is to set the antenna to the predicted co-ordinates at suitable time intervals. How often this has to be done depends on the beamwidth of the antenna. The narrower the beamwidth, the more often you have to update the position of the antenna. A 4 yagi array on 432MHz ought to be updated at not greater than 10 minute intervals.

Special Research Permits

Since power levels in excess of the UK legal limit are almost always required for EME working, it is unfortunately rarely possible to operate on EME within the terms of the normal UK licence. A limited number of "Special Research Permits", which in some cases allow operation at higher power levels, may be available to licenced amateurs who can demonstrate a need for one. These are issued by the DTI as an extension to the normal licence, and enquiries should be addressed to the RSGB, c/o the Chairman of the Licensing Advisory Committee (David Pratt, G3KEP). The

RSGB has been asked to process all applications for these permits prior to their submission to the FTI. It should be noted that the Special Research Permits allow the use of high power *only* for the purpose for which they are issued, in this case EME.

Further Information

In this short series on EME operation, I have tried to cover all of the necessary background needed to become active on EME. Best of luck! For further information, the following publications are recommended:

1. "432 and above EME News". This is a monthly newsletter intended for active EME stations needing sked information. It is published by Allen Katz, K2UYH, RD#4, Old Trenton Road, Trenton, NJ 08691, USA. In order to receive the newsletter, SAEs should be sent to K2UYH, together with \$1 per envelope.
2. "The EIMAC EME Notes". These contain a lot of very useful information about EME and are available free of charge from Bob Sutherland, W6PO, c/o Eimac Division of Varian, 301 Industrial Way, San Carlos, California, USA.
3. RSGB VHF/UHF Manual, by G.R. Jessop G6JP, pp. 10.16-10.20.

Acknowledgements

I would like to thank G4FRE, G3SEK, and G3LTF for providing some of the information used in this series.



FANTASTIC SAVINGS AT Western

"HURRY"! YAESU'S FT757/FP757/FC757

ALL FOR ONLY £966.00.

Full warranty available via Yaesu authorised distributor. At WESTERN you'll get a good deal PLUS full after sales service from the longest established UK supplier of Yaesu. Remember WESTERN have been importing Yaesu for 15 years.

YAESU PRICE LIST (INC VAT FREE DELIVERY)

HF EQUIPMENT

Cat No	Type	Description	Price £	General Coverage Receiver with Memory ATU	399	1258 NC-7C	Base Charger for FT-208/708	29
1195 FT-102	Transceiver		684	1254 FRT-7700	44	1260 FBA-2	Battery sleeve for NC-7/8	3
1196 SP-102	Speaker		49	1255 FRA-7700	36	1261 MMB-10	Mobile Bracket	7.50
1197 SP-102P	External speaker & phone patch		69	1257 FRV-7700	83	1262 NC-9C	Compact Trickle Charger	8
1198 FV-102DM	VFO Scanner		219	1273 MEM7700	59	1263 FT-230R	2m FM Mobile Transceiver, 25W	249
1199 FC-102	ATU		170	1246 FL-2100Z	499	1237 FT-726R	VHF/UHF Multiband, multimode	
1206 FAS-1-4R	Antenna Switch		39	1251 Cabinet for FT-101Z	20	1238 430/726	Transceiver c/w 2m	699
1204 FT-1	Transceiver All Mode/General Coverage		1399	1276 AM Unit	17	1239 SAT726	70cm module	239
1224 FT-101Z/AM	Transceiver with AM unit		515	1200 NC-1	19	1259 PA-3	Satellite Unit	90
1225 FT-101Z/AM	Transceiver (digital) with AM unit		589	1201 PA-1	19	MICROPHONES/ACCESSORIES		
1228 DIG101	Digital Unit		99	1205 FP-4	42	1208 MH1 B8	Hand mic, scanning	14
1274 Fan B	Fan		13	1220 FP-80A	53	1214 YM-35	Hand mic, scanning, for FT-1/102/707 series	15.95
1229 FT-77	Compact Transceiver		439	1234 FT-290R	259	1215 YM-36	Noise cancelling mic, 4-pin, 50K	15.95
1230 Marker Unit	FM Unit for FT-77		10	1202 CSC-1A	395	1221 YD-148A	Desk mic, 50K/600 ohms, 4-pin, for FT-101 series	22.75
FM Unit for FT-77			25.90	1210 MMB-11	80	1235 YM-38	Desk mic, scanning, for FT-1/102/707 series	26.50
FP-700	PSU		119	1211 NC-11C	219	1250 YM-49	Speaker/mic, for FT-290/230R	17
FC-700	ATU for FT/707		94	1241 FT-720RU	189	1213 QTR-24D	24-hour quartz clock	32
FV-700DM	Digital VFO		190	1242 FT-720RV	14.50	1216 YH-55	Lightweight headphones	10.50
1247 FT-980	Transceiver (CAT)/General Coverage		1149	1217 E-721	37	1219 YH-77	Lightweight headphones	11
1243 SP-980	Speaker		56	1218 S-72S	189	1278	Battery Holder for FRG-7	
1244 FT-757GX	All Mode Transceiver/General Coverage		650	1233 FT-208R	49			
1245 FP-757GX	AC PSU		139	FT-708R				
FC-757AT	ATU		219	1253 NC-8C				
1248 FRG-7700	General Coverage Receiver		349					

KENWOOD PRICE LIST. 2 Yr warranty. Free delivery.

Cat No	Type	Description	Price £	De luxe VFO knob	11.50	1343 TR-8400	70cm Transceiver	279
1331 TS-9030S	Transceiver, HF, W, gen cov. receiver		1099	1354 YK-88C	36	1368 PS-10	DC PSU	52.50
1330 TS-930S +ATU	As above, with automatic ATU		1199	1309 MC-30S	259	1369	SP-40 Compact Mobile Speaker	15.75
1329 SP-930	Speaker and filters		57	1328 R-600	8.26	1371 MC-46	Auto-patch Up/Down microphone	42.50
1313 MC-60A	Desk Top Microphone, scanning		54	1333 DCK-1	219	1313 MC-60A	Desk Top Microphone, built-in pre-amp.	50
1357 YK-88A1	6kHz AM filter		32	1332 R-1000	8.26	1339 TR-9130	2m All Mode Transceiver, 25W	419
1358 YK-88C1	500Hz CW filter		32	1318 SP-100	399	1372 BP-9A	System Base	
1348 YG-455C-1	500Hz CW filter		75	1333 DCK-1	33	1373 SP-120	External Speaker	
1349 YG-455C-1	270Hz CW filter		75	1335 R-2000	8.26	1374 PS-30	DC Power Supply	114
1324 TS-430S	Transceiver, HF, w. gen cov. receiver		719	1355 YG-455C	32	1370 BC-1	AC Adaptor for memory back-up	6.43
1310 PS-430S	DC power supply, de luxe cooled		113	1337 TR-2400	399	1371 MC-46	Touch-tone microphone	41.50
1319 SP-430	External speaker		30.50	1301 ST-1	45	1313 MC-60A	Deluxe Desk Top Mic. + pre-amp.	52
1334 FM-430	FM Unit		33.75	1309 MC-30S	14	1369 SP-40	Compact Mobile Speaker	
1321 MB-430	Mobile Mount		12.59	1338 TR-2500	219	1341 TR-9500	70cm All Mode Transceiver	429
1322 AT-250	Automatic ATU		280	1304 ST-2	52	1372 B0-9/A	System Base	48.50
1313 MC-60A	Desk Top Microphone		54	1360 MS-1	32	1373 SP-120	External Speaker	34
1320 AT-130	Antenna Tuning Unit		57	1342 VB-2530	75	1370 PS-20	DC Power Supply	59
1354 YK-880	500Hz CW filter		36	1306 SMC-25	17	1370 BC-1	AC Adaptor for memory back-up	6
1315 YK-88CN	250Hz CW filter		36	1361 BT-1	6.50	1313 MC-60A	Deluxe Desk Top Mic. + pre-amp.	50
1352 YK-88SN	1.8kHz SSB filter		45	1311 PB-25	26	1373 SP-120	Compact Mobile Speaker	15.75
1353 YK-88A	6kHz AM filter		45	1305 SC-4	14	1316 TL-922	2KW HF Linear Amplifier	799
1314 PS-30	DC PSU		609	1362 LH-2	14	1376 SM-220	1.8-150MHz Station Monitor	250
1326 TS-530S	Transceiver, HF		45	1363 TU-35A	14	1351 HC-10	Digital World Clock	65
1327 SP-230	External Speaker		149	1364 RA-4	14	1350 PC-1A	Phone Patch	50
1325 AT-230	Antenna Tuning Unit		54	1366 RA-4	26	1303 RA-1	Antenna	8
1313 MC-60A	Desk Top Microphone		32	1367 RA-3	14	1379 MC-42S	Spare Up/Down Microphone	16
1312 MC-50	Desk Top Microphone		32					

Penetrate the four corners of the earth with the Western DX "PENETRATOR"

IN USE FROM VK7 to VE7!

HERE'S THE SPECIFICATION...

- ★ 3 elements on each band
- ★ heavy duty 2kW rated
- ★ Gain up to 8dB

- ★ Broadband operation
- ★ Stainless steel hardware
- ★ SWR less than 1.3:1

HERE'S WHAT THE CUSTOMERS SAY!

1. VK7NOW "I have recently installed a DX-33 beam and I would like to advise you that I am extremely satisfied with it. It certainly outperforms the TH3JNR which I previously used and also the VSWR is lower"

2. G3AAE "This letter is to tell you how pleased I am with the DX-33 antenna. On unpacking the DX-33 I was immediately impressed with the quality of the hardware and in operation it is just as impressive. I have used it on all three bands and have been obtaining excellent reports from DX stations all over the world. I have conducted tests with other stations and these show that the electrical figures included in the DX 33 specification are fully met in practice. Congratulations on a very fine product!"



DX 33
3 Element
3 Bands

WESTERN ANTENNAS (Carriage paid)

Cat No	Type	Description	Price £
1075 DX 7/2	2MHz 2 ele Yagi	Gamma matched 20' boom	239.00
1076 DX 7/3	2MHz 2 ele Yagi	Gamma matched 40' boom	354.20
1077 DX 5/1	Rotary dipole	for 28,24,21,18 and 14MHz	90.95
1080 DX 6V	1080m Multi-band vertical	plus 30m	99.00
1081 DX 3/1	Fipolr	10/15/20m 2Kw p.e.p.	81.65
1082 DX 3/2	2 element	10/15/20m 2Kw p.e.p.	125.35
1083 DX 3/3	3 element	10/15/20m 2Kw p.e.p.	182.85
1084 DX 3/4	4 element	10/15/20m 2Kw p.e.p.	258.45
1085 DX 3/1/32	Conversion Kit		50.80
1086 DX 3/2/33	Conversion Kit		63.25
1087 DX 3/3/34	Conversion Kit		75.90
1089 DX 10/3	3 element 10m Yagi		90.85
1090 DX 10/5	5 element 10m Yagi		113.85
1093 DX 4K	Converts DX 31/2/3/4	to 40m dipole	89.00
1094 DX 27/1	Rotary dipole	for 27MHz C.B.	12.65
1095 DX 27/3	3 ele Beam	for 27MHz Gamma matched	36.80
1096 DX 24Q	2 ele quad	2, 10, 15 & 20m	199.99
1097 DX 26Q	2 ele quad	2, 10, 15, 16 & 20m	224.25

The ULTIMATE in DESIGN... the ULTI-MAST
 Our structural engineering department came up with the maximum of strength for the minimum of cost. It's impossible to get MORE strength for LESS cost ... so beware of cheap copies ... they may not have the correct materials.

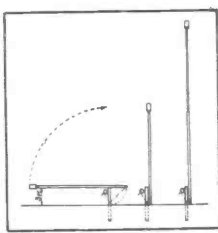

PRICES (inc carr & Vat)
 Ultimast UM-1 £263.35
 Reducer head, UHD £8.05
 Rotor head, UHD-2 £35.65

SERVICES:
BARCLAYCARD ACCESS
 Orders can be left on our answering machine

Western Electronics (UK) Ltd FAIRFIELD ESTATE, LOUTH, Lincs LN11 OJH
 Tel: Louth (0507) 604955, Telex: 56121 WEST G

Agent-Northern Ireland
 Torn Greer GI4TGR
 Nomra Greer GI4TBP
 Tel: Drumbo (023 126) 645

OPEN HOURS: 08.00-12.00; 13.00-16.30 Mon/Fri; SATURDAYS BY APPOINTMENT

Radio Yesterday

We could hardly believe our ears, but the order was quite clear. The Section had to provide wireless communication for a Company of Infantry who had been detailed to maintain order during a Hindu religious festival at Horwar, on the banks of the River Ganges, and the radio equipment would be carried

used to operating "Mule Mobile" — both phone and CW, whilst walking alongside the mule on the move. Nobody had even considered using elephants, and few had been nearer to those large animals than a visit to the zoo or viewing them in procession in one of the Indian Princely States, and

standing on the ground and the base of the antenna is clearly visible.

Another photograph (B) shows this type of set mounted on a mule, the pannier on the opposite side carried the batteries to operate the equipment. The high tension of 150 volts was made up from 100 1.5 volt inert cells and two volt accumulators were used to heat the valve filaments. The close-up photograph of the Wireless Set No.1 on the ground provides a good indication of the size of the equipment; towards the right hand side, just underneath the second control knob is an attachment for housing a gents pocket type watch, the compartment on the right houses the headphones, microphone and morse key, and the small drawer above that compartment contains spare valves

Mounting the equipment on the elephants presented many problems, as, even with the animal lying or kneeling down, its back was a good six or seven foot above ground, and when the elephants 'saddles' had been designed wireless sets had not even been invented. The 'saddles' were designed to carry the mahout (driver) and two passengers with little room to spare. Eventually it was decided to fit the radio equipment in the space normally occupied by the passengers and the operators would ride with their legs dangling over the side of the elephant.

Not a very comfortable position but it was the only way to overcome the problem — needless to say the operators comments were hardly printable!

The festival lasted a week, six 'Elephant Mobiles' were used and their slow steady pace did not damage the radio equipment but played havoc with the operators

Have you ever operated a 'Mule Packet'? Or been mobile on an Elephant? Well, George Metcalfe, G6VS, has...

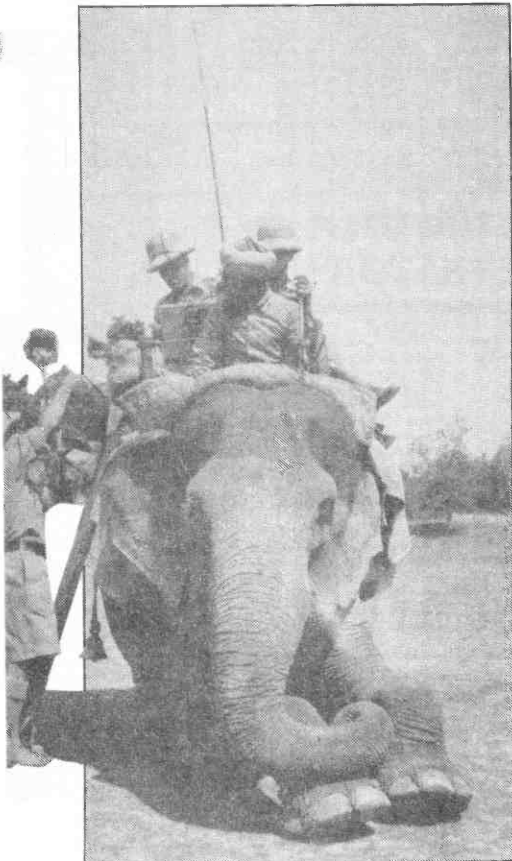

mobile on ELEPHANTS!

The Wireless Set No.1 had been carried on mules for some time and the operators were well

there was no opportunity for a trial run to see how the equipment could be fitted and carried on the elephants. The only solution was to take all the harness used for mule transport and adapt it as best we could when we had an "Eyeball" with the elephants.

By present day standards, the military radio equipment we used in the mid 1930's would be considered very primitive. The Wireless Set No.1 was housed in a case approximately 14 inches high, 22 inches wide and about 8 inches deep, and the transmitter consisted of an RF pentode with anode and screen pins at one end and grid and filament connecting pins at the other end, mounted horizontally, as a Colpitts Master Oscillator driving a PM1LF power amplifier giving about 2.0 W — truly a QRP rig. The frequency range was approximately 4.0 to 7.0 MHz. The receiving side consisted of the same type of RF pentode, followed by detector and two low frequency stages using the same PM1LF type of valves with resistance capacity coupling. The antenna was a vertical rod approximately eight feet long mounted on an insulated base which was fitted to the top of the case. Photograph A shows this set

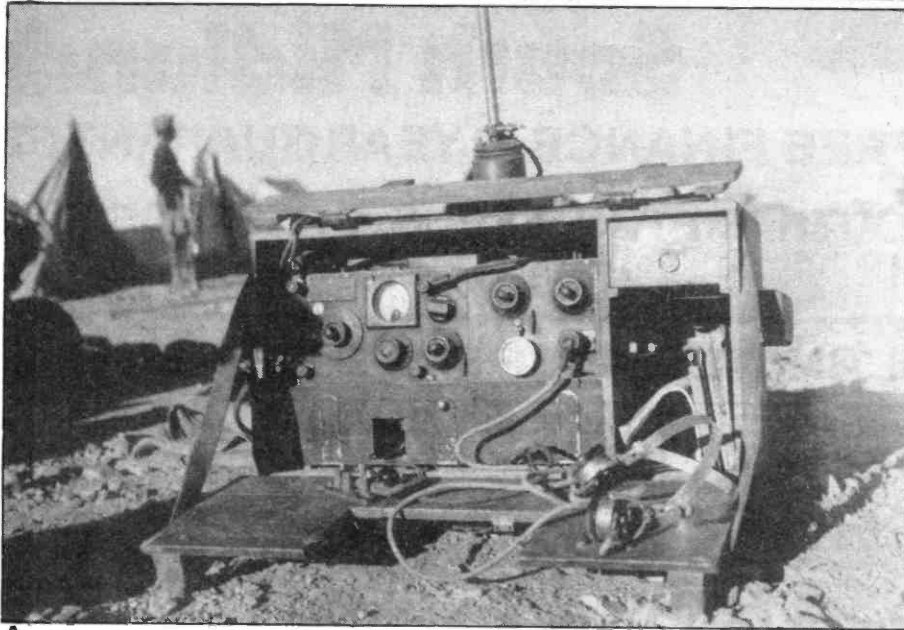

stomaches! However by the end of the week most of them overcame the 'elephant sea-sickness' and operating procedure improved considerably.

As far as the writer is aware, this was a unique experience and possibly the only time, certainly the only time before the war, that radio equipment has been carried and operated from elephants on the move.

Photo D shows a 'holy man' sitting on a bed of nails — the nails were very sharp — that was taken at the same festival. The final picture (E) shows a base wireless station on the North West Frontier, the petrol generator and operator are in the foreground and W/T Set 'A' with its bright emitter valves can be seen in the background.

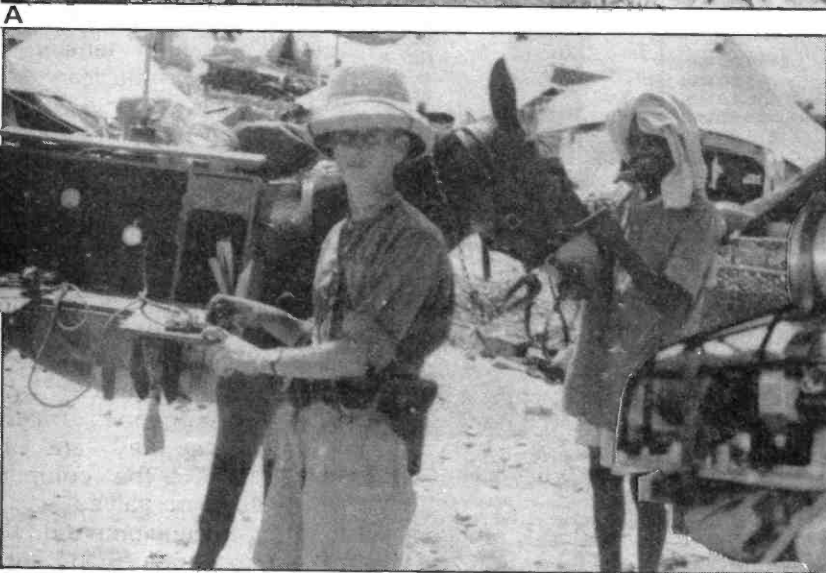

D

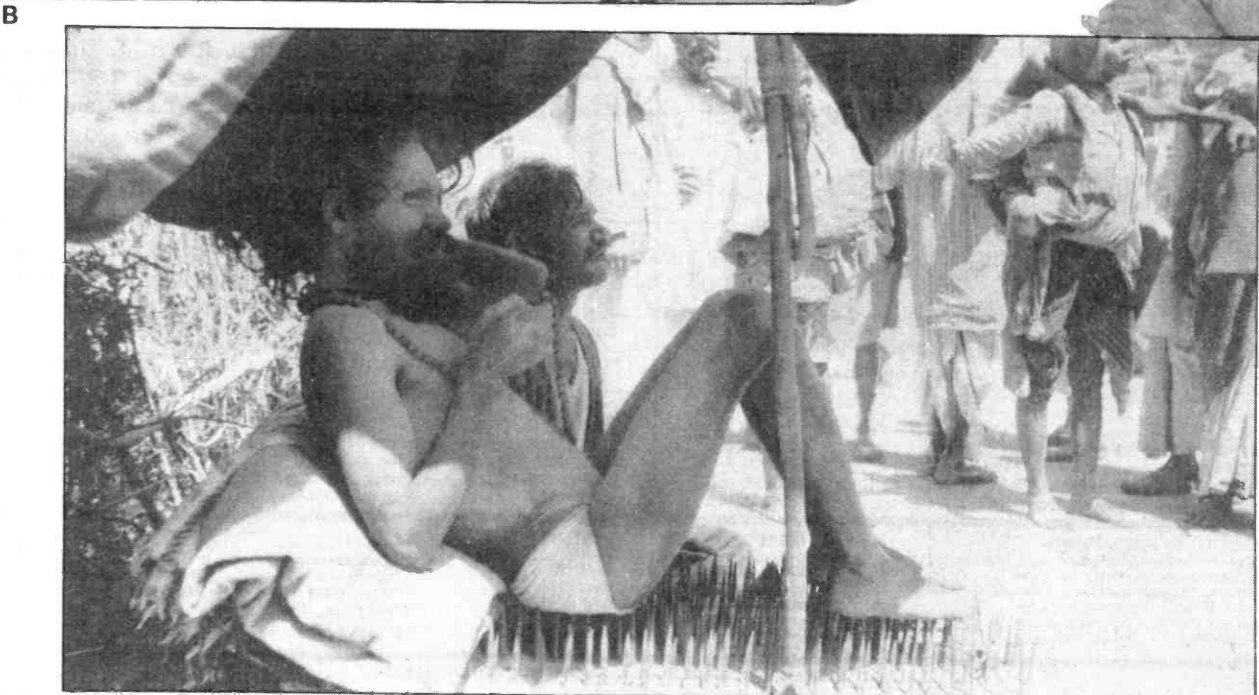
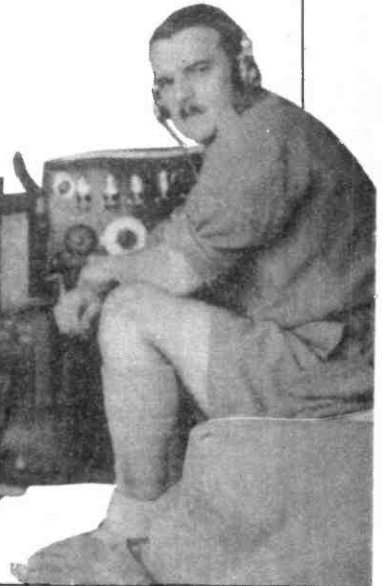

C



South Midlands

FREE FINANCE 2 YEAR GUARANTEE

BRANCHES AT: SOUTHAMPTON, LEEDS, CHESTERFIELD,

'YAESU' YOUR ULTIMATE CHOICE FOR EQUIPMENT



FT203R YAESU'S NEW COMPACT 2M HANDIE



The ultra compactness of the FT203R is due mainly to Yaesu's chip component circuit board assembly, the chip components being installed automatically by robots. The 203's features include thumbwheel frequency selection, built in S/PO meter, 2.5W RFO/P at 10.8V, (1.5W O/P with FNB4). Vox activated switching is possible when used in conjunction with YH-2. Accessories supplied include FNB3, FTE* tone unit, CSC6 case and YHA-14A antenna.

FT203R	2.5W transceiver	£169.00 inc.
FBA5	Case for 6AA cells	£6.50 inc.
FNB4	12V Nicad pack	£36.40 inc.
CSC7	Soft case (when FNB4 is used)	£6.50 inc.
YH-2	Headset/Mic	£13.80 inc.
MH-12A2B	Speaker Mic	£16.85 inc.
SMC8.9AA	Charger (13A style)	£8.05 inc.
MMB21	Mobile mounting bracket	£7.65 inc.



HANDHELDS FOR 2m or 70cm FT208R & FT708R



FT208R	2m Handheld 2.5W	£199.00 inc.
FT708R	70cm Handheld 1W	£209.00 inc.
SMC8-9AA	(13A style) Handy charger	£8.05 inc.
NC7	Bass charger	£32.95 inc.
NC8	Base quick charger+PSU	£54.05 inc.
PA3	DC adaptor and charger	£15.35 inc.
NC9C	Slow charger	£8.80 inc.
FNB2	Nicad Battery Pack	£21.45 inc.
FBA2	Battery pack sleeve	£3.45 inc.
FLC5	Heavy duty case	£25.30 inc.
MMB10	Mobile bracket	£8.05 inc.



FT726R MULTIMODE UHF, VHF, HF.



FT72R(2)	Transceiver c/w 2m	£739.00 inc.
21/24/28	HF module	£200.00 inc.
50/726	6m module	£185.00 inc.
430/726	70cms module	£250 inc.
SAT726	Full duplex module	£95.00 inc.
XF455MC	600Hz CW filter	£39.85 inc.



MULTIMODES FOR 6m, 2m and 70cm



FT690R	Multimode Transceiver 6m	£249.00 inc.
FT290R	Multimode Transceiver 2m	£269.00 inc.
FT790R	Multimode Transceiver 70cm	£249.00 inc.
SMC2.2C	2.2Ah Nicads 'C' size	per set £21.60 inc.
SMC8C	220mA Charger (13A Style)	£8.80 inc.
MMB11	Mobile Mount	£26.85 inc.
CSC1A	Carrying case	£4.20 inc.
FL6010	6m 10W Amplifier	£49.00 inc.
FL2010	2m 10W Amplifier	£63.25 inc.



FM TRANSCEIVERS FOR MOBILE

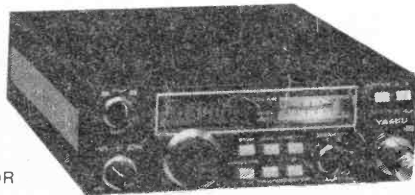

FT230R

FT230R	2m Transceiver 25w	£259.00 inc.
FT730R	70cm Transceiver 10w	£229.00 inc.
FT720RVH	Transceiver 2m 25W	£209.00 inc.
FT720RU	Transceiver 70cms 10W	£229.00 inc.



COMMUNICATIONS RECEIVER FRG7700

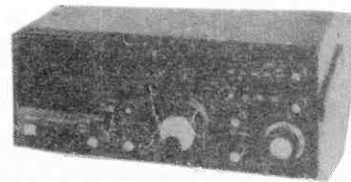

FRG7700	Receiver 0.15-30 MHz AM/CW/SSB/FM	£369.00 inc.
FRG7700M	Receiver c/w 12 channel memory	£435.00 inc.
MEMG7700	Memory option	£69.00 inc.
FRT7700	Antenna tuner/switch	£46.00 inc.
FRA7700	Active antenna	£41.80 inc.
FF5	Low pass filter 500 KHz	£10.75 inc.

SMC SERVICE

Free Securicor delivery on major equipment. Access and Barclaycard over the phone. Biggest Branch agent and dealer network. Securicor 'B' Service contract at £5.00. Biggest stockist of amateur equipment. Same day despatch wherever possible.

* FREE FINANCE

On many regular priced items SMC offers Free Finance for invoice balance over £120. 20% down and the balance over 6 months or 50% down and the balance over a year. You pay no more than the cash price!! details of eligible items available on request.

GUARANTEE

Importer warranty on Yaesu Musen products. Ably staffed and equipped Service Department. Daily contact with the Yaesu Musen factory. Tens of thousands of spares and test equipment. Twenty-five years of professional experience. 2 Year warranty on regular priced Yaesu products.

SMC STOCK CARRYING AGENTS WITH DEMONSTRATION FACILITIES

Neath John GW4F01 (0639) 52374 Day (0639) 2942 Eve

Bangor John G13KDR (0247) 55162

Stourbridge Andrew G4BJY (0384) 390916

Communications Ltd.

MAIN DISTRIBUTOR FACTORY BACKED

BUCKLEY, STOKE, GRIMSBY, JERSEY, EDINBURGH.



'SMC' YOUR ULTIMATE CHOICE FOR SERVICE

FT980



FT980	Transceiver with general coverage Rx	£1265.00 inc.
SP980	External L/S with audio filter	£58.65 inc.
SP980P	External L/S with phone patch	£74.85 inc.
F1F1F80	Computer interface for NEC PC8001	£99.65 inc.
FIF65	Computer interface for Apple	£51.35 inc.
FIF232C	Computer interface	£54.80 inc.

FT77



FT77	8 Band Rx/Tx 100W output	£459.00 inc.
FT77S	8 Band Rx/Tx 100W output	£425.00 inc.
FP700	Matching AC PSU	£135.00 inc.
FC700	Matching antenna tuner	£98.90 inc.
FV700DM	Digital VFO unit	£200.00 inc.
MKT77	Marker unit	£10.35 inc.
FMUT77	? unit	£27.20 inc.

FT757GX THE 'NO OPTIONS' RADIO



FT757GX	All Modes and Filters Fitted	£685.00 inc.
FP757GX	Switched Mode PSU 50% Duty	£149.50 inc.
FP757HD	Heavy Duty PSU 100% Duty	£162.50 inc.
FC757AT	Automatic Antenna Tuner	£231.50 inc.

THE BUY OF THE YEAR FT707 8 BAND HF TRANSCEIVER



£499.00
now only
£425 inc.

FT707	matching AC PSU	£125.00 inc.
FV707DM	Digital VFO	£149.00 inc.

FT102 ALL MODE TRANSCEIVER



FT102	Transceiver 9 band	£685.00 inc.
SP102	External speaker	£52.50 inc.
FC102	Antenna coupler	£179.00 inc.
AMFMUT102	AM/FM unit option	£46.75 inc.

FT ONE 'THE ULTIMATE'



FT ONE	Transceiver HF All Mode	£1495.00 inc.
KEYT 901	Curtis Keyer	£28.75 inc.
DCT1	DC Power Cable	£10.35 inc.
RAMT1	Non volatile memory	£13.80 inc.
FMUT1	FM unit	£42.85 inc.

LEEDS
SMC (Leeds)
257 Otley Road
Leeds 16, Yorkshire
Leeds(0532) 782328
9-5.30 Mon-Sat

CHESTERFIELD
SMC (Jack Tweedy) Ltd
102 High Street
New Whittingdon, Chesterfield
Chesterfield(0246) 453340
9.5 Tues-Sat

BUCKLEY
SMC (TMP)
Unit 27, Pinfold Lane
Buckley, Clwyd
Buckley(0244) 549563
10-5.00 Tues-Fri
10-4.00 Sat

STOKE
SMC (Stoke)
76 High Street
Talke Pits, Stoke
Kidsgrove(07816) 72644
9-5.30 Tues-Sat

GRIMSBY
SMC (Grimsby)
247A Freeman Street
Grimsby, Lincs
Grimsby(0472) 59388
9.30-5.30 Mon-Sat

JERSEY
SMC (Jersey)
1 Belmont Gardens
St. Helier, Jersey
Jersey(0534) 77067
9-6 p.m. Mon-Sat

EDINBURGH
SMC Scotcomm,
23 Morton Street
Edinburgh EH15 2HN
Tel: 031-657 2430
10-5 Tues-Fri, 9-4 Sat

**HEAD OFFICE S.M. HOUSE, RUMBRIDGE STREET, TOTTON, SOUTHAMPTON, SO4 4DP, ENGLAND,
& MAIL ORDER Tel: Totton (0703) 867333, Telex: 477351 SMCMM G, Telegram: "Aerial" Southampton**

Trio TS530SP— a good rig for the Common Man

I have reviewed many transceivers in the last year, almost all of them having transistorised PA stages, and this new version of the Trio 530 is, therefore, unusual by to-

former, the subject of this review, includes a 'turntable' notch filter.

The rig can only operate as it stands on AC, and is therefore only intended for home station use. The

tre indented), notch filter (with in/out button), AF and RF receiver gain (concentrically mounted), drive (requires peaking on Rx and Tx), plate tuning (with pointer to give approximate frequency position of control), output transmit loading, and a rotary for RIT/XIT. Miniature rotary controls adjust VOX delay, VOX gain, noise blanker level, and RF carrier Tx level. Push buttons select noise blanker on/off, VOX on/off, Tx MOX, 20 dB RF attenuator on Rx processor in/out and IF narrow/normal (optional filters available for narrow CW and SSB). 500Hz and 270Hz CW and 1.8kHz SSB filters are available to special order, with installation details given in the instruction book. Further push buttons select XIT, RIT and crystal marker at 25kHz intervals. This marker is much more convenient than that on the 830 — which is, somewhat unusually, engaged by turning the mic gain off. Two rotary switches are provided for metering (ALC, plate current, relative output

The Trio TS530SP offers the potent combination of modern RF semiconductor technology, without extraneous 'bells and whistles', with rugged valve PAs — and at a reasonable price. Eminently practical thought HRT, and so did Angus McKenzie, G3OSS, as this review reveals.

day's standards as it incorporates both valves for the driver and PA output stages, the PA including two 6146B valves operating at around 900V HT. The transceiver covers all amateur bands from 1.8 to 29.5MHz in 500kHz chunks. There is only one intermediate frequency which is at 8.83MHz, whereas the TS830 has two IFs, thus enabling variable selectivity which is omitted from the 530. The significant difference between the 530SP and the 530S is that the

main tuning VFO rotates at a rate of 25kHz per revolution, and comes up against end stops, giving around 75kHz overlap at each end of the selectable bands, a band change switch allowing for the three new ones, and, on 10m, 28.5 to 29.0, and 29.5 to 30MHz being accommodated by pushing in a 500kHz 'up' button. The mode switch has just four positions; tune, CW, USB and LSB, AM and FM being omitted. Rotary controls on the front panel include mic gain, IF shift (cen-

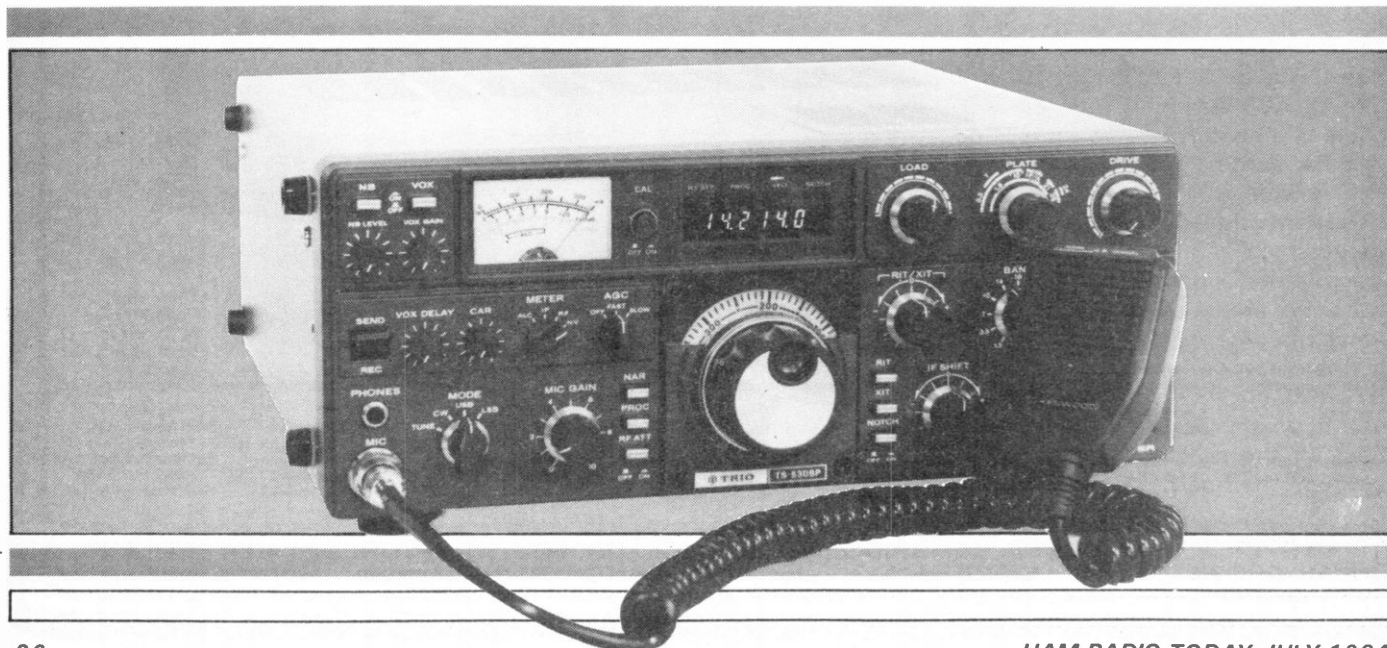

power and HT supply voltage) and AGC off/fast/slow.

Frequency is indicated by a fluorescent type display, reading in 100Hz increments which very easy to read with a blue on black colouring. The frequency display section also has lights for indicating notch filter, internal/external VFO, processor and RX attenuator in use. The meter is rather small, and therefore not easy to read at a glance. The front panel includes a 1/4 inch jack for headphones and a four pin microphone socket to the usual Trio standard, (which is not compatible with Icom or Yaesu microphone connections). The mains on/off switch is complemented by a 'heaters off' switch for the PA and driver valve heaters. A de-luxe tuning knob is available as an accessory, with a finger hole in it for ease of use which is ball bearing mounted, the normal knob having at least an acceptable finger hole, which didn't cause too much friction and is somewhat larger than the usual tuning mechanism finger hole.

Designed For Operability?

On the back panel is a smooth and quiet fan for keeping the PA valves cool, which runs all the time. The antenna socket is an SO239, and underneath it is a shrouded DC biasing screw driver pre-set for adjusting the PA standing current. Another pre-set adjusts the relative output power reading. A large wing nut is available to secure a separate earth (although the captive mains lead is three core) and a fuse is fitted by its side. The mains voltage input can be set to either 220 or 240V AC. As with the TS830, there is a switch which can ground the PA screen grids, thus leaving the valves in a conducting mode between grid and cathode, if the heaters are on. As supplied, no transverter Tx drive output is fitted, but there are two pins on the driver valve board which will give a suitable output if required, and Lowe Electronics recommend that you fit an appropriate socket on the back of the rig for this, and interconnect the board and socket with coax. This would then allow TS530SP to give a few tens-of-milliwatts drive. Similar to that

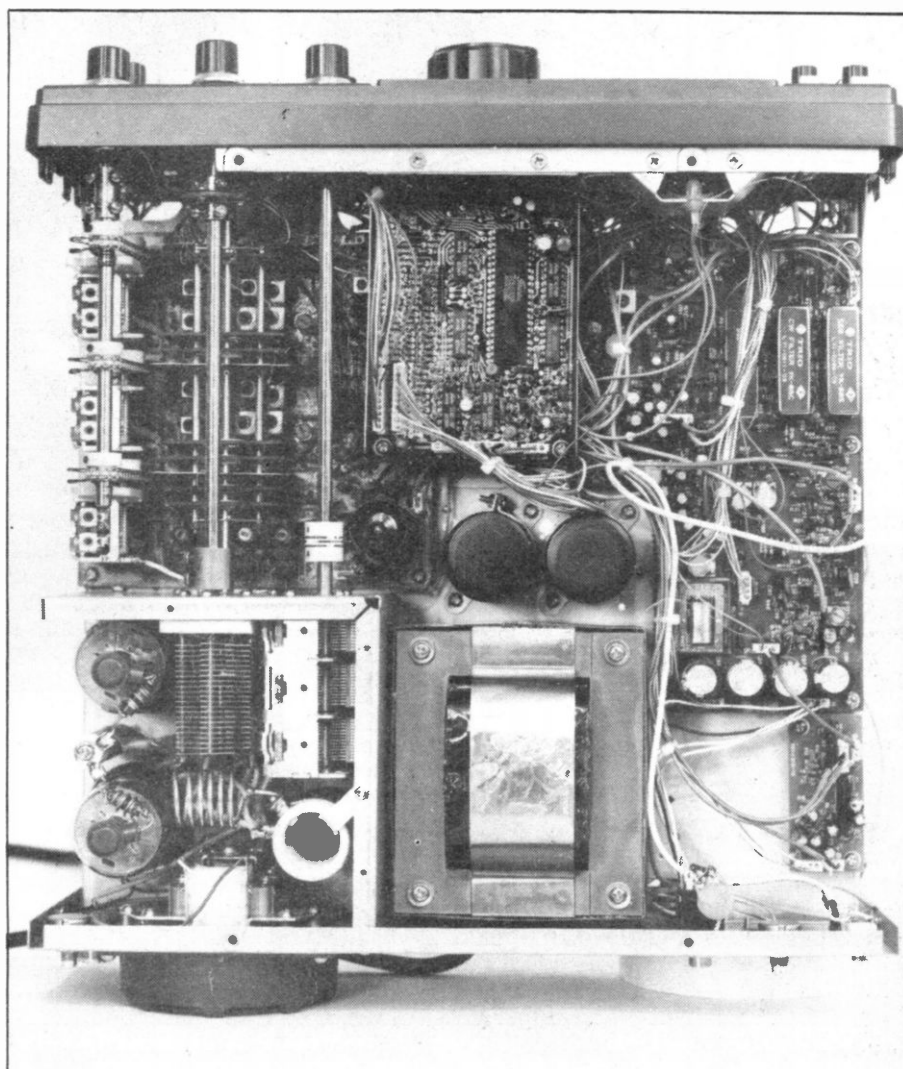

From the top. . .

available from the TS830. There are several conveniently pre-drilled holes for fitting extra sockets on the back of the TS530SP.

I am delighted to report that the drive available for feeding transverters is subject to ALC *when the screen grids are switched to earth* as the PA valves remain conductive. This is extremely useful as the majority of rigs omit ALC on the transverter drive — with sometimes dire results.

A normal 1/4 inch CW key jack is provided, and by its side is an 'antivox' pre-set control. A 3.5mm jack can be used to feed an external speaker. Two multi-pin DIN sockets provide interfacing for an external VFO (various options are available), and a remote control socket incorporating pins for AF output into 8 ohms and interconnections for external relays (shorting across to a pin on either Tx or Rx), PTT, and ALC input. There is no provision for antenna Rx 'breakpoints' etc, as is

available on the TS830S.

The rig is completely encased in metal and has a reasonably good but fairly small speaker in the top casing which throws sound upwards. A carrying handle is fitted to the right side cheek whilst feet are provided both on the left side cheek and on the lower casing. The latter are quite large, and the front ones can have extensions on them to raise up the front half of the rig. The TS530SP is quite handsome and is finished in two-tone grey.

On The Air

I used this rig over two weekends and have found it very pleasant to use. On receive the TS530S appeared to be very sensitive indeed, even on 10m, whilst the front end intermodulation performance seemed quite good. I did not note any problems at LF provided I sensibly used the 20dB RF attenuator. Signals seemed to be

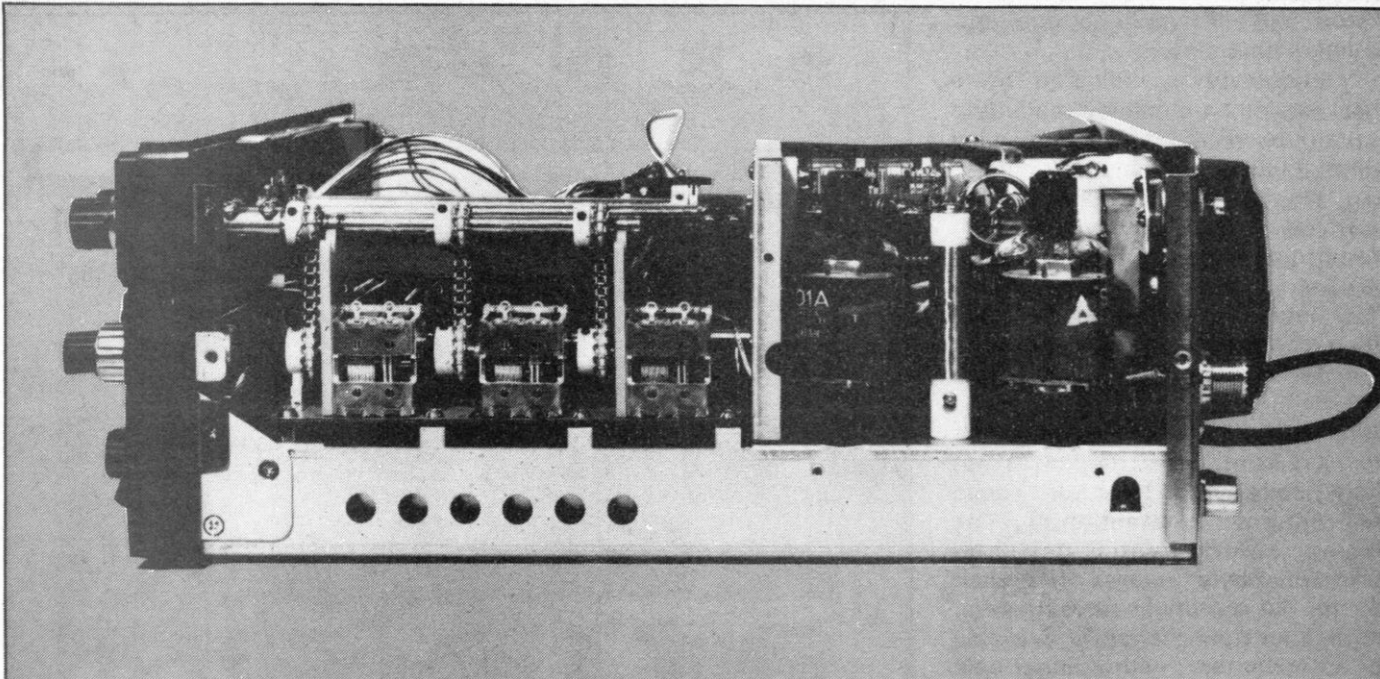

The mechanical construction of the TS530S is rather more rugged than many of the current HF transceivers on the market.

very clean, and the IF pass band quite reasonable for both SSB and CW. The notch filter worked particularly well and was, of course, useful in removing annoying carriers, particularly on 80m. I already own a TS830, and found the handling very similar indeed, PA tuning and loading being simple, whilst drive tuning always seemed to be right on Tx when I peaked the control up on Rx, where the control doubles as a preselector.

The AGC characteristics seemed reasonable, but perhaps long AGC was a little fast. Very strong signals did seem to interfere very slightly with extremely weak ones on 80m, showing that the filter was not rejecting too well waydown it's pass band. Audio quality is very good with plenty of

volume available on the internal speaker. I liked the feel of the VFO, and it is rather pleasant to get away from a synthesised one for a change. This may well influence prospective purchasers since there are many folk who do not like synthesiser 'steps'. The noise blanker seemed reasonable, and the VOX circuits worked well. The IF shift control operated well and gave a good range of adjustment. The transmitted quality was considered "better than average", and the transmissions were very narrow. There are not too many bells and whistles' on the rig, and many operators will undoubtedly appreciate this; the rig is easy to master and straightforward in use. It is also very simple to interface the TS530SP with a linear, and it

would obviously work admirably with the Trio 922 model for which the interfacing is particularly suitable. Finally, the rig was very free from received spuri.

In the Lab

The input sensitivity was quite the best that I have checked out on any HF transceiver in the last year. The TS530SP will thus winkle out remarkable weak DX on 10m when the band is almost closed, showing the benefits to be gained from good sensitivity. It was phenomenally sensitive at LF, although this is really not necessary (see my article on receivers in April '84 HRT). All the measurements were taken after carefully peaking the preselector.

The mixer performance was

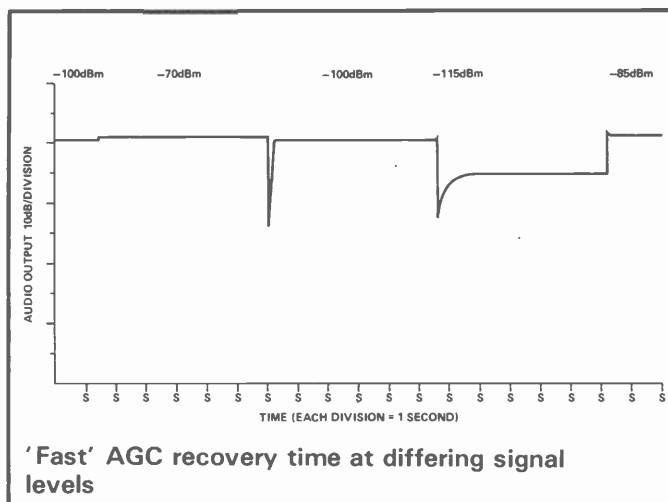
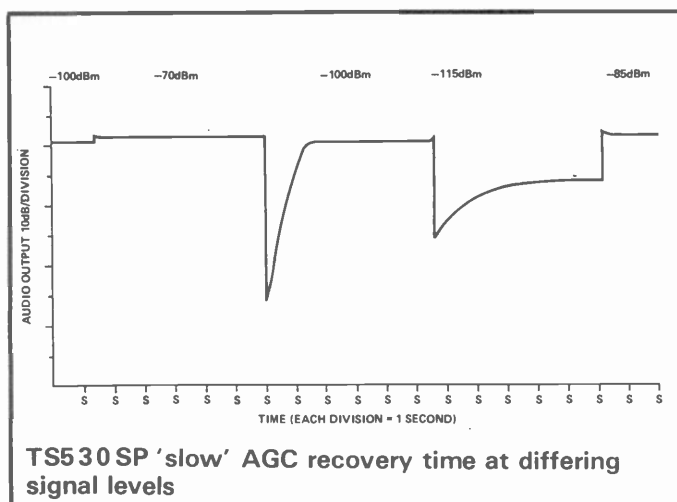

good, with the RF intercept point being quite acceptable although not in the very top league. To put matters into perspective, this parameter is far better than on most older transceivers, let alone many receivers. However, somewhat surprisingly, the reciprocal mixing performance, whilst not being poor, was nowhere near as good as it could have been, especially as it was not synthesised, and Trio need to increase the signal-to-noise ratio of their local oscillator feed to improve matters here. The IF selectivity on SSB was beautifully shaped down to -60dB but (the response) opened out badly below this level. The CW selectivity was not quite so sharp, but reasonably well optimised in practice, although again the filter response opened out badly below -60dB .

Useful 'S' Meter

The S meter produced a reasonable reading of S9 for $40\mu\text{V}$, gave 34dB difference between S1 and S9 and gave useful and reasonably logarithmic readings up to full scale deflection. The product detector worked extremely well, giving surprisingly low distortion, which obviously contributed to the clean received audio. Output power was adequate into an external 8 ohm speaker, and appreciably more power was available into 4 ohms. The receiver frequency calibration was accurate to within 10Hz , which is superb. I was pleased to see that when you switched from upper to lower sideband, neither the indicated frequency nor the carrier reinsertion frequency changed, which is ideal in my opinion. The position of the filter on CW coincides with USB, and, when switching from LSB to USB and vice-versa, I was pleased to see that there was almost no change in the relative position of the pass band referred to the carrier, with the variable band pass IF shift in its centre 'indent' position. The AGC pen charts show 'fast' AGC to be very fast indeed, whilst 'slow' is slightly faster than average, but having a slower recovery on weaker signals. The notch filter measured extremely well, and far better than those on most of the competition. The notch was quite sharp, so the filter can be used

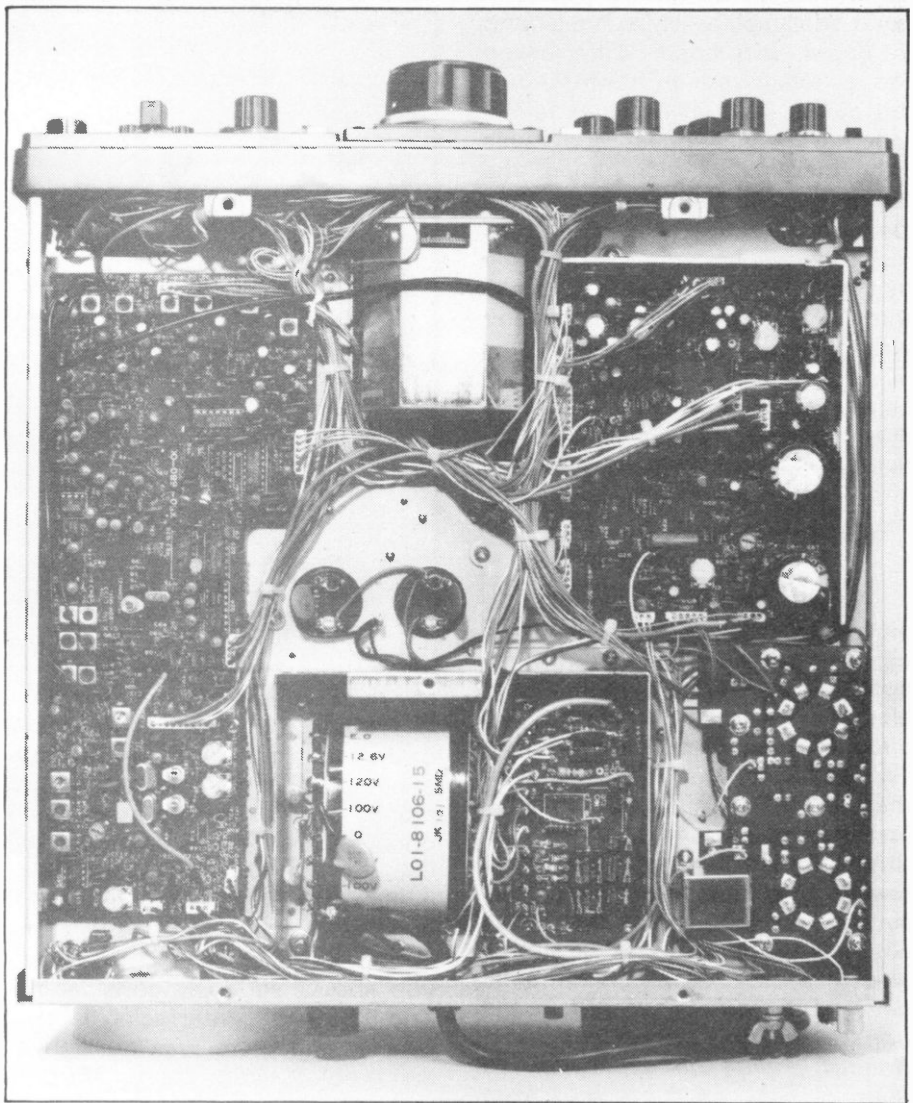

... to the bottom

within a speech pass band without affecting intelligibility too much. The RIT control had a range of approximately $\pm 2.6\text{kHz}$ which is a little limited for some special needs.

Very Low Harmonics

The transmitter gave between a maximum of 100 to 112W output on CW, whilst SSB PEPs were around 120W across the bands. We had a good look at the intermodulation products at both 100W and 25W PEP output resulting from two-tones in the audio pass band. You can see from the photographs that high order products fell back very rapidly, which obviously contributed to the good transmitted audio reports. They clearly vanished more quickly than I have usually noted on transistorised PA stages, and it is for this reason that many operators prefer valve PAs. The

specification for transmitter harmonic rejection states that none should be higher than -40dB . The worst measurement was 5dB better than spec, and this was almost always the second harmonic (this was common across the spectrum of the bands). I don't think that anybody could possibly moan about the harmonic performance, 21MHz being particularly good. We checked the residual carrier and noise output referred to the peak sideband output level, and rejection was excellent. Alternative sideband rejection was amazingly good at -63dB . The transmit frequency accuracy on CW was within 20Hz which is stunningly good.

The transmitted frequency response, checked from the mic socket input to RF carrier out, was very flat from 400Hz to 2kHz and 3dB down at 2.3kHz , falling very steeply above 2.7kHz . I consider the response just about ideal for

good intelligibility whilst preserving a narrow pass band. We checked the receive response from the output of the product detector to the external speaker socket, and it was only marginally wider than the transmit pass band, and is thus ideal. In practice, therefore, the response will be controlled entirely by the IF filter. I was pleased to see that it was not tailored in any strange way, and in my opinion this helps readability a lot, for tailoring can severely effect intelligibility. I did not notice any VFO drift in practice after a brief warm-up period.

Conclusions

Before giving my overall opinion of this rig, I do want to have a big grumble about the instruction book which fails to contain any block diagram or explanation of the circuitry. I gain the impression that Trio seem to be talking down to their intending purchasers, and I feel they must improve on this attitude. I also feel that Trio should have provided a transverter drive socket, which is, in this case, after all, only a piece of coax and a phono socket. *Lowe Electronics have kindly offered to put in the transverter drive socket and cable free of charge on application to them for any products sold from*

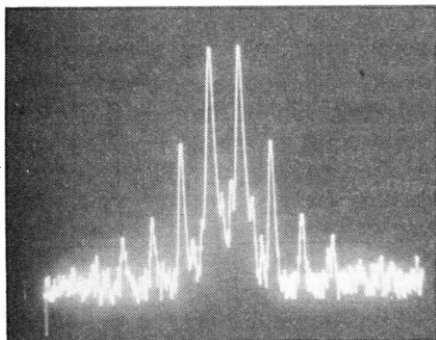

TS530 SP Transmit two-tone intermodulation.
Upper pic. At 25W output.
Lower pic. At 100W output.

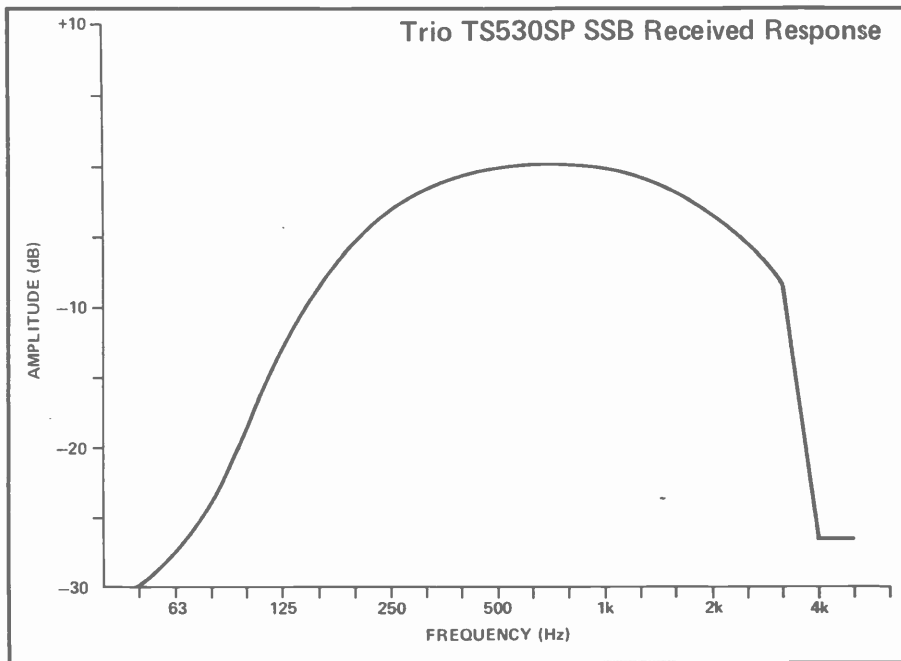
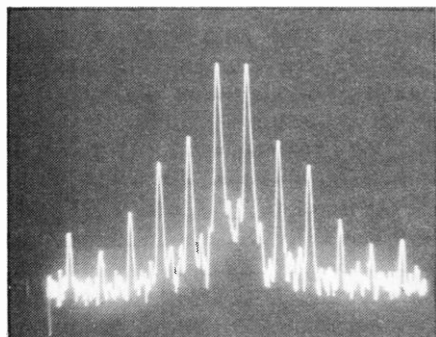

the publication of this review.

Noting that this design was 2 or 3 years old, I was pleasantly surprised that almost all the performance measurements were very good, some being superb. We couldn't find *any* parameter that could really be regarded as poor. If you want a basic rig that has a few extra frills which all work well, then you should seriously consider the Trio TS530SP. Interfacing is very simple, and there was no sign of any problems with the rig. My only real criticism performance wise is the reciprocal mixing performance, but again there are many more expensive rigs that are worse in this respect. Do not think that because the TS530SP has been on the market for quite a time that it is "old hat", for I am much happier with a rig that has proven RF performance rather than some 'whiz-bang' modern ones that are all too

often cluttered up with 'bells and whistles'. I must admit to preferring the TS530SP to the TS430S, but this is a very personal opinion. It is as a result of considerable demand from radio amateurs that Trio have retained this model in their catalogue, and I hope it will remain available for quite a time. Do not rule out this rig just because it has valves in it, for I consider this a good rather than a bad point. Ergonomically it is very well designed, and is a worthy little sister for the TS830 and 930 models.

I would like to thank Lowe Electronics for the loan of this rig, and my colleague Mike Hatch, G1DEW, for spending many happy hours peering at all the meters and oscilloscope screens. Highly recommended then as a sensibly designed rig, particularly useful for driving VHF transverters because of its sensible ALC provisions.

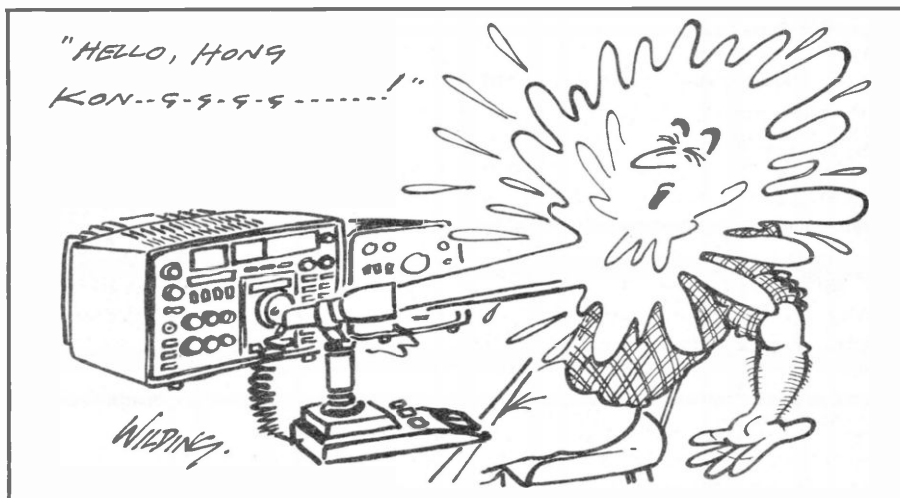

TRIO TS530SP LABORATORY MEASUREMENTS

Receiver Measurements

Sensitivity for 12dB Sinad, SSB (1kHz beat note)

28.4 MHz	-124dBm (0.14uV)
21.3 MHz	-124.5dBm (0.13uV)
14.3 MHz	-125dBm (0.12uV)
7.05 MHz	-125dBm (0.12uV)
3.7 MHz	-124dBm (0.14uV)
1.9 MHz	-125dBm (0.13uV)

Measured RF attenuator value (at 14.2MHz) 20dB

Selectivities

	SSB	CW (Narrow)
3dB Bandwidth	2.4kHz	0.4kHz
6dB Bandwidth	2.5kHz	0.6kHz
40dB Bandwidth	3.4kHz	1.1kHz
60dB Bandwidth	4.2kHz	1.3kHz
80dB Bandwidth	22.1kHz	8.8kHz

Reciprocal Mixing Performance

RF Levels required off channel to degrade Sinad by 3dB (ref. noise floor)

20kHz spacing	86.5dB
50kHz spacing	91.5dB
100kHz spacing	94.5dB
200kHz spacing	107.5dB

RFIM Performance, SSB

Carriers spaced at 100/200 kHz off channel for 12dB Sinad product.

	RF Level (ref. 12dB Sinad)	Calculated RF intercept pt.
28.4MHz	81 dB	-2 dBm
7.1 MHz	85 dB	+2 dBm
1.9 MHz	86 dB	+4 dBm

S Meter: RF Levels required to give the following readings

S1	-109.5dBm (0.75uV)
S3	-107dBm (1.0uV)
S5	-102dBm (1.8uV)
S7	-91dBm (6.4uV)
S9	-75dBm (40uV)
S9 + 20dB	-51dBm (0.65mV)
S9 + 40dB	-30dBm (7mV)
S9 + 60dB	Not Calibrated

SSB Received Frequency Accuracy

+/- 10Hz

Product Detector Distortion 0.7%

Audio distortion at 125mV output (8ohms) 0.7%

Maximum audio output level for 10% THD into 8 ohms 2.1Watts

Maximum audio output level for 10% THD into 4 ohms 3.3Watts

T Notch Depth (average)

Ratio between two tones notched in turn

37 dB

Transmitter Measurements

RF output Power, CW (after careful tuning)

28.4 MHz	100W
24.9 MHz	108W
21.3 MHz	100W
18.1 MHz	105W
14.3 MHz	107W
10.1 MHz	102W
7.05 MHz	105W
3.7 MHz	112.5W
1.9 MHz	105W

RF output power, SSB PEP

approx. 120W on all bands.

Transmitted Frequency Accuracy, CW (28.4 MHz) + 20Hz

Harmonic output (at full power ref. fundamental)

	2nd	3rd
28.4 MHz	-48dB	-60dB
21.3 MHz	< -60dB	-60dB
14.3 MHz	< -55dB	-65dB
10.1 MHz	< -52dB	-63dB
7.05 MHz	-46dB	-65dB
3.7 MHz	< -46dB	-67dB
1.9 MHz	< -45dB	-67dB

SSB Residual Carrier and Noise

-57dB

Unwanted Sideband Suppression, USB

-63dB

Two Tone Transmitted Intermodulation Products. (See photographs)

	Full Power	1/4 Power
3rd Order	-25.5dB	-31dB
5th order	-34dB	-54.5dB
7th order	-52dB	-62dB
9th order	-73dB	-70dB
11th order	-67dB	In noise

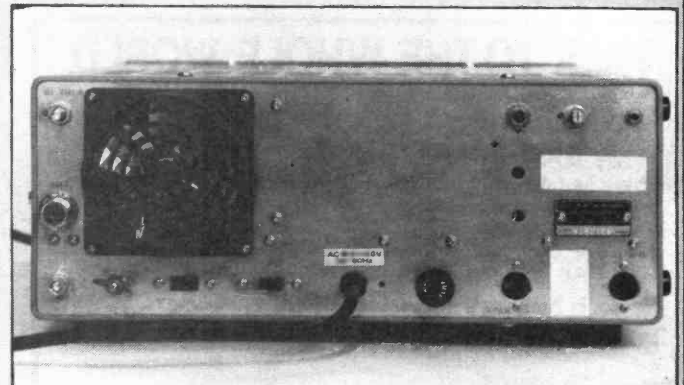

HAM

RADIO

NEXT MONTH

TODAY

ANTARCTIC DX-ING FROM VP8ANT

Richard Newstead, G3CWI, answered an advertisement in the daily papers and found himself in the Antarctic as VP8ANT

CUT-PRICE QUAD

Build yourself a quad for a reduced cost, with Harry Leeming, G3LLL

SCANNING RECEIVERS

An investigation by Tony Bailey, G3WPO

HIGH PERFORMANCE 2m GaAsFET PREAMP

Interested in DXing on 2m? Then build yourself this innovative design, by John Matthews, G3WZT

QUARTZ CRYSTALS

CRYSTALS FOR 2 METRES
 HC25 £2.15 FOR ONE CRYSTAL £1.96 WHEN 2 OR MORE PURCHASED
 HC6 £2.15 FOR ONE CRYSTAL £2.05 WHEN 2 OR MORE PURCHASED

TX CRYSTALS
 HC6/U 3MHz 30PF 44 MHZ SERIES RES. R0 TO R7 S11, S20 TO S23
 HC25/U 12MHz 30 & 40PF 44 MHZ SERIES RES. R0 TO R7 S8, TO S23 & S32
 HC25/U 18 MHz 25 & 20PF 14/15 MHZ 20 & 30 PF R0 TO R7 S8, TO S23 & S32
 HC25 SCANNER XTLS (NOT SR9) R0 TO R7 S8, TO S23 & S32

STOCK CRYSTALS
 £1.96 WHEN 2 OR MORE PURCHASED
 £2.05 WHEN 2 OR MORE PURCHASED

CHANNELS IN STOCK
 R0 TO R7 S11, S20 TO S23
 R0 TO R7 S8, TO S23 & S32
 R0 TO R7 S8, TO S23 & S32
 R0 TO R7 S8, TO S23 & S32

full list available on request please send SAE

4 METRE CRYSTALS FOR 70.25 IN HC6/U AT £2.40 each
 TX 8.78250 RS 29.78000

70CM CRYSTALS £5.00/pr or £2.50 each
 For Pye PF1 PF2 & PF70 series Wood & Douglas and FDK MULTI U11
 SUB(433.2) SU20 RB0 RB2 RB4 RB6 RB10 RB11 RB13 RB14 RB15.
 ALSO for MULTI U11 ONLY SU12 SU16 SU18

CONVERTER CRYSTALS IN HC18/U AT £2.85 each.
 22.000, 38.666, 70.000, 96.000, 116.000, 101.500, 116.000

FREQUENCY STANDARDS £2.75 each
 HC6/U 200kHz 1000kHz 3.50 MHz 5.00 MHz 10.000 MHz 10.700 MHz
 HC18/U 10000kHz 7.00 MHz 10.70 MHz 48.00 MHz 100.00 MHz
 Also HC6/U 200 kHz 455 kHz £3.25 each

TO NEBURST, I.F. & MPU CRYSTALS IN HC18 £2.25 EACH
 7.168 MHz (For 1750 Hz Tone), 10.245 (for 10.7 I.F.)
 3.2768 5.0688 14.3180 15.00000

YAESU CRYSTALS for FT101's FT901 & etc £4.00 each
 Many available ex stock (A list is available on request please send S.A.E.)

FUNDAMENTALS		MADE TO ORDER CRYSTALS	
FREQUENCY RANGE	PRICE	FREQUENCY RANGE	PRICE
5 TO 50 KHZ	£21.00	21.00 TO 65.00 MHZ	£4.55
50 TO 150 KHZ	£11.00	60.00 TO 110.0 MHZ	£5.10
150 TO 500 KHZ	£7.80	110.00 TO 125.0 MHZ	£7.40
160 TO 999 KHZ	£11.90	125.00 TO 175.0 MHZ	£10.00
1 TO 1.5 MHZ	£10.75		
1.5 TO 2.0 MHZ	£5.10		
2.0 TO 6.0 MHZ	£4.75		
6 TO 21 MHZ	£4.55		
21 TO 25 MHZ	£6.50		
25 TO 30 MHZ	£8.50		

Unless otherwise requested fundamentals will be supplied for 30pf load capacitance and overtones for series resonant operation.

HOLDERS:— PLEASE SPECIFY WHEN ORDERING— else HC25/U supplied for XTLS above 3 MHz HC13/U 6-200 kHz HC6/U & HC33/U 170 KHz-175 MHz HC18/U & HC25/U 2-175 MHz

DISCOUNTS: Price on application for 10+ units to same frequency/spec. or bulk purchases of mixed frequencies. We supply FREE xtals for use in U.K. repeaters.

COMMERCIAL CRYSTALS: available on fast delivery and at competitive prices. Please send for list stating interests

EMERGENCY SERVICE: for XTALS 1 to 125 MHz. Add the surcharge for each XTAL. Days refer to working days. 4 days +£12, 6 days +£7, 8 days +£5, 13 days +£3.

CRYSTAL SOCKETS HC25 £0.20 ea. HC6 £0.25 ea. MINIMUM ORDER CHARGE £1.50 unless ordered with crystals

TERMS: Cash with order post inc. to U.K. & Ireland. Cheques & P.O.'s to QSL LTD.
 A stamped addressed envelope with ALL enquiries please.

QuartzSlab
 MARKETING LTD
 P.O. Box 19
 Erith
 Kent DA8 1LH

ALL PRICES ARE EX VAT PLEASE ADD 15%

Telephone: 01-318 4419 24Hr Ansafone: Erith(03224)30830
 Telex: 8813271 GECOMS-G (Attention QUARTSLAB)

TALK TO THE WHOLE WORLD

Study now for the RADIO AMATEUR'S EXAMINATION

We have had 40 years successful experience in training men and women for the G.P.O. Transmitting licence.



FREE R.A.E. brochure without obligation from:—

British National Radio & Electronics School
READING, BERKS. RG1 1BR

Name

Address

HRT/7/846 BLOCK CAPS PLEASE

Addendum

- Practicalities, May '84**
The capacitors in Fig. 3 are 10p not 10n.
- Active Aerial, June '84**
The capacitor in series with the antenna is mica. All the other capacitors could be polystyrene except the 10n and 100n, which are ceramic.
- Plain Man's Guide To 6m Reception, June '84**
This was missed off the contents page by mistake.
- Plain Man's Guide To 6m Reception, June '84**
This was missed off the contents page by mistake.

This is PY1ZFX mobile...

When I first heard about G3UPK's Trans South American journey I was immediately interested in getting him to write an Amateur Radio flavoured travelogue for HRT. He had taken an Atlas 215X HF transceiver with him and reports had filtered back to me of Roger working UK stations with a ¼ wave

were to see of her until Montevideo, Uruguay on 1st February 1982, the beginning of an adventure during which this plucky little 4 cylinder diesel van would take us over a dozen passes in the Andes and Rockies, 5 of which were at 15,000ft, and over thousands of miles of unsealed

Roger Crofts, G3UPK (ex ZD8AY, ST2AY and VK6YA to name a few), and Mary Carpenter set out on a journey that was to take them the length and breadth of South America. This is their story, seen through Mary's eyes.

'whip' antenna made of wire supported by a piece of the Brazilian jungle (you mean a 'twig' — Ed. CB).

I wrote to Roger's home address only to find that he was out of the country on business, in Cameroon, Africa. His father kindly wrote back to me and said he would pass the letter on to Roger who would be in Africa for some months yet. However, shortly after this, I received a letter from Mary Carpenter, Roger's girlfriend, who had shared the journey with him. Roger's father had told her about my request. She had kept a careful diary of the journey — would I like her to write the journey up for HRT? Looking at Mary's prose style, I decided to tell her to go ahead.

This is the result. It perhaps isn't what readers usually find in HRT inasmuch that Mary is a radio spectator rather than an operator and the emphasis in this article is on the travel rather than the radio. That being said, I hope you all enjoy reading this as much as I did. **G3ZZD**

On a cold December day in 1981, we dropped off Myrtle, our 1974 LWB land Rover, at Harwich Port which was partially covered with snow and ice after recent snowfalls. That was the last we

roads. One set of tyres was to succumb to the sharp gravel roads of Patagonia and another to the attack of Mexican prickly pear thorns. (I don't have this problem mobile on the M1 — Ad Manager G4NXV).

After delays and hold-ups with the shipping company, we were told finally when the ship would arrive and flew out to meet it, changing planes at Paris, the last we would see of wonderful Europe for 16 months. There was alarm when only my bag arrived as Roger's bag contained his camera, binoculars and the ham radio gear among the important items! The lady at the airline office was very helpful, a trait we found almost everywhere in Uruguay, and a few days later the bag reappeared minus its handles but with all its contents intact. Not unexpectedly the ship bringing our car had been further delayed in the meantime.

So we had to stay for 10 days in a pension, run by a kindly middle-aged couple who spoke no English (the case we found through most of Latin America) — and our Spanish was very poor at that stage, too — though we enjoyed our stay there. It was an old place, cheap enough, the best part being the hot water shower! I need not elaborate on the plumbing which we found the same in most places in Latin America. When the toilet blocks there



Myrtle with 'twig' antenna

is no water, no-one seems very concerned about it! This 'manana' attitude was difficult to accept at first, but obvious right through to Mexico.

Myrtle Arrives

The ship with Myrtle aboard finally arrived but, as our home-on-wheels was being unloaded by crane, we could already see that the thieves had got to her. Myrtle's side window had been force. The thieves were probably disturbed in the act, as our sleeping bags and various items were scattered about on the floor and we had lost only a few unimportant things. The jemmy marks are still a reminder of the determined but ultimately unsuccessful attempt to get into the main cupboard. With formalities completed, we waved goodbye to our friends and headed east to Punta del Este and Fortaleza de Santa Teresa, only to be pulled up by three traffic cops for overtaking in a forbidden zone. After much persuasion, telling them it was our first day on South America roads, and with the Customs sticker still glued to the front window, they let us off with a reprimand, saluting us courteously before bidding us "Buen Viaje" (Good journey).

Unfortunately this good police attitude was not to be found in many other parts of South America.

Uruguay was our first South American country and the best one by our experience. We then spoke very little Spanish and I shall never forget the kindness of most of the Uruguayans we met. We crossed to Argentina over the huge Uruguay River at Fray Bentos (*Corned Beef Country!* — Ed) on 8th February, passing through mosquito ridden swamp country, south to Buenos Aires, where we spent five days with an Argentine friend. He and his lovely wife extended us wonderful hospitality and delighted in showing us places of interest by day and night, taking in restaurants with one inch thick steaks, a tango show with wonderful dancing and music, and theatre shows which appeared to be censored by the military Government. The people of Buenos Aires are proud of their cosmopolitan city, which boasts as many theatres as London or New York and more taxis than either of them. People eat very late and the restaurants are packed after midnight. If you think parking in UK is bad, you should try Buenos Aires. Parked cars are literally bumper-to-bumper in every street and it is always necessary to shunt several of them to make a little room to get in or out. Driving a Land Rover has distinct advantages!

Southern Travelogue

After Buenos Aires we headed south across the pampas, visited a sea-lion colony on the Valdes Peninsular, the petrified forest near Sarmiento, and enjoyed a real Welsh tea in a quaint tea-house in Gaiman, a town in the old Welsh colony where the people still speak Welsh. We arrived in Ushuaia, the most southerly town in the world, on 25th February at the height of their summer, although it had snowed the previous day. In Tierra del Fuego we battled through the strongest winds we have ever encountered as Patagonia is known for its winds and, no matter in what direction we headed, they always seemed to be against us! We then made a very worthwhile detour to the magnificent Perito Moreno glacier and on into the beautiful lakes district. The Puyehue Pass into Chile was another amazing experience, the vegetation being extremely beautiful, especially the



Oro Preto, Brazil

fuschia flowers which grew in wild profusion. From Osorno, passing snow-capped volcanoes, north to Santiago to cross the Andes again at Las Cuevas on 16th March, (already snow on the ground!) down to Mendoza (a popular wine area of Argentina) and back to Buenos Aires. It was a very quick departure north on 1st April, heading for the Iguacu Falls and the next day we heard on the BBC of the invasion of the Falklands. There was dancing in the streets and the blue and white Argentine colours flying from every car and house. We were lucky to get through numerous military checks and safely onto a the ferry across the Iguacu River to Brazil on 5th April.

On-Air In Brazil

We then spent three months in Brazil, keeping a low profile until

the war ended and, just off the Belem-Brazilia highway, we toasted the victory with champagne (on ice since Rio, two months earlier). Twice we visited Rolf, PY1RO, a very keen and well known 160m operator, and his charming wife, Rosangella. She spoke little English and we no Portuguese but we enjoyed marvellous hospitality with churrascarrias (Brazilian barbecues) and trips to beautiful beaches, some of which we camped peacefully by for days while sunbathing and catching up on odd tasks which never seem to get done whilst on the move. While in Brazil, we had a great reception from Europe on 14MHz. From the beginning of May, Roger made contact with Eddie, G4KHG, and Frank, G4HBI, almost every night, up till we reached Florida at the end of September, 1982. After this reception deteriorated, Europe cut out by the seemingly thousands of North American stations on-the-air.

Viva Gran Britannia

We missed Frank and Eddie very much for the remainder of the trip. They were such fun to speak with and we had some hilarious and tense moments when some irate Argentinian stations would come on-the-air, abusing the Falkland Islanders, British and anyone else who supported them. But, from the point when we crossed to Paraguay over the Parana River, most of the people we met in Bolivia, Peru and Ecuador applauded 'Gran Britannia'. There seems little love lost between the South American nations. Another example of this occurred while we were watching the World Cup, Brazil v Italy match on

Mt. Salcantay, Peru





Street urchins from Rio de Janeiro, Brazil

an open air TV in Ascuncion. We were surprised when everytime the Italians scored, the Paraguayans went wild with joy. Meantime, in Brazil, the hospitals were being overwhelmed with cardiac patient

We had Myrtle's engine serviced because Paraguay is the only South American country where anyone has heard of Land Rover. There was 19,000 miles on the clock since Montevideo. On the next stage of our journey we were held up, first, by unseasonal rain, which washed out the road for several days, and then by soldiers demanding gifts. After spending a night under military guard, we were ordered to take two officers and a soldier's wife to the border outpost, a day's drive down the track. There was much handshaking and backslapping with their military friends at each checkpoint plus a quick stop for lunch along the otherwise deserted track, which reminded me of the Australian Outback. This land was the scene of a bitter and bloody war, fought against Bolivians earlier this century in the mistaken belief that oil lay beneath the infertile surface.

By late afternoon we reached the border outpost and our passengers left us without a backward glance or "gracias", except for the wife, a young, part Guarani, Indian girl, with a gap in her front teeth as so many of the Indian people seem to have. She politely offered us a delicious grapefruit, and her husband, who was there to meet her, thanked us for bringing her safely home. This extremity of character, the aggressive arrogance of the rich and

those in power set against the gentleness and humbleness of the lower classes, made itself felt through all Latin America, especially in Andean countries. About this time, Roger realized he was not fully equipped for the cold of the approaching high Andes. The air waves hummed with urgent messages and the knitting needles of G4HBI's Mum were set into motion. In next-to-no-time, a pair of extra thick, high-altitude type, woolly socks were winging their way to Bolivia!

Cassette And Run

At the next checkpoint we reached, the officer who lived in the adobe hut was after music (so he said). He spotted our cassette player and there followed a detailed search. The HF transceiver was of no interest but his eyes lit up when he opened our box of cassette tapes. We begrudgingly parted with "The Carpenters Greatest Hits". "That's her name", said the officer, pointing at me. "We have a cassette player but no tapes", he explained — which made us wonder if that, too, had also been procured from some unsuspecting travellers like us. They insisted on hearing the tape played and the officer tapped his finger and the soldiers danced completely out-of-step to the music, but none-the-less, they pronounced it good and gave us back our passports. The pleased officer even drew a small map to the next town, Boyuibe, as from then on the country was very isolated. In the 1½ days it took us to get to Boyuibe, we passed only a

few ranchos and three vehicles — and no signposts!

Stopping for the night, we camped just off the track, hidden in the thickening vegetation, and heard on the BBC World Service that a coup had taken place that day in La Paz, the capital. Later, we heard the droning of engines and saw headlights approaching. We switched off the inside light and, peering through Myrtle's little roof window, we saw a convoy of army trucks, packed with heavily armed soldiers, grind past. They were going because of the coup we thought. But it was such a long way across the mountains to Sucre, let alone La Paz. Where could they be going way out here at this time of night? . . .

Next morning from our camp, we could see the beginning of the majestic Andes once more. The last time we had seen then was from Argentina. The weather was gorgeous. Being still in the lowlands, it was fine with clear blue skies and the night had been warm and balmy, such a contrast to the humidity and rain of much of Brazil. At Boyuibe town we were escorted to meet the (local) Colonel, who invited us for lunch consisting of delicious vegetable soup followed by salad. The other officers present were courteous and the Colonel was proud to show off his English, dismissing our attempts to speak Spanish. The Colonel had hoped that he might change 1,000 dollars of our money for us but accepted the 100 dollars that we wanted to change willingly enough. It turned out that everything in Bolivia was so cheap

that 100 dollars was plenty for our two week stay. Diesel, for example, was only 12p per gal. and petrol not much more.

After Boyuibe it was into the mountains, climbing higher and higher up to the Altiplano, never leaving them until Nazca on the coastal plain of Peru (OA). It took four days to reach Sucre, one of the best kept old Spanish towns in South America. We had to wait here six days to pick up our mail as the Post Office was on strike. The restaurants were so excellent and cheap that we ate out every night but always returned to our secluded camp site in a eucalyptus forest, on one of the hilltops overlooking the town. Our only visitor there was Alfredo, a little Indian shepherd boy, who stayed for lunch, consisting of sandwiches, tea, and cracker biscuits with marmite. The marmite was, of course, new to him and he loved it. Later he went home and we were surprised when he returned half an hour later carrying an armful of maize for us and insisted on putting some of it on the gas to boil, which seemed to take ages, as it was very hard, the only variety able to grow at 10,000 ft.

Potent Cheap Music

We enjoyed a concert at the local theatre of the delightful music of the Andes, produced, in part, by that exquisite instrument, the pan pipes, the haunting sounds of which conveyed to me all the heaviness, sadness and suffering of the life of the South American Indian. Cost of the two hour concert? — around 5p each.

From Sucre it took two days to reach Cochabamba, in a warm and dusty valley that produces an abundance of fruit and vegetables. That was the last of the warm weather, for the next day we climbed the two miles to the barren windswept Altiplano. We spend the first evening in a blizzard, parked near a lake by the deserted roadside, deep in our sleeping bags, gloves and caps to combat the bitter cold. The next morning there was a covering of snow and the lake had frozen over. Just down the road a truck full of Indians had broken down. None of them were wearing gloves, and they had only sandals on their feet — the hardiness of these people never ceased to amaze me. In the

cold and rarified atmosphere, starting the engine was a real problem even with aerosol ether. The solution was to park Myrtle facing east and lift the bonnet before taking breakfast. The early morning sun luckily did the rest.

We had virtually no trouble with the military in Peru but found the civilians the opposite of the Bolivians. We remembered that the Colonel and his officers had told us that the Peruvians were "mucho loco". They were right! We only once had occasion to use public transport (thank heavens), from Ollantaitambo to Machu Picchu, the famous Inca ruins, by train, which arrived five hours late and packed. After arguing with, and being thrown off the train by the conductors in the first and second class carriages (we had first class tickets!), we eventually jumped on to the outside of the train and hung on, as the train slowly chugged out of the station, leaving many people behind, including three English back-packers, who vehemently cursed Peru Rail! I was also suffering from altitude sickness and fainted up at the ruins, while waiting for the fast bus to take us back down the thirteen hair-pin bends (*I'll stick to the M1 — G4NXV*) to the station below. After two failed attempts to revive me with smelling salts, I recovered in the little clinic after oxygen was administered by a kind nurse. The train back was four hours late and total chaos, as about 200 tourists and Peruvians fought their way onto an already packed three carriages.

On the shores of the iceberg filled waters of Lago Argentino, Patagonia, Argentina

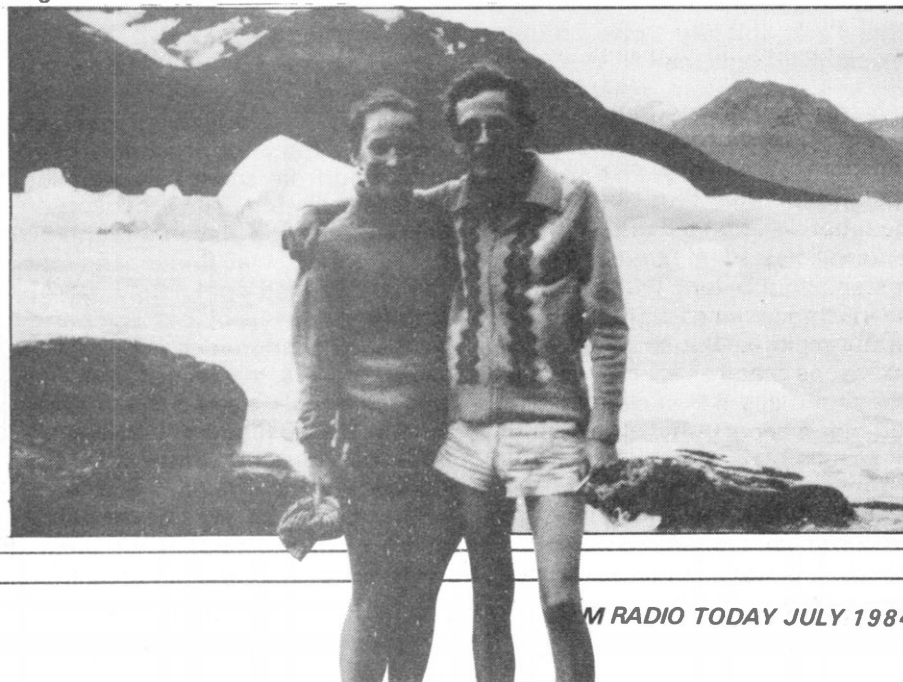

Goodbye To South America

After the month in Peru, we crossed into Ecuador at the noisy, filthy, border town of Huaquillas. There are, invariably, at least three policemen at every road junction in Ecuador. One signals you to stop, whilst another frantically waves you on. A third makes such ambiguous signals that you don't have a clue what he means. Whatever you do, you are bound to be wrong. It's good idea to take several driving licences as these are frequently torn up into little pieces and scattered all over the road. The Ecuadorians have built a monument to mark the exact and precise line of the equator, just north of Quito. We visited the monument and also the equator itself — which is located a little bit further on! From Ecuador we shipped Myrtle to Miami whilst flying ourselves but, at the time of writing, we still have not reached our goal of Alaska. This we hope to do in July 84, but that is another story.

Roger and Mary are presently finishing their Trans American journey. This time Roger has equipped Myrtle with a 1KW amplifier for the Atlas 215X. Look out for him on the American County Hunter's net on 14.336MHz from 1400 UTC onwards. A further instalment should be appearing in a future HRT...

A Plain Man's Guide to 6m Reception

This article is the sequel to my article in last month's issue which introduced the reader to "Fifty", meaning 50MHz, meaning Six Metres. It will take this expedition a

back on 2 metres or 70 centimeters — to enable him to take his report direct from you on a band you are entitled to use.

So much by way of foreword.

2m and 70cm seem a little familiar these days? You could try exploring 6m or 4m with this intrepid little converter from VHF guide Jack Hum, G5UM. Simple step-by-step construction without even denting the bank balance.

few stages further, but, most important, it will introduce the simplest-ever converter for construction by those wishing to essay "Six" for the first time.

Before getting that far, though a comment on a query which a number of people have made. It is this: "Am I allowed to listen on the 6 metre band?". The answer is simple: "Of course you are". Anyone is allowed to listen anywhere they like within the amateur radio spectrum. If this were not so, how would, say, the budding Class B aspirant to the so-called HF bands ever acquire any knowledge about them if he never listened on them? (You could say that if he did listen on them he might be dissuaded from wishing to use them, but that's another story).

It should be emphasised, then, that even though you may not be licensed to transmit on 6 metres (or, for that matter, 4 metres) there is nothing to stop you from listening there. You may report back what you hear on those bands, but you must do so on a band for which you are licensed. Never embark on a crossband contact with a station using a band which you are not permitted to use. Put another way, this means that if a local friend asks you, as a Class B licence holder, to give him a report on his emissions on 4 metres or 6 metres, tell him that you will be glad to oblige, but emphasise that you must meet him

On now to the world's simplest converter for use on "Six". It is called the *Extrapolator*, a name which perhaps requires a modicum of explanation.

Look in the dictionary for the definition of "extrapolate" (accent on the second syllable) and you will find it to mean: "Calculate from

known terms a series of other terms which lie outside the range of the known terms". This exactly fits the concept of the intended converter for 6 metres. It is a venture into the (comparatively) unknown, and it lies outside the range of our "known terms".

Fig. 1: The basic concept of the "Extrapolator" converter described here is shown in block form, crystal oscillator at right, RF stage at left, each of them feeding its output to the mixer stage, centre, to give output at 5 MHz.

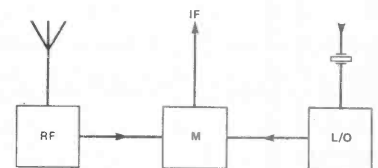

Wearing his VHF field day headgear, Author G5UM contemplates his first mock-up prototype of the "Extrapolator" 70/50 MHz converter described here.



These "known terms" are represented by any existing converter design for the 4 metre band, and their number is considerable. We could take a known 70MHz three-transistor converter and by altering its inductor and crystal values, change it into a 50MHz converter. You extrapolate from the known (70MHz) into the unknown (50MHz).

Something else we need in addition to our extrapolation device is to provide ourselves with a reasonably adequate aerial system for "Six", a requirement which was dealt with here last time. Often one is told by newcomers to the 433MHz band that they are pressing into service their 145MHz antennas rather than instal something that will do justice to 433MHz — and then, wondering why their results on 433MHz appear to be so dismal, they abandon the band without having given it a real chance.

The same thinking applies to "Six". Maybe the sizeable beams, big as a Band 1 television aerial, which would do justice to the band are beyond your pocket — and your backyard space: but at least instal something that is resonant at 50MHz rather than attempt to make do with something which isn't.

What IF To Use?

Back to the converter, then. Remembering that its output is to be presented to the station receiver used as a tunable IF, the constructor must decide at the outset what value of intermediate frequency he wishes to employ. The options were set forth here last time. Although the "Extrapolator" uses 5MHz as its IF, there is no reason at all why readers should not choose a different one if this should suit their circumstances. One elegant professionally designed 6 metre converter provides an IF in the amateur 2 metre band by mixing the incoming 50MHz signal with a local oscillator frequency of 95MHz, and by this additive process up-converts to 145MHz.

The "Extrapolator" by contrast presents the incoming 50MHz signal with a local oscillator value of 45MHz and by a subtractive process down-converts to 5MHz. It could have presented the incoming

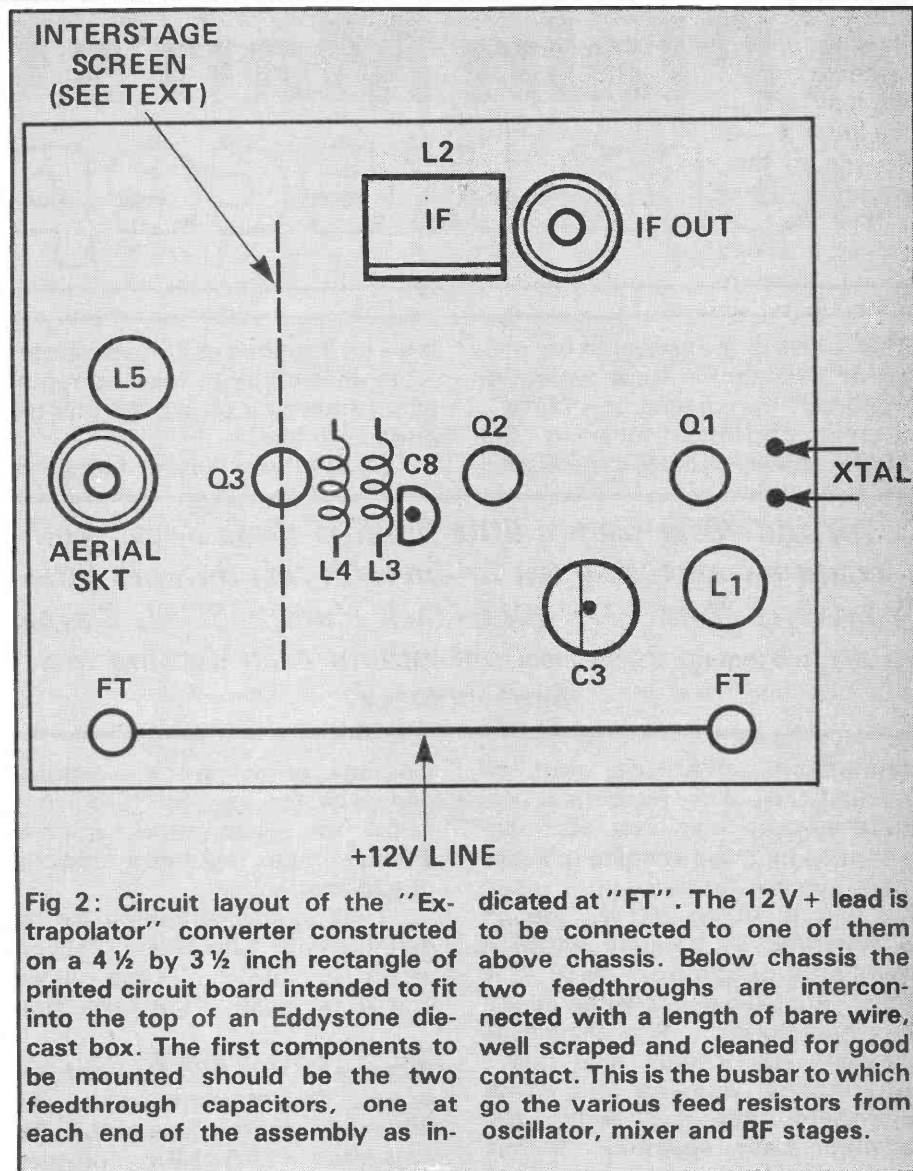

Fig 2: Circuit layout of the "Extrapolator" converter constructed on a 4 1/2 by 3 1/2 inch rectangle of printed circuit board intended to fit into the top of an Eddystone die-cast box. The first components to be mounted should be the two feedthrough capacitors, one at each end of the assembly as in-

dicated at "FT". The 12V+ lead is to be connected to one of them above chassis. Below chassis the two feedthroughs are interconnected with a length of bare wire, well scraped and cleaned for good contact. This is the busbar to which go the various feed resistors from oscillator, mixer and RF stages.

signal with a local oscillator at 22MHz: the IF would then have been the 28 to 30MHz band. Some readers may prefer this IF to the 5MHz in the present design.

As will be seen, to select one's IF is to select one's required crystal value, 45MHz in the present instance. Contact with Bruce Norcliffe at P.M. Crystals (whom G5UM has used for many years) established that 45MHz crystals were stock items. Within days one appeared in the morning's mail, complete with tiny plastic socket using 10mm pin spacing and centre-fixing lug for printed circuit board mounting.

Next item on the construction agenda was: What oscillator circuit to use? The number of options is legion. The sure-fire one shown in Fig 3 was adopted for the present project. And what transistor to use with it? The writer has a penchant

for that workhorse the BF180, and a visit to the emporium of Frank Elliott (Elliot Electronics) not far from the home base produced a fistful (you will have seen his regular advertisement in the 'Emporium Guide' in HRT).

Many would-be constructors will wish to use what they have to hand in their spares boxes such as the old-time but ubiquitous 2N708, ZT81 and the like, which though elderly should loaf along at the comparatively DC frequency of 50MHz. "Using what I've got" is one of the rewarding features of any home construction project.

Layout Considerations

Before construction can commence, the following question asserts itself: What form of mechanical design layout should be

employed? If you are into PCBs and the photographic-and-etching processes of the contemporary scene, you may well prefer to use them. If you are not — and this article is addressed to the thousands of HRT readers likely to be in that category — then the following simple layout is recommended:

Purchase from one of the HRT components advertisers an Eddy-stone (or similar) aluminium die-cast box measuring 120 by 95 by 50mm deep. You will not need the lid for the "Extrapolator" converter, but keep it lest it should come in useful for some future project. The space occupied by the metal lid is to be filled by a rectangle of single-sided PCB cut to fit the top of the die-cast box. If you already have some PCB you can mark off the required dimensions in pencil and then carefully hacksaw it to fit the box. If you don't, then ask your supplier if he can do the job for you when you buy the box.

Radius the corners of your newly acquired piece of 'raw' PCB to fit the radiused angles of the die-cast box. Drill 4 BA holes in each corner — to secure the PCB to the box when the converter to be built upon it is completed.

Single sided PCB is to be used, as I have said previously. This allows components to be mounted on to the insulated side of the PCB (to face downwards). The copper clad side is to face upwards. Small holes are to be drilled in it through which will pass the wire ends of those components (beneath the PCB lid) which need to be grounded. In addition to these earthing points, the only items visible on the top face of the PCB will be the coaxial socket for aerial input, another coaxial socket for IF output, the IF transformer, and a couple of feed-through capacitors. From one of these will extend the +ve DC supply lead, a length of red wire. The -ve DC supply lead, a length of black wire, is to be soldered firmly to the edge of the copper laminate on the top face of the PCB. At extreme right of the PCB top the tiny crystal socket is mounted. (see Fig. 2 which shows the PCB from the 'lower' component side). Beneath the PCB the two feed-throughs will be interconnected with a length of stout bare wire. To this 'HT rail' will be soldered those resistors which re-

quire a 12 volt positive supply.

Take One Oscillator. . .

Down the years the custom at G5UM when building converters is to start with the oscillator section. One knows "clever devils" who are able to start with the RF section and work with insolent ease through the mixer section and build the oscillator section last. If you have the expertise, fair enough, do it that way in the present instance. If you don't then play safe and get the oscillator going first. It's position on the PCB chassis is shown in this half-size diagram, Fig 2, which gives an idea of the compact construction of the unit.

In Fig 3 is shown the 'sure-fire' oscillator circuit referred to earlier, complete with a table of component values, and, equally impor-

tant, a description of what each component does.

Let construction commence! Lay resistors and capacitors on the insulated side of the PCB so that their wire ends may pass through holes on to the copper-clad upper side of the PCB where they are to be grounded, or to the "HT Rail", the feed through capacitors where they are to accept the +12 volt supply. The tuning capacitor C3 and it's related inductor L1 are the largest components and should be mounted first. When soldering in the transistor, grip its lead-out wires with a pair of long nosed pliers which will act as a heat sink and prevent the heat of the soldering iron from killing the semiconductor.

With construction of the CO stage completed, it is time to plug in the 45MHz crystal and to rotate

FIG 3: The "Extrapolator" converter crystal oscillator stage:

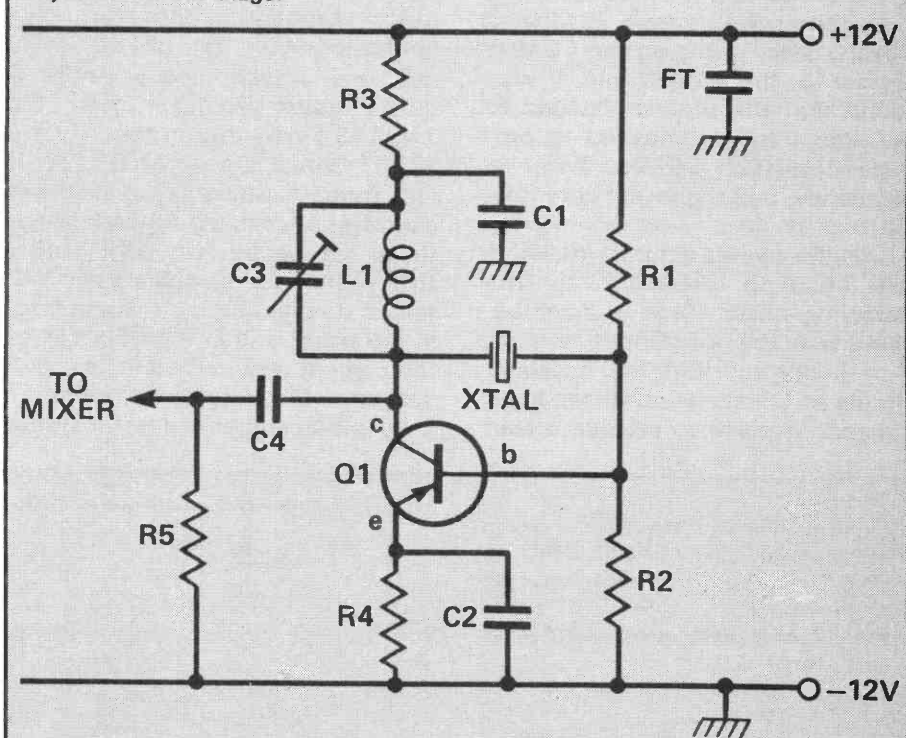

- | | |
|----|---|
| R1 | 22 Kohms and R2, 12 Kohms, base bias network. |
| R3 | 750 ohms, collector output decoupling. |
| R4 | 2.2 Kohms, emitter bias. |
| R5 | 150 Kohms, mixer input load resistor |
| C1 | 1,800 pF, collector output decoupling |
| C2 | 1,800 pF, emitter decoupling |
| C3 | 0-15 pF miniature trimmer (3 plate + 4 plate), collector tuning |
| C4 | 5pF, coupling to mixer input. |

- | | |
|------|---|
| FT | 2,200 pF feedthrough capacitor, feed-line decoupling |
| L1 | inductor to resonate with crystal X: approx 12 turns of 24 SWG enamel or dcc wire close wound on 1/4-inch former fitted with iron dust core slug. |
| X | crystal, 45 MHz, for 50 MHz version, 65 MHz for 70 MHz version. |
| Tr 1 | 2N708, ZT80/81, BF180 or similar |

C3 to induce oscillation.

"But how shall I know if the stage is oscillating?". The question is a basic one. A few lucky readers who possess a receiver with 45MHz in its tuning range will actually be able to listen on that frequency for the oscillator 'starting up'. For everybody else a visual means of observing that the CO is functioning is essential. This is how to go about it:

Insert a low reading milliammeter or multimeter set to a low DC mA range in the 12-volt-**plus** lead and rotate the preset trimmer C3. A change in the standing current will be noted when oscillation starts. Touch the crystal socket with the fingers: the standing current will change again because oscillation has probably stopped.

In the prototype converter, the 65MHz crystal used in the 70MHz version went into oscillation with the C3 trimmer almost fully out and the ferrite core of the inductor barely in. Extrapolating from 70MHz to 50MHz after changing the 65MHz crystal for the 45MHz one, it was found that the trimmer needed to be almost fully enmeshed to produce oscillation 20MHz lower in frequency, and the ferrite core fully in.

In the circuit diagram at Fig 3 the coupling capacitor to the following mixer stage is included, along with the mixer input resistor. It is important that the oscillator should be checked with these components in place to provide a load

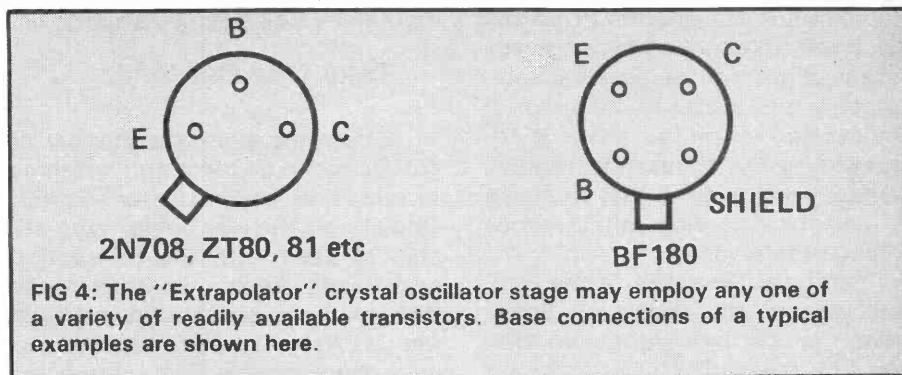

for transistor Tr1.

...Next, Mix Gently

As with the oscillator stage so with the mixer: several configurations suggest themselves. Earlier converters built at G5UM have employed the ubiquitous BF180, and indeed the initial layout of the present project used it.

A change to one of the earlier FETs, the 2N3819, provided a useful reduction in converter noise compared with the BF180. Why not, one argued, use a device a dozen years younger than the 2N3819? Why not, in fact, try the BF981 small signal MOSFET? It was found to be readily available at a modest price in the Ambit International list issued with HRT earlier this year. Four samples were obtained to evaluate their worth both in the mixer and in the RF stage of the present design (two in use, two spares just in case of fatalities).

Fig 5 (a) shows the mixer layout

when a 2N3819 is used, and Fig 5 (b) with a BF981 MOSFET. The latter improved both performance and oscillator isolation.

In the IF output circuit, the inductor resonating at the IF of 5MHz would traditionally have a few turns of wire wound around its earthy end to provide a low impedance output. Less traditional is the capacitor output network shown in Figs 5(a) and (b). It was suggested to the writer many years ago by G8ACE, has been incorporated in many home built converters since then, and offers the advantage of a two-terminal IF output instead of a four-terminal one.

Now heat up. . .

At this point, by interconnecting the oscillator of Fig 3 with the mixer of Fig 5, the constructor will have a ready-to-work converter to hand but by no means a 'hot' one. Add a stage of RF heating' by preceding the mixer with a high gain front end amplifier and the

Fig 5 (a): The "Extrapolator" converter mixer stage using a 2N3819 FET:

- R5 150,000 ohms mixer input load resistors.
- R6 2,200 ohms source bias resistor.
- R7 100 ohms IF inductor feed resistor.
- C4 5 pF coupling from oscillator.
- C5 2,200 pF feedthrough HT decoupling.
- C6 1,800 pF source decoupling bypass capacitor.
- C7 33 pF gate circuit blocking capacitor.
- C8 0-15 pF preset trimmer, mixer input tuning.
- C9 320 pF, IF inductor output network.
- C10 47 pf IF inductor output network.
- C11 1,000 pf output coupling to IF output socket

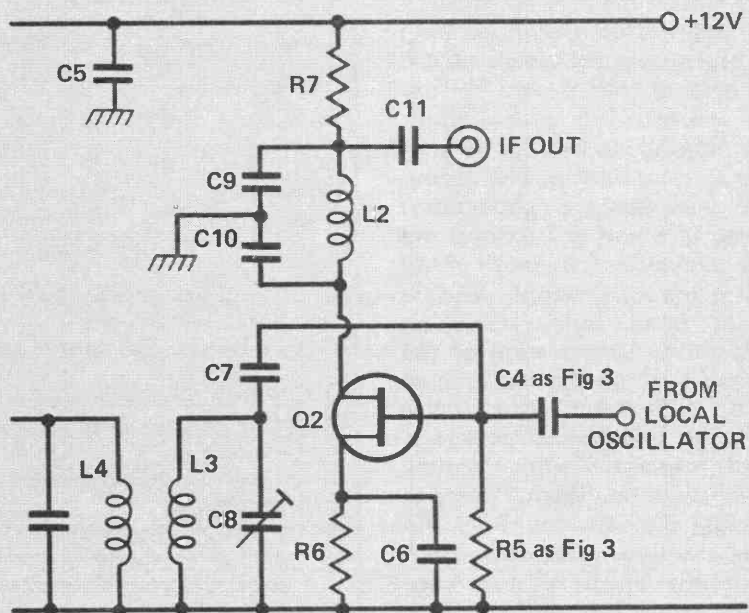

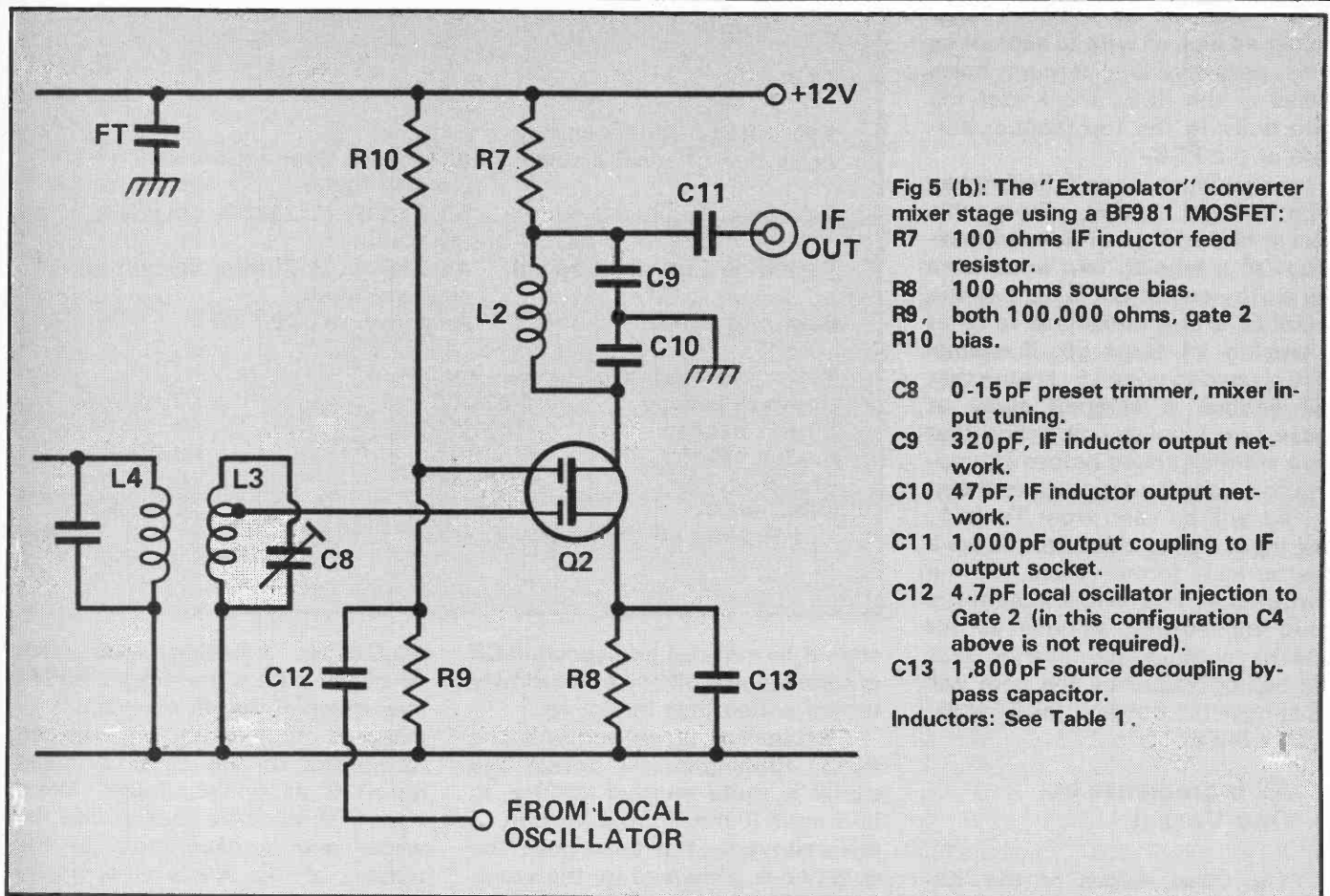

Fig 5 (b): The "Extrapolator" converter mixer stage using a BF981 MOSFET:

- R7 100 ohms IF inductor feed resistor.
 - R8 100 ohms source bias.
 - R9, both 100,000 ohms, gate 2 bias.
 - R10 bias.
 - C8 0-15 pF preset trimmer, mixer input tuning.
 - C9 320 pF, IF inductor output network.
 - C10 47 pF, IF inductor output network.
 - C11 1,000 pF output coupling to IF output socket.
 - C12 4.7 pF local oscillator injection to Gate 2 (in this configuration C4 above is not required).
 - C13 1,800 pF source decoupling bypass capacitor.
- Inductors: See Table 1.

converter is ready to do justice to itself — and the reader's efforts in making it.

This RF stage like the mixer is to be a BF981 and the circuit diagram is given in Fig 7, quite straightforward and no frills. Coupling to the mixer stage is from L4 into L3, the two coils close-coupled. Their construction is left to the readers ingenuity: they may be wound end-to-end on a single plastic former fitted with a separate ferrite core for each with which to peak them up at mid-band. Or they may be air-spaced, wound separately and positioned in close proximity for maximum coupling between them.

The 12 volt feed to the BF981 drain is via a small RF choke. It so happened that the G5UM spares box contained an old 1.6MHz IF coil that was small enough to be accommodated on the compact PCB layout of the converter.

Although the functions of the remaining components are described in the table of values, a word of explanation about the aerial input inductor is necessary. This component on the G5UM prototype was positioned vertically close to the

aerial input socket so that it would not be in the same plane as the RF stage output coil. Self-oscillation of this stage was thus avoided. No screen across the RF stage MOSFET connections was found to

be necessary. The prudent constructor nevertheless may wish to mount a strip of copper foil at this point, so that input coil does not 'see' output coil. If such a screen is provided this need measure more

TABLE 1

The "Extrapolator" 70/50MHz Converter: inductor details.

- L1 to resonate with 65MHz and 45MHz crystals. Approx 12 turns of 24SWG enamel or dcc wire close wound on ¼-inch former fitted with iron dust core slug.
- L2 IF output coil, 65 turns on ¼-inch former to fill ¾-inch. Wire size 28 to 32SWG. Former fitted with adjustable ferrite core.
- L3 mixer input inductor: 70MHz 11 turns 28SWG enamelled on ¼-inch former, or self-supporting.
50MHz 19 turns as above.
- L4 RF stage output: 70MHz 13 turns 28SWG enamelled on ¼-inch former, or self-supporting.
50MHz 24 turns as above.
- L5 aerial input inductor: 16 turns 28SWG enamelled on ¼-inch former (fitted ferrite core). Aerial input tapping 2 turns from earthy end, Gate 1 tapping 11 turns from earthy end. Coil resonates to 50MHz with slug full in and to 70MHz with slug nearly full out.

than 1 inch tall by 2 inches long. Solder an inch of wire to each of its ends, pass this wire through holes drilled in the PCB, and solder the wire ends to the top, copper surface of the PCB.

Aerial input is via a Belling-Lee type coaxial socket. From this socket half an inch of bare wire extends to a tapping two turns from the earthy end of L5. Gate 1 of the MOSFET is also connected to L5 at a tapping 11 turns up. If enamel wire is used to wind L5, ensure that the enamel is scraped away at these two tapping points and that they are well tinned before attempting to solder the tappings to them.

As will be seen from Table 1, this input coil is close-wound on a quarter-inch former fitted with a ferrite core. This single inductor is good for 70MHz as well as for 50MHz without any change. For the higher frequency the core will be almost full out and for 50MHz, almost full in.

All Ingredients In One Vessel. . .

The three stages of the 'Extrapolator' converter have now been dealt with in detail. No diagram of the complete unit is necessary: the inter-connection of the three is self evident from Figs 3, 5 and 7 and a suggested physical layout is at Fig 2.

The moment has come to check that all the ingredients have come together happily and that the result is "a tasty dish". To do so proceed as follows:

Connect a short length of thin coaxial cable from the output IF socket on the top face of the converter to the input socket of the station receiver. To minimise IF breakthrough, bond converter to receiver ground terminal via a separate lead.

Connect a 9 volt or 12 volt battery pack to the converter via the black lead which has been soldered to the upper, copper face of the PCB and via the +ve red lead which extends from one of the feed-through capacitors.

Plug in the 65MHz crystal and set the station receiver at 5MHz. At once an increase in the receiver's noise level should be evident, to tell the constructor the joyous news that the converter is working. A further increase in conversion noise

TABLE 2

Your "free" signal generators for "Six"		
Television Channel 2 vision:	51.75MHz	(just within the amateur band).
Television Channel 3 sound:	53.25MHz	(1.25MHz outside the band).
Television Channel 2 sound:	48.25MHz	(1.75MHz below the amateur band).
Beacon GB3SIX:	Anglesey, 50.02Mhz	
Your "free" signal generators for "Four"		
Cornwall beacon	GB3CTC	70.03MHz
Sussex beacon	GB3WHA *	70.04MHz
Buxton beacon	GB3BUX	70.05MHz
Angus beacon	GB3ANG	70.06MHz
Irish beacon	EI4RF	70.13MHz
* Presently off-the-air due to site problems.		

should be noticed as capacitor C8 is adjusted and all coil cores slowly turned within their inductors.

Achieving converter hiss is one thing. Homing-in on a real live signal is quite another. Where to find one? If the 70MHz version of this converter has been built, the question is answered by the word: 'beacons' (See Table 2). One of these beacons, high in the hills of Derbyshire, is GB3BUX, available all day on 70.05MHz and audible over much of England if a reasonable aerial is used. When the 65MHz crystal is in position in the converter and the station receiver set to 5.05MHz the GB3BUX beacon is likely to be detectable. If it is not, switch receiver BFO on to listen under CW conditions. Finally, readjust capacitors and ferrite coils in the converter for maximum signal from GB3BUX on "Four".

With 6 metres a different set of circumstances prevails. There is at the time of writing but one UK beacon available, GB3SIX on

50.02MHz, beaming west from Anglesey. The signal from GB3SIX over much of the UK mainland is so marginal that even experienced navigators of the 50MHz ocean report it as rarely audible. What hopes, then, have people like the writer and perhaps most of the readers of this article who merely paddle on the edges of that ocean?

Nil desperandum: all is not lost by any means. Available on "Six" there are many permanent signal generators that will assist the alignment of the 50MHz of this converter. They are called television broadcast stations! Three of them with frequencies near the 50MHz band are listed in Table 2. Let us take a closer look at how they may be used:

After the converter prototype had been safely breached on GB3BUX on the 4 metre band, its parameters were extrapolated to the 6 metre band by the simple expedient, already described, of changing the crystal from 65MHz

Fig 6 (a) Connections to the 2N3819

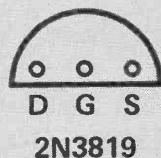
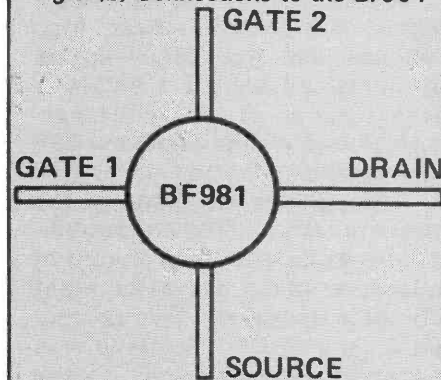

Fig 6 (b) Connections to the BF981



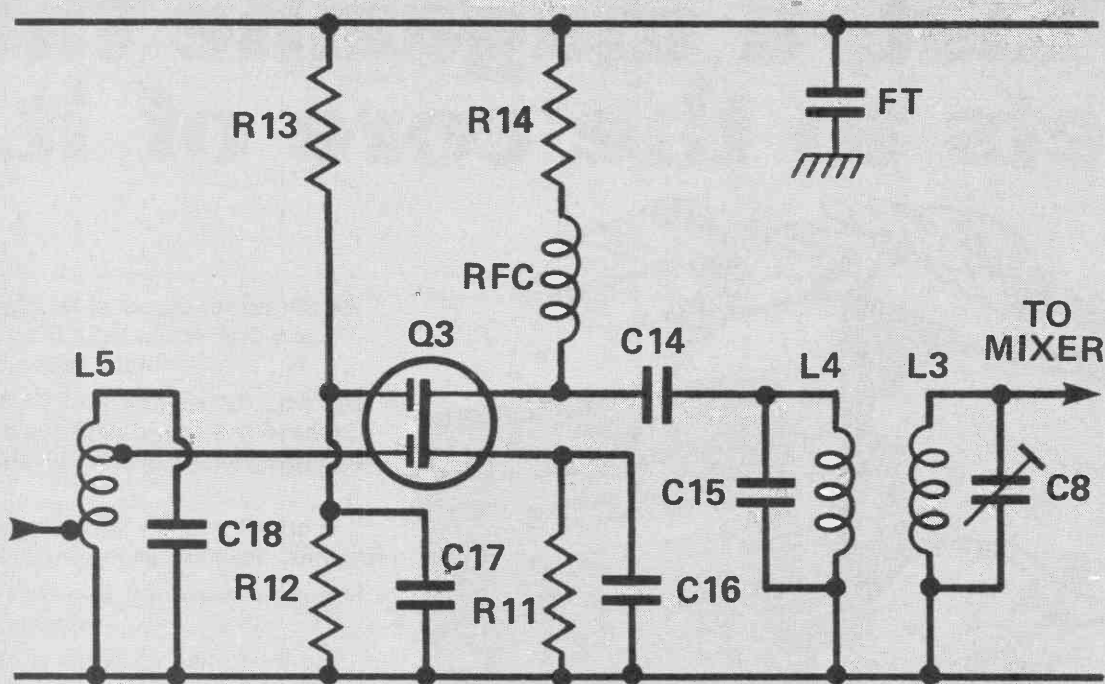

Fig 7: The "Extrapolator" converter r.f. stage, using a BF981 MOSFET.

C8 mixer input tuning as Fig 5.

C14 18 pF, drain circuit blocking capacitor.

C15 6.8 pF output stage tuning (select for maximum signal out-

put).

C16 1,000 pF source bias decoupling.

C17 1,000 pF gate 2 bias decoupling

C18 18 pF input tuning (select for maximum signal output)

FT feedthrough decoupling, as Fig 5.

R11 100 ohm source bias.

R12 47,000 ohms gate 2 bias.

R13 68,000 ohms gate 2 bias.

R14 100 ohms drain feed resistor.

RFC drain feed choke (see text)

Inductors: See Table 1

to 45MHz and replacing inductors L3 and L4 for the larger size versions shown in Table 1. The station receiver was set at 6.75MHz, representing 51.75MHz where the Holme Moss vision signal should appear — and it did! Tweaking of the mixer input capacitor C8 brought the 405-line buzz up to a full throated roar. The IF inductor having been initially peaked at 5MHz on converter noise needed a small adjustment of it's ferrite core to peak it at 6.75MHz, and up came the video buzz to even greater strength (this on a horizontal dipole in the roof space at 80 miles from the station).

The next operation was to set the station receiver at 3.25MHz to represent 48.25MHz, or somewhat below the limit of the 50MHz band, and up came the Channel 2 sound signal.

Each constructor will have available in this own district BBC video and sound transmissions in Television Band 1, on which to check that the "Extrapolator" is capable of receiving signals from the outside world.

More satisfactory, of course, is to receive a real amateur signal

within the 50-52MHz band. You may be fortunate enough to hear one if you tune slightly above 5MHz (representing 50MHz) outside of television hours. You may be even more fortunate to have locally one of the few holders of 50MHz transmitting permits who would be pleased to radiate a signal for you on which to align your "Extrapolator".

If listening to your first amateur signal on "Six" you feel inclined to murmur to yourself: "Rarely, rarely comest thou spirit of delight" you can console yourself with the thought that "spirits of delight" exists somewhat more plenteously at present on the higher frequency band of 70MHz. I hope you feel that you should have facilities for listening on *both* bands. You can, with the greatest of ease: go ahead and build yourself two "Extrapolator" converters while you are about it, one for "Four" and the other for "Six". The two of them won't cost you much!

Final-Final

The foregoing discourse has said nothing about in-house test

facilities. It has assumed that very few readers will have access to professionally built signal generating and alignment equipment, much less *own* such expensive artefacts. It has been suggested that both versions of the "Extrapolator" converter be evaluated on external signals. This is a valid and practical procedure. But other methods exist for those readers who are prepared to construct their own cheap and cheerful home testing equipment. More of this in a later article.

Reader should note this article is not intended to be in the realms of the latest "state-of-the-art" of converter construction. Perhaps it will appal the cognoscenti. No matter: it will appeal to the constructor-domesticus. That is my intention at any rate. In its development stages it was "made up as one went along", prompting the thought that it might have been called "The Extemporizer" instead of "The Extrapolator"! One hopes that you, too, will extract as much enjoyment from building it as the writer did, and that you will gain quiet satisfaction from the loud results it gives you.

At last, a magazine that gets to the core of it.



As the proud owner of an Apple, you know that really helpful magazines don't grow on trees.

But now there's Orchard Computing. Orchard is a brand new quarterly put together specifically to suit the Apple user.

It brings you the very best in useful routines, business and games software. And not a word of it that isn't directly relevant to you.

So if you like an Apple a day, take Orchard quarterly.

It's just what the doctor ordered.

Orchard
COMPUTING
Britain's best buy for Apple users

OUT

NOW

RADIO

Building Blocks

FM circuitry is nearly always within the context of VHF. All the following examples assume operation at VHF frequencies (or transposing

system filter is the most important component in any successful NBFM transceiver design. The correct choice is far more signifi-

25kHz channel spacing, it must pass, with negligible phase error, a band of frequencies 15kHz wide derived from the expression $2(f_{dev} + f_{mod})$ while providing a minimum of 80dB of rejection for signals just 25kHz away.

This month Frank Ogden, G4JST, delves into FM, in particular FM IF strips.

from them in the case of discussion about IF strips) and that the mode is narrow band FM. There are other frequencies and FM modes used in amateur radio such as SSTV, RTTY, wideband FM for microwave but these are not often encountered; FM means narrow band FM in 98 per cent of cases.

A Bit About FM

Everyone knows what FM stands for (I hope!) but what does it actually *mean*? You start off with a carrier at constant amplitude and then waggle it about at a rate determined by the modulation frequency. The amount by which the carrier frequency is altered gives the amplitude of the modulation. Unlike SSB or AM where the bandwidth is limited to a precise value determined by the modulation frequency, the sidebands of an FM carrier are much wider, naturally, but extend out much further than the peak deviation would suggest. Unlike AM, FM sidebands show a Gaussian distribution at the sum of the peak deviation and modulation frequency. In practice, this means that it is very difficult to tell if that box of grubby looking filters offered for sale by a grubby looking trader at a mud-up-to-the-ankles rally is a bargain or not.

Choosing A Filter

The delight of NBFM is that the circuitry is simple; any other mode is a nightmare by comparison. However looks are deceptive. The

cant than, say, transmitter output power, receiver de-emphasis or even the 'front end' noise performance. The incorrect choice (or circuit design for an otherwise suitable unit) leads directly to receiver blocking, audio distortion low-level signal readability and one or two other nasties. If you don't read any other part of this article, make sure that you take in the next bit.

There are two ways (three, actually but I don't propose to discuss DC PLLs here) of designing a practical NBFM receiver system. The first, shown in Fig. 1, uses single conversion to 10.7MHz where the signal is both amplified and detected. Chips such as Plessey SL6650 can provide the entire IF/demod function for NBFM at this single frequency very effectively.

The second variety of design, as depicted in Fig. 2, is by far the commonest and full of treacherous pitfalls. The circuitry here uses double conversion: from signal frequency to 10.7MHz, and from 10.7MHz to 455kHz. Nearly all the amplification and detection is carried out at this last low frequency. Either variation requires a top quality crystal filter which operates at 10.7MHz. Assuming that the hypothetical system is designed for

This type of performance does not come cheap. Any useful NBFM design requires a first crystal filter with at least 8 poles. A design using a filter with less than this will show an unacceptable disposition to co-channel interference. With decent units costing in the region of £20 to £30, there is a great temptation to use those ubiquitous three legged 2-pole filter units or, even worse, ceramic filters as intended for FM tuners. The result will never be satisfactory, even though the filter may be simply providing the 'roofing' function in the double conversion scheme shown in Fig. 2. It may appear that, since the 15kHz bandwidth is provided by a ceramic filter operating at 455kHz, then the requirements of the 10.7MHz filter before the 2nd mixer are lessened. This is not the case. The second mixer provided on chips such as the MC3357 is of a low level type. If a 'barn door... as wide as' type filter is used ahead of it then the contents of around 12 FM channels adjacent to the wanted one are heterodyned down to it simultaneously. The result is 'sproggies', intermod and an unbelievable amount of co-channel interference. Adjacent signals of just 100uV at the aerial can wipe this type of IF clean of useable signal if the first filter is of

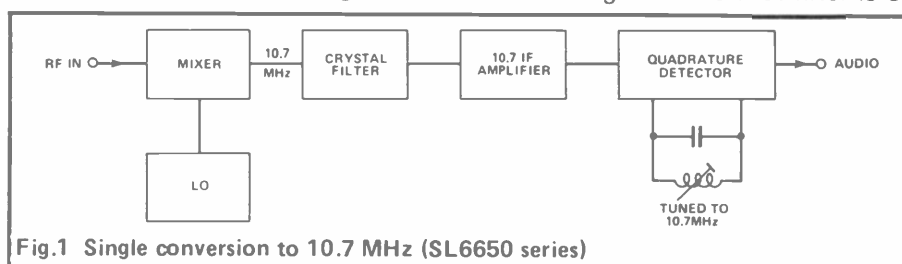

Fig.1 Single conversion to 10.7 MHz (SL6650 series)

the cheap and cheerful type, no matter how good the 455kHz unit is.

Terminating The Filter

Monolithic crystal filters are very fussy about what they are connected to. The high rejection and the closely defined bandwidth is produced by the critical coupling of a number of independent crystal resonators, 'the poles'. The unit will only function as a single controlled bandwidth resonator if the termination conditions, particularly in respect of the resistance, are carefully controlled. They must 'see' a non reactive resistance as specified by the manufacturer — typically in the range 1 to 4 kilohms in parallel with a specified capacitive loading — generally around 20pF. These conditions should prevail at each end.

Most IC IF strips require around 5 to 15 microvolts to achieve satisfactory noise limited operation. The output of the average front end using a couple of dual gate MOSFETs tends to be around two or three microvolts at noise limit. The difference between the two represents a shortfall in amplification when going straight from front end to IC via a filter. Fig. 3 shows how to bridge the gain gap and provide a very predictable termination for both ends of the filter. The IF transformer presents a very high impedance load to the drain of the mixer MOSFET. Any resistance placed across it becomes the 'real' resistance presented to the filter. In use, the tuning slug of the transformer is adjusted for minimum passband ripple. The input resistance of the following JFET stage is determined entirely by the gate resistor with a small value capacitor for reactive adjustment.

I make no apologies for going on at length about the qualities and requirements of the first IF filter. The goodness or otherwise of this component and its installation sets the standard for the finished piece of equipment. Even some of the biggest names in amateur radio equipment — I'm thinking of Icom gear in particular — tend to economise on this component for their FM boxes with a shortfall in performance as a result. The almost universally poor perfor-

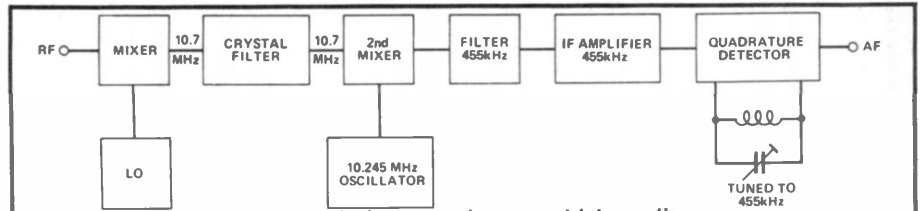

Fig.2 Double conversion technique requires very high quality 10.7 MHz filter to avoid blocking of 2nd mixer with adjacent channel signals

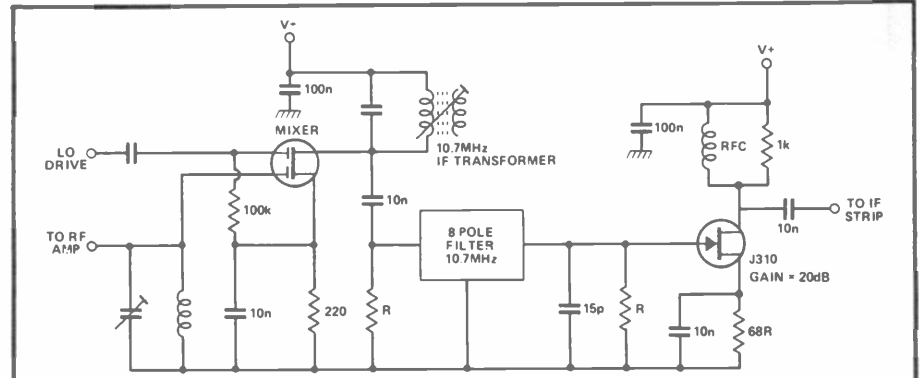

Fig.3 Amplification with good termination

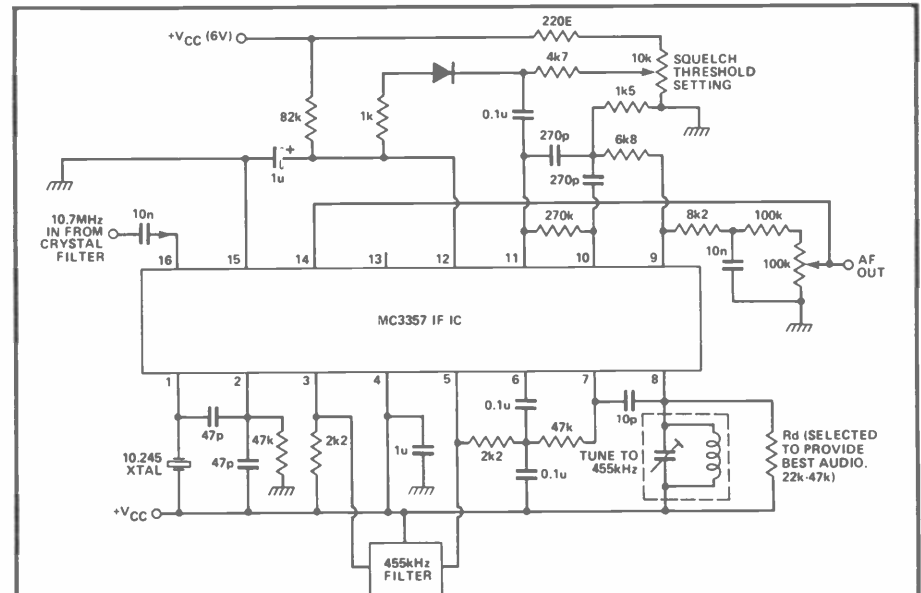

Fig.4 MC3357 application example

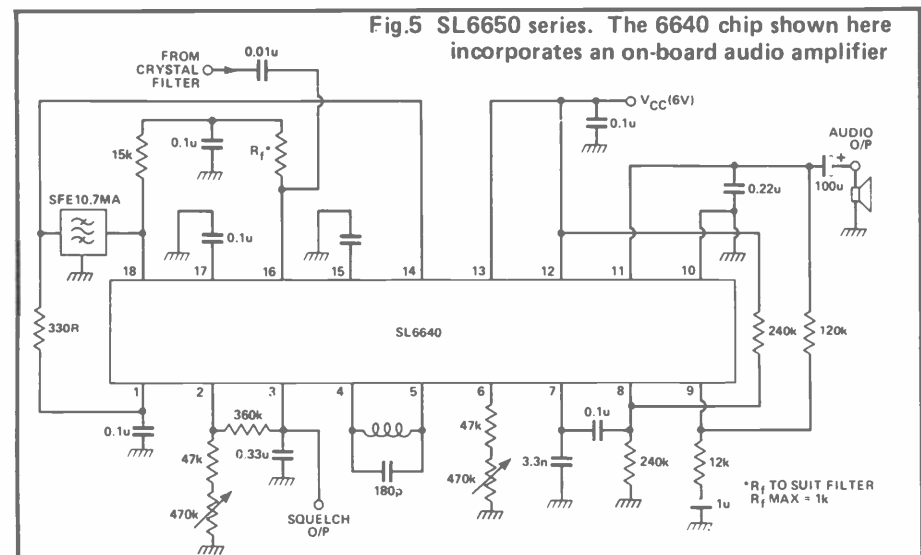

Fig.5 SL6650 series. The 6640 chip shown here incorporates an on-board audio amplifier

mance of CB set receivers (the transmitters are almost universally good) can be attributed directly to the filter factor.

If you have fitted a decent filter and the recovered audio is distorted at low signal strengths — and you can't get it any better with adjustment of the quadrature coil at the end of the IF strip — then the termination conditions of the filter are probably wrong. It is possible to verify this by setting up a weak carrier from a slowly tuneable signal generator and then tune through the receiver IF passband. If the termination conditions are wrong, it is possible to hear ripple as a series of peaks and troughs in the noise. Remember that these represent phase errors which lead directly to distortion of the modulation envelope recovered from the detector. This is because NBFM is all about phase. Addition of the JFET circuitry as shown in Fig. 3 nearly always effects a dramatic improvement in low signal performance under these circumstances.

If you have got the filter right and delivering enough IF signal to whatever follows it, the choice of what chip to use to provide the bulk of amplification and detection is largely immaterial. It will depend on what you have to hand, the squelch

characteristics (I have a personal hate for squelches with hysteresis as found on the *MC3357/9*) and the power supply (only use a CA3089 if you've got a built in generator).

I offer a few experiences of the common types.

MC3357 Family

The typical circuit diagram is shown in Fig. 4. The basic circuit works well but extra amplification after the first crystal filter is usually needed. Low power drain, around 4 mA, is a real asset, which is why this device (MC3357) has become the standard component for hand-talkies manufactured the world over. The logic level output from pin 13 derived from the squelch circuit is useful for switching off the entire power supply to the AF section. A *VN66AF* driven from this pin can be used as the switch element itself. I have never found any instability problem with this device largely because it is of the double conversion variety. 10.7MHz to 455kHz; 10.245MHz oscillator on chip (crystal needed).

SL6650 Family

Typical circuit is shown in Fig.

5. A difficult device to use because all the amplification is done at 10.7MHz. With around 100dB available on a single chip, the layout requires extreme care. It is my view that a groundplane PCB is mandatory. Also, the device needs to be handled with great care as it is extremely sensitive to static. A badly earthed soldering iron will kill it stone dead. This circuit and all the Plessey radio chips are very fragile. This is because the small geometry transistors which exhibit such excellent RF properties are as sensitive to *static damage* as the old fashioned MOS devices.

Having said this, the Plessey circuits are my choice for the majority of FM IF applications. The current requirements are minimal (about the same as the *MC3357*) there is a DC volume control, the squelch system uses a series of detectors throughout the chip which provides a log response (SL6650 only). It provides the only on-chip S meter function which gives readings that make sense with NBFM (think of all the other S meters which read S9 with 4uV). There are operating disadvantages. The quadrature coil core requires critical adjustment and an outboard gain stage is mandatory.

CA3089 Family

The original IC as used in successive generations of FM tuners. The power consumption of this chip is very high and the low impedance of the quadrature circuit means that the coil is excessively damped when the chip is used for NBFM at 10.7MHz. It is possible to increase the recovered audio by using a 0.5uH coil tuned by around 270pF. The coupling inductance needs to be reduced to around 10uH under these conditions. Good qualities of the chip include an excellent log response on the S meter feed. An outboard IF stage is mandatory.

TBA120S

Very primitive chip. No mute or S meter function (it was intended for a TV sound strip). Lacking in gain at 10.7MHz but works reasonably effectively as the second NBFM IF at 455kHz. Next month — product detectors and SSB generators.

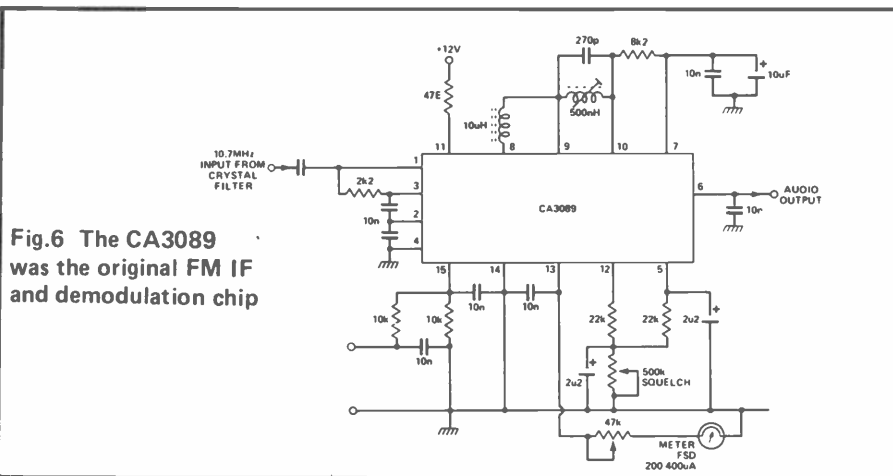

Fig.6 The CA3089 was the original FM IF and demodulation chip

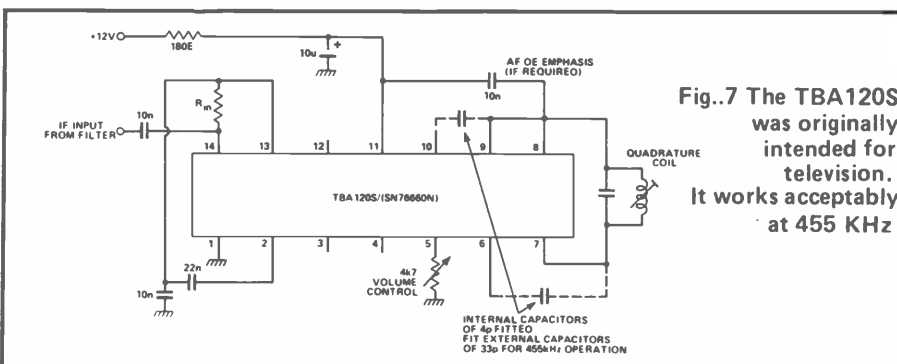

Fig.7 The TBA120S was originally intended for television. It works acceptably at 455 KHz

Practicalities

One problem, always present for the home constructor, is that of how to achieve a reasonably professional finish to the metalwork with the minimum of equipment. A few months ago, I mentioned a way of labelling front panels to improve their appearance, and here are a few more ideas to help make the finished article more presentable.

One way in which the appearance of a piece of equipment can be greatly improved is to have a nicely *painted* case and front panel. This is most easily achieved by purchasing one of the large selection of ready painted

Get a professional finish and build a dummy load with Ian Poole, G3YWX

cases available from most major component stockists! The main drawback with this (apart from the expense of course) is that the paintwork is very easily spoiled when the necessary drilling is being done. One trick I have found very successful in overcoming this is to cover all

metalworking I have done is an Abrafile. This tool is possibly not well known to many home constructors and is extremely useful for cutting large or irregular holes in sheet metal. It is therefore ideal for making cutouts in front panels for which the correct size drill is not available or the hole is not circular. Basically, an abrafile is a long circular file about one sixteenth of an inch in diameter and designed to fit into a standard hacksaw frame. If a hacksaw is already available, all that has to be bought is the abrafile and the small fitments for either end of the file. These are all readily available from hardware shops. To use an Abrafile, a hole large enough to take the file should first be drilled. The file can then be fed through the hole and attached to the hacksaw frame. The file should be kept under tension by tightening the nut at the end of the hacksaw by two turns (on most types of saw) after the slack has been taken up. This tension is sufficient to prevent the file bending unduly and thus causing the saw to wander, and not so much that the file snaps. It is then a simple matter to make the cutout follow an outline — which should have been marked out previously, of course.

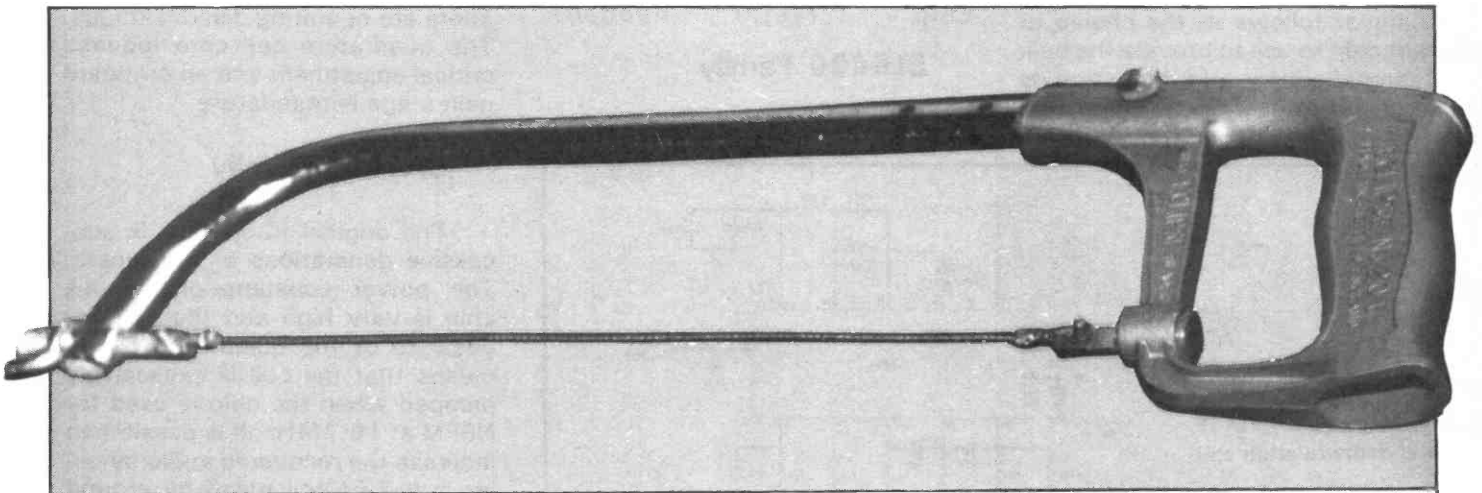

An Abrafile in place

the vulnerable areas with masking tape, remembering that any exposed surfaces which are uncovered will be at risk. It is better to cover too much rather than too little! One further advantage of this is that having covered the surfaces which are to be drilled, then it is possible to draw on the masking tape and plan out the layout of the panel *before* drilling starts. If the project becomes delayed — as many of mine have done — and the masking tape remains on the panel for more than about two weeks, the job of removing the tape becomes progressively more difficult and, also, the surface will remain sticky after the tape has been removed. If this happens, as much of the tape as possible should be removed and the remainder cleaned off with a freon based solvent, which is often used in the aerosol cleaners available from many electronics shops.

One tool which I have found very useful in the

Homebrew Dummy Loads

With the availability of many off-the-shelf ancillary pieces of equipment, very often it is easy to forget that

Fig. 2 Matrix construction

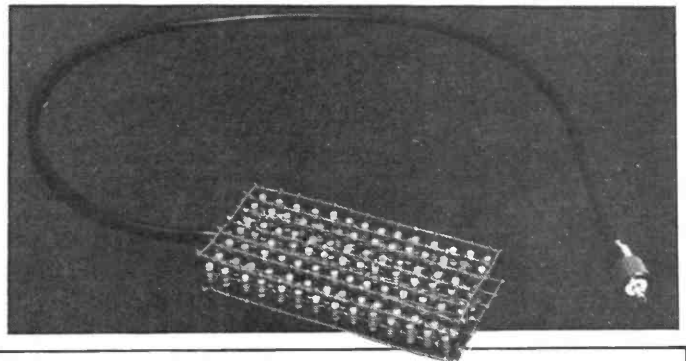

some of them are easy to construct. Although the homebrewed equivalents may not look quite as professional, they do perform perfectly satisfactorily. I found myself in this position some time ago when I wanted to repair an HF sideband transmitter that I had bought cheaply in a partly working state. I looked through the advertisements for 'dummy loads' only to

find that the cost of a suitable one cost nearly as much as the transmitter! However, in fairness to these loads they did possess an excellent frequency specification.

Accordingly I decided to build a load from a bank of discreet resistors. The main point to watch when constructing an RF load is to avoid introducing any inductance. With this in mind, wire-wound resistors must be avoided at all costs because they become almost totally inductive at RF and hence totally useless for this purpose. Carbon or metal film resistors are both equally suitable, and the load which I constructed actually used carbon resistors as they are available quite cheaply. This used 100 5K1 resistors to give a 51 ohm load — which is near enough to 50 ohms not to pose any problems! In order to reduce the overall inductance to a minimum, the leads should be kept as short as possible within the load itself. If only a few resistors are to be used, then the arrangement shown in Fig. 1 can easily be used. If more resistors are to be used then the matrix style of layout shown in Fig. 2 will probably be more easily constructed and the leads kept as short as possible. One point to be born in mind is that there should be sufficient spacing between the resistors for ventilation; also, if the load is to be mounted in a case there should be adequate air flow through to avoid overheating.

This type of approach is normally quite suitable for HF loads — in fact the unit which I built gave SWRs of below 1.2:1 at 30MHz. However at VHF, the inductance of both the leads and the resistors becomes more significant giving rise to a substantial increase in reflected power.

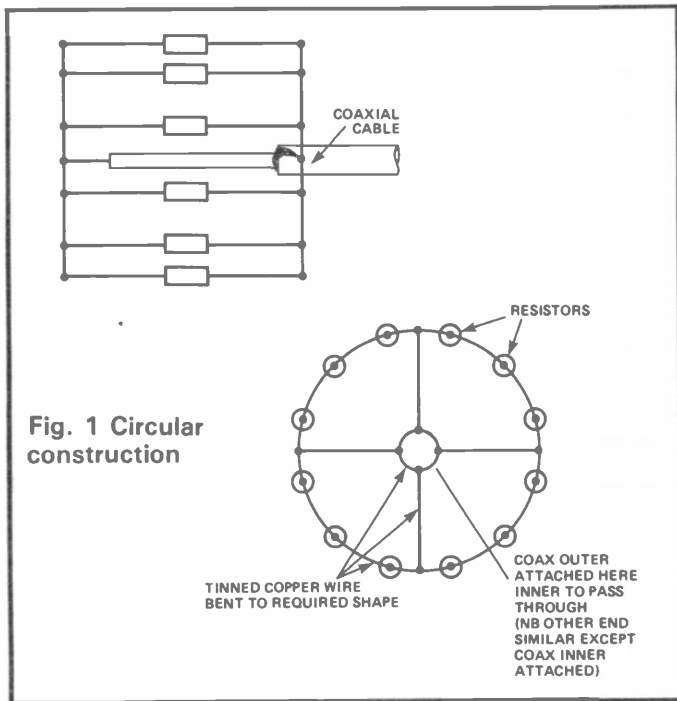

ADVERTISERS INDEX

HAM RADIO TODAY JULY 1984

Amcomm..... IFC
 Bi-pak..... 9
 B.N.R. & E.S..... 42
 CirKit Holdings 16,17
 Gamma Aerial Products IFC
 Quartslab Marketing 42

South Midland Communications... 34
 The C.Q. Centre OBC
 Western Electronics 31
 Wood & Douglas IFC
 W.P.O. Communications 12

And don't forget, when calling an advertiser, mention Ham Radio Today, it helps them and us.

**73's David Gadsden G4NXV
 Advertisement Manager**

Free Readers' ADS!

Vintage Radiogram GD 1050C in three upright cabinets walnut. 1). 5 band radio band-spread tuning 2). Turntable with record storage 3). Bass reflex speaker cabinet. Exchange modern G.C. receiver or offers. Tel: Newcastle 2868291

Yaesu FT 290R with motor matched preamp and mobile mount, NICads, charger. Mint condition £250 ono. George, 8 Kestrel Drive, Dalton. In Furness Cumbria 0229 63284 after 6 pm.

NRD 515 Rx. Mint Condx 18 months old. £750 D. Menzies, 11 Glebe Road, Newton Mearns, Glasgow.

Tonna 9 element crossed YAGI 144MHz £25.00 ono. IC260 needs attention £130.00. Pye pocketfone PFZUB 3 Ch's. £30.00. Extel Teleprinter 50/75 Bauds £190.00. Tel: 025 481 3182

Linear Amplifier: Skipmaster HF-15 2-30 MHz. AM-FM-SSB Pre-ampt 5-10in 20-15 out: £60.00 ono. Tel: 01-998-4713

Wanted — Crystal set for exhibition. Must be genuine item of the early 1920s. Details please to: Stan, G3XON, 14 Dageden Road, Shalford, Guildford, Surrey. GU48DD or telephone Guildford (0483) 36953.

Exchange Realistic Pro 2001 Scanner Brand new. Programmable with memories. Covers all VHS, UHF bands. For HF transceiver, tel: St. Albans 39333.

Heath Kit Short Wave receiver S.W.717 and general coverage. Phones and Manual good order. £20.

Wanted Digital readout of frequency for FRG 7. Telephone 0325 — 482983 Evenings. G6BCG QTHR

URGENT QST's from 1970 to 1983. Ring with Price. For

disposal radio comms Mags 1968 to 1983 offers. Watned information for Book 2. Whats on frequencies from 36 MEegs to 4 GHz with so many scanners about a lot must be known. Ring for free book 1. Anytime. 0473-85526.

R600 General coverage receiver, good condition, two years old. £200 (ono) G4GLT 'Newhaven', Beveridge Lane, Bardonhill, Leics., LE6 2TB. Tel: Coalville 35835.

Commercial Multi band dipole £10. Icom Electret desk mike £15. 2m 5/8 mag mount £10. AIWA HS-JO2 Personal Stereo as new £50. wanted good unmodified WS No.62. Kemp 0793 (Swindon) 783462 after 6pm.

Yaesu FRG7000 General coverage communications receiver 0 to 30 MHz digital frequency display very good condition £150. Tel: Hampton (01) 941-0993 after 5.30 pm.

Reftec for sale. Perfect working order £200. Phone Brighton 774381 after 6pm.

Yaesu FT757GX HF transceiver plus YM 38 Mic, Hardly used, £630. G4BUO. Tonbridge (0732) 359742.

Wanted F.M. Board for Yaesu

Victor Brand, G3JNB (centre) is the new President of Thames Valley ARTS

FT101ZD and **SP.901** ex-speaker good working order and condition. Please phone John Reading 598326 anytime.

Wanted PLL data books and **SSB CB frequency extension/modification handbooks** (won't be used to pirate 10m). Reasonable price paid. Contact W. Jones, Henrhyd Isaf Farm, Colbren, Nr. Neath, West Glam. S. Wales, SA10 9PH.

D-104 Silver Eagle, very good conditon £35.00 or swop for good 444D. Also TM1000 Transmatch by Zetagi as new £25.00 (0952) 57670.

Yaesu FT 301D 6 band S/State CW Filt. Recently serviced good condition £350. Tel: Letchworth 5023 (G4UVQ).

TONO 9000E. Communications Terminal Unit, Rtty, ASCII, CW Graphics, light pen, word processors, split screen etc. £500. G3SSQ. QTHR. Phone St. Albans 51518.

SWAN 100 MX Transceiver 80m-10m SSB/CW R.I.T. Good condition modern transistor Rig £190 MBA/RO morse Rtty reader own display 12 volts plug into audio output receiver £120.00 VFO 7 MHz £5.00. 30 P.A., Ferrites £4.00, 30 Rozel Court, Beck

Row, Bury St. Edmunds, IP28 8AX.

ICOM 730 plus IC-PS20 brand new boxed £520. Please phone G4NJC Crowthorne 77 4775

ICOM IC701 Solid state 100W HF Rig, 160 to 10 metres complete with matching IC701PS PSU and ICSM2 desk mike. Very little use from new only £500. G4IVN QTHR. Great Yarmouth 728194

DATONG Multi mode filter model FL2 together with MPU AC Adaptor £45 the lot. Carriage paid UK please telephone (0534) 51504 or write. Jovault "Chant Du Vent", Maufant, St. Saviour, Jersey. Channel Islands. or would swop for other radio equipment.

Cossor 1049 Tube only £6 set valves £5. Manual £3 KW204 manual £3. Six way heavy duty ceramic switch £4. various Cossor 1049 Bits, transformer £3 each. 470 Ohms 25 watt resistors 50p each, new G4GHB QTHR 061 368 9724.

Yaesu 7700 receiver for sale 3 months old £250. Mint condition. Runcorn 61439

Yaesu FR101 S.D19 FL101 trans. Yaesu 70-100



monitorscope. YD-844A desk mike. Ext. Speaker. Manual's for FR101 FL101 and YO-100 £550 ono. TTC power SWR meter model C3005 free with station. Write to N. Pugh, 5 Back Lane, Nomansheath, Malpas, Cheshire SY14 8DR

Oscilloscope model N IO-102 requires new fet £12. RF Signal generator model N IG-102 £10. VVM Model N may require new meter £7. Transistor/Fet checker £15. All with manuals and working. **Part Completed S.S.T.V. REX** as per RAD COMM Feb-Mar 83 includes RS, CS PCBs. All ICs less 3 £40. phone Atherton (0942) 891140.

Trio 130V HF transceiver. 80M to 10m inc. warc bands C.W. 250C filter. Mint Boxed £400 ono. Yeasu FT200 FP200 HiFi trans. V.G.C. boxed black finish model £220 ono. Tel: Weymouth 0305 786930

General Coverage receiver Century 21 complete coverage 150KHz to 29.999MHz excellent condition £70 ono. Texas Instrument T199 computer complete with teach yourself BASIC software Book of programs/games etc. 3 months old. £85 ono. Tel: Chester 311496.

FT101ZD, FM, FV101Z, SP101, £475. KW Vespa Mk I, £50. Microwave modules converters, 2m, 4m, 70cm, £15 each HRO coils, gen. coverage £5 each. bandspread £7 each. Tibbert, 32 Prescott Close, Mickleover, Derby. Tel: 515212.

IC120 23 cm PLL FM transceiver £399; Daiwa 2m Lin. Amp. 1.5-4W i/p 50+W o/p £70. Each unit brand new. Telephone Doug G4/VK4AIZ Watford 0923 662425.

FDK 700EX, 2M FM mobile, 25W, V.G.C., £120. Jaybeam 10XY/2M, £25. Would consider exchange for MMT 432/144-R transverter and Jaybeam MBM48/70CM or similar. G6TK1 QTHR. Tel: Gravesend (0474) 59346.

MMT 432/144R 70cm Transverter, 1.6 shift, 10 watts output, standard attenuator suits 10 watts 2

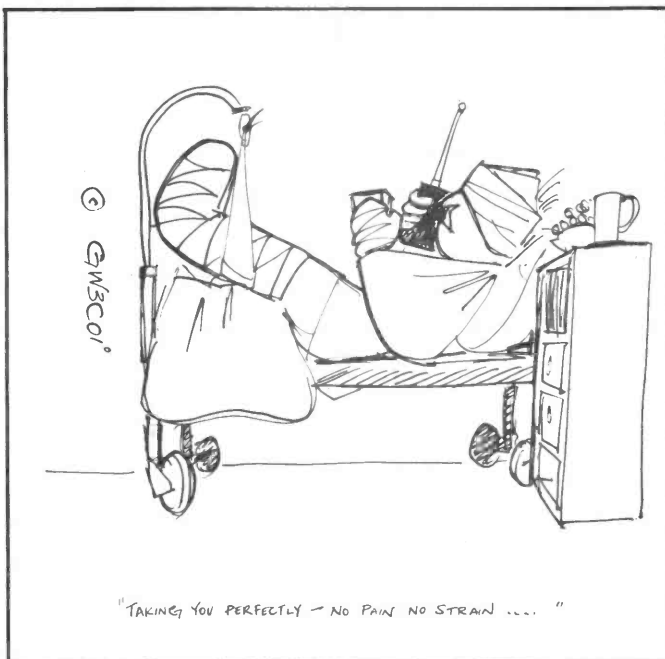

metre Rigs plus 7dB attenuator (list £14.50) suits FTZ90R etc., Mint, 6 months old, hardly used £110 ono. Plus 70cm wavemeter "Packer WM7" Free!! Would swap for 2MTX/RX or something interesting. Tel: 01-247 6097.

Wood and Douglas 70 cms Atr. JxRx half watt output ch36 vhf tv preamp filter £6t5 ITC CIC4000 camera lv comp video out £40 2x Spectrum 48K £500s or software £165 WMLCV IC202S 70cm tx-Rx RM. G4PLM. Tel: Coalville 812102.

Yaesu FRG 7700 as new mint condition 9 months old £240. FRV 770A 118 MHz-150 MHz. FRT 7700 A.T.U. £70. or £290 complete package. Hastings, East Sussex 0424 51795.

Wanted Manual or circuit diagram of photostat of Heathkit RG1 will pay expenses etc. Tel: 01-845-5904.

Sony 2001 receiver FM/AM/SSB digital push button tuning with scan and memory. Two sets NiCad batteries plus charger plus AC122 mains unit. £75. Phone 01-727 3199.

FRG7 Yaesu communications receiver excellent condition. Also 2 metre converter £135.00 for both. Ring Yateley 0252 875810.

As New Yaesu F.T. 980 transceiver £900.00 also Yaesu FT.726 VHF UHF transceiver with satellite converter £750.00. Telephone after 5 pm. 0277-823434. Brentwood, Essex.

Wanted Scope, Dual trace. Modern, Compact, manual. Also frequency counter to 50 MHz. J.W. Johnson, 6 Waveney Grove, Clayton, Newcastle, Staffs. (0782) 634780.

Tandy TRS80 computer with VDU, expansion interface and disk drive £650. Marconi TF851 Deviation Meter £50. AVO LF120 synthesised audio generator £50. Marconi TF995 signal generator £150. Wanted solid state RF signal generator may PX. Telephone Mr. Finch 0274-563722.

Rotator Hirschmann 250 almost new £25. Four element quad £15. 6 amp ham power supply new condition £18. 4 amp power supply £9. Tel: 01-540 3959.

Help private tuition needed to pass RAE City & Guilds exam "B" licence. Prepared to pay for tuition plus expenses. Please ring Slough 28304 after 8pm. Ask for Tony.

Practical wireless 115 copies 1960/1984. Morse keys (small) £2 each. Electronic ignition, new £12.50 wanted, Ex-RAF forage cap; WWII RX.

Also letters from Ex-RAF WWII W/ops (Blackpool, Compton Bassett). Frank Glynn, 41 Crossways Avenue, East Crossstead, Sussex. Tel: (0342) 22967.

GEC BRT 400 communications receiver II valve superheterodyne with an integral mains-operated power supply unit using 3 valves (14 valves in all). Frequency 150-33,000 Kc/s £80. Tel: 0672 40365 (evenings). Also similar wartime set (not working).

POCKETPHONE on SU8 stand in charger good working order £30 ono. Also 4 element 2 metre quad jaybeam £15. Also 2 brand new C.B. Rigs rotel RVC220 in box with 11 month guarantee from comet £16 each. Would exchange HF QRP TX.RX or WHY G4GMT Huddersfield, QTHR 0484 643124 W. York's.

Wood and Douglas 70 cms F.M. Transceiver, scanner, toneburst, S. Meter, microphone, P.T.T. change-over speaker 12V 6AH Nicads 2 channels fitted RB14, SU8 built in aluminium box. Good working order £90 ono. Would exchange for S.S.B. transceiver for 70 cms. or H.F. transceiver. G4GMT QTHR 0484-643124.

HF receiver realistic DX 160 150KHz to 30MHz £80.00. Contact John G6KBS Baldock 0462-892831.

Have 'AOR 245' 1-5 watt 2m handheld (similar to IC2E), 140-150 MHz (5kHz steps), repeater shifts, Helical and telescopic whips, mobile and base chargers/PSUs. Swap for ICF 2001, CR2021, DX400 etc., Phil Bridges G6DLJ, 0703 (Southampton) 891975.

Wanted Mechanical bug key, 70cm transverter, 70cm linear **For Sale ZX81(1K) £30** (or exchange above cash adjustment). Jim Hunt G3KQH NOT QTHR 0229 63397.

Wanted 2Mtr Handheld with charge or mobile. Exchange ELIZO 350 SL Mac RO super 8 sound camera supersound projector screen. Terry 01-622 0809 London.

Free Readers' ADS!

Buy, sell or exchange your gear through our free service to readers

CONDITIONS

1. These advertisements are offered as a free service to readers who are not engaged in buying or selling the same equipment or services on a commercial basis. Readers who are should contact our advertising department who will be pleased to help.

2. Advertisements will be inserted as and when space becomes available.

3. The insertion of advertisements will be on a first-come, first-served basis, subject to condition (2). As a result, it will not be possible to guarantee the insertion of a particular advertisement into any particular issue of the magazine.

4. Readers should either write out their advertisement in BLOCK CAPITALS or type it, underlining any words that are to appear in **bold**.

5. The magazine cannot accept any responsibility for printers' errors in the advertisements; however, we will do our best to ensure that legibly written advertisements are reproduced correctly. In the event of a gross error, at the Editor's discretion, a corrected version of the advertisement will be printed (at the advertiser's request) at the earliest issue in which space is available.

6. The magazine or its publishers will not accept responsibility for the contents of the advertisements, and by acceptance of these conditions,

the advertiser undertakes to indemnify the publisher against any legal action arising out of the contents of the advertisement.

7. The magazine reserves the right to refuse to accept or to delete sections of advertisements where this is judged necessary.

8. Advertisements are accepted in good faith; however, the publisher cannot be held responsible for any untruths or misrepresentations in the advertisement, nor for the activities of advertisers or respondents.

9. Advertisers must fill in their names, addresses and (if available) telephone number in the space provided, and sign the form to indicate acceptance of these conditions (forms returned without a signature will not be used).

10. All that is to be reproduced in the advertisement should be entered into the space provided on the form printed in the magazine – note that a **photocopy is not acceptable**. All advertisements must give either a telephone number and/or address for respondents to contact, and this must be included in the wording of the advertisement.

11. Advertisements must be 40 words or less in length (telephone numbers normally count as two words, exchange or exchange code plus number).

Name

Address

.....

.....

I accept the conditions above.

Signature

Send this form to: Free Readers' Ads, Ham Radio Today, 1 Golden Square, London WC2,

ENTER YOUR ADVERTISEMENT HERE:

EMPORIUM GUIDE

AVON



6 GOLF CLUB
LANE,
SALTFORD,
BRISTOL

Tel: 02217 2402
Open Tues Sat 9am - 9pm
Close Mondays

HAMPSHIRE

FARNBOROUGH COMMUNICATIONS

97 Osborne Rd, North Comp,
Farnborough. Tel. 0252-518009
Open: 6 days 10-6
Yaesu, Icom, FDKs, Mosley aerials, Jaybeams,
G Whips

LANCASHIRE

ISHERWOODS ELECTRONICS

Hozier Street, Blackburn
Tel. 0254-57616
Open: Mon-Fri 9-5, Sat 10-1
An Aladdin's Cave of Components



Radio Communications
Amateur P M R Marine

UPPINGTON
Tele-Radio 001270 Ltd

12 14 PENNYWELL ROAD, BRISTOL, BS5 0TJ

KENT

THANET ELECTRONICS

95 Mortimer St, Herne Bay
Tel: (02273) 69464

Open Mon-Sat 9-5.30pm
except Thursday 9-1pm

LEICESTERSHIRE

ELLIOTT ELECTRONICS

28-28 BRAUNSTON GATE,
LEICESTER. TEL: 553283

Open: Mon-Sat 9.00am to 5.30pm



BUCKS

Photo Acoustics Ltd. • OF NEWPORT PAGNELL •

See the Professionals



JAYBEAM, WELZ, DAIWA
58 High St, Newport Pagnell
Milton Keynes, Bucks
Tel: 0908 610625



SCARAB SYSTEMS AMATEUR RADIO SOFTWARE

ICOM STOCKISTS

29 Stafford Street, Gillingham
0634-570441

W. MIDLANDS

DEWSBURY ELECTRONICS

176 Lower High St, STOURBRIDGE
Tel: (0384) 390063

Open: 9.30-5.15. Closed Thurs. & Sun.
ACCESS/BARCLAYCARD



CHESHIRE

DW ELECTRONICS G3X CF

Amateur Radio Supplies
71 Victoria Rd, Widnes
Tel: 051-420 2559

Open Mon-sat 9-6 (closed Weds) Sun 9.30-12
We supply Yaesu, Trio, Kenwood, Tonna, Jaybeam,
Microwave Modules, Datongs etc

ADVERTISE
YOUR BUSINESS
HERE
Tel: 01-437 0699

HEWARD'S HOME STORES LTD. (Est. 1963)

822/4 Kingstanding Rd., Birmingham
B44 9RT. Tel. 021-354 2083
G4RJM with 38 years in The Radio Trade
Ham Equipment urgently wanted!
Open: Mon-Sat 9-6

ESSEX

ARROW

Electronics Ltd

5 The Street, Hatfield, Peverel
Nr. Chelmsford, Essex CM8 3YL
Tel: 0245 381673/381626

Trio/Kenwood, Tonna, Welz, T.E.T
K.D.K., Daiwa, Tono, Tasco

AMTRONICS (TONBRIDGE) G4 SYZ THE AMATEUR RADIO SPECIALISTS IN KENT

IT'S AMATEUR RADIO

from AMTRONICS

8 Tollgate Buildings
Hadlow Road, Tonbridge, Kent
Tel: (0732) 361850

FDK, AZDEN, YAESU, JAYBEAM,
FORTOP, DATONG, etc.

Technical
enquiries
G4STG

NEW IDEA LTD

133 Flaxley Road,

Stechford, Birmingham

Stockists of Yaesu, Trio, Kenwood,
Totsuko, Tonna Antennas, Bantex.
Full servicing repairs on all makes of
amateur radio. Open Mon-Sat, 10am-7pm,
Sundays, 10am-1pm.

Tel: 021-784 3129

SALES
G4SOV

R. Withers Communications

584 Hagley Road West,
Oldbury, Warley B68 0BS
Tel: 021-521 8201/2 Tel: 021-550 9324

Opening hours: Mon-Sat 9.30-5.30pm
Late night Thursday 8pm

For all your communication requirements.

HAMPSHIRE

CALBRESO LTD

258 Fratton Road

Portsmouth

Tel. 0705 735003

Open 10.30am-6pm 6 days

Sunday by appointment

COMMUNICATIONS EQUIPMENT
COMPONENTS, BOOKS, ACCESSORIES



LANCASHIRE

AMATEUR ELECTRONICS U.K./HOLDINGS



Yaesu, Tet, J-Beam, Frequency
Counters, Draa, Datong, FT101
Experts Repairs 6JS6C, 12BY7A,
6KD6, RF Clipper, Double Balanced
Mixer, Warc Kit etc. S.A.E. List: 15
min. Junc. 31 M8. Free parking.
45 Johnston Street
Blackburn B22 1EF
(0254) 59595
CLOSED THURSDAYS

AUTRONICS

142 Priory Road, Hall Green
Birmingham B28 0TB Tel: 021-474 4638

10.30am-6pm Tues-Fri. Closed Mon.

Sat 10-5. Closed lunch 2-3

Surplus equipment/components &
P.C.B assembly

EMPORIUM GUIDE

GREATER MANCHESTER

BETA COMM

Open 7 days a week
Ham Radio CB & TV. 27 + 934 MG combined rig
Computer software ● Aerial fitting service
231 Chorley Road, Swinton, Manchester
Tel: 061-793 1010

NORFOLK

SPANNER CITY CB CENTRE

 Parkside Garage
Thursford
Fakenham
Tel: Thursford
402

Grandstand
LA 83
27 to 934 MHz
TRANSVERTER

Open 6 days
9am-6pm

D.P. HOBBS (Norwich) Ltd
13 St. Benedicts Street, Norwich
Tel: 615786
Open Mon-Sat 9-5.30
Closed Thurs
Stockists of:
YAESU, FDK, ICOM, JAYBEAM
& Electronic Component Specialists

Eastern Communications

 31 Cattle Market Street
NORWICH

OPEN: 9.30-5.30 Mon-Fri
9.30-5 Sat

(0603) 667189

MAILORDER

ACCESS: BANCLYCARD



NOTTINGHAM

SP ELECTRONICS
48 Limby Rd
Huckhall, Nottingham
Tel: (0602) 640377
open Monday-Saturday
8.30-5.30

SCOTLAND

JAYCEE ELECTRONICS
JOHN GM30PW

20 Woodside Way, Glenrothes, Fife KY75DF
Tel: 0592 756962
Open: Tues-Sat 9-5

Quality secondhand equipment in stock. Full range of TRIO goodies. Jaybeam - Microwave Modules - LAR.

SOMERSET

G6HKT **AVCOMM LTD** G8KVG
25 Northoad Street,
Glastonbury
Tel: 0458-33145
Open 9.30-5.30. Closed Wed

SUSSEX

SOUTH-DOWN
RADIO SUPPLIES

40 TERMINUS RD (opp. Railway Strn.)
EASTBOURNE
Tel: (0323) 639351

Open: Mon-Sat 10-6 (Closed Tues)
Stockists of: Yaesu, Trio, Tonna, FDK etc +
secondhand and ex-Government equipment in
stock

SURREY

GUILDFORD COMMUNICATIONS
34 Aldershot Rd., Guildford

Open Mon-Fri 8am-6.30pm
Sat 8am-5.30pm

Secondhand wanted

TYNE & WEAR

Approved Dealer

ALYNRONICS

129 Chillingham Rd, Newcastle-upon-Tyne
Tel: 0632 761002
Open: Tues-Sat 10am-6pm

YORKSHIRE

4 Cross Church St, Huddersfield Tel:
Open: 6 days 9-5.30. 0484 20774
Closed Weds. Thurs 9am-8pm
G4MH Mini Beam
Always a good selection of new & 2nd hand equipment in stock

 **Amateur Radio Shop**

DISCOVER THE WORLD WITH AMATEUR RADIO FROM
SALES: 27 CHORLEIGH ST. TEL: 1460. LS2 3AG
  
LEEDS 452657 OPEN MON-SAT
9am - 5pm
the PROFESSIONALS!

TRIO ICOM YAESU
LEEDS AMATEUR RADIO MAIL ORDER & SERVICE DEPT OPEN MON-FRI
60 GREEN ROAD, MEANWOOD LEEDS LS6 4JP TEL: 182224 8.30am - 5pm

BRITISH MADE    LAR PRODUCTS

TELECOM
6 New Street, Barnsley
South Yorkshire
Tel (0226) 5031
Specialists in Yaesu, Icom
and So-Kamp

WILTSHIRE

PACE ELECTRONICS
76 Victoria Road, Swindon
Tel: (0793) 46807

Yaesu equipment, BBC Computers + Software for the
Spectrum, Commodore 64 & Amtror.
Open 9-5 6 days a week
We do everything for the BBC

Please include my business details in the
next available issue of Ham Radio Today

Only £17.50 per insertion, call us
for series discounts on 01-437 0699

Business Name:

Address:

.....

Tel. No:

Open Hrs:

.....

Contact (Office Use Only):

.....

Post to: Emporium Guide, Ham Radio Today,
1 Golden Square, London W1.

Lineage:

35p per word (minimum 15 words)

Semi Display: (minimum 2 cms)

£7.00 per single column centimetre

Ring for information on series bookings/discounts

All advertisements in this section must be prepaid.

Advertisements are accepted subject to the terms and conditions printed on the advertisement rate card (available on request)

01-437 0699

EXT 332

Send your requirements to:

Debbie Miller

ASP Ltd.,

1 Golden Square,
London W1

EQUIPMENT

ALPHA KEYS

Precision engineered keys for the connoisseur. Twin or Single paddle, and now the new "pump handle". One of the lightest and smoothest movement ever.

CAVITY WAVEMETERS

For the UHF/VHF operator, one wave-meter to cover 144 mhz to over 2500 mhz. Can measure rf as low as 50 mill watts with suitable meter.

COAXIAL RELAY KITS

The cavity block is pre machined to take either BNC or N type sockets. Two types of cavity available. Alum. type for HF, Brass for the higher frequency.

Send large SAE for more information to:

Paul Sergeant, G4DNF
6 Gurney Close, Cottessey
Norwich NR5 0HB
Tel: (0603) 747782

HIGH QUALITY CABLES

POPES H100 Super Low Loss ... 50 ohm ... 80p per M (Post 5p/m) 10% off 50m ... 20% off 100m

POPES RG213U ... Same as UR67 ... Very High quality. 1/2" dia 50 ohm. 60p per M (Post 5p/m)

POPES RG58C/U ... 5m dia High Quality to Mil Spec 50 ohm. Same as UR76 ... 23p per M (post 3p/m)

UR57 ... Low Loss 1/2" dia 75 ohm Coax ... 60p per m (post 5p/m)

RG174U ... Miniature 50 ohm Coax ... 25p M or UR95 @ same price (Post 2p/M)

UR70 ... 75 ohm 6mm dia Coax ... 23p per M (post 5p/m)

300 Ohm SLOTTED RIBBON ... by BOFA in Sweden ... 20p per M (post 3p/m)

75 OHM TWIN ... 18p per M (post 2 1/2p per M)

14 s.wg. HARD DRAWN AERIAL WIRE ... 20p per M (post 3p/m)

STRONG PVC COVERED AERIAL WIRE ... 6p per M (post 2 1/2p/m)

N. PLUGS ... GREENPAR 50 ohm Suits UR67/RG213/H100 ... £2.40 ea Cnassis Sockets ... £1.80 ea. In line Sockets ... £2.20 ea (Post 40p per Order)

Send SAE for Full lists.
W. H. WESTLAKE
Clawton, Holsworthy, Devon

BRITISH TELECOM plug sockets & leads etc. Tel: C.W.A.S (0274) 731532. Or visit our showroom opposite Odsal Stadium, Bradford.

BOOTH HOLDINGS
BATH, 6 GOLF CLUB LANE
SALTFORD, BRISTOL BS18 3AA

Tel: SALTFORD 2402

INCORPORATES HAM HIRE AND RENT-A-RIG

ANY
EQUIPMENT TO
SELL THEN FILL
IN THE COUPON

BETA COMM

ALL AMATEUR AND CB NEEDS
ICOM, TRIO and YAESU, CYBERNET
HARBARD and UNIDEN.
TAGRA, G.WHIP, HOXIN, MICRODOT
RTTY, SWR & power meters.
Receivers & linears. Plus all other
accessories.
Aerial Fitting Service
231 Chorley Rd., Swinton,
Greater Manchester.
Tel: 061-793-1010

RALLYS

IDIOTS will miss the McMichael Home Counties Rally, Slough, 11am 22nd July. 1/2hr from London on M4 (JN6). Talk-in S22, SU8.

AERIALS

AERIAL WIRES & ACCESSORIES
Hard drawn copper wire 140ft 14swg £7.90 50 metres 16swg £6.90 10 metres 12swg soft enamelled copper wire £3.50. 50 metres 1.4mm soft enamelled copper wire £5.75. G5RV Type Aerials. 1/2 size £12.00. Full size £13.95. 4mm Polypropylene Rope 50 metres £3.95. 4mm Nylon Guy Rope 50 metres £6.90. Ceramic Egg Insulators Large 50p. Small 40p. All items postage paid.

S. M. TATHAM, 1, Orchard Way
Fontwell, Arundel, West Sussex

COURSES

COURSES - RADIO AMATEURS EXAMINATION City & Guilds. Pass this important examination and obtain your licence, with any RRC Home Study Course. For details of this and other courses (GCE, professional examination, etc.) write or phone — THE RAPID RESULTS COLLEGE, Dept. JN2, Tuition House, London SW19 4DS. Tel: 01-947 7272 (9am-5pm) or use our 24 hr Recordcall Service: 01-946 1102 quoting Dept. JN2.

G4B Mk Radio Software

Dragon & Coco, CBM 64, Acorn, Atom, VIC20.

RTTY Transceive. Split screen type ahead any Baud rate etc.

ALSO for Dragon:

Morse Transceive. Decodes & sends morse to 150wpm.

Morse Tutor. Any speed, any spacing. Includes a send practice facility.

Amtor System. Available soon.

Grosvenor Software (H. R. T.)
22 Grosvenor Road, Seaford
E. Sussex BN25 2BS
Tel: (0323) 893378

MORSE NOVICE TO EXPERT: 16/48k Spectrum. Phonetic and character display for novice, random groups or personal text for more able. Variable speed. Price £4.95. Also C90 Cassettes (exchangeable) with 5-10 morse exercises. State speed. £2.95. Both compiled by professional operator. MMX, 30 Waterside View, Leysdown, Sheerness ME12 4PW.

COMPONENTS

AERIAL AMPLIFIERS improve weak television reception. Price £6.70. S.A.E. for leaflets. Electronic Mailorder, Ramsbottom, Lancashire, BLO 9AGH.

RTTY

RTTY TERMINAL BOARDS. TTL output for computer £35 incl. and for teleprinter £39 incl. All boards come completely wired and tested with FSK and AFSK. S.A.E. for details to B. Brookes Electronics, 2 Leicester Street, Norwich. Tel: (0603) 24573.

Radio & RTTY Books

Confidential frequency list. Lists 10,000 CW, aero, Coastal, fax, etc. frequencies £8.25 + 60p P&P.

Guide to RTTY Frequencies. Lists 4,500 commercial aero, UN, Coastal, etc. frequencies £7.35 + 50p P&P.

World Press Services Frequencies. News RTTY Services listing GMT, and country plus more £5.55 + 50p P&P. 2 + books P&P free.

INTERPRODUCT LTD
HR1, Stanley, Perth PH1 4QQ
Tel: 073882-575

COMPUTER RTTY

Use your micro to transmit and receive RTTY

PL1 - PLL RTTY Terminal unit 170Hz Shift ... Transmit & receive

Also handles ASCII ... TTL in/out Kit ... £13.50 ... Built £17.50

FP1 - Two channel active filter & PSU for PL1. Requires 15V/0.15v AC.

Kit ... £7.25 ... Built £10.75

Software for the DRAGON 32

RTTY send-receive program by G4BMK

Split screen receive - Type ahead buffer. QSO review & many other features.

Cassette £12.00

ROM Cartridge £21.00

MORSE transceive program up to 150 wpm!

Cassette £9.75 Cartridge £18.50

Hardware interface also available.

Please add postage to all orders - U.K. 60p Overseas £1.50 Other hardware available for the DRAGON 32

For further details & full price list please send LARGE S.A.E. to:-

PNP COMMUNICATIONS

62 Lawes Avenue, Newhaven
East Sussex BN9 9SB
P. Simmons G3XUS
Tel: (0273) 51

Callers by appointment only please.

SOFTWARE EDUCATIONAL

BUY,
SELL,
SWOP

Tel:
01-437 0699

CBM64, VIC20, Spectrum, ZX81-16K
MORSE TUTOR Absolute beginner to any test standard. Teaches in easy stages. Letters, figures, words, plain language.

You won't find a better program
QTH LOCATOR Worldwide. Locator or lat & long. Distance, beam heading, VHF contest points and total.

RAE MATHS TUTOR All you need to become perfect. VIC 20 needs expansion.

All programs are menu-driven easy to use and come with full instructions. Only £6 each, inc. p&p 1st Class by return.

technical software
Fron, Cesarea, Caernarfon LL54 7RF
Tel: 0286 881886

**CARDS, STICKERS
& BADGES**

QUALITY RUBBER STAMPS, club emblems from 85p each completely mounted address stamps £2.75. Free catalogue: Jones (HRI) St Ivy, North Rd., Queenborough, Kent. (0795) 665789.

**THIS SPACE
COULD BE YOURS
PHONE DEBBIE
ON 01-437 0699
FOR DETAILS**

LISTENER & QSL CARDS. Quality printing on coloured & white Glass Card at competitive prices. S.A.E. for samples: S.M. Tatham, "Woodside", Orchard Way, Fontwell, Arundel, W. Sussex.

RUBBER STAMPS. Personalise your QSL, Special designs no problems. Discount for quantity. Two day service. S.A.E. for catalogue. Ben Nevis, 42-44 Princes Rd., Hull. (0482) 48134.

PERSONALISED QSLs, Amateur, or CB, 1000 £13.75. S.A.S.E. for samples. H. Hope, 89 Derwent Street, Blackhill, Consett, DH8 8LT.

CASWELL PRESS — estab. 1974. Quality Q.S.L. cards to your own design. S.A.E., 21 Holmethorpe Ave, Redhill, Surrey. Tel: Redhill 71023.

**CARDS, STICKERS
& BADGES**

QUALITY
Personalized QSL's cards any quantity from £11.00
**Nutley Press, 11 Barons Way
Woodhatch, Reigate, Surrey
Tel: Redhill 71023**

HIGH CLASS QSL Cards. Fast delivery. S.A.E. for samples and prices to: J.S. Coates, 57 Worrall Street, Morley, Leeds LS27 0PJ.

QSL cards at competitive rates. SAE samples. Sigmaprint (HRT), 62 Newark Lane, Ripley, Surrey.

**ADVERTISE
YOUR CARDS
HERE**

**PUT YOUR
BUSINESS
ON THE
MAP USE
"Ham Radio
Today"**

**SURVEILLANCE
DEVICES**

**MICRO-MINI
TRANSMITTERS**
— all supplied ex-stock return post delivery, no special equipment required, built, tested, with instructions.
CT10H, 4 mile range, broadcast quality speech pick-up £13.98.
CT10M, prof grade, extra high power, tunable freq 70-120MHz variable microphone sensitivity, £19.48.
CT10MB, as above + unique dual microphones to eliminate echoes, noise etc £21.40.
All specialised requirements catered for.
EVEN RADIO STATIONS — + telephone line recorded device.
Please enquire: 061-905 1040.
S.A.T. ELECTRONICS
164 Washway Rd, Sale, Cheshire M33 1RH

FOR SALE

2 METER SSB Transceivers from £138. Full range including ICOM, TRIO, YAESU, ASDEN, ETC. Credit facilities. Guilford CB, 0483 574434

AMATEUR EQUIPMENT bought, sold, exchanged. Tel: 04024/55733; or send S.A.E. for current list. G3RCQ 65 Cecil Avenue, Hornchurch, Essex.

CERAMIC TAG STRIP (Jackson) 15 Tags 10 for £1. 6 Way Stand off terminals 10 for 75p. List 15p + S.A.E. Durrant Components, 9 St Marys St, Shrewsbury.

AMATEUR RADIO EQUIPMENT bought, sold, exchanged. Telephone G4OWY Weymouth 0305 786930.

BOOKS

AIRCRAFT COMMUNICATIONS HANDBOOK (Europe) including UK spot MF, HF, VHF, UHF frequencies, Military, Civil, ATC, Airports, Long Range Stations, Beacons, Callsigns, Co-Ordinates, Broadcast times etc. £6.95p. inc P/P. PLH Electronics, 70 Vallis Road, Frome, Somerset BA11 3EJ.

MORSE SOFTWARE

RADIO MORSE READING PROGRAM FOR ZX81
Unexpanded memory. Prints translated morse code on screen with spaced scroll action — easy to read. Variable speed. £7. Spectrum version £8.
Pinehurst Data Studios
69 Pinehurst Park, West Moors Wimborne, Dorset BH22 0BP

CLUBS

RADIO CAROLINE SOUVENIRS. For list send S.A.E. For all offshore radio news. Subscribe to our magazine. Send £3 Subscription to Caroline Movement, Dept A, BCM-BFRM, London WC1N 3XX.

ALARMS

BURGLAR ALARM EQUIPMENT. Please visit our 2,000 sq ft showrooms or write or phone for your free catalogue. C.W.A.S. Ltd, 100 Rooley Avenue, Bradford BD6 1DB. Telephone 0274 731532.

**HAM RADIO TODAY
CLASSIFIED ADVERTISEMENT — ORDER FORM**

Advertise nationally in these columns to over 100,000 readers for only 35p per word (minimum charge 15 words). Simply print your message in the coupon and send with your cheque or postal order made payable to Argus Specialist Publications Ltd to:

CLASSIFIED DEPT., HAM RADIO TODAY
1 Golden Square, London W1R 3AB.
Tel: 01-437 0699

Please indicate classification required.

Name

Address

.....

.....

Tel. No. (Day)

Please place my advert in Ham Radio Today for months. Please indicate number of insertions required.



Or Debit my Access/Barclaycard
(Delete as necessary)



--	--	--	--	--	--	--	--	--	--	--	--	--	--	--	--	--	--	--	--

HAM RADIO TODAY MORSE COURSE

The most effective route yet to your Class A amateur licence!

Professionally produced for HAM RADIO TODAY by Shirley Hesketh G4HES and Ron Ray G3NCL, this advanced interactive learning system makes use of the stereo cassette format to provide tuition to the 12wpm test standard.

With its carefully designed structure, we think that the HRT MORSE COURSE is more effective than either morse classes or electronic morse generators.

Based on TWO C-60 cassettes, it offers the controlled prompting so necessary for the initial stages of morse tuition, followed by carefully paced test material to bring the student up to speed. Full tuition notes are provided with the cassettes.

To receive your MORSE COURSE simply fill in the coupon below and return it to: 'HRT MORSE COURSE', Argus Specialist Publications Ltd, No1 Golden Square London W1R 3AB



Please send me the 'HRT Morse Course' at £11.45 all inclusive of P & P and VAT. I enclose cheque/ PO for £..... (payable to ASP Ltd) OR Debit my Access/ Barclaycard (delete as necessary)

Please use BLOCK CAPITALS

Name (Mr/ Mrs/ Miss)

Address

..... Postcode

Signature

Date

Please allow 21 days for delivery

THE C.Q. CENTRE

10 Merton Park, Parade, Kingston Road, (Near Nelson Hospital) London SW19 Telephone: 01-543 5150/4212
 Mon-Friday 9.30-6.00 Sat. 9.30-4.30 LONDON'S NEWEST AND BRIGHTEST

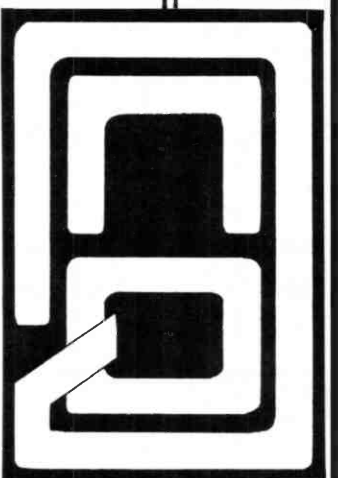

**OUR CRUMBLING WALL
AND PRICES**

**CONFIDENTIAL
FREQUENCY LIST.
LATEST EDITION
COMING SOON
RING NOW FOR
DETAILS**

SPECIAL

HB9 CV's
2mts or 70cms mail
order **£10** inc p&p

Credit available for
B+A licence holders
through
SHEPHERD FINANCE
Ask for written details.

7MHz
traps
£18.50
inc
1.1 Baluns
£11.50
inc

C.W. THE EASY WAY
Get a G4HXZ Morse tape
including 2 simulated GPO
tests and a hi-mound
telegraphy Key HK706/7
The pair **£19.50** inc p&p

MET

ANTENNAS
London's
only
stockist.

SPR

2mts or
70cms
Mail order.
£8.50
inc p&p.

G5RV
Full or half size
only **£11.50**
inc p&p

NEW LINES
THE CLUNKER
At last! a heavy solid brass handmade Morse key from the
G4HXZ stable, a unique design on marble or wooden base,
with brass name plate, impossible to describe fully here.
Ring now for more details.
THE C.Q. PHASER
Phasing problems on 2+70 solved for only **£10.50** inc p&p.

IN STOCK NOW
FOR ONLY **£29.95**
23CMS CONVERTERS
Just plug in your aerial and T.V.
Tune to channel 36 approx
and your away.



Part ex.
welcome.
Anything
considered.

**BARGAIN OF
THE MONTH**
COMMODORE VIC 20
Boxed **£70.00** new,
extend for one month only.

If your thinking about
amateur radio or short wave
listening or in fact any
aspect of radio communica-
tion then pop in and have a
chat and a cup of tea. It's a
near certainty we'll be able
to help.

SHORT WAVE LISTENERS CORNER

The ultimate receiver:
Collins R390/A. **£350.** no offer
Global A.T.U. **A.T. 1000**
0.2-30mhz only **£38.00**
LIGHTWEIGHT YAESU HEADPHONES
YH77 £11.50