

**HAM**

AN ARGUS SPECIALIST PUBLICATION

MAY '84

*Morgan*

# RADIO

95p

# TODAY



**Reviewed:**  
**the FT-757 GX –**  
with a glance at an older Yaesu success

**Earth-Moon-  
Earth Working**  
using simple  
equipment!

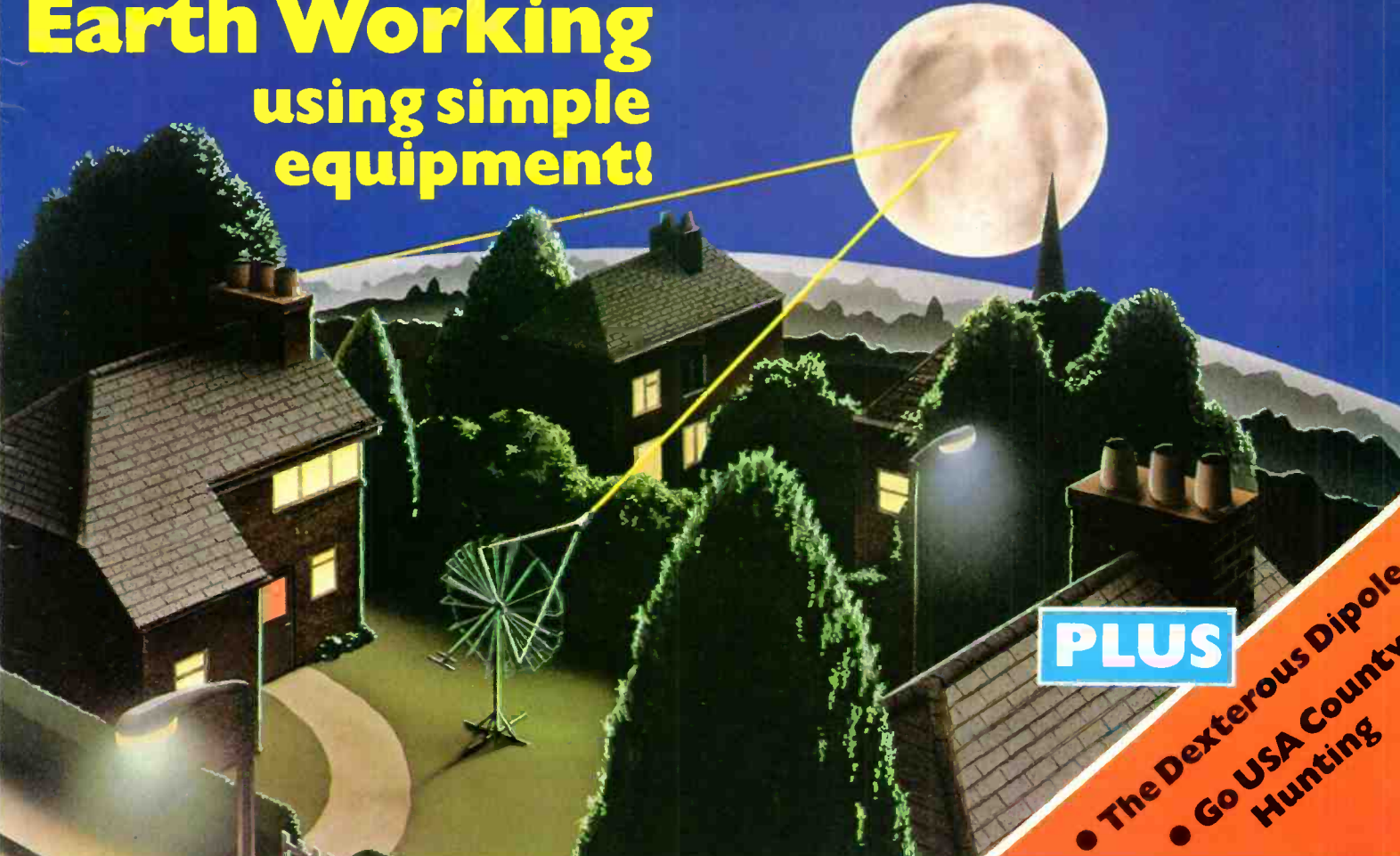

**PLUS**

- The Dexterous Dipole
- Go USA County Hunting

# Western

Get

# GLC APPROVAL

WESTERN are pleased to have received approval from the Greater London Council (GLC) for their 'Westower' telescopic tilt-over steel tower. What does this mean for you, you may well ask! Well, firstly if you live in the GLC area then you only need to state in your planning application that you propose to erect a 'Westower' and the GLC will be satisfied that the structure has been properly engineered to British Standards. The GLC have inspected our drawings, checked our ENGINEERING CALCULATIONS and found them to be satisfactory. Anyone can make a tower but only a reputable company has the ability to properly engineer and design a structure to take the stresses involved into account and produce the engineering calculations required. If you live outside the GLC area, then it's reassuring to know that you are buying a reputable product properly engineered and not just something knocked up in someone's back-shed!

Western Electronics structural engineering calculations have also been checked by various UK government departments and overseas governments. Our motto is "FIT AND FORGET". And if you think that all 3-legged towers with Zig-Zag bracings are the same, you should ask the people who selected the 'Westower' to replace their previous "gale victim"!

## WESTOWER

### THE STRONGER ONE!

You could call it, "A BRITISH STANDARD TOWER," because it has been designed to:-  
 B.S. 449, "USE OF STRUCTURAL STEEL IN BUILDING".  
 B.S. CP3, CH5, PE.2 (1972 REV.), "WIND LOADS".  
 B.S. 729, "HOT DIP GALVANISING".  
 B.S. 4872 (TO WHICH OUR WELDERS ARE APPROVED).



# Western

for

## KENWOOD and YAESU

- ★ FULL AFTER SALES SERVICE
- ★ FACTORY SERVICE BULLETINS

- ★ FACTORY SPARES BACK-UP
- ★ EXTENSIVE SERVICE DEPARTMENT

### YOUR ONLY INDEPENDENT IMPORTER

Since it was "WESTERN" who introduced the brandname of Yaesu into the UK back in 1970, we can rightly claim to be "the BRAND LEADER". Similarly, more recently the KENWOOD (as opposed to TRIO) BRAND. By having nothing to do with the UK Distribution system set-up of our competitors YOU gain the benefit of price flexibility. Naturally we ARE an AUTHORISED DISTRIBUTOR — HOW ELSE COULD WE GET THE EQUIPMENT! So beware of importers who try to 'mislead' you into believing otherwise.



### ANOTHER **Western** WINNER!

*Remember... the **ulti-mast** was so called because it is the*

## ULTIMATE IN DESIGN

Our structural engineering department came up with the maximum of strenght for the minimum of cost. It's impossible to get **MORE** strength for **LESS** cost

... so beware of cheap copies  
 ... they may not have the correct materials

- |                                |                                 |
|--------------------------------|---------------------------------|
| <b>Slim, unobtrusive</b>       | <b>One-winch operation</b>      |
| <b>For VHF and HF antennas</b> | <b>Telescopic and Tilt-over</b> |
| <b>Simple ground fixing</b>    | <b>Self-supporting</b>          |

THIS IS THE TELESCOPIC YOU CAN AFFORD

Ultimast UM-1 .....	£263.35
Reducer head, UHD-1 (reduces to 2" dia stub) .....	£8.05
Rotor head, UHD-2 (takes up to Emoto 1038??) .....	£35.65

PRICES INCLUDE DELIVERY AND VAT at 15%

## The 30ft ULTIMAST

### 115% MORE HEAD LOAD!

At 100 m.p.h. the "ULTI-MAST" takes 3.87 sq. ft. The SM-30 takes 1.8 sq. ft. only.

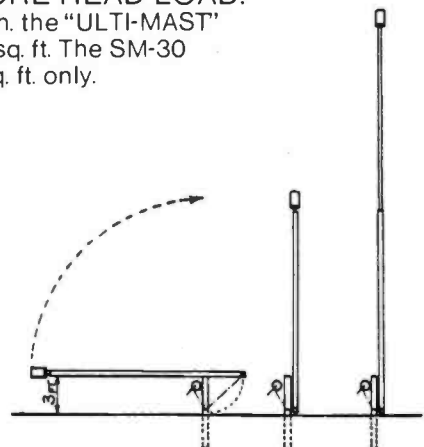

**Western Electronics (UK) Ltd** FAIRFIELD ESTATE, LOUTH, LINCS LN11 OJH  
 Tel: Louth (0507) 604955, Telex: 56121 WEST G

OPEN HOURS: 09.00-12.00: 13.00-17.00 Mon/Fri. SATURDAYS By appointment.

Goods supplied by return of post.

Agent:-  
 Northern Ireland  
 Tom Greer G14TGR  
 Norma Greer G14TBP  
 Tel: Drumbo (023 126) 645

# HAM RADIO TODAY

## CONTENTS

VOLUME TWO NO.5 MAY 1984

**Acting Editor**  
Steve Ireland, G3ZZD  
**Consultant Editor**  
Dave Bradshaw

**Advertisement Manager**  
David Gadsden, G4NXV  
**Classified Sales Executive**  
Debbie Miller

**Managing Editor**  
Ron Harris  
**Chief Executive**  
T. J. Connell

**Published by:**  
Argus Specialist Publications Ltd.,  
1, Golden Square,  
London W1R 3AB.  
**Telephone:** 01-437 0626

**Distributed by:**  
SM Distribution Ltd.

**Printed by:**  
The Garden City Press Ltd.

**Subscription Rate:**  
UK £14.00  
O/Seas Sur: £14.45  
O/Seas Air: £27.00  
Ham Radio Today,  
Subscriptions Dept,  
Infonet Ltd,  
Times House,  
179 The Marlowes,  
Hemel Hempstead,  
Herts HP1 1BB  
Tel: (0442) 48432

Ham Radio Today is normally published on the first Friday in the month preceding cover date. The contents of this publication including all articles, designs, plans, drawings and programs and all copyright and other intellectual property rights therein belong to Argus Specialist Publications Limited. All rights conferred by the Law of Copyright and other intellectual property rights and by virtue of international copyright conventions are specifically reserved to Argus Specialist Publications Limited and any reproduction requires the prior written consent of the Company. © 1983 Argus Specialist Publications Ltd. All reasonable care is taken in the preparation of the magazine contents, but the publishers cannot be held legally responsible for errors. Where mistakes do occur, a correction will normally be published as soon as possible afterwards. All prices and data contained in advertisements are accepted by us in good faith as correct at time of going to press. Neither the advertisers nor the publishers can be held responsible, however, for any variation affecting price or availability which may occur after the publication has closed for press.

### TODAY

## REGULAR COLUMNS

LETTERS .....	4
RADIO TODAY .....	6
RADIO TOMORROW .....	10
PRACTICALITIES .....	38
RADIO YESTERDAY .....	58

## CONSTRUCTION

THE DEXTEROUS DIPOLE .....	19
<i>160 - 10m from a semi-detached suburban</i>	
VOGAD SPEECH PROCESSOR .....	25
<i>Pep up your signals with this simple but effective design</i>	
PROJECT OMEGA .....	50
<i>Part 8 - Tony Bailey describes the construction of a suitable case</i>	

## FEATURES

EARTH-MOON-EARTH WORKING - SIMPLY! .....	12
<i>In Part 1, Charles Suckling, G3WDD, introduces the exciting world of 'moonbounce'</i>	
USA COUNTY HUNTING .....	21
<i>Make friends across the pond. Ellis Evans, GW3CDH, explains</i>	
RADIO BUILDING BLOCKS .....	45
<i>Frank Ogden, G4JST, tackles MOSFET and diode mixers</i>	

## REVIEWS

YAESU FT-757GX HF MULTIMODE TRANSCEIVER .....	28
<i>Angus McKenzie looks at the FT-757GX with a backward glance at the FT101B</i>	
SAMSON ETM5C ELECTRONIC KEYS .....	40
<i>Ian Poole, G3YWX, gets thoroughly keyed up</i>	
AD INDEX .....	37
NEXT MONTH IN HRT .....	42
Free Readers' Ads .....	60
Emporium .....	63
Classified .....	65

# LETTERS

## 27 MHz SSB?

Sir, I wish to stir up that forbidden subject of 27 MHz SSB. I feel that it should be legalised and used like an amateur novice service. The allocation should be from 26.5 to 27.599 MHz, with a maximum power of 25 W during the day and 250 W between the hours of 1am and 6am.

The operator should be expected to pass a short questionnaire before being expected to pass a licence. The licence fee should be the same as the amateur fee. The operator should state his or her callsign on the licence application and that callsign should be registered.

This service should be available to licensed amateurs, both As and Bs as another band in their allocation. This would allow amateurs and novices to converse about their common interest.

An idea of how the band could be used is shown below;

26.5-27.0 CW practice and SSB  
27.0-27.599 SSB only.

The band should be un-channelised to allow the use of amateur equipment and some of the better CB type rigs.

I hope these ideas are seen as a serious step to the legalisation of an amateur type novice band for SSB use.

## R COMPTON

*The Radio Amateurs Examination is regularly passed by individuals ranging from 14 to 70 years of age, with backgrounds ranging from research physics to taxi driving.*

*The privileges you ask for as a novice are too great; they would devalue the hard won rights of those that have passed the RAE — which tests your application to the wonderful subject of radio rather than how intelligent you are. Don't waste your time writing to me — join the local radio society (you will get plenty of conversation about radio there) and investigate the possibilities of an evening course in the RAE at the local tech.*

## WHERE HAVE ALL THE CLASS-B LICENCES GONE?

Sir, I have been licenced since 1976 when the GM8 'B' Class series was at GM8L and the A class was at GM4F. Now in 1983 thanks to the 'CB' boom we have now completed the 8s, gone right through the 6s and are now well into the 1s. At the same time the 4

series has only gone from F down to U. If we look at the actual numbers of licences issued we find that in fact very few of the 'B' classes have in fact up-graded.

Now, if we take a graph of actual activity on the 2m band (FM), I'm sure many would agree that the level of activity has more or less remained the same. So — where are all the people going? It seems to me that there must be cupboards throughout the country filled with unused gear gathering dust.

I would expect to be shouted down, but I'm bound to say that in my opinion more harm than good has been done to Amateur Radio by rigs like the FT290 and the SLIM JIM antenna. I have heard countless GM8s, GM6s and GM1s say that they are "using a Slim Jim, 2½ watts from a TR/FT. . . ." After a few weeks these stations seem to disappear from the face of the earth. I asked the question, why, at my own club last week and a few suggestions were put forward;

There are too many licenced listeners, ie those of us, myself included who sit and monitor a particular frequency, perhaps a repeater. We seldom transmit, unless we hear someone on that we know. GM1 so and so can call CQ until he is blue in the face, but we seldom go back to him. WHY? Are we some form of superior being who has forgotten what our first few QSOs were like? Have we begun to use 2m like a telephone? Are we as I've heard in various CB circles, snobbish? Just because a guy says "What's you're twenty?" rather than "What's your QTH?", do we turn our backs on him? What's the difference anyway, when we're on 2m FM local 5 and 9 contacts we should be using plain language and not gobbledegook! Whether we use the ten code or the 'Q' code is irrelevant.

What we should be doing is guiding the newcomer along the right lines, helping him over the initial operating hurdles, giving advice about how to improve antennae, explaining the points about VSWR, etc, persuading the newcomer to upgrade his licence to the real standard that allows communication worldwide. We should encourage the use of SSB, which opens up DX modes, Aurora, Tropo, Satellite, TV and all activities in which the 'B' licensee may take part if they are shown the way.

Not every A class licensee works into the Pacific Ocean every day of the week, but I'm sure it is a more

enjoyable, rewarding experience to talk with those outside our own country than that everyday contact on 2m across Glasgow or wherever. We should also encourage the study of CW. Yes, I'm the first to admit that it's not easy, but there again, nothing worthwhile ever is. However a few minutes of constant study every day should produce results. Many local clubs have classes. Join one. There are also slow morse transmissions on 2m and 10m every Wednesday and Thursday evening in most areas.

Even though I'm involved with this Group's new repeater application (GB3PA), and a co-opted member of the CSFMG Committee, Mr Editor, I must castigate the repeater system. I can remember the days before GB3CS. Many nets were held on simplex channels on various week nights. Many QSOs took place 60-70-80 miles distant, people knew each other the length and breadth of the country, but now we in Glasgow sit on 'CS, while those in Edinburgh sit on 'FF, and so on.

Come on, B-Class licencees, throw away your Slim Jims, instead of spending all your money on that new rig, spend about £50 on your antenna system. Your antenna system is still the most important part of your station.

## TOM WYLIE, GM4FDM

*The above letter originally appeared in Central Scotland and Border FM Group News, and is reproduced here with the author's permission. We feel that the issues raised are important, and reiterate the author's call for others to write in.*

## NATIONAL WIRELESS MUSEUM REVISITED

Sir, I wish to bring to your notice errors that appear in the article "Visit to the National Wireless Museum" featured in the March 1984 issue of Ham Radio Today.

1. Page 36. The crystal set kits sold by Woolworths were not 6d a time. The kits consisted of four items, namely a case, a panel, a variometer and a crystal detector. Each item was priced at 6d but you couldn't buy the items separately, you had to buy all four at a cost of 2/- (10p).
2. Page 36. The set named "Radcom" made in 1923 was not

"long before the existence of the RSGB" as the Radio Society of Great Britain obtained its present title in 1922, being previously known as the London Wireless Society.

3. Page 37 and Page 38. The store of A. W. Gamage Ltd. (and not A. W. Gammages Ltd. as stated on Page 37) was basically a toy shop and not an electrical and hardware store. In their heyday, around the mid-1920s, they sold everything from pet monkeys to motor-bikes.

4. Page 38/39. The paragraph describing the functioning of a 30-line disc television receiver is really a load of rubbish. The motor speed did not have to be adjusted continually as once it had been run up to 750 RPM, the picture would lock due to the 375 c/s (Hz) synchronising pulse that was transmitted.

Sound and Vision was transmitted simultaneously and no synchronisation of the two was necessary; the "blip on the screen" to which reference is made in the article was probably the sync. pulse, which appeared as a black bar between frames.

There were four half-hour transmissions a week, all during broadcasting hours. It was only during the very early days, before the BBC took over responsibility from the Baird Company, that transmissions were made after normal broadcasting hours.

One other point, I find it odd that the March issue appears as "Volume Two No. 2 February 1984" on the Contents page.

**N G HYDE, C.Eng, MRAeS,  
MIERE, G2AIH**

*We thank N G Hyde for the improved information on the various items featured in the article; the date and volume number was a simple error on our part.*

### MORE ABOUT THE A1A MODE

Sir, I was interested to read the G5UM thoughts on CW on 2m (HRT, March). There is no doubt that CW is for the amateur the most reliable means of communication at very low signal strengths. However, one of the problems is that unlike professional data transmission codes it has no redundancy — miss a few individual dots and dashes out of a stream and it can become unreadable.

Ordinary slow QSB presents fewer problems because the listener can tell what is going on. But the QSB on some of the Oscar 10 passes is so deep that reading callsigns can be quite difficult (the satellite rotates at about 1 rev per sec. Once in a QSO via Oscar 10 everything becomes readable because of repeats of things one expects to hear. On a pass when I have serious trouble reading the CW I go to SSB and enjoy successful QSOs: the great thing about speech is that it has plenty of redundancy: you can

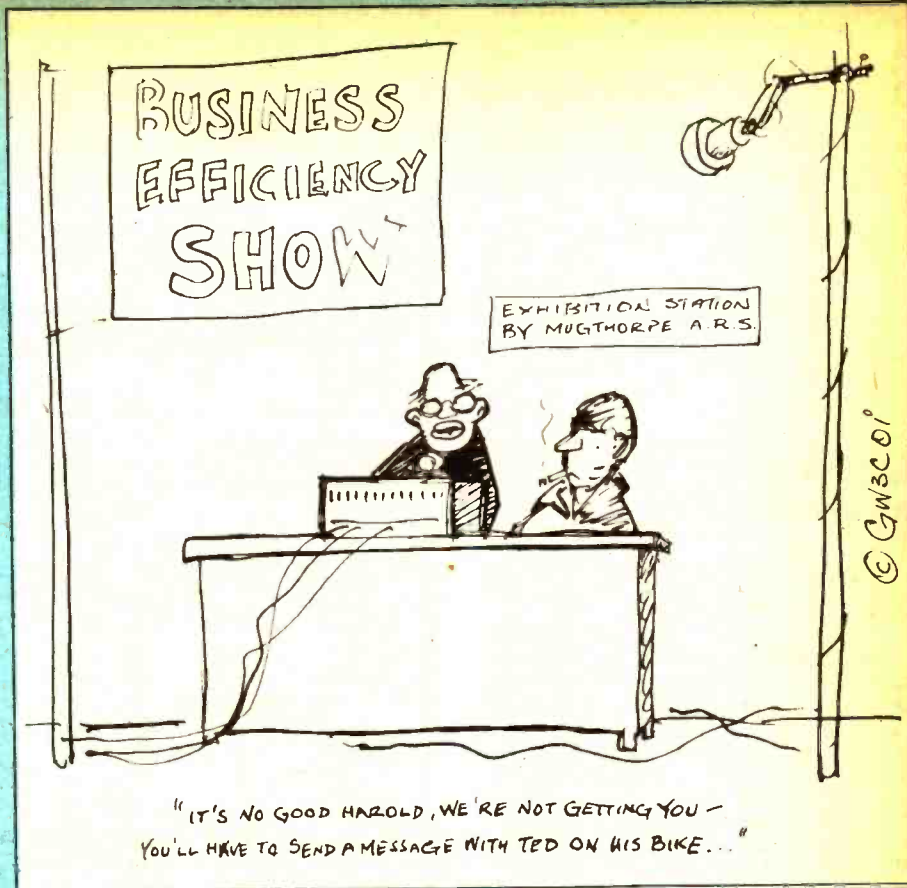

"mess it around", punch holes in it and it is still understandable within reason.

Apropos the G5UM comment about memory-retention of CW, I am reminded that after gaining my licence I was compelled to use CW for the first twelve months: it was a licensing condition. What it did for me was to engrain the morse code into my mind for ever. After leaving amateur radio for ten years I found that upon returning I could go straight into a CW QSO without turning a hair: my memory banks had not been erased or corrupted even though my speed was temporarily down to 15 wpm.

A final thought for CW operators: Never call CQ on the CW calling channel and then you don't waste time on a QSY! Near it, yes, but not on it!

**BRIAN ARMSTRONG, G3EDD**

### FINAL PHONETICA

Further to the letter from George Metcalfe G6VS in your letters section of April 1984, I am pleased to be able to fill in the blank phonetics.

A Ack. B Beer. C Charlie. D Don. E Edward. F Freddie. G George. H Harry. I Ink. J Johnny. K King. L London. M Monkey. N Nuts. O Orange. P Pip. Q Queenie. R Robert. S Sugar. T Tec. U Uncle. V Vic. W William. X X-Ray. Y York or Yorker. Z Zebra.

Numbers were apparently covered too, Wun tew, fower, fife, sixer, niner.

The information comes from a News Chronicle Edition of Everything Within. The date of publication is not shown in the book but postage at the time is priced at 1½d for 2 ozs. and ½d per each 2oz. King George V was still Monarch and it is recorded in the careers section that a top London journalist could earn as much as £1,000 per year whilst a junior working for the Marconi Wireless Telegraph Company may be employed on a salary of £100 per year!! (Eventual promotion to Instructor or Depot Superintendent could pay as much as £500 per year or more).

The same book also includes a reprint of the original highway code and a very comprehensive section on wireless in which the latest topics such as the Edison Effect, Heavyside Layers and a very great deal more besides are discussed.

I hope that the complete list of phonetics is of use to those interested and that I might have brought a little nostalgia to a few readers.

Thanks for a much improved magazine,

**MIKE SHREAD, G6TAN**

Please address correspondence to:  
Ham Radio Today,  
1, Golden Square,  
LONDON W1R 3AB.

# RADIO TODAY

## GB3PS — The New Frontier

A 23cm repeater is shortly to go into regular action in Cambridge. Originated by the Cambridge Repeater Group it will be located at Barkway, alongside GB3PI and GB3PT and will use slot aerials to give omni-directional coverage with *horizontal polarisation*. GB3PS will operate on 1297.075MHz output and 1291.075 input and is licensed as a beacon/repeater, meaning that it will radiate a carrier at all times, with a 500Hz FSK CW callsign being sent every 15 seconds. When a 1750Hz toneburst is received on the input frequency, the 'box' switches into repeater mode — with a time-out of ten minutes!

## Repeater Update

**GB30C** — This 2m repeater is the first offspring of the Orkney — Caithness repeater group, is located on Wideford Hill, near Kirkwall, Orkney at 730' ASL and should give coverage of the extreme north of Scotland and the Orkney Isles. The repeater can be found on Channel R2 and the transmit side gives some 11W to a ground plane antenna. **GB3CA** This is the callsign of the (proposed) 70cm repeater for the Carlisle area and will be located on RB12. GB3CA is the first repeater of the Scottish Border FM Group to have microprocessor control. A licence is believed to have been recently issued for the repeater, but we were unable to confirm this at the time of going to press.

Newer Class B licencees sampling the delights of the 2m and 70cm bands often come to the conclusion that "repeaters have always been there". But as older readers of HRT will recall from the articles here (December 1983 and January 1984) about the UK repeater service, this is not true. Repeaters are made available to the Amateur Service *only* because groups of amateurs like the aforementioned, get together, and decide to "go in for a

repeater", and then, most important, *raise the cash* for their brainchild. Its 2m unit high on the hills to the north west of Leicester city centre has attracted a considerable "audience" not only from its local members (there are nearly 200 of them) but also from the constant traffic passing it on the nearby M1 motorway. This 2m unit, callsign **GB3CF**, was in fact the second Leicester repeater to be commissioned: its companion **GB3LE** on 70cm (Channel RB4) pre-dated it by about a year.

The Leicestershire Repeater Group has firmly maintained that it must be self-funding, both to maintain its existing repeaters and to provide additional services such as microwave beacons from its prime VHF site. To this end, the club invites readers of HRT in the East Midlands who have not considered joining it — maybe have not even heard of it! — to ponder the attractions of membership. The annual subscription is £5 (payable to Treasurer G4MGG, 565 Uppingham Road, Leicester), and the advantages of membership include regular meetings, both social and "tech", and receipt of the quarterly magazine LENS. Don't forget, if you use a repeater regularly, support the appropriate repeater group.

## Third Party Traffic With Australia

ARTAC (Amateur Radio Third Par-

The Lencom LC160 — see 'Topband Lives Again'

ty Action Committee) is a group of Australian Radio Amateurs who consider it is about time that a number of countries, especially Commonwealth countries, were encouraged to follow Australia's lead in allowing members of their Amateur Radio Service to pass messages on behalf of a third party and to use third-party operation; thereby removing a long standing, most unnecessary and highly political stranglehold on the Amateur Radio Service. ARTAC's standpoint is that members of the Amateur Radio Service are always ready and willing to provide their skills and equipment free of charge for the benefit of the whole community and that, internationally, the Amateur Radio Service provides one of the stabilizing factors for world peace, by breaking the political and racial prejudicial barriers.

ARTAC asks, "Why should the International Amateur Radio Service be treated like irresponsible children by authorities in so many countries, (in disallowing third party traffic of any kind) when in fact they are, in most cases, more responsible than many of these countries' leaders."

Many Australian radio amateurs, like VK3QQ, are ex-patriate English people, with relatives and friends in the UK. UK amateurs who are interested in forming a similar pressure group should write to AD Tregale, VK3QQ at 38 Wattle Drive, Watsonia 3087, Australia.

## Deadline For 50MHz Permits Puts Back

The closing date for which G3WSN, RSGB 50MHz co-ordinator, can accept completed questionnaires for further permits has been put back to 30th April 1984. Questionnaires can be obtained from RSGB Headquarters at Alma House, Cranbourne Road, Potters Bar, Herts and should be returned to G3WSN at 45 Cauldron Crescent, Swanage, Dorset BH19 1QL.

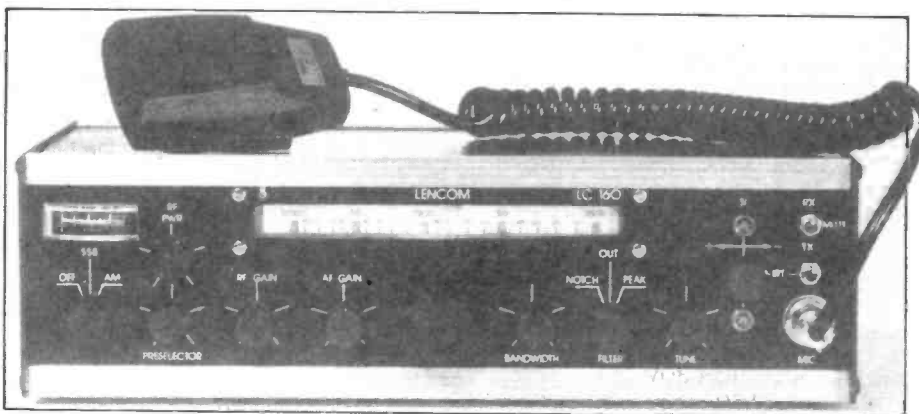

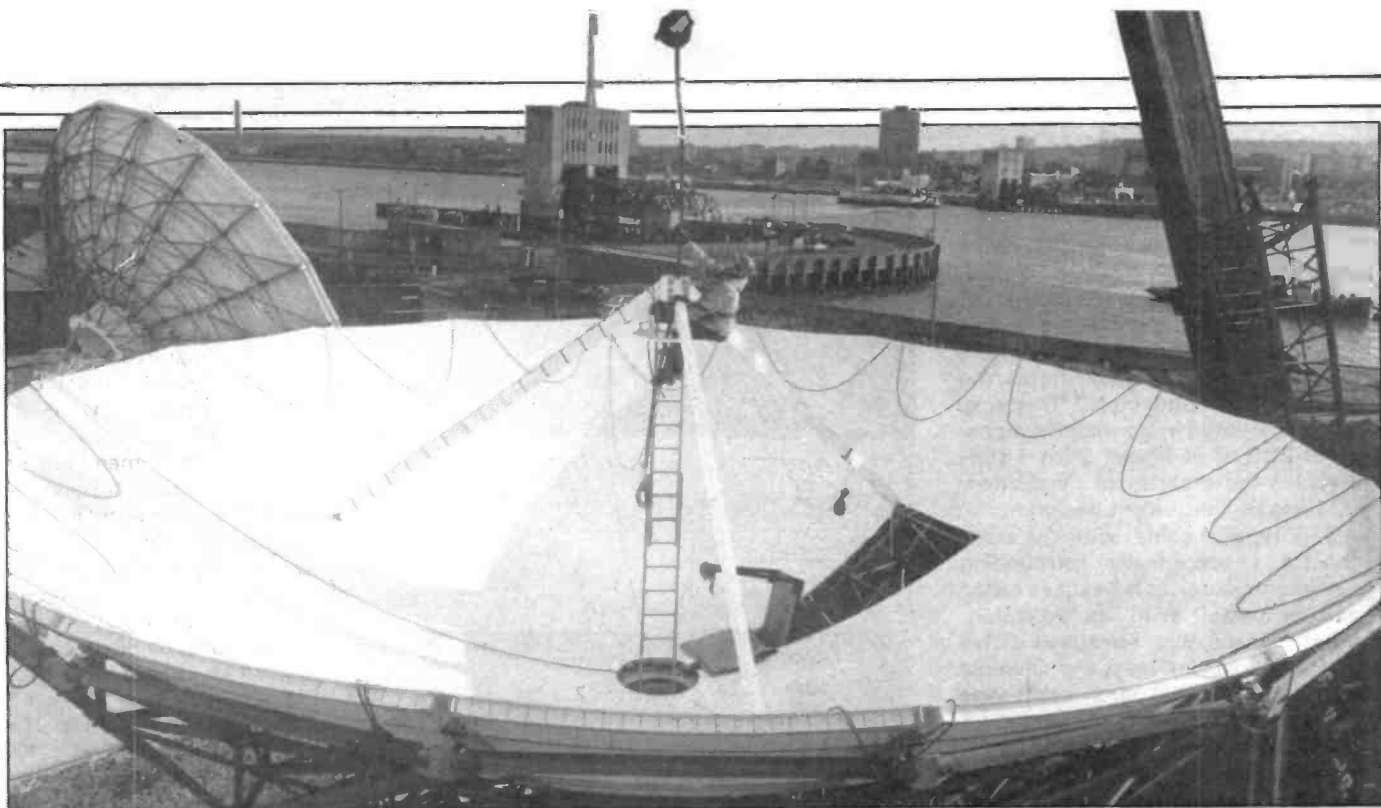

The nearly completed 2nd Dish at BT's London Dockland EME Station

## Paint-on Screening

Electolube have introduced a silver conductive paint (SCP to the initiated) into their range of products. You can screen that noisy micro or plastic cased rig with a bottle of SCP and a paintbrush. Other applications could include repairs to PCB and car rear window heater tracking. SCP has a surface resistivity of 0.03 – 0.01 ohms (at a spread rate of 0.6 to 2 g/100cm<sup>2</sup>) and an electrical rating of 0.1W/cm<sup>2</sup> (dependant on substrate). The product is available from a number of outlets, including Maplin Electronics, and is priced around £2.50 for a small bottle (prices can apparently vary considerably, so shop around).

## Top Band Mobile Lives Again!

Northampton Communications are the first company to take advantage of the current upsurge of interest in 160m operation ('bout time too – Editor). The LC160, 160m SSB/AM/CW transceiver, suitable for mobile and home station use, is entirely solid-state, of modular construction and has a mechanical filter at 455kHz which the manufacturer's claim gives excellent i.f. selectivity. Further selectivity is provided by an integral audio filter, which can provide 'peak' or 'notch' functions, the bandwidth of which are variable. Audio clipping is provided on transmit – using the microphone supplied with the rig, this should be about 12dB. RF output is claimed better than 30W PEP. Priced at £199 the LC160 measures a compact

30 x 16.5 x 9cm. Further details from Northampton Communications on 0604 33936. *Readers looking for a cheaper but equally state-of the art alternative should keep their eyes on HRT – we hope to publish a single band SSB/CW transceiver design suitable for 160m and the higher bands – with a full kit of parts available – in a forthcoming issue.*

## Ambit Move To Accommodate Expansion

As a result of continuing expansion, Ambit International is to move its headquarters from Brentwood to Broxbourne in Hertfordshire, though it will be retaining a sales counter in the town. Demand for Ambit's services had apparently risen steadily to the point where the premises at Brentwood were no longer sufficient to provide the necessary facilities. The move is apparently being made, "to enable the company to maintain the present pattern of growth."

The new premises at Broxbourne, which is the headquarters of Ambit's parent company, Cirkit Holdings PLC and sister company, Broxlea Limited, is at Park Lane, Broxbourne, Herts, EN10 7NQ.

## London Dockland Earth Station

As Aerial 1 on British Telecom International's new earth station comes

on stream, the second aerial is already being lowered into position in the capital city's dockland. Less than six months after the first spade went into the earth at the docklands site at Pier Road, North Woolwich, the first dish aerial is transmitting and the second is near completion.

The first customer is Satellite Television whose nightly TV entertainment programme – Skychannel – will be transmitted to a potential half-million audience in seven European countries. An agreement with British Telecom – for use of an Intelsat satellite and the London Earth station – has already been reached with United Cable programmes, the consortium that includes Rediffusion, Visionhire Cable, Rank Satellite and Cable, Plessey, and UIP TV. The site, close to the old King George V dock was, until last Autumn, a power-cable manufacturing complex with a number of Victorian buildings.

## Read all abah it. . .

Irish HRT readers may be interested, if they don't already know about it, to hear of the regular column in the Belfast Evening Telegraph *devoted to Amateur Radio*. Joe Beattie, G13NQH, has been writing in the Saturday evening sports edition of the BET, better known as 'Ireland's Saturday Night', under the pen name of "Rectifier" for some thirty years. The column has actually been running in the BET for fifty years! Joe believes that the column is the only one of its kind in the UK – anybody interested in challenging that?

## Happy Birthday Dear Coax

In a letter to Ludwig Köffler, dated February 10th 1884, Werner Siemens described for the first time a method of constructing an induction-free cable. "It consists of individual conductors covered by a sheath which forms the common return conductor." This concept was patented in German Reichspatent No 28978 of March 27th 1884, and solves the problem of "induction-free cables of lightweight design."

This type of cable, with the outer conductor concentrically surrounding the inner conductor, is nowadays called a coaxial cable! With its invention, Werner Siemens was far ahead of his time for it was not until the Olympic Games in 1936 that such cable was used — between Berlin and Leipzig.

A coaxial cable in one of today's communication systems can transmit up to 10,800 telephone calls and one television programme simultaneously.

## Computerised Communications

'Micropatch' is a new high performance Morse, Baudot and ASCII (RTTY) software/hardware interface package from ICS, makers of the AMTOR AMT-1 unit. The Micropatch incorporates a software MBATEXT ROM for either a Commodore 64 or the VIC-20 micros'. This plug-in cartridge module is very sophisticated featuring 4 pole Chebyshev active filtering, automatic threshold correction when one tone is obliterated by QRM, 800Hz active CW filter and internal sine generator for AFSK output. The makers claim that tuning in to RTTY and CW with this unit is easy, using the triple LED indicator. The Micropatch is priced at £129 inc VAT and further details may be obtained from ICS on 024 365 590.

For the lazy and fairly broke, a Morse Reading Programme for the ZX81, which needs no interface between the receiver and the ZX81, is being marketed by Pinewood Data Studios at 69 Pinehurst Park, W. Moors, WIMBOURNE, Dorset, retailing at £7.00. The Morse is displayed on your screen "with spaced scroll action" (?), which is aimed at making the morse print-up easy to read, and the program is claimed to be variable speed — only the very slowest of beacon transmissions apparently confusing the computer. Although the Editor tends to decry such devices, Brian Baily, proprietor of Pinewood Data Studios, claims that the reader has actually helped him to learn CW — by listening to slower transmissions as they print up on the screen.

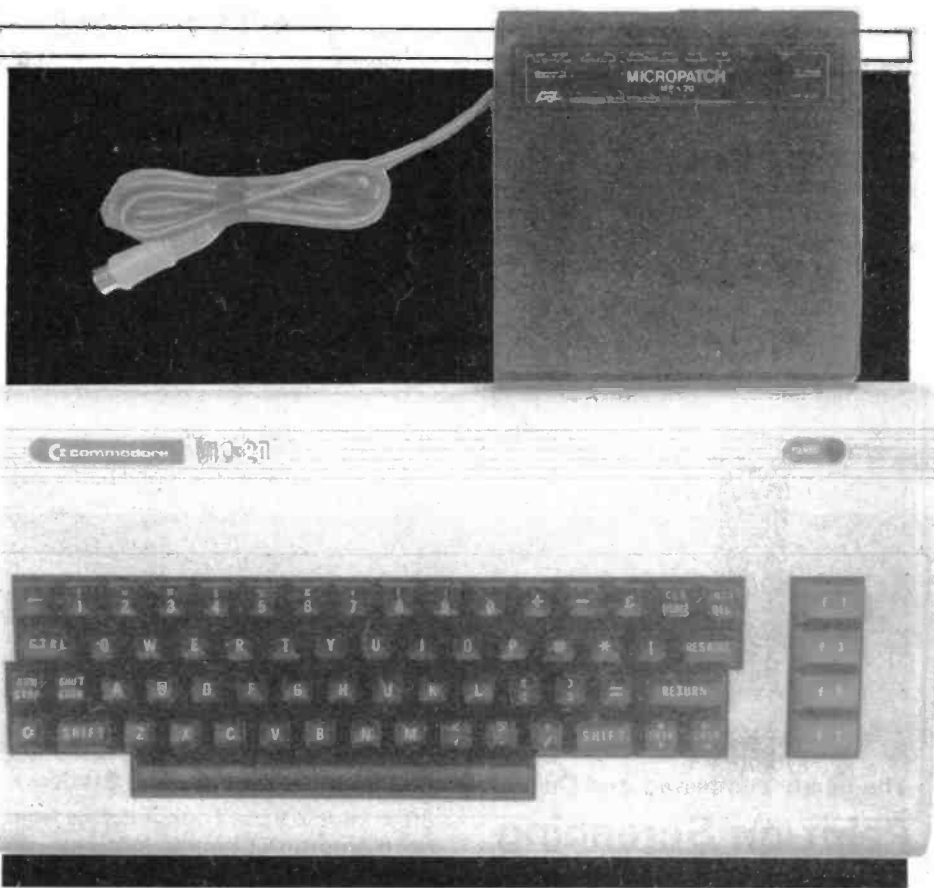

The 'Micropatch' CW/ASCII/Baudot interface from ICS

## Cable TV/FM System In Milton Keynes — RFI!

A special report by Michael Shread G6TAN. Regular listeners of the RSGB Sunday News Service will no doubt recall the mention of interference to the two metre band caused by the cable TV/FM system operated by British Telecom.

Although the interference has apparently existed for some time, it was first noticed by the author in early December 1983, upon setting up his station at a new address. Other local amateurs have found the same type of interference on various VHF frequencies and at varying strengths, according to their location in the City and proximity to the 'passive auxiliary equipment' connected with the system.

The type of interference heard is a high pitched whistle or hum. The strength of signal varies from S1 to as much as S7. At the time of writing most of the frequencies concerned are affected both day and night whilst a few carriers are intermittent. The cable system carries the normal television channels BBC, ITV and has the facility for two local broadcasts, only one of which, carrying films only for a few hours each day, is operational. The system allows FM radio to be heard also. Signals for the system are collected by strategically placed aerials and then transmitted to local distribu-

tion points on VHF where they are again turned into UHF before being relayed to individual houses on a type of ring main, each house having a junction box and wall socket. The TV/FM system is financed by quarterly subscription.

When the interference was discovered a telephone complaint was made to British Telecom Radio Interference Service at Bedford, who sent an engineer to witness the problem at first hand, the same day. It transpired that one other amateur in Bletchley had also complained and that BT Research Division in London were trying to develop a notch filter which, hopefully, would solve the problem. It was explained by the engineer that the cabinets used at local distribution points were known to have been leaking RF for some time, but since no one had complained . . .

The RSGB were made aware of the problem immediately and complaints also made to the RRD and Mr William Benyon, the MP for the area concerned. Action from RSGB Headquarters was swift. A letter from David Evans, G3OUF, General Manager and Secretary appeared almost by return of post requesting further details. One week after the complaint to BT was made there was a second visit from their engineer and a notch filter was fitted to the local distribution box. The result, a mere attenuation of the main carrier on 144.365 MHz from S7 to S3. The other frequencies remain unimproved.



**SAVE £4.25 by receiving a FREE magazine binder when you subscribe to.....**

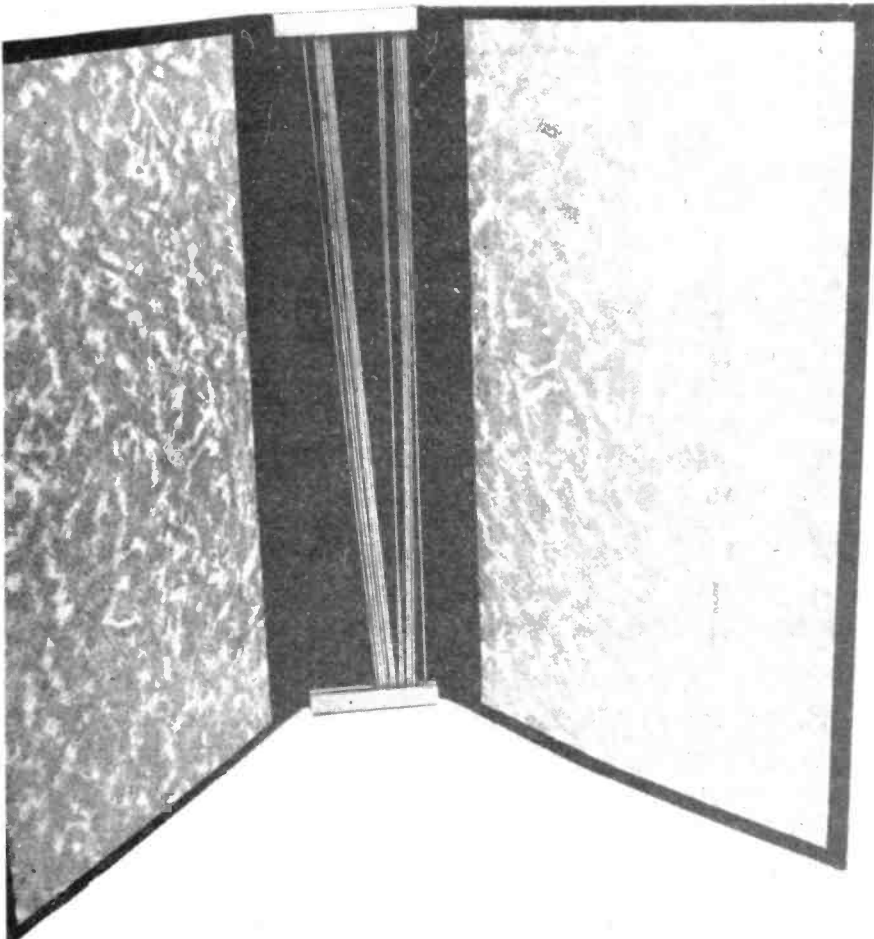

It's true, by subscribing to *Ham Radio Today* you will not only receive your personal copy direct to your door for a whole year but also have a superb magazine binder in which to keep your copies AND IT'S FREE!

All you have to do to receive your FREE binder is book a new subscription or renew an existing subscription to *Ham Radio Today*.

What could be simpler? Normally priced at £4.25, these attractive binders will hold approximately 12 issues of *Ham Radio Today*.

Not for you any longer the chore of having to track down dogeared copies of your favourite magazine, instead you will merely go to your bookshelf and they will be waiting for you in pristine condition. Don't miss out on this outstanding offer — subscribe today and receive your FREE binder within 14 days of your order being received.

**SPECIAL OFFER**

**SUBSCRIPTION ORDER FORM**

Cut out and send to:  
**HAM RADIO TODAY,**  
**INFONET LTD,**  
**TIMES HOUSE,**  
**179 THE MARLOWES,**  
**HEMEL HEMPSTEAD,**  
**HERTS HP1 1BB**

Please send my free binder and commence my personal subscription to HAM RADIO TODAY with the

**SUBSCRIPTION RATES**

(tick as appropriate)

£14.00 for 12 issues UK  
 £14.45 for 12 issues Overseas Surface  
 £27.00 for 12 issues Overseas Air Mail

*I am enclosing my (delete as necessary) Cheque/Postal Order/International Money Order for £..... (made payable to ASP Ltd) OR Debit my Access/Barclaycard\* (\*delete as necessary) Insert card no.*

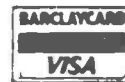

.....

Please use BLOCK CAPITALS and include post codes.

NAME (Mr/Mrs/Miss) .....  
 (delete accordingly)

ADDRESS .....

..... POSTCODE .....

Signature .....

Date .....

# RADIO Tomorrow

- |        |  |        |  |   |
|--------|--|--------|--|---|
| 2 Apr  | Swale ARC: Informal<br>Braintree: <i>Interference Problems</i> .<br>Leighton Linslade RC: Homebrew Nite<br>Horndean ARC: <i>A Year of Amateur Radio by G4BEQ</i><br>Southdown ARS: Junk Sale<br>Midland ARS: This club is open from Monday to Friday(!) at 249a Broad Street, Birmingham.<br>Monday, Construction; Tuesday, Computers; Wednesday, Morse and Natter Nite; Thursday, HF on-air; Friday, RAE Class — and at weekends, Contesting! | 14 Apr | Sutton and Cheam DRS: subject pending<br>BARTG Spring VHF/UHF Contest  |   |
|        |  | 15 Apr | Stevenage DARS: 2m FM Contest 1300-1700 GMT. Details from PRO<br>Lough Erne Mobile Rally, N.I. at Killyhevlin Hotel, Enniskillen at 12 noon. Trade Stands, Bring and Buy, plus boat trips and pony rides for the kids! Admission £1. Information G14UHA<br>Glenrothes DRC: <i>Mountaineering by Iain McLeod</i><br>East London RSGB Group: Question and Answer session with G8VR and G3VPK at 2.30pm, Wanstead House, Wanstead, London E1<br>RSGB Low Power Contest<br>Braintree DARS: <i>Home Brew PCBs by G6MCB</i><br>Leighton Linslade RC: <i>AMTOR by G3NRW</i><br>Glenrothes DARC: Informal<br>Thornton Cleveleys ARS: Film Show |   |
| 3 Apr  | Fylde ARS: <i>RTTY by G4RSA</i><br>Wakefield DRS: AGM<br>Chichester DARC: AGM  |        | Fylde ARS: Informal and Morse Class<br>Biggin Hill ARS: Visit by CM Howes Communications<br>Wakefield ARS: Visit to West Yorks Police Station, Bradford<br>Leighton Linslade RC: Quiz at the Aylesbury Valley RS.<br>Goole RES: On-Air<br>Lincoln SWC: CW/RAE  |   |
| 4 Apr  | Lincoln SWC: CW/RAE<br>Wirral DARC: D & W at Irby CC<br>Chestnut DARC: <i>A Trip the Antipodes by G3NEE</i>  | 17 Apr | S. Bristol ARC: VHF NFD Preparations<br>Wirral ARS: Video of G6CJ's Aerial Circus<br>Bath DRC: AGM<br>Nene Valley RC: Visit by County Emergency Planning Officer<br>Fareham DARC: On-air<br>Cheshunt DARC: <i>The Royal Observer Corps Today by G8LXB</i>  |   |
| 5 Apr  | Colchester RA: Constructor's Evening<br>Horsham ARC: <i>Interference Prevention</i><br>East Kent RS: <i>Interference</i>   |        | 19 Apr   | Chichester DARC: ring PRO for details   |
| 6 Apr  | S. Manchester RC: Spring 1.8MHz DF Contest   |        | 23 Apr   | Thornton Cleveleys ARS: Natter Nite   |
| 7 Apr  | Axe Vale RC: Check out your construction techniques!<br>Harrow RS: Informal and Practical<br>Sutton and Cheam: subject pending<br>Dunstable Downs RC: Talk by Leighton Linslade RC<br>Amateur Radio — Computing — Electronics Weekend at Pontins, Southport. Organised by the Northern Amateur Radio Societies Association. Contact P. Denton, G6CGF, on 051 630 5790  |        | 24 Apr   | Mid-Warwickshire ARS: Natter Nite<br>Goole RES: Club Outing<br>Lincoln SWC: Activity Night<br>Ipswich RA: AGM<br>S. Bristol ARC: 10m FM Night<br>Three Counties ARC: <i>Special Event Stations by G3TBT</i><br>Farnborough (Hants) DRC: Bring Your (radio!) Problems night<br>Fareham DARC: Junk Sale<br>Wirral DARC: <i>Japanese Morse by G3CSG</i><br>Cheshunt DARC: Natter Night<br>Edgeware DRC: Informal |
| 8 Apr  | Swansea Mobile Rally at the Patti Pavillion (next to St Helens Cricket Ground on the A4067 Swansea to Mumbles coast road) 1030-1700. Trade Stands. Bring and Buy. Food and Drink. Talk-in on S22.<br>RSGB 432MHz CW Contest  |        | 25 Apr   | S. Manchester RC: Construction Contest<br>Dunstable Downs RC: 2m & 160m DF Hunt<br>Thornton Cleveleys ARS: Barbeque<br>Fylde ARS: Visit to HMS Inskip<br>Swale ARS: 2m Foxhunt (t.b.c.)<br>Wakefield DRS: On-Air/Natter Nite<br>Goole RES: Natter Night<br>Chichester DARC: ring PRO for details  |
| 9 Apr  | Exeter ARS: Visit to Radio Devon<br>Stratford-Upon-Avon DRS: <i>Mobile Interference Suppression by G3AYJ</i><br>Thornton Cleveleys ARS: Construction Night<br>Milton Keynes ARS: <i>AMTOR by G3NRW</i><br>Mid-Warwickshire ARS: <i>Radio in a POW Camp by G3BA</i><br>Dudley ARC: <i>VHF/UHF Operation by G6FK</i><br>Goole ARC: <i>Unusual Aerials by G6IDL</i><br>Bury RS: <i>Early Radio by G8VF</i>  |        | 26 Apr   |   |
| 10 Apr | Lincoln SWC: <i>VHF Then and Now by G5UM</i>   |        | 27 Apr   |   |
| 11 Apr | Greater Peterborough ARC: Junk Sale  |        | 30 Apr   |   |
| 12 Apr | Edgeware DRC: <i>Antenna Radiation Patterns by G3GC</i><br>Abergavenny and Neville Hall RC: AGM  |        | 1 May  |   |
| 13 Apr | S. Manchester RC: <i>Radio in British Rail by G8WEN</i><br>Harrow RS: ring PRO for details   |        |  |   |

- |  |  |
|--|--|
| <p>2 May Lincoln SWC: CW/RAE<br/>S. Bristol ARC: <i>23cms Operation by G4MCO</i><br/>Wirral ARS: ring PRO for details<br/>Nene Valley RC: Ladies Night with Buffet<br/>Fareham DARC: On-Air</p> <p>3 May Colchester RA: Nostalgia II by Frank Osborne<br/>Horsham ARC: <i>Astral and Solar Observation by Henry Hatfield</i></p> <p>4 May Sutton and Cheam DRS: AGM<br/>West Kent ARS: AGM<br/>S. Manchester RC: Discussion Evening<br/>Axe Vale RC: <i>Aerials by G3GC</i></p> <p>4-5 May RSGB 432MHz-24GHz Contest</p> <p>7 May Braintree DARS: <i>Receivers, Old and New</i><br/>Horndean DRC: <i>The RSGB by G8FG</i><br/>Thornton Cleveleys ARS: <i>Aeroplanes by Jerry Vallely</i></p> <p>8 May Mid-Warwickshire ARS: <i>The Electron Microscope by G300Q</i><br/>Goole RES: <i>Computer Logic by G8VHL</i><br/>Wirral DARC: Inter-Club Quiz at Chester ARS<br/>Bury RS: <i>Confessions of a TV Repair Man by G8XUR</i></p> <p>9 May Lincoln SWC: <i>DX-pedition to St. Pierre et Miquelon by W1FBH/FP8BH</i><br/>Three Counties ARC: Natter Night<br/>Fareham DARC: Planning for Arts and Crafts Exhibition<br/>Wirral DARC: <i>Build a Repeater! by G8UZZ</i><br/>Edgeware DRC: ring PRO for details<br/>S. Manchester RC: <i>Japanese Morse by G3CSG</i><br/>Dunstable Downs RC: TV Show Repeat(?)</p> <p>13 May WAB LF Phone Contest 1400-2100 GMT<br/>Wirral DARC: DF Contest</p> <p>14 May Exeter ARS: Surplus Equipment Sale<br/>Stratford-Upon-Avon DRC: <i>Aerials by G3PGQ</i><br/>Thornton Cleveleys ARS: On-Air Night<br/>Milton Keynes ARS: Video of G6CJ's Aerial Circus<br/>Southdown ARS: Homebrew Evening and Microwave Demonstration with Frank Ogden, G4JST</p> <p>15 May Fylde ARS: Equipment Sale<br/>Biggin Hill ARS: On-Air night<br/>Wakefield ARS: Junk Sale<br/>Goole RES: Bill Richards Trophy DF Contest at 7.30pm</p> <p>16 May S. Bristol ARC: Fox Hunt Briefing<br/>Wirral DARC: D &amp; W at The Sanghall Massie Hotel<br/>Cheshunt DARC: <i>AMTOR, Packet Radio and RTTY by G3NRW</i></p> <p>17 May Colchester RA: Preparations for NFD and Anglian Rally</p> | <p>18 May Chichester DARC: ring PRO for details<br/>West Kent ARS: Construction Contest<br/>S. Manchester RC: AGM<br/>Sutton and Cheam DRS: <i>Amateur Satellites by G3AAJ</i></p> <p>19-20 May RSGB 144MHz and SWL Contest</p> <p>20 May Glenrothes DARC: Informal</p> <p>21 May Braintree DARS: AGM<br/>Leighton Linlade RC: Talk on Model Engineering<br/>Thornton Cleveleys ARS: NFD Preparation</p> <p>22 May Mid-Warwickshire ARS: <i>The Electron Microscope by G300Q</i><br/>Goole RES: Instructional Evening!</p> <p>23 May Three Counties ARC: VHF Repeater Groups<br/>S. Bristol ARC: <i>2m SSB Night with G6ZTY/G6ZTX</i><br/>Fareham DARC: Show at Portchester Arts and Crafts Exhibition<br/>Wirral DARC: <i>Equipment Demonstration by G3LEQ</i><br/>Cheshunt DARC: Natter Nite<br/>Greater Peterborough ARC: VHF NFD preparations</p> <p>24 May Edgeware DRS: Constructor's Contest and NFD Briefing</p> <p>25 May S. Manchester RC: Talk by winners to the Construction Contest<br/>Dunstable Downs RC: <i>Oscar 10 by G3VZV</i></p> <p>27 May Ipswich RA: <i>East Suffolk Wireless Revival at The Hollies, Ipswich. Details Jack Toothill 0473 44047</i><br/>Plymouth Amateur Radio Rally at the Devonport Secondary School, Park Avenue, Devonport, Plymouth. Trade Stands. Talk-in.</p> <p>28 May Stratford-Upon-Avon DRC: Construction<br/>Thornton Cleveleys ARS: Natter Night</p> <p>29 May Wakefield DRS: <i>Yugoslavia by G4KLN</i><br/>Goole RES: Evening of Video's</p> <p>30 May S. Bristol ARC: ATV Night with G8WAX<br/>Fareham DARC: On-Air/Natter Nite<br/>Wirral DARC: DF Practice<br/>Cheshunt DARC: 2m Portable Operation from Baas Hill Common</p> <p>1 June West Kent ARS: Junk Sale<br/>Axe Vale ARC: The Entertaining Electron<br/>S. Manchester RC: <i>Modifications to the FT221R by G4MYB</i></p> <p>2-3 Jun HF NATIONAL FIELD DAY</p> |
|--|--|

Will Club Secretaries please note that the deadline for the July segment of Radio Tomorrow (covering radio activities from 4th June - 6th July) is 23rd April.

#### Contacts

Bath DRC	Colin Ashley	0373-63939
Biggin Hill ARS	Ian Mitchell	09598-376
Bridgend DRC	Clive	0656 93 226198
Bury RS	Bryan Tydesley	0282 25254
Cheshunt DRC	Roger Frisby	0992 464795
Chichester DARC	Chris Bryan	0243 789587
Dudley ARC	Mrs C. Wilding	09074 5636
Dunfermline RS	N. G. Patersen	0383 728778
Edgeware DRC	John Cobley	Hatfield 64342
Fylde ARS	PRO	Lytham 737680
Fareham DARC	Brian Davey	0329 234904
Farnborough (Hants) DRS	Peter Taylor	0252 837581
Goole RES	Richard Sugden	040 584 462
Leighton Linlade RC	Pete Brazier	0525 23 270
Midland ARS	Tom Brady	021 357 1924
Mid-Warwickshire ARS	Carol Finnis	092 681 4765
S. Bristol ARC	Len Baker	0272 834282

# EARTH-MOON-EARTH with simple equipment

The purpose of this short series of articles is to introduce the exciting subject of moonbounce communication to readers of *Ham Radio Today*. For many years, amateurs have made use of 'moonbounce' for working "real DX" on the VHF/UHF and microwave bands. While the challenge of put-

"rogers". Morse code is the normal modulation code, although some of the better-equipped stations can manage to work EME successfully on SSB. You do not have to be a CW expert, though, as the morse speeds are fairly slow and the QSO information is repeated many times. I know a number of EME sta-

*In the first of a two part article specially commissioned by Ham Radio Today, Charles Suckling, G3WDG, introduces the highly exciting but relatively little known world of 'moonbounce communication'. A BSc and a large bank balance is not necessary in order to make use of this article!*

ting together and operating a moonbounce station is still quite considerable, the techniques have become refined over the years, such that, nowadays, it is possible to be successful with relatively "simple" equipment. In this first article, I will introduce some of the more important background information relating to moonbounce operation.

## What Is Moonbounce

The principle of moonbounce (or EME, which stands for "Earth - Moon - Earth") is very simple. The moon is used as a reflector of radio signals, and stations work each other by beaming their antennas at the moon, as shown in Fig. 1. The distance between the two stations does not affect the strength of the signals, and communication is possible between most points on the Earth, provided that the stations can both "see" the moon. Unfortunately, owing to the long overall length of the signal path (about half a million miles), and the fact that only a small fraction (about 7%) of the signal reaching the moon is reflected Earthwards, the signals received back from the moon are rather weak. This means that QSOs tend to be simple, being limited normally to an exchange of call signs, signal reports, and

tions who have a copy of the Morse Code fixed prominently at the operation position! What is needed, however, is the skill to be able to decipher the weak signals.

The "rubber stamp" nature of most EME contacts does not seem to worry those people who have caught the EME bug. From the operating point of view the satisfaction comes from simply making the contacts. I think that many people also gain a lot of pleasure from just getting the equipment working. Hearing one's first EME signals, making that first EME QSO, or the first time that you hear your own echoes from the moon, are usually "magic" moments.

Even today, getting an EME Array of 4 NBS yagis used by G4FRE on 70cms

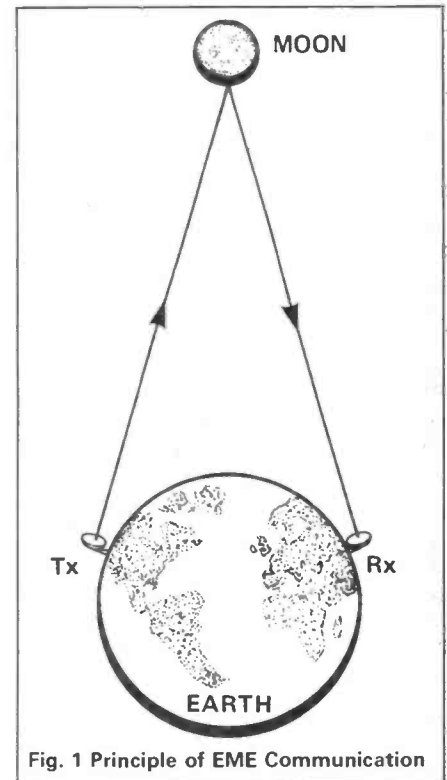

Fig. 1 Principle of EME Communication

station together is still relatively challenging. Even if you are rich enough to be able to assemble a station from commercial equipment, which is possible on the lower frequency bands used for EME, a considerable amount of know-how is still needed, particularly in the areas of operating, mechanical engineering and to some extent, astronomy.

## Which Bands Are Used For EME

Since EME is a marginal mode of communication, it is necessary to use frequency bands where there is an optimum compromise between receiver noise level (arising from both the performance of the receiver itself and external noise), the size of antennas necessary to obtain sufficient 'gain', and the ease of generating enough transmitter power. At the lower end of the spectrum, HF is ruled out due to the high levels of external noise, while at the high end of the spectrum the SHF bands

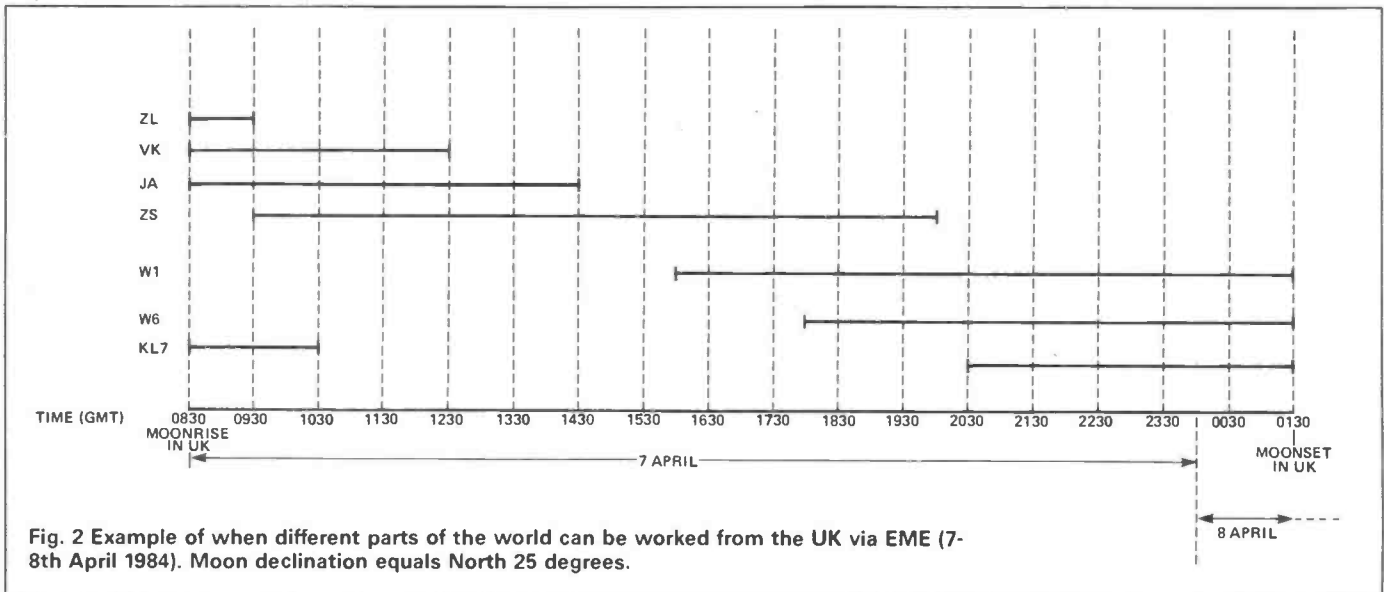

Fig. 2 Example of when different parts of the world can be worked from the UK via EME (7-8th April 1984). Moon declination equals North 25 degrees.

are unsuitable since it is very difficult to generate much power there. So, most EME operation is carried out on the VHF/UHF bands, ie 2m, 70cm, and 23cm. These bands are now well established for EME work: there are several hundred stations currently active on 2m, about 100 on 70cm and about 25 on 23cm. The "frontier" at the moment is 13cm, where a few stations are just starting to get active.

It is difficult to recommend the best band to get started on. From my experience, I would recommend 70cm as the best choice, but it does depend rather on your local circumstances, as we shall see below.

### Differences Between EME And Non-EME Equipment

In the past there was a big difference in the performance of equipment used for EME working and for everything else. Nowadays, the standard of "normal" equipment has improved to the point where on some bands EME signals can be heard, or even EME QSOs made, with good 'tropo' or meteor-scatter type equipment. This is particularly true on 2m, where there are several stations who can be heard or worked using only a single long-yagi. For example, quite a number of UK stations have worked K1WHS in this way. However, this is only possible when there is a "big" station at the other end — and these are rather few and far between. Thus only limited participation in EME is possible with this type of equipment.

Without doubt, more satisfying results will be obtained by putting together equipment which is more typical of that used by most EME stations active. Then it will be possible to work many more stations, and to hear your own echoes. The main difference between such equipment and that used for normal working is in the size of the antenna required on 2m and 70cm: this means a minimum of *four* long yagis. Of course the antenna system needs to be mounted such that the elevation as well as the azimuth (horizontal heading) of the antenna can be controlled, in order to keep the antenna pointing at the moon. Such an antenna system for 2m is quite large, and may present a problem at some locations. On 70cm, the situation is quite different, in that a 4 yagi array is physically 3 times smaller, and is therefore a much more practical proposition for many people.

As far as the rest of equipment is concerned, the EME station does not differ too much, if at all, from a higher 'tropo' or meteor-scatter station. It is more a question of "system engineering", to ensure that every last ounce of performance is squeezed out of the equipment. What this means in practice will be covered later.

### How Equipment Performance Relates to EME Performance

Unlike most other modes of communication used by amateurs, it is possible to predict with some

accuracy signal levels over an EME path. This means that you can calculate in advance whether your particular station will be able to communicate with others — before actually putting it together. Such calculations are useful also for designing your station, as the "weak" points can be identified early on. This can avoid much frustration later, if things do not work out as expected due to some unforeseen snags.

All the factors which govern the overall performance can be taken into account: these include receiver noise figure, external noise, cable losses, receiver bandwidth, transmitter power and antenna gains. The calculations are not too difficult to do longhand (ref 1), but I have found it much more convenient to use a computer to do them. The program given below was developed using an Apple II, but uses as far as possible *simple BASIC*, and should run without many, if any, changes on any small home computer. I would strongly recommend that anyone seriously interested in becoming active on EME should be able to have access to such a computer, not only to be able to run this program, but more importantly, for working out the position of the moon. More of this later.

The program requires the following input data: receiver overall noise figure, receiver bandwidth, frequency, details of Station 1's antenna, details of Station 2's antenna, Tx power and feeder loss. Some of these quantities can be entered in different forms, and so I

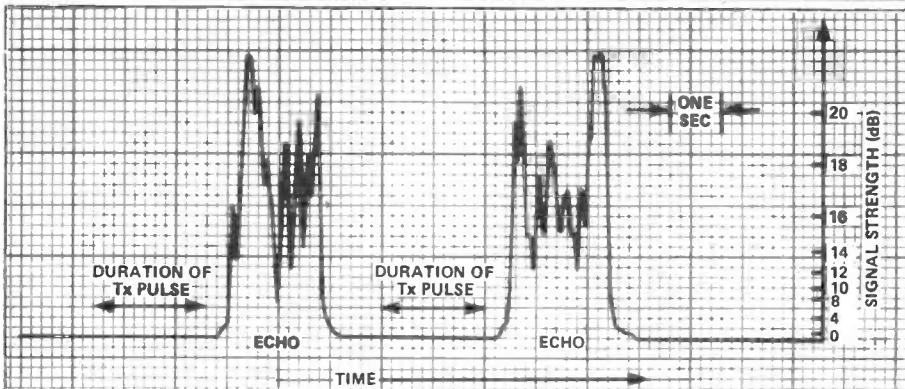

Fig. 3 Chart recordings of EME echoes showing libration fading — made by W2NFA using a sixty foot dish(!) and 400W

will discuss them in a little more detail.

### 1. Receiver noise figure

This is entered as the overall noise figure of the receiver, in decibels. The overall noise figure of the receiver is *not* the same as the noise figure of the preamp; it includes the effects of feeder losses and noise contributions from the rest of the receiver. A BASIC program will be given in Part 2 of this series, to allow the overall noise figure of a typical EME receiving system to be determined.

### 2. Receiver bandwidth

This is entered as in bandwidth of the receiving system, in Hertz. The figure used is generally not the same as the actual bandwidth of the receiver as defined by the filters in the receiver. The reason for this, is that the human ear is able to distinguish signals which are below the noise, and, to allow for this fact, a bandwidth narrower than the actual receiver bandwidth is more realistic. For a good operator receiving CW, a bandwidth of 50 — 100 Hz is normally assumed.

### 3. Frequency

This is the frequency of operation in megahertz.

### 4 and 5. Antenna Gain

These parameters are *related* to the gains of the antennas in use. Each may be entered in two ways. If the number entered is *greater* than 1, the program interprets this as referring to the *diameter* of a dish antenna, in feet. A number *less* than 1 is interpreted as the *gain* of the antenna in decibels, divided by 100. To make this clear, if a dish antenna with a diameter of 15ft is being used, the entry would be .15, while for an antenna with 26dB gain, the entry would be .26.

### 6. Transmitter power

This is entered as the

transmitter power which is fed into the feeder, in watts.

### 7. Transmitter feeder loss

This is entered as the loss, in decibels, of the cable used to feed the transmit power to the antenna.

The use of this program is best illustrated by a few examples. Imagine that, we want to find out if it is possible on 70cm for one station equipped with a 4 yagi array to work another station using a 20ft dish, given the following equipment parameters (which are typical for a good EME station): overall receiver noise figure = 1dB, bandwidth = 50Hz, gain of array of 4 long yagis = 22dB, transmitter power = 800W and transmitter feeder loss = 1dB. The program input prompts, and the entries would be as follows:

```
OVERALL RX NOISE FIGURE? 1
RX BANDWIDTH (HZ)? 50
FREQUENCY (MHZ)? 432
ANTENNA 1 PARAMS. DIA(FT) OR .DB?
.22
```

K1WHS's array of 24 Cushcraft 'boomers' which has given many single yagi stations their first 2m QSO

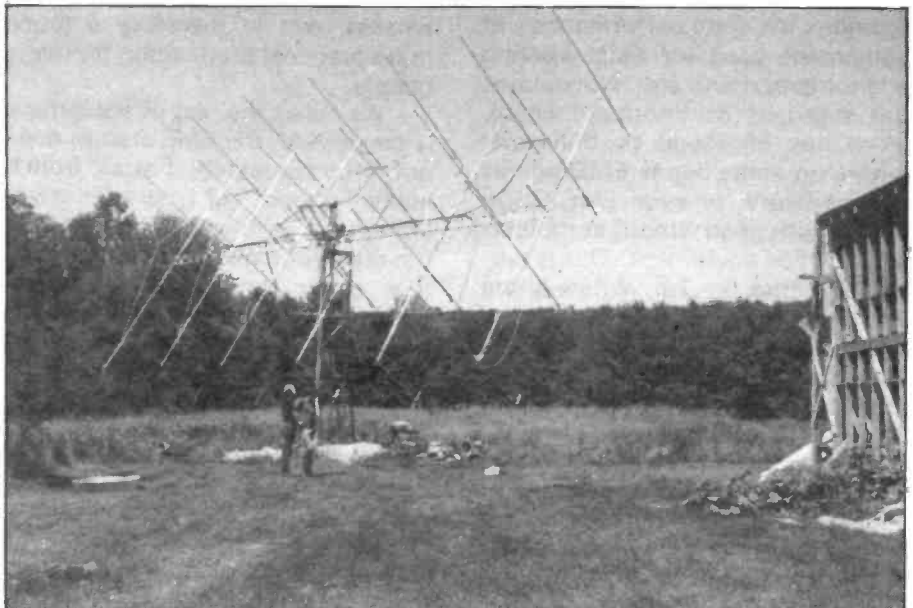

```
ANTENNA 2 PARAMS. DIA(FT) OR .DB?
20
```

```
TX POWER (W)? 800
```

```
TX FEEDER LOSS (DB)? 1
```

The program then prints out the parameters which have been entered, followed by the calculated signal to noise ratio, as follows:

CODE	PARAMETER	CURRENT VALUE
1	OVERALL RX NF	1DB
2	BANDWIDTH	50HZ
3	FREQUENCY	432MHZ
4	ANTENNA1	22DB
5	ANTENNA2	20FT
6	TX POWER	800W
7	TX FEEDER LOSS	1DB

SIGNAL TO NOISE RATIO = 4.99DB

The figure of 4.99dB predicted for the signal-to-noise ratio would be a reasonable EME signal, and one would therefore expect that the two stations would be able to work each other without too much difficulty.

After producing the above output, the program comes up with the prompt:

NEW PARAM CODE, RE-RUN (R) OR QUIT?

If we wanted to change one of the parameters, all that has to be done is to reply to this prompt with the number code of that parameter. For example, if we wanted to see whether our 4 yagi system would be able to receive its own echoes, we would reply 5, and after the next prompt for that parameter then we would reply .22. The output from the program would then be:

CODE	PARAMETER	CURRENT VALUE
1	OVERALL RX NF	1 DB
2	BANDWIDTH	50HZ

```

100 REM EME LINK BUDGET
PROGRAM
110 REM DATA INPUT DRIVER
120 GOSUB 210
130 GOSUB 230
140 GOSUB 250
150 GOSUB 270
160 GOSUB 290
170 GOSUB 310
180 GOSUB 330
190 GOTO 360
200 REM INITIAL DATA INPUT
210 INPUT "OVERALL RX NOISE
FIGURE? ";N
220 RETURN
230 INPUT "RX BANDWIDTH (HZ)?
";B
240 RETURN
250 INPUT "FREQUENCY (MHZ)? ";F
260 RETURN
270 INPUT "ANTENNA 1 PARAMS.
DIA(FT) OR .DB? ";D1
280 RETURN
290 INPUT "ANTENNA 2 PARAMS.
DIA(FT) OR .DB? ";D2
300 RETURN
310 INPUT "TX POWER (W)? ";P
320 RETURN
330 INPUT "TX FEEDER LOSS (DB)?
";FL
340 RETURN
350 RETURN
360 REM ANTENNA CALCULATIONS
370 D = D1: GOSUB 410
380 G1 = G:A1$ = D$:A1 = A
390 D = D2: GOSUB 410
400 G2 = G:A2$ = D$:A2 = A: GOTO
450
410 IF D < 1 THEN GOTO 430
420 D$ = "FT":G = (4.3422 * LOG
(5.094 * D * D * F * F)) - 60:A
= D: GOTO 440
430 D$ = "DB":G = 100 * D:A = G
440 RETURN
450 REM CONVERSION OF NOISE
FIGURE TO NOISE TEMPERATURE
460 NN = 290 * ( EXP (0.2303 *
N) - 1)
470 REM CALCULATION OF
RECEIVER NOISE POWER

```

Computer program for assessing overall performance of an EME station

```

3 FREQUENCY 432MHZ
4 ANTENNA1 22DB
5 ANTENNA2 22DB
6 TX POWER 800W
7 TX FEEDER LOSS 1DB

```

SIGNAL TO NOISE RATIO = 1.21DB

This signal is somewhat weaker than in the previous example, since a 4 yagi array has *less* gain than a 20ft dish. 1.21dB is not a very strong signal, but should still be audible, meaning that it ought to be possible to receive one's own EME echoes with this size of antenna.

One final example will be presented, to show how the program can be used to identify any "weak spots" in one's station. Suppose that in the above example, the overall receiver noise figure were increased to 2dB. This might arise from a poorer preamp, or some feeder loss between the antenna and the preamp. The output from the program would then be:

```

480 RS = - 228.6 + (4.3422 *
LOG (NN + 50)) + 4.3422 * LOG
(B)
490 REM CALCULATION OF PATH
LOSS
500 PL = - 271 + 8.6844 * ( LOG
(1296 / F))
510 REM CALCULATION OF SIGNAL
TO NOISE RATIO
520 SN = G1 + G2 + (4.3422 *
LOG (P)) + PL - RS - FL
530 REM DATA OUTPUT SECTION
540 PRINT : PRINT : PRINT "CODE
PARAMETER CURRENT VALUE"
550 PRINT
560 PRINT "1 OVERALL RX NF
";N;"DB"
570 PRINT "2 BANDWIDTH
";B;"HZ"
580 PRINT "3 FREQUENCY
";F;"MHZ"
590 PRINT "4 ANTENNA1
";A1;A1$
600 PRINT "5 ANTENNA2
";A2;A2$
610 PRINT "6 TX POWER
";P;"W"
620 PRINT "7 TX FEEDER LOSS
";FL;"DB"
630 SN = INT (SN * 100) / 100
640 PRINT
650 PRINT "SIGNAL TO NOISE
RATIO = ";SN;"DB "
660 REM RE-RUN MENU
670 INPUT "NEW PARAM
CODE, RE-RUN(R) OR QUIT(Q)? ";A$
680 REM DATA INPUT FOR NEW
PARAMETER
690 IF A$ = "Q" THEN GOTO 790
700 IF A$ = "R" THEN GOTO 120
710 IF A$ = "1" THEN GOSUB 210
720 IF A$ = "2" THEN GOSUB 230
730 IF A$ = "3" THEN GOSUB 250
740 IF A$ = "4" THEN GOSUB 270
750 IF A$ = "5" THEN GOSUB 290
760 IF A$ = "6" THEN GOSUB 310
770 IF A$ = "7" THEN GOSUB 330
780 GOTO 360
790 END

```

```

CODE PARAMETER CURRENT VALUE
1 OVERALL RX NF 2DB
2 BANDWIDTH 50HZ
3 FREQUENCY 432MHZ
4 ANTENNA1 22DB
5 ANTENNA2 22DB
6 TX POWER 800W
7 TX FEEDER LOSS 1DB

```

SIGNAL TO NOISE RATIO = -1.24DB

Notice that the signal-to-noise ratio is now negative, signifying that this signal is *below* the noise and would almost certainly not be audible. Also, note that the effect of increasing the noise figure by only 1dB has decreased the signal-to-noise ratio by 2.45dB! (Yes, this is correct!). This demonstrates just how important a good receiver is for EME work.

### Equipment Examples

In this section, I will describe typical antennas and equipment used by stations with full EME capability, ie *the ability to receive*

*their own 'echoes'.* It takes radio signals about 2.5 seconds to travel the half a million miles to the moon and back. Therefore it is possible to transmit a signal, and then hear it again 2.5 seconds later! Apart from being a lot of fun, hearing your own echoes can be taken as the final proof that all the equipment is working properly. You can be assured that other stations will also be able to receive you, and that you are then ready to make contacts.

### What Antenna?

When considering what type of antenna to use for EME, the choice is usually between dishes or arrays of yagis. On 2m, the latter is preferred by almost all stations, mainly because dishes have to be quite sizable in order to produce sufficient gain. For example, at this frequency a dish would need to be nearly 30ft in diameter to have the same gain as an array of 4 long yagis. Consider that in your back garden! The 4 yagi array works well on 2m, but is quite large if "full size" yagis are used (as is usually the case). Some stations go even bigger than this, and arrays of 8 to 16 yagis are to be found on the band! The colinear array is also quite efficient at this frequency, and 80 or 160 element versions are used by some stations with very good results.

On 70cm, both yagi arrays and dishes are used, in roughly equal proportions. (A few stations have tried large colinears, but the results have been rather disappointing). The choice between yagis or dishes depends on one's local circumstances. Where space, visual impact or the necessity to get the antenna up high are the important factors, then yagis are certainly the right choice. If these factors are not important, then dishes are certainly the right choice. If these factors are not important, then dishes are worth considering. They do not have to be as large as on 2m: on 70cm, a 13ft dish has the same gain as 4 yagis. Also, a dish constructed for one band can be used on higher bands, eg a 70cm dish can be used on 23cm, by changing only the feed antenna. *Thus, if multiband operation is envisaged, think dish!* There are also one or two other reasons for choosing a dish antenna — which will be explained in later sections. As we have seen above, an array of 4

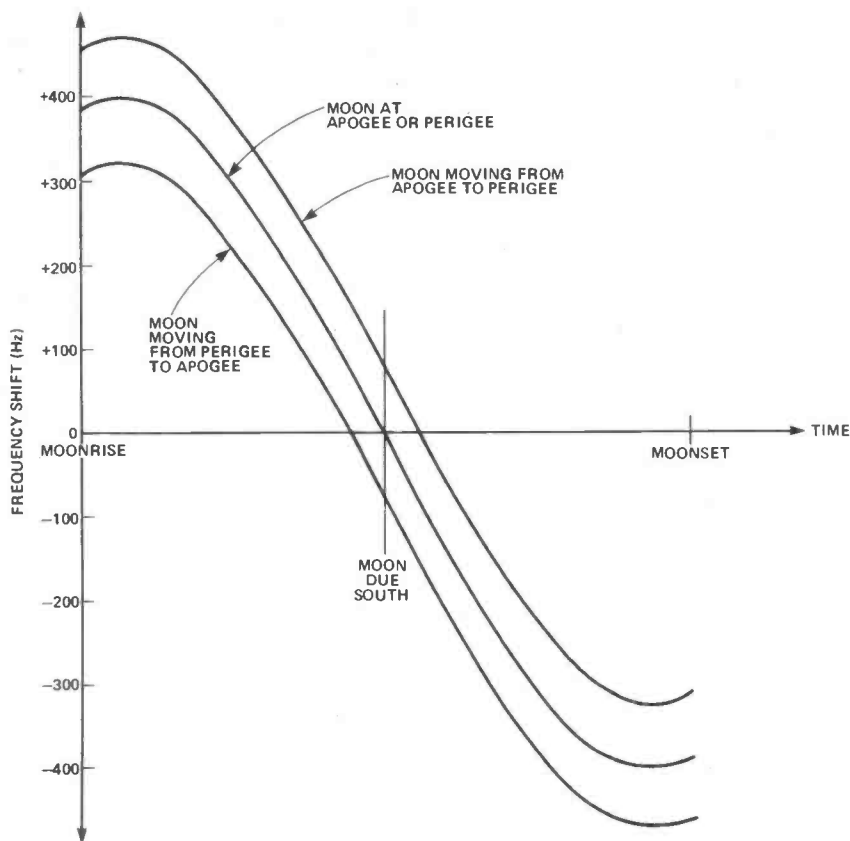

Fig. 4 Maximum one way Doppler shift between moonrise and moonset on 432MHz (from the UK)

yagis is about the smallest antenna which will give useful results on 70cm. Quite a few stations have gained the WAC (Worked All Continents) award with this size of antenna. Moving up in size, arrays of 8 yagis are quite popular and are worth considering if you have a bit more room. The 2.5 or so dB extra gain of 8 yagis over 4 can often be a big help. Needless to say, 16 yagis are even better — if you can afford the space (and/or the cost!). This size of antenna is quite popular in the USA. As to dishes, 13ft diameter is about the smallest size in regular use. Most stations using dishes go larger, to 20ft or more.

On the higher bands, dishes reign supreme, as it is very difficult indeed to generate the gain required with yagis. Not only would a large number of yagis be needed (32 or more), but also the distribution losses in the phasing harness would get prohibitively high. Also, circular polarisation is the standard on bands above 1GHz, which means that normal yagis would suffer a 3dB performance penalty due to the mismatch between linear and

circular polarisation. At these frequencies, some success can be achieved with quite small dishes: antennas down to 6.5ft diameter have made contacts on 23cm! The average, though, is somewhat larger as many stations use their 70cm dishes also on 23cm.

With most forms of amateur communication some contacts can be made with low power. With EME this is rarely if ever true: one needs enough power to overcome the very high path loss, and as we have seen above many hundreds of watts are needed, and even then the signals are weak. Thus high power is mandatory if you are going to make contacts via EME. In the UK, the normal amateur licence unfortunately does not permit the use of these power levels, and it is necessary to obtain special permission to run high power. The procedure for applying for a high power permit will be given in Part 2 of this series.

On 2m and 70cm, most stations use power amplifiers based on the 4CX250B valve, or one of its ruggedised variants (eg 4CX250R, or 8930). Two valves

in parallel or push-pull can give up to 1000W on these bands, although many stations prefer to limit their output power to 700-800W to increase the lifespan of the PA valves! On 23cm, almost everybody on EME uses amplifiers employing 4 or 6 2C39 type valves. Power outputs of 300-500W are the norm. However quite a few EME contacts have been made on this band with power levels as low as 100W, which means that EME operation on this band is feasible without a high power permit. Of course, a reasonably large antenna is then necessary, to make up for the low power. I would not recommend using a dish much less than 13ft diameter with this sort of power level.

On the receive side, almost all EME stations use GaAs FET preamps. In the early days of EME it was very difficult to put together a receiver with sufficient sensitivity to be useful for EME work, and rather exotic devices such as parametric amplifiers had to be used. These were very difficult to make, and the devices used in them were quite expensive. Nowadays, things are very different, owing to the availability of GaAs FETs which have very low noise figures at VHF/UHF. These devices are no longer expensive — many good GaAs FETs cost less than £10 — 15. In order to reduce the effect of feeder loss between the antenna and the preamp, most EME stations use antenna mounted preamps. It is also common practice to use at least one more stage of low-noise amplification before the converter/transverter. This ensures that the noise contribution from the rest of the receiver is reduced to a low level. At least one of these stages is normally also located at the antenna.

## EME Propagation

EME propagation differs in quite a few ways from the propagation of signals over terrestrial paths. Some of the propagation effects have a considerable bearing on EME operating practices, and therefore it is important to have a good understanding of what happens to the signal over the EME path.



The fundamental requirement for EME communication to be possible between two stations, is that the moon must be above the horizon at both locations, or in EME jargon, a common "window" must exist. Since the distance between the moon and the Earth is very much larger than the radius of the Earth, communication is possible between stations *at almost opposite sides of the Earth*. In fact, from the UK there is no area of land which could not be worked by EME. The length of time for which a common "window" exists between two stations depends on their relative positions on the Earth, and on the position of the moon in its orbit. From the UK, the best windows occur to most centres of activity *each month* when the moon is located in the northern half of its orbit. Fig. 2 shows when the EME path is open to different parts of the world throughout one lunar "day", at this time of the month. At other times, when the moon is in the southern part of its orbit, windows are shorter, and may even not occur at all (eg UK to New Zealand).

There is another reason for operating when the moon is in the northern half of its orbit, which concerns the pick-up of noise from extra-terrestrial noise sources. When the moon is located in a "noisy" region of the sky (which are more plentiful in the southern part of the moon's orbit), the noise picked up by the antenna may mask the EME signals. This is more of a problem on 2m than on the higher bands.

### Polarisation Rotation

As mentioned above, it is possible to calculate signal levels over the EME path with some accuracy. However, it sometimes happens that you cannot hear your own echoes, or two stations cannot make a contact, although the sums say that it should be possible, and all the equipment is working well. This seemingly unfair state of affairs is more often than not due to the phenomenon of *Faraday rotation*. When radio signals pass through the Earth's ionosphere the polarisation of the radio waves is *rotated*. This happens both on the outward and return journeys; the

net result is that the signal arriving at the receiving antenna may not be polarised in the same plane as the antenna, causing a reduction in the signal level. Often, Faraday rotation seems to be non-reciprocal. For example, one station may be hearing the other quite well, but there are no signals at all the other way round. Sometimes the polarisation mismatch can be total (90 degrees) and no signals can be heard *at all* one end of the prospective link. With fixed polarised antennas, eg Yagi arrays, there is nothing that can be done to retrieve the situation — all you can do is to try again later. *With dish antennas however, we can easily adjust the antenna polarisation to match that of the incoming signal, by rotating the feed antenna, so that maximum signal can be obtained whatever Faraday rotation is 'doing'*. This facility is extremely useful: an experienced dish operator can even help a yagi station at the other end of the path by adjusting his transmit polarisation for best signals. In this context, dish antennas have a considerable advantage over yagis.

The amount of polarisation rotation suffered by the signal depends on a number of factors, the most important being the frequency used, and the electron density in the ionosphere (which may vary considerably in different parts of the ionosphere — hence the different Faraday rotation effects often experienced). Since the electron density changes continuously due to variations in the solar flux, the rotation angle also changes, and it is not uncommon for signals to peak up and then fade away again during one sked. On 70cm, the amount of rotation is considerably less than on 2m, and changes therefore much more slowly. Faraday rotation is not a problem on 23cm, as circular polarisation is standard on this band. A bit more rotation has no effect.

It is difficult to predict exactly what Faraday will be like from day to day, but in general it is less severe at night, in Winter and when the Sun is less active.

Another effect, possibly allied to Faraday rotation, is polarisation 'spreading'. This seems to happen during periods of high solar activity: when this occurs all signals

seem weaker than normal and stations with rotatable polarisation have found that signals from other EME stations come in at almost the same signal strength, *whatever* polarisation is tried.

There is one more propagation effect which can affect signal strength, and that is the variation of the distance between the moon and the Earth. The moon's orbit is not perfectly circular, and during the lunar month the distance varies from a maximum to a minimum. The point of closest approach is called the *perigee* point, and the point of maximum distance is called the *apogee* point. The variation of signal strength between perigee and apogee is 2dB, which may not sound very much, but the effect on signal readability can be quite significant when signals are close to the noise level. All other things being equal, most stations like to run difficult skeds around perigee.

The next propagation effect which makes EME different to normal operation is "libration fading". Since the moon's surface is rough and the Earth and moon are moving relative to each other, fading of the signal occurs due to multipath effects. This is analogous to the multipath fading experienced during mobile operation. The depth of the fading can be up to 20dB or so, and signals are rarely strong enough to be audible in the trough of the fades. The rate at which the signal fades depends on two factors, the frequency of operation and the position of the moon in the sky. The rate increases with frequency and is highest when the moon is due south of your station. Examples of libration fading are shown in Fig. 3, and were obtained by W2NFA on 23cm using a 60ft dish and high power: the signals were so strong that they could be resolved even at the lowest 'troughs'.

The frequency of the fading is important, as it has a big effect on the readability of the signals. If the fading rate is fairly slow then the ear can accommodate quite easily. This is usually the case on 2m. On 70cm and 23cm, the fading rate is often high enough for dots to be lost, or for dashes to be chopped up into what sounds like several dots. This can make reading morse rather tricky! It can be rather frustrating

for the newcomer to be able to hear the signals quite clearly, but to copy very little. With experience, you learn to cope with the fading by "filling in" the missing bits in your head. Since the information is repeated many times it is possible to eventually piece everything together. The stronger the signal, the easier this becomes.

Generally speaking, most stations like to make contacts or run skeds when the moon is well above the horizon. The moon is then clear of local obstructions, and the pick-up of extra noise, both man-made and thermal noise from the Earth, is at a minimum. However, there can be times when it is an advantage to operate when the moon is close to the horizon. This is because it is possible for the ground in front of the antenna to act as a reflector, and an extra signal will then reach the antenna. When the reflected and direct signals add up in phase, the signal strength can increase by up to 6dB! This phenomenon is called "ground gain". Of course, it is also possible for the ground reflected signal and the direct signal to be out of phase —

whereupon they cancel each other out and nothing is heard! Ground gain is most common on 2m, and is sometimes encountered on 70cm. The ground is a better reflector at lower frequencies.

One question which is often asked about EME propagation concerns the effects of clouds or rain on signal levels. The answer is simple: no measurable absorption has ever been detected.

Most of the propagation topics discussed above have dealt with how the strength of EME signals can vary. The frequency of the signals is also affected by propagation over the EME path, due to the *Doppler effect*. *When the moon is rising at your location, you are effectively travelling towards the moon, and so there is a Doppler shift — which causes the signal to shift slightly higher in frequency.* The opposite situation occurs at moonset, with the signal shifting lower in frequency. Between moonrise and moonset the frequency offset varies continuously. There is a second effect which causes a small additional Doppler shift. This is caused by the move-

ment of the Earth, as the moon goes between apogee and perigee. The additional Doppler shift is zero when the moon is exactly at the apogee and perigee points, and is at the maximum when the moon is halfway in between. Fig. 4 shows how the Doppler shift changes between moonrise and moonset with the moon at these points in its orbit. The amount by which the signal is shifted depends on the operating frequency. On 2m, it is one third of that experienced on 70cm, and on 23cm it is three times the 70cm figure. The Doppler shift of course, will affect both the outward and return signals. If the transmitter and receiver are not at the same place, the total Doppler shift is the sum of the different shifts for the two sites. In the case where the transmitting station and the receiving stations are co-sited, the outward and return Doppler shifts are the same, and the total shift is simply twice that shown in Fig.4.

*In the second part of this article, Charles will tell us about the assembly of a successful EME station and explain the procedures used in EME operation.*

# THE CENTRE

LONDON'S NEWEST AND BRIGHTEST EMPORIUM

**HB9 CVS**  
2metres and 70cms £9.50 + p&p  
Slim Jims, 2 metres and 70 cms £8.00 inc  
Base station Slim Jim £8.50 + p&p

**MEI ANTENNAS**  
London's only agents

PERSONALISED SERVICE

NEW & USED

YAESU — TRIO — ICOM — DATONG — MICROWAVE MODULES  
FDK — DRAE — JAYBEAM — BNOS — ADONIS MICS — WELZ  
STANDARD — MUTEK — HANSEN — DAWA

FOR THE D.I.Y. ANTENNA ERECTOR!  
WE HAVE A FULL RANGE OF POLES, LASHING KITS,  
WALL BRACKETS, ROTATORS, CO-AX, BALUNS, ETC.

WE TRY HARDER!

GOT A GENERAL COVERAGE RECEIVER? TIRED OF TUNING AROUND?  
HOW ABOUT A CONFIDENTIAL FREQUENCY LIST? THIS IS A THICK  
PAPERBACK BOOK THAT LISTS FREQUENCIES FOR EMBASSIES —  
INTERPOL — MILITARY — MARINE — AERO — SPACE COMMS — AND  
MANY OTHER INTERESTING FREQUENCIES. £9.95 inc p + p

LOMBARD TRICITY  
FINANCE

**KENPRO KT200 VHF HANDHELD**  
TX/RX. 140-150mhz. Coverage.  
Battery charger and built in charger.  
Antenna. Battery pack inc Ni-cads.  
Carry strap. Belt clip. Ear piece, plugs etc.  
SPECIAL OFFER ONLY £139.00.  
While stocks last.

IN STOCK H100 low loss  
Co-ax and N type plugs.

Now in stock  
24cms converters  
£29.95 G4HXZ Morse  
practice tapes. £6.50  
(inc sample test)

PART  
EXCHANGE WELCOME

G4HXZ & G6DSS  
10 MERTON PARK PARADE  
KINGSTON ROAD  
(JUNCTION MERTON HALL RD.)  
LONDON S.W.19.  
TEL: 01-543 8150/4212  
MON-FRI 9.30-6.00, SAT 9.30-4.30



# The Dexterous Dipole

Much has recently been written in the popular Radio Press concerning LF aerials for small gardens; some of them eminently suitable for unwary wives and children — others, less fraught with danger but more peculiar in appearance and likely to arouse neighbourly comment!!

the extremity!! To get a 66' run of aerial in a straight line I had to go along the side of the building towards the front garden. At each end of the run I installed two 30' scaffold poles, held upright in steel tabernacles (See Fig. 1).

At first I put up a KW Trapped

and secured via an insulator. This arrangement worked perfectly on 5 bands with a low SWR on each (less than 2.5/1) — however an ATU was adopted to achieve 1/1 on all bands.

The antenna worked well 80-10m but in order to accommodate 160 metres operation the feeders had to be strapped — which worked only indifferently, as I had unfortunately expected, since the maximum current point was down at the Tx end of proceedings!!

After some months of unsatisfactory 160m operation it was decided to add two further traps and extensions to give true dipole action on Top Band.

The traps were obtained from Wight Traps (G3IMX) along with some suggestions for their installation. After some digestion of these ideas, the 80m traps were attached some 6' up from the bottoms of the vertical sections, the requisite extra 20' of wire was attached to the other side of these traps. These 'tails' were brought back toward each other and immediately below the top run — the distance between their ends was filled with nylon cord and two insulators. The completed antenna is shown in Fig. 2. The attachment of the 80m traps at point 15' down the vertical portions was made as a result of suggestions in the IMX data that this would *broaden* the bandwidth of the antenna on 80m. The 6' tails were made off with insulators to the garden fence!

With a little ingenuity the arrangement shown can be adapted

*If you regularly work 160m you will doubtless have heard the excellent signal radiated by Brian Herbert, G2WI. Here he reveals the secrets of his antenna system — which will work from 160-10m and fit into the garden of a typical suburban home.*



The details of all have been perused with some interest, but have aroused no compulsion to adopt any in substitution for that which has been in use here since 1968; it has proven successful on all bands 160-10m and will work world-wide under normal (*not*, highly favourable!) conditions.

The aerial is a trapped dipole.

No! It is NOT a "Beam" (at least I do not think so! — although in trying to analyse the performance of the antenna I have become suspicious that there might be a bit of "addition" involved somewhere in the set-up!!)

## Setting Up

Lest anyone is thinking I have acres of ground and tall masts, let me say at once that my back garden is 22' from the Bungalow to

dipole, the 66' section between the masts, fed in the centre with the 75ohm 'balanced twin' feeder as supplied. The two 40m traps were at the ends of the 66' run (and at the top of the poles) and the remaining 'tails' of 21' each were brought vertically down the masts

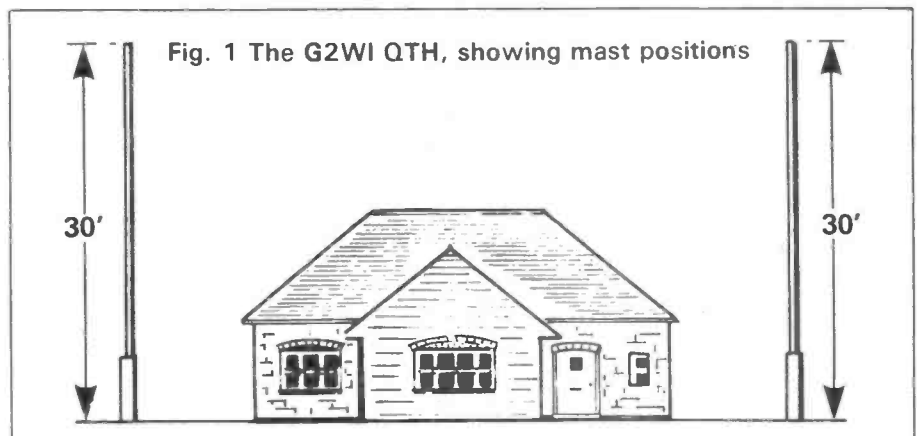

to suit most situations for antenna erection. The vertical sections need not be precisely so, but must *not* be brought back *under* the top as this upsets the SWR badly. The horizontal tails should be parallel to the 'top run' but do not have to be necessarily directly beneath it. The Feeder is some 80' long with a 'T match' ATU at the Tx end.

### In Action

After converting to six band operation, the first call put out was on 160 (as you might expect!) and immediately a reply came from a EI in Donegal Bay, 5/9 in SW Ireland. Subsequently an SWL report was received from North Dakota USA — Q5/S7!!

On the other bands, the aerial has been entirely successful, working world-wide with consistent reports (although not the kind a 3 element beam might be expected to give!), in general around Q5/S6-8, this with about 100 watts from a pair of 6146Bs. Finally, the antenna has another great feature!! No TV!! We have 3 sets in the bungalow, all interference free, and have received no complaints from

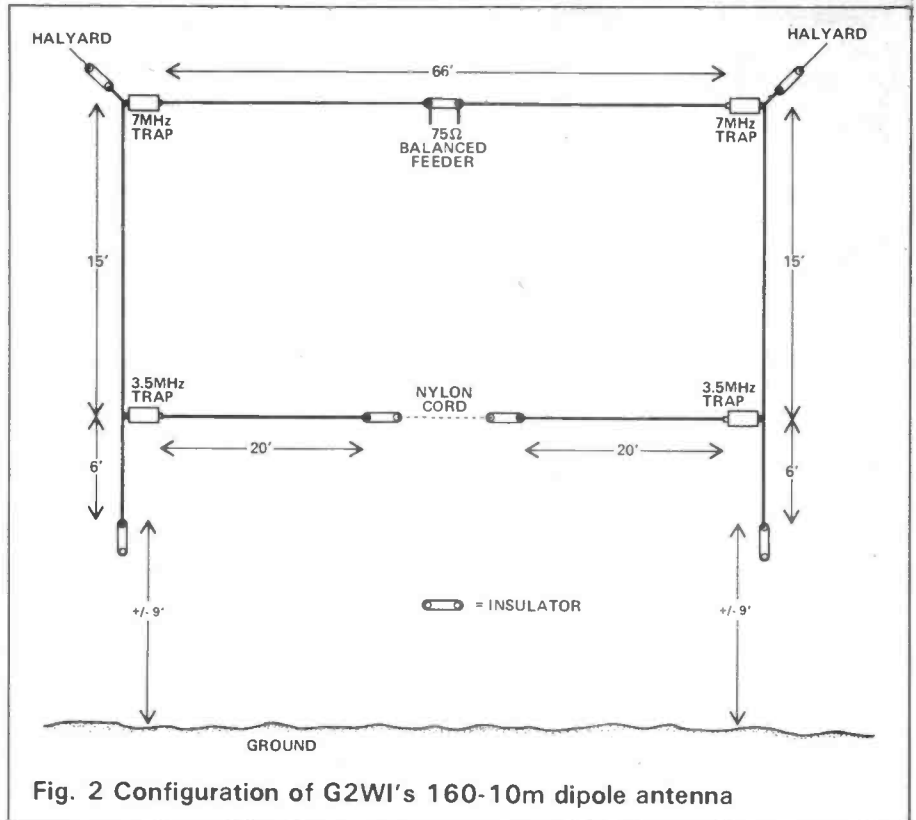

Fig. 2 Configuration of G2WI's 160-10m dipole antenna

the close adjacent neighbours!! I attribute this mainly to the *balanced* shielded feeders and to the fact that the ATU has an *in-built Balun* to the feeders.

It is hoped that this article will give heart to those struggling in awkward locations. It's amazing what a little ingenuity can do — go on, give it a try!!

Setting up a station?

## AR2001



- ★ CONTINUOUS COVERAGE FROM 25-550 MHz WITHOUT GAPS
- ★ 3 switchable modes — AM, FM wide & FM narrow
- ★ Led display shows frequency, mode & memory channel
- ★ Memory channels store frequency & mode
- ★ Full range of scan facilities
- ★ Typical sensitivity of 0.2µV for 12dB SINAD across the entire range

PRICE £325 INC

Consult the professionals

You'll find all you need at Photo Acoustics. We can offer help and advice, the chance to try out the gear and financial facilities too. We offer Creditcharge Instant Finance and accept Access and Barclaycard. Part exchange welcome.

Four minutes from the M1 Exit Junc. 14. Head for the High St, Newport Pagnell. We're at No. 58. Parking at rear, opposite, or round the corner in Silver St.

★ SPECIAL OFFER ★

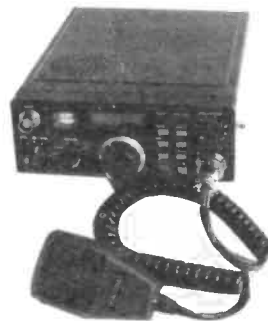

FT790R + FL7010 £299 Inc



THE FABULOUS TRIO TR9130  
SUPERB CONTEST RIG  
£442.00 INC

Photo Acoustics Ltd.  
● OF NEWPORT PAGNELL ●  
Tel: 0908 610625



We also stock a comprehensive range of rotators — Microwave Modules — BNOS — DRAE — Welz & Daiwa products

# Go USA County Hunting

It seems a long haul from the 'blackboxes' of today to the more primitive era of TU5B units driving 807 PA's accompanied by assortments of ex-government surplus receivers, but that's how GW3CDH took to the air in those far off days of 1947. The initial year on CW was a good training ground, enabling many of the American states to be worked

how the rig was working out, "I can work Yanks like 'shelling peas'". He looked at me straight and said, "then work this lot," handing me a mint copy of the United States County-Hunters Awards directory. This was something completely new to me, obviously I'd heard of states before, but *American counties?* I never knew they existed; they never appeared in

least up till Roosevelt, as I could see one in Montana, and one in New Mexico... but there was no sign of Truman county. It seemed that most of the Indian tribes were represented, such as Navajo, Comanche and Cherokee. As I looked down the list, I enthused on the ultimate challenge of possibly working them ALL... that's if it was ever possible.

***Looking for a new interest? Why not try USA County Hunting? It's fun, friendly, challenging and your American Geography will undoubtedly improve! Ellis Evans, GW3CDH, explains.***

with comparatively low power, and extremely simple aerial systems. A sloping 132' long wire running East and West proved so effective, that, by the time TV (on VHF) came to Wales and put me off the air, I had notched up 44 states and amassed more than the necessary 100 countries to qualify for DXCC. Living in what was a fringe TV area meant that my HF days were over for the foreseeable future; subsequently GW3 Charlie Delta Hotel was only to be heard on 160m mobile, and very occasionally on 2m AM, graduating to SSB with a Liner 2.

This went on for approximately 25 years, until, in 1978, a change of QTH (all of 40 yards), and some spare cash left over from the change of houses, meant that my sympathetic wife suggested the purchase of a new and hopefully TVI-proof YAESU FT101E... Compared to the AM/CW days of long ago the new transceiver was a complete revelation. No more calling and then tuning the band for a reply, I soon knew if I was getting out by just listening on the frequency. So, with a few very simple dipoles made from the cheapest bell-wire, HF operation was all so easy. As the dipoles ran North and South, I was back working the USA with comparative ease. As I said to a local 'ham' when he enquired

any mailing address. But there they were, all 3076 of them... yes, an unbelievable 3076, from the 3 in the smallest state of Delaware to the 254 (!) in the 'lone star' state of Texas. I saw that New York boasted 62, and Montana, which was one of the states I'd never heard let alone worked, had 56. I was fascinated by some of the county names; there were 3 Ellis counties, and I thought how super it would be to work just one of them. And then, down in South-East Georgia, there was an Evans county! All the USA presidents were there, at

The author with his 500 counties award



I found out that it was, that world wide, it had actually been done by nigh on 350 'hams', the bulk of them somewhat naturally in the USA. However, two people had achieved this from the UK. In 1974 the very first European award winner had been Frank, G4JZ, to be followed a year later by one of my fellow countrymen Bob, GW3NWV. Apparently they'd had a private 'battle', and Frank had come out the winner... only just. Since then, only two more Europeans have claimed the award, SM4EAC in 1980, and then, early last year in 1983, ON4UN added the USA-CA to his total of DX trophies. I also found out that you could claim the basic award by working just 300 counties, and then apply for the further endorsements in blocks of 300 up to the maximum 3076.

## Starting Off

So with this goal to aim for, I made a start, asking for the county with each new 'stateside' contact I made. This added considerably more interest to the QSO, especially when the operator the other end hadn't a clue to the county he lived in, and, say, would have to ask another member of the family! County identification sometimes created problems, especially in contests when many operators are often working from relatively unfamiliar locations. As initially almost every contact meant a new county, my running total increased by leaps and bounds, and I found it easy to work 20, 30, or even 40 new ones during the course of a week. A contest usually brought a

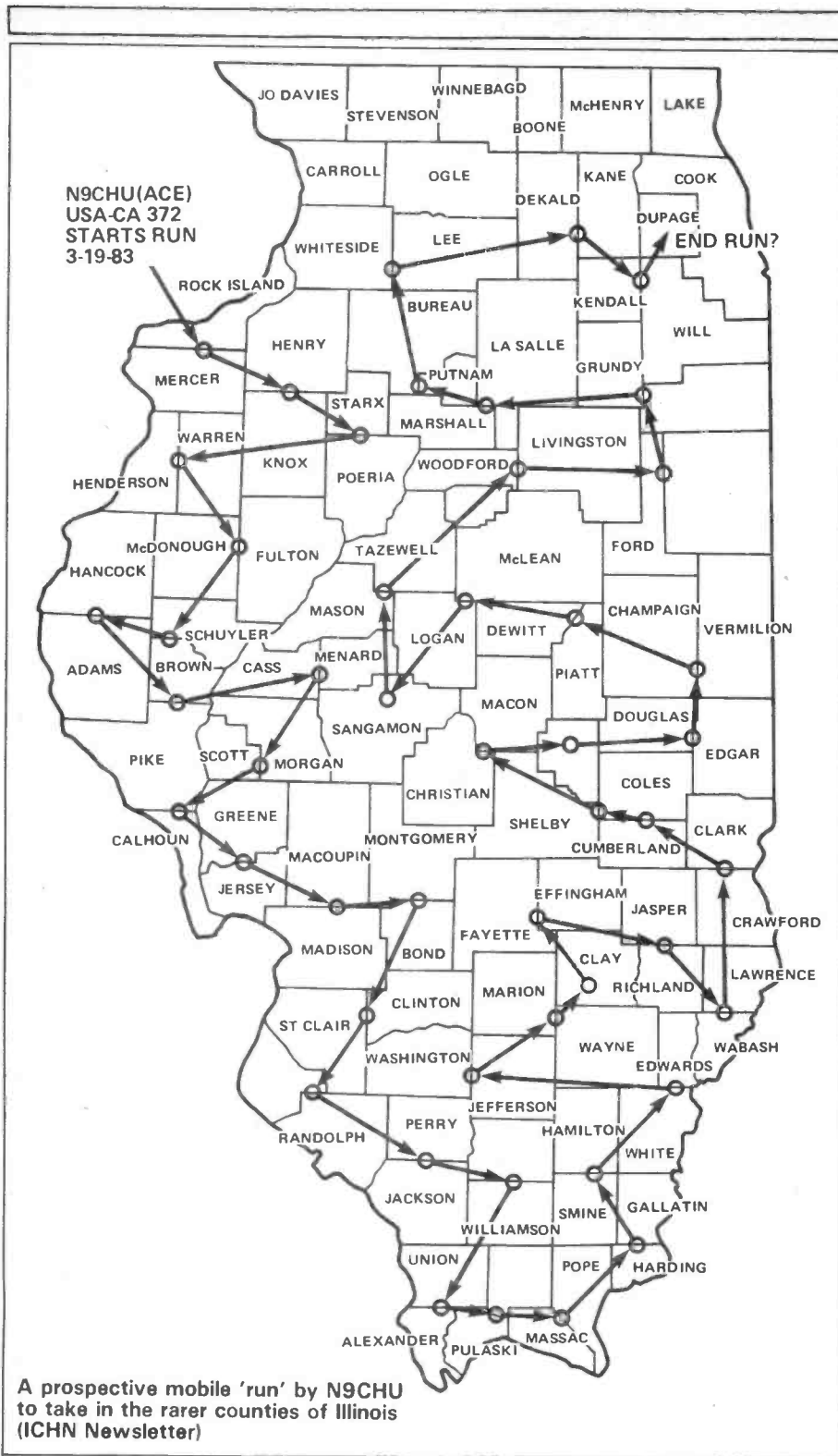

N9CHU(ACE)  
USA-CA 372  
STARTS RUN  
3-19-83

END RUN?

A prospective mobile 'run' by N9CHU to take in the rarer counties of Illinois (ICHN Newsletter)

bonanza as I was never averse to asking the name of the county – even during the height of the contest activity. Most people, I must say, were only too happy to give it and many were PROUD to do so, breaking into a 'pile-up' with "D'you want Howard county, Maryland" or "D'you need mine, . . . Pitt county, North Carolina?" So that in about eight months of fairly concentrated operating, I had reached that magical 300. I phoned GW3NWV in North Wales for infor-

mation on how to apply for the award, and he broke the news to me that CQ magazine had taken over sponsorship, and had increased the basic requirement to 500 counties. . . so it was back to the FT101E, and the remaining 200. However with the sunspots in the ascendancy, it was only a short four months before the 500 were in the bag. When the award was eventually applied for, GW3CDH became the proud owner of the coveted USA – CA 500 No 1131 –

second in Wales. . . I like to think First in South Wales. It was well worth working and waiting for, as it surely must be THE most attractive of all the awards in Amateur Radio, as the illustration shows. The 50 flags of the USA providing the border surrounding the unfurled flag of America, . . . all in glorious colour. I'm sure SWLs will be pleased to know that it is also available to listeners on a 'heard only' basis, details would have to be applied for.

### Population Concentration

To fully appreciate all that's involved in county-hunting, one thing has to be understood – and this is basic to the whole operation. Statistics say that 90% of all USA 'hams' live in just 400 or so counties. That means the remaining 10% live in the 2676 odd that are left! Obviously, *no way* is it possible to work *all* the counties from purely fixed stations. There are some counties where hardly anyone lives at all, let alone radio 'hams'. This means that you have to rely on mobile operation. Fortunately there is no lack of this in the States, not even on the HF bands, and, given almost any time of day, or night for that matter, literally hundreds of mobiles are to be found 'on-the-air'. Many of them operate on the ICHN – the Independent County-Hunters – Net frequency of 14.336 MHz, from approximately 1400hrs GMT, providing radio conditions are suitable of course, up until 0300hrs, or even as late as 0700hrs GMT. Given suitable propagation you can hear stations checking-in from all corners of the USA. Only by operating on the ICHN net is one able to work those very rare counties in the Dakota's, Montana, Nebraska, Wyoming, Oklahoma, and the like. It's comparatively easy to pick up the counties on the East coast, or even on the extreme West coast, but the Mid-West seems to be, in the vernacular, a completely different 'ball-game'. I have been operating on the ICHN net almost exclusively for the past two or three years, and my present county total stands at 2806. Practically all the new counties worked these days are the rare ones away from the interstates and the regular traffic routes. . . it would seem that I have almost completely worked out the beaten tracks! One of the great and curious advantages of working mobile stations is the fact that they can be worked on county lines. Let me

explain; if the 'mobile' is parked with the front wheels of the vehicle in one county and the rear wheels in the next, *both* counties can be claimed. There are also tri-county lines, and even four-county lines! If you were to look at the county map of some of the states, particularly Illinois (illustrated), Iowa, Kansas and Nebraska, and saw how they must have drawn the county lines — as if with a ruler — you would understand why. However MARAC, the 'Mobile Amateur Radio Awards Club' which oversees the county awards system, tends to frown on tri and four county lines, because of the possible margin of error in map reading (*I'm not sure if it is terribly sporting either! -Ed.*). I never cease to marvel at the seemingly incredible feat of working a mobile parked on a county line in some deserted part of a Western state such as Nevada, with a minimum of power and simple whip antennae on the back of his car, in addition to the fact that he has spared the time in travelling across country to give a handful of 'hams' (perhaps thousands of miles away) the chance to work that county. The odds in favour of being able to make this kind of contact are not all that good, but I must admit that I find it a little easier now that the simple dipoles have given way to the three element beam and an FL2100B linear gives an added boost to the RF. However, don't let this put you off, *I was able to gain my 500 and 1000 awards without their help.* Also, in case you might think I live in a good location, I might add that when I'm beaming west towards the States, I have to negotiate 1200' mountains just a mile up the road.

### On The Net

Anyone who listens on the ICHN will appreciate that it is controlled by a group of 'hams' who act as voluntary net controllers — the more hardened of which have been known to 'sit in' for upwards of six or seven hours or maybe more. Each mobile is allowed approximately 10 mins to 'run' the county (ie to operate on net from a county location), so, with so many fixed/mobile stations wanting contacts, there is usually only time for callsigns and reports to be passed. The Controllers are there to announce the county, or counties, to be run along with the callsign of the mobile running it, and then to check that the correct reports are passed to, and

UNITED STATES OF AMERICA

COUNTY AWARD

THE RADIO AMATEUR'S JOURNAL

Be it known to all those present, that on this day \_\_\_\_\_

has provided satisfactory evidence in communicating with five-hundred or more different counties of the United States of America, with special Band/Mode endorsements affixed hereto.

Endorsements \_\_\_\_\_

1-22-79 USA-CA-900-11311-ALL S. B. #2 AWARDS TO ONE

Certificate no. 1311

Date January 22, 1979

W. HOSPER, PROP.

USA-CA Custodian

2500 COUNTIES    2000 COUNTIES    1000 COUNTIES    1500 COUNTIES    3000 COUNTIES

from, the mobile. In order that DX stations are given 'a fair crack of the whip', as they tend to be swamped by the much stronger US signals, a short period is generally allowed for DX stations only. Every effort is made to enable DX county-hunters to work the mobiles. Such is the friendship that exists on the net, that DXers usually have no problem finding QSL managers among the US county hunters... which brings me to the vexed question of QSLing.

### How To QSL

As all county contacts have to be confirmed (and here we are talking

about the USA—CA as sponsored by CQ magazine, and *not* the US—CHA, originated by the late Cliff Evans K6BX and now re-established by KE6RN, for which no confirmations are required), a lot of time and money can be involved in QSLing. I pass on my own experience for what it's worth. My QSLs are sent via the bureaux, direct, or, *through a stateside QSL manager.* WB9YSA was my first manager, in fact, he offered to help out in this role and enjoyed it until he had to QSY to the Caribbean. As he was a teacher with access to the school's printing press, Joe used to duplicate my QSL card for me! My current manager is John,

## Recommended Reading

Counties Award Records Book, price \$1.25 from CQ Publishing Inc., N. Broadway, Hicksville N.Y. 11801.

The Hammond Whole Earth Atlas. Very useful for county identification. Includes Gazetteer for cross-reference, identifying towns in specific counties.

A must for all 'hams' even if not interested in county-hunting.

The USA County-Hunters Record/Colouring Book. price \$7.50 from P.O. Box 146 Lakeside CA. 92040. The B & B Shop 1348 Pinewood Dr. Woodbury, MN. 55125.

Or general information . . . GW3CDH Ellis Evans, 'Nantcelyn', Grove Rd, Risca, GWENT.NP16GL SASE for reply please.

County-Hunters Handbook . . . The B & B Shop as above. price \$2.50.  
Rand McNally Atlas (USA Canada Mexico). Very useful for following mobiles across country, but county lines not very clearly marked. Approx \$6.00 available USA and some good book stalls.

N8BGF, who is a steel-worker and unfortunately has not got the same facility, so I have to send out a quantity of QSLs for his use. Let me explain the arrangement with my QSL manager. Periodically I will send out copies of my log sheets to John, anyone wanting a card will send theirs to John, together with an SASE. He will then fill the QSL out on *my* behalf and return it in the SASE. Ideally, little expense is involved apart from the postage to send the batch of cards back to the UK, the US stations wanting my card only having to pay inter-US postage rates.

## Be Friendly

Many US 'hams' are actually anxious to act as 'managers'. QSLing direct, of course, for us means having access to the current USA call-book. If you haven't got one check with your local radio club, as most progressive clubs will have one in their library, or if they haven't they ought to. Otherwise, just ask for the mailing address over the air; this may be the most reliable way, as callbooks tend to date reasonably quickly. I have always found our American friends most happy to QSL, even without SASEs, maybe that's one of the advantages of having a GW call. But I'm convinced that the secret of successful QSLing is just to be *plain friendly*. Spare that extra bit of time to fill out the back of the card with a bit of friendly chat and if there's no room, write a short note and attach it to the card. If you want that county confirmed badly enough, then you'll find the time. I've even been known to slip in a few stamps, the used commemorative type, as used Welsh ones are often hard to come by over in the US, and you'll be surprised, this works wonders. If a QSL is required direct, I

insist on maybe one or two 40c air-mail stamps, instead of IRC's, as this enables me to build up a small stock of stamps for SASE use . . . these I find are essential when QSLing mobile QSO's.

For confirming contacts made on the ICHN, a special mobile bureau has been set up run by W6CCM, and it involves the use of MRC's (Mobile Reply Cards) as well as the normal QSL's. Dave is able to almost guarantee a 90% return of cards sent through the mobile bureau. It is possible to confirm on one card many counties 'run' by a mobile, and so cut down on expenses considerably.

For DX stations, (as a G or GW you are DX) the cost of processing on MRC is just 10c including one's regular QSL. It must be said that the cost is so reasonable, because it is heavily subsidised by our American counterparts. As a matter of interest, for the USA-CA, MRCs or QSLs do not have to be submitted as with the DXCC or WAS awards, though it *is* possible that a stipulated number of cards might be requested on a random choice basis.

The extent to which some of our American friends will go to help us achieve the award is almost unbelievable. I shall never ever forget how I came to work Sumter Co, Florida. It was 0700 hours one morning, and 20m was wide open. WA6NEV/4 came back to my CQ call. We passed the usual pleasantries, and he seemed interested in my county hunting activities, but disappointed that I'd already confirmed his home county of Marion. When I told him I still needed Sumter just South of him, there was a whispered aside, and he said that his XYL Rosemary felt like a breath of fresh air. If I cared to hold on to the frequency, they would get the

car out, put the whip up and drive the 30 or so miles down to the county line to give me the county . . . and that's exactly what they did. And this was at 0200hrs in the morning their time. I just wonder if the shoe was on the other foot whether my XYL would suggest driving down to the Gwent/South Glam county line to help out some completely unknown US 'ham' going for his UK county award . . . I could quote numerous incidents just like the aforementioned. In fact, I'm certain that if ever I'm able to get down to my last one or two counties for 'the whole ball of wax', as they say over there, there are a number of folk who would happily drive hundreds of miles 'to do the honours'. I might add that the mobile station would receive a very attractive plaque for putting out GW3CDH's last county . . .

## Most Elusive

I've often been asked which of all the counties is the most difficult to work. Perhaps the most difficult county to work is Kalawao county, one of the five in the Hawaiian Islands. This is especially difficult because, sadly, it's a leper colony and only a licensed medico is allowed to operate from there. However, once or twice a year, the local KH6s get together a DXpedition and visit it to put it on the map.

With 2806 counties worked, there are still 270 more to go, but confirmations still trail by approximately 300 until the next batch comes in from N8BGF. Conditions don't help at the moment, they have been extremely poor, and, like many others, I'm waiting for the upturn in the sunspot cycle. Till then, I live in hopes of picking up the odd county needed. An exciting 'spin-off' from my involvement in the USA-CA has been the opportunity of attending two of the Annual MARAC County Hunters Conventions. Denver in 1980 and Charleston, West Virginia in July of 1983. These were unforgettable occasions when my XYL and I were able to meet personally some of the friendly folk who spend so much of their time and cash putting the US counties 'on the air'. K9EAB, Cliff Corne Jnr, was the very first radio 'ham' to work 'em all way back in 1965. Now, subsequently, every 'ham' who follows in his footsteps, gets a Cliff Corne number in memory of him. Good county hunting. Ellis Evans. (GW3 Counties Desired Here).



# VOGAD

## Speech Processor

The advantages of speech processing in the transmission of SSB signals are well known, and many circuits have been described in amateur radio publications. Not-

simple explanation of the principles behind speech processing are referred to 'Talkpower: a guide to speech processing' published in this magazine in September 1983.

attack and delay time of the AGC system are determined by the values of a few external components. Either balanced or unbalanced low-level microphone input circuits may be used.

*This speech processor won't improve your grammar, but it might make it easier to understand your transmissions none the less. Design by N. G. Hyde, C.Eng, MRAeS, MIERE, G2AIH.*

withstanding the superior performance obtained through the use of RF processing, audio speech processors can be built that are extremely cost-effective. The circuit described in this article uses the Plessey SL6270 gain-controlled preamplifier, and, assuming all components are brought new, it can be built for a cost of less than £3.50.

Readers who are interested in a

The SL6270 is contained in an 8-pin DIL package and consists of a microphone preamplifier, a main amplifier and an AGC detector. The latter circuit element controls the gain of the preamplifier so as to provide an output that is essentially constant for a 60dB range of input signal. Overall gain is of the order of 50dB and the main amplifier delivers an output voltage of approximately 90mV. AF bandwidth,

Fig. 1 shows the circuit diagram of the processor. A single-ended input configuration is employed with the microphone connected to pin 5 of the IC. Pin 4, the unused input, is decoupled to earth by C2. C5 is the external coupling capacitor between preamplifier and main amplifier circuits, and the value of this component determines the low-frequency cut-off point; the value shown gives a response 3dB down at 300Hz. HF roll-off is dependent on C4, the value shown giving an upper frequency limit of 3kHz. An optional resistor, shown as R6 on the circuit diagram, may be included to reduce the gain of the main amplifier if desired. As an example a 1kΩ resistor will reduce the gain by 20dB; however, R6 should not have a value of less than 680 ohms.

Attack and decay parameters of the AGC system are determined by R2 and C3 in parallel connected between pin 1 and earth. With the values shown the attack time is approximately 20ms and the decay rate is 20dB/sec. RV1 and RV2 serve as input and output level controls respectively, with the series resistors R1 and R4 providing matching to the impedance of the microphone (in this instance 500 ohms) and the input to the transceiver. These values may require adjustment according to the particular application in which the processor is used.

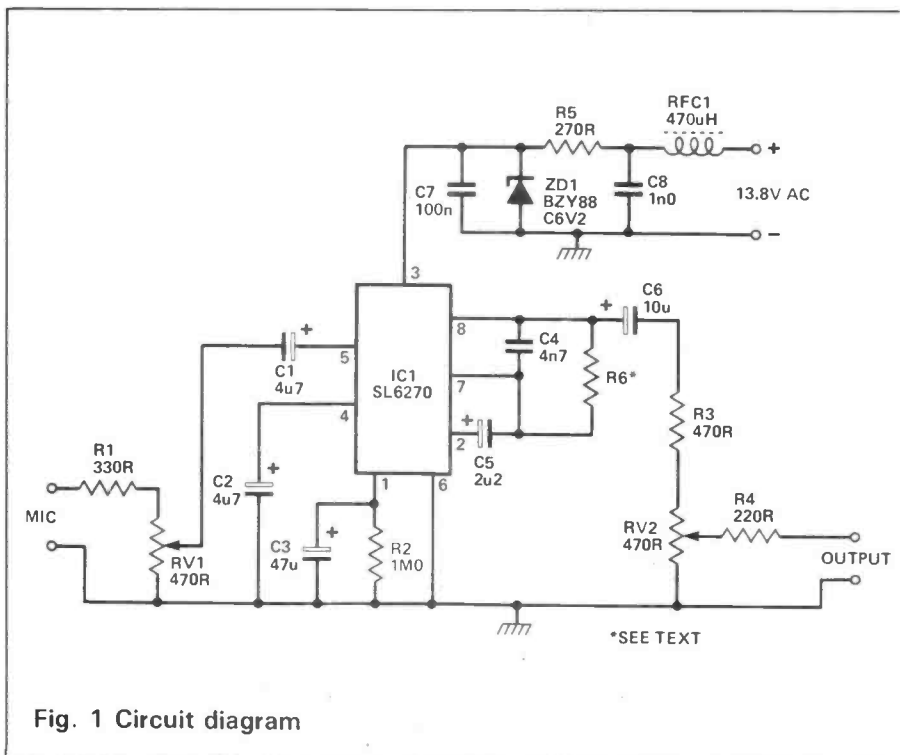
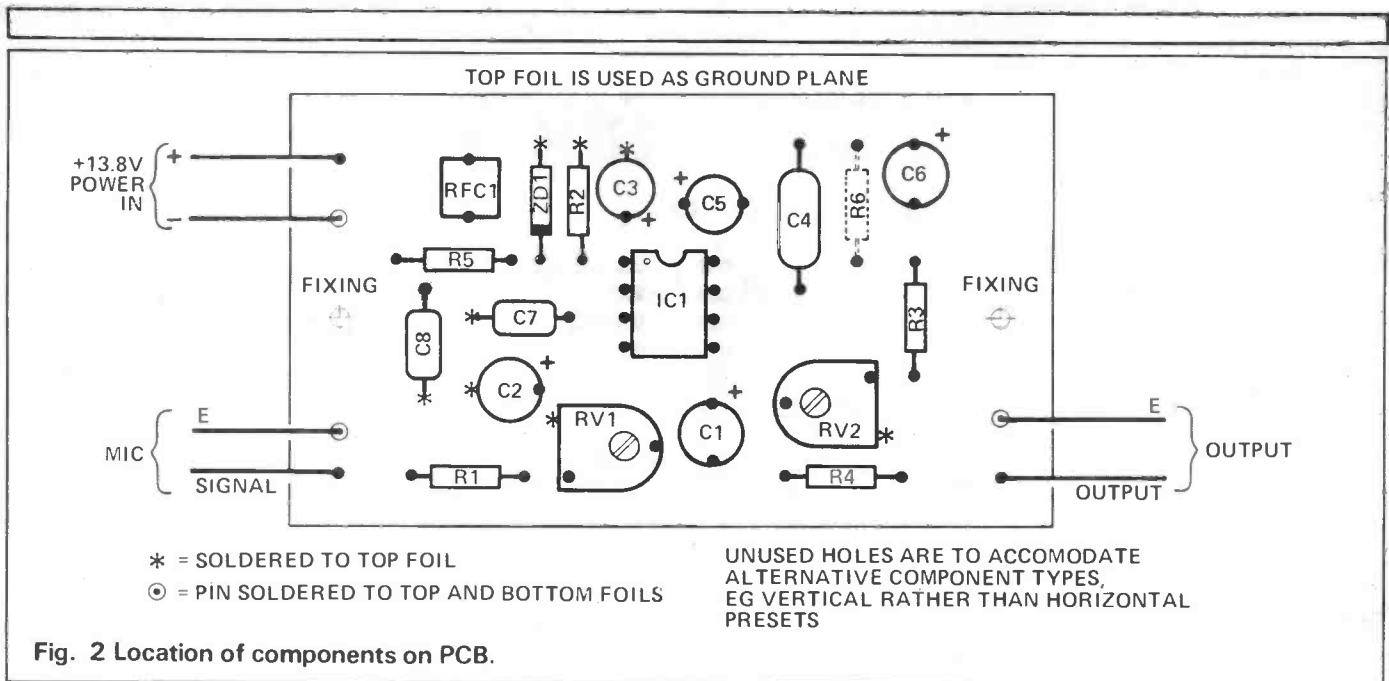

Fig. 1 Circuit diagram

### Construction and Setting Up

Construction is on a double-sided printed circuit board measuring 2.75in x 1.5in (Fig. 2 and 3)



COMPONENTS LIST	
<b>RESISTORS</b>	
R1	330R 1/8 w
R2	1M 1/8 w
R3	470R 1/8 w
R4	220R 1/8 w
R5	270R 1/2 w
R6	optional — see text
RV1,2	470R 100mW horizontal preset
<b>CAPACITORS</b>	
C1,2	47u 10V tantalum bead
C3	47u 10V tantalum bead
C4	4u7 30V polystyrene
C5	2u2 35V tantalum bead
C6	10u 10V tantalum bead
C7	100n 18V ceramic disc
C8	1n0 50V ceramic disc
<b>SEMICONDUCTORS</b>	
IC1	Plessey SL6270
ZDI	BZY88C6V2
<b>MISCELLANEOUS</b>	
RFC1	470 uH Toko 7BA

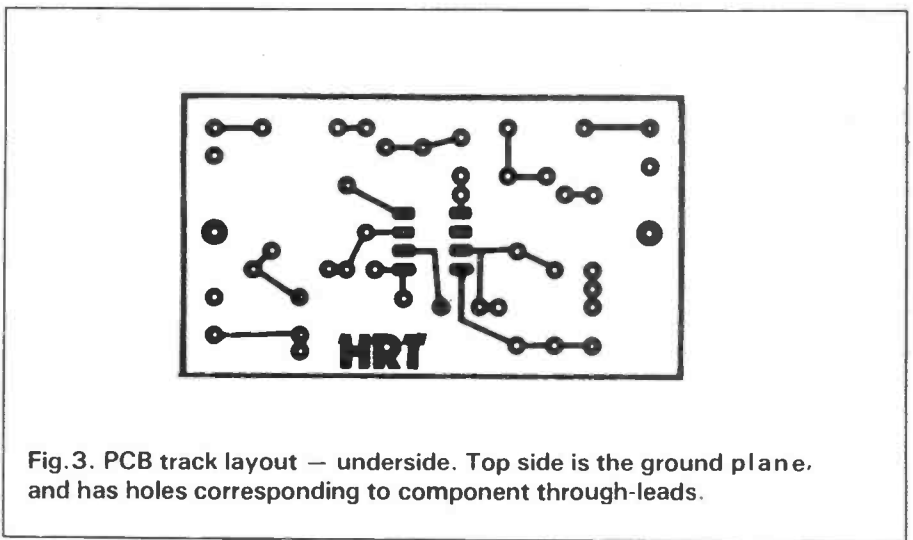

with the topside serving as an earth plane to which all component earth return leads are soldered. It should be noted that no hole should be drilled in the PCB corresponding to earth pin 6 of the IC; earthing is achieved by bending the pin outwards through 90 degrees and soldering it to the topside earth plane. All other pins are soldered to the appropriate lands on the underside of the board. The earth tags of RV1 and RV2 are treated in a similar manner. Fig.2 shows the location of components on the PCB. Provision has been made for fitting R6 should a reduction in main amplifier gain be found necessary.

To prevent RFI from the transmitter the PCB should be mounted in a screened enclosure with RF filters connected between the PCB terminations and input and

output plugs or sockets. In the unit described the filters consisted of series-connected VHF chokes with 1n0 ceramic capacitors across the terminating pins on the PCB. A DPCO slide switch was fitted to switch the processor into and out of circuit.

To set the speech processor without use of an oscilloscope it is necessary to have the co-operation of another station, to whom a strong, steady signal can be radiated. Proceed as follows:

1. Set RV1 and RV2 to approximately mid-position
2. Adjust RV1 until ambient noise just disappears and back off the control slightly
3. Adjust RV2 until distortion of the signal becomes apparent, indicating flat-topping, and back off the control until the distortion disappears.

# Bredhurst electronics



### H.F. RECEIVERS

	£	C&P
Icom IC-R70 Gen. cov. receiver	549.00	(-)
Trio R 2000 Gen. cov. receiver	421.00	(-)
Trio VC-10 VHF converter for R2000	113.00	(-)
Yaesu FRG 7700M with memory	435.00	(-)
Yaesu FRG 7700 without memory	369.00	(-)
Yaesu FRT 7700 antenna tuner	46.00	(1.50)
Yaesu FRA 7700 active antenna	41.80	(1.50)
Trio R 600 Gen. cov. receiver	263.00	(-)

### H.F. TRANSCEIVER

	£	C&P
Trio TS 430S Gen. Cov. Receiver	752.00	(-)
Trio TS 830S	731.00	(-)
Yaesu FT 757GX Gen. Cov. Receiver	685.00	(-)
Trio TS 530 SP	638.00	(-)
Trio TS 130S	555.00	(-)
Yaesu FT77	459.00	(-)

### ANTENNA BITS

	£	C&P
HI-Q Balun 1:1 5kW PEP	9.95	(0.75)
W2AU Unadilla 4:1 Balun	18.99	(1.20)
7.1/14/21/28 MHz Unadilla traps — pair	18.99	(1.20)
7.1 MHz Rai-traps — white epoxy — pair	8.95	(1.50)
Self amalgamating Tape 10m x 25mm	3.95	(0.75)
T-piece Polyprop. Dipole centre	1.50	(0.40)
Polyprop Strain insulators	0.50	(0.10)
Small ceramic egg insulators	0.50	(0.10)
Large ceramic egg insulators	0.75	(0.10)
75ohm Twin Feeder — Light duty per metre	0.16	(0.04)
300 ohm Twin Feeder — per metre	0.14	(0.04)
UR67 Low loss coax 50 ohm per metre	0.65	(0.20)
UR76 50 ohm coax per metre	0.25	(0.05)
UR70 70 ohm coax per metre	0.30	(0.05)
4mm Polyester Guy Rope(400kg) per metre	0.18	(0.04)

### UHF/VHF RECEIVERS

A.O.R. AR2001 25-500MHz	325.00	(-)
J.I.L. SX200N	299.00	(-)
F.D.K. ATC720 Airband handheld	159.00	(-)
F.D.K. RX40 handheld 141-179 MHz	132.00	(-)

### HEADPHONES

Trio HS5 deluxe	23.69	(1.50)
Trio HS6 Ultra lightweight	16.79	(1.50)
Yaesu YH55 padded	11.75	(1.50)
Yaesu YH77 lightweight	11.75	(1.20)

### TEST EQUIPMENT

V.H.F. Wavemeter (130-450 MHz)	27.50	(-)
DM 81 Trio Dip Meter	71.00	(0.75)
Black Star Frequency Counter(600MHz)	134.00	(1.50)

### VHF/UHF TRANSCEIVERS

Trio TS 780 2M/70cm multimode	759.00	(-)
Yaesu FT726R (2M fitted) multimode	739.00	(-)
Trio TW4000A 2M/70cm FM mobile	469.00	(-)
Trio TM401A 70cm FM mobile	299.00	(-)
Trio TM201A 2M FM mobile	269.00	(-)
Yaesu FT290R 2M multimode portable	269.00	(-)
Trio TR3500 70cm handheld	256.00	(-)
Yaesu FT790R 70cm multimode portable	249.00	(-)
Trio TR2500 2M handheld	237.00	(-)
Icom IC02E 2M handheld	229.00	(-)
Icom IC4E 70cm handheld	219.00	(-)
Yaesu FT 208R 2M handheld	199.00	(-)
Yaesu FT708R 70cm handheld	179.00	(-)
Icom IC2E 2M handheld	169.00	(-)

**BREDHURST ELECTRONICS — HIGH ST — HANDCROSS — W. SUSSEX — 0444 400786**

**AMATEUR-PMR-MARINE  
AUTHORISED**

**YAESU MUSEN STOCKIST**  
CONSULT THE EXPERTS FOR ALL  
RADIO REQUIREMENTS.  
STAFFED BY G3NXU, G3XOD, G8DPH  
**£1000.00 INSTANT CREDIT**  
BY LOMBARD TRICITY

**TRANSMITTERS RECEIVERS ETC.**  
All frequencies, well known makes,  
ICOM, FDK, AZDEN, LOWE, STAN-  
DARD, DATONG. Power supplies, wave-  
meters, test meters, frequency count-  
ers, Welz SWR and Power meters. Mic-  
rowave modules, linear amps, RTTY  
etc. Quality equipment for am-ateur,  
PMR and Marine use.

★ Open 9.30am-9pm Tuesday to Sunday inclusive ★

**6 GOLF CLUB  
LANE,  
SALT FORD,  
BRISTOL**

**Tel: 02217 2402**  
*RING FOR ADVICE*  
24-HOUR ANSAPHONE  
SERVICE

Suppliers of Radios to  
**CAMEL TREK LTD. KENYA**

## TALK TO THE WHOLE WORLD

Study now for the  
**RADIO AMATEUR'S  
EXAMINATION**

We have had 40 years successful experience  
in training men and women for the  
G.P.O. Transmitting licence.

**FREE R.A.E. brochure without obligation from:—**

**British National Radio & Electronics School**  
READING, BERKS. RG1 1BR

Name .....

Address .....

**HRT/5/846** **BLOCK CAPS PLEASE**

### MAIL ORDER PROTECTION SCHEME

If you order goods from Mail Order Advertisers in this magazine and pay by post in advance of delivery, this publication will consider you for compensation if the advertiser should become insolvent or bankrupt, provided:

1. You have not received the goods or had your money returned; and
2. You write to the publisher of this publication explaining the position not earlier than 28 days from the day you sent your order and not later than 2 months from that day.

Please do not wait until the last moment to inform us. When you write, we will tell you how to make your claim and what evidence of payment is required.

We guarantee to meet claims from readers made in accordance with the above procedure as soon as possible after the advertiser has been declared bankrupt or insolvent to a limit of £1,800 per annum for any one advertiser, so affected, and up to £5,400 p.a. in respect of all insolvent advertisers. Claims may be paid for higher amounts, or when the above procedures have not been complied with, at the discretion of this publication, but we do not guarantee to do so in view of the need to set some limit to this commitment and to learn quickly of reader's difficulties.

This guarantee covers only advance payment sent in direct response to an advertisement in this magazine (not, for example, payments made in response to catalogues, etc. received as a result of answering such advertisements):

**CLASSIFIED ADVERTISEMENTS ARE EXCLUDED.**

# Please mention Ham Radio Today when replying to adverts

## It's easy to complain about advertisements.

**The Advertising Standards Authority.**  
If an advertisement is wrong, we're here to put it right.

ASA Ltd. Brook House, Torrington Place, London WC1E 7HN

# REVIEW: Yaesu FT757GX HF multimode transceiver

There can be no doubt that this new Yaesu transceiver has created more interest amongst radio amateurs than probably any other rig has done for a long time. Yaesu's philosophy was to design into the rig as many functions

keep the price down, and, rather unusually, many items normally available as optional extras are included for the price. The rig has transmit capability on all nine amateur hf bands with 100W RF output and has

row CW filter is built-in as is a proper AM filter giving a reasonable bandwidth, and not the dreaded 'standard' AM facility on most modern rigs — that is, received with an SSB filter! Let's have a look at some of the remarkable facilities on this very ergonomically designed and handsome rig.

*Well endowed with useful operating aids and presently competitively priced, the FT757 GX could be Yaesu's biggest selling HF transceiver ever.*

*Angus McKenzie, G3OSS, looks inside the technology of Today with a glance at the Past — the FT101B.*

and modes as possible, whilst keeping the price as reasonable as possible. They have planned a very large production of this model in order to

receive, general coverage from 500kHz to 29.9999MHz. The following modes are incorporated: LSB and USB, CW, AM and FM. A nar-

The main VFO tuning knob tunes at a rate of 10kHz per revolution; this cannot be switched to a faster tuning rate unfortunately, which makes a QSY of, say, 250kHz somewhat laborious. Two VFOs are incorporated together with a split facility allowing you to transmit on one VFO and receive on the other. Eight memories are fitted, these accept *frequency* but not mode, unlike many other memories. The 'Up' and 'Down'



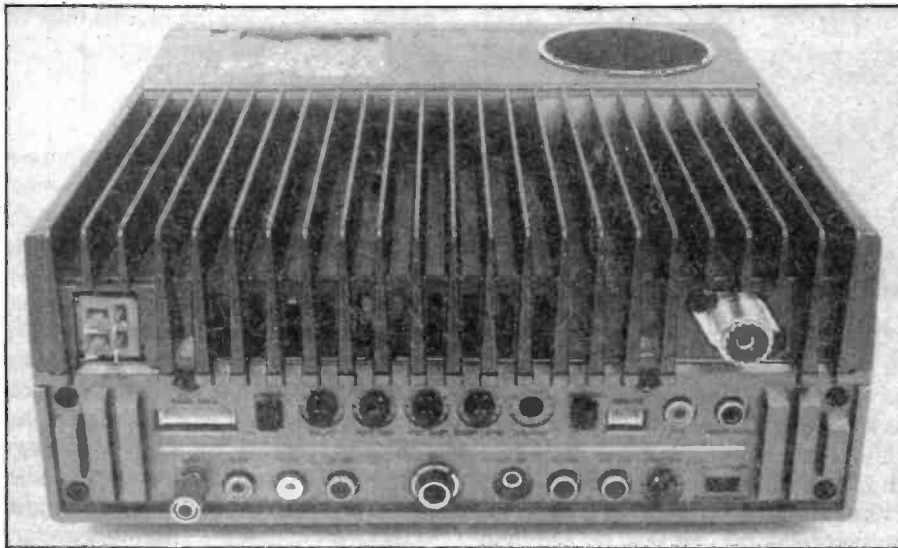

### At the back

band changing buttons normally changes the frequency through the amateur bands only, but if the 500kHz step button is depressed they shift frequency in 500kHz increments allowing general coverage. A programmable memory scan facility allows 'searching' from the frequency recovered from a memory to the adjacent high number memory channel. Buttons allow instant access to memories, with or without VFOing from the recovered memory frequency, whilst the usual buttons put a dialled frequency into memory, or will swap a memory with the VFO function and back. This facility is rather useful, for it allows you to store a VFO setting, go to memory and VFO from it and then go back to your original setting at the push of a button. Unlimited receiver incremental tuning (IRT) and frequency lock buttons are mounted just above the VFO. Other facilities include, on buttons, power on/off, metering ALC or power out, RX preamp on/off, RX RF attenuator in/out (18dB attenuation measured on 1.9MHz), processor on/off, noise blanker on/off and AGC fast/slow (no provision for switching AGC off), MOX Tx on/off and VOX on/off. The rotary mode switch instantly selects the required mode. Several split concentric rotaries are provided to control RF and AF gain on Rx, shift and width for IF, squelch and noise blanker variable, and Tx mic gain/output drive level. We noted that the mic gain is fixed for FM but variable on SSB. The front panel includes a quarter inch jack socket for headphones and a Yaesu standard 8-pin mic socket. An appropriate microphone, the Yaesu MD-1B8 table stand mic, has lock or

unlocked Tx PTT and buttons for scanning slow or fast, fast being just under 20 seconds to shift 100kHz, and slow, one tenth of this speed. I would have preferred the fast scanning to have been appreciably faster – to overcome the very slow tuning knob tuning rate.

The top of the rig incorporates a huge heat sink with air ducts – with a built-in fan which is thermostatically controlled to come on when necessary. This fan is very quiet which is welcome. To the front of the top is a small built-in speaker facing upwards and, to its side, are some additional controls which select full or semi 'break-in' keying for CW, manual or auto keying, and a slider for selecting keying speed.

### At The Rear

The back panel is stuffed with goodies, allowing great flexibility in use. The antenna socket is an SO239 and the 13V power socket is on a special 4-pin plug which is supplied. Pushbuttons select 'normal' or 'special' linear amp control facilities, the latter function, if also provided on the linear, allows full break-in keying. This position can also be used with the matching auto FT757 ATU. A second pushbutton selects a receive crystal marker coming up every 25kHz. It seems a little stupid to put this on the back panel, and many users, including 'white stick' operators, would probably have much preferred this on the front. Miniature presets are provided for VOX delay, VOX anti trip, VOX gain, TX compression level and an AM preset carrier/modulation level – which is recessed

requiring a screwdriver to adjust it – and, finally, a preset for altering the sensitivity of the built-in SWR meter. A minute switch by this control allows the multi-function front panel meter to read SWR. However, this facility, I feel, is very much a "use it once in a month" one, rather than one that can be used on a daily basis! Once again, I feel these two controls should have been on the front panel.

### Getting Connected

Seven phono sockets provide interconnections for external PTT line, phone patch input/AFSK tones, and an external ALC input, AF output at a fixed level of approximately 200 mV into not less than 50kohms (for feeding external tape recorders or RTTY terminals etc). The source impedance of this audio feed is approximately 15Kohms. The remaining phono sockets give low power RF output for feeding transverters (approx -6dBm into 50 ohms, ie just over 100mV), +8V DC at up to 100mA, and +12V DC at up to 500mA. A quarter inch key jack can be used with a conventional key or an auto type or with a paddle, taking advantage of the internal keyer, the jack socket being of the stereo type providing a tip, ring and screen interconnection. A 3.5mm mini jack provides power to an external speaker, which can be of 4 - 16 ohms impedance. A band 'data' socket gives TTL level band switching signals and DC power for the 757 AT automatic aerial tuning unit. Pin 6 of this socket also provides high speed synchronised switching for TX/RX control of a linear with QSK facilities. A 3-pin socket, labelled 'remote', is provided for interfacing with an external micro computer with serial bit coding. Interface units are available for this as optional extras. The FIF80 at just under £100 works with the NEC PC8001, the FIF65 at around £51 with the Apple 2 and probably the most useful interface, the FIF232C at £55, works with any standard RS232 microprocessor source. Yaesu's CAT system provides for external control of VFO frequency and memory functions from the operators personal computer when linked with the appropriate CAT interface unit.

Two different power supply units are available; the cheapest is the switched mode FP757 at £150 which is quite small but is only suitable if not more than a 50% duty cycle is to be

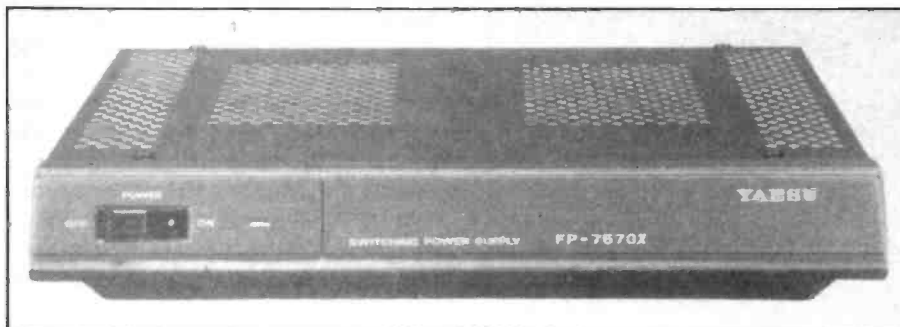

### The switched mode FP-757GX PSU

used ie 50W FM max, or 100W SSB/CW. RTTY would also be limited to 50W max. If you want a 100% duty cycle for up to 30 minutes at a time, then the FP757HD will provide this, having conventional circuitry and, also, a built in extension speaker and a fan, and costing around £162.50.

The rig is provided with a carrying handle on the right and a pull-forward metal foot to raise the front of the rig to around 3 cms. Right underneath the tuning mechanism is an adjustment hole for altering the tuning knob tension. The rig weighs 5.5kg and measures 238 x 93 x 238mm. The unit can be worked mobile. No mobile mount was supplied with the review sample, kindly loaned by SMC in Southampton, but a Yaesu MMB-2 (£17.50) can be used.

### Subjective Tests

I used this rig over Christmas '83 and obtained some *excellent* reports of transmitted audio quality both on FM and SSB. The Yaesu MD-1B8 microphone had rather a coloured sound quality, though, but a Heil microphone, kindly loaned by Am-comm in Harrow, Middlesex, gave a stunning improvement to the intelligibility and punch on SSB, although one or two stations reported that the Heil mic's presence boost was slightly fatiguing for local contacts. I felt that the transmitted audio response was ideal and this was confirmed in the lab. The processor worked very well, giving additional punch without sounding nasty. No problems of any kind occurred on Tx, although FM deviation on 10m was a little high if I spoke too close to the mic.

On general coverage, the received performance seemed to be excellent throughout. I found the switchable receive preamp and attenuator very useful indeed, sensitivity on 10m seeming good but not superb. When listening without an ATU in circuit on 160m, there were some IM

products created from strong medium wave signals, but these went completely when the ATU was switched in. I tried using the Yaesu FRT7700 RX miniature ATU and this greatly improved reception on MW by allowing rejection of the strongest interfering signals whilst peaking up the required station with fairly high 'Q'. No RFIM problems were noted on 80 and 40M. The built-in speaker gave very good audio quality on CW and SSB, and FM was also good although the passband was slightly on the wide side for 10kHz channelling. 'Slow' AGC was slower than usual-which is all to the good and thus gives a wider dynamic range in speech reproduction, whilst 'fast' was excellent for bring up weaker-than-average signals when in a net situation quite rapidly. The noise blanker worked well, although it only partly coped with the particular 'woodpecker' it was tried upon.

The FM receive response was very well controlled and did not have as much HF cut as some other rigs - which are often too muffled. The absence of a tone control however is a slight disadvantage when the rig has to cope with a very 'toppy' transmission. The SSB audio response was ex-

cellent - allowing the crystal filter to control the subjective response.

### Rare Birdies?

We tuned over all the amateur bands looking for 'birdies' and whilst there were a number of extremely weak ones, only one could possibly be slightly annoying at around 28.822MHz - although even this one was below S1. I did not have the patience to tune all the way from 500kHz up to 30MHz in the general coverage mode - for, at one tuning rev per second this would have taken 50 minutes and an incredibly sore finger! As it is, I nearly wore my finger out covering just the amateur bands. I very much regret the absence of a faster tuning rate which is likely to be the most annoying ergonomic feature of this rig. As I have said, in other respects ergonomics were superb, in particular, access to and from memories being rapid and not confusing in any way. The programme search facility worked well, but searching speed was painfully slow, making it inappropriate for FM or AM searching. The selectivity controls, bandwidth and shift, operated well but I was sorry to note the absence of a centre indent giving an immediate 'positive' centre point. The squelch control works on all modes which could be useful. I cannot understand why Yaesu did not provide a 25kHz switchable marker as an 'off-click', that is to say by clocking the mic gain to off as is provided on the Trio TS830. The carrier level control increased power from almost nothing (well below 1W) to full power giving a very wide range of adjustment. The

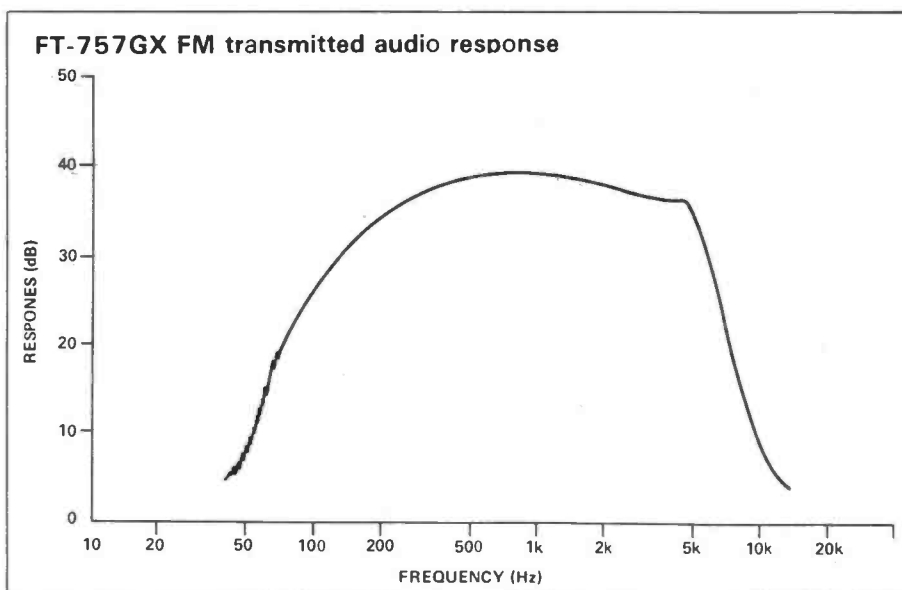

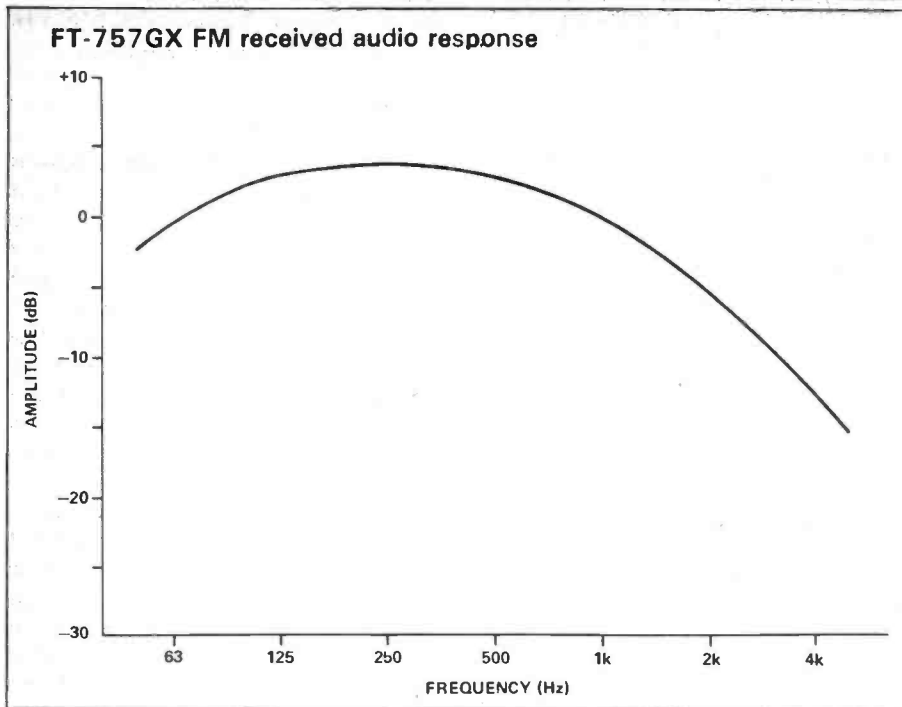

transfer from 10W to 100W unfortunately occurs much too rapidly – in about 20% of the rotation around the centre. The frequency readout was to the nearest 100Hz, and this also displays A or B VFO in use, memory channel, dial lock and clarifier information and when the Tx side is on-air. The meter is calibrated in normal S units on Rx, and is scaled 120W FSD on TX, or ALC from 0dB to 12dB. VOX control was excellent, and the CW auto keying controls were very easy to use.

### Objective Tests

The RF sensitivity with the preamp in was good throughout on all amateur bands, although needlessly so towards the LF end of the transceiver frequency average. The 10m sensitivity at 0.18uV will be good enough for all normal purposes, but a dB or two improvement might have been welcome for 10m SSB mobile use when a simple aerial is in use. The FM sensitivity left perhaps a little to be desired at 0.36uV for 12dB sinad. This was partly due to the FM bandwidth being too wide, for 10kHz selectivity was clearly not too good for 10m FM although the 25kHz selectivity was reasonable. The SSB IF selectivity was very good indeed down to the -60dB point, but the poor, close-in 'reciprocal mixing' performance gave a considerable widening of the selectivity effective pass-band for -80dB at 11.6kHz bandwidth. The wide CW bandwidth is the

same as the SSB one. The narrow CW filter (600Hz), CW – N position on the mode switch, was fairly sharp at the top of its response, for 3dB bandwidth, with side skirts falling reasonably quickly but opening out too much at very low levels (although the -80dB bandwidth was narrower than for the SSB filter. Incidentally, there is some audio HF filtering on CW receive, which I think is very helpful). Narrow CW sensitivity was excellent at 0.07uV (-130dBm).

AM sensitivity for 10dB S/N was quite reasonable, which allowed quite weak broadcast stations to be received at HF.

### Protective AGC?

We had some strange problems in measuring RFIM at various spacings at HF, particularly when the interfering carriers were close-in. The 'roofing' filter after the first mixer is very wide as it has to cope with wide FM, although perhaps it is wider than necessary. Thus, the close-in measurements gave an approximate RF intercept point of 0dBm for 20/40kHz spacing – which is actually very good for this spacing. Carriers spaced much wider away gave an RF intercept point of +10dBm with the RF preamp in – which is excellent. There seemed, however, to be a strange long-term 'hysteresis' effect, for, as we watched the meters, the on-channel product became weaker and weaker, resulting in our continuing to 'turn up the steam' more and

more to offset this strange effect. It seemed to us as if the receiver was gradually reducing its RF sensitivity as we turned up the RF input level, almost pleading with us to turn the generators down! The importers were unable to give an explanation for this; perhaps it is some strange form of protective AGC which allows quite a wide bandwidth to control gain. We were unable to find a solution to this, despite close attention to the FT-757 circuit diagram using a reasonable magnifying glass. We also checked RFIM on 80 and 160m, measuring generally around 0dBm for the intercept point, which is very good considering the RF preamp was in. We also checked RFIM on 1.85MHz with interfering carriers at 1.65 and 1.45MHz, measurements again being the same showing that very strong MW signals could indeed cause a problem (see my article on Receiver RF Performance in last month's HRT).

### Reciprocal Mixing

The reciprocal mixing ratio was not at all good at 20kHz spacing when checked with our special Mutek oscillator, but matters improved dramatically at wider spacings, 50kHz being good, and 100kHz spacing excellent. FM reciprocal mixing showed a similar trend, causing me to conclude that the first local oscillator was rather noisy close-in to the carrier but very good further out, which seems typical of several modern Yaesu rigs (Icom are much better here).

The 'S' meter gave a surprisingly similar performance on SSB and FM which is useful, for too many rigs when switched to FM have an 'S' meter performance which is purely of use in showing the presence of a signal or not! S9 at only just above 100uV is rather on the lean side, whilst S1 at 1.8uV is again insensitive, but shows a reasonable logarithmic ratio with S9. There was 44dB difference, incidentally, between S9 and 9 + 60dB which at least shows willing. The RF preamp gave 10dB gain, and as it improved the FM sinad by around 10dB, it is clear that the sensitivity was dependent upon noise from the mixer and not, noise from the preamp.

The AGC fast and slow pen charts showed that there is a lack of gain at the IF, which is why weak signals failed to come up enough in the swit-

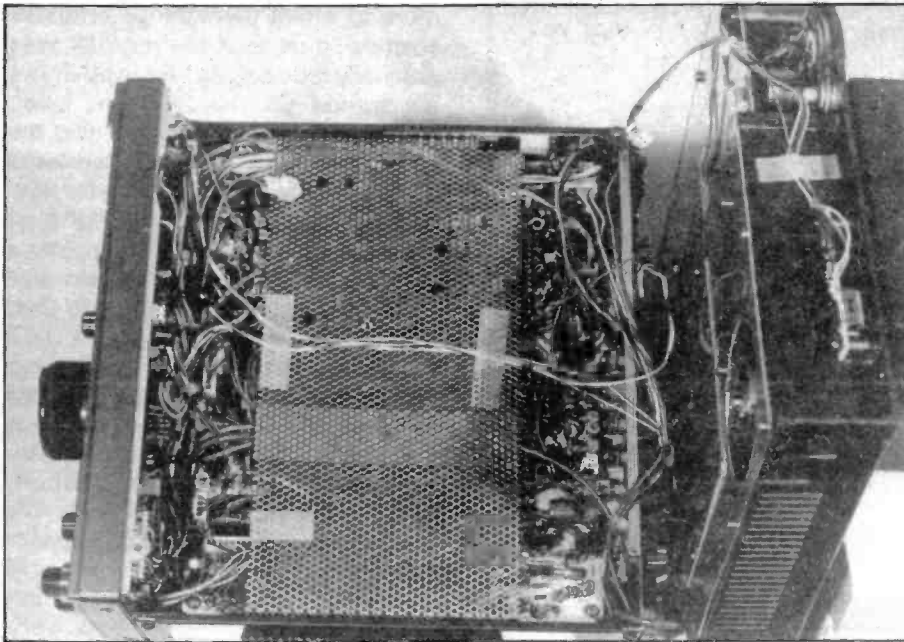

Inside the Technology of Today! (PA, fan and speaker assembly shown on RHS)

ching sequence. I would have preferred around 8dB more IF gain, providing that this did not compromise any other areas, and that it could be reduced again by backing-off the RF gain control. The maximum audio power available into an 8 ohm load was quite adequate for normal use, and product detector distortion was as low as I have measured for a long time, which explained the very 'clean' audio quality. Distortion on NBFM though was on the high side, even with only 2kHz deviation at a 1kHz rate. The FM 'capture ratio' was very good indeed, but this is in fact typical for a wide FM filter. We checked the audio quieting at the RF level, which gave 12dB sinad, and the marginal improvement in capture ratio to 13.5dB is a further indicator that the FM filter bandwidth is too wide. Squelch sensitivity could be set to open over a range from -121dBm to -104dBm (0.2uV to 1.4uV). Received frequency accuracy on SSB was only fairly good showing the internal crystal standard to be a little off on Rx, but transmit CW accuracy was a lot better.

### Perfect Responses

If you examine the pen charts of the receive responses on SSB and on FM you will see the well-nigh ideal plots. Note that for SSB the generator offset was changed under programme control with the generator set to give a very high RF level, way above S9, with fast AGC so that we were able to see the response from the product detector onwards.

CW and SSB transmitted powers were all at around 110W. Slightly more power was available on 15m, whilst FM power was again similar to CW power. Minimum RF power was around 0.3W. Peak FM deviation, set internally, was 6.5kHz which is really too high. Residual carrier noise, including carrier breakthrough on SSB, was way down at around 50dB below full output. The FM transmitted response from mic socket input to carrier output was checked with 750uS de-emphasis switched-in on the Marconi 2305 automatic modulation test meter. The response can be seen to roll off gently below 300Hz, but extends upwards to only 5dB down at 5kHz. This is too wide for normal channel spacing, which explains the somewhat high maximum peak deviation. I would have preferred to see at least 12dB per octave roll

off above 3kHz. You could almost say that the transmitted quality, when auditioned on a wide-band FM receiver would be *too* hi-fi rather than lo fo! This could cause 'spitch' interference to someone using an adjacent channel, so be careful if you are using the rig on FM.

No frequency drift problems were noted in the laboratory tests, or when operating the rig. The worst RF harmonics were produced from the 10MHz band and even these were well below -50dB ref full fundamental output. On the 24MHz band the rig produced some strange sidebands, however, at -45dB at around +/- 2.5MHz spacing which is worthy of note, although it should not cause any trouble. Other bands were generally better than -60dB for harmonic distortion. RFIM tests showed that the rig indeed transmits reasonably clean signals, and I have no criticism at all from anyone about the transmitted signal 'spreading'.

### Summing Up

For its price, I feel this rig is *extremely* good value for money? for, the receive performance is generally better than average, and the facilities very useful and in no way confusing. The rig was simple to operate, and gave me a lot of pleasure. Yaesu have paid a lot of attention to good audio quality on both the receiver and the transmitter sections which certainly goes down well with me as I am rather fussy about audio! I was fascinated to see the excellent interfacing facilities which allow this rig to be used with a very wide range of external equipment. I have no doubt that the FT757 is one of the most useful rigs to have been marketed for HF in quite a time,

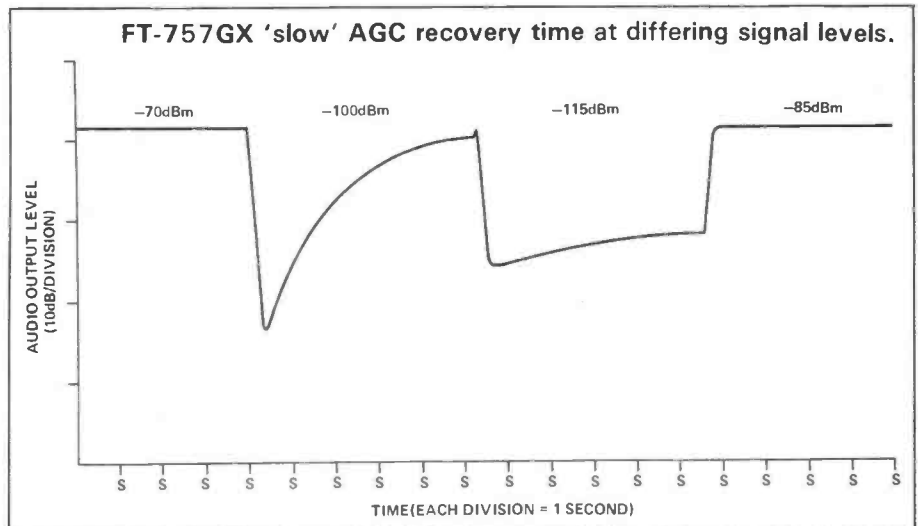



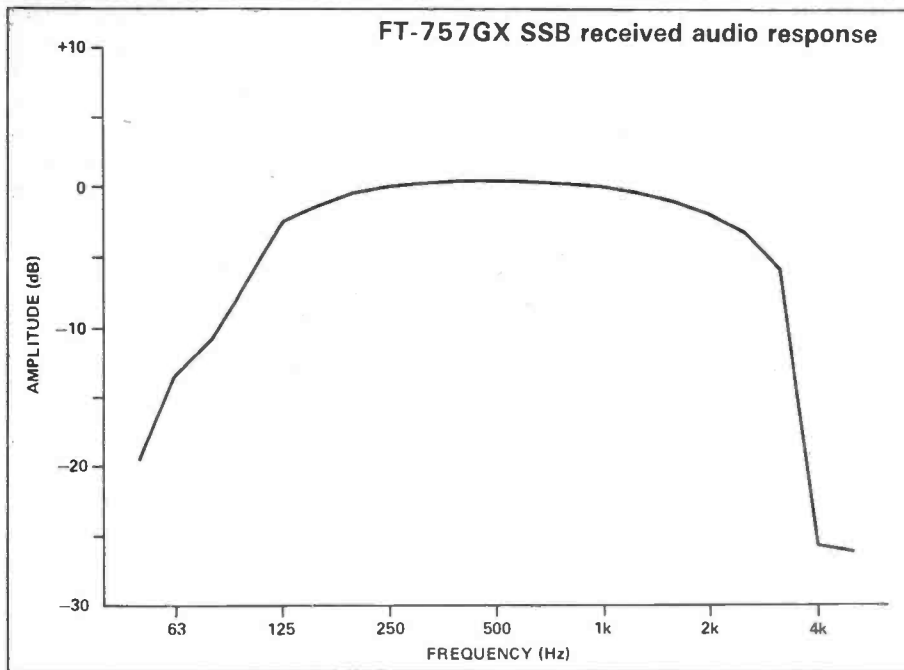

and it is going to give its competitors quite stiff competition. I particularly like the general coverage receiving facility, and there is much of interest to be heard on the short wave bands — which are missing from most amateur radio rigs. Many users of the latter may make an excuse by saying they are not interested in listening to 'broadcast propaganda' but many hours' perusal of short wavebands kept my interest going over the Christmas period. It's rather too easy to say that you don't want short wave reception if you haven't got it, and I am convinced that the FT757, in offering general coverage, is that much more of a good buy. Thinking of it another way, many greatly inferior general coverage receivers cost around a half of the total cost of this rig, and a few receivers with comparable but not superior performance cost a lot more!

### The FT101B And FT757 Compared

The Editor thought that it would be an interesting idea for us to look at a veteran FT101B to see in what areas a good modern rig such as the 757 shows superiority. One of *Ham Radio Today's* most enthusiastic readers, Alan Holmes, G4CRW, kindly loaned us his old 101B to measure. Let's have a look at the differences, some of which are very surprising. RF sensitivity on SSB was around 6dB worse on the 101B, and so the FT757 would show a very considerable improvement in 10m recep-

tion capability when the band is 'dying out'. This amount of gain can easily make the difference between making and not making a QSO. The sensitivity of the 101B was far worse on 160m, but this is irrelevant for normal purposes as you don't need much sensitivity on the lower frequency bands. We looked at the RFIM performance on 40m and measured an RF intercept point at  $-16\text{dBm}$  which I consider appalling. I found that I had to put the attenuator in to get rid of IM products on 40m when propagation was at peak in the evenings, but this reduced the sensitivity too much for

clear reception of very weak DX, which was *so much* better on the 757. RFIM on 10m was 1dB worse, but this is not so bad in practice, particularly as now we are entering the minimum sunspot activity period and strong signals on 'ten' will be pretty rare. Reciprocal mixing at 20kHz spacing was actually 11dB better on the 101B than on the 757, which is fascinating, but there was hardly any improvement further out beyond 50kHz, which was itself still 10dB better on the 101B. At 100kHz spacing the 101B gave a ratio of 110dB to noise, whilst the 757 had improved to 108dB, thus in the same ball park. At 200kHz the 757 was actually some 5dB better than the 101B.

### Dreadful Distortion?

SSB selectivity for a 3dB bandwidth was marginally wider on the 101B. The 60dB selectivity was only marginally wider again, thus the shape-factor of the 101B came out as *identical* to that of the 757. Product detector distortion on the 101B was dreadful at 4.5% at an output of 125mW as compared with the 757's 0.6%! The 101B gave less audio output for 10% distortion, although it was adequate. The 101B's S meter was very poor indeed, for whilst S9 required 90uV, S1 was given by around 6uV, only 23dB lower! The meter got stuck at "9+40", and despite pushing the rig like mad, we couldn't get it any higher! As ex-

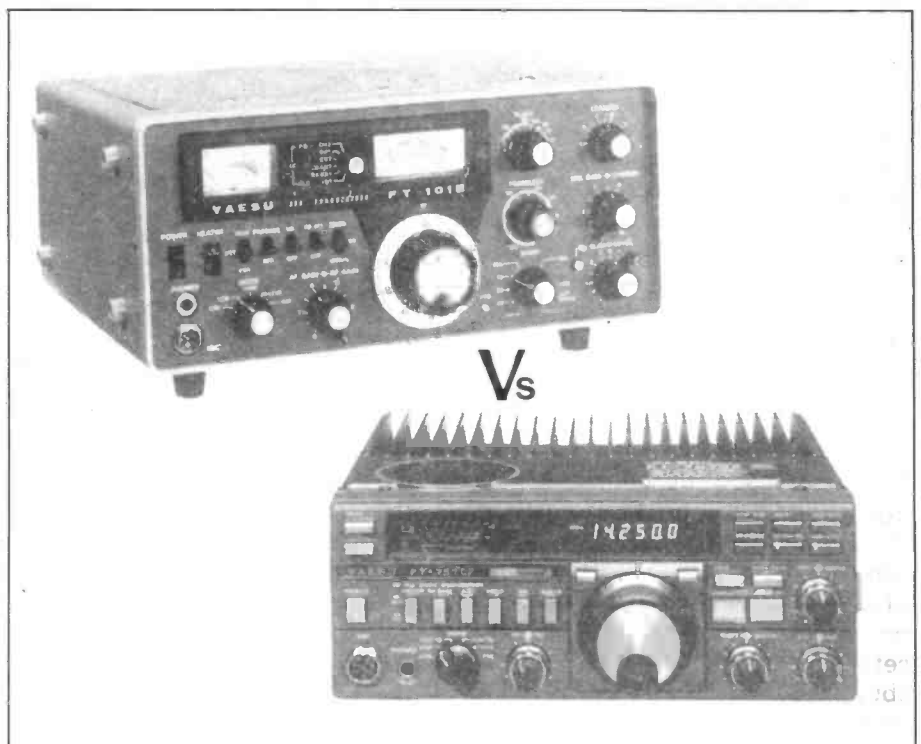

pected, the AGC charts showed a great lack of IF gain, so you had to alter the audio gain control up and down like a yoyo whilst scanning for average signal strength stations on HF unless the band was wide open. AGC speed was reasonable enough on the 101B, but it could not be switched to fast. We looked at the audio output levels for RF input levels, and a 2.2uV input signal produced 14dB less audio than a rather stronger one. The SSB audio pass band was reasonable enough, but was not so well shaped as that of the 757.

### An Unpleasant Experience

After testing so many modern rigs, I found listening to the 101B a rather unpleasant experience, audio distortion on the majority of signals being so great as to be fatiguing. I used to own a 101B a very long time ago, and it's fascinating that the immediate comparison has made the 101B rather worse than I had remembered. It is strange how slow but steady improvements in receiver design are not so immediately noticeable, and it is only by comparing two such rigs as the 101B and the 757 that one can realise how astonishingly good a modern rig can be in comparison. If we look at the cost versus inflation, we can see that the modern rig is not only cheaper but incorporates far more facilities in around half the size!

### Recapping

Recapping on the technical differences; front ends have clearly improved dramatically with better RF sensitivity and greatly improved intermodulation performance of mixers, together with the realisation by the Japanese designers that higher quality audio helps a rig sound a lot better. Particularly fascinating, though, was the fact that the old rig had a quieter local oscillator, although reciprocal mixing further out from the carrier becomes better on the modern rig due to the effects of 'blocking' in the old equipment, and the presence of poorer noise floors. Filters are not that much better now than they used to be on SSB, although some modern filters are superb and cost less than they used to, *relatively* speaking. Some of the switches on the old 101B needed some cleaning to remove intermitancies, and the RF attenuator switch was in a particularly bad state. Fixing



The styling of the FC-757AT matches the FT-757GX

these didn't take long and we did this before taking any measurements.

### The FC757AT Accessory Automatic Aerial Tuning Unit

At the time that SMC supplied the review sample of FT757, they did not have any stock of the ATUs, and so, very kindly, Amcomm in Harrow lent me one of their stock ones for appraisal to enable this review to be more complete – as the ATU is especially intended for auto use with the FT757. The FC757AT interconnects with the main rig with a special lead which enables band switching data from the rig to control the ATU and also provide 13.5V DC for operating the ATU. It has an SO239 for interconnection with the transmitter, and two SO239s for feeding two

separate antennas. A built-in 50 ohm dummy load is provided – which can take up to 100W for short periods – to assist tuning up measurements. On the front panel are switches to select ATU 'in' or 'out', dummy load or antennas, power out/return, and an SWR indication which is automatic, not requiring forward FSD to be set. Power ranges of 15W and 150W are provided. It is emphasised that this ATU is *not suitable* at all for use with a linear presenting more than 150W to it, and this is an annoying disadvantage.

Press buttons on the ATU front panel select not only which antenna of the two is to be fed, but can also energise any of four alternative terminals controlling an 'optional extra' aerial coaxial switch which can be driven by one of the output sockets. Once an appropriate antenna has

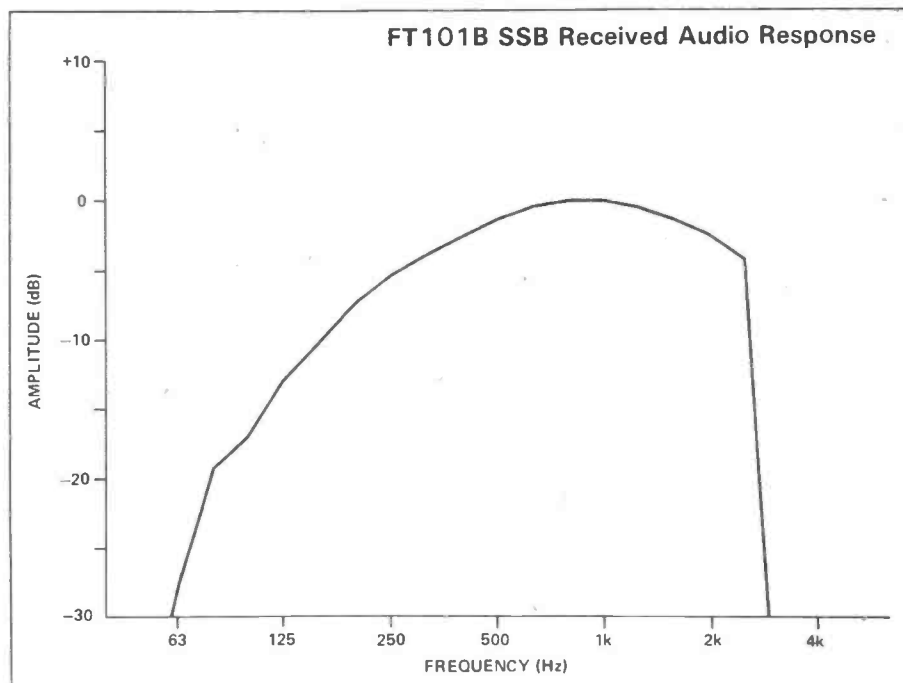

been selected for each band, the ATU automatically selects it when the main rig is tuned to that band. At any time though, the automatic choice can be overridden, which is very useful. When tuned to any particular band, the ATU can be tuned manually, or it will itself tune up on that band, usually to an SWR better than 1.2:1, but in extreme circumstances, at the bottom and top ends of 160m for example, it cannot achieve better than 1.5:1. A problem is that it can take between 5 and 20 seconds to set up automatically and 20 seconds is a long time when you hear that juicy piece of DX calling "QRZ"! (*I wish I could tune my 'Z' Match in 5 seconds - Ed*) A sensitivity control can be set to make the auto circuits more or less sensitive, since sometimes you may not wish it to retune again and again with every small change in rig frequency. When you switch to a new band, you automatically get the ATU tuned up in the position remembered as being last used, the memory having a back-up source for this. The ATU can also be used directly with the FT980, and with other rigs provided you feed it with 13.5V, and also manually change bands.\*

### Slow On The Draw?

Two rotary controls are provided to vary DC levels to the motors controlling the capacitors, whereas the band change switches operate selectors to choose the appropriate coil winding. Two inductance settings are provided for 160m to give the best match. In general use I found the unit worked very well, but I was irritated by its slowness in automatic tuning, especially as I have become used to the incredibly fast Icom alternative, the AT500 which sets up in an average of 1.5 seconds, and which can take up to 1kW throughput. The Icom, however, does not have any manual override functions on the front panel, apart from ATU bypass, and does not allow you to switch antennas (other than automatically), which is a nuisance. I highly recommend the FC757AT for use with the main rig, and its price of £230 seems very reasonable, especially considering that it has a built-in power/SWR meter.

\*The FC757AT can be used automatically with the FT980 providing the two are interconnected with the D1004 lead - priced at £25.70!

## YAESU FT-757GX LABORATORY RESULTS

### Receiver Measurements

#### Sensitivity for 12dB Sinad, FM (1kHz modulation, 4kHz deviation)

1.95 MHz	- 118.5 dBm
3.65 MHz	- 118.5 dBm
7.05 MHz	- 119.5 dBm
14.05 MHz	- 120.5 dBm
21.25 MHz	- 116.5 dBm
29.60 MHz	- 116.0 dBm

#### Sensitivity for 12dB Sinad, USB (1kHz beat note)

1.95 MHz	- 122.5 dBm
3.65 MHz	- 122.5 dBm
7.05 MHz	- 123.5 dBm
14.05 MHz	- 122.0 dBm
21.25 MHz	- 121.0 dBm
28.40 MHz	- 122.0 dBm

#### Sensitivity for 10dB Signal/Noise, AM (90% mod.) - 114.5 dBm

#### Sensitivity for 10dB Signal/Noise, CW Wide - 126.0 dBm

#### Sensitivity for 10dB Signal/Noise, CW Narrow - 130.0 dBm

#### Selectivity, FM

-/+ 12.5kHz spacing	61.8/30 dB
-/+ 25.0kHz spacing	66.0/58.5 dB

#### Selectivity, USB

3 dB Bandwidth	2.2 kHz
6 dB Bandwidth	2.5 kHz
40 dB Bandwidth	3.3 kHz
60 dB Bandwidth	3.6 kHz
80 dB Bandwidth	11.6 kHz

#### Selectivity, CW

	Narrow
3 dB Bandwidth	0.5 kHz
6 dB Bandwidth	0.7 kHz
60 dB Bandwidth	2.9 kHz
80 dB Bandwidth	3.5 kHz

#### SSB Shape Factor

1.6

#### RFIM Ratio (3rd order intermod, to give 12dB Sinad), FM

25/50 kHz spacing	88.9 dB
50/100 kHz spacing	84.1 dB

#### RFIM Ratio (3rd order intermod to give S5 product), USB

20/40 kHz spacing	54 dB
60/120 kHz spacing	61.5 dB

#### Calculated RF intercept point

0 - 10 dBm  
(see text)

#### Reciprocal Mixing performance, FM and USB

Spacing	Reciprocal Mixing Ratios (ref. noise floor)	
	FM	USB
20 kHz	85 dB	88 dB
50 kHz	87 dB	101 dB
100 kHz	99 dB	110 dB
200 kHz	102 dB	116 dB

Audio Quieting, FM ( 12dB Sinad) - 13.4 dB

Capture Ratio 5.8 dB

3dB Limiting point, FM - 113.4 dB

**S Meter Readings; RF Levels Required**

S Point	FM	USB
1	-102 dBm	-101 dBm
3	-90.5 dBm	-89.0 dBm
5	-81.0 dBm	-80.0 dBm
7	-73.5 dBm	-73.0 dBm
9	-66.0 dBm	-65.0 dBm
9+20	-56.0 dBm	-55.0 dBm
9+40	-40.0 dBm	-38.0 dBm
9+60	-22.0 dBm	-21.0 dBm

Maximum Audio output power into 8 ohms (10% THD) 2.7 Watts

**Distortion, FM at 125mW into 8 ohms**

2kHz deviation	2.7%
3kHz deviation	4.0%
4kHz deviation	5.2%

Product Detector Distortion, USB (- 80 dBm) 0.6%

**Squelch Sensitivities, FM**

Minimum	-104 dBm
Maximum	-121 dBm

**Transmitter Measurements**

Output Powers	FM	CW	SSB (PEP)
1.81 MHz	114W	114W	115W
3.75 MHz	108W	107W	110W
7.05 MHz	109W	108W	110W
10.1 MHz	110W	110W	115W
14.3 MHz	110W	110W	115W
18.1 MHz	110W	112W	115W
21.3 MHz	115W	115W	120W
24.8 MHz	114W	110W	115W
29.6 MHz	111W	110W	110W

Transmitted Carrier Accuracy, FM + 1kHz

Peak Deviation, FM 6.5 kHz

Residual Carrier and Noise, SSB - 50 dB ref. full output power

**YAESU FT-101B  
LABORATORY MEASUREMENTS**

**Receiver Measurements**

**Sensitivity for 12dB Sinad, SSB**

1.9 MHz	-110 dBm
3.5 MHz	-114 dBm
7.05 MHz	-112 dBm
14.2 MHz	-121 dBm
21.3 MHz	-116.5 dBm
28.4 MHz	-117 dBm
29.4 MHz	-116 dBm

**Selectivity, CW and SSB**

SSB Shape Factor	1.4:1	
	SSB	CW
3dB Bandwidth	2.4 kHz	0.7 kHz
6dB Bandwidth	2.5 kHz	0.8 kHz
40dB Bandwidth	3.4 kHz	1.2 kHz
60dB Bandwidth	3.8 kHz	1.4 kHz

**RFIM Performance, SSB (For 12dB Sinad RFIM Product)**

7.02 MHz	Spacing	Ratio
	20/40 kHz	64dB
	50/100 kHz	66dB
100/200 kHz	68dB	
Calculated RF intercept point		-16dBm
28.4 MHz	20/40 kHz	67dB
	50/100 kHz	69dB
	100/200 kHz	68dB

Calculated RF intercept point - 17dBm

**Reciprocal Mixing Performance, SSB**

Spacing	Reciprocal Mixing Ratios (ref noise floor)
20 kHz	99 dB
50 kHz	109 dB
100 kHz	110 dB
200 kHz	110 dB

**S Meter; RF Levels required for the following S points**

1	-91 dBm
3	-85 dBm
5	-81 dBm
7	-75 dBm
9	-68 dBm
9+20	-45 dBm
9+40	-28 dBm
9+60	Not Attainable

Product Detector Distortion (- 80 dBm) 4.5%

Maximum Audio output for 10% THD (8 ohms) 2.1 Watts

Audio distortion at 125mW (8 ohms) 4.5%



# WPO COMMUNICATIONS

## NEW 160-15M QRP TRANSCEIVERS

FOLLOWING THE GREAT SUCCESS OF OUR DSB80 AND DSB 160 PROJECTS, WE NOW INTRODUCE THE DSB2 RANGE OF QRP HF SINGLE BAND TRANSCEIVERS — TRY ONE FROM THE HF SPECIALISTS.

A new range of rigs in build-it-yourself form incorporating refinements and additions over the DSB80. Now available for any individual band from 160M through to 15 metres (including WARC bands). Utilises the MINISYNTH simple PLL VFO (available separately) for complete coverage of each band. Features include semi break-in keying (relay controlled), 2 watts min. CW or DSB out, on-board active filter, bombproof VMOs PA, +12v operation, mic gain control, sidetone for CW (via VFO), and on-board provision for a digital readout for any of the bands. The sensitivity on receive is more than adequate for general communications, with high dynamic range, utilising an encapsulated double balanced mixer at the RF input.

THIS PROJECT IS IDEAL FOR BEGINNERS or QRP enthusiasts, and comes complete with comprehensive instructions/drawings, and typical voltages. The DSB2 Kit comes complete with all components, pcb (drilled and tinned) with component positions screened on, and connecting wire. The pcb alone is available if the complete kit is not wanted. You will need a microphone, key, antenna and power supply (+12v @800mA) to get you on the air. WE ALSO HAVE A CASE, drilled and punched but plain aluminium panels for your own finish. It comes complete with hardware (connectors, knobs, sockets, brackets, dial plate, nuts/bolts etc).

PRICES:	BASIC DSB2 Kit (no VFO)	£42.00
	DSB2 Kit with MINISYNTH VFO	£68.00
	Drilled case with hardware	£23.35
	DSB2 + VFO + Case	£89.50
	Digital Display Kit (160/80M)	£24.10
	Digital Display Kit (40 - 15M)	£30.00
	DSB2 PCB Only inc instructions	£ 7.50

PLEASE STATE BAND REQUIRED i.e. DSB2/160 (or 80/40/30/20/17/15M).

## NEW MINIATURE PLL VFO KIT

AT LAST — A VFO IN KIT FORM! Developed from the PROJECT OMEGA VFO, this miniature PLL SYNTHESISED VFO will cover any one single Amateur Band from 160M through to 10 metres (28-28.6). It is available for direct conversion designs (i.e. output at signal frequency), or for 10.7MHz/9MHz i.f.'s. We also have a version for 5-5.5MHz for FT101's etc (built that long awaited outboard VFO). Size is 100 x 56mm on one pcb. Sidetone generator, offset circuit (for direct conversion CW use) and high stability come with this design, and the output is sufficient to drive a double balanced mixer.

The Kit comes with all components, VFO capacitor and reduction drive, pcb (drilled, tinned and screened layout), connecting wire and comprehensive instructions, and should be constructable by almost anyone.

PRICE: Kit £29.70. PLEASE STATE THE BAND and i.f. required i.e. Mnisynth 80/10.7 or MINISYNTH/5 for the 5-5.5MHz version. PCB alone is £5.60 inc instructions. COMING SOON — a 2 metre version with digital readout.

ALL OTHER KITS ARE STILL AVAILABLE including the original DSB80 or DSB160 at £37.45 (case and display same prices as for DSB2). We have QRP Transceivers to get you on HF Tx/Rx from 2 metres, 2 metre FM transceivers, 6 metre converter, an HF ATU Kit, and PROJECT OMEGA — a major 9 band High Performance HF Transceiver being published, and now nearing completion. Full illustrated catalogue 50p in stamps or Short Form for s.a.e. Lots more interesting projects on the way.

ALL prices include VAT. Post free over £10 — add 60p below. Most items ex-stock but allow 10-28 days if not. Post Office C/D over £30. Telephone Mon-Fri, 10am-4pm. MAIL ORDER only or AGENTS Amateur Radio Exchange.

### STOCK CRYSTALS

### QUARTZ CRYSTALS

### MADE TO ORDER CRYSTALS

CRYSTALS FOR 2 METRES  
£1.00 FOR ONE CRYSTAL  
TX CRYSTALS

HC6/U	4 & 8MHz 30PF
HC25/U	12MHz 30 & 40PF
HC25/U	18MHz 25 & 20PF

RX CRYSTALS

44MHz SERIES RES
44MHz SERIES RES
14/15MHz 20 & 30PF

£1.74 WHEN 2 OR MORE PURCHASED  
CHANNELS IN STOCK

RO TO R7	S11, S20 TO S23
RO TO R7	S8, TO S23
RO TO R7	S8, TO S23

4 METRE CRYSTALS FOR 70.25 IN HC8/U AT £2.25 each

TX 6.78250 RX 29.78000 6.74666

700CM CRYSTALS £3.00/pr or £2.50 each

For Pye PF1 PF2 & PF70 series. Also Wood & Douglas

SUB(433.2) RB0 RB2 RB4 RB6 RB10 RB11 RB13 RB14 RB15.

Also for MULTI U11 - SU12, SU16, SU18, and SU20.

CONVERTER CRYSTALS IN HC18/U AT £2.85 each.

22,000, 38,666, 70,000, 96,000, 116,000, 101,500, 116,000

FREQUENCY STANDARDS £2.75 each

HC6/U	200kHz	455kHz	1000kHz	3.50MHz	5.00MHz	10.00MHz	10.700MHz
HC18/U	1000kHz	7.00MHz	10.70MHz	48.00MHz	100.00MHz		

TO NEBURST, I.F. & MPU CRYSTALS IN HC18 £2.25 EACH

7.150MHz (For 1750 Hz Tone) 10.245 (for 10.7 I.F.)

3.2768 5.06888

YAESU CRYSTALS for FT101s FT901 & etc £4.00 each

Many available ex stock (A list is available on request please send S.A.E.)

A stamped addressed envelope with ALL enquiries please



**QuartzLab**

MARKETING LTD.

P.O. Box 19  
Erith Kent DA8 1LH

FUNDAMENTALS

FREQUENCY RANGE

6 TO 30kHz	£23.00
30 TO 80kHz	£16.00
80 TO 159kHz	£10.90
160 TO 999kHz	£7.00
1 TD 1-5MHz	£10.76
1.5 TO 2.5MHz	£5.00
2.5 TO 4.0MHz	£4.76
4 TO 21MHz	£4.55
21 TO 25MHz	£8.50
25 TO 30MHz	£8.50

MADE TO ORDER CRYSTALS

PRICE

3rd OVT	21.00 TO 65.00MHz	£15.00
5th OVT	60.00 TO 110.00MHz	£16.00
5th OVT	110.00 TO 125.00MHz	£16.00
5th, 7th & 9th OVT	125.00 TO 150.00MHz	£16.00
5th, 7th & 9th OVT	150.00 TO 250.00MHz	£16.00

OVERTONES

FREQUENCY RANGE

2.0 TO 125.0MHz	2 TO 3 weeks
1.0 TO 2.5MHz	3 TO 4 weeks
Other frequencies	6 to 8 weeks

PRICE

£15
£16
£16
£16
£16

Unless otherwise requested fundamentals will be supplied for 30pf load capacitance and overtones for series resonant operation.

HOLDERS: PLEASE SPECIFY WHEN ORDERING — also HC25/U supplied for XTALS above 3MHz

HC13/U 6-200kHz HC6/U & HC33/U 170kHz-170MHz HC18/U & HC25/U 2-250MHz

DISCOUNTS: Price on application for 10+ units to same frequency/spec. or bulk purchase of mixed frequencies. We supply xtals for use in U.K. repeaters.

COMMERCIAL CRYSTALS: available on fast delivery and at competitive prices.

Please send for list stating interests

EMERGENCY SERVICE: for XTALS 1 to 125MHz. Add the surcharge for each XTAL. Days refer to working days.

4 days + £12, 6 days + £7, 8 days + £5, 13 days + £3.

CRYSTAL SOCKETS HC6 & HC25 £0.20 each. MINIMUM ORDER CHARGE £1.50

TERMS: Cash with order post inc. to U.K. & Ireland. Cheques & P.O.'s to QSL LTD.

ALL PRICES ARE EX VAT PLEASE ADD 15%

Telephone: 01-690 4889 24Hr Answerphone: Erith (03224) 30830  
Telex: 8813271 GECOMS-G (Attention QUARTSLAB)

## H.R.T. Advertisers Index, May 1984

Amcomm	49
Arrow Electronics	OBC
ASP Software	44
Bi-pak	43
B.N.R.&E.S.	27
Booth Holdings	27
Bredhurst Electronics	27
Commutech	IBC
C.Q. Centre	18

Gamma Aerial Products	49
International FM Guide	49
Photo Acoustics	20
Quartzlab Marketing	59
Scarab Systems	IBC
Western Electronics	IFC
Wood & Douglas	IBC
W.P.O. Communications	59

# Practicalities

Amateur radio can be a very expensive hobby if everything is bought from the local shop. Whilst I have no axe to grind about black boxes, I do find that it helps relations with the bank manager if my radio costs are kept down. The first section this month is about the proper use of NiCads so as to get the maximum of life out of them, and the second describes the construction of a simple but effective TV high pass filter which can be built very cheaply avoiding the purchase of a ready made unit.

*This month Ian Poole, G3YWX, tells how to get the best out of your NiCads and describes a sure-fire way to stop TVI.*

## Use and Abuse of NiCads

Looking through the advertisements in the magazines and listening 'on-the-air' one cannot help but realise that there is a lot of portable equipment being used, especially on 2 metres and 70 centimetres. Most of this equipment will be powered from the popular Nickel-Cadmium *rechargeable* batteries as they are the most economical source of power. It is, however, quite easy to shorten the life of these batteries by not looking after them properly, and replacements are rather expensive. With this in mind, I thought that a few hints and tips on battery care would not go amiss.

The factor that we are most interested in for a battery is the length of life before it is 'worn out'. This is dependent on several factors in the case of NiCads,

most of which are governed by the way it is used and recharged. A battery or cell which is used normally will have a useful life, ie a life where its actual maximum charge is over half its rated maximum charge, of several years or several hundred charge/recharge cycles. The life of a battery is normally limited by temperature conditions or overcharging or a combination of both of these factors. With regard to temperature, the performance of a battery will be degraded especially by high temperatures, but low ones are also harmful. In fact the NiCad will perform at its best around 'room temperature' and will last longest at these temperatures. Most failures in NiCads probably result from incorrectly charging the batteries, and the manufacturer's instructions regarding charging should be followed carefully. Excessive charge rates will soon lead to a degradation in performance. Lower charge rates will not damage the battery but the NiCads will obviously take longer to charge which, in the case of a portable rig you wish to use fairly often, is somewhat inconvenient. There are two categories of overcharging, both of which degrade the performance to differing extents. The first is a slight but prolonged overcharge which manifests itself (after charging has finished) by the output voltage being lower than normal. This fortunately can be rectified considerably by giving the battery a deep *discharge*, but will still result in a small amount of permanent damage (ie shortening of battery life). The other form of overcharge damage occurs when the amount is excessive, and the temperature of the NiCad rises and gases are produced — which escape through a vent provided on the battery to prevent excessive pressures

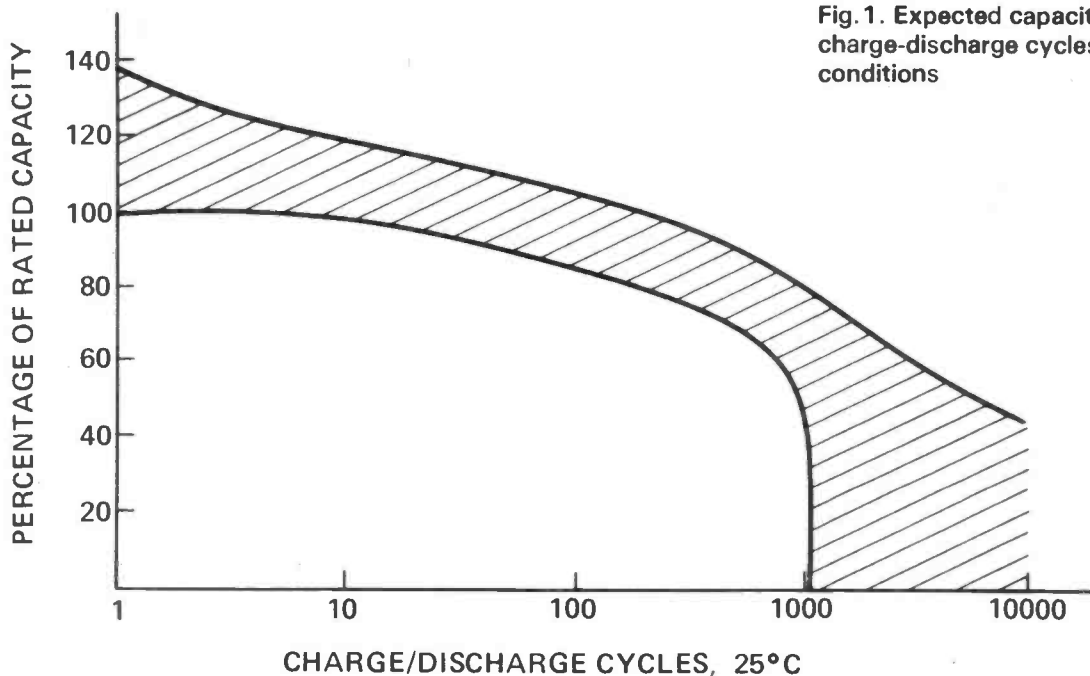

Fig. 1. Expected capacity against charge-discharge cycles under good conditions

being built up. The amount of active 'chemicals' within the NiCad is reduced by the overheating and accordingly the amount of charge the battery can store is also reduced.

One of the best ways to overcome this problem is to use a charger with a timer and then only to give a full charge when the battery is in a fairly low state of charge. When charging a set of cells it is perfectly permissible to charge them in series as the charging is dependent on the amount of current passing through the cell, and this has to be the same for each cell, and hence each cell will receive the same amount of charge. *Cells should not however be charged in parallel* as their characteristics will be different and each cell will pass a different amount of current which could mean one cell will be overcharged whilst the other is undercharged. Conversely, if some cells need a deep discharge they should not be discharged in series as each cell will hold a different amount of charge. As the whole 'battery' nears discharge, some cells will have no charge left at all whilst others will still be quite well charged. This will mean that the cells with no, or least, charge will become *reverse charged* which will lead to damage of the cell because in this condition gases are also released.

One interesting effect, first detected in the NiCad battery packs used in space craft, was what is known as the "memory effect". This occurs when the cell is *repeatedly partially discharged*. The cell appears to memorise the amount of charge which has been normally drawn; after this point of partial discharge has been reached the voltage drops. This effect can be overcome by giving the cell or battery a deep discharge.

If a cell or battery is going to be stored for any length of time without any use then it should be stored in a charged state to prevent the formation of internal short circuits. If this precaution is taken nicads should last for a considerable time if they are not used.

### Simple High Pass TV Filter

Now that the vast majority of people watch TV on UHF television, interference is not as widespread as it used to be when the second and third harmonics of some of the HF amateur bands fell right into the centre of the lower and most widely used channels. However this does not mean to say that TVI does not exist any more — especially if one lives in a built-up area with transmitting aerials fairly close to the house. My own aerial is just a lowly longwire, and as this has an unbalanced feed it is more prone to causing TVI. Very often the interference is not the result of harmonics from the transmitter but is caused by the input of the television becoming overloaded with the *very strong* local amateur transmissions. Fortunately when the TVI did occur, it was in my house and I was able to cure it with a simple high pass filter as shown in Fig.3. This can either be mounted into a small box and connected between the aerial and the TV set or, as in my case, mounted directly onto the input of the tuner — inside the television itself. The coils consisted of three turns of 20 swg tinned copper wire air spaced with a 1/4 inch internal diameter and wound over a length of 3/8 inch. One does have to be careful when adopting the latter approach because it may void any warranty arrangements or service contracts on the TV! It does have the advantage though that there are no untidy boxes

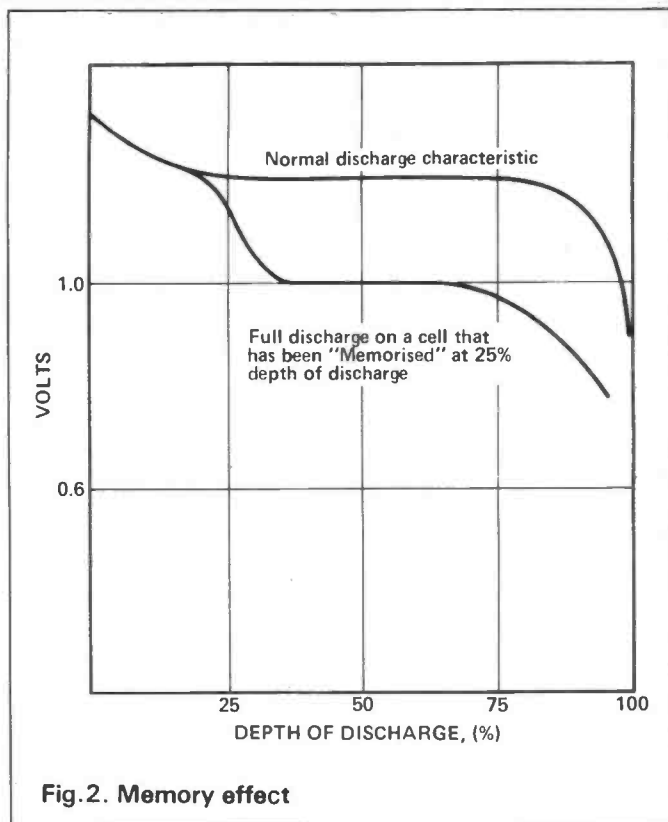

Fig.2. Memory effect

hanging down from the back of the television and there is no metalwork to be done in making a suitable box.

The commercial boxes suitable for this type of project are rather expensive for what they are (and not too easy to come by). Old tobacco tins can be used — provided that one does not mind 'Old Holborn' or the like being advertised at the rear of the television!

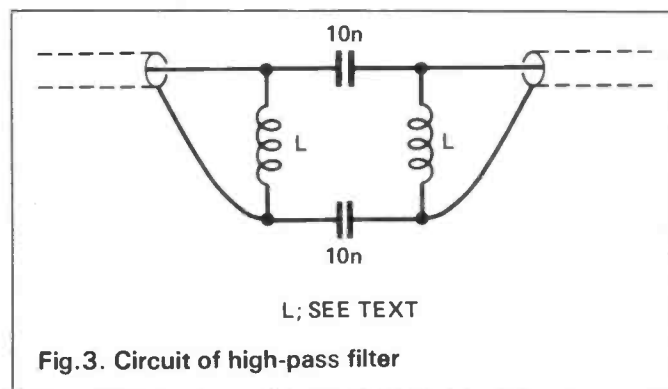
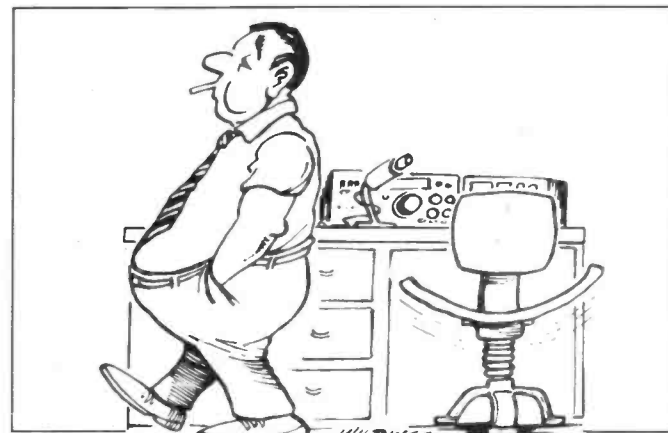

Fig.3. Circuit of high-pass filter



# REVIEW:

# Sampson ETM5C

# Electronic Key

Despite the fact that many people think that CW is an outdated or dead mode of operation, it is still widely used in both amateur and commercial circles. Accordingly, there is a reasonable selection of operating aids which, although not as wide as for phone operation, still provides the prospective buyer with a fair choice.

Probably one of the more useful aids is an electronic keyer, which although not essential, provides several benefits over both 'straight' or mechanical semi-automatic 'bug' keys. One of the improvements is the greater ease of operation, especially at speed or which operating for long periods. Keyers can also give improvements in the quality of the morse sent because a fixed mark-to-space ratio is more easily and accurately maintained which tends to give a signal which is easier to read. This can be of great importance when chasing DX through a pile-up — where the easiest signal to be pulled out of the pile may not necessarily be the strongest. It can also be of great benefit when 'chatting' on CW where a well proportioned signal will considerably reduce operator strain.

The keyer under review here — a Samson ETM5C — has just recently been introduced onto the market. It is imported from Germany by Spacemark Ltd. of Altrincham who have been marketing Samson Keyers for nearly 20 years. The predecessor to the ETM5C was the ETM3C which bore many resemblances to the new keyer, and this was used quite widely in professional operating circles.

## Technical Description

A summary of the technical specification is given in Table 1. From this it can be seen that the

keyer provides all the facilities which would normally be required for CW operation. It does however not have a message memory, and if this is required, the ETM8C keyer can be used.

The outward appearance of the

unit is quite pleasing, the case being constructed from four aluminium extrusions mounted between the front and rear panels. The top, bottom and side panels are then mounted onto these extrusions. One feature of the case which seem very well thought out was that the bottom panel required the simple removal of one knurled screw, which can be accomplished without any tools. Sliding the bottom panel out of the extrusion conveniently reveals the keying mechanism (enabling minor ad-

justments to be easily made), the component side of the circuit board and the battery pack. The paddle 'travel' is adjusted by a knurled screw for each paddle and the 'tension' by an allen screw — for which an allen key is provided.

*Ian Poole, G3YWX, tries out the latest in the line of keyers from Samson and offers some observations on learning to live with an 'el-bug'.*

unit is quite pleasing, the case being constructed from four aluminium extrusions mounted between the front and rear panels. The top, bottom and side panels are then mounted onto these extrusions. One feature of the case which seem very well thought out was that the bottom panel required the simple removal of one knurled screw, which can be accomplished without any tools. Sliding the bottom panel out of the extrusion conveniently reveals the keying mechanism (enabling minor ad-

The front panel is uncluttered, having the paddle mounted through it, and the speed and ratio controls mounted onto it. I felt presence of the ratio control on the panel was useful as each individual operator will be able to adjust the mark-to-space ratio (i.e. the amount of space between consecutive dots and dashes) to suit their own requirements at a particular speed — without having to adjust a pre-set control either at the back of the unit or on the circuit board (as is sometimes the case on commercial

Table 1

### ETM5C Specification

<b>Keying:</b>	instant starting; self completing dots and dashes; 'tune' button (i.e. shorts key out — necessary for tuning up with some Tx's); speed range 8-50 words per minute; adjustable dash/dot: pause ratio nominally 3:1:1; built in side-tone generator; iambic (squeeze) operation; and dash and dot memory
<b>Keyed Output:</b>	relay keying max. 250V or .5A and 25W transistor keying positive to ground, max. 65V and 100mA
<b>Power Requirements:</b>	4 size AA 1.5V batteries (built in battery holder); idling current 1. A;
<b>Dimensions and Weight:</b>	45.5 x 113 x 160 (height, width, depth); 800g (no batteries)
<b>Semiconductors:</b>	6 CMOS I.C.'s; 4 transistors and 4 diodes



keyers I have encountered — Editor). Some people may query the inclusion of a ratio control saying that a fixed ratio of 3 : 1 should be sufficient. However, I have found that at speeds above about 15 words per minute a slight modification on the ratio makes the morse sound far 'smoother', therefore making it easier to read. Normally a ratio 'elongation' of around a few percent is quite ample, and this type of control is included on most keyers.

### Inside The Box

Internally the layout is neat and uncluttered, allowing access to most of the areas required. All the integrated circuits are mounted on IC holders which, some may argue, can be a source of problems. However, in all the pieces of equipment I have designed and built, both at work and for amateur radio, I have never had any problems from IC holders. The component in a keyer, seems most prone to failure which is the relay used for keying the output, and access to this is easily gained by removing the backpanel and sliding the printed circuit board out from the extrusions. It should however be mentioned at this stage that it is unlikely that any faults will occur, even with the relay! The ETM5C, as I have said, is used by many professionals and has been found to give very reliable service under conditions of very heavy useage. Also mounted internally on the board is a slide switch to enable and disable the dot and dash memory.

The keyer circuit contains six CMOS integrated circuits and four transistors. Owing to the fact that CMOS technology has been used the quiescent current is about 1 uA which means that the keyer can be left on without running the battery down. The circuit is fairly straightforward. A clock oscillator is used to drive two divider circuits to generate the correct dot and dash ratios. The oscillator in turn is only started when one of the paddles is pressed, thus giving an instantaneous start. The output from the dividers is then passed through an inverter with a CR network to modify the pulse length to give the correct ratio. This output is then amplified to drive the keying circuit, and it also enables the sidetone

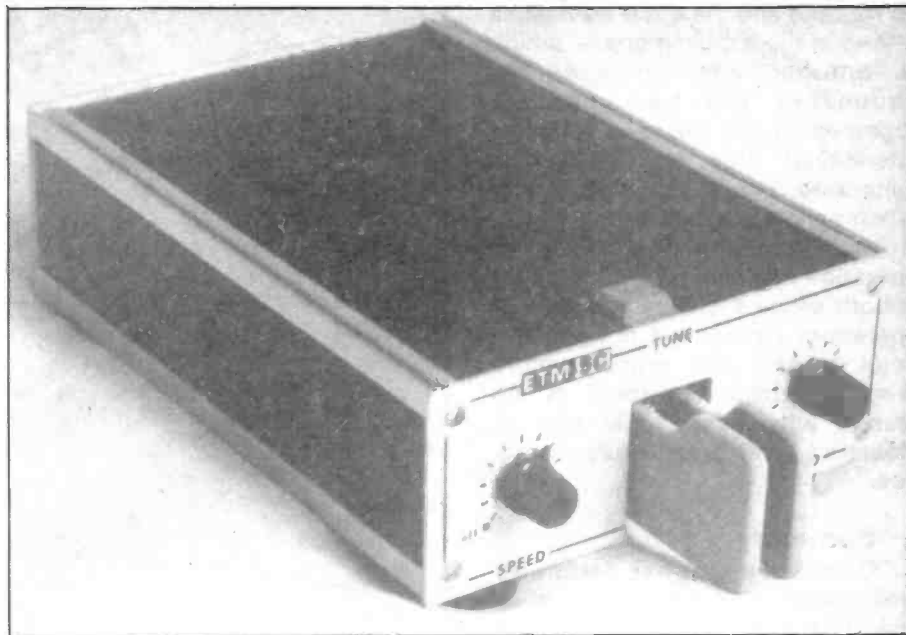

oscillator. Both the sidetone oscillator and keyed outputs are available through a DIN socket on the back panel. A DIN plug is supplied with the unit which is a nice (and convenient!) touch.

If required, a jumper on the printed circuit board can be easily altered so that the keyer output is keyed directly by a transistor.

### Handling and Operation

At this stage I thought that it would be useful to describe not only the operation of the ETM5C but also to include some comments about the handling and operation of keyers in general. To put some of these comments into perspective it is probably worth mentioning that I have used CW since obtaining my licence, with a break of a few years when HF operation was not possible because suitable HF aerials could not be erected. For most of my CW operating an Eagle mechanical semi-automatic key was used, I believe that the upshot of this is that the learning time on the ETM5C would be somewhat different to that if I had only used a straight key before.

I was very pleasantly surprised when starting to use the keyer how well it remained in place on the bench and did not slip around. From this point of view it was far superior to the much heavier mechanical key. The four fairly large rubber feet on the base plate proved to be very effective. The paddles were easily adjusted, both

for travel and tension and once this had been done its operation was pleasant.

After the keyer had been set up, some 'off air' practice seemed essential. However, after about an hour, I felt quite able to venture into the midst of the CQ World Wide DX contest — with encouraging results. Mistakes were a bit more frequent than on the old key but in view of the speeds used this was not surprising. I fairly quickly noticed that it felt easier to get through a pile up than before, owing to an improvement in the overall quality and 'regularity' of the morse being sent.

After spending more time on the key, the number of my sending errors reduced. I reckon that after a week or so of intermittent operation it should be possible for an average operator to become proficient at sending about 15 to 20 words per minute. In fact, whilst timing my sending of a set section of text I was surprised how fast I was able to operate with comparative ease. However, one point which was mentioned to me and I found to be true is that the number of sending mistakes which are made on a fully automatic keyer is *greater* than on a 'semi-automatic' or 'straight' key during times of fatigue i.e. after a couple of solid hours of contesting or rag chewing.

One facility which I have not been mentioned yet is the iambic mode of operation. The keyer can be used in the normal automatic mode — where one paddle is press-

ed for dots and the other for dashes — and in the iambic mode — which is brought into operation by squeezing the two paddles together. In this mode, a series of interleaved dots and dashes is generated. This is especially useful when sending letters such as C, L, Q etc. Although this mode of operation can give an improvement in both sending quality and ease of operation, I believe it is more difficult to use and requires more practice. However, there is no reason why this should not be mastered with a little extra practice.

### Summary

Overall the unit has performed well, been a great pleasure to operate and improved the quality of my morse sending. The keyer itself is neatly packaged and thought has obviously been put into the design so that access can easily be gained to all the necessary areas. The constructional standards is high and the keyer should provide a long and trouble free service. The cost of the unit at £69, including VAT and

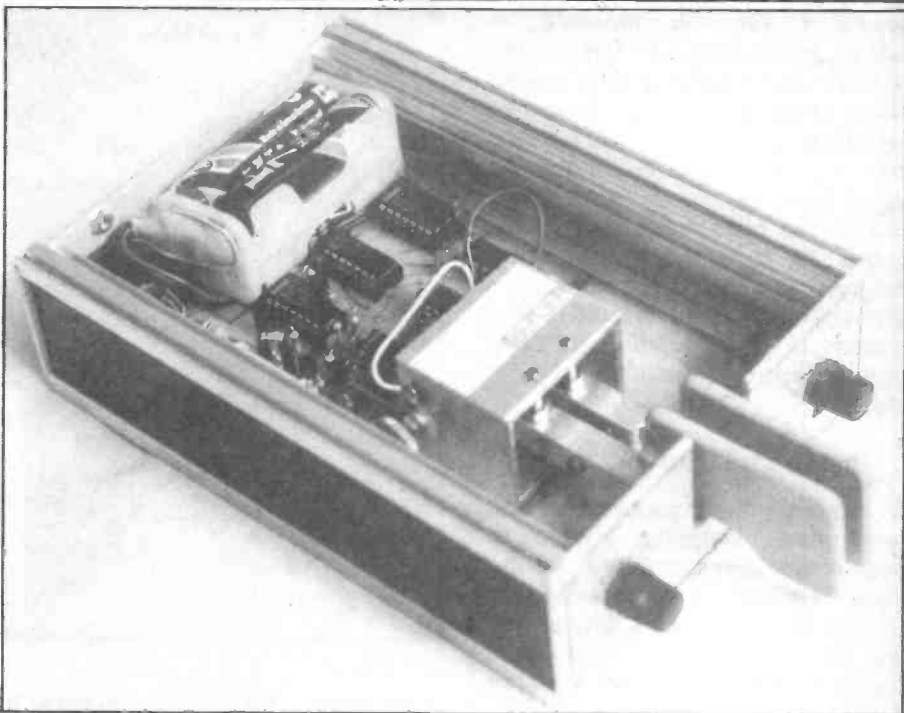

The Paddle and Circuitry are easily accessible

postage, may seem high but all the all-in-one keyers (i.e. electronics plus paddle) with a similar specification to the ETM5C cost around the same amount as this

one. The sole UK distributors are Spacemark Ltd., Thornfield House, Delamer Road, Altrincham, Cheshire. Telephone 061-928 8458.

# HAM RADIO TODAY

## NEXT MONTH

### THE CIVILISED ART OF CONTEST OPERATION

Al Slater, G3FXB, distils over 20 years of experience into this blow-by-blow guide to the philosophy and practical requirements of successful HF contesting.

PLUS

### COMPILING A PRACTICAL E-M-E STATION

CONVERT YOUR FT101 TO 'NEW BANDS', WITH HARRY LEEMING, G3LLL

### SWL PROJECT — NO ROOM FOR WIRE ANTENNAS?

Build a simple active aerial.

REVIEWED — FDK MULTI-750XX BUDGET 2m MULTIMODE

# BI-PAK BARGAINS

## BI-PAK SOLDER - DESOLDER KIT

Kit comprises: ORDER NO. VP80  
1 High Quality 25 watt General Purpose Lightweight Soldering Iron 240v mains incl 3/16" (4.7mm) bit.  
1 Quality Desoldering Pump High Suction with automatic ejection knurled anti-corrosive casing and Teflon nozzle  
1.5 metres of De-Soldering braid on plastic dispenser  
2 yds (1.83m) Resin Cored Solder on Card  
1 Heat Shunt tool tweezers Type  
Total Retail Value over £12.00  
**OUR SPECIAL KIT PRICE £9.95**

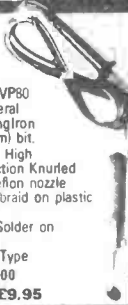

## BI-PAK PCB ETCHANT AND DRILL KIT

Complete PCB Kit comprises  
1 Expo Mini Drill 10,000RPM 12v DC incl 3 collets & 3 x Twist Bits  
1 Sheet PCB Transfers 210mm x 150mm  
1 Etch Resist Pen  
1 #b pack FERRIC CHLORIDE crystals  
3 sheets copper clad board  
2 sheets Fibreglass copper clad board  
Full instructions for making your own PCB boards  
Retail Value over £15.00  
**OUR BI-PAK SPECIAL KIT PRICE £9.95**  
ORDER NO. VP81



## DIGITAL VOLT METER MODULE

3 x 7 segment displays Basic Circuit 0-2V± instructions provided to extend voltage & current ranges Operating voltage 9/12v. Typ. Power Consumption 50mA  
O/No. VP99 Once only price **£9.95**



## SILICON BRIDGE RECTIFIERS

Comprising 4 x 1 1/2 Amp rectifiers mounted on PCB. VRM - 150 vits IFM - 1.5 Amps

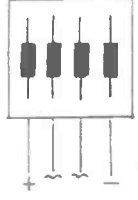

Size: 1 inch square  
10 off £1.00  
50 off £4.50  
100 off £7.50

ORDER NO: 4R1 B Rect.

## SINGLE SIDED FIBREGLASS BOARD

Order No	Pieces	Size	Sq. Ins	Price
FB1	4	9 x 2 1/2"	100	£1.50
FB2	3	11 x 3"	100	£1.50
FB3	4	13 x 3"	156	£2.00

## DOUBLE SIDED FIBREGLASS BOARD

FB4	2	14 x 4"	110	£2.00
-----	---	---------	-----	-------

## INTRUSION ALARM

The DOOR BIRD DB 2000 alerts you before your door is opened. Just hang on the inside door knob - alarm is activated as soon as the outside door knob is touched.  
**ONLY £3.95**



## OPTO 7-Segment Displays

Brand new 1st Quality LITRONIX DL 707R 14-pin  
Red 0.3" Common Anode Display 0-9 with right hand decimal point TTL compatible 5v DC Supply. Data supplied

IN	5 pieces	£3	(60p each)
PACKS	10 pieces	£5	(50p each)
OF	50 pieces	£20	(40p each)
	100 pieces	£35	(35p each)
	1,000 pieces	£300	(30p each)

**THE MORE YOU BUY - THE LESS YOU PAY**

## TECASBOTY

### THE ELECTRONIC COMPONENTS AND SEMICONDUCTOR BARGAIN OF THE YEAR!

This collection of Components and Semiconductors for the hobbyist is probably the most value-packed selection ever offered, it consists of Resistors, carbon and wirewound of various values. Capacitors: All types, sorts and sizes including electrolytics. Potentiometers - single, dual, slider and preset. Switches, Fuses, Heatsinks, Wire, P.C.B. Board, Plugs, Sockets etc., PLUS a selection of Semiconductors for everyday use in popular Hobby Projects. These include: SCR's, Diodes, Rectifiers, Trnacs & Bridges as well as a first class mix of Transistors and I.C.'s. In all, we estimate the value of this in current retail catalogues to be over £25! So, help yourself to a great surprise and order a Box TODAY for just £6.50 ONLY at BI-PAK. Remember, stocks are limited so hurry! You can call us on 0920-3182/3412 and order with your Barclaycard or Access Card - 24hr Answerphone Service NOW. Order No. V.P. 85.



## OUR GREAT NEW CATALOGUE

Presented with a Professional Approach and Appeal to ALL who require Quality Electronic Components, Semiconductors and other Accessories ALL at realistic prices. There are no wasted pages of useless information so often included in Catalogues published nowadays. Just solid facts i.e. price, description and individual features of what we have available. But remember, BI-PAK's policy has always been to sell quality components at competitive prices and THAT WE STILL DO.

We hold vast stocks "in stock" for fast immediate delivery, all items in our Catalogue are available ex stock. The Catalogue is designed for use with our 24 hours "ansaphone" service and the Visa/Access credit cards, which we accept over the telephone.

To receive your NEW 1983 BI-PAK Catalogue, send 75p PLUS 25p p&P to:-

## VALUE PACKS

Pak No.	Qty	Description	Price
VP1	300	Assorted Resistors Mixed Types	£1.00
VP2	300	Carbon Resistors 1/4 Watt Pre-Formed	£1.00
VP3	200		
VP4	150	1/4 Watt Resistors 100 ohm-1M Mixed	£1.00
VP5	200	Assorted Capacitors All Types	£1.00
VP6	200	Ceramic Caps Miniature - Mixed	£1.00
VP7	100	Mixed Ceramics Disc. 1pf - 56pf	£1.00
VP8	100	Mixed Ceramic Disc. 68pf - 015pf	£1.00
VP9	100	Assorted Polyester/Polystyrene Caps	£1.00
VP10	60	C280 Type Caps Metal Foil Mixed	£1.00
VP11	100	Electrolytics - All Sorts	£1.00
VP12	60	Bead Type Polystyrene Min Caps	£1.00
VP13	50	Silver Mica Caps Ass. 5.6pf - 150pf	£1.00
VP14	50	Silver Mica Caps Ass. 180pf - 4700pf	£1.00
VP15	50	High Voltage Disc. Ceramic 750v - 8Kv Mixed	£1.00
VP16	50	Wirewound Res. 9W (avg) Ass. 1 ohm - 12K	£1.00
VP17	50	Metres PVC Covered Single Strand Wire Mixed Colours	£1.00
VP18	30	Metres PVC Covered Multi Strand Wire Mixed Colours	£1.00
VP19	40	Metres PVC Single/Multi Strand Hook-Up Wire Mixed	£1.00
VP20	6	Rocker Switches 5 Amp 240v	£1.00
VP21	20	Pcs. 1 - 2 & 4 mm Plugs & Sockets Matching Sizes	£1.00
VP22	200	Sq. Inches Total, Copper Clad Board Mixed Sizes	£1.00
VP23	20	Assorted Slider Pots. Mixed Values	£1.00
VP24	10	Slider Pots 40 mm 22K 5 x Log. 5 x Lin	£1.00
VP25	10	Slider Pots 40 mm 47K 5 x Log. 5 x Lin	£1.00
VP26	20	Small .125" Red LED'S	£1.00
VP27	20	Large 2" Red LED'S	£1.00
VP28	10	Rectangular 2" Green LED'S	£1.00
VP29	30	Ass. Zener Diodes 250mW - 2W Mixed Vits Coded	£1.00
VP30	10	Ass. 10W Zener Diodes Mixed Vits. Coded	£1.00
VP31	10	5 Amp SCR'S TO-66 50-400v Coded	£1.00
VP32	20	3 Amp SCR'S TO-66 Up To 400v Uncoded	£1.00
VP33	200	Sil. Diodes Switching Like IN4148 DO-35	£1.00
VP34	200	Sil. Diodes Gen. Purpose Like OA200/BAX13/16	£1.00
VP35	50	1 Amp IN4000 Series Sil. Diodes Uncoded All Good	£1.00
VP36	8	Bridge Rects. 4 x 1 Amp 4 x 2 Amp Mixed Vits. Coded	£1.00
VP37	8	Black Instrument Type Knobs With Pointer 1" Std	£1.00
VP42	10	Black Heatsinks To Fit TO-3, TO-220 Ready Drilled	£1.00
VP43	4	Power-Fin Heatsinks 2 x TO-3 2 x TO-66 Size	£1.00

## SEMICONDUCTORS FROM AROUND THE WORLD

**100** A collection of Transistors, Diodes, Rectifiers & Bridges SCR's, Triacs, I.C.'s & Opto's all of which are current every-day useable devices.

Guaranteed Value Over £10 Normal Retail Price.

Data etc in every pack. Order No. VP56

Our Price £4.00

## BI-PAK'S OPTO SPECIAL

A selection of large and small sized LED's in various shapes, sizes & colours, together with 7 Segment Displays both anode & cathode plus photo transistors emitters and detectors. Cadmium Cell ORP12 and Germ. photo transistor OCP71 included. In all a total of 25 Opto pieces valued over £12 Normal Price

Order No. VP57  
Our Super Value  
Price Just **£5.00**



## HYBRID LED COLOUR DISPLAYS



Red, Green, Yellow - 3/5/6 inch Mixed types and colours NUMERIC & OVER-FLOW Common Anode/Cathode. GaAsP/GaP. Brand New, Full Data incl.

10 pieces (our mix) ..£4.00  
Normal Retail Value Over £10.00  
Order No. VP58

## IC BARGAINS

VP40 30 Assorted 74 Series TTL I.C.'s Gates, Flip-Flops & M.S.I.'s + Data Book. All New. Normal Retail Value Over £6.00. Our price **£2.50**  
VP41 30 Assorted CMOS I.C.'s CD4000 Series. Pack includes 00/09/12/14/18/21/23/25/28/30/35/44/68 AY/TE Types Plus Date Sheet Value Over £8.00. Normal retail **£2.50**  
YOU MAY ORDER any ONE TYPE of the above CMOS at £2.00 per 25 pieces. ORDER AS VP41 + type number required

## TRANSISTOR CLEARANCE

All Sorts Transistors. A mixed Bag NPN, PNP Silicon & Germ. Mainly Uncoded You 100 To Sort Pack includes Instructions For Making Simple Transistor Tester. Super Value. Order No. VP80 **£1.00**

## POWER SUPPLY OUR PRICE £3.25

Power supply fits directly into 13 amp socket Fused for safety. Polarity reversing socket. Voltage switch. Lead with multi plug Input - 240V AC 50HZ. Output - 3, 4, 5, 6, 7.5, 9 & 12V DC Rating - 300 ma MW88.

## MULTITESTERS

1,000 opp Including test leads & Battery  
AC volts - 0-15-150-500-1,000  
DC volts - 0-15-150-500-1,000  
DC currents - 0-1ma-150ma  
Resistance - 0-25 K ohms 100 K ohms  
Dims - 90 x 61 x 30mm

O/No. 1322. OUR PRICE £6.50 ONLY

## ELECTRONIC SIREN

12v DC

Red plastic case with adjustable fixing bracket. Emits high-pitched wailing note of varying pitch - 100 cycles per minute. Dims - 90mm (dia.) 60mm (depth). Power - 12v DC.

Our Price: **£5.50**

## RATCHET SCREWDRIVER KIT

Comprises 2 standard screwdriver blades 5 & 7mm size. 2 cross point size 4 & 6. 1 Ratchet handle. 5-in-1 Kit. £1.45 each. O/No 3298

## REGULATED VARIABLE POWER SUPPLY

Variable from 2 30 volts and 0 2 Amps Kit includes  
1 VPS30 Module 1 25 volt 2 amp transformer.  
1 0 50v 2" Panel Meter 1 0 2 amp 2" Panel Meter.  
1 470 ohm wirewound potentiometer 1 4K7 ohm wirebound potentiometer Wiring Diagram included Order No. VPS30 KIT **£2.00**

## MINIATURE FM TRANSMITTER

Freq: 95-106MHz. Range: 1 mile  
Size: 45 x 20mm Add: 9v batt **ONLY £5.50**  
Not licenced in UK  
Ideal for: 007-MI5-FBI-CIA-KGB etc.

# BI-PAK

Send your orders to Dept **HAS** BI-PAK PO BOX 6 WARE, HERTS  
SHOP AT 3 BALDOCK ST. WARE, HERTS  
TERMS CASH WITH ORDER SAME DAY DESPATCH ACCESS  
BARCLAYCARD ALSO ACCEPTED TEL (0920) 3182 GIRD 388 7006  
ADD 15% VAT AND 75p PER ORDER POSTAGE AND PACKING



Use your credit card. Ring us on Ware 3182 NOW and get your order even faster. Goods normally sent 2nd Class Mail. Remember you must add VAT at 15% to your order. Total Postage add 75p per Total order.

# HAM RADIO TODAY MORSE COURSE

The most effective route yet to your Class A amateur licence!

Professionally produced for HAM RADIO TODAY by Shirley Hesketh G4HES and Ron Ray G3NCL, this advanced interactive learning system makes use of the stereo cassette format to provide tuition to the 12wpm test standard.

With its carefully designed structure, we think that the HRT MORSE COURSE is more effective than either morse classes or electronic morse generators.

Based on TWO C-60 cassettes, it offers the controlled prompting so necessary for the initial stages of morse tuition, followed by carefully paced test material to bring the student up to speed. Full tuition notes are provided with the cassettes.

To receive your MORSE COURSE simply fill in the coupon below and return it to: 'HRT MORSE COURSE', Argus Specialist Publications Ltd, No1 Golden Square London W1R 3AB



Please send me the 'HRT Morse Course' at £11.45 all inclusive of P & P and VAT. I enclose cheque/PO for £..... (payable to ASP Ltd) OR Debit my Access/Barclaycard (delete as necessary)

Please use BLOCK CAPITALS

Name (Mr/ Mrs/ Miss) .....

Address .....

..... Postcode .....

Signature ..... Date .....

Please allow 21 days for delivery

# Radio Building Blocks

As well as offering a bit of theory last month, the discussion concerned mainly JFET style mixers. It was pointed out that these things worked superbly as 'front ends' for receivers, but had drawbacks with the limited gain available and the high LO drive requirements. Dual gate MOSFETs overcome both these disadvantages while sacrificing little in the way of performance.

*This month Frank Ogden, G4JST, explores dual gate MOSFET and diode mixer circuitry.*

The dual gate MOSFET is so useful because it possesses *three* potential input terminals — source, G1, G2 — whilst having the very desirable characteristic of high input impedance on two of them. In other ways their performance as mixers is very comparable to JFETs. The DC conditions are very similar — with around 10mA of standing current, noise figures of around 10 to 12dB are readily achievable, although the output intercept will be a couple of dBs lower than that of a JFET mixer run under similar conditions. The conversion gain will be typically 12dB or more thus lessening the gain demands of the IF amplifier.

## Single Ended Stage

The standard single ended stage dual gate MOSFET mixer is shown in Fig.1. By convention the signal is applied to gate 1, the local oscillator drive to gate 2 and the source of the transistor is decoupled at both RF and IF. There is nothing to prevent a change of order in the way that signals are applied. However, routinely using the

same source as an input terminal would be rather a waste of the high impedance characteristics of the MOSFET. The DG MOSFET can be considered as two separate FETs connected in series, one on top of the other (cascode configuration). Fig.2 shows how. The two separate transistors are depletion devices; the gates have to be biased negative with respect to each

source to 'cut' the transistors off. In the standard mixer circuit shown in Fig. 1, the effect of the local oscillator signal on gate 2 is to modulate the drain-source voltage of the lower FET structure. This directly varies the transconductance of the FET, producing a multiplicative mixing effect.

It may be imagined, quite cor-

rectly, that the optimum operating point for a DG MOSFET mixer requires very precise DC conditions. Significant variations from this point produce big changes in conversion gain, noise performances and intercept point. It has been shown experimentally that optimum mixing performance is nearly always achieved when gate 2 and source terminal are at the same DC potential with gate 1 biased around one volt negative to these two points. The classic circuit of Fig. 1 derives from this. Gate 2 and source are held at the same potential by a relatively high value resistor connected between them, while gate 1 is held ground potential by the input circuit. The source resistor is selected to self bias the transistor to exactly +1V with respect to ground. Note the low value resistor connected in series with gate 2 in this and subsequent circuits. It's function is to suppress

Fig. 1 Single ended DG MOSFET mixer

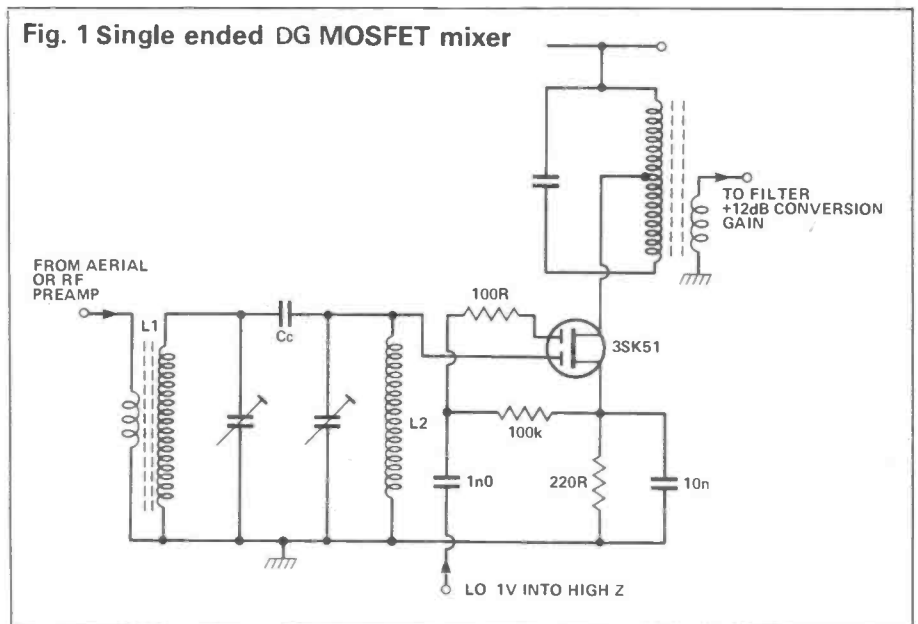

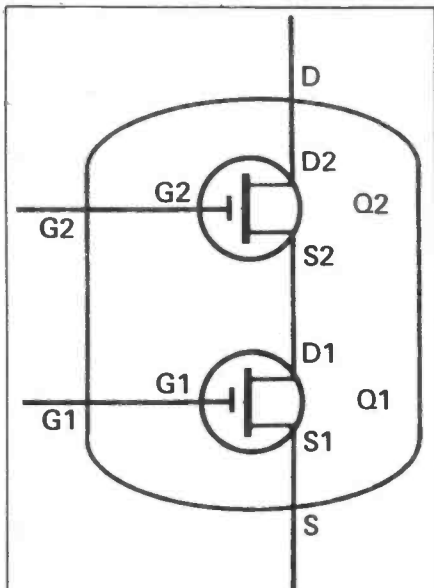

Fig. 2 The equivalent circuit of a dual gate MOSFET

UHF and SHF parasitic oscillations although it has no effect at DC or signal frequencies. Unless this type of MOSFET is operating with signals into the UHF range (where the typical device gain is still prodigious) some degree of parasitic damping will always be required.

### Balanced Mixers

All the mixer circuits so far discussed have been 'single ended'. Although this is not much of a disadvantage in VHF and UHF receiver front ends, where the signal and local oscillator frequencies are substantially higher than the IF, major problems can occur when using single ended mixer

stages in the MF and HF region. This is all to do with IF breakthrough: let me explain.

Say, for example, that the receiver IF is 9MHz. There are a number of powerful broadcast stations around the same frequency. Any signal which finds its way to either gate of the MOSFET will be transferred — with amplification — directly to the drain. The fact that a large amount of local oscillator drive is being applied to the other gate is of no consequence. Even though these stray signals may not be within the passband of the crystal filter, they could well be at a high enough level 'to go around the outside' of the filter and pass through the gain stages of the IF amplifier.

In most amateur radio gear the detector will be of the product variety. This means that it should not be sensitive to off-frequency AM ... in theory, powerful AM signals tens of kHz away will produce no audible output from a product detector. Remember, though, that the AGC on the IF strip will usually be of the audio derived variety: if there are no in-band wanted signals, then the strip reverts to full gain. Off-frequency leakage into the IF strip can saturate both this, and the subsequent product detector causing all manner of audible intermodulation products — whistles, warbles, noises — from signals that should produce nothing at all!

Balanced mixers largely cure the problem of IF breakthrough. In a

single balanced design as shown in Fig.3 the signal is applied directly to the paralleled input gates of a pair of MOSFET transistors which have their drains connected in push-pull configuration. The local oscillator drive is applied in push-pull with 180° phase difference to the two gate structures.

### Double Advantage

There are two instant advantages in this connection. Input signals cannot pass directly to the output. Although they find their way to the individual drain circuits in the normal manner, the balanced push-pull output transformer, L3 in the diagram, cancels them out. The precise degree of cancellation is dependent both on the physical layout of the circuit and the electrical balance of the components. The preset potentiometer in the source circuit offers a high degree of fine tuning. Input rejections of 40 to 50dB should be obtainable.

The second advantage is the degree of isolation which the configuration provides between the RF and oscillator circuits. With single ended DG MOSFET circuits the capacitance between gate 1 and gate 2 couples substantial amounts of energy backwards into the signal circuitry. This can lead to significant RF radiation in the receive mode. In the transmit mode, more seriously, LO energy can find its way into the PA strip causing spurious outputs. This leads to the gross dissatisfaction of your normally friend-

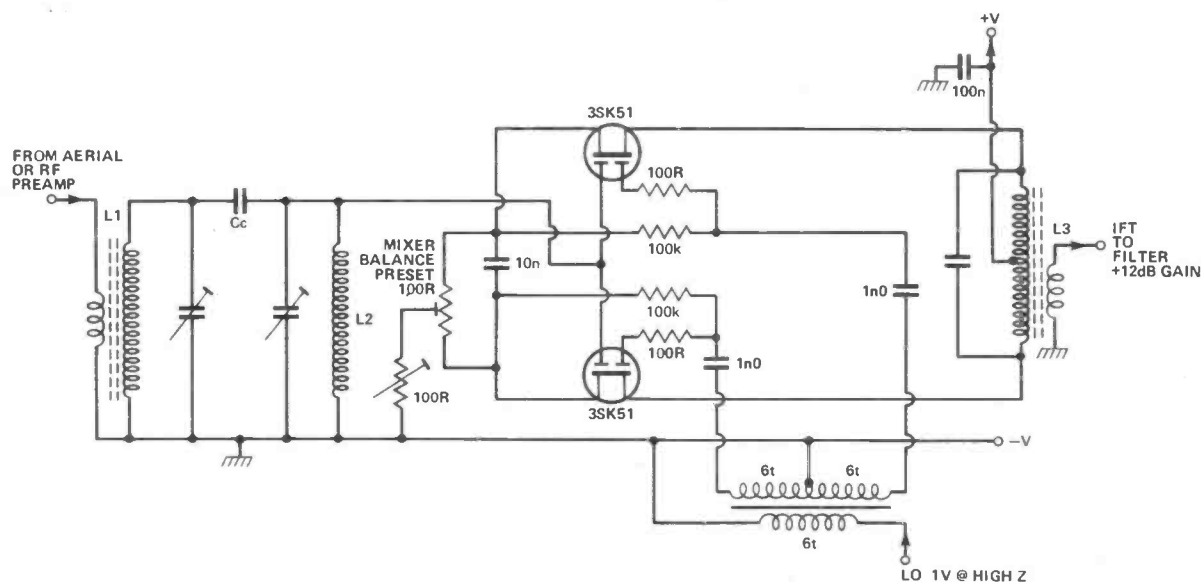

Fig. 3 Balanced dual gate MOSFET mixer

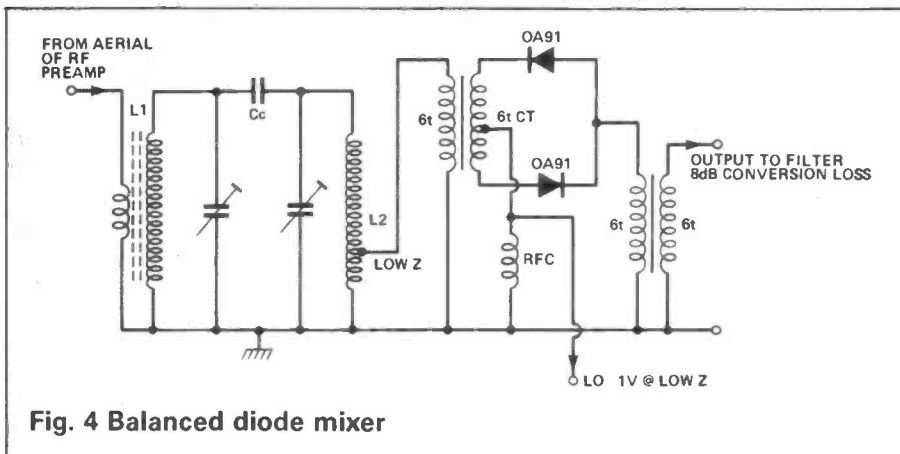

Fig. 4 Balanced diode mixer

ly and helpful Buzby.

The balanced MOSFET circuit shown in Fig.3 represents an excellent choice for HF receivers; the only one which could be described as better for the application would be a pair of balanced JFETs operated in the common gate mode. Note that an RF pre-amp cures the radiation problem in VHF DG MOSFET mixer circuits.

### Passive Mixers

Passive mixers usually means diode mixers. They are termed 'passive' because they require no DC supply for operation. This type of circuit always exhibits conversion loss, usually in the region of 6 to 8dB, and thus may not be thought of as useful for receiver front ends.

The fact that they lose gain is not nearly the handicap which it appears to be. The mixer, on its own, imposes a 6dB noise penalty. It is

entirely feasible to build an IF stage following the mixer which exhibits a 2dB noise figure. Allowing for a 1dB deterioration for preselector loss, an overall system noise figure of 9dB or so is attainable. Because the signal level has been reduced by 7dB before it gets to the first amplifying device, the system dynamic range has actually been increased by 7dB. Not bad for a circuit without any gain!

By comparison, a good MOSFET, or better still JFET, mixer circuit will turn in a comparable or even slightly better noise performance than the diode mixer and low noise IF combination. However, the dynamic range of the overall system will be worse by several dB. If an RF pre-amp is added to improve the noise factor, the strong signal performance of the MOSFET circuit will become severely limited where the diode circuit remains largely unaffected.

There is another massive ad-

vantage in using diode mixers as shown in Fig.4 or 5: they operate in *both* directions. They will convert signal to intermediate frequency, or IF to signal frequency without switching. Thus the same frequency conversion path can be used both for receive and transmit purposes. Diode mixers operate in a different way to active circuits although the results are the same. Where transistors can be used to 'multiply' one signal with another to obtain a product, diodes effectively switch a signal source on-and-off at the local oscillator frequency to build up an output signal which is a series of 'slices' of the input signal. Because this action is switching rather than amplifying, square law response is not necessary or even desirable.

### Ring Mixers

Diode ring mixer circuits have featured fairly prominently in the pages of *Ham Radio Today*. G3WPO and I have received a considerable number of enquiries from home builders pointing out that the local oscillator drive signal to these rings often owes more to a square wave than a sine one. We can honestly say that this is intentional! Diode mixer rings (and other configurations) which are in reality no more than high speed switches, produce the best results with a switching, ie square wave, LO signal. The fact that all sorts of harmonics are present in this signal is of no consequence — provided that

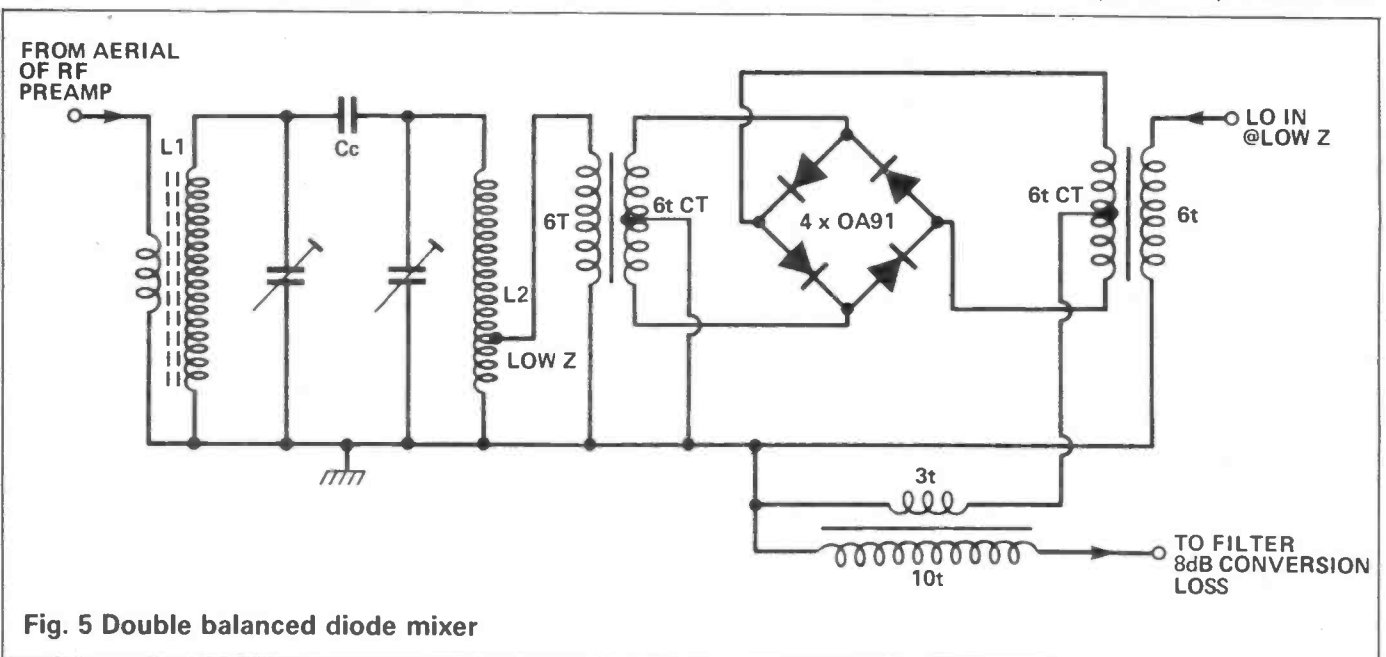
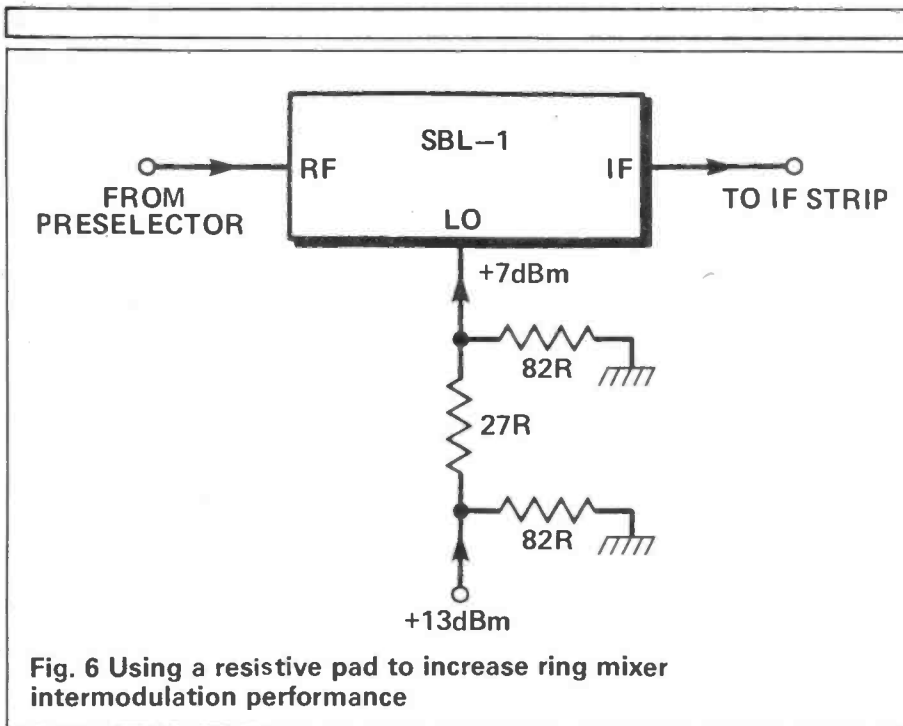

Fig. 5 Double balanced diode mixer



**Fig. 6 Using a resistive pad to increase ring mixer intermodulation performance**

the LO frequency is substantially higher than that of the signal input or IF output. A good designer will always arrange for this to be so.

The reason for this is relatively straightforward. The harmonic product ( $2 \times \text{LO}$ ) - RF cancels out because of the inherent mixer balance. Similarly the ( $2 \times \text{LO}$ ) - IF product will also be absent provided that the double balanced ring is used. However the significant response which occurs at  $(3 \times \text{LO}) \pm \text{RF}$  (or IF) will always be well outside the passband of the preselector.

### Choice of Diode

There are three sorts of useable diode: germanium (OA91) silicon (1N4148 type) and Schottky diodes. Each group exhibits a different compromise between device balance, RF burn-out level and stored charge. This last characteristic is possibly the most critical parameter because it dictates both the susceptibility of the mixer ring to spurious RF responses outlined earlier and the maximum frequency at which the mixer will operate.

**Germanium diodes** exhibit very low stored charge and a typical device such as an OA 91 will operate effectively well into the UHF region. They possess a medium resistance to burn-out - a four diode ring will accept up to 50mW of drive power - but the balance between devices tends to

be rather poor. The majority of OA91 balanced mixer applications will require some form of preset balance control to obtain satisfactory carrier suppression.

When used in switched transmit/receive circuits, considerable care needs to be exercised to ensure that the transmitter output power never reaches the mixer, for instance, during relay changeover 'dead' periods.

**Silicon switching diodes** such as the 1N914 show good device balance, very high resistance to burn-out but have a very poor frequency response. The store charge leads to a substantial 3rd harmonic response; a diode ring set to operate at 7MHz exhibits a -10dB response at 21MHz (source: Solid State Design for the Radio Amateur, ARRL). In spite of this, their low cost, high conversion performance and good intrinsic balance make them ideal for HF exciter circuits.

**Schottky diodes** with their virtually zero stored charge and very good device balance make them ideal choice for low level mixer circuits. The low reverse voltage rating - a few volts only - and low current capacity precludes their use in very high level mixer circuits. The resistance of Schottky diodes to burn-out is very poor. Complete mixer rings together with their associated transformers are readily available under the SBL-1 and MD500 style type numbers. The local oscillator power must be

held within fairly close limits within the 10mW region. Too little power will reduce intercept and conversion gain. The same situation will prevail if the drive power is too high. This is because the cores of the miniature transformers enclosed in their small encapsulations saturate very easily.

### A Few General Points

As said previously, passive diode mixer configurations are multi-directional and of low port impedance. Invariably one port will be connected to a preselector filter circuit (note the low impedance tapping shown in Figs. 4 and 5) while another typically connects with an IF bandpass filter. Because of the nature of the filters, the impedance which they present to the mixer circuit has a massive modulus of impedance against frequency. At some frequencies they will appear as a short circuit, at others, an open one. If all three mixer ports face a very low impedance - well below the design value - interfering signals will cause intermodulation problems unless one of the ports is maintained at a substantially correct value.

A ring mixer is like a pressure vessel with three holes. Fluid can pass in and out of the holes provided that at least one of them is unblocked. Block up all three and the vessel bursts. In the same way one port of a ring mixer needs a resistive termination. Convention usually dictates that the IF port has some sort of resistive pad. However, this configuration loses signal. It is better practice to feed the LO port via a resistive pad - while feeding the input to the pad with a *higher* level drive signal to make up for the loss in the network.

Fig. 6 indicates how this is done. The drive power requirement of an SBL-1 is around 7dBm. The local oscillator feeds drive power to a 6dB 50 ohm attenuator pad at the 13 dBm power level (20mW). The resistor network cuts this down to around 50 mW while allowing the mixer to 'see' a guaranteed resistive condition. The improvement in mixer performance is more than worth the extra trouble of providing higher drive power.

*Next month: IF sub-systems*



# THE GAMMA TWIN

2 METRE FOLDED 1/2 WAVE ANTENNA

Copyright Gamma Aerial Products 1982

This antenna is based on the very popular and successful "SLIM JIM" design.

The GAMMA TWIN has the following unique features:

★ VERY LOW ANGLE OF RADIATION.

★ ADJUSTABLE RADIATOR. (140—150 MHz)

★ COMPLETELY WEATHERPROOF CONNECTING BOX

★ VERTICAL FIX DIRECTLY TO MAST

**£7.95**  
incl. VAT  
+ £1.15 p&p

Available from your usual stockist or direct from the manufacturers

**Gamma Aerial Products**

MANUFACTURERS OF AMATEUR RADIO & CB ANTENNA  
BALDS LANE, LYE, STOURBRIDGE  
WEST MIDLANDS LYE 891132/891474  
TRADE ENQUIRIES WELCOME



## The Key Element

SSB clarity starts at the microphone...

Hell Sound, the company that pioneered proper audio equalization techniques for major performing groups and communicators, invites you to be part of one of the biggest advancements in Single Sideband transmission since the "Donald Duck" vs. AM days. If you are not satisfied with the "sound of your station" - It's no wonder - most "communications" microphones used today were designed for "public address" use, not for sophisticated SSB techniques.

No one microphone can be all things to Hams, so this new

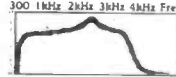

HC-3 element and HM-5 mic were developed only for maximum clarity on SSB transmissions. The response of this tiny ceramic element rolls off sharply under 350 Hz and above 3100 Hz with a peak at 2400 Hz for high articulation in the speech range.

Hams who care about maximum results in getting over, around and through DX pile-ups now have another weapon in their arsenal...

The Key Element! You can easily install this small, advanced HC-3 element, with its broad-range impedance-matching characteristics, into virtually any microphone case you own, or purchase the custom HM-5 with HC-3 installed.

Have not yet heard an FT-101 sound any better than when used with The Key Element... - Paul, G3AWP

I now have a comfortable feeling that my audio is better than the rig was originally capable of... - Rex, M9QZB

Thank you for the fine report, all reports to date have been excellent... - Lee, W1SE

For those who desire the ultimate audio ino and out of your transmitter/transceiver, consider the ideal combination of the Hell EQ-200 audio equalizer and HM-5 microphone.



All prices include VAT and Carriage. E. + OE.

For further information, or to order the HC-3 cartridge element at £17.99, the HM-5 SSB microphone at £49.95 or the EQ-200 at £85.95 contact our Sole European Distributor, Amcomm Services Ltd., 194 Northolt Road, South Harrow, Middlesex or Telephone 01-422 9585.



Hearing is Believing...

# THE INTERNATIONAL VHF-FM GUIDE

Sixth Edition - 128 Pages

A unique source of information for anyone who works through VHF REPEATERS IN U.K. & ABROAD

Maps of coverage areas and locations of all UK VHF amateur repeaters together with full details of callsigns, channels, access and reaccess requirements, talk-through times, QTH locators etc. In fact everything you need to know to work every repeater in the UK with confidence. The overseas section covers most of Europe/Scandinavia plus S. Africa & Australasia with country by country maps showing repeater locations keyed to full listings of callsigns, channels, locators, powers etc.

Anyone planning to operate abroad will find the

**RECIPROCAL LICENSING INFORMATION for 35 countries**

to be invaluable. In what is undoubtedly the most comprehensive and up-to-date publication of its type in the world, we have collected addresses of licensing authorities, with details of the advance notice, payments and info that they each require to issue you with a licence to operate on your holiday or business trip.

The book also includes charts of FM repeater and simplex channel frequencies, 10 metre, 6 metre and VHF & UHF beacons and a wealth of other useful information.

Now in its tenth year of publication the GUIDE has received world wide acclaim and is perhaps the best value for money of any book published by and for Radio Amateurs.

Available from any amateur Radio dealers or by post at £2 + 30p p&p direct from the publisher:-

J. Baldwin G3UHK  
41 Castle Drive  
Maidenhead  
Berks SL6 6DB

NATIONAL GIRO No 22 442 4009

# ALL MODE TRANSCEIVER Project

## Where is the PA module?

Tony and I have been promising the appearance of the *Omega* high power PA module for some time. The fact that we haven't published details yet does not mean that we won't! It simply says that development has not gone as smoothly as we anticipated.

HF broadband strips are very tricky items. Low frequency response is obtained by using lots of ferrite in the output transformer. This material can store prodigious amounts of electrical energy which is normally channelled into the aerial system. Under disconnection fault conditions (such as one produced by disconnecting the aerial at full drive), the stored charge can smash the delicate transistor junctions to bits with back EMF.

Our first pass at the *Omega* high power module worked beautifully, producing over 70W of RF from 12V between 1.5 and 30MHz with just 2½W of drive. Unfortunately the simple Zener limiting circuitry which the design featured has not proved totally adequate; output transformer leakage inductance caused significant voltage overswing at high frequen-

## PROJECT



## Part 8

*This month, Frank Ogden, G4JST, and Tony Bailey, G3WPO, describe the construction of a suitable case and give a general Omega update.*

cies — which smashed the Zener protection while leaving the transistors intact!

Keeping to our promise of not publishing until we are happy with the design, we have kept the PA article back. G4JST

## Down to Business

Since Project *Omega* was started on the JULY '83 issue of HRT, there have been articles describing 12 of the modules published, versions of which are now scattered on a fair number of radio enthusiasts benches. We have had a large number of requests for a suitable case to house the Project, and especially for some form of ready-finished front panel to give a professional appearance to the whole Transceiver. There are of course those who have built their own cabinets, and we hope to show some photographs of these at a later date.

This part of the series will describe the construction of a suitable case, which will be made available as a kit by WPO Communications; and also how the various modules can be installed inside this. The whole cabinet has been kept as simple as possible, and allows some considerable freedom of layout internally — with



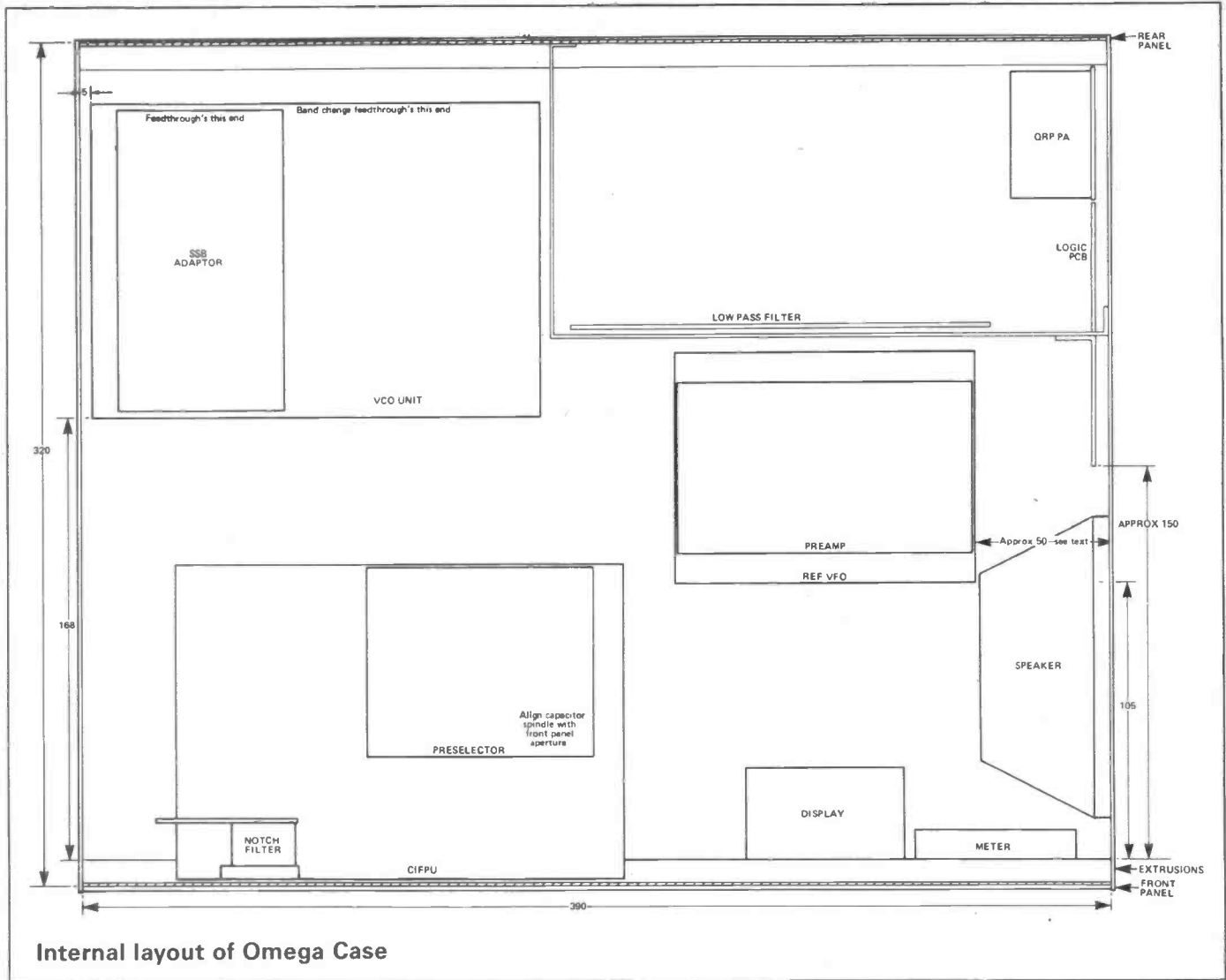

**Internal layout of Omega Case**

the exception of the CIFPU, Preselector and Reference VFO units which have controls which necessarily determine the front-panel layout. The cabinet houses all of the modules described to date, and also those still to come, including the QRO PA and its associated heatsinks, FM and AM Adaptors, and an electronic keyer, a new addition, which will be described in a future issue. The case is not designed to accommodate the mains power supply, which will have to be built as a separate unit, but does allow the incorporation of a speaker. Inspection of the various photographs will give the general layout.

There is no compunction for you to use this case design — many of you will be accomplished metalworkers who can produce your own cabinet to your own tastes. The design is purely for those who have limited metalworking facilities, and desire most of the

hard work to be taken out of 'metal bashing'. The case kit is supplied with the panel ready drilled, screened and punched for all front panel controls, including the meter and digital display bezel, but no other drilling has been done on the remainder of the case — this is left to the individual builder. The assembly is extremely simple — the front, rear, top and bottom panels are slotted into aluminium angle extrusions, both top and bottom, and the side panels then simply screw into holes in the side of the extrusions.

### Well Finished

Together with some internal support brackets, and an internal aluminium screen, the assembled case is rigid and pleasing to the eye, as well as robust. The top and bottom panels are finished in a black plastic textured finish, and the side panels in a textured black

paint which will not mark easily. The front panel is black anodised, and screen printed in white with all the necessary legends. These panels will be available separately if you want to build them into your own case, but please note that the method of fixing is not directly compatible with 'normal' case construction, and some extra holes will have to be drilled to suit. The aluminium extrusions are *not* available separately. Also available will be a set of knobs, connectors, bushes, extension spindles and other odd items so that constructors will be able to reproduce the photographed exterior and mechanical construction.

The majority of the knobs used on the panel are 15mm diameter matt black types, with caps and nut covers for a neat finish. The two 'Meter Function' and 'Band Change' switches are low profile. 21mm types without nut covers. For the VFO tuning, a 38mm

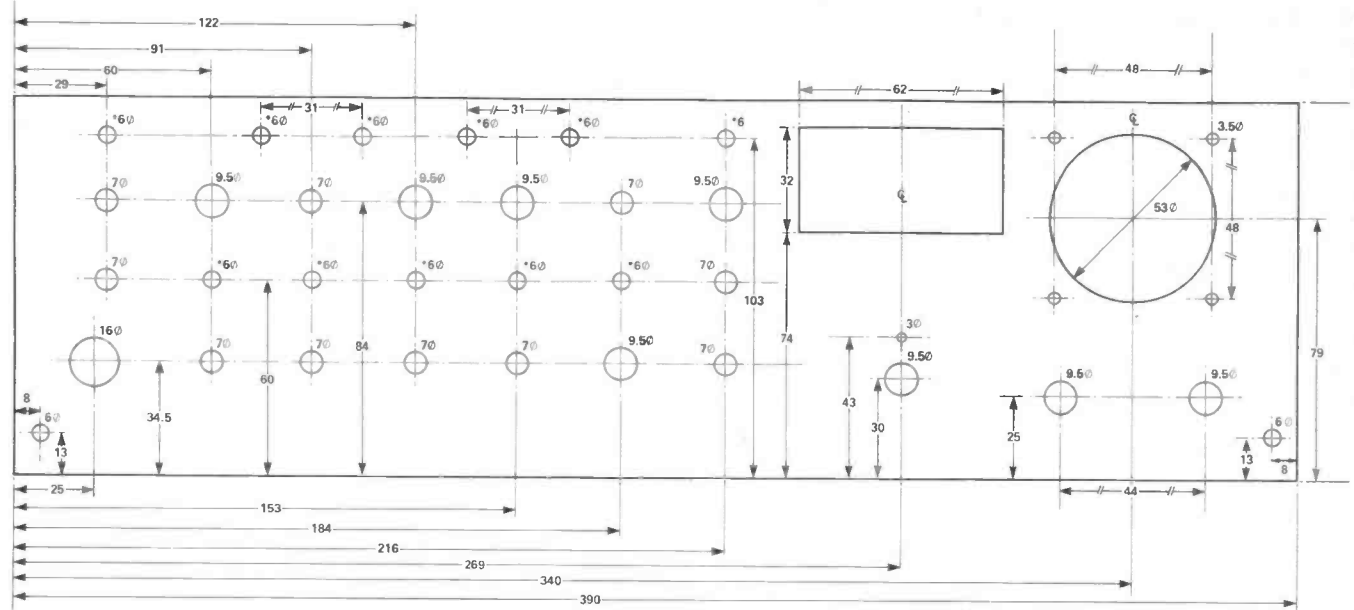

HOLES MARKED \* SHOULD BE 8mm Ø IF ILLUMINATED SWITCHES ARE USED

ALL DIMENSIONS IN mm. MATERIAL: 18swg ALUMINIUM

### Front Panel drilling detail

diameter knob with an additional crank handle has been used — this aids rapid tuning round the bands which I find is an invaluable aid to a rig's operability.

### Alternative Switches

To date, some modules have been supplied with small toggle switches for the front panel. A number of people asked whether some more 'modern' switches could be used, and we have attempted to accommodate them in the following manner. The photograph of the original prototype panel in a previous issue showed the panel with these toggle switches. The photograph in this issue (of an actual production panel) uses some alternative push-button switches which can be illuminated with LED's. Like most improvements they do however cost a lot more, but are available as a set from WPO Communications if preferred. The actual panel is drilled with holes of a size suitable for the original switches and chrome bezelled LED indicators (both 6mm dia). To use the alternative switches and indicators, it will be necessary to drill or ream out the appropriate holes to a diameter of 8mm. This, if carefully done, will not show when the switches are mounted, and should not damage the panel — as would be the case if

it had been painted rather than anodised.

In a couple of cases, there is no *direct* means of illuminating the switch as there is no suitable switching voltage available. This can be overcome with simple additional transistor driver circuits shown later. Note that LED's **MUST** be used for all indicators — filament bulbs take much too much current!

### Getting It Together

For the purposes of this article, we will assume that the project is now complete up to the QRO PA stage and that these modules are to be built into the case design shown. At the time of photographing, the QRO PA had not been built into the case due to some teething problems with the final version (see the leader to this article), although the heat sinks are shown in place. However, it mounts against the back panel, facing the low pass filters, with its heatsinks on the rear of the panel, with an intermediate dural sheet. Note that the design of the case does not allow reasonable easy addition of later modules, and, by removing one or other of the side panels, easy access to the other modules already in place.

The first job, if not already done, is to drill suitable mounting holes in the bases of the diecast-

boxes of all modules. The CIFPU box needs one at the end furthest from the panel at approximately mid position (missing the pillar). The holes for the VCO box are drilled at approximate centre (missing internal pillars) of the long sides. There is just sufficient room between the side of the box and the PCB to do this in all cases. For the reference VFO, again two holes adjacent to the long sides are needed, between the capacitor and PCB positions.

The RF Preamp has been mounted on the lid of the reference VFO simply by turning the bolts on the preamp round so that they protrude from the underside of the box, and drilling suitable mounting holes in the VFO box lid (marked through from the preamp box holes). Check that the bolts do not touch the VFO capacitor when the VFO lid is eventually screwed back down.

The SSB Adaptor sits on the top left hand side of the VCO box, with the connectors facing the case front. In this case, the two mounting holes are drilled near the short ends of the box, marked through to the VCO box lid. With both this unit and the Preamp, the boxes sit on the lids — so that they avoid the screw holes already on the lid.

The Preselector unit is a little awkward to fix in place. This sits on top of two 25mm 6BA bolts

protruding from the lid of the CIFPU box, such that the Preselector Capacitor aligns with the front panel hole for the spindle. The exact position of this unit will also depend on the type of variable capacitor used, but it should be mounted near the rear of the CIFPU box, as indicated, in order to clear the Mode switch. Using a series of 6BA nuts on the bolts, the whole unit can be moved vertically until the spindle aligns properly. Any slight error in alignment is taken up by a 1/4" brass or nylon extension spindle and the flexible coupler used between the shaft and spindle. Both the spindle from this unit, and the Reference VFO are taken through 1/4" brass bearing bushes screwed into the front panel.

This is, in fact, the next job that should be undertaken — getting the 'Preselector' mounting holes in the right position. You will need to temporarily mount the CIFPU Box against the front panel to do this. First, remove the nuts and washers from the pots and switch on the CIFPU Box. Then, check that the bushes do go through the panel OK (depending on the accuracy of your original drilling). If not, you will have to carefully file out the holes in the CIFPU Box until they fit (also make sure that the moulded lugs on the pots are removed). Now screw a nut on to each pot (still not mounted on the panel), and tighten

up, checking that there is still a good fit. Then with the controls pushed through the panel, replace the washers and fix into place *with an additional nut* (supplied with case). The CIFPU Box will slope slightly downwards from the front to back relative to the panel but this is OK. If you haven't already done it, you also need to reduce the length of the spindles protruding from the CIFPU Box to 10mm each — so that the knobs fit nicely against the panel when complete.

Incidentally, the spindles on the ALPS pots are 6mm in diameter — not 1/4" like rotary switches and the capacitor 'drives'. This is worth noting because 1/4" spindle knobs will run eccentric if used on these. The correct type of knob to use is a 1/4" collet fix type, *which suits either size spindle*.

The position of the Preselector unit can now be determined and the mounting holes marked through, after which the CIFPU unit can be removed, and the holes drilled in the lid and the bolts and nuts fixed in place. There are no other units to be mounted on this lid so it will not have to be removed again.

### Warning!

**Before you actually start mounting any of the units in the case, be sure that you have checked each**

**carefully, and that all are working as they should. There is nothing worse than having to remove a unit after it has been wired up. This situation gets progressively more difficult as the wiring gets more advanced!**

### Case Drilling

With the CIFPU unit still attached to the front panel, the case should be partially assembled with the front extrusions, bottom and side panels in place, plus the lower rear extrusion, ready for marking the mounting hole positions prior to drilling.

At this stage you will also need to make the internal screen, as shown in the drawing and photographs. This has been dimensioned in such a way that small bending and dimensional errors will still allow it to fit in place — providing the bends are made in the manner suggested. The original was made with a 'Workmate' and a block of wood only. The 18swg aluminium sheet used should be marked, drilled and finally bent — *in that order*.

This screen holds the low pass filter module, feedthroughs for power to the filter, a +12V feed to the remainder of the units. It also screens the QRO and QRP PAs, plus half of the logic board, from the remainder of the units. it also

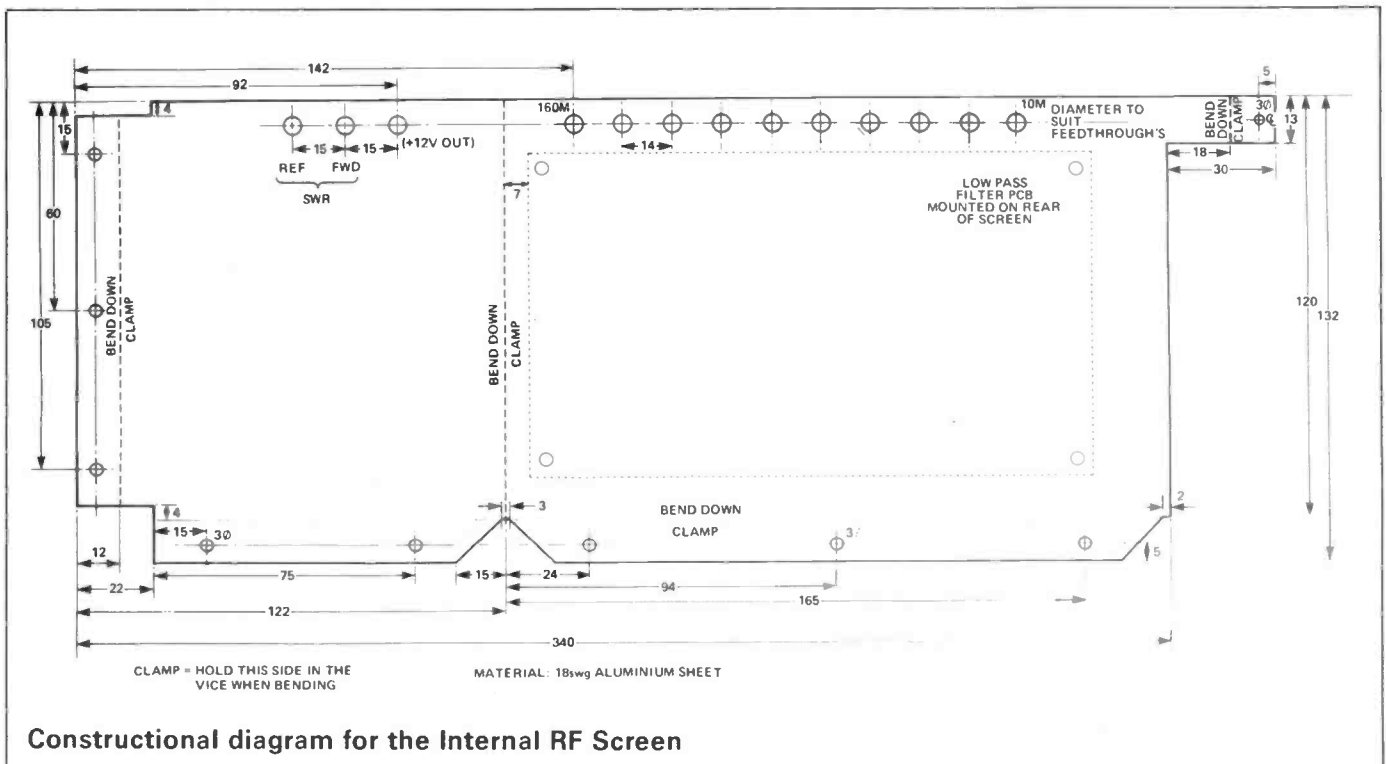

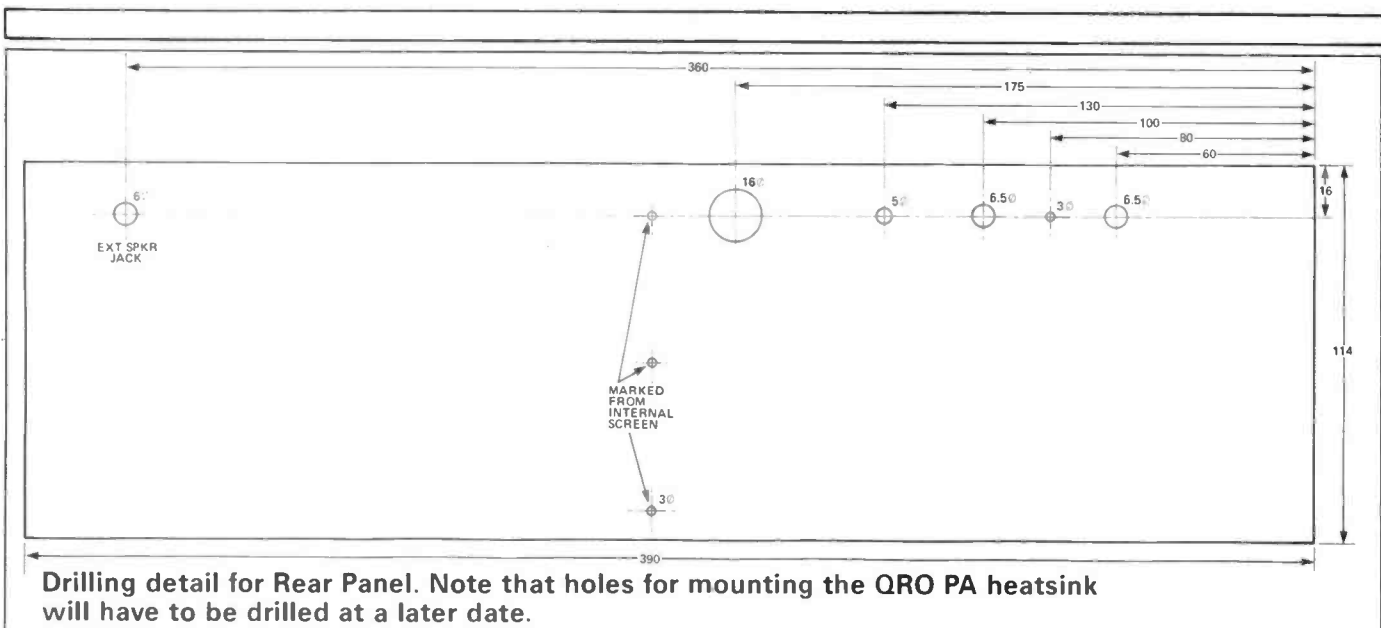

adds some further rigidity to the cabinet by locking the rear and base panels to each other. This additional screening is not strictly necessary as all the RF sensitive units are already screened in boxes, and anyway, a number of the leads go into the enclosure without filtering. However, the majority of the RF from the PA and Low Pass Filters will be contained in this way, which is not a bad feature, and mounting for the LPF board was needed. If you are particularly keen, a slightly more elaborate screening enclosure could be made which would act as a *total* RF screen, with additional feedthroughs and coaxial sockets where required.

Exact drilling dimensions for many of the holes are not given, as they are marked through from the various boxes etc. This does help in taking up any drilling errors and means you don't have to be quite so accurate a metalworker to achieve a tidy result.

With the case partly assembled, the first job is to mark the posi-

tions of the two small brackets which are placed midway down the side panels to support the base panel. These come with the case, but can be made from small pieces of aluminium or even aluminium angle. The slotted holes should be placed against the side panels to allow final adjustment vertically.

Now place the finished screen in place and insert the rear upright panel. Adjust the screen position so that it is touching the rear panel *and* the right side panel, then check everything is at right angles and mark the holes through — you may find it easier to mark a couple of holes, drill, bolt in, then mark the rest.

Following the location drawing, place the reference VFO in position the correct distance from the front extrusion (together with extension spindle and flexible coupler) and adjust so that it is square and correctly aligned with the hole in the front panel (which should have its 1/4" bush in place). Now mark the positions of the two

mounting holes. The remainder of the modules can now be placed where indicated and the holes marked — the spacing dimensions given for the boxes are measured at the tops with the lids on the boxes.

Once the position of the right hand side of the internal screen is known, the logic board can be moved into position. This mounts on the right hand side panel so that the actual logic chips are towards the *front* of the case, with the cut-out on the screen just adjacent to the logic board vertical screen (thus placing the actual antenna switch *inside* the screening panel. The QRP PA sits next to this, near the back panel, with the output pin remote from the logic switch.

### Mounting The Speaker

On the model shown, the speaker was mounted on the right hand side panel near the front, with a black baffle mounted on the outside of the cabinet. The particular speaker used was a 4.5" high

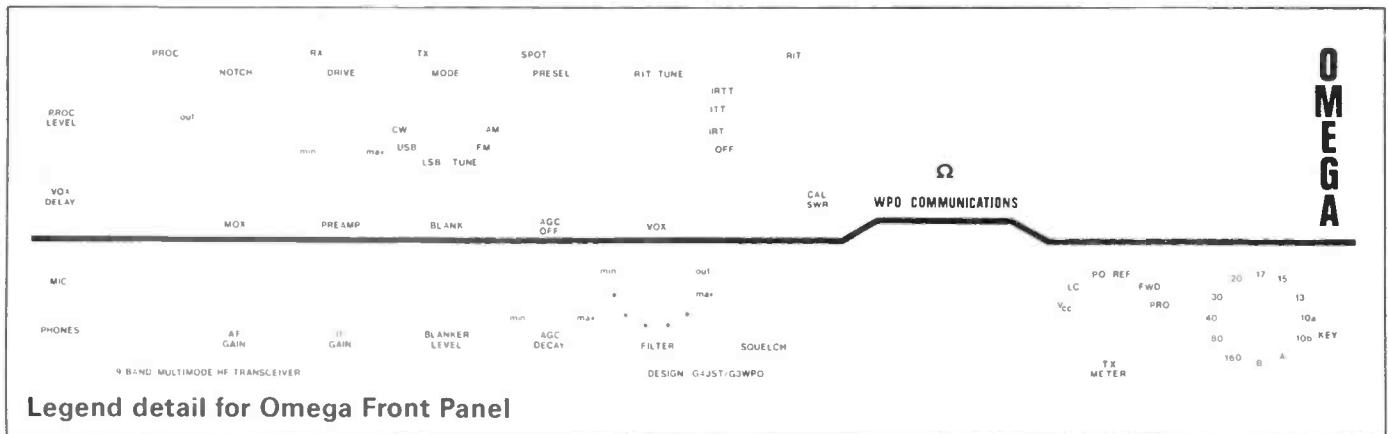

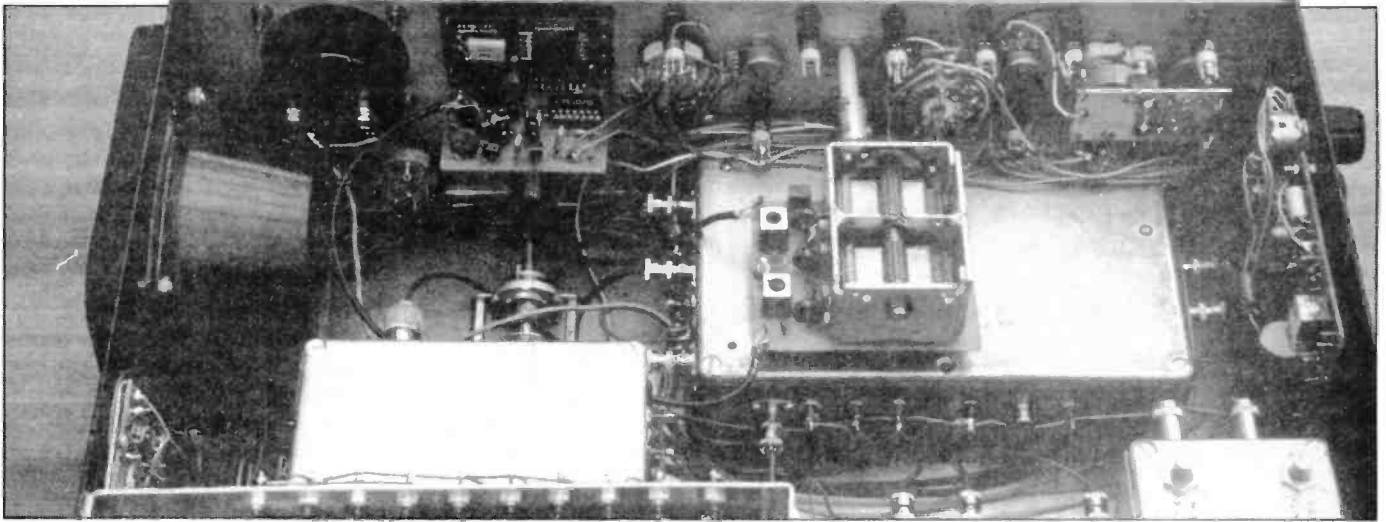

View from rear of Omega Case towards Front Panel

power type, which happened to be to hand, and gives very acceptable reproduction. Both the baffle and this speaker are also available if required. The drilling detail is given for this type of speaker and ensures that the speaker magnet clears the internal modules. If preferred, there is room to mount a speaker on the top panel, but it will need to have a fairly low profile magnet (an elliptical type would be best), and a suitable baffle would need to be found for the opening. One source of these are car accessory shops (Halfords do a couple of suitable types), or you could fabricate something yourself from an extruded aluminium mesh.

### Digital Display

We originally thought that this display would need screening, but this has not proved necessary in practice, as no audible spurs can be heard from it, even when mounted close to the *open* CIFPU board. A mounting bezel comes with the display, but does not have any direct provision for attaching it to the display. The best way to do it is to fit the bezel into the front panel, apply a very small amount of cyanoacrylate type adhesive to the front face close to the four corners, and accurately snap-fit it into the back of the bezel. You are advised to check how well it fits before applying any adhesive, as, if you get it wrong, it is difficult to remove!

### Rear Panel

At this stage, the rear panel can be drilled for the input power

connectors (2 x 10 amp 4mm/screw type), SO239 antenna socket, and extension speaker socket (3.5mm jack), plus the internal screen mounting holes. The QRO PA mounting holes will need to be drilled at a later date.

### Earth Straps

A good earth connection is advised between each of the panels, and will be made anyway between the top, bottom, and front and back panels when assembled. However, additional earth connections between each panel should also be made by using solder tags from a suitable bolt position on each panel with wire links. The front has a hole for a 6BA bolt and tag behind the tuning knob. You will also need to scrape away the paint on the inside of the side-panels behind the two support brackets in order to ensure a 'good earth' connection.

### Populating The Panel

Once you have all the units tested fully, you can start to assemble and wire up the whole transceiver. Reassemble the CIFPU box to the front panel, if you have removed it, with the Preselector mounting bolts in place on the lid. Then use 6BA nuts and bolts to fix the rear of the diecast box to the base panel. This is best done on a flat bench, so that you can check that the front panel is at *right angles* to the bottom panel — if necessary you may need to insert some spacing washers under the diecast box to achieve this. When properly mounted, the front of the

box should just be resting on the front extrusion. Do not overtighten the fixing nuts on the pots and switch when finally in place as you will distort the front panel.

Next, fix in the VCO and reference VFO boxes, check vertical alignment of the VFO spindle with the front panel bush (use spacing washers under the VFO box if required) and leave the spindle and coupler off the drives for the moment while wiring up. Now mount the meter, bush for the Preselector extension spindle, mic socket (4 pin Yaesu type) and the logic and QRP PA boards. The latter should have a couple of 6BA nuts under them to space them from the panel. It is also advisable to clear the paint away from at least one of the mounting holes on the panel for each to ensure a good earth.

### Mode Switch

As the Mode Switch has a large number of connections made to it, it is best to pre-wire this out of the case, with suitable colour coded wires long enough to reach *each* connection to the switch in-situ. If you haven't got enough wires to colour code it then tag each free end with a small piece of paper to identify it for the moment. After this is done, mount the switch in place. Unused wires can be insulated and coiled up for eventual connection. It is useful to have a couple of extra wires available from the +12V Rx and +12V Tx connections for attachment to some of the front panel controls. In addition, some pre-wiring of the RIT Switch is advisable to save

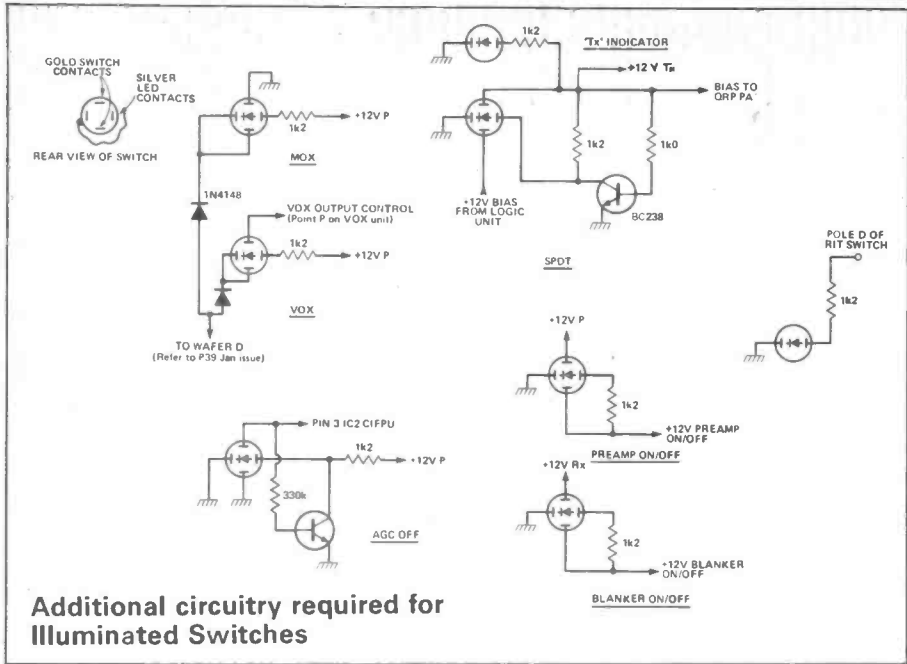

**Additional circuitry required for Illuminated Switches**

later problems.

The Notch Filter can also be mounted in place, with the PCB to the left of the panel, together with the remaining controls, including the 12 position band-switch, and the Meter Function switch. All spindles need to be shortened to 10mm. There are a couple of control positions which are not yet used at this stage, the RF Processor, Squelch and Set SWR pots. For the sake of appearance, dummy pots could be used for the present. All the toggle or push button switches in place should now be mounted in place, together with the indicators (either chrome LED type, or those to match the push switches), and the two 3.5mm jack sockets (key and headphones).

### Wiring Up

You are now ready to commence the wiring up operation, with the front and bottom panels actually bolted together at the moment — the right side panel with the PA etc on can be left lying by the side while wiring is in progress, leaving the wire lying with enough extra length to allow neat looming later. You will also need to bolt in the internal screen with the Low Pass Filter PCB attached to it (also wire up the connections to the feedthroughs before bolting into place, and attach a length of coax from the output pin long enough to reach the PA/Logic switch). Sufficient information has been given in each article for the majority of con-

nections and further information is given as we go along.

Start by wiring up the CIFPU and VFO/VCO's, checking as much as possible that things are working in-situ as you go along, if necessary with temporary connections. **Do not wire everything up and then see if it works** — it is much easier to locate a wiring fault with only part complete wiring. For instance, the CIFPU can be checked for AF output and the wiring of the headphone socket checked quite early on, using a temporary power connection to the VCO/VFO, rather than waiting until all 13 connections are made to the VCO box. When this is done check all the 'receive' functions, blanker etc, carrying on when these are correct with the 'transmit' functions (also wire up the toggle illuminated switches as the appropriate functions become connected).

The +12V permanent supply line for those modules that require it is brought from the rear power connector through a feedthrough on the left of the internal screen out to the VCO +12V feedthrough, then the wiring continued to each module from that point. Front panel controls and any of the modules can pick up any required voltages from the nearest convenient point.

Although looming up all the cable will give a nice neat appearance, we suggest you don't actually do this until you have everything in and tested — otherwise you will almost certainly find that you have to remove a wire for

some reason or another and thus destroy your once-neat cabling harness! All the wires which come from the front panel switches should be taken by the shortest route to their destination. Most of these will go over the top of the CIFPU box near the front panel (you can just about get them *under* the illuminated switches). For wires which pass behind the CIFPU and in front of the VCO box, run them so that they pass *in front* of the internal screen.

The connections to the 10 VCO supply pins from the band-switch should run from the VCO up to the feedthrough for the appropriate low pass filter relay, then on round to the bandswitch — this gives the shortest cabling run. Coaxial connections should be taken by the shortest and neatest route available. The mic socket connections should be wired to suit the microphone in use on your rig. The prototype uses a Shure 444 which gives very good audio quality.

### Illuminated Switch

If you are using this option, then some words of explanation on connecting the switches are in order. To get the LEDs inside the switch, the legs need reducing to about 10mm in length (preserve the slightly longer leg length on each - this is the end which goes to positive volts) after which they are carefully pushed into the receptacle inside the switch body. The first one may prove difficult to fit but easy fitting soon comes with practice. Each switch is a single pole changeover type, which does mean that a couple of changes are required with respect to the switch wiring given in the article on the SSB adaptor (Jan. '84 Issue p39).

The VOX switch is shown as a changeover switch but will have to be wired as a pure ON/OFF connection (see drawing). The illumination itself requires an additional steering diode (1N4148) to prevent other Rx/Tx control lines switching on the LED. A 1k2 series current limiting resistor from the +12V line driving each LED is needed in all cases with the cathode going to the nearest available earth point via a short length of wire, or as depicted on the drawing.

For the Rx and Tx indicators,



the feeds are the +12V Rx and +12V Bias (QRP PA side of 'SPOT' switch) lines from the logic switch, which are available on the mode switch in the case of +12V Rx. The reason for using the Bias line for the Tx LED is so that when the 'SPOT' function is being used the T/x light will not come on. The 'SPOT' LED itself is controlled by an extra NPN transistor (BC238 or sim) which prevents the LED being illuminated when Bias is present. The feed for the RIT LED is taken from the pole of the RIT switch, *before* the dropper resistor for the Zener (this is mentioned later in the corrections for the VFO). The MOX (Manual Tx/Rx switch) also needs a steering diode — otherwise the LED to it will illuminate whenever the rig is put into transmit by any other method!

The AGC OFF function is implemented by taking pin 3 of the 741 (IC2) in the CIFPU unit to earth, via one of the spare feed-throughs advised in an earlier part. Again an external NPN transistor controls the LED illumination. For the normal toggle switches, only 3 indicators are used — Rx, Tx, and RIT plus a spare, and these connect in a similar fashion to that shown for the illuminated versions, again with series limiting resistors.

### Meter Switch

A six position switch is used for various transmitter monitoring functions. At this stage, only the QRP PA output indicator can be wired up and the wiring was indicated in that article — use the position on the meter switch which coincides with the front panel legend.

### Wiring Again

When you have as much of the wiring completed as possible and have checked out operation, then the sides of the case can be screwed on and the rear panel fixed into place with its various connectors. A 100n and 100uf/16V paralleled decoupling capacitor pair should be wired from the +12V input connector to the negative connector, the latter being earthed. A hole is marked on the rear panel for an earth terminal for an external earth lead — if used in your station. Five feet were also used on the pro-

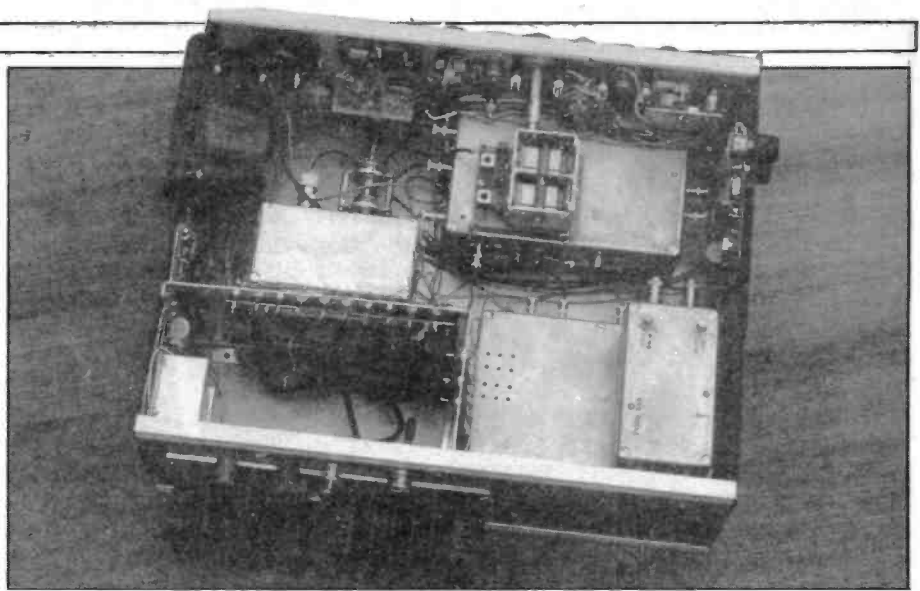

**Omega from above. The prototype QRO PA can be seen in place on lower LHS**

totype on the underside of the case — one centrally placed.

### Case Kits

The case as described in this article is available from WPO Communications for £26.50 plus £3.50 post and packing (UK and Eire only — overseas post extra). This includes nuts bolts etc. Front panels only are also available for £8.00 inc post. Seperate sets of knobs and hardware as used in this article are also available — please contact WPO Communications for details.

### CORRECTIONS

#### OMEGA Part 7 (Broadband Preamplifier)

In the article as published, both D1 and D3 are shown reversed on the component PCB layout, but correctly on the circuit diagram.

#### OMEGA Part 4 (Logic Switch and PA)

D8 on the layout diagram is shown reversed.

#### OMEGA Part 3 (PLL Synthesised VFO)

On Page 19, describing the VCO alignment, there is a piece of text missing which should read as follows: .... at the same time shorting the gate of Q24 to earth with a 1n or higher value capacitor (to ensure that the VCO is not oscillating). When you have done this, removing the short should drop the current by a small amount (showing the VCO is now

oscillating) and applying +12V to one of the VCO connections should drive up the current by a further 80-100mA or so. Delete the next paragraph concerning Q26. On page 19, the length of wire for the 2 turn part of T1 should be 5cm not 2cm. Also on page 19, in alignment instruction 3, the drain voltage of Q24 should read 4 to 6V, not 8V.

There have been a number of problems with the Digital Display due to saturation of the input amplifier stages. This has now been overcome with the following modifications: Remove D1, D2 and C1. Link across C1 position. ;Remove R1, 2, 5 and 6. Connect an 82k resistor between the collector and base of Q1, and a 4k7 resistor between the collector and base of Q2. Also reduce C100 on the VCO unit to 4p7 from 390pF. This modification to self-bias the input stages will increase the sensitivity by a factor of 10, and overcome the tendency for the display to stop reading above 20MHz. This also removes the loading from the VCO output, but does not cause any problems, as was thought at first.

IRT — A number of people have reported varying frequencies when switching between IRT, ITT etc. This is due to the +12V used to switch this function varying slightly depending on its origin ie from +12V Tx or 12V Rx. The cure is to stabilise the supply to the IRT pot at around +10V by adding a series 1k5 resistor between the switch pole and the top of the IRT pot, with a 10V zener between, connected to earth.

# Radio Yesterday

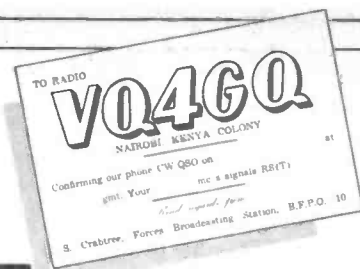

As a VQ4 in the late 50s life was very pleasant. The number of active Amateurs in Kenya was limited so I found myself more than somewhat sought after. The three upper HF bands were in general use — very little activity seemed to take place on 7 or 3.5 MHz until the growth of SSB

ding constructors generally collected sufficient items in the UK to see them through their tour of duty.

Most of the equipment in use was similar to that in the UK at the time. The Panda Cub, PR 120V, various Minimitter and Labgear equipment were mainly used on the transmitting

famous American receivers were 'surplus to requirements' and to be disposed of.

I could hardly contain myself. Here was a chance to become a big time dealer! I told no one of my discovery but swapped shifts at work so that I could attend. Prior to the auctioneering I inspected the receivers more thoroughly — very casually so as not to arouse interest by others — and found them to be generally in good order. A few were the original type with 6D6, 6C6 line up but some had the metal octal valves.

I waited patiently through the morning whilst dealers shouted over Indian carpets and the household effects of various expatriates returning home. Then the moment came.

"For sale in one lot", the auctioneer announced. Good, I thought — just the way I wanted it.

There were only two bidders. Myself and a prominent Sikh dealer who soon dropped out when he realised he wasn't sure what he was buying. I got the lot for just under £10. This worked out at ten East African Shillings for an HRO, PSU and 7 coils — around 50p at today's conversion.

I had talked a friend into coming in with me as a partner and having got them home we gradually started checking over the whole shipment. A few had been badly knocked around but we salvaged dials, crystals and tuning capacitors from these. We then did first line servicing — chiefly valve changes and in two weeks everything was ready. I made an announcement during the Sunday morning net; "HRO's for sale".

The response was an anti-climax. No one was really interested. A Kampala man thought he could use a PSU but didn't think it was worth a £1! Another in Mombasa offered £1 for 5 bandspread coils! Our project was severely under subscribed! Looking

---

*Amateur Radio in Kenya in the late fifties was an eminently colourful experience. Stan Crabtree, GM3OXC ex-VQ4GQ, does some recollection.*

---

operation resulted in substantial DX operation at the top end of the 80 metre band. A few CW enthusiasts occasionally delved into the 40 metre band but the contention with the 'mush' of QRN and broadcast stations operating above 7015 kHz deferred most operators.

East African Amateurs held a Sunday morning net at 0900 hours on 40 metres AM. The band at this time was absolutely clear of all but participating amateur stations. No QRM. Callers-in were from Kampala and Entebbe in the north, ranging down to Dar-es-Salaam, in what was then Tanganyika. Additionally there was the odd report from the remoter parts such as Tabora, Iringa and Dodoma. (Have a look at an old atlas!) The control was generally handled from Nairobi and the net commenced with a local weather report. This was really a joke as apart from Monsoon Season the climate was always the same — the equivalent of a perfect English Summer Day. Then perhaps someone returning from UK leave would relate what he had acquired from the depths of Lisle Street and arrange the distribution of the odd items he had for various friends on the net. As can be imagined, components generally were scarce in East Africa and bud-

side with the Eddystone 640 and the stalwart HRO for receiving. Occasionally the more affluent would appear with an American rig. One sported a BC610 'rescued' from a mobile army unit in the late 40s' and still running well. SSB came to Kenya with the sudden appearance of a Centronics 20A Exciter. This did the rounds, changing hands at varying costs to the early addicts of the mode. VQ4GX built a stable VFO for this rig and used it to drive a homebrew linear amplifier. He lived in a block of flats in the centre of Nairobi and made the mistake of fixing a neon to the top of his 14MHz ground plane antenna. This resulted in a visit from the police when neighbours and people in the street reported a flashing light during the early evening. He had to accompany the officers to the police station but was allowed to return home when his 'credentials' were established.

## For Sale

One day, purely by chance, I called at Muter and Oswald, Nairobi's biggest auctioneers and saw a sight for radio eyes. Around 20 HROs piled up in a corner with a few power supplies and a large box of coils. I learnt later that the Civil Aviation were updating to Eddystone 680Xs and these

back now I can't remember what happened to the sets in the end. I know my colleague and I retained the two best — and he went on to make a fantastic renovation of his model. So much of my time as a war surplus dealer.

Amateurs in the three Territories had been given dispensation to handle communications relating to movement in the Coronation Safari Car Rally. This later became a yearly event at Easter under the title of the East African Safari. The information passed was invaluable to the organisers as



Stan adjusting a maritime transmitter during his Kenyan sojourn.

the route taken passed through some very remote areas. If an Amateur was not living close-by the 'road' in these spots, volunteers took their mobile equipment and camped out. The control centre in Nairobi thus always had a fairly good idea of where just each entry was. Communications took place on 40 metres AM and in 2 metres in the Nairobi area.

The suspect cycle and HF Radio conditions were at their peak during these years. I can well remember a typical Sunday. From around noon there was an excellent path into the UK and Europe on 10 metres. Looking back it seems incredible what 50 watts of AM could achieve. A few hours later US stations would appear on 'ten' and remain until dusk. Probably the most commonly used directional antenna at this time was the legendary but now rare G4ZU mini-beam. I used a home brew cubical quad for 10 and 15 metres which gave excellent results.

### DXCC King

The patriarch of East African Amateurs was undoubtedly Robbie

VQ4ERR, now alas a 'silent key'. His involvement in Amateur Radio went back to between the wars. His chemists shop in what was then Delamere Avenue in the centre of Nairobi served as the VQ3,4 and 5 QSL Bureau. Robbie was a 100% phone man and it was a standing joke that he refused to even consider CW operation. One observer related how, at a local 'junk sale', Robbie had extracted a brass morse key, held it disdainfully between two fingers at arms length and exclaimed, "What on earth is this?"

Part of my time in Nairobi was spent in a hotel with obvious restrictions for Ham Radio. I was thus very grateful when Robbie invited me to use his station occasionally. I could go on CW provided I brought my own key! The 'shack' was a detached brick built affair the size of a small bungalow. It housed separate transmitters for 20, 15 and 10 metres. These were almost identical in appearance — large rack mounted jobs each with two 813's in the final. Two Collins 75A1 receivers made up the main assembly. I remember one evening when I was enjoying his hospitality we discussed his position in the DXCC listings — he was invariably in the Honour Roll amongst the top in the 'phone ratings. Rumour had it that a new Russian had appeared on the scene. He gave me strict instructions as he prepared to leave me.

"If you manage to work UM8KAA ask him to go up to the phone section. Then call me immediately on the house phone."

Robbie was renowned for his dry humour and he often left people he was in contact with completely con-

fused. An instance with a W5 comes to mind.

"Just a minute old man," Robbie let the microphone drop. "Hubert," he called, turning his head away and speaking to the distant wall. "Just round a little to the right I think." He spoke into the microphone again. "Sorry about that — just want to get the beam right on you."

There was a pause from the other section. Then.

"Gee," came the sound of a Texan drawl, "you got a houseboy servant there just to crank up the beam?"

"Oh no," replied Robbie. "Hubert's a giraffe. We give him a few tit-bits and find him very useful for turning the beam with his neck." Silence from the loudspeaker.

We had our share of visiting Amateurs from all parts of the world. One distinguished visitor in the early 60's was Gus Browning, W4BPD, on one of his world tours. To Gus a holiday was a DXpedition! He wanted to go to Zanzibar (then VQ1 and with separate country status) but needed a local to accompany him in order to take out the licence. I had made a brief journey there the year before with VQ4HT (now G3FBN) but another colleague at work seemed a more likely partner this time. He was an ex-Marine Radio Officer and a dedicated CW man. We all met in the New Stanley Hotel and Gus summarised the proposition. Some expenses paid, operation of a Collins KWM1 transceiver (then the ultimate in equipment) and a chance to make history! My friend was obviously interested and yet strangely reticent about taking part. He said the dates of the proposed event clashed with some prior arrangements he had made. He would try and resolve this.

Two days later we met again. Gus's face fell when he heard my colleague couldn't make it. I too was dismayed — for his sake.

"Why," I queried. "It's the opportunity of a lifetime.."

"I know," he replied rather wistfully. "I've tried to rearrange things but it's just not possible."

We remained silent for a while. I tried again.

"I don't understand you — you always said you wanted to be at the right end of a pile up. You're throwing away a big chance."

He looked at me sorrowfully. "Well I'm just as disappointed as you. 'I've tried everything but it's no good — she won't postpone the wedding."

# Free Readers' ADS!

**ICOM 720A** HF transceiver. IC-SP3 extension speaker. Kenwood AT230 ATU. ICOM SM5 desk mike. ICOM PS15 power supply. Emotator 502sax rotator and control. Plus HF antenna. J. Beam 10.15.20m. plus many extras. Must be sold complete. Telephone Barnsley 203365.

**Icom IC701** as new 10 hours use only. Complete with mains P.S.U. and Desk Mike £500, G4IVN QTHR. Great Yarmouth 728194.

**EXCHANGE VIC 20** Unexpanded, tapeunit, manuals, basic learning kit, choplifter and river rescue cartridges. Arcadia, Gridrunner & Tornado gamestapes, Joystick. Six months old. Cost £275 for FRG7700, R1000, Grandstand LA83, 934MHZ, CB Transverter, phone Ripley 812653. Keith. 239 Alfreton Road, Blackwell, Derby's. DE55 5JN anytime.

**WANTED HF** Linear at least 500W p.e.p. out. No rubbish. Please G4SWD. 08926 3485.

**FT1012D MKIII** fan Yaesu ATU and speaker. Cost over £700 except £560, ovno. Exchange the lot for FT102, TS430 or similar. Wanted Tri-band Yagi, FT102 acc and Shure 444 (Cash Waiting) (0279) 28857. Evenings pse.

**UNIDEN 2030:** Two metre mobile (FM) 13 crystal channels. 10W or 1W output. Manual toneburst ideal cheap way to get on 'two' or second rig for the car. £60 Contact Andrew McKechnie. Reading (0734) 872366. Could deliver within reason.

**KW 2000** £200 Tel. Fairseat 823598. Ask for Nigel.

**Have stacker DX9 SF** converted to 10m covers 28.205 - 28.99mh, and 29.000 - 29.900FM. Would exchange for mobile 2m unit. Anytime synthesised considered.

Please write for more details to A.W. Sharp, 6 Sedgefield Close, Salford, Manchester M5 4JL. All letters answered.

**Have Pye m294** mobile transceiver with circuits, easily converted. Will exchange for RF signal generator, preferably calibrated output or frequency counter. Please write A. W. Sharp, 6 Sedgefield Close, Salford, Manchester M5 4JL. All letters answered.

**TRIO 7010** 2mtr. s.s.b. rig. 40ft lattice tower cushcraft 11ele. 2mtr ant Herchman rotator. 18ft stub mast, 20mtr UR67 feeder, 20mtr rotator control cable. £300 ono. Contact G6TUP. Telephone Scunthorpe 853417.

Wood and Douglas 70cms transceiver, crystalled 5 channels tonburst, scanning, smart cabinet and icom mike. Aligned by W&D £70. G3DV. Tel Tedburn St mary 472 (day) 753 evenings.

**YAESU FC102** antenna tuner £130. Tono 9000E communications terminal. Rtty ASCII cw Word Processor etc. £500 Middleton 49 Wolseley Road, Stafford St, 16 3 XW.

**Semi Automatic** mechanical morse keyer £5 plus postage G3YWX QTHR. Tel Staines 50947.

**FT902 DM** HF rig, mint condition, hardly any use, original packing and manual £640. G4FXB WTHR. Phone 021 4583537.

**ICOM IC740** 6 months old excellent, desk mike. internal PSU £590. Racal RA1217, general coverage receiver 0-30MHZ £380. telex Mobile Headset Boom Mike £12. Marconi morse key ballrace pivot £70. All plus carriage. Please G3WMX QTHR. 073687-405 Cornwall.

**Otter 12 foot** fibreglass Sailing

**Dinghy.** Full racing cruising equip. Spinnaker, new outboard, cover trolley, car roof rack, £500 will exchange for HF Transceiver or what have you. Phone Stewart 0383 822303.

**Storno Viscount, 520, 522, 523, R5, R7.** (RX Deaf) leads, control box, mains power unit £20 F.M. 10-40W amplifier complete with mains power unit £15 buyer collects G4F5I. Tel. 0252 715218 (Farnham, Surrey).

**TRIO 8400.** 70cms F.M. mobile trans. 10W/1W mint original packing E.T.C. £160 o.n.o. Pye, Varactor Triplier, 70cms, £15. Tel. Weymouth 786930 G4OWY.

**Wanted 2m rig** SSB or FM preferably less than £100 will consider anything working or not Mr D Nunn. Tel. Wolverhampton (0902) 330331.

**Sugiyama F850S** Transceiver all mode, 1.8, 3.5, 7, 14, 21, 26 to 30 MGHZ 50 to 54 MGHZ 144 to 146 MGHZ 10 watts output all filters fitted, most versatile rig ever built, £800. No offers, 08894 70961, Exchange Considered.

**Wanted older H.F. Transceiver** SSB/CW. Preferably covering at least five or six bands e.g. KW2000 or FT200 G. Charman "Tara," Staple Lane, West Quantoxhead, Taunton, Somerset, TA4 4DE, or Telephone: Williton (0984) 32080. Please ask for Glen, weekdays after 4.15 pm, if possible.

**R206 Mk 1** Photocopied Manuals £3.00 each + 50p p&p. Send to A. Bunting, 5 Fritchley Close, Chaddesden, Derby, DE2 4PP.

**Wanted for Solartron CD513** Solarscope manual and/or cir-

cuit diagram or photostat copy of same will buy or pay postage and any costs incurred phone 051 644 6028.

**Wanted, February 1983 and May 1983 backnumbers of H.R.T.** Mr. Ian Liston-Smith, 48 Swansea Road, Reading RG1 8HA. Telephone: 0734 596806.

**FT107M.** Suit D.I.Y. man. Fitted memory C.W. filter 10/18MHz. Working but poor 21MHz up with microphone, workshop manual, £300, carriage extra. FP107 P.S.U. available if required. Details G41OT QTHR. Phone: Folkestone 76063.

**Brand New! + boxed!** MML/144/100LS linear 1/3W in 100-W-out, £130 o.n.o. Belcom Valve 2M. Linear preamp 2 spare valves 10-20W-in 100W-out £90 o.n.o. FDK2025 25 watts Synth 2M F.M. mobile £150 o.n.o. Wanted U.H.F. 10W mobile would p.x. any above. Cash difference E.C.T. Telephone: Weymouth 787747 after 6 p.m. Evenings please.

**Electrolytics** 100V 1000uf 25p, 100V 5000uf 50p. Brand new MM144/100LS 100 watt linear, unwanted gift of shack clearout. Pye Westminster mid-band £15. Brand new boxed Pye Olympic no crystals, £90, CA39BE, value £15. G8WXW QTHR, Winsford 06065 52834.

**DSB-80** Wanted. Must be in case and in working order. Will collect 50 miles from Oxford. Telephone: 0491 651560.

**Receiver Wanted** to cover H.F. bands by poor aspiring amateur, also any other unwanted equipment etc. Please write to: Howard Ketley, 1 Tewkesbury Ave., Mansfield Woodhouse, Notts. NG19 8LA or phone Mornings Mansfield (0623) 20990.

**Eddystone 680X** £100, Eddystone 880/2 £285,

Halicrafters S27 modified £50, Halicrafters S72 £50, Pye PTZ704 £15; Hudson with 2M synthesizer £50. Phone: Wokingham 782236.

Belcom Liner 2, 144MHz TRX £70. Command RX 3 to 6MHz £10. Wanted, Wanted, Wanted! any old rubbish for 10GHz. G6MEN 0704 74792.

Racal R17L HF receiver £285. Eddystone 840C HF receiver £75. Redifon VHF radiotelephone £110. Large desk radio consol £100. All o.n.o. Henry Howard, 108 Lindenthorpe Road, Broadstairs, Kent. Phone: 0834 601041.

YAESU FRG700 general coverage receiver, fitted with FF5 filter, memory. Also TRV 7700 converters (covers two metre band) and FRT7700 antenna tuner. New approx £548 will accept £300, mint condition. Barrie, Berkhamsted 4711, after 6.30 p.m.

Collins S-Line 758.3, 325.3 P.S.U. manuals good condition. Offers to G4RGJ. Tel: (0905) 421908.

Azden 2 metre handheld synthesised, S. Meter, memories, 1 or 3 watts, mains and mobile charger, speaker/mike. All in new condition and boxed, cost £220, accept £150 o.n.o. G4TUW. Tel: Harleston 852733 (Norfolk).

Sharp MZ-80K Personal Computer for sale. 48K RAM, built in B+W monitor, and cassette unit. Also, several 48K program tapes. 100% as new condition, £200, only for quick sale. Please contact G1DQY P.O. Box 33, Kidderminster, Worcs DY10 3JT.

Wanted KW-107 Supermatch A.T.U. Details to G3CIM 15, Heatherwood Close, Thorpe End, Norwich. Tel: 0603 38282.

Wanted for Icom IC700T, board which contains Audio amp modulator oscillator crystal filter or crystal filter only, also Heathkit electronic switch S-3U G4FQW QTHR. Tel: Accrington 391682, evenings.

Wanted Circuits for amateur band modification of

radiotelephone equipment: FM, Westminster, Motorola, Maxar, Marconi, Messenger, 4M, amplifier, integrated circuit CA21 AQ for Marconi Messenger. Any information on modifying single crystal CB to 10 metres. Des Walsh, 17 Owenabue Rise, Carrigaline, Eire.

10 Meter, 3 element lagi Boom 9ft longest element 18ft £25. Also 10 meter Valve Linear Amplifier 200 WTS, PEP 100 C.W. £55. Buy two for £75, will deliver via Securicor if required. Tel: Merthyr Tydfil 0685 74061.

Wanted frequency counter audio oscillator C.W. filter for FT101ZD and SWR PWR meter. D. M. Peach, 56 Basford Park Road, Maybank, Newcastle under Lyme, Staffs ST5 OPS. Tel: 0782-625661.

FT102 HF Rig, FM and Narrow SSB fitted. Four months old, original packing. A gift at £630. Contact G6AJV QTHR. (02974) 3654.

Standard C8800 2M, FM transceiver, Memo Scan, 1 or 10 watts output, Slipemount unmarked condition £200, also FRG 7000 H.F. receiver mint condition with hand books £200. Both sets can be seen working. Phone: Braintree 47631.

Eddystone 730/4 excellent condition, includes operating manual and a brand new set of valves. Coverage is 0.5MHz to 30MHz, will send by Securicor £110. Tel: Merthyr Tydfil, South Wales. Tel: 0685 73020 after 2 p.m.

YAESU FT3015 H/F rig matching FT221R 7 bands inc. 10MHz all filters £275 o.n.o. T.W. 10/2 transverter + P.S.U. needs work £20, G411L QTHR. Brighton 607737.

PSU 13V 17 amp £65, MML 432/100 70 cm 100 watt linear £150, Oric BBC programs RTTY £7.50, Morse Tutor £4.50, GEC HI-Band mobile £15. T. Tugwell, 11 The Dell, Stevenage, Herts. Tel: 0438 354689.

Wanted RCA AR88LF communication receiver, good

working order. Also Eddystone 958 required, good price and transit paid. ALA. Geo. Campbell, 23 Ladeside Crescent, Stenhousemuir, FK5 3DG, Stirlingshire.

Shack Clearout Fritel FD-4 multiband HF aerial (dipole type) £15, Icom IC-SM5 Electret desk mike £15, 10 element 2M Yagi £15, Asahi Pentax MV-1 camera, offers or swop for 2M FM TX/RX. Kemp 0793 783461.

AVO Type 8 Mk 5 £65, Sharp car radio P/B £10. Ford car radio £8. G8BBO QTHR. Tel: 0438 62586.

Rotator light/medium duty £30, Adonis compressor mic £25, Diawa SWR power meter with N type connectors £20, 13.8V, 5A P.S.U. £7. 5 ELE 144MHz J. Beam, £6 all o.n.o. Phone: Farnborough 0252 514127.

Complet Super 8 sound cine outfit Chinon 806SM camera, power zoom with macro focusing also boom microphone and movie light, the projector is Chinon 7500 with two speed forward and reverse, £175 o.n.o. or good ATU. Phone Farnborough Hant's 548494.

Wanted a small quantity of Mullard FX1593 Ferrite rings. Any reasonable price paid. R. E. Sharp, Hope Hall, Prince Of Wales Rd, University Of Exeter, Exeter, Devon.

Yaesu SP120 loudspeaker, matches FT221 or FT301 series £20. G2DAF receiver, spare valves and manual £55. W.S. 19 set and rotary P.S.U. key mic and phones £35. Dubus magazine's and handbook £15. Ring Dursley 811454 after 6 p.m.

Sommerkampff FT/76DX (707) at present used for S.W.L. 80-10MTS C.W. filter £325. Telephone: (0935) 72182 (Yeovil).

Wanted Receivers: Eddystone S640. National H.R.O. R.A.F. 1084. Marris 35. Kingswood House, Farnham Road, Slough SL2 1DA.

My Entire GB stamp collection catalogue, value approx £2,500 (to large to list), exchange for Communications

Receiver and Transmitter (H.F.), or 2 mtrs or what have you. Callers only, 214 Horninglow Rd, Firth Park, Sheffield S5 6SG.

Wanted 144/28 and 144/432 transverters, fair price paid for perfect condition. Also required VFO for FT101ZD and FM board for same. Write with details to: GW4RGI. Roger Baker, 40 Owen Street, Pembroke Dock, Oyfed.

TEAC X3R stereo tape recorder, automatic reverse, cost £400, will exchange for IC251E or 1st class SX28 RCVR and cash adjustment. Telephone: Hitchin 815016, Ext: 2453. Office hours or write to: 2 The Crescent, Shortstown, Bedford MK42 0UJ.

TRIO 7200G 2M FM transceiver xtalld for S20, S21, S22, S24 and R6, R7, R8 - 10W Kenwood VFO to match 144-146MHz plus microphone. Yaesu Magnet and Oscar 7/8 whip in mint condition, plus Home Brew SUM Jim Antenna. Complete mobile and base station for £120 + p&rp. Phone: 041 959 8465 after 6 p.m.

KW Vanguard, modified for CW-DSB. 160M, 80M, 40M, 20M, 30W input £40. No offers. Collect from Derby G3VKR. Tele: (0332) 762684. Resolute Buyers only please.

Have Microwave modules MMC144/28LO 2M converter (new) and HW-202 2M transceiver with manual (needs P.A. transistor), would exchange for Morse Tutor or 35mm S.L.R. or W.H.Y. Telephone: 0752 788798 (Plymouth).

Wanted KW Ezee match or similar. Tel: 0234 782443.

Cabin Cruiser wooden construction 18½ft 9½HP outboard. Genuine reason for sale, disabled and broke. Please no more time wasters. Phone: Medway 573739 any time £950 o.n.o.

SX200N Scanning Receiver, three months old, complete with wideband R.F. pre-amp, discone, mains PSU, manuals £250. Tel: 08893 3495 evenings.

# Free Readers' ADS!

*Buy, sell or exchange your gear through our free service to readers*

## CONDITIONS

1. These advertisements are offered as a free service to readers who are not engaged in buying or selling the same equipment or services on a commercial basis. Readers who are should contact our advertising department who will be pleased to help.

2. Advertisements will be inserted as and when space becomes available.

3. The insertion of advertisements will be on a first-come, first-served basis, subject to condition (2). As a result, it will not be possible to guarantee the insertion of a particular advertisement into any particular issue of the magazine.

4. Readers should either write out their advertisement in BLOCK CAPITALS or type it, underlining any words that are to appear in **bold**.

5. The magazine cannot accept any responsibility for printers' errors in the advertisements; however, we will do our best to ensure that legibly written advertisements are reproduced correctly. In the event of a gross error, at the Editor's discretion, a corrected version of the advertisement will be printed (at the advertiser's request) at the earliest issue in which space is available.

6. The magazine or its publishers will not accept responsibility for the contents of the advertisements, and by acceptance of these conditions,

the advertiser undertakes to indemnify the publisher against any legal action arising out of the contents of the advertisement.

7. The magazine reserves the right to refuse to accept or to delete sections of advertisements where this is judged necessary.

8. Advertisements are accepted in good faith; however, the publisher cannot be held responsible for any untruths or misrepresentations in the advertisement, nor for the activities of advertisers or respondents.

9. Advertisers must fill in their names, addresses and (if available) telephone number in the space provided, and sign the form to indicate acceptance of these conditions (forms returned without a signature will not be used).

10. All that is to be reproduced in the advertisement should be entered into the space provided on the form printed in the magazine – note that a **photocopy is not acceptable**. All advertisements must give either a telephone number and/or address for respondents to contact, and this must be included in the wording of the advertisement.

11. Advertisements must be 40 words or less in length (telephone numbers normally count as two words, exchange or exchange code plus number).

Name .....

Address .....

.....

.....

I accept the conditions above.

Signature .....

Send this form to: Free Readers' Ads, Ham Radio Today, 1 Golden Square, London WC2,

### ENTER YOUR ADVERTISEMENT HERE:

# EMPORIUM GUIDE

## AVON

**Booth Holdings Bath**

6 GOLF CLUB LANE, SALT FORD, BRISTOL  
Tel: 02217 2402  
Open: Tues-Sat 9am-9pm  
Close Mondays

RING 557732 BRISTOL

Radio Communications  
Amateur P.M.R. Marine

**UPPINGTON**  
Tele-Radio 1981 LTD

12-14 PENNYWELL ROAD, BRISTOL, G55 0TJ

## KENT

### THANET ELECTRONICS

95 Mortimer St, Herne Bay  
Tel: (02273) 69464

Open Mon-Sat 9-5.30pm  
except Thursday 9-1pm

### SCARAB SYSTEMS AMATEUR RADIO SOFTWARE

 STOCKISTS

29 Stafford Street, Gillingham  
0634-570441

## W. MIDLANDS

### DEWSBURY ELECTRONICS

176 Lower High St. STOURBRIDGE  
Tel: (0384) 390063

Open: 9.30-5.15. Closed Thurs. & Sun.  
ACCESS/BARCLAYCARD



### HEWARD'S HOME STORES LTD. (Est. 1983)

822/4 Kingstanding Rd., Birmingham  
B44 9RT. Tel. 021-354 2083  
G4RJM with 38 years in The Radio Trade  
Ham Equipment urgently wanted!  
Open: Mon-Sat 9-6

## NOTTINGHAMSHIRE

### PHOTO ACOUSTICS LTD

Tel: 0908 610625

Trio, Yaesu, Icom, FOK, Tona,  
Jaybeam, DRIWA, Welz.  
Instant credit, Barclaycard, Access  
58 High St, Newport Pagnell

### AMTRONICS (TONBRIDGE) G4 SYZ THE AMATEUR RADIO SPECIALISTS IN KENT

IT'S AMATEUR RADIO  
from AMTRONICS

8 Tollgate Buildings  
Hadlow Road, Tonbridge, Kent  
Tel: (0732) 361850

FDK, AZDEN, YAESU, JAYBEAM,  
FORTOP, DATONG, etc.

Technical enquiries  
G4STG

NEW IDEA LTD  
133 Flaxley Road,  
Stechford, Birmingham

Stockists of Yaesu, Trio, Kenwood,  
Totsuko, Tonna Antennas, Bantex.  
Full servicing repairs on all makes of  
amateur radio. Open Mon-Sat. 10am-7pm,  
Sundays. 10am-1pm.  
Tel: 021-784 3129

SALES  
G4SOV

## CHESHIRE

### DW ELECTRONICS G3X CF

Amateur Radio Supplies  
71 Victoria Rd, Widnes  
Tel: 051-420 2559

Open Mon-sat 9-6 (closed Weds) Sun 9.30-12  
We supply Yaesu, Trio, Kenwood, Tonna, Jaybeam,  
Microwave Modules, Datongs etc

## LANCASHIRE

### AMATEUR ELECTRONICS U.K./HOLDINGS



Yaesu, Tel, J-Beam, Frequency  
Counters, Draz, Datong, FT101  
Experts Repairs: 6JS6C, 12BY7A,  
6KD6, RF Clipper, Double Balanced  
Mixer, Warc Kit etc. S.A.E. List 15  
min. Junct. 31 M6. Free parking.  
45 Johnston Street  
Blackburn BB2 1EF  
(0284) 59595  
CLOSED THURSDAYS

### R. Withers Communications

584 Hagley Road West,  
Oldbury, Warley B68 0BS  
Tel: 021-521 8201/2 Tel: 021-550 9324

Opening hours: Mon-Sat 9.30-5.30pm  
Late night Thursday 8pm

For all your communication requirements.

ADVERTISE YOUR  
BUSINESS DETAILS  
HERE: Tel: 01-437 0699

## GREATER MANCHESTER

BETA COMM

Open 7 days a week  
Ham Radio CB & TV. 27 + 934 MG combined rig  
Computer software • Aerial fitting service  
231 Chorley Road, Swinton, Manchester  
Tel: 061-793 1010

## HAMPSHIRE

### FARNBOROUGH COMMUNICATIONS

97 Osborne Rd, North Comp,  
Farnborough. Tel. 0252-518009

Open: 6 days 10-6  
Yaesu, Icom, FDKs, Mosley aeriels, Jaybeams,  
G Whips

## ESSEX

### ARROW

Electronics Ltd  
5 The Street, Hatfield, Peverel  
Nr. Chelmsford, Essex CM8 3YL  
Tel: 0245 381673/381626



Trio/Kenwood, Tonna, Welz, T.E.T.  
K.D.K., Daiwa, Tono, Tasco

## LEICESTERSHIRE

ELLIOTT ELECTRONICS  
FOR THE RADIO ENTHUSIAST

26-28 BRAUNSTON GATE,  
LEICESTER. TEL: 553283

Open: Mon-Sat 9.00am to 5.30pm



## NORFOLK

### SPANNER CITY CB CENTRE



Open 6 days  
9am-6pm

Parkside Garage  
Thursford  
Fakenham  
Tel: Thursford  
402

Grandstand  
LA 83  
27 to 934 MHz  
TRANSVERTER

# EMPORIUM GUIDE

## NORFOLK

**Eastern Communications**  
 36 Cattle Market Street  
 NORWICH  
 Tel: (0603) 667189  
 MAIL ORDER ACCESS-BANKCARD  
 ICOM

**D.P. HOBBS (Norwich) Ltd**  
 13 St. Benedicts Street, Norwich  
 Tel: 615786  
 Open Mon-Sat 9-5.30  
 Closed Thurs  
 Stockists of:  
 YAESU, FDK, ICOM, JAYBEAM  
 & Electronic Component Specialists

## NOTTINGHAMSHIRE

**R.A.S. (NOTTINGHAM)**  
 P. Owen G8UUS  
 3 FARNDON GREEN; WOLLATON PARK  
 NOTTINGHAM: TEL: 0602 280267  
 Open: Tues-Fri 10-5.30, Sat 9-5  
 YAESU: FDK: ICOM: TONNA  
 HALBAR: WELZ: ANTENNAS & OWN GW5 H.F.

**SP ELECTRONICS**  
 48 Limby Rd  
 Huckhall, Nottingham  
 Tel: (0602) 640377  
 open Monday-Saturday  
 8.30-5.30

## SCOTLAND

**JAYCEE ELECTRONICS**  
 JOHN GM30PW  
 20 Woodside Way, Glenrothes, Fife KY7 5DF  
 Tel: 0592 756962  
 Open: Tues-Sat 9-5.  
 Quality secondhand equipment in stock. Full range of TRIO  
 goodies. Jaybeam - Microwave Modules - LAR.

## SOMERSET

G6HKT **AVCOMM LTD** G8KVG  
 25 Northload Street,  
 Glastonbury  
 Tel: 0458-33145  
 Open 9.30-5.30. Closed Wed

## SUSSEX

SOUTHDOWN  
**RADIO** 40 TERMINUS RD (opp.  
 EASTBOURNE Railway  
 SUPPLIES Tel: (0323) 639351 Stn.)  
 Open: Mon-Sat 10-6 (Closed Tues)  
 Stockists of: Yaesu, Trio, Tonna, FDK etc +  
 secondhand and ex-Government equipment in  
 stock

## SURREY

**GUILDFORD COMMUNICATIONS**  
 34 Aldershot Rd., Guildford  
 Open Mon-Fri 8am-6.30pm  
 Sat 8am-5.30pm Secondhand wanted  
 ICOM FDIC ASDEN TO75UK4

TO BOOK THIS  
 SPACE — PHONE  
**ASP CLASSIFIED**  
 01-437 0699

## TYNE & WEAR

Approved Dealer **ALYNTRONICS**  
 ICOM  
 129 Chillingham Rd, Newcastle-upon-Tyne  
 Tel: 0632 761002  
 Open: Tues-Sat 10am-6pm

## YORKSHIRE

4 Cross Church St, Huddersfield Tel:  
 0484 20774  
 Open: 6 days 9-5.30  
 Closed Weds. Thurs 9am-8pm  
 G4MH Mini Beam  
 'Always a good selection of new & 2nd hand equipment in stock'  
**Amateur Radio Shop**

DISCOVER THE WORLD WITH AMATEUR RADIO FROM  
 LAR Sales 27 Cookridge Street Leeds LS2 3AG  
 LEEDS 452657 OPEN MON-SAT  
 The PROFESSIONALS! 9am-5pm  
**TRIO ICOM YAESU**  
 LEEDS AMATEUR RADIO MAIL ORDER & SERVICE DEPT OPEN MON-FRI  
 60 GREEN ROAD MEANWOOD LEEDS LS6 4JP TEL 782224 8.30am-5pm  
 BRITISH MADE LAR PRODUCTS

**TELECOM**  
 6 New Street, Barnsley  
 South Yorkshire  
 Tel (0226) 5031  
 Specialists in Yaesu, Icom  
 and So-Kamp

## WILTSHIRE

**PACE ELECTRONICS**  
 76 Victoria Road, Swindon  
 Tel: (0793) 46807  
 Yaesu equipment, BBC Computers + Software for the  
 Spectrum, Commodore 64 & Amstruc.  
 Open 9-5 6 days a week  
 We do everything for the BBC

Please include my business details in the  
 next available issue of Ham Radio Today

Only £15.00 per insertion, call us  
 for series discounts on 01-437 0699

Business Name: .....

Address: .....

.....

Tel. No: .....

Open Hrs: .....

Contact (Office Use Only): .....

Post to: Emporium Guide, Ham Radio Today,  
 1 Golden Square, London W1.



## Lineage:

35p per word (minimum 15 words)

**Semi Display: (minimum 2 cms)**

£7.00 per single column centimetre

Ring for information on series bookings/discounts

All advertisements in this section must be prepaid.

Advertisements are accepted subject to the terms and conditions printed on the advertisement rate card (available on request)

01-437 0699

EXT 342

Send your requirements to:

Debbie Miller

ASP Ltd.,

1 Golden Square,  
London W1

## EQUIPMENT

# THOMSON

## ELECTRONICS

BASEMENT OFFICE, 5 DAVID PLACE, ST. HELIER, JERSEY, C.I.

### "MORSE MODULE"

Ready to use tone practice Osc.

Works with all Keys.

Price £5.50 + P&P 50p.



## RTTY

### RTTY TERMINAL BOARDS.

TTL output for computer £35 incl. and for teleprinter £39 incl. All boards come completely wired and tested with FSK and AFSK. S.A.E. for details to B. Brookes Electronics, 2 Leicester Street, Norwich. Tel: (0603) 24573.

RTTY for Spectrum/ZX81. 26 memories, split screen, buffered keyboard, auto TX/RX, P.C.B.'s, kits, RTTY/CW terminal units. For details SAE to G4MJC - G4FDW, 3 Aylesbury Ave, Eastbourne.

## EQUIPMENT

## RTTY

### ALPHA KEYS

Precision engineered keys for the connoisseur. Twin or Single paddle, and now the new "pump handle". One of the lightest and smoothest movement ever.

### CAVITY WAVEMETERS

For the UHF/VHF operator, one wave-meter to cover 144 mhz to over 2500 mhz. Can measure if as low as 50 mill watts with suitable meter.

### COAXIAL RELAY KITS

The cavity block is pre machined to take either BNC or N type sockets. Two types of cavity available. Alum type for HF, Brass for the higher frequency.

Send large SAE for more information to:

Paul Sergeant, G40NF  
6 Gurney Close, Costessey  
Norwich NR5 0HB  
Tel: (0603) 747782

## HIGH QUALITY CABLES

H100 50 ohm SUPER LOW  
LOSS ..... 80p per M (post 5p per m)  
Discounts:  
50m less 10% ..... 100m 20%  
UR67 .. 50 ohm LOW  
LOSS ..... 60p per m (post 5p p/m)  
UR43 .. 50 ohm  
stranded ..... 23p per m (post 3 p p/m)  
UR76 .. 50 ohm  
stranded ..... 23p per m (post 3p p/m)  
UR70 .. 75 ohm  
Coax ..... 23p per m (post 3p p/m)  
75 ohm Jwin  
Feeder ..... 18p per m (post 2p p/m)  
300 ohm twined slotted ribbon  
..... 20p per m (post 2p p/m)  
14 swg HD Copper  
As wire ..... 20p per m (post 2 1/2p p/m)  
STRONG PVC Covered Cu  
As wire ..... 6p per m (post 2 1/2p p/m)

SAE FOR FULL LISTS

**W. H. WESTLAKE**  
G8MWW  
Clawton, Holsworthy  
Devon

## Radio & RTTY Books

**Confidential frequency list.** Lists 10,000 CW, aero, Coastal, fax, etc, frequencies £8.25 + 60p P&P.  
**Guide to RTTY Frequencies.** Lists 4,500 commercial aero, UN, Coastal, etc, frequencies £7.35 + 50p P&P.  
**World Press Services Frequencies.** News RTTY Services listing GMT, and country plus more £5.55 + 50p P&P.2 + books P&P free.

### INTERPRODUCT LTD

HR1, Stanley, Perth PH1 4QQ  
Tel: 073882-575

## COMPUTER RTTY

Use your micro to transmit and receive RTTY

PL1 - PLL RTTY Terminal unit  
170Hz Shift ..... Transmit & receive  
Also handles ASCII ..... TTL in/out  
Kit ..... £13.50 ..... Built £17.50  
FP1 - Two channel active filter & PSU  
for PL1. Requires 15/0/15v AC.  
Kit ..... £7.25 ..... Built £10.75

Software for the DRAGON 32

RTTY send-recv program by

G4BMK

Split screen receive - Type ahead  
buffer. QSO review & many other  
features.

Cassette £12.00  
ROM Cartridge £21.00

**MORSE transceiver program up to  
150 wpm!**  
Cassette £9.75 Cartridge £18.50  
Hardware interface also available.

Please add postage to all orders -  
U.K. 60p Overseas £1.50  
Other hardware available for the  
DRAGON 32

For further details & full price list  
please send LARGE S.A.E. to:-

### PNP COMMUNICATIONS

62 Lawes Avenue, Newhaven  
East Sussex BN9 9SB  
P. Simmons G3XUS  
Tel: (0273) 51 4465  
Callers by appointment only please.

**BRITISH TELECOM** plug sockets & leads etc. Tel: C.W.A.S (0274) 731532. Or visit our showroom opposite Odsal Stadium, Bradford.

Reach the  
right audience  
at the right  
price, with  
**HAM RADIO TODAY  
CLASSIFIED**  
Tel: 01-437 0699

**BOOTH HOLDINGS**  
BATH, 6 GOLF CLUB LANE  
SALTFORD, BRISTOL BS18 3AA

Tel: SALTFORD 2402

INCORPORATES HAM HIRE AND RENT-A-RIG

## SOFTWARE EDUCATIONAL

**NEW PRODUCT!** Elbug no moving parts. Electronic Morserey. £27.50, or S.A.E. to EI-Tronics, P.O. Box 393, Chelmsford, Essex.

## AERIALS

**AERIAL WIRES & ACCESSORIES**  
Hard drawn copper wire 140ft 14swg  
£8.90. 50 metres 16swg £5.90. 10  
metres 12swg soft enamelled copper  
wire £3.50. 50 metres 1.4mm soft  
enamelled copper wire £5.75. G5RV  
Type Aerials. 1/2 size £12.00. Full size  
£13.95. 4mm Polypropylene Rope 50  
metres £3.95. 4mm Nylon Guy Rope 50  
metres £6.90. Ceramic Egg Insulators  
Large 50p. Small 40p. All items  
postage paid.  
S.M. TATHAM, 1 Orchard Way  
Fontwell, Arundel, West Sussex

**CERAMIC TAG STRIP** (Jack-  
son) 15 Tags 10 for £1. 6 Way  
Stand off terminals 10 for 75p.  
List 15p + S.A.E. Durrant Com-  
ponents, 9 St Marys St,  
Shrewsbury.

## G4B Mk Radio Software

Dragon & Coco, CBM 64, Acorn,  
Atom, VIC20.

**RTTY Transceive.** Split screen type  
ahead any Baud rate etc.

ALSO for Dragon:

**Morse Transceive.** Decodes & sends  
morse to 150wpm.

**Morse Tutor.** Any speed, any spacing.  
Includes a send practice facility.

**Amor System.** Available soon.

Grosvenor Software (H.R.T.)  
22 Grosvenor Road, Seaford  
E. Sussex BN25 2BS  
Tel: (0323) 893378

## DOUBLE H SOFTWARE

Complete Morse Tutor for 48K Spectrum

**MORSE READER**

Key morse to your Spectrum and see the  
plain English shown on your T.V.

**READER Tape** (Caps Shift key) £8.50

**READER TAPE** with Interface to link

morse key to your Spectrum £21.50

**SPECIAL READER TAPE** to link your

key to the ZX Interface 2 £11.00

**MORSE SENIOR**

Sends morse code sentences, words,  
letter/No. groups and own messages.

1000 word dictionary. 1-99wpm £5.50

Complete Package 1 - Morse Sender

Reader and Interface £26.00

Complete Package 2 - for users of ZX

Interface 2 £16.00

1 Woodridge Close, Haywards Heath  
West Sussex RH16 3EP

## ALARMS

**BURGLAR ALARM EQUIP-  
MENT.** Please visit our 2,000  
sq ft showrooms or write or  
phone for your free catalogue.  
C.W.A.S. Ltd, 100 Rooley  
Avenue, Bradford BD6 1DB.  
Telephone 0274 731532.

ADVERTISE  
YOUR SOFTWARE  
PROGRAMMES  
HERE:-

## BETA COMM

### ALL AMATEUR AND CB NEEDS

ICOM, TRIO and YAESU, CYBERNET  
HARBARD and UNIDEN.

TAGRA, G.WHIP, HOXIN, MICRODOT

RTTY, SWR & power meters.

Receivers & linears. Plus all other

accessories.

Aerial Fitting Service

231 Chorley Rd., Swinton,

Greater Manchester.

Tel: 061-793-1010





# GENERAL COVERAGE RECEIVER KIT FCR 130

This is a complete kit which allows you to build and learn as you go. Suitable for anyone who has an interest in radio and can manage a soldering iron. It really is within the scope of most beginners. You don't have to be a 'semi-professional amateur' to understand how it works as we supply very comprehensive and complete instructions, written in plain language. Well spaced components so its OK for fat fingers! The receiver tunes, in 3 bands from 1 to 30 Mhz. Solid aluminium tuning and control knobs and base panel. Black anodised front panel. Nice to build . . . nice to look at . . . nice to own.

Model FCR 130 Receiver kit . . . . . **ONLY £75.30 inc VAT. Post & Packing £2.40**

- ★ 30:1 Geared analogue tuning
- ★ 3 Band switch with spare position
- ★ Tape record socket
- ★ Headphone socket
- ★ Signal Meter
- ★ Internal speaker + On/Off sw.
- ★ A.F. Gain and Tone Control

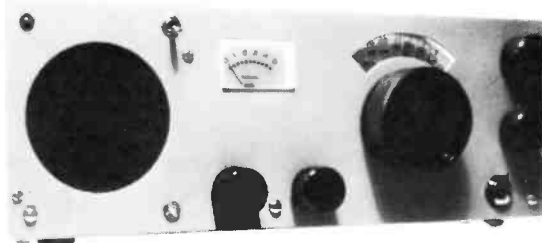

**COMMUTECH (Devon) LTD** Chapel Street, Holsworthy,  
Devon EX22 6AR Tel: (0409) 253504



## SCARAB SYSTEMS RTTY SYSTEMS

SCARAB SYSTEMS produce a more comprehensive range of amateur radio software/hardware for most popular home micro computers than any other company, including programs for RTTY, Morse tuition and QTH locators (BBC now includes the G4ANB system).

### MPTU-1 TOMORROWS TECHNOLOGY FOR TODAY'S PERFORMANCE

THE MPTU-1 terminal unit is perhaps the biggest step forward in PLL design and combines high performance with low cost and no compromises. The unit is ready built and contained in its own case with internal power supply. It will work with any computer system that operates at logic level. The unit eliminates the need for endless preset alignments, preamplifiers and filters, all increasing the likelihood of failure. The MPTU-1 is as sensitive as most active filters (less than 10mV) it can handle much higher baud rates than active filters without circuit adjustments (up to 300 typically), wider shifts are catered for without loss of performance, the unit can be set up to decode the RTTY output from modern H.F. transceivers (i.e. 2125 & 2295 Hz) if required. Output from the AFSK generator can be varied from the front panel (upto 100mV). Logic connections are provided on a robust 3-pin socket, while the connections to the transceiver are made via 3.5mm jack sockets, all the plugs are supplied. **Don't be put off by the advertisements declaring PLL circuits are low performance.** With a design like the MPTU-1 our competitors have good reason to be worried.

MPTU-1 £69.70 (REF:MH50H)

MPTU-1 + software for BBC, VIC20 or PET £76.00

(COMING SOON RTTY FOR COMMODORE 64)

To use the MPTU-1 with the Sinclair range of computers another interface board will be required please write for details of this and our other products.

SPECTRUM RTTY WITH SPLIT-SCREEN. This program offers many outstanding features including 9 useable memories, cw ident, type ahead buffer, PTT output, real time clock, 3 adjustable baud rates and many more useful features.

Trade enquiries welcome

**SEE US AT THE NEC  
STAND E19. APRIL 28-29**



39 Stafford St, Gillingham  
Kent ME7 5EN  
Tel: Medway (0634) 570441



## WOOD & DOUGLAS

### HAVE YOU an IC4E?

Would you like 10W output?

Then you need our **NEW 70LIN10 UHF Linear**

This module is based on our popular 70LIN3/10E pcb which incorporates not only a well designed linear amplifier stage but also a temperature compensated bias network and full r.f. changeover facility. The PIN diode circuitry allows a straight through path during receive periods or when the power supply is disconnected making the unit failsafe to accidental damage. If you wish to use it for SSB transmissions the internal 'hang-time' will be advantageous as will the hard switching capability. Just apply 1.5W of drive for 10W output or 1W for typically 7W output!

The board is available as a pcb kit or assembled tested module without external hardware although boxes and heatsinks are available if desired.

INTRODUCTORY PRICE

Kit: **£32.50**

Assembled: **£44.25**

HAVE YOU SEEN OUR PACKAGE OFFERS?

	Kit
1. 50mW TV Transmit (70FM05T4 + TVM1 + BPF433)	30.00
2. 50mW TV Transceiver (As 1 above plus TVUP2 + PSI 433)	50.00
3. 10W TV Transmit (As 1 above plus 70FM10 + BDX35)	50.00
4. 10W TV Transceiver (As 2 above plus 70FM10 + BDX35)	70.00
5. 70cms 500mW FM Transceiver (70T4 + 70R5 + SSR1)	70.00
6. 70cms 10W FM Transceiver (As 5 above plus 70FM10)	90.00
7. Linear/Pre-amp 10W (144PA4/S + 144LIN10B)	36.00
8. Linear/Pre-amp 25W (144PA4/5 + 144LIN25B)	40.00
9. 70cms Synthesised 10W Transceiver (R5+SY+AX+MOD+SSR+70FM10)	120.00
10. 2M Synthesised 10W Transceiver (R5+SY+SY2T+SSR+144FM10)	100.00

Delivery of our products is usually from stock but due to the heavy demand we have experienced in past months please allow 28 days maximum. Please include 75p for postage and handling on your total order and an SAE with any written enquiries. Telephone orders are gladly accepted or try one of our many agents such as:-

**ANNLEY TECHNICAL SERVICES**  
AIRCOM  
DEWSBURY ELECTRONICS  
J BIRKETT

Bristol 632622  
Abergavenny 2566  
Stourbridge 390063  
Lincoln 20767

See us at  
the NEC  
on stand  
No A2.

TRY A KIT WE KNOW YOU WILL ENJOY IT!

UNIT 13  
YOUNGS INDUSTRIAL ESTATE  
ALDERMASTON, READING RG7 4PQ  
Tel: 07356 5324 Tx: 848702



# ARROW

**CHOICE**

When you are tempted to a new rig you owe it to yourself to go to a store where you can see the competing models. It doesn't make sense to travel 100 miles or more to see one brand. ARROW STOCK YAESU, TRIO/KENWOOD & ICOM.

**COME AND TRY THEM SIDE BY SIDE**

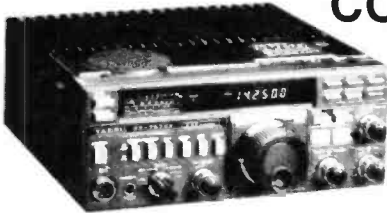

FT757GX



TS-90S



IC745

How about a new receiver, does your dealer offer you a choice of current models or only one brand? AT ARROW YOU CAN TRY:



R2000

R70



R71E

FRG  
7700



**HAVE YOU TESTED & COMPARED 2M HANDHELDS IN YOUR LOCAL DEALER?**

ARROW HAVE A TOP LINE 2500 LS200E C110/IC2E for you to try, together with all accessories plus the 70cm version. Some more HOT news soon the SK202E from ICOM, the FT2000 from Yaesu and the SK202 from SOMMERKAMP which will really be a winner on price and performance.)

DOES YOUR DEALER PUSH HIS CREDIT CARD AT YOU, or do we offer you a choice of payment methods? ARROW will accept AMEX, BARCLAYCARD, EUROCARD, MASTERCARD, VISA, TRUSTCARD, CREDIT CHARGE (in STORE PAID), and of course we have our own card to Travelees, Travellers cheques, in all major currencies (and we can offer special export schemes saving tax). Or how about Interest Free Credit, No Hire purchase, No Deposit HP? We will be happy to advise you on the most economic method for your purchase.

**EXPERTISE.** Everyone claims to have it, but rest on our reputation. No every company can have designed and manufactured transmitters for commercial use including some of the very best frames in Show business.

**SERVICE.** Not just the ability to mend your rig, but a sales system where equipment is tested before despatch, where the sales staff are interested users of the equipment, who will never refuse to service your equipment "because you didn't buy it from us" or suchlike.

**PRICE.** With 3 store buying power Arrow buys competitively as any dealer — bulk buying is the answer to our terrific price deals. **WE BUY BIG — RING US FOR PLEASURES!**

**ARROW ELECTRONICS (SCOTLAND)**  
51 Hyndland Street, Glasgow.  
Tel: 041 339 6445  
Where Bill McJimpie G6NHJ will be happy to serve you with a good selection from our product range and Bill has full stocks of all our discount offers.  
If you speak Welsh or English it's all the same at  
**ARROW ELECTRONICS**  
14 Carreg-y-gad, Llanfair-p-g, Anglesey.  
Tel: 0248 714657  
where John Lewis GW8UZZ will be pleased to discuss that new rig.

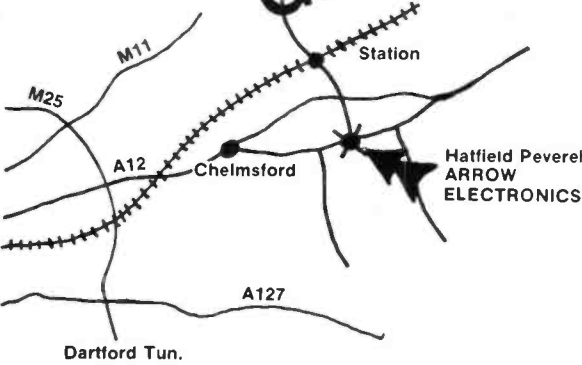

**GRAND OPENING 30th MARCH**



"PHONE YOUR ORDER FOR TODAY'S DESPATCH ALL WE NEED IS YOUR  OR  NUMBER. SMALL SPARES - PLUGS - AERIALS - PHONE FOR A QUOTE FOR THAT NEW RIG!"

OPEN 5 DAYS A WEEK. CLOSED THURSDAYS