

HAM

AN ARGUS SPECIALIST PUBLICATION

APRIL '84

RADIO

TODAY

**Remember the DSB80?
Meet the DSB-2!
Simple, low power
transceiver**

PLUS

**New series -
RF Building Blocks
by G4JST**

RADIO OPERATOR'S GREAT CIRCLE
MAP OF THE WORLD

presented free with November 1983
issue of TODAY

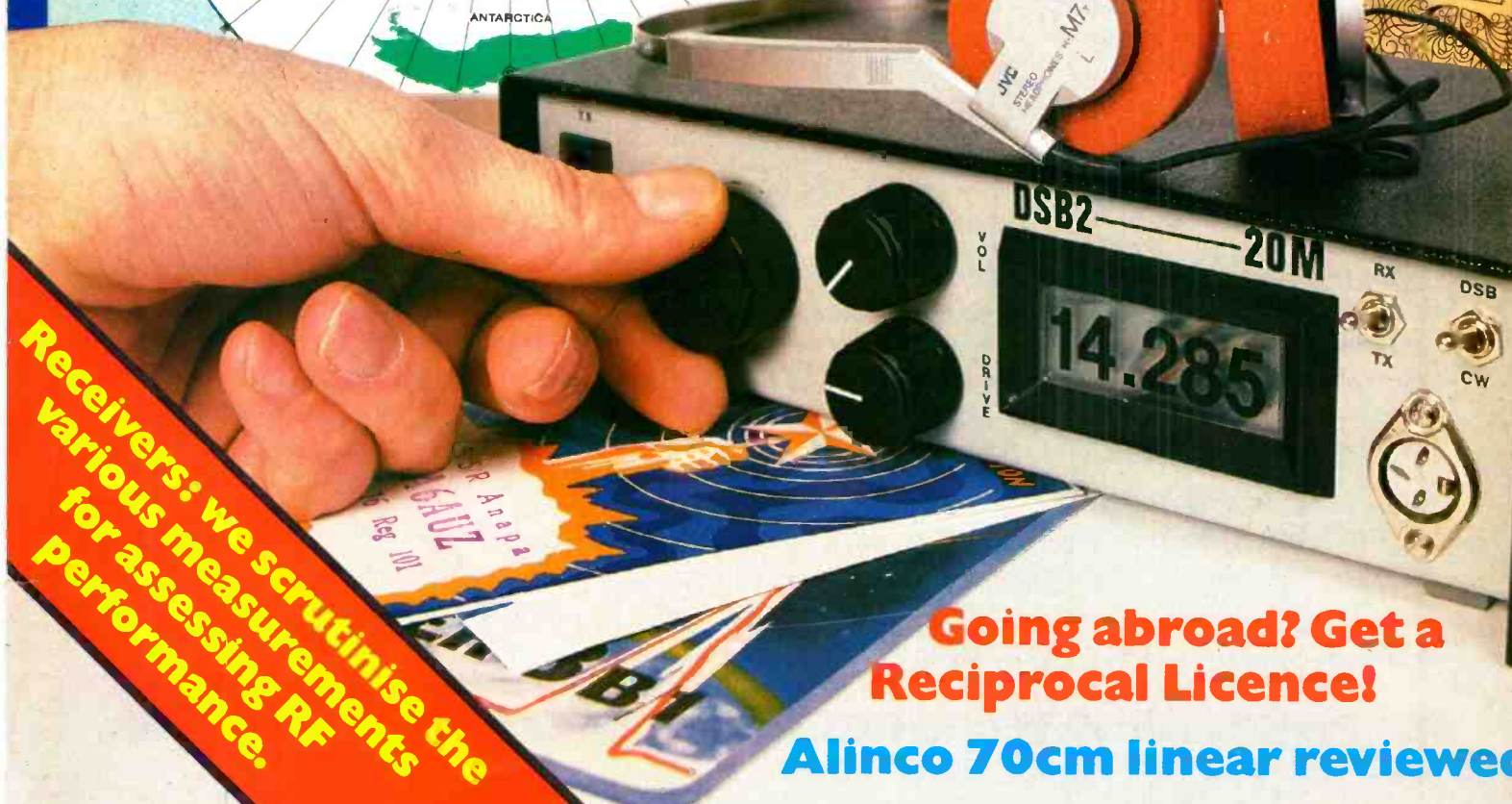
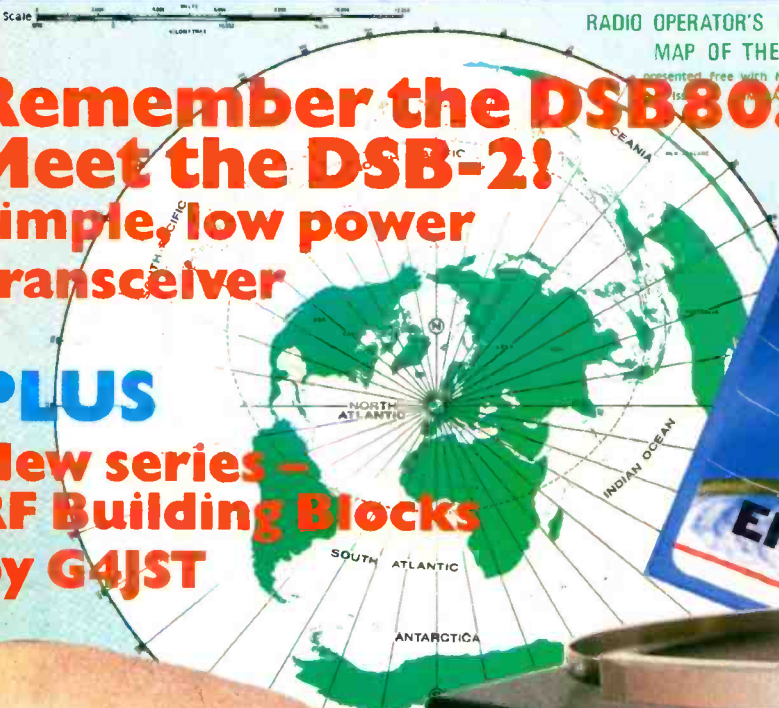

**Receivers: we scrutinise the
various measurements
for assessing RF
performance.**

**Going abroad? Get a
Reciprocal Licence!**

Alinco 70cm linear reviewed

HAM RADIO TODAY MORSE COURSE

The most effective route yet to your Class A amateur licence!

Professionally produced for HAM RADIO TODAY by Shirley Hesketh G4HES and Ron Ray G3NCL, this advanced interactive learning system makes use of the stereo cassette format to provide tuition to the 12wpm test standard.

With its carefully designed structure, we think that the HRT MORSE COURSE is more effective than either morse classes or electronic morse generators.

Based on TWO C-60 cassettes, it offers the controlled prompting so necessary for the initial stages of morse tuition, followed by carefully paced test material to bring the student up to speed. Full tuition notes are provided with the cassettes.

To receive your MORSE COURSE simply fill in the coupon below and return it to: 'HRT MORSE COURSE', Argus Specialist Publications Ltd, No1 Golden Square London W1R 3AB

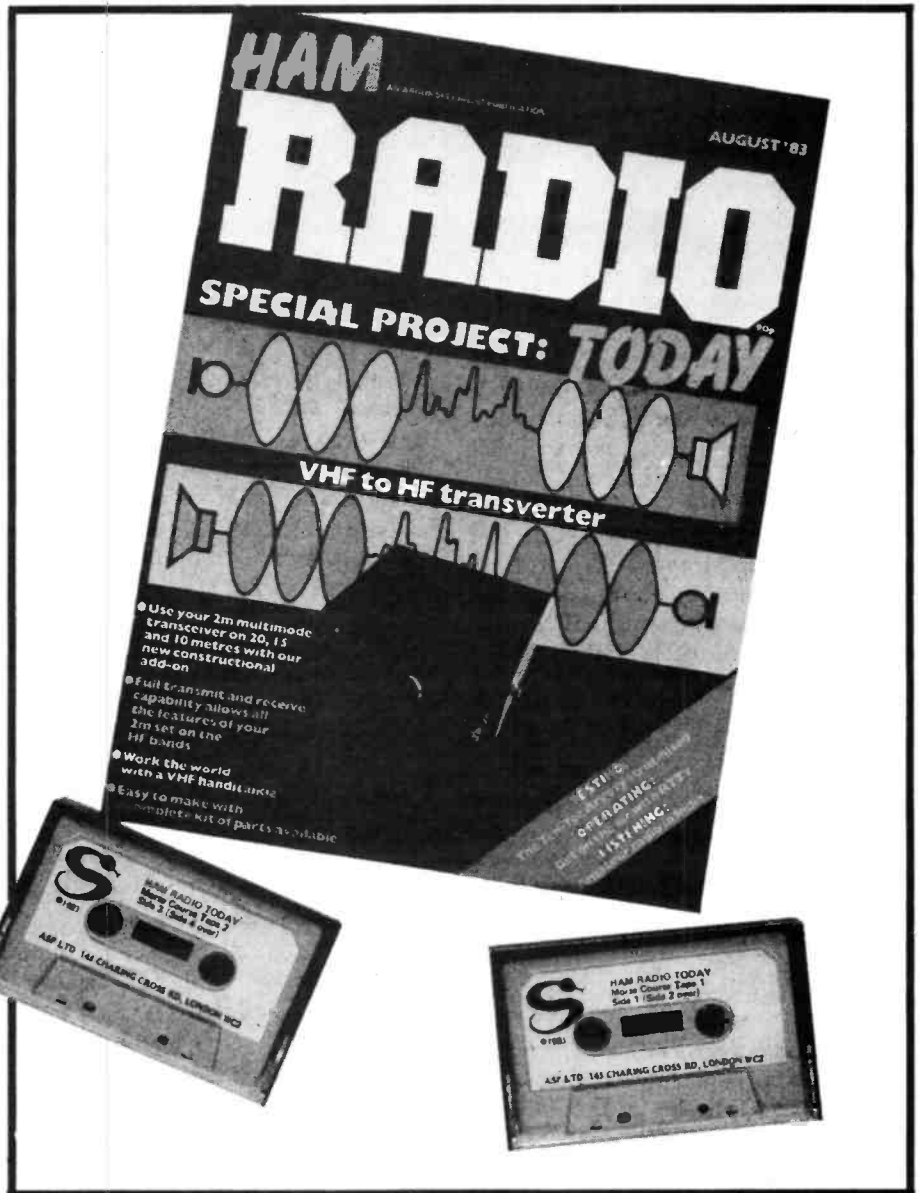

Please send me the 'HRT Morse Course' at £11.45 all inclusive of P & P and VAT. I enclose cheque/PO for £..... (payable to ASP Ltd) OR Debit my Access/Barclaycard (delete as necessary)

Please use BLOCK CAPITALS
 Name (Mr/ Mrs/ Miss)
 Address

 Postcode
 Signature Date

Please allow 21 days for delivery

HAM RADIO TODAY

CONTENTS

VOLUME TWO NO. 4 APRIL 1984

Acting Editor
Steve Ireland, G3ZZD
Consultant Editor
Dave Bradshaw

Advertisement Manager
David Gadsden, G4NXV
Classified Sales Executive
Debbie Miller

Managing Editor
Ron Harris
Chief Executive
T. J. Connell

Published by:
Argus Specialist Publications Ltd.,
1, Golden Square,
London W1R 3AB.
Telephone: 01-437 0626

Distributed by:
SM Distribution Ltd.

Printed by:
The Garden City Press Ltd.

Subscription Rate:
UK £14.00
O/Seas Sur: £14.45
O/Seas Air: £27.00
Ham Radio Today,
Subscriptions Dept.,
PO Box 35,
Wolsey House,
Wolsey Road,
Hemel Hempstead,
Herts, HP2 4SS

Ham Radio Today is normally published on the first Friday in the month preceding cover date. The contents of this publication including all articles, designs, plans, drawings and programs and all copyright and other intellectual property rights therein belong to Argus Specialist Publications Limited. All rights conferred by the Law of Copyright and other intellectual property rights and by virtue of international copyright conventions are specifically reserved to Argus Specialist Publications Limited and any reproduction requires the prior written consent of the Company. © 1983 Argus Specialist Publications Ltd. All reasonable care is taken in the preparation of the magazine contents, but the publishers cannot be held legally responsible for errors. Where mistakes do occur, a correction will normally be published as soon as possible afterwards. All prices and data contained in advertisements are accepted by us in good faith as correct at time of going to press. Neither the advertisers nor the publishers can be held responsible, however, for any variation affecting price or availability which may occur after the publication has closed for press.

REGULAR COLUMNS

LETTERS	4
RADIO TODAY	6
RADIO TOMORROW	8

CONSTRUCTION

MEET THE DSB-2!	10
<i>For any single band 160 to 15m</i>	
MINISYNTH	38
<i>Simple, flexible, high stability synthesised VFO – to suit the DSB-2 to the FT101</i>	

FEATURES

RADIO BUILDING BLOCKS	25
<i>Frank Ogden, G4JST, looks at mixer design.</i>	
THE LONGEST CALLSIGN?	29
<i>In Part 2, Steve Lowe, G4JVG, describes the Market Reef radio operation.</i>	
RECEIVERS: ASSESSING RF PERFORMANCE	47
<i>Angus McKenzie investigates what we need from a 'front end'.</i>	
RECIPROCAL LICENSING	56
<i>Want to take the rig abroad? Read Sharon Metcalfe's article first!</i>	
SPACE SHUTTLE POST MORTEM	58
<i>Mike Jones, G6GOS, sums up.</i>	

REVIEWS

TRIO TM201A COMPACT 2m FM TRANSCEIVER	35
<i>George Metcalfe, G6VS, gives the driver's point of view.</i>	
ALINCO ELH710 70cm LINEAR	35
<i>Trevor Butler, G6LPZ, puts more poke on 70cm.</i>	
JOB OPPORTUNITY – HRT NEEDS YOU!	24
NEXT MONTH IN HAM RADIO TODAY	28
ADDENDUM	55
AD INDEX	55
Free Readers' Ads	60
Emporium	63
Classified	65

LETTERS

BOOKS FOR BEGINNERS

Sir, As a one time organiser of an RAE class, I found your reply to Miss A. Cox surprisingly unhelpful, since you obviously try to encourage beginners.

Surely when someone asks for a recommendation they've already tried libraries and bookshops and either been baffled or disappointed by the paucity of suitable books.

When I asked the same question I always recommend one book as essential — the 'Radio Amateurs Examination Manual' — and one as a very useful basis — the 'Guide to Amateur Radio'.

Both are available from RSGB Publications Sales, Alma House, Cranbourne Road, Potters Bar, Herts EN6 3JW, respectively priced at £3.42 and £3.44 — unless you are a member of the RSGB when they are 10% less.

HRT knows all this of course — Miss Cox doesn't. You would be helping a lot of others, by passing this information on.

John Butcher G4GWJ/DA1DC

Miss Cox's letter requested help in understanding the 'electronics and mathematics' which go into Ham Radio. If anyone enquires, wanting a general introduction to the hobby, the very first thing we do at HRT is to recommend them 'A Guide to Amateur Radio' — as a must — and send them hotfoot to the local radio society. The next recommendation is to find a nearby college/education centre which runs a course in the RAE and to purchase the RSGB RAE manual

Excellent as both those book are, they are not really, and were probably not intended to be, basic blow-by-blow guides to electronic theory. I personally found the level of the RAE manual to be rather higher than I could manage when I first wanted to read about radio — although I found the 'principles' chapter of the 'RSGB Radio Communication Handbook' to be of enormous help. Modmags publish a book called 'Electronics — It's Easy' by Peter Sydenham which is distributed by our parent company at PO Box 35, Wolsey House, Wolsey Road, Hemel Hempstead, Herts HP2 4SS for £4.95 which gives a good, general and contemporary introduction to electronics. With luck, all the above may be found in the local library.

OMNI OWNER

Sir, Having just brought a GPV-5 omni-directional co-linear antenna I read with interest G5UM's comments

regarding 'inconsiderate hams who use omni-directional antennas and inflict his/her signal on hundreds of others to whom it is not directed'.

I wonder how Jack goes on when he is in a 'net' or on with more than one station? Does he continuously swing his beam from one station to another?

What about SWLs who might have enjoyed listening in but were in the wrong direction?

I would be interested in knowing what other omni-directional antenna owners think of his comments?

J. Hunter G6ZBW

If you had a 2m beam you would find the side and back lobes of a reasonably sited antenna of this type quite large enough for your signal to be easily heard in all directions, locally and semi-locally. Net operation on VHF usually tends to fail within these two categories in my experience — your signal might not be S9 + 20 with all the stations on the net, perhaps just a mere(?) S9. And just think of all that lovely DX that you could work with ease. . .

STILL HOT STUFF

Sir, My interest in short wave radio has recently been rekindled after a lapse of several years. It originally began when the most exciting general purpose receivers available to the price conscious enthusiast were Bomber Command's R.1155, Marconi's CR100 and the HRO.

On picking up a recent issue of *Ham Radio Today* as the first step in determining what represent today's top notch receivers I see that I am confronted by an array of names that thirty years ago would have seemed well nigh unpronounceable. What is a bit more disturbing though is the tendency to reform the English language as evidenced by adverts for "2 Meter Transceivers". One might substitute color(ugh) for colour but meter and metre are not interchangeable since one is a measuring instrument, the other a unit of length. In fairness to HRT this is advertisers copy and not editorial, so I hope other readers 'copy' me.

H. Humphries

NOT 'AN HRT FIRST'!

Sir, "A HRT First?" No — it wasn't. We had special-event stations on the Practical Wireless stands at Breadboard '80 (190 contacts), Breadboard '81 (221 contacts) and Electronic Hobbies Fair '82 (only 50 contacts — we were kept too busy

talking to visitors and demonstrating SSTV reception).

G C Arnold, Editor.

WORKED ALL BRITAIN

As the acting Contest Manager for the 'Worked All Britain' group, I am writing to you to ask if you would kindly print our contest dates in your magazine.

The Worked All Britain group was first established in April 1969 by the late John Morris, G3ABG. WAB is entirely a voluntary organisation and no radio amateur has ever received payment for his work in WAB.

Worked All Britain is just what it says, the idea is to exchange reports from "areas" which are defined by the National Grid reference system of Great Britain and Northern Ireland.

To become a member of WAB you simply have to buy a WAB record book at a cost of £4.50.

The profits that are made are used for two aims:

1) To use to buy certificates, print WAB record books and produce other items ie. trophies for the WAB contests (see *Radio Tomorrow* for details — Ed)

2) We until recently made payments of RAIBC (Radio Amateurs Invalid and Bedfast Club) to assist other amateurs less fortunate than most.

We have recently been forced to have our record books printed commercially and this has required most of our profits.

There are now 4200 members of WAB, or bookholders. We have a constitution and a committee, and we have regular committee meetings and an AGM, which is held each year at Drayton Manor Rally.

Our nets are on the air most days on 3.5, 7.0 and 1.8MHz.

Steve Lawrence G4EOF

KW2000 ON 10MHz

Sir, it is with some interest I read the somewhat vituperative correspondence between G3KVG and G3TNO on the KW2000 mod. for 10MHz.

I tend to agree with G3KVG that the use of 6577.5KHz and doubling is bad practice. G3TNO's comment that "the intermodulation would be there" is, I am sure, not quite what he means — the discussion is on the subject of mixer spurious products rather than multiple input signal modulation. However, mixers of the sort used in the KW2000B give widely differing levels of spurious, depending upon injection levels, voltages, coil Q's

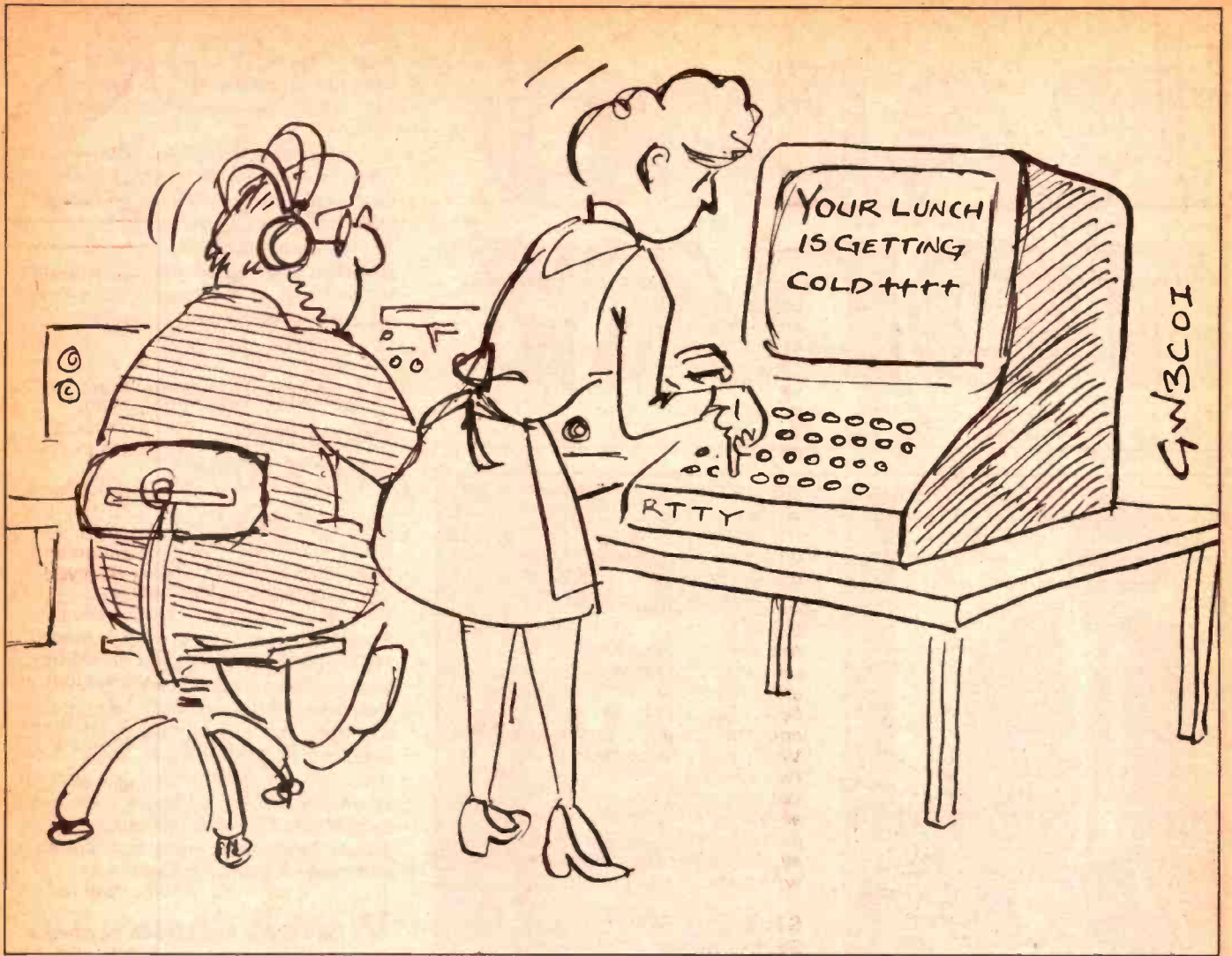

earth loops, etc., and the results may well vary from equipment to equipment. Anyone interested in typical performance should read Pappenfus, Bruere and Schoenike, Single Sideband Fundamentals and Circuits, published by McGraw Hill in 1964 — and probably the best 5 quids worth of text book I've ever bought!! Although written around valves, an awful lot of it applies still.

Reduction of Q in the anode circuit of the xtal oscillator is not difficult, so the use of 13.155MHz, would, I feel, not offer insurmountable problems.

Strangely enough, there were quite a number of us who worked at KW believed that in many ways, the '2000A was better! Such as the price of progress!

Pete E. Chadwick G3RZP

PHONETICS REVEALED!

Sir, The list of Vintage Phonetics shown as 'Military Exercise' and 'Inter Service Use' in the letter by Basil Spencer G6VAN are, according to The Curator of the Royal Signals Museum, the service phonetics introduced in 1938 and 1941 respectively.

For the information of Peter Murray G4UBV who originally requested information on this subject, there were three previous phonetic alphabets

introduced in 1904, 1914 and 1927.

They were:

1904	1914	1927
Ack	Ack	Ack
Beer	Beer	Beer
C	C	Charlie
D	Don	Don
E	E	Edward
F	F	F
G	G	G
H	H	Harry
I	I	Ink
J	J	Johnny
K	K	K
L	L	L
Emma	Emma	Monkey
N	N	N
O	O	O
Pip	Pip	Pip
Q	Q	Queen
R	R	R
Esses	Esses	Sugar
Toc	Toc	Toc
U	U	U
Vic	Vic	Vic
W	W	W
X	X	X
Y	Y	Y
Z	Z	Z

There was, apparently, no phonetic equivalent where a single letter is shown, but it is interesting to note that with the passage of time more and more phonetics were introduced, but it was

not until 1938 that a full phonetic alphabet was introduced for Service use.

George Metcalfe G6VS (Ex-VU2EU)

SPEECH PROCESSOR

Sir, With reference to your September issue of Ham Radio Today, could you please advise me where to obtain the SL6270 integrated circuit as used in the speech processor.

I have tried to obtain this from C.M. Howes Communications but they refuse to supply any components unless required as spares for a kit already purchased from them.

Brian Sheriff

Don't be too hard on CM Howes Communications, they have to obtain their components from suppliers just like you or I — which costs them time and money and the only way they can really make that up is by selling complete kits. The IC is readily available from Ambit International, 200 North Service Road, BRENTWOOD, Essex (0277-230909) for £2.00 plus postage and the catalogue number is 61-06270.

Please address correspondence to:
Ham Radio Today,
 1, Golden Square,
 LONDON W1R 3AB.

RADIO TODAY



Keith Fisher, G3WSN, introduces Tony Whittaker, G3RKL, talking on SSB repeaters, at the Midlands VHF Convention (Photo G8DJC)

Sweet Caroline

Perhaps not the best present for legal radio operators is a new book on the life and times of Radio Caroline, written by the longest serving of the station's DJs, Andy Archer. The book is 40 pages long and costs £4.00 per copy from Seagull Sales, BCM Box 66, London WC1. (And you thought HRT was expensive at 95p for 68 pages!)

Satellite Software

Following a few teething troubles at the start of the Amsat-UK software service, there is now a range of tapes available for satellite applications. Programs include satellite tracking routines, RTTY, and EME tracking. More details from the Hon. Sec./Treasurer, Amsat-UK, Ronald J.C. Broadbent, 94 Herongate Road, Wanstead Park, London E12 5EQ (SAE probably appreciated!).

RSGB Clarifies Transceiver Usage

The RSGB has entered in to the controversy over the legality of the use of transceivers by SWLs for receive only, and has stated that this is perfectly legal provided the transmit facility is not used.

Confusion is generated by Section 1 of the 1949 Wireless Telegraphy Act, which makes it an offence to establish or use *any* station or wireless for wireless telegraphy without a licence; since the abolition of the licence for receiving broadcast transmissions, it would seem to be illegal to possess even the family tranny!

However, Regulation 3 of the Wireless Telegraphy (Broadcast Charges and Exemption) Regulations 1970 makes it legal to install or use sets for receiving broadcast and amateur transmissions without a licence. The RSGB point out (and have had this point confirmed by the

Department of Trade and Industry) that the exemption makes *no* reference to the capabilities of the apparatus used – so it does not prohibit the use of transceivers, but rather the actual transmission of signals.

So how did Michael John Craven come to be fined for using a transceiver purely for listening (HRT August 1983)? Unless there was a miscarriage of justice, it would seem that the only possible explanation must be that he was unwittingly transmitting, as was suggested by one of our readers in the November 1983 Letters section.

Tighter Specs For Modified FRG7700M

Surrey Electronics Ltd, of The Forge, Lucks Green, Cranleigh, Surrey GU6 7BG (telephone 0483 275997) say that they have tightened up the specifications of their Broadcast and Communications Receiver, which is a modified Yaesu FRG7700M. According to Surrey Electronics, the principal modifications that they make to the receiver are to redesign the front end stages, flatten the audio response on SSB and AM, improve the distortion on AM, correct the FM de-emphasis, provide a balanced line audio output and buffered IF output and improve mains safety. Prices start at £437, including VAT and carriage.

Want A Chance To Go On 50 MHz?

Then write to the RSGB before 31st March! The 50MHz 'experiment' is to be extended from the present 40 stations up to 100 stations, and the RSGB will be choosing who should get the go-ahead.

If you have already contacted the RSGB and submitted a completed questionnaire to them, all you need to do is to write confirming that you're still interested. If you haven't submitted a questionnaire, you'll have to contact them to get a questionnaire, and pretty quickly. Write to The Secretary (50MHz) at RSGB headquarters, Alma House, Cranbourne Road, Potters Bar, Herts EN6 3JW. Forms have to be returned by 31st March at the latest.

Grim Prospects For Radio In Brazil

We have received disturbing reports of the conditions under which Brazilian amateurs are working, due to their equivalent of the RSGB. A group of Brazilian amateurs are now trying to overthrow the monopoly that their radio society, LABRE, has.

The group point to the absence of activity of Brazilian amateurs in a wide range of areas, such as UHF, microwave, RTTY, SSTV, satellite work, EME and DX-peditions. They allege that while they pay about the same as ARRL members, all they get from LABRE is the QSL beauro, not even a monthly newsletter. At the same time, they say that the headquarters of LABRE offer luxurious facilities to officials (not a charge one could level at the RSGB!).

Another area of dissatisfaction is that Brazilian amateurs are obliged to join LABRE; if they leave, the authorities take away their licence. The group state that by complaining about LABRE, they risk losing their licences anyway.

We would very much like to know more of the situation in Brazil; if anyone has recently come to the UK from there, or has had contact with any PYs, please get in touch and tell us more of what is going on.

G5CCI On Page 3!

Angelika Voss, G5CCI, recently graced page 3 of a certain national newspaper (no, not the Sun, the Guardian). This was as a result of her leading the very successful campaign to retain G5 callsigns for foreign amateurs who live in the UK.

The argument revolves around the use of the G5 block. There are a total of 17,000 callsigns that could be used with the G5 prefix. At the moment, about 4,000 have been allocated to foreign amateurs resident in the UK, although only about 200 to 600 are believed to be current. That leaves 13,000 unallocated signs that could be used, or 8,500 if the block were split down the middle for administrative convenience. However, the RSGB say that they need the whole block of 17,000 to meet their projected needs (even though the whole of both the G7 and G9 blocks have been allocated to research).

The G5s have now been offered a one-year stay of execution, and the allocation of corresponding G0 or G1 callsigns; so, for instance, Angelika would become GOCCI. But what will happen when the RSGB eventually issues (or rather, reissues) the callsign G5CCI?

Angelika says that the G5s intend to keep their campaign going for as long as they possibly can, and that the campaign is receiving wide support – including that from Ham Radio Today.

PS. As if to add insult to injury, the Post Office circular to Angelika started "Dear Mr Voss . . .".

Only Kings And Ladies

Gloria Hils, G4UYL, from Gillingham, Kent, was rewarded contact with Dr

Owen Garriott, W5LFL, in the Space Shuttle Columbia. Dr. Garriott listened in to thousands of calls from radio amateurs all over the world, but only a very few were singled out for return calls. Gloria, who shared this honour with King Hussein of Jordan, thinks that the comparative rarity of women's voices on the airwaves could be the reason that her signal was picked out. Her station, which Gloria shares with her husband G8STO, puts about 100W into a 14 element Parabeam about 6m above the ground and is in a somewhat less than favourable location for VHF operation.

On a rather sadder note, she finds that being a woman radio amateur these days is not always a happy experience, often being subjected to extremely male chauvinistic remarks on-the-air. We at HRT think this is *extremely* disgusting to say the least and the perpetrators more than somewhat sick. 'Vive la difference' and congratulations to Gloria! *For more on the Space Shuttle experiment see Mike Jones', G6GOS, Post Mortem, elsewhere in this issue.*

New General Purpose Oscilloscope

A new general purpose, dual trace oscilloscope announced by Bridge Scientific Instruments Ltd., Skipton, costs less than £200 (excluding VAT) and is British built. The design concept of the DB242 has been specially developed to take into account the needs of educational and industrial laboratories, test bays and service departments. Small in size and highly portable, the new oscilloscope is also suitable for radio and TV maintenance.

Sensitivity can be varied from 50mV/cm in independent switched sequences for each channel. Sweep speeds can be varied between 1us/cm and 0.2s/cm using calibrated switch positions.

A cheaper single trace version, the Bridge SB11 oscilloscope is also available. The general specification is similar but without the twin channel facilities.

Launch Date Confirmed By NASA

NASA has formally confirmed it will launch UOSAT-B, the University of Surrey's second experimental scientific and educational spacecraft, and the University's UOSAT Project Team is racing against time to get the spacecraft built and tested in time for launch on 1 March

To design, build and test a spacecraft of such complexity and get it to the launch-pad in under five months is a task probably without precedent in space engineering. The offer by NASA of a launch opportunity at such short notice is an extremely generous one and emphasises the high esteem in which NASA holds the University Project Team.

UOSAT-B, to be known after launch as UOSAT-2, will go into space as a secondary payload with LANDSAT-5 on a Delta 3920 rocket from the Western Test Range, Vandenberg, California. The launch is at present scheduled for 1 March 1984 at 1759 to 1809 hrs GMT, and should lift UOSAT-2 into a sun-synchronous polar orbit at a planned height of 700 km (435 miles).

The spacecraft will carry scientific and engineering experiments for use by professional scientists and radio amateurs, together with educational experiments primarily for schools and colleges. Working with Surrey University in building the experimental hardware are the Rutherford-Appleton Laboratory (SERC), the Universities of Sussex and Kent, and the UK, USA and Canada branches of the International Amateur Satellite Corporation (AMSAT).

Surrey University's Department of Electronic & Electrical Engineering is providing two educational and scientific experiments – a second speech synthesiser with a larger vocabulary than that carried on UOSAT-1, and an improved TV camera. The Department's UOSAT Project Team, led by Dr Martin Sweeting, is also responsible for building the spacecraft itself and all the communication, attitude control and other 'housekeeping' systems.

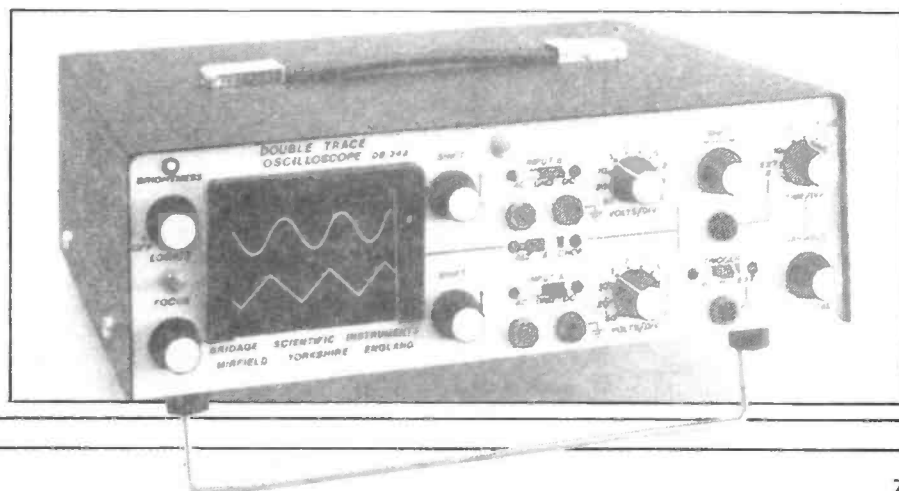

RADIO Tomorrow

Your at-a-glance guide to what's happening around the clubs, on the air and in general radio-wise.

3 Mar	RSGB 144/432MHz + SWL Contest	17 Mar	RSGB Town and County 1.8MHz Phone Contest
5 Mar	Stourbridge ARS: informal	18 Mar	Glenrothes DARC: informal
	Leighton Linlade RC: ring PRO for details	19 Mar	Stourbridge ARS: AGM
	Swale ARC: informal. Note venue now Ivy Leaf Club, Dover Street, Sittingbourne at 7.30pm every Monday.		Swale ARC: informal
	Stowmarket ARS: Junk Sale	20 Mar	Braintree DARC: <i>DF Hunting by G4PQY</i>
	Braintree DARS: <i>Radio Propagation</i>		Fylde ARS: <i>DF Equipment for 160m by G3AEP and G8GG</i>
	Todmorden ARS: <i>Satellites</i>		Stevenage DARS: AGM
	London RAFARS 2m Netr on S13 (every monday night at 2000 hours)		Biggin Hill ARC: 'Check your rig' evening
	Horndean ARS: <i>Special Event Stations by G4RLE</i>	21 Mar	Nene Valley RC: Natter Nite
6 Mar	Fylde ARS: <i>Electronics and Air Traffic Control</i>		Lincoln SWC: CW/RAE evening
	Stevenage DARS: <i>The Worked All Britain Scheme by G4ISO</i>		South Bristol ARC: SWL Night
	Chichester DARC: <i>Microwave Radar</i>	22 Mar	Cheshunt DARC: GB3PI Road Show
	Cheshunt DARC: Junk Sale		Three Counties ARC: AGM
7 Mar	Lincoln SWC: CW/RAE Class		Wirral DARC: <i>Aerial masts by G3EGX</i>
	South Bristol ARC: <i>AMTQR by G4KUQ/G4MCQ</i>		Colchester RA: <i>Marconi and his work</i>
	Wirral DARC: <i>HF Propagation by G3LEQ</i>	23 Mar	Greater Peterboro ARC: <i>Submarine Radio by G4SQB</i>
	Nene Valley RC: Natter Nite	24 Mar	South Manchester RC: Junk Sale
8 Mar	Colchester RA: Film Evening		Sutton and Cheam DRS: Annual Dinner at 'The Woodstock'
9 Mar	West Kent ARS: <i>Transport Communications</i>	25 Mar	Barking RES 2m All Mode Contest. 1300-1700GMT.
	South Manchester RC: <i>FM!! by G8TYY</i>		Exchange reports, serial number and administrative county
10 Mar	RSGB Commonwealth Contest	26 Mar	Swale ARC: informal
12 Mar	Exeter ARS: <i>Static and Chips by G3RSJ</i>		Stratford-Upon-Avon DRC: AGM and Beer Tasting
	Swale ARC: informal		Droitwich ARC: <i>QRP by G3RJV</i>
	Stratford-Upon-Avon DRC: <i>History of Amateur Radio by G8MWR</i>	27 Mar	Dudley ARC: <i>DXing from a difficult QTH by G3ZPF</i>
13 Mar	Dudley ARC: <i>TV Outside Broadcasting</i>	28 Mar	Lincoln SWC: AGM Agenda Night
	Bury RS: <i>ICs by G4EXK</i>		Wirral DARC: <i>Treasure hunt by G6SNO</i>
14 Mar	Lincoln SWC: <i>Amateur Radio on a Shoestring by G3RJV</i>		Ipswich RA: Constructors Contest
	Wirral DARC: <i>Power Supplies by G6ALH</i>		South Bristol ARC: Computers with G6SVR
	Ipswich RA: <i>Talking Books for the Blind</i>		Belfast College of Tech. ARS: <i>RTTY with the ZX81 by G18KRC</i>
	South Bristol ARC: Construction with G8XIH and G4JUQ		Cheshunt DARC: Natter Nite
	Cheshunt DARC: Natter Nite		Three Counties ARC: <i>QRP by G4BCY</i>
	Three Counties ARC: <i>Talk by Wood and Douglas Ltd</i>		Farnborough (Hants) DARC: Mystery Evening
	Farnborough (Hants) DRC: <i>Equipment Design by G4JNT</i>	30 Mar	Nene Valley RC: John Nelson of the RSGB
	Nene Valley RC: Video — 'The Truth about Amateur Radio	1 Apr	South Manchester RC: Lecture Evening
15 Mar	Chichester DARC: ring PRO for details		RSGB ROPOCCO Contest
16 Mar	Sutton and Cheam DRS: Constructional Contest		White Rose ARS RALLY at the University of Leeds. Opens 1100. 50 stands. Parking. Talk-in 2m and 70cm (Details Alan Bramley, G4NDU 0532 689880)
	South Manchester RC: 2m Foxhunt	2 Apr	Swale ARC: informal
			Braintree DARS: <i>Interference Problems</i>

- Leighton Linslade RC: ring PRO for details
 Todmorden ARC: 'Homebrew' nite
 Horndean ARC: *A Year of Radio by G4BEQ*
3 Apr Fylde ARS: *RTTY by G4RSA*
4 Apr Lincoln SWC: CW/RAE Evening
 South Bristol ARC: Data Communications
 Wirral DARC: Junk Sale
 Nene Valley RC: Natter Nite
5 Apr Colchester RA: Constructors Evening
 Horsham ARC: *Interference Prevention*
6 Apr South Manchester RC: Spring 1.8MHz
 Contest
 Axe Vale RC: Check out your construction
 techniques!
7 Apr Amateur Radio — Electronics — Computing
 Weekend at Pontins, Southport. Organised by
 the Northern Amateur Radio Societies
 Association. Contact P. Denton, G6CGF, on
 051 630 5790.
8 Apr Swansea Mobile Rally at the Patti Pavilion
 (next to St Helens Cricket Ground on the
 A4067 Swansea to Mumbles (coast road)
 1030-1700. Trade Stands. Bring and Buy.
 Food and Drink. Talk-in on S22.
 Buxton Mobile Rally at the Pavillion Gardens,
 Buxton (close to the Railway Station) Open
 from 1100. Trade Stands. Bar and Cafeteria.
 Talk-in S22. Details G6MIF 0298 6174.
9 Apr Exeter ARS: Visit to Radio Devon
 Stratford-Upon-Avon DRS: *Mobile
 Interference Suppression by G3AYJ*
11 Apr Lincoln SWC: *VHF-Then and Now by G5UM*
 Ipswich RA: *Marconi — his middle years*
 South Bristol ARC: HF Night with G4TSS
 Three Counties ARC: Junk Sale
12 Apr Greater Peterboro' ARC: Junk Sale
13 Apr South Manchester RC: *Radio in British Rail by
 G8WEN*
15 Apr Stevenage DARS: 2m FM Contest
 1300-1700 GMT. Details from PRO.
16 Apr Braintree DARS: *Homebrew PCBs by G6MCB*
 Leighton Linslade RC: ring PRO for details
 Glenrothes DARC: informal
17 Apr Fylde ARS: informal and Morse Class
 Biggin Hill ARC: Visit by CM Howes
 Communications

- 18 Apr** Lincoln SWC: CW/RAE Class
 South Bristol ARC: VHF NFD preparation
 Wirral DARC: Video of G6CJ's Aerial Circus
 (Can I Come? — Editor)
25 Apr Lincoln SWC: Activity night
 Ipswich RA: AGM
 South Bristol ARC: 10m FM night
 Three Counties ARC: *Special Event Stations
 by G3TBT*
27 Apr South Manchester RC: Construction Contest
1 May Fylde ARS: Visit to HMS Inskip

ACME INSURANCE COMPANY RADIO CLUB



"... You're 5 and 9 plus a bonus of 20 dB ..."

Will Club Secretaries please note that the deadline for the June segment of Radio Tomorrow (covering radio activities from 4th May to 1st July '84) is 7th April.

Contacts

Axe Vale ARC	Bob Newland	Lyme Regis 5282
Belfast College of Tech.	James Barr	Belfast 227244
Biggin Hill ARC	Ian Mitchell	09598 376
Bury RS	Brian Tydesley	Burnley 24254
Cambridge Repeater Grp	Chris Lorek	0354 740672
Cheshunt CRC	Roger Frisby	0992 464795
Colchester RA	G3FIJ	0206 851189
Droitwich ARS	G. Taylor	02993 3818
Exeter ARS	Roger Tipper	Exeter 75858
Dudley ARC	C. Wilding	Codsall 5636
Farnborough (Hants) DRC	Peter Taylor	0252 837581
Fylde RS	PRO	Lytham 737680
Horsham ARC	Peter Head	0403 64580
Sheffield ARC	G. Hancox	0742 682963
South Bristol ARC	Len Baker	0272 834282
South Manchester RC	D. Holland	061 973 1837
Stourbridge ARS	Malcolm Davies	038482 4019
Swale ARC	Brian Hancock	Minster 873147
West Kent ARS	Peter Reeve	0892 24689
Wirral DARC	C. Cawthorne	051 625 7311

Meet the DSB-2!

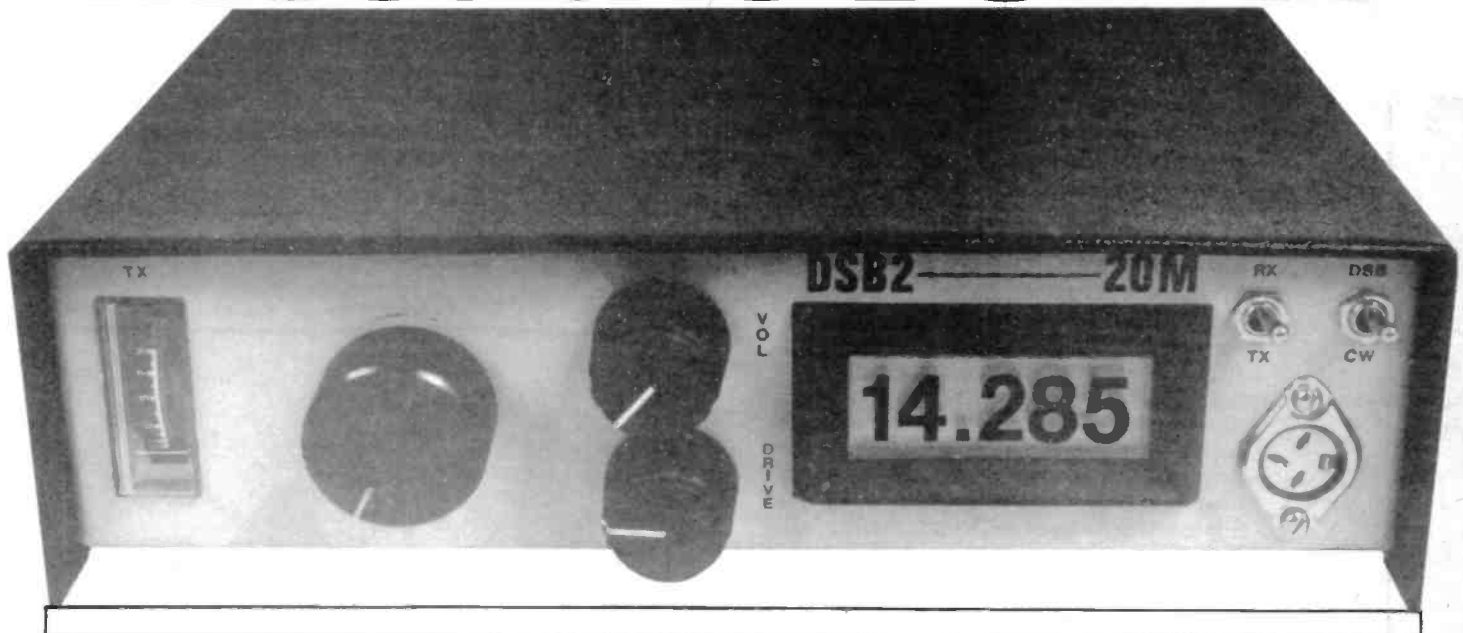

Back in the March 1983 issue of *Ham Radio Today*, a design was published for a simple 80 metre direct conversion Transceiver suitable for double sideband and CW use. This proved to be extremely successful and many hun-

is a well known problem with a VFO running at the same frequency as the PA and there is insufficient isolation in the original design for the higher frequencies. The method used for the Tx/Rx switching again didn't help operation at higher fre-

can now be built to cover any single band between 1.8 and 21MHz, DSB and CW. A new main board accommodates all the remainder of the circuits, other than the VFO.

Tony Bailey, G3WPO, has taken the DSB80 circuitry and added many improvements — some suggested by readers. This simple, low-power DSB/CW transceiver will work on any single band between 160 and 15m, has active audio filtering, semi 'break-in' CW and is perfectly complimented by the 'Minisynth' VFO.

Additional features over the original DSB80 are:

1. Relay switching between Tx/Rx.
2. Semi break-in CW keying.
3. Addition of a simple on board active filter.
4. Sidetone circuit for CW monitoring. (via Minisynth)
5. Additional microphone amplifier stage.
6. Provision for addition of a preamplifier.

The original features of the DSB80 are retained:

1. Low cost but high performance.
2. Immunity to image problems.
3. Good sensitivity.
4. High level mixer for good strong signal handling.
5. Easy to build with minimal coil winding and alignment.
6. Printed circuit board for reproductability.
7. Ideal first rig and excellent for QRP working.

dreds are known to have been built and got 'on-the-air'. Performance is excellent for such a simple design — some people even suggested that the Rx side was better than their black boxes! This latter effect I feel is due to one of the principle attractions of a direct conversion receiver — the *purity* of the signals has to be heard to be believed.

Many people have asked whether the DSB80 design can be got going on other bands as was suggested in the original article. While 160 metres is not a great problem, frequencies higher than 4MHz were found to be problematic due to RF feedback into the VFO which was built on the same board as the transmitter. This

quencies, although perfectly OK at 3.5 and 1.8MHz. Also, the simple VFO design originally used is not particularly stable above its design frequency, and would suffer from thermal effects induced as the PA heated up at these higher frequencies.

With these thoughts in mind, and a number of simple operational improvements possible, here is the MARK II design — the DSB-2.

The basic circuit is similar to the original DSB80 as this proved so reliable and gave good performance. In this issue the MINISYNTH PLL synthesised VFO is described, and this forms the basis of an extended frequency coverage DSB design. *The Mk II*

The sensitivity is the same as the original design, with around 0.3uV of signal copyable. This is adequate with a good aerial system, but for those with less than perfect aerials on 14MHz and above, there

is provision for the addition of a suitable preamplifier in the receive circuit. It is extremely unlikely that any form of preamp would be required below 14MHz (See Angus McKenzie's article on Receiver RF performance! — Ed). The Broad-band amplifier designed for the OMEGA project is eminently suitable, as this will cope with the levels of RF around on transmit, maintains the high dynamic range, and can be accommodated in the same case as shown here. The OMEGA preamp gives 15dB of gain on any of the HF bands.

A digital frequency readout option can be built, with the necessary prescaling (used above 4MHz — see later) for the counter also on the main transceiver pcb. As with the DSB80 design, complete kits of parts are available for each of the bands described, or PCBs alone.

Double Sideband

The transmission of an extra sideband may be considered wasteful of frequency space, even if it is a saving of crystal filters. Well, it is, but not in its context. As with the DSB80 we see this extended design as useful for semi-local chatting on the LF bands during the daytime, when there is normally plenty of space for everybody. Not that you have to restrict it to local chatting — many people happily worked round Europe on DSB with the DSB80 during the evening. This type of

operating certainly gets your operating procedures sorted out — competing with the high power boys. With a decent antenna, the same sort of results are possible on the higher HF bands — whilst testing one of the prototypes America was worked on 20. On CW the rig comes into its own and will give a good account of itself against commercial transceivers.

Circuit Description

The first difference from the DSB80 is the absence of an on-board VFO, in favour of a separate design which can be used in other applications — it will feature in some forthcoming 'WPO' projects. Hence, a direct capacitively coupled input is provided to the SBL-1 double balanced mixer for a VFO. Input voltage required is around 700mV into 50 ohms, and this can be derived from any suitable VFO design for the frequency in question, if the MINISYNTH is not used. Being a direct conversion receiver, the local oscillator is of course at signal frequency.

The SBL-1 double balanced mixer is the heart of the design, and it has three ports, RF, LO and IF. The IF port is used for injecting AF in the DSB transmit direction, and for recovering the audio in the receive direction. In the original article, the point was made that a higher specification SBL1-8 would be advantageous, in that performance tends to fall off within an octave of the stated band edge.

(The -1 device has a minimum operating frequency of 1MHz, against the 1 — 8 device at 0.1MHz.) This is still true, but in practice there is so little discernible and measurable actual performance difference that the SBL-1 has been used on all the bands for which the DSB-2 is designed. With a large antenna system on 160m it is just possible that the 1-8 version might be needed. In receive mode, signals are coupled to the RF port through the preselector filter L1/L2, where they are mixed down to audio by the double balanced mixer. The audio appears at the IF port (pins 3&4), through the simple low pass filter, R7/C4, active filter (IC1) and are then brought up to a level suitable for driving a speaker (4-8 ohms) by Q8/9, and IC2, an LM380N. The AF preamp (Q8/9) has a gain of about 70dB.

Active Filtering

The active filter was added to provide some additional selectivity which is a distinct advantage when operating with a direct conversion receiver. The dc receiver, when used with an mixer such as the SBL-1, is as sensitive as most commercial units, and probably has better dynamic range, but suffers from the disadvantage of a wide bandwidth. The reception bandwidth is defined by the audio amplifier, a parameter which can never be defined as closely as is possible with a crystal filter arrangement. Also, it is equally as sensitive to both upper and lower sidebands, or to both audio sidebands of a cw signal. The DSB80 had provision for an external multipole active filter design (as used in Project OMEGA) and this could be used in this design if wanted. However, the simple filter included here does make a good contribution to filtering out a lot of the rubbish, especially on the lower bands, and the bandwidth is adjustable by changing the value of R28. The value given is suitable for most phone and CW applications — *if CW is primarily to be used then the value can be increased to 4.7M for a narrower bandwidth* — too much increase will cause the filter to ring, though.

The AF preamp uses a double ganged volume control RV6. This increases the dynamic range — if

DSB-2 PCB

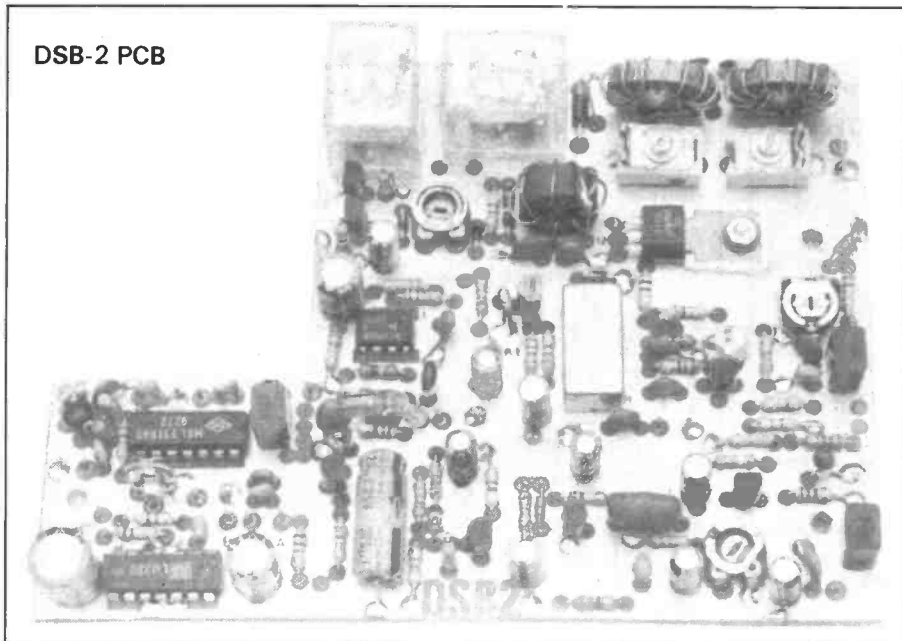

N.B LINK F-G IS ALREADY MADE ON PCB
SEE TEXT FOR PREAMP INSERTION

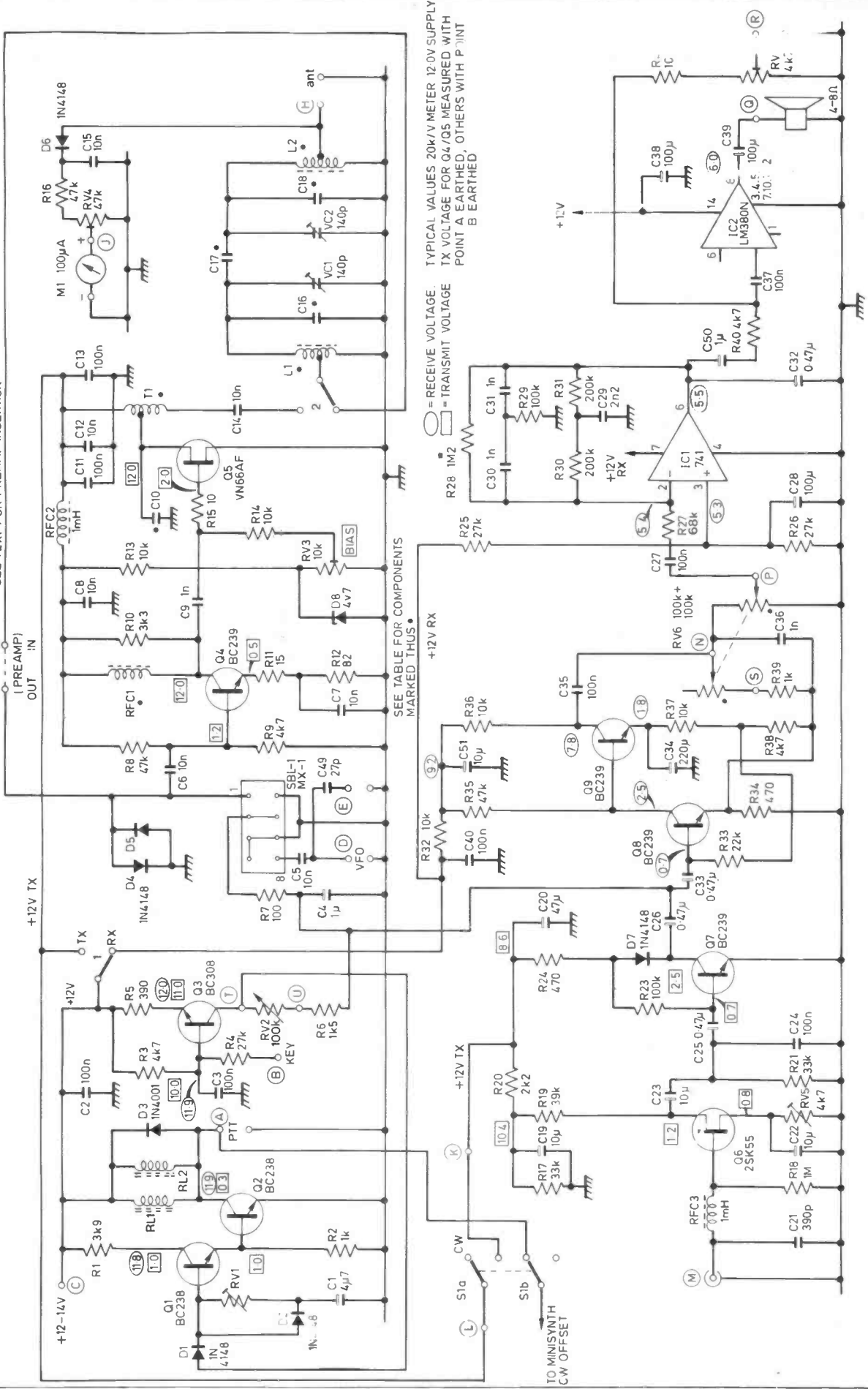

SEE TABLE FOR COMPONENTS
MARKED THUS.

TYPICAL VALUES 20kV/METER 12.0V SUPPLY.
TX VOLTAGE FOR Q4/Q5 MEASURED WITH
POINT A EARTHED, OTHERS WITH POINT
B EARTHED

Circuit diagram of DSB-2

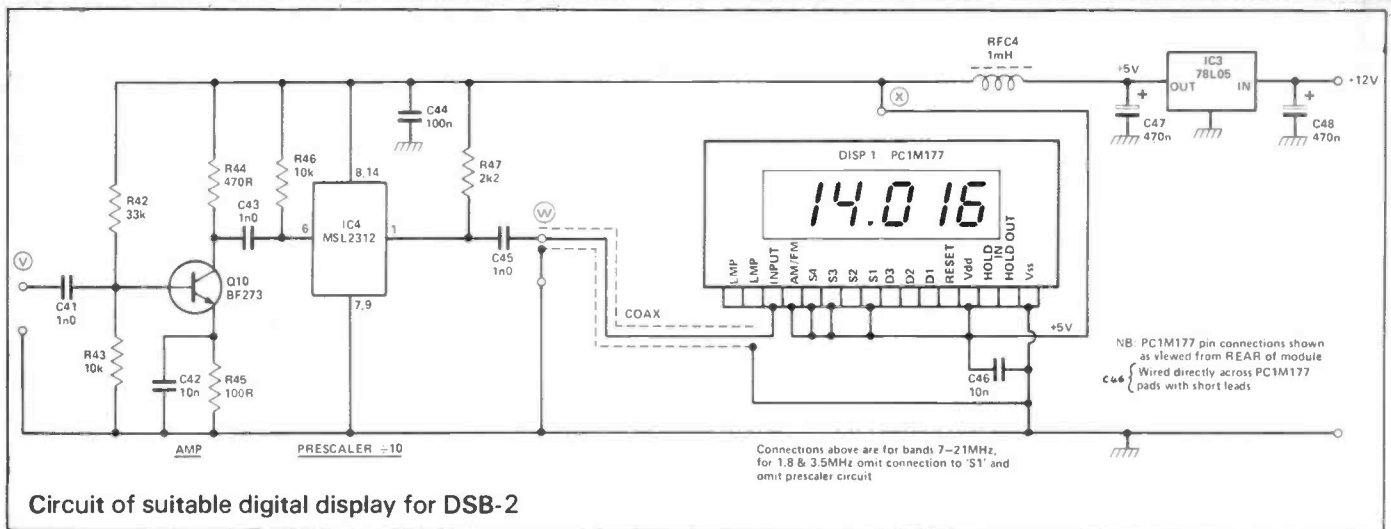

just a single control were used between Q9 and IC2 there would be a real chance that the preamp circuit would overload on strong signals. If just a single control was used ahead of the whole AF amplifier, then strong signals would be as noisy as weak ones (remember that the receiver has no AGC system — this is almost impossible to add to a dc design).

Sidetone for CW transmit (so you can monitor your sending) is derived from the MINISYNTH VFO, and injected via RV7 and R41, setting the preset for a suitable volume level. This level is independent of the receiver volume control setting.

Transmit

To generate double sideband, low level signals from a suitable dynamic microphone (ideally about 5K, but most other impedances from 600ohm to 50K will work), are amplified by Q6/Q7 and applied to one port of the DBM. D7 isolates the collector resistor of Q7 (R24) in the receive mode. The amplifier output level can be adjusted via present RV5 — in the original DSB80 the gain was fixed with a single stage only, which limited the type of microphone needed to a high output type. Power is removed from the mic amplifier circuit on CW by S1a.

On CW transmit, the easiest way to generate some carrier is to unbalance the DBM by applying some current to the IF port, and this is done via Q3 and RV2/R6, with RV2 effectively comprising a 'drive' control by varying the current applied. When the base of Q3

is taken to earth via R4 and a key, then Q3 conducts. This stage also provides the means of getting semi 'break-in' keying on CW, where closing the key contacts immediately puts you into transmit, without the need to manually switch from receive to transmit.

A portion of the current is taken to the DC amplifier pair Q1/Q2 which actuate the relays — the purpose of C1 is to provide a delay before the rig returns to receive, otherwise the relays would be continually changing over, and the DSB2 circuit is not made to tackle full break-in! D1 and D2 serve as DC isolation — D1 prevents C1 discharging back through the drive circuit, and D2 allows C1 to charge instantly, but only discharge through RV1 and the base of Q1. The delay can be varied by RV1, but is nominally about 1-2 seconds which should suit most operators. If a delay outside of the adjustable range is required, then C1 can be increased or decreased in value. C1 should be a tantalum capacitor with a low leakage current, otherwise the delay time is likely to vary depending how long you have been keying for. For PTT operation on phone, the relays are actuated directly by connecting the microphone PTT contacts (one side to earth) to point A. Alternatively, a front panel toggle switch can be connected to this point for manual transmit/receive switching. The voltage appearing at the collector of Q3 is also used to switch the CW offset voltage on the MINISYNTH VFO, so that the offset is 'in' on receive and 'off' on transmit — this may sound the wrong way round but it saves another inverter stage,

and is of no consequence providing you know which way it is going (see later).

Output Stage

The PA strip uses a single bipolar transistor connected as a Class A voltage amplifier coupled to the gate of Q5, a VN66AF MOSPOWER transistor. The inductance of RFC1 has been chosen to resonate with the input capacitance of the MOSFET on the band in use, and is a prewound RF choke with R10 increasing the bandwidth of the stage. Incidentally, the high input capacitance is the reason why the rig will not work satisfactorily above 21MHz² — resort to series matching networks, and possible neutralisation of the PA would be required for 28MHz, and it was felt that this would complicate the project too much for the beginner. Although a different type number the PA stage is in fact the same as that used in the DSB80 (2N6657) — just a different package. The latter proved very difficult to get hold of and expensive, so the VN66AF is used here, much cheaper, but with a different mounting arrangement. The standing current is set by the bias control, RV3 — normally 100mA with no drive, rising to 400 — 600mA on peaks of DSB or CW.

The MOSFET needs to see a load of about 12 ohms to develop its output power with a 12V supply line. The ferrite transformer T1 is wound with a 2:1 turns ratio, the actual number of turns depending on the band in use, raising the output impedance to the 50 ohms required by the preselector circuit.

Interconnection diagram for DSB-2

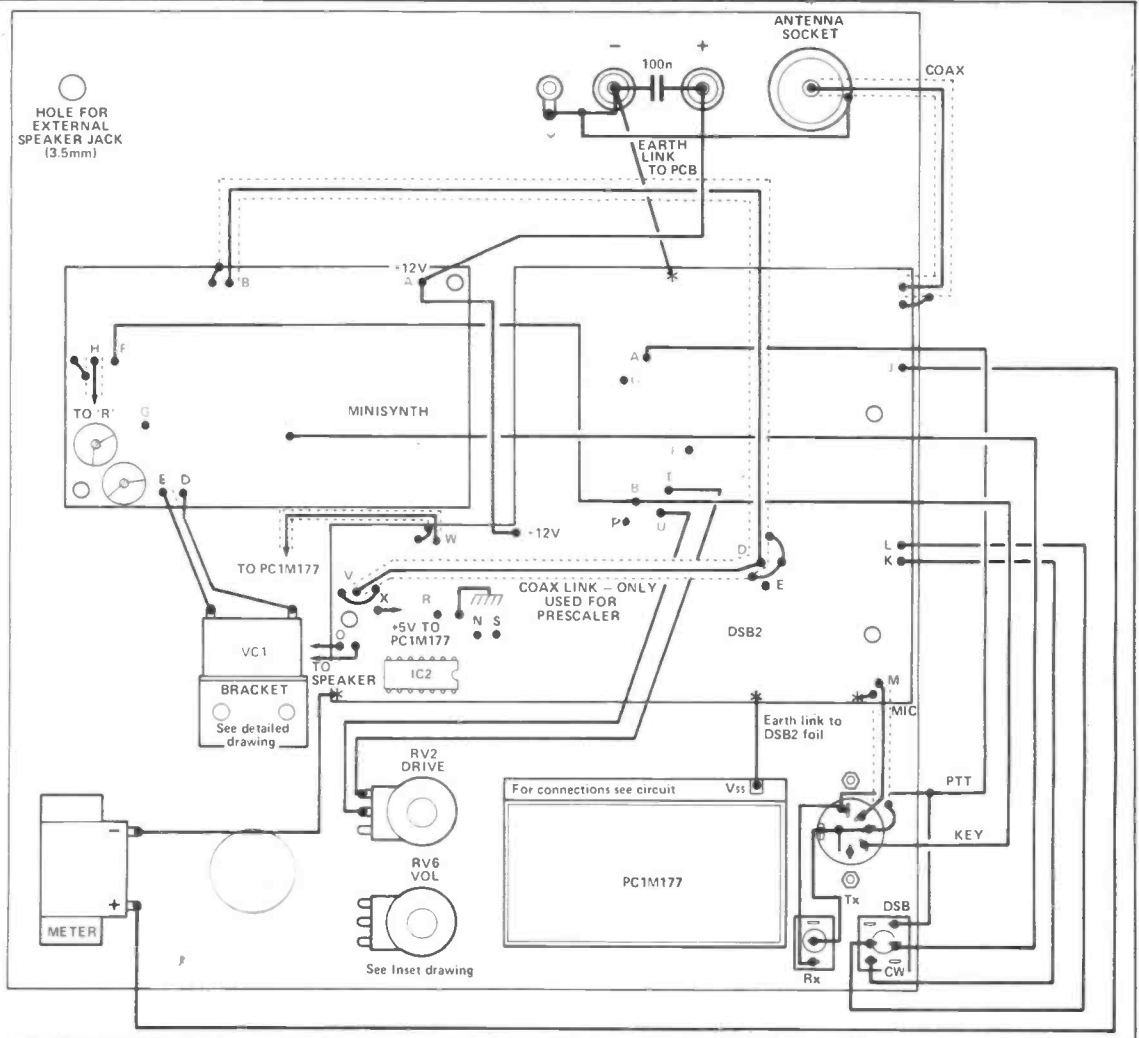

Diodes D4 and D5 give protection to the DBM from any RF pulses which may be generated as the transmit/receive relays changeover — which could destroy the mixer. *It is important that the relays are break-before-make types otherwise the full transmit power would be applied to the mixer with disastrous results.* The major advantage of a MOSFET PA stage is that it is almost totally 'bombproof' — a great help if this is your first attempt at a rig.

Antenna matching

NOTE THAT IT IS IMPORTANT that the rig sees a correctly matched 50 ohm load; if a 'long wire' antenna is to be used the use of matching unit of some sort is mandatory! *A bad match will not only reduce output power but can lead to instability of the PA itself.* Whilst the receive side has no 'S-Meter' function, a simple power output meter has been provided, by rectification of a small amount of the RF output power via D6/C15. RV4

sets the meter deflection. Note that if you are operating into a mismatched load, the meter may well read *higher* than normal — this does not mean you are getting more power — it is just reading the sum of the forward and reflected currents now flowing in the mismatched load.

Preselector

The preselector network, L1/L2 and associated components, is symmetrical, so that it can handle signals going in both directions, via the aerial changeover relay. The values have been selected so that the preselector — 3dB response covers the entire amateur band desired. If you have an interest in the CW allocations only, then the values could usefully be adjusted to narrow the bandwidth. This won't affect the selectivity of the receiver, or the perceived performance, but will reduce the possibility of overload from high level out-of-band broadcast signals, or other strong local signals. The only adjustment needed to this part of the circuit is to

peak the two trimmers for 'maximum smoke' on transmit, via an SWR Bridge or power meter.

Digital Readout

One of the features of the DSB80 was that a digital readout could be added if required. This appealed to a lot of people so it has been retained here. The PCIM177 frequency display module is probably the best value in counters around for this sort of application. However, it does suffer from only working as it stands up to 4MHz. This is OK for 1.8 and 3.5MHz, where one can then have a display resolution to 100Hz. Above these bands, the VFO input has to be divided by a factor of 10 to bring the frequency within range of the PCIM177 module, with the display then reading with a resolution of 1KHz up to 21MHz. All of these options are allowed for on the PCB, with a 5V IC regulator (IC3) providing power for either the PCIM177 direct, or for the PCIM177 and prescaler, IC4. With

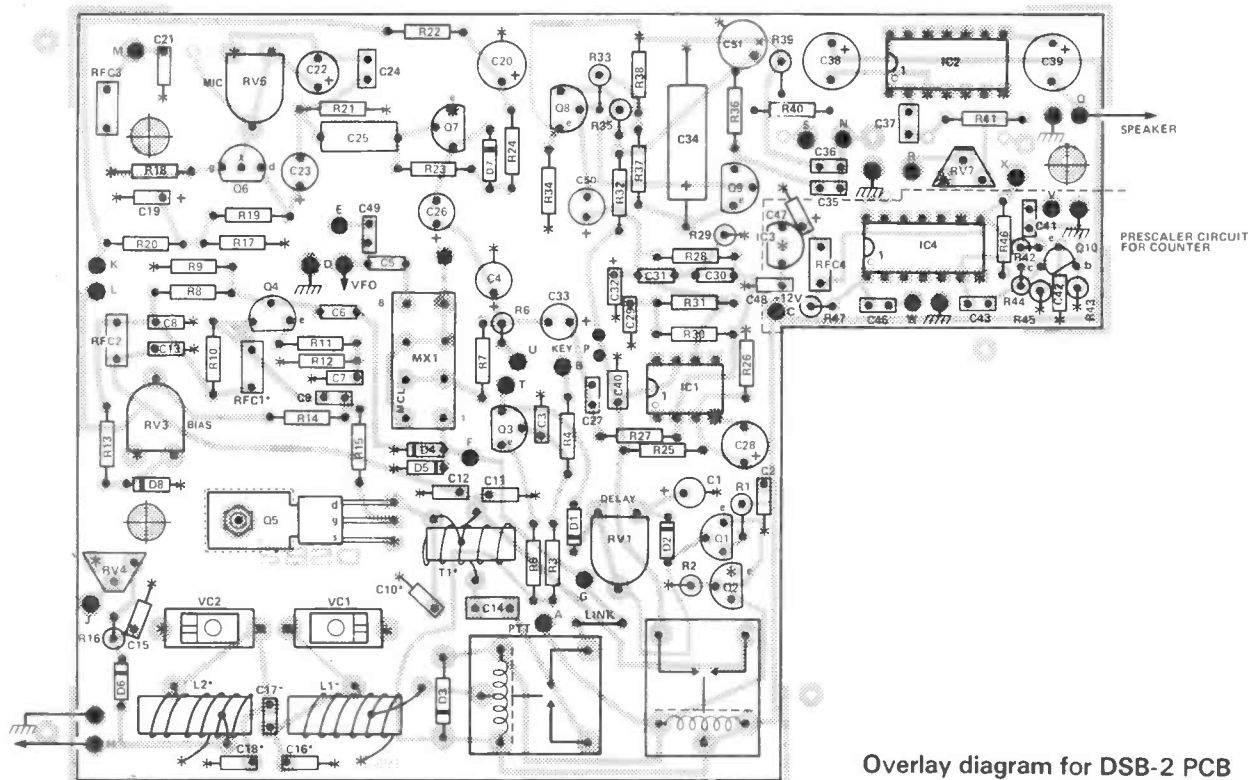

Overlay diagram for DSB-2 PCB

the latter circuit, Q10 provides some RF amplification for the pre-scaler chip, an MSL2312 which uses low power Schottky techniques — this IC does also have a divide by 100 function on board, not used in this application. Input from the VFO is taken using a coax link. If the digital readout is not required, then these components are simply left off the board, but can be added at a later date.

Construction

As mentioned earlier, the DSB2 is intended to be driven from the MINISYNTH PLL VFO described elsewhere in this issue, and this will need to be built first, using the appropriate direct conversion design. Use of the MINISYNTH is not mandatory — any suitable VFO could be used. The whole transceiver except for the VFO is built on one double sided PCB — the reason for the cut-out in the PCB is so that it will fit in the same case used for the original DSB80, with the VFO accommodated in this cut-out. Again, any suitable case can be used, providing the VFO capacitor can be mounted fairly close to the VFO for stability reasons. You may make the PCB yourself, or buy it ready

made. The upper side consists of an earth plane, with 'clearance pads', where there is no copper, for all component leads which go through to the other side of the board. All earth connections are made directly to the upper surface of the PCB, bending the leads of components where necessary. When soldering all the components in place, try to keep leads as short as possible to aid stability of performance — transistors sitting on 10mm of leads above the PCB will almost certainly lead to RF instability. The accompanying photograph of the PCB show the sort of construction techniques to aim for. If the digital readout option is not being used then all the components within the dotted line around IC4 can be left out (except pin C). If used for 1.8 or 3.5MHz then only IC3, and C47/C48 need be inserted, otherwise use all components within the dotted line for 7 — 21MHz readouts.

1. Insert and solder the 29 1mm dia PCB connection pins. These need pushing home with some force from the underside of the board. If you are not going to use the preamp at any time then pins F & G may be omitted. Note that the

pin to the right of C5 is soldered both sides as an earth through-link.

2. Insert and solder the following components to aid positioning of later components: C34, RV3/RV5 (one leg of each as marked soldered to the top foil), RV1, MX-1, VC1/VC2 (one end of each soldered to top foil), IC1 (pin 4 soldered to top foil), RFC2/RFC3, C25, RFC1 (check table for value), and the wire link adjacent to point A (use insulated wire for this).

3. The next stage is to insert and solder all the fixed resistors. Start at the top right hand corner of the board, and work across to the left, then down the board. Make sure that earth connections are made to the top foil where indicated by a cross. The resistor bodies should lie flat against the PCB where they are mounted horizontally, and one end of the body also against the PCB where vertical. Note that R29, R30, and R31 are 1% types and have a different coding to normal (200K = red, black, black, orange, 100K = Brown, black, black, orange).

4. Insert C22/C28/C38/C39/ (watch polarity) — the earth connections for C22/28/38 are made via tracks on the underside of the board, so no separate earth con-

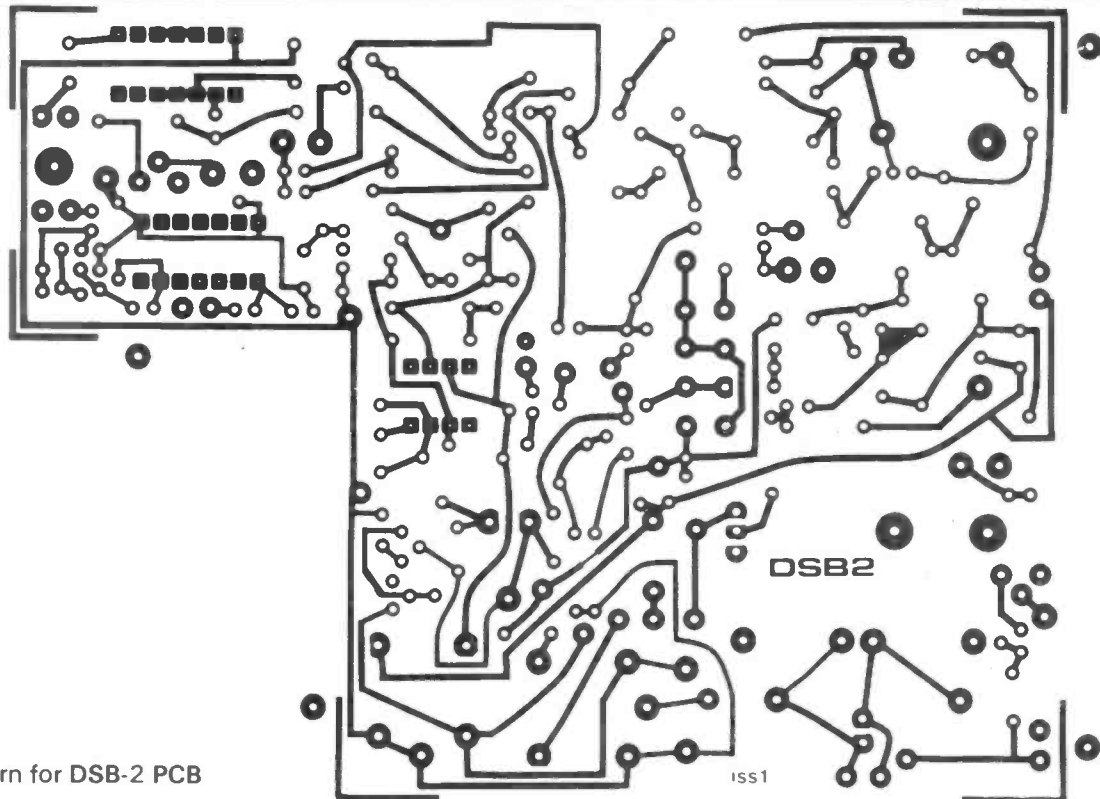

Foil pattern for DSB-2 PCB

nections are needed to the top.

5. Now insert and solder the remainder of the fixed capacitors, working from the top right hand corner of the board. Be careful of component 'polarities' where applicable (electrolytics and tantalum types). For C10/C16/C17/C18, consult the table for values and whether they are to be used or not.

6. Insert and solder all the diodes, observing that the cathode (banded) end goes where indicated. D8 is mounted vertically. Be careful that D4/D5 are opposite ways round as otherwise the DBM protection will not work.

7. Insert the solder RV4 (one leg soldered to top foil), and RV7.

8. Insert and solder IC2 (and 3 & 4 if used). Make sure you solder all the pins marked with a cross to the top foil, including the centre pin of IC3, if used.

9. Insert and solder all the transistors EXCEPT Q5 (VN66AF). Q2 has its emitter earthed to the top foil.

10. Wind T1. Look up the number of turns used in the table — this is the total including the centre tap. The core used is grey in colour and 13mm in diameter. Wind on half the number of turns given (i.e. for a 13 turn coil wind on 6 turns), form a loop for the tap, then carry on in the same winding direction for a

further equal number. Cut the ends of the windings to about 8mm in length, strip off the insulation for about 5mm, and strip the insulation off the loop. Tin the bare ends, then solder the winding ends into place, with the core resting on the board. Use an offcut of wire to bring a lead up from the PCB for the centre tap connection.

11. Now wind L1 and L2. Both coils are identical for a given band and are wound on Amidon dust iron cores (Yellow for — 6 types and red for — 2 types). The winding direction is shown in the drawing — this is important so that the taps come out on the correct side of the coil. Look up the number of turns in the table, then start winding from the lead marked * in the drawing, until you have reached the point where the tap is (the number of turns are counted by the number of loops of wire you can count on the outside of the toroid). So if you need the tap at 4 turns then you should count 3 loops of wire — the wire is then looped for the tap connection, making turn 4, then carry on until you have the total turns required. *Make sure you don't reverse the winding direction at the tap loop.*

12. Strip and cut the wires as for T1, then solder the winding ends into place, again with the base of the core resting on the PCB (one

end is soldered directly to the foil — and it must be the end nearest the tap — this was a common reason for DSB80s not working!). Make the connection to the taps as for T1.

13. Nearly there. Now T5 is soldered into place. The transistor is STATIC SENSITIVE — *do not handle it by its leads but by the metal tab only* and you should have no problems. You should also use a well-earthed soldering iron. As it comes in a TO202 package, and needs to be mounted flat against the PCB for heatsinking, a metal spacer washer is required and an insulating washer (both supplied with the kits). The drawing shows the method of mounting. Smear a small amount of heatsink compound (or use Vaseline) around the area of the PCB which will be under the tab, then rest the insulating washer in place with the hole aligned. Then put the metal spacer on top of that, after smearing the underside with compound. Then smear the top of the metal washer with compound. Now push the VN66AF through the holes (with the legend on the transistor facing upwards) and bend it over carefully until you can align the tab hole with the other holes. Avoiding touching the leads on the underside, screw it into place, using a 6BA 6mm bolt (inserted from

Constructional details for DSB-2 PCB

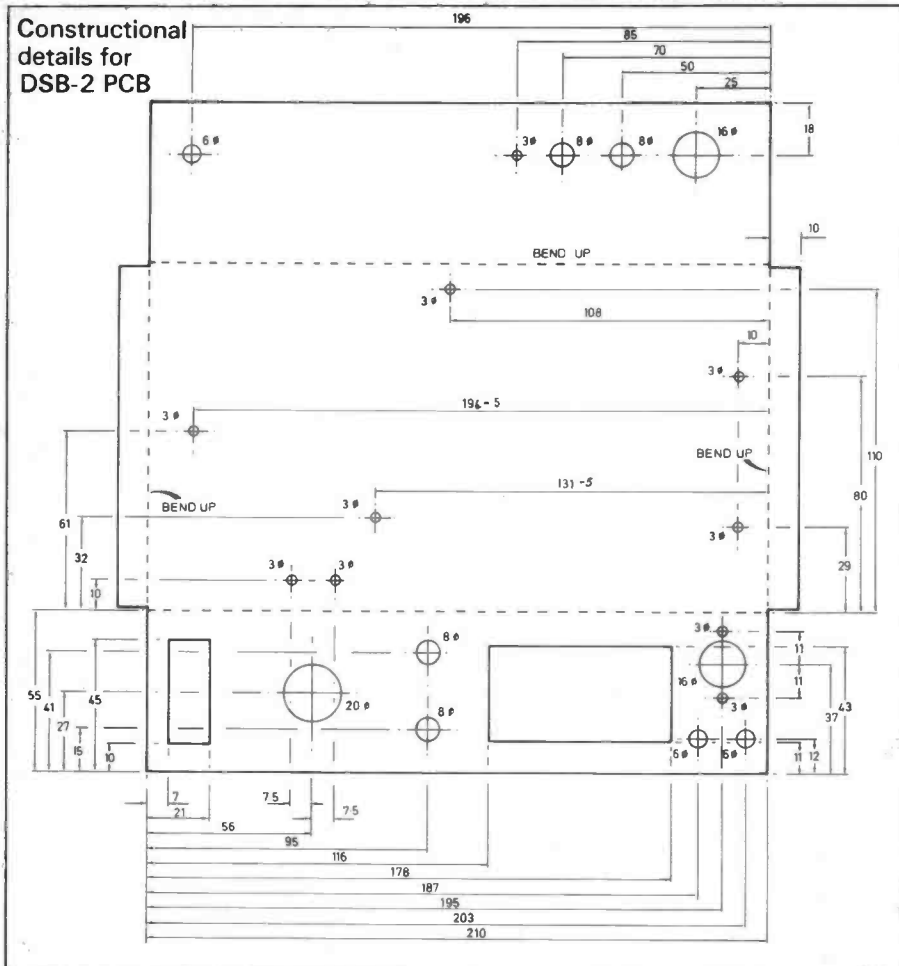

does, look for a solder bridge somewhere!

Testing

The components external to the PCB need to be wired in before alignment and testing is started. First wire up the volume control as shown in the drawing, using screened audio cable. Connect a meter (100-200uA FSD) to point J (positive meter terminal), with the other meter lead to the top foil. Connect a speaker to point Q, again using screened wire. If CW is going to be used, wire in RV2 — if not connect pins T & U together (the drive control only works on CW). Also connect pins L & K together for the moment. You will also need to connect the VFO to point D, using coaxial cable. If the MINISYNTH is not available, a signal generator can be used, providing it can deliver the correct output (you will hear signals with about 200mV of injection, but will not get correct performance of Tx output power). If the digital frequency display is to be used, refer to the drawings for the connections for whichever version you are using. On 160 & 80m a coax lead goes direct from point E to the PCIM177 input, otherwise link point D to point V using coax, and point W to the PCIM177 input, again with coax. Also connect point X to VDD on the PCIM177. Don't forget to wire C46 across the VDD and VSS pads on the display (with as short lead lengths as possible).

the underside), then place a 'shakeproof' washer and nut on the other side and tighten up.

14. Solder the Source lead of the VN66AF to the top foil, then the remaining leads on the underside. Clip off any excess lead lengths.

15. Finally, solder the two relays into place.

Double Check

Before rushing into applying power, double check all your component positions, orientations, and that all connections to the top foil of the PCB have been made. A check with an ohmmeter from the + 12V connection (point C) should not reveal a direct DC short — if it

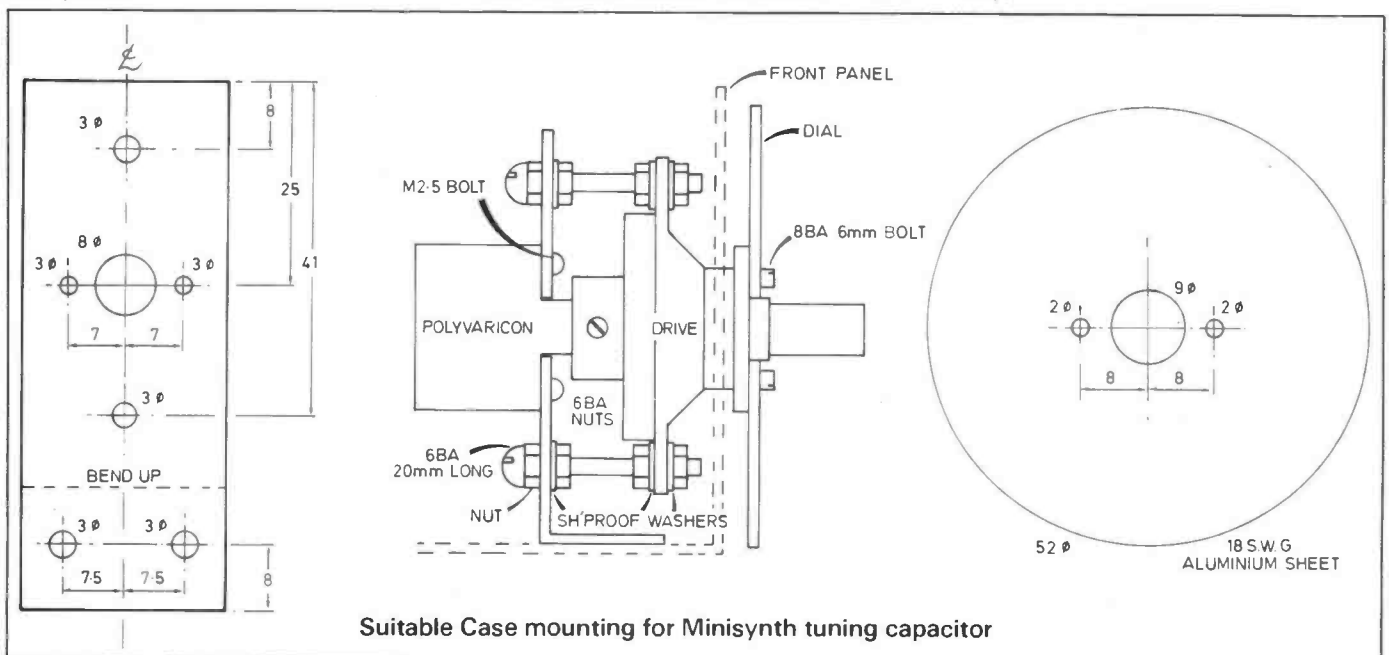

Suitable Case mounting for Minisynth tuning capacitor

Connect up the leads from the power supply (12 to 14V max) to the DSB2 board (negative lead to the top foil), preferably with a meter in series (it will take about 600mA max on transmit) to *check current consumption*. Also, you will need a means of monitoring the output power, such as a power meter, or an SWR bridge, and a 50 ohm load (use a 47 ohm carbon composition resistor of suitable power rating if no proper dummy load is to hand).

1. Preset RV3 and the AF gain control fully anticlockwise, and the other 'presets' to mid-travel.

2. Apply power. The relays should not operate (if they do you have a short or something else wrong around Q1/2/3) — the current should not exceed about 150mA with the prescaler in circuit. If far more then look for shorts or misplaced components etc.

3. Turn up the volume control — you should hear a hiss indicating that the AF stages are working. If nothing, put your finger or a screwdriver on pin 2 of the LM380N — if this makes some noise, then the fault is in the filter or following stages, otherwise somewhere around IC2 itself.

4. If you connect an aerial you should hear signals although possibly not strong as the preselector has not yet been peaked. You can adjust VC1/2 for maximum signals if you like, although readjustment will be needed on transmit. It is important that the antenna is a good 50 ohm match for best results — especially on transmit, but also on receive.

5. Switch to transmit by earthing pin B. The relays should change over — releasing the earth should cause them to change back after a second or so (the initial delay may be shorter than subsequent ones). RV1 will vary the delay over a small range.

6. Now earth pin A (PTT) — this will switch to transmit without carrier injection or any delay. Monitor the total current consumption, and then adjust RV3 slowly until it rises by 100mA. You should find that this adjustment is smooth with no sudden jumps. If not, look around the PA stage for something wrong (have you got 50 ohms on the output?).

7. Now revert to earthing pin B. Watching your SWR bridge, alter-

nately adjust VC1 and VC2 for maximum power output (you can use the internal RF meter providing you are using a dummy load — set RV3 so that this doesn't hit the end stop when you go on to transmit!). This adjustment will need to be made a few times. You should be able to achieve 2 watts output on any of the bands, with probably 3-4 watts on 160 & 80m, falling to 2 watts on 21MHz. On the higher bands, adjusting the spacing of the turns on L1 and L2 may produce an improvement. With capacitor and winding tolerances (and variations in the permeability of the cores), you may find that the values of C18 and C16 might need changing if the two trimmers are at one end of their adjustment ranges. You should peak VC1/VC2 in the portion of the band you use most.

8. If you can't get any output power, then check the windings of T1, and L1/L2 carefully, especially the tap positions. If you have a scope, you should be able to see where you are losing RF by working forward from the DBM. Incidentally, trying to measure the RF voltage from the VFO at the DBM input will give misleading readings due to the VSWR existing at this port.

9. Set RV4 so that the meter reads just below FSD at maximum power output.

10. Now check the DSB audio circuits. Connect a suitable microphone (most impedance microphones will work but 5K is best) to point M using screened cable. Earth point A (PTT) and whistle strongly into the mic. Set RV5 (mic gain) so that the power output shown on the meter just starts to reduce while whistling. This will ensure that you don't overdrive the circuits. If no output then look around Q6/Q7 (is emitter of Q7 earthed?).

11. If not already done, connect the MINISYNTH offset circuit up as shown, and using the display or a counter, set it so that the receive frequency is 800Hz lower than transmit (in the DSB2, the offset is operative on 'receive', and out of circuit on 'transmit'). Remember you MUST listen to the lower frequency side audio tone from a received CW signal in order to *ensure that the other chap will hear you when you transmit* (with a dc receiver you can hear *both* audio images from a CW signal, rather

than only one which you would hear from a receiver with a narrow SSB filter).

Sidetone

If the MINISYNTH sidetone is being used, connect a screened cable between pin H on the MINISYNTH, and pin R on the DSB2. Adjust RV7 for a comfortable audio level when sending CW (setting is not affected by the main volume control). Otherwise, any suitable key controlled audio oscillator output can be fed into pin R for sidetone.

Casing Up

This completes the tests on the DSB2, and you can now build it into a cabinet. Some basic drawings for the cabinet used here are shown (identical to the DSB80 cabinet) but you can use anything that suits. A small bracket is used for mounting the VFO capacitor, and the 6:1 reduction drive for bandspread (see drawings). The boards are mounted on 6BA nuts to space them from the base. Be very careful that there is sufficient clearance for the PA transistor mounting bolt not to short out (you can put a piece of tape under it on the cabinet base for safety).

Frequency calibration is no problem with the digital display, and for an analogue version, a circular dial can be mounted on the flange of the reduction drive and suitably marked (the flange needs two short 8BA bolts). The drawings should give sufficient detail for assembly. The display used comes with a mounting bezel, but unfortunately there is no provision for actually fixing the two together. The way to do this is to fix the display into the back of the bezel using a small amount of cyanoacrylate adhesive, taking care that none gets on the front of the display in the process.

One point that seems to confuse newcomers is the use of audio and RF cables. Many times AF cable has been seen used where RF coaxial cable is needed. The appearance of the two is quite different once you know, and the electrical characteristics also quite different. Audio cable used at RF has a very high capacitance, and will cause all sorts of problems. If you are not sure, look at the screen

C41,43,45	1in ceramic disc
C42,46	10n ceramic disc
C44	100n monolithic ceramic
C47,48	470n tantalum bead
Q10	BF273
IC3	78L05
IC4	MSL2312 or MSL2318
RFC4	TOKO type 7BA or 7BS 1mH
DISP1	PCIM177 frequency counter

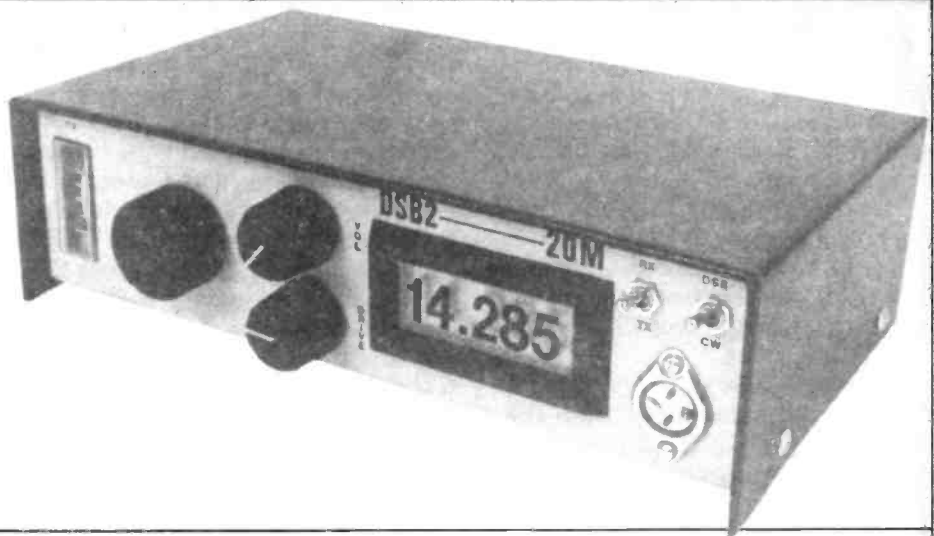

BAND	RFC1	C10	C16/18	C17	T1	L1/L2
160m	100uH	—	680pF	100pF	13T CT	T68-2 40t tap 13t
80m	33uH	470pF	330pF	56pF	13T CT	T68-2 25t tap 7t
40m	6.8uH	390pF	120pF	15pF	13T CT	T68-2 19t tap 5t
30m	4.7uH	—	47pF	18pF	11T CT	T68-2 15t tap 4t
20m	2.2uH	—	47pF	18pF	9T CT	T68-6 12t tap 4t
17m	1.2uH	—	47pF	18pF	5T CT	T68-6 9t tap 3t
15m	1uH	150pF	47pF	18pF	5T CT	T68-6 9t tap 3t

Key: — means component not used

CT = centre tapped.

All taps for L1/2 are made near earthy end of coil.

L1/2 wound using 0.56mm dia enameled copper wire.

T68-2 cores have red colouration.

T68-6 cores have yellow colouration.

T1 is wound on Fair-Rite core S9-61001101

Choke codings —

100uH = 101,
 33uH = 330,
 6.8uH = 6R8,
 4.7uH = 4R7,
 2.2uH = 2R2,
 1.2uH = 2R2,
 1uH = 1R0.

Note on aligning the DSB-2

You will find that the polyvaricon capacitors show a *short term* mechanical backlash due to the temporary deformation of the plastic dielectric when

near-fully meshed. This is of little concern in the practical case. However, the substitution of an air-spaced capacitor of similar value will eliminate the effect completely if it is found to be annoying.

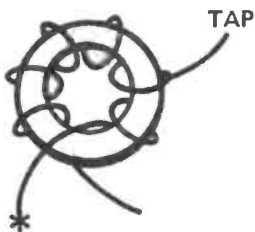

L1 COIL WINDING DIRECTION

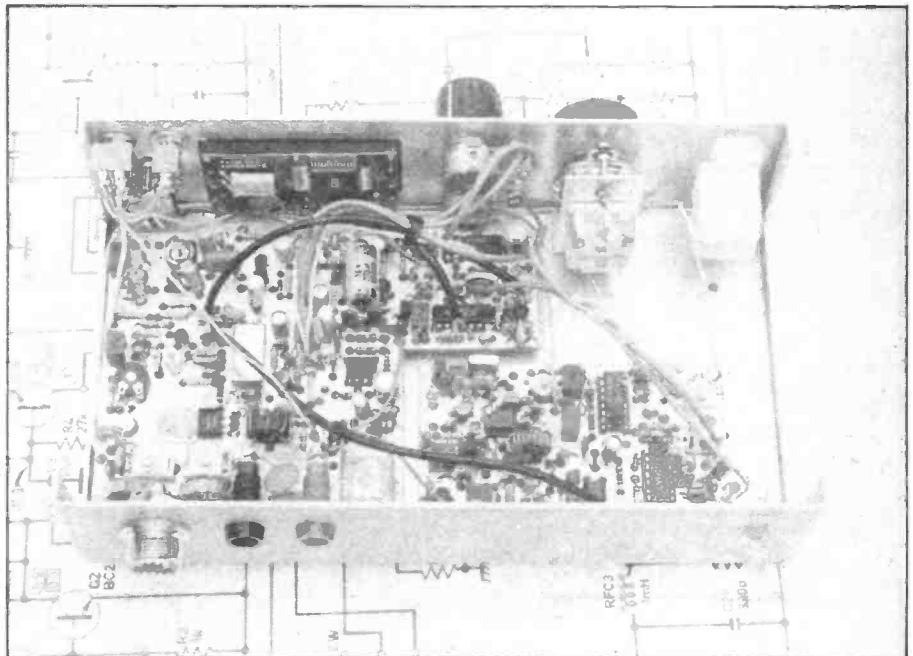

Note the neat interconnection wiring — care with this will aid trouble-free operation.

BI-PAK BARGAINS

MINIATURE TOOLS FOR HOBBYISTS



Miniature round nose side cutters - insulated handles 1/4 inch length. Order No. Y043.



Miniature long nose pliers - insulated handles 5/8 inch length. Order No. Y044.



Miniature bend nose pliers - insulated handles 5/8 inch length. Order No. Y045.



Miniature end nippers - insulated handles 1/4 inch length. Order No. Y046.



Miniature snipe nose pliers with side cutter and serrated jaws - insulated handles 5/8 inch length. Order No. Y042.

ALL AT **£1.25** each

FLEXEY DRIVER

A flexible shaft screwdriver for those awkward to get at screws. Overall length 8 1/2 inch. Order No. FS-1 Flat blade 4mm FS-2 Cross point no. 1 £1.75 each.



GRIP-DRIVER

8 inch long screwdriver with spring loaded grip on end to hold screws in position while reaching into those difficult places. Order No. SD-1 Flat blade 4mm SD-2 Cross point no.0. £95p each.



SILICON BRIDGE RECTIFIERS

Comprising 4 x 1/2 amp rectifiers mounted on PCB.

VRM - 150 volts
IFM - 1.5 Amps

Size: 1 inch square
10 off **£1.00**
50 off **£4.50**
100 off **£7.50**

Order No. As:4R1 BRect

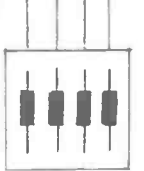

REGULATED VARIABLE STABILISED POWER SUPPLY

Variable from 2.30 volts and 0.2 Amps. Kit includes -
1 VPS30 Module, 1 25 volt 2 amp transformer, 1 0.50v 2" Panel Meter, 1 0.2 amp 2" Panel Meter, 1 470 ohm wirewound potentiometer, 1 4K7 ohm wirewound potentiometer. Wiring Diagram included. Order No. VPS30 KIT **£20**

MINIATURE FM TRANSMITTER

Freq: 95.106MHz. Range: 1/2 mile
Size: 45 x 20mm. Add. 9v batt.
Not licenced in U.K.
Ideal for: 007-M15-FBI-CA-KGB etc.

ONLY **£5.50**

8 BIT MICROPROCESSOR

National INS8080AN 40 Pin DIL N Channel Silicon GATE MOS TECHNOLOGY As used in Nationals N8080 Micro Computer Family
Instruction Cycle Time 2 µs
Supplied with functional Block Diagram
BRAND NEW
NOT seconds or reclaims
100% perfect ORDER NO. SX8080
Normal Sell price £4.50 each
Our BI-PAK Special Price
SO HURRY LIMITED STOCKS
only **£2.00**

40 Pin IC Socket to fit SX8080
ORDER NO. 1609
Offer price **30p**

TRANSISTOR CLEARANCE

All Sorts Transistors. A mixed Bag NPN-PNP Silicon & Germ. Mainly Uncoded You To Sort Pack includes Instructions For Making Simple Transistor Tester. Super Value. Order No. VP60 **£1.00**

MULTITESTERS

1,000 opv including test leads b Battery
AC volts 0-15-150-500-1,000
DC volts 0-15-150-500-1,000
DC currents 0-1ma 150ma
Resistance 0-2.5 K ohms 100 K ohms
Dims - 90 x 61 x 30mm

O/No.1322.OUR PRICE **£6.50 ONLY**

5T21 SCREWDRIVER SET

6 precision screwdrivers in hinged plastic case. Sizes - 0.8, 1.4, 2, 2.4, 2.9 and 3.8mm **£1.75**

5T31 NUT DRIVER SET

5 precision nut drivers in hinged plastic case. With turning rod. Sizes - 3, 3.5, 4, 4.5 and 5mm. **£1.75**

5T41 TOOL SET

5 precision instruments in hinged plastic case. Crosspoint (Philips) screwdrivers - H0 and H1 Hex key wrenches. - 1.5, 2 and 2.5mm **£1.75**

5T51 WRENCH SET

5 precision wrenches in hinged plastic case. Sizes - 4, 4.5, 5, 5.5 and 6mm **£1.75**

ELECTRONIC SIREN 12v DC

Red plastic case with adjustable fixing bracket. Emits high-pitched wailing note of varying pitch - 100 cycles per minute. Dims - 90mm (dia.) 60mm (depth). Power - 12v DC.

Our Price: **£5.50**



BRAND NEW LCD DISPLAY MULTITESTER

RE 188m
LCD TO MEGOHM INPUT IMPEDANCE
*3 1/2 digit *16 ranges plus hFE test facility for PNP and NPN transistors *Auto zero, auto polarity *Single-handed, pushbutton operation *Over range indication *12.5mm (1/2 inch) large LCD readout *Diode check *Fast circuit protection *Test leads, battery and instructions included.

Max indication 1999 or -1999
Polarity indication Negative only
Positive readings appear without + sign
Input Impedance 10 Megohms
Zero adjust Automatic
Sampling time 250 milliseconds
Temperature range -5°C to 50°C
Power Supply 1 x PP3 or equivalent 9V battery
Consumption 20mW
Size 155x88x31mm

RANGES **£35.00**
DC Voltage 0-200mV
0-2-20-200-1000V. Acc. 0.8% each
AC Voltage 0-200-1000V
Acc. 1.2% DC Current 0-200µA
0-2-20-200mA, 0-10A. Acc. 1.2%
Resistance 0-2-20-200K ohms
0-2 Megohms. Acc. 1%
BI-PAK VERY LOWEST PRICE

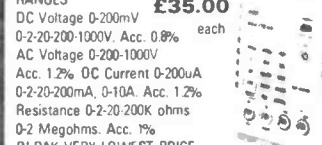

DIGITAL VOLT METER MODULE
3 x 7 segment displays Basic Circuit 0-2V - instructions provided to extend voltage & current ranges
Operating voltage 9/12v
Typ Power Consumption 50mA
D/NO SX99 Once only price **£9.95**

Leather Case for 188m £2.50 EACH

VALUE PACKS

Pak No.	Qty	Description	Price
VP1	300	Assorted Resistors Mixed Types	£1.00
VP2	300	Carbon Resistors 1/4 Watt Pre-Formed	£1.00
VP3	200		
VP4	150	1/4 Watt Resistors 100 ohm-1M Mixed	£1.00
VP5	200	Assorted Capacitors All Types	£1.00
VP6	200	Ceramic Caps Miniature - Mixed	£1.00
VP7	100	Mixed Ceramic Disc. 1pf - 56pf	£1.00
VP8	100	Mixed Ceramic Disc. 88pf - .015pf	£1.00
VP9	100	Assorted Polyester Polystyrene Caps	£1.00
VP10	50	C280 Type Caps Metal Foil Mixed	£1.00
VP11	100	Electrolytics - All Sorts	£1.00
VP12	60	Bead Type Polystyrene Min Caps	£1.00
VP13	50	Silver Mica Caps Ass. 56pf - 150pf	£1.00
VP14	50	Silver Mica Caps Ass. 180pf - 4700pf	£1.00
VP15	50	High Voltage Disc. Ceramic 750v - 8kv Mixed	£1.00
VP16	50	Wirewound Res. 9W (avg) Ass. 1 ohm - 12K	£1.00
VP17	50	Metres PVC Covered Single Strand Wire Mixed Colours	£1.00
VP18	30	Metres PVC Covered Multi Strand Wire Mixed Colours	£1.00
VP19	40	Metres PVC Single/Multi Strand Hook-Up Wire Mixed	£1.00
VP20	6	Rocker Switches 5 Amp 240v	£1.00
VP21	20	Pcs. 1 - 2 & 4 mm Plugs & Sockets Matching Sizes	£1.00
VP22	200	Sq. Inches Total, Copper Clad Board Mixed Sizes	£1.00
VP23	20	Assorted Slider Pots. Mixed Values	£1.00
VP24	24	Slider Pots. 40 mm 22K 5 x Log. 5 x Lin	£1.00
VP25	10	Slider Pots. 40 mm 47K 5 x Log. 5 x Lin	£1.00
VP26	20	Small 125° Red LED'S	£1.00
VP27	20	Large 2° Red LED'S	£1.00
VP28	10	Rectangular 2° Green LED'S	£1.00
VP29	30	Ass. Zener Diodes 250mW - 2W Mixed Vts. Coded	£1.00
VP30	10	Ass. 10W Zener Diodes Mixed Vts. Coded	£1.00
VP31	10	5 Amp SCR's TO-66 50-400v Coded	£1.00
VP32	20	3 Amp SCR's TO-66 Up To 400v Uncoded	£1.00
VP33	200	Sil. Diodes Switching Like IN4148 DO-35	£1.00
VP34	200	Sil. Diodes Gen. Purpose Like OA200V BAX13/16	£1.00
VP35	50	1 Amp IN4000 Series Sil. Diodes Uncoded All Good	£1.00
VP36	8	Bridge Rects. 4 x 1 Amp 4 x 2 Amp Mixed Vts. Coded	£1.00
VP37	8	Black Instrument Type Knobs With Pointer 1/2" Std	£1.00
VP42	10	Black Heatsinks To Fit TO-3, TO-220 Ready Drilled	£1.00
VP43	4	Power-Fin Heatsinks 2 x TO-3 2 x TO-66 Size	£1.00

TECASBOTY

The Electronic Components and Semiconductor Bargain of the Year! This collection of Components & Semiconductors for the

hobbyist is probably the most value-packed selection ever offered, it consists of Resistors, carbon and wirewound of various values. Capacitors: All types, sorts and sizes including electrolytics. Potentiometers - single, dual, slider and preset. Switches, Fuses, Heatsinks, Wire, P.C.B. Board, Plugs, Sockets etc., PLUS a selection of Semiconductors for everyday use in popular Hobby Projects. These include: SCR's, Diodes, Rectifiers, Triacs & Bridges as well as a first class mix of Transistors and I.C.'s. In all, we estimate the value of this in current retail catalogues to be over £25! So, help yourself to a great surprise and order a Box TODAY for just **£6.50**

ONLY at BI-PAK. Remember, stocks are limited so hurry! You can call us on 0920-3182/3412 and order with your Barclaycard or Access Card - 24hr Answerphone Service NOW. Order No. V.P. 85.



OUR GREAT NEW 1984 CATALOGUE

Presented with a Professional Approach and Appeal to ALL who require Quality Electronic Components, Semiconductors and other Accessories ALL at realistic prices. There are no wasted pages of useless information so often included in Catalogues published nowadays. Just solid facts i.e. price, description and individual features of what we have available. But remember, BI-PAK's policy has always been to sell quality components at competitive prices and THAT WE STILL DO.

We hold vast stocks "in stock" for fast immediate delivery, all items in our Catalogue are available ex stock. The Catalogue is designed for use with our 24 hours "ansaphone" service and the Visa/Access credit cards, which we accept over the telephone.

To receive your NEW 1984 BI-PAK Catalogue, send 75p PLUS 25p p&p to:-

SIREN ALARM MODULE

American Police type screamer powered from any 12 volt supply into 4 or 8 ohm speaker. Ideal for car burglar alarm, freezer breakdown and other security purposes. 5 watt, 12v max.

£3.85
Order No. BP124.



The Third and Fourth Hand . . .

you always need but have never got until now. This helpful unit with Rod mounted horizontally on Heavy Base Crocodile clips attached to rod ends. Six ball & socket joints give infinite variation and positions through 360° also available attached to Rod a 2 1/2 diam magnifier giving 25x magnification. Helping hand unit available with or without magnifier. Our price with magnifier as illustrated ORDER NO. T402 £5.50. Without magnifier ORDER NO. T400 £4.75



MW398 NI-CAD CHARGER

Universal Ni-Cad battery charger. All plastic case with lift up lid Charge/Test switch LED indicators at each of the five charging points.
Charges -
PP3 (3V) Power - 220-240V AC
U12 (1.5V penlite) Dims - 210 x 100 x 50mm
U11 (1.5V "C") 210 x 100 x 50mm
U2 (1.5V "D") **£6.95**

POWER SUPPLY OUR PRICE £3.25

Power supply fits directly into 13 amp socket Fused for safety. Polarity reversing socket. Voltage switch. Lead with multi plug Input - 240V AC 50HZ, Output - 3, 4, 5, 6, 7.5, 9 & 12V DC Rating - 300 ma MW88.

TRIACS - PLASTIC

4 AMP - 400v - T0202 - TAG 136G.			
1 OFF	10 OFF	50 OFF	100 OFF
40p	£3.75	£17.50	£30.00
8 AMP 400v - T0202 - TAG 425			
60p	£5.75	£27.50	£50.00

VOLTAGE REGULATORS T0220

Positive +	Negative +
7805 - 40p	7905 - 50p
7812 - 40p	7912 - 50p
7815 - 40p	7915 - 50p
7824 - 40p	7924 - 50p

BI-PAK

Send your orders to Dept. 401 BI-PAK PO BOX 6 WARE, HERTS SHOP AT 3 BALDOCK ST. WARE, HERTS
TERMS CASH WITH ORDER. SAME DAY DESPATCH. ACCESS. BARCLAYCARD ALSO ACCEPTED. TEL (0920) 3182. GIRD 388 7006
ADD 15% VAT AND 75p PER ORDER POSTAGE AND PACKING



Use your credit card. Ring us on Ware 3182 NOW and get your order even faster. Goods normally sent 2nd Class Mail. Remember you must add VAT at 15% to your Total order. Postage add 75p per Total order.

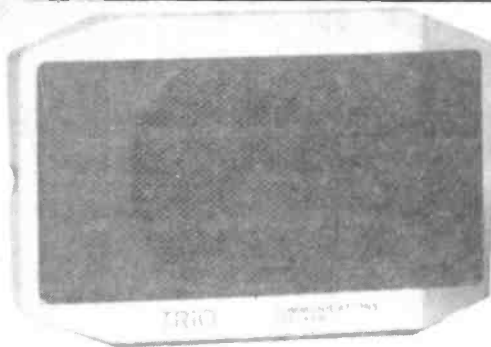

A Look at the



TM201A 2m FM Transceiver

Planning a move to a large urban conurbation and realising that it would be necessary to frequently remove the rig from the car for the purposes of security, it was decided to investigate a number of the various small VHF transceivers available, with particular attention to the ease of removal and refitting into the vehicle, coupled with a reasonable output power. The new generation of physically very small mobile rigs were very attractive in case it was necessary to carry the equipment any distance and after some study of various brochures my final choice was the Trio TM201A.

A phone call to Dewsbury Electronics, of Stourbridge resulted in a small package being delivered less than 48 hours later, and the removal of the packaging material revealed one of the neatest two metre FM transceivers yet seen. Weighing only 1.25 kg with physical dimensions 141 mm wide, 183 mm deep and on-

obstructed by the spokes in the steering wheel. It was finally decided to mount the TM201A cradle on to a 5½" x 7" five-ply board and screw the board onto the parcel itself immediately below the vehicles fuse box. This tilted the rig at an angle providing full visibility of dial and controls and operation from the driving position.

7/8 wavelength gutter mounted antenna with a Diawa CN630 VHF/UHF power/SWR meter in circuit.

Built-in dual digital VFO's are selected from a front panel VFO-A/B switch, and these tune in either 25 or 5 kHz steps independently from 144.000 to 145.995 MHz.

The TM201A has been fitted with internal lithium batteries to retain memory data when the main power source is disconnected; the estimated life of these batteries is five years. There are five memories available: the Priority Alert function is Memory 1; single frequencies are stored in Memories 2 and 3 while Memories 4 and 5 independently store transmit and receive frequencies to permit operation through repeaters having both standard and odd offset frequencies.

In order to overcome the difficulty in reading the dial display in sunlight, the TM201A has been provided with yellow LED digital frequency display which is quite visible even in bright sunlight. In addition, it has a bargraph to indicate receive signal strength or power out, together with 'Busy', 'MR' (memory recall); 'Alert' and 'On Air' LED indicators which fill the remaining half of the display indicator panel and are all easy to read even in high ambient light conditions.

Manual frequency selection is by

George Metcalfe, G6VS, tells how this neat little 2m transceiver shapes up from a driver's point of view.

ly 39.5 mm high, with a front panel giving the appearance of efficient flexibility coupled with ease of operation.

Installation

A Vauxhall Nova car appears, like many other modern cars, to have considerable space available for fitting a mobile transceiver, but although the parcel shelf extends the full width of the vehicle the depth within hands reach from the driving position was only about six inches. As the parcel shelf has a fairly deep rim it was not possible to mount the fitting bracket directly on the shelf. Various other positions were tried — under the shelf fouled the drivers legs, under the dashboard either blocked access to the fuse box or the visibility of the TM201A control panel was

Due to the complex nature of the various facilities offered, the TM201A does take a little time to learn to 'drive'! However, after a short familiarisation period it was found to be easy to operate all the various functions of the rig. Care was needed when pressing the control keys as the compact design necessitates close proximity of these keys and two could accidentally be pressed instead of one, while mobile.

Features

The transceiver offers a choice of two output powers at a touch of a button — 5 watts or 25 watts. The specifications appear to be very conservative as measurements into a dummy load indicated 6.1 and 27.6 watts respectively. Almost identical figures were obtained when fed into a

means of a large knob situated on the left of the control panel; immediately above are located the Offset Selector switch used to get the transmit frequency (either up or down) when operating through a repeater with the standard offset, and alongside this is a push-button to transpose the receive and transmit frequencies, usually used for listening on the 'input' when working through a repeater. The frequency display, bargraph and light indicators occupy about two thirds of the upper half of the front panel and immediately below are the volume/on/off and squelch controls together with the six functional switches in two rows of three switches.

These mainly dual function switches (one actually has 3 functions) select the five individual memories, memories four and five holding receive and transmit frequencies independently, in addition to initiating the various special operations that the transceiver can perform. These include 'priority alert', which checks memory one every six seconds, whether scanning or receiving, selection of the dual digital VFOs, which can also be controlled from the

microphone, and memory scan. Operation of the switches activates an audible 'beeper', enabling audible confirmation of the function selected by a counting of the number of beeps emitted.

Due to the compact design of this transceiver and to provide flexibility of installation, a separate high quality mobile loudspeaker is supplied. This considerably improves the sound reproduction when compared with the usual small downward speakers in the majority of mobile rigs.

Optional Extra

Available as an extra is the FC.10 Frequency Controller which is fitted with a flexible lead and plug to connect into the TM201A. This is literally a remote controller with an image of the frequency/bargraph display and some of the function keys of the transceiver. My first impression was that this would be ideal to mount on top of the dashboard so that it would be easily visible to the driver/operator. Unfortunately there is a warning on the unit, which has a back lighted LCD display, not to mount it in any place

which could be affected by bright sunlight!

Conclusions

From a driver/operators viewpoint the TM201A offers all the facilities ever likely to be required for efficient mobile operation. The 'listen on input' facility is very convenient but the function found to be most useful was the monitoring of the frequency stored in M1 every six seconds — if this is set to, say, one of the simplex channels it avoids the necessity of retuning to check that the channel is clear when moving from repeater to simplex operation (after checking that the other station can be heard direct using the 'listen on input' facility first, of course!)

My only criticism is the ease in which two (or even more) functional keys can be accidentally pressed at the same time whilst using them 'on the move', but with care and *practice* this problem was easily resolved.

This new mobile transceiver from Trio is aesthetically pleasing to the eye, transmitted audio quality has been reported as excellent and the 'in car' audio is ideal for the mobile operator.

RSGB National Amateur Radio Convention

National Exhibition Centre, Birmingham

Saturday 28th April 10am to 6pm Sunday 29th April 10am to 5pm

FEATURING

 Lectures on Propagation, VHF and Microwaves.

 Introduction to Amateur Radio for Beginners

 Annual RSGB HF Convention

 Major Exhibition of Amateur Equipment & Components.

 Forum for VHF and Repeater Enthusiasts.

 RSGB stand with book sales and representation by many of the Society's committees.

 Bigger Flea market as a result of last year's success.

Entrance Fee £2 (Children ½ price) Car Parking Free

Organised by the Radio Society of Great Britain



HAM RADIO TODAY

NEEDS

We require an organised, literate and technically competent radio enthusiast for duties as **Editorial Assistant**. These duties will include all aspects of magazine production: subbing, writing and communicating with design and print departments. It would help if you have previous experience, but if you haven't, don't let that stop you applying!

Applicants should be cheerful in the face of adversity, enjoy writing and be able to handle a typewriter. A willingness to learn is essential. A current amateur radio licence is highly desirable. We are willing to consider applications for both full-time and part-time employment.

If you are interested, please apply with full CV to Ron Harris, Managing Editor, Argus Specialist Publications Ltd, 1 Golden Square, London W1R 3AB.



YOU!

IT LIVES AGAIN!

From the past it came, growing daily, striking terror into the hearts of lesser publications, and spreading its influence across the country in its quest to infiltrate every town, every home, every mind.

Not a horror story, but a success story. And if electronics theory strikes terror into you, then you need the help of **Electronics — It's Easy**. Originally a long-running series in Electronics Today International, **Electronics — It's Easy** was printed as a set of three books. They sold out. It was reprinted as a single volume. Now this phenomenally successful publication is available again, in its third reprint. **Electronics — It's Easy** is a comprehensive and simply-written guide which explains the theory (and the practice) of electronics step by step. Every aspect of the subject is covered, starting with the basic principles and working through to the how and why of today's technology.

You can obtain your copy of **Electronics — It's Easy** by mail order using the coupon below. Make cheques or postal orders payable to ASP Ltd, alternatively you may pay by Access or Barclaycard.

Send to: Sales Office (Specials),
PO Box 35, Wolsey House, Wolsey Road,
Hemel Hempstead, Herts HP2 4SS
Please send me copies of **Electronics — It's Easy**. I have enclosed £..... (£4.95 each including p&p).

NAME

ADDRESS

Please debit my account
My Access/ Barclaycard No. is

Signature



Radio Building Blocks

A mention of 'homebrew' over the air will polarise radio amateurs into three groups: those who do (a minority) those who don't (also a minority) and those who have tried without much success (the majority). The aim of this series is to take some of the fear out of home building by offering a bit of

direct conversion sets depend on them. The effectiveness of the mixer will often dictate the overall performance of a radio system. Fig.1 shows a hypothetical block diagram of the average transceiver locating the mixer position. This block subdivides into two kinds: active or passive. Active

scientific quantification.

Most FET mixers are ideally said to possess a *square law characteristic*. This is a precise description of the way an amplifier stage distorts to produce a mixer effect. Any kind of overdriven amplifier can be used as a mixer. Any device which shows a distorted relationship between input voltage and input current will act as a mixer element. A diode is a good example. Square law devices (which diodes never are) produce a distortion product voltage which rises linearly with input power. In this case, the *low order* distortion products are proportional to the square of the input voltage. Low order products are what one wants from a mixer. Where two tones are supplied to a mixer simultaneously, low order products would be $F1 + F2$ or $F1 - F2$. More importantly, the production of *high order products* (the main ones are $2F2 - F1$ and $2F1 - F2$) are minimised in a mixer with square law characteristics. This is very desirable because such electronic 'mush' appears very close to a wanted signal.

A mixer in the front end of a receiver is designed to accept two signals: one strong one, ie the local oscillator and a relatively weak one, the wanted station. These two frequencies can either sum or difference to produce the intermediate frequency, typically 10.7MHz or 455kHz. In the real world, there are usually several strong signals present within the mixer. These could be the harmonics present in the local oscillator signal, an unterminated 'image' IF or co-channel broadcast stations. Take the co-channel signals for example. Let F1 be a high power station on 7.1MHz. Let F2 be another high power broadcast station on

Judging from our postbag, one of the most popular of the HRT regular columns has been Frank Ogden's late lamented 'Technicalities'. In this new series, Frank will be taking a typically down-to-earth look at the problems of RF homebrewing and design.

reason to the contradictions of RF design. It must be said that you do need a few basic things to make radio gear. Elementary test equipment helps — signal generator, multimeter — but *interest and time* are the main commodities. Also, the sure and certain knowledge that nobody ever builds a piece of gear which works perfectly first time is quite a comfort when yours doesn't either.

Mixers

Mixer circuitry is at the core of any radio design. Receivers, transmitters,

mixers nearly always offer some degree of *conversion gain* (the increase in amplitude of a mixer product over an input signal). Passive mixers use diodes and always show *conversion loss*. This doesn't prevent them from being very useful however.

A Few Buzz Words

Mixer circuits of any description generate more incomprehensible jargon than any other part of a radio set. This is perhaps because they are more important, less predictable and almost completely unyielding to

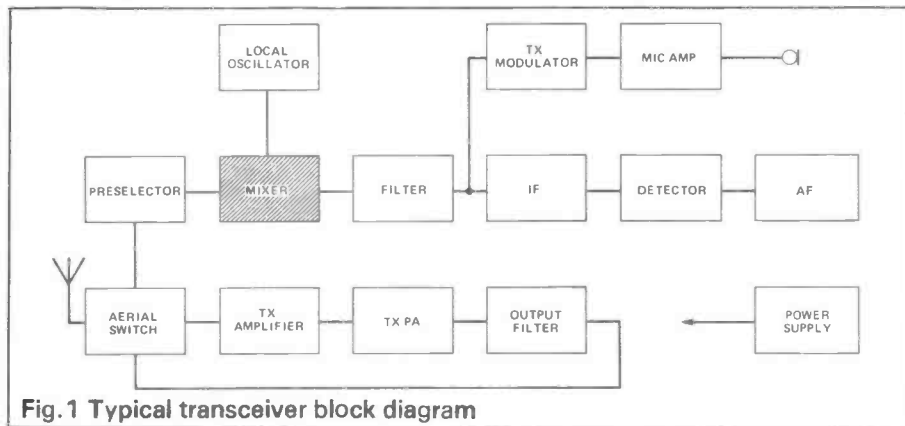

Fig. 1 Typical transceiver block diagram

7.15MHz. Let F3 be something that you are trying to listen to on 7.05MHz. One of the principle *third order products* derives from the distortion product $(2 \times F1) - F2$. Substituting the frequency values in the example gives the result: $(2 \times 7.1) - 7.15 = 7.05\text{MHz}$. Thus the principle third order product from two stations that we shouldn't be able to hear stands a good chance of blocking a frequency within an amateur band. This particular example of *cross modulation* would produce a series of interference spikes at 50kHz intervals either side of the two high power stations.

The susceptibility of a mixer to cross modulation and other nasties is defined by its *third order intercept* performance. This is a theoretical point located at the intercept of two graphs. One is the plot of wanted signal against input level while the other is a plot of third order mixer products against input level.

The importance of this otherwise completely useless third order concept is that this type of distortion product follows a cubical law. If you *double* the input to a typical mixer, you get *double* the output of what you want but you also get *eight times* that which you don't. In figures, each 6dB increase in input signal level gives rise to an 18dB increase in third order distortion products.

One might wonder how a mixer ever appears to work at all. It all depends on where you start the calculations from. If you believe in third mixer laws (and they are much more of a fuzzy guideline than a law) then it is possible to predict the intermod performance of a mixer (or amplifier) given a value for third order intercept. For instance, a mixer specifies a +24dBm level of intercept. You want to know how it will behave with a 0dBm input signal level (220mV). This figure is 24dB below the intercept. In theory the distortion products will be in the region of (24×3) or 72dB below intercept level. This is the same as saying that it is as 48dB below the 0dBm signal level. Equally one may predict that the electronic 'mush' would be equivalent to a signal of around 0.8mV.

Active Mixers

Radio design is very much horses for courses. You first have to decide what you are trying to do and then look around for something which

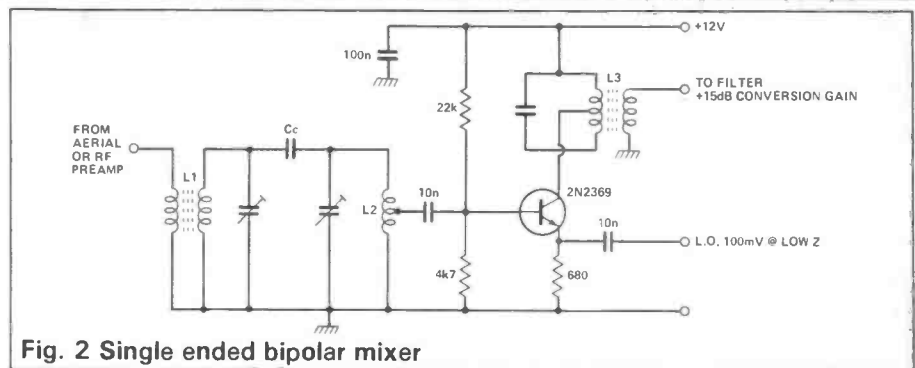

Fig. 2 Single ended bipolar mixer

might fulfil the requirement. Naturally everyone wants the best in performance but this is not always possible or even necessary. As it relates to mixers, the following usually applies: high rather than low standing current in the mixing device together with the high rather than low local oscillator drive. However tens of milliamps and milliwatts of LO drive are not practical when designing a front end for a 2m handtalkie. Similarly, the strength of signals received on a helical aerial will usually be low and therefore undemanding of the mixer strong signal performance. Low noise and low battery drain would be far more helpful here.

Bipolar mixer. The generic type is shown in Fig.2. It offers the highest conversion gain yet requires only a very modest supply current. The LO requirements are also among the lowest of all mixer types. However, the intercept performance is inferior to every other type of mixer and only becomes moderately good when the mixer transistor bias current is increased from around 2 to 20mA measured at the collector. The conversion gain is relatively independent of collector voltage, although this voltage does have a major bearing on strong handling (as it does with all other types of active mixer; use the highest supply voltage possible.)

The DC bias conditions should typically set the transistor collector

current for a value around 1mA with the LO drive disconnected. Application of LO drive should raise the standing current by around 50 per cent. The transistor should be of an RF type suitable for the frequency in use. It is more important to choose a device for its low collector base capacitance than its high f_t . ZTX314 or 2N2369 are an excellent choice for low current front end design to around 150MHz. Conversion gain and low noise performance depends on careful matching of the signal input circuit (L1 and L2) to the base of the transistor. The impedance tends to be in the region of 200 ohms at VHF rising to around 600 ohms at HF.

It should be noted that the conversion gain figures are relative for Fig.2. and the successive circuits. The realised gain may be much higher with an active mixer circuit — although this will be at the expense of intermod performance. I have attempted an 'off the cuff' normalisation with the figures that are quoted.

FET mixer. The JFET mixer shown in Fig.3 looks very similar to the bipolar transistor circuit although the actual performance characteristics are very different. The noise performance derived from a well matched input circuit will be much better: 5 to 10dB against the 15dB of a bipolar stage. The strong signal performance will be very good provided that a high transconductance device such as a J310 or similar is used.

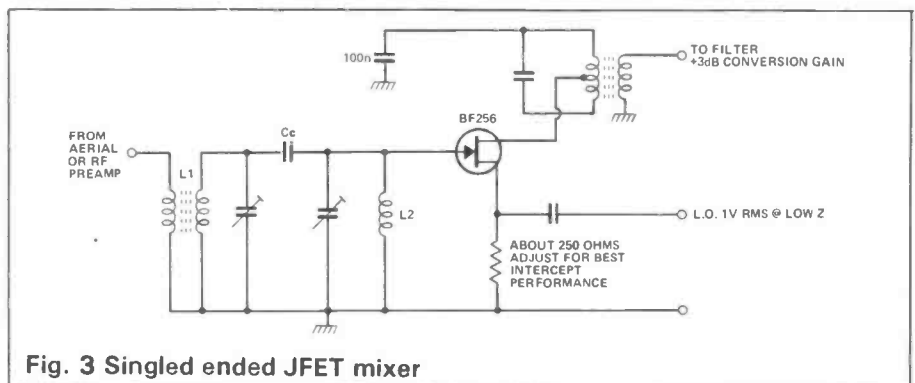
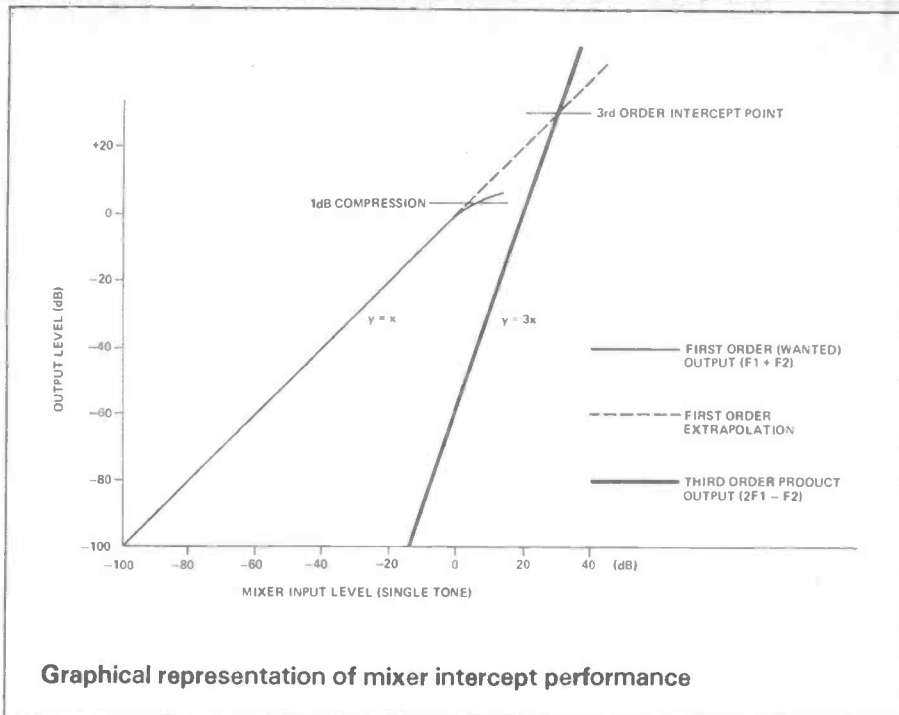

Fig. 3 Singled ended JFET mixer

JFETs (and MOSFETs) display the desirable square law characteristic provided that the biasing conditions are selected carefully. The precise bias point would be selected on test. A rule of thumb suggests that half the 'pinch-off' voltage — the pinch-off voltage being that value of negative gate bias which just ceases drain conduction — coupled with an LO injection level, peak to peak, which matches the pinch-off voltage offers the optimum performance.

For instance, a J310 with a conductance of 10 to 18mA/V and a pinch off voltage of 3V would work best as a mixer when biased to -1.5V relative gate to source potential, while being driven with an LO voltage of 1V RMS applied to the source terminal. The gate would offer the best noise match into around 2k ohms (VHF) with a similar value of IF load in the drain circuit. The transistor gain will be as much as 6 to 8dB with a J310.

A cheaper transistor such as the BF256 exhibits around one quarter of the transconductance of a J310. The pinch-off and bias points will be about



the same although the conversion gain will be a bit lower. The standing current should be in the region of 5mA. The source bias resistor will be around 68 ohms for a J310 or 270 ohms for a BF256. Both transistors

exhibit gain into the microwave region. Look out for parasitics removing them with low value series resistors if evident.

Next month Frank will be looking at dual gate MOSFET and diode mixers.

G3WPO
G4KEI

HASSOCKS (07918) 6149

20 FARNAM AVENUE HASSOCKS
WEST SUSSEX BN6 8NS

WPO COMMUNICATIONS

NEW 160-15M QRP TRANSCEIVERS

FOLLOWING THE GREAT SUCCESS OF OUR DSB80 AND DSB 160 PROJECTS, WE NOW INTRODUCE THE DSB2 RANGE OF QRP HF SINGLE BAND TRANSCEIVERS — TRY ONE FROM THE HF SPECIALISTS.

A new range of rigs in build-it-yourself form incorporating refinements and additions over the DSB80. Now available for any individual band from 160M through to 15 metres (including WARC bands). Utilises the MINISYNTH simple PLL VFO (available separately) for complete coverage of each band. Features include semi break-in keying (relay controlled), 2 watts min. CW or DSB out, on-board active filter, bombproof VMOS PA, +12v operation, mic gain control, sidetone for CW (via VFO), and on-board provision for a digital readout for any of the bands. The sensitivity on receive is more than adequate for general communications, with high dynamic range, utilising an encapsulated double balanced mixer at the RF input.

THIS PROJECT IS IDEAL FOR BEGINNERS or QRP enthusiasts, and comes complete with comprehensive instructions/drawings, and typical voltages. The DSB2 Kit comes complete with all components, pcb (drilled and tinned) with component positions screened on, and connecting wire. The pcb alone is available if the complete kit is not wanted. You will need a microphone, key, antenna and power supply (+12v @800mA) to get you on the air. WE ALSO HAVE A CASE, drilled and punched but plain aluminium panels for your own finish. It comes complete with hardware (connectors, knobs, sockets, brackets, dial plate, nuts/bolts etc).

PRICES:	BASIC DSB2 Kit (no VFO)	£42.00
	DSB2 Kit with MINISYNTH VFO	£68.00
	Drilled case with hardshell	£23.35
	DSB2 + VFO + Case	£89.50
	Digital Display Kit (160/80M)	£24.10
	Digital Display Kit (40 - 15M)	£30.00
	DSB2 PCB Only inc instructions	£ 7.50

PLEASE STATE BAND REQUIRED i.e. DSB2/160 (or 80/40/30/20/17/15M).

NEW MINIATURE PLL VFO KIT

AT LAST — A VFO IN KIT FORM! Developed from the PROJECT OMEGA VFO, this miniature PLL SYNTHESISED VFO will cover any one single Amateur Band from 160M through to 10 metres (28-28.6). It is available for direct conversion designs (i.e. output at signal frequency), or for 10.7MHz/9MHz i.f.'s. We also have a version for 5-5.5MHz for FT101's etc (build that long awaited outboard VFO). Size is 100 x 56mm on one pcb. Sidetone generator, offset circuit (for direct conversion CW use) and high stability come with this design, and the output is sufficient to drive a double balanced mixer.

The Kit comes with all components, VFO capacitor and reduction drive, pcb (drilled, tinned and screened layout), connecting wire and comprehensive instructions, and should be constructable by almost anyone.

PRICE: Kit £29.70. PLEASE STATE THE BAND and i.f. required i.e. Minisynth 80/10.7 or MINISYNTH/5 for the 5-5.5MHz version. PCB alone is £5.60 inc instructions. COMING SOON — a 2 metre version with digital readout.

ALL OTHER KITS ARE STILL AVAILABLE including the original DSB80 or DSB160 at £37.45 (case and display same prices as for DSB2). We have QRP Transceivers to get you on HF Tx/Rx from 2 metres, 2 metre FM transceivers, 6 metre converter, an HF ATU Kit, and PROJECT OMEGA — a major 9 band High Performance HF Transceiver being published, and now nearing completion. Full illustrated catalogue 50p in stamps or Short Form for s.a.e. Lots more interesting projects on the way.

ALL prices include VAT. Post free over £10 — add 60p below. Most items ex-stock but allow 10-28 days if not. Post Office COD over £30. Telephone Mon-Fri, 10am-4pm. MAIL ORDER only or AGENTS Amateur Radio Exchange.

HAM

RADIO TODAY

NEXT MONTH

WORKING EARTH—MOON—EARTH
With Simple Equipment
Charles Suckling, G3WDG, de-mystifies
moonbounce communications.
This is the definitive article!

FT-757 GX — YAESU'S BIGGEST SELLER YET?
We look at the technology of Today, but with
reference to the technology of Yesterday — that
trusty old warhorse, the FT101B.

JUST IN CASE!
Tony Bailey proudly presents a container for the
Project Omega.

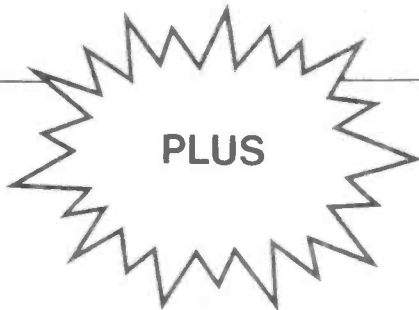

The Dexterous Dipole

Go USA County Hunting



TALK TO THE WHOLE WORLD

Study now for the
**RADIO AMATEUR'S
EXAMINATION**

We have had 40 years successful experience
in training men and women for the
G.P.O. Transmitting licence.



FREE R.A.E. brochure without obligation from:—

British National Radio & Electronics School
READING, BERKS. RG1 1BR

Name

Address

HRT/4/846 BLOCK CAPS PLEASE



Northampton Communications

TOP BAND BASE/MOBILE TRANSCEIVER
For only £199.00 inc VAT! + carriage.

HOW?

With the new LENCOM LC160
Features ■ Solid state. ■ Rugged PA
■ 30W. PEP. Full RF drive control. ■ SSB, AM, CW.
■ Audio filter. ■ Visual signal indicator. ■ A compact 12" x 6½" x 3½".

UK Sole distributor.

Spec sheet available.



Northampton Communications Limited
76 Earl Street, Northampton. NN1 3AX.
Telephone: (0604) 33936 or 38202



BARGAIN CORNER



WATCH THIS CORNER EVERY MONTH

KENWOOD TS-430S FITTED

FM-430 Unit £599 ONLY

Don't delay! Rush your Order in To-Day!
(Special Warranty Applies)

SECONDHAND EQUIPMENT

YAESU FT-101ZD (Shop Soiled - New)	£529
YAESU FT-101E, Mic, CW Filter	£399
YAESU FT-707 + FV-707DM + Mic	£550
YAESU FT-902DM, Mint Cond	£635
YAESU FP-4 Power Supply	£39

Western Electronics (UK) Ltd

Fairfield Estate, Louth, Lincs. LN11 0JH Tel. Louth (0507) 604955 Telex 56121 WEST G
Northern Ireland Agents: Tom & Norma Greer G14TGR/G14TBP Drumbo (023 126) 645

Please mention
**Ham Radio
Today**
when replying
to adverts

The Longest Callsign in the World?

We sailed around the island to the calmer waters on the south-west side of the island to decide what to do. There was a long and occasionally heated discussion in Swedish between Kee, Lars and Bruno, with Gerben and I looking on and again fearing the worst. What transpired was that Bruno

before everything was ashore. Each of the tower sections and beam elements were twice as long as the rowing boat, and I had to sit on the end of the tower to prevent it toppling into the sea. We finally bade farewell to Bruno, who chugged off, "Merit" disappearing to a tiny dot on the horizon very quick-

get from one building to the other during very heavy seas. Market Reef is only three or four metres above sea level and at times the whole island can be covered by sea during bad storms, especially in winter. Vertical iron ladders at either end of the cat-walk give access from the rocks to the buildings. From north to south there is the lighthouse itself, which also contains the living accommodation, the diesel generator building with a store-room below containing dozens of gas cylinders for the light and the cooking facilities, and finally a third building which contains an emergency radio for the use of stranded yachtsmen, and below that a brick store-room where we stored our fresh food. To the north of the lighthouse a substantial brick and stone sea wall has been erected to afford some sort of protection from the elements to the buildings. The lighthouse is a square, three-storey building, striped a conspicuous red and white, and with the traditional spiral staircase. Its walls are over a metre thick and made of stone, so that the building remains cool in the summer, but does not get so

Will Steve Lowe, G4JVG, get to activate the longest callsign? Read on...

would take the boat as close to shore as he could on the calm south-west side and Lars (who, amongst other attributes, is a qualified diving instructor) would swim ashore and row back to "Merit" in the rowing boat kept on Market Reef. Bruno edged the boat closer and closer to the island until we could clearly see the jagged rocks only inches below the bottom of the boat and Kee, standing in the bows, suddenly yelled "stop!" and threw out the anchor. We were still at least a hundred metres from shore where Lars donned an inflatable life-jacket, jumped into the cold waters, swam ashore, and after a while had single-handedly dragged the heavy wooden rowing boat into the sea and was rowing back towards "Merit". Meanwhile the rest of us had piled up the equipment to be taken ashore on the leeward side of "Merit" and as a very cold and shivering Lars arrived back at the larger boat we handed him some warm clothes and loaded up the rowing boat with as much equipment as possible. Kee rowed back to Market Reef with Lars and the first consignment of equipment, and after ten or fifteen minutes returned alone to take more, and Gerben, ashore. Kee had to make a total of six or seven trips to and fro, the sweat pouring off him, and rowed probably a mile or more in total — with a very heavy boat loaded almost down to the water-line with equipment —

ly, and we were alone on the small island in the Baltic for the next week.

Kee said this was the first occasion in his experience that there had been any delay or difficulties in getting to Market Reef — though *leaving* was sometimes a different matter! With this ominous thought Gerben and I explored the island and our new home in the lighthouse.

Settling Down

There are only three buildings on the island, connected together by a concrete cat-walk about six or seven metres above the level of the rocks, so that it is still possible to

The lighthouse proved very convenient for antenna erection



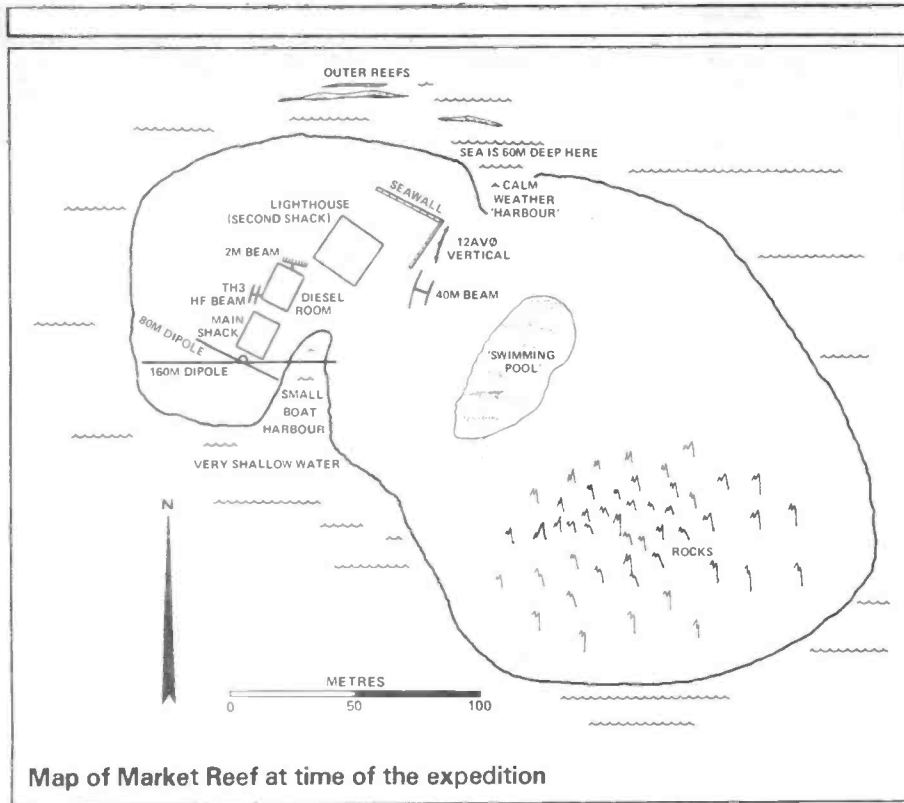

Map of Market Reef at time of the expedition

desperately cold in the winter. The building has been unoccupied (apart from radio DXpeditions!) since 1975, when the lighthouse was made automatic, and although structurally very sound it is not surprising that inside it is now beginning to decay. Plaster is falling off the ceiling and walls, and damp has caused a grey-green mould to grow on some of the walls. There was a dank, musty smell in the rooms, though this seemed to disappear after we had lived-in for a few days.

Getting Going

Kee assembled the TH3 beam and erected it on top of the generator room. We put together the main station (my Drake T4XC, R4C and National NCL-2000 linear, and Kee's TR7 and Alpha linear) in the building containing the emergency radio and connected the antenna. I had the privilege of making the first QSO, with JH7VEP, on 14MHz SSB at 1802 GMT on 25th July, using the call G4JVG/OH0/OJ0, and three whole days later than had been originally planned.

All electric power on Market Reef is provided by a single ancient diesel engine which will provide up to 4kW at around 220 volts, but at 75Hz. There were four generators in the diesel room, but only one

was in working order. Kee was of the opinion that a second could be made to work by cannibalising the others, but with the island uninhabited except during DXpeditions no-one had ever attempted this. The output voltage varied tremendously depending on the load, and Kee forbade anyone to switch off any equipment once he had brought the voltage up to 220V after everything had been turned on (in the past a TR7 had been blow up when the voltage had risen to about 300 volts after other equipment had been turned off). The 75Hz mains frequency provided by the generator had a number of interesting effects, the most

The 75Hz (!) Generator Room

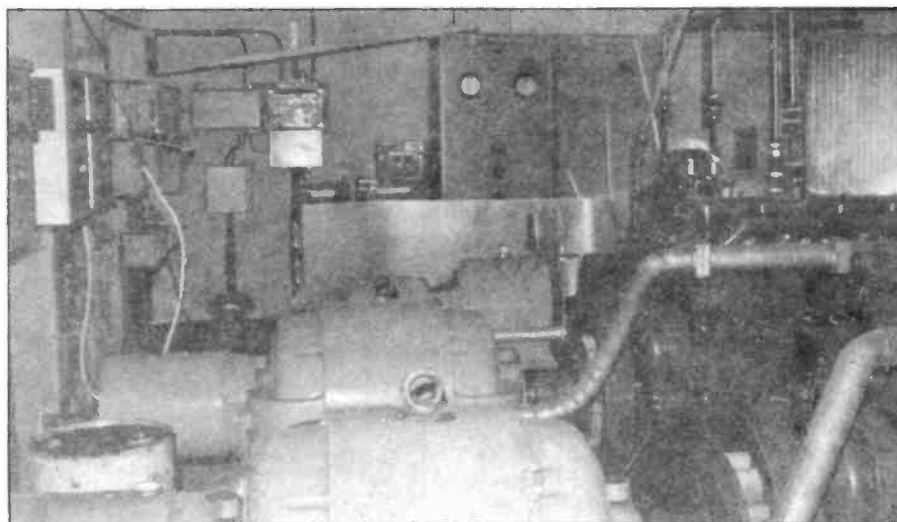

noticeable being that the 50Hz antenna rotators turned at tremendous speed, analogous to a 33 r.p.m. record being played at 45!

Unfortunately it transpired that Kee's TR7 and Alpha had both developed faults sometime between leaving his QTH on Aland and setting up the station on Market Reef, so it was as well that we had brought along my station as a spare.

Meanwhile Lars' equipment, a Yaesu FT901DM and a Heathkit SB220 linear, had been set up in the lighthouse building, and this became the second station.

Shift Work

We worked out a rota so that every three hours throughout the twenty-four there was a "main" operator and a "second" operator. The main operator had the choice of which station he wished to operate and on which band he wanted to work, whilst the second took the other station and whichever other band he wished. The other two operators were either sleeping, or preparing meals or coffee. Both stations had to close down for fifteen minutes before every third hour (i.e. 0245-0300, 0545-0600 etc.) to avoid causing interference to automatic weather-data gathering equipment, which sent its information to the Finnish mainland by microwave link during these periods. These fifteen-minute breaks became the only time when all four of us would talk about conditions, how big the pile-up was or even more everyday things — over

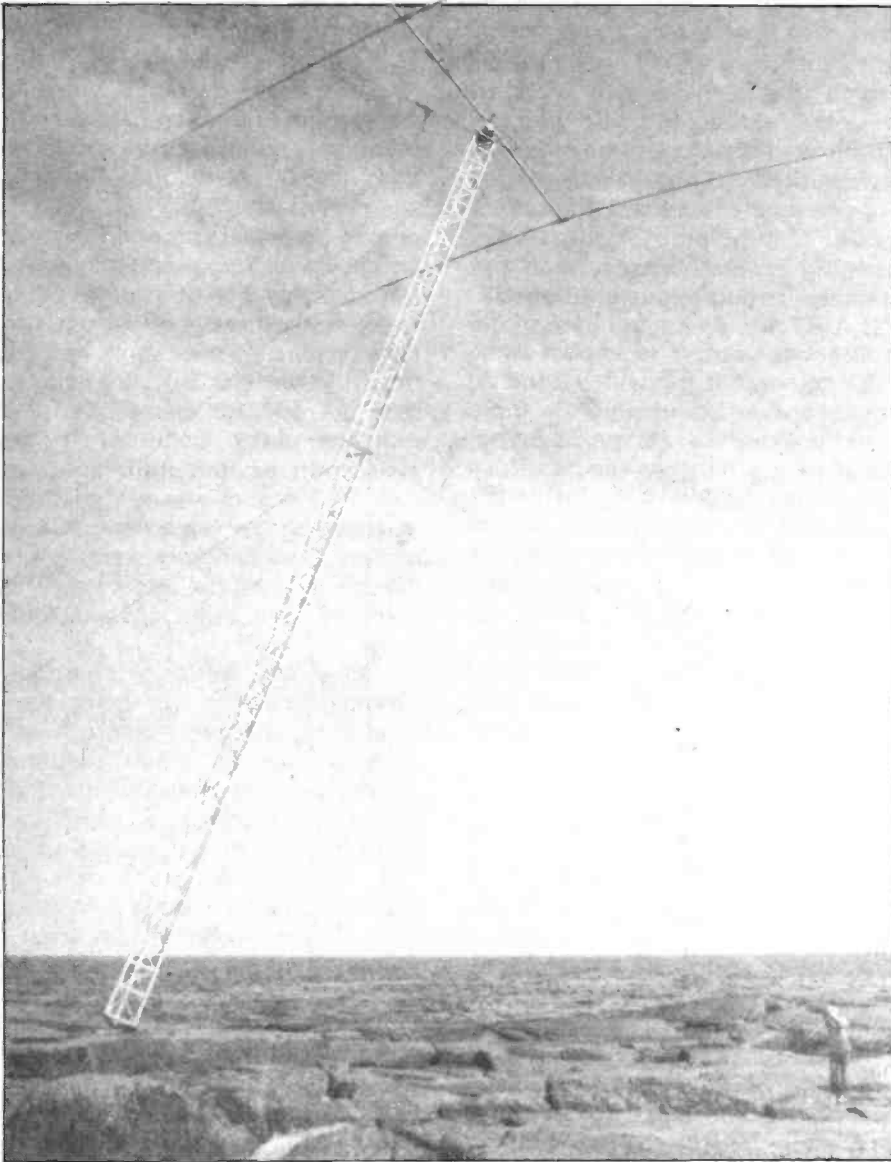

Going up! — the 40m beam. Note the small human figure on RHS

a cup of coffee, or perhaps a beer. After the quarter-hour was up, two would immediately disappear back to the rigs. Luckily there was little mutual interference between the two stations, especially if one was on CW and the other on SSB, though certain spot frequencies had to be avoided.

By nightfall on the day of our arrival we had established the two stations, erected the TH3 beam, dipoles for 80 metres and 160 metres, and set up a link between the two stations consisting of a 25 metre length of RG8 co-axial cable with an SO239 socket on both ends, so that any antenna could be plugged to either station. One major job remained, though, and this was left until the next morning.

After an excellent continental breakfast of tasty Finnish cheese, Swedish-style hard bread

("Ryvita") and freshly-brewed coffee, we discussed the considerable problem of how to erect the Hy-Gain 402BA 40 metre 2-element beam on top of the fifteen-metre tower. A suitable site for the tower had been found quite easily: there was a small area of quite flat and absolutely horizontally level rock close to the lighthouse, and about the only place on the island where a mast could be put up without looking like the leaning tower of Pisa! Kee bored three holes straight into the rock using a power drill (brought along especially for this purpose) and the hinged base plate of the tower was screwed into the rock surface. Meanwhile the 402BA had been assembled and the three sections of the tower were put together and laid on the rocks. It looked enormous (see the photograph!) and was extremely

heavy — when the beam and heavy-duty rotator had been fitted to the top end of the tower it was as much as one could do to just raise the end of a few inches above the ground, and I had no idea how the whole lot was going to be raised to the vehicle. Kee had anticipated this problem and had brought along an absolutely vast block-and-tackle set and hundreds of metres of strong rope. Whilst all this frenzied activity was going on the weather was getting steadily worse and worse. The day had started clear and sunny but gradually the visibility decreased until at worst we were in a real "pea-soup". It seemed that the cloud level had decreased to sea level. Relative humidity must have been 100% and for Gerben and I, who wear glasses, it became extremely trying. It was pointless to clean or dry ones glasses because within ten seconds they were completely misted-up again. Despite my poor eyesight I decided I could actually see a lot more clearly without them. Fog-horns boomed away from passing ships and from the Swedish coast, and visibility was so low we could only see half way across our very small island.

The Big Lift

Eventually the block-and-tackle was rigged and everything was ready for the big lift. It took all the combined strength of Gerben and myself pulling on the end of the rope attached via a sort of noose to the top of the lighthouse to the pulleys and then on to the top end of the tower to raise the beam just a few inches. At that point I thought it was going to be absolutely impossible to raise it fully but we kept on pulling. Yards and yards of rope came through the pulley system but the beam rose only inches at a time. As it came higher and higher the effort required became less and less, and after some time it was unnecessary to have two people pulling. From the moment when the tower was at 45° to the horizontal it went up very easily. The six guy ropes were secured to the metal ties which had, like the base plate, been screwed straight into the rock, and all four of us stood back to admire the huge beam, its forty-odd foot

long elements drooping slightly and swaying in the wind. It had taken the whole day, from breakfast-time to supper-time to get the beam up. Was it worth the effort? To be honest, I doubt it. In the summer-time, and especially at the latitude of Market Reef, when the nights are very short (it is daylight until after 11 p.m. local time) there is not very much DX to be worked on 40 metres. Probably 95% of the stations we worked on that band could also have been worked on a simple 40 metre dipole which would have taken one person thirty minutes to put up. On the other hand, the remaining 5% were very interesting stations and I'm sure we would not have been able to work them on another antenna: my best DX was CEOEVG/OZ on Juan Fernandez Island in the Pacific Ocean and Lars and Gerben worked a number of West Coast USA stations on CW.

And so began six days of continuous operation, twenty-four hours per day (with the exception of the fifteen-minute breaks) and much of the time with two stations in operation. Unfortunately Kee, who had had a bad cough for several days, developed what must have been laryngitis and completely lost his voice. He therefore spent most of his operating time on RTTY, which was a shame because it was a real pleasure to hear him handling a big pile-up on SSB, though no doubt the RTTY operators were quite happy! Kee's wasn't the only medical problem we had during our stay. Lars must have strained a muscle during his swim ashore and was in agony for quite some time, and for two or three days he found it difficult to negotiate the verticle iron ladders from the rocks up to the level of the lighthouse. Fortunately it was nothing more serious than a bad sprain and by the time we left he was fully fit again.

You Can't Please Everybody

Conditions were generally poor on all bands throughout our stay. Twenty metres was open to the whole of Europe most of the day and until quite late in the evening, but many stations contacted on 20 metres asked us for skeds on the other bands, especially 10 and 40

metres. Often the second station was already on the band requested, but usually we would not know on which frequency, so we left it to the other station to try to find us. There was absolutely no propagation at all on 10 metres except during one day, when there was a very good "short-skip" sporadic-E opening around Europe, with extremely strong signals from OE, YU, UB5 etc. A number of stations contacted seemed to expect us to QSY to another frequency band on request, even when we knew there was unlikely to be propagation. Most of the time we would refuse to do this, mainly because of the likelihood of causing QRM to our other station, but also because we could work two or three stations per minute in the pile-up on 20 metres and did not want to QSY to, say, 10 metres only to find a dead band there, and leave a lot of people waiting for us on our original frequency.

Beaming Stateside

We specifically tried to contact as many USA stations as possible, as OJO is considered very rare in the States and there are so many active DX-ers there, many of whom still require Market Reef for their DXCC or Five-Bands DXCC awards. Therefore most of the time we "parked" the TH3 beam in a north-westerly direction, the theory being that we would still be able to work all of Europe no matter which way the beam was pointing, and

The author — probably dealing with a 14MHz pile-up.



with it beaming to the States we worked the occasional W1, 2 or 3 in the European pile-up.

Later in the evenings, when 20 metres faded-out, and throughout the night, we spent most of the time on 80 metres, often with the second station on 40 or 160 metres as well. The main problem on the lower frequency bands was an extremely high static level which made contacts on 160 metres very difficult and painful (!) — and not much easier on 80 metres. The best DX on 160 metres was SSB contacts with UA9CBO in the Asian part of the USSR and with two EA9 stations in north Africa, all three on the same night. On 80 metres most contacts were around Europe, but we did also work 7P8, TR8 and a few other similar DX stations.

When we were not operating, sleeping or eating we spent some time designing and trying out wire antennas for the lower frequency bands. Lars also brought his fishing tackle and managed to catch two large fish which we had for dinner one evening. Even though the island is quite tiny there is so much open space available that even a 160 metre dipole looks deceptively small. Lars experimented in attempting to make the 160 metre dipole more broadbanded by placing a 1 metre long bamboo spreader at both ends and bringing the wire of the element back on itself, so that the extremities of either end were diamond-shaped: a sort of compromise on the cage-dipole design.



The voiceless Kee, OHONA/OJO, operating RTTY

This seemed to raise the lowest point of SWR considerably, but it did indeed flatten the SWR curve also. We could not decide whether it was better to have an antenna with a 1:1 SWR at one particular frequency, or one with a 3:1 SWR over half of the band. Since we used rigs with valve PAs it probably didn't make much difference either way.

We also experimented with the 80 metre antenna, adding an extra half-wave long piece of wire on to one end of the dipole, with a matching stub, so that it became two half-waves fed in phase and theoretically should have had some gain over the original dipole. This also had the effect of raising the SWR dramatically, but after some pruning it was possible to bring it down to a more reasonable level. However, after two or three evenings of operation it was clear to me that we were just not getting out as well as we should have been. Although we did get quite good signal reports we found we were not able to create the sort of interest in our presence that OJO *should*: in short, the pile-ups were very small ones! Some people repeated our callsigns incorrectly and it was very difficult to maintain a clear frequency — after a few minutes operation a strong station very close to our frequency would start causing interference, obviously unable to hear us. Since we were using high power and had a perfect sea-path take-off in all directions, something was wrong. In retrospect I think we would have done far better just using the original dipole (!), but that is the way things go.

Best OPs from JA?

It has become almost an amateur radio cliché to say that the

Japanese are the best operators in the world, but it was very clear to us that this was probably the case. It is comparatively easier to work JAs from Scandinavia than from the UK and it was quite easy to create a large pile-up of JA stations on 15 and 20 metres. When it became impossible to pick out a single callsign or even part of a call one would ask for just JA1's and only JA1's would reply, then JA2's etc. Try doing this with Europeans! Sometimes, though, the Japanese are *too* disciplined and if you ask for "the JH3 station ending in 'X-ray'" to repeat his call there would be absolute silence and you would have to ask again. Still silence. When you said "QRZ?" there would again be an enormous pile-up and, eventually, you would pick out the station who was originally calling — not a JH3 ending in X-ray, but a J13 station ending in X-ray! On the rare occasions when a JA station called out of turn there would be an angry-sounding babble of Japanese as half a dozen JA "policemen" told him to wait his turn!

After a couple of days we had a visit from four people in a helicopter who came from the Swedish coastguard station that we could just see on the horizon. They had come, ostensibly, to check the emergency radio link. As already mentioned, the Swedish-Finnish border runs across Market Reef and although the Finns are responsible for the maintenance of the lighthouse it is the Swedes who look after the emergency radio. We wondered afterwards if they had come specifically because we were there: since Market Reef is now normally uninhabited any occupation of the island is probably closely looked into by both sides!

It wasn't until our final full day

on Market Reef that we had a really good opening to the States on 20 metres. What a pile-up! I have never heard anything like it, except when Heard Island came on the air — and I had certainly never been on the receiving end of such a pile-up before. For the first time on the expedition it was necessary to work 'split': transmitting on 14195KHz and listening between 14200 and 14210KHz. I must say that it was a pleasure to work so many American stations, most of whom were really good operators and who were so obviously very pleased to contact Market Reef. Unfortunately we found that many of the Europeans were not as good, and I found that many of the G stations (and especially the then recently licensed G4S's and G4T's) would insist on giving me their name and QTH, spelling them, phonetically, twice (even with 59+ signals), then tell me about their rig, their antenna, the weather and about Uncle Bill's geraniums and their grandmother's false teeth despite the fact that they **MUST** have known there were many other stations patiently waiting to contact us. Gerben said he found Dutch stations the same (whereas I found the PAO's to be very good) so perhaps it was probably just the effect of finding a compatriot in such an unusual place.

I like to have a "rag-chew" from time to time, but *please* do not try to have a "rag-chew" type QSO with a DXpedition station unless he (the DX station) makes it obvious that he wishes it.

Home Time

At 2345 GMT on 31st July I had to close down for one of our fifteen-minute breaks, and handed over the operating reins to Gerben, who started up again at midnight. He was delighted to inherit a big W pile-up, but I went to sleep because we were thinking of leaving the island the next day, and it was already 3 a.m. local time. I had been asleep just an hour when I was woken by Kee, who insisted that we should all start to dismantle the gear as the weather looked perfect for leaving and we should not waste the opportunity. Kee and I had no pressing reason to get back to civilization so early, but Lars was meant to be back at work

the next day, and Gerben had to travel back to the Netherlands and be back at work later in the week. If the weather deteriorated again we could be stuck on the island for a few days longer, so it was unanimously decided that we should take advantage of the good weather and leave as soon as possible.

Accordingly, we left the main station and the TH3 till last, but took down and packed everything else, and called Bruno on the radio-telephone link. He confirmed that the weather also looked perfect from his side and that he would set out at 9 a.m. This gave us just enough time to have some breakfast after our very early start, and a last few QSOs on 20 metres before the TH3 was taken down. The 40 metre beam and fifteen-metre tower, came down very easily and in a fraction of the time they had taken to erect (*Don't antennas always - Ed.*)

Our final tally when we added them up later was about 8500 QSOs with stations in about 125 DXCC countries, the vast proportion being worked on 20 metres.

Kee thought it would be calm enough for Bruno to bring "Merit" into the natural harbour on the north side of the island, but this meant that we had to carry our ton and a half or more of equipment a good 100 metres by hand to where the boat would dock. When you have carried your fiftieth cardboard box containing lengths of cable you begin to wonder if it was necessary to bring *quite* so much, "just in case it is needed"! We were still carrying boxes when "Merit" arrived. It was one of those perfect summer days, with bright sunshine, very warm and with just a slight sea breeze. The sea was absolutely flat and there was no problem this time in tying the boat up against the rocks.

Parting Thoughts

On the way we saw some Baltic seals following the boat but, two and a half hours later, we were back at Storby in Aland and once again heaving the gear, this time from "Merit" into our three cars which we had left on the quay side whilst we were on Market Reef.

So ended a fascinating week, my first major DXpedition. I hope I have given some impression of the vast amount of organisation required to put on such an effort, something perhaps not always recognised by the average amateur contacting an expedition station. I have not mentioned the endless (and quite expensive) telephone calls and lengthy QSOs in order to work out the fine details, which started months before the actual expedition, nor the long hours spent QSLing afterwards. It was great fun, though, and I am looking forward now to participating or even organising some future expeditions, perhaps to more exotic places.

My thanks go to the other expedition participants, whose good humour helped to make it such fun, but especially to Kee, without whom it would not have been possible at all. Also thanks to Bruno; and to my fiancée Eva Telenius, "Hawk" SM5AQD, and the Northern Californian DX Foundation who helped with QSL design, printing, and expenses respectively.

PM COMPONENTS LTD. VALVE & COMPONENT SPECIALISTS

SELECTRON HOUSE, WROTHAM ROAD, MEOPHAM GREEN, MEOPHAM, KENT

PHONE 0474 813225. TELEX 966371 PM COMP

NEW BRANDED VALVES

A2087	11.50	ECC83	0.85	EL519	6.95
A2134	14.95	ECC85	1.35	EL521	8.90
A2293	6.50	ECC86	0.60	EL822	12.95
A2900	11.50	ECC88	0.85	EM80	0.70
C1148A	115.00	ECC91	2.00	EM81	0.70
DAF91	0.70	ECC93	2.50	EM84	1.65
DAF96	0.85	ECC94	0.60	EM95	1.10
DET22	26.00	ECC807	2.50	EM97	2.50
DET23	39.00	ECC808	0.85	EN91	1.10
DET24	35.00	ECC82	0.85	EN92	4.50
DF91	0.70	ECC96	1.70	EY84	6.95
DF92	0.50	ECC97	2.50	EY88/87	0.50
DF96	0.65	ECC98	1.00	EY88	0.50
DK91	0.90	ECC42	1.00	EZ80	0.60
DK92	1.20	ECC81	0.58	EZ81	0.60
DK96	2.50	ECC84	0.89	EZ90	0.96
DL92	0.60	ECC87	0.60	GZ32	1.00
DL96	2.50	ECC82	0.65	GZ33	4.50
DL910	13.50	ECC84	0.74	GZ24	2.15
DL916	10.00	ECC86	0.90	GZ37	4.50
DM160	2.75	EFC3A	2.00	KT66 UK	7.15
DY86/87	0.85	EFC39	1.00	KT66 UK	14.95
DY802	0.72	EFC42	3.50	KT77 Gold Lion	9.50
E80CC	7.00	EFC55	3.80	Special	9.50
E80CF	10.00	EFC80	0.58	KT88 USA	8.00
E80F	13.50	EFC83	3.50	KT88 Gold Lion	12.00
E80L	11.50	EFC85	0.50	Special	15.95
E81CC	3.50	EFC96	1.25	KTW61	2.00
E82CC	3.50	EFC98	0.88	M8033	3.25
E83CC	3.50	EFC91	1.50	M8137	5.50
E83F	8.50	EFC92	2.50	M8162	5.50
E86C	9.00	EFC93	0.89	N78	14.95
E86C	9.95	EFC94	0.85	OA2	0.85
E86CC	3.50	EFC183	0.85	OB2	0.85
E130L	19.95	EFC184	0.85	PC97	1.10
E180F	6.50	EFC90A5	11.50	PC900	1.25
E182CC	9.00	EFC90A6	14.80	PCF80	0.85
E810F	16.80	EH90	0.72	PCF82	0.80
EAT6	1.95	EK90	0.72	PCF96	1.20
EABC80	0.70	EL34	2.28	PCF200	1.80
EAF47	1.20	Philips	3.50	PCF201	1.80
EBC1	0.60	EL34	2.28	PCF801	1.35
EBC91	0.85	EL36	1.50	PCF802	0.80
EBC91	0.75	EL38	6.00	PCF905	1.25
EBC90	0.50	EL41	3.50	PCF908	1.25
EFC90	1.10	EL82	0.58	PCF200	1.50
ECC81	1.15	EL84	0.80	PCL82	0.80
ECC82	0.55	EL85	4.80	PCL83	2.50
ECC82	0.85	Philips	0.85	PCL84	0.85
ECC83	1.35	Mullard	1.35	PCL85	0.85
ECC83	0.85	EL360	7.95	PCL805	0.50

PFL200	1.25	GAM5	6.00	12AT6	0.85
PL36	0.95	GAN5	3.95	12AT7	1.15
PL81A	0.72	GAO5	1.20	12AT7WA	2.80
PL84	0.85	GAS5	1.80	12AU6	1.50
PL504	0.95	SASTG	7.90	12AU7	4.15
PL508	1.95	GAT6	0.75	12AV6	0.80
PL509	4.85	SAU6	0.85	12AX7	0.85
PL519	4.95	SAV6	0.75	12AX7WA	2.50
PL802	5.95	SAWBA	2.95	12AY7	4.00
PV88	0.85	SBAS	0.85	12AZ7A	1.95
PV800A	1.95	SBAS7	4.50	12BA6	1.50
PV800	0.79	SBAS8	3.50	12BE6	1.05
PV801	1.75	SBAS9	0.72	12BH7	1.80
QOV02-6	12.75	SBAS10	1.00	12BL6	1.75
QOV03-10	5.50	SBAS11	1.95	12BY7A	2.75
QOV03-20A	18.50	SBAS12	1.25	12C1	17.95
QOV06-40A	18.00	SBAS13	4.95	30FL2	1.35
KT66	28.00	6BR8A	2.15	40KD6	8.50
KT66 UK	14.95	6BS7	5.50	39HE7	4.50
KT77 Gold Lion	9.50	6BW6	5.25	85A1	6.50
KT88 USA	8.00	6BZ6	2.50	85A2	2.00
KT88 Gold Lion	12.00	6C4	1.10	90CG	13.15
KT88 Gold Lion	12.00	6CB6A	1.95	92AV	12.50
KT88 Gold Lion	12.00	6CD6GA	4.50	150B2	6.50
KT88 Gold Lion	12.00	6C85	8.50	150C4	1.15
KT88 Gold Lion	12.00	6CL6	3.80	807	1.50
KT88 Gold Lion	12.00	6CW4	7.25	811A	12.95
KT88 Gold Lion	12.00	6DK6	2.50	813	18.50
KT88 Gold Lion	12.00	6D05	3.35	833A	118.00
KT88 Gold Lion	12.00	6D05B	2.50	5642	8.80
KT88 Gold Lion	12.00	6E48	2.50	5651	3.20
KT88 Gold Lion	12.00	6F6G	2.00	5670	3.80
KT88 Gold Lion	12.00	6F28	1.25	5687	4.60
KT88 Gold Lion	12.00	6GH8A	0.80	5696	3.80
KT88 Gold Lion	12.00	6GK6	2.00	5749	2.50
KT88 Gold Lion	12.00	6H6	1.25	5751	3.50
KT88 Gold Lion	12.00	6J4	1.10	5814A	3.25
KT88 Gold Lion	12.00	6J5	1.95	5842	11.00
KT88 Gold Lion	12.00	6J5GT	1.50	5965	2.25
KT88 Gold Lion	12.00	6J6	0.80	6060	2.25
KT88 Gold Lion	12.00	6J6B	3.95	608X	5.75
KT88 Gold Lion	12.00	6J6C	3.95	6146B	7.50
KT88 Gold Lion	12.00	6K6D	5.50	6550A	8.00
KT88 Gold Lion	12.00	6L6CC	2.95	6883B	9.95
KT88 Gold Lion	12.00	6L6CC	1.15	6973	3.75
KT88 Gold Lion	12.00	6L6F	4.50	7025	2.50
KT88 Gold Lion	12.00	6L6G	4.50	7027A	4.65
KT88 Gold Lion	12.00	6L6H	0.85	7199	3.95
KT88 Gold Lion	12.00	6M6	0.85	7247	2.00
KT88 Gold Lion	12.00	6M6T	0.55	7360	9.50
KT88 Gold Lion	12.00	6N6	3.00	7475	5.90
KT88 Gold Lion	12.00	6N6A	3.50	7551	5.75
KT88 Gold Lion	12.00	6N6B	1.65	7591A	6.00
KT88 Gold Lion	12.00	6N6C	1.15	7591B	3.95

INTEGRATED CIRCUITS

AN2140	2.50	AN2140	2.50
AN240	2.80	AN240	2.80
LA4400	4.15	LA4400	4.15
LA4422	2.50	LA4422	2.50
LC7120	3.25	LC7120	3.25
LC7130	3.50	LC7130	3.50
LC7131	5.50	LC7131	5.50
LC7137	8.60	LC7137	8.60
MB3712	2.00	MB3712	2.00
SL901B	6.85	SL901B	6.85
SL917B	1.95	SL917B	1.95
SN76033N	1.95	SN76033N	1.95
SN76033N	1.95	SN76033N	1.95
SN76033N	1.95	SN76033N	1.95
SN76033N	1.95	SN76033N	1.95
SN76131N	1.30	SN76131N	1.30
SN76544N	1.95	SN76544N	1.95
TA0651B	1.20	TA0651B	1.20
TA7061AP	3.95	TA7061AP	3.95
TA7100	1.65	TA7100	1.65
TA7130	1.50	TA7130	1.50
TA7193	1.50	TA7193	1.50
TA7204	2.18	TA7204	2.18
TA7205AP	1.50	TA7205AP	1.50
TA7222	1.80	TA7222	1.80
TA7310	1.80	TA7310	1.80
TA7314	1.80	TA7314	1.80
TBA1205	0.70	TBA1205	0.70
TBA520Q	1.10	TBA520Q	1.10
TBA530	1.10	TBA530	1.10
TBA540	1.25	TBA540	1.25
TBA550Q	1.45	TBA550Q	1.45
TBA641 BX1	0.80	TBA641 BX1	0.80
TBA800	3.00	TBA800	3.00
TBA810S	1.85	TBA810S	1.85
TBA920Q	1.85	TBA920Q	1.85
TDA1004A	1.25	TDA1004A	1.25
TDA1170	1.95	TDA1170	1.95
TDA1190	2.15	TDA1190	2.15
TDA1327	1.70	TDA1327	1.70
TDA2020	2.45	TDA2020	2.45
TDA2030	2.80	TDA2030	2.80
TDA2532	1.95	TDA2532	1.95
TDA2540	1.25	TDA2540	1.25
TDA2580/3	2.95	TDA2580/3	2.95
TDA2611A	1.95	TDA2611A	1.95
UPC566H	2.95	UPC566H	2.95
UPC575C2	2.75	UPC575C2	2.75
UPC1025	2.50	UPC1025	2.50
UPC1156H	2.75	UPC1156H	2.75
UPC1182H	2.95	UPC1182H	2.95
UPC1185H	3.95	UPC1185H	3.95
UPC2022H	1.95	UPC2022H	1.95

SEMICONDUCTORS

AC127	0.20	BC170B	0.15
AC128	0.25	3C171	0.25
AC141K	0.34	BC172	0.10
AC176	0.22	BC173B	0.10
AC176K	0.31	BC182	0.10
AC187	0.25	BC183	0.10
AC187K	0.28	BC184LA	0.09
AC188	0.28	BC212	0.09
AD142	0.79	BC212L	0.09
AD149	0.70	BC213	0.09
AD161	0.39	BC213L	0.09
AD161/2	0.90	BC237	0.10
AD162	0.39	BC238	0.09
AF124	0.34	BC307	0.09
AF125	0.35	BC327	0.10
AF126	0.32	BC451	0.35
AF127	0.32	BC478	0.20
AF139	0.40	BC547	0.10
AF239	0.42	BC548	0.10
AU106	2.00	BC549A	0.08
AU107	1.75	BC557	0.08
AU110	2.00	BC558	0.10
AU113	2.95	BD131	0.32
BC107	0.10	BD132	0.35
BC108	0.10	BD133	0.40
BC109B	0.12	BD135	0.30
BC139	0.20	BD136	0.30
BC140	0.31	BD137	0.32
BC141	0.25	BD138	0.30
BC142	0.21	BD139	0.32
BC143	0.24	BD140	0.30
BC147	0.09	BF179	0.34
BC148	0.09	BF180	0.29
BC149	0.09	BF183	0.29
BC157	0.12	BF194	0.11
BC158	0.09	BF196	0.11
BC159	0.09	BF197	0.11
BC160	0.28	BF198	0.16

BF199	0.14	TIP32C	0.42
BF200	0.40	TIP41C	0.45
BF250	0.28	TIP42C	0.45
BF259	0.28	TIP47	0.68
BF336	0.34	TIP146	2.75
BFX29	0.30	TIP2955	0.80
BFX84	0.26	TIP3055	0.85
BFX85	0.32	TI591	0.20
BFX86	0.30	2N3054	0.59
BFX88	0.25	2N3055	0.82
BFY50	0.21	2N3702	0.12
BFY51	0.21	2N3704	0.12
BFY52	0.25	2N3705	0.12
BFY90	0.77	2N3773	1.95
BT106	1.49	2N3708	0.12
BT108	1.89	2N3773	1.95
BT116	1.20	2N5294	0.42
BU105	1.22	2N5296	0.48
BU108	1.89	2N5496	0.85
BU124	1.00	2SA715	0.95
BU126	1.60	2SA715	0.95
BU2			

REVIEW: Alinco ELH710 70cm Linear

Many of the commercial transceivers in the increasingly popular world of 70 centimetres tend to produce some one to two watts of output — how useful it is to have that little extra power up one's sleeve, if only to initiate a contact so that experimentation with lower power may then be car-

take up the majority of space in many portable transceivers! It is on this point, of size, that the ELH 710 comes into its own. Measuring just 152 x 91 x 28mm it can be hidden away — under the dashboard of the car or beneath the table in the shack. Does its size affect the units performance though? I shall ad-

The device arrived in a cardboard box complete with mobile mounting bracket, hardware to fix same, a spare fuse (5A), a fused power supply lead and simple instruction leaflet. Mobile mounting proved to be straight forward, and ample room should be found in any mobile installation for this piece of equipment.

This cheap and neat linear amplifier seems to answer the prayers of the ever growing number of enthusiasts with low power 70cm equipment. Or does it? Trevor Butler, G6LPZ, investigates.

ried out. Although there are several UHF Power Amplifiers and linears on the market, some in kit form, others ready-built into boxes or heatsink extrusions, one which came to our attention recently seemed to be at a budget price — the Alinco ELH 710.

Size is often an important consideration when thinking in terms of application of Amateur Radio equipment; indeed Japanese manufacturers in particular seem to have gone to some lengths to miniaturise modern-day equipment, and it is often the batteries which

dress this point in particular later in the review.

Power!

Having entered the exciting world of UHF to try and escape the congestion sometimes found on VHF, especially around the larger conurbations of this country, I had been experimenting with low power operation. I found myself somewhat eager to test and evaluate this linear amplifier — which allowed me ten times my previous level!

First impressions of the ELH 710 are that it is very small and compact, without appearing to have any form of heatsink to allow the dissipation of generated heat. Designed to operate from a twelve volt DC supply the unit will tolerate an operating voltage of 11 to 15 volts.

Facilities

An early thought to cross the author's mind was the lack of any provision for a pre-amplifier with this equipment. His personal UHF equipment seems to have a sufficient receive performance to match the increased power output — otherwise some form of pre-amp TR switching arrangement would be necessary. The front panel of the ELH 710 provides just one con-

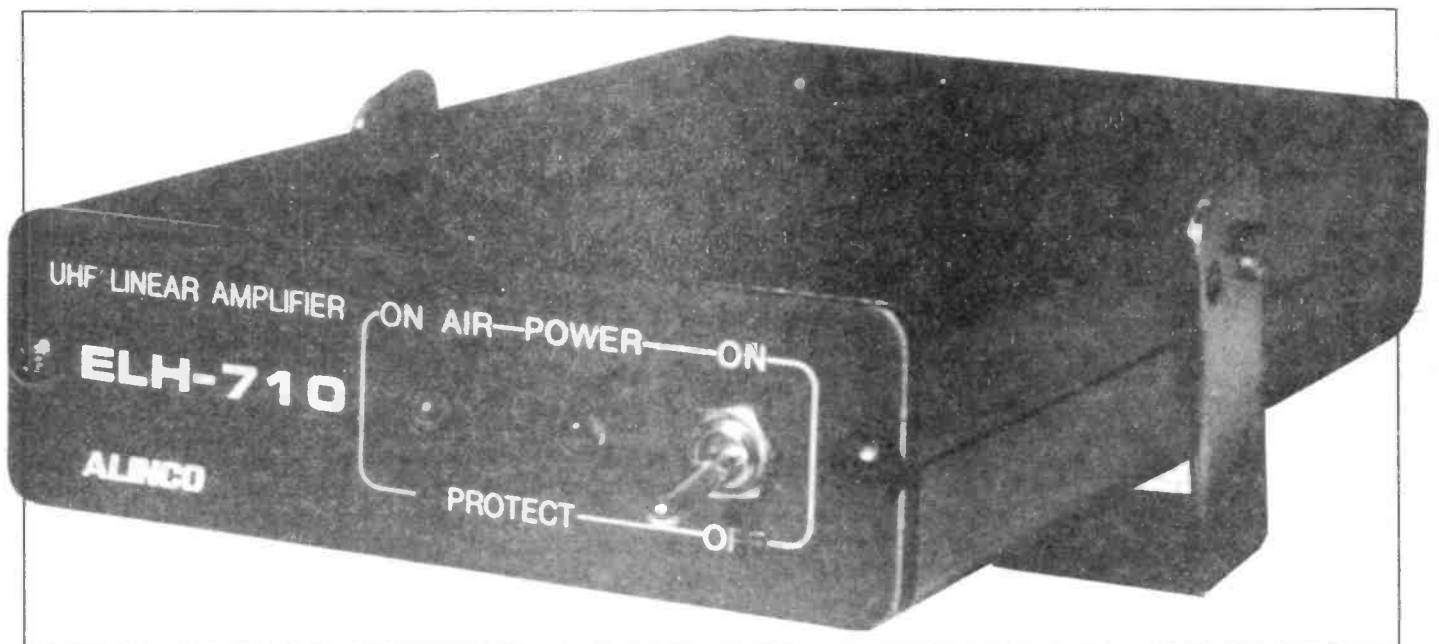

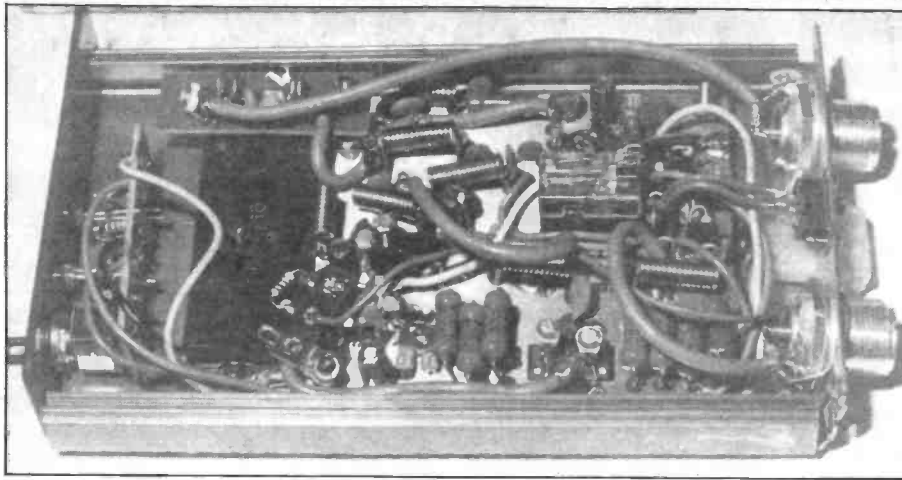

Inside the ELH710

trol, a DC on-off toggle switch, and three indicators — a green LED to show that the unit is switched into circuit and a red LED to indicate that the device has switched to the transmit mode *because of receiving an RF input*. A third LED indicates that the internal protection circuit has been operated (ie when there is an external fault affecting the unit — more about this later). Further controls are to be found on the rear and the base (!) of the unit — this was thought to be somewhat inconvenient initially, but in operation the controls need not be adjusted frequently. To the rear is the mode switch which selects either SSB or FM modes. On SSB this switches in circuitry allowing a slow 'drop-out' of the RF sensed transmit-receive switching — so the linear does not switch to transmit everytime one pauses for breath! A further switch, underneath the unit, selects the amount of RF input power necessary to 'drive' the amplifier — either 1W or 3W. Of course with a 1W input the '3W' setting may still be used, resulting in a reduction of the linear output power.

In Operation

Having established how to operate this equipment, a full operational 'burn-in' was then carried out. Whilst considering the connection of the linear between rig and antenna it was interesting to note that SO239 type sockets had been employed on the ELH 710 for RF connections. Whilst often referred to as UHF sockets, their specifications recommends use up to a frequency of 200 MHz. Operation up to 500 MHz is possible *but*

with diminished performance. 'N' type, or even 50ohm BNC sockets, would therefore have been preferred — but then they do tend to be rather more expensive! Soon after operational trails had begun, I noticed that whilst operating the amplifier on FM an extraordinary amount of heat was produced, causing most of the metal casing to become warm — indeed, it was felt that transmissions should temporarily cease altogether for fear of causing damage to the unit. However, after discussions with the suppliers, it was suggested that with careful use and "a well matched aerial" the level of heat generated should be "comfortable" — and not a problem at all if using the linear in an SSB mode.

Further tests were conducted and although the level of heat generated when using the linear on SSB seemed "comfortable", I was a little anxious about FM transmissions and sought a solution.

Unlike many other RF amplifiers (and AF come to that) there is no external heatsink on the ELH 710, and its small thin metal case seemed inadequate as an alternative. So with a little care I attached a heatsink to the base of the unit, and was able to bolt the output stage package onto it. Whilst, of course, it should not be necessary to start re-building brand new commercial equipment (!), this modification was both simple and cheap to do. A much lower level of heat was now noticeable, the new heatsink seemed to be dissipating much of the unwanted heat, at the cost of about £1 and a slight deterioration in the general appearance of the amplifier. Considering the low cost of the amplifier and its otherwise

excellent performance this modification was considered very worthwhile.

In SSB operation it is often the case that amplifiers tend to drop in-and-out of transmit. This can be both annoying to the operator, with relays clacking, and to the receiving station as signal levels change rapidly. As was mentioned earlier, a device is fitted to the ELH 710 giving a time-delay which simply allows the device to linger in transmit after an RF input has been detected to take account of speech troughs on SSB. The handbook supplied states, and I quote: "as high sensitive carrier control circuit is not built into this equipment, it is not necessary to do remote control...". What I think they mean is that wiring the linear Tx/Rx changeover control to your microphone PTT switch is not essential — certainly no need of this was found as the Tx/Rx switching delay worked excellently on SSB (and FM) at all times.

However, PTT operation can be easily provided if required and details are given in the linear handbook.

A Few Snags

One thing to be careful of, though, is the straight-through allocation (ie amplifier in circuit but not in operation) with the ELH 710. If the amplifier is connected, in line, it will operate straight-through *providing it has a DC supply connected to it* — with the operational switch on the unit in the 'off' position, of course. Without a DC supply 'receive' and 'transmit' functions are disabled, the unit acting as a large attenuator between transceiver and aerial.

During tests a loss of about 0.5W was rather surprisingly found when using the device in a straight-through situation with DC volts applied. This seems to be the result of a fault in my particular unit, and not because of any design fault.

A fairly elaborate protection circuitry is employed within the unit to, hopefully, prevent any damage caused by: (i) too high a DC voltage being applied; (ii) too high a level of RF at the input; (iii) a poorly matched antenna system, or simply no antenna being connected to the output at all. In any of these situations the unit should switch off,

with the LED glowing on the front panel indicating that the protection circuitry is in operation. To restore the amplifier to its normal working order after rectifying the 'fault' switch the device 'off' and 'on' — this acts as a reset.

Having mentioned the handbook, I feel that this is worthy of a few lines of discussion. Consisting of an eight-page A5 sized document, the sheets stapled in the top left-hand corner, it resembles more a 'home' photo-copy production — indeed, a number of the illustrations lack quality because of the printing process. This particularly applied to the circuit diagram which is just about large enough to read with good vision. Some of the translation, presumably from a Japanese original, has lost its meaning — thereby resulting in a number of interesting statements such as: "When it shall be shocked with excessive power, it may be caused a trouble. So please be careful", although it can generally be understood. Various specifications are quoted, and a number of these have been tested with the results at the end of this article.

Test Results

R.F. Input: 1.1 W from an FT 790R transceiver
 Device at 13.5v DC : Input setting 1W and 10.8W produced with a current drain of of 4.2A (3Amps is its Spec)
 Device at 13.5v DC Input setting 3W and 6.7W produced-current drain 3.3amps
 Device at 12 v DC Input setting 1W and 9W produced. Input setting at 3W and 5.4W produced.
 RF measurements were made with a Marconi Powermeter TF1152/1.

The actual output device consists of a sealed encapsulated unit which bolts directly to the chassis and therefore may cause certain problems in the event of a fault. Indeed, it is necessary to remove a seal on the outside of the case to gain access to the internal workings. This seal warns that if it is removed all warranty clauses would be invalid. To what extent the suppliers would enforce this is not clear, for although it is unwise to attempt any sort of internal repairs or alterations to equipment under guarantee, many amateurs have a genuine interest in the working of their equipment, and would, perhaps, like to have a quick glimpse

at the innards of any new piece of equipment. All consumers statutory rights, will not obviously be affected by this seal or its message.

Conclusions

A small, efficient UHF Liner Amplifier, producing over 10W or RF, even if current consumption is a little high. The unit gets rather warm under FM use, although no damage seems to result. The sole importers, Amateur Radio Exchange, are currently selling the ELH 710 at £59.00 including VAT. We understand from ARE that a new 50 W version is due very soon at around £110.

DEWSBURY



ELECTRONICS



THE TRIO TS430 IS NOW AVAILABLE
 EX STOCK **Price £752** — inc VAT &
 SECURICOR.



ALL B.N.O.S. products available from
 appointed MAIN MIDLANDS AGENT

DEWSBURY ELECTRONICS — A FULL TIME SPECIALIST AMATEUR RADIO
 RETAILER WITH A WIDE RANGE OF EQUIPMENT TO SUIT THE MOST DISCERNING
 TASTES. ALL THAT IS GOOD IN RADIO — FROM TRIO to JAPAN RADIO
 COMPANY.

Dewsbury Electronics offer a full range of Trio Equipment

always in stock.

Instant credits available to licensed amateurs subject to status.

We are also stockists of DAIWA - WELTZ - DAVTREND - TASCOS TELEREADERS - MICROWAVE MODULES -
 ICS AMATOR - AEA PRODUCTS - DRAE



Dewsbury Electronics, 176 Lower High Street, Stourbridge, West Midlands.

Telephone: Stourbridge (0384) 390063.

Closed Monday



The MiniSynth — a miniature synthesised VFO

One of the problems facing a designer of a receiver or transmitter is that of a stable VFO. Many designs have been published but there is often no guarantee of stability above 10MHz or so without attention to temperature

The OMEGA Project has an extremely stable PLL synthesised VFO with a very low noise contribution, and it seemed to us that a simplification of this successful design could be a possibility, offering a versatile and useful VFO

30MHz. Use with say 5.5MHz i.f. systems (or indeed, any i.f. frequency) is also possible — data for 5 — 5.5MHz is given (outboard VFO's for FT101's etc!) and other frequencies should not be difficult by interpolation of the data given in this article.

Not only is this the perfect compliment to the DSB-2 RF circuitry but is eminently suitable for other direct conversion transceivers from 1.81 - 21MHz and transmitter/receiver systems with 5.5, 9 and 10.7MHz i.f. systems. Full design data is provided for all these options. By Frank Ogden, G4JST, and Tony Bailey, G3WPO.

The MINISYNTH is primarily intended for use with the DSB2 — the Mark II version of the DSB80 single board transceiver system, also published in this issue, but is suitable for use with virtually any rig. In addition to a highly stable output, suitable for driving a double balanced mixer, it will also provide sidetone for CW and has an automatic offset facility for direct conversion transceivers so that they may be used on CW. Stability is excellent, to a matter of 10's of Hz over long periods, and the finished unit is small (PCB 94 x 57mm). The instructions are extremely comprehensive so that the project can be handled by beginners as well as experienced constructors.

compensation. Also, for reproducibility, a printed circuit board is of great assistance and this is often missing from designs. here is the first ever published VFO design, for any HF band and for almost any receiver/transmitter combination — with a full kit of parts available.

suitable for single band designs. The circuit offered here meets this objective, and by simple changes to some of the component values on one single printed circuit board, can be used for direct conversion, 9MHz or 10.7MHz i.f. systems with the design data given, for any single band between 1.8 and

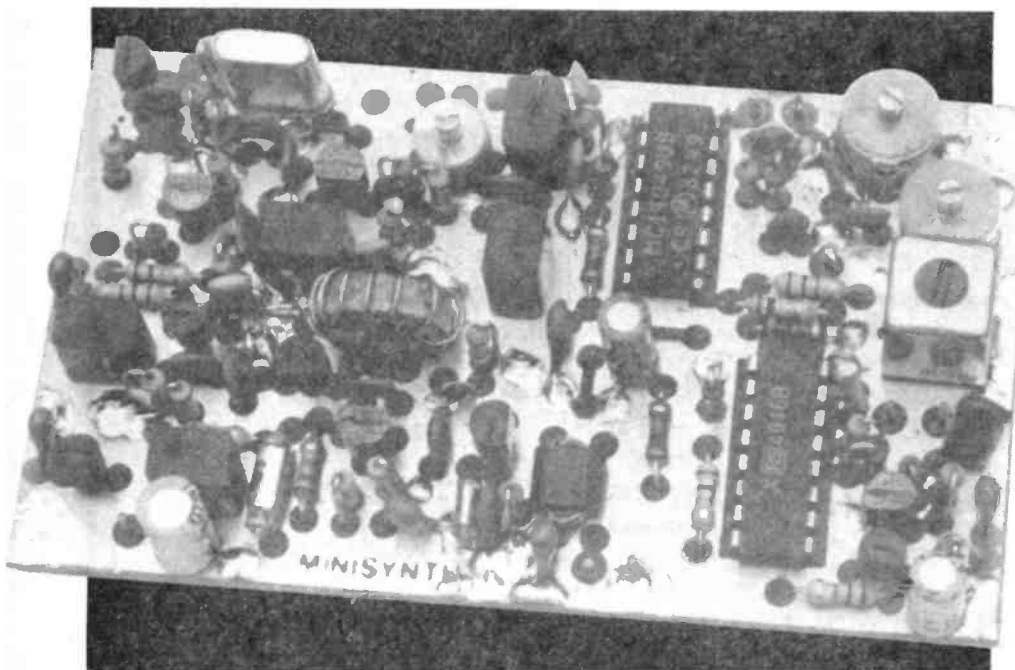

Circuit Description

One of the difficulties of building your own radio gear is the problem of obtaining high stability local oscillator signals at high frequencies. Many of the simple equipment designs perform superbly in every respect except that of frequency stability. Commercial free running VFO designs seldom operate much above 6MHz. The idea of building a free running VFO for the 10 or even 20m band is just not on.

There are, however, a number of ways of obtaining a stable VFO design for the higher bands. Before digital synthesiser circuitry became commonplace, the VFO signal was generated by mixing a low frequen-

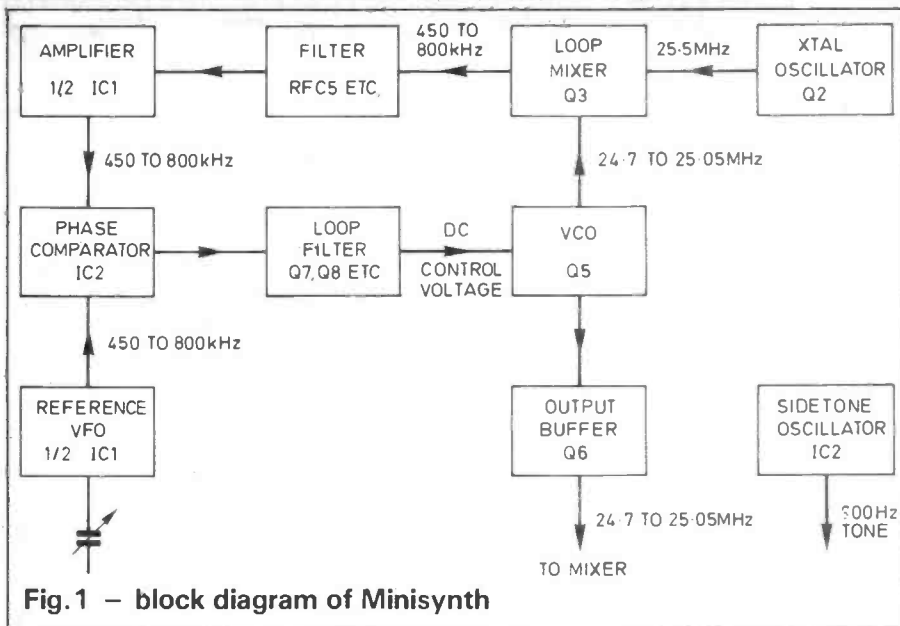

Fig. 1 - block diagram of Minisynth

cy variable oscillator with a fixed frequency crystal oscillator. A filter bank was used to sort out the wanted mixer product and subsequently amplified to produce the desired VFO/LO output. The signal thus produced often contained fairly large quantities of unwanted mixer products which led directly to spurious responses in the receiver. To separate out the wanted signal required that the variable oscillator should operate at a fairly high percentage of the fixed crystal oscillator frequency. This type of circuit wasn't particularly stable because of this, although it was a great improvement on a free running oscillator operating directly at the output frequency.

A Question Of Stability

Lesser amounts of frequency coverage at very high degrees of frequency stability can be obtained with variable crystal oscillators (VXO). However, these are only good for about 20kHz of frequency coverage at HF. By compensation, they do have a very pure spectral output. Our 'Minisynth' design covered in this article provides a stability of around 50Hz/hour, ten minutes after switch on, combined with a potential frequency coverage of over 800kHz. This level of performance is almost completely independent of the frequency band. As with the Omega VFO system from which it has been derived, the spectral purity is only a little under that of a free running crystal or LC oscillator circuit.

The block diagram, Fig. 1, shows how it works. A fixed frequency crystal oscillator mixes its output with a narrow band VCO. A buffer transistor, Q6, provides a +10dBm output suitable for driving diode ring mixers directly. Another portion of the VCO signal mixes in Q3, the loop mixer, to produce a difference frequency between the crystal and the VCO. This difference signal is filtered out by the circuitry associated with RFC5, amplified by a series of CMOS buffers configured as an amplifier and applied to the phase detector of a 4046 PLL circuit. This is compared with a reference frequency derived from a free running low frequency LC oscillator configured from a pair of CMOS buffers. This output is fed to the other terminal of the 4046 phase detector.

Any frequency or phase error appears as a DC voltage, after filtering by the loop filter components, at the input to the VCO. This brings the oscillator back into perfect lock. The control loop bandwidth is around 10kHz. This is quite sufficient to 'clean up' the VCO output spectrum over the few critical kilohertz either side of the output frequency.

The small physical size of the PCB together with its high, stable output enable it to be built into commercial rigs for dual VFO, split frequency working. As we have shown in the table, a 6MHz crystal and a couple of extra turns on the VCO inductor allow the Minisynth to be used over the range 5 to 5.5MHz.

Construction

The complete VFO except for the variable capacitor is built on a single double sided PCB. This ensures reproducibility and stability for constructors. Before starting construction you should read the following text in conjunction with Table 1. This details the value and type of the various components which vary with the frequency coverage chosen. It may look complex, but only one line will be of interest to you for the version you are building. If you underline this it will help reference while building. If you are building a version for a 10.7MHz i.f., you are unlikely to need the CW offset circuit as the great majority of transceiver designs use tone injection for CW generation, and no offset is required (the sidetone circuit can be used here). If so, you may omit the components associated with the offset circuit - these are Q1/R1,2,3/C1/RFC1 and D1/CT1 or L3, leaving C2 in circuit.

While only the values of some components change with the variation in frequency coverage, others may not be used at all. In particular, the frequency of the crystal has the most effect. Let me explain, for crystals under 20MHz, parallel resonant types are used and a corresponding oscillator circuit to suit. This is the circuit shown in the main diagram. With this, the following components are *not* used: C5/C6/L3 and their locations on the layout drawing can be ignored. Above 20MHz, series resonant 3rd overtone crystals are used, with an overtone oscillator (diagram shown separately). In this version R6 is replaced by a tuned circuit (L4), and C3 is omitted - *all this is shown in Table 1*. The only complication is with the series inductor (L3) used for the direct conversion CW offset for 3rd overtone crystals. Although shown as an inductor, with the higher frequency crystals it is in fact replaced by the trimmer, CT1, used for the parallel resonant circuits. This is because the value of inductance needed was so small as to be unmanageable at the higher frequencies. Again, Table 1 reflects this by stating 'CT1' under L3 where necessary.

The low frequency VFO uses a number of inductors depending on

Circuit diagram of Minisynth

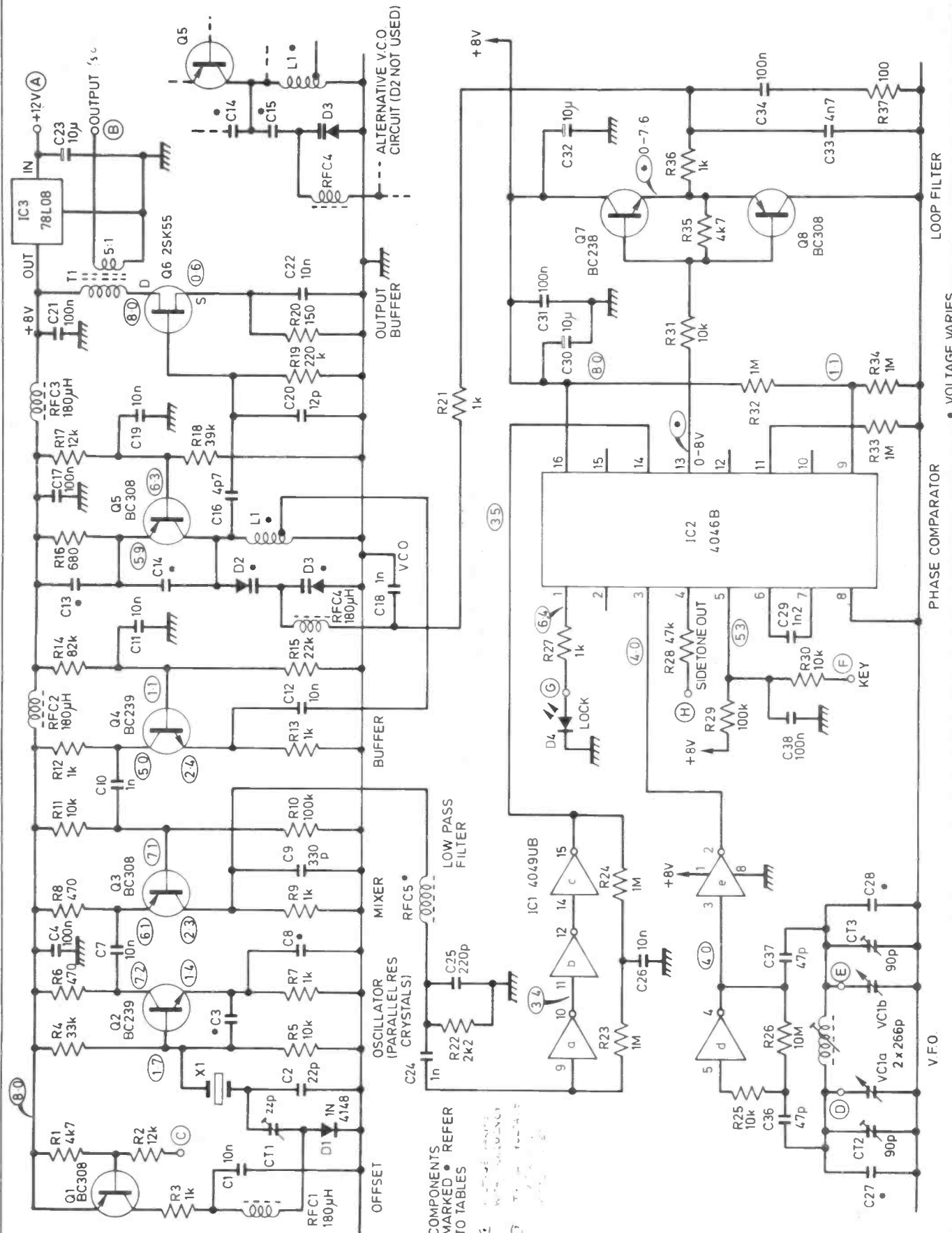

COMPONENTS MARKED • REFER TO TABLES

• VOLTAGE VARIES

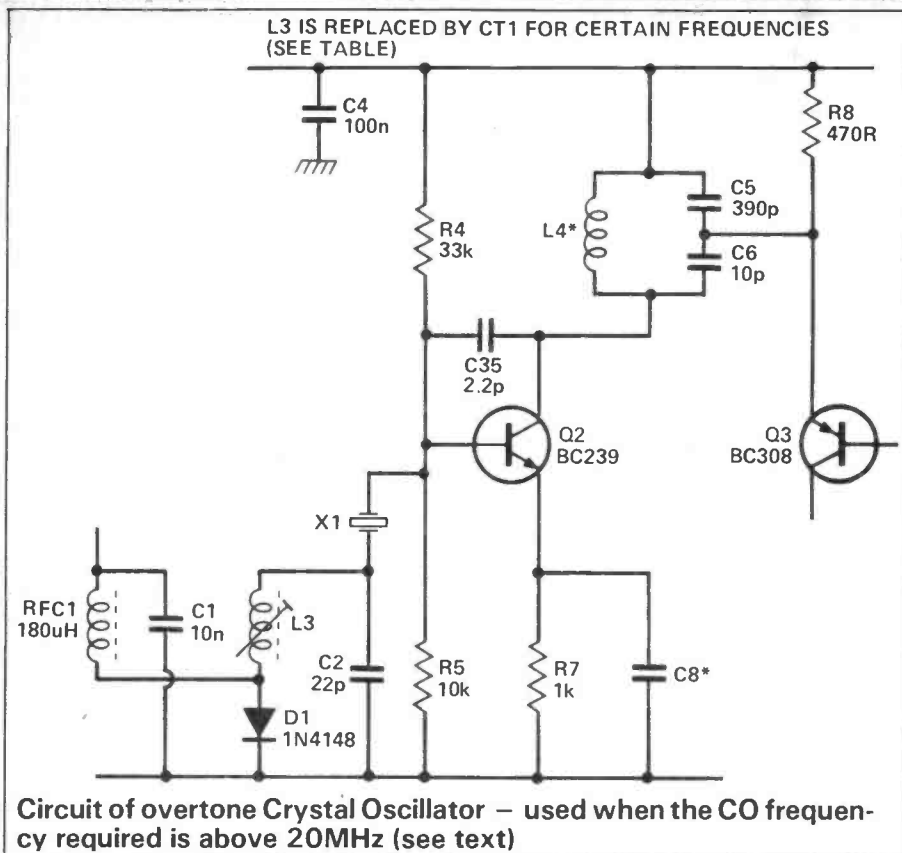

the coverage required. Each of the inductors allows a wide range of frequency coverage by the setting of the variable inductor, trimmer capacitors, and the addition of padding capacitors. The crystal frequencies and VFO coverages given are those we determined to be most suitable, bearing in mind the VFO swing required, availability of crystals without special ordering, and the fact that the crystal must be on the high side of the VCO frequency.

There are a multitude of other combinations possible if you have other crystals to hand. The only point to bear in mind is that when the VFO is below 300kHz, it is difficult to get large frequency swings (unless you use a higher swing capacitor) and this will to some extent determine the crystal frequency limits. The VFO itself will oscillate past 2.5MHz, but you can expect the stability to suffer if it is used at this high a frequency. If you stick to the values given in the tables, which have all been evaluated, then minimal constructional problems will be experienced.

Soldering Iron Ready!

Armed with the above notes, you can now proceed with the con-

struction. The following sequence is recommended to assist location of components and selection of those that alter dependent on frequency. Try to keep component leads short, with components mounted flat against the PCB whenever possible. The photographs illustrate the technique.

1. Firstly, insert and solder the 9 PCB connection pins where indicated, noting that two of these need soldering both sides.
2. Insert and solder RFC's 1, 2, 3, 4 & 5. Check Table 1 for the value of the latter (180uH except for direct conversion 1.81-2.0MHz).
3. Make the two links shown near IC1 using insulated wire (links on top of PCB).
4. See if C15 is used – if so, solder it in place, otherwise, if no value is given, link across the two holes where it would go with a piece of insulated wire.
5. Check which diodes are used for D2/D3. If KV1236 then this is inserted as shown in the small layout diagram with the legend on the diode package facing RFC4, and with the second pin from the

right soldered to the top foil. If BB204 and C15 are not being used (both diodes are in the same package with the common connection already made to the centre pin internally) then insert this as shown in the main layout drawing, again with one pin (right hand) soldered to the top foil. If C15 is used then one of the BB204 diodes has to be shorted out by linking its left hand lead (looking at the layout from the top) to its centre lead (link under the PCB).

7. If a crystal above 20MHz is being used, select and solder in C5 (390pF), C6 (100pF), C8 (47pF), C35 (2p2), C13 (470p) and C14 (100pF) – C3 and C7 are not used.
8. If the crystal is below 20MHz, then select and solder in C3 (220pF), C8 (150pF), C7 (10n), C13 (820pF polystyrene), and C14 (220pF) – C5, C6 and C35 are not used.
9. From Table 1, determine the type of Inductor used for L2, and whether or not C27/C28 are needed. Insert and solder these components – the can of L2 should be soldered to the top foil on the left hand side. *Note that with TOKO parts, the letters prefixing the numbers are sometimes different – as long as the numbers match those given you have the right part.*
10. Insert and solder CT2 and CT3. One pin of each should be carefully soldered to the top foil without melting the plastic part of the capacitors.
11. If a crystal under 20MHz is being used, solder in R6 (470R) where L4 would otherwise go (using the closer spaced holes. Otherwise, look up the correct type for L4, cut off the square protruding lugs on the sides of the base and solder into place.
12. Now, working from the top right hand corner of the PCB, insert and solder all the fixed resistors and capacitors with the exception of C36, C29 and R21. Check for correct polarities of electrolytics and that all connections to the top foil have been made where

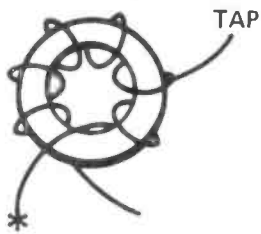

L1 COIL WINDING DIRECTION

needed. C33 and C34 have the earth connections to them made on the underside of the PCB and *do not need one lead soldering to the top foil.*

13. Insert and solder all the transistors and D1, ensuring correct orientation of the cases against the drawing. D1 has the cathode end (earth) marked with either a black or a broad yellow band depending on the maker. Note that Q8 has its collector lead soldered on the top foil of the PCB.
14. Insert and solder the appropriate crystal, with the case resting against the PCB. *Do not attempt to solder the case of the crystal to the PCB.*
15. Wind T1 on the small two hole Balun core. The primary requires 33cm of 0.2mm wire. Insert one end through one of the holes, leaving about 10mm wire protruding, then take the other end back down the other hole — this is one turn. Now continue until there are 10 turns — mark this end of the core with nail varnish or what you have so you know which end is the primary. The secondary needs 4.0cm of wire.

Insert one end of the wire through from the same end that the primary wires are coming, and leave 10mm of wire protruding from the other end (i.e. primary and secondary windings come from opposite ends of the core). Then wind two turns. Cut all four free ends to 10mm, and strip about 3mm of insulation off each end. Solder into place ensuring the primary is nearest R32. It doesn't matter which lead of

the secondary is soldered to the top foil.

16. IC1 and IC2 are both CMOS types. Providing you have a well earthed soldering iron, or an isolated type, you are unlikely to cause these any damage — as a precaution avoid handling the leads if possible. Insert them into place taking care to pin 1 in the correct place on each(!), and solder. *Both IC1 and IC2 have pin 8 soldered to the top foil.*
17. Solder in C29, and C36.
18. All components are now in place with the exception of L1 (VCO coil) which is added after initial alignment. *Finally, double check all component positioning before proceeding further.*

Alignment

For this stage you will need a multimeter (preferably analogue and *not* digital), and a frequency counter capable of measuring from 100kHz at the low end, up to the highest VCO frequency you are using. It is possible to do the alignment without the counter but this is not so easy.

1. Connect up an earth to the top foil, and lead from a +11 to +14v DC power supply to pin A, preferably with a milliammeter (100mA range) in the lead. Also connect up VC1 to the two terminals D & E (the polyvaricon has five leads emerging from one side of it — the long lead is the earth lead which is soldered to the top foil of the PCB and the two shorter leads nearest the spindle are those which go to points D & E).
2. Switch on and check that the current consumption does not exceed about 30mA. If it does, then look for wrongly connected components or 'shorts' between tracks etc.
3. If the crystal is above 20MHz, adjust L4 for a dip in the current consumption, and if possible use a counter connected to the emitter of Q3 to see that X1 is oscillating (the frequency should be within a few kHz of the nominal crystal frequency).

4. If you are using the offset circuit, earth pin C and adjust L3 or CT1 for an 800Hz shift in frequency when point C is earthed.
5. Next, the VCO frequency is adjusted to ensure that the loop will lock correctly when connected up, so L1 will need to be wound. The direction of winding the core is important — *so that the tap comes out on the correct side of the inductor* (see drawing). Start the winding at the bottom of the core and wind on enough turns to get to the tap. There are several answers as to defining how many turns a toroidal inductor has! We define the number of turns as the number of turns of wire you can count on the outside edge of the core, ignoring the start and the end leads (the drawing shows six turns). Form the wire into a loop about 8mm long for this tap, and then continue the rest of the winding. Cut the two ends to about 10mm in length, strip off 5mm of insulation, strip the tap loop, and then solder into circuit. The connection to the tap can be made using a short piece of offcut wire protruding from the PCB.
6. Temporarily connect one end of R21 to the pad just above IC2. The other end needs a temporary source of variable voltage connected to it. The best way to do this is to take a potentiometer (any value between about 100k and 1k), connect one end to earth, the other end to the output of IC3 (8v) and the wiper to the free end of R21. This pot simulates the control voltage from the loop which is not connected at the moment.
7. Connect your multimeter to the wiper of the pot (10v range) and a frequency counter to point B (VCO buffer output). Power up and you should get a frequency reading somewhere in the region of that required. Set the wiper voltage to 4v, and then squeeze or open the turns on L1 until the highest VCO frequency required occurs at 4v or so. This is

Component Listing

R1,35	4k7
R2,17	12k
R3,7,9,1- 2,13,21,- 27,36	1k
R4	33k
R5,11,30,31	10k
R6,8	470R
R10	100k
R14	82k
R15	22k
R16	680R
R18	39k
R19	220k
R20	150R
R22	2k2
R23,24,- 32,33,34	1M0
R25,28	47k
R26	10M0
R29	100k
R37	100R

All resistors 0.25 watt 5% carbon film types.

C1,7,11,- 12,19,22,26	10n ceramic disc
C2	22pF min. cer. disc
C3	min. cer. disc (see tables)
C4,17,2- 1,31,34,38	100n mono. ceramic

C5	390pf min. ceramic disc
C6	100pF min. ceramic disc
C8	min. ceramic disc (see table)
C9	330pF min. ceramic disc
C10,18,24	1n min. ceramic disc
C13	polystyrene (see tables)
C14,15	min. ceramic disc (see table)
C16	4p7 min. ceramic disc
C20	12p min. ceramic disc
C23,30,32	10uF 16v min. electrolytic radial.
C25	220pF min. ceramic disc
C27,28	min. ceramic disc (see tables)
C29	1n2 polystyrene (see text)
C33	4n7 Mylar
C35	2p2 min. ceramic disc
C36,37	47p min. ceramic disc
CT1	22pF max 7.5mm dia film trimmer
CT2,3	90pF max 10mm dia film trimmer
VC1	twin gang 266pF polyvaricon variable

Q1,3,5,8	BC308 or BC309
Q2,4,7	BC238 or BC239
Q6	2SK55 or BF256
IC1	4049UB (must be UB suffix)
IC2	4046B
IC3	78L08
D1	IN4148
D2,3	BB204B or KV1236 (see table)
D4	red LED
RFC1,2,3,4	180uH choke. TOKO type 7BA or 7BS (marked in 181 plus letter). see tables
RFC5	see tables
L1,2,3,4	see tables.
X1	see tables.
T1	Primary 10 turns. secondary 2 turns 0.2mm dia en Cu wire wound on Fair Rite balun core type 43-002402

Also required:

9 off 1mm dia PCB connection pins; 1 off PCB; 1 off 6:1 epicyclic reduction drive; Short length of Miniature coaxial cable (RG174A/U).

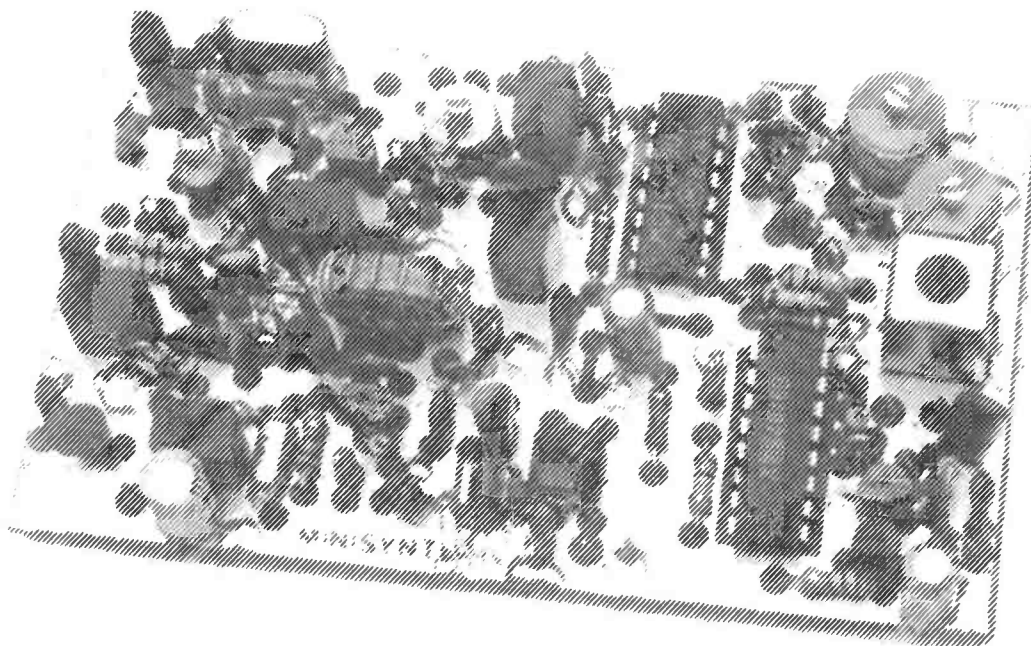

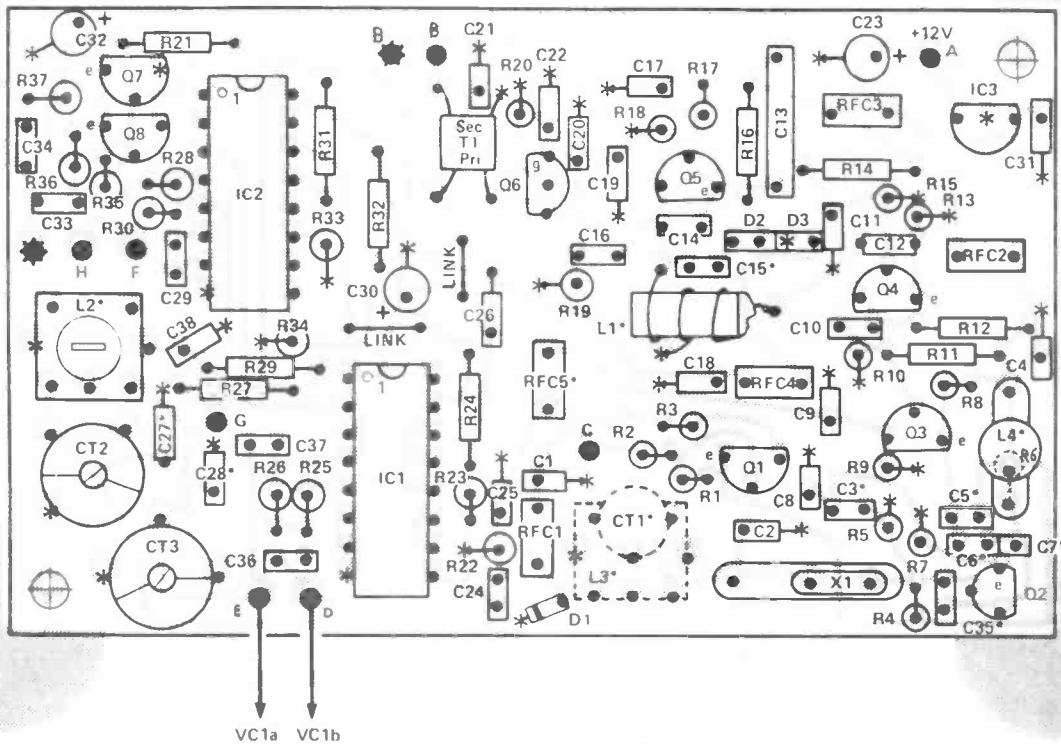

- = CONNECTION PIN
- ★ = CONNECTION PIN SOLDERED BOTH SIDES
- * = LEAD SOLDERED TO TOP FOIL

NB. Components marked * refer to Table 1 for value if used

Overlay diagram of Minisynth — with KV1236 shown in D2/3 position

fairly critical to set but only needs to be accurate to within a few 100kHz (the lower the VCO frequency the more accurate it can be set at this stage). The VCO will also drift about like mad but this is no consequence, as you will see in the stability of the actual synthesiser output.

Because of variations in permeability between samples of the same core, you may find that adjustment to the turns is needed — this is especially likely with the lower frequency coils. Also, it doesn't matter whether the turns are tightly bunched together or far apart to get the required coverage.

8. Now set the VFO frequency limits. A counter connected to pin 3 of IC2 will read the VFO frequency. Adjust the two trimmers to mid frequency and the polyvaricon to maximum capacity (fully

anticlockwise). Adjust L2 until the frequency is just below that of the lower limit given in Table 1 (how near you adjust depends on how much overlap you want at the band

limits — the frequency 'bandsread' of the prototypes varied — depending on the band in use). Now turn VC1 fully clockwise and adjust the two

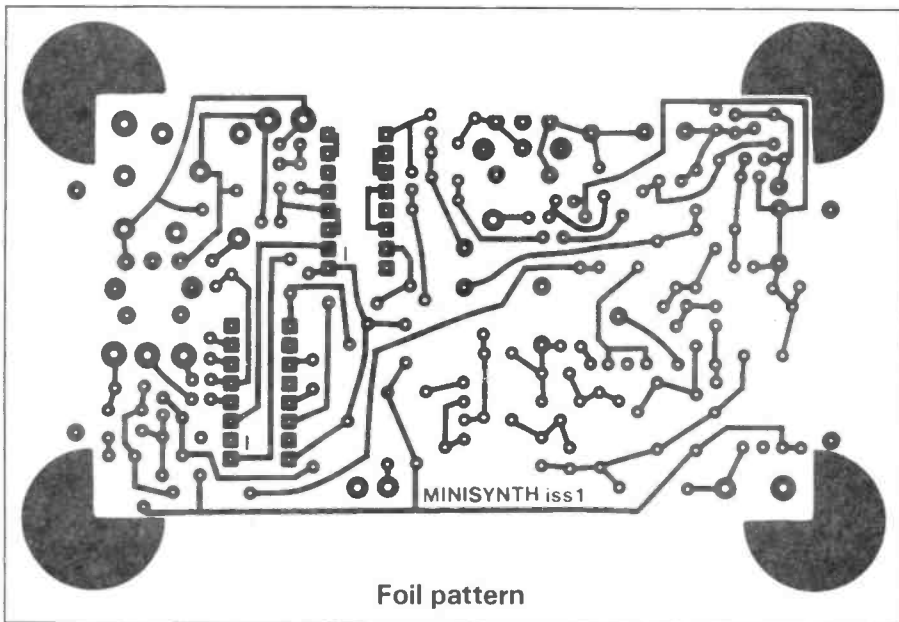

Foil pattern

trimmers equally until you are just above the upper limit. This will affect the lower frequency setting so go back and readjust L1 at the bottom end, and continue the two adjustments until the desired coverage is obtained. If you have too much swing, it can be reduced either by adding C27/C28 (say, 100p) or adding more capacity in parallel if they are already used. Too much capacity, though, will mean L2 is unable to compensate eventually. You will find that the core of L2 may be well out of the former on some bands, and this should be locked in place when all alignment is finished.

9. Remove power and connect R21 into circuit. You can also attach the LED 'lock' indicator to point G (the longer lead of the LED goes to point G).
10. Applying power again should result in the whole circuit functioning as required ie the 'lock' light will come on brightly and the VCO output should be locked to the VFO within the frequency limits set for the VFO. *Note that due to the fact the crystal is higher than the VCO frequency, adjusting the VFO lower in frequency causes the VCO output to go higher in frequency. This should be remembered if any readjustments are made to the coverage.*

If any problems in alignment are encountered, look for solder bridges etc, and do another check on all the components values/positions.

The most likely problem, if there is one, will be that the 'loop' initially refuses to lock — with the voltage from pin 13 of IC2 staying high or low. If no faults are found electrically, then it is possible that the VCO swing is too large and this will prevent the loop from locking properly (unlikely with the Table 1 values).

This can be checked easily by reverting to the pot arrangement while watching the voltage at pin 13 of IC2

VFO AND CRYSTAL DATA																
DIRECT CONVERSION																
	VCO	CRYSTAL	VFO	COVERAGE	L2	C27/28	C5	C8	C13	C14	C15	D2/D3	L1	L3	L4	RFC5
160	1.8 - 2.0	2.250	0.25 - 0.45	350E	----	220p	150p	820p	220p	link	1236	A	C11	----	1.0mH	
80	3.5 - 3.8	4.4416	0.64 - 0.94	6A77	----	220p	150p	820p	220p	link	1236	B	C11	----	180uH	
40	7.0 - 7.1	7.5728	0.27 - 0.57	350I	220p	220p	150p	820p	220p	link	BB204	C	C11	----	180uH	
30	10.1-10.15	10.240	0.09 - 0.14	1979	100p	220p	150p	820p	220p	47p	BB204	D	C11	----	180uH	
20	14 - 14.35	15.000	0.65 - 1.00	6A77	----	220p	150p	820p	220p	68p	BB204	E	C11	----	180uH	
17	18.06-18.16	18.400	0.25 - 0.35	350I	150p	220p	150p	820p	220p	27p	BB204	H	C11	----	180uH	
15	21 - 21.45	21.800	0.5 - 0.80	350E	----	---	47p	470p	100p	47p	BB204	H	3335	0800	180uH	
13	24.89-24.99	25.250	0.25 - 0.35	350E	150p	---	47p	470p	100p	22p	BB204	J	1731	0700	180uH	
10	28 - 28.6	29.000	(1.40 - 1.00)	350E	----	---	47p	470p	100p	47p	BB204	K	1893	0700	180uH	
10.7MHZ I.F.																
160	12.5-12.7	15.000	0.30 - 0.50	350I	----	220p	150p	820p	220p	56p	BB204	L	C11	----	180uH	
80	14.2-14.5	15.000	0.50 - 0.80	6A77	100p	220p	150p	820p	220p	68p	BB204	G	C11	----	180uH	
40	17.7-17.8	18.000	0.20 - 0.30	350I	150p	220p	150p	820p	220p	27p	BB204	H	C11	----	180uH	
30	20.8-20.85	21.000	0.15 - 0.20	350I	220p	---	47p	470p	100p	22p	BB204	H	3335	0800	180uH	
20	24.7-25.05	25.500	0.45 - 0.80	6A77	----	---	47p	470p	100p	27p	BB204	H	1731	0700	180uH	
17	28.76-28.86	29.050	0.19 - 0.29	350I	100p	---	47p	470p	100p	22p	BB204	J	1893	0700	180uH	
15	31.7-32.15	32.500	0.35 - 0.80	350I	----	---	47p	470p	100p	47p	BB204	K	C11	0600	180uH	
13	35.59-35.69	36.000	0.31 - 0.41	350I	220p	---	47p	470p	100p	27p	BB204	L	C11	0600	180uH	
10	38.7 - 39.5	39.700	(1.40 - 1.0)	350I	----	---	47p	470p	100p	68p	BB204	M	C11	0500	180uH	
9.0MHz I.F.																
	VCO	CRYSTAL	VFO	COVERAGE	L2	C27/28	C5	C8	C13	C14	C15	D2/D3	L1	L3	L4	RFC5
160	10.8-11.0	11.155	0.155-0.355	1898	----	220p	150p	820p	220p	68p	BB204	I	C11	---	180uH	
80	12.5-12.8	15.000	0.2 - 0.5	350I	----	220p	150p	820p	220p	68p	BB204	E	C11	---	180uH	
40	16.0-16.1	16.235	0.133-0.233	1898	----	220p	150p	820p	220p	47p	BB204	G	C11	---	180uH	
30	19.1-19.15	19.250	0.10 - 0.15	1979	100p	220p	150p	820p	220p	22p	BB204	H	C11	---	180uH	
20	23.0-23.35	25.700	0.35 - 0.70	350I	----	---	47p	470p	100p	47p	BB204	H	1731	0800	180uH	
17	27.06-27.16	27.460	0.30 - 0.40	350I	220p	----	47p	470p	100p	22p	BB204	J	1893	0700	180uH	
15	30.0 - 30.45	30.700	0.25 - 0.70	350I	----	---	47p	470p	100p	47p	BB204	K	C11	0600	180uH	
13	33.89-33.99	34.200	0.21 - 0.31	350I	----	---	47p	470p	100p	22p	BB204	L	C11	0600	180uH	
10	37.0 - 37.6	38.000	0.4 - 1.0	350I	----	---	47p	470p	100p	68p	BB204	M	C11	0600	180uH	
-	5.0 - 5.5	6.000	(0.5 - 1.0)	6A77	----	---	150p	820p	220p	link	BB204	N	C11	---	180uH	

Key: for L4 - 0800 is TOKO 518 8.5 turns (white)
 0700 is TOKO 518 7.5 turns (violet)
 0600 is TOKO 518 6.5 turns (blue)
 0500 is TOKO 518 5.5 turns (green)
 All with ferrite cores

for L3 C11 means use 22p trimmer instead of inductor
 3335 is TOKO transformer type KANK3335R
 1893 is TOKO transformer type MKANSK1893
 1731 is TOKO transformer type MKANSK1731

for L2 6A77 is TOKO transformer type RWD6A7752EK (green core)
 350E is TOKO transformer type CAN1A350EK (red core) or CAN1A879AD (black core)
 1898 is TOKO transformer type CAN1898HM (orange core) or CAN1898BX (yellow core)
 1979 is TOKO transformer type CAN1979A (white core)

for L1 see Table 2
 ---- means component not used.

for RFC5 180uH chokes are TOKO type 7BA or 7B5 (green or white) and coded 181 (plus letter)
 1.0mH chokes are TOKO type BRB (black) and coded 102 (plus letter)

CRYSTALS: All crystals below 20MHz are parallel resonance types HC18/U 30pf loading.
 All crystals above 20MHz are series resonance 3rd overtone types HC18/U

Table 1 - VFO and Crystal Data for the Minisynth - data for 5.5MHz operation

with R21 disconnected. Starting with the pot at minimum voltage (lowest VCO frequency) the control voltage should be high — indicating that the loop is trying to pull the frequency higher. Increasing the pot voltage will increase the VCO frequency until the difference

between the VCO and the crystal is the same as that of the VFO. At this point the loop voltage will go low as it tries to pull the frequency back down again. If there is a problem with VCO coverage then you will find that there will be several changes to the loop voltage, with extra ones

occurring at the high and/or low ends of the swing. The remedy is to add C15 (or reduce its value if already present) so that the VCO swing is reduced until all is normal (this shouldn't need to be done with the values shown).

11. Finally, check the sidetone circuit if this is being used. Earthing point F should cause an approximately 800Hz tone to appear at point H (amplitude at CMOS voltage). The frequency will probably be out a little — if so, either make an adjustment to the value of R32 or R34, or change the value of C29 in small amounts until it is close to 800Hz. When used with your receiver or transmitter, the output voltage at point H will need reducing to a suitable level using a potential divider.
12. If the VCO output voltage is lower than required for some reason, decreasing the value of C20 will increase it, (too much drive to the buffer will give a poor output waveform, although this is of no consequence when driving a double balanced mixer such as the SBL1).

Using The Minisynth

Now that the unit is complete you are ready to use it to good effect. The output voltage from the VCO buffer is sufficient to drive a double balanced mixer of the SBL-1 type, or similar circuit requiring a *high* local oscillator drive level. If your circuit needs a lower level, then we suggest you use a resistive 50 ohm attenuator pad on the output as this will not affect the performance.

There is no particular need to screen the unit, but it will fit into a standard diecast box if you want to. If this is done, the input voltage and other DC connections should be made via a 1n or 10n feed-through capacitor, and the connections to VC1 made via insulated leadthroughs on the box. RF would come out through a suitable coaxial socket. The connection from the variable capacitor, VC1, to the MINISYNTH is best made using two short pieces of stiff wire.

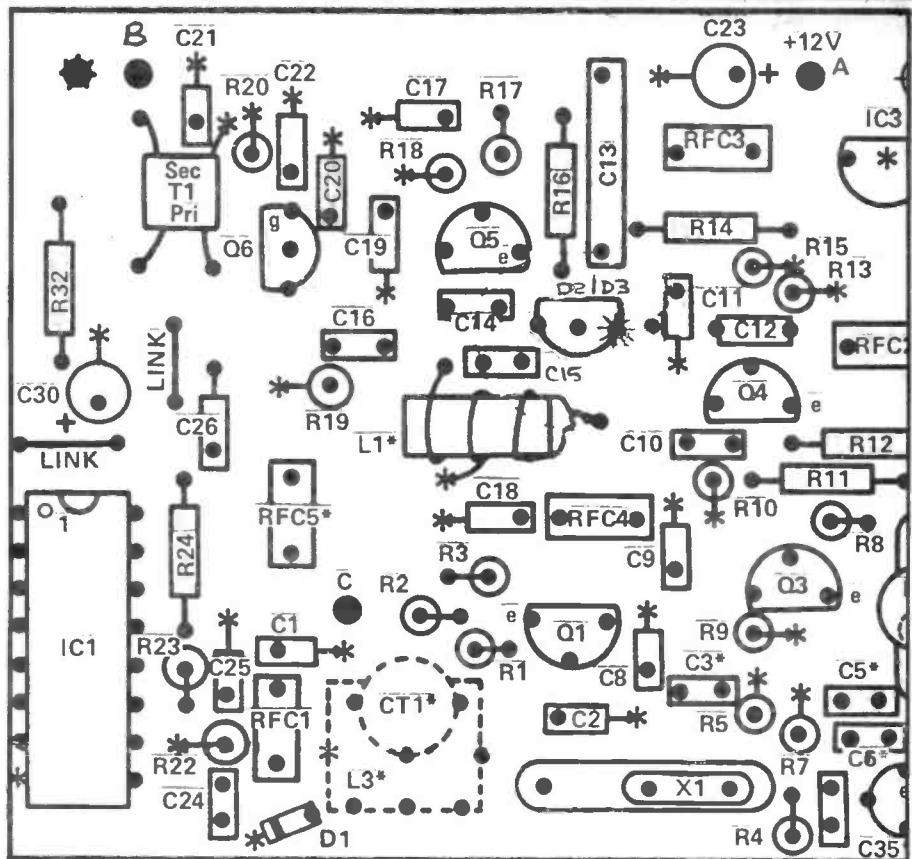

Overlay of Minisynth — with BB204 shown in D2/D3 position

TABLE 2
L1 INDUCTOR DETAILS

REF	CORE	GAUGE	TOTAL TURNS	TAP AT TURNS
A	T50-2	0.25	68	10
B	T50-2	0.25	35	9
C	T50-6	0.56	21	4
D	T50-6	0.56	14	3
E	T50-6	0.56	11	2
F	T50-6	0.56	10	2
G	T50-6	0.56	8	2
H	T50-6	0.56	7	2
J	T50-6	0.56	6	1
K	T50-6	0.56	5	1
L	T50-6	0.56	4	1
M	T50-6	0.56	3	1
N	5-5.5 T50-2	0.56	26	5

Key: Cores are Amidon dust iron 0.5" diameter.
 -6 types have yellow colouration.
 -2 types have red colouration.

All wire is enameled copper type.

RECEIVERS: assessing RF performance

The overall performance of a receiver has to be a compromise between the cost of its manufacturer and the practical requirements of the user. The 'front end' performance often has to be a balance between RF sensitivity and intermodulation characteristics, usually within the mixer. IF performance, including selectivity, must be related to the bands in use — requirements for HF reception are very different to those for VHF and UHF. In this article I will be considering some of the tension between our (the users) requirements and what is actually offered to us on the market. I hope that I will be able to stir up some educated enthusiasm, and encourage other users to apply some gentle pressure in the market place in order to get manufacturers to give us all what we want, rather than what they want to push! I am getting a little tired of endless 'bells and whistles' being provided on rigs — which may be seriously deficient in quite important areas. Therefore I ask, "Are we really getting what we need and what we are being asked to pay for?"

Let's have a look to see what we actually need in terms of front end sensitivity and performance on the various bands.

Sensitivity Versus Frequency

Starting with the very lowest amateur band, 160m, I have found that with a reasonable aerial you don't really need a front end noise figure much better than around 25dB, even when the band conditions are such as to produce poor

propagation, and therefore, fairly low noise. Most rigs have at least a switchable RF preamp in the front end, or alternatively, a 20dB attenuator. A rig which has a basic sensitivity at LF of around 0.2uV for 12dB signal to noise ratio, is far better than it need be, and I almost invariably switch in my attenuator at LF to reduce further any RFIM products. I have a particular pro-

strengths are so much higher that a sensitivity better than 1uV for 12dB S/N is totally unnecessary, and you will in fact be lucky if the interference level is anywhere as near as low as 1uV! On 40m the receiver has to cope with massively strong signals between 7.1 and 7.4MHz whilst allowing you to receive comparatively weak DX that may be around 7.05MHz. My

Angus McKenzie, G3OSS, scrutinises the various measurements used to assess RF performance — what they mean, how they affect what you hear — and gives an insight into the problems of actually measuring them. This is an article to be slowly and carefully digested!

blem at Finchley; extremely strong received signals on MW from two independent local radio stations and also from BBC Brookmans Park, all of which can create chaos with a bad receiver. Even a 30dB effective noise figure is normally good enough, but surprisingly perhaps, for mobile use, you can benefit from a better front end, which would usually mean switching out the attenuator, provided you have eliminated ignition interference etc. The average 'top band' mobile whip brings in a much weaker signal, relative to receiver noise, than would a half wave dipole for example, and during and mid morning a 20dB noise figure can be useful for mobile. Fortunately, I have not yet come across a rig that has any limitation in sensitivity which matters on this band.

On 80m the situation is much the same, but in the evenings signal

colleagues and I tried an interesting experiment towards the end of a winter afternoon whilst I was writing this article. I use a 75ohm twin centre fed antenna with traps on 40 and 80m, which gives an effective half wave on the three LF bands. At the shack end I use a balun with the unbalanced output interconnected with an Icom auto AT500 ATU. We connected the output of this straight into a Hewlett Packard B558B spectrum analyser via a 20dB attenuator. We took two photographs of the screen, one with the ATU bypassed (Fig. 1), and the second with the ATU matching the antenna at around 1.9MHz. Several MW signals can be seen to produce from -5 to 0dBm levels, whilst one or two signals in top band are slightly above 0dBm (i.e. 1mW) taking the attenuator into account. This is almost a terrifying state of

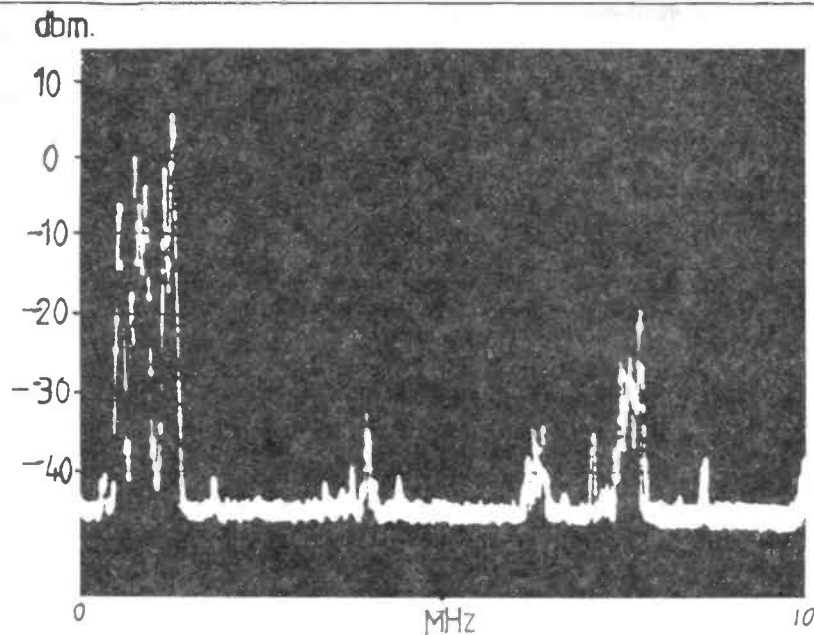

Fig. 1

Without ATU.

affairs when you consider what an RF front end has to withstand! Look at Fig. 2 with the ATU switched in and note how the MW signals are considerably attenuated. We checked the total power coming off the aerial with the ATU switched out and noted an astonishing +5dBm, although I suspect that this was under read somewhat by a power meter whose action is rather sluggish. With the ATU switched in on top band, the total energy was reduced to -5dBm, a lot more sanitary. The total energy with the ATU switched to 80m was around -20dBm at around 5.00pm and this level can shoot up during the evening by at least 10 or 15dB. We tried connecting the balanced feeders together, and tuning these against earth into the analyser, and achieved horrific levels on medium wave of up to +10dBm (*Gulp!* — *Editor*) on one particular carrier, and previously I have received signals of up to +13dBm! Remember that +13dBm is 20mW!

To expect to receive a very weak signal at LF surrounded by incredibly strong ones with typical amplitudes as described is quite a tall order, so you can see where some of the problems begin!

On 20m a noise figure of around 15dB is probably sufficient, even when the band is about to close. However, above 14MHz more and more sensitivity is re-

quired, and I find that around a 12dB noise figure is useful on 21MHz, but on 10m quite a lot can be gained for specific requirements with a front end as good as 6 to 8dB noise figure. When the HF bands are open, of course they are noisy, so you don't need an extremely good sensitivity, *but the difference between making or not making that QSO with a rare DX station when the band is closing can be the difference between say 8dB and 12dB noise figure at the front end.* If the DX station is using low power, and you are using high power, then of course your receiver is stretched to the limit. The more modest your antenna, the weaker will be both the signal strengths and the band noise, and so the more sensitive your receiver has to be for the receiver generated noise to be lower than that coming from the antenna. In mobile installations (i.e. with an electrically short antenna and with much electrical noise) you will need a much more sensitive front end to *hear* stations — even if you can't work them.

Going VHF

For the 6m band you will probably need a noise figure of around 4.5dB at best, for ground wave propagation reception, particularly in the early hours of the morning when the band is now in use in the UK. On 4m, propagation is fairly

similar and there is not much point in having a system noise figure better than around 3.5dB unless you are right out in the sticks and hundreds of yards from the nearest thermostat! I should stress here that the average noise picked up by a reasonable antenna in urban areas on 6 and 4m can be equivalent to a noise figure of at least 8dB, for unfortunately one seems to pick up ignition and other electrical interference emanating from sources hundreds of yards away. I like to operate on 4m sometimes, on Sunday mornings and you should hear the racket coming out of my speaker. It seems that every household in the vicinity is hard at work with DIY power drills which are unsurpressed, with additional thermostats, old bangers' ignition and anything else that makes a noise present at the same time!

System Figures

At VHF and higher frequencies one has to consider the effective system noise figure, which takes into account any coax cable losses between the antenna and the first RF stage. Let's have a look at a typical system on 2m (145MHz). An amateur might be using a 9 element Yagi with a rotator at around 40 feet above ground level. His run of coaxial cable and connectors could be introducing a loss of 3dB and the rig, especially if it is an oldish one, might have a typical noise figure of 7dB. Old rigs such as the Trio TS700 series, Yaesu FT221, Icom 201 etc would come into this category. The system noise figure would be 10dB at the antenna, and frankly this is hopelessly inadequate for picking up real DX. After making many measurements of aerial noise, and discussing reception problems with experts such as Chris Bartram of Mutek, I have arrived at an ideal noise figure for 145MHz, for the complete system, of around 3dB. You can work this any way you like, i.e. a masthead preamp with a 2.5dB noise figure and, say, 14dB gain into a good receiver, or a cable loss of 1dB into a 2dB receiver, such as the IC271 with Mutek front end reviewed last month. What is important is that the effective system figure should be around

3dB for terrestrial use. In my opinion, there is no point in having an overall system figure any better than 3dB because the band noise is higher than this even in the middle of the night. If you are going to do moon bounce or meteor scatter where you are elevating your antennas so that they receive much less noise from the ground, then you can benefit by having a better overall performance. However, the moment you switch in a masthead preamp, the overall system IM performance deteriorates dramatically, and I'll explain this later.

On 70cms, a system noise figure of around 1.5dB can be extremely useful in the middle of the night, but there is some band noise in the day from electrical appliances, and even from the sky and sun. This will mean that you will get an enormous benefit in almost all installations by employing a very good masthead preamp. I use a Microwave Modules transverter having a 2.2dB noise figure on 70cms with a cable loss of around 1.75dB. There is a marked improvement when I switch in a 1dB noise figure preamp at the masthead. Even more marked though is the improvement gained when I switch in a masthead preamp on my FM installation for 70cms, in which I use 2 x 10 element yagis mounted vertically and feeding a power divider straight into the masthead preamp (SSB Products). The coax loss is around 1.5dB, and the rig a Trio TW4000A with a noise figure of around 5dB. Thus the system noise figure of 6.5dB improves to around 1.25dB when I switch in the masthead pre-amp and this allows considerably improved readability of FM DX. The improved audio signal-to-noise ratio on very weak FM signals is around twice that of the RF noise figure improvement, so that if you can gain 2dB in noise figure on 70cm FM on a signal that is around 10dB signal to noise plus distortion, then you'll get around 14dB sinad, a very marked improvement. The limiting characteristics of various FM rigs are quite different and so the quoted improvement is an average; some rigs will be improved by 5dB for a 2dB RF noise figure improvement.

It is on 23cms and above, that you will benefit from the best possible noise figure that you can

manage on the entire system. My own system has around 1.3dB noise figure and consists of an SSB Products thruline masthead preamp with the new Microwave Modules 23cm transverter at the bottom end. Switching the masthead preamp in and out improves the system subjective signal to noise ratio by around 7dB, and *since the band noise is so very low*, this is very dramatic indeed. It is therefore virtually essential to have a masthead preamp on microwave bands, for even the best cable will lose several dB.

Sensitivity Measurements

Very many precautions have to be taken when you are measuring the sensitivity of a preamplifier or RF receiving system. I use a Marconi 2019 signal generator into a 20dB 'N' type attenuator which feeds into a flexible Andrews FSJ4 coaxial cable of around 2m length into an additional 10dB 'N' type attenuator which feeds directly into the rig being tested. The attenuators are very accurate, and the loss of the Andrews coax can be ignored up to 1000MHz! The figures quoted are EMF/2, i.e. the PD that would be developed across a pure 50 ohm load. I have checked and rechecked the Marconi's ac-

curacy and have calibrated such that the error even at UHF is not more than 0.5dB or so at 1uV, and around 1dB maximum error at 0.1uV into the rig. It is essential to use a generator that is very tightly specified as to its RF leakage. Furthermore, I use the Andrews coax because the screening is extremely good, thus effectively bonding the earth plane of the generator to the chassis of the rig under test. Under some circumstances, a normal UR67 cable can leak. By employing attenuators at both ends of the line, leakage is minimised, and the line matching is optimised, such that the rig sees a very accurate 50ohm source, whatever its own input impedance is. Even this series of precautions is not good enough, for computer noise can sometimes get into a rig that has poor external screening. When this occurs the tests are repeated with the computer switched off, an improvement of up to 1dB sometimes being noted.

FM Sensitivity

There are two separate measurements of sensitivity that can be carried out on FM systems. The first is termed 'quieting' and can be measured by applying an appropriate deviation of 1kHz audio frequency to the carrier and

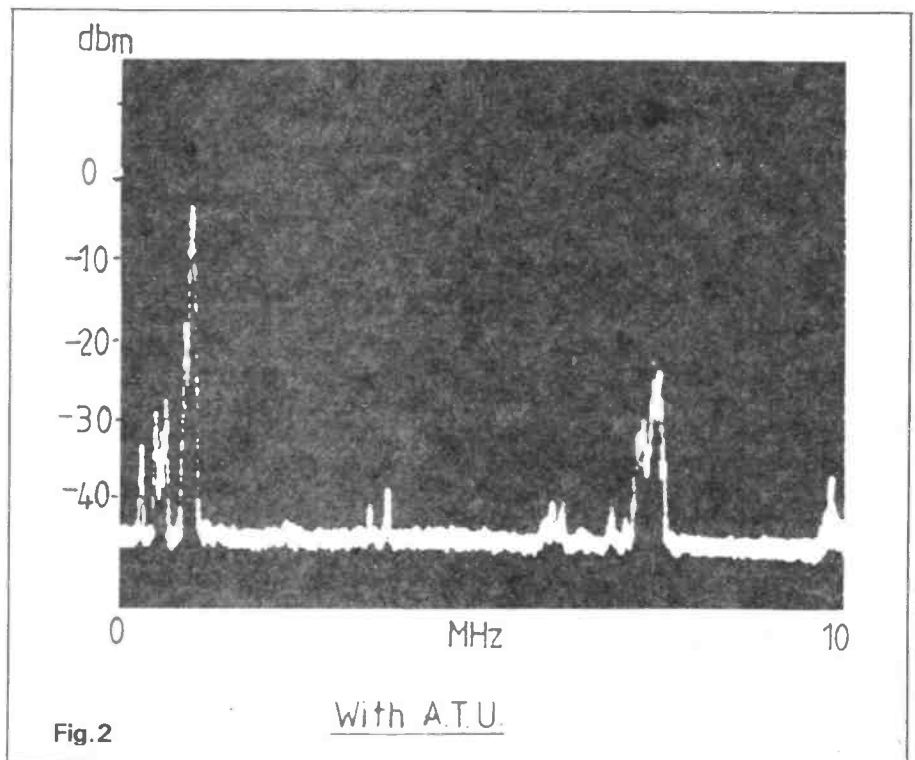

measuring the audio output level from the rig, then cutting the modulation and measuring the noise. This figure represents the signal-to-noise ratio obtained at the particular RF level used. Various filters can be inserted in the audio output which can have different 'weighting' characteristics. A high pass and low pass filter unit can be set to measure the noise in the passband from 300Hz to, say, 3kHz. In high quality systems I use either unweighted figures, or CCIR weighting, the latter curve being used very frequently in hi-fi circles. The other way of quoting the sensitivity of FM receivers is to use what is termed the *sinad* rating. In this test the modulation is left on all the time, and the rating is defined as the dB ratio between the entire modulation output, including noise and distortion, to the measurement of the noise and distortion components, with the fundamental modulation nulled out with a form of distortion meter. It is important to appreciate that at a particular RF level a *sinad* measurement will always be worse than a normal signal-to-noise quieting measurement (please note quieting rather than quietening is the correct term). The reason for this is that an FM receiver generates considerable distortion of very low level signals, including crackling noises behind the modulation, whereas when the modulation is withdrawn the carrier has just normal noise on it. The *sinad* measurement thus takes account of the subjective background when modulation is present—which, of course, determines the actual readability of modulation on a very weak carrier. Signal-to-noise ratio is almost meaningless in practice on an FM system until you are way above the limiting threshold of the discriminator.

SSB Sensitivity

In the case of SSB receivers, sensitivity measurements are actually quite difficult unless you have very good gear. The problem is that even with extremely weak signals, many rigs have a significant but small amount of AGC action. If you measure noise on an SSB receiver with RF gain set to maximum, and at a reasonable setting of the audio output level, and then apply a carrier which gives a

GLOSSARY

Noise Figure — the excess noise produced by the RX at standard room temperature compared with the noise produced from the nominal source resistance, usually 50 ohms, also at room temperature.

RFIM (Radio Frequency InterModulation) — the products, at frequencies displaced from the original frequencies, of two or more strong RF carriers. The frequency of these intermodulation products is mathematically predictable (see also accompanying figure).

Reciprocal Mixing — degradation of wanted signal caused by noise on a local oscillator.

RF Intercept Point — an artificial point which is calculated to be the input level at which intermodulation products would rise to the *same* levels as the carriers creating them. The intercept point cannot be regarded in practice for obvious reasons (i.e. as you can never have a signal suffering 100% distortion).

RF Input Levels — these can be quoted either as e.m.f. from the signal generator (th O/cct voltage), p.d. across the Rx input, or the p.d. across 50 ohms — instead of the receiver as a load. *I use the latter, p.d. 50 ohms — usually quoted as e.m.f. — 2, which is true provided the generator is 50 ohms source impedance. P.d. across Rx input is too dependent on the Rx input impedance — which can vary more than somewhat from 50 ohms — and generator e.m.f. can be misleading for many readers.*

beat note of 1kHz, the ratio between the two is not necessarily valid. If you can switch AGC off, it becomes reasonably valid if you take care, *but you cannot do this on many rigs*. I therefore use *sinad* again, and distortion should never be introduced on weak SSB carriers unless the rig is exceptionally 'grotty'. There is a serious snag in *sinad* measurement though, for one is usually dealing with a system bandwidth of around 2.3kHz or so, and you have to consider the bandwidth of the 'suckout' circuit of the distortion meter itself. This would usually be somewhere between 150 and 300Hz for 3dB points, so noise either side of the carrier beat is omitted from the measurement, and therefore the reading is slightly optimistic. It is easy to calculate the correction factor of somewhere between 0.5 and 1dB that you have to degrade the reading by to get a meaningful result. There is one more snag in SSB sensitivity measurements which concerns the response of the audio amplifier after the product detector. An unmodified IC271 with an HF response rolling off continuously above around 500Hz, was 9dB down. The audio bandwidth for 3dB points *was only around 1kHz wide*, so again the *sinad* measure-

ment would be artificially good *unless you compensate the result*. I try and compensate for all these problems by quoting a calculated noise figure based on the measurement of both the *sinad* rating and the overall audio bandwidth of the system, and here I have discovered that some rigs do not defy the laws of physics as they appear to do before the bandwidth compensation is allowed for.

Now for CW

For measuring the CW sensitivity of a rig with a very narrow IF bandwidth, the measurement problem is considerable as one cannot use any form of *sinad* measurement with a normal distortion meter because of the *bandwidth* of the suckout. The measurement is simple and obvious for signal-to-noise if AGC can be switched off, but if it cannot be, or disabled internally, then there are two ways which can be used. The first is to put all gain controls flat out, but with the audio backed off slightly if necessary, and measure noise. Then, advance an RF carrier level until the output audio increases by an appropriate amount, e.g. frequently 10dB. A more correct method is to use an FFT analyser with the centre frequency at 1kHz covering the 3dB

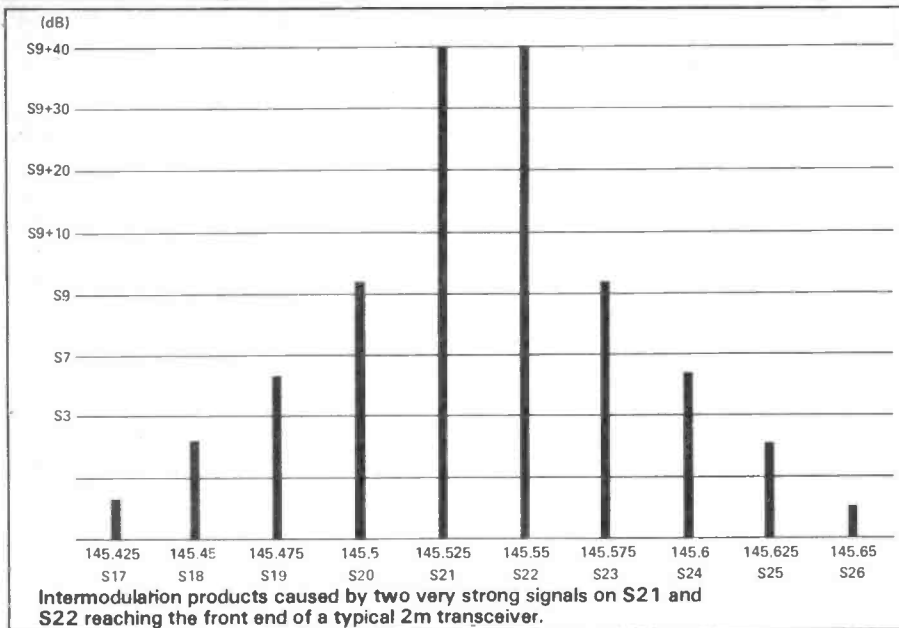

bandwidth of the filter used. A computer can then be programmed to add up all the noise other than that due to the carrier itself and refer this total power to the power of the carrier beat. This allows the noise contribution in the vicinity of the beat note to be taken into consideration, thus allowing any S/N ratio to be calculated. We have actually used this procedure for measuring audio tape modulation noise and it takes only around 30 seconds to do it! The problem is that the total cost of the equipment for this test alone, is around £30,000! It also required many days of programming to sort it out, so I do not propose to use it for testing amateur radio rigs!

RF Selectivity

Most valve receivers, and very many transistorised ones, have a tunable front end which then drives into the mixer. Mixers used to be rather poor in their RFIM performance and so the RF bandwidth had to be as *narrow* as reasonably achievable, bearing economics in mind. *This allowed out of band signals to be rejected to a varying degree*, but it did not help problems caused by strong in-band signals. Most modern rigs have bandpass filters around the RF stages, which themselves have a lower gain — just sufficient for the preamp to overcome most of the mixer noise and thus minimise mixer RFIM problems. If we have another look at Figs 1 and 2 we can see that a rig not having a high-pass filter at

around 1.8MHz when tuning across the 160M band, is going to be in a *lot* of trouble unless an external ATU is used. Some rigs have such a filter but all too many do not. Low pass filters are also important to keep higher frequencies from generating mixer products. One reasonable way of testing the RF bandwidth is by checking RFIM using two carriers spaced by differing amounts away from the tuned frequency. If you tune a rig on 145MHz for example, you could put one generator on 146 and the other on 147 and check how much you have to raise the 147MHz level to cause intermod, having checked the rig's sensitivity at 146MHz. The test can be repeated at various spacing to check bandwidth, but the procedure is extremely time consuming. It is perhaps easier to dig inside the set and touch an active probe on the mixer input, the probe feeding a spectrum analyser. Most general coverage receivers now incorporate switchable high and low pass filters for the various bands, but an external ATU will almost always make an improvement if this is required, as is easily seen in Figs. 1 and 2.

RFIM

A normal mixer mixes input frequency, f_r , with the local oscillator frequency, f_l , to provide an IF frequency, f_i . f_i can be $f_r + f_l$, $f_r - f_l$, or $f_l - f_r$. The IF output is thus a second order IM product of the input and local oscillator frequencies. Unfortunately, mixers also generate

higher even order products as well as many odd order ones. In discussing RFIM under normal conditions, one normally considers the intermodulation products developed with two or more signals coming into the front end. Third order products are $2f_1 - f_2$, and $2f_2 - f_1$ with f_1 and f_2 as two frequencies well within the front end passband. Rather than quoting stacks more formulae, let's just consider two aggro signals on S21 and S22 (145.525 and 145.550MHz). Third order products are developed on S20 and S23. 5th order products, i.e. $3f_1 - 2f_2$ etc, are developed at S19 and S24, and if things are really bad you will get additional odd order products every 25kHz down and up the band until your temper runs out! The calculation is just the same for SSB signals near the bottom of the band. In carrying out an RFIM test on FM, we can receive $f + 2s$ where s is the basic spacing. Another IM product would be developed at $f + 3s$. One of the interfering carriers must be modulated, the one with the single term, for if you modulate the 2f term you will get double the deviation appearing on the third order product being measured which plays havoc with measurements! Thus you modulate the generator furthest away in frequency from the IM product frequency being measured. I set the two carriers at the same level into the set as equal EMFs, with two Marconi 2019 generators mixing in a hybrid transformer (I use a very good MCL device type ZFSC-2-5 available from Dale Electronics and fitted with N type sockets for input and output ports). This device offers a port isolation between the generators of at least 30dB over an extremely wide frequency range, and a through loss for each generator to the output port of marginally over 3dB. This prevents the output from one generator from intermodulating with the output of the second within the generator's output circuit. You have to be careful to leave some attenuation in on each of the generators. I again use a 10dB pad at the rig end, and allow the two generators to go up and down in level together, and find the point at which a 12dB sinad product is generated in the receiver on the IP frequency. The

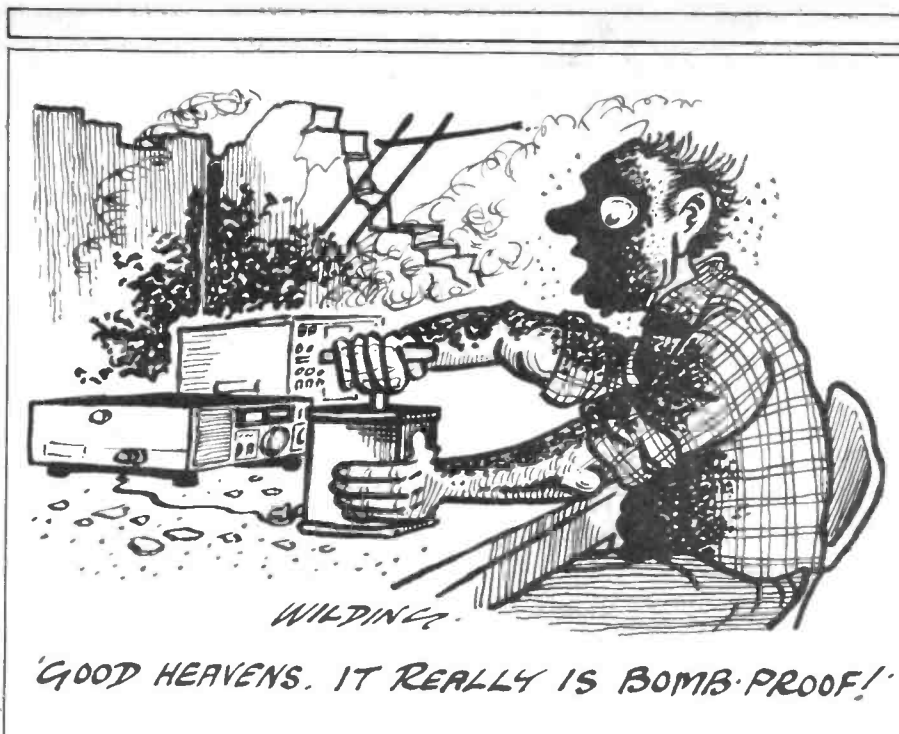

'GOOD HEAVENS. IT REALLY IS BOMB-PROOF!'

ratio of each of the generator's EMF/2 level at the rig, to the pre-measured 12dB sinad point of the receiver becomes the IM ratio for the particular input level tested. You can arrive at an approximate RF intercept point from this measurement.

In the case of SSB receivers, the generators, hybrid transformer and general set up are the same, but it is necessary to pre-calibrate the 'S' meter. One tunes in the set at a nominal frequency, and then generators G1 and G2 are set at s and $2s$ spacings away from the tuned frequency. You may have to move the tuning slightly to get a maximum S meter reading from the IP. I usually use two or three S meter levels, say S2, S5 and S9 and determine the input EMF/2 required from each of the generators to develop a product for the required S meter reading. Having calibrated the S meter, one can assume that the product is equal to an equivalent of x μ V input to the set. This method requires caution, for ABC can occasionally be taken off to a degree from a point after a roofing filter but before the main IF filter and this needs watching, requiring another method to be used. You can refer the IM ratio to the 12dB sinad point by obtaining a 12dB sinad IP. Let's take an example and check how we can estimate the intercept point. If S5 is 1μ V (-107 dBm/50ohms), and the receiver requires two signals each

of 10 mV (-27 dBm) then the IM ratio at that input level will be 80dB, resulting in an intercept point some 40dB higher, i.e. $+13$ dBm ($-27+40$). If S9 corresponds to 10μ V, then we would find that we would need around 22 mV into the same receiver to give an S9 product. 22 mV is -20 dBm, generating a -87 dBm product, the difference being 67dB. To calculate the intercept point you add half the difference between each of the causatory carriers and the equivalent product level to the carrier level. The test should be carried out at the point at which the IP is 60dB below each of the carrier levels, the intercept point then being 30dB higher than each input level. If one thinks about all this you can see that a 7dB higher input level into the receiver generates IPs actually at 21dB worse, and so improving the intercept point by a fairly small amount can greatly reduce RFIM. A 10dB improvement in intercept point actually lowers the product levels by 30dB which is well worth having, and this can be the difference when you switch a masthead preamp having 10dB gain in and out of the system, assuming the preamp itself is contributing a negligible amount to the overall RFIM performance other than by the effect of its gain. A transceiver, such as the IC751, has an RF intercept point of $+13$ dBm with RF preamp in, but $+25$ dBm

without preamp, i.e. preamp bypassed. The 12dB improvement in intercept point can mean the difference between rubbish appearing all over 80m in the background, and no problem occurring at all. The sensitivity with preamp in and out measured a difference of only 6dB or so, useful on 10m, but totally pointless at frequencies below, say, 160MHz. If you attenuate before the front end, then of course the RF intercept point improves by an equivalent amount, and this can make all the difference on many poorer receivers, such as early FT101s, on 40m.

Unfortunately, the real intercept point can in practice be considerably inferior to that which is conventionally "guessed at" from the method described, as other stages than the mixer can contribute in degrading intercept point at higher levels. You can always tell that this is happening by plotting two or three IP levels against the input levels causing them. Where the line diverges from a straight one becomes the onset of problems! RF intercept point is of course an essentially *imaginary* one anyway, but it is useful figure to discuss.

Expressing RFIM

Chris Bartram of MuTek and I have had considerable correspondence about RFIM and whilst we are in agreement generally about measuring techniques and interpretation, we differ over other ways of expressing RFIM, but I am not really adamant about my being right for Chris's methods are just as relevant, assuming that the intercept point, or Chris's preferred 1dB compression point, is only indirectly relevant in practice, although giving a guide to performance at lower levels. In a simple mixer the RF intercept point should be at around 15dB above the 1dB compression point.

Once again we have to relate RFIM performance to what is actually required on the band. At lower HF we need a receiver which is bomb proof, but on 23cms, RFIM is hardly important at all, unless my friend G3JXN is firing right at me from Ealing off channel when I am trying to work somebody in the Channel Isles! Quite frankly, we

MINI CIRCUITS LABS MIXER TESTS

MIXER 1 (ZFM-148)			MIXER 2 (ZFM-150)			MIXER 1 repeat with improved matching		
RF INPUT LEVEL (dBm)	IM PRODUCT RATIO (dB)	CALCULATED RF INTERCEPT POINT (dBm)	IM PRODUCT RATIO (dB)	CALCULATED RF INTERCEPT POINT (dB)	IM PRODUCT RATIO (dB)	CALCULATED RF INTERCEPT POINT (dBm)	IM PRODUCT RATIO (dB)	CALCULATED RF INTERCEPT POINT (dBm)
-25	70	+10	75	+13	75	+12.5		+12.5
-20	63	+11.5	63	+11.5	71	+15.5		+15.5
-15	57	+13.5	54	+12	66	+18		+18
-10	52	+16	44	+12	60	+20		+20
-5	41	+15.5	35	+12.5	57	+23.5		+23.5
0	32	+16	32	+16	40	+20		+20
+5	22	+16	16	+13	18	+14		+14
+10	15	+17.5	12	+16	14	+17		+17

give each other hell and have both had to redesign our front end gains accordingly! The problem is the same for you if you have two local amateurs who happen to beaming across you at the same time that you are trying to wrinkle out some rare DX. A few examples of RFIM are interesting. I was accused once of transmitting over the top of the dreaded GB3SL by two or three nearby amateurs. Someone was radiating a carrier exactly halfway between my frequency and that of GB3SL's output frequency, and their receivers were very poor! Many mobile enthusiasts have had problems in central London with noise appearing all over 2m, resulting from intermodulation products occurring from out of band, very strong digital signals, emanating from a building not very far north of the Post Office Tower! The FT227R was particularly bad in this respect, and also used to bring in police stations at the top end of 2m "walking all over the repeaters", to use a dreadful CB phrase which I cannot resist! If you use a preamp as well in an effort to hot up a deaf rig, then watch out for IM products. It is far better to rebuild a front end, or completely change it for a MuTek one where available in order to get good sensitivity combined with an improved RFIM performance.

We thought it might be interesting to measure two different Mini-Circuits laboratory mixers, both of which required 10mW input at the local oscillator frequency, and with a specified loss of 6dB between input and output levels. We drove the local oscillator port from a MuTek 96MHz crystal oscillator at +10dBm and first interconnected the output from the IF port through a Drake 30MHz low pass filter into the HP8558B spec-

trum analyser. For very low level tests, we inserted a Marconi RF amplifier immediately in front of the analyser to help reduce the noise floor. Two Marconi 2019 signal generators were tuned to 106 and 107MHz respectively, with their outputs coupled in an Mini-Circuits hybrid with it's output port driving the RF input port of the mixer. IF frequencies of 10 and 11MHz were produced, together with RFIM components at 1MHz spacings either side. We realised that the IF port matching was poor, but probably typical of many receivers in practice! The two generators were set initially to -22dBm which gave mixer input levels of -25dBm. The 3rd order IP ratios were then checked on the analyser, which had been carefully calibrated, then levels were stepped up in 5dB steps. The table shows the results obtained with the two stairs, columns showing the input level of each carrier, and the 3rd order resultant ratios. We also included the calculated RF intercept point from each separate measurement and you can see that it varies all over the place. We then thought it relevant to pad the IF output port of the higher quality mixer, which had actually given inferior results, by 10dB, thus stabilising the load on the mixer. As expected, the IP performance dramatically improved at low levels and a more predictable intercept point was noted at approximately +20dBm. It would have been even higher and the results more linear, if we had also more carefully terminated the RF input and local oscillator ports with 6dB attenuators, but we feel that these comparative results should bring home the importance of loading mixers properly. MuTek take great care to do just this in their special front ends. Note that the 1dB com-

pression point is approximately 15dB below an intercept point, and that the latter, in a passive ring mixer, should be around 10dB above the local oscillator injection level. It is possible to achieve an even higher intercept ratio with everything carefully matched, but mismatched mixers, as you can see, can be barely above the LO injection levels. At higher input levels, 5th, 7th and even higher order products can be seen, and these were not taken into account in our measurements, but if they had been, the calculated intercept points from very high input levels would of course be worse, and more correct.

Reciprocal Mixing Problems

I would like to acknowledge, with reference to reciprocal mixing, the invaluable work in this area carried out by Peter Hart who reviews for Radcom. He really got me going when he introduced the problem on the Yaesu FT1, which apparently had considerable noise present, presumably on the first local oscillator. Reciprocal mixing is actually very important indeed, but is very difficult to measure. It actually concerns effects produced in reception caused by local oscillator noise. In practice, a receiver having a bad RM performance can produce noise which 'bobs' up and down beneath a weak signal as a result of a stronger one being present off channel. It can be exaggerated if you switch in a noise blanker. So frequently I have heard a transmission blamed for the trouble, and this is not necessarily incorrect, but is more usual to have the problem in reception. What actually occurs is that a strong off channel signal (of say 20kHz) actually mixes with local oscillator noise at 20kHz off



its frequency to give a modulated noise signal in the IF passband. The effect is rather like the equivalent of a receiver trying to cope with a rugby scrum. Imagine you were desperately trying to wrinkle out a 144.25MHz signal of 0.1uV when a station at 144.27MHz is creating a received input signal of 1mV, some 80dB stronger. If the reciprocal mixing performance at this offset gives a ratio of 80dB between receiver noise and the level required to increase this on channel by 3dB, then you would see that the background noise will be bobbing up and down by 3dB so that your required signal will be bobbing up and down apparently between inaudible and audible! I have measured receivers with reciprocal mixing ratios from as bad as 74dB on a Drake TR7, to 106dB on an IC271, so you can see that there is a vast difference between bad and good. The measurement problem is that the stronger signal which has to be set off channel has itself to be far superior to any local oscillator that is likely to be encountered. Modern transistorised signal generators are hopeless for this test unless you use an incredibly sharp filter in their output, and Peter Hart uses this method at 21.4MHz. I found originally that a very old valve Marconi 995 was far quieter than any modern generator, but much better still is a crystal controlled oscillator with special

circuitry to reduce noise, made for me by MuTek, which is absolutely fabulous.

Using this technique I have actually measured very remarkable RM ratios such as 120dB on the IC271 well away from the received frequency. If you consider a 2kHz bandwidth, then the total noise will be 33dB higher than that for 1Hz bandwidth, so the Marconi generator might therefore itself give noise totalling -97dBc at an offset where the rig itself is appreciably better. Many rigs can be very bad fairly close to the received frequency, but improve dramatically further out, whereas others seem to reach a noise floor which may not be fully satisfactory. If you want to hear reciprocal mixing problems at their worst, then have a listen to a Bearcat, and note the noise around almost any input carrier. This is almost entirely due to the very noisy oscillators.

For reciprocal mixing testing we mix the output from an appropriate source such as the MuTek oscillators, or Marconi 995 generator with the low level output of a Marconi 2019 generator spaced in frequency as required. We develop a 15dB sinad signal and increase the off channel strong signal level from low to very high until the sinad ratio is degraded by the same amount as it degrades with a 3dB reduction of signal generator level. The level of the strong signal to

that of the receiver noise floor becomes the reciprocal mixing ratio at the spacing used, although I also frequently quote a slightly lower ratio from high level signal to 12dB sinad point.

The difference between a good receiver and a poor one in this parameter can be stunning, particularly on 2m. Quite frequently a local oscillator will itself be modulated with many frequencies from within the synthesiser, so you might get a strong signal also appearing as a very weak one at intervals across the band, the Liner 2 is the best example of this, but one recent HF transceiver had reciprocal mixing products develop at 50kHz intervals up and down the band. If you hear your local beacon appearing in various places, on the band as well as the proper one, the problem can be due to reciprocal mixing, but there may also be a contribution from other causes.

Conclusions

I hope you will see that a good front end performance has to be a compromise between performance and cost. What upsets me though is when almost every front end parameter is compromised against bells and whistles for a given price. Too many VHF rigs are just not sensitive enough, whilst also having a much poorer RFIM performance than they should. Sometimes it is a matter of pence in manufacturing costs, for replacing a cheap transistor with one costing a little more could make all the difference. Too many rigs are maladjusted in quality control, or drift badly in performance in the long journey from Japan to the UK. Just because we are 'radio amateurs,' does not mean we should be happy with a mediocre performance, for it anything, our standards are much higher than those of many professionals. I just cannot understand why it should be necessary for MuTek to have to supply greatly improved front ends, for example, for rigs that should be better in the first place. If the design was done properly, either the cost would only be marginally higher, or one whistling function could be omitted! Reviewing so many rigs in the last year has been absolutely fascinating, but sometimes depressing.

Addendum

2m Talkbox Tx (March 1984)

On page 22:

Instruction 14 should read "Wind L7/L8".

On page 23:

Instruction 2 — L1 core should be 1mm *into* former *not* out of former.

On the overlay diagram, C41 is shown with the wrong polarity and should be reversed; antenna and PTT connections should also be reversed; the capacitors between the crystals are the ones referred to in the components listing as CP, and the left-hand side of each should be soldered onto the top foil of the PCB; the legend by the asterisk should read: "SOLDER LEAD TO TOP FOIL".

On page 25:

C33 is 10uF 16V radial electrolytic; the descriptions of the winding of RFC3 and RFC4 are incorrect and should be interchanged.

On page 26:

Position of diode between the external power socket and the battery charger socket on the rear panel drawing is incorrect — please follow the enlarged drawing above this.

ADVERTISERS INDEX

ASP Morse/Software	IBC
Amcomm	IBC
Bi-pak	21
B.N.R&E.S.	28
Dewsbury Electronics	37
Kw-Ten-Tec Ltd	55
Northampton Communications	28
Northern Amateur Radio	IBC
P.M. Components	34
Radio Society Great Britain	23
Western Electronics	28
Wood & Douglas	IBC
W.P.O. Communications	27

Beta Comm	Classified
Booth Holdings	Classified
Double H Software	Classified
Paul Sergent	Classified
PNP Communications	Classified
Richard Wilmot	Classified
Scarab Systems	Classified
W.H.Westlake	Classified

And don't forget, when calling an advertiser, mention Ham Radio Today, it helps them and us.

73's David Gadsden G4NXV
Advertisement Manager

KW-RECOGNISED INTERNATIONALLY BY AVIATION MINISTRIES FOR THEIR EXPERTISE IN RADIO COMMUNICATIONS — ALSO PROVIDE SERVICE TO RADIO AMATEURS

THE HIGH STANDARDS required in aviation communications, and the expertise of KW in the maintenance and servicing of facilities around the world form the backing of the TEN-TEC range of equipment. available in the UK only through KW.

TWO HF TRANSCEIVERS are currently available, the CORSAIR and the ARGOSY II, both giving outstanding performance and value.

THE CORSAIR has been an immediate success in the USA, having the 10-160 metres bands as well as crystals for the three new bands. With 200 watts input; full break-in on CW; built-in Speech Processor and Noise Blanker; Variable Passband and Notch Filter; AGC for smoother operation, and all solid-state, this HF SSB/CW Transceiver is tops in any league.



The KW TEN-TEC CORSAIR

TEST CERTIFICATES are provided by KW giving performance figures measured under laboratory conditions for each Transceiver sold.

FOR MORE NEWS and information on the ARGOSY II and the full range of accessories and services available from KW, write or phone straight away.

KW TEN-TEC LTD,
Vanguard Works, Jenkins Dale,
Chatham ME4 5RT.
Telephone: 0634 815173

Reciprocal Licensing

Do I need a reciprocal licence for use in Northern Ireland? Can I have a reciprocal licence for France, I'm going tomorrow? These are just two of the questions commonly asked of the

case is that of matching up the UK licences (A and B) with the five American classes.

All the American licences require some form of theory test and a Morse

the price of a stamp or telephone call!). Members are welcome to contact the Membership Services Department and will be sent all the information available on their computer for the country they are to visit, together with an application form where this is needed. Non-members will be unable to obtain such information (there must be some perks to paying your subs!) but will be given the address of the national radio society that they should contact. (For a reciprocal licence to use in the UK it is the Post Office address given in Table 2.)

Going abroad for your holidays? Like to operate your rig? Sharon Metcalfe, G6LCC, gives a breezy guide to the legal niceties.

RSGB (no, I'm not just making them up!). If you are a UK licensed amateur you should know that, by the licensing conditions, the answer to the first question is "No". The second one may be a little harder to answer but the simple answer is "a reciprocal licence for France" — yes — but "for tomorrow" — not a chance!

If you are going abroad for your holiday or you are a non-UK amateur coming to Great Britain this summer, don't just think about applying for that reciprocal licence, get on with it or you'll be too late! But more of that later.

A reciprocal licence is available when there is an arrangement between countries to honour the validity of each others licence. This means that each country must have licence requirements (eg, RAE equivalents and Morse tests) and facilities (eg. the bands and powers available) which are broadly similar. When these do coincide satisfactorily, reciprocal licences are usually possible (see Table 1). In general, countries following the ITU Regulations not imposing Morse code requirements for use on 30MHz and above, may be suitable for reciprocal licences with UK licence classes A and B. Several years ago Spain did not require a Morse test for operation on the HF bands and this, being radically different from UK licensing conditions, prohibited UK amateurs from obtaining reciprocal licenses! However, this has changed and reciprocal licences are now available.

Anomalies

Even when reciprocal arrangements have been agreed in principle, problems still do arise when one of the countries offers more classes of licence than the other. An interesting



test. The UK class A licensee will automatically get the top (Extra) class licence under the reciprocal arrangements. Conversely, the top three American classes (General, Advanced and Extra) all have tests similar to our RAE and Morse test and hence they will get a UK class A licence. So far so good. But what about a UK class B licensee who has not proved his Morse capabilities? Since the Americans have no class which is independent from Morse, there is no equivalent American licence. So, because the conditions of the UK class B licence cannot be reciprocated, a UK class B licensee cannot get any American licence.

A few other countries have similar anomalies which can make the applicant's life a bit tricky, so you'll need to check with the RSGB (if you are a member) or with the equivalent radio society in the country for exact details. Indeed this seems a good time to 'plug' the RSGB, for this is one of the many areas in which they can smooth the way for members (for just

Visiting the UK

A foreign amateur visiting the UK and staying at a fixed address will be issued with a licence G4/own call for G6/own call, depending on the nature of his own licence. This will cost the usual £12, be valid for a year and be renewable for the payment of the licence fee. A visitor touring the UK and having no fixed address may have a three month mobile licence, also costing £12 but not being renewable. Occasionally where a reciprocal licence has not been granted (perhaps because the application was too late or there were problems over the currency for the fee) a seven day temporary licence may be issued by the UK authorities as a goodwill gesture.

If you as a UK amateur have a foreign amateur with a reciprocal licence visiting you, the visitor may operate your station under supervision. However, there is no difficulty for him to bring his own equipment into the UK unless it includes the 10m or 11m wavebands. In this case he will need an "Import Authority Letter" which is obtainable from the Radio Regulatory Dept of the Trade and Industry (see Table 2) at no charge. By the way, a foreigner staying for a longer time and aged over 14 years may now take the RAE and apply for a domestic UK licence, the nationality requirements have been lifted.

It Takes Time

For the UK amateur travelling abroad the case is far less clear cut, everything depending on the country

you are visiting. However there are several things in common for most "holiday" countries. Most applications will take at least two months to process. On the shorter side is West Germany whose Deutscher Radio Club suggests six weeks while at the longer end is Australia whose Wireless Institute say three months. In fact, Australia also has an "over the counter" service for personal applicants in Sydney, Hobart, Fortitude Valley, Adelaide, Perth and Melbourne. On paper Spain appears to have the shortest postal period of issue (three to four weeks) but there may be a delay of an additional four weeks to arrange payment by International Postal Giro. The best advice that I can give is to allow at least three months (if not four!) between posting your application form and accompanying documents and your departure date.

Costs Vary

The cost of a reciprocal licence is generally cheap. Typically it costs approximately £7 in Spain, £5 in Italy, £10 in France or £12 in Australia (top price of the countries I examined). Bargain of the world must be the USA where a licence is available free of charge! Most licences are valid for three or twelve months but Belgium has the interesting feature of a basic fee (about £7) with an additional sum of about 50p per month for using a transmitting power of up to 125W or about £1 per month if using Tx power 125-250W.

The question of how you are going to pay seems to provide more of a problem, with every country requiring payment by a different method. Italy even has two different departments dealing with reciprocal licences. One of these requires the payment of \$8 US in cash while the other requires 5100 lira paid in International Reply Coupons. West Germany require 15DM paid in currency or Giro but not by IRCs. Spain will only accept their 1600pts if paid by International Postal Giro whereas France will accept their 125Fr by draft, international money order or giro. (It could even take an extra month to find out that the country has changed its method of payment — or any of its other requirements — without notifying its national radio society or the RSGB!)

The USA, France, Italy and West Germany are among the countries re-

Table 1 — Reciprocal Arrangements exist between the UK and . . .

Austria	Irish Rep.	Portugal
Belgium	Israel	South Africa
Brazil	Italy	Spain
Denmark	Jordan	Sweden
Dominican Rep.	Luxembourg	Switzerland
El Salvador	Monaco	USA
Finland	Netherlands	West Germany
France	Norway	and most British
Iceland	Poland	Commonwealth countries

Table 2 — Further information may be obtained from . . .

International VHF FM Guide (current Ed.) obtainable from RSGB Publications at Alma House, Cranbourne Road, Potters Bar, Herts.

Radio Regulatory Dept, Dept of Trade and Industry, Waterloo Bridge House, Waterloo Road, London SE1.

Post office, Radio Amateur Licencing Unit, Chetwynd House, Chesterfield, Derby S49 1PF (Chesterfield (0246) 2075555).

quiring application on a special form. In general, the RSGB can supply it's members with photocopies of the relevant forms, saving the applicant considerable time. (France even requires two photocopies of your completed application form.)

The foreign countries all require a copy of your UK licence and proof of it's current validity. The validity can be confirmed by obtaining a letter from the Radio Regulatory Department (see Table 2) and this is available free of charge. This is something that you can do now, while waiting for the application information to arrive from the RSGB (up to a week) or the country's, that you wish to visit, radio society (who knows how long . . .).

Basic Details

Every country will want such details as your UK address, date of birth etc, and will want your temporary residential address while there. No, you can't have a reciprocal licence for a day trip to Calais, though that is what I had in mind when I first investigated the idea of obtaining a reciprocal licence. In fact it was a holiday in France two years ago that started me thinking. I took my new handheld 2m rig with me just to listen to what was going on there (and improve my schoolgirl French?). I was extremely frustrating to hear a local French repeater and be unable to use it. I vowed that on my next visit I would get a reciprocal licence. My next trip was a day trip to Calais, but I thought that I would make enquiries and get a licence just for the fun of it.

At this point I discovered the necessity for an actual address so unfortunately no reciprocal licence was possible for my excursion.

Looking back I may well have been illegal 'importing' a transceiver for my holiday! Indeed every country has it's own customs regulations and you will need to check up on these with the national radio society. In fact the Spanish customs may require a payment of 50,000pts (about £214) 'import duty' on your rig (fortunately this is reclaimable). Most countries require details of the equipment you are proposing to use before they'll even consider granting a reciprocal licence. In most cases the manufacturer and model of the rig, together with it's band(s) and power, and the aerial will suffice. However, according to information from the RSGB, Belgium requires "basic details of the transmitting equipment which will be used. (Eg. a block diagram plus a circuit diagram of the final transmitter stages)."

By now you will be able to answer my second original question for yourself and hopefully appreciate some of the problems of applying for a reciprocal licence. However, unless you are going on a six week continental tour and wish to transmit from a different country every week, there really is no problem: it just takes time and the knowledge of who to apply to. My advice here is to join the RSGB as it will cut out so much of your initial paperwork. Enjoy your holiday and foreign operating! I still say, thank goodness English is the international language of the air!

Space Shuttle Post Mortem

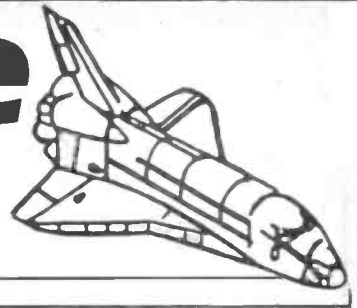

It would be all too easy for me to sum up the Space Shuttle mission carrying the first Radio Amateur in space as an almighty flop and the worse demonstration of operating technique and bad manners that I have ever had the displeasure of hearing on any band – and that includes CB. Yet despite this the mission was, in my final opinion and that of others, an unqualified success in terms of publicity for NASA and the Amateur Radio Community around the world.

quency of 145.550MHz, FM during the even minutes of each pass and scanned the uplink frequencies during the odd minutes. There were several 'uplink' frequencies to choose from including 144.700MHz and every 25KHz 'channel' up to 144.875MHz plus 145.350MHz and 145.450MHz.

Problems With Procedure

The procedure W5LFL intended to follow was that he would transmit

it, after listening to the tape he identified five UK call signs including G4UYL, whose contact can now be regarded as officially confirmed. Any other station who thought they may have contacted W5LFL should contact the RSGB.

Unfortunately the work schedule for the astronauts and scientists, and thus the periods Dr Garriott had free for Amateur Radio, was altered by NASA 48 hours before 'lift off'. Had the RSGB been able to pass this information on using their Sunday morning news service then a great deal of frustration caused to many amateurs could have been avoided.

As I mentioned earlier, the possibility of contacting the W5LFL would have been greatly enhanced had the correct radio procedure been adopted by all radio amateurs. Unfortunately a great deal of the interference on the downlink frequency was caused by stations who had not taken the trouble to find out what the correct operating procedure was. Further interference was caused by 'policing' stations telling other stations to clear the downlink frequency. Even Dr Garriott himself was told to clear the downlink at 1525 UTC on the Sunday by some irate amateur who obviously did not know who he was talking to.

The recent attempts at amateur radio from the Space Shuttle 'Columbia' have caused considerable controversy within the amateur radio community.

Mike Jones, G6GOS, sums up.

Not since the last moon landing has there been so much publicity surrounding a NASA (North American Space Agency) mission at both national and local levels. Indeed, the publicity was so successful that the Potters Bar Chamber of Commerce sent the RSGB a letter after the event thanking them for putting Potters Bar on the Map. The BBC spent several days at Potters Bar filming the RSGB's attempts at contacting Dr Owen Garriott as he flew over the United Kingdom in the space shuttle "Columbia". National and local press were hungry for news of any contact which was not forthcoming until Wednesday 7th when Gloria Hills, G4UYL, made the first confirmed contact with W5LFL. (*See Radio Today*)

In terms of communication technology the shuttle mission was not a great challenge for us on the ground because, when the space craft was overhead, S9+ signals could be received from W5LFL with modest equipment. What was required, though, was a high degree of operator discipline, combined with good operating procedure and an accurately timed watch of the 'up' and 'down' frequencies. W5LFL transmitted on the 'downlink' fre-

a general CQ on the first even minute, listen for replies during the first odd minute, noting the call signs, and would then re-transmit these on the next even minute – thus confirming the contact with the ground stations he had heard during the previous odd minute.

Unfortunately Dr Garriott found it impossible to follow this procedure for several reasons:

- 1) The headset he was using in the spacecraft was of the open type and did nothing to reduce the noise level inside the space craft, which was surprisingly high. Dr Garriott thus found it very difficult to hear the information coming out of the earpiece.
- 2) Whereas he was the only station who was officially using the downlink frequency, *several hundreds of amateurs were calling him on each of the uplink frequencies.*
- 3) Excessive jamming and interference on the 'downlink' frequency by other amateurs. (*Licensed amateurs? Hmm - Editor*)

So for the majority of the time Dr Garriott modified his method of working, transmitting for 30 seconds or so and then listening for 90 seconds whilst recording the signals he received on a tape recorder for later analysis on his return to earth. As I understand

Organisational Back-Up

On the whole, I think the RSGB came out of this exercise fairly well having run a very successful national press campaign, in addition to which they supplied press kits to all affiliated club for distribution to the local press. Also, throughout the flight of Columbia they ran a special bulletin station on several of the Amateur bands, including HF, to inform as many amateurs as was possible of the latest developments and to supply them with the possible contact times for the next 24 hours. Orbital data was supplied to the RSGB by AMSAT UK, which is a group of Amateurs who are interested in Satellite communica-

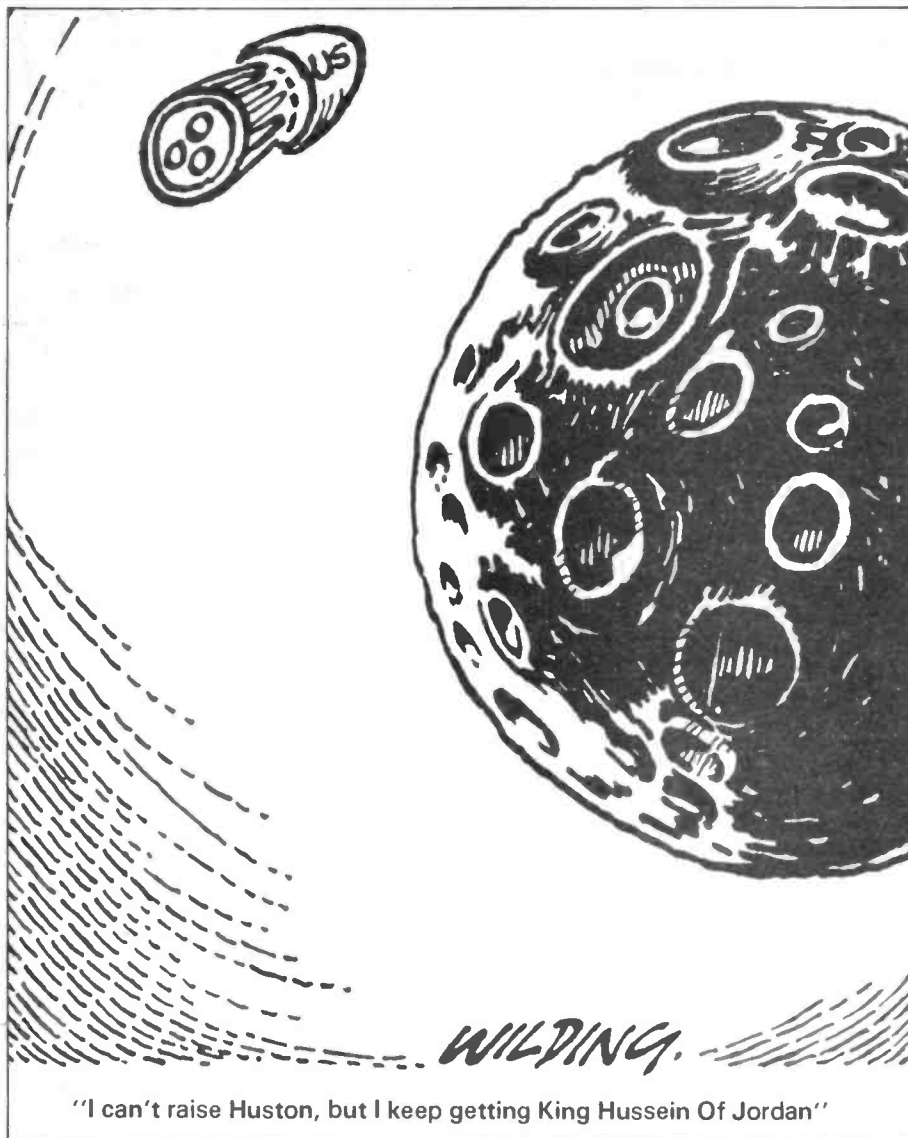

"I can't raise Huston, but I keep getting King Hussein Of Jordan"

tions. Other details of the mission were supplied by the American Radio Relay League and NASA themselves. The ARRL also ran two special event stations during the mission. One from the Kennedy Space Centre in Florida to cover the launch and the other at Edwards air base where Columbia landed on lakebed runway 17 after spending more than 9 days in orbit.

Other Activities

The STS-9 mission was unique for several other reasons apart from carrying the first radio amateur into space, or perhaps I should say *operational* amateur radio station in space. This is because Dr Garriott spent 59 days in space aboard Skylab 3 in 1973 when he also clocked up nearly 14 hours of spacewalks during three separate extravehicular activities. The Commander of Columbia during the mission was John W. Young who has now logged six missions in space

and has flown in the Gemini, Apollo and shuttle programmes including STS-1 and now STS-9. In 1972 he and Charles Duke drove 27 kilometres on the moon exploring the highlands at Descartes.

The STS-9 mission carried the European Space Agencies space laboratory package in the cargo bay of Columbia. 'Spacelab', which cost over a billion dollars to develop, was built by various contractors throughout Europe including British Aerospace and EMI. During the mission no less than 70 experiments were carried out for both the ESA and NASA by an international scientific crew, which included one European scientist. This was the first international crew to fly on an American space mission. It may interest readers to know that the problems experienced with the spacecraft's computers prior to landing was traced to the 2nd General Purpose computer - found to have metallic particles inside it!

NASA were delighted with the amount of publicity that the mission and the "Amateur radio operator in space" attracted and as several of the other NASA astronauts are amateurs there is a good chance that the whole experiment will be repeated. Apart from his contacts with amateurs around the world, Dr Garriott carried out a series of more serious tests with members of the ARRL, including some designed to see if 2 metres could be reliably used for emergency space-ground communications. These tests, as with the rest of the mission, proved to be very successful.

Different Frequencies

If another amateur does go into space then there is an argument that different frequencies should be chosen, say 70 or even 23 cms. But, if this were so, then the number of amateurs who are equipped to join in would be restricted and surely this is not the spirit in which amateur radio activities should take place. For, if nothing else, we are an open society *and open to all those who care to join us*. There will always be a few people who will seek to spoil the pleasure that the majority of amateurs get from an event such as the shuttle experiment. The best way to deal with stations of this type is to ignore them and their activities and to teach them correct procedure *by example*.

The space lab programme brings with it a unique opportunity for scientists to study the environment in which we live to the betterment of mankind. A few radio amateurs have, as a result of the mission, got the contact of a lifetime. To the hundreds of thousands of amateurs around the world who listened in for Dr Garriott as he flew overhead in Columbia, the mission brought some considerable happiness and innocent excitement; those are things we can all do with. Our thanks and thoughts should go out to all those who made it possible. *Those Amateurs who wish to send in reception reports to the ARRL should: Send the report of date, time (UTC), equipment, aerials and signal report along with a self addressed envelope to which three international reply coupons have been affixed to:* Reception Report STS-9/ Ham Radio, The American Radio Relay League, 225 Main Street, Newington, Connecticut 06111, United States of America.

Free Readers' ADS!

For sale Atlas transceiver. Also Drake Tr4 transceiver. Both in very good order. £250 each with instruction manuals Atlas has mobile gear G3HZF. QTHR

M/M 2m to 70cms converter. £18.00 Pye 2m to 70cms Tripler. £15.00 R.T.T.Y G4BMK transceiver programme. Cassette. £8.00 P.N.P comms. Phidra FPIA R.T.T.Y boards transmit £15.00 all above for Dragon 32 Tel Weymouth 786930.

Wanted. Any information on adding extras bands to Yaesu FTDX401, also to possibly borrow January 1982 CQ Amateur Radio, can copy and return A.1. condition. All costs refunded. G6MVM 24 Seaview Road, Herne Bay, Kent CT6 6JA.

Sale or exchange. Yaesu FT2F. 2m.F.M. transceiver 10W/1W auto T/B mobile mount mic fully XTALD manual perfect condition plus DX 100L gen coverage receiver 15K.H. 30MHz. For 2m multimode any make. Call Mike on 0908 676 809 after six p.m. Price for both £125.

Wanted Collins, Kokusai or Toko 455KHz mechanical SSB filter. Wanted spares for Collins 32S-1 and or 755-1 scrap set considered. Telephone Dunstable (0582) 62621.

IC255E mobile 2m.FM rig. 1 or 25W 5 memories. Scan facilities on memory or band reverse repeater etc. Complete with mobile mount and handbook etc. £150 ovno Tel. Hull (0482) 859445.

Trio R1000 communication receiver. AM. SSB., CW, boxed, digital readout. Offers about £195 Telephone 0787 75931 anytime.

For Sale Creed 7B/RP printer/perforator, Creed 656 tape reader. Complete with silencer cover and complete Creed service manuals. All in full working order and excellent condition. Buyer collect or

haggle over delivery. Offers please to Yoxall (0543) 472054.

Wanted back issues of Q.S.T. 1950-1979. Eddystone panoramic display unit EP15. Eddystone 850/4 L.F. receiver. Phone Wokingham 782236.

Microwave modules MML144 30LS 30W linear. Suits FT29OR etc. Mint £48 ono also MMT432/144R 70cm transverter with attenuator for FT29OR (14.50 list) £150 ono mint condition. Ring 012476097 day 014464932 evenings. Also 70cm colinear £10 and 70cm wavemeter with helical £18.

TS430S, boxed as new used few hours receive only. Cost £780 including AM filter. W/S manual. Best offer cash or possible exchange for high grade base rig (TS830S/902DM/ similar) change of plans. No longer need ultra compact G.C. rig. Tel. 061-439 9637

Yaesu FT290, carrying case and strap, 8 amp power supply, nicads and charger, 5 element beam, half wave vertical omnidirectional, 1 kilowatt power/SWR meter. £230. Aylesbury (0296) 21612.

Yaesu FT780R, 70cms multimode transceiver as new never used mobile telephone Chester (0244) 311496 £250.00.



Members of the Fylde Radio Society on a recent excursion to Blackpool Airport.

Selling TR2300 VB2300 MB2 mounting Mex 55 boom mic Valor Magmount Azden speaker packer A145 ATU soft carry case RA1 rubber helical antenna Lars PS1200 charger P.S.U. V.G.C. £212. Patrick No3 Castleacre Close, South Wootton, King's Lynn PE30 3TD.

Phillips N1700 + tapes cassette holder stuck £30 ono. Might require large hammer. Tel 01-987 2296 after 7pm.

Trio 2300 auto tone listen on input/reverse. No ni-cads £100.

IC-240 23CH 12W £100. Wanted Trio 3200 or Icom IC-30A to buy or swap for the 2m rigs. G4DOV Tel Cheslyn Hay 0922 414927 after 6p.m.

Wanted Yaesu FT780R 70cms multi-mode transceiver. Preferably still within guarantee. Also wanted. Two 2C39 (or equivs.) valves complete with bases or holders. Tel. 0475 33544.

Drake RX SSR1 - good £75. Heathkit hamonic distortion meter 1M58. Good £20. Generalelec RX type CG 46116 1.5Mc-9Mc £20. Cossor 1035 scope, transformer US. £10. GEC scope good £20. McMichael Radio MOD 472 £10.

Selling Tranzmatch by S.E.M. with built in Ezitune £75 ono Sandown (0983) 402273.

Exchange Pentax SV F1.8 Takumar good condition for Datong D70 morse tutor. SRB2 or W.H.Y wanted big brass morse key and Racall manuals. G3BYT Huntingdon 53748.

TS130V including microphone £375. Also FT230R with intermitent fault - offers. Hallicrafters seven section mast 35 feet when assembled £30. Telephone John 01-253 0661 ext 129.

Enthusiast-Restorer. Pye Manuals required. Pye VANGUARD AM25T. Pye Cambridge AM10D. Pye manuals of any/all equipment requested, either original or good photocopies. Please Tele after 6pm. 0782-612868.

Icom IC240. exc. cond. £120 ono. G8PUY 01-599 6667.

Datong automatic notch filter model ANF with mains power unit model MPU cost £74.75p. Brand new boxed instructions guarantee £60. Want Drake SCC-4 calibrator 5NB noise blanker. Trowell G2HKU 'Hamlyn' Saxon Avenue, Minster Sheerness, Kent ME12 2RP. Tel. (0795) 873100.

Trapped dipole 10 to 160 metres as new made by G2DYM. £40 Macdonald Market Harborough 65609.

Swop twelve foot double skinned unsinkable sailing boat with road trailer and winch for H.F. or test gear.

Yaesu FT227R memoriser 2metres-FM 10 watts mint condition very little used £110. Yaesu FT101 350Hz CW filter 160 to 30 metres looks and works like new G4ENW QTHR. Southend 525569 £250.

Selling FDK multi 11 2 metre FM transceiver, autoscan, toneburst, 10W O/P £100. Earth leakage circuit breaker £10. Paraffin 1kW heater for shack £5. 4CX250B new £25. MW/LW car radio £5. Roller blind new £5. Tel Mick, Milton Keynes 316052.

Wanted Eddystone 888 or similar RX for SWL. Non worker considered. For sale tech TE20D RF SIG GEN £15. Contact A. Dunsmore 21 East Croft Ratho Mid-Lothian.

Exchange Hitachi video disc player with films Time Bandits, Kramer Vs Kramer, Poltergeist etc. Little used. Exchange for FRG7 or 2mtr hand held, or good oscilloscope. Steele, Mayberry, Chilboton, Stockbridge, Hants.

Tandy realistic DX200 HF receiver hardly used £50. Also realistic scanner PRO2008 not working £15 buyers collect. 061 477 6889 Stockport.

Bellhowell 636 16mm sound projector, exchange for 2 meter transceiver, or linear amp for FT227R. Or 16mm sound films. Projector value £150. G8BSK 290 Priory Road, St. Denys Southampton. SO2 1LS.

Standard C78 70cm FM rig £140. Belcom liner 2 144MHz SSB rig £70. Pye Cambridge VHS AM rig £20. Polaroid sun 600 camera £20. Wanted 70cm expander for FDK 750E or similar transverter. Will consider part exchange. G6MEN 0704 74792.

Amateur H.F. station. Base or mobile. Yaesu FT707 100 watts with matching power supply and A.T.U., FP707 and FC707. All boxed with manuals. Cost £700 new. Sell for £450. Carriage extra. G14PCQ Tel. Belfast (0232) 62533.

Early pre-1939 QSL cards still needed by collector. I buy 'silent key' clearances of old cards also early wireless books and documents. Send to G3BDQ, Whitefriars, Guestling, near Hastings for appraisal. All postal expenses repaid.

COMPLETE CB STATION. Comprising Binatone "Breakerphone" 40 channel rig, 3 Amp mains psu, mobile mag-mount aerial, home-base aerial, and SWR meter. £45. Phone 01-889 8843 after 6p.m.

Motorola HT220 RB2UHF xtals £50.00. Tel 025 481 3182.

Yaesu FT200 100 watt H.F. transceiver, perfect condition with desk mike £220 o.n.o.

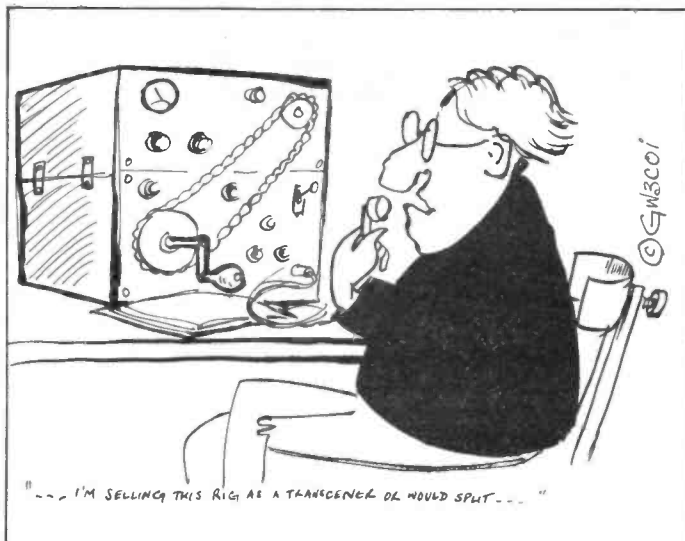

Realistic DX300 digital communications receiver £120 o.n.o. **Trio 2300** portable two metre F.M. transceiver with nicads charger and power supply £125 Moss G4WBK. Phone Sheffield 488564 evenings.

FR7700 + ATU + 144/2mm £250 + P **SX200N U/HOT** £220 + P two radio control tanks one control system £35 + P. Ultrasonic alarm system + keyboard £50 + PCB base station FM by G/Electric. £60 + P. **Multimeter** £10 + P. **Micrometers** eng/metre £12.75 + P each. **Tr30** port. Multiband 27 to 175MHz. **20A PSU** £35. 0473 85526.

Wanted copy or loan of circuit for Yaesu FRDX400 receiver, also need in any condition BC221 or LM freq meter, Vespa TX, back issues QST, CQ Ham. Radio, magazines octal o miniature valves W.H.Y. Ian G3YRQ QTHR (0942, 679948).

ST5/MCD and Creed 444 perfect working order must sell as wife don't like noise £135 phone 01 743 8352 anytime also Atari 48K 400 with recorder £150.

Wanted cavity wvometer to cover 2mts to over 2500MHz. P. Sergeant 6 Gurney Close, Costessey, Norwich (0603) 747782.

Wanted CCT diagrams and data on Airmec wave analyser 248A and 853 also B.T.H. Rotabalance type 38 reasonable price paid. Gretory The Well House, The Downs, Herne Bay. CT6-6JP. Phone 02273 4774.

Wanted Mullard Ferrite rins type FX1593. Small quantity urgently required. R. Sharp, Hope Hall, Prince Of Wales Road, University of Exeter, Exeter, Devon.

Wanted; wanted; RTTY program or EPROM and interface for Acorn Atom (surely not that obsolete?) Also for sale: confidential frequency list was £8.95 new only £5 including postage (unused). G1BNE Luton 33885.

Exchange. FT208 plus Armstrong stereo. Amplifier for Standard C58 2m multimode. Stephen Keen Telephone 01-995-7339.

For sale: Heathkit solid state dip meter HD1250 £30 plus postage cost. G3PTD 47 Newstead Road, Urmston, Manchester 747 6201.

Yaesu FRV7700 model F converter little used under guarantee £55 ono wanted FT290R Thompson Leitholm, Tunstead Rd Hoveton, Horwich Tel Wroxham 2109.

Intending beginner to your hobby offers £300 of Trix-twin 00 gauge model railway in best condition for beginners type receiver with instructions advice and associated equipment - Jack McMillan, 30 Drumbrae Walk, Edinburgh EH4 8DQ.

RTTY rectifier 66B 160-80+80 A.C. input 240 tapped £15 rectifier 26B 80+80 £10 low pass filter 4B £3. T.G. unit £2. Telephone Poole Dorset (0202) 707013.

Wanted handbook for H.R.O. receiver. Model 5T. Will pay for photocopy. Tel. Galashiels, 2355. Scotland. Or write to Keith Wintrup 1 Wilderburn Galashiels, Scotland.

Unwanted purchases unused. Tonna 21EL.ATV antenna. 70cm mast head pre-amplifier fortotop TVC 435/40 ATV up-converter. Mains H.T. transformer and box used Ex-TV valves. £50 the lot. C.M. Aubrey 01-370 3992.

Modems Racal 2400/1200 B.P.S. B.T. approved G.W.O. £40 pair or £25 each. ZX81 case & keyboard - never used £2.50. **Mains filter** prevents spikes crashing your computer ideal for ZX81 or radio gear. Uncased £2.50. Phone G4PEY Horsham (0403) 69835.

Need information signal gen. CT2.18 RF section. Valve voltmeter AS576 and how to remove SM drive from HRO dial. Presence of grub screw is noted! Will reimburse or swap old valves. Jim Knox 051 336 1907 after 6pm.

Sharp MZ80K. Green screen. 48k memory. Books and newsletters. RTTY, QRA, callbook programs plus games £225 01-607 1211 evenings.

Sale NEC PC8000 Mucro Z80 64K RGB port, cassette port NBASIC, RS232C port centronics parallel port etc. also PC8023BC printer 120cps, + proportional spacing + graphics tc. £390 ono will split/or exchange FT780 or similar. Ring 0734 863881 after 7.00pm G6VRQ.

TX90 RGB PCB built and working £12.50 tel 0202 894546.

NATIONAL PANASONIC DR28 receiver, Battery/mains, FM long medium, plus three SW bands 10 to 90 metres double conversion, digital readout, S-meter, BFO, £100 o.n.o. 01-959 7715.

Wanted American D.A.T.A. books digital I.C.S. linear I.C.S. recent edition. Wanted Tektronix I.A.I. plug in. Wanted spares for Collins 75S-1 32S-1 equipment. Telephone Dunstable (0582) 62621.

Free Readers' ADS!

Buy, sell or exchange your gear through our free service to readers

CONDITIONS

1. These advertisements are offered as a free service to readers who are not engaged in buying or selling the same equipment or services on a commercial basis. Readers who are should contact our advertising department who will be pleased to help.

2. Advertisements will be inserted as and when space becomes available.

3. The insertion of advertisements will be on a first-come, first-served basis, subject to condition (2). As a result, it will not be possible to guarantee the insertion of a particular advertisement into any particular issue of the magazine.

4. Readers should either write out their advertisement in BLOCK CAPITALS or type it, underlining any words that are to appear in bold.

5. The magazine cannot accept any responsibility for printers' errors in the advertisements; however, we will do our best to ensure that legibly written advertisements are reproduced correctly. In the event of a gross error, at the Editor's discretion, a corrected version of the advertisement will be printed (at the advertiser's request) at the earliest issue in which space is available.

6. The magazine or its publishers will not accept responsibility for the contents of the advertisements, and by acceptance of these conditions,

the advertiser undertakes to indemnify the publisher against any legal action arising out of the contents of the advertisement.

7. The magazine reserves the right to refuse to accept or to delete sections of advertisements where this is judged necessary.

8. Advertisements are accepted in good faith; however, the publisher cannot be held responsible for any untruths or misrepresentations in the advertisement, nor for the activities of advertisers or respondents.

9. Advertisers must fill in their names, addresses and (if available) telephone number in the space provided, and sign the form to indicate acceptance of these conditions (forms returned without a signature will not be used).

10. All that is to be reproduced in the advertisement should be entered into the space provided on the form printed in the magazine – note that a **photocopy is not acceptable**. All advertisements must give either a telephone number and/or address for respondents to contact, and this must be included in the wording of the advertisement.

11. Advertisements must be 40 words or less in length (telephone numbers normally count as two words, exchange or exchange code plus number).

Name

Address

.....

.....

I accept the conditions above.

Signature

Send this form to: Free Readers' Ads, Ham Radio Today, 1 Golden Square, London WC2,

ENTER YOUR ADVERTISEMENT HERE:

EMPORIUM GUIDE

AVON

Booth Holdings Bath

6 GOLF CLUB LANE,
SALTFOURD,
BRISTOL
Tel: 02217 2402
Open: Tues-Sat 9am-9pm
Close Mondays

RING
557732
BRISTOL

Radio Communications
Amateur P.M.R. Marine

UPPINGTON
Tele-Radio *Imports Ltd*

12 1/2 PENNYWELL ROAD, BRISTOL, BS5 0TJ

NOTTINGHAMSHIRE

PHOTO ACOUSTICS LTD
Tel: 0908 610625

Trio, Yaesu, Icom, FOK, Tona,
Jaybeam, DRIWA, Wellz.
Instant credit, Barclaycard, Access
58 High St, Newport Pagnell

CHESHIRE



PARBOOTHAM & CO LTD

58-62 Lower Hillgate, Stockport
Tel. 061-480 4872 Open: Mon & Wed 9-6
late nights Tues & Fri 9-7pm. Sat 9-5.30.
Closed Thurs
Yaesu, Sommerkamp, Diawa, Jaybeam, Kenpro,
Weltz, Datong

DW ELECTRONICS G3X CF

Amateur Radio Supplies
71 Victoria Rd, Widnes
Tel: 051-420 2559
Open Mon-Sat 9-6 (closed Weds) Sun 9.30-12
We supply Yaesu, Trio, Kenwood, Tonna, Jaybeam,
Microwave Modules, Datongs etc

HAMPSHIRE

FARNBOROUGH COMMUNICATIONS

97 Osborne Rd, North Comp,
Farnborough. Tel. 0252-518009
Open: 6 days 10-6
Yaesu, Icom, FDKs, Mosley aerials, Jaybeams,
G Whips

CALBRESKO LTD

258 Fratton Road
Portsmouth
Tel. 0705 735003
Open 10.30am-6pm 6 days
Sunday by appointment
**COMMUNICATIONS EQUIPMENT
COMPONENTS, BOOKS, ACCESSORIES**



KENT

Thanet Electronics



143 Reculver Rd., Herne Bay
Tel. 02273-63859

Open: Mon-Fri 9-5.30
(Closed for lunch 1-2)

SCARAB SYSTEMS
AMATEUR RADIO SOFTWARE



STOCKISTS
29 Stafford Street, Gillingham
0634-570441

AMTRONICS (TONBRIDGE) G4 SYZ
THE AMATEUR RADIO SPECIALISTS IN KENT

IT'S AMATEUR RADIO
from **AMTRONICS**

8 Tollgate Buildings
Hadlow Road, Tonbridge, Kent
Tel: (0732) 361850

FDK, AZDEN, YAESU, JAYBEAM,
FORTOP, DATONG, etc.

LANCASHIRE

**HOLDINGS/AMATEUR ELECTRONICS
NORTH WEST**

Full range of T.E.T. & YAESU + J BEAM,
DRAE, DATONE, etc. etc.
Consult G3LLL.
15 mins junct. 31 M6. Free parking
45 Johnston Road, Blackburn
Tel: (0254) 59595
Closed Thursday

**ISHERWOODS
ELECTRONICS**

Hozler Street, Blackburn
Tel. 0254-57816
Open: Mon-Fri 9-5, Sat 10-1
An Aladdin's Cave of Components

LEICESTERSHIRE

**ELLIOTT
ELECTRONICS**
FOR THE RADIO ENTHUSIAST

28-28 BRAUNSTON GATE,
LEICESTER. TEL: 553293

Open: Mon-Sat 9.00am to 5.30pm



W. MIDLANDS

DEWSBURY ELECTRONICS

176 Lower High St, STOURBRIDGE
Tel: (0384) 390063

Open: 9.30-5.15. Closed Thurs. & Sun.
ACCESS/BARCLAYCARD



**HEWARD'S HOME
STORES LTD.** (Est. 1963)

822/4 Kingstanding Rd., Birmingham
B44 9RT. Tel. 021-354 2083
G4RJM with 38 years in The Radio Trade
Ham Equipment urgently wanted!
Open: Mon-Sat 9-6

Technical
enquiries
G4STG

NEW IDEA LTD
133 Flaxley Road,
Stechford, Birmingham

Stockists of Yaesu, Trio, Kenwood,
Totauko, Tonna Antennas, Bentex
Full servicing repairs on all makes of
amateur radio. Open Mon-Sat. 10am-7pm,
Sundays, 10am-1pm.
Tel: 021-784 3129

SALES
G4SOV

**THE CENTRE
(BIRMINGHAM)**

584 Hagley Road West
Oldbury, Warley B68 0BS
021-421 8201 021-550 9324
Opening hours: 9.30-5.30 Tues-Sat.
Late nights Thursday and Friday
For all your communication requirements

GREATER MANCHESTER

BETA COMM

231 Chorley Rd., Swinton,
Greater Manchester.
Tel: 061-793-1010
Open: 7 days a week
TRIO, YAESU, ICOM, GWHIP

NORFOLK

SPANNER CITY CB CENTRE

Open 6 days
9am-6pm

Parkside Garage
Thursford
Fakenham
Tel: Thursford
402

Grandstand
LA 83
27 to 934 MHz
TRANSVERTER

EMPORIUM GUIDE

NORFOLK

Eastern Communications
 36 Cattle Market Street
NORWICH
(0603)667189
 OPEN: MON - SAT 10.00am - 5.00pm
 MAIL ORDER  ACCESS: BANGLAYMO

D.P. HOBBS (Norwich) Ltd
 13 St. Benedicts Street, Norwich
 Tel: 615786
 Open Mon-Sat 9-5.30
 Closed Thurs
 Stockists of:
 YAESU, FDK, ICOM, JAYBEAM
 & Electronic Component Specialists

NOTTINGHAMSHIRE

R.A.S. (NOTTINGHAM)
 P. Owen G8UUS
 3 FARNDON GREEN, WOLLATON PARK
 NOTTINGHAM: TEL: 0602 280267
 Open: Tues-Fri 10-5.30, Sat 9-5
 YAESU, FDK, ICOM, TONNA
 HALBAR: WELZ: ANTENNAS & OWN GW5 H.F.

SP ELECTRONICS
 48 Limby Rd
 Huckhall, Nottingham
 Tel: (0602) 640377
 open Monday-Saturday
 8.30-5.30

SCOTLAND

AXDON
 32 Atholl Street, Perth
 Tel. 0738-23753. Open: 6 days
 ICOM, TONA, TONO, RSGB Books, Maps &
 log books. Full range of components
 Mail order available — send for price list.

JAYCEE ELECTRONICS
 JOHN GM30PW
 20 Woodside Way, Glenrothes, Fife KY7 5DF
 Tel: 0592 756962
 Open: Tues-Sat 9-5
 Quality secondhand equipment in stock. Full range of TRIO
 goodies. Jaybeam — Microwave Modules — LAR.

SOMERSET



G6HKT **AVCOMM LTD** G8KVG
 25 Northoad Street,
 Glastonbury
 Tel: 0458-33145
 Open 9.30-5.30. Closed Wed

SUSSEX

SOUTHDOWN **RADIO** SUPPLIES **40 TERMINUS RD EASTBOURNE** (opp. Railway Stn.)
 Tel: (0323) 639351
 Open: Mon-Sat 10-6 (Closed Tues)
 Stockists of: Yaesu, Trio, Tonna, FDK etc +
 secondhand and ex-Government equipment in
 stock

TO BOOK THIS
 SPACE — PHONE
ASP CLASSIFIED
 01-437 0699

SURREY

GUILDFORD COMMUNICATIONS
 34 Aldershot Rd., Guildford
 Open Mon-Fri 8am-6.30pm
 Sat 8am-5.30pm
 **Secondhand wanted**
 
 FDC ASDEN
 TRIO T075UK4

YORKSHIRE

4 Cross Church St, Huddersfield **Tel: 0484 20774**
 Open: 6 days 9-5.30.
 Closed Weds. Thurs 9am-8pm
 G4MH Mini Beam
 'Always a good selection of new & 2nd hand equipment in stock'
Amateur Radio Shop

DISCOVER THE WORLD WITH **AMATEUR RADIO** FROM
 Sales 27 Cookridge Street Leeds LS2 3AG
 LEEDS 452657 **OPEN MON-SAT**
 the PROFESSIONALS! 9am - 5pm
TRIO ICOM YAESU
 LEEDS AMATEUR RADIO MAIL ORDER & SERVICE DEPT **OPEN MON-FRI**
 60 GREEN ROAD MEANWOOD LEEDS LS6 4JP TEL 782224 8:30am - 5pm
 BRITISH MADE  **LAR PRODUCTS**

TELECOM
 6 New Street, Barnsley
 South Yorkshire
 Tel (0226) 5031
 Specialists in Yaesu, Icom
 and So-Kamp

TYNE & WEAR

Approved Dealer **ALYNTRONICS**

 129 Chillingham Rd, Newcastle-upon-Tyne
 Tel: 0632 761002
 Open: Tues-Sat 10am-6pm

Please include my business details in the
 next available issue of Ham Radio Today

Only £15.00 per insertion, call us
 for series discounts on 01-437 0699

Business Name:

Address:

.....

Tel. No:

Open Hrs:

Contact (Office Use Only):

Post to: Emporium Guide, Ham Radio Today,
 1 Golden Square, London W1.

Lineage:
 30p per word (minimum 15 words)
Semi Display: (minimum 2 cms)
 £6.00 per single column centimetre
 Ring for information on series bookings/discounts
 All advertisements in this section must be prepaid.
 Advertisements are accepted subject to the terms and conditions printed on the advertisement rate card (available on request)

01-437 0699
EXT 212
 Send your requirements to:
 Debbie Miller
 ASP Ltd.,
 1 Golden Square,
 London W1

SOFTWARE APPLICATIONS

SCARAB SYSTEMS

39 Stafford Street
 Gillingham
 Kent ME7 5EN
 Tel. (0634) 570441



RTTY PROGRAMS for ZX81, SPECTRUM, VIC-20 and DRAGON 32 — as these programs come in various packages, please write for details.
BBC £9.20
PET £7.50
 Morse tutor programs at £5 each for SPECTRUM, BBC, DRAGON 32, TRS80. More BBC programs CWQSO complete RX/TX program £7.50.
 Multifile — a versatile filing system £10.25.
 Teletex 21 page video magazine £15.

All prices include VAT and postage. Write for further details of these and other programs.

WANTED. Amateur radio, technical and business software for all popular home micros.

RTTY

RTTY TERMINAL BOARDS. TTL output for computer £35 incl. and for teleprinter £39 incl. All boards come completely wired and tested with FSK and AFSK. S.A.E. for details to B. Brookes Electronics, 2 Leicester Street, Norwich. Tel: (0603) 24573.

RTTY for Spectrum/ZX81. 26 memories, split screen, buffered keyboard, auto TX/RX, P.C.B.'s, kits, RTTY/CW terminal units. For details SAE to G4MJC — G4FDW, 3 Aylesbury Ave, Eastbourne.

COURSES

COURSES - RADIO AMATEURS EXAMINATION City & Guilds. Pass this important examination and obtain your licence, with any RRC Home Study Course. For details of this and other courses (GCE, professional examination, etc.) write or phone — THE RAPID RESULTS COLLEGE, Dept. JN2, Tuition House, London SW19 4DS. Tel: 01-947 7272 (9am-5pm) or use our 24 hr Recordacall Service: 01-946 1102 quoting Dept. JN2.

NEW!! Scientifically prepared five-day courses to get you through the R.A.E. examination: 01-346-8597.

NOW AVAILABLE: 'Questions & Answers' the self test manual for R.A.E. Students. £2.75 pp. Peter Bubb (Tuition), 58 Greenacres, Bath BA1 4NR. SAE for details.

COMPUTER RTTY

Use your micro to transmit and receive RTTY
 PL1 - PLL RTTY Terminal unit
 170Hz Shift Transmit & receive
 Also handles ASCII TTL in/out
 Kit £13.50 Built £17.50
 FP1 - Two channel active filter & PSU for PL1. Requires 15/0/15V AC.
 Kit £7.25 Built £10.75

Software for the DRAGON 32
 RTTY send-recv program by G4BMK
 Split screen receive - Type ahead buffer. QSO review & many other features.

Cassette £12.00
 ROM Cartridge £21.00

MORSE transceive program up to 150 wpm!
 Cassette £9.75 Cartridge £18.50
 Hardware interface also available.

Please add postage to all orders - U.K. 60p Overseas £1.50
 Other hardware available for the DRAGON 32

For further details & full price list please send LARGE S.A.E. to:-

PNP COMMUNICATIONS
 82 Lawes Avenue, Newhaven
 East Sussex BN9 9SB
 P. Simmons G3XUS
 Tel: (0273) 514465
 Callers by appointment only please.

SOFTWARE EDUCATIONAL

Pass RAE and MORSE with your micro

RAE MATHS tests you completely on all RAE formulae and gives all the practice you need to become perfect in this vital part of the exam.
 Don't let your maths make you fail. Use this program to PASS.

MORSE TUTOR. Absolute beginner to any test standard. Introduces characters in stages for faster, easier learning. Completely flexible amount and speed from 1 to 30wpm+. Random letters, figures, words or typed plain language.
 You won't find a better program.

QTH for the licensed amateur
QTH LOCATOR. Enter locator or lat & long of anywhere in the world and get distance, beam heading, VHF contest points and total. Saves you hours working out your score.

All programs are menu-driven, easy to use and come with full instructions.

For Commodore 64, Spectrum or ZX81-16k
 Morse tutor also for Dragon and VIC20

All tapes only £6 each inc p&p from
 Richard Willmot, GW3RR1
 Fron, Caernarfon, Gwynedd, LL54 7RF
 Tel: 0286 881886

DOUBLE H SOFTWARE

Complete Morse Tutor for 48K Spectrum

MORSE READER

Key morse to show Spectrum and see the plain English shown on your T.V.

READER TAPE (Caps Shift key) £8.50

READER TAPE with Interface to link morse key to your Spectrum £21.50

SPECIAL READER TAPE to link your morse to the ZX Interface 2 £11.00

MORSE SENDER

Sends morse code sentences, words, letter/No. groups and own messages.

1000 word dictionary. 1-99wpm **£5.50**

Complete Package 1 - Morse Sender Reader and Interface **£26.00**

Complete Package 2 - for users of ZX Interface 2 **£16.00**

1 Woodridge Close, Hawards Heath West Sussex RH16 3EP

WISH TO ADVERTISE? THEN PHONE DEBBIE 01-437 0699

EQUIPMENT

ALPHA KEYS

Precision engineered keys for the connoisseur. Twin or Single paddle, and now the new "pump handle". One of the lightest and smoothest movement ever.

CAVITY WAVEMETERS

For the UHF/VHF operator, one wave-meter to cover 144 mhz to over 2500 mhz. Can measure rf as low as 50 mill watts with suitable meter.

COAXIAL RELAY KITS

The cavity block is pre machined to take either BNC or N type sockets. Two types of cavity available, Alum. type for HF, Brass for the higher frequency.

Send large SAE for more information to:

Paul Sergeant, G4ONF
 6 Gurney Close, Costessey
 Norwich NR5 0HB
 Tel: (0603) 747782

TO BOOK THIS SPACE Phone Debbie 01-437 0699

TRANSMITTERS RECEIVERS ETC.

All frequencies, well known makes, ICOM, YAESU, MUSEN, FDK, AZDEN, LOWE, STANDARD, etc. etc. Power supplies, wave-meters, test meters, frequency counters, Welz SWR and Power meters. Microwave modules, linear amps, RTTY etc. Quality equipment for amateur, PMR and Marine use. Aerials, Co-ax cable, plugs. See our advert under Emporium Guide. £1000 INSTANT HP available and ACCESS - Booth Holdings Bath, 6 Golf Club Lane, Salford, Bristol BS183AA. Tel (02217) 2402. Staff includes G3N XW, G3XOD, G8DPH.

HIGH QUALITY CABLES

H100 50 ohm SUPER LOW
 LOSS 80p per M (post 5p per m)
 Discounts:
 50m less 10% 100m 20%
 UR67 ... 50 ohm LOW
 LOSS 60p per m (post 5p p/m)
 UR43 ... 50 ohm
 stranded 23p per m (post 3 p p/m)
 UR76 ... 50 ohm
 stranded 23p per m (post 3 p p/m)
 UR70 ... 75 ohm
 Coax 23p per m (post 3p p/m)
 75 ohm twin
 Feeder 18p per m (post 2p p/m)
 300 ohm ribbon
 Twine 12p per m (post 2p p/m)
 14 swg HD Copper
 As wire 20p per m (post 2 1/2 p p/m)
 STRONG PVC Covered Cu
 As wire 6p per m (post 2 1/2 p p/m)

SAE FOR FULL LISTS

W. H. WESTLAKE
 G8MWW
 Clawton, Holsworthy
 Devon

NEW PRODUCT! Elbug no moving parts. Electronic Morserey. £27.50, or S.A.E. to El-Tronics, P.O. Box 393, Chelmsford, Essex.

BETA COMM

ALL AMATEUR AND CB NEEDS

ICOM, TRIO and YAESU, CYBERNET, HARBARD and UNIDEN. TAGRA, G.WHIP, HOXIN, MICRODOT RTTY, SWR & power meters. Receivers & linears. Plus all other accessories.

Aerial Fitting Service

231 Chorley Rd., Swinton, Greater Manchester. Tel: 061-793-1010

AERIALS

HARD DRAWN COPPER AERIAL WIRE

140c 14 swg £6.90
50 metres 60 swg £5.90

GR5V TYPE AERIALS
½ size £12
full size £13.95

All items post paid
1 Orchard Way, Fontwell
Arundel, Sussex BN18 0SH

CERAMIC TAG STRIP (Jackson) 15 Tags 10 for £1. 6 Way Stand off terminals 10 for 75p. List 15p + S.A.E. Durrant Components, 9 St Marys St, Shrewsbury.

2 METER SSM from £119, FM from £150.00. Full range ICOM, FT77 £460. OM Linears from £16. 2M from £39.50. 70cm transceivers from £195. Guildford Communications 0483 574434.

FOR SALE

2 METER SSB Transceivers from £138. Full range including ICOM, TRIO, YAESU, ASDEN, ETC. Credit facilities. Guilford CB, 0483 574434

FOR SALE. Yaesu FT707, Power supply FP707, Trio antenna tuner, Yaesu desk mike, mobile head mike with scan, mobile mounting bracket. £500 o.n.o.

YAESU 7700 receivers £295. FT290R £250 plus new and used 2M CB GLAR. FM CB 0634 400179. Visa, Access.

AMATEUR EQUIPMENT bought, sold, exchanged. Tel: 04024/55733; or send S.A.E. for current list. G3RCQ 65 Cecil Avenue, Hornchurch, Essex.

YAESU FT707 HF transceiver. Unused £400. Possible px on car or m/cycle. Telephone So'ton 788787.

CARDS STICKERS & BADGES

RADIO CAROLINE SOUVENIRS. Send S.A.E. for all the Caroline News in our magazine. Send £3.00 subscription to: Caroline Movement, Dept. B, BCM-BFRM, London WC1N 3XX.

QUALITY Personalized QSL's cards any quantity from £11.00 SAE, Nutley Press, 11 Barons Way, Woodhatch Reigate, Surrey. Tel: Redhill 71023.

HIGH CLASS QSL Cards. Fast delivery. S.A.E. for samples and prices to: J.S.Coates, 57 Worrall Street, Morley, Leeds LS27 0PJ.

PERSONALISED QSLs, Amateur, or CB, 1000 £13.75. S.A.S.E. for samples. H. Hope, 89 Derwent Street, Blackhill, Consett, DH8 8LT.

RUBBER STAMPS from £2.20, foil printed business/club membership cards from £5 per 100. SAE for catalogue. Plan Centre, Bromyard Rd., Industrial Estate, Ledbury HR8.

DO YOU SPECIALISE IN HAM EQUIPMENT etc.

Want to sell it?

Phone Debbie

01-437 0699

HAM RADIO TODAY CLASSIFIED ADVERTISEMENT — ORDER FORM

**IF YOU HAVE SOMETHING TO SELL
DON'T TURN THE PAGE — TURN TO US!**

RATES OF CHARGE: 30p per word (minimum 15 words)

Advertise nationally in these columns to over 60,000 readers for only 30p per word (minimum charge 15 words). Simply print your message in the coupon and send with your cheque or postal order made payable to Argus Specialist Publications Ltd. to:

CLASSIFIED DEPT. HAM RADIO TODAY
145 Charing Cross Rd, London WC2H 0EE.
Tel. 01-437 0699

Please indicate classification required.

Name

Address

.

.

Tel.No.(Day)

Please place my advert in Ham Radio Today for months. Please indicate number of insertions required.



OR Debit my Access/Barclaycard
(Delete as necessary)



--	--	--	--	--	--	--	--	--	--	--	--	--	--	--	--	--	--	--	--

Northern Amateur Radio Societies Association

The Association is holding its 22nd Annual Radio/Electronics Exhibiton at Pontins Holiday Village, Ainsdale, Southport on Saturday 7th April and Sunday 8th April 1984 opening at 11.00 a.m. each day.

It will include interclub quiz, construction contest, grad raffle, R.S.G.B. book stall, amateur computers, N.A.R.S.A. stands and trophy, a demonstration station and Trade Stands featuring all types of radio/electronic equipment. Bring-Buy Stall.

Admission will be £1 per day but lots of 20 or more tickets may be booked in advance from Mike Bainbridge G4GSY, 7 Rothbury Close, Bury BL8 2TT at a 20% discount by sending the appropriate cash and s.a.e.

Chalets may be booked direct from Pontins(0704) 77165 and range from £11 + VAT (* persons) to £31 + VAT (6 persons).

Bar and Restaurant facilities will be available during the day while the Restaurant will be open for breakfasts and from 1700 to 1900 on the Saturday evening. There will be evening entertainment limited by the capacity of the entertainment hall. Children's play areas will be available during the days.

Car parking will be available at a small charge but please follow all instructions of attendants to avoid congestion.

Talk in will be available on S22 or other available simplex channels.

Come along and enjoy yourself at this family weekend exhibition and make it a great success.



The Key Element

SSB clarity starts at the microphone...

Heil Sound, the company that pioneered proper audio equalization techniques for major performing groups and communicators, invites you to be part of one of the biggest advancements in Single Sideband transmission since the "Donald Duck" vs. AM days. If you are not satisfied with the "sound of your station" - It's no wonder - most "communications" microphones used today were designed for "public address" use, not for sophisticated SSB techniques.

No one microphone can be all things to Hams, so this new

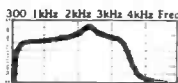

HC-3 element and HM-5 mic were developed *only* for maximum clarity on SSB transmissions. The response of this tiny ceramic element rolls off sharply under 350 Hz and above 3100 Hz with a peak at 2400 Hz for high articulation in the speech range. Hams who care about maximum results in getting over, around and through DX pile-ups now have another weapon in their arsenal... The Key Element! You can easily install this small, advanced HC-3 element, with its broad-range impedance-matching characteristics, into virtually any microphone case you own, or purchase the custom HM-5 with HC-3 installed.

All prices include VAT and Carriage, E. + OE. For further information, or to order the HC-3 cartridge element at £17.99, the HM-5 SSB microphone at £49.95 or the EQ-200 at £45.95 contact our Sole European Distributor, Amcomm Services Ltd., 194 Northolt Road, South Harrow, Middlesex or Telephone 01-422 9585.

"... Have not yet heard an FT-101 sound any better than when used with The Key Element..." - Paul, G3AWP

"... I now have a comfortable feeling that my audio is better than the rig was originally capable of..." - Ken, M9UBS

"... Thank you for the fine report: all reports to date have been excellent..." - Lee, WISE

For those who desire the ultimate audio into and out of your transmitter/transceiver, consider the ideal combination of the Heil EQ-200 audio equalizer and HM-5 microphone.



Hearing Is Believing...

WOOD & DOUGLAS

HAVE YOU an IC4E?

Would you like 10W output?

Then you need our **NEW 70LIN10 UHF Linear**

This module is based on our popular 70LIN3/10E pcb which incorporates not only a well designed linear amplifier stage but also a temperature compensated bias network and full r.f. changeover facility. The PIN diode circuitry allows a straight through path during receive periods or when the power supply is disconnected making the unit failsafe to accidental damage. If you wish to use it for SSB transmissions the internal 'hang-time' will be advantageous as will the hard switching capability. Just apply 1.5W of drive for 10W output or 1W for typically 7W output!

The board is available as a pcb kit or assembled tested module without external hardware although boxes and heatsinks are available if desired.

INTRODUCTORY PRICE Kit: £32.50 Assembled: £44.25

HAVE YOU SEEN OUR PACKAGE OFFERS?

	Kit
1. 50mW TV Transmit (70FM05T4 + TVM1 + BPF433)	30.00
2. 50mW TV Transceiver (As 1 above plus TVUP2 + PSI 433)	50.00
3. 10W TV Transmit (As 1 above plus 70FM10 + BDX35)	50.00
4. 10W TV Transceiver (As 2 above plus 70FM10 + BDX35)	70.00
5. 70cms 500mW FM Transceiver (70T4 + 70R5 + SSR1)	70.00
6. 70cms 10W FM Transceiver (As 5 above plus 70FM10)	90.00
7. Linear/Pre-amp 10W (144PA4/S + 144LIN10B)	36.00
8. Linear/Pre-amp 25W (144PA4/5 + 144LIN25B)	40.00
9. 70cms Synthesised 10W Transceiver (R5+SY+AX+MOD+SSR+70FM10)	120.00
10. 2M Synthesised 10W Transceiver (R5+SY+SY2T+SSR+144FM10)	100.00

Delivery of our products is usually from stock but due to the heavy demand we have experienced in past months please allow 28 days maximum. Please include 75p for postage and handling on your total order and an SAE with any written enquiries. Telephone orders are gladly accepted or try one of our many agents such as:-

ANNLEY TECHNICAL SERVICES
AIRCOM
DEWSBURY ELECTRONICS
J BIRKETT

Bristol 632622
Abergavenny 2566
Stourbridge 390063
Lincoln 20767

TRY A KIT WE KNOW YOU WILL ENJOY IT!

UNIT 13
YOUNGS INDUSTRIAL ESTATE
ALDERMASTON, READING RG7 4PQ
Tel: 07356 5324 Tx: 848702



CUT IT OUT!

A 'Western Which Report' about:-

ROTATORS

Various advertisers will naturally try to persuade you that their product is best (and we are no exception, of course!) but what we will not do is mislead you. So the following are FACTS taken from Manufacturers specifications on their products.

- Fact 1: Even small rotators will turn a fairly large antenna, what they will not do is KEEP IT STATIONARY under strong wind conditions. To do this requires good BRAKE TORQUE. this is measured in Kg. cms.
- Fact 2: Low voltage rotators (24v ac) require higher current. This causes a greater voltage loss along the cable than with a higher voltage motor unit. Cable voltage loss will reduce rotational torque.
- Fact 3: Some rotators use unbalanced braking. Under strong winds, this places an unbalanced stress on the casing of the motor unit and can cause it to fracture. Balanced braking is thus superior.

Position	Make	Model	Brake Torque kg cms	Cost per kg cm	Price £	Comment
1	Emoto	1102MXX	10,000	2.40p	240.35	75% better braking torque than HAM-4 and costs less
2	Emoto	1103MXX	10,000	2.46	246.10	
3	Emoto	1102MSAX	10,000	3.17	317.40	
4	Emoto	1103MSAX	10,000	3.20	320.95	
5	Western	WE-1145	1,000	4.00	39.99	92% better braking torque than CDE KR-40 and over £50 cheaper
6	Emoto	105TS	3,000	4.06	121.90	New model 50% better b torque than similarly priced Kenpro KR-200RC and Daiwa DR7500R
7	Emoto	502SAX	4,000	4.22	169.05	
8	Daiwa	DR7600R	4,000	4.25	170.00	
9	Kenpro	KR600RC	4,000	4.45	178.00	
10	CDE	HAM 4	5,700	4.54	258.75	Max single brake. Emoto 1102/3 have twin balanced braking
11	Daiwa	DR7500R	2,000	6.00	120.00	188% better b torque than similarly priced KR40
12	Western	FU-400	1,500	6.13	92.00	63% better b torque than CDE CD-45 and £41.40 cheaper
13	Emoto	103SAX	1,500	6.36	95.45	
14	Kenpro	KR400RC	2,000	6.37	127.50	
15	Kenpro	KR250	600	7.50	45.00	
16	CDE	Big Talk BT1	920	10.00		
17	CDE	AR22XL	520	13.00		
18	CDE	CD45	920	14.87	136.85	
19	CDE	AR40	520	17.47	90.85	

These figures may have changed. As no current prices were available, information taken from last available

From this you will see that the WE-1145 rotator is a very good buy! We even think we are selling it too cheaply! And here's another FACT. When we used to sell another brand of rotator, we had to increase our stock of spares to over £1,200 to ensure that we had adequate spares! We have been able to reduce that stock by 90% by selling Emoto due to their reliability. You don't believe us? Then next time you go to an exhibition just take a look at the Emoto range and then the other brands. See which ones have 'grotty' little screws underneath to which you have to try and attach the multi-way cable! See which have decent input plugs. See which have stainless steel hardware and then come back and tell us! (We told you so!)

BEST BUYS

FOR: VHF Antennas: WE-1145. Smaller HF. Ant: FU-400 103SAX or 105TS. Larger HF. Ant: Emoto 1102/3.

SO CONSULT THE EXPERTS! WE HANDLE ONLY "FIT AND FORGET" QUALITY ROTATORS.

It's Western for KENWOOD and YAESU

Since we first introduced the "Yaesu Musen" brand name to the UK market in 1970 and more recently the "Kenwood" name for Amateur Radio equipment, you can buy with confidence where experience counts. We maintain links with the factories for spares though we maintain stocks also. We also have extensively equipped service facilities with extensive (and expensive) test equipment. It's gratifying to hear that more and more discerning prospective customers object to the "knocking and false rumours" put around by our competitors. Remember, Kenwood is THE brand name throughout the world. It's only for UK that Trio is used. At WESTERN we are not part of any illegal price ring and we are pleased to supply KENWOOD brand equipment known and recognised throughout the world.

"W.E." will not be under-cut! Prices forced down by "W.E." from the KENWOOD STABLE FOR . . . the discerning DX-OPERATOR . . . OR . . . DX-SWL NOW ONLY £1099 for the TS-930s . . . and . . . £279 for R-1000



Since at WESTERN we sell both Yaesu and Kenwood, we do not try to push a prospective purchaser into a particular brand of equipment . . . we have no "axe to grind" one way or the other.

Our MD (He's spoilt! He just takes home what he fancies for a trial evaluation) thought he'd try the top of ranges FT-1 and TS-930S. He promptly brought the FT-1 back to the stock room. Then he took the FT-102. He hitched the FT-102 and TS930S up together but brought the FT-102 back. Said he's got too old and lazy to bother with controls like PA Tune, PA Load Pre-selection tuning when the TS-930S does the same job with less knobs. The Noise Blanker really cuts old "Woody Woodpecker" down to size! UA's will have to find something new to annoy a TS-930S owner.

How often have you found a rare DX-station only to discover he has a good pile-up too! With the R.30 you just press "M In" and store his frequency in the memory and carry on tuning round or QSO elsewhere. Then to come back smack onto the rare DX you just select Memory instead of the VFO, and up pops your DX station. Since there are 8 memory channels there are more than enough for anyone.

The R-1000 is an uncluttered simple to use and excellent general coverage receiver. It brings the world to your fingertips in seconds. With its PLL synthesised receiver you get excellent stability and accuracy.

FEATURES ARE:

- Covers 200kHz to 300MHz continuously
- 30 1MHz bands
- Noise Blanker
- Terminal for external tape recorder

- Built-in 12 hr quartz digital clock with auto-timer facility to switch 'On' at pre-determined time
- 'S' meter and dimmer control to panel lighting
- Built-in 4" speaker
- Built-in attenuator to prevent overloading
- Digital readout to 1kHz and analogue dial

Special Bargain of the Month. Yaesu FT-980 £999 only. Special Guarantee

THANK YOU GENTLEMEN!
ALL SOLD ON ONE DAY RECENTLY!

TS-530S Kenwood to Mr. S. of Fife
TS-530S Kenwood to Mr. S. of Liverpool

TS-930S Kenwood to Mr. F. of Ross-Shire
R-2000 Kenwood to Mr. W. of Grimsby

NEW LINE OF FILTERS

FILTERS DJOAV Carriage paid (send SAE for leaflet)

1554	HPY	High pass filter	£8.62	1558	LSY	Loud speaker 125 watt	£6.80
1555	HPM45	High pass module	£3.45	1559		220v/6A Mains twin toroid	£5.75
1556	HPY170	High pass	£8.62	1560		Plug extension	£1.15
1557	MTY	Braid breaker	£6.90	1561		ES-1 complete kit of cat. nos. 1554-61 inc.	£34.50

• ACCESS • BARCLAYCARD • H.P. ARRANGED • DINERS CLUB • PART EXCHANGE

Western Electronics (UK) Ltd

FAIRFIELD ESTATE, LOUTH, LINCS LN11 0JH
Tel: Louth (0507) 604955 Telex: 56121 WEST G

OPEN HOURS: 09.00-12.00; 13.00-17.00 Mon/Fri; Saturdays: By Appointment.

AGENT:

NORTHERN IRELAND
Tom Greer G14TGR
Norma Greer G14TBP
Tel: 023126645