

# EVERYDAY **ELECTRONICS**

APRIL 1990

INCORPORATING ELECTRONICS MONTHLY

£1.40

ENGINE EFFICIENCY METER  
**Drive in the Green!**

ENLARGER TIMER / EXPOSURE METER

DIGITAL EXPERIMENTER'S UNIT

DIODE DATA

FREE INSIDE! 32 page

**GREENWELD**  
1990 SPRING CATALOGUE SUPPLEMENT

ISSN 0262-3617



9 770262 361003

The Magazine for Electronic & Computer Projects



## BAKERS DOZEN PACKS

All packs are £1 each. Note the figure on the extreme left of the pack ref number and the next figure is the quantity of items in the pack, finally a short description.

- BD2 5 13A spurs provide a fused outlet to a ring main where devices such as a clock must not be switched off.
- BD9 2 6V 1A mains transformers upright mounting with fixing clamps.
- BD11 1 6 1/2in speaker cabinet ideal for extensions, takes our speaker. Ref BD137.
- BD13 12 30 watt reed switches, it's surprising what you can make with these—burglar alarms, secret switches, relay, etc., etc.
- BD22 2 25 watt loudspeaker two unit crossovers.
- BD30 2 Nidac constant current chargers adapt to charge almost any nicad battery.
- BD32 2 Humidity switches, as the air becomes damper the membrane stretches and operates a microswitch.
- BD42 5 13A rocker switch three tags so on/off, or change over with centre off.
- BD45 1 24hr time switch, ex-Electricity Board, automatically adjust for lengthening and shortening day. Original cost £40 each.
- BD49 5 Neon valves, with series resistor, these make good night lights.
- BD56 1 Mini uniselector, one use Is for an electric jigsaw puzzle, we give circuit diagram for this. One pulse into motor, moves switch through one pole.
- BD67 1 Suck or blow operated pressure switch, or it can be operated by any low pressure variation such as water level in water tanks.
- BD103A 1 6V 750mA power supply, nicely cased with mains input and 6V output leads.
- BD120 2 Stripper boards, each contains a 400V 2A bridge rectifier and 14 other diodes and rectifiers as well as dozens of condensers, etc.
- BD128 10 Very fine drills for pcb boards etc. Normal cost about 80p each.
- BD132 2 Plastic boxes approx 3in cube with square hole through top so ideal for interrupted beam switch.
- BD134 10 Motors for model aeroplanes, spin to start so needs no switch.
- BD139 6 Microphone inserts—magnetic 400 ohm also act as speakers.
- BD148 4 Reed relay kits, you get 16 reed switches and 4 coil sets with notes on making c/o relays and other gadgets.
- BD149 6 Safety cover for 13A sockets—prevent those inquisitive little fingers getting nasty shocks.
- BD180 6 Neon indicators in panel mounting holders with lens.
- BD193 6 5 amp 3 pin flush mounting sockets make a low cost disco panel.
- BD199 1 Mains solenoid, very powerful, has 1in pull or could push if modified.
- BD201 8 Keyboard switches—made for computers but have many other applications.
- BD211 1 Electric clock, mains operated, put this in a box and you need never be late.
- BD221 5 12V alarms, make a noise about as loud as a car horn. Slightly soiled but OK.
- BD242 2 6in x 4in speakers, 4 ohm made from Radiomobile so very good quality.
- BD252 1 Panostat, controls output of boiling ring from simmer up boil.
- BD259 50 Leads with push-on 1/4in tags—a must for hook-ups—mains connections etc.
- BD263 2 Oblong push switches for bell or chimes, these can mains up to 5 amps so could be foot switch if fitted into pattress.
- BD268 1 Mini 1 watt amp for record player. Will also change speed of record player motor.
- BD283 3 Mild steel boxes approx 3in x 3in x 1in deep—standard electrical.
- BD305 1 Tubular dynamic mic with optional table rest.
- BD400 4 Books, useful for beginners, describes amplifiers equipment and kit sets.
- BD653 2 Miniature driver transformers. Ref. LT44. 20k to 1k centre tapped.
- BD548 2 3.5V relays each with 2 pairs changeover contacts.
- BD667 2 4.7 µF non-polarised block capacitors, pcb mounting.

There are over 1,000 items in our Bakers Dozen List. If you want a complete copy please request this when ordering.

**TOASTERS** 2 slice toasters—may need slight attention. Only £3.00 each. Ref 3P84.

**PERSONAL STEREOS** Again customer returns but complete and with stereo head phones. A bargain at only £3.00 each. Our ref 3P83.

**MICROWAVE CONTROL PANEL** Mains operated, with touch switches. This unit has a 4 digit display with a built in clock and 2 relay outputs—one for power and one for pulsed power level. Could be used for all sorts of timer control applications. Only £6.00. Our ref 6P18.

**EQUIPMENT WALL MOUNT** It is a multi-adjustable metal bracket that could be used for mounting flood light, loudspeaker, TV camera, even a fan and on almost any sort of wall or ceiling even between wall and ceiling. The main fixing brackets rotate such that an inward or an outward corner can be accommodated. Front panel also tilts upward or downwards to a reasonable angle and can be easily removed separately for wiring. A very useful bracket. Regular price would be around £6 each. Our price only £3. Our ref 3P72. Or 2 for £5. Our ref 5P152.

**SUB-MIN TOGGLE SWITCH** Body size 8mm x 4mm x 7mm SBDT with chrome dolly fixing nuts. 3 for £1. Order ref BD649.

**COPPER CLAD PANEL** for making PCB. Size approx 12in long x 8 1/2in wide. Double sided on fibreglass middle which is quite thick (about 1/16in) so this would support quite heavy components and could even form a chassis to hold a mains transformer, etc. Price £1 each. Our ref BD683.

## POWERFUL IONISER

Generates approx. 10 times more IONS than the ET1 and similar circuits. Will refresh your home, office, workroom etc. Makes you feel better and work harder—a complete mains operated kit, case included. £12.50+£2 P.P. Our ref 12P51.

**REAL POWER AMPLIFIER** for your car, it has 150 watts output. Frequency response 20Hz to 20KHz and signal to noise ratio better than 60dB. Has built in short circuit protection and adjustable input level to suit your existing car stereo, so needs no pre-amp. Works into speakers ref. 30P7 described below. A real bargain at only £57.50. Order ref: 57P1.

**REAL POWER CAR SPEAKERS.** Stereo pair output 100W each. 4-Ohm impedance and consisting of 6 1/2" woofer, 2" mid range and 1" tweeter. Each set in a compact purpose built shelf mounting unit. Ideal to work with the amplifier described above. Price per pair £29.96. Order ref: 30P7.

**STEREO CAR SPEAKERS.** Not quite so powerful—70w per channel. 3" woofer, 2" mid range and 1" tweeter. Again, in a super purpose built shelf mounting unit. Price per pair: £27.95. Order ref: 28P1.

**VIDEO TAPES** These are three hour tapes of superior quality, made under licence from the famous JVC Company. Offered at only £3 each. Our ref 3P63. Or 5 for £11. Our ref 11P3. Or for the really big user 10 for £20. Our ref 20P20.



**ELECTRONIC SPACESHIP.** Sound and impact controlled, responds to claps and shouts and reverses when it hits anything. Kit with really detailed instructions. Ideal present for budding young electrician. A youngster should be able to assemble but you may have to help with the soldering of the components on the pcb. Complete kit £10. Our ref. 10P81

**12" HIGH RESOLUTION MONITOR** Amber screen, beautifully cased for free standing, needs only a 12v 1.5 amp supply. Technical data is on its way but we understand these are TTL input. Brand new in makers' cartons. Price: £22.00. Free delivery. Order ref: 25P10.

**14" COLOUR MONITOR** made by the American Display Tek Company. Uses high resolution tube made by the famous Japanese Toshiba company. Beautifully made unit. Intended for console mounting, but top and sides adequately covered by plated metal panels. Supplied with full technical spec. We have a limited number of these. All brand new still in makers' cartons. Price: £89 each plus £6 insured carriage. Order ref: 89P1.

**COMPOSITE VIDEO KITS** These convert composite video into separate H sync, V sync and video. Price £8.00. Our ref 8P39.

**BUSH RADIO MIDI SPEAKERS** Stereo pair. BASS reflex system, using a full range 4in driver of 40hms impedance. Mounted in very nicely made black fronted walnut finish cabinets. Cabinet size approx 8 1/2in wide, 14in high and 3 1/2in deep. Fitted with a good length of speaker flex and terminating with a normal audio plug. Price £5 the pair plus £1 post. Our ref 5P141.

**3 1/2in FLOPPY DRIVES** We still have two models in stock: Single sided, 80 track, by Chinon. This is in the manufacturers metal case with leads and IDC connectors. Price £40, reference 40P1. Also a double sided, 80 track, by NEC. This is uncased. Price £59.50, reference 80P2. Both are brand new. Insured delivery £3 on each or both.

**10 MEMORY PUSHBUTTON TELEPHONES** These are customer returns and "sold as seen". They are complete and may need slight attention. Price £6.00. Ref. 6P16 or 2 for £10.00. Ref. 10P77. BT approved.

**REMOTE CONTROL FOR YOUR COMPUTER** With this outfit you can be as much as 20 feet away as you will have a joystick that can transmit and a receiver to plug into and operate your computer and TV. This is also just right if you want to use it with a big screen TV. The joystick has two fire buttons and is of a really superior quality, with four suction cups for additional control and one handed play. Price £15 for the radio controlled pair. Our ref 15P27.

**ASTEC PSU.** Mains operated switch mode, so very compact. Outputs +12v 2.5A, +5v 6A, ±5v .5A, ±12v 5A. Size: 7 1/2in long x 4 1/4in wide x 2 1/4in high. Cased ready for use. Brand new. Normal price £30+, our price only £12.95. Order ref 13P2.

**VERY POWERFUL 12 VOLT MOTORS.** 1/2rd Horsepower. Made to drive the Sinclair C5 electric car but adaptable to power a go-kart, a mower, a rail car, model railway, etc. Brand new. Price £20 plus £2 postage. Our ref. 20P22.

### PHILIPS LASER

This is helium-neon and has a power rating of 2mW. Completely safe as long as you do not look directly into the beam when eye damage could result. Brand new, full spec. £35 plus £3 Insured delivery. Our ref. 35P1. Mains operated power supply for this tube gives 8kv striking and 1.25kv at 5mA running. Complete kit with case £15. As above for 12V battery. Also £15. Our ref 15P22.

**GEIGER COUNTER KIT** Includes PCB, loudspeaker, and all components to build a 9v battery operated geiger counter. Only £39. Our ref 39P1

**12V TO 220V INVERTER KIT** This kit will convert 12v DC to 220v AC. It will supply up to 130 watts by using a larger transformer. As supplied it will handle about 15 watts. Price is £12. Our ref 12P17.

**FULL RANGE OF COMPONENTS** at very keen prices are available from our associate company SCS COMPONENTS. You may already have their catalogue, if not request one and we will send it FOC with your goods.

**HIGH RESOLUTION MONITOR.** 9in black and white, used Philips tube M24306W. Made up in a lacquered frame and has open sides. Made for use with OPD computer but suitable for most others. Brand new. £16 plus £5 post. Our ref 16P1.

**12 VOLT BRUSHLESS FAN.** Japanese made. The popular square shape (4 1/2in x 4 1/2in x 1 1/4in). The electronically run fans not only consume very little current but also they do not cause interference as the brush type motors do. Ideal for cooling computers, etc., or for a caravan. £8 each. Our ref 8P26.

**MINI MONO AMP** on p.c.b. size 4" x 2" (app.) Fitted Volume control and a hole for a tone control should you require it. The amplifier has three transistors and we estimate the output to be 3W rms. More technical data will be included with the amp. Brand new, perfect condition, offered at the very low price of £1.15 each, or 13 for £12.00.



## J & N BULL ELECTRICAL

Dept. EE 250 PORTLAND ROAD, HOVE, BRIGHTON, SUSSEX BN3 5QT.

MAIL ORDER TERMS: Cash, PO or cheque with order. Monthly account orders accepted from schools and public companies. Please add £2.50 postage to orders. Access and B/Card orders accepted—minimum £5. Phone (0273) 734648 or 203500. Fax No. (0273) 23077.

## POPULAR ITEMS — MANY NEW THIS MONTH

**MAINS FAN** Snail Type construction. Brand new approx. 5" x 4". 60 watt silent motor. Only £4. Ref. 4P58.

**KEYBOARDS** Brand new, uncased with 80 keys. Only £2. Ref. 3P89.

**SINCLAIR C5 WHEELS** Set of four wheel complete with tyres and inner tubes, 2x16" and 2x13". Our price £24 set. Ref. 24P3.

**EHT TRANSFORMER** 8kV output. Good for high voltage experiments. Only £2. Ref. 2P277.

**JOYSTICKS** for BBC Atari, Dragon Commodore, etc. All £5.00 each. All brand new, state which required.

**TELEPHONE TYPE KEYPAD.** Really first class rear mounting unit. White lettering on black buttons. Has conductive rubber contacts with soft click operation. Circuit arranged in telephone type array. Requires 70mm by 55mm cutout and has a 10 IDC connector. Price £2.00. Ref. 2P251.

**SUB-MIN PUSH SWITCHES** Not much bigger than a plastic transistor but double pole PCB mounting, 3 for £1.00. Our ref BD688.

**AA CELLS** Probably the most popular of the rechargeable NICAD types. 4 for £4.00. Our ref. 4P44.

**20 WATT 4 OHM SPEAKER** With built in tweeter. Really well made unit which has the power and the quality for hifi 6 1/2" dia. Price £5.00. Our ref. 5P155 or 10 for £40.00 ref. 40P7.

**MINI RADIO MODULE** Only 2in square with ferrite aerial and solid dia. tuner with own knob. It is superhet and operates from a PP3 battery and would drive a crystal headphone. Price £1.00. Our ref. BD716.

**BULGIN MAINS PLUG AND SOCKET** The old and faithful 3 pin with screw terminals. The plug is panel mounted and the socket is cable mounted. 2 pairs for £1.00 or 4 plugs or 4 sockets for £1.00. Our ref. BD715, BD715P, or BD715S.

**MICROPHONE** Low cost hand held dynamic microphone with on/off switch in handle. Lead terminates in 1 3.5mm and 1 2.5mm plug. Only £1.00. Ref. BD711.

**MOSFETS FOR POWER AMPLIFIERS AND HIGH CURRENT DEVICES** 140v 100watt pair made by Hitachi. Ref 2SK413 and its complement 2S1118. Only £4.00 a pair. Our Ref. 4P42.

Also available in H pack Ref 2S1118 and 2SK343 £4.00 a pair. Ref. 4P51.

**TIME AND TEMPERATURE LCD MODULE** A 12 hour clock a Celsius and Fahrenheit thermometer a too hot alarm and a too cold alarm. Approx 50x20mm with 12.7mm digits. Requires 1AA battery and a few switches. Comes with full data and diagram. Price £6.00. Our ref. 6P12.

**REMOTE TEMPERATURE PROBE FOR ABOVE.** £3.00. Our ref. 3P60.

**A REAL AIR MOVER** Circular axial fan moves 205 cubic foot per min which is about twice as much as our standard 4 1/2" fans. Low noise mains operated 6 1/2" dia, brand new. Regular price over £30.00. Our price only £10.00. Our ref 10P74.

**600 WATT AIR OR LIQUID MAINS HEATER** Small coil heater made for heating air or liquids. Will not corrode, lasts for years. Coil size 3" x 2" mounted on a metal plate for easy fixing. 4" dia. Price £3.00. Ref. 3P78 or 4 for £10.00. Our ref. 10P76.

**EX-EQUIPMENT SWITCHED MODE POWER SUPPLIES** Various makes and specs but generally +5, +12v ideal bench supply. Only £8.00. Our ref. 8P36.

**ACORN DATA RECORDER** Made for the Electron or BBC computer but suitable for others. Includes mains adaptor, leads and book. £12.00. Ref. 12P15.

**PTFE COATED SILVER PLATED CABLE** 19 strands of .45mm copper will carry up to 30A and is virtually indestructible. Available in red or black. Regular price is over £120 per reel. Our price only £20.00 for 100m reel. Ref. 20P21 or 1 of each for £35.00. Ref. 35P2. Makes absolutely superb speaker cable!

**NEW PIR SENSORS** Infra red movement sensors will switch up to 500w mains, UK made, 12 month manufacturers warranty, 15-20cm range with a 0-10min timer, adjustable wall bracket. Only £20.00. Ref. 20P24.

**MITSUBISHI 3 1/2" DISC DRIVES** Brand new drives, 1/2 height double sided, double density warranted. Our price £60.00. Ref. 60P5.

**NON-MEMORY PUSHBUTTON TELEPHONES.** Same condition as 10 Memory with redial £3.00. Our ref. 3P79. BT approved.

**SPECTRUM SOUND BOX** Add sound to your Spectrum with this device. Just plug in. Complete with speaker, volume control and nicely boxed. A snip at only £4.00. Our ref. 4P53.

**BBC JOYSTICK INTERFACE** Converts a BBC joystick port to an Atari type port. Price £2.00. Our ref. 2P261.

**TELEPHONE EXTENSION LEAD** 5m phone extension lead with plug on one end, socket on the other. White. Price £3.00. Our ref. 3P70 or 10 leads for only £18.00! Ref. 18P2.

**LCD DISPLAY** 4 1/2" digits supplied with connection data £3.00. Ref. 3P77 or 5 for £10. Ref. 10P78.

**CROSS OVER NETWORK** 8 Ohm 3 way for tweeter midrange and woofer nicely cased with connections marked. Only £2.00. Our ref. 2P255 or 10 for £15.00. Ref. 15P32.

**REVERSING LIGHT ALARM** Fits to car reversing light and sounds when reversing. Only £2.00. Our ref. 2P248.

**BASE STATION MICROPHONE** Top quality uni-directional electret condenser mic 600r impedance sensitivity 16-18KHz — 68db built in chime complete with mic stand bracket. £15.00. Ref. 15P28.

**MICROPHONE STAND** Very heavy chromed mic stand, magnetic base 4" high. £3.00 if ordered with above mic. Our ref. 3P80.

**SOLAR POWERED NICAD CHARGER** 4 Nicad AA battery charger. Charges 4 batteries in 8 hours. Price £6.00. Our ref. 6P3.

**MAINS SOLDERING IRON** Price £3.00. Our ref. 3P85.

**SOLDERING IRON STAND** Price £3.00. Our ref. 3P86.

**SHARP PLOTTER PRINTER** New 4 colour printer originally intended for Sharp computers but may be adaptable for other machines. Complete with pens, paper etc. Price £16.00. Our ref. 16P3.

**CAR IONIZER KIT** Improve the air in your car, clears smoke and helps prevent fatigue. Case req. Price £12.00. Our ref. 12P8.

**NEW FM BUG KIT** New design with PCB embedded coil 9v operation. Priced at £5.00. Our ref. 5P158.

**NEW PANEL METERS** SOUA movement with three different scales that are brought into view with a lever. Price only £3.00. Ref. 3P81.

**STROBE LIGHTS** Fit a standard edison screw light fitting 240V 40/min. flash rate available in yellow, blue, green and red. Complete with socket. Price £10 each. Ref. 10P80 (Ist colour required).

**ELECTRONIC SPEED CONTROL KIT** Suitable for controlling our powerful 12v motors. Price £17.00. Ref. 17P3 (Ist heatsink required).

**EXTENSION CABLE WITH A DIFFERENCE** It is flat on one side making it easy to fix and look tidy. 4 core, suitable for alarms, phones etc. Our price only £5.00 for 50m reel. Ref. 5P153.

**METAL PROJECT BOX** Ideal for battery charger, power supply etc. Sprayed grey size 8" x 4" x 4 1/2". Louvred for ventilation. Price £3.00. Ref. 3P75.

# EVERYDAY ELECTRONICS

INCORPORATING ELECTRONICS MONTHLY

ABC

MEMBER OF THE ASSOCIATION OF PUBLISHERS

VOL 19 No 4 APRIL 1990

The Magazine for Electronic & Computer Projects

ISBN 0262-3617  
PROJECTS . . . THEORY . . . NEWS . . .  
COMMENT . . . POPULAR FEATURES . . .

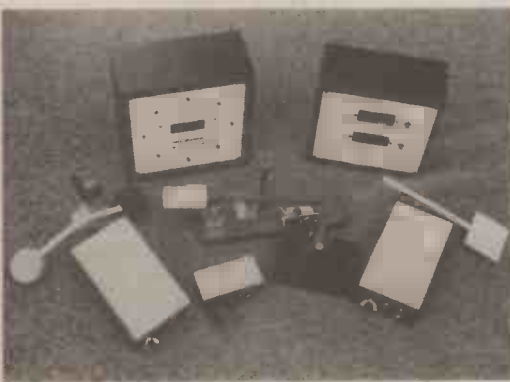
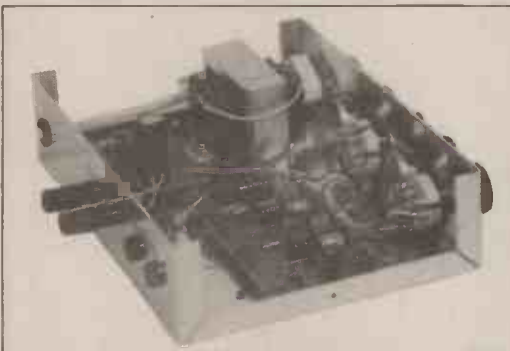

Cover photograph by Reflections of Bournemouth

© Wimborne Publishing Ltd 1990. Copyright in all drawings, photographs and articles published in **EVERYDAY ELECTRONICS** is fully protected, and reproduced or imitations in whole or in part are expressly forbidden.

Our May '90 Issue will be published on Friday, 6 April 1990. See page 223 for details.  
Everyday Electronics, April 1990

## Projects

- ENGINE EFFICIENCY METER** by Steve Garrison 232  
Shows you when your engine is at its most efficient speed
- DIGITAL EXPERIMENTER'S UNIT** by Robert Penfold 236  
A power supply and pulse generator in one unit
- STEREO NOISE GENERATOR** by Andy Flind 248  
Noise is elusive when you want it — this unit is the answer
- FROST ALERT** by Chris Bowes 257  
A "pocket money" project for the winter
- ENLARGER TIMER/EXPOSURE METER** by Chris Brown 262  
For the amateur photographer — invaluable in the darkroom
- EE WEATHER STATION** by Mike Feather 274  
Part 3: Rainfall gauge and sunlight recorder

## Series

- MICRO IN CONTROL — PART 5** by John Hughes 242  
Sequential logic and pulse circuits
- AMATEUR RADIO** by Tony Smith G4FA1 252  
Microsats Up, More from the Shuttle, Banned Countries
- ACTUALLY DOING IT** by Robert Penfold 254  
Winding coils for s.w. radios
- ROBOT ROUNDUP** by Nigel Clark 260  
Investigating the world of robots
- BBC MICRO** by Robert Penfold 266  
Communications applications
- ON SPEC** by Mike Tooley 282  
The place for Spectrum and Sam micro owners

## Features

- EDITORIAL** 231
- FOR YOUR ENTERTAINMENT** by Barry Fox 246  
CT2 phones, Hot line, CD pirates, Direct sales
- SHOP TALK** by David Barrington 251  
Product news and component buying for projects
- DOWN TO EARTH** by George Hylton 256  
Error detection
- DIODE DATA** by Mike Tooley 268  
A selection from the EE Data Book — everything you need to know about diodes
- DIRECT BOOK SERVICE** 284  
Selected technical books by mail order
- PRINTED CIRCUIT BOARD SERVICE** 288  
P.C.B.s for EE projects
- ADVERTISERS INDEX** 292

**FREE** between pages 256 and 257  
**GREENWELD SPRING CATALOGUE SUPPLEMENT**

Readers Service • Editorial and Advertisement Departments 231



# FREE INSIDE!

## SPECIAL AMATEUR RADIO SUPPLEMENT MORSE TUTOR — S.W. RECEIVER — DIY AERIALS

An innovative Morse Tutor that allows groups of letters to be learned together, is portable and also produces text. A Short Wave Reception feature which includes a crystal set design plus a TRF receiver which tunes from 1.4 MHz to 25MHz in three wavebands. Also included is an interesting feature on DIY Aerials for use where space is limited.

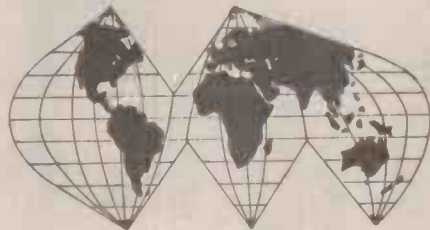

## AMSTRAD SPEECH SYNTHESISER

This unit fits onto the CPC expansion port, and provides its speech output via the computer's built-in loudspeaker. The circuit is based on the popular SPO256 speech synthesiser chip. This is a relatively cheap speech chip, but is one which gives an unlimited vocabulary. Unlike some methods of speech synthesis, the one used by the SPO256 does not require large amounts of the computer's memory in order to store a few words.

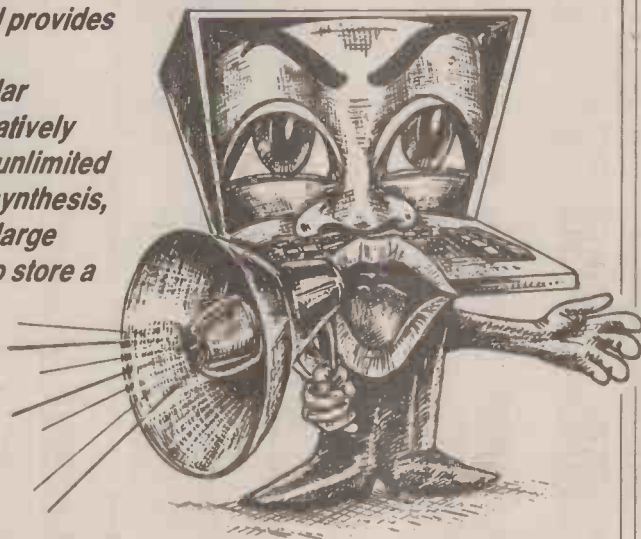

## QUIZMASTER

The Quizmaster is a "first to press" indicator which was originally designed to be used in a team quiz game. It can be used with up to eight contestants, each contestant having his or her own pushbutton which controls a corresponding l.e.d. on the Quizmaster module.

## ELECTRONIC BAROMETER

An instrument for measuring atmospheric pressure from 950 millibars to 1050 millibars. The unit has a simple "memory" circuit to retain the value of the previous reading.

# EVERYDAY ELECTRONICS

MAY ISSUE ON SALE FRIDAY APRIL 6 1990.

We deliver from stock - The fastest way to order is a fax !

### ULTRASONIC CAR ALARM



Complete Kit including case  
44.367BKL £ 30.40

This system is specially designed to protect your car and its contents against potential thieves. Low current consumption and high noise immunity are just two of its distinguishing features.

In addition the system has a voltage sensing device i.e. the alarm is also triggered if appliances are switched on by an unauthorised person (e.g. the interior lighting when the door is opened).

### SPM 130 Decibel Meter

(Elektronik September 89)

Depending on their physical and mental state, human beings respond subjectively to ambient noise. Objective, absolute sound pressure level measurements therefore invariably require a specially designed test instrument, the decibel meter.

This portable instrument gives an accurate indication of the sound pressure level (SPL). The three SPL ranges (40 to 130 dB), three response modes,

and linear or A-weighted filtering provided by the meter enable many types of measurement to be carried out, from the tracing of ambient noise sources to establishing the sensitivity of a loudspeaker.

Complete kit 44.472BKL £ 99.50  
Ready assembled module 44.472F £ 160.50



### DIGITAL PROFESSIONAL ECHO 1000

(Elektronik Electronics June 89)

This low cost echo unit is certain to impress music lovers - amateur and professional - everywhere. Excellent specification and top performance make the EU 1000 a winner and despite meeting professional requirements the unit will not make too big a hole in your pocket.

Working on the delta modulation principle on a digital base, delay times up to one second are possible at full bandwidth and large signal to noise ratio.

EU 1000, complete kit 44.255BKL £ 99.50  
EU 1000, ready assembled 44.255F £ 134.50



#### Specification

Input sensitivity:  
Input 1 : 2 mV  
Input 2 : 200 mV  
Delay Time:  
variable from 60 ms to 1 s  
Bandwidth :  
100 Hz to 12 kHz

#### Additional features:

- inputs mixable
- single and multiple echo
- adjustable delay level
- switchable vibrator
- switch-controlled noise suppression

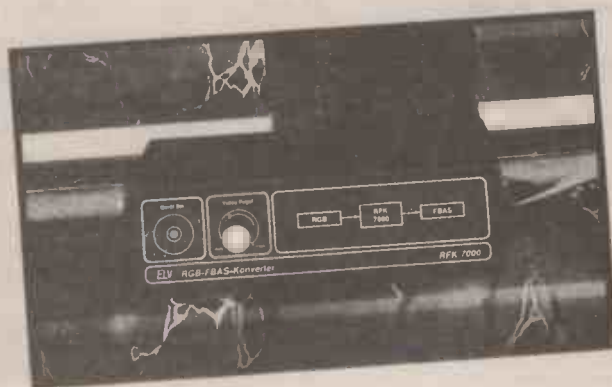

### RFK 700 RGB-CVBS Converter

(Elektronik Electronics October 89)

Nearly all computers supply as an output signal for colour monitors RGB signals. With the help of the RFK 7000 it is possible to record this signals with a videorecorder or to give them onto a

colour TV. The voltage supply is gained from a 12V/300mA-DC voltage mains adaptor.

Complete kit 44.525BKL £ 66.50

Ready assembled module 44.525F £ 119.50

#### Ordering and payment:

- all prices excluding V.A.T. (French customers add 18.6%T.V.A.)
- send Euro-cheque, Bank Draft or Visa card number with order. Please add £ 3.00 for p & p (up to 2 kg total weight)
- postage charged at cost at higher weight Air/Surface -
- we deliver worldwide except USA and Canada
- dealer inquiries welcome

We deliver from stock - The fastest way to order is a fax !

### S-VHS-RGB-CONVERTER SVR 7000

(Elektronik May 89)

Superb picture quality!

With the SVR 7000 video recorders and cameras of the new super VHS generation can be connected to colour TV sets which have a scart input socket, without adjusting the TV set itself. Connected between the S-VHS and TV, the SVR 7000 converts the separate luminance and chrominance signals of a super VHS into an equivalent, high-quality RGB signal.

Three controllers for contrast, colour and brightness optimise the picture quality even if input signals deviate from the norm.

A 4-pole mini-DIN input socket for the S-VHS picture signal; two BNC input sockets for left and right stereo-audio sound channels (only one BNC socket is required for mono) and a scart output socket are available to connect the unit. The voltage supply is gained from a 12V/300mA-DC voltage mains adaptor.

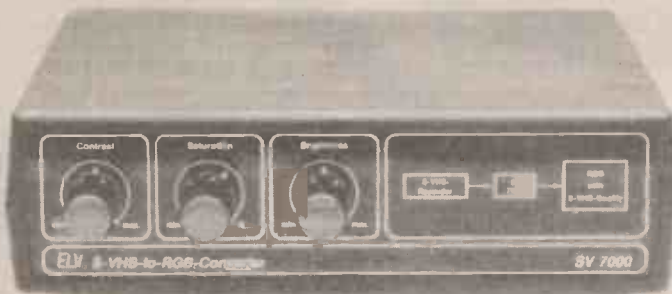

Complete Kit  
Ready Assembled Module

44.497BKL £ 76.25  
44.497F £ 176.00

### VIDEO RECORDING AMPLIFIER

(Elektronik April 89)

Losses can easily occur when copying video tapes resulting in a distinct reduction in quality. By using this video recording amplifier, with no less than four (!) outputs, the modulation range is enlarged and the contrast range of the copy increases.

Two level controllers for edge definition (contour) and amplification (contrast range) allow individual and precise adaptation.



Complete Kit  
(including Box, PCB and all parts)  
44.324BKL £ 14.75

### MG 7000 MINI-FUNCTION GENERATOR



Complete Kit  
Ready Assembled Module

44.2388KL £ 62.15  
44.238F £ 123.95

- Frequency Range: 0.2Hz to 200kHz
- Functions: Sine, Triangular, Saw-Tooth Square Wave
- Output Voltage: max. 10V<sub>pp</sub> - adjustable via attenuator
- Distortion Factor: approx. 0.5% (1kHz)
- Power Supply: via 2 x 9V block batteries

### GLP 7000 TRACKING TESTER

(Elektronik July/August 89)

Complete kit 44.385BKL £ 49.80  
Ready assembled modul 44.385F £ 119.50

Wow and Flutter Test Cassette  
Side A: 3150Hz - 10dB (DIN)  
Side B: white noise - 10dB for adjusting the sound head by ear  
44.385MK £ 11.00

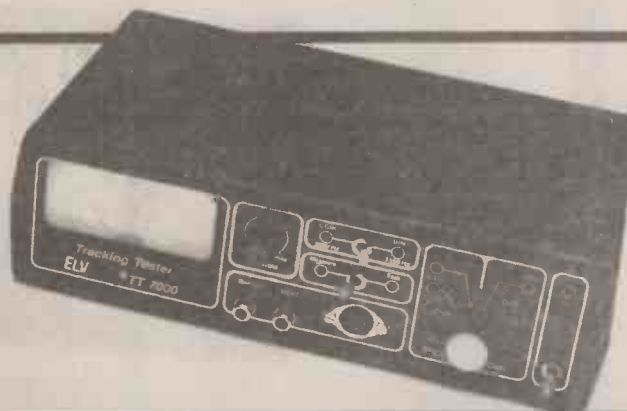

Good wow and flutter characteristics are a mark of quality in tape decks, reel-to-reel tape and VCRs. This tester not only allows you to take quick and exact measurements of wow and flutter, but also of drift.

- Here are the main features in brief:
- built-in, quartz-stabilised reference tone generator
  - switchable frequencies for wow and flutter measurements for DIN (3150Hz) and CCIR (3000Hz)
  - 1 additional range for drift measurements (+/-5%)

### IC TESTER FOR IBM-PC-XT/AT

With the ELV IC tester logic function tests can be carried out on nearly all CMOS and TTL standard components, accommodated in DIL packages up to 20 pin. The tester is designed as an insertion card for IBM-PC-XT/AT and compatibles. A small ZIF test socket PCB is connected via a flat band cable. Over 500 standard components can be tested using the accompanying comprehensive test software.

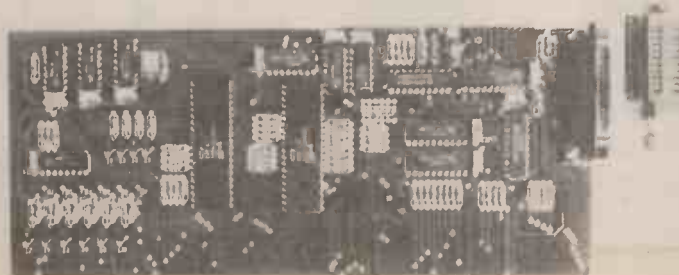

Complete Kit including Textool socket, connectors, sockets, Flat band cable, PCB, Software  
44.474BKL £ 60.85  
Ready Assembled Module GB474F £ 113.00  
Software, single 44.474SW £ 17.85

# HIGH GRADE COMPONENT PARCELS

**EVERYTHING  
MUST  
GO!**

## UNIVERSAL EVERYTHING PARCEL

This one contains some of just about any component you care to name! There are passives (resistors, capacitors, tants, presets), opto devices (couplers, LEDs of all shapes and sizes, infra-red components, 7-segment displays), semiconductors (transistors, diodes, ICs, rectifiers), and all kinds of other odds and ends (relays, VDRs, neons, battery connectors, mixed components packs). A stunning range of components – enough to get a workshop or lab. started – at a ridiculously low price.

The components are of excellent quality, in packs originally intended to sell at £1 each. To make sure you get a good variety, the 20-pack parcel will have no more than two of any one pack, the 100 pack parcel will have at most five of any one pack. Packs supplied as they come – our choice.

PARCEL 1A: 20 PACKS for £10 + VAT  
PARCEL 1B: 100 PACKS for £39! + VAT

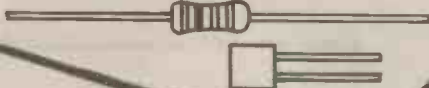

## INTEGRATED CIRCUITS

This parcel contains nothing but ICs. The mixture offers TTL and CMOS logic, interface ICs, linear, data converters, op-amps, special functions, and so on. Some of the ICs are pre-packed with data sheets, some (TTL, CMOS, op-amps) we expect you to identify for yourself, others will be covered by the free *data pack* provided, and the rest you'll have to identify under your own steam. If you know your ICs you'll be in for a few nice surprises.

PARCEL 3A: 100 ICs for £12! + VAT  
PARCEL 3B:  
500 ICs for £49!  
+ VAT

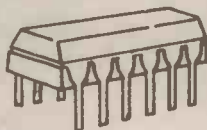

## ELECTROLYTICS

A first class selection of good, modern electrolytics. The mixture ranges from small coupling caps up to huge power supply electrolytics – you'll be hard pressed to find any value between 1 $\mu$ F and 2200 $\mu$ F that isn't represented. A wide range of very useful components. Go for it!

PARCEL 5A:  
1000 ELECTROLYTICS for £8 + VAT  
PARCEL 5B:  
2500 ELECTROLYTICS for £16 + VAT

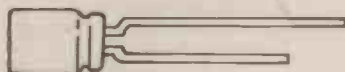

## TANTALUM CAPACITORS

A nice range of tants in values up to 47 $\mu$ F. Lots of useful caps, and we're not mean with the most expensive ones. A fine selection.

PARCEL 4A: 100 TANTS for £6.80 + VAT  
PARCEL 4B: 500 TANTS for £29! + VAT



## TRANSISTORS

A mix of general purpose silicon transistors, mostly bipolar NPN and PNP, with a few FETs and unijunctions thrown in (when available) to spice the mixture. The contents vary from month to month – at the moment there are BC212s, BC213s, BC548s, BC238Bs, MTJ210s, and so on. Next month – who knows? All top quality components.

PARCEL 6A:  
200 TRANSISTORS for £7.80! + VAT

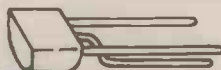

## MASSIVE CLEARANCE SALE

Once again, a general purpose parcel containing a huge variety of components: resistors, capacitors, ICs, transistors, electrolytics, tants, triacs, LEDs, diodes, thermistors, trimmers, VDRs, all sorts. All new, top quality components. This is mostly remainders from our own stock – stuff we forgot to advertise, or have in too small a quantity to sell individually. Guaranteed to be worth at least eight times the price if valued from any standard component catalogue! What more can I say?

PARCEL 2A: 1000+ top grade components for £12! + VAT  
(Value £100+)  
PARCEL 2B: 5000+ top grade components for £49! + VAT  
(Value £500+)



## LEDs

All shapes, sizes and colours of LEDs. Round ones in various sizes, rectangular ones, red, green, amber and yellow ones, clear and tinted lenses, all sorts.

PARCEL 7A: 100 LEDs for £5.90 + VAT  
PARCEL 7B: 500 LEDs for £24.90 + VAT

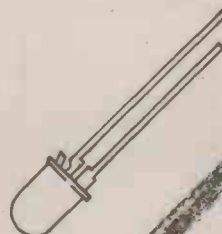

## CAPACITORS

An exciting selection of capacitors. There are ceramics for decoupling and general use, Polystyrenes for high performance circuits, dipped and moulded polyesters in values from a few nF up to 2.2 $\mu$ F (very expensive!), tants and aluminium electrolytics – just about any capacitor you'll ever need. Don't miss this one!

PARCEL 8A:  
1000 CAPACITORS for £6.50 + VAT

PARCEL 8B:  
2500 CAPACITORS  
for £14.90 + VAT



Unless otherwise stated, all the clearance parcels we offer contain brand new, top grade components. If some of the offers look too good to be true, all I can say is that the optimists will get some stunning bargains, the cynics will never know what they've missed, so everybody will be happy! All offers apply only while current stocks last – watch out for next month's parcels or, better still, be the first to hear about any new offers by putting your name on our mailing list. (Please write in, or phone Pete Leah on 0272 522703 after 6.30 pm).

## HIGHGRADE COMPONENTS LTD

Unit 111, 8 Woburn Road, Eastville, Bristol BS5 6TT

**UK Orders:**  
Please add £2.50  
towards postage and  
packing and 15% VAT  
to the total  
**Europe and Eire:**  
Please add £6.00 carriage  
and insurance. No VAT  
**Outside Europe:**  
Please add £12.00 carriage  
and insurance. No VAT



## THE RTC MONITOR II

100 WATT SPEAKER KIT £60.00 + £3.50 P&P (pair)  
RESPONSE: 55Hz-20kHz

BASS POLYMER CONE D: 22cm  
DOME TWEETER: 14mm  
OVERALL SIZE  
(HWD): 382,252,204mm

RECOMMENDED AMP POWER:  
10-100 watts per channel

The performance standard achieved in this compact design is distinctively superior to anything else available at the price. The drive units used are of sophisticated design and have been carefully integrated with a Complex Crossover.

Stereo performance is exceptionally good with a well focussed sound stage and sharp resolution of detail. Distortion throughout the frequency range is low even at quite high power input and this gives a great sense of dynamic range and openness especially when used in bi-wired mode.

Supplied with:— 2 READY CUT BAFFLES, ALL CROSSOVER COMPONENTS, 2 BASS MID-RANGE, 2 DOME TWEETERS, HOOK UP WIRE, GRILLE CLOTH, SCREW TERMINALS AND SCREWS.



## GOODMANS 60W CAR GRAPHIC



As new condition but have been returned by customers or shops, so they may need some attention. Hence the price of only £8.00 each. Order six of these units and you get the seventh one free. Postage £2.90

**LCD DIGITAL MULTI TEST METER AC DC**  
Volts resistance and DC Amps. Most of these units are new but have been returned or rejected by the store and sold with all faults at £11.00 each. Postage £1.00. (Made by Ross Electronics).

## ROSS PUSH BUTTON RADIO

Mains and battery operated. High quality VHF/FM, Medium and Long Wave reception.  
6 pushbutton selected preset stations.  
Fully retractable telescopic aerial.  
Headphone/earphone jack socket.



Size 230H x 150W x 65D.  
Ref RE-5500.  
Brand new.  
Listed price over £30.00.

Price £14.95  
+ £2.80 P&P

Hi-Fi stereo cassette deck transport mechanism, complete with 3 digit rev counter and tape heads, 12V d.c. operation. Unused manufacturers surplus JAPAN made

£6.20 + £1.50 P&P 2 for £10 + £2.50 P&P

HILLS KITS IN STOCK ★ SEND FOR CATALOGUE

## MAIL ORDER £1 BARGAIN PACKS BUY 20 GET 1 FREE

Please state pack(s) required

No.	Qty. per pack	Description
BP013	3	8"x5" Speaker 4Ω 6 watt made by E.M.I.
BP015B	1	30W dome tweeter. Size 90x66mil JAPAN made
BP016	6	2200µf can type Electrolytic 25V d.c. computer grade made in UK by PHILIPS
BP017	3	33000µf 16V d.c. electrolytic high quality computer grade UK made
BP018	3	2000µf 50V d.c. electrolytic high quality computer grade made in USA
BP019	20	20 ceramic trimmers
BP020	4	Tuning capacitors, 2 gang dielectric a.m. type
BP021	10	3 position, 8 tag slide switch 3 amp rated 125V a.c. made in USA
BP022	5	Push-button switches, push on push off, 2 pole change over. PC mount JAPAN made
BP023	6	2 pole 2 way rotary switch
BP024	2	Right angle, PCB mounting rotary switch, 4 pole, 3 way rotary switch UK made by LORLIN
BP025	4	3 pole, 3 way miniature rotary switch with one extra position off (open frame YAXLEY type)
BP026	4	4 pole, 2 way rotary switch UK made by LORLIN
BP027	30	Mixed control knobs
BP028	10	Slide potentiometers (popular values)
BP029	6	Stereo rotary potentiometers
BP030	2	100k wire wound double precision potentiometers UK made
BP031	6	Single 100k multitune pots, ideal for varicap tuners UK made by PHILIPS
BP032	4	UHF varicap tuner heads, unboxed and untested UK made by PHILIPS
BP033	2	FM stereo decoder modules with diagram UK made by PHILIPS
BP033A	4	6"x3/8" High grade Ferrite rod. UK made
BP034	3	AM IF modules with diagram PHILIPS UK made
BP034A	2	AM-FM tuner head modules. UK made by Mullard
BP034B	1	Hi-Fi stereo pre-amp module inputs for CD, tuner tape, magnetic cartridge with diagram. UK made by MULLARD
BP035	6	All metal co-axial aerial plugs
BP036	6	Fuse holders, panel mounting 20mm type
BP037	6	In line fuse holders 20mm type UK made by BULGIN
BP038	20	5 pin dim, 180° chassis socket
BP039	6	Double phono sockets, Paxolin mounted
BP041	3	2.8m lengths of 3 core 5 amp mains flex
BP042	2	Large VU meters JAPAN made
BP043	30	4V miniature bulbs, wire ended, new untested
BP044	2	Sonotone stereo crystal cartridge with 78 and LP stylus JAPAN made
BP045A	2	Mono Cassette Record and play heads
BP046	4	6-0-6 4VA mains transformers, PC mount UK made
BP047	1	24V 0.3VA mains power supply. Brand new boxed UK made by MULLARD
BP049	10	OC44 transistors. Remove paint from top and it becomes a photo-electric cell (ORP 12) UK made by MULLARD
BP050	30	Low signal transistors n.p.n., p.n.p. types
BP051	6	14 watt output transistors. 3 complimentary pairs in T066 case (ideal replacement for AD161 and 162s)
BP052A	1	Tape deck pre-amp IC with record/replay switching No LM1818 with diagram
BP053	5	5 watt audio ICs. No TBAB800 (ATEZ)
BP054	10	Motor speed control ICs, as used with most cassette and record player motors
BP055	1	Digital DVM meter I.C. made by PLESSEY as used by THANDAR with diagram
BP056	4	7 segment 0.3 LED display (red)
BP057	8	Bridge rectifiers, 1 amp, 24V
BP058	200	Assorted carbon resistors
BP059	1	Power supply PCB with 30V 4VA transformer. MC7818CT IC & bridge rectifier: Size 4"x2 3/4"
BP061	5	6.35mm Mono jack plugs
BP063	5	6.35mm stereo switched jack sockets
BP064	12	Coax chassis mount sockets
BP066	1	3mtr Euro-mains lead with chassis socket

## 30+30 WATT AMPLIFIER KIT



An easy to build amplifier with a good specification. All the components are mounted on the single P.C.B. which is already punched and backprinted.

■ 30W x 2 (DIN 4 ohm)  
■ CD/Aux, tape I, tape II, tuner and phono inputs.

■ Separate treble and bass  
■ Headphone jack

Size (H.W.D.) 75 x 400 x 195mm

Kit enclosed: case, P.C.B., all components, scale and knobs £36.80, post £3.50

(Featured project in *Everyday Electronics* April 1989 issue). Reprint Free with kit.

## AMPHONIC 125+125 POWER AMPLIFIER



125 watt per channel stereo power amplifier with independent volume controls, professional 19" rack mount and silent running cooling fan for extra reliability.

Output power ..... 125W RMS max. per channel  
Output impedance ..... 4 to 16 ohms (max. power into 4 ohms)

Sensitivity ..... 450V at 22K ohms

Protection .... Electronic short-circuit and fuses

Power ..... 220-240V a.c. 50Hz

Chassis dim ..... 435 x 125 x 280mm

£142 + £7.00 p&p

## STEREO DISCO MIXER MX7770



4-channel stereo disco mixer with built-in 5-band graphic equalizer capable of mixing a total of 8 line, phono or mic inputs, switchable on the front panel. Controls include cross fade between channels 1 and 2, headphone cue, DJ mic talkover, channel level markers and stereo/mono switch. Twin 12 LED bargraph display. Output to amp, tape and headphones.

Input sensitivity..... Mic. 0.3mV, Phono 3mV, Line 150mV  
Input impedance..... Mic. 600Ω, Phono 47kΩ, Line 47kΩ  
Max. input level..... Mic. 30mV, Phono 140mV, Line 5V  
Output impedance..... >600Ω  
Rated output..... Amp 800mV  
Hum and noise ..... >3mV  
Frequency response: Mic. .... 50-20000Hz  
Phono ..... 50-20000Hz  
Line ..... 20-30000Hz

Equalizer section:  
Control frequencies ..... 60Hz, 250Hz, 1kHz, 3.5kHz, 12kHz  
Control range ..... ±12dB, boost or cut  
Power ..... 240Vac  
Dims ..... 380 x 270 x 96mm

£86.95 + £5.80 p&p

**KOSS STEREO HEADPHONES** High quality light weight stereo headphones fitted 3.5mm jack with adaptor to 6.4mm jack. Ideal use Hifi or personal stereos-made to sell for nine pounds. Our price for this unit £4.25. Postage 60p.

## MULTIBAND RADIO

VHF 54-176 MHz + AM CB BANDS 1-80

Listen to: AIR TRAFFIC CONTROL,  
AIRCRAFT, RADAR,  
PUBLIC UTILITIES,  
RADIO AMATEURS AND  
MANY MANY MORE

£17.95

POSTAGE

£2.85

SQUELCH CONTROL

"RUBBER DUCK AERIAL"

## RADIO AND TV COMPONENTS ACTON LTD

21 HIGH STREET, ACTON LONDON W3 6NG  
MAIL ORDER TERMS, POSTAL ORDERS and/or CHEQUES with orders.  
Orders under £20 add £3.00 service charge. Nett monthly accounts to Schools, Colleges and P.L.C. only. ACCESS VISA. Phone orders between 9.30 & 12pm please. Overseas readers write for quote on delivery.  
Phone: 01-723 8432 or 01-992 8430.  
Callers 323 Edgware Road, London W2.

## SOLAR POWERED WOODEN MODELS

ATTRACTIVE AND EDUCATIONAL



Now you can experiment with solar energy - the energy source of the future!

Our solar powered static wooden model kits are designed to let you build your own models. Everything is supplied. A set of pre-cut and marked plywood, PVA cement, instruction sheet, solar cell module; a "music" i.c. (for the gramophone model) or a small d.c. motor (for the helicopter and aeroplane models), connecting leads and sandpaper.

Helicopter with motor  
£8.40 plus £1 p&p

Aeroplane with motor  
£8.00 plus £1 p&p

Gramophone model with "music" i.c.  
£8.40 plus £1 p&p

SPECIAL OFFER — BUY ALL THREE and get the postage FREE

# MAGENTA ELECTRONICS LTD

MAIL ORDER AND SHOP:  
EE87 135 Hunter Street,  
Burton-on-Trent,  
Staffs. DE14 2ST  
Tel: 0283 65435  
Fax: 0283 46932



All prices include VAT  
Shop open 9-5 Mon-Fri;  
9-2 Saturday  
Official orders welcome

Add £1  
p&p to  
all orders

## SUPERHET BROADCAST RECEIVER

EE MAR '90

At last, an easy to build SUPERHET A.M. radio kit. Covers Long and medium Wave bands, built in loudspeaker with 1 watt output. Excellent sensitivity and selectivity provided by ceramic I.F. filter. Simple alignment and tuning without special equipment. Kit available less case, or with pre-cut and drilled transparent plastic panels and dial for a striking see-through effect.

£15.99

KIT REF 835

## D.C. MOTOR GEARBOXES

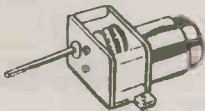

Ideal for Robots and Buggies. A miniature plastic reduction gearbox coupled with a 1.5-4.5 Volt mini motor. Variable gearbox reduction ratios are obtained by fitting from 1 to 6 gearwheels (supplied). Two types available:

SMALL UNIT TYPE MGS **£3.99**

Speed range 3-2200 rpm. Size 37x43x25mm

LARGE UNIT TYPE MGL **£4.55**

Speed range 2-1150 rpm. Size 57x43x29mm

Supplying Electronics  
for Education,  
Robotics, Music,  
Computing and much,  
much more!

Send NOW for our  
illustrated  
CATALOGUE  
Only £1.00!

## STEPPING MOTORS

A range of top quality stepping motors suitable for driving a wide range of mechanisms under computer control using simple interfacing techniques.

ID35 PERMANENT MAGNET MOTOR — 48 steps per rev. **£16.50**

MD200 HYBRID MOTOR — 200 steps per rev. **£16.80**

MD35 1/4 PERMANENT MAGNET MOTOR — 48 steps per rev. **£12.70**

MD38 PERMANENT MAGNET MOTOR — 48 steps per rev. **£8.95**

## MICRO IN CONTROL NEW SERIES STARTED EE DEC '89

STARTER KIT **£21.95**

ALL PARTS LISTED IN TABLE 1  
INCLUDING 5V 250mA SUPPLY  
AND K12 840 PIN BREADBOARD

## EDUCATIONAL BOOKS & BOOK PROJECTS

### ADVENTURES WITH ELECTRONICS

The classic Easy to Follow book suitable for all ages. Ideal for beginners. No soldering, uses an S-DEC breadboard. Gives clear instructions with lots of pictures. 16 projects — including three radios, siren, metronome, organ, intercom, timer, etc. Helps you learn about electronic components and how circuits work. Component pack includes an S-DEC breadboard and all the components for the series.

ADVENTURES WITH ELECTRONICS **£4.75**  
COMPONENT PACK (less book) **£22.35**

### FUN WITH ELECTRONICS

From the USBORNE Pocket Scientist series — An enjoyable introduction to electronics. Full of very clear full colour pictures accompanied by easy to follow text. Ideal for all beginners — children and adults. Only basic tools are needed. 64 full colour pages cover all aspects — soldering — fault finding — components (identification & how they work). Also full details of how to build 6 projects — burglar alarm, radio, game, etc. Requires soldering — 4 pages clearly show you how.

The components supplied in our pack allows all the projects to be built and kept. The book is available separately.

FUN WITH ELECTRONICS Book **£2.25**  
COMPONENT PACK (less book) **£17.55**

## EVERYDAY ELECTRONICS KIT PROJECTS

ALL KITS HERE HAVE BEEN FEATURED IN EE. IF YOU DO NOT HAVE THE MAGAZINE WITH THE ORIGINAL ARTICLE, YOU WILL NEED TO ORDER THE REPRINT FOR 80p EXTRA. REPRINTS ALSO AVAILABLE SEPARATELY. KITS INCLUDE CASES, PCB'S, HARDWARE AND ALL COMPONENTS (UNLESS STATED OTHERWISE) CASES ARE NOT DRILLED, LABELS ARE NOT SUPPLIED.

Ref	Price	Ref	Price
835	£15.99	578	£10.05
834	£9.69	569	£13.24
833	£29.95	563	£67.98
815	£39.95	561	£10.86
814	£19.98	560	£20.89
812	£13.80	559	£14.52
807	£22.71	556	£30.19
806	£10.28	544	£8.33
803	£31.93	542	£12.28
800	£28.72	528	£28.70
796	£26.61	523	£28.16
790	£26.57	513	£29.76
786	£7.44	512	£9.39
780	£16.35	497	£19.95
769	£52.95	493	£44.25
763	£14.53	481	£5.83
739	£22.31	464	£8.95
740	£18.65		£8.95
744	£31.03		£5.47
734	£18.29	461	£6.60
728	£15.24	455	£8.05
730	£14.45	453	£26.89
724	£40.89	444	£20.85
718	£28.25	430	£7.36
719	£28.17	392	£38.61
720	£71.43		£5.89
722	£12.93	387	£9.24
715	£13.41	386	£14.00
707	£16.54	362	£25.71
700	£37.97	337	£6.05
581	£8.94	263	£6.06
584	£22.28	240	£7.31
		205	£18.78
		108	£10.03
		106	£8.33
		101	£6.67

## 30 SOLDERLESS BREADBOARD PROJECTS

A book of projects by R. A. Penfold covering a wide range of interests. All projects are built on a Verobloc breadboard. Full layout drawings and component identification diagrams enable the projects to be built by beginners. Each circuit can be dismantled and rebuilt several times using the same components. The component pack allows all projects in the book to be built one at a time.

Projects covered include amplifiers, light actuated switches, timers, metronome, touch switch, sound activated switch, moisture detector, M.W. Radio, Fuzz unit, etc.

30 SOLDERLESS BREADBOARD  
PROJECTS Book 1 **£2.95**  
COMPONENT PACK **£27.15**  
VEROBLOC **£7.49**

## ENJOYING ELECTRONICS

A more advanced book which introduces some arithmetic and calculations to electronic circuits. 48 chapters covering elements of electronics such as current, transistor switches, flip-flops, oscillators, charge, pulses, etc. An excellent follow-up to Teach-in or any other of our series. Extremely well explained by Owen Bishop who has written many excellent beginners' articles in numerous electronics magazines.

ENJOYING ELECTRONICS Book **£3.60**  
COMPONENT PACK **£14.31**  
VEROBLOC **£7.49**

Note — A simple multimeter is needed to fully follow this book. The M102 BZ is ideal. **£13.98**

## A FIRST ELECTRONIC COURSE

A copiously illustrated book that explains the principles of electronics by relating them to everyday objects. At the end of each chapter a set of questions and word puzzles allow progress to be checked in an entertaining way. An S-DEC breadboard is used for this series — soldering is not required.

A FIRST ELECTRONIC COURSE BOOK **£3.75**  
PACK **£22.35**

## INSULATION TESTER

EE APRIL 85



A reliable electronic tester which checks insulation resistance of wiring appliances etc., at 500 volts. The unit is battery powered simple and safe to operate. Leakage resistance of up to 100 Megohms can be read easily. One of our own designs and extremely popular.

KIT REF 444

£20.85

## PET SCARER

EE MAY 89

Produces high power ultrasound pulses. L.E.D. flashes to indicate power output and level. Battery powered (9V-12V or via Mains Adaptor).

KIT REF 812

Mains Adaptor £1.98

£13.80

## DIGITAL FREQUENCY 200 MHz METER

EE NOV 86

An 8 digit meter reading from AF up to 200 MHz in two ranges. Large 0.5" Red LED display. Ideal for AF and RF measurements. Amateur and C.B. frequencies.

KIT REF 563

£62.98

## DIGITAL CAPACITANCE METER

EE DEC 85

Simple and accurate (1%) measurement of capacitors from a few pF up to 1,000  $\mu$ F. Clear 5-digit LED display indicates exact value. Three ranges - pF, nF, and  $\mu$ F. Just connect the capacitor, press the button and read the value.

KIT REF 493

£44.25

## 3 BAND SHORT WAVE RADIO

EE AUG 87

Covers 1.6-30 MHz in 3 bands using modern miniature coils. Audio output is via a built-in loudspeaker. Advanced design gives excellent stability, sensitivity and selectivity. Simple to build.

KIT REF 718

£28.25

## MOSFET VARIABLE BENCH 25V 2.5A POWER SUPPLY

EE FEB 88

A superb design giving 0.25V and 0-2.5A. Twin panel meters indicate Voltage and Current. Voltage is variable from zero to 25V. A Toroidal transformer MOSFET power output device, and Quad op-amp IC design give excellent performance.

KIT REF 769

£52.96

## MINI STROBE

EE MAY '86

A hand held stroboscope which uses 6 "ultra bright" LEDs as the light source. Designed to demonstrate the principles of stroboscope examination, the unit is also suitable for measuring the speed of moving shafts etc. The flash rate control covers 170-20,000 RPM in two ranges.

KIT REF 529

£14.76

## ACOUSTIC PROBE

EE NOV '87

A very popular project which picks up vibrations by means of a contact probe and passes them on to a pair of headphones or an amplifier. Sounds from engines, watches and speech travelling through walls can be amplified and heard clearly. Useful for mechanics, instrument engineers and nosey parkers!

KIT REF 740

£18.65

## 4 CHANNEL LIGHT CHASER

EE Jan '90

A 1000W per channel chaser with zero volt switching, hard drive, inductive load capability, mic sound sensor and sophisticated 'beat' detector. Chase steps to music or auto when quiet. Variable speed and mic. sens. LED mimic on front panel. Switchable for 3 or 4 channels. P552 output. Ideal for rope lights, pin spots, disco and display lighting.

KIT REF 833

£29.95

## EE EQUALISER

EE MAY '87

A mains powered loniser with an output of negative ions that give a refreshing feeling to the surrounding atmosphere. Negligible current consumption and all-insulated construction ensure that the unit is safe and economical in use. Easy to build on a simple PCB.

KIT REF 707

£16.54

## MUSICAL DOORBELL

EE JAN '86

This project uses a special I.C. pre-programmed with 25 tunes and 3 chimes. A Magenta design, the circuit is battery powered and only draws current whilst producing sounds. Two rotary switches select the tune required. Provision is made for three bell pushes, each of which sounds a different tune, so that three points of entry can be identified.

KIT REF 497

£19.95

## EPROM ERASER

EE OCT '88

Safe low-cost unit capable of erasing up to four EPROM's simultaneously in less than twenty minutes. Operates from a 12V supply. Safety interlock. Convenient and simple to build and use.

KIT REF 790

£26.57

## LIGHT RIDERS

EE OCT '86

Three projects under one title - all simulations of the Knight Rider lights from the TV series. The three are a lapel badge using six LEDs, a larger LED unit with 16 LEDs and a mains version capable of driving six main lamps totalling over 500 watts.

KIT REF 559 CHASER LIGHT

£14.52

KIT REF 560 DISCO LIGHTS

£20.89

KIT REF 561 LAPEL BADGE

£10.86

## EE TREASURE HUNTER

EE AUG '89

A sensitive pulse induction Metal Detector. Picks up coins and rings etc., up to 20cms deep. Low "ground effect". Can be used with search-head underwater. Easy to use and build, kit includes search-head, handle, case, PCB and all parts as shown.

KIT REF 815

Headphones

£39.95  
£1.99

## STEPPING MOTOR INTERFACE

EE AUG '85

This interface enables 4 phase unipolar stepping motors to be driven from four output lines of any computer user port. The circuit is especially suitable for the ID35 motor and our MD200 which are commonly used in buggies and robot arms. Supplied complete with ribbon cable and connector for the BBC user port.

KIT REF 464

£8.95

# TK FOR KITS

## GUARD DOG KIT



One of the best burglar deterrents is a guard dog and this kit provides the barking without the bite! Can be connected to a doorbell, pressure mat or any other intruder detector and produces random threatening barks. Includes mains supply and horn speaker.

**XK125 £24.95**

## DISCO LIGHTING KITS



**DL8000K** 8-way sequencer kit with built-in opto-isolated sound to light input. Only requires a box and control knob to complete .... **£39.95**  
**DL1000K** 4-way chaser features bi-directional sequence and dimming 1kW per channel .. **£23.95**  
**DLZ1000K** Uni-directional version of the above. Zero switching to reduce interference ..... **£13.95**  
**DLA1** (for DL & DLZ1000K) Optional op-to input allowing audio 'beat/light response' ..... **95p**  
**DL3000K** 3-channel sound to light kit, zero voltage switching, automatic level control and built-in mic. 1kW per channel ..... **£19.55**

## POWER STROBE KIT

Produces an intense light pulse at a variable frequency of 1 to 15Hz. Includes high quality PCB, components, connectors, 5Ws strobe tube and assembly instructions. Supply: 240V ac. Size: 80x50x45.  
**XK124 STROBOSCOPE KIT. £17.25**



## PROGRAMMABLE ELECTRONIC LOCK KIT

Keys could be a thing of the past with this new high security lock. Secure doors to sheds, garages, even your home or prevent the unauthorised use of computers, burglar alarms or cars. One 4-digit sequence will operate the lock while incorrect entries will sound an alarm. The number of incorrect entries allowed before the alarm is triggered is selected by you. Further entries will be ignored for a time also set by you. Only the correct sequence will open the lock and switch off the alarm. The sequence may easily be changed by entering a special number and code on the supplied keyboard. Kit includes; keyboard, alarm buzzer, high quality PCB and all electronic components. Supply 5-15V DC. Will drive our Latch Mechanism (701 150 @ £16.50) or relay directly.

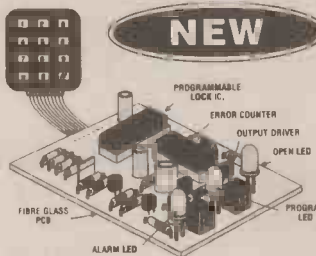

**XK131 £19.95**

## SIMPLE KITS FOR BEGINNERS

Especially aimed at the beginner. Have fun with your project even after you have built it and also learn a little from building it. These kits include high quality solder resist printed circuit boards, all electronic components (including speaker where used) and full construction instructions with circuit description.



**SK1 DOORCHIME** plays a tune when activated by a pushbutton **£4.50**  
**SK2 WHISTLE SWITCH** switches a relay on and off in response to whistle command **£4.50**  
**SK3 SOUND GENERATOR** produces FOUR different sounds, including police/ambulance/fire-engine siren and machine gun **£4.50**

**XK118 TEN EXCITING PROJECTS FOR BEGINNERS** this kit contains a solderless breadboard, components and a booklet with instructions to enable the absolute novice to build ten fascinating projects including a light operated switch, intercom, burglar alarm and electronic lock. Each project includes a circuit diagram, description of operation and an easy to follow layout diagram. A section component identification and function is included, enabling the beginner to build the circuits with confidence .... **£17.25**

## SUPER-SENSITIVE MICROBUG

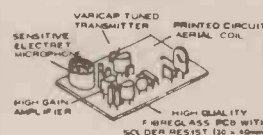

Only 45x25x15mm, including built-in mic. 88-100MHz (standard FM radio). Range approx. 300m depending on terrain. Powered by 9V PP3 (7mA). Ideal for surveillance, baby alarm etc. **£6.35**

## VERSATILE REMOTE CONTROL KIT



Includes all components (+ transformer) for a sensitive IR receiver with 16 logic outputs (0-15V) which with suitable interface circuitry (relays, triacs, etc details supplied) can switch up to 16 items of equipment on or off remotely. Outputs may be latched to the last received code or momentary (on during transmission) by specifying the decoder IC and a 15V stabilised supply is available to power external circuits. Supply: 240V AC or 15-24V DC at 10mA. Size: (exc. transformer) 9x4x2 cms. Companion transmitter is the MK18 which operated from a 9V PP3 battery and gives a range of up to 60ft. Two keyboards are available - MK9 (4-way) and MK10 (16-way).  
**MK12 IR Receiver** (inc. transformer) ..... **£19.55**  
**MK18 Transmitter** ..... **£8.95**  
**MK9 4-way Keyboard** ..... **£2.75**  
**MK10 16-way Keyboard** ..... **£7.95**  
**601133 Box for Transmitter** .. **£2.95**

## ELECTRONIC WEIGHING SCALE

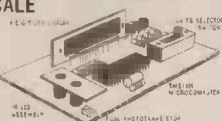

Kit contains a single chip microprocessor. PCB, displays and all electronics to produce a digital LED readout of weight in Kgs or Sts/Lbs. A PCB link selects the scale-bathroom/two types of kitchen scales. A low cost digital ruler could also be made.  
**ES1 £8.25**

## VOICE RECORD/PLAYBACK KIT

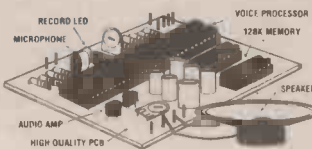

This simple to construct and even simpler to operate kit will record and playback short messages or tunes. It has many uses - seatbelt or light reminder in the car, welcome messages to visitors at home or at work, warning messages in factories and public places. In fact anywhere where a spoken message is announced and which needs to be changed from time to time. Also suitable for toys - why not convert your daughter's £8 doll to an £80 taking doll!!

Size ..... 76 x 60 x 15mm  
 Message time ..... 1-5 secs normal speed, 2-10 secs slow speed  
**XK129 £25.95**

## PROPORTIONAL TEMPERATURE CONTROLLER KIT



Uses 'burst fire' technique to maintain temperature to within 0.5°C. Ideal for photography, incubators, wine making, etc.  
 Maximum load 3kW (240V AC). Temperature range up to 90°C.  
 Size: 7x4x2.5cms. **MK4 ..... £8.95**

# TK ELECTRONICS

**TK ELECTRONICS**  
**13 Boston Road**  
**London W7 3SJ**  
**Tel: 01-567 8910**  
**Fax: 01-566 1916**

**ORDERING INFORMATION** All prices INCLUDE VAT. Free P & P on orders over £60 (UK only), otherwise add £1.15. Overseas Customers divide total order by 1.15 then add P & P: Europe £3.50, elsewhere £10.00. Send cheque/PO/Visa/Access No. with order. Giro No. 529314002. Local Authority and educational institutions orders welcome. Shop Open: Tuesday-Thursday 10 am - 5 pm. Saturday 10 am - 4 pm.



**ORDERS: 01-567 8910 24 HOURS**

# EVERYDAY ELECTRONICS

INCORPORATING ELECTRONICS MONTHLY

The Magazine for Electronic & Computer Projects  
Vol. 19 No. 4 April '90

**Editorial Offices**  
EVERYDAY ELECTRONICS EDITORIAL,  
6 CHURCH STREET, WIMBORNE,  
DORSET BH21 1JH  
Phone: Wimborne (0202) 881749  
FAX: (0202) 841692

See notes on **Readers' Enquiries** below—we regret that lengthy technical enquiries cannot be answered over the telephone

**Advertisement Offices**  
EVERYDAY ELECTRONICS ADVERTISEMENTS  
HOLLAND WOOD HOUSE, CHURCH LANE,  
GREAT HOLLAND, ESSEX CO13 0JS.  
Frinton (0255) 850596

## CAT.

Another catalogue for you this month — I find they are always interesting and usually encourage you to spend some money — or at least tempt you! There is such a wide variety of components, equipment and devices now available that it's difficult not to be tempted. Greenweld have also included a free soldering iron offer which looks excellent.

## RADIO

Next month we have a special supplement on amateur radio — three different articles with plenty to interest everyone. Even those with little or no interest in radio will probably find the *D.I.Y. Aerials* article fascinating. There is always plenty going on on the amateur bands. We are going to publish a short series of projects on simple receivers which will form an excellent starting point for anyone who wants to find out what amateur radio is all about.

## BOOK

I'm pleased to announce that the *Everyday Electronics Data Book* is now available — many component stockists are carrying it and it can be ordered by post through our *Direct Book Service*. This issue carries the section on Diodes taken from the book. Please note that we have had to reduce the size of the artwork and all the tables, to fit it in — it's all very clear and easy to read in the book.

In addition to Diodes the book also has sections on: Fundamentals; Passive Components; Networks, attenuators and filters; Transistors; Integrated Circuits; Circuits, plus Appendices covering Abbreviations, Symbols, Series and parallel component tables, Decibels and power, voltage and current ratios, Exponential growth and decay.

Each of the main chapters has plenty of worked examples and hints and tips which Mike Tooley has added to give the reader the benefit of his wide experience. I'm sure most readers will find the book very helpful.

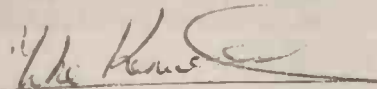

## SUBSCRIPTIONS

Annual subscriptions for delivery direct to any address in the UK: £16.00. Overseas: £19.50 (£37 airmail). Cheques or bank drafts (in £ sterling only) payable to Everyday Electronics and sent to EE Subscriptions Dept., 6 Church Street, Wimborne, Dorset

BH21 1JH. Subscriptions can only start with the next available issue. For back numbers see below.

## BACK ISSUES

Certain back issues of EVERYDAY ELECTRONICS are available price £1.50 (£2.00 overseas surface mail—£ sterling only please—inclusive of postage and packing per copy. Enquiries with remittance, made payable to Everyday Electronics, should be sent to Post Sales Department, Everyday Electronics, 6 Church Street, Wimborne, Dorset BH21 1JH. in the event of non-availability one article can be photostatted for the same price. Normally sent within seven days but please allow 28 days for delivery. We have sold out of Sept. Oct. & Dec. 85, April, May, Oct. & Dec. 86, Jan., April, May & Nov. 87, Jan., March, April, June & Oct. 88.

## BINDERS

Binders to hold one volume (12 issues) are available from the above address for £4.95 (£6.95 to European countries and £9.00 to other countries, surface mail) inclusive of post and packing. Normally sent within seven days but please allow 28 days for delivery. Payment in £ sterling only please.

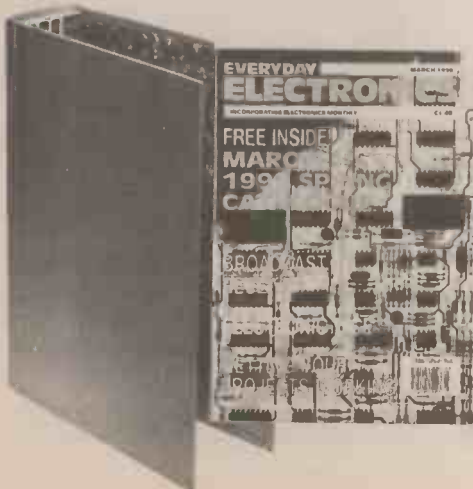

**Editor** MIKE KENWARD

**Secretary** PAMELA BROWN

**Deputy Editor**

DAVID BARRINGTON

**Business Manager**

DAVID J. LEAVER

**Editorial:** WIMBORNE (0202) 881749

**Advertisement Manager**

PETER J. MEW Frinton (0255) 850596.

**Classified Advertisements**

Wimborne (0202) 881749

## READERS' ENQUIRIES

We are unable to offer any advice on the use, purchase, repair or modification of commercial equipment or the incorporation or modification of designs published in the magazine. We regret that we cannot provide data or answer queries on articles or projects that are more than five years old. Letters requiring a personal reply must be accompanied by a **stamped self-addressed envelope** or a **self-addressed envelope and international reply coupons**.

All reasonable precautions are taken to ensure that the advice and data given to readers is reliable. We cannot, however, guarantee it and we cannot accept legal responsibility for it.

## COMPONENT SUPPLIES

**We do not supply electronic components or kits** for building the projects featured, these can be supplied by advertisers.

We advise readers to check that all parts are still available before commencing any project in a back-dated issue.

**We regret that we cannot provide data or answer queries on projects that are more than five years old.**

## ADVERTISEMENTS

Although the proprietors and staff of EVERYDAY ELECTRONICS take reasonable precautions to protect the interests of readers by ensuring as far as practicable that advertisements are *bona fide*, the magazine and its Publishers cannot give any undertakings in respect of statements or claims made by advertisers, whether these advertisements are printed as part of the magazine, or are in the form of inserts.

The Publishers regret that under no circumstances will the magazine accept liability for non-receipt of goods ordered, or for late delivery, or for faults in manufacture. Legal remedies are available in respect of some of these circumstances, and readers who have complaints should address them to the advertiser or should consult a local trading standards office, or a Citizen's Advice Bureau, or a solicitor.

## TRANSMITTERS/BUGS/ TELEPHONE EQUIPMENT

We would like to advise readers that certain items of radio transmitting and telephone equipment which may be advertised in our pages cannot be legally used in the U.K. Readers should check the law before using any transmitting or telephone equipment as a fine, confiscation of equipment and/or imprisonment can result from illegal use. The laws vary from country to country; overseas readers should check local laws.



# ENGINE EFFICIENCY METER

## STEVE GARRISON

An inexpensive unit that helps you to drive in the most fuel efficient way. Gives a "green" output at efficient engine speeds.

WE HAVE OUR OWN domestic version of a Black Hole known as the family car fuel-tank - whatever the noxious substance we attempt to run our car on, be it petrol, diesel, cooking oil!, etc, we are constantly astounded by the rate at which the needle plummets towards the red line. There have been a myriad of additives proposed to alleviate this depressing syndrome, some mechanical, some chemical, and of course a plethora of electronic circuits. If you're frightened of performing major surgery on your pride and joy, try this little circuit instead.

### DESIGN BASIS

The project is based on the simple fact that the engine is a device designed to convert the energy stored in the chemical bonds of the chosen fuel into rotational kinetic energy - torque - at the wheels. The efficiency of this conversion is expressed by the torque curve of the engine - the curve for typical car engine is shown in Fig. 1.

It shows that the engine produces more torque at some speeds than at others, the peak being somewhere near 3,500rpm in this case. This is different from the maximum power, which peaks much higher up the rev. range and in a very inefficient operating region of the engine. Using this knowledge - that we get a higher efficiency of conversion at the top of the torque curve - the basis for this meter can now be understood.

The design intent is that the circuit should be able to pick out the peak of the torque curve, and be able to display its successful detection to the driver of the vehicle. It uses an engine speed input taken from the ignition coil which is then processed by a digital band-pass filter to drive a tri-colour l.e.d. as the indicator. The l.e.d. shows red outside the chosen band, and green when the area of peak torque (and thus efficiency) is reached.

The circuit is continuously variable when it comes to setting the speed band, allowing

you to match it to any vehicle easily. It could, therefore, easily be used as a "red-line" warning for cars without rev-counters.

### CIRCUIT DESCRIPTION

The input signal for the circuit (Fig. 2) is taken from the ignition coil of the vehicle, where we can obtain a signal proportional in frequency to the speed of the engine. The connection is made to the low tension terminal of the ignition coil which is switched by the points (remember those?), or, more commonly these days, the ignition amplifier. This point is switched between car supply and ground at controlled times to generate the HT in the secondary of the coil, which is generally visible as sparks at the plugs.

The input circuit components (R1, D1, C1) clamp this signal to prevent any high voltage spikes or high frequency noise from entering the system, which could cause spurious triggering or fried chips. The components are mounted at the engine end of the cable to prevent the undesirable signals getting anywhere near our circuit board. This sanitised signal is then relayed

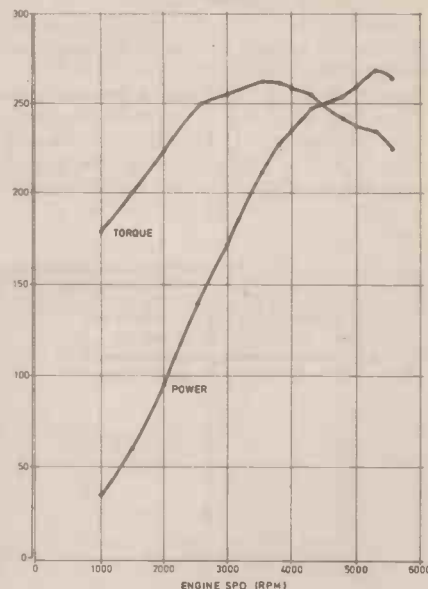
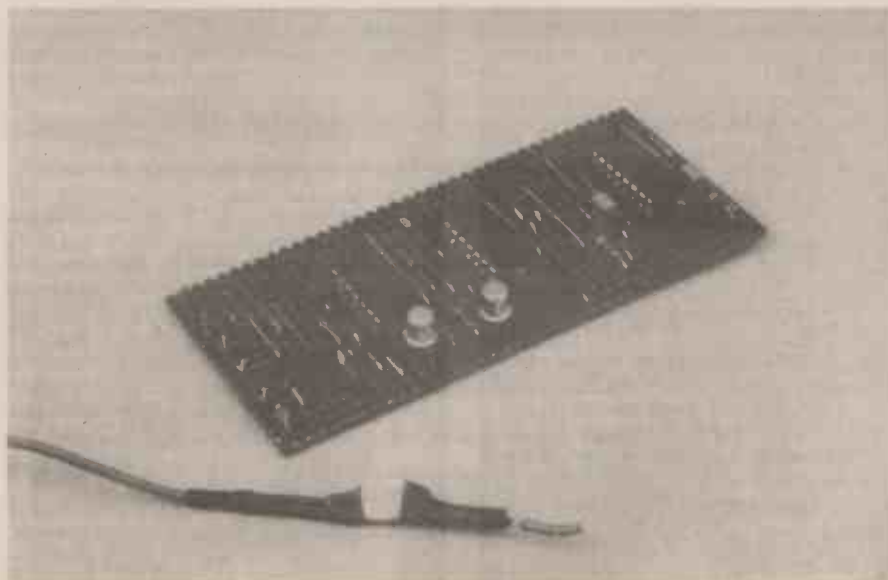

Fig. 1. Relationship of torque and power to engine speed.

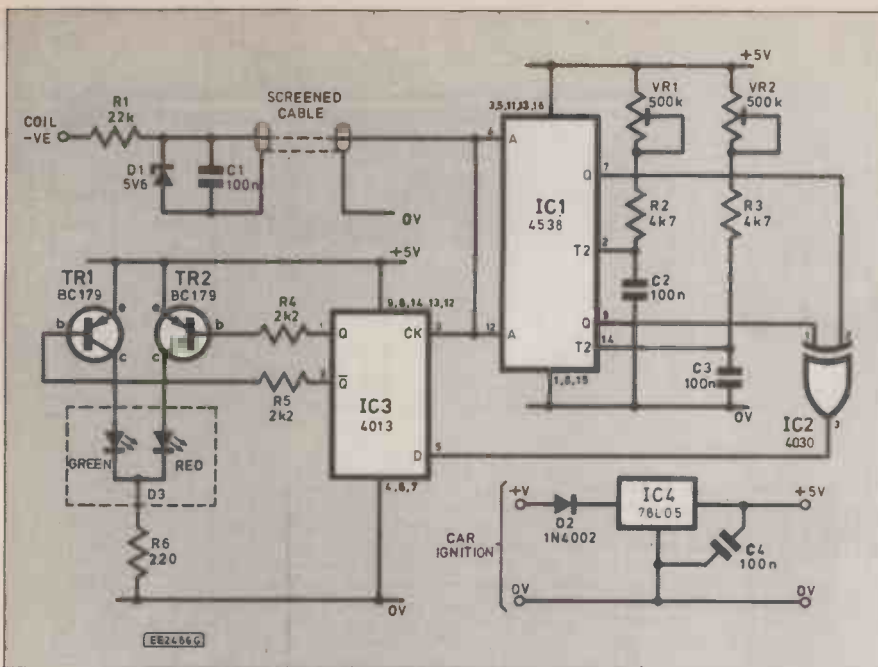

Fig. 2. Circuit diagram of the Engine Efficiency Meter.

via the protective screened cable to the main body of the circuit, where it is to be used as a clock signal, varying with the speed of the engine, and thus available for digital filtration!

The speed signal is used to trigger two monostable blocks, contained in the 4538 (IC1). The construction of these electronic blocks allows us to trigger their outputs into a transitory (or unstable) state for a period of time which we can set by external components i.e. pulses to order. These blocks are monostable since they return to their rest (or stable) state after the timed period, whereas a bistable block would remain in the new state until it was retriggered — it has two stable states.

The circuit shows that we use both of the monostables in IC1 and that both have similar timing components specified around them. Preset multiturn potentiometers are used to set the pulse times accurately, since it is these that will determine the filter cut-off points.

As mentioned already, both monostables are triggered together and the pulses that appear at their outputs are fed to an exclusive OR gate (IC2) which effectively acts as the filter element. The logic table for the gate is shown in Fig. 3 and it demonstrates the subtle difference of the exclusive device over its standard OR companion, namely that if all the inputs are high the output switches low. It is this characteristic that creates the opportunity for its use in this role.

INPUTS		OUTPUTS	
A	B	OR	EXOR
0	0	0	0
1	0	1	1
0	1	1	1
1	1	1	0

Fig. 3. Comparison of two input OR and EXOR gate functions.

## FILTERING

To explain how the filtering is achieved, we must consider another characteristic of the particular monostable we are using, namely that it can be retriggered whilst still in its "unstable" state. Therefore, we can extend the length of the pulse at its output indefinitely if we keep triggering the block before it gets a chance to "time-out".

By careful specification of the point where the monostable just starts retriggering, we can pinpoint a particular frequency of the trigger/clock pulses, and, therefore, define the cut-off points for our filter. By setting the monostable pulse-widths to different values, we can define a window of frequencies that can correspond to the peak of the torque curve, and Fig. 4 shows the three states of the monostable outputs as the frequency increases.

In the figure, monostable A is set to

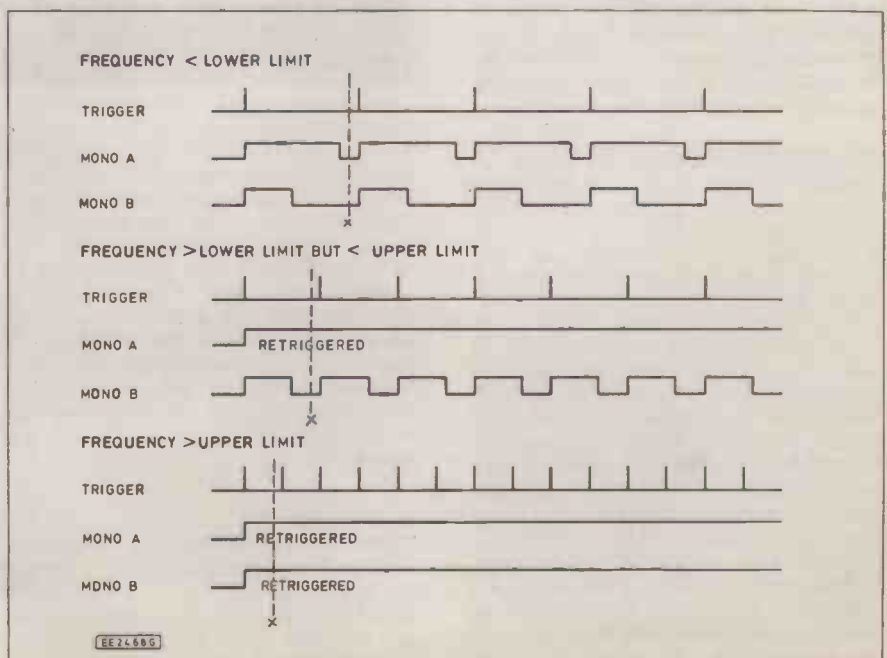

Fig. 4. Changes in monostable output as engine speed rises.

## COMPONENTS

### Resistors

R1	22k
R2, R3	4k7 (2 off)
R4, R5	2k2 (2 off)
R6	220

### Potentiometers

VR1, VR2	500k multiturn square trimmer (2 off)
----------	---------------------------------------

### Capacitors

C1 to C4	100n (4 off)
----------	--------------

### Semiconductors

D1	5V6 Zener
D2	1N4002
D3	tricolour l.e.d.
TR1, TR2	BC179 or BC479 (2 off)
IC1	4538B
IC2	4030B
IC3	4013B
IC4	78L05

**Shop Talk**

### Miscellaneous

Screened connecting lead — see text; Veroboard, 38 holes by 16 strips; auto type connecting wire; plastic case approx 115 x 75 x 35mm; d.i.l. i.c. holders, 16 pin, 14 pin (2 off); connectors; fixings etc.

See page 251

Approx cost.  
Guidance only

**£8**

## OUTPUT

The remaining task, as I have suggested, is to sample the output of the EXOR gate to determine the frequency range we are in. And also latch it in some sort of memory to be able to display it to the driver. This function is achieved by a cousin of the monstable—the bistable. We use a specialised version in this circuit, known as the D-type, and in the configuration shown here (IC3), whenever it is triggered, the output assumes the same state that it finds on the D input at that instant of trigger. This condition is then held until the next trigger pulse—in effect the D-type has remembered the state of its input for us at a moment in time. Just what we need—the output of the EXOR gate can be memorised. But what do we trigger it with?

We use the same signal as we did for the monstables, which occurs just at the right moment for sampling. The secret is that we make use of what is known as the propagation delay of the monstables—the time it takes before the output of the device responds to a change at the input. Therefore, we can sample the state of the outputs just before they are affected—a matter of under a microsecond, but perfectly long enough in the digital world!

Finally, we need to display the condition that the D-type has found the EXOR gate in, in other words, the part of the torque curve that we are on. By using other circuitry in the D-type to good effect, we can do this quite simply. The bistable has complementary outputs, which means that there is a "straight" output and an inverted output, known as Q and  $\bar{Q}$ . When the circuit detects a 1 at the output of the EXOR gate, Q is 1 and  $\bar{Q}$  is 0, and the reverse when it detects a 0.

It would seem to be a good idea to wire the l.e.d.s directly from these outputs, but the current drive of CMOS chips is rather limited and to get the best out of our display we must resort to a little current amplification. Therefore, two p.n.p. transistors are included to make sure our l.e.d. shines brightly.

To keep the pulse-widths of the monstables constant (and therefore accurate) over the car battery voltage range, we need to stabilise the voltage supply to the circuit. A 78L05 regulator comes to our rescue here, providing a stable 5V from the car supply, with a series diode protecting against reverse supply connections.

## CONSTRUCTION

The layout shown in Fig. 5 is based on a piece of 0.1 inch matrixboard size 38 holes by 16 strips. This may, of course, be increased to suit a particular box, or if mounting holes are to be included, but the size was felt to be the minimum to keep construction easy. Having cut the board, the track breaks should be made as indicated, either by using the appropriate spot face cutter, or a sharp drill bit. Before component assembly commences, the board mounting holes should be drilled—the location of these is shown on the layout diagram, with adjacent track breaks to prevent electrical shorts if metal mounting equipment is used.

And so to the component assembly stage, and it is recommended that this sequence is followed—i.e. sockets, links, capacitors, resistors, and terminal pins. Make sure that the copper tracks are bright and clean before beginning to solder—a rub with a piece of emery cloth or a p.c.b. cleaning

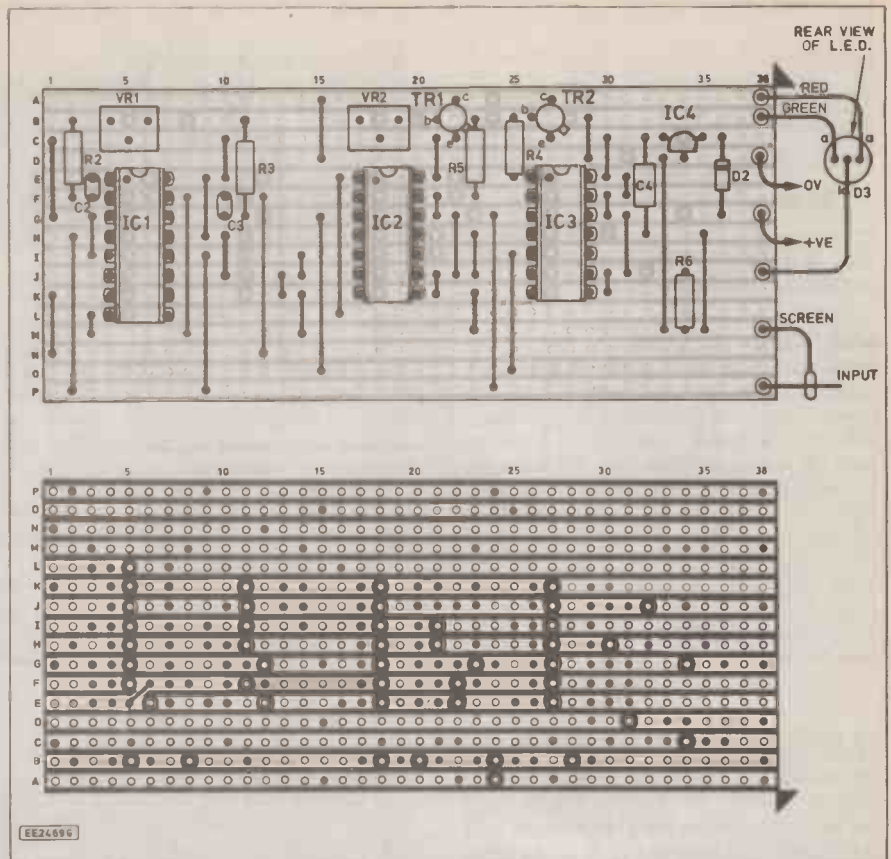
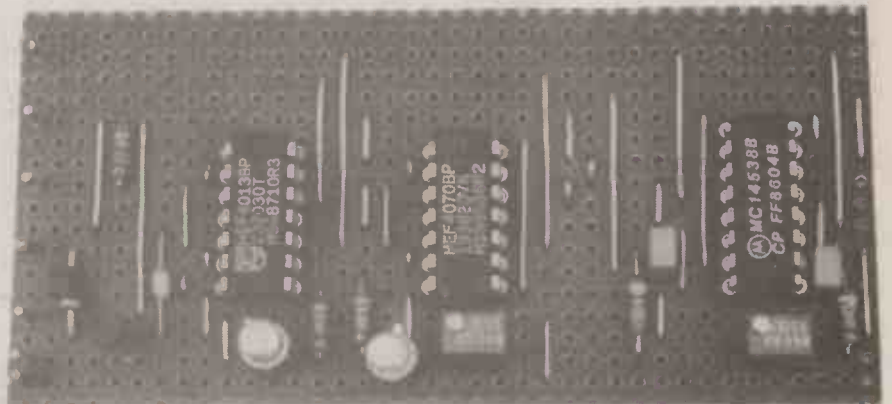

Fig. 5. Veroboard layout and wiring, note the underside link on IC1.



stick would do the job. Not forgetting also that a soldering iron tip in a similar condition helps enormously. The result of a little care and attention here will be quick soldering, tidier joints, not to mention a more reliable construction.

On completion of the population of the board, a few careful minutes should be spent checking the board layout—the component positions, the links, all the track breaks, and most importantly, a close examination of the copper side for any dry joints, solder splashes, and bridges between tracks. Time spent here can save hours of trouble later on.

## CASE

Once you have confidence in your efforts, the board can be temporarily fitted in the box using stand-off pillars as necessary. Flying connections to the circuit can now be added—these being to the tricolour l.e.d. (D3), signal input, and power.

If it has been decided to mount the l.e.d. on the box itself, a suitably sized and

positioned hole should be drilled (taking care not to demolish the circuit board). A plastic bezel and collar may be used, or the l.e.d. simply pushed through and glued. Wiring should be undertaken with care as there are various approaches to tricolour l.e.d. leg identification by different manufacturers. Careful sleeving of the connections is recommended here to prevent shorts.

Alternatively, if it is decided to mount the l.e.d. on or in the car dashboard, remote from the box, a long flying lead can be fitted. Sleeving of the connections would be essential here to provide strain relief as well as leg separation! Individual wires could be used or some low current 3-core mains cable.

## CAR CONNECTIONS

Another hole in the box will be required for the signal pick-up cable, which is specified as single core, overall screened. There are two connections to the board for this



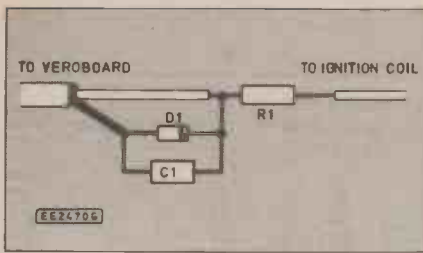

Fig. 6. Wiring of the protection components in the input lead.

cable—one for the screen and one for the signal wire. Cut back about half an inch external insulation, and separate all the screen wires from the central wire, twisting them into a bunch that can be soldered onto the screen terminal pin. Trim the insulation from the signal wire carefully back a quarter of an inch and, having twisted the exposed wires neatly, solder to the signal pin. Tinning the cable ends and the terminal pins beforehand makes life a little easier.

The other end of this cable is a little more complicated, for this is where the connection to the signal source will be made. First assess the distance between the box mounting position and the car ignition coil—not as the crow flies, but by the safest route avoiding fan blades, exhaust pipes, battery acid, etc. then cut the cable to length. Strip the outer insulation back about one and half inches, and refer to Fig. 6 for how the components fit together.

Note that an extra piece of cable is added at the extreme end, and this should be of the type used for the power leads. To improve the long-term survival chances of the assembly in the engine compartment, it is recommended to lacquer/conformal coat the components then seal them in heat shrink or epoxy resin. The photo shows the final item with the connection wire protruding from the sensor. Finally, a hole needs to be provided for the power leads, which should be attached to the appropriate terminal pins, and cut to the desired length, having decided on the power supply point in the vehicle.



Photo of the protection components and the finished insulated lead.

Before inserting the integrated circuits, a couple of final checks are advisable. Measure the resistance across the power leads to see if there are any shorts that haven't been spotted, then if all's well, remove the meter and apply 12V to the circuit. Use the meter to check that the i.c.'s get a 5V supply to their power pins (see circuit diagram)—wire extensions to the meter probes are useful to get into the i.c. sockets. Remove the supply ready for the grand finale—the insertion of the i.c.'s, not forgetting to take care over identification, orientation, static, and pins bent underneath!

### TESTING AND CALIBRATION

With the whole circuit assembled, it must now be calibrated to produce a meaningful display. The simplest way is to use a vehicle with a believable rev-counter and make the adjustments with the unit temporarily connected. Check the workshop or owners manual for the vehicle into which the unit is to be finally installed to find the engine speed at which the peak torque is developed, and that the engine on the calibration car has the same number and configuration of cylinders.

To define our window of peak torque, write down a figure for the upper limit 500 r.p.m. above this speed, and the lower limit 500 r.p.m. below, these figures being chosen so that the "green" window is not too difficult to maintain when driving. Hook up the unit to the vehicle to be used for calibration, taking care with the

polarity of the supply connections. The fused radio supply may be a handy point to use for a supply source. Now attach the end of the sensor cable to the switched terminal of the ignition coil (normally marked -ve) ideally by using a Lucar connector on to the spare blade, or with a Scotchlock connector.

Having verified that the cable is away from moving parts and the l.e.d. is lit up, turn VR1 and VR2 clockwise to their positions of least resistance. Then start the engine and rev. to the lower limit calculated above. Whilst holding the speed at this value, turn VR1 slowly anti-clockwise until the l.e.d. just changes from red to green. This pot. is now adjusted. Now rev. to the upper limit and adjust VR2 similarly until the l.e.d. just changes from green to red.

The unit is now calibrated and can be permanently installed on the chosen vehicle. If the adjustments don't appear to be having much effect on the l.e.d., check all the connections, especially the one to the coil which should be switching between 0V and 12V either through the action of the points or the drive of the ignition amplifier.

### IN USE

The Efficiency Meter seems to be of the most use when the vehicle is cruising, and thus under stable throttle conditions where the "green" can be maintained quite easily. You may be surprised to learn the difference between what feels like a "happy" cruising speed, in comparison with that indicated by the meter.

Since the settings for the thresholds are continuously variable, the circuit can be used for a variety of tasks on the car that are engine speed linked—such as a rev. limit warning to prevent engine overspeed, or even, with a few imaginative modifications, a radio volume control which increases the sound level in "harmony" with engine noise.

In fact, the unit can be driven by any square wave applied at the input as long as the amplitude is 5V or greater. As a consequence, the circuit finds applications far beyond vehicle systems. □



## EVERYDAY ELECTRONICS

### SUBSCRIPTION ORDER FORM

Annual subscription rates (1990): UK £16. Overseas £19.50 (surface mail) £37 (air mail)  
To: Everyday Electronics, Subs. Dept., 6 Church Street, Wimborne, Dorset BH21 1JH.

Name.....

Address.....

I enclose payment of £..... (cheque/PO in £ sterling only payable to Everyday Electronics)    
Access or Barclaycard/Visa No.

--	--	--	--	--	--	--	--	--	--

Signature..... Card Ex. Date.....  
Please supply name and address of card-holder if different from the subscription address shown above.

Subscriptions can only start with the next available issue. For back numbers see the Editorial page.

## EVERYDAY ELECTRONICS

INCORPORATING ELECTRONICS MONTHLY

### NEWSAGENT ORDER FORM

Please reserve/deliver a copy of **Everyday Electronics** for me each month.

Signed.....

Name and Address.....  
(BLOCK CAPITALS PLEASE)

Everyday Electronics is published on the first Friday of each month and distributed by Seymour.  
**Make sure of your copy of EE each month—cut out this form, fill it in and hand it to your newsagent.**

# DIGITAL EXPERIMENTER'S UNIT

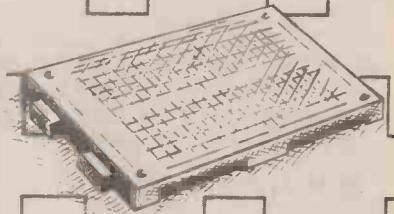

**ROBERT PENFOLD**

*This low cost, fairly basic unit provides a 5V power supply and a pulse generator which provides a wide range of output frequencies and mark/space ratios.*

**T**ESTING even quite simple prototype circuits used to be a long and painstaking business. There was no alternative to building the unit using some form of soldered construction.

What was probably worse than the initial time taken to build prototype units was the difficulty involved in making a few adjustments to circuit values. It required a lot of tedious desoldering and resoldering. Even modest changes to a circuit could be very difficult to implement, necessitating a substantial amount of dismantling and rebuilding.

These days there are numerous solderless breadboards available which make building and testing prototype circuits a very much easier business. Although you might think that these units are only suitable for building relatively small circuits, they can in fact be used for quite complex designs.

Suitably large breadboards are available, or several smaller units can be clipped together. Components can be whisked out and new ones fitted with minimal effort. Quite large changes to circuits often take no more than a few minutes work.

The main requirements for building most prototype digital circuits, apart from the breadboards, are a 5 volt power supply and a pulse generator to provide clock signals. Ready made units which combine these two functions with a solderless breadboard assembly are available, but tend to be quite expensive. This unit provides a low cost home constructor alternative that is fairly basic, but offers a useful level of performance.

## PULSE GENERATOR

Pulse generators range from something as simple as a fixed frequency squarewave generator, to complex crystal controlled circuits offering a wide range of output frequencies and mark-space ratios. Ideally a unit of this type should be able to operate at very low frequencies (about 1Hz) so that circuits can be run slowly enough for their operation to be accurately followed using a logic probe, or perhaps using some i.e.d. indicators temporarily wired to strategic

outputs. Operation at a higher frequency so that circuits can be clocked at something approximating to their normal rate is also highly desirable.

Some circuits require short pulses for their clock signals, and the ability to vary the mark-space ratio to some degree significantly boosts the versatility of a pulse generator. Finally, a few circuits require two phase clock signals. This simply means anti-phase signals, and it is a simple feature that should be available on any pulse generator.

This circuit achieves a wide range of output frequencies and mark-space ratios, but is nevertheless quite simple and inexpensive. In fact it can provide any output frequency and mark-space ratio within reason. It lacks the high levels of precision associated with crystal controlled pulse generator circuits, but for most purposes its accuracy is more than adequate.

Rather than setting an output frequency and mark-space ratio, the circuit is set for specific mark (high) and space (low) output durations. Both are continuously variable over five ranges, as detailed below:-

- Range 1 10 $\mu$ s - 100 $\mu$ s
- Range 2 100 $\mu$ s - 1ms
- Range 3 1ms - 10ms
- Range 4 10ms - 100ms
- Range 5 100ms - 1s

The actual ranges covered are slightly wider than those quoted above. This allows for component tolerances, and avoids gaps in the coverage.

*Fig. 1. Complete circuit diagram for the Pulse Generator section of the Digital Experiment's Unit. The Mark and Space durations are separately adjustable.*

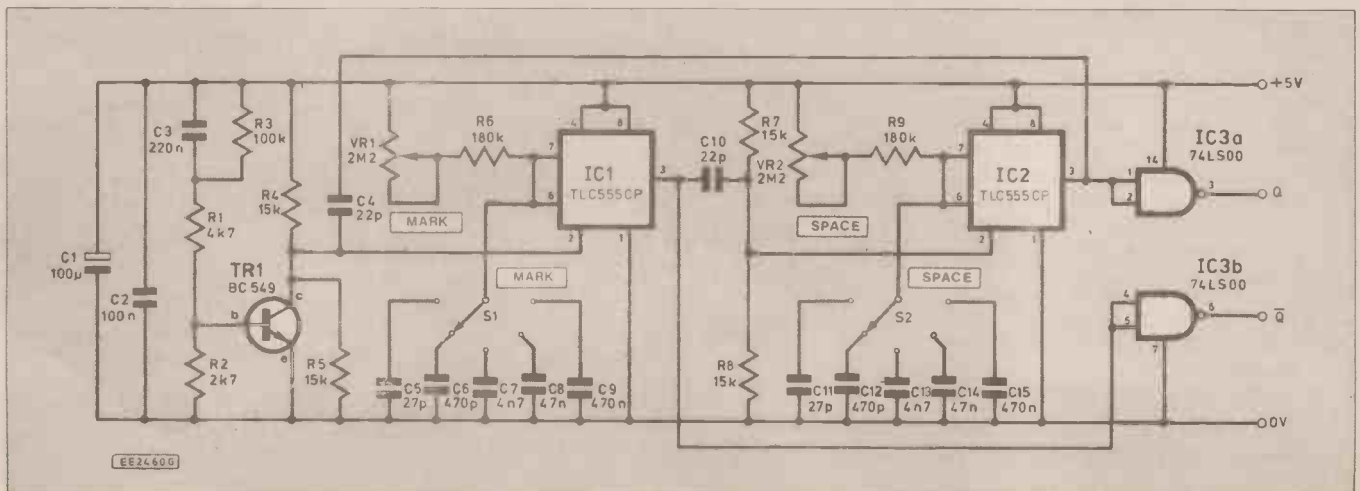

This method of control avoids the erroneous results that can be obtained with simple circuits that have frequency and pulse length controls (which often permit the setting of impossibly long pulse durations for the selected frequency). When dealing with logic circuits it is often the pulse times rather than frequencies that are of primary interest anyway. However, if necessary it is not too difficult to work out the correct control settings for given frequencies and mark-space ratios.

## EXAMPLE

As an example, assume that an output frequency of 10kHz and a 1 to 4 mark-space ratio are required. First work out the duration of one cycle by dividing one by the required output frequency. With the frequency in hertz, kilohertz, and megahertz, the answer is respectively in seconds, milliseconds, and microseconds. In this example dividing 1 by 10kHz obviously gives an answer of 0.1ms, or 100µs in other words. With a 1 to 4 mark space ratio the output is obviously in the high state for one fifth of the time, and low for the other four fifths. Multiplying 100µs by 0.2 and 0.8 gives answers of 20µs for the mark period, and 80µs for the space duration.

The circuit has Q and not Q anti-phase outputs. These are provided by standard LS TTL outputs, and the unit is therefore TTL compatible. It cannot, in theory at any rate, be guaranteed to drive CMOS circuits properly. However, in practice the outputs switch between voltages that should enable any CMOS circuits to be driven properly.

## PULSE GEN. CIRCUIT

The full circuit diagram for the pulse generator appears in Fig. 1. This is based on two monostable multivibrators connected in a type of circuit called a "ring" oscillator. The monostables are connected such that as the pulse from one of them ceases, it triggers the other monostable. Provided a pulse is applied to one of the monostables at switch-on in order to initiate oscillation, the circuit will then oscillate indefinitely.

An oscillator of this type is unnecessarily complicated for some purposes, but it is well suited to an application of this type. One oscillator sets the mark duration, while the other sets the space time. This makes it easy to obtain any pulse durations and separations within the pulse time range of the monostables.

Both monostables are of the standard 555 variety. They are actually based on a low power version of the 555, the TLC555CP. In this application it is the higher switching speed rather than the low power consumption that is of primary importance. It aids good accuracy at short mark and space durations. Both monostables have a set of five switched capacitors to provide five ranges, plus a variable resistor to permit the pulse duration to be continuously varied over each range. Although C5 and C11 may look to be about 20p too low in value, the internal capacitance of the TLC555CPs makes up the missing capacitance.

The monostables are of the negative edge triggered type, and will therefore trigger in the required manner on the falling edge of the positive output pulses. However, the monostables are a form of retriggerable

type, and consequently require brief trigger pulses, or the output pulse durations will be stretched by the trigger pulses. A resistor and capacitor network at the input of each monostable provides suitable biasing and pulse shaping.

A common problem with ring oscillators is a reluctance to start. In order to provide reliable operation there must be a circuit to trigger one of the monostables at switch-on. In this case a simple one-shot pulse generator based on TR1 is used to provide the triggering. At switch-on C3 charges up via the base circuit of TR1, momentarily switching on this device. When activated, TR1 pulls pin 2 of IC1 low, and triggers this monostable. TR1 then switches off and enables the circuit to operate normally.

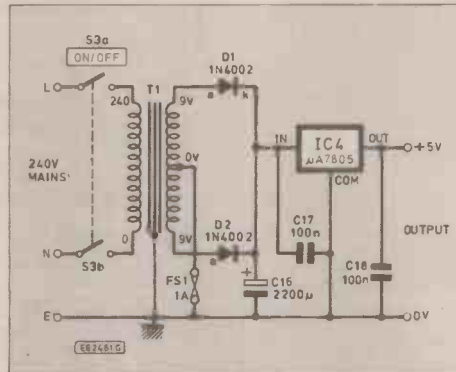

Fig. 2. Circuit diagram for the 5V 1A Power Supply.

## OUTPUTS

The outputs of the two monostables provide complementary Q and not Q outputs. These are buffered by two LS TTL NAND gates (IC3a and IC3b) that provide TTL compatible output levels.

In practice the outputs of IC1 and IC2 would probably be quite acceptable without this buffering, but having genuine TTL outputs avoids any possible compatibility problems. Also, overloads on the output of a ring oscillator can cause it to stall. Having buffers on the outputs should avoid this possibility (but the oscillator can be restarted simply by switching off and then switching on again if it should stall).

As current consumption of the circuit is only few milliamperes, it does not significantly reduce the power available for external units connected to the power supply section of the unit.

## POWER SUPPLY

The power supply circuit (Fig.2) is very simple and very conventional. It has fullwave push-pull rectification followed by a 5 volt monolithic voltage regulator (IC4). The maximum output current is 1 amp. The maximum available output for external circuits is about 980 milliamps or so.

Although at one time bench power supplies for logic circuits often had multiple output voltages and maximum output currents of several amps, this type of thing is not often needed these days. Most logic circuits will work quite happily from a single 5 volt supply rail, and modern logic integrated circuits have relatively modest power supply requirements.

IC4 incorporates output current limiting which protects the unit against overloads and accidental short circuits on the output. Fuse FS1 provides further protection, but is mainly needed in case the circuit itself becomes faulty. It might be necessary to use an anti-surge fuse for FS1 as a quick-blow type might be blown by the initial surge current as capacitor C16 charges up. However, a quick-blow type gives slightly better protection, and proved to be satisfactory on the prototype unit.

## CONSTRUCTION

Construction of a unit such as this can take one of several general forms. At the most simple level the unit can be built as a normal project, with the breadboards being entirely separate. While this may not be the neatest approach, it does have the advantage of making it easy to use the unit with several breadboards. Often two or three circuits are under development at any one time, and with this discrete approach it is easy to have several breadboard circuits, and to connect to the unit whichever one you wish to work on at the time.

Another approach is to have the breadboard or breadboards fitted on top of the unit. This is a simple but effective way of doing things in that it gives quite a compact finished unit which is easy to use, and construction is very straightforward.

Modern breadboards often seem to lack any obvious means of screw fixing, but in some cases they can be fixed via self-tapping screws fitted through holes in the case and into the holes in the bases of the breadboards. In most instances the only options are to glue the breadboards in place, or to improvise some form of mounting bracket, fabricated from sheet aluminium perhaps.

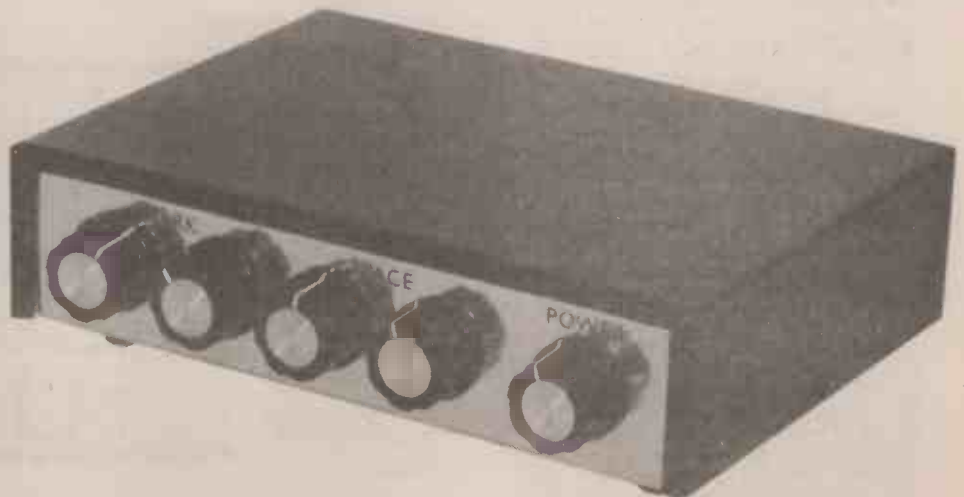

Some Bostik Blue-Tack or a similar adhesive will hold the breadboards in place adequately, and this method has the advantage that it permits the user to easily remove one breadboarded circuit and fit another one in its place. This is the method that was found to be most satisfactory.

A third approach is to build the unit in the normal way, and then to fix it and the breadboards on a fairly large baseboard. The power supply/pulse generator is fitted at the rear of the board, with the breadboards mounted well towards the front. This keeps everything together in one neat unit, but in order to make the unit really useable the baseboard might need to be a little larger than you might expect.

It is very easy to produce a unit which looks very plausible, but which is difficult to use in practice because the breadboards plus components tend to obstruct the controls of the power supply/pulse generator unit. Either leave plenty of vacant space in between the breadboards and the main unit, or mount the main unit on something that will hold it above and well clear of the breadboards.

### P.S.U. AND GENERATOR

Whatever basic form the unit takes, the power supply and pulse generator unit will presumably be constructed as an ordinary cased project first, and then merged with the breadboards in the required way once it has been built and tested. Here we will only consider the construction of the main unit - constructors can please themselves as far as the overall form of the unit is concerned.

The Power Supply and Pulse Generator circuits are built on separate printed circuit boards, details of which are provided in Figs.3 and 4 respectively. This complicates construction slightly, but does make things easier if you only wish to build one or the other of these circuits. Construction of both boards is in the main straightforward. None of the integrated circuits are static sensitive, but we would still recommend the use of holders for IC1 to IC3.

Five link wires are needed on the pulse generator board, and these can be made from 22 s.w.g. tinned copper wire, or just trimmings from resistor leadout wires. The capacitors should be of the specified types or they will be unlikely to fit into the board layouts easily. In the case of the polyester capacitors, they should have 7.5 millimetre lead spacing. Fit pins to the board at the positions where connections to off-board components will be made.

### HEATSINK

There is a slight complication with the power supply board in that IC4 will need to dissipate quite high power levels when the unit is operated at high output currents, and this necessitates the use of a substantial heatsink. The cheapest solution is to house the unit in a metal case which then acts as the heatsink as well. Some means of bolting both IC4's heat-tab and the circuit board to the base panel of the case is then required. (The circuit board must be insulated from the metal case).

Probably the easiest way of achieving this is to use the method outlined in Fig.5. Here IC4 is not mounted on the top side of the board in the usual manner, but has its leadout wires bent upwards at right angles, and is fitted on the underside of the board.

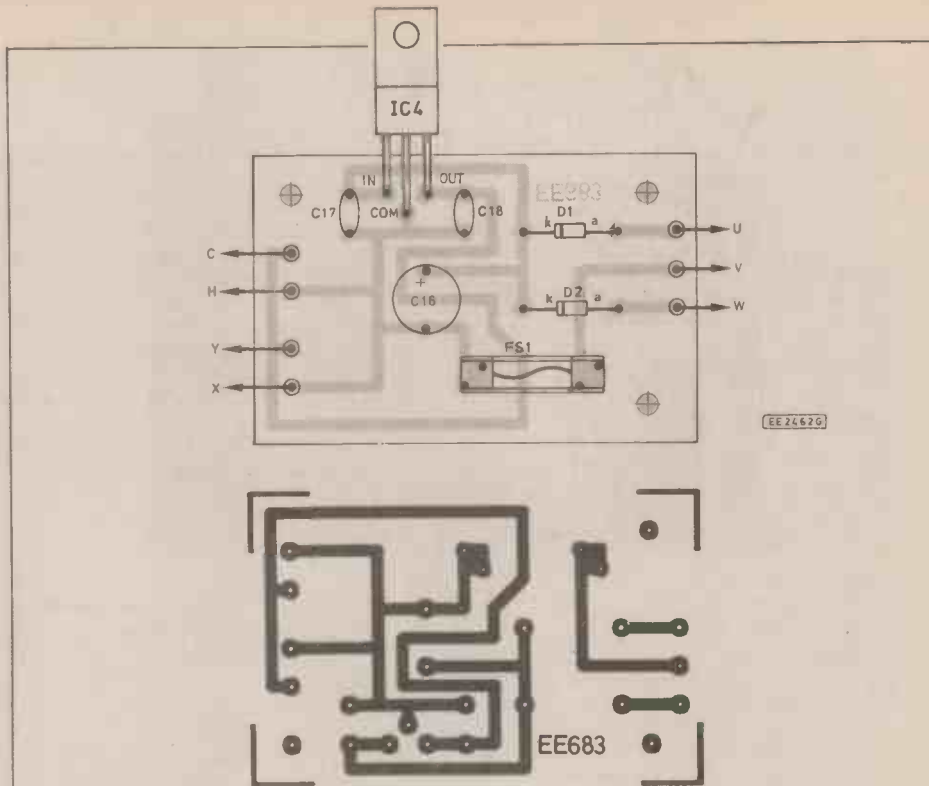

Fig. 3. Component layout and full size printed circuit board copper foil master pattern for the Power Supply. This board (code EE683) and the Pulse Gen board (code EE682) below are available from the EE PCB Service.

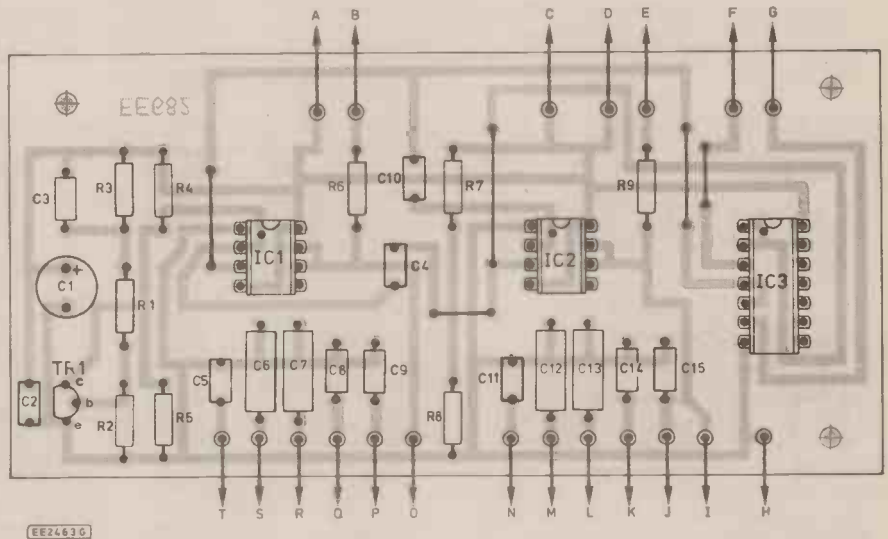
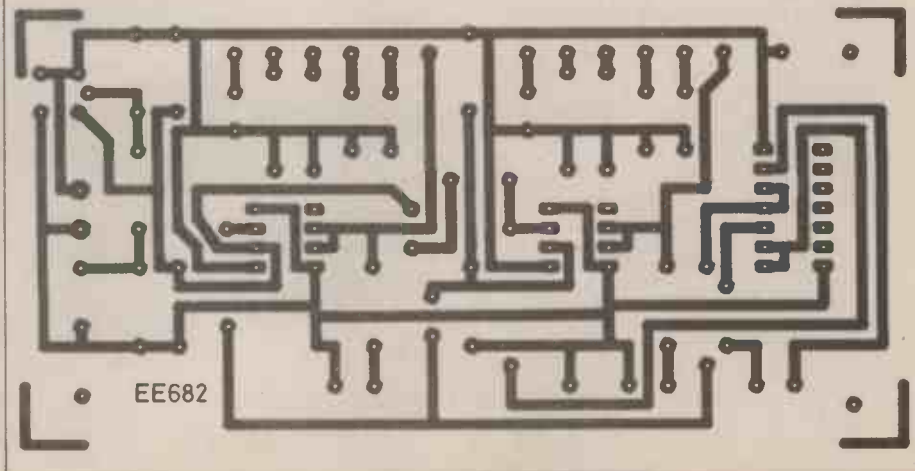
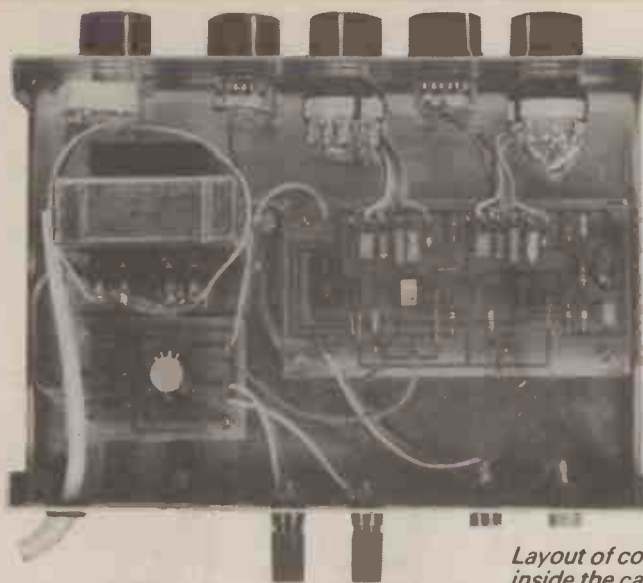

Fig. 4. Pulse Generator printed circuit board component layout and copper foil master pattern.





Layout of components inside the case.

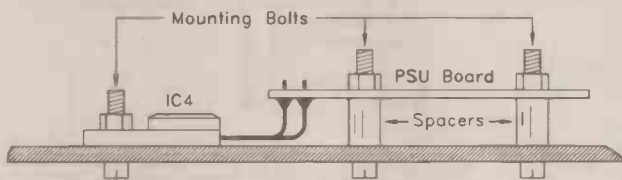

Fig. 5. A simple method of using the bottom of the aluminium case as the heatsink for IC4.

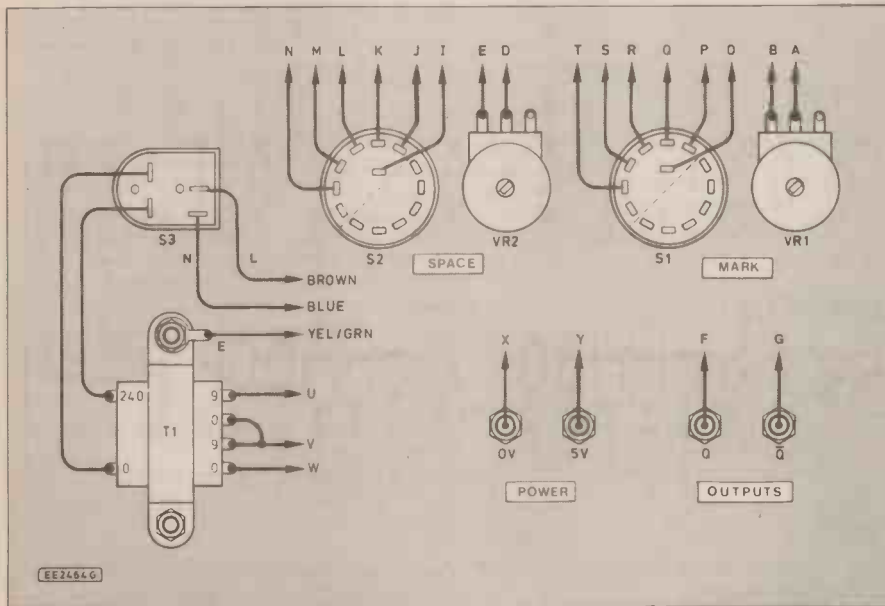
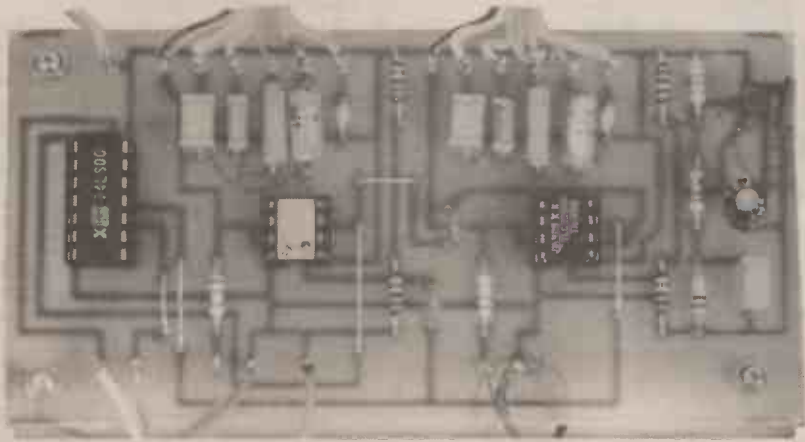

Fig. 6. Details of interwiring to the boards. This is best carried out using multi-coloured ribbon cable.



Using 6 millimetre long spacers on the mounting bolts for the board brings the heat-tab of IC4 close to the base panel of the case, and it can then be carefully manoeuvred into place flush against the panel. The position of its mounting hole can then be marked, after which the board is removed, the hole is drilled, and everything is reassembled again.

Note that no insulating kit is needed for IC4. Its heat-tab connects internally to its common terminal, which connects to the earthed casing anyway.

## COMPONENTS

**Shop  
Talk**

See page 251

### Resistors

R1	4k7
R2	2k7
R3	100k
R4,R5,	
R7,R8	15k (4 off)
R6,R9	180k (2 off)

All 0.25W 5% carbon

### Potentiometers

VR1,VR2 2M2 lin (2 off)

### Capacitors

C1	100 $\mu$ radial elect. 10V
C2,C17,	
C18	100n disc ceramic (3 off)
C3	220n polyester
C4,C10	22p ceramic plate (2 off)
C5,C11	27p ceramic plate (2 off)
C6,C12	470p polystyrene (2 off)
C7,C13	4n7 polystyrene (2 off)
C8,C14	47n polyester (2 off)
C9,C15	470n polyester (2 off)
C16	2200 $\mu$ radial elect. 16V

### Semiconductors

IC1,IC2	TLC555CP low power timer (2 off)
IC3	74LS00 quad TTL NAND gate
IC4	$\mu$ A7805 1A +5V regulator
D1,D2	1N4002 100V 1A rectifier (2 off)
TR1	BC549 silicon <i>npn</i>

### Miscellaneous

T1	mains primary, 9 - 0 - 9 volt 1A secondary transformer
S1,S2	12-way 1-pole rotary switch with end-stop (2 off)
S3	rotary mains switch
FS1	20mm 1A quickblow fuse with p.c.b. mounting holder

Metal instrument case about 206 x 150 x 52mm; pulse generator printed circuit board and power supply printed circuit board, both available from the *EE PCB Service*, order codes EE682 and EE683; red terminal post; black terminal post; green 4mm socket; blue 4mm socket; control knob (5 off); 8 pin d.i.l. i.c. holder (2 off); 14 pin d.i.l. i.c. holder; mains lead; plug; solder pins; wire; solder; etc.

Approx cost.  
Guidance only

**£30**

## CASE

A metal instrument case having approximate outside dimensions of 206 by 150 by 52 millimetres will just about accommodate all the parts. The power supply board and mains transformer T1 are mounted towards the extreme right hand side of the unit, leaving room for the pulse generator board on the left hand section of the base panel. Use six millimetre spacers over the mounting bolts for the pulse generator board - mounting of the power supply board was described above. A solder tag is fitted on one of T1's mounting bolts, and this acts as a connection point for the mains Earth lead. For reasons of safety it is essential that the case should be properly earthed to the mains Earth lead.

## CONTROLS

The five controls are mounted on the front panel with S3 well towards the right hand end of the panel so that it is close to T1. Due to a lack of front panel space I mounted the output sockets on the rear panel, but if a larger case is used it will be possible to accommodate them on the front panel.

I used 4 millimetre sockets for the pulse generator outputs, plus red and black 4 millimetre terminal posts for the positive and negative supply outputs. However, any appropriate types of socket could obviously be used successfully. An entrance hole for the mains lead is drilled in the rear panel of the case near to T1. This hole should be fitted with a p.v.c. grommet to protect the cable.

There is a fair amount of hard wiring needed in order to complete the unit. This is shown in Fig. 6, which should be used in conjunction with Figs. 3 and 4. Each connection point in one diagram connects to the point of the same letter in one of the other two diagrams (point "A" in Fig. 4 connects to "A" in Fig. 6 for example). Ordinary multi-strand connecting wire is suitable for these interconnections, but coloured ribbon cable is probably easier to use and will give neat results with a minimum of effort.

Be very careful when fitting the mains wiring as mistakes here could cause costly damage, and could also be extremely dangerous indeed.



The Power Supply output terminals and the Pulse Generator output sockets on the rear panel. The solderless "breadboards" can be mounted on top of the case and interlocked to form one large board or kept well apart to form several small "test beds".

A 9-0-9 volt transformer is required in the T1 position, but modern mains transformers seem to offer twin secondary windings rather than the centre tapped variety. This does not matter as simply wiring the two windings in series (as shown in Fig. 6) gives the desired result. The wiring of any project should be thoroughly checked before switching it on and testing it, but this is especially important for a mains powered project.

## TESTING

Before connecting the output of the power supply to a circuit it would be advisable to check using a multimeter that the correct output voltage is present. You may like to leave the positive supply lead to

the pulse generator circuit unconnected until this check has been made and the correct output voltage has been verified. If the output voltage is not within about five per cent of 5 volts, switch off at once and recheck all the wiring again.

You really need an oscilloscope in order to thoroughly check the pulse generator circuit. However, it can be checked quite well by driving l.e.d. indicators from the Q and not Q outputs, with a 330 ohm current limiting resistor being used to protect each one. The cathode (k) terminals of the l.e.d.s are the ones which connect to the 0 volt rail. With long mark and space durations selected you will be able to see the l.e.d.s flash on and off as the outputs change state, with one l.e.d. switching on as the other switches off.

At short pulse durations the flashing of the l.e.d.s will be too rapid for the human eye to perceive it properly. However, varying the mark-space ratio of the output signal will alter the apparent brightness of the l.e.d.s. The greater the proportion of the time that an output is high, the brighter the l.e.d. driven from that output will appear to be. □

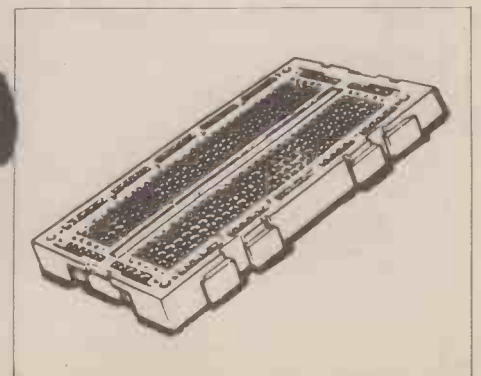
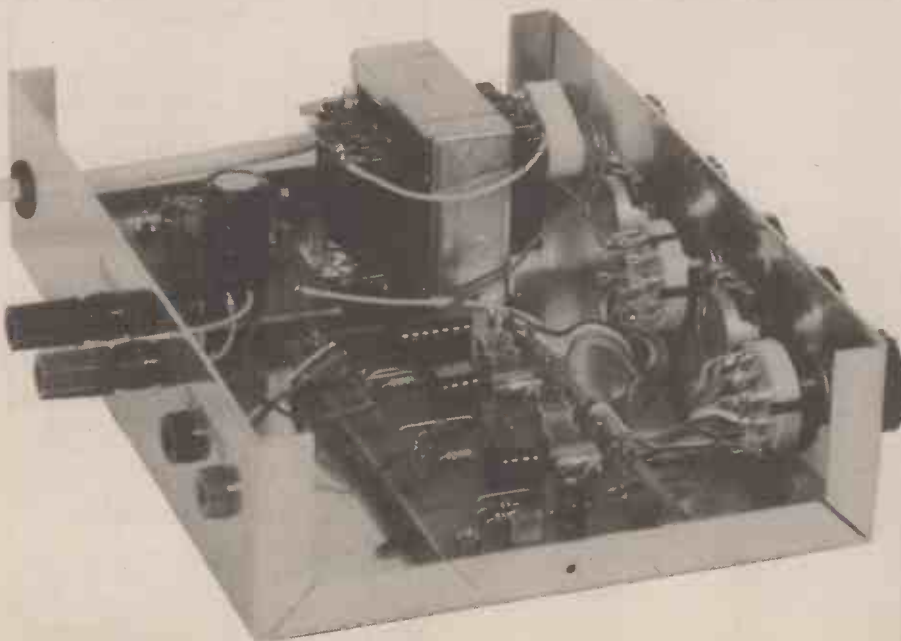

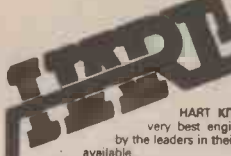

# HART AUDIO KITS — YOUR VALUE FOR MONEY ROUTE TO ULTIMATE HI-FI

HIGH QUALITY REPLACEMENT CASSETTE HEADS



HART KITS give you the opportunity to build the very best engineered hi-fi equipment there is, designed by the leaders in their field, using the best components that are available.

With a HART KIT you have direct access to the friendly HART service, you are not dealing through, or paying for, any middlemen. Every HART KIT is not just a new equipment acquisition but a valuable investment in knowledge, giving you guided hands-on experience of modern electronic techniques.

Telephone or write for our FREE LISTS giving full details of all our Kits, components and special offers. Here are a few selected items.

## AUDIO DESIGN 80 WATT POWER AMPLIFIER

This fantastic amplifier is the flagship of our range, and the ideal powerhouse for your ultimate hi-fi system. Featured on the front cover of the May issue of Electronics Today International, this complete stereo power amplifier offers World Class performance with the option of a stereo LED power meter and a versatile passive front end giving switched inputs, volume and balance controls. Tape, CD players, or indeed any 'flat' input may therefore be directly connected to bypass tone controls or give a 'stand-alone' facility. The amplifier can also be supplied in 'slave' and 'monobloc' versions without the passive input stage and power meter.

All versions fit within the standard 420x260x75mm case to match our 400 Series Tuner range. ALL power supplies are stabilised, the heavy current supplies using the same mosfet devices as the amplifier. The power supply, using a toroidal transformer, is in fact a complete module contained within a heavy gauge aluminium chassis/heat sink and fitted with IEC mains input and output sockets. All the circuitry is on a proper printed circuit with low-resistance blade connectors for the six stabilised DC outputs. HART KITS don't leave you to fasten a few capacitors to the floor of the main chassis and wire the power supply the hard way! Remember with a HART KIT you get the performance you want at the price quoted through proper engineering design and the right components. We do not insult your intelligence by offering a kit at what seems a fair price and then tell you that you have to spend three times as much to get an upgraded model!

**K1100 Complete Stereo Amplifier Kit with LED Power Meter and 3-input Passive Stage. Total cost of all parts is £418.88**  
Our Discount Price for the Complete Kit ..... £385.98  
**K1100S Stereo Slave Version, with plain Front Plate** ..... £309.43  
**K1100M 'Monobloc' mono version, with plain Front Plate** ..... £224.15  
**RLH10 Reprints of latest 'Audio Design Amplifier' articles** ..... £2.70  
**K1100CM HART Construction Manual with full parts lists** ..... £4.50

Reprints and construction manual can be purchased separately and their cost credited against subsequent kit purchase.

All versions are supplied with dual primary mains transformers for use on 220/240v or 110/115v mains. Monobloc price does not include the construction manual.

SPECIAL OFFER until the end of February the K1100 kit will be supplied with the new ALPS low noise precision pots at NO EXTRA CHARGE.

## LINSLEY-HOOD 400 SERIES SUPER HIGH QUALITY AM/FM TUNER SYSTEM

This is the ideal companion tuner to the 80W Audio Design Amplifier in any ultimate hi-fi system with case size, front plate layout and even control pitches unified for stacking. Like the 80W Audio Design Amplifier this is your route to EX+ performance for a few tenths of the cost! Two designs by John Linsley Hood make up this combination of his ultra high quality FM tuner and stereo decoder described in 'Electronics Today International' and the Synchronyne AM receiver described in 'Wireless World'. Novel circuit features in the FM section include ready built pre-aligned front end, phase locked loop demodulator with a response down to DC and advanced sample and hold stereo decoder together making a tuner which sounds better than the best of the high-priced exotics but, thanks to HART engineering, remains very easy to build and set up. The Synchronyne section with its selectable band width provides the best possible results from long and medium wave channels, so necessary in these days of split programming, if you want the very best in real HiFi listening then this is the tuner for you. Since all components are selected by the designer to give the very best sound this tuner is not cheap, but in terms of its sheer sound quality, it is incredible value for money. To cater for all needs AM only and FM only versions are available as well as the full AM/FM model, with any unit being upgradable at any time. For further details see our fully illustrated lists.

**K400 FM Only version, total cost of all parts is £211.90.**  
Our special discount price for complete kit only ..... £189.52  
**K400 AM/FM version, Discount Price for complete kit** ..... £249.08

## STUART TAPE RECORDER CIRCUITS

Complete stereo record, replay and bias circuit system for reel-to-reel recorders. These circuits will give studio quality with a good tape deck. Separate sections for record and replay give optimum performance and allow a third head monitoring system to be used where the deck has this fitted. Standard 250mV input and output levels. These circuits are ideal for bringing that old valve tape recorder back to life. Suitable stereo heads are available at very reasonable prices.

**K900W Stereo Kit with Wound Coils and Twin Meter Drive** ..... £90.68  
**RJ51 Reprints of Original Descriptive Articles** ..... £2.60

## LINSLEY-HOOD CASSETTE RECORDER CIRCUITS

Complete record and replay circuits for very high quality low noise stereo cassette recorder. Circuits are suitable for use with any high quality cassette deck. Switched bias and equalisation to cater for chrome and ferric tapes. Very versatile and easy to assemble on plug-in PCBs. Complete with full instructions.

**Complete Stereo Record/Play Kit** ..... £57.60  
**VU Meters to suit** ..... £3.98 each  
**RLH1 & 2 Reprints of Original Articles** ..... £2.70

Our latest lists also give details of our ranges of specialist high quality AUDIO CONNECTORS and LEADS, cassette decks and seasonal special offers. Write or telephone for your FREE copy. (Overseas 2 IRCs Please, or 5 for Airmail).

Do your tapes lack treble? A worn head could be the problem. Fitting one of our replacement heads could restore performance to better than new! Standard inducements and mountings make fitting easy on nearly all machines and our TC1 Test Cassette helps you set the azimuth spot on. As we are the actual importers you get prime parts at lower prices, compare our prices with other suppliers and see All our heads are suitable for use with any Dolby system and are normally available ex stock. We also stock a wide range of special heads for home construction and industrial users.

**HS16 Sendust Alloy Stereo Head.** High quality head with excellent frequency response and hyperbolic face for good tape contact. £17.86  
**HC40 NEW RANGE High Beta Permalloy Stereo head.** Modern space saver design gives excellent high-frequency response with easy fitting and lower cost. Suitable for chrome, metal and ferric tapes, truly a universal replacement head, with ample quality for Hi Fi decks and cheap enough for car players! ..... £6.85  
**HX100 Special Offer Stereo Permalloy Head** ..... £2.86  
**HRP373 Downstream Monitor Stereo Combination Head** ..... £44.39  
**HQ551 4-Track Record & Play Permalloy Head for auto-reverse car players or quadraphonic recording** ..... £16.79  
**H524 Standard Erase Head** ..... £2.59  
**SM166 2/2 AC Erase Head, Standard Mount** ..... £12.50  
**HS9510 2/4 Stereo DC Erase Head** ..... £8.70  
**HQ751E 4/4 AC Erase Head, tracks compatible with HQ551** ..... £57.06  
We can supply card reader heads for OEMs at very keen prices.

## REEL TO REEL HEADS

**999R 2/4 Record/Play 110mH.** Suits Stuart tape Circuits ..... £13.34  
**998E 2/4 Erase Head 1mH.** Universal Mount. Suits Stuart ..... £11.96

## TAPE RECORDER CARE PRODUCTS

**HART TC1 TEST CASSETTE** Our famous triple purpose test cassette. Sets tape azimuth, VU level and tape speed ..... £5.36  
**DEM1 Mains Powered Tape Head Demagnetizer,** prevents noise on playback due to residual head magnetisation ..... £4.08  
**DEM115 Electronic, Cassette Type, demagnetizer** ..... £8.61

Our new Winter '89 price list is FREE. Send for your copy now. Overseas customers welcome, please send 2 IRCs to cover surface post, or 5 for Airmail.

We now accept inland and overseas orders by post or telephone on all Access, Master and Visa Credit Cards.

Please add part cost of carriage and insurance as follows:  
**INLAND:** Orders up to £20 — £1; Orders over £20 — £2.50; Next day — £9. **OVERSEAS:** Please see the ordering information with our lists.

## QUALITY AUDIO KITS

24hr SALES LINE  
(0691) 652894

ALL PRICES INCLUDE VAT

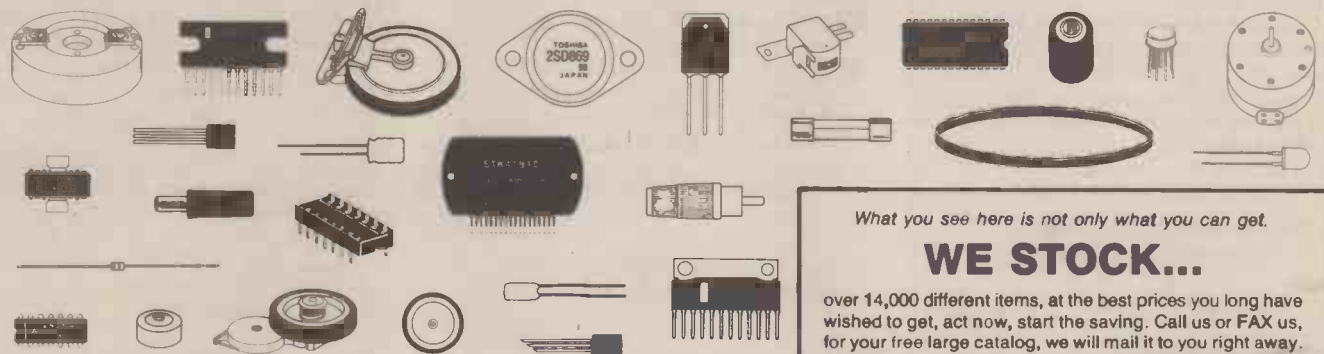

What you see here is not only what you can get.

## WE STOCK...

over 14,000 different items, at the best prices you long have wished to get, act now, start the saving. Call us or FAX us, for your free large catalog, we will mail it to you right away. Or FAX us your inquiry. (213) 727-6032 OR (213) 888-6032

## YOUR RELIABLE ELECTRONIC COMPONENTS SUPPLY

- HIGH QUALITY PRODUCTS
  - BEST PRICES YOU LONG HAVE WISHED TO GET
  - FOR IMMEDIATE DELIVERY & RAPID SHIPMENT
  - ORIGINAL REPLACEMENT PARTS
  - ASK FOR YOUR FREE COPY CATALOG
  - AGENTS & DISTRIBUTORS (IMPORT & EXPORT)
  - WE REPLY TO YOUR INQUIRY IN THE SAME DAY
  - COMPETITIVE PRICES, DISCOUNTS FOR WHOLESALE QUANTITIES
  - WE SHIP YOUR ORDER ON THE DATE OF YOUR CONFIRMATION WITH FAST COURIER
  - SO ACT NOW AND START SAVING
  - IF YOU DON'T SEE IT, ASK FOR IT
  - SPECIALIST IN EXPORT
- We are continuously updating our inventory, let us hear from you of things we do not have, we will give it a study.
- TO ORDER: INFORM US YOUR INQUIRY, OR ASK FOR YOUR FREE FULL CATALOG AND PRICES.**

**DALBANI CORPORATION OF AMERICA**

2733 CARRIER AVENUE  
LOS ANGELES, CALIFORNIA 90040  
UNITED STATES OF AMERICA

Tel: (213) 727-0054  
Fax: (213) 727-6032  
Fax: (213) 888-6032  
Tlx: 3722489

ALL SALES IN U.S. DOLLARS



WE ACCEPT VISA / MASTERCARD

# MICRO IN CONTROL

JOHN HUGHES

Part Five

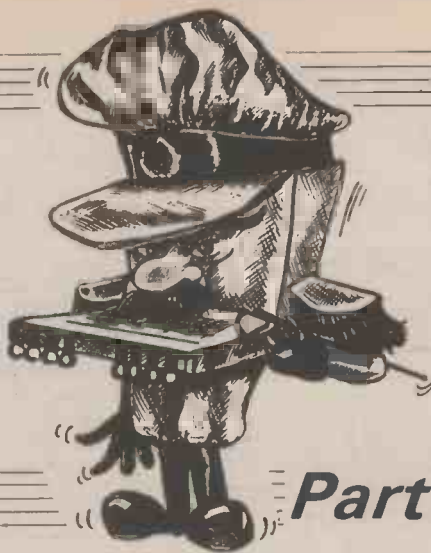

Starting from very basic principles this series quickly builds through logic to simple microprocessor control.

**T**HIS month we get to grips with Sequential Logic and some pulse circuits.

## EXERCISE 10 Does it Count?

**S** How much do we need to know about binary numbers?

**T** A fair amount (I nearly said "bit"), much of which will become apparent as we proceed. As usual, we'll tie the theory in with the practical exercises as far as we can.

We've already talked about a BISTABLE circuit (the "candle" one, which could stay On or Off indefinitely, remember?). Let's build one more circuit around our NAND gates (the 7400 chip which may still be in the breadboard).

Notice how this circuit, using TWO gates, is entirely symmetrical. However, we'll connect an indicator to ONE of its possible output points only, at first, otherwise we'll be bogged down with considering which half is which! (Fig. 5.1).

When you've wired it up, try various input combinations and investigate the behaviour of the circuit.

**S** (eventually) It isn't reliable/it varies/etc.

**T** Perhaps it's reliable, but in an unexpected way?

Try this:

- Leave BOTH inputs at Logic 1, then:
- Switch input A to logic 0 for a moment, then return it to logic 1 and leave it there.
- Next, do the same for input B, that is, switch it BRIEFLY to logic 0, then back to logic 1.

Repeat these momentary logic 0 inputs to A and B in turn, so that you can be sure of the effects. Always leave both at logic 1 afterwards.

**S** One puts it ON, the other OFF, every time.

**T** Exactly. It's a "bistable" circuit, often called a FLIP-FLOP because one input of a logic 0 PULSE flips it ON, the other input flops it OFF. (Actually, the

term "flip-flop" was originally coined for what we now call a "monostable" circuit, not as widely used, though we'll meet it later.)

**S** It's like a switch. If we had two buttons, we could press one for ON, the other for OFF.

**S** I've seen circuits where you press the SAME button to switch ON, then press it again for OFF.

**T** Yes, that's a development we'll use later (a bedside lamp operates as a mechanical version of such a switch, doesn't it?).

**S** And video records and such like have electronic ones, too.

**T** Yes. Now first, let's note the circuit symbol for our bistable or flip-flop. It's often drawn like this (Fig. 5.2). Notice that it's symmetrical. Because the outputs are always the opposite (inverse) of each other, and the symbol Q is used for the upper one, what would you expect for the other?

**S** (after "U", "uke", etc.) NOT Q

**T** Good. In a real flip-flop chip, both outputs are sometimes used, but not always, as we'll see. A bistable of this simple type has many uses, and is called a "SET-RESET" or S-R flip-flop. In a sense, it "remembers" which input was last applied.

**S** A memory circuit, then.

**T** Just so.

Because the output from this circuit

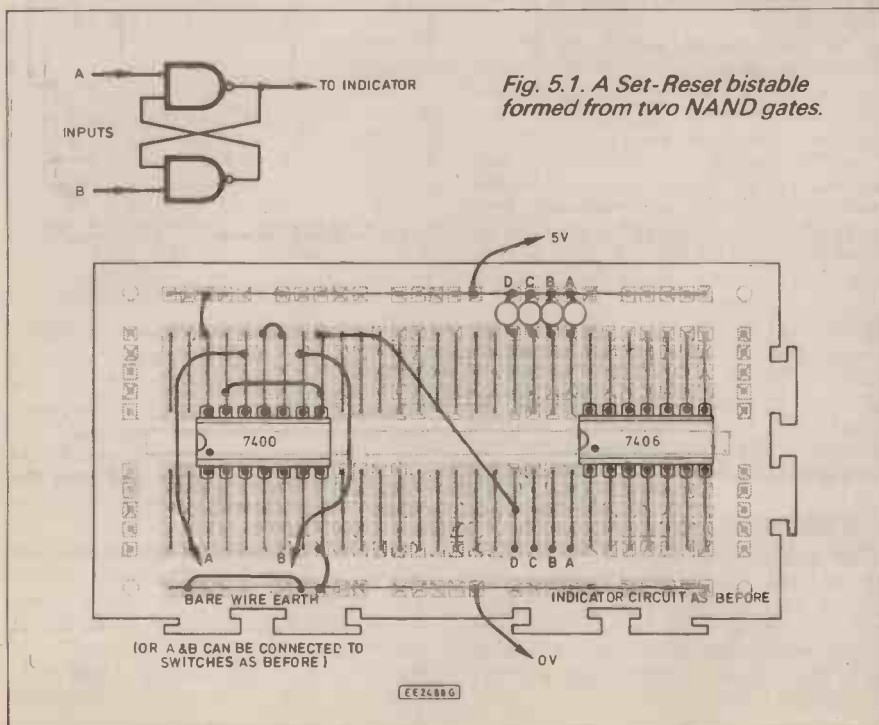

Fig. 5.1. A Set-Reset bistable formed from two NAND gates.

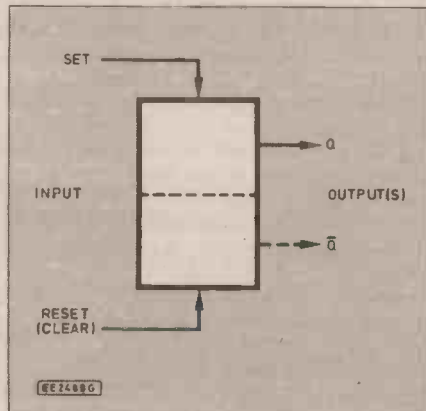

Fig. 5.2. Symbol for an S-R bistable (flip-flop).



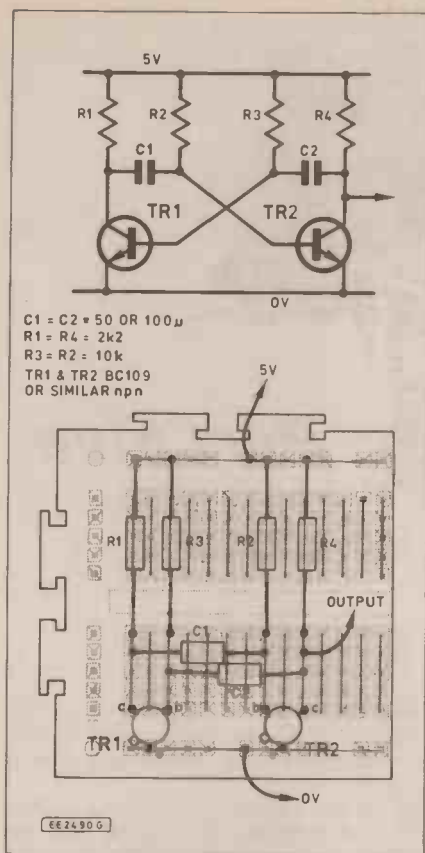

Fig. 5.3. An astable multivibrator using transistors.

depends upon the order (the SEQUENCE) in which inputs are applied, we call circuits of this type SEQUENTIAL LOGIC systems. They, and the COMBINATIONAL LOGIC systems we looked at earlier, form the basis of all digital systems, computers, controllers, and so on.

Among the most widely-used chips are those which COUNT how many input pulses they receive. To study these counter circuits we'll need some PULSE GENERATOR circuits. These can be a lot of fun, too, so let's go.

**S** Are they called "multivibrators"?

**T** Yes, many of them are. In fact the term is used for three related kinds of circuit. The "popular" one is the ASTABLE MULTIVIBRATOR ("astable" means "never stable"). We've already met a form of BISTABLE multivibrator (the one which stays "on" or "off" indefinitely). The third type is the MONOSTABLE one, also mentioned earlier. This one is useful because it gives a single, clearly-defined pulse of a definite duration whenever it's triggered (often by pressing a button). We may need one at some stage.

**S** I suppose there are chips for them all.

**T** Of course. We'll be using them, no doubt. However, it can be instructive to build a circuit using two transistors, such as the ones in your kit. You'll find them in many projects, maybe in this journal. I suggest you use a corner of your breadboard or, better still, a separate small board, for this. Here's the circuit I'd like you to put together now (Fig. 5.3).

**S** This one's symmetrical, too.

**T** Yes, though we'll take an output from one side only for now. How would the possible output from the other side relate to this one?

**S** It would be its opposite/its inverse/its "NOT"

**T** Quite so, because of the symmetry.

Now we'll switch on and see if it generates pulses by linking the output to one of our indicators. Then you can add a second indicator to the other output. OK?

**S** It's just like a motorway fog warning/or a pedestrian crossing

**T** Isn't it? Can you imagine what would be the effect of substituting smaller capacitors for C1 and C2?

**S** It will go faster/increase the frequency.

**T** It will. Try substituting, say 10μ for the 50μ or 100μ you have at present.

**S** Can we try changing just ONE capacitor?

**T** Sure. What do you expect to happen?

**S** It may settle "in-between"/go irregularly?

**T** Have you tried it? Yes, it "limps", because the time ON and the time OFF are no longer equal. We say the "mark/space ratio" has changed.

**S** It was one-to-one before, wasn't it?

**T** Yes, both equal. Now it's more like five-to-one (or one-to-five).

Could you suggest another way to alter the frequency?

**S** Change the supply/change the resistors.

**T** We'd best stick to the same supply, though changing it might affect the frequency a little. Try changing the base resistors, or one of them at least. (Don't reduce them too far, though.)

**S** In case the transistor is overloaded?

**T** Quite. We must always remember this danger.

**S** When you think of it, the resistor/capacitor pair connected to each base will have its "time-constant" changed by altering EITHER component.

**T** You're ahead of me again. Well done. Now I want you to substitute two quite small capacitors, say 0.01μ (0μ01). Keep the original resistors.

**S** Both my outputs are the same/a bit dimmer

**T** Why, do you think?

**S** The frequency is too high for the flickering to be visible/like a cinema or TV picture.

**T** Exactly. Once more, we believe something we can't see. Is there a way we might detect if it's "oscillating"?

**S** Use an oscilloscope? Connected to one output?

**T** We could indeed, and if you get the chance later, please try it. However, here's another way, in which we can use our ears, rather than our eyes.

A useful transducer (energy converter) is a small loudspeaker or earphone. It may not need an amplifier (though if it does, we know how to build one, don't we?). Fig. 5.4 shows how to connect it either with or without an extra amplifier stage. If you try both, you can hear what a difference the amplifier can make.

**S** It's a steady buzz, or note/quite clear/it must be producing a string of pulses/oscillating.

**T** Good. If some of you haven't got the sound, check all the connections. Remember what I said about the fussiness of circuits unless all connections are spot on.

### EXERCISE 11 The mini Wurlitzer.

**T** We mustn't take too long, but we can spare a few minutes to realise that we have here the basis of many kinds of electronic organ. In fact, similar circuits can be used both for controlling machinery and for producing musical sounds.

**S** And some not so musical.

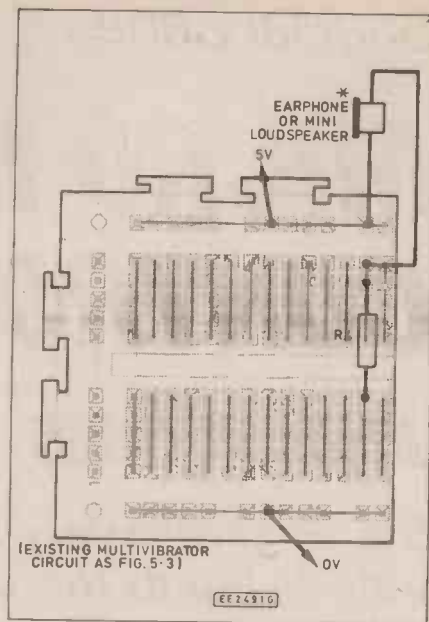
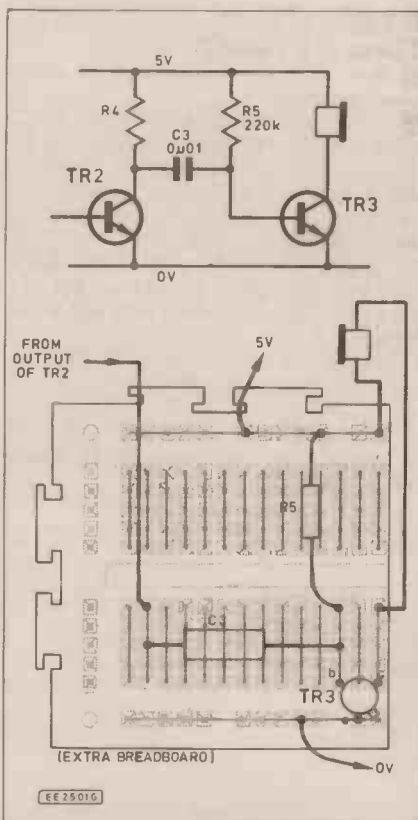

Fig. 5.4(a). Moving coil type earphone or loudspeaker output. (b) Adding an amplifier stage (below).



**T** True again. As a little light relief, here's just about the most elementary circuit I know for an "organ" on which you can actually play a tune. It's only necessary to provide some kind of "keyboard" (it hardly deserves the name as you'll see) which enables us to start and stop the sound, and to control its pitch. Thus to "play" it. (Fig. 5.5)

The trick is to control one of the base resistor circuits by including in it (as well as a fixed "safety" resistor) a contact which can provide different values according to where it is touched on the "keyboard".

**S** I see. The graphitic film has a high resistance, and the oscillation stops if the circuit is broken.

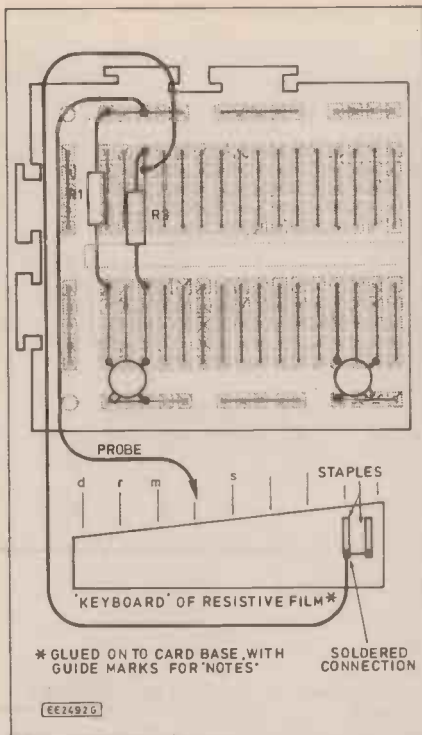

Fig. 5.5 Adding a rudimentary "keyboard" and probe to the circuit of Fig. 5.3.

**T** Exactly. The graphite film can EITHER be a narrow strip of resistive paper (if you can find some) OR just a thick "scribble" from a black pencil (containing graphite, of course). It's important to make sure the staple at one end makes good contact (two staples may be better). It's best to make soldered connections.

**S** (eventually) Mine squawks, rather.

**T** Well, it's not really a Wurlitzer. But you'll find you can improve with practice. Try making a quick, firm contact rather than allowing the probe to "brush" over it. And try to be accurate to get the right pitch. You can mark a sort of "scale" on the supporting card. In fact, the whole thing can be built permanently on a card if you want a souvenir. (Fig. 5.6)

**S** I can produce a sound through me. Listen. (Holds probe in one hand and touches "keyboard" with finger of other hand) It's better if you lick your finger first.

**S** (another) Typical. A LOW sound.

**T** Yes, your body does conduct, then.

Now that we've learned a little about multivibrators, we can go on to meet a "ready-made" chip, the 555. It's also pos-

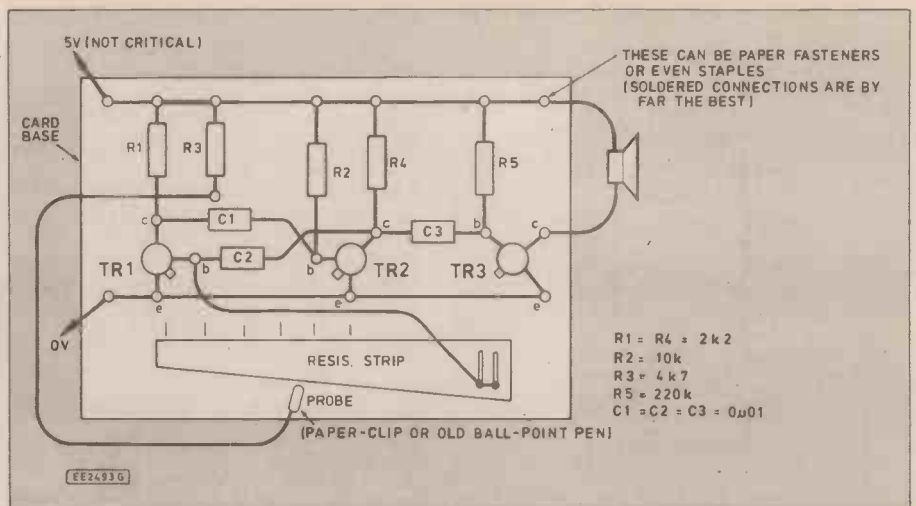

Fig. 5.6. A very mini Wurlitzer can be built on cardboard.

sible to use a TTL i.c. as an oscillator. Here are some circuits you can try when you have time (Fig. 5.7). For now, we'll use our original slow pulse generator, or a ready-made one if available with suitable leads. Maybe some of you will build your own versions, with slow and fast switched options.

**S** Changing the capacitors?

**T** Yes, that's right. Mounted in a box or case, it'll be useful for many tests and exercises.

It would also be useful to have a single-pulse generator (a "monostable"), or just a Set-Reset (S-R) bistable, too. Here are their circuits for those who like to build up their own collection of useful items (Fig. 5.7).

(Notice how the monostable is unsymmetrical, with one half like a bistable, the other like an astable circuit.)

**S** If we use an LDR as a base resistor, we could play tunes by covering and uncovering it.

**S** (another) Or we could use a pot (variable resistor).

**S** (another) or build a proper keyboard with selected or adjusted resistors.

**T** Getting ambitious, now? Well, yes, to all those ideas which, as you can imagine, have been followed up by many enthusiasts. But we must not be tempted further.

**S** (some) Shame!

**T** Leaving the "organ", now to count the pulses. To start with, I'd like to deal with just one pulse at a time, then we'll try out the oscillator.

## EXERCISE 12 The J-K bistable

**T** Firstly, we'll examine a very popular and versatile type of flip-flop. It's called the J-K type, for it has several inputs, including two labelled J and K, as well as the SET and RESET inputs we've already met. It also has a single "central" input called the "clock" input. Like the simple S-R type, it has just two complementary outputs, Q and NOT Q (written thus, remember:  $\bar{Q}$ )

Here is the symbol for a J-K flip-flop, with all possible inputs and outputs labelled (Fig. 5.8). There are two J-K bistables in the 7476 chip. Study its pinout diagram. Note the power supply pins 5 and 13.

**S** Not at the corners this time

**T** No, they're not. What I'd like you to do is to leave the "old" 7400 i.c. where it is, already wired up as an S-R bistable. Then build up the 7476 circuit alongside it on the breadboard thus (Fig. 5.9). Again, we'll only take the Q output to an indicator for now.

Because the inputs, as usual, "float" up to logic 1, we can save time (and switches) by just connecting short wire leads to each input we use. A pulse of logic 0 can then easily be applied just by "earthing" the lead to a bare wire connected to logic 0 (the 0V line). Try it with the SET and RESET inputs (these are often labelled "preset" and "clear" respectively).

Check that, as for our home-brew flip-flop, a 0V dab onto the SET input puts the

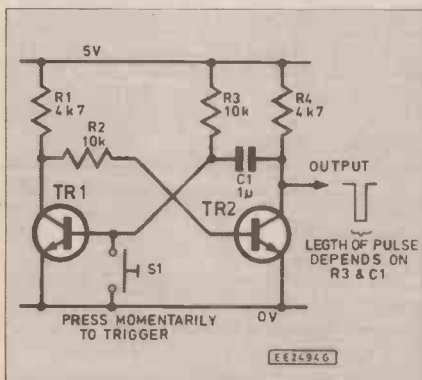

Fig. 7a. Monostable, sometimes called a "one shot".

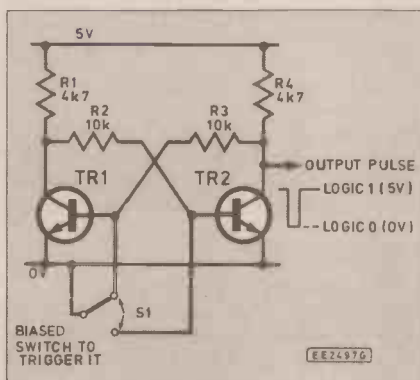

Fig. 5.7b. De-bounced switch (push button) using S-R bistable (transistor version).

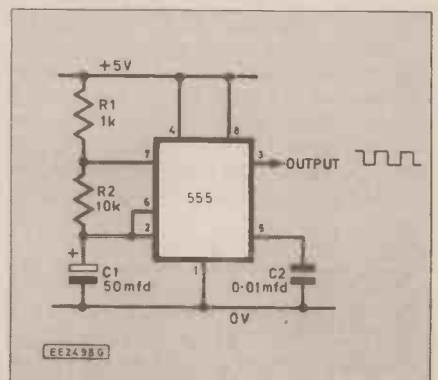

Fig. 5.7c. Using a 555 timer i.c. as a pulse generator.

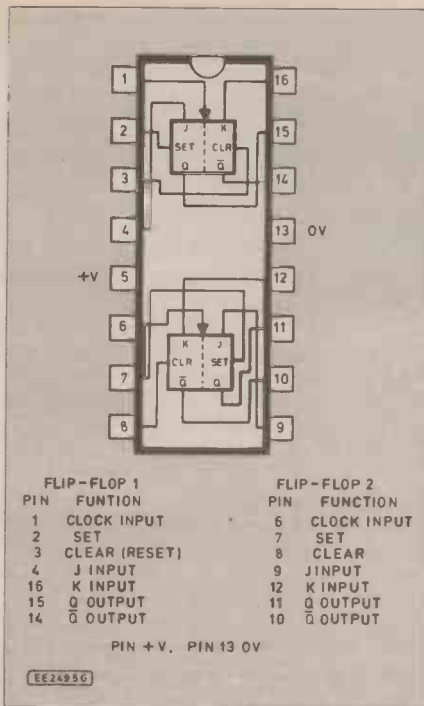

Fig. 5.8. Dual J-K flip-flop type 7476.

output ON, a similar dab onto the RESET input puts it OFF.

**S** You mean, dab the input wire on to the 0V line?

**T** Exactly. This is a way of getting a logic 0 "pulse" onto it.

**S** Seems to work OK.

**T** Good. Now leave these two inputs unconnected (so that they'll float up to logic 1, remember?). Then put a wire lead to the "CLOCK" input pin, and try dabbing that to 0V.

**S** It seems to work erratically/at random/sometimes

**T** Right. As expected.

**S** Why is it called the clock input?

**T** Because, as we'll soon see, it's convenient to use a string of pulses, at a steady rate, (like a clock) to operate sequential circuits. This is the pin they go to. We'll be using a "clock" circuit soon, but for our earliest exercises, we'll use single pulses.

**S** That's why we built our multivibrator oscillator.

**T** Yes. We'll soon be fed up with manual pulsing.

**S** Why are the effects so unpredictable?

**T** They are, aren't they? This is where we'll find a use for the S-R flip-flop. Let me explain:

When we dab our input wire (at logic 1, normally) on to the "earthy" 0V wire, we would see, if we used an oscilloscope, that the contact is very dicey. The wires make contact intermittently as they meet, even if we hold them tightly together afterwards. It's as if we were brushing one wire over the other, so the voltage signal actually reaching the input might look like this (Fig. 5.10).

**S** So it gets several "pulses"?

**T** It does indeed, and, because these TTL circuits are extremely "quick on the draw", each pulse is noted. Now, I didn't mention this before, but what the clock input actually does in this circuit is to change the output over each time it receives a pulse (like the bedside lamp we spoke of some time ago). So, because the intermittent pulses may be few or many in the fraction

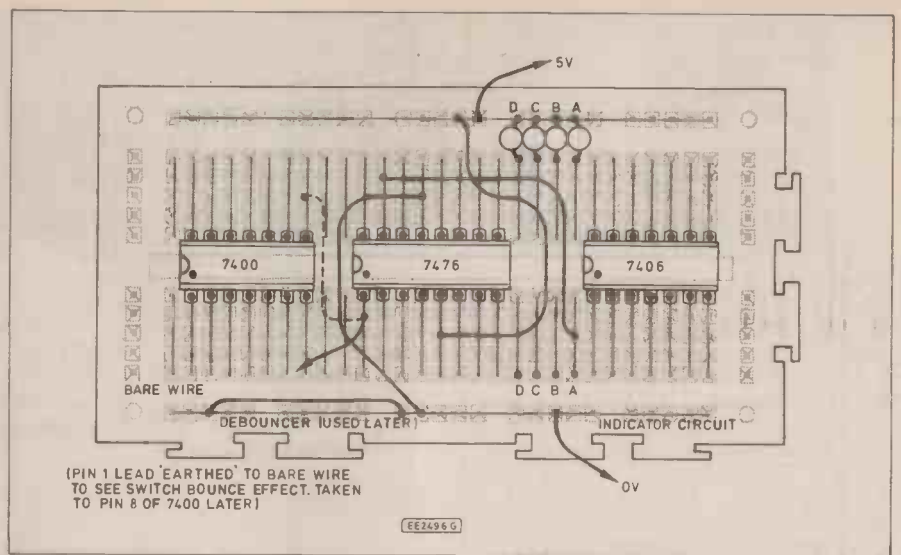

Fig. 5.9. Testing a J-K flip-flop.

of a second it takes to make firm contact, we may end up with the output ON or OFF apparently at random.

**S** Depending if it was an odd or even number of pulses.

**T** That's it exactly.

**S** I tried the proper switch, and it's still funny.

**T** Even a switch produces this effect.

This is where the 7400 circuit is useful. If we link its output to the clock of the 7476, we can send just ONE single pulse to the clock, without any pretty patterns to upset it. We can do it by just moving an "earth" lead (0V) from one to the other of the 7400 inputs A and B in turn. Try it. If you still have an indicator linked to the 7400 output, you'll see that what you are sending is a pulse of 0V, as in the sketch (Fig. 5.11).

**S** Now the final output IS predictable. Is this what's called a "debouncing" circuit?

**T** You're ahead of me. Yes, the intermittent signal (it only lasts a small fraction of a second) is called "switch bounce or contact bounce". Quite a good name for it, don't you think? The 7400 flip-flop is acting as a "de-bouncer" as you said. It deserves to be noted for future use.

**S** Why doesn't the 7400 need a de-bouncer?

**T** Anyone offer an answer to that one?

**S** (after a pause) It doesn't matter how many times the SET or RESET inputs bounce, because after the first pulse, it STAYS set (or reset) indefinitely.

**T** Well done. Any extra pulses have no effect, as you say. But for the 7476 clock, they DO "count". In fact, this brings us to the matter of COUNTING CIRCUITS, which we will investigate next month.

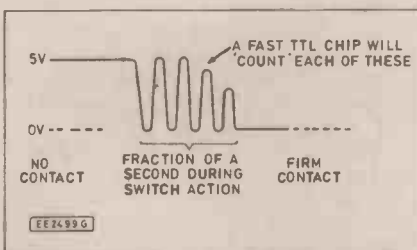

Fig. 5.10. Pattern of voltage applied by an ordinary switch (switch bounce).

Fig. 5.11 (right) Logic 0 pulses from "debounced" circuit.

TABLE 2. Items needed for next stages

**Breadboard:** If desired, extra breadboarding space, though not essential, can save much time by allowing useful circuits to be kept. Additional components, of course, will also be needed for these.

**Resistors and Capacitors:** A few extra values are needed. To the set in Table 1 we can add:

- 2 each 2k $\Omega$ , 10k $\Omega$ , 220k $\Omega$
- 3 capacitors 0.01 $\mu$ F (0 $\mu$ 01 or 10n)

**Semiconductors:** As well as spares, one or two extra npn transistors are needed (e.g. BC108, 2N3704 etc.), and a 555 timer i.c.

**Other items:** A second miniature relay (or a pair) with single-pole two way contacts, will be needed.

At least one push-button or biased (spring-loaded) switch with two-way (changeover) contacts.

By now, it will be realised that alternatives can be chosen. For example, a pulse generator requires either a 555 timer or a two-transistor circuit, but not both. As mentioned in Part 1, components values, too, are rarely very critical, so that reasonable substitutions can be tried.

#### Construction of models

When tackling mechanical assemblies, such as the building of a model lift, the constructor will naturally approach the design in such a way as to use his or her own particular skills. Some may prefer to make use of suitable construction kits. The details given should not be regarded as the only possible design, and individual variations add spice to the process. It should be added, however, that our purposes are better met by a simple model which works reliably than by one which, though visually attractive, is a mechanical or electrical flop! Good building.

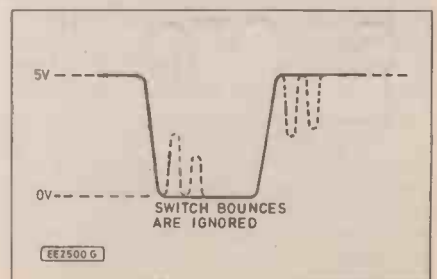

# FOR YOUR ENTERTAINMENT

BY BARRY FOX

## Want to Bet

I recently lost a bet. I'd bet that CT2 would make a dent in cellular phone sales. Now it is clear they won't. The once golden idea has turned to lead. It's the same old story. The one sure way to kill a product is to confuse the public with different and incompatible systems.

The DTI created this mess, by releasing frequencies for digital cordless phones without insisting on a common standard. Both Shaye (formerly Sinclair) and Libera (now Ferranti) spent so much money developing different systems that neither could afford to climb down.

When the rest of Europe saw what was happening and insisted on a standard, the DTI helped create the Common Air Interface. This means there will soon be three incompatible CT2 systems working side by side in Britain.

To stimulate competition, the DTI granted four licences. So to make calls you need to find a base station or "telepoint" which not only matches the technology of the handset (Shaye, Ferranti and in future CAI) but is on the right network.

You need to find a Zonephone for a Ferranti handset, a Mercury Callpoint for a Callpoint Forum handset made by Shaye and a British Telecom Phonepoint for a Phonepoint Forum made by Shaye. Finding the right telepoint will get even more like winning the pools, when the BYPS consortium starts with CAI telepoints — it's worse than VHS versus Beta versus V2000.

## Long Odds

The original talk was of a home base station and cordless handset for around £200, with the cordless phone working — as a bonus — from public base stations or telepoints. Now we have the phone alone costing more than that and home base stations, if and when available, doubling the price.

Although I haven't been given the chance to use a system yet, I understand that range is far less than expected — a very few tens of metres at most, instead of the 200 metres promised.

In London I've only ever seen a couple of telepoint signs although I am sure there are the hundreds we are told there are. BT's transition to card phones and blitz on vandalism, and Mercury's push on card phones too, hasn't helped CT2 either.

When I do radio phone-in programmes I never get a single call on CT2. No-one is interested, and those who are interested are turned off by the confusion. Personally, I wouldn't dream of buying hardware from any operator and paying connection charges.

I reckon CT2 is going to go down in history as the biggest lost opportunity of the new decade. Launch budgets are already fast being swallowed up for virtually no response and as a result sales projections have been scaled down to around half.

PCN (personal communications network), the new generation of pocket cellular phones that work digitally and on much higher frequencies than today's cellphones, is due within a few years. PCN phones will both make and take calls on the move. If PCN prices are reasonable, goodbye CT2.

## Hot Line

The ITV companies are now really running scared. I was recently phoned by a market research company, called Continental Research, who wanted to ask me questions about my TV viewing habits.

Normally I say no, get knotted, to these time-wasting antics. But in this case I wanted to hear what the questions were because I thought I knew who was behind the survey.

After a long and absurdly unsubtle string of questions about which TV stations I watch and which programmes I liked, we finally got to the crunch. It was so obvious I was able to tell the researcher what she was going to ask next.

"Did I approve of the government's plan to throw ITV franchises open to the highest bidder, and did I think that Thames and LWT deserve to get new franchises?"

They won't have liked my answer which was: No, Thames and LWT couldn't even be bothered to publicize the launch of Nicam stereo, which suggests they have lost interest even before bidding for the franchises.

And why have they lost interest? They have a two-pronged plan.

Along with Anglia and Granada, the London stations are already gearing up to become production facilities, for whoever wins those franchises. They could make more money out of making programmes for new franchises than in broadcasting.

The other plan is to take transponders on Astra's second satellite, and broadcast a menu of "the best of London's ITV" from 19 degrees East in competition with Sky. That would make Astra a very hot bird. Thames has taken an option for two

channels on the second Astra satellite due this winter.

One final thought. Whoever drafted the survey questions must be potty. There were so many that most people will either opt out before the end, or start giving ill-considered answers simply to get the researcher off the line.

## Off The Record

It was just recently (Mar '90 issue) that we commented on the task facing would be "pirates" if they wanted to make copies of CD recordings and the further measures that companies would like to take to combat this threat to their income. However, recent events make it only a question of time before the pirates crack the CD problem.

The pointer comes from a recent court case in which the record industry trade bodies the BPI and IFPI, succeeded in putting two pirates in jail. They had been trading unauthorised LPs and CDs of unreleased albums, "The Black Album" by Prince, and Paul McCartney's Russian-only album "Back in the USSR".

In February 1989 Damont Audio of Hayes, received an order to press 2000 CDs of a tape titled "Songs for Tribes" by Mandigo. Damont, which presses only LPs, would have had to sub-contract production to a Swedish CD plant.

The BPI had been keeping a watch on the pirates since the previous June and Damont listened to the "Songs of Tribes" tape. They recognised that it was the Prince recording under a different name. Mandigo is Zulu for black. "Songs for Tribes" was in fact "The Black Album". Damont contacted the BPI who got the West Drayton police to set a trap.

Although justice was done and the two pirates both got jail sentences, the incident points to the way pirates are likely to operate in the future. They will mis-label master tapes on the assumption that at least some of them will sail through the CD production process without anyone either bothering to listen, or recognising the music on the tape for what it really is.

## Direct Sales

The Dell Computer Corporation of Texas has carved itself a market niche by selling computers direct to the public. This cuts out the middle man, or dealer.

On the face of things, this sounds a dangerous idea. Dealers provide pre-sales advice and after-sales service and technical back-up. Or, more accurately, they should.

In the computer business, dealers spring up like mushrooms, and often disappear just as quickly. Sales staff are often horribly ignorant even before clinching a sale; afterwards you have to be very lucky to find someone who both knows and cares. Staff turnover is also rapid.

Although computer manufacturers come and go, too, most of them last longer than most dealers. People who make a product

are more likely to understand how it works (and how it can be repaired) than a shop selling a wide range of different makes.

Founded in Austin, Texas in 1984, Dell started direct sales in Britain, in June 1987. The company promises a complete package of sales and after-sales support, with telephone advice line and on-site maintenance. I admit I was deeply suspicious of the venture when it was first launched, but people who have bought from Dell speak very highly of their technical support and repair service.

Already other computer firms are following suit and selling direct. Dealers have only themselves to blame. If they had done a better job, there would never have been room for Dell's approach.



## SOLDER SPECIAL OFFER

**18SWG RESIN SOLDER**  
60% Tin 40% Lead Melting Point 185°C  
500gm. REEL 1+ 10+ 100+  
**£4.95 £4.70 £3.95**

**22SWG RESIN SOLDER**  
500gm. REEL 1+ 10+ 100+  
**£4.99 £4.75 £3.99**



Orders of 5 or more reels please add a further 75p P&P

### HOME ALARM PACKAGE

includes:

- ★ Optima Alarm Control Panel
- ★ External Red Bell Box
- ★ 2 x 1 Internal Passive I.R.
- ★ 2 x Door Contacts
- ★ Siren for bell box
- ★ 100 mtrs. cable and clips
- ★ Full fitting instructions

**ONLY £115 + £2.50 CARRIAGE**  
(Phone for further details)

### 12V TWIN FLUORESCENT LAMP 12" DOUBLE TUBES

**ONLY £5.99**

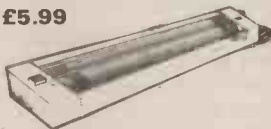

ATTRACTIVE WHITE FITTING, RIBBED PERSPEX  
DIFFUSER, ON/OFF SWITCH, 3FT CABLE,  
TRANSISTORISED CIRCUITRY, KEYHOLE FIXING  
12V DC 8W TUBES. DIMENSIONS: 368x67x43MM.

IDEAL FOR BOATS, CARAVANS, VANS ETC.

### NI-CAD CHARGER

Charges AAA, AA, C, D & PP3 Ni-Cads.  
240V AC.



**£4.99**

### NI-CAD RECHARGEABLE BATTERIES

	PRICE	EACH
AAA	£1.50	10+
AA	95p	85p
C	£1.95	£1.80
D	£2.00	£1.85
PP3	£3.90	£3.75

### ANTEX IRONS

C-15W IRON	£7.65
CS-17W IRON	£7.75
XS-25W IRON	£7.85
XS KIT 25W	£10.85
CS KIT 17W	£10.75
C-KIT 15W	£10.75
ALL BITS FOR IRONS — £1.60	
ELEMENTS £3.95	STANDS £2.99

**ORYX PORTASOL GAS  
SOLDERING IRON**  
**£18.75 TIPS £5.50**

### QUARTZ HALOGEN SPOT-LIGHT

Hand-held or hanging. 12R. Curly cable, 5  
times normal headlamp intensity. On/off  
switch. Simply plugs  
into cigar lighter  
socket.



**£5.99**

Please add £1.50 P&P  
unless stated.

### 12V CHARGER

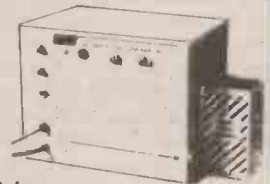

Order  
Code: SO/135

Price — **£11.50 (+£2.00 P&P)**

### 12V RECHARGEABLE UNITS

10 x 'D' size ni-cads (4ah) encapsulated in a black plastic case. Fuse holder. Gives 12V output when charged. Ex-equipment. Fully guaranteed.  
Dimensions: 245x75x75mm  
\* This unit is supplied, depending on availability. Either in 4-pin version or 6-pin version. The price is the same for either version.

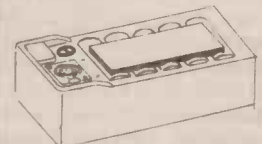

Order Code: SO/132

Price: 1+ **£9.20 (+£2.12 P&P)**

10+ **£8.05 (P&P £4.50 per 10)**

### SURVEILLANCE SCOOP!!



LOWEST PRICES

PRICE ONLY **£149.99**

Simply Add £12 P&P to each order.  
Nothing More to add - V.A.T. Included in price.

### DESOLDERING PUMP

**£2.99**

ORDER CODE  
TOOL/DR30L

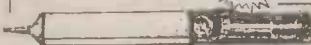

STAR  
BUY

**£5.99**

### ONLY ONE

Hewlett Packard

HP1631D

Logic

Analyzer

**ONLY £4,950**

List price

£14,000

Please ring for

full details

### SATELLITE CONNECTORS F-TYPE

Quick connect twist-on type:

For RG58 cable 25p each

For RG6 cable 35p each

Solderless crimp style:

For RG58 cable 20p each



### ELECTRET MICROPHONE INSERT

10mm diam. 6.5mm thick 3V-10V

(9V typ.) 600ohm. 20-12000Hz

Order Code: AUD/MIC1 **65p**

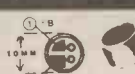

### JUST ARRIVED

### SATELLITE CABLE



CT100. British made. Manufactured by Volex.

Available in 3 lengths - price incl. VAT & P&P

100 Mts ..... **£35.00 per reel**

250 Mts ..... **£85.00 per reel**

500 Mts ..... **£165.00 per reel**

Available by the Metre ..... 0.60 per metre

### "CLOSED-CIRCUIT" TELEVISION SYSTEM



1 x CAMERA 1 x MONITOR 1 x CAMERA BRACKET  
**PRICE: £175 Plus £12.00 carriage**

★ FULL RANGE BABANI BOOKS ★

### TELEQUIPMENT D755 OSCILLOSCOPE

- ★ Dual trace
- ★ 50Mhz delay sweep
- ★ Secondhand — Excellent value

★ Solid state

Full Manuals Supplied  
**£300 (P&P £15)**

### MARCO KITS

Ceramic 50V (125)	£3.99
Electrolytics Rad. (100)	£8.50
Fuse 20mm Q B (80)	£4.75
Fuse 20mm A S (80)	£8.50
Pre-set Pots. Horiz. (120)	£7.75
Pre-set Pots. Vert. (120)	£7.75

### RESISTORS

0.25W Popular (1000)	£6.99
0.25W 5 off (305)	£3.75
0.25W 10 off (610)	£5.10
0.5W Popular (1000)	£10.75
0.5W 5 off (365)	£5.40
0.5W 10 off (730)	£8.75
1W5 off (365)	£15.25
2W5 off (365)	£25.00
Zener Diodes 5 off (65)	£3.99

### PCB EQUIPMENT

### Economy Photo-etch PCB

Good quality board, manufactured in FRG-50 laminate with positive working UV sensitive resist. Boards are protected by a black plastic film.



Available in both single and double sided.

Single sided	Order Code	1+	10+
100x160	PCB/PB/SS1	£1.75	£1.60
100x220	PCB/PB/SS2	£2.05	£1.90
114x203	PCB/PB/SS3	£2.15	£2.00

Double sided	Order Code	1+	10+
110x160	PCB/PB/DS1	£2.05	£1.90
100x220	PCB/PB/DS2	£2.25	£2.10
114x203	PCB/PB/DS3	£2.35	£2.20

### DRILL PRESS



**£85**  
Plus £5.00 carriage.

5 speed single phase, 1/2 hp motor drives 13mm chuck belt

### SOLDERLESS BREADBOARD

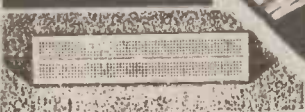

Y035A **£3.50** GL10

No. of contacts ..... 640  
Contact material ..... Silver plated nickel silver  
Dims ..... 175x42x12mm

### FM TRANSMITTER

Very High Quality 'MINI-BUG' - Ideal for Baby Alarm etc !!  
A very good range is obtainable - we have obtained over 1/2 mile, but it does depend on conditions. Simply remove cover - insert battery - and you're ready to go. Reception can be obtained on any FM radio. Frequency: 105-109MHz FM. Power: PP3 9V battery (not included). Dimensions: 4.25"x2.25"x0.75". Order Code - SO.004. Price: £9.99



# STEREO NOISE GENERATOR

ANDY FLIND



*A neat inexpensive experimenters circuit which can provide noise for many applications.*

**N**OISE, electrically speaking, is strange stuff. From the amount of time and effort spent in trying to control it, especially in sensitive circuits such as preamplifiers, it might be thought that it was to be found everywhere in large quantities. When one wants some noise then, it comes as some surprise to find that it is, in fact, quite difficult to generate.

## WHY NOISE?

Why should anyone actually want noise? Well, there are many possible uses for it. Amplified and fed into a loudspeaker, it produces a 'rushing' sound, similar to a waterfall or high wind in trees. The obvious use is in sound effect generators, but the effect on it's own is quite relaxing and thus of interest to people working with Biofeedback and similar projects.

A soothing noise output is far better than a monotonous and irritating tone for a relaxation monitor, for example. 'Pink' noise, where higher frequency components are progressively reduced, has been used with some success to assist patients to relax in medical practice, particularly by dentists. A device is available for use in modern 'open-plan' offices, where the sound produced reduces the chance of conversation being overheard without being too irritating for the occupants.

## NOISE SOURCES

Various circuits using noise generators have appeared in the electronics press from time to time, usually in 'wind and rain' effects projects. The noise sources vary, but common amongst them are Zener diodes and other reverse-biased junctions, such as ordinary silicon diodes and the base-emitter junctions of transistors.

The problem with all these sources is that their output when used in this manner varies considerably between devices, and is

almost always very small. This makes them unsatisfactory for circuits intended for publication, where the performance should be readily repeatable, and the high levels of gain needed to obtain usable output can cause problems of instability. So whilst they might be suitable for a one-off in the designer's workshop, they do not lend themselves well to publication.

Two rather more practical noise sources are the custom 'sound-effects' chip, and 'noise diodes'. The chips work, but most of them have rather high quiescent currents. A standing drain of 45mA is not much use where the power supply is a single PP3 battery! Noise diodes were better.

A device that used to be available from a major supplier had an output of about 100mV r.m.s., and operated from very low current. Unfortunately, it required around twenty volts for operation, which necessitated some form of multiplier circuit in most battery-operated projects, and it became rather expensive. Even more unfortunately however, it disappeared from their catalogue and enquiries revealed that

manufacture had been discontinued! A fresh source of 'noise', therefore, had to be sought.

## PSEUDO-RANDOM

The solution eventually discovered was a 'pseudo-random' generator, using a shift register with its output EXclusive-OR'd with the output taken from a tap partway along its length, and fed back to the input. Fig. 1 shows the basic arrangement in block form. It will be seen that in this case a 33-stage register is used, with the tap at the 20th stage. The object is to obtain the longest possible apparently random output sequence before it repeats itself.

For any given number of steps in the register, there is a tapping that will give this longest sequence. The mathematics are tricky though, so it's best to simply obtain the 'magic numbers' from a reference book! The sequence repeat time obviously depends upon the clock frequency, and with the arrangement shown, a 1MHz clock speed gives a repeat time of about a second, long enough to avoid any suggestion that it isn't actually random for most applications.

Moving to Fig. 2, the arrangement used is shown in more detail. To keep current consumption to a minimum the active devices are CMOS types, the most useful shift register for the purposes being the 4006B device. This is internally organised as four independent registers, two of which are four stages long and two either four or five, depending on connection. The first provides a total of sixteen stages, and with the first four-stage of the second gives the twenty stages to the tap. The remaining stages, used as two fours and a five, take the total to thirty-three. A 4070B provides the EXclusive-OR function, and since it has three more gates available, two of these serve as the clock generator.

It is possible for this circuit to enter a state where, if output and tap are both low, the output of the EX-OR gate will also be low, so it will have nothing but low states circulating around it and the resulting output will appear to be a continuous low condition. To prevent this a simple 'self-starter' has been added, using the 1M resistor and 100nF capacitor at one input to the gate. If the output from the tap is continuously low, the resistor will soon pull the gate input high, setting the circuit into correct action.

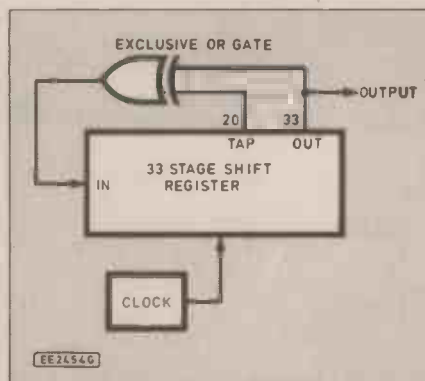

Fig. 1. Basic noise generator arrangement.

# COMPONENTS

## Resistors

R1	27k
R2	1M
R3 to R6	22k (4 off)
R7 to R10	10k (4 off)
R11, R12	33k (2 off)
R13 to R16	47k (4 off)
R17, R18	4k7 (2 off)

All 0.6W metal film type

## Capacitors

C1	10pF ceramic
C2, C6	100n miniature polyester layer (2 off)
C3, C4	470pF polystyrene (2 off)
C5	100μF radial lead elect. 25V

## Semiconductors

TR1, TR2	BC184L silicon npn (2 off)
IC1	4070B CMOS quad Exclusive-OR gate
IC2, IC3	4006B CMOS shift registers (2 off)
IC4, IC5	CA3080E transconductance amplifiers (2 off)

## Miscellaneous

P.C.B. available from the *EE PCB Service*, order code EE681; 14-pin d.i.l. sockets (3 off); 8-pin d.i.l. sockets (2 off);

Approx cost. **£10.50**  
Guidance only

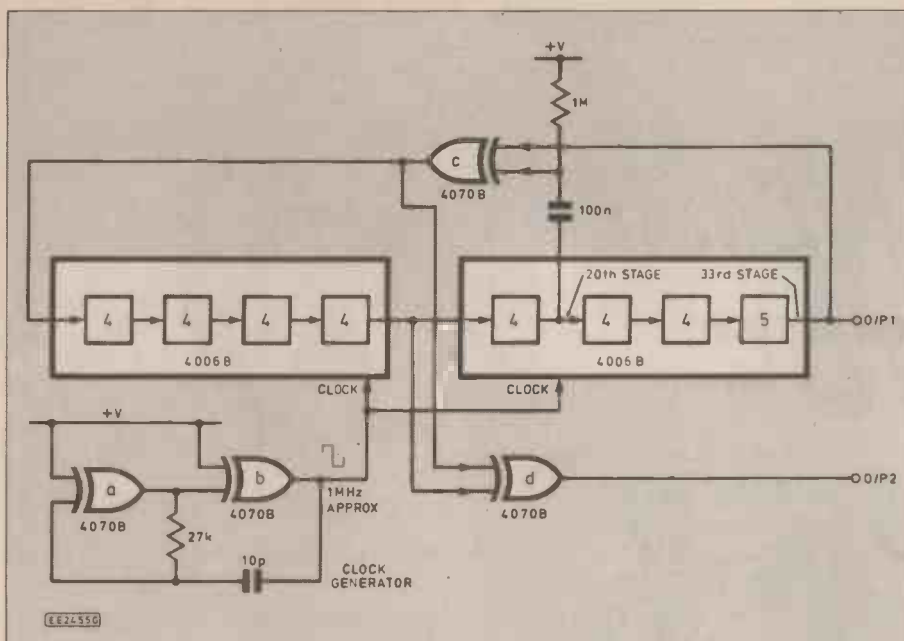

Fig. 2. Noise arrangement in more detail

## STEREO NOISE

Mono noise, whilst more useful than simple tone for many applications, can still lack that certain 'something'. Stereo, given by a separate noise source for each channel, gives an immediate impression of 'depth', like wind in tall trees or rushing water.

Simply picking off two more tapping points from the circuit and combining them in the remaining gate of the EX-OR chip produces a second output. Obviously this is related to the first, but on the scope they look totally different and played through an amplifier they certainly sound 'right'. Maybe some of you mathematicians out there might like to try and work out the relationship between them, but for the present the circuit is providing what most definitely sounds like a bona-fide stereo noise source.

This is a project for experimenters, possibly for use in other designs, so to make it more useful (and interesting) an extra fea-

ture is included; independent voltage control of the output amplitude from each channel. This feature is optional, as are the output buffers; notes on this will be given later following details of construction.

## FULL CIRCUIT

Turning to the full circuit of Fig. 3, the clock consists of IC1a and IC1b, connected as a simple astable running at approximately 1MHz. This drives the clock inputs, pin 3 on both IC2 and IC3. The output from the first four stages in IC2 is taken from pin 8 straight to the input of IC3, pin 1.

The output from IC3 is taken from pin 9, and EX-OR'd with the output from the 20th stage tap, from pins 4 and 13, by IC1c. The output from this gate is passed back to IC2's input, pin 1. It also goes to IC1d, where it is EX-OR'd with a tap from stage 16, pin 8 of IC1, to give the second output. Variable gain is provided by

a pair of transconductance op-amps, IC4 and IC5. The polarity of output of these depends upon the input, but the output current depends on the 'bias current' fed to pin 5, in this case through R11 and R12.

The outputs are also pulled towards half the supply voltage by, respectively, R13 and R14, and R15 and R16. Thus the amplitude of the output is symmetrical about the centre of the supply voltage, with amplitude governed by the voltage applied

Fig. 3. Full circuit of the Stereo Noise Generator.

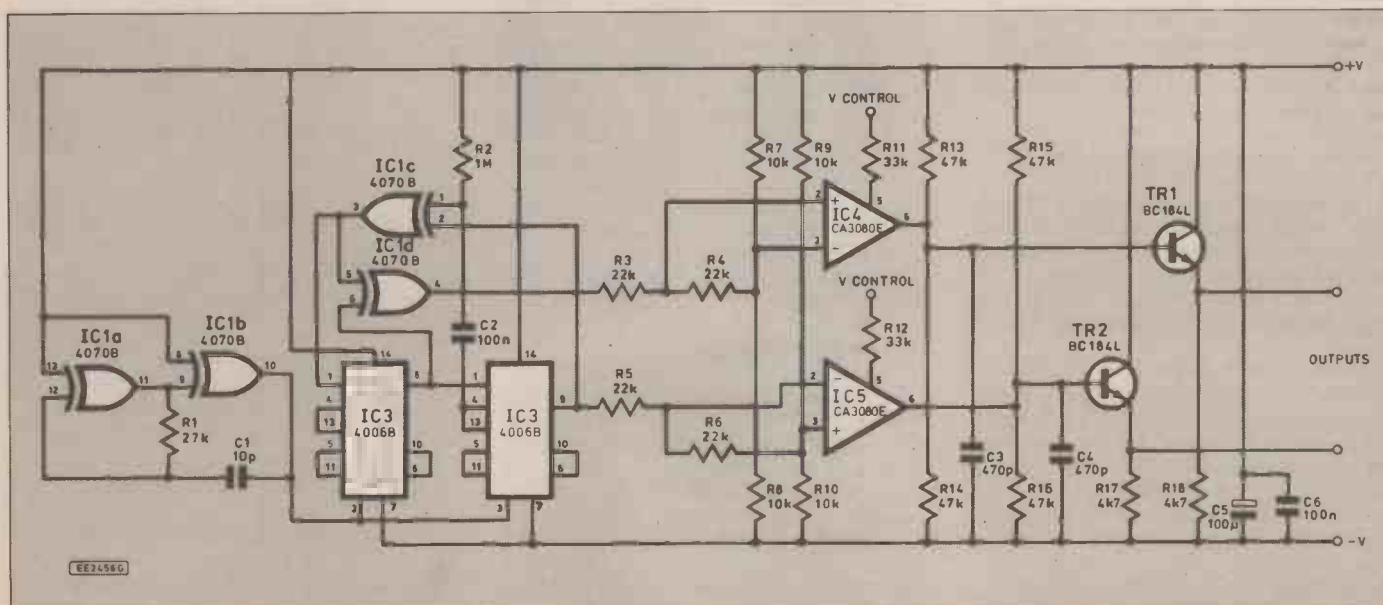

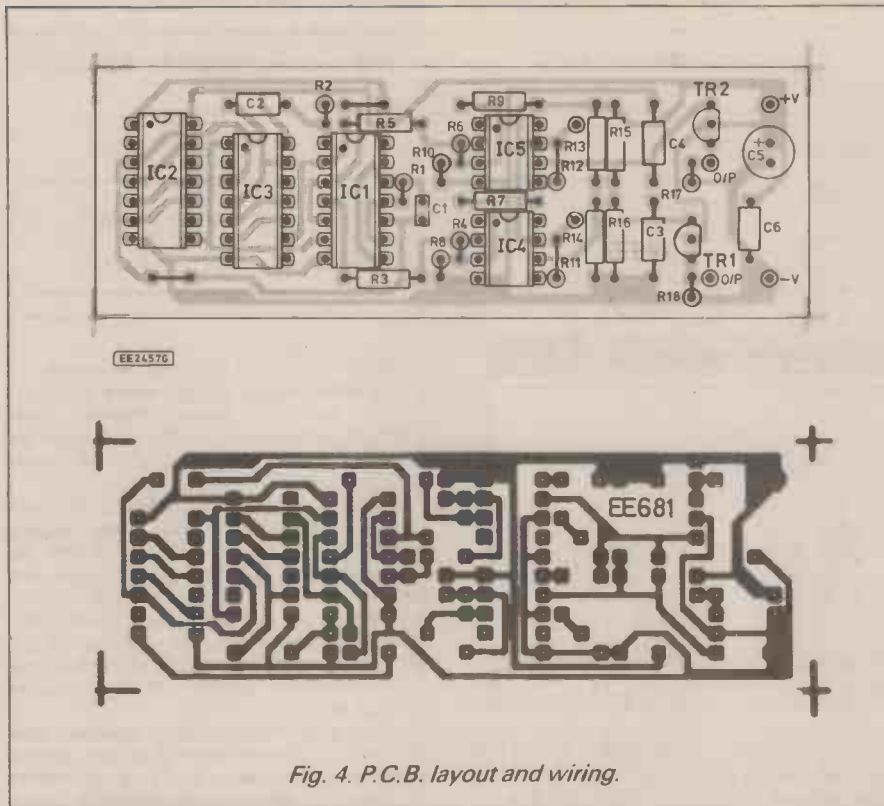
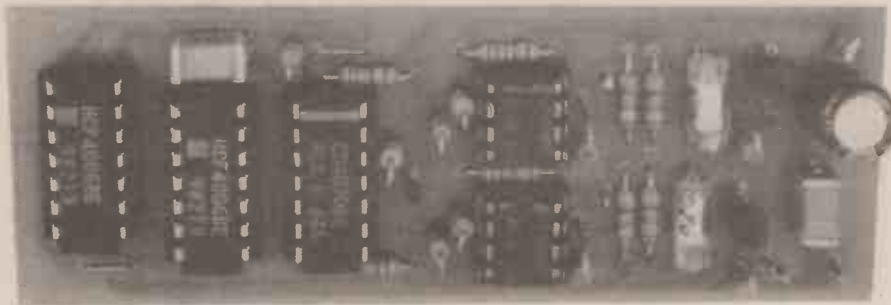

Fig. 4. P.C.B. layout and wiring.



to R11 and R12. The output at this point still jumps between just two levels, however. To shape it into something more like true analogue noise, low-pass filtering is required.

The simplest filters possible are quite adequate, provided by C3 and C4, which give a corner frequency around 15kHz. This gives a noise bandwidth covering the full audio band. Finally, since the outputs have a fairly high impedance, they are buffered by transistors TR1 and TR2, here used as emitter followers. C5 and C6 decouple the supply rails to the circuit.

## CONSTRUCTION

Construction is straightforward, though this project does have a fairly compact layout so care and a fine-tipped soldering iron are required. The positions of all components are shown in Fig. 4. Sockets are advised for the five i.c.s, which should not be plugged in at this stage.

Veropins are useful for external connections as they make life easier and avoid frequent soldering of the p.c.b. itself, which can cause track damage. Check C5 is fitted the correct way round when positioning it on the p.c.b.

The board may be used with supplies from 5V to 15V. Testing should start with the application of a 10V supply, and checking of the voltage at the two outputs. Without IC4 and IC5 in place, the two

output transistor bases will be at half supply voltage, so the outputs should be 0.6V below this, or 4.4V.

Next, IC1, IC2 and IC3 should be plugged in and the power reapplied. A check on IC1 pin 10 should show roughly 5V, indicating that the clock is running. If a 'scope is available, the clock waveform can be observed — an approximate squarewave. Checks on IC1 pin 4 and IC3 pin 9 should similarly show about half-supply, indicating that they are switching, in other words the shift-register section of the circuit is operating. Following this, IC4 and IC5 can be fitted, the two control inputs shorted together and fed from a 10k pot across the supply as shown in Fig. 5, and the outputs monitored with a scope or amplifier. The classic noise signals should appear from both channels, and their amplitudes should be variable from zero to full with the pot.

## OPTIONS

Some options are possible with this circuit if some of the features are not required. Firstly, if the voltage control option is not needed, it can be omitted by leaving out amplifiers IC4 and IC5 and all the resistors save R1, R2, R17 and R18. The points for pins 2 and 6 for each amplifier should be linked. This will convert each side of the circuit to Fig. 6a, where the low-pass filters are still operational at about the same cut-

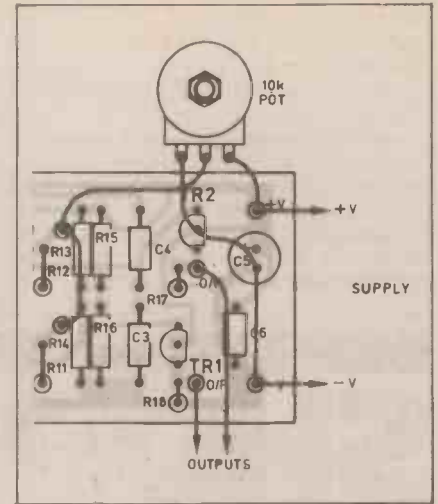

Fig. 5. Connections for testing the unit.

off frequency, together with the transistor buffers.

The two emitter resistors R17 and R18 could be replaced with pots as shown in Fig. 6b for a really simple gain control circuit; log pots should be used for audio volume control applications. The value of the coupling capacitor will depend on the input impedance of the circuit to be driven. D.C. voltages across gain pots can give unpleasant effects as they are varied though, so the arrangement of Fig. 6c may be better for some applications.

Finally, the buffers can also be dispensed with, and the output taken directly from

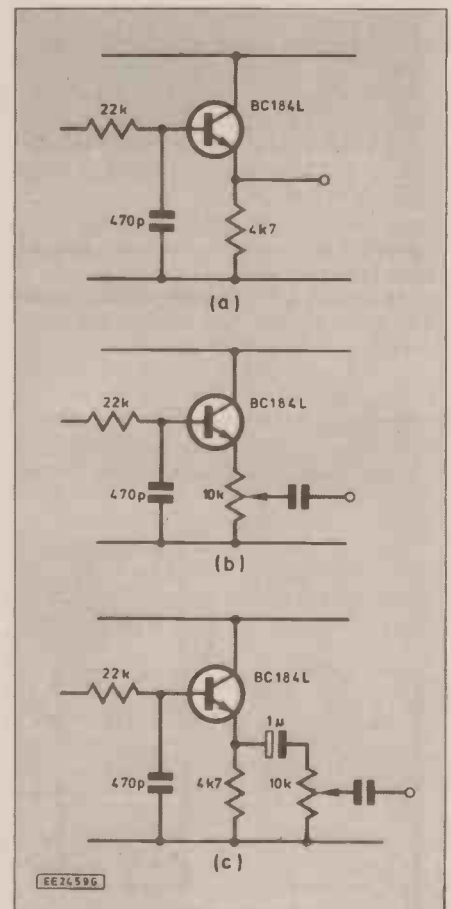

Fig. 6(a). Simple output circuit. (b) Output circuit with simple gain control. (c) Alternative improved output with control.



their base connection points on the p.c.b. This is not recommended for driving impedances of less than 100k, though. If the position of the 22k and 470pF components is altered suitably, and the decoupling capacitors dispensed with (they may not be necessary in some circuits) the right-hand section of the board may be scrapped, leaving a dual noise generator only about 30mm x 45mm in size.

Some typical performance figures for the circuit for different supply voltages and configurations are shown in Table 1. □

Table 1. Performance details for Stereo Noise Generator.

Supply Voltage	Passive filter only		Transistor buffers		Buffers with IC4, IC5	
	Supply	Output	Supply	Output	Supply	Output
5	1.5mA	420mV	2.3mA	430mV	2.5mA	0-280mV
10	5.5mA	760mV	7.2mA	770mV	7.6mA	0-660mV

# SHOP TALK



BY DAVID BARRINGTON

## EE Weather Station

Looking through the parts lists for the *Rainfall Gauge* and the *Sunlight Recorder*, this month's concluding projects for the *EE Weather Station*, only a couple of items look as though they could cause local sourcing problems.

The slotted opto-switch used in the *Rainfall Gauge* is the standard version and *not* the one with an integral Schmitt trigger. The standard version should be available from most component suppliers.

As far as we can ascertain, the dual version of the diode/transistor opto-isolator used for both the *Rainfall* and *Sunlight* circuits is a standard device and stocked by most advertisers. This "i.c." appears to be listed with two similar type numbers, namely ILD or ISD74, but both should work in this circuit.

The 5-digit l.c.d. counter/display modules used for the two display readouts were purchased from Maplin, code FS 13P (Counter Module). The 5in plastic funnel for the rain collector should be available at any Supermarket store under their kitchenware accessories section.

The three printed circuit boards, codes EE685, 686 and 687, are obtainable from the *EE PCB Service*— see page 288.

Returning to the *Anemometer* project (Feb '90), we understand that the frequency-to-voltage converter LM2917 (IC2) comes in two differing packages.

The 8-pin device should be used as the printed circuit board is designed around this version. The type number for this i.c. is LM2917-N8.

The 14-pin package will necessitate alterations to the p.c.b. The internal make up of the two packages is shown for guidance.

## Enlarger Timer/Exposure Meter

The only item required for the *Enlarger Timer/Exposure Meter* that requires special attention is the relay. The 12V relay contacts should be rated at least 10A 240V a.c. and be a p.c.b. or 0.1in. matrix mounting type. The one used in the prototype model was an ultra miniature, high power mains relay purchased from Maplin, code YX97F (10A Mains Relay).

The four-pole shrouded inline plug and four-pin chassis socket used in the model are Bulgin types and most component advertisers should be able to supply these. If any readers do have difficulties, they may be obtained from Maplin, codes HL33L (Mains Plug SA2367) and HL34M (Mains Socket SA2368). As the leads to the sensor are not high current carrying, it is not essential to use the inline mains plug and socket, but for safety reasons these must be fully insulated types.

As part of the printed circuit board carries mains voltages, it is most important that the unit be disconnected from the mains when carrying out *any* work on the circuit board. The printed circuit board is available from the *EE PCB Service*, code EE684 (see page 288).

codes 115-023 and 126-590 respectively.

The 7mm cermet presets were also purchased from the above company, code 187-270. However, most parts stockists should be able to offer a suitable preset potentiometer.

The dual precision multivibrator i.c. type 4538B may cause some local supply problems but it is currently listed by **Cricklewood, Cirkit, Electrovalue and Omni**. Tricolour l.e.d.s are now widely available and should not cause any problems. Alternative devices for TR1/2 and IC2 are: BC479 or any general purpose *pnp* transistor and a 4070 Exclusive OR-gate i.c.

Autotype connectors and connecting wire can be purchased from a garage spares counter, or any auto spares store. When connecting the unit to the vehicle it is *most important to disconnect* the car battery first and to double-check the wiring *before* reconnecting!

## Frost Alert

The "negative coefficient" thermistor used in the *Frost Alert* — this month's "pocket-money" project — is one from the range of miniature disc types. (The number 61-0200 is **Rapid Electronics** (☎ 0206 751166) catalogue code and is not a component designation).

The one chosen has a resistance of 5k at 25°C and a suitable type should be stocked by most good component suppliers. Some suppliers may offer one rated at 4.7k which, as both devices are rated at plus or minus 10 per cent tolerance, should work in this circuit. In some instances however it may mean that the values of resistors R3 and R5 may require adjustment.

## Digital Experimenter's Unit

The only point to emphasize when about to purchase the components required for the *Digital Experimenter's Unit* project, is to make it clear to the salesperson that you require the "low power" version of the 555 timer i.c. This i.c. will be designated with the letters TLC and is stocked by most of our component advertisers. It is quite possible that the ICM version will work in this circuit but it has not been tried.

The two printed circuit boards — EE682 (Pulse Gen) and EE683 (PSU) — are obtainable from the *EE PCB Service*, see page 288.

## Stereo Noise Generator

There do not appear to be any parts listed in the "comp list" for the *Stereo Noise Generator* that will cause readers local sourcing problems.

When ordering the BC184L transistor it is important to specify the suffix *L* for this device as other versions have different pin connections. The small single-sided printed circuit board is available through the *EE PCB Service*, code EE681 (see page 288).

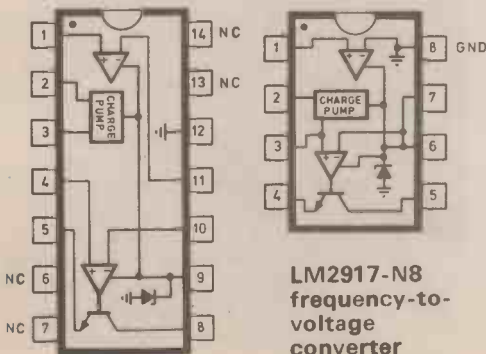

## Engine Efficiency Meter

With the tight packing of components on the stripboard for the *Engine Efficiency Meter*, it follows that some components will have to be scrutinized for physical size rather than values. This applies particularly to the preset potentiometers and capacitors.

Capacitors C2 and C3 should be sub-miniature polyester types and C1 and C4 ceramic axial types. The ones used in the designer's model are all RS types available through Electromail (☎ 0536 204555)

# REPORTING AMATEUR RADIO

TONY SMITH G4FAI

## MICROSATS UP

AMSAT (the Radio Amateur Satellite Corporation) successfully launched its first multiple satellite mission at 01.35 hours on 22 January. Six satellites were lifted by an *Ariane* launch vehicle together with the European Space Agency's primary mission, *SPOT-2*.

The amateur radio packet satellite *PACSAT* is sponsored by AMSAT North America. *DOVE*, (see EE, Feb) is to be used for amateur radio and educational applications, and is sponsored by AMSAT Brazil. *WEBERSAT* was developed by students at Weber State College, Utah and will, among other things, photograph earth from space with a special CCD camera, storing the results in its on-board computer memory to be downloaded later as packets to ground stations.

*LUSAT* is basically a clone of *PACSAT* and is AMSAT Argentina's first satellite. *UOSAT-D* also has digital store-and-forward facilities, but at a much higher data rate of 9600 baud, continuing the University of Surrey's existing programme in this field, while *UOSAT-E* contains a number of experiments including an on-board camera.

An AMSAT Launch Information Network Service was relayed worldwide from the USA and from the European Space Agency's launch site at Kourou in French Guiana. I tuned in to AMSAT-UK's own pre-launch net on 3.777Mhz at 0030 hours and listened to excited amateurs calling in for the latest information, particularly as the launch had been aborted six minutes before take-off 24 hours earlier. At 0100 the relayed information service from the States came through and the clamour of activity around the frequency died away as everyone settled down to listen to the commentary.

## APPLAUSE

Excitement was intense as lift-off time approached and the applause heard from the control room at Kourou as the rocket went up, and again as the satellites were deployed some twenty minutes later, must have been echoed by the thousands of amateur enthusiasts around the world avidly following the course of events.

AMSAT are to be congratulated on the good quality of their transmissions which were received without any problem, except for a short period ten minutes after lift-off when, unbelievably, some idiot tuned up his rig dead on the frequency blotting out the commentary!

At 0200, when I reluctantly switched off, preparations were in hand to activate the radio systems on the satellites in the coming hours. At the time of writing, a few days later, good signals are being received from all of them.

It was a most interesting and exciting event. It has even made me feel I ought to try satellite operating myself. That's the only trouble with amateur radio. There

are so many different aspects, all very absorbing and time consuming, it just isn't possible to try everything you'd like to, especially if you are already enjoying other facets of this incredibly varied hobby.

## MORE FROM THE SHUTTLE

According to the W5YI REPORT, ambitious arrangements are being made to cover two forthcoming space shuttle flights. The shuttle *Columbia* is due to be launched for a ten day mission on April 26, when Dr Ron Parise, WA4SIR, will operate voice and packet amateur transmissions, and on June 4, the shuttle *Atlantis* will begin a five day mission when the pilot, Lt. Col. Ken Cameron, KB5AWP, will operate voice and packet, plus slow and fast scan amateur TV.

The orbital track of both missions will put the shuttles out of range of American stations so AMSAT-NA is to establish ground station networks to relay communications from Africa, Australia, Mexico, South America and possibly Japan. Amateur satellites, commercial satellite channels, shortwave links and other telecommunications facilities will be used for this live hook-up.

Co-ordinating stations will broadcast 24 hours a day on most amateur bands and using these as their source VHF and UHF repeaters across the USA can re-transmit the material for local dissemination. The network will carry official NASA Mission commentary, frequent bulletins to advise amateurs of planned transmissions by the astronauts and all two-way voice and TV transmissions with the spacecraft.

## SCHOOL REPORT

A prime objective is school participation. A pre-flight videotape shows the astronauts explaining their equipment, and includes an orbital tracking map and much other information, plus an explanation of amateur radio. Each astronaut will make at least one transmission on NASA video and audio circuits to show their stations and a post-flight video will be made available to all clubs and schools taking part.

Additionally, AMSAT-NA and the American Radio Relay League (ARRL) are co-sponsoring a Teleconference Radio Net feeding most amateur repeaters in the USA. This will enable youngsters in schools, with the help of individual amateurs or clubs, to share directly in the flights. Many will have their questions answered and some may even be able to speak directly to the astronauts.

## THE BEST LAID PLANS

The proposed expedition to Bouvet Island by an American team of radio amateurs and scientists reported previously was cancelled just before Christmas. This was due to the non-availability of the hired ship for a proposed expansion of activities to

include operation in other sub-Antarctic islands. A month long search for a suitable alternative had been unsuccessful so sadly a decision was made to postpone the expedition indefinitely and perhaps permanently.

In the meantime, the rival Norwegian Club Bouvet expedition set out to land on Bouvet some five weeks before the proposed American landing for a planned 23 day stay on the island. Despite their own disappointment, the American team sportingly put out a press release encouraging support for the Norwegian expedition which went on the air with the call 3Y5X on December 28 attracting a massive "pile-up" of stations around the world anxious to work them.

## BANNED COUNTRIES

It is always pleasing to report occasions when the fraternal nature of amateur radio overcomes artificial barriers between nations. I found it rather disappointing therefore to see a list of countries, published recently under the international radio regulations, which have banned contacts with certain other countries.

For example, six countries ban contacts with South African amateurs, and seven with Israel. Bahrain prohibits contacts with any country with which it is "at variance", and six others permit contacts only with countries with which there is "reciprocity".

Obviously feelings run high between some of these countries and where there are hostilities security considerations have to be taken into account. Nevertheless amateur radio by definition is a non-political activity providing opportunities for friendly co-operation within technical and non-controversial fields.

Last year (March 1989) I reported that restrictions on contacts between Russian and Israeli amateur stations, and with those in certain other countries, had been lifted. It would be nice to see this liberalisation being taken up by some of the other countries still restricting their radio amateurs.

## CHANGING AUDIENCE

Robin Harwood VK7RH, in a recent issue of *Amateur Radio* journal of the Wireless Institute of Australia, comments on the changing pattern of shortwave listening audiences around the world. Fifty years ago, he says, the majority of the audience was in Europe and North America while today it is predominantly in Africa and Asia where TV is not so prevalent.

However, he reports, broadcasting organisations have found a 300 per cent increase in their mail from eastern Europe and the USSR since "Glasnost", and DX clubs are springing up in the latter, particularly in the Baltic region and around Moscow. The demise of many jammers makes it much easier to receive Western broadcasts while mail restrictions have been abolished.

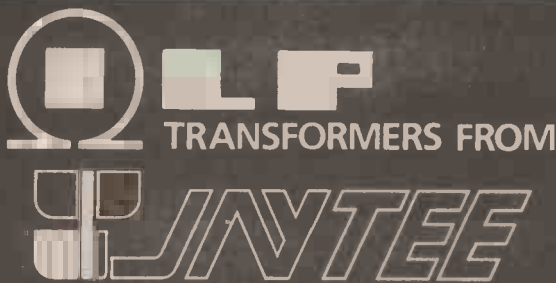

## The UK Distributor for Standard Toroidal Transformers

- \* 106 types available from stock
- \* Sizes from 15VA to 625VA
- \* Dual 120v primaries allowing 110/120v or 220/240v operation

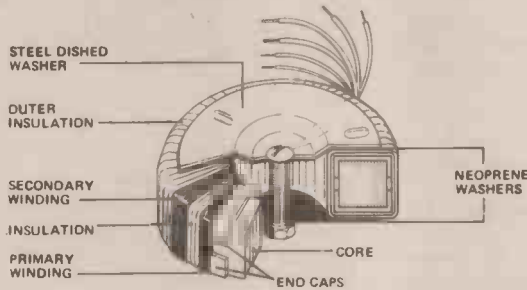

TYPE	SERIES NO.	SEC VOLTS	RMS CURRENT	TYPE	SERIES NO.	SEC VOLTS	RMS CURRENT
15VA £9.80	03010	6+6	1.25	160VA £17.70	53011	9+9	8.89
	03011	9+9	0.83		53012	12+12	6.66
	03012	12+12	0.63		53013	15+15	5.33
	03013	15+15	0.50		53014	18+18	4.44
	03014	18+18	0.42		53015	22+22	3.63
	03015	22+22	0.34		53016	25+25	3.20
	03016	25+25	0.30		53017	30+30	2.66
30VA £11.20	13010	6+6	2.50	225VA £19.35	63012	12+12	9.38
	13011	9+9	1.66		63013	15+15	7.50
	13012	12+12	1.25		63014	18+18	6.25
	13013	15+15	1.00		63015	22+22	5.11
	13014	18+18	0.83		63016	25+25	4.50
	13015	22+22	0.68		63017	30+30	3.75
	13016	25+25	0.60		63018	35+35	3.21
50VA £12.75	23010	6+6	4.16	300VA £21.10	73013	15+15	10.0
	23011	9+9	2.77		73014	18+18	8.33
	23012	12+12	2.08		73015	22+22	6.82
	23013	15+15	1.65		73016	25+25	6.00
	23014	18+18	1.38		73017	30+30	5.00
	23015	22+22	1.13		73018	35+35	4.28
	23016	25+25	1.00		73026	40+40	3.75
23017	30+30	0.83	73025	45+45	3.33		
80VA £14.10	33010	6+6	6.66	500VA £27.95	83016	25+25	10.0
	33011	9+9	4.44		83017	30+30	8.33
	33012	12+12	3.33		83018	35+35	7.14
	33013	15+15	2.66		83026	40+40	6.25
	33014	18+18	2.22		83025	45+45	5.55
	33015	22+22	1.81		83033	50+50	5.00
	33016	25+25	1.60		83042	55+55	4.54
33017	30+30	1.33	83028	110	4.54		
120VA £15.00	43010	6+6	10.0	625VA £30.65	83029	220	2.27
	43011	9+9	6.66		83030	240	2.08
	43012	12+12	5.00		93017	30+30	10.41
	43013	15+15	4.00		93018	35+35	8.92
	43014	18+18	3.33		93026	40+40	7.81
	43015	22+22	2.72		93025	45+45	6.94
	43016	25+25	2.40		93033	50+50	6.25
43017	30+30	2.00	93042	55+55	5.68		
43018	35+35	1.71	93028	110	5.68		
43028	110	1.09	93029	220	2.84		
43029	220	0.54	93030	240	2.60		
43030	240	0.50					



Prices include VAT and carriage

Quantity prices available on request  
Write or phone for free Data Pack

Jaytee Electronic Services

143 Reculver Road, Beltinge, Herne Bay, Kent CT6 6PL  
Telephone: (0227) 375254 Fax: 0227 365104

# D-MM GOOD VALUE!

Cirkit's new range of Digital Multimeters offer a quite unbeatable combination of features and value:



- Ranges include: frequency, capacitance and temperature
- Housed in strong ABS cases
- Overload protection on all ranges
- Full one year warranty
- 3½ digit, auto zero, auto polarity LCD, plus low batt indication
- 200 hour battery life
- All meters supplied with test leads, battery and manual

## TM5315B

- Remarkable value
- 18 ranges
- 10A dc current

dc volts: 200mV-1kV  
ac volts: 200V, 750V  
dc current: 200uA-10A  
resistance: 200Ω-20MΩ

Continuity and diode test  
Basic dc accuracy: ±0.8%  
Size: 128 x 72 x 33mm

Price £19.99

## TM5375

- Frequency measurement to 20MHz
- ac/dc current to 10A
- 24 ranges

dc volts: 200mV-1kV  
ac volts: 200mV-750V  
dc current: 200uA-10A  
ac current: 200uA-10A

Resistance: 200Ω-20MΩ  
Frequency: 2kHz-20MHz  
Continuity, diode & HFE test  
Basic dc accuracy ±0.5%

Price £36.75

## TM5365

- 30 ranges
- Frequency & capacitance measurement
- Compact size

dc volts: 200mV-1kV  
ac volts: 200mV-750V  
dc current: 200uA-10A  
ac current: 200uA-10A

Resistance: 200Ω-2000MΩ  
Frequency: 2kHz-200kHz  
Capacitance: 2nF-20uF  
Logic, continuity, diode and HFE test

Price £37.90

## TM175

- Freq. measurement to 10MHz
- Capacitance measurement 1pF to 20uF
- 39 ranges

dc volts: 200mV-1kV  
ac volts: 200mV-750V  
dc current: 200uA-10A  
ac current: 200uA-10A  
Resistance: 200Ω-2000MΩ

Capacitance: 2nF-20uF  
Frequency: 2kHz-10MHz  
Continuity, diode, HFE, logic & LED test.

Price £57.49

## TM135

- Temp. measurement
- Capacitance measurement
- 40 ranges

dc volts: 200mV-1kV  
ac volts: 200mV-750V  
dc current: 200uA-10A  
ac current: 200uA-10A

Resistance: 200Ω-2000MΩ  
Temperature: 200°-750°C  
Capacitance: 2nF-20uF  
Diode, HFE & continuity test

Price £45.95

## TM115

- 0.5% accuracy
- Transistor HFE test
- 26 ranges

dc volts: 200mV-1kV  
ac volts: 200mV-750V  
dc current: 200uA-10A  
ac current: 200uA-10A

Resistance: 200Ω-2000MΩ  
Continuity, diode & HFE test  
Basic dc accuracy ±0.5

Price £33.67

Prices Inc VAT.  
Please add 90p for p&p.

# Cirkit



Cirkit Distribution Ltd.  
Park Lane, Broxbourne, Herts EN10 7NQ.  
Telephone (0992) 444111.

# ACTUALLY DOING IT!

by Robert Penfold

**E**LECTRONIC components, like any other product, have a limited commercial lifespan. Sooner or later, every electronic component becomes obsolete and goes off the market. Often an old component is replaced by an "improved" type that will more or less directly replace the original. In some cases though, components are dropped by manufacturers with nothing comparable being offered in their place.

Fortunately, in most cases components are available for a long period of time, and even after they are no longer manufactured, stocks at wholesalers and retailers usually remain available for a year or three. It has to be admitted that occasionally components do seem to disappear from the marketplace rather suddenly, probably leaving some constructors with 90 per cent of the parts for a project, with little chance of ever getting the other 10 per cent.

## WINDING-UP

Fortunately this sort of thing is extremely rare, and even if you should get caught out, presumably a fair percentage of the components for the project could be reused in other designs. Please do not blame publishers and authors if components should suddenly disappear. We have no control over component manufacturers and suppliers. We can only ensure that all the parts are available at the time a project is published. Thereafter it is down to market forces, and other circumstances beyond our control.

It is worth repeating a much given warning here. If you decide to build a project published some time ago, check on the availability of any unusual components before buying any of the parts.

If a high-tech component such as a specialist integrated circuit is given the "chop" by the manufacturer, there is probably little or nothing that the home constructor can do in order to remedy the situation. There might be a broadly similar device available from another manufacturer, and revamping the relevant stage of the project to use this component might give satisfactory results. This is not something for the beginner to try though, and is strictly for those with a reasonable grasp of electronics theory and a fair amount of practical experience.

## COILS

With the more simple components it might be possible to improvise something. An obvious example of this is coils. At one time there were several ranges of coils available from at least three different manufacturers. These days there seems to be a choice between Japanese "Toko" coils

on the one hand, and nothing or perhaps a different range of "Toko" coils on the other hand.

This has left a lot of radio circuits in books and magazines, including some quite recent publications, that are based on coils that are no longer available. In particular, supplies of the very popular "Denco" range of coils seem to have "dried up" over the last year.

The advice of not to start buying the components for any project unless you are sure that you can obtain all the components, is presumably "cold comfort" to someone who has designs for some receivers that they would like to build, with none of them using currently available coils. Some recent readers' letters would tend to suggest there are a number of people in this position.

If you like to experiment and have a reasonably adventurous nature, there is the alternative of winding your own coils. There is no guarantee of success, but in practice it is usually possible to improvise something that will provide results not that far removed from good quality ready made coils.

These notes are aimed primarily at those who have radio circuits for which the specified coils can no longer be obtained. However, they should be of value to anyone interested in dabbling with radio designs.

## FERRITE AERIALS

Probably the easiest coils to make are ferrite aerials. To be honest, winding your own is probably not necessary anyway. In my experience these components are largely interchangeable, and if the particular ferrite aerial specified in a book or article is not available, a type that is obtainable (such as one from Cirkit) should be quite suitable. There can be a slight problem in that the physical size of the alternative aerial is likely to be different.

If the substitute aerial is a bit smaller, this will probably make little difference to the performance of the set, and electrically it will probably

be of little significance. Obviously there could be problems with a larger aerial, simply because it might not fit into the available space.

Cutting ferrite is not an easy task, and using a larger case is an easier option. If you really must trim a ferrite rod down to size, probably the best method is to use a hacksaw to cut a groove right around the rod at the point where the divide must be made. The deeper the groove the better, and with a good hacksaw blade you might even be able to cut right through the rod. Ferrite is very hard though, and in trying to cut right through you will probably only succeed in blunting a few hacksaw blades! As well as being very hard, ferrite is also very brittle. With the groove made, you should find that the rod can be fairly easily broken at this point.

It is perhaps worth mentioning here that any ferrite component, but especially expensive ones such as large pot cores, should be treated very carefully. Even dropping one a couple of feet onto a hard floor could result in it smashing into numerous pieces.

With a complex component such as a pot core, anything more than a few minor chips will probably render the component useless. Surprisingly perhaps, with a ferrite rod that has been accidentally broken in two, using some tape or super-glue to join the two pieces together will often give perfectly satisfactory results.

## DIY APPROACH

If you decide to take the d.i.y. approach, a medium wave ferrite rod can be made using the basic scheme of things shown in Fig. 1. An aerial of this type has a main winding, and a much smaller coupling winding. The smaller winding is left unused in some circuits, and should obviously only be included if it is actually needed. Wind the main coil first (22 s.w.g. enamelled copper wire is suitable), using bands of tape to hold the ends of the winding in place, and to prevent the winding from springing apart.

When winding any coil, keep all the turns running in the same direction, with no doubling back so that some turns go in the opposite direction. With a medium wave

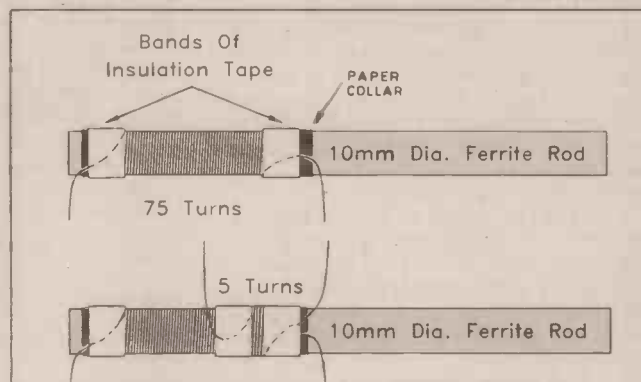

Fig. 1. Details of a simple DIY ferrite rod aerial. The small winding is not always needed.

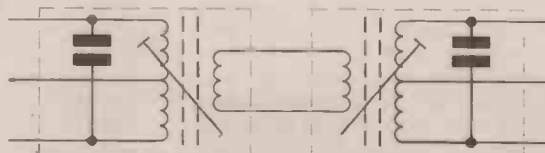

Fig. 2. Using two single tuned I.F.T.s to act as a double-tuned type.

coil there should be no difficulty in winding it neatly in a single layer with the turns as close together as possible. Once the main winding is in place the smaller coupling winding can be added. Again, use bands of tape to hold the leadouts and the winding as a whole in position.

#### MOVING COIL

With some radios, especially the superhet types, it is necessary to have the ability to slip the aerial coil up and down the ferrite rod for alignment purposes. In these cases a simple solution is to make a paper tube or collar about 60 to 75 millimetres long, and fit it over the ferrite rod. An easy way of making the tube is to roll some paper around the rod until it is a few layers deep, trim it off, and then use some tape to hold the tube together. The coil is then wound onto and fixed to the paper former, rather than direct onto the rod.

If a long wave coil is required, about 175 turns of thin (approximately 32 s.w.g.) enamelled copper wire should suffice. This is wound several layers deep and does not need to be particularly neat. However, remember my earlier advice about keeping all the turns going in the same direction with no doubling back. Like the medium wave coil, it can be wound on a paper former if it must be moveable for alignment purposes.

precise characteristics of the coil former, etc. However, these suggestions represent a good starting point that should give reasonable results in the majority of cases.

#### VARIATIONS

A coil former having an adjustable dust iron core should always be used for short wave coils, so that the frequency coverage can be adjusted. If necessary though, you can alter the frequency coverage of the coils to a greater extent by using more or fewer turns on the main winding. More turns increases coverage in the low frequency direction — fewer turns has the opposite effect.

You may find that results can be improved by altering the number of turns on the smaller winding or windings. In fact you may even be able to obtain better results than those provided by ready made coils. Radio designs for the home constructor are based on the most suitable coils available, but this often means compromises having to be made. If you are producing do-it-yourself coils you can experiment a little to find the turns ratios that give optimum results.

Note that in some cases the phasing of windings is important. If the regeneration control of a T.R.F. set has the wrong effect, with results worsening as it is advanced, then the feedback winding has the

much in most respects if the windings are a bit ragged looking. However, it is important that the coils are fairly rigid and that none of the windings are free to vibrate and move around on the former. Wind them as tightly as possible, and glue them in place.

Ready made coils often seem to be constructed by having adhesive smeared over the coil former, with the windings then being placed onto this. This is a bit messy for the home constructor, and is really only viable once you have perfected a coil and are sure about the optimum number of turns per winding, and the correct phasing. Probably a more practical approach for d.i.y. coils is to use a generous helping of adhesive once a coil has been perfected. Virtually any general purpose adhesive should suffice, but my preference is for an epoxy type.

Always start with the main winding. Strip the insulation from one end of the wire, solder it to the appropriate tag of the former, wind the coil as tightly and neatly as possible, trim the wire to length, strip the insulation from the end of the wire, and then solder it to the allotted tag of the former. Some small pieces of tape can be useful for holding everything in place. The coupling windings are then wound on top of the main winding using the same basic method. Some glue is then used to bond everything in place.

### D.I.Y. SW COILS

#### Aerial/R.F. Coils

Range	Main Winding	Aerial/ Input	Output Coupling
1	42.5	11	4
2	15.5	4	2
3	6.5	2	1

#### Oscillator Coils (Transistor)

Range	Main Winding	Collector	Emitter
1	32	11	7
2	14	4	2
3	5.5	2	1

#### Oscillator Coils (Valve/f.e.t.)

Range	Main Winding	Feedback
1	32	7
2	14	4
3	5.5	2

#### T.R.F. Receiver

Range	Main Winding	Aerial	Feedback
1	42.5	11	20
2	15.5	4	8
3	6.5	2	4

#### SHORT WAVE

Do-it-yourself short wave coils represent something of a problem. It is not that they are terribly difficult to wind, but is more a case of no suitable plug-in formers being available any more. You could opt for single band operation with the coils being soldered into place, but this might not be a convenient way of handling things.

A plug-in coil former makes coil winding relatively easy as its pins provide physical tie points for the ends of the winding. With a little ingenuity it is possible to fix a 10 millimetre diameter coil former onto a multi-way plug of some kind, but you will need to use a fairly large type (such as an old "octal" style plug), and the adhesive must be a good quality gap filling kind such as an epoxy adhesive.

Short wave coils consist of a main winding which determines the frequency coverage, plus one or two other windings. The convention seems to be to have the short wave spectrum divided into three tuning ranges. The table included above gives some suggestions for the number of turns for various windings on a selection of short wave coil types. This can only be a set of suggestions rather than precise winding details, since the optimum number of turns depends on the exact circuit used, the

wrong phasing. Simply swop-over the connections to this winding and everything should work perfectly. In a similar vein, you might find that the oscillator stage of a superhet fails to work. Reversing the connections to one of the coupling windings will probably rectify this problem.

With aerial and r.f. stage coils the phasing is often of no importance. However, if a stage seems a bit lively and prone to oscillation, reversing the connections to the coupling winding should improve matters.

#### WINDING FOR SW

When winding short wave coils it is generally best to use the thickest wire that is feasible. As very few turns are needed for high frequency coils, there will probably be no difficulty in using a gauge of wire as thick as 20 s.w.g. For lower frequency coils it will need to be much thinner at around 30 s.w.g.

Commercial coils for low and medium frequency use are often wound using a special type of wire called "Litz" wire. You are unlikely to be able to obtain any of this, and it can be quite difficult to use anyway. Ordinary enamelled copper wire is therefore the order of the day.

Try to make a neat job when winding coils. Performance is not likely to suffer

#### I.F.T.s

In general, there is no great difficulty in using a Toko 10 millimetre i.f.t. (intermediate frequency transformer) in place of an obsolete type. For first, second, and third i.f.t.s use part numbers YRCS11098, YRCS12374, and YHCS11100 respectively. Some superhet radio designs call for double tuned i.f.t.s, but these would not seem to be available at all these days. One solution is to use a single tuned type instead. Simply take the output signal from the untuned secondary winding instead of using the tapping on the tuned secondary winding. You can use two single tuned i.f.t.s to act as a double tuned type using the arrangement shown in Fig. 2. This gives the same selectivity as a double tuned type, but should be easier to align (double tuned i.f.t.s are notoriously difficult to align really accurately). The only slight drawback of this method is that it is likely to give slightly higher losses than a double tuned i.f.t.

Some short wave receivers are designed to operate with an intermediate frequency of 1.6MHz. As far as I can ascertain, there are no i.f.t.s of this frequency currently available. However, a Toko KANK3333R with a 220p capacitor wired across the main winding seems to work quite well.

# DOWN TO EARTH

BY GEORGE HYLTON

IF YOU have a TV set which can receive teletext you may have observed what happens when reception is marred by noise. If the broadcast message is INTERNATIONAL NEWS, then under conditions of mild noise some letters drop out, giving, say I-TER-ATIO-AL NE-S. When noise gets worse, not only do some characters drop out but others are "printed" incorrectly, e.g. ISTER-A-IOXAL N-PS.

Evidently the system is able to tell that there's an error when interference is slight but gets fooled into printing out mistakes when conditions are worse.

## PARITY BITS

Why is this? There are now well-tried techniques for automatic error detection. The standard technique is to add to the code for any character an extra bit. Codes are often quite complicated, but for the purpose of illustration I'll use the simplest 5-bit code. This gives 32 possible combinations (from 00000 to 11111) and so is enough for the English alphabet and a few other symbols.

The extra bit is automatically chosen to bring the total number of 1's to an even number. Thus, if the character code is 11010, which has three 1's, the extra bit is a 1, to make four 1's, and the transmitted character becomes 110101. If the original character code is 11000, which already has an even number of 1's, the added bit is 0, giving 110000. These extra bits are called Parity Bits, parity meaning evenness in this context.

## DETECTION

At the receiver, any incoming character which has an odd number of 1's must be in error and the system is programmed not to print it, but to leave a blank. This detection system can break down if there is more than one error. Thus 1000001 might become 111001, which still has an even number of 1's but is wrong.

Clearly, double errors are more likely under very noisy reception conditions than in slight noise. This explains the behaviour of systems like teletext. (In actual practice the basic coding system usually involves more than 5 bits per character, but the principle is the same. The teletext system actually used in Britain has 16 bits per character, of which two are parity bits.)

## DOUBLE CHECKS

Can the system do better? Yes. If there is enough capacity, you can design codes in which it's sufficient for most of the bits to be correct. When there is an error of only one bit, out of a large enough number of bits, (say one in ten) the character which most nearly matches the received signal is the correct one. The receiver can thus remove single-bit errors.

In commercial two-way transmission systems there's the possibility of the equipment at the receiving end talking back to the transmitting end, in effect saying: "Hey. There's something wrong

CHARACTER BITS

0	1	1	0	1	1
0	1	0	1	0	1
1	0	1	1	0	1
1	1	0	1	1	0
0	0	1	1	0	0
0	1	0	0	0	

↑ PARITY

ERROR POSITION

Fig. 1 A block of binary-coded keyboard characters. In each line, except the last, the first five bits are the code for the transmitted character. The sixth bit gives a rough check on the accuracy of the other five. Similarly, the bottom row gives a check on the accuracy of the bits in each column.

with that last section of message. Please repeat it."

It's also possible, for a modest cost in extra bits, to enable the system to make a reasonable attempt to find out which bits are wrong. To do this, you arrange the characters in blocks, and send some extra parity bits at the end of each block. For a basic 5-bit code, it's convenient to send characters in blocks of 5. If they are stacked neatly as in Fig. 1 the basic characters form five rows of 5. Because of the neat stacking they also form five columns of 5.

By adding up the 1's down each column you are able to append a parity bit at the foot of each column. The 1 in the square marked "error position" has become a 0 because of noise, its position is now pinpointed. It's in Row 2, and Column 3, and only one bit out of the 25 basic character bits fits this description. The system need not ask for re-transmission. It can correct the error itself, at the receiving end.

The square in the bottom right corner is not occupied by either row-parity-bits or column-parity-bits. It might be useful to add up all the 1's in both lines of parity bits and insert an extra parity bit into this space. This gives a rough check on whether there is an error somewhere among the parity bits. Various other checks are possible. You might, for example, add up the 1's in the diagonals of the basic 5 x 5 block and send parity bits for these.

All sorts of schemes are used in practice. They are elaborations of the same basic idea: send a small amount of extra information cunningly arranged so as to indicate errors.

## HUMAN ERROR DETECTION

When the message transmitted is in real words, as in teletext, then the human being at the receiving end can act as an error detector. If the TV prints NEXS instead of NEWS then the existence of the error is identifiable from the fact that in the English language there is no such word as NEXS. What's more, the letter X is rare and the combination XS rarer still. This makes it likely that the X is wrong.

There are two common words, NETS and NEWS, and one less common one, NESS which might fit. The context often says which. Thus in HOME NEXS it is virtually certain to be NEWS, while in FISHING NEXS it might plausibly be either NEWS or NETS but not NESS. In LOCH NEXS on the other hand, it's sure to be NESS because LOCH NESS is well-known Scottish lake which is frequently in the news, while LOCH NEWS and LOCH NETS make poor sense.

Unfortunately, much commercial information consists not of words but of numbers. A numerical error may escape human detection. If somebody orders 275 computers and this is changed by noise to 278 nobody may realise. For this reason it's advisable to devote some thought, in preparing a message, to making errors noticeable. One way, for instance, might be to add up all the numbers of items on an order and send the total twice. The recipient can then be reasonably sure that he has the correct total and check this against the items ordered.

## ERRORS AT SOURCE

While this sort of ingenuity can guard against errors in transmission it may not be able to do anything about errors which creep in at source, as when an operator taps the wrong key. If a letter is addressed to number 39 Smith Street instead of number 49 it will just be mis-delivered.

Those who run the system must guard against this by careful selection and training of keyboard operators. Simple rules like: "Double check all numbers and names" will reduce the frequency of errors.

## SPEECH RECOGNITION

In some situations, however, there is no way of double-checking. An automatic speech recognition system may have to respond to a word spoken only once, in noisy surroundings. A feature of these systems is that they have very restricted vocabularies. Some recognise only the digits 0 to 9. More ambitious systems recognise a hundred or so individual words or short phrases.

Often, the system works only with voices already made familiar to it by "training sessions". Even then, recognition may fail if background noise increases or if the speakers' voices change, e.g. if they have a cold.

Speech recognition has relied heavily on so-called template techniques. The name comes from analogy with a hypothetical mechanical system. If you want a machine to recognise a printed word you could stamp out the shape of the word on a template (Fig. 2). By moving the template over a printed page it is possible to see when the word on the page fits the holes in the template. The word is then recognised.

continued on page 281

**GREENWELD**

**1990 SPRING SUPPLEMENT  
32 PAGES OF  
BARGAINS!**

**FREE!**



**FREE**  
MINIATURE MAINS 15W  
**SOLDERING IRON**  
See Page 6 for details

**METEX M-4650**

Hello again! Welcome to our latest selection of electronic components and equipment

I'd like to thank so many of you for responding to our questionnaire in the Main Catalogue - we've already implemented some changes that you have asked for, and we're working on others. We'll shortly be supplying a reply paid envelope with every order despatched, and giving tokens that can be exchanged for free valuable gifts!

We now have someone whose sole responsibility is to maintain our mailing list and organize Bargain List despatches at regular intervals, ensuring a faster, better service for Bargain List Subscribers.

Featured in this edition of our Catalogue Supplement are many new lines. On pages 10&11 there's some terrific value disco gear, and you'll find some super high power amplifiers on page 4. Our range of extremely popular Metex Digital Meters has been expanded to include 12 new models - they're all listed in the centre pages. Lots of new test gear, too, on pages 14&15. You'll not be surprised to find a further selection of surplus lines, starting from page 17 and on page 8 are some amazing value Mosfets including surface mount types from just 10p each!! All in all, these 32 pages are packed with some incredible bargains - so place your order today by phone, fax, post or in person. We're happy to accept cash, P.O.'s, cheques, VISA & ACCESS, foreign currency banknotes and book tokens for any item. Use the Order Form on page 29 or phone your order through - we try to despatch all orders on the day of receipt. My Manager Kevin Jarvis and his team of willing workers look forward to hearing from you soon!

Peter Green  
Managing Director

**GREENWELD ELECTRONICS LTD**  
443 MILLBROOK ROAD  
SOUTHAMPTON SO1 OHX

TEL (0703) 772501/783740  
FAX (0703) 787555

## CONTENTS

Aerials, Ropelight, Metal detector, Power supply, Bullhorn	3
Audio - Amps, mixer, Speaker Switches	4
Knobs, Batt holders, PIR alarm, Indicators, Power supply	5
Tools - Vices, Drill, Knife set, Tin snips, Calipers	6
Computer Chips	7
MOS Devices	8
Door Entry Systems, Lamps	9
Disco Lighting	10-11
Solar Kits, Buggy	12
Disco Turntable, Wireless Mic	13
Test Gear - Generators, Bridges etc	14
Test Gear - Insulation Tester, dB and Lux meter, Oscilloscopes	15
Metex digital meters	16-17
Bargain List 56	18-19
Bargain List 55	20-21
Bargain List 54	22-28
Questionnaire	29
Order Form	30
Amazing Bargains - Helping hands, PSU, Vox	31
Digital Multimeter offer	32







UK1645 Indoor UHF/VHF/FM aerial with built-in amplifier and variable gain control. Variable dish shaped UHF antenna and telescopic VHF/FM antenna. VHF gain 20dB, UHF gain 18dB. Mains operation. £14.95

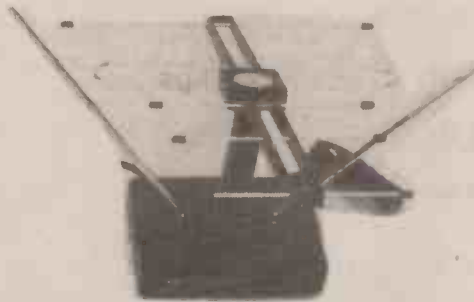

UK650 Indoor UHF/VHF/FM aerial with built-in high gain amplifier. Fully adjustable for angle and position. Black and chrome finish. 15dB gain. 40-860MHz bandwidth. Mains operation. £17.95

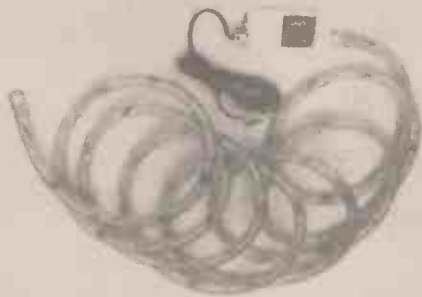

LW188 Ropelight with built-in speed control. Plugs directly into the mains. 6m long. High quality extremely tough poly tubing. £39.95



VMD100 Voltage and metal detector. Will differentiate between voltages and metal. Has audio and visual indicator. Takes standard PP3 battery (not supplied), full instructions Price £8.95



### BULLHORN

P117

£53.85

Hand held or shoulder hanging model with detachable noise cancelling microphone (on curly lead). Anti-howl amplification. Mic has press-to-talk switch and volume control. Horn has rubber bumper rim and pistol grip. Made of ABS plastic and metal (blue and grey).

Output power . . . . . 10W(nom.), 16W(max.)  
Audible range . . . . . 0.5-1km  
Power . . . . . 12Vdc (8 x 'C' batteries not inc.)  
Dims . . . . . 230(dia.) x 340(L)mm  
Weight . . . . . 1.65kg

## SWITCH MODE PSU

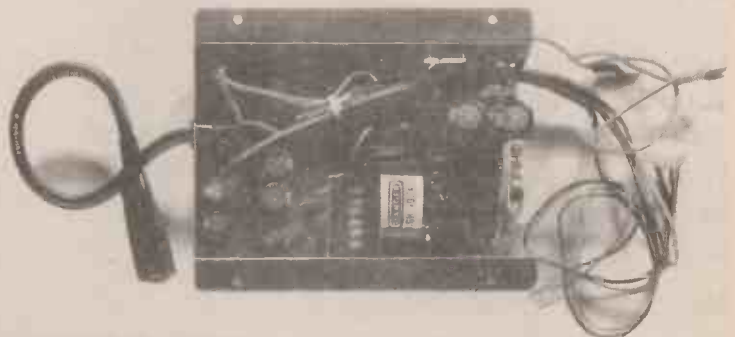

ASTEC Model AA12531

I/P: 115/230Vac 50/60Hz  
O/P: V1 + 5V 5A V2 + 12V 0.15A  
Dims: 160 x 104 x 45mm

£6.95

Partially enclosed panel with fixing holes in steel case on 120 x 125mm centres.  
Inputs and outputs are on colour coded leads; there is also an EEC socket on a flying lead.

CREDIT CARD HOTLINE: (0703) 772501/783740 FAX: (0703) 787555



**2 x 75W POWER AMPLIFIER**

**B001** £42.00

High power, high quality in-car power amplifier. 75W per channel stereo output. Inputs from low level inputs from car radio/cassette pre-amp or high level inputs from radio/cassette speaker outputs. Variable gain control. Speaker outputs via spring terminals.

- Output power . . . . . 2 x 75W stereo
- Output impedance . . . . . 4 - 16Ω
- Frequency response . . . . . 25 - 20000Hz
- Input . . . . . Hi 10kΩ, Lo 23kΩ  
65mV to 2.5V (adjustable)
- Power . . . . . 13.8Vdc nom.
- Current . . . . . 350mA (idling), 15A (max)
- Dims . . . . . 193 x 66 x 153mm



**4 x 100W POWER AMPLIFIER**

**B005J** £99.05

A four channel high power in-car amplifier, 4 x 100W stereo or 2 x 80W mono (switchable). Inputs accepted from low level sources or speaker outputs from a car radio cassette. Full short circuit protection. Low input gain control.

- Output power . . . . . 4 x 100W max  
2 x 80W mono
- Output impedance . . . . . 4 - 8Ω
- Distortion . . . . . 0.06%
- Power . . . . . 11 - 16Vdc
- Dims . . . . . 196 x 60 x 300mm



**2 x 150W POWER AMPLIFIER**

**B005K** £85.00

A high power stereo in-car amplifier, 2 x 150W stereo or 120W mono (switchable). Inputs accepted from low level sources or speaker outputs from a car radio cassette. Full short circuit and overheat protection. Low input gain control.

- Output power . . . . . 2 x 150W max  
120W mono
- Output impedance . . . . . 4 - 8Ω
- Distortion . . . . . 0.05%
- Power . . . . . 11 - 16Vdc
- Dims . . . . . 196 x 65 x 250mm



**G105A 4-CHANNEL MIXER**

£27.95

4 channel mono to mono/stereo micro mixer. Each channel has inputs for line or mic level, gain control and left to right panpot. Output is controlled by a master gain control and a stereo/mono switch. All black finish. Powered by internal battery or external power supply (not supplied).

- Input sensitivity . . . . . 1mV or 150mV
- Output level . . . . . 0.775V/0dB, 1.55V max
- Distortion . . . . . Less than 0.1%
- S/N ratio . . . . . Greater than 70dB
- Frequency response . . . . . 25 - 30000Hz
- Power . . . . . 9Vdc
- Dims . . . . . 220 x 60 x 120mm



**A098B SPEAKER SWITCH**

£10.50

Designed for mounting on the rear of the amp. Allows two pairs of speakers to be used where the amp normally allows only one pair. Inputs via phono sockets, speaker connections via spring terminals. Parallel resistive protection.

Dims . . . . . 110 x 58 x 30mm

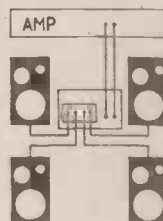

**A098 SPEAKER SWITCH**

£7.50

A beautifully finished control box provides facility for using 4 pairs of speakers where stereo amplifier allows only one pair. 1, 2, 3 or 4 pairs may be used in any combination. Quick-action spring terminals. Series and parallel resistive protection.

Dims . . . . . 148 x 85 x 50mm

CREDIT CARD HOTLINE: (0703) 772501/783740 FAX: (0703) 787555



**F001A** **27p**  
 - To take two AAA size batteries. Solder terminals.  
 Dims: 52 x 22 x 13mm

**F001B** **45p**  
 To take four AAA size batteries. Solder terminals.  
 Dims: 52 x 26 x 25mm

**F001C** **42p**  
 To take four AAA size batteries side by side. Solder terminals. Dims: 52 x 48 x 12mm





**F601** **£19.95**  
 Pocket sized portable passive infra red detector alarm. Dual function; alarm sounds a high pitch warble on detection, chime sounds a two-tone annunciator on detection. Operated from a PP3 battery (not supplied). Supplied with a wall mounting bracket for more permanent installation.

Detection coverage . . . . . 10m (30ft)  
 Detection angle . . . . . 60°  
 Power . . . . . 9Vdc (PP3 battery)  
 Exit delay time . . . . . 10 seconds  
 Auto reset time . . . . . 30 seconds  
 Dims . . . . . 108 x 68 x 35.5mm



**B049 IMMERSION HEATER £1.99**  
 A handy mobile immersion heater for boiling water, soup, etc. Plugs into cigar lighter socket. Power . . . . . 12Vdc 120W Lead length 1m.

A range of coloured LED's in chromed metal bezels. Built-in dropping resistor. All 12Vdc 15mA.

			
<b>24p each</b>	<b>24p each</b>	<b>62p each</b>	<b>80p each</b>
Black plastic with 8mm tails. Requires 8mm hole in panel. Dims: 15mm (long), 10mm (dia).	Black plastic with 10mm tails. Requires 6mm hole in panel. Dims: 12mm (long), 7mm (dia).	Dims: 28mm (long) x 7.3mm (bezel). Mounting hole: 6.9mm.	Dims: 37mm (long) x 10mm (bezel). Mounting hole: 8.0mm.
<b>F157N AL02R</b> Red 10mA 2.0V <b>F157P AL02G</b> Green 10mA 2.0V	<b>F157Q AL03R</b> Red 10mA 2.0V <b>F157R AL03G</b> Green 10mA 2.0V	<b>F158 R961LR</b> Red <b>F158A R961LG</b> Green <b>F158B R961LA</b> Amber	<b>F158F R963LR</b> Red <b>F158G R963LG</b> Green <b>F158H R963LA</b> Amber



**F049A** **38p/m**  
 RG6 (CT100). Semi air-spaced. 75Ω. 1/1.0mm conductor. Copper braid and aluminium foil screens. 6.5mm OD. Black.

**POWER SUPPLY**

**B034** **£2.50**

DC to DC adaptor. Plugs into car cigar lighter aperture. Outputs 3, 4.5, 6, 7.5, 9, 12V @ 800mA. Has universal output spider plug, also 9V battery snap and polarity reversing facility.



A complete range of grey plastic knobs with pointers and coloured caps.

Fitting . . . . . Collet  
 Spindle dia . . . . . 6.35mm

28mm (dia) x 19.5mm			
<b>F191</b>	<b>RN110DR</b>	Red	80p
<b>F191A</b>	<b>RN110DB</b>	Blue	80p
<b>F191B</b>	<b>RN110DG</b>	Green	80p
<b>F191C</b>	<b>RN110DY</b>	Yellow	80p
21mm (dia) x 19.8mm			
<b>F191D</b>	<b>RN110ER</b>	Red	70p
<b>F191E</b>	<b>RN110EB</b>	Blue	70p
<b>F191F</b>	<b>RN110EG</b>	Green	70p
<b>F191G</b>	<b>RN110EY</b>	Yellow	70p
15.5mm (dia) x 17.5mm			
<b>F191H</b>	<b>RN110FR</b>	Red	65p
<b>F191J</b>	<b>RN110FB</b>	Blue	65p
<b>F191K</b>	<b>RN110FG</b>	Green	65p
<b>F191L</b>	<b>RN110FY</b>	Yellow	65p
10mm (dia) x 15mm			
<b>F191M</b>	<b>RN110GR</b>	Red	60p
<b>F191N</b>	<b>RN110GB</b>	Blue	60p
<b>F191P</b>	<b>RN110GG</b>	Green	60p
<b>F191Q</b>	<b>RN110GY</b>	Yellow	60p

Ribbed black plastic with coloured caps. Modern styling. Grooved pointer. Caps are interchangeable.

Dia. . . . . 13mm  
 Depth . . . . . 15.5mm  
 Fitting . . . . . Grub screw  
 Spindle dia . . . . . 6.35mm

<b>F179A</b>	<b>RN115BR</b>	Red cap	30p
<b>F179B</b>	<b>RN115BY</b>	Yellow cap	30p
<b>F179C</b>	<b>RN115BG</b>	Green cap	30p
<b>F179D</b>	<b>RN115BB</b>	Blue cap	30p
<b>F179E</b>	<b>RN115BBK</b>	Black cap	30p

Ribbed black plastic knob with extended pointer and brightly coloured cap.

Dia. . . . . 25mm  
 Depth . . . . . 16mm  
 Fitting . . . . . Grub screw  
 Spindle dia . . . . . 6.35mm

<b>F179G</b>	<b>RN118DR</b>	Red cap	45p
<b>F179H</b>	<b>RN118DY</b>	Yellow cap	45p
<b>F179J</b>	<b>RN118DG</b>	Green cap	45p
<b>F179K</b>	<b>RN118DBU</b>	Blue cap	45p

CREDIT CARD HOTLINE: (0703) 772501/783740 FAX: (0703) 787555



**Y010AC** BABY BENCH VICE **£5.90**

Cast steel miniature bench vice. 65mm jaws open to 60mm. Two bolt fixing to bench. Red enamel finish.  
Dims ..... 100 x 65 x 70mm



**Y010AD** CLAMP-ON VICE **£3.70**

Cast steel miniature clamp-on vice. 42mm jaws open to 40mm. Clamp fixing to bench up to 45mm thickness. Blue enamel finish.  
Dims ..... 80 x 135 x 42mm



**Y024B** TIN SNIPS **£1.99**

10" drop forged tin snips. Bright steel blades with blue enamelled handles. Blister packed on an attractive display card.

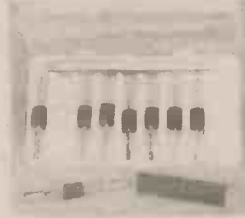

**Y012B** 10 PIECE TOOL SET **£2.75**

10 piece tool set comprising of 1 pair of tweezers, 1 tool holder and 8 double ended tools giving 4 nut drivers, 2 cross head screwdrivers, 2 bradawls, 4 flat blade screwdrivers and 4 hex wrenches, all contained within a hinged plastic case.

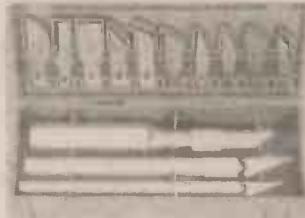

**Y004B** 16 PIECE KNIFE SET **£7.95**

16 piece precision knife set consisting of two lightweight blade holders, one heavy duty blade holder and 13 blades in a variety of shapes and sizes. All contained within a hinged plastic case with magnetic blade holder.

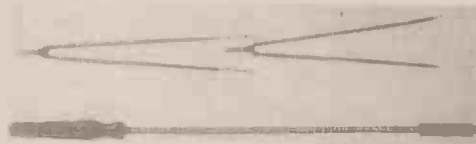

**Y017** TOOL KIT **£2.40**

3-piece tool kit comprising 12 inch flexible magnetic grab, one pair of 6 inch plastic coated straight nosed tweezers and one pair of 6 inch plastic coated bent nose tweezers. Packed on blister card.



**Y007A** HAND DRILL **£3.95**

High quality hand drill. Cast iron body. Machined gear wheels. Hardwood handles. 3/8" 3-jaw chuck. Overall length 13".



**Y024C** 5" VERNIER CALLIPER **£2.75**

5" metric and imperial vernier calliper for measuring inside diameters, outside diameters and depth to an accuracy of 0.1mm or 0.01". Knurled locking ring. Bright plated steel.



## 240 Vac Mains Soldering Iron

Yes this super little iron is absolutely ideal for all miniature and precision jobs!!! Rated 15watts with a 3 mm bit. Overall length 200mm and its yours FREE when you order over £20 worth of goods from any of our current Catalogues and Lists!



## COMPUTER CHIPS

Regular stock items are listed below: for quantity prices contact sales.

ALL PRICES QUOTED ARE FOR 1 OFF INCLUDE V.A.T.

### 6500 Series

The 6500 series 8-bit microprocessor and associated peripheral integrated circuits feature advanced system architecture for enhanced performance. The 6500 devices are bus compatible with 6800 series devices and are designed to operate at 1MHz. Supplied in standard DIL plastic packages.

Type	Function		Price
6502	8-bit CPU 1MHz	DIL 40	£4.12
6522	Versatile interface adaptor	DIL 40	£4.12
6332	RAM, I/O, interval timer	DIL 40	£5.62
6551	Asynchronous comm, interface.	DIL 28	£5.87

### CMOS 6500 Series

CMOS version of the popular 6500 series 8-bit microprocessor and associated peripheral integrated circuits. Will operate at up to 2MHz with considerable savings in power consumption making them ideal for use in battery operated equipment. Supplied in standard DIL plastic packages.

Type	Function		Price
65C02	8-Bit CPU 2MHz	DIL 40	£5.62
65C21	Peripheral interface adaptor 2MHz	DIL 40	£4.87
65C22	Versatile interface adaptor 2MHz	DIL 40	£4.62

### 6800 Series

The 6800 series 8-bit microprocessor and associated peripheral integrated circuits use a single 5V supply thus reducing system cost and complexity. All parts are supplied in standard DIL plastic packages.

Type	Function		Price
6800	8-bit CPU 1MHz	DIL 40	£3.12
6802	Improved 8-bit CPU 1MHz	DIL 40	£2.12
6809	High performance 8-bit CPU	DIL 40	£3.12
6810	128x8 Static RAM 450nS	DIL 24	£1.75
6821	Peripheral interface adaptor	DIL 40	£1.00
6840	Programmable timer module	DIL 28	£1.87
6850	Asynchronous comm. interface	DIL 24	£1.87
6852	Synchronous serial data adaptor	DIL 24	£3.00
6875	Two phase clock generator	DIL 16	£6.25
6880	Quad tri-state inv. trans.	DIL 16	£1.25

### 8080A/8085A Series

The 8080A/8085A series 8-bit microprocessor and associated peripheral circuits are a well established means of assembling micro systems. All parts are supplied in standard DIL plastic packages.

Type	Function		Price
8085AC	8-bit CPU 3MHz	DIL 40	£4.00
8156C	Input/output timer with RAM	DIL 40	£4.75
8251AC	Programmable comm. interface	DIL 28	£4.37
8253C	Programmable interval timer	DIL 24	£4.62
8255C	Programmable peripheral interface	DIL 40	£4.00
8259AC	Programmable interrupt control	DIL 28	£5.00

### Z80A Series

The Z80A series 8-bit microprocessor and associated peripheral integrated circuits provide the means to construct extremely cost effective high performance microcomputer systems. The Z80A series operates at up to 4MHz clock rate with a minimum instruction execution time of 1µs. All parts are supplied in standard DIL plastic packages.

Type	Function		Price
Z80A CPU	8-bit CPU 4MHz	DIL 40	£2.00
Z80A PIO	2 port parallel input/output	DIL 40	£2.00
Z80A CTC	4 channel counter/timer	DIL 28	£2.00
Z80A SIO	2 channel serial input/output	DIL 40	£6.50
Z80A DMA	Direct memory access controller	DIL 40	£6.50

### CMOS Z80A Series

CMOS version of the popular Z80A series 8-bit microprocessor and associated peripheral circuits. Operating speed 4MHz with considerable savings in power consumption, the PIO draws a mere 2mA at 4MHz and the CTC 3mA at 4MHz. Supplied in standard DIL plastic packages.

Type	Function		Price
CMOS Z80A CPU	8-bit CMOS CPU 4MHz	DIL 40	£4.37
CMOS Z80A PIO	2 port parallel input/output	DIL 40	£3.75
CMOS Z80A CTC	4 channel counter/timer	DIL 40	£4.12

### Eproms

Electrically programmable read only memories which are suited for uses where fast turn around and pattern experimentation are required. The devices incorporate a transparent window to permit erasure of the programmed pattern by exposure to ultraviolet light. A new active pattern can then be written into the device.

Type				Price
2716	2048 x 8	16K	5V	£4.37
2532A	4096 x 8	32K	5V	£6.12
2732A	4096 x 8	32K	5V	£4.75
2764-250	8192 x 8	64K	5V	£3.50
27C64-250	8192 x 8	64K	5V	£3.37
27128-250	16384 x 8	128K	5V 12.5V	£4.50
27256-250	32768 x 8	256K	5V 12.5V	£5.62
27C256-250	32768 x 8	256K	5V 12.5V	£4.87
27512	65536 x 8	512K	5V 12.5V	£13.12

### CMOS low power static RAMs

Random access memories or read/write memories are normally used for temporary data storage applications. CMOS types which are ideally suited to battery powered and back-up circuits.

Type	Price
6116LP3	£1.87
6264LP15	£4.75
62256LP15	£13.12

### Dynamic RAMs

Dynamic random access memories provide higher capacity storage with reduced chip area than static RAMs. We offer the 16K, 64K and the new 256K devices.

Type	Price
4116N	£0.87
4164-15	£1.50
41256	£4.37

### Special offers on the following:

Type	Date	MNF'R	Quantity	Price
MC6809P	8725	M	199	£2.75
TSC9402CJ	8805	TEL	1551	£3.00
MSL8279-5	-	MIT	756	£1.50
TMP82C53-P2	8742	TOS	942	£3.50
MC146818AP	8717	M	945	£1.50
MSM80C85ARS	-	OKI	850	£2.60
9400CJ	8824	TEL	150	£1.50
MC68008L8	8334	M	696	£2.00
MC68000G8	8531	M	48	£3.50
MC146805E2P	8223	M	36	£4.00

## FANTASTIC MOSFET OFFER!!

Take advantage of our buying skills and help yourself to some FET's and MOSFET's at incredibly low prices! All goods are new full spec by Siliconix, IR and are offered at well below normal prices! Limited stock of some types, so order now!

### POWER MOSFETS

TYPE	CASE	N/P	VDS	RDS	ID	PD	Price Each	Pack
2N7004	4PINDIP	N	100	0.6	1.0	6.25	55p	5/£2
2N7005	4PINDIP	N	200	1.5	0.6	6.25	65p	4/£2
2N7006	4PINDIP	N	350	5.0	0.32	6.25	70p	4/£2
2N7014	T0220	N	100	0.8	3.5	19.5	60p	5/£2
BUZ31	T0220	N	200	0.2	12.5	75	£1.60	
BUZ41A	T0220	N	500	1.5	4.5	75	£1.50	
IRF122	T03	N	100	0.4	7.0		£1.85	
IRF150	T03	N	100	0.055	40	150	£4.00	
IRF250	T03	N	200	0.085	30	150	£5.00	
IRF620	T0220	N	200	0.8	5.0	40	60p	5/£2
IRF710	T0220	N	400	3.6	1.5	20	40p	6/£2
IRF720	T0220	N	400	1.8	3.0	40	40p	6/£2
IRF820	T0220	N	500	3.0	2.5	40	65p	4/£2
IRF9230	T03	P	200	0.8	6.5	75	£3.50	
IRF9520	T0220	P	100	0.6	6.0	40	85p	3/£2
IRF9620	T0220	P	200	1.5	3.5	40	£1.20	2/£2
VN0300D	T0220	N	30	1.2			60p	5/£2

K576 Mixed pack of TO220 & 4 pin DIP devices from above list with data & pin outs. 25 £8.00

### SMALL SIGNAL JUNCTION FETs

CODE	CASE	N/P	VDS	VGS	IG	PD	PRICE
J112	TO92	N	35	5	.05	.36	5/£1
J113-18	TO92	N	35	3	.05	.36	5/£1
J271	TO92	P	30	2	.05	.36	3/£1
J300B	TO92	N	25	7	.01	.36	4/£1
J305-18	TO92	N	30	3	.01	.36	5/£1
U1899	TO92	N	40		.01	.36	5/£1
2N4220	TO18	N	30	4	.01	.3	2/£1

\* Internal gate source Zener

K578 Mixed pack of small signal FETs from above lists with data & pin outs 30 £5.00

### SURFACE MOUNT FET's

CODE	CASE	Device Mkg	N/P	TYPE	RATINGS	mA	mW	PRICE	
SST215	SOT143	D15	N	DMOS	30V	50R	50mA	350mW	10/£1
* SST4340	SOT23	P40	N	JUNCTION	50V		50mA	350mW	10/£1
* SST4341	SOT23	P41	N	JUNCTION	50V		50mA	350mW	10/£1
* SST4392	SOT23	C92	N	JUNCTION	35V		50mA	350mW	10/£1
* SST4857	SOT23	C57	N	JUNCTION	40V		50mA	350mW	10/£1
* SST5458	SOT23	P58	N	JUNCTION	25V		16mA	350mW	10/£1
* SST5459	SOT23	P59	N	JUNCTION	25V		16mA	350mW	10/£1
* SST5460	SOT23	S60	P	JUNCTION	40V		16mA	350mW	10/£1
* SST5461	SOT23	S61	P	JUNCTION	40V		16mA	350mW	10/£1
* SST5462	SOT23	S62	P	JUNCTION	40V		16mA	350mW	10/£1
2N7001	SOT23	701	N	MOS	240V	45R	45mA	200mW	10/£1
2N7002	SOT23	702	N	MOS	60V	7R5	115mA	200mW	10/£1

\* These are surface mount versions of 2N numbers

K577 Mixed pack of surface mounted FET's, including above types with data & pin outs 50 £4.00

CREDIT CARD HOTLINE: (0703) 772501/783740 FAX: (0703) 787555



**P155 £10.95**

A door entry system for use in flats, bedsits, offices, etc. The system comprises of: room stations; 2, 3, 4 or 6-button door stations with built-in weatherproof microphone and speaker; complementary 4, 6 and 10-button expanders to extend the system for larger installations. The door stations and expanders are flush mounting with brushed aluminium plates and illuminated name plates. The room stations have an electric door lock release button and can be wall mounted or free standing.

Power . . . . . 12Vdc (suitable power supply: P005A-AL12)  
Cable . . . . . 4-cores per station (plus 2 if door lock fitted)



**DOOR STATION**  
252 x 103 x 65mm

**£19.95 DR2MB**  
Small 2-button door station

**£21.95 DR3MB**  
Small 3-button door station



**£24.95 ELECTRIC DOOR LOCK DL3**

Solenoid operated door lock complete with 5-lever cylinder lock, manual release and mounting hardware.

Power . . . . . 12Vdc 0.5A  
Dims . . . . . 130 x 105 x 38mm



**£2.95 CONSOLE LAMP DL138**

For disco consoles, Hi-Fi equipment, CB rigs, etc. where extra illumination is essential. 12V lamp in enclosed head with switch. Flexible chrome gooseneck on mounting plate with screw holes. Flying leads for connection to external 12Vdc supply.

Length . . . . . 300mm  
Lamp . . . . . 12Vdc 5W tubular filament



**£27.95 DOORPHONE DP2SB**

Two station handset type doorphone, allowing conversation with visitors without opening door. The room station is provided with a volume high/low switch and an electric door lock release button. Free standing or wall mounting. Flush mounting door station.

Power . . . . . 240Vac 50Hz  
Dims . . . . . 225 x 110 x 70mm



**£13.95 EXTERIOR FLOODLIGHT**

Weatherproof exterior floodlight made of black lacquered aluminium with bright aluminium reflector. Rubber sealed connection box and hinged glass fronted bulb protection to IP44. Adjustable mounting bracket. Takes a halogen bulb max. 500W. (F018Z below).

Dims . . . . . 185 x 110 x 140mm (body)

**EXTERIOR SECURITY LIGHT**



**£7.20 TUNGSTEN HALOGEN BULB THB1**

Replacement bulb for tungsten halogen lamp above. 240Vac 500W.

**ALL OUR PRICES INCLUDE VAT – JUST ADD £2 POST/PACK TO TOTAL ORDER VALUE**

CREDIT CARD HOTLINE: (0703) 772501/783740 FAX: (0703) 787555



**PAR36 SPOT**  
**£13.95**      **PAR36**

High quality PAR36 spot lamp with mounting bracket. Can contains safety isolating transformer and screwdriver release fuseholder. Lamp supplied separately.  
 Power ..... 240Vac 50Hz  
 Weight ..... 1.25kg

**BULB**  
**£12.60**      **AN56**

PAR56 bulb. 240Vac 300W. Focused narrow beam.



**PAR56 SPOT**  
**£49.95**      **PAR56**

PAR56 spot lamp with mounting bracket. Complete with frame for coloured filters. Accepts 300W PAR56 lamps (supplied separately).  
 Power ..... 240Vac 50Hz  
 Weight ..... 1.2kg



**BULB**  
**£5.95**      **AN36**

PAR36 bulb. 6V 30W. Focused narrow beam.



Individual cube lighting pod containing a standard rear reflector coloured spot lamp. Pods can be interlocked to produce a large block of lights.

**POD + BULB**      **£5.95**

- G003
- G003A
- G003B
- G003C
- G003D
- G003E
- G003F
- G003G



**BULB ONLY**

- Red      G003S    £1.50
- Blue     G003T    £1.50
- Green    G003U    £1.50
- Orange   G003V    £1.50
- Yellow   G003W    £1.50
- Rose     G003X    £1.50
- Turquoise G003Y    £1.50
- Violet    G003Z    £1.50



**SOUND-TO-LIGHT**  
**£29.50**      **RDL1130**

3-channel sound-to light column with built-in microphone and sensitivity controls for each channel. Three 60W coloured spot lamps (included).  
 Power .... 240Vac 50Hz

**SOUND-TO-LIGHT**  
**£53.95**      **RDL1600**

3-channel sound-to light powering six 60W coloured spot lamps (included). Built-in microphone and individual channel sensitivity controls included.  
 Power .... 240Vac 50Hz



**RUNNING LIGHT**  
**£69.95**      **RRL1600**

6-channel running light with six 60W coloured spot lamps (included). Sound activated with speed and sensitivity controls.  
 Power .... 240Vac 50Hz

**TRIPLE E.T.**  
**£47.95**      **MF3743**

A single central 300-500W quartz halogen lamp, focused through three coloured lenses creating simple but stunning effect of three horizontal flat beams. Fan cooling of casing.  
 Power ..... 240Vac 300/500W  
 Height ..... 160mm



**ROPE LIGHT**  
**£28.45**      **SL215M**

5m tough but very flexible plastic tube rope light. 4 circuits of 20 coloured bulbs. Unique design of the tube acts as a lens, greatly increasing the light output. Powered from any standard rope light controller. May be connected end to end to increase length.  
 Length ..... 5m  
 Dia ..... 21mm



CREDIT CARD HOTLINE: (0703) 772501/783740 FAX: (0703) 787555



**COLOUR WHEEL SPOT**  
**£13.95 5CWNS**

5-colour rotating colour wheel spot light utilising a standard E37 rear-reflector spot bulb. Compact rectangular case containing colour wheel motor. Adjustable mounting bracket. Supplied with 5 colour gels and bulb.

Power . . . . . 240Vac 50Hz  
 Dims . . . . . 205 x 120 x 145mm  
 (less bracket and wheel)  
 Weight . . . . . 1.3kg



**£80.00 4-LAMP HELICOPTER SL444L**

4 PAR36 lamps rotating at 50rpm. Lampholders fully adjustable for angle. Smooth, reliable motor. Safety isolating transformer and screwdriver release fuseholder. Lamps supplied separately.

Power . . . . . 240Vac 50Hz  
 Height . . . . . 255mm  
 Weight . . . . . 5kg

**COLOUR WHEEL SPOT**  
**£46.95 SUP5CW**

5-colour rotating colour wheel spot light with PAR36 lamp (complete). Compact rectangular case contains transformer for lamp, colour wheel motor and fuseholder. Adjustable mounting bracket. Supplied with 5 colour gels.

Power . . . . . 240Vac 50Hz  
 Dims . . . . . 210 x 155 x 115mm  
 (less bracket and wheel)  
 Weight . . . . . 2.25kg



**EGG STROBE**  
**£9.95**

G010 F30T Clear  
 G010A F30Y Yellow  
 G010B F30BU Blue  
 G010C F30G Green  
 G010D F30R Red

Self contained egg shaped strobes in a range of colours. Grey plastic bodies with coloured lenses. Fits Edison screw lampholders.

Flash rate . . . . . 40/min. approx.  
 Power . . . . . 240Vac 50Hz  
 Dims . . . . . 77 (max. dia.) x 127mm (overall length)



**£110.00 8-LAMP HELICOPTER SL448L**

8 PAR36 lamps rotating at 40 rpm. Lampholders fully adjustable for angle. Smooth reliable motor. Safety isolating transformer and screwdriver release fuseholder. Lamps supplied separately.

Power . . . . . 240Vac 50Hz  
 Height . . . . . 240mm  
 Weight . . . . . 6.5kg



**£27.95 SCANNER SL441L**

PAR36 single lamp scanner. 270° rotation forward and reverse. Smooth running motor. Mechanical reverse. Can contains safety isolating transformer and screwdriver release fuseholder. Lamp supplied separately.

Power . . . . . 240Vac 50Hz  
 Height . . . . . 280mm  
 Weight . . . . . 1.8kg



**£95.25 4-LAMP SCANNER**

4 PAR36 scanners on a single beam, each with its own motor. 90° scan with mechanical reverse. Lampholders adjustable for angle.

Power . . . . . 240Vac 50Hz  
 Height . . . . . 220mm  
 Length . . . . . 900mm



## SOLAR WOODEN MODELS

This range of Solar Kits makes an ideal project for children or students wanting to experiment with Solar energy and develop practical skills.

There are 3 different kits, complete with Solar Cell, pre-cut plywood model, glue, sand paper, and either a miniature DC motor or musical IC



**K611** Helicopter model with motor. Dia 280mm x length 220mm. Price £6.95



**K612** Gramophone model with music horn. 140mm long. Price £6.95

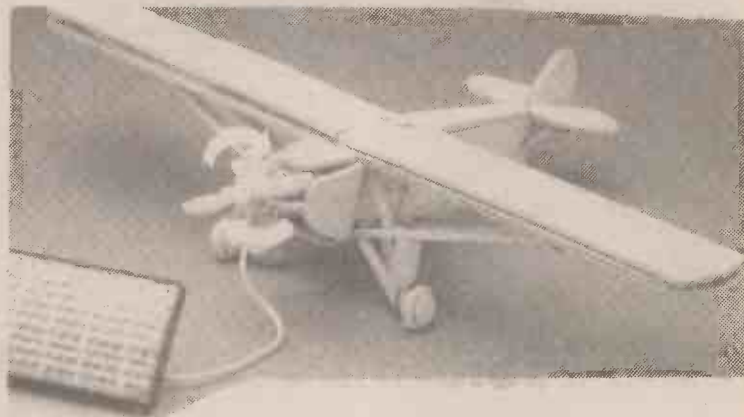

**K613** Aeroplane model with motor. Wingspan 310mm. Price £6.95

## BUMP 'n' GO SPACESHIP KIT

This spaceship is sonic-controlled and reacts to any type of sound. When it bumps into any obstacle it just goes in another direction. Just as it isn't hindered by obstacles, it can move on all types of ground - smooth or rough. It combines electronic and mechanical parts, is highly educational, and is easy to assemble - you just follow the instructions and look at the illustrations and you will be completely successful!

ORDER CODE: K619 price £8.95

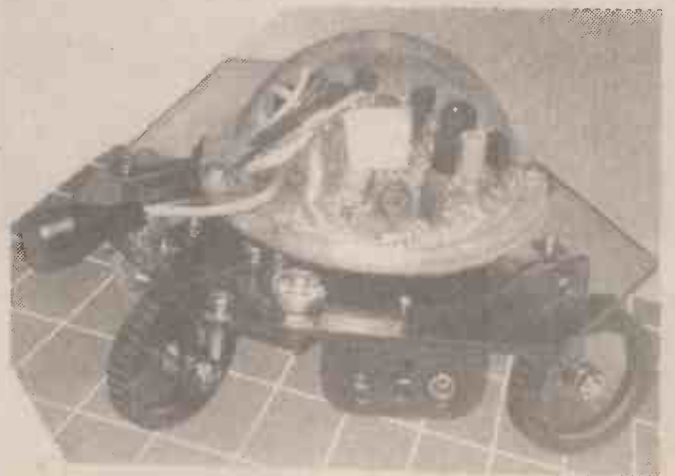

CREDIT CARD HOTLINE: (0703) 772501/783740 FAX: (0703) 787555



£90.00 **SIGNAL RECEIVER RC300**

Professional wireless microphone receiver for use with G202, G203 and G204 transmitters. Single super heterodyne system for dependable operation. 2-channel, 5-LED indicators for carrier and output signal levels. Output gain and signal squelch controls.

Power . . . . 240Vac 50Hz or 12Vdc via external adaptor (not supplied)

Receiver specification same as G200 (WMS202)



£70.00 **WIRELESS MIC HT300**

Professional wireless mic. Shock proofed high quality dynamic insert. Crystal controlled direct FM transmission for stable oscillation frequency under changing temperature and battery voltage conditions. Low battery and mic on indicators on base.

Power . . . . . 3 x AA batteries (not included)

Receiver specification same as G200 (WMS202)



**TIE CLIP MIC PT300**  
£55.00

Tie clip wireless mic. High quality electret insert connected to transmitter pack by 1.6m lightweight screened lead. Lightweight transmitter pack (125g with batteries) with belt clip and on/off switch.

Power . . . . . 3 x AA batteries (not included).

Transmitter specification same as G200 (WMS202)



**GUITAR TRANSMITTER GT300**  
£53.00

Professional wireless guitar transmitter. Guitar connected to transmitter pack via a 1.4m double screened noiseless lead, with 6.35mm plug. Lightweight transmitter pack (125g with batteries) with on/off switch and belt clip.

Power . . . . . 3 x AA batteries (not included).

Transmitter specification same as G200 (WMS202)

## PROFESSIONAL DISCO TURNTABLES

### QUARTZ DIRECT DRIVE

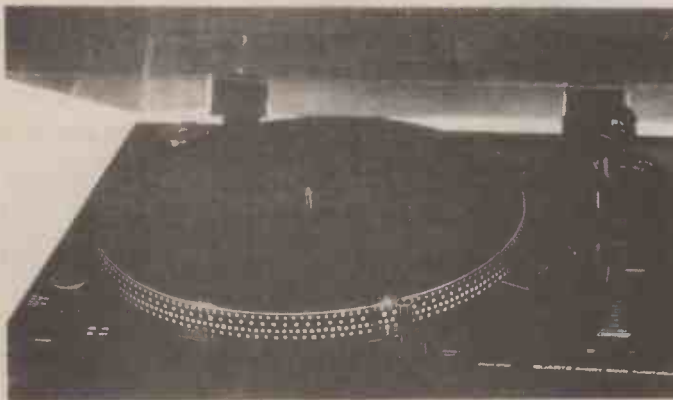

High quality belt driven or quartz direct drive disco turntable. Fast start and stop from push button switch. Electronically controlled 33/45rpm with pitch control and strobe. Well balanced tone arm with anti-skate control. Built-in record cue light. Complete with leads and 7" single adaptor.



- ★ FAST START/STOP
- ★ REMOTE START/STOP
- ★ HIGH QUALITY TONE ARM
- ★ ANTI-SKATE
- ★ CUE LIGHT
- ★ PITCH CONTROL
- ★ TURNTABLE STROBE
- ★ FULL MANUAL OPERATION
- ★ ELECTRONICALLY CONTROLLED 33/45 rpm
- ★ SPRUNG FEET

£157.00 **DLP3**

Quartz controlled direct drive fully manual turntable.

Wow and flutter . . . . . Less than 0.15% wrms  
 Turntable platter . . . . . 309mm dia. aluminium  
 Speed . . . . . 33<sup>1</sup>/<sub>3</sub>" rpm and 45 rpm  
 Tone arm . . . . . Statically balanced  
 Power supply . . . . . 240V 50/60Hz  
 Power consumption . . . . . 5.0W  
 Dims . . . . . 419 (W) x 115 (H) x 335 (D) mm  
 Net weight . . . . . 10kgs

ALL OUR PRICES INCLUDE VAT – JUST ADD £2 POST/PACK TO TOTAL ORDER VALUE

A RANGE OF HIGH QUALITY TEST EQUIPMENT AT ATTRACTIVE PRICES



### FUNCTION GENERATOR

**Y134B FG2020A**

A versatile and compact function generator capable of generating high quality sine, square and triangular waves of high stability and accuracy. The sine and triangular waveforms can be amplitude and frequency modulated by applying external voltages at the VCA (voltage controlled amplitude) and the VCF (voltage controlled frequency) inputs. Output frequency is adjustable from 0.5Hz to 500kHz in 6 ranges. The DC offset of all waveforms can be adjusted  $\pm 10V$  by front panel adjustment.

Frequency range . . . . . 0.5Hz to 500kHz  
Waveforms . . . . . Sine, triangular and square  
Amplitude . . . . . 20Vp-p max. open circuit  
10V p-p max. into 50 $\Omega$   
Frequency accuracy . . . . .  $\pm 5\%$  of full scale  
DC offset . . . . . Variable  $\pm 10V$  open circuit  
 $\pm 5V$  into 50 $\Omega$   
Sine wave distortion . . . . . 1% typical at 1kHz  
Square wave . . . . . 500nS typical rise time  
Power . . . . . 240Vac 50Hz  
Dims . . . . . 205 x 72 x 162mm

**PRICE . . . . . £108.00**



### AC MILLIVOLTMETER

**Y134A MV3002A**

A highly sensitive and precise AC millivoltmeter used for measuring AC voltages in the range of 300 $\mu V$  to 100V between 5Hz and 1MHz. The output terminals allow this unit to be used as a wide-band high gain amplifier or pre-amplifier. Calibrated with AC volts and two decibel scales.

**Voltmeter:**  
Voltage range . . . . . 300 $\mu$  to 100Vac  $\pm 3\%$   
Frequency range . . . . . 5Hz to 1MHz  
Input resistance . . . . . 10M $\Omega$   
Input capacitance . . . . . Below 50pF

**Amplifier:**  
Output voltage . . . . . 1V no load  
Frequency range . . . . . 10Hz to 500kHz  
Output impedance . . . . . 600 $\Omega$   $\pm 20\%$   
Power . . . . . 240Vac 50Hz  
Dims . . . . . 142 x 195 x 205

**PRICE . . . . . £96.00**



### SIGNAL GENERATOR/COUNTER

**Y142A SG4162AD**

A combined radio frequency signal generator and frequency counter. A six character LED display allows direct reading of internally generated signals or signals from an external source. Frequency generator has a range of 100kHz to 150MHz, which can be externally modulated and has output level control. Frequency counter has a range of 10Hz to 150MHz. 6 step frequency range selector, frequency fine control, crystal socket, crystal oscillator/internal modulation/external modulation selectors, 20dB attenuator switch and external modulation sockets.

#### RF SIGNAL GENERATOR:

Frequency range . . . . . 100kHz to 150MHz  
RF output . . . . . 100mV rms (up to 35MHz)  
Output control . . . . . 0/20dB and fine adjuster  
Modulation . . . . . Internal 1kHz, external 50kHz - 20kHz  
at less than 1V rms

#### FREQUENCY COUNTER:

Frequency range . . . . . 10Hz to 150MHz  
Input voltage . . . . . Less than 50mV  
Max input voltage . . . . . 3V  
Input impedance . . . . . High frequency 1M $\Omega$  VHF 50 $\Omega$   
Power 240Vac 50Hz Dims . . . . . 215 x 150 x 200mm

**PRICE . . . . . £179.00**



### AUDIO GENERATOR/COUNTER

**Y142B AG2603AD**

A combined audio frequency signal generator and frequency counter. A six character LED display allows direct reading of internally generated signal or signals from an external source. The frequency generator has a range of 10Hz to 1MHz with either square or sine waveforms and adjustable output level. The frequency counter has a range of 10Hz to 150MHz. Frequency range controlled by a 5-step selector and fine control. Adjustable output level with 0/20/40dB attenuation.

#### AUDIO GENERATOR

Frequency range . . . . . 10Hz to 1MHz  
Output impedance . . . . . 600 $\Omega$  unbalanced  
Output control . . . . . 0, -20, -40dB and fine adjuster  
Output control: Sine . . . . . 8V rms max  
Square . . . . . 10V p-p max

#### FREQUENCY COUNTER

Frequency range . . . . . 10Hz to 150MHz  
Input voltage . . . . . Less than 50mV  
Maximum input voltage . . . . . 3V  
Input impedance: High frequency . . . . . 1M $\Omega$   
VHF . . . . . 50 $\Omega$   
Power . . . . . 240Vac 50Hz  
Dims . . . . . 215 x 150 x 200mm

**PRICE . . . . . £175.00**



### SIGNAL TRACER/INJECTOR

**Y133 SE6100**

Signal tracer/injector for fault finding in audio and radio frequency circuits. Built-in Vu meter and internal speaker for indication. Tracer and injector level controls. 0-60dB attenuation switch and function control switch. Input, output, external speaker and injector sockets on front panel. Supplied complete with leads and instruction manual.

Tracer: Gain . . . . . 60dB max @ 1kHz  
Attenuation . . . . . 0-20-40-60dB  
Input impedance . . . . . 100k $\Omega$   
Output impedance . . . . . 600 $\Omega$  (unbalanced)  
Meter . . . . . Vu 100 $\mu A$

Injector: Frequency . . . . . 1kHz (approx.) square wave  
Level . . . . . 4.5V max P-P

Power . . . . . 9Vdc (PP3 battery)  
Dims . . . . . 200 x 140 x 96mm

**PRICE . . . . . £55.00**



### FREQUENCY COUNTER

**Y134 FC5250**

7-digit digital frequency counter for frequencies between 10Hz and 150MHz. Power on/off, x1/x10 gate time and VHF/HF switches. Inputs via BNC sockets. Supplied complete with instruction manual and test lead. Requires an external 9Vdc nom 200mA power supply.

Frequency range . . . . . HF 10Hz to 30 MHz  
VHF 10MHz to 150MHz  
Input voltage . . . . . 50mV nom, 3V max  
Gate time . . . . . 1 sec, 5 sec  
Input impedance . . . . . HF - 1M $\Omega$   
VHF - 50 $\Omega$

Dims . . . . . 140 x 65 x 122mm  
Power . . . . . 7 - 10Vdc 200mA

**PRICE . . . . . £65.00**



### LCR BRIDGE

**Y134C LCR3000A**

A fully transistorised AC bridge which allows accurate measurement of resistances, capacitances, inductances and transformer turns ratios.

Resistance range . . . . . 0.1 to 11.1M $\Omega$   $\pm 1\%$   
Inductance range . . . . . 1 $\mu H$  to 111H  $\pm 2\%$   
Capacitance range . . . . . 10pF to 1110 $\mu F$   $\pm 1\%$   
Power . . . . . 9Vdc (PP3 battery)  
Dims . . . . . 200 x 138 x 90mm

**PRICE . . . . . £115.00**



### INSULATION TESTER K3111V

1000Vdc, battery operated insulation tester. Internal battery condition test and 0-600Vac measurement functions included. Complete with leads, instruction manual, batteries and carrying case.

Measuring voltage.....1000Vdc  
 Measuring range....0.1M +5%  
 AC voltage range...0-600Vac +4%  
 Batteries.....6xAA (supplied)  
 Dims.....169x106x36mm  
 Price.....£79.00

### SOUND LEVEL METER YF20

Sound level meter for measuring intensity of ambient noise. Dual scale calibrated for 40 to 120dB. Complete with zipped carrying case, battery and instruction manual.

Operating range....40 to 120dB  
 Power....9Vdc (PP3 battery)  
 Dims.....160x65x38mm  
 Price.....£42.00



### DIGITAL LUX METER YF1065



A compact digital light level meter (lux meter) with three ranges. The selenium cell sensor is hermetically sealed for long term stability.

The meter is provided with a data hold switch and output terminals for connection to a recorder for long term tests. Supplied complete with carrying case.

Range . . . . . 0-200-2000-20000 lux  
 Display . . . . . 3½ digit LCD  
 Photosensor . . . . . Selenium cell  
 Power . . . . . 9Vdc (PP3 battery)  
 Dims: Meter . . . . . 119 x 64 x 26mm  
           Sensor . . . . . 125 x 66 x 36mm

Price £53.00

For higher quality, better spec. and reliability, it's worth paying a little extra! Hitachi's record is second to none and to back their confidence a 2 year warrantee covering parts and labour is given with every oscilloscope.

A brief spec. of some models is shown here but for a more comprehensive colour brochure, contact our sales department.

The following models are kept in stock. All others in the Hitachi range are available, generally within a few days.



V212 DC-20MHz, 1mV/div, dual channel . . . . . £385.00



V223 As above, with single time base delayed sweep . . . . . £545.00



V522 DC-50MHz, 1mV/div, dual channel, DC offset function, alternate magnifier function . . . . . £730.00



V209 DC-20MHz, 1mV/div, dual channel, battery operated portable . . . . . £860.00



**£94.00 M4650**

- ★ 4½ digit 15mm LCD display
- ★ 30 ranges including 20A ac/dc
- ★ Frequency counter
- ★ Capacitance ranges with zero adjust
- ★ Transistor and diode test
- ★ Continuity test with LED and buzzer
- ★ Data hold switch

AC volts . . . . . 0-200m-2-20-200-750Vac ±0.5%  
 DC volts . . . . . 0-200m-2-20-200-1000Vdc ±0.05%  
 AC current . . . . . 0-2m-200m-20Aac ±1.0%  
 DC current . . . . . 0-200μ-2m-200m-20Aac ±0.5%  
 Resistance . . . . . 0-200-2k-20k-200k-2M-20MΩ ±0.15%  
 Capacitance . . . . . 0-2000pF-200n-20μF ±2.0%  
 Frequency . . . . . 0-20k-200kHz ±2.0%  
 Transistor hFE . . . . . 0-1000 NPN/PNP  
 Dims . . . . . 176 x 90 x 36mm



**£84.00 M4630**

- ★ 4½ digit 15mm LCD display
- ★ 30 ranges including 20A ac/dc
- ★ Capacitance ranges with zero adjust
- ★ Transistor and diode test
- ★ Continuity test with LED and buzzer
- ★ Data hold switch

AC volts . . . . . 0-200m-2-20-200-750Vac ±5%  
 DC volts . . . . . 0-200m-2-20-200-1000Vdc ±0.05%  
 AC current . . . . . 0-2m-200m-20Aac ±1.0%  
 DC current . . . . . 0-200μ-2m-200m-20Aac ±0.5%  
 Resistance . . . . . 0-200-2k-20k-200k-2M-20MΩ ±0.15%  
 Capacitance . . . . . 0-2n-20n-200n-2μ-20μF ±2.0%  
 Transistor hFE . . . . . 0-1000 NPN/PNP  
 Dims . . . . . 176 x 90 x 36mm



**£67.00 M818**

- ★ 3¾ digit 17mm LCD display
- ★ Autoranging voltage and resistance
- ★ High and low frequency ranges
- ★ True RMS AC voltage and current
- ★ Diode and continuity test
- ★ Data hold switch

AC volts . . . . . 0-40-400-750Vac ±1.5%  
 DC volts . . . . . 0-400m-4-40-400-1000Vdc ±0.5%  
 AC current . . . . . 0-4m-40m-400m-2-10A ac ±1.5%  
 DC current . . . . . 0-4m-40m-400m-2-10A dc ±1.2%  
 Resistance . . . . . 0-4k-40k-400k-4M-20MΩ ±0.8%  
 Frequency . . . . . 0-4k-40k-400kHz ±2%  
 Dims . . . . . 187 x 87 x 34mm

**AUTO RANGING**

**M4C**  
 As above but with 40 point analog bargraph display



**M4630B**  
 As above but with 40 point analog bargraph display



**M818B**  
 As above but with 40 point analog bargraph display



**£80.00 M4600**

- ★ 4½ digit 15mm LCD display
- ★ 30 ranges including 20A ac/dc
- ★ Transistor and diode test
- ★ Continuity test with LED and buzzer
- ★ Data hold switch

AC volts . . . . . 0-200m-2-200-750Vac ±0.5%  
 DC volts . . . . . 0-200m-2-20-200-1000Vdc ±0.05%  
 AC current . . . . . 0-200μ-2m-20m-200m-2-20Aac ±0.8%  
 DC current . . . . . 0-200μ-2m-20m-200m-2-20Aac ±0.5%  
 Resistance . . . . . 0-200-2k-20k-200k-2M-20MΩ ±0.15%  
 Transistor hFE . . . . . 0-1000  
 Dims . . . . . 176 x 90 x 36mm



**£61.00 M80**

- ★ Large 3¾ digit 21mm LCD display
- ★ Autoranging volts, ohms, amps and frequency count
- ★ 20 Amp ac/dc ranges
- ★ Data hold function
- ★ Ruggedised, weatherproof case
- ★ Diode and continuity test
- ★ Auto polarity and zero

AC volts . . . . . 0-400-700Vac ±1.8%  
 DC volts . . . . . 0-400m-4-40-400Vdc ±0.5%  
 AC current . . . . . 0-4m-40m-400m-2-20Aac ±1.8%  
 DC current . . . . . 0-4m-40m-400m-2-20Aac ±1.2%  
 Resistance . . . . . 0-4k-40k-400k-4MΩ ±1.2%  
 Frequency . . . . . 0-4k-20kHz ±2.0%  
 Dims . . . . . 182 x 85 x 34mm

**AUTO RANGING**



**£37.00 M3800**

- ★ 3½ digit 12mm LCD display
- ★ 32 ranges including 20A ac/dc
- ★ Transistor test
- ★ Diode test
- ★ Rugged yellow case
- ★ Fuse protection
- ★ Automatic polarity and zero

AC volts . . . . . 0-200m-2-20-200-700Vac ±0.8%  
 DC volts . . . . . 0-200m-2-20-200-1000Vdc ±0.5%  
 AC current . . . . . 0-20μ-200μ-2m-20m-200m-2A-20Aac ±1%  
 DC current . . . . . 0-20μ-200μ-2m-20m-200m-2A-20Aac ±0.5%  
 Resistance . . . . . 0-200-2k-20k-200k-2M-20MΩ ±0.5%  
 Transistor hFE . . . . . 0-1000 PNP/NPN  
 Dims . . . . . 172 x 88 x 36mm

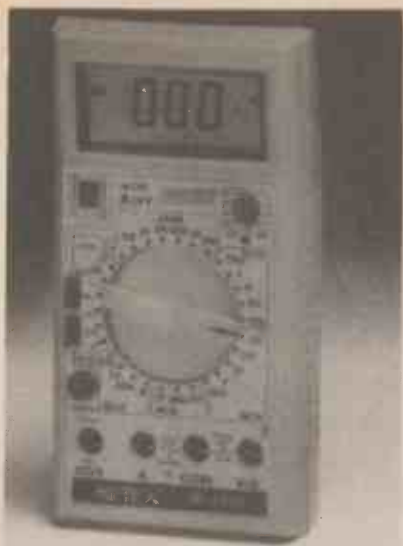

**£62.00 M3650**

- ★ 3½ digit 17mm LCD display
- ★ 30 ranges including 20A ac/dc
- ★ Frequency counter
- ★ Capacitance test with zero adjust
- ★ Continuity test with LED and buzzer
- ★ Transistor and diode test

AC volts . . . . . 0-200m-2-20-200-750Vac ±0.8%  
 DC volts . . . . . 0-200m-2-20-200-1000Vdc ±0.3%  
 AC current . . . . . 0-2m-200m-20Aac ±1.8%  
 DC current . . . . . 0-200μ-2m-200m-20Adc ±0.5%  
 Resistance . . . . . 0-200-2k-20k-200k-2M-20MΩ ±0.5%  
 Capacitance . . . . . 0-2000pf-200n-20μF ±2.0%  
 Frequency . . . . . 0-20k-200kHz ±2.0%  
 Transistor hFE . . . . . 0-1000 NPN/PNP  
 Dims . . . . . 176 x 90 x 36mm

**£57.00 M3630**

- ★ 3½ digit 17mm LCD display
- ★ 30 ranges including 20A ac/dc
- ★ Capacitance ranges with zero adjust
- ★ Transistor and diode test
- ★ Continuity test with LED and buzzer

AC volts . . . . . 0-200m-2-20-200-750Vac ±0.8%  
 DC volts . . . . . 0-200m-2-20-200-1000Vdc ±0.3%  
 AC current . . . . . 0-2m-200m-20Aac ±1.0%  
 DC current . . . . . 0-200μ-2m-200m-20Adc ±1.2%  
 Resistance . . . . . 0-200-2k-20k-200k-2M-20MΩ ±0.5%  
 Capacitance . . . . . 0-2n-20n-200n-2μ-20μF ±2.0%  
 Transistor hFE . . . . . 0-1000 NPN/PNP  
 Dims . . . . . 176 x 90 x 36mm

**£47.00 M3610**

- ★ 3½ digit 17mm LCD display
- ★ 30 ranges including 20A ac/dc
- ★ Transistor and diode test
- ★ Continuity test with LED and buzzer

AC volts . . . . . 0-200m-2-20-200-750Vac ±0.8%  
 DC volts . . . . . 0-200m-2-20-200-1000Vdc ±0.3%  
 AC current . . . . . 0-200μ-2m-20m-200m-2A-20Aac ±1.0%  
 DC current . . . . . 0-200μ-2m-20m-200m-2A-20Adc ±0.5%  
 Resistance . . . . . 0-200-2k-20k-200k-2M-20MΩ ±0.5%  
 Transistor hFE . . . . . 0-1000 NPN/PNP  
 Dims . . . . . 176 x 90 x 36mm

**M3650B**  
 As above but with 40 point analog bargraph display



**£74.00**

**M3630B**  
 As above but with 40 point analog bargraph display



**£70.00**

**M3610B**  
 As above but with 40 point analog bargraph display



**£60.00**



**TACH & DWELL METER**

**METEX®**  
**PROFESSIONAL RANGE**

A fully integrated range of high quality multimeters at competitive prices.

**TEST LAB**



All meters are supplied complete with:—

- PP3 Battery
- Carrying case
- Instruction manual
- Shrouded test leads

All Metex Meters are built and tested to IEC348

**£60.00 M3900TD**

- ★ 3½ digit 17mm LCD display
- ★ 20A ac/dc ranges
- ★ Dwell angle display
- ★ Low and high RPM ranges
- ★ Diode and continuity test
- ★ Rugged yellow case

AC volts . . . . . 0-200-750Vac ±1.2%  
 DC volts . . . . . 0-200m-2-20-200-1000Vdc ±0.3%  
 AC current . . . . . 0-2-20Aac ±1.8%  
 DC current . . . . . 0-2-20Adc ±1.2%  
 Resistance . . . . . 0-200-2k-20k-200k-2M-20MΩ ±0.5%  
 Low tach . . . . . 4, 5, 6, 8 cylinders - reading RPM ±2%  
 High tach . . . . . 4, 5, 6, 8 cylinders - reading x10RPM ±2%  
 Dwell . . . . . 4, 5, 6, 8 cylinders - dwell angle ±2%  
 Dims: . . . . . 176 x 90 x 36mm

CREDIT CARD HOTLINE: (0703) 772501/783740 FAX: (0703) 787555

Liberator Computer. This was a lap type portable made by Thorn EMI which never really sold well. We have some bits and pieces from it described below ;



**Z8882** Keyboard 278x124mm. 62 keys. Some of these have been used. Output to 20 way connector. £5.00



**Z4285** Complete CPU panel. 272x98mm containing D70008, 27C256 EPROM, 9xD4364C-20L plus other chips, connectors etc...£12.00

**Z4286** Partially assembled panel, as above. Contains 20 LS chips, D70008C, HN61364, TC5517BPL-20. None of these are soldered in. £5.00

**Z4287** Panel. 272x98 presumably used with CPU panel. This one has onboard HD6305, 63A50x2, 7660x4, 8211x2 + other chips, also 2x8 pin DIN sockets, switches, back up Nicads etc... £8.00



**Z1815** Facilites Cartridge. Inside a plastic case 60x50x16 with a 48 way plug is a 27256 Eprom. Supplied boxed with instructions for use with Liberator. £2.00



**Z8884** Acoustic coupler for use with Liberator. Made by Sendata, 700F series. One end has PCB with lots of chips plus 4xAA Nicads to power. Other end has socket to take mains power supply (supplied). Also included is a communications cartridge and a comprehensive 46 page manual. New. £20.00



**Z1808** small piezo transducer 24mm wide x 4mm thick. 2 for £1.00



**Z4281** Double sided adhesive tape. Big reel (175mm dial). Gives 50m x 20mm wide. Tesafix 959. £1.50

**Z4282** High insulation adhesive tape, like brown translucent sellotape. 33m reel x 12mm wide. £0.70

**Z4283** Self adhesive profiled sealing strip. Cross section 9x4mm (sample free). Price per metre 20p. 50 metre roll £6.00



**Z1814** Computer tape head by DRI, type 09-170. 9 track for half inch tape. Has 47 wires attached. New and boxed. £10.00

**Z4284** Head assembly. DRI head type 09-250 mounted on diecast alloy frame with capstan which has 10 way IDC socket attached to it. £15.00



**Z1807** Piher 0.1W enclosed horizontal presets, 33k. Pack of 25. £1.00

**Z1816** Miniature PCB mntg switch, spco. Gold plated pins. Red flat toggle. 3 for £1.00

**Z1813** "E" cell. Interesting little device this! Made by Plessey for use in an air-freshener. The basic principle is that the cell is charged up and can then be discharged by reversing the polarity. Fuller details and circuit of the air-freshener are supplied with each device. £4.00

**Z1817** Miniature axial choke SC30. 1mH. 10 for £1.00



**Z4280** Finned Heatsink in black aluminium. 180x108x14mm drilled for 2xT03 transistors. Extremely useful size. £2.50

**Z1812** T0126/220 Heatsink 30x30x12mm with lugs for insertion into PCB. Pack of 6 £1.00



**Z4302** Power supply by Thorn EMI (Presumably intended for Liberator). Contains main supply transformer rated 12-0-12 @ 0.83A (20VA). There is room inside to mount bridge rect and smoothing cap if required. Mains lead 2m long with 13A plug attached to one end of case, 3 pin socket on lead 2m long at other end. Only £3.00

**Z4292** Mains transformer size 80x80x66mm 110/230V pri, 9V 6A sec. £5.00

Toroidal Transformers made by Belclere. These are all physically the same size, rated at 35VA but have different windings as listed below. 75mm dia x 33mm thick. Fixing by means of a tapped bush. All mains primaries.

**Z4289** Type TR7457 8.5-0-8.5 @ 1A and 15-0-15V @ 500mA. £2.50

**Z4290** Type TR7353 5V 1.4A and 12-0-12V @ 120mA. £2.50

**Z4291** Type TR7252 12V @ 130mA; 12V @ 80mA; 5-0-5v @ 600mA. £2.50



**Z8881** Switch mode PSU. 252 watt enclosed unit 235x95x65mm made by Intelligence Power Technology. Type FET 204.02. Mains input, outputs +5v @ 15A; +15v @ 3A; -15v @ 3A; +24v @ 3A. With instruction sheet. £32.50

Half AA Nicads available in 3 styles. Each cell rated 1.2v 0.25 Ah. Normal charge 25mA for 16hr



**Z1809** Cell with wires attached both ends. £1.00

**Z1810** cell enclosed in black heatshrink with wires attached both ends. £1.00

**Z1811** Pack of four cells, enclosed in black heatshrink with wires attached at both ends. £3.95



**Z4299** Hourmeter. This has a 12-24V quartz movement and measures to 99999.99 hours (11 and a half years!). Face 52x52mm, depth 50mm. £4.60

**FOR THE WIDEST  
RANGE AT  
THE LOWEST  
COST...  
GET IT AT  
GREENWELD!**

ALL OUR PRICES INCLUDE VAT - JUST ADD £2 POST/PACK TO TOTAL ORDER VALUE



CREDIT CARD HOTLINE: (0703) 772501/783740 FAX: (0703) 787555



**Z4293** Panel 225x95mm with a number of tuned circuits using small pot cores and close tol. caps. Also on board is a 10 way DIL switch, 17 mostly LS chips and 7x741 in T099 case. £2.00



**Z4294** Neat panel 213x37mm with 5 keyboard switches, 3 red LED's and a DL1416 4 digit LED display with built in memory. There's a half metre of grey ribbon cable attached to a 34 way IDC socket. £5.00



**Z4284** Converter, S5/8-RS232. Box 88x62x24mm with small panel inside contains socketed ICL232 chip (replaces 1488/89) and 74HC14. Coming from box are 2 leads: one is 0.5m long with a 25W socket, the other is 1.2m long with 8 pin DIN plug. Chips alone cost £9.00! £6.00



**Z4295** Error Correction Card, made by Tulsedata Ltd, this 130x86mm board contains a 80C85A microprocessor, 82C51x3, 5864-15, 2764-15, +9 other chips, a 10 way DIL switch R's C's etc... There's a 14 way ribbon cable to a small PCB with 2x1489. Originally cost over £70.00. Our low price £10



**Z4301** Panel 306x195mm crammed full of chips, nearly all 74LS. Good range of gates and complex logic. 118 IC's for just £5.00

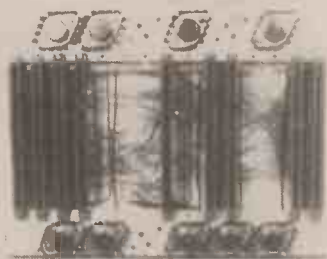

**Z4296** Metal chassis 310x230x25mm with 9x50 way double sided 0.1 edge connectors +9xLM309k steel 5V 1.2A/T03 voltage regulators on small heatsinks. £10.00



**Z4300** Nice panel 330x170mm with 3 chunky heatsinks 47x36x32mm, each with T0220 voltage reg. Also 56x74 series IC's including L+LS. 3x40W IDC plugs, few tants etc... Attached to the board are 2x0.5 metre long twisted and flat ribbon cables terminated in 50 way IDC sockets. £4.00



**Z4297** Panel 95x57mm with 2x18 way D/S 0.156 inch edge connectors plus 34 way IDC plug. £1.00

**Z4298** Panel 95x57mm with 18 way D/S 0.156 inch edge connections plus 50 way IDC plug. Also 8 way DIL switch. £1.00



**Z4288** CMOS Panel. 25 chips mostly CMOS gates. £1.00



**Z4279** Interesting little panel (75mmx40mm), with 16 position BCD channel switch (24 pins), two dual green seven seg displays, two min keyboard switches, and a short a 4093. Attached by a short length of ribbon cable is a second panel (same size) with 4518, 4019 and two x 5068 chips. Supplied with circuit. Only £2.20



**Z8883** Extremely large panel 510x335mm. Consists of 2 PCB's each 245x285mm joined together by an ally strip along one side and a finned heatsink 510x105mm along the other. This has mounted on it 12 assorted power transistors-2N3055/3772/3789. Another smaller heatsink 152x105x24mm has 4x2N3055. There are 3 more 2N3055 on the PCB, also an assortment of chips, 30 transistors, wirewound R's C's +2 heavy duty 12V relays in sockets with 3 sets of change-over contacts rated 6A. £15.00



**CHIPS**  
RC107 Op-amp - gen. purpose compensated. TO99 case. £1.00  
NE531 Op-amp - hi slew rate TO99 case. 75p

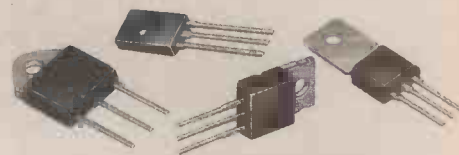

**K575** Plastic Power Pack, mainly TO126 & TO220 transistors, SCR's, Triacs etc. All new full spec marked devices offering fantastic value. Lots of TIP & BD types. 50 for £7.50



**Z1805** LED display. 11 green 5 x 2mm leds in plastic housing 69mm long. The centre LED is positioned vertically, the others horizontally. 60p



Software - some odd tapes have just become available:

For the Dragon 32:  
Z4266 'Monster Mine' £1.00  
Z1774 'Golf' £1.00  
For the BBC 'B':  
Z4268 'Util-1.' Contains character define and envelope editor. With comprehensive instruction manual. £1.50  
Z1777 'Galactic Empire' £1.00  
For the ZX Spectrum:  
Z4267 'Mountains of Ket'. These look like returns so only. 50p  
For the Commodore 64: (not all have library cases)  
Z1775 English language revision. £1.00  
Z1776 Maths 1 revision. £1.00  
Z1778 Chemistry revision. £1.00  
Z1779 Biology revision. £1.00



**K574** Wire link pack. A wide range of sizes from 3mm to 50mm for use with breadboards or PCB's. Some are bare, a few are not preformed. A pack of 250. £1.00

**Z1806** We also have bandoliered wire links, 60mm long 24SWG. Pack of 200 £0.00; 1000 £3.00; reel of 15,000 £25.00



**Z8880** Multicore cable. Black PVC sheath 17mm dia. contains 50 cores of 16/0.2 flex. £1.00 per metre.

CREDIT CARD HOTLINE: (0703) 772501/783740 FAX: (0703) 787555



Z4263 Memory PCB. Panel 310 x 200mm with 45 HM4816AP-4 chips + another 50 assorted LS etc. £10.00

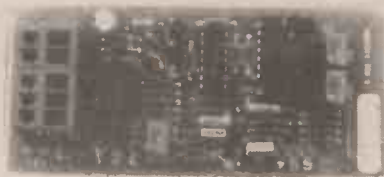

Z1795 PCB 110 x 50mm with 9400, LM339, 24V DIL relay, 2 x BC182L, BC212L, 3 trimpots, R's C's etc. £1.00

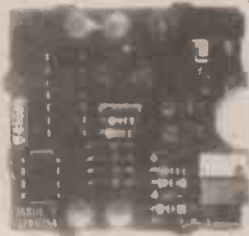

Z1794 Small PCB 45 x 47mm with 9402, OP07, 78L15, 2N3703, 2 trimpots R's C's etc. 2 for £1.00



Z4269 Flash Module. PCB 60 x 25mm containing all circuitry (except discharge capacitor) to drive small xenon tube. Needs 100-500 mF 350V cap. Or I suppose you could use it as a "shock machine". 2 for £1.00



Z1799 Belling, Lee L2723 fused switched mains inlet (DP on/off rated 6A). Needs cut out 60 x 28mm. Clip fix. Their price £3.75 Our price £1.00



Z4270 High power pre-set horizontal by Berco.11R, 3.4A, 127W. 'Slider' can be set to any position along rheostat winding. Ceramic former. Fixing centres 187mm. £4.00



Z1792 6V 400mA PSU with moulded on European 2 pin plug. Mains input. Output lead 1.5m long fitted with 2.5mm power socket. £2.00  
Z1793 As above, but 9V 400mA. £2.00

Our packs of tweezers & scissors are now almost sold out but we do have a quantity of one particular type of scissors & tweezers:



Z4256 Stainless steel scissors with sharp points 130mm long. £1.00



Z4255 These tweezers are finest quality stainless steel 130mm long with serrated ends. 75p



Z1801 VHF Tuner by GTE Sylvania. Screened Case 80 x 62 x 20mm with clip on lids both sides. No info. except number on lid "F3720 GTE Video" £2.50

Z4276 Heatsink. Nice chunky finned TO3 sink in black aluminium with T slots. 100 x 57 x 32mm. £2.00

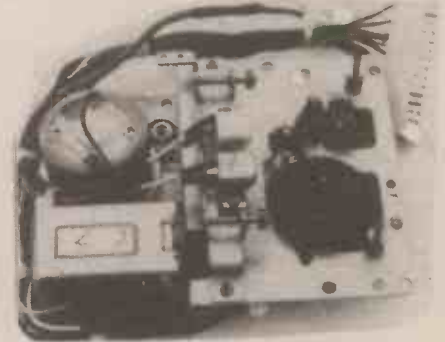

Z4274 Micro cassette mechanism 100 x 74 x 35mm used in dictaphone answer phones. Complete with record/playback and erase heads, 6V solenoid and motor. Speed control is by optical sensing and hall effect switch. Outputs from heads, solenoid, motor & sensors wired onto 15 way 0.1" socket. Only £2.00



Z1800 Cassette for above - Only a limited quantity available - and they're not cheap! £1.00



Z4278 Condenser mic. 17mm dia x 20mm soldered to the end of a 460mm long lead with phono plug attached. 75p



Z4273 1/8" bore red nylon compressed air line 150 psi max. 50p metre; 15m coil £6.00



Z1796 Extra flexible Silicon rubber insulated multicore cable, 1.5m long. Brown sheath 8mm dia. 5 cores, each 24/0.2. 50p

Z4271 Mains lead 2m long. 13A moulded play one end with fitted 5A fuse, right angle EEC socket the other. £1.50

CREDIT CARD HOTLINE: (0703) 772501/783740 FAX: (0703) 787555



Z4275 'Home Alert II' Programmable Electronic Burglar Alarm. Fitted to any door, it will sound an alarm when opened if the correct code has not been punched in. Easy and reliable to use, simple to install. Powered by single PP3 battery. On presentation card with full instructions. Size 220 x 40 x 30mm. Attractive wood grain finish. £14.95

G251 Poly bags, self seal 200g 75 x 58mm 75p/100 £4.48/1000 (sample free)

G252 As above, but 145 x 102mm. £1.50/100 £9.95/1000 (sample free)

Sub-min LED's, ideal for model railways. Only red & green though, no yellow. Body size 3 x 2 x 2mm - lens 1mm dia. Axial leads.

Z1802 Pack of 6 red £1.00

Z1803 Pack of 6 green £1.00

Z1804 Also some larger red LED's with a 2mm dia lens, 5mm dia body. Radial leads. Pack of 6 £1.00



Z1797 Membrane Keyboard 155 x 113mm with 80 x 22mm aperture for display from case Z4245. 22 keys. Output to 11 way flexible connector. Self adhesive. Only £1.00

Z1798 Brushed Aluminium sheet 1.2mm thick (18g) 144 x 108mm, drilled with a 4mm hole in each corner & an additional 4mm hole on one side. Film protected. Pack of 5 sheets £1.00

More returns of Flash accessories from Hanimex including a series of dedicated modules.



Z4264 Hot shoe adapter. Plastic part slides on to camera: 150mm lead to miniature co-ax plug. 3 for £1.00

Below are listed the dedicated modules. Nearly all are boxed with instructions, but have not been tested by us and are sold 'as seen' without guarantee.



Z1780 Module M for Minolta XG, XD. £2.00

Z1781 Module O for Olympus OM1 2, 10 etc. £2.00

Z1782 Module N for Nikon EM, FE, FM. £2.00



Z1783 Module HPI for Pentax ME, MG, MV, LX etc. £2.00

Z1785 Module CA for Canon A1, AE1, AV1, AT1. £2.00

Z1784 Module P for Pentax ME, MV. £2.00

Z1786 Module HC2 for Canon most models. £2.00

Z1787 Module HN2 for Nikon FG & FE2. £2.00

Z1788 Module HR1 for Ricoh XR & KR. £2.00

Z1789 Module CX for Contax 138, 139. £2.00

Z1790 Module HO1 for Olympus OM1, 2, 10, 20 & 30. £2.00

## FLASH GUN RETURNS

Hanimex electronic flash units that have been returned by the consumer to the place where purchased. These are offered complete & in good condition (many in original boxes) but have not been tested by us, so are offered without any guarantee. 4 models available, as listed:



Z4259 Type X140. Hot shoe attachment. Size 75 x 60 x 25mm off/on switch & test button. Takes 2 x HP7. Originally sold at £7.10. £3.00

Z4260 Type X215. Similar to above £3.20

Z4262 Type TC1.25. Much more sophisticated 'Thyristor computer.' Fully dedicated for a whole range of cameras, including Canon A1, AE1, AV1, Olympus OM2, Nikon EM/FE, Contax, Yashica, Minolta etc. 20m ISO 100 on normal. Wide angle difuser included. 1 manual 2 auto settings. Can be switched from ISO 25-1000. Takes, 4xHP7. Originally sold at £19.95. Comprehensive instruction book included. £8.50



Z4272 Etri fan, mains operated 80mm dia. Fixing centre 90 or 100mm. Die cast ally frame. £5.00

Z4277 25mF ± 10% 450V 50Hz capacitor. 110mm long x 70mm dia. £5.00



Z4265 Barrier strip 3 way high current (15A) screw to tag by Cinch. Farnell's price 57p each. Our price 4 for £1.00

Z1791 Hexagon socket countersink head screws 1/4BSF x 1". In boxes of 100. £2.00

BETTER VALUE...  
BETTER SERVICE...  
YOU'D BETTER  
GET IT AT  
GREENWELD!!

ALL OUR PRICES INCLUDE VAT - JUST ADD £2 POST/PACK TO TOTAL ORDER VALUE



**Z8872** Air pressure regulator with motor drive. This unit consists of a strong steel case (175mm W x 250mm L x 100mm H) which is suitable for wall mounting. Air inlets and outlets are fixed to the bottom of the base and fit 1/2" olives.

Inside there is a pressure regulator (between 100 and 2 psi) max input pressure 150 psi. The regulator has one air output leading to the outlet, another leading to a pressure gauge (by Budenberg) reading to 100 psi. Size; 65mm dial. The motor drive consists of a 250 rpm @ 50Hz motor wired for 110 Vac use (wirable for 22JV). Fixed to the motor is a 500:4 reduction gear box, the output shaft of which is connected to the regulator adjustment screw.

The motor is stopped between two limits by micro switches. Height of motor and regulator 197 mm. **£38.00**

**Z602** Intercom kit. All parts to make this simple 2 way intercom. Circuit + layout + instructions included, also 2 cases for main and remote. Uses TBA820 chip. Needs 9V battery. **£6.95**



**Z652** Coin operated mechanism. Made by Coin Controls, this will accept various size coins by simple adjustment of 4 screws. Incorporates various security features - magnet, bent coin rejector etc. Microswitch rated 5A 240V. Front panel 115x64. Depth 130mm. Cost £10.85. Our price **£4.00**



### SILVER RECOVERY SYSTEM

**Z8875** A disposable 'pick up head' (anode) encased in a plastic container 195 x 75 x 35mm removes silver from photographic fixer solution when used as directed. Comprehensive instruction leaflet, mains power supply. **£6.95**

**Z8876** As above but power supply is for US - 120V input, 2VDC 30mA output. **£4.95**

**Z8877** As above but without power supply. (Anode needs about 2V @ 30mA). **£2.95**



**Z8873** Industrial compressed air 'cyclone' moisture trap and filter.

Moisture trap works by generating a chamber full of circulating air which centrifuges out moisture droplets and particulate matter. A scintered brass filter removes any remaining particles. Max pressure 250 psi (16 BAR) 1.5" BSP fittings.

Height 250mm Length 200mm Width 100mm **£24.00**

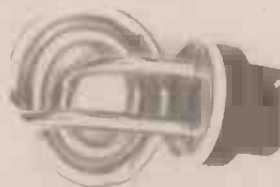

**Z4238** Kettle Element for jug kettle. Standard mains input via normal 3 pin plug. Rated 240V 1KW. Complete with thick washer & locking nut. Normally sell at around £8.00. Our low price **£3.00**



**Z8874** Telephone answering machine. Superb piece of equipment manufactured in Germany by Anderhoff for their domestic market, so needs mod to be compatible with our system. This uncased model looks complete & is believed to be working. Size overall 305 x 163 x 57mm. On the PCB is a mains transformer (220v), relays & associated components. There are 2 mini-cassette decks, 6 position switch, Mic + amp circuit to record outgoing message. 2m main lead with 2 pin plug, + a 6 core lead for connexion to telecom socket. Excellent quality & value. **£12.50**



**Z974** Mixer Amp Panel 115 x 115mm and gives 1W O/P from a TBA820M chip. There are two inputs, one via a pre-amp, from phono sockets and separate volume controls. A third pot is used to fade from one input to the other. There are also 2 4p 3w rotary switches. Attached to the PCB by flying leads is a panel on which are mounted the 2 input skts, 2 x 5 pin DIN skts and 2 pin DIN speaker skt. A data sheet is supplied. All this for just **£2.50**

GREAT VALUE

ON ALL GOODS

WHEN YOU...

GET IT AT

GREENWELD!!

CREDIT CARD HOTLINE: (0703) 772501/783740 FAX: (0703) 787555

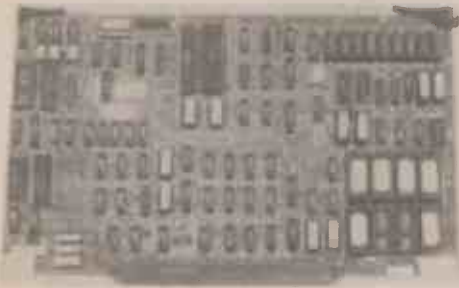

**Z4235** Superb panel 340 x 200 packed with high quality parts, giving outstanding value for money! 6809 microprocessor in skt 6840, 6850, 6844 support chips; 6x27128-25 EPROMS's in sockets; 9x8264A-10 RAM's; over 50 other chips, LS, linear etc. **£20.00**

**Z4236** 2x27C256-20 EPROM's that fit onto above board into 2 vacant sockets. Supplied in sealed plastic box. **£3.00**

**Z8868** DVC mk 11f by Digital microsystems Ltd. 2 part ally case 368 x 316 x 66mm (black base, cream top) with PCB 342 x 215 containing 66 IC's all in sockets including Z80 CPU, 2 x 8251 MK3882, Z80CTC, 3 x 2716 lots of LS and best of all 8 x 4416-2 RAMs. Also on board are xtals, transistors, led's trimpots etc. Self contained stabilized PSU. Mains operated. On the back panel are 8 S0239 sockets. These units were used in bookmakers for distribution of incoming signal to monitors. **£20**

A new parcel recently purchased contained a large qty of components, surplus to the manufacture of sophisticated electronic timers for heating systems. As well as the components there are a lot of made up PCB's in various states & these are described below: (for bulk prices, where available, please see separate sheet).



**Z4245** Case. Light/dark brown ABS case 185 x 138 x 170mm high with front panel consisting of data entry membrane keyboard with 20 keys & window for display. Bottom part of case is hinged both sides, so top can be removed completely or just swung open from either side. **£3.50**

**Z4246** Case (Z4245), display panel (Z4243), microprocessor panel (Z4242) wiring panel (Z4241) power supply PCB (Z4240). **£14.00**



**Z4244** Panel 155 x 104mm with 2 x 4.8V 100mAH Varta Memopac cells, CDP1805, CDP1878, HM6264-15 + 9 other mostly CMOS chips, crystal, R's C's etc. **£3.20**

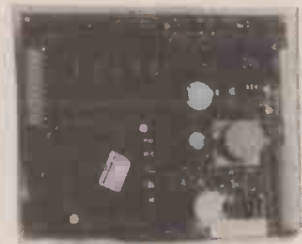

**Z4240** Power supply PCB. Panel 154 x 128mm containing mains transformer Z4248, 5 relays Z1718, back up battery Z1719, 5 fuseholders Z1721, 4 way DIL switches, 2 x W005 bridges, SKB2/02 bridge, 8211, R's C's, 7805 & 7824 on small heat sink. **£7.00**

**Z4241** Wiring Termination Board 148 x 114mm with 2 x 16 way termination blocks & a couple of header plugs. **£1.00**

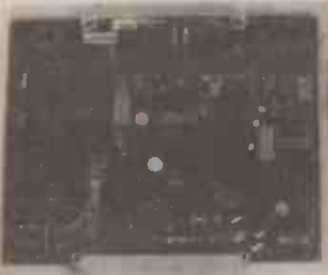

**Z631** PCB 170 x 135mm with 2 x LM324, 2 x ILQ74, 2 x MC14416, 4519, 2 x 4510, 2 x 4099, 4001, 4584, 2 x 741, HC14 LS05, 74125, 2 relays, R's C's etc. **£2.00**

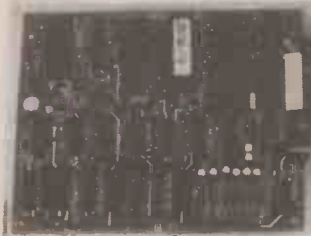

**Z4242** Microprocessor panel 155 x 120mm with 80C85 & 27C256 in sockets, 6264, 82C53, plus another dozen or so LS & HCT chips, crystal, T's, R's, C's etc. **£2.70**

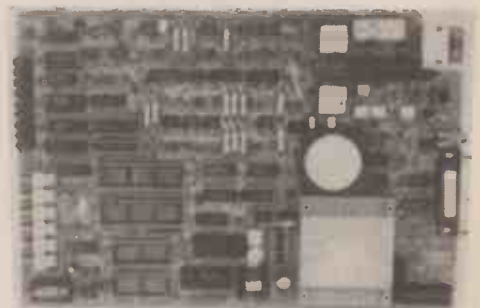

### Modem Panel

**Z4229** PCB 270 x 185mm covered in top quality components. Mains input to sealed transformer. 7812, 7912 & 7805 regs. 6 way telecom socket. Relay, line transformers, speaker, 3V Lithium cell, 2 xtals, 9 LED's, 6 way min. switchbank, 12 x MC1458, MC6173, MC6172, 18 HC/CMOS, 3 opto isolators, few other linears, DIL switch, 25 way D socket, etc. etc. 2 x 28 pin & 2 x 40 pin sockets with chips missing. Few only **£10.00**

**Z762** PCB 68 x 48 for display (Z541) + chip (7107 or sim) (Iascar) **50p**



**Z4145** Vero motherboard (slot assembly). New in original boxes, Vero code 243-27538B. PCB 128 x 120mm has 5 x 96 way DIN 41612 sockets with 5V, +12V connectors, 18 SIL networks + 8 caps. Vero's price £100. Our price **£30.00**

**Z4243** Display panel 152 x 112mm with NEC 8 digit display (Z1731); 8279-5, MC146818, 3 x uPA80C, & a couple of LS chips, crystal, etc. Plugs directly into above panel. **£2.90**

CREDIT CARD HOTLINE: (0703) 772501/783740 FAX: (0703) 787555

## Flash Units

Another delivery of assorted flash units reveals 6 different types, some of which have not previously been listed:



**Z4225** Like Z4100, only no relay  
**£2.10**



**Z4227** Similar to Z4176, but with an even larger discharge cap, but with no Xenon flash tube. **£3.00**



**Z4228** Similar to above, with 880uF 330V cap, but no light sensor or flash tube. **£2.40**



**Z4226** Similar to Z4165, but different shaped PCB's **£2.90**



**Z1729** Heater. Neat element 51mm long x 6.25mm dia. Rated 240V 150W. Operating temperature 427°C. **£1.50**

**Z1730** As above, but 120V. **£1.20**



**Z4303** Mains lead with moulded on 13A plug fitted with 3A fuse. Some of the pins may be slightly corroded. Pack of 3 **£2.00**

**Z4304** Toroidal transformer. High quality semi screened in a 96mm dia aluminium case. Overall depth 48mm. Fixing by means of tapped aluminium bush in centre. 110/240V input, output 25V @ 3A. **£7.50**



## Ribbon Cable

Slightly different from normal - this has a copper mesh running the width of it, embedded in the plastic sheath. Available in 2 sizes:

**Z4233** 20 way, 50p/m or 100 ft reel **£10.00**

**Z4234** 26 way, 70p/m or 100 ft reel **£14.00** Only a few reels, so be quick!



**Z8871** Multicore cable. Highly specialized one, this. 8mm dia PVC grey sheath overall screen containing 2 x insulated screened single core cables & 3 insulated twin core screened cables. Normally around £3 per metre - Our price **£1.50 per metre**. Small sample length free.



**Z4231** 6 way telecomm lead. 6 way plug one end, bared leads the other. 3m long, light grey. Has moulded on square grommet. Only **£1.60**

**Z8867** Heavy duty 3 core cable, rubber insulation 40/0.2mm conductors. Rated 2.5A. Price per box of 250ft (sample free) **£40.00**



**Z533** Danavox transducer - used as a speaker in pocket pagers. Impedance 50R. 20mm dia leads 90mm long. Extremely high quality unit. 50p **10/£4.20 50/£17**

Are you a Bargain List Subscriber? Keep up to date with all the surplus bargains we are constantly being offered. Just add £1 to your order for the next 5 issues, published at monthly intervals.

**MORE FOR  
YOUR MONEY  
WHEN YOU...  
GET IT AT  
GREENWELD!!**

**Z528** Switch top, 2 part. Clear plastic top clips over blue base. Fits over 3.5mm sq spigot. Size: 12 x 12mm. Pack of 20 **£1.00**

CREDIT CARD HOTLINE: (0703) 772501/783740 FAX: (0703) 787555

## SWITCHES



**Z4106** 10A switch/circuit breaker. Extremely neat clip fix by Airfax. 3 pole, 12.5A max. 50 x 41 x 39mm **£2.00**

**Z548** Toggle by Arco DPDT rated 13A 250V. Plastic toggle & fixing nut. **£1.20**



**Z1523** PCB mntg illuminated keyboard switch. High quality single pole reed with 5V lamp made by FR. Model RSM83-IAL 18 x 18mm. No tops unfortunately. **3 for £1.00**

**Z1393** PCB mntg keyboard switch with in built yellow LED. SP. Size: 12.5 x 12.5mm. No tops. **5 for £1.00**



**Z1710** Toggle switch Double pole on/off rated 10A 250V ac. Threaded bush with plastic & metal nut, also can be clipped in panel. **£1.50**

**Z1711** Another toggle switch, very similar to above. No rating printed on body, but looks about 10A. This one does not have a clip fix. **£1.20**

## RELAYS



**Z229** Keyswitch KMK2 48V DC 10A DPCCO contacts. **£1.00**

**Z211** Hamlin HE621C 12V SPCO reed 1000R coil. **80p**



**Z271** P & B KUP14A11 240V coil 3PCO 5A contacts. **£1.50**

**Z272** PCB mntg 4PCO. **£1.00**



**Z280** Relay, DIL. 24 volt coil 288R.SP contacts. OMRON G6B-1114P. **£1.00**

**Z1718** Solid state relay 43 x 25 x 70mm. Control voltage 3-24V DC switches 240V ac 4A. RS price £7.82. **£3.00**



**Z296** Holder for 4PCO MY4. Solder tag. **30p**

**Z297** Holder for 2PCO 'continental' solder tag. **25p**

**Z298** Holder for 4PCO 'continental' solder tag. **30p**

**Z299** Holder for 2PCO 'continental' PCB mntg. **25p**

## CAPACITORS



**Z1541** Ceramic disc 2200pF 7mm dia 5mm pitch. **20 for £1.00**

**Z1708** 0.47mF 40V solid axial tant **10/£1**

**Z1709** 0.01mF 50V bead ceramic **30/£1; £20/1000** sample free.

**Z788** Sprague 8u 25V elec axial caps. **Pack of 25 £1.00**



**Z1528** 2.2u 400V polyester axial cap 30 x 25 x 16mm. **2 for £1.00**

**K236** Miniature PCB mntg trimmer, 3-15pF. **Pack of 10 £1.00**

**Z758** Paper block capacitors 15uF 160V 50 x 45 x 25mm **2 for £1.00**



**Z4250** 10.000mF 16V electrolytic can, C431 by Mullard. These are a bit oversize (80 x 40) by current day standard, & so are being offered at **4 for £1.00**

## PRECISION RESISTORS

**Z1738** 0.25% precision metal film by Holco, type H8, 0.125W, 15ppm. Values in pack: 97K6, 99K, 120K, 144K, 173K, 249K, 299K, 325K, 358K, 396K, 430K. **Pack of 25 assorted £2.00**

**Z1739** Also 0.1% H2 0.5W in 1M only. **4 for £1.00**

**Z760** 75K 0.5% 50ppm precision metal film 1/4W. **Box of 100 £1.50**

## POTS



**Z1742** Precision 10 turn pot by Spectrol, model 860, 10K  $\pm$  3%. Linearity  $\pm$  0.25%. Body 45mm dia x 50mm long. Standard 0.25" spindle. **£3.00**

**Z4171** 10K lin pot, standard except 10mm long spindle. **Pack of 5 £1.00**

**Z1726** Multiturn cermet trimmer 9.5 x 9.5 x 4.8mm. Sperrnice T93YB 5K. **4/£1.00**

**Z1727** As above but 200R. **4/£1.00**



**Z1728** Spectrol multiturn pot, 10K. Rated 1 watt. 25mm long body. Adjusting spindle can be accessed from either end. **2/£1.00**

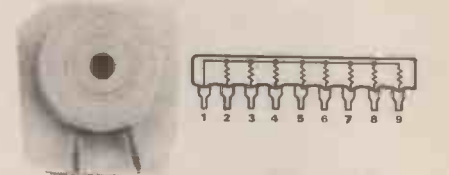

**Z988** RS power section 7R 0.7A. **4 for £1.00**

**Z786** 9 pin SIL resistor: 8 x 100K. **Pack of 10 £1.00**

**Z357** 5R 5% 5 watt wirewound resistors. **Pack of 10 £1.00**

Our Bargain List stocks constantly need replenishing! We buy surplus electronic components & equipment in parcels both large & small.

Send details/samples to:  
**The Managing Director,**  
**Greenweld Electronics Ltd.**  
**443 Millbrook Road,**  
**Southampton, SO1 0HX**

CREDIT CARD HOTLINE: (0703) 772501/783740 FAX: (0703) 787555

## TRANSFORMERS



**Z4248** Mains transformer, 110/240V input via PCB pins. Secondary; 6.5V @ 8VA, 22V @ 8VA, 22V @ 1VA, 1.5-0-1.5V @ 1VA. Nicely made by Skot. **£3.00**

All mains primary. Secondaries as listed:

**Z4213** 25V 1.5A. Clamp type 70 x 57 x 47mm terminated with wires. **£3.00**

**Z4214** 0-6-25V 1A. Clamp tyre 60x50x44mm Tags. **£2.20**

**Z4206** 20-0-20 @ 3A + 24v @ 200mA plus a tap to increase these values by 10%. 86 x 72 x 86mm. High quality 'drop through' design. Tags **£7.00**

**Z4207** 30v @ 1.5A, 6V @ 0.5A 80 x 65 x 72mm 4 way fix design. Tags. **£4.60**

## POWER SUPPLIES



Small qty of Gardners NV22 series DC-DC converters. All are 90 x 63 x 30mm and have terminating pins on the base, for PC mntg. All have inhibit and oscillator output pins. Normally costing £70+, these are exceptionally cheap to clear. Few only.

**Z1585** 24V DC input, output 12V 1.85A. **£8.00**

**Z1587** 24V DC input, output 15V 1.5A. **£8.00**



**Z673** Sinclair PZ8 power supply panel. PCB inc heat sink 115 x 127mm. 4 transistor circuit + bridge rect + cap. Needs TX. Believed to be 40V ± 5V variable output. Supplied with circuit **£2.00**



**Z1705** Varta Lithium cell, 1/2 AA size. 3V 1000 mA AH rating. Dated Jan. 1989. List £3.45 **Our Price £2.00**

**Z1706** Brand new PP3 Eveready batteries. Normally £1.07 each. Our special low price for these American imports is **3 for £2.00**



**Z1719** Back-up battery 4.8V 110mA PCB mntg. 23.5mm dia x 16.5mm made by Emmerich. Normally £3.76. **£1.50**

**Z1720** Lithium Manganese coin cell. Extremely thin, just 1.6mm x 20mm dia. Model 2016. Normally £1.67. **70p**

## SEMICONDUCTORS



**Z704** Heatsink 50 x 36mm with BU826 (removed from equip) **50p**

**Z721** 2 matched 2N397 Ger. PNP alloy transistors. **40p**

## DISPLAYS



**Z1814** Intelligent display by Densitron. LCD 16 character (5x7 dots) 3.07x5.73mm + Hitachi HD44780A00 micro-processor on PCB 80x36mm. 15 way connector on edge of board. Same as Farnell LM020L, their price **£21.00** Supplied with full data. **£8.00**



**Z4148** LCD as Z4115 but 6 digit, 50 pins. Like RS 588-601. Their price 10.86. **£3.00**

**Z1732** Epson LCD 4 digit 8mm high. **£2.00**



**Z1731** NEC Vacuum Fluorescent Display FIP8BII. 8 digit multiplexed output 10mm high. Heater voltage 2V, grid/anode voltage 24V. (Use Z4248 transformer to power) **£3.00**

**Z1560** 7 seg display, 20mm high. Common anode. **Only 70p! 25+ 50p 100+ 42p.**

**Z1743** TIL143 opto isolator. These have cropped leads & some are ex-equip, but are all working. **Pack of 3 £1.00**

## IC's

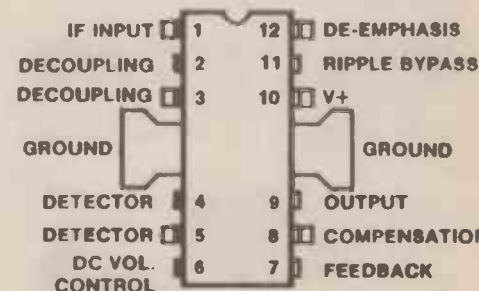

**TDA1035** Extremely useful chip which gives 4 watts of audio output. It has overload protection, stabilizing circuit, electronic volume control and also on board is an IF amp and demodulator! Supplied with circuit diagrams and data. **Only £1.00**



CREDIT CARD HOTLINE: (0703) 772501/783740 FAX: (0703) 787555



**MBL8086-2** Microprocessor. **£6.00**  
**P8088** Microprocessor. **£4.00**  
**D2764** (blown) EPROM. **2 for £1.00**  
**REGULATOR**

**Z950** LAS1510 10V 1.5A reg TO3. **60p**

### CRYSTAL



**Z1654** 8.863256MHz wire ended. **50p**

**Z1744** Crystal by IQD, wire ended 4.000 MHz **50p**

### DIODES

**K237** 200 diodes type SD3, soldered in pairs with cropped leads. **£1.00**

**K242** 10 x S2AR2 rects. **£1.00**

**K129** 8 x AA113 diodes. **£1.00**

**Z547** 3 x 5B1 bridge rects. **£1.00**

### TRIAC

**Z552** TAG 300-500 triac. These look new. **3 for £1.00**

### CONNECTORS



**Z1748** 2.5mm power connector line plug. Fits PO64. **3 for £1.00**

**Z1722** 16 pin SIL socket. **5/£1.00**

**Z1723** 16 pin SIL Header Plug. **10/£1.00**

**Z767** 26 way transition connector, IDC type. **10/£1.00**

**Z1724** PCB mntg screwed terminal block, 2 way. Rated 6A 380V ac **10/£1.00**

**Z1725** As above but 45' connexion. **10/£1.00**



**Z1712** 12 way connector: one side connects to PCB edge (0.2 pitch), other side has screw terminals. **£2.00**

**Z739** DIL header plug. 40 pin, no cover. **3/£1.00**



**Z1741** High quality 10 pin chassis socket & cable mounted plug, gold plated contacts. Made by SATO, 30mm FC. Plug 41 x 30 x 13mm. **£1.50**

**Z1606** Belling Lee 3 pole shrouded plug L1436/P **2 for £1.00**

**Z1399** BNC socket. Single hole chassis mntg by Greenpar. Very high quality in sealed packets. **2 for £1.00**

**Z4070** 3 way socket 4mm pitch by amp. **10 for £1.00**

**Z1717** 'UIKEJECT' low extraction force IC sockets designed by Vero. 64 way. **50p**



**P4064** New Line. Telephone extn. lead 3m long with plug one end and 4 extn sockets the other. BT Approved. **£9.95**

### IDC CONNECTORS



**Z962** 16 pin right angle wire wrap plug, with ears **50p**

**Z963** 26 pin do **60p**

**Z964** 40 pin do **70p**

**Z965** 50 pin do **80p**



### Polarised socket connectors

**J018** 26 way socket connector **51p**

**J019** 30 way socket connector **58p**

**J020** 34 way socket connector **65p**

**J021** 40 way socket connector **71p**

**J022** 50 way socket connector **80p**

**J023** 60 way socket connector **100p**

**J024** 64 way socket connector **105p**

**J025** 64 way DIN style socket connector **193p**

### DIN 41612 CONNECTORS



**Z1733** Right angle PC mntg socket 64 way (Rows A & C) **£1.00**

**Z1734** Right angle PC mntg plug 64 way (Rows A & C) **£1.00**

**Z1735** Right angle PC mntg socket 96 way. **£1.00**

**Z1736** Straight wire wrap socket 64 way (Rows A & C) **£1.00**

**Z1737** Straight wire wrap socket 32 way (Rows A & C even pins) **£1.00**

### PC MOUNTING DIN SOCKETS



**Z1713** 5 pin 180' **100/£10.00**

**Z1714** 5 pin 240' **100/£5.00; £30/1000**

**Z1715** 6 pin **100/£10.00**

**Z1716** 7 pin **100/£10.00**

**Pack of any 10 £1.80; any 25 £4.00; any 100 £12.00**

**Z743** 24 way socket, connexions on 5mm centres. Like RS466-933. Their price £4.74. **Our price £1.00**

### INDICATORS



**Z1385** Amber indicator, push fit into 8mm hole 5V. **4 for £1.00**

**Z1598** Red indicator 240V requires 6mm hole. Long leads. **4 for £1.00**

**Z1407** Min wire ended bulb 6 x 3mm 5V. **10 for £1.00**

**Pack of 100 £7.00**

CREDIT CARD HOTLINE: (0703) 772501/783740 FAX: (0703) 787555

## HARDWARE



**Z683** Solder washers 0.3" OD, 0.2" ID in plastic pots of 2500 (sample free). **£2.50**



**Z433** Bakelite washers 6BA. Sample free. **1000 for £2.00**

**Z435** 1.25 x 4BA cheeshead screws, steel **50p/100**

**K251** M6 x 60mm high tensile steel bolts + nuts, 10 off **£1.00**

**Z4088** Cable clip for 2 x 2.5 T&E cable. **Box of 100 £2.00**

**Z013** Sleeves, silicon rubber, 8mm O/D, 5mm I/D. Length 15mm. **Pack of 100 £1.00**

**Z742** Polarising key. **Pack of 10 50p**

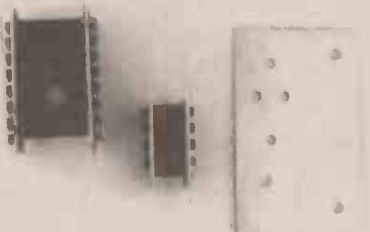

**Z1524** Heatsink 32 x 23 x 15mm. **5 for £1.00**

**Z1525** Heatsink 50 x 30 28mm. **4 for £1.00**

**Z356** Heatsink 80 x 50mm for TO3. **4 for £1.00**

**Z472** Clock case, oval format. Overall size 130 x 68mm x 87mm deep with built in stand. Rear panel punched to accept 4 switches & AWD. No front panel. White. **40p**



**Z4251** Silicone coating spray - RS552-501. Their price £4.89. Few only at **£3.00**

**Z1745** Heatsink compound, RS554-311 20ml tube. Their price £2.01. **£1.25**

**Z1746** As above but 100g tubes by Don Corning. **£4.00**



**Z4247** Cable gland with strain relief. Overall length 80mm dia 11mm. Takes cables 4mm to 8mm dia. **6/£1.00**

**Z655** Dispenser tube with valve. As used on cream dispenser. 185mm long, with extra tube & connectors 250mm long. **80p**

### ALFAC PACKS

Discontinued lines from 1988 Catalogue

EC803	12	EC993/2	8
EC948	3	EC918	10
EC970/2	6	EC993/1	6
EC970/1	2	EC964/2	6
		EC964/1	8

Originally costing **£3.45** for 5 sheets - now clearing at **£2** per pack or 6 assorted packs **£9**



**Z1747** Fuse clip, RS412 - 784 (our F001). **Pack of 100 £1.00**

**Z1721** Fuseholder. Vertically mounting PCB model. Bulgin F456 rated 10A 250V for 20mm fuses. Screwdriver release. Farnell sell these at £1.09 each. Our low price. **3 for £1.00**

**Z1530** Fuseholder, Belling Lee L1382 32mm finger release top. High current. Solder terminals. **60p**

### VIC SOFTWARE

A small qty of VIC software has just become available. All in original boxes but some are a bit tatty. Quantities very small. First come, first served.

Quizmaster

GCE/CSE English language

BBC Mastermind.

**ALL £2.00 each**

An introduction to Basic - Part 1 consists of large manual, 2 cassettes and template for drawing flow charts. **£5.00**

Book - Programmers Reference Guide for VIC 20. Includes circuit 288pp. **£2.00**

### BBC SOFTWARE



**Z4239** Another piece of software to go with that on page 2 of our catalogue. Recorder Tutor Classroom Ensemble Network Pack, for use when several micro's are being utilized. Includes 2 disks, a cassette & book **£4.95**

## STOP PRESS

**Z8878** 10 Mbyte HARD DISK DRIVE by Rodime. Full height. Originally made for WANG. Part no: R0202. Ex-equip, working. **£40.00**



## QUESTIONNAIRE

This questionnaire has been designed to be as painless as possible and is intended to help us give you a better service in the future. As an added incentive to fill it in, there'll be a prize draw of all completed sheets around Christmas time, and another sometime in 1990.

1. If you've filled this in before, tick here       2. If you object to filling in forms, tick here
3. How long have you been using Greenweld as a supplier? .....
4. How many times have you used Greenweld over the past year?
  - a) Mail order    0  1-3  4-9  10+  Total spent .....
  - b) Shop customer 0  1-3  4-9  10+  Total spent .....
5. What do you think of the response time - i.e. how long it takes for the order to arrive?  
Excellent     Very good     Good     Average     Poor     Awful
6. What about the quality of packing - Did goods arrive in perfect condition?  
Excellent     Very good     Good     Average     Poor     Awful
7. And value for money of goods ordered?  
Excellent     Very good     Good     Average     Poor     Awful
8. How much do you spend on electronics in a year? £
9. If you use other suppliers how do you rate their overall service compared with ours?

Supplier	Better	Same	Worse	Comments
.....	<input type="checkbox"/>	<input type="checkbox"/>	<input type="checkbox"/>	.....
.....	<input type="checkbox"/>	<input type="checkbox"/>	<input type="checkbox"/>	.....
.....	<input type="checkbox"/>	<input type="checkbox"/>	<input type="checkbox"/>	.....
10. What are our best points? .....
11. And our worst? .....
12. What products not currently stocked would you like to be able to buy from us? .....
13. You'll have noticed we've increased post & packing to £2 per order to give a better service. Do you think this is outrageous  expensive  acceptable  cheap  ?
14. Which electronic/computer magazines do you buy regularly? .....
15. Which do you think are best for constructional articles? .....
16. Do you own a computer? Yes  No  Make/model .....
17. Have you ever purchased shareware PD software? .....  
Name ..... Please enter my name in the prize draw.   
Address ..... Please send me the next 5 Bargain Lists - I have  
..... included £1 with my order.   
.....  
.....

## G180A VOICE ACTIVATED MIC



Voice-activated microphone system for hands-free use especially in cars etc. Comprises gooseneck microphone and voice-sensitive relay control unit. Automatically switches transceiver to transmit mode during speech. Adjustable delay time before reverting to receive mode. Indicator LED's for transmit and standby. Full wiring instructions and mounting hardware included. Controls for delay time, sensitivity and power.

- Type ..... Omni-directional
- Impedance ..... 600Ω
- Response ..... 300—5000Hz
- Output ..... 500mV max.
- Delay time ..... 0.5—3 sec.
- Accessories ..... Foam windshield
- Power ..... 9—14Vdc
- Dims: Controller ..... 100 x 100 x 29mm
- Mic ..... 13(dia) x 450mm

AMAZING OFFER PRICE:

**£22.95**

ORDER NOW!!

## T070 DOOR CHIME



Electronic door chime which plays a tune each time the button is pushed. Supplied complete with door bell push button and 1.7m of 2-core lead. Ivory and chrome finish.

- Power ..... 3Vdc (2 x AA batteries)
- Dims ..... 155 x 100 x 38mm

AMAZING OFFER PRICE: **£1.99**

## Y057A HELPING HANDS



As Y056 but with plastic magnifier. Rod mounted horizontally on heavy base. Crocodile clips attached to rod ends. Eight ball and socket joints allow infinite variation through 360°.

AMAZING OFFER PRICE:

**£2.50**

ONLY AVAILABLE WHILE STOCKS LAST!!

## P006A POWER SUPPLY



Regulated power supply with voltage selector switch designed for use in fixed installations or fitted on flying leads. Input and output via screw terminals. Internal thermal fuse for overload protection.

- Input voltage ..... 240Vac 50Hz
- Output voltage ..... 6/9/12Vdc (selectable)
- Output current ..... 500mA continuous
- Stability ..... 2%
- Ripple ..... 25mV
- Dims ..... 142 x 65 x 60mm

AMAZING OFFER PRICE:

**£3.99**

# NEW FROM

## GREENWELD

ELECTRONIC  
COMPONENTS

# DIGITAL MULTIMETER

## ALT26

(Ref. No. Y122AA)

- 3½ digit 12mm LCD display
- 6 ranges including 10Adc
- Diode test
- Rugged bright yellow case with clear range marking
- Fully shrouded test leads
- Battery installed
- Auto zero and polarity
- Low battery indication
- Range overload indication



ACTUAL SIZE

*A compact and rugged low cost multimeter for the professional.*

Special  
Introductory  
Price

£15.00

AC volts .....	0-500V ±1.2%
DC volts .....	0-20-200V ±0.7%
DC current .....	0-10A ±1.5%
Resistance .....	0-2k-2MΩ ±0.75%
Dims .....	148 x 73 x 32mm

## FROST ALERT

CHRIS BOWES



Protect your valuable plants or water pipes from a sudden drop in temperature with this low cost audible frost alert. Has many other possible uses.

**T**HIS design is for a simple temperature sensing system which will set off the alarm when the temperature falls below a pre-set level. It has been designed specifically to give warning of frost so it may be used to warn of impending destruction of sensitive plants or burst pipes etc.

### HOW IT WORKS

The project makes use of a special form of resistor called a thermistor. A thermistor is manufactured so that the actual resistance of the component varies as the temperature rises or falls.

In this circuit the thermistor is used in an arrangement with other resistors to form a potential divider. The effect of this circuit is that as the temperature rises and falls so the alteration in the value of the resistance of the thermistor will cause the output voltage from the potential divider to change. The output from the potential divider circuit is compared with a fixed reference voltage in a simple comparator circuit which is used to switch on and off a buzzer through a simple transistor circuit.

### CIRCUIT DESCRIPTION

The circuit diagram for the Frost Alert is shown in Fig. 1. The heart of the circuit is a

comparator formed from a single CA3140 operational amplifier. This i.c. has an inverting input and a non-inverting input. In this circuit the inverting input is connected to a voltage divider chain comprising R1, VR1 and R2. These set a reference voltage, obtained from the wiper of VR1, which can be adjusted as necessary at pin 2 of IC1.

R1 and R2 are fixed resistors which "pad" the variable resistor to limit the range through which the reference voltage can be adjusted. This gives greater sensitivity to the adjustment of the reference voltage.

The non-inverting input of IC1 is connected to a voltage divider circuit comprising R3, R4, and R5. R4 is the thermistor, the resistance of which changes as the temperature varies. In the case of the specified components the resistance of the thermistor increases, with the result that the voltage at pin three of IC1 also increases, as the temperature falls. R3 and R5 are "padding" resistors which are inserted into the circuit in order to limit the voltage swing which is produced by the variation of the resistance of R4.

The comparator circuit compares the voltages present at the non-inverting input (pin 3) and the inverting input (pin 2). The thermistor has an inverse law, in that as the temperature falls so the resistance in-

creases. This causes the voltage present at pin 3 of IC1 to rise steadily as the temperature measured by the thermistor falls.

When the temperature is higher than that which is set by VR1 for the alarm to go off the voltage at pin 3 is lower than the voltage at pin 2. In this state the output voltage at pin 6 of IC1 is at virtually 0 volts. As the temperature decreases so the resistance of R4 increases causing the voltage at pin 3 of IC1 to rise. Eventually this voltage will be greater than the voltage set at pin 2 at which point the output voltage of pin 6 of IC1 switches rapidly to the battery voltage.

In order to increase the current handling capacity of the integrated circuit a simple transistor current amplifier is incorporated to operate the audible warning device. When the battery voltage is present at pin 6 of IC1 this causes a current to flow through R6 and the base/emitter connection of TR1. Current is limited by R6 which is incorporated into the circuit to prevent excessive current being drawn through TR1 and causing damage to it.

The small current flowing through the base/emitter connection of TR1 causes a greater current to flow through the collector/emitter connection of TR1. This increased current flows through the audible warning device causing it to sound the alarm. Switch S1 is incorporated into the circuit in order to turn the Frost Alert off when it is not required.

### CONSTRUCTION

This project has been designed to be constructed on a stripboard as shown in Fig. 2. The first stage is to cut the stripboard to the correct size, which is 14 holes by 17 strips. Once the board has been cut to the correct size then the tracks should be broken in the positions shown using either a stripboard cutter or a 4mm drill.

It is very important that the track is broken completely in the places shown so that not even a tiniest sliver of copper is left to bridge across the track break. Once the tracks have been broken the board should be carefully turned over, making sure that the orientation of the board is as shown in Fig. 2. In order to make this easier the strips have been lettered and the holes numbered on both diagrams.

The next stage is to insert the correct components into the correct places as shown in Fig. 2. Although the order in which the components are inserted will make no difference to the operation of the circuit you will probably find it easiest to

Fig. 1. Complete circuit diagram for the Frost Alert.

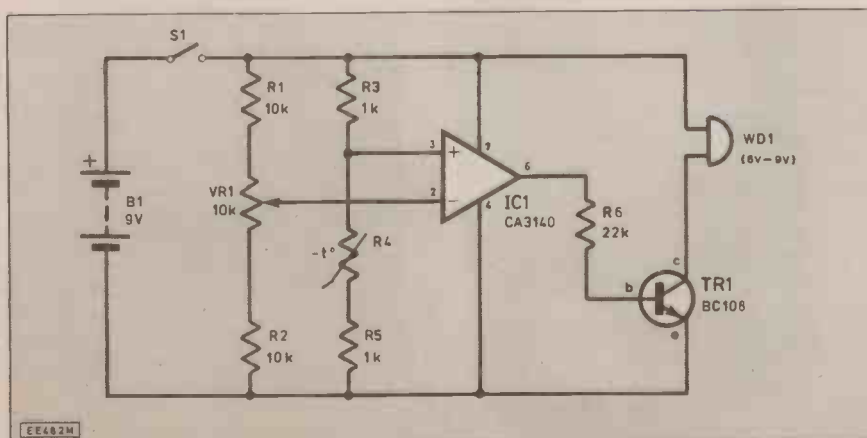

install the smaller components first and then the remaining components in ascending order of size.

The integrated circuit should be held in an i.c. holder. This should be inserted into the stripboard and soldered into place along with the other components. Care should be taken to ensure that the notch in the i.c. holder has the same alignment as shown in Fig. 2. This is because the integrated circuit is polarity sensitive and if it is inserted into the circuit the wrong way round it will not work.

The other polarised component is TR1 and care should be taken when installing this component to make sure that it is also installed with its orientation as shown in Fig. 2. Once the stripboard mounted components have been installed then the connecting wires joining the circuit to S1 and the audible warning device can also be installed along with the battery connector.

Before the battery is connected a careful check should be made of the stripboard to ensure that all components are in the correct place, are correctly polarised and that there are no solder bridges shorting out adjacent tracks or unbroken tracks where there should be broken tracks. Once this visual check has been completed then IC1 can be inserted into its holder, care being taken to ensure that the notch of the integrated circuit aligns with the notch on the i.c. socket.

## TESTING

The first stage of checking the circuit is to make sure that the circuit works as described in the circuit description. S1 should be switched on and VR1 should be adjusted until the point is reached where the audible warning device is just switched off. A cold object, such as an ice cube, should then be touched onto the thermistor and the buzzer should then sound.

Fig. 2. Component layout and details of breaks in the underside copper tracks.

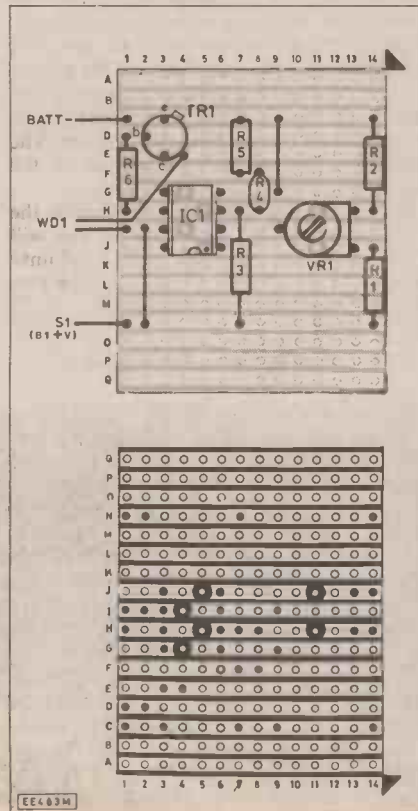

## COMPONENTS

### Resistors

R1, R2	10k (2 off)
R3	1k
R4	Thermistor — negative characteristic (5k @ 25°C)

R5	1k
R6	22k

All 0.25W 5% carbon unless otherwise stated

### Potentiometer

VR1	10k skeleton preset
-----	---------------------

### Semiconductors

TR1	BC108
IC1	CA3140 CMOS op. amp.

### Miscellaneous

S1	s.p.s.t. toggle switch
WD1	9 volt buzzer or other audible warning device (6 volt type can be used if 9V type cannot be found)

Case; stripboard 14 holes x 17 strips; battery, PP3 type with connectors; connecting wire etc.

Approx cost.  
Guidance only

**£7.50**

If this test is conducted satisfactorily this will prove that the circuit is working as it is intended and all that is necessary to do is to set VR1 to the correct position for the circuit to operate properly. The easiest way to do this is to set the voltage at pin 2 by adjusting VR1 so that it is slightly higher (by about 0.5 volts) than the voltage measured at pin 3 when an ice cube is attached to R4. This should cause the alarm to trigger when the temperature falls to one or two degrees C. This adjustment should be performed before the circuit is mounted into a case.

The stripboard installed on the lid with switch S1 and buzzer mounted inside the case.

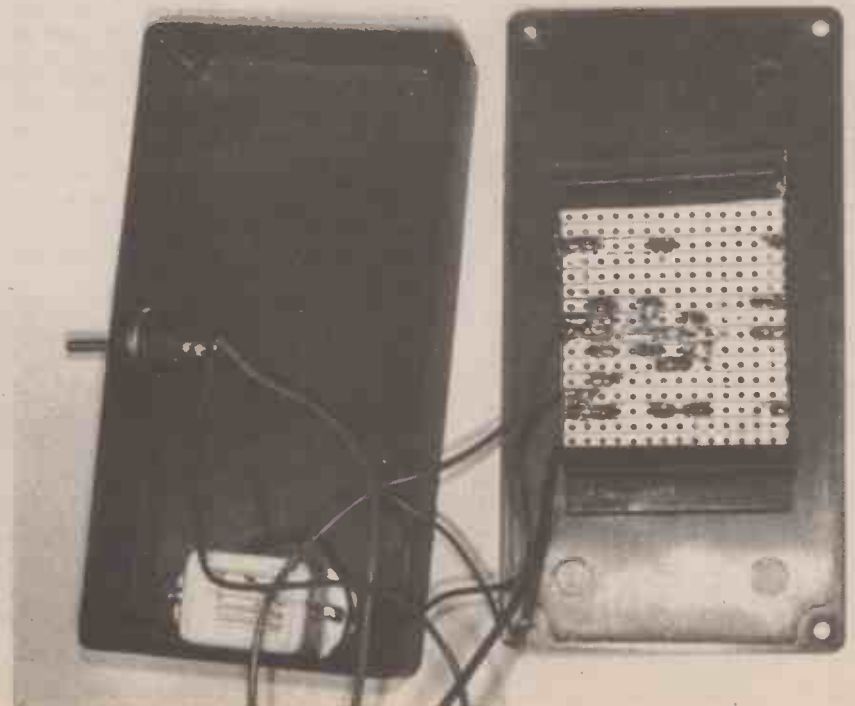

## FAULT FINDING

If the circuit does not work as described above it will be necessary to fault find in order to see why it is not operating as required. The first stage is to check that the battery voltage is as we would expect it to be (approximately 9 volts) both when the battery is disconnected from the circuit and when the battery is connected to the circuit.

If the battery voltage falls markedly when the battery is connected to the current and S1 is turned to the on position, then the circuit board should be carefully inspected to ensure that there are no accidental short circuit between the negative and positive power supply strips on the board. Likely causes of this are solder blobs or incorrectly inserted wire links. The orientation IC1 should also be checked to ensure that it has been inserted into the circuit with its polarity as shown in Fig. 2.

The next test is to check that the battery voltage is present between pins 4 and 7 of IC1. If the battery voltage is not measurable at this point it will be necessary to check the continuity of the circuit, from the battery connectors through to the integrated circuit, along both power rails, to see where the battery voltage disappears.

The battery voltage present at pins 2 and 3 should also be measured with respect to 0 volts. The precise voltages which are present will depend upon the settings of VR2, (at pin 2) and the ambient temperature (at pin 3). However, these voltages should be somewhere in the region of between 2 and 7 volts. If the measured voltages are outside of this range then the appropriate resistor chain should be checked with a voltmeter to ensure that there is continuity through the resistor chain and between the resistor chain and the appropriate pin of IC1.

In general a voltage which is very much lower than is expected would indicate either a break in the circuit between the integrated circuit and its junction with the resistor chain or between the positive power supply rail and the resistor chain.



Similarly a higher voltage than expected would indicate a break in the resistor chain between the 0 volt rail and the point at which the resistor chain is connected to the integrated circuit.

## VARYING VOLTAGES

The next stage is to check that the voltages of pins 2 and 3 alter as described in the circuit description. The voltage at pin 2 should rise and fall as VR1 is adjusted and the voltage at pin 3 should alter when the temperature of the thermistor (R4) alters. This is easily achieved by heating R4 with a soldering iron and cooling it with an ice cube whilst measuring the rise and fall of the voltage with a voltmeter.

If these adjustments do not cause an alteration in the voltages present at pins 2 and 3 then the variable components in the resistor chain should be checked. A likely cause of VR1 not altering the voltage of pin 2 when adjusted is a short circuit in the vicinity of the connections to the variable resistor. Similarly if the temperature of R4 fails to alter the voltage present at pin 3 then the connections to R4 should be inspected specifically to make sure that there is no short circuit across R4. If these checks reveal nothing amiss then a further check is to ensure that there is no accidental short circuit (caused by a solder blob) between pins 2 and 3 and pins 3 and 4 of IC1.

The next step is to check that the output at pin 6 is at the battery voltage when the voltage present at pin 3 is greater than the voltage present at pin 2. Then adjust VR1 until the voltage present at pin 3 is less than that present at pin 2. When this occurs the output voltage at pin 6 should fall to approximately 0 volts. If the output voltage of pin 6 remains locked to the battery voltage irrespective of the voltages present at pins 2 and 3 then a check should be made to ensure that there is not a short circuit between pins 7 and 6 of IC1.

If the voltage present at pin 6 is the same as the voltage present at pin 3 then a check should be made to ensure that the break between pin 3 and pin 6 is complete. If all other checks reveal nothing amiss but the output at pin 6 of IC1 remains at the same voltage irrespective of the voltages present at pins 2 and 3 then it must be suspected that IC1 is faulty and it should be replaced.

## OUTPUT CHECKING

The transistorised output circuit is easily checked. Firstly the audible warning device should be tested to ensure that it is operat-

*Finished circuit board.*

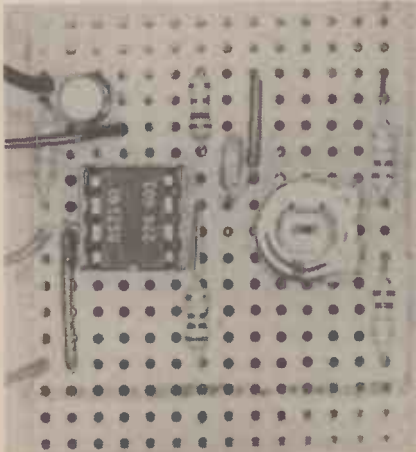

ing correctly, by making a temporary connection to short out the collector and emitter of TR1. This should cause the device to operate. If there is no sound when the emitter and collector of TR1 are shorted out then the voltage across the sounder should be measured.

If the battery voltage is measured across the terminals of the device but it does not sound then the polarity should be checked. If this is found to be correct or the component is not polarised then it must be assumed that the warning device is faulty.

If the battery voltage is not measurable across the sounder then the connection between the positive power supply input to the stripboard and the buzzer and the connection between the negative power supply rail and the emitter of TR1 should be checked for open circuits. Similarly the connection between the collector of TR1 and the buzzer should also be checked.

If the buzzer operates when the emitter and collector of TR1 are shorted out but does not operate when the output from IC1 is at the battery voltage, with the short between the emitter and the collector of TR1 removed then the voltage between the emitter and base of TR1 should be checked. When the output from IC1 is at the battery supply voltage then the voltage between the emitter and base of TR1 should be approximately 0.7 volts.

If no voltage is measurable between the emitter and base of TR1 the connection from the output of IC1 (pin 6) through R6 to the base of TR1 should be carefully checked to ensure that there are no open circuits. If a voltage of 0.7 volts is measurable between the base and the emitter of TR1 but the audible warning device does not operate then TR1 should be suspected of being faulty and replaced.

It is important to reset VR1 as described above if it has been adjusted in the course of fault finding and to remove the short circuit between the emitter and collector of TR1.

## CASE

This project must be mounted into a case for correct operation. The first stage in determining the layout of the case is to decide whether the thermistor is to be mounted on the circuit board and protrude through a suitable hole in the case or whether it is to be mounted remote from the rest of the project and connected to it by means of a long piece of wire. This will be determined by how the Frost Alert is to be used.

If the thermistor is to remain fixed directly to the stripboard and project

through the case then it will be necessary to decide upon a suitable position on the case lid where the stripboard can be mounted. When deciding where to position the stripboard it will be necessary to take into account the positions of S1, the audible warning device and the battery within the case.

Once the positions of the components have been decided then a suitable hole should be drilled in the case through which the thermistor will protrude. Holes should also be drilled into the case for S1 and for the mounting points of the audible warning device.

In the prototype illustrated the stripboard was affixed to the underside of the case with self adhesive mounting rails. An alternative method of construction is to drill four mounting holes in the stripboard and drill four corresponding holes in the lid of the case through which bolts can be fitted to secure the stripboard.

Once the holes have been drilled into the case it may be lettered if required with rub down lettering which must then be protected by several layers of clear spray on varnish. This must be allowed to dry thoroughly before any further construction proceeds.

If the thermistor is to be mounted remotely from the case then a similar process should be followed with the exception that the stripboard may be mounted on the inside of the case if desired. A suitable socket should be fixed to the case to which the leads going to the thermistor can be connected.

Once the varnish protecting the case lettering has dried then the components may be mounted inside the case and wired to the stripboard. The operation of the circuit should be checked before the case lid is screwed down.

## IN USE

To use the Frost Alert the system should be switched off by operating S1 and the Frost Alert placed in the appropriate position. If the thermistor is to be mounted remotely from the main body of the project then it will be necessary to place it in the desired position and run a connecting cable to the socket on the main project case. The unit should then be switched on by the operation of S1.

When the temperature falls below the temperature set by VR1 then the unit will be triggered and the alarm will sound until either the temperature rises above the pre-set level or the unit is switched off. □

*Completed Frost Alert showing thermistor protruding through the case lid.*

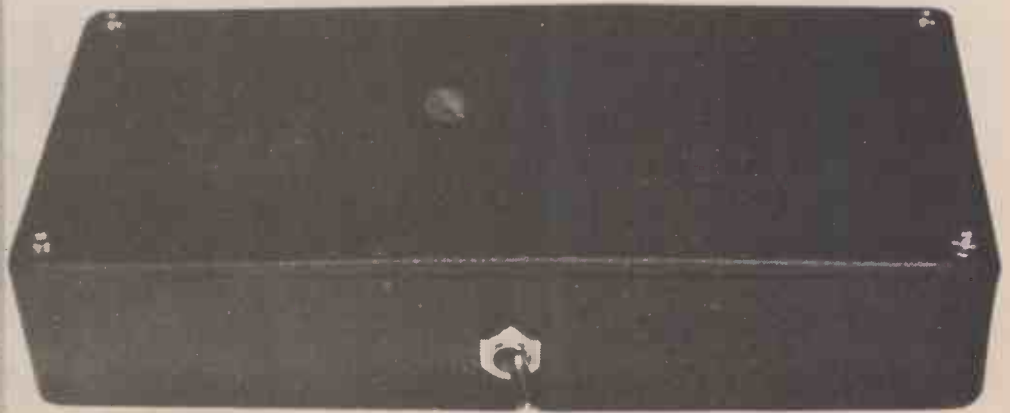

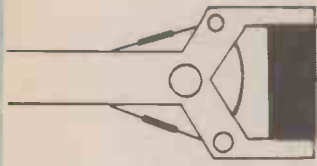

# Robot Roundup

NIGEL CLARK



## GRANTS

Local education authorities and schools will be able to take advantage of a range of grants under the government's Education Support Grants to help meet the cost of implementing the design and technology section of the National Curriculum, due to be introduced in September this year.

So said Alan Howarth, the schools minister, when he was opening the British Education and Technology Training exhibition at the Barbican, London in January. He was predicting that schools would be making substantial demands for equipment to implement the design and technology section.

No doubt that was music to the ears of the assembled hardware and software suppliers. And the news that there would be Government assistance in obtaining the equipment needed would have helped calm any worries they may have had about the schools' being able to pay their bills.

Closer inspection however caused doubts to begin to creep in about how effective these grants are likely to be. For the almost 30,000 schools to which the grants apply there is an extension in the present year of the existing £10m scheme for the buying of microcomputer systems and a further £10m, rising to £17m in 1990/91, as part of the grant supporting the technology part of the National Curriculum. The microcomputer systems grant covers only 60 per cent of the costs, the balance being met by the school or LEA.

## LMS

In addition there is £15m available to help schools get equipped with the necessary technology to implement local management for schools under which schools take over the running of their own budgets. The money will cover hardware, software and training. It will rise to £25m in 1990/91 and the following year.

The Department of Education and Science says it is aiming to provide every primary and secondary school with the necessary equipment and expertise in order to implement LMS (Local Management for Schools). It conveniently fails to give a date by which it hopes to achieve this.

All of which leaves us with an extension of an existing scheme and a grant under the technology section of the National Curriculum, money which could be said to be new money but which is hardly generous. The equipment grant (£17m in 1990/91) will be expected to cover the costs of assessing pupils' performance as well as equipment.

The grant for the implementation of the LMS can have little relevance to the teaching of design and technology unless the school head and secretary are to

share their computers with the children who will spend part of their day in the school office!

It is not the best way to ensure that what is to all intents and purposes a new subject is given the best possible start. In the great traditions of British education system teachers will be expected to cobble something together from the existing limited resources.

## BETT EXHIBITION

The exhibition itself was not very interesting for anyone searching for innovations in the robotics area. The biggest news came from Feedback Instruments — they have decided to phase out the large HRA934 oil hydraulic arm, formerly known as the Genesis, and the smaller mechanical arm, the EA1010 or Armatrol. That leaves Feedback with two SCARA arms, the PW801 and the IVAX901, which they are attempting to upgrade to make them suitable for the industrial market.

The company said that there was no longer a market for these types of arms in education which is looking either for something much bigger and more accurate or smaller and less expensive. A shortage of companies selling arms at the show seemed to confirm that view.

As usual the company which did not conform to this general view was Cybernetic Applications which took along its five robots. They had them working together in their usual configuration with a workcell and under the control of the Cybernetic Walli operating software, picking and placing little plastic blocks as well as making plastic name plates which were very popular with the passing hoards.

The legend to be drilled into the plate was entered via an IMB PC, a black plastic block with a white covering was positioned in a holder, drilled and placed on a conveyor for delivery.

The only problem with this carefully

worked out system was that the picking up was done by suction and if there was too much drilled in the area where the plate was to be picked up the suction did not work — back to the drawing board chaps!

## MAC ADAPTOR

One of the few new items on show was a controller from Resource, the Doncaster-based local authority-backed operation; it was so new that no-one on the stand had any details.

It turns out to be an adaptor to make an Apple Macintosh into a BBC, its creation is based on the view that many people have been upgrading to the more powerful Macintosh and then been left with Beeb add-ons they can no longer use.

For about £20 (prices vary according to quantities) it is possible to get the controller, which electrically mimics the BBC. It can run almost all the BBC add-ons — it is best to check with Resource that it will run the hardware you have before buying — but uses the Mac as its host computer.

It can accept four inputs at a time and has a standard 8K RAM but this can be upgraded to 40K by changing the 8K chip for a 32K and plugging the 8K RAM into one of the ports. There is enough capacity to allow control programs to be downloaded and then for the controller to be detached and operate on its own.

Alternatively it can be run in tandem with another program, users switching from whatever they were doing on screen into the control program to see how it is progressing.

Other news from the show was that Commodore in its effort to sell more machines into education is planning Logo links to allow the Amiga to drive the Valiant and Jessup turtles and links to allow it to control other devices. Announcements are expected in the near future.

*Feedback Instruments HRA 934 hydraulically powered arm.*

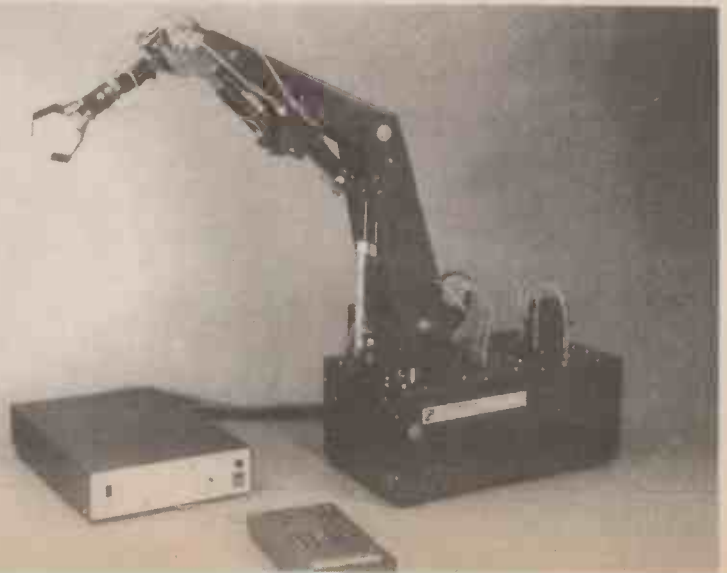

# The Archer Z80 SBC

The SDS ARCHER – The Z80 based single board computer chosen by professionals and OEM users.

- ★ Top quality board with 4 parallel and 2 serial ports, counter-timers, power-fail interrupt, watchdog timer, EPROM & battery backed RAM.
- ★ **OPTIONS:** on board power supply, smart case, ROMable BASIC, Debug Monitor, wide range of I/O & memory extension cards.

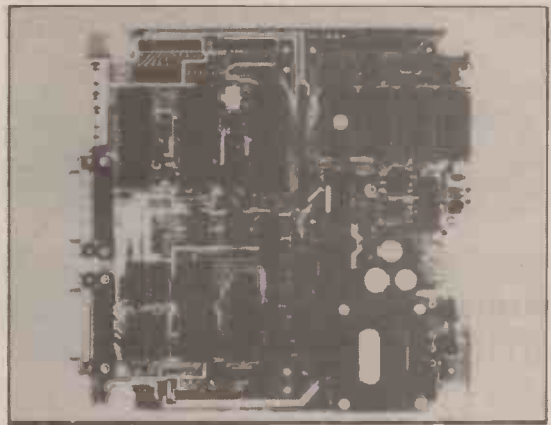

# The Bowman 68000 SBC

The SDS BOWMAN – The 68000 based single board computer for advanced high speed applications.

- ★ Extended double Eurocard with 2 parallel & 2 serial ports, battery backed CMOS RAM, EPROM, 2 counter-timers, watchdog timer, powerfail interrupt, & an optional zero wait state half megabyte D-RAM.
- ★ Extended width versions with on board power supply and case.



## Sherwood Data Systems Ltd

Sherwood House, Unit 6, York Way, Cressex Industrial Estate, High Wycombe, Bucks HP12 3PY. Tel: 0494 464264



### HILLS COMPONENTS established since 1973

can offer the trade a selection of nearly 4,000 product lines covering the following ranges

- Aerials & Accessories
- Batteries & Accessories
- Cables & Accessories
- Computer Accessories
- Connectors (all types)
- Electronic kits/Modules
- Filters/Fuses
- Hardware/Fixings
- Headphones/Intercoms
- Connecting leads (all types)
- Microphones
- Multimeters
- Passive Components
- P.C. Boards
- Relays
- Speakers
- Switches
- Service Aids
- Soldering Equipment
- Telephones & Accessories
- Transformers

#### TRADE ENQUIRIES ONLY

Please phone or write quoting your company name & address for a copy of our 1990 catalogue

TRADE ONLY

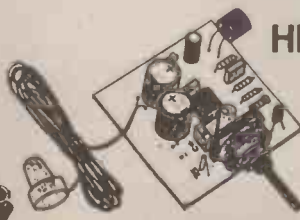
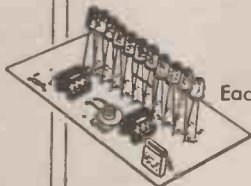
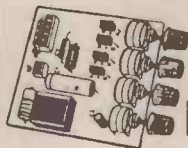

### ELECTRONIC KITS & MODULES

FOR HOBBYISTS ELECTRONICS ENTHUSIASTS  
EDUCATIONAL ESTABLISHMENTS ETC.

Build your own:  
Geiger-Mueller Indicator, Metal Detector,  
Stereo Amplifier, Digital Combination Lock, or  
any of the many other kits available for numerous applications

Each kit comes in component form with easy to follow instructions for assembly

#### OVER 100 KITS TO CHOOSE FROM

Some of the popular kits include

- \* Antenna Amplifiers
  - \* Lie Detectors
  - \* Alarm Systems & Monitors
  - \* Infra-Red Light Barriers
  - \* Sirens – Kojak-Warship-FBI-Ships-Space
  - \* Micro-Wave Indicators
  - \* Radios & Receivers
  - \* Electronic Barking Dog
  - \* Lighting Consoles
  - \* Amplifiers (up to 200w)
  - \* Car Aerial Amplifiers
- PLUS MANY MANY MORE

Call us now for details of your local Stockist

### HILLS COMPONENTS LTD

Units 5 & 6  
Melinite Industrial Estate  
Brixton Road, Watford  
Herts WD2 5SL  
0923 52000

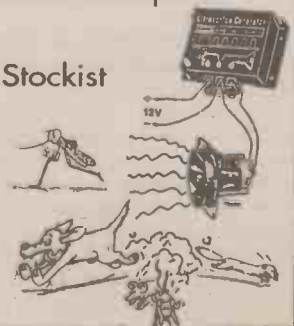
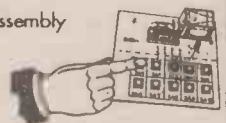
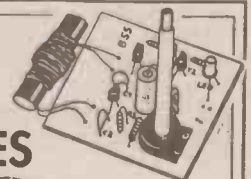

# ENLARGER TIMER/EXPOSURE METER



**CHRIS BROWN**

*A simple aid for the photographer. Controls the enlarger lamp and provides timing flashes for shading work.*

**P**HOTOGRAPHIC printing involves exposing a sheet of light sensitive paper to a negative image focussed on its surface. Expose the paper to light for too long, and it all turns black. Conversely, too little light means the paper stays white. To find the optimum balance requires the darkroom worker to produce numerous "test strips" for every picture he wishes to print. However, there is a way of doing this laborious task electronically. This project does just that and it will also switch the enlarger lamp on for between one and twenty seconds. Also, for real printing buffs, there's an l.e.d. that flashes at one Hertz – handy for timing shading work.

## HOW IT WORKS – COMPARATOR

The section that evaluates the exposure required is no more than a simple comparator. VR1 (Fig.1) acts as a potential divider, and provides a reference voltage at the inverting input of an op. amp (IC1a). The non inverting input is wired to another potential divider built around R1 and a photo conductive cell PCC1. As light on the cell decreases, so its resistance increases, which effectively "moves" the non inverting input towards the 0V line. When this goes below the preset reference voltage, the op. amp output goes low, and D5 conducts via R3.

As light on the cell increases, the cell's resistance decreases, "moving" the non inverting input towards the supply line. When this exceeds the reference level, the op. amp output goes high, which means D5 cannot conduct, and so it goes out. By calibrating VR1 the amount of light falling on PCC1 can thus be measured.

Resistor R2 supplies a small amount of positive feedback, which helps the l.e.d. switch cleanly from one state to another.

## TIMER

The timer uses another potential divider to set up a reference voltage, this time on the non-inverting pin of IC1b. With C2 discharged, the op. amp output is high, which causes TR2 to conduct via R6, so energising the relay and turning on the enlarger lamp. Current travels via VR2, and starts to charge up C2. When the voltage across C2 exceeds the reference level, the i.c.'s output goes low, so cutting off TR2, which stops conducting. Capacitor C4 stops the relay "chattering" as it turns off, whilst resistor R7 allows the push button on the sensor box (S1) to turn the relay on and off to enable the operator to adjust/focus his image on the baseboard.

Each timing period is initiated by pressing S2. This connects one side of C3 to positive which turns on TR1. Due to conditions within the circuit, this capacitor never discharges totally, with the net result that TR1 would keep conducting. To cure this, a Zener diode D6 has been incorporated. As soon as the voltage across R4 drops below 2.7V, the Zener stops conducting. Thus, TR1 receives a brief pulse at its base, which in turn causes C2 to be shorted via current limiting resistor R12, thus discharging the capacitor. When the switch is released, the charge on C3 leaks away via R5. This section of the circuit ensures that R12 is only shorted to 0V briefly thus preventing undue current drain.

## PULSE TIMER

The one Hertz pulse circuit is very simple. With C5 low, the op. amp (IC1c) output is high. This high voltage is fed back through VR4, and charges up the capacitor. As soon as the voltage across C5 exceeds the reference voltage set up by R8/R9, the output goes low. Now VR4 discharges C5, until the voltage drops below the reference, whereupon the situation reverses yet again. Ad infinitum! These on/off pulses bias TR3 into conduction, and so D4 flashes. R11



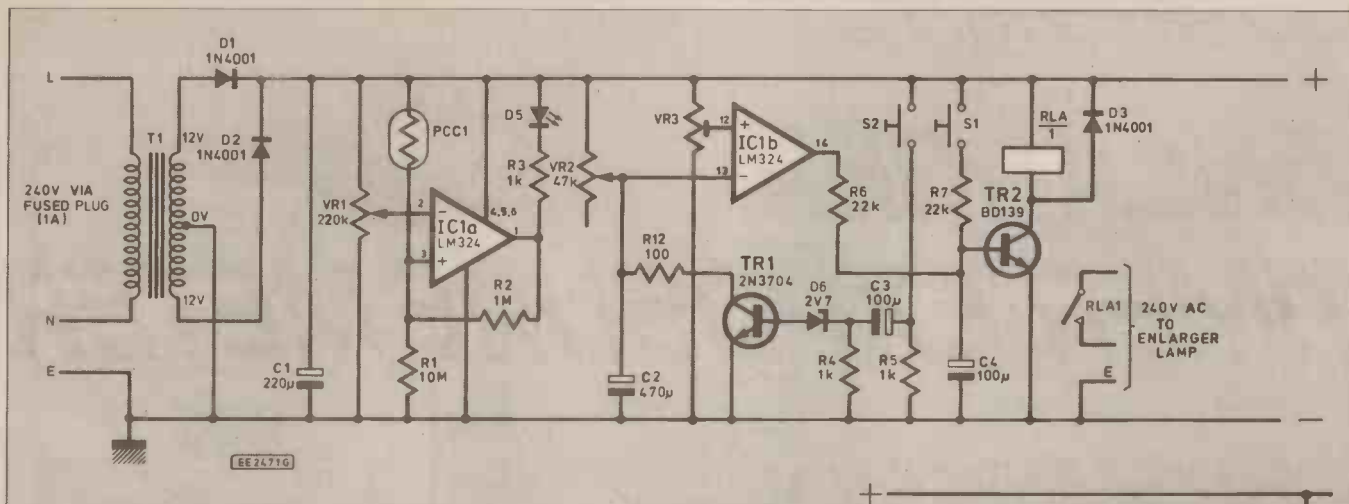

Fig. 1. Circuit diagram of the Enlarger Timer/Exposure Meter. Components PCC1, D5 and S1 are mounted in the sensor box.

## COMPONENTS

Approx cost. Guidance only **£23**

<b>Resistors</b>		<b>Shop Talk</b> page 251
R1	10M	
R2, R8	1M (2 off)	
R3 to R5, R11	1k (4 off)	
R6, R7	22k (2 off)	
R9	56k	
R10	100k	
R12	100	
<b>Potentiometers</b>		
VR1,	220k lin	
VR2	47k lin.	
VR3, VR4	22k sub. min. enclosed preset (2 off)	
<b>Capacitors</b>		
C1, C6	220µ elect. 20V (2 off)	
C2	470µ elect. 20V	
C3, C4	100µ elect. 20V (2 off)	
C5	4µ7 elect. 20V	
<b>Semiconductors</b>		
D1, D2, D3	IN 4001 (3 off)	
D4, D5	red i.e.d. (2 off)	
D6	2V7 Zener 400mW	
IC1	LM324 quad op. amp.	
TR1, TR3	2N3704 (2 off)	
TR2	BD139	
PCC1	ORP12	
<b>Miscellaneous</b>		
T1	12-0-12V 100mA miniature mains transformer	
RLA	12V, 320Ω relay with 10A 240V a.c. s.p.c.o contacts, ultra miniature type	
S1	s.p.s.t. push to make, push to break, push button	
S2	s.p.s.t. push to make release to break push button	

Four-pole chassis mounting mains socket and matching inline plug; four core cable – length as required; 14 pin d.i.l. socket; i.e.d. mounting clip (2 off); cable grommet (2 off) and cable clamps (2 off); 20mm plastic stand-off pillars (2 off); 15mm plastic stand-off pillars (2 off); calibrated knob for VR1; plain skirted knob for VR2; plastic or metal cases (see text) approx 150x80x50mm and 50x38x25mm; p.c.b. available from the *EE PCB Service*, order code EE684; mains cable and fused (1A) mains plug; three-way mains connecting block; M3 fixings and solder tag; connecting wire, solder etc.

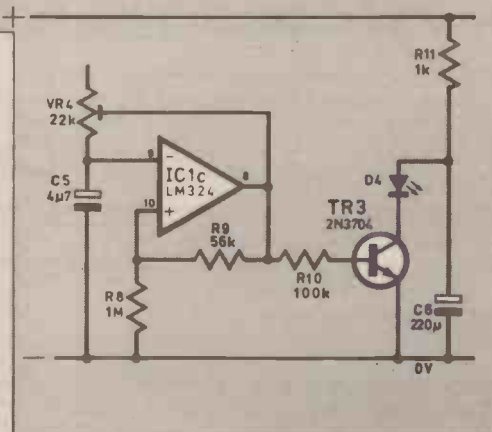

requiring just four holes; one for the i.e.d., one for the switch, one for the cable entry, and of course, one to let light reach the photocell which is glued to the back of the lid (Fig. 4).

The presets are also glued to the lid of the main control box, care being taken not to get adhesive on the rotating sector of the control. Working in this way enables the lid to be screwed into position, thus enclosing the mains voltage parts, yet adjustments can still be made to VR3 and VR4.

## SETTING UP

Armed with a clock with a sweep second hand, and a screwdriver, turn VR3 to about 11 o'clock, and VR2 almost fully anticlockwise. Anticipate when the sweep hand is about to move, and then press S2. Adjust VR3 to obtain a timing of around 18 to 21 seconds. Now fine tune to exactly 20 seconds by turning VR2 slightly and then mark the case. NB: As you press the start button, start count from "0", not, as you'd expect from "1".

Next, move VR2 almost fully clockwise, and carry out the above fine tuning to obtain the one second mark. This time, the relay should click as the sweep hand moves, and then click off again as the hand moves to the next division. Continue working in this way to find other timing divisions.

To set up the i.e.d. move VR4 to about 10 o'clock, set the timer to 20 seconds, start the timer, then slowly adjust until the i.e.d. flashes each time the clock's second hand moves to a new figure. You have to have the timer operating as when C2 charges and the relay operates, the supply voltage drops a little, and so the flash rate differs slightly from the "at rest" flash rate. Adjust the preset slowly, as even small adjustments make large differences to the timing range.

and C6 provide D4 with a decoupled supply, this prevents the pulses from affecting the other circuitry.

## CONSTRUCTION

There are two safe methods of construction that could be used for this project; metal boxes which have earthed solder tags connected to both control box and sensor, or alternatively, (and the approach used in prototype), plastic components throughout, with no external metal parts showing – no metal bolts, switch casings etc. This is why plastic stand offs have been used to support the circuit board and the connection block. Bolts had to be used to hold the transformer, but these have been connected to earthed solder tags as mentioned above.

Board construction is quite straight forward (Fig. 2), just remember to watch the orientation of the transistors, chip and

electrolytic capacitors. Incidentally, if you find that C3 produces a constant "high" voltage as you hold S2 closed, it probably means C3's been soldered into place back to front, (a "fault" which took me three hours to locate!).

To start, place the p.c.b. copper tracks down, inside the box, about half inch down from the top. Mark the positions of the stand off holes. Above this, mark two holes which will be used to fix the unit to a wall. These are, of course, optional. Next, cut the hole for the sensor connector. Having done this, locate the transformer above the connector, and again, mark the places where the securing bolts will go. To the left of the connector, and below the transformer, mark the position of the connector block. Finally, drill and cut the case lid to hold the various controls. Fig. 3 shows the connections between the p.c.b. and various other components.

The sensor box is quite easy to construct,

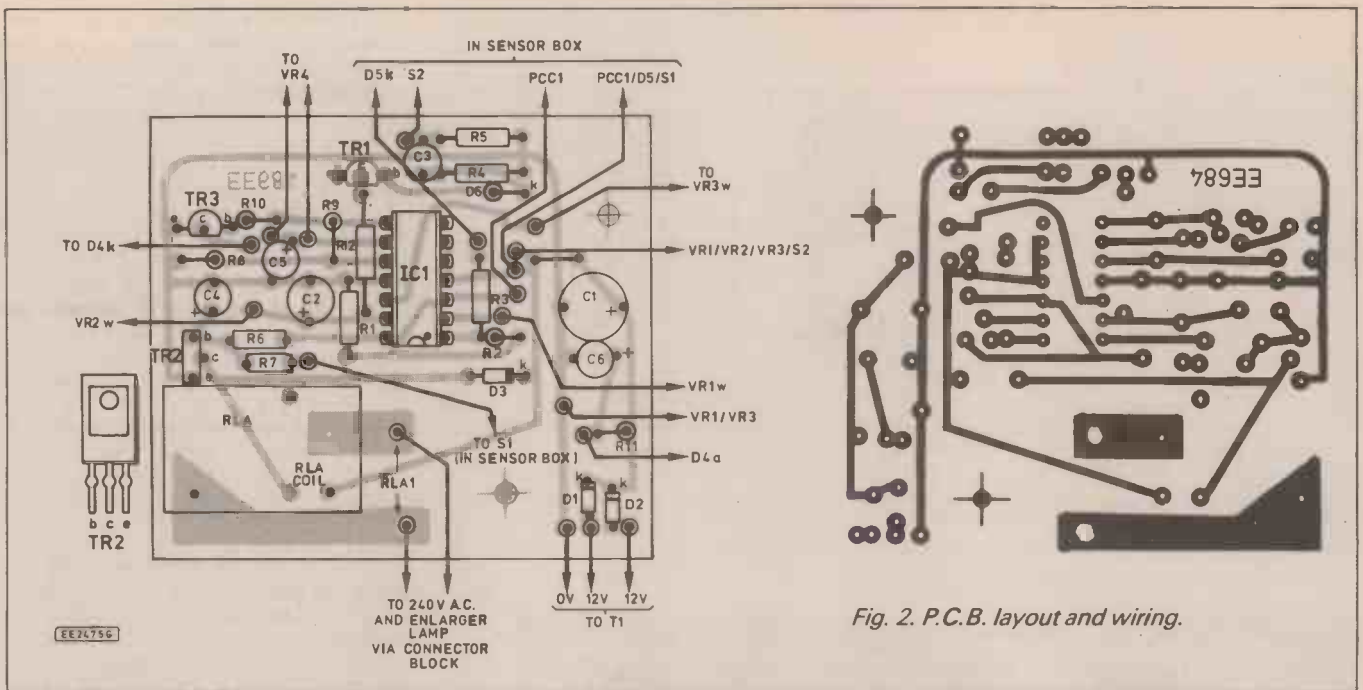

Fig. 2. P.C.B. layout and wiring.

Before you can calibrate the exposure sensor, you must make one or two additional items. First, construct a light scrambler — a piece of tracing paper held in a simple card frame. Next, produce a perfect print at an exposure time of five seconds. Having done so, and without altering the enlarger in any way, place the

sensor on the baseboard. Press the on/off switch so that the image falls on the cell, then hold the scrambler beneath the lens. Having adjusted VR1 until the l.e.d. (D5) goes out, close the enlarger lens by one stop, and the l.e.d. should come on again. Return the lens to the correct stop, and the l.e.d. may — but probably won't — go out.

Close one more stop, and the l.e.d. should go out. Chances are, you won't get this to happen first time, but simply move VR1 marginally until you get the desired result.

Once the ideal setting has been found, write it on the photo paper packet. You'll need to find the "paper speed" of every pack of paper grade you use. Even if you only use one manufacturer's paper, you may find the speed of the paper varies from batch to batch of the same paper type! Ah well, you only need to find this setting once thankfully.

### IN USE

Let's say the packet of paper has a speed of "6". You dial "6" on VR1, set the timer to five seconds, and then compose/focus your image. You now scramble the light falling on the sensor, and adjust the lens aperture until you find the setting where one stop turns the sensor l.e.d. on, and two stops down, the l.e.d. goes out. Choose the middle stop. Having pressed the button (S1) to turn off the lamp, you place the photo paper on the baseboard, press S2, the lamp comes on, goes out after five seconds and you should end up with a perfect print!

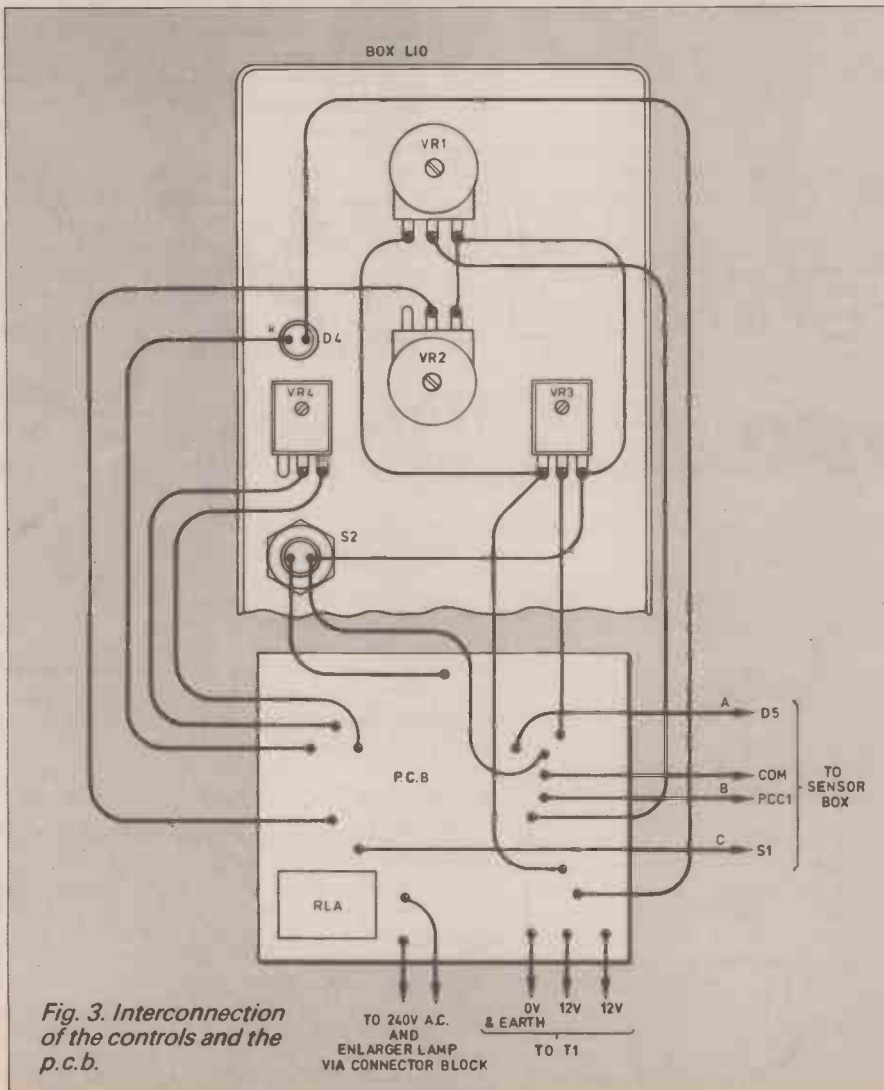

Fig. 3. Interconnection of the controls and the p.c.b.

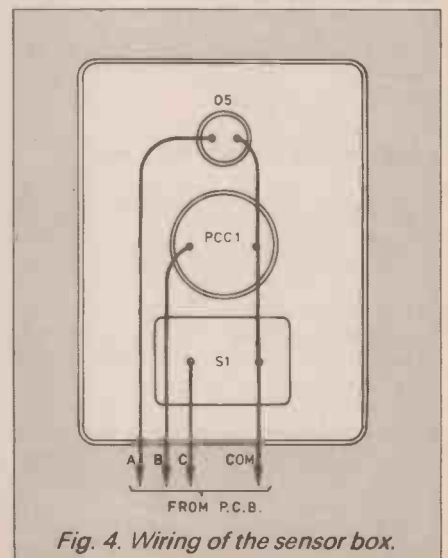
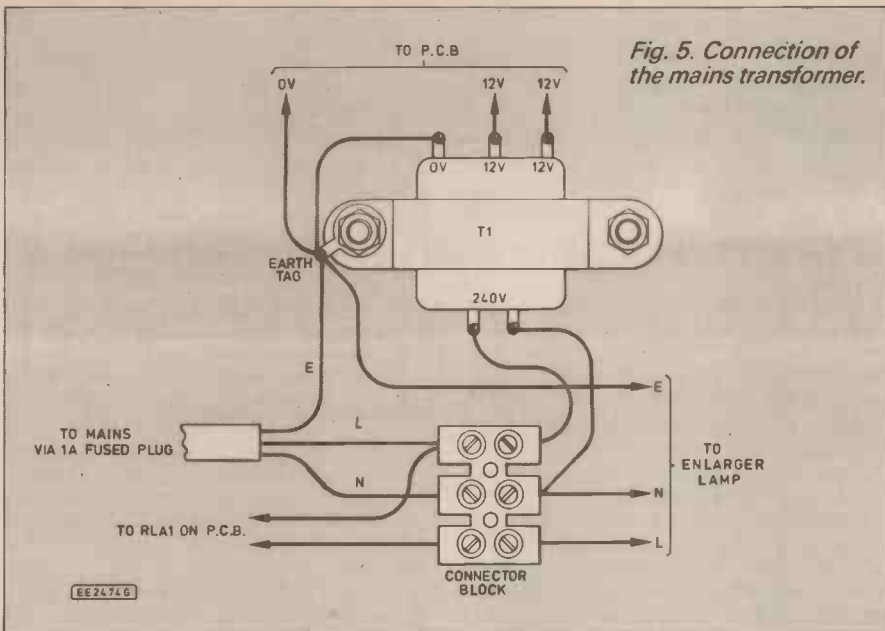

Fig. 4. Wiring of the sensor box.



I say "should" end up with a perfect print as very thin light negs, or very dense black negs can fool the cell into setting the wrong aperture. However, that said, the prototype produced reasonable prints from a wide range of negs, some of which in theory should have totally confused the unit!

Printing technicians who like to "burn in" and "shade" their work can use the longer timer settings, plus the flashing l.e.d. Let's say the sky needs a 10 second exposure, and the land a 15 second exposure. Set the dial to 15 seconds, anticipate when the l.e.d. is about to come on, and press the start button. Watching the flashes out of the corner on your eye, (in the dark, they're clearly visible), you count 10 flashes/seconds, and then start shading the sky. Once the total 15 seconds has elapsed, the timer switches off!

### ACCURACY

The accuracy of the device obviously isn't as good as those controlled by crystals and divider circuits, but for the majority of darkroom workers, it should be accurate enough for its low price. Also, the timing range is a little limited, but few darkroom workers need the 0.1 timing divisions offered by some commercial timers. And if you ever need the 100 seconds plus offered by some units, well, all you need to do is select 20 seconds, and then press the start button, each time the lamp goes off, a total of five times.

Calibrating the unit might seem a bit daunting, but it looks worse in print than it actually is. Plus, it only needs to be done once, so it is worth taking a little time to set it up carefully.

You may one day wonder how you ever managed without it!

Remember the new Component Catalogue available from early 1990

# CRICKLEWOOD ELECTRONICS



## BIGGER AND BETTER 1990 COMPONENTS CATALOGUE

- ONE OF THE LARGEST RANGES OF COMPONENTS IN THE UK
- FAST AND EFFICIENT SAME DAY PERSONAL SERVICE
- VERY COMPETITIVE PRICES; QUANTITY DISCOUNTS AVAILABLE
- DISCOUNT VOUCHERS INCLUDED
- NO MINIMUM ORDER

FILL IN THE COUPON AND POST IT WITH YOUR CHEQUE, PO ETC FOR £1.50 TO RECEIVE YOUR 1990 CRICKLEWOOD ELECTRONICS CATALOGUE AND VOUCHERS WHICH YOU CAN USE AGAINST YOUR NEXT PURCHASE

**Cricklewood Electronics Ltd**  
 40 CRICKLEWOOD BROADWAY, LONDON, NW2 3ET  
 Tel: 01-450 0995/452 0161  
 Fax: 01-208 1441 Telex: 914977

### CRICKLEWOOD ELECTRONICS 1990 COMPONENTS CATALOGUE

PLEASE SEND ..... COPIES OF THE 1990 CRICKLEWOOD ELECTRONICS CATALOGUE AT £1.50 TO:

NAME .....

ADDRESS .....

.....  
 .....

Remittance enclosed £..... E

## ... Morse ... Computer Communications ... Radio Teletype ...

COMPUTERS seem to be taking an increasingly important role in many aspects of electronics, including radio communications. Some modern communications receivers, transmitters, and transceivers actually have an interface that enables them to be controlled by a computer.

This permits such things as automatically scanning certain frequency ranges at predetermined times, or simply taking control of the receiver (or whatever) via the computer's keyboard. The scanning feature is one that is included in many communications receivers and transceivers that have a computer interface, but the advantage of using the computer to control this facility is that it can give far greater scope than most integral scanning facilities.

Using the computer to control the equipment, or for partial control, also has its advantages. You can, for example, program "hot keys" so that a single key press will have practically any desired function. If your main interest is the broadcast bands, you could have a row of keys programmed so that pressing each one immediately sets the tuning to the middle of the desired broadcast band.

As yet, computer control of communications equipment, as far as amateur users are concerned anyway, is still very much of a minority interest. A more common use for computers in amateur radio circles is for encoding/decoding c.w. (Morse) and RTTY (Radio Teletype) signals. The sophistication of such systems varies enormously, from simple receive-only morse units which require no additional hardware, to complex interfaces that permit encoding and decoding of any standard system with the computer taking a minimal percentage of the workload

### Tone Decoder

With their plethora of ports the BBC computers are well suited to communications applications. This includes both the control of suitable receivers, and various forms of signal encoding and decoding.

If we consider the decoding aspect first, the most simple way of tone decoding a c.w. signal would seem to be via the cassette port. However, this is probably not a very good way of handling things. The BBC computers have one of the better cassette ports, and usually provide good reliability if they are used with even moderately good cassette recorders and tapes.

The cassette port is designed to operate at 1200 baud, which is much higher than the effective baud rate of most c.w. signals, and is certainly much higher than the usual baud rates for RTTY etc. This would seem to make it easier to obtain reliable results.

The real drawback of using the cassette port is that it is used in a role for which it was not really designed. This inevitably results in compromises that are reflected in the overall performance of the system.

The main problem is that a cassette port is designed to deal with the usual "hiss" type tape noise, but nothing more than this. The short wave bands tend to be so crowded these days that any c.w. or RTTY signal is almost certain to be infested with at least a certain amount of adjacent channel interference, plus any "static" type interference from lightning etc.

I am not sure if the cassette port of a BBC computer can be used as a c.w. or RTTY interface, but I should think that it could almost certainly be used as a tone decoder for c.w. signals. The level of performance from systems of this type that I have seen in operation is such, that I suspect it is not really worthwhile pursuing this approach. A proper tone decoder having good filtering is not a particularly complex piece of equipment, and should provide vastly better results.

decoding), and in an extreme case would result in a continuous output signal from the intermittent input.

### Phase Decoding

The alternative approach is to use a phase-locked-loop (p.l.l.) decoder. There is a popular p.l.l. integrated circuit designed specifically for this purpose in the form of the NE567. This is normally used in the arrangement shown in Fig. 1, which provides a form of synchronous detection.

The phase detector, lowpass filter, and voltage controlled oscillator (v.c.o.) form a standard phase locked loop. This is not the place for a detailed description and discussion of phase locked loop theory. Suffice to say that the basic action of the circuit is to maintain the v.c.o. at the same frequency as, and in-phase with, the input signal.

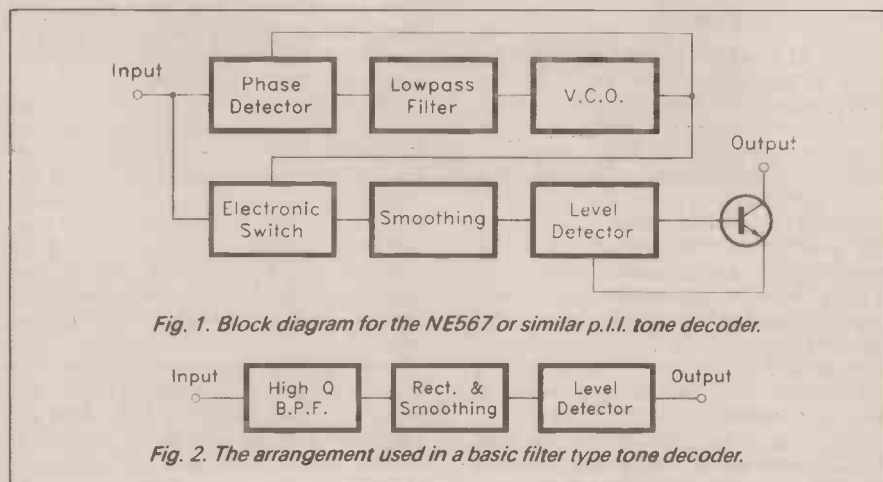

Fig. 1. Block diagram for the NE567 or similar p.l.l. tone decoder.

Fig. 2. The arrangement used in a basic filter type tone decoder.

There are two basic approaches to tone decoding, one of which is to rely on filtering plus a level detector. The filter is an audio bandpass type which is designed to pass the c.w. signal (which must be carefully tuned to give an audio output at the correct pitch), but to severely attenuate the noise which will mainly be at frequencies outside its passband.

A simple level detector then provides a high output if the c.w. signal is present, taking the signal level above the threshold amplitude. A low output is produced in the absence of the c.w. signal, as only a small amount of background noise will then be present, resulting in a signal level well short of the threshold amplitude.

This method can work well, particularly if the filter is a high quality type having a narrow bandwidth and high roll-off rate. Although it might seem that a really high-Q filter having an extremely narrow bandwidth could be used, things are not quite as simple as this in practice.

The problem with a very high-Q filter is that it tends to suffer from "ringing" effects which smear the output signal. This can distort the timing of the output signal (which is crucial in both c.w. and RTTY

Of course there is a limit to the frequency range that the p.l.l. can track, and this can be a wide range or a very restricted one depending on the design of the circuit. In the present application it would normally be made quite narrow. This gives the unit good immunity to adjacent channel interference, and enables it to be used for RTTY decoding...

### RTTY Decoding

In many p.l.l. applications it is the control voltage to the v.c.o. that is of interest (in f.m. demodulators for instance). In this case it is the output of the v.c.o. that is required, and it is used to operate an electronic switch. The input signal is fed through this switch, which is closed on positive v.c.o. half cycles, and opened on the negative ones.

If the v.c.o. is locked onto the input signal, this results in positive half cycles being passed through the switch, and negative ones being blocked. In other words, the input signal is half wave rectified by this system of synchronous detection.

The output signal is smoothed to produce a strong d.c. bias. This signal drives a level detector circuit, which in turn drives an



open collector *npn* output transistor. The latter is therefore switched on when the p.l.l. has achieved lock.

If the input signal is outside the p.l.l.'s lock-in range, or there is no tone signal, only noise at the input, the v.c.o. will simply free-run at its centre frequency. The phasing of the switching action and the input signal will then be completely random, resulting in both positive and negative signals being passed through to the smoothing circuit.

These signals largely cancel one another out, giving no significant d.c. output signal from the smoothing circuit. Consequently, the level detector circuit is not activated, and the output transistor is not switched on.

If this type of circuit is applied to morse detection, it obviously gives the desired effect provided the signal is tuned so that its pitch is brought within the lock-in range of the phase locked loop. Provided the smoothing circuit has a suitably short time constant, the output transistor will then be switched on and off in sympathy with the incoming Morse code signal. The decoded output can then be coupled to a digital input of the computer (such as one of the BBC computer's user port lines), with software converting the ons and offs to the correct letters etc.

## Two-Tone Signals

An RTTY signal is not tone encoded using simple morse style on/off keying. RTTY signals are basically just ordinary serial signals, much like those used for communications via the BBC computer's RS423 serial port. They are encoded using a simple two tone system, with a different frequency being used for each logic level.

In practice this is normally done by switching the carrier wave between two slightly different frequencies, rather than amplitude modulating the audio tones onto the carrier wave. RTTY signals are therefore received in the c.w. or s.s.b. mode if the receiver does not have a reception mode specifically for this type of signal.

Using a p.l.l. tone decoder of the type described previously, RTTY signals can be decoded by tuning the receiver so that one of the tones falls within the "lock-in" range of the circuit, but the other does not. The output goes to one logic level when this tone is present, and the opposite logic level when it is absent (and the other tone is present).

The right tone must be selected or the output signal will be of the wrong phase, although an inverter is all that is needed in order to correct this. Many RTTY decoders have a switched inverter at the output so that the phase of the output signal can be corrected if necessary.

By no means do all RTTY decoders actually use phase locked loop decoders. Many are based on audio filters and level detectors. A basic circuit of this type uses the very simple set up of Fig. 2.

The input signal is first filtered by a narrow bandwidth bandpass circuit which reduces the noise level on the signal. It is then rectified, smoothed, and fed to a level detector circuit. In the presence of a suitable tone there will be a strong enough d.c. signal to activate the level detector — in its absence there will be an inadequate level to activate it.

The circuit therefore gives a decoding action which is very much like that of the p.l.l. decoder. This is essentially the same

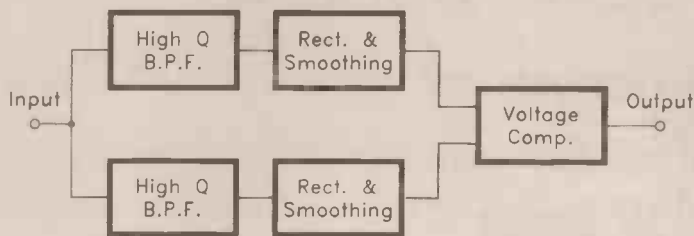

Fig. 3. The arrangement used in a twin filter RTTY tone decoder.

system that is used in a filter type c.w. decoder, and described previously.

## Twin Filter

Practical filter type RTTY tone decoders are generally a bit more complex than this. A more normal arrangement would be something along the lines of the set up shown in Fig. 3. This has separate filters, rectifiers, and smoothing circuits for the two tones.

There is obviously no point in feeding these to separate level detectors, as this would simply give two output signals, with neither of them giving better reliability than a single tone decoder circuit. Some means of integrating the two signals is needed, and this action is usually provided by a simple voltage comparator.

This might not seem to give any real advantage over a single tone decoder, but in practice a circuit of this type will often provide much improved results. If the wanted signal is weak and the noise level is high, the difference between the d.c. signal levels produced by the tone and no tone will be quite small. The double tone decoder circuit effectively doubles this difference, increasing the chances of error-free decoding.

Probably of greater importance is that it can give better immunity to errors due to signal fading. Although you might expect the two tones to fade and recover in unison, due to the vagaries of the atmosphere it does not always work this way. In fact it is quite common for one tone to fade

down to virtually nothing while the other one is still quite strong.

This type of decoder will operate perfectly well provided at least one of the tones is present at good strength. With a circuit that is based on a single tone decoder, if the detected tone fades out, reception is lost regardless of how strong the other tone might happen to be.

Although it is possible to use software in the computer to undertake all the decoding of an RTTY signal, most of the decoding is usually achieved using hardware. As the decoded signals are basically just standard RS232C type serial signals, they can be decoded using standard serial interface chips such as UARTs (universal asynchronous receiver/transmitters).

There is a slight complication in that many RTTY signals use the old Baudot system of 5-bit codes and a shift system to move between two character sets. Not all serial chips can handle 5-bit word formats, and the 6850 used in the BBC computers is certainly unable to do so.

This can be easily overcome by using a UART to provide the decoding and then feeding the 5-bit parallel data to the user port. Software in the computer then handles the shifting between the two character sets.

Next month we will continue our look at computers and radio communications, including some practical circuits for Morse and RTTY decoding.

## EVERYDAY ELECTRONICS BINDERS

**Don't let your valuable issues of EE get binned, burned or bitten (by the dog!). Get one of our exquisite orange hard-back binders, slip each issue into it as you get them and you will always know just where they are — we hope!**



Binders to hold one volume (12 issues) are available from Everyday Electronics, 6 Church Street, Wimborne, Dorset BH21 1JH for £4.95 (£6.95 to European countries and £9.00 to other countries, surface mail) inclusive of postage and packing. Payment in £ sterling only please.

Binders are normally sent within seven days of receipt of your order but please allow up to 28 days for UK delivery — more for overseas.

# DIODE DATA

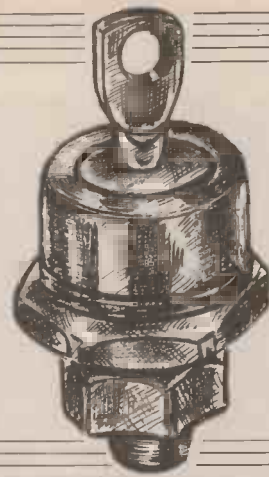

## MIKE TOOLEY

The characteristics, codes, data, encapsulations and various formulae relating to diodes, thyristors, triacs and l.e.d.s.

THE new *Everyday Electronics Data Book* has just been published. This article is one section of the book which also covers — Fundamentals; Passive Components; Networks, attenuators and filters; Transistors; Integrated Circuits; and Circuits — in a similar way to the following.

### Diode characteristics

Semiconductor diodes generally comprise a single p-n junction of either silicon (Si) or germanium (Ge) material. In order to obtain conduction, the p-type material must be made positive with respect to the n-type material (the p-type connection constitutes the anode whilst the n-type connection constitutes the cathode). The direction of current flow is from anode to cathode when the diode is conducting, as shown in Fig. 1. Very little

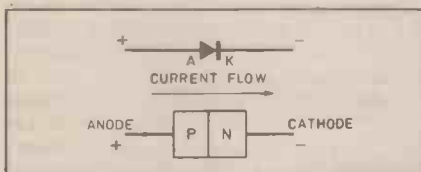

Fig. 1. Forwards biased (conducting) diode

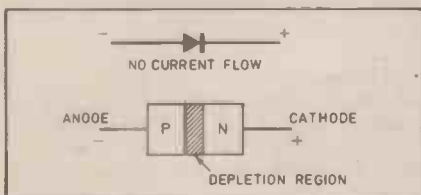

Fig. 2. Reverse biased (non-conducting) diode.

current (negligible in the case of most silicon devices) flows in the reverse direction (Fig. 2).

Diodes exhibit a low resistance to current flow in one direction and a high resistance to current flow in the other. The direction in which current flows is

referred to as the *forward* direction whilst that in which negligible current flows is known as the *reverse* direction. When a diode is conducting, a diode is said to be forward biased and a small voltage (ideally zero) is dropped across it. This voltage is known as the forward voltage drop. The maximum reverse voltage that a diode can tolerate is usually specified in terms of its reverse repetitive maximum voltage ( $V_{RRM}$ ) or peak inverse voltage (PIV).

Typical values of forward current and forward voltage for commonly available silicon and germanium diodes are given below:

Forward current	Forward voltage drop		
	Silicon (1N4148)	Silicon (1N5401)	Germanium (OA91)
10 $\mu$ A	0.43V	—	0.12V
100 $\mu$ A	0.58V	0.55V	0.26V
1mA	0.65V	0.60V	0.32V
10mA	0.75V	0.65V	0.43V
100mA	—	0.72V	—
1A	—	0.85V	—

Germanium diodes conduct at lower forward voltages than their silicon counterparts (typically 100mV as compared with 600mV), but they tend to exhibit considerably more reverse leakage current (1 $\mu$ A as compared with 10nA for an applied reverse voltage of 50V). Furthermore, the forward resistance of a conducting silicon diode is much lower than that of a comparable germanium type. Hence germanium diodes are used primarily for signal detection purposes whereas silicon devices are used for rectification and for general purpose applications. Typical forward and reverse characteristics for comparable germanium and silicon diodes are shown in Fig. 3.

Diodes are often divided into signal and rectifier types, according to their principal field of application. *Signal diodes* require consistent forward characteristics with low forward voltage drop.

*Rectifier diodes* need to be able to cope with high values of reverse voltage and large values of forward current, consistency of characteristics is of secondary importance in such applications. Rectifier diodes are often available in the form of a *bridge* (see Fig. 4) which provides full-wave rectification. Various diode encapsulations are illustrated in Fig. 5.

### Diode coding

The European system for classifying semiconductor diodes involves an al-

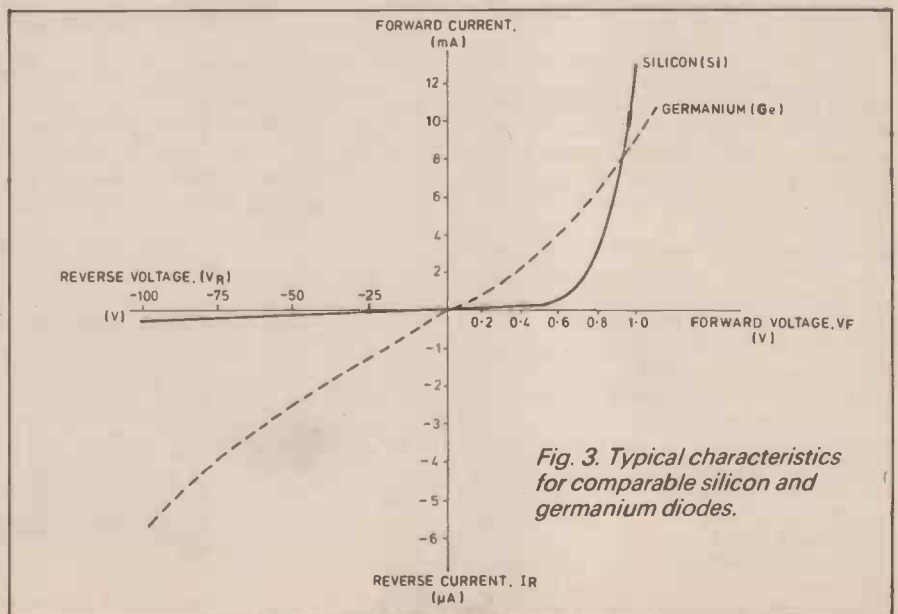

Fig. 3. Typical characteristics for comparable silicon and germanium diodes.

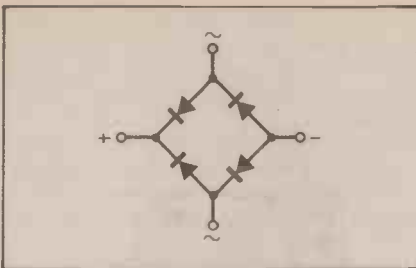

Fig. 4. Bridge rectifier arrangement.

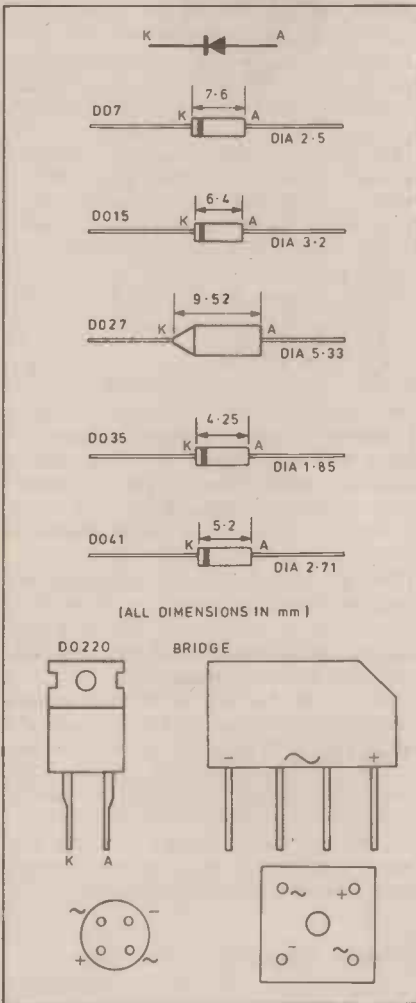

Fig. 5. Diode encapsulations.

phanumeric code which employs either two letters and three figures (general purpose diodes) or three letters and two figures (special purpose diodes). The first two letters have the following significance:

**First letter** - semiconductor material:

- A germanium
- B silicon
- C gallium arsenide etc
- D photodiodes etc

**Second letter** - application:

- A general purpose diode
- B tuning (varicap) diode
- E tunnel diode
- P photovoltaic diode
- Q light emitting diode
- T controlled rectifier
- X varactor diode
- Y power rectifier
- Z zener diode

In the case of diodes for specialised

applications, the third letter does not generally have any particular significance. Zener diodes have an additional letter (which appears *after* the numbers) which denotes the tolerance of the zener voltage. The following letters are used:

- A  $\pm 1\%$
- B  $\pm 2\%$
- C  $\pm 5\%$
- D  $\pm 10\%$

Zener diodes also have additional characters which indicate the zener voltage (e.g. 9V1 denotes 9.1V).

### Example 1

Identify each of the following diodes:

- (i) AA113
- (ii) BB105
- (iii) BZY88C4V7

Diode (i) is a general purpose germanium diode.

Diode (ii) is a silicon diode for tuning applications (sometimes referred to as a varicap).

Diode (iii) is a silicon zener diode having 5% tolerance and 4.7V zener voltage.

### Diode data

The following tables summarise the characteristics of a variety of popular semiconductor diodes:

#### Devices, applications, equivalents and case styles

Device	Material	Application	Near equiv.	Case style
1N4001	silicon	rectifier		DO41
1N4002	silicon	rectifier		DO41
1N4003	silicon	rectifier		DO41
1N4004	silicon	rectifier		DO41
1N4005	silicon	rectifier		DO41
1N4006	silicon	rectifier		DO41
1N4007	silicon	rectifier	BY127	DO41
1N4148	silicon	general purpose	1N914, 1N916	DO35
1N5400	silicon	rectifier		DO27
1N5401	silicon	rectifier		DO27
1N5402	silicon	rectifier		DO27
1N5404	silicon	rectifier		DO27
1N5406	silicon	rectifier		DO27
1N5407	silicon	rectifier		DO27
1N5408	silicon	rectifier		DO27
1N914	silicon	general purpose	1N916, 1N4148	DO35
1N916	silicon	general purpose	1N914, 1N4148	DO35
AA113	germanium	general purpose		DO7
AA119	germanium	RF detector		DO7
BAR28	Schottky	RF detector		DO35
BAX13	silicon	general purpose		DO35
BAX16	silicon	general purpose		DO35
BY126	silicon	rectifier	1N4005	DO15
BY127	silicon	rectifier	1N4007	DO15
HSC1001	Schottky	RF detector		DO35
OA200	silicon	general purpose		DO7
OA202	silicon	general purpose		DO7
OA47	germanium	general purpose		DO7
OA90	germanium	RF detector		DO7
OA91	germanium	general purpose	OA95	DO7
OA95	germanium	general purpose	OA91	DO7

#### General purpose, signal and RF diodes

Device	Material	PIV	$I_f$	$I_r$ max
1N4148	silicon	100V	75mA	25nA
1N914	silicon	100V	75mA	25nA
1N916	silicon	100V	75mA	25nA
AA113	germanium	60V	10mA	200 $\mu$ A
AA119	germanium	45V	35mA	350 $\mu$ A
BAR28	Schottky	70V		200nA
BAX13	silicon	50V	75mA	200nA
Bax16	silicon	150V	200mA	100nA
HSC1001	Schottky	60V	15mA	200nA
OA200	silicon	50V	80mA	100nA
OA202	silicon	150V	40mA	100nA
OA47	germanium	25V	110mA	100 $\mu$ A
OA90	germanium	30V	10mA	1.1mA
OA91	germanium	115V	50mA	275 $\mu$ A
OA95	germanium	115V	50mA	250 $\mu$ A

#### Silicon rectifier and power diodes

Device	PIV	$I_{f0}$	$V_f$	$I_r$ max
1N4001	50V	1A	1.1V	10 $\mu$ A
1N4002	100V	1A	1.1V	10 $\mu$ A
1N4003	200V	1A	1.1V	10 $\mu$ A
1N4004	400V	1A	1.1V	10 $\mu$ A
1N4005	600V	1A	1.1V	10 $\mu$ A
1N4006	800V	1A	1.1V	10 $\mu$ A
1N4007	1000V	1A	1.1V	10 $\mu$ A
1N5400	50V	3A	1.1V	10 $\mu$ A
1N5401	100V	3A	1.1V	10 $\mu$ A
1N5402	200V	3A	1.1V	10 $\mu$ A
1N5404	400V	3A	1.1V	10 $\mu$ A
1N5406	600V	3A	1.1V	10 $\mu$ A
1N5407	800V	3A	1.1V	10 $\mu$ A
1N5408	1000V	3A	1.1V	10 $\mu$ A
BY126	650V	1A	1.1V	10 $\mu$ A
BY127	1250V	1A	1.1V	10 $\mu$ A
BY397	200V	2A	1.1V	10 $\mu$ A
BY399	800V	2A	1.1V	10 $\mu$ A

#### Bridge rectifiers

Typ/series	Encapsulation	Mounting surface	Max. forward current (A)
Vm	4-pin d.i.l.	PCB	0.9
DB	4-pin d.i.l.	PCB	1
WO	cylindrical	PCB	1
SKB2	in-line	PCB	1.6
BR8	in-line	PCB	2
BR3	square	PCB	3
KBPC	square	PCB	2 to 6
BR6	square	PCB	6
BR15	epoxy-potted	heatsink	15
SKB25	epoxy-potted	heatsink	6 to 35

Note: Most of the bridge rectifiers listed are available in 200V, 400V and 600V versions. It is important to ensure that manufacturers' voltage ratings are not exceeded.

#### Hints and tips

★ When designing power supply circuits (in which appreciable currents are present) it is important to allow for the forward voltage drop associated with each rectifier diode. In a bridge rectifier, for example, two diodes will be conducting any one time. The total forward voltage drop associated with these diodes can approach 2V and this should be allowed for when determining the a.c. input voltage to the rectifier.

★ The reverse leakage current of a diode increases markedly as the junction temperature increases. This results in a reduction in overall efficiency (ratio of forward current to reverse current) at high temperatures.

★ Operating a diode at, or beyond, the stated limits for  $V_{RRM}$  or PIV will result in a high risk of breakdown. Since rectifier failure can have disastrous consequences, it is always advisable to operate diodes well within the stated limits (to ensure safety, a 100% margin should be allowed).

★ Schottky diodes exhibit a forward voltage drop which is approximately half that of conventional silicon diodes coupled with very fast reverse recovery. Schottky diodes are thus preferred in switching applications (e.g. switched mode power supplies) where very low forward voltage drop and fast switching is a prime consideration.

#### Zener diodes

Zener diodes are silicon diodes which are specially designed to exhibit consistent *reverse breakdown* characteristics. Zener diodes are available in various families (according to their general characteristics, encapsulation and power ratings) with reverse breakdown (zener) voltages in the E12 and E24 series (ranging from 2.4V to 91V). A typical characteristic for a 5.1V zener diode is shown in Fig. 6.

The following series of zener diodes are commonly available:

#### BZY88 series

Miniature glass encapsulated diodes rated at 500mW (at 25 deg. C). Zener voltages range from 2.7V to 15V (voltages are quoted for 5mA reverse current at 25 deg. C).

#### BZX55 series

Low-power diodes rated at 500mW and offering zener voltages in the range 2.4V to 91V.

#### BZX61 series

Encapsulated alloy junction rated at 1.3W (25 deg. C. ambient). Zener voltages range from 7.5V to 72V.

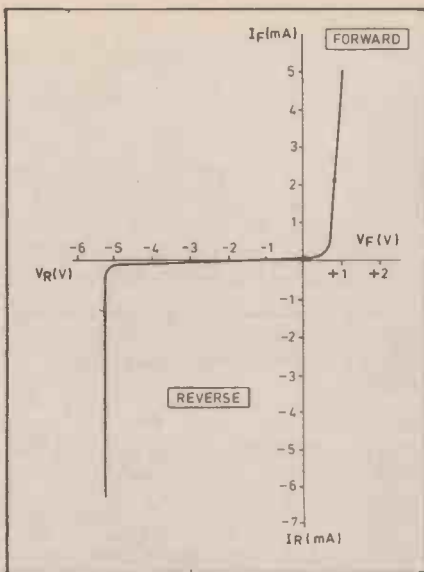

Fig. 6. Typical zener diode characteristics.

#### BZX85 series

Medium-power glass-encapsulated diodes rated at 1.3W and offering zener voltages in the range 5.1V to 62V.

#### BZY93 series

High power diodes in stud mounting encapsulation. Rated at 20W for ambient temperatures up to 75 deg. C. Zener voltage range from 9.1V to 75V.

#### BZY97 series

Medium power wire-ended diodes rated at 1.5W and offering zener voltages in the range 9.1V to 37V.

#### 1N5333 series

Plastic encapsulated diodes rated at 5W. Zener voltages range from 3.3V to 24V.

Zener diodes are generally plastic or glass encapsulated in the same manner as conventional silicon diodes. As with conventional silicon diodes, the cathode connection is marked with a stripe (see Fig. 7).

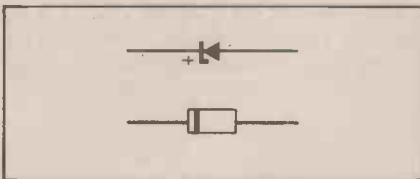

Fig. 7. Zener diode encapsulation.

The *slope resistance* of a zener diode is the rate of change of reverse voltage (zener voltage) with diode current. Slope resistance is measured in the breakdown region and expressed in ohms. An ideal zener diode would have zero slope resistance (i.e. the diode would conduct perfectly at its rated zener voltage). In practice, values of 20Ω, or less, can be achieved.

The *temperature coefficient* of zener voltage is the change of zener voltage (from its rated value) which results from a temperature change of 1°C. Temperature coefficient (which should ideally be zero) is expressed in mV/°C. In many

voltage reference applications, it is essential for the reference diode to exhibit a zener voltage which does not vary with temperature. The following data (for the BZX55 series) is typical of most low-power zener diodes:

Zener voltage (V)	Slope resistance (Ω)	Temperature coefficient (mV/°C)
2.7	100	-3.5
3.3	95	-3.5
3.9	90	-3.5
4.7	80	-3.5
5.1	60	-2.7
5.6	40	-2.0
6.2	10	+0.4
6.8	12	+1.2
7.5	14	+2.5
8.2	16	+3.2
9.1	18	+3.8
10	20	+4.5

#### Example 2

A zener diode is to be used as a voltage reference. The diode has the following specifications:

Zener voltage (at 20°C): 9.1V

Temperature coefficient: +4mV/°C

If the equipment is designed to operate over the range -10°C to +40°C, determine the extreme values of reference voltage and the percentage change in reference voltage over the working range. The temperature coefficient is positive and thus the zener voltage will increase with temperature. At 40°C the zener voltage will be given by:

$$V_z = 9.1V + ((40 - 20) \times 4mV) \\ = 9.1V + 80mV = 9.18V$$

At -10°C the zener voltage will be given by:

$$V_z = 9.1V - ((20 - -10) \times 4mV) \\ = 9.1V - 120mV = 8.98V$$

The total change in temperature will be 50°C and the corresponding change in zener voltage will be 50 × 4mV or 200mV. The percentage will thus be given by:

$$\% \text{ change} = \frac{200mV}{9.1V} \times 100 = 2.2\%$$

#### Hints and tips

★ Zener diodes may be connected in series to obtain higher voltages. As an example, a 15.9V reference can be produced by connecting a 6.8V zener diode in series with a 9.1V zener diode.

★ Care must be taken to ensure that zener diodes operate within their rated power dissipation.

★ Zener diodes generally perform best when rated at voltages of between 5V and 6V. Hence, in order to obtain optimum performance (in terms of both slope resistance and temperature coefficient) reference voltage sources based upon zener diodes should utilise components which have zener voltages of between 5.1V and 6.2V. where necessary, external circuitry can be used to provide voltage amplification.

★ Zener diodes can generate a significant amount of noise and, in applications which involve significant voltage gain (e.g. the stabilisation of an amplifier bias supply) it is essential to provide adequate decoupling. A parallel connected capacitor of between 1μF and 100μF will prove effective in most applications.

#### Thyristors

Thyristors (or silicon controlled rectifiers) are three-terminal devices which can be used for switching and a.c. power

control. Thyristors can switch very rapidly from a non-conducting to a conducting state. In the off state, the thyristor exhibits negligible leakage current whilst, in the on state the device exhibits very low resistance. This results in very little power loss within the thyristor even when appreciable power levels are being controlled. Once switched into the conducting state, the thyristor will remain conducting (i.e. it is latched in the on state) until the forward current is removed from the device. In d.c. applications this necessitates the interruption (or disconnection) of the supply before the device can be reset into its non-conducting state. Where the device is used with an alternating supply, the device will automatically become reset whenever the main supply reverses. The device can then be triggered on the next half-cycle having correct polarity to permit conduction. Like their conventional silicon diode counterparts, thyristors have anode and cathode connections; control is applied by means of a *gate* terminal (see Fig. 8). The device is *triggered* into the conducting (on state) by means of the application of a current pulse to this terminal.

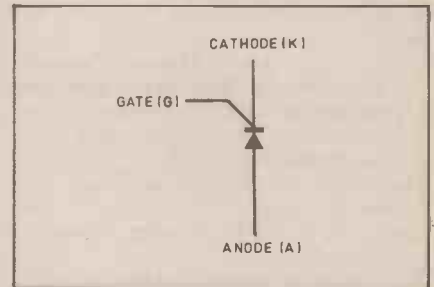

Fig. 8. Thyristor connections.

#### Thyristor data

The table summarises the characteristics of a variety of popular thyristors:

Type	$I_{RAV}$	$V_{RRM}$	$V_{GT}$	$I_{GT}$	Case style
2N4443	5.1A	400V	1.5V	30mA	TO220
2N4444	5.1A	600V	1.5V	30mA	TO220
BT106	1A	700V	3.5V	50mA	Stud
BT152	13A	600V	1V	32mA	TO220
BTX18-400	1A	500V	2V	5mA	TO5
BTY79-400R	6.4A	400V	3V	30mA	Stud
BTY79-600R	6.4A	600V	3V	30mA	Stud
BTY79-800R	6.4A	800V	3V	30mA	Stud
TIC106A	3.2A	100V	1.2V	200μA	TO220
TIC106B	3.2A	200V	1.2V	200μA	TO220
TIC106C	3.2A	300V	1.2V	200μA	TO220
TIC106D	3.2A	400V	1.2V	200μA	TO220
TIC106E	3.2A	500V	1.2V	200μA	TO220
TIC106M	3.2A	600V	1.2V	200μA	TO220
TIC106S	3.2A	700V	1.2V	200μA	TO220
TIC106N	3.2A	800V	1.2V	200μA	TO220
TIC116A	5A	100V	2.5V	20mA	TO220
TIC116B	5A	200V	2.5V	20mA	TO220
TIC116C	5A	300V	2.5V	20mA	TO220
TIC116D	5A	400V	2.5V	20mA	TO220
TIC116E	5A	500V	2.5V	20mA	TO220
TIC116M	5A	600V	2.5V	20mA	TO220
TIC116S	5A	700V	2.5V	20mA	TO220
TIC116N	5A	800V	2.5V	20mA	TO220
TIC126A	7.5A	100V	2.5V	20mA	TO220
TIC126B	7.5A	200V	2.5V	20mA	TO220
TIC126C	7.5A	300V	2.5V	20mA	TO220
TIC126D	7.5A	400V	2.5V	20mA	TO220
TIC126E	7.5A	500V	2.5V	20mA	TO220
TIC126M	7.5A	600V	2.5V	20mA	TO220
TIC126S	7.5A	700V	2.5V	20mA	TO220
TIC126N	7.5A	800V	2.5V	20mA	TO220
TICP106D	2A	400V	1V	200μA	TO92
TICP106M	2A	600V	1V	200μA	TO92

#### Hints and tips

★ Wherever possible, thyristor trigger pulses should have the fastest possible rise times. Signals with slow rise times or poorly defined edges are generally unsatisfactory for triggering purposes.

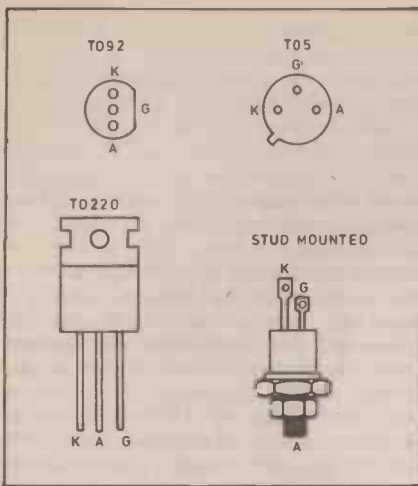

Fig. 9. Thyristor encapsulations and pin connections.

★ Sufficient gate current must be made available in order to ensure effective triggering (it is thus necessary to minimise the impedance of the gate driver circuitry as far as possible).

★ Thyristors will turn on faster (and power dissipation within the device will be minimised) as gate current is increased. Care should, however, be taken to ensure that the peak value of gate does not exceed the rated value for the device.

★ The pulse width of the trigger pulse applied to the gate of a thyristor must be kept short in order to minimize gate power dissipation. Negative gate voltages should also be avoided in order to prevent power loss.

★ In order to obtain an adequate range of control in a.c. power control applications, the thyristor triggering circuit should be designed so that it will provide effective triggering over a sufficiently wide angle of the applied a.c. voltage. Failure to observe this rule will result in a limited range of control.

## Triacs

Triacs are a refinement of the thyristor which, when triggered, conduct on both positive and negative half-cycles of the applied voltage. Triacs have three terminals known as *main-terminal one (MT1)*, *main terminal two (MT2)* and *gate (G)*, as shown in Fig. 10. Triacs can be triggered by both positive and negative voltages present at the gate. Triacs

thus provide full-wave control and offer superior performance in a.c. power control applications when compared with thyristors which only provide half-wave control.

In order to simplify the design of triggering circuits, triacs are often used in conjunction with *diacs* (equivalent to a bi-directional zener diode). A typical diac conducts heavily when the applied voltage exceeds approximately  $\pm 32V$ . Once in the conducting state, the resistance of the diac falls to a very low value and thus a large value of current will flow. The characteristic of a typical diac is shown in Fig. 11.

## Triac data

The following table summarises the characteristics of a variety of popular triacs:

Type	$I_{T(RMS)}$	$V_{RRM}$	$V_{GT}$	$I_{GT(TYP)}$	Case style
BT139	15A	600V	1.5V	5mA	TO220
TIC206M	4A	600V	2V	5mA	TO220
TIC216M	6A	600V	3V	5mA	TO220
TIC225M	8A	600V	2V	20mA	TO220
TIC226M	8A	600V	2V	50mA	TO220
TIC236M	12A	600V	2V	50mA	TO220
TIC246M	16A	600V	2V	50mA	TO220
TICP206D	1.5A	400V	2.5V	2.5mA	TO92
TICP206M	1.5A	600V	2.5V	2.5mA	TO92

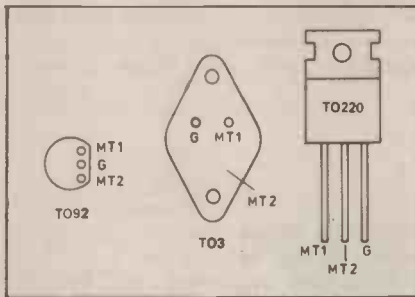

Fig. 12. Triac encapsulations and pin connections.

## Hints and tips

★ Thyristors and triacs switch on and off very rapidly. In a.c. power control applications, this rapid switching can result in transients which may be conveyed some distance via the a.c. mains wiring. To minimise such effects and prevent radiation of noise, an L-C filter should be fitted in close proximity to the power control device, as shown in Fig. 13.

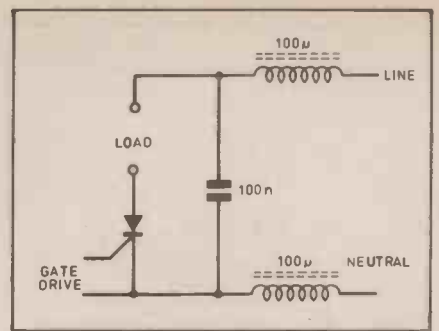

Fig. 13. Simple power line filter for use with a thyristor or triac power controller.

## Light emitting diodes

Light emitting diodes (LEDs) can be used as general purpose indicators and, compared with conventional filament lamps, operate from significantly smaller voltages and currents. LEDs are also very much more reliable than filament lamps. Most LEDs will provide a reasonable level of light output when a forward current of between 5mA and 20mA is applied.

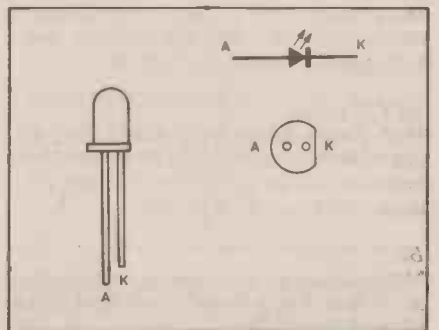

Fig. 14. Round LED encapsulation

Light emitting diodes are variable in various formats with the round types being most popular. Round LEDs are commonly available in the 3mm and 5mm (0.2 inch) diameter plastic packages (see Fig. 14) and also in 5mm x 2mm rectangular format. The viewing angle for round LEDs tends to be in the region of 20° to 40° whereas, for rectangular types this is increased to around 100°. Typical characteristics for commonly available LEDs are given below:

Parameter	Type of LED			
	standard	standard	high efficiency	high intensity
Diameter (mm)	3	5	5	5
Max. forward current (mA)	40	30	30	30
Typical forward current (mA)	12	10	7	10
Typical forward voltage drop (V)	2.1	2.0	1.8	2.2
Max. reverse voltage (V)	5	3	5	5
Max. power dissipation (mW)	150	100	27	135
Peak wavelength (nm)	690	635	635	635
Typical unit cost	15p	18p	24p	35p

In order to limit the forward current to an appropriate value, it is usually necessary to include a fixed resistor in series with a LED indicator, as shown in Fig 15. The value of the resistor may be calculated from:

$$R = \frac{V - V_F}{I}$$

Fig. 10. Triac connections.

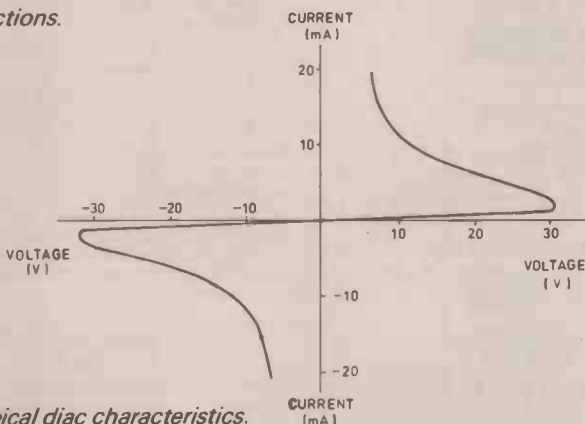
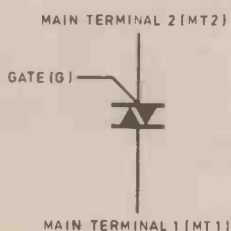

Fig. 11. Typical diac characteristics.

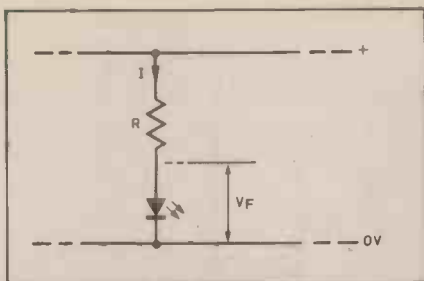

Fig. 15. Typical LED indicator circuit.

where  $V_F$  is the forward voltage drop produced by the LED and  $V$  is the applied voltage. It is usually safe to assume that  $V_F$  will be 2V and choose the nearest preferred value for  $R$ . Typical values of LED series resistor are given in the table:

Supply voltage (V)	Series resistance ( $\Omega$ )		
	low power LED (5mA nom)	standard LED (10mA nom)	high power LED (20mA nom)
3	220	180	56
5	680	270	150
6	820	390	220
9	1.5k	680	390
12	2.2k	1k	560
15	2.7k	1.2k	680
18	3.3k	1.5k	820
24	4.7k	2.2k	1.2k

#### Example 3

An LED is to be used to indicate the presence of a 21V d.c. supply rail. If the

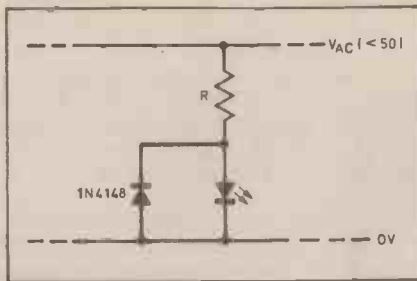

Fig. 16. LED indicator for a.c. operation.

LED has a nominal forward voltage of 2.2V, and is rated at a current of 15mA, determine the value of series resistor required.

Here we can use the formula:

$$R = \frac{V - V_F}{I} = \frac{21V - 2.2V}{15mA} = \frac{18.8V}{15mA} = 1.25k\Omega$$

The nearest preferred LED value is 1.2k $\Omega$ . The power dissipated in the resistor will be given by:

$$P = I \times V = 15mA \times 18.8V = 280mW$$

Hence the resistor should be rated at 0.33W, or greater

#### Hints and tips

★ Avoid inadvertent reverse LED connection - reverse voltages in excess of about 5V will cause permanent damage!

★ For battery powered equipment (particularly where a number of LED indicators are used) minimal values of forward current should be employed in order to ensure long battery life. A forward current of 5mA (per LED) will be perfectly adequate in many applications.

★ Where several LEDs are to be used together, they should be connected in series (and not in parallel) in order to ensure equal levels of light output.

★ Yellow and green LED generally give less light output (for a given forward current) than their standard red counterparts. To maintain an equal light output when several LEDs of different colours are used together, different values of series resistor may be employed. As a rule of thumb, series resistors for yellow and green LEDs should be chosen so that they are 10% to 15% lower in value than those used with red diodes (care should, however, be taken to ensure that operating currents are still within the manufacturer's specified maximum upper limit).

★ In applications involving low a.c. voltages, a conventional low-current silicon diode (e.g. 1N4148) can be wired in parallel with a LED to provide a simple a.c. indicator (see Fig. 16). □

Full details on the Everyday Electronics Data Book, including ordering details can be found in the Direct Book Service pages.

**QUALITY... SECURITY SUPPLIES FOR DIY & TRADE**

**...AT LOWEST PRICES**

**CONTROL UNITS**  
 ■ Automatic ■ Modular  
 ■ Lighting ■ Timer

**CARS & VANS**  
 ■ Contacts ■ Pressure Pads  
 ■ Security Lighting ■ Cable Etc. Etc.

**SENSORS**  
 ■ Passive Infra-Red  
 ■ Ultrasonic  
 ■ Infra-Red Beam

**ACCESSORIES**

**PRODUCT OF THE MONTH**  
**SWITCHABLE DUAL RANGE P.I.R. RP33**

7m or 12m range for effective coverage of all sizes of installations.  
 ■ Size only 80x60x40mm. ■ Switchable detection indicator. ■ Wide 85° coverage.  
 ■ Suitable for use with most security systems. ONLY £23.95 +VAT  
 Quantity discounts start at only 3 units

**The Security Specialist**  
**RISCOMP LIMITED**  
 Dept. EE4, 51 Poppy Road, Princes Risborough, Bucks. HP17 9OB  
 Callers by Appointment Office hours Mon-Fri 9am-5pm  
 (084 44) 6326

TELEPHONE OR SEND FOR FREE LITERATURE TODAY

**NEW PRODUCT!**

For your copy of "PC-DIY" send a cheque for £7.95. (postage included) to Blackmore Electronics of phone out 24 hour hotline with your Access Card details. Available only from us! Order today!

If you WANT A PC BUT CAN'T AFFORD ONE, or perhaps you want to upgrade yours but don't know how, send for our NEW book "PC-DIY" which explains all about how to build, upgrade and fault-find PC XT and AT computers at LOW COST. "PC-DIY" suits beginners and is a valuable reference for experts too! We list all the parts you need, suggest sources of supply and give detailed descriptions of how to assemble a PC XT or AT to your specification. With "PC-DIY" it's easier than you might think!

**74HC series ICs**

74HC00 19p	74HC02 19p	74HC03 19p
74HC04 19p	74HC08 19p	74HC10 19p
74HC11 26p	74HC14 39p	74HC20 19p
74HC27 31p	74HC30 35p	74HC74 38p
74HC86 29p	74HC107 36p	74HC138 41p
74HC161 48p	74HC175 52p	74HC393 69p

**74LS series ICs**

74LS00 20p	74LS02 20p	74LS05 20p
74LS30 20p	74LS32 20p	74LS51 20p
74LS90 30p	74LS93 30p	74LS107 23p
74LS112 23p	74LS138 35p	74LS139 35p
74LS151 38p	74LS164 38p	74LS193 55p
74LS245 58p	74LS374 52p	74LS375 64p

**CMOS 4000 series ICs**

4001 19p	4002 19p	4011 19p
4012 25p	4013 26p	4014 45p
4015 56p	4016 91p	4017 40p
4018 63p	4019 29p	4020 45p
4023 19p	4027 36p	4040 45p
4046 51p	4049 29p	4066 29p
4070 21p	4071 19p	4075 19p
4076 74p	4081 19p	4082 19p
4510 47p	4511 47p	4514 £1.06

We can supply a wide range of components and TTL, CMOS and ECL ICs. We also supply PC, XT and AT spares at LOW PRICES. Write or phone for our FREE catalogue.

Serial I/O card for XT or AT only £16.00

Resistors at bulk prices *Your Mix*  
 Carbon film, 0.25W, 5% 1p each or 45p for 50  
 Metal film, 0.25W, 1% 3p each or £1.35 for 50  
 Bargain pack, 100 mixed common value 0.25W 90p

IC sockets, solder type (pin:price)  
 14:10p, 16:11p, 20:14p, 24(0.6 or 0.3):16p.

Prototyping boards (Vero)  
 IBM XT £45.00, IBM AT £52.00

ACCESS or AMERICAN EXPRESS welcome by post or phone. Callers by appointment please. VAT INCLUDED. Please add £1 for post and packing. Catalogue free. No minimum order charge.

**BLACKMORE ELECTRONICS LTD.**  
 FREEPOST, Blandford Forum  
 Dorset DT11 7BR  
 Office address: 4 The Plocks, Blandford  
 0258 451347 (24hr answerphone)

**SPECIAL OFFER!**

**COMPUTER BITS**  
 Special offer! Floppy drive cleaning kits only 2.70 postage included. (State 5 1/4 or 3 1/2)  
 We also sell mailers, pens, labels, binders, spares etc, etc.

## PUBLIC ADDRESS AND DISCO EQUIPMENT

# YOU PAY TRADE PRICES!



### MIXERS

Choose from 25 models ■ Mixers for home use, disco's, public address and studio use ■ From 4 to 16 channels ■ Also 6 and 8 ch midi systems ■ Equalizer mixers MRT60 and many more.

### ECHO'S

■ VC1 analogue ■ 6040 stereo amplifier ■ 8040 digital echo ■ Also mini echo's.

### DIGITAL DELAY/REVERB

■ 19" rack systems ■ Digital reverb with 63 user programs ■ Digital delay up to infinite repeat ■ Also multi-effects programmable unit.

### GRAPHICS

■ 19" rack systems ■ 31 band single channel ■ 2 x 15 band two channel, and 2 x 31 band two channel.

### CHASSIS SPEAKERS/CABINETS

■ PA speakers 5 1/4" to 12" ■ Twin cone from 40 to 100 Watts ■ Various models disco/group speakers 10" to 18" various types ■ Bass speakers ■ Bass mids and mids ■ Also Rexine cabinets 10", 12" & 15" ■ Plus range of cabinet fittings and portable speaker stands and brackets.

### PIEZO TWEETERS

■ 10 models stocked from £2.95 to £7.95 ■ Square piezo £4.95.

### PUBLIC ADDRESS SPEAKERS

■ For PA and background music system with and without 100 volt line ■ OUTDOOR. Range of weatherproof systems at various power ratings ■ INDOOR. Columns for speech, columns for music ceiling speakers, suspension speakers, corridor speakers, wall speakers, music speakers - various sizes and types.



### DECKS

3 models heavy duty top quality with plinth/cover. ■ DLP1 belt drive quick start. ■ DLP2 direct drive system. ■ DLP3 quartz controlled quickstart direct drive.



### POWER AMPLIFIERS

■ Power boosters single channel: 100W, 175W and 2kW. 2-ch/stereo: 135 + 135W, 160 + 160 Watt and 1500 + 1500 Watt.

### AMPLIFIERS

■ With preamps ■ 240V AC models and 12V DC/240V AC or 24V DC/240V AC ■ From 15 Watts up to 175 Watts ■ Also background music tape amplifiers and paging amplifiers. ■ Plus range of mixer-amplifiers. ■ Choose from 25 models.

### MOBILE AMPLIFIERS

■ Range of 12 volt amplifiers up to 100 Watts ■ Also portable megaphones stocked and 12 volt power boosters.

### MICROPHONES/STANDS

■ XLR/Jack etc ■ Mics for disco, public address and Hi-Fi ■ Good quality at low cost ■ Also stands, booms etc. and wireless microphone system

### OUTDOOR HORNS

■ Various models up to 12" with or without 100 volt line with drivers ■ Also range of horns with choice of drive units. ■ Accessories: Leads ■ Plugs ■ Adaptors ■ Transformers etc, for all PA requirements.

### HORN/CROSSOVERS

■ 100 Watt midrange and tweeter horns ■ Also matching crossovers and filters up to 300 Watts.

CALL IN OR PHONE FOR BEST PRICES  
OPEN 6 DAYS A WEEK

**HENRY'S** AUDIO ELECTRONICS

404 Edgware Road, London W2 1ED  
Telephone: 01-724 3564  
Fax: 01-724 0322  
Sales Office: 01-258 1831

TRADE/EDUCATION/EXPORT SUPPLIED

PA - DISCO CATALOGUE WITH DISCOUNT VOUCHERS Ref PA1  
Send A4 SAE (£1.00 UK) or £2 UK full products catalogue

## Hobby Kit Electronics

### JUST A SMALL SELECTION OF KITS FROM OUR EVER INCREASING RANGE

Kit No.	Description	Price (each) £ (incl. VAT)
1001	0.2 WATT FM TRANSMITTER	4.16
1004	LIGHT SWITCH	5.83
1006	800 WATT MUSIC TO LIGHT	4.99
1009	1 WATT FM TRANSMITTER	5.42
1013	AM-FM-VHF RECEIVER	13.33
1018	GUITAR TREMELO	7.08
1020	0-5 MINUTE TIMER	5.42
1022	METAL DETECTOR	4.16
1026	RUNNING LIGHTS	8.33
1027	NI CAD BATTERY CHARGER	7.08
1029	4 SOUNDS ELECTRIC SIREN	4.99
1034	CAR BATTERY CHECKER	2.92
1036	TRANSISTOR TESTER	3.75
1038	AM-FM AERIAL AMPLIFIER	2.92
1044	GRAPHIC EQUALIZER	12.91
1045	SOUND EFFECT GENERATOR	6.66
1047	SOUND SWITCH	9.58
1055	RM RECEIVER USING TDA 7000	12.49
1059	TELEPHONE AMPLIFIER	8.33
1065	INVERTER 12V DC TO 220V AC	20.82
1069	12V DC FLUORESCENT TUBE UNIT	5.42
1073	VOICE ACTIVATED SWITCH	6.24
1075	ELECTRONIC DICE WITH LED'S	6.66
1091	GUITAR PRE-AMPLIFIER	7.50
1098	DIGITAL THERMOMETER WITH LCD DISPLAY	20.82
1114	ELECTRONIC LOCK	7.50
1117	TV PATTERN GENERATOR	9.17
1119	TELEPHONE LINE RECORDING	4.16
1122	TELEPHONE CALL RELAY	6.66
1124	ELECTRONIC BELL	4.99
1125	TELEPHONE LOCK	6.66
1129	NEGATIVE ION GENERATOR	14.16
1131	ROBOT VOICE	6.66
1133	STEREO SOUND TO LIGHT	9.52
1203	MINI FM TRANSMITTER WITH MICROPHONE	4.16

All kits are supplied complete including Silk Screened pcb, Components, Solder, Wire and full instruction sheet.

Purpose built boxes with silk-screened front panels are available for some of the above. Please consult our catalogue.

★ ★ ★ ★ ★  
LARGE STOCKS OF INTEGRATED CIRCUITS, SEMI'S, OTPO ELECTRONICS, CAPACITORS, RESISTORS, SWITCHES AND OTHER MISCELLANEOUS PRODUCTS ARE ALSO AVAILABLE FROM - **Hobbykit**

★ ★ ★ ★ ★  
For latest kit catalogue and price list send a large 45p S.A.E. to:

# Hobbykit Ltd.

ACCESS CREDIT CARD HOTLINE  
☎ 01-205 7485 VISA

UNIT 19, CAPITOL INDUSTRIAL PARK  
CAPITOL WAY,  
LONDON NW9 0EQ  
FAX NO: 01-205 0603

# EE WEATHER STATION

PART THREE

MIKE FEATHER

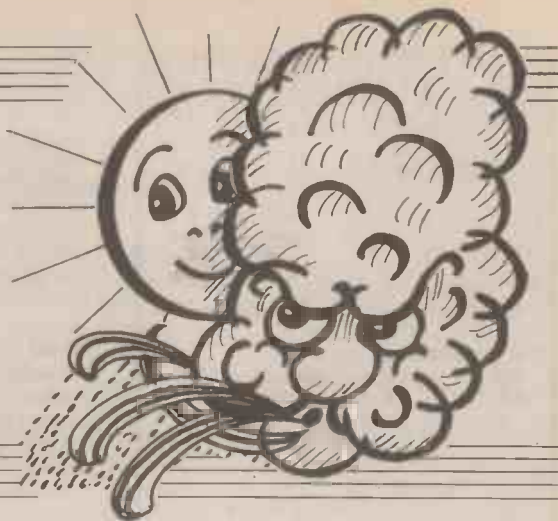

With the effects of the environment becoming more important each year, why not add some high-tech to your weather forecasting.

**W**ITH the abnormally high winds, rainfalls and droughts experienced over the last 18 months, and the ever increasing interest being shown by the media in the world's climate, it seems fitting that we conclude the *EE Weather Station* series with two units for measuring rainfall and recording sunlight.

## MEASURING RAINFALL

The measurement of rainfall within a given period of time — usually twenty four hours — can be achieved by means of a number of different techniques, but common to most of these is a standard sized collecting funnel of five inches (127mm) diameter.

A very simple gauge could be made using a plastic funnel and an empty bottle or can to collect the water. It should be noted that the depth of the water in the can or the bottle is not the depth of rainfall. In such an arrangement, a separate measuring cylinder calibrated in millimetres (mm) of rainfall is normally used in order to measure the catch.

The Rainfall Gauge used in the *EE Weather Station* employs the standard five inch funnel as the collector but a somewhat different technique is used for the measurement of the catch and its conversion to millimetres of rainfall.

Rain from the funnel is collected in a small bucket and it is arranged that one millimetre of rain tips the bucket so causing it to empty completely. Each tip of the bucket is detected using a slotted opto-switch and the pulses produced by this counted.

In order to work out the volume held by the bucket just before tipping takes place, we need to work out what volume of water is represented by a one millimetre fall of rain collected by the five inch funnel. We need, therefore, to calculate the volume of a cylinder of 127mm diameter and height 1mm. This is given by  $\pi R^2 h$  where  $R$  is the radius of the cylinder and  $h$  its height. Using our values of 63.5mm for the radius and 1mm for the height, we have  $V = \pi \times 63.5^2 \times 1 = 12661\text{mm}$ . Dividing this by 1000 gives a value of approximately 12.7cm or 12.7ml.

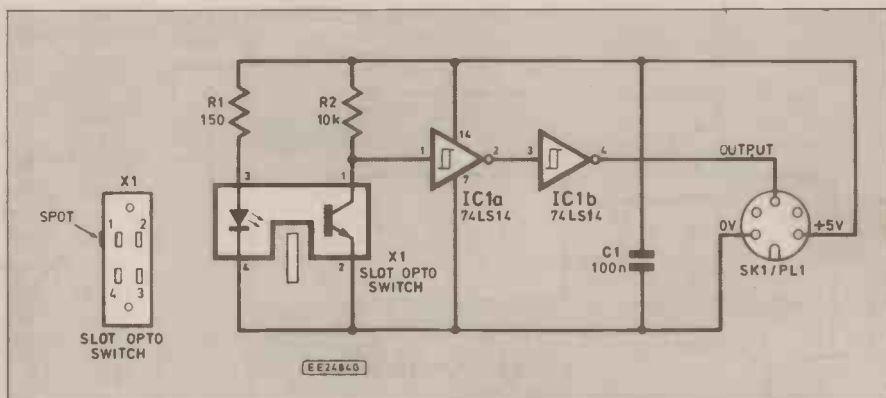

Once this volume has been collected and the bucket begins to tip, it is essential that the tipping continues so that the bucket empties itself completely, ready for the next catch of rainfall. To achieve this, the lever upon which the bucket is mounted has been made deliberately unstable by positioning the pivot somewhat below the axis of the lever arm. After a certain amount of experimentation with this positioning, the dimensions outlined in Fig. 6 were arrived at and these produce satisfactory results.

As with the other sensors in the Weather Station, the design of the Rainfall Gauge has been kept simple and uses readily obtainable materials and components. Constructors should experience little difficulty in realising a reliable and reasonably accurate gauge.

## CIRCUIT DESCRIPTION

The complete circuit diagram for the Rainfall Gauge is shown in Fig. 1. The circuit is split into two sections; rain gauge head or collector and counter display.

As mentioned, a slotted opto-switch assembly X1 is used to detect the tipping of the bucket. The bucket lever carries a small aluminium plate which sits in the gap of the switch when the bucket is filling. When the amount of rain collected tips the bucket, the lever swings the plate clear producing a pulse from the opto-switch.

The output from the collector of the opto-switch's transistor is applied to the

## COMPONENTS

### RAINFALL SENSOR HEAD

#### Resistors

R1	150
R2	10k

All 0.25W  
5% carbon film

#### Capacitor

C1	100n disc ceramic
----	-------------------

#### Semiconductors

IC1	74LS14 HEX Schmitt trigger inverter
X1	Slotted opto-switch

#### Miscellaneous

SK1/PL1	5-pin 240° DIN socket and plug
---------	--------------------------------

Printed circuit board available from *EE PCB Service*, code EE687; 14-pin d.i.l. socket; 5in. dia. plastic funnel; materials for tipping mechanism — see text; self-adhesive pad, for mounting p.c.b.; connecting wire; nuts, bolts and washers; solder pins (6 off); solder etc.

Approx cost guidance only

£8



# COMPONENTS

## RAINFALL COUNTER/DISPLAY

**Resistor**  
R3 330

All 0.25W  
5% carbon film

### Semiconductors

IC2 Opto-isolator (ISD74)  
X2 5-digit counter/display module (Maplin FS13P)

### Miscellaneous

S2 Push-to-make switch  
SK2/PL2 5-pin 240° DIN socket and plug

Printed circuit board available from *EE PCB Service*, code EE685 (this board is also part of the sunlight circuit and the power supply); 8-pin d.i.l socket; solder pins (6 off); AA size battery for display; coloured connecting wire; nuts, bolts and washers; solder etc.

**Shop  
Talk**

See page 251

input (pin 1) of the Schmitt inverter IC1a whose output is then inverted by IC1b. This provides a clean TTL level output pulse for each tipping cycle.

## COUNTER/DISPLAY

Counting of the pulses is achieved by using a ready made five-digit l.c.d. counter module. The use of a five-digit maximum count may seem to be somewhat pessimistic in terms of the rainfall that this would represent and a three digit arrangement could be used. Indeed, the author originally built a three digit counter/display unit for the Weather Station but this worked out as being slightly more costly than the five-digit unit!

The counter module is battery operated, requiring a single 1.5V cell. Power consumption during non switching periods is quoted as being a mere 8µA, so it was decided to adhere to the battery supply rather than attempt to derive a 1.5V supply from the main unit.

As an input, the counter looks for a switch closure between pins 3 and 4 rather

than the TTL level pulses generated by the gauge collector unit. An opto-isolator IC2b provides the solution to this interfacing problem.

With the l.e.d. section of IC2b turned on, the transistor conducts and effectively provides the switch closure between pins 3 and 4 of the counter module. The switching current flowing is very tiny (about 10µA) so that there is no need for any current limiting resistor on the transistor side of the opto-isolator.

Resetting of the counter module is achieved by the push-to-make switch S2 which momentarily joins pins 2 and 4 of the counter/display module.

The power supply for the Rainfall Gauge and the Sunlight Recorder (to be described) is the usual +5V TTL requirement and this is derived via IC6, a 7805 five volt regulator, from an 18V unregulated supply from the secondary winding of transformer T1. The regulator and the associated bridge rectifier D1 — D4 and reservoir capacitor C4 are mounted on the main printed circuit board and supply a regulated 5V supply for both circuits.

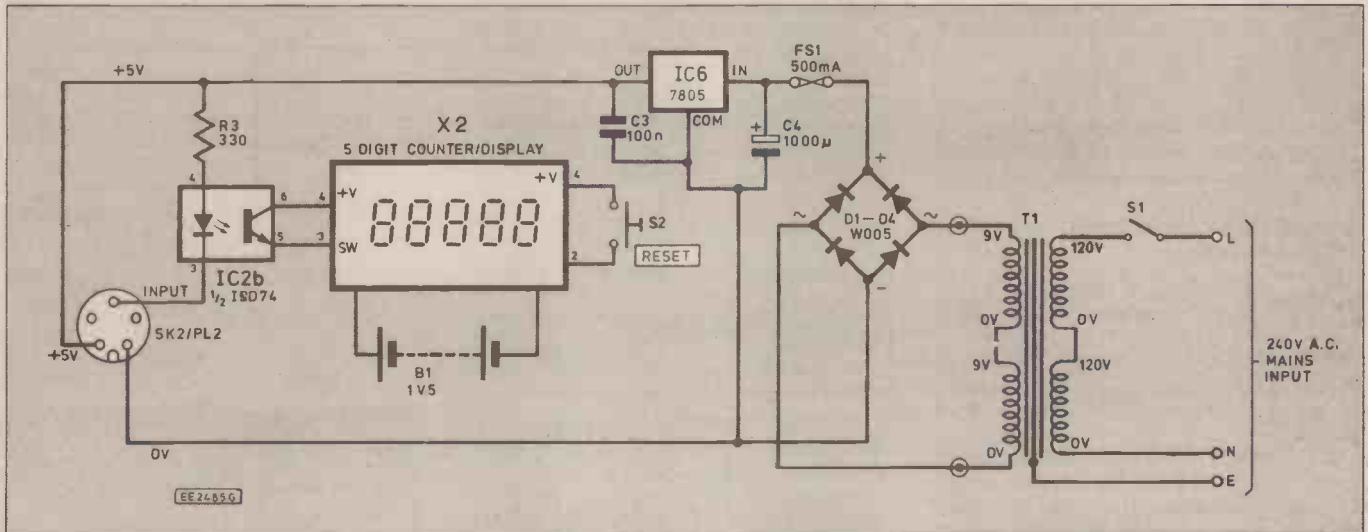

Fig. 1. Complete circuit diagram for the Rainfall Gauge. The rainfall collector/sensor section is shown opposite. The power supply also drives the Sunlight Recorder.

### POWER SUPPLY (both units)

#### Capacitors

C3 100n disc ceramic  
C4 1000µ radial elec. 25V

#### Semiconductors

D1-D4 W005 50V 1.5A bridge rec.  
IC6 7805CT +5V 1A voltage regulator

#### Miscellaneous

T1 Mains transformer, 0-9V, 0-9V secs.  
S1 Mains on/off toggle switch  
FS1 500mA fuse and p.c.b. fuseholder

Mains cable; cable clamp; printed circuit board — code EE685, see above; connecting wire; solder tag; solder pins (2 off); nuts and bolts etc.

The completed EE Weather Station showing the two display units and the wind, rain, sunshine and temperature sensor heads.



Approx cost  
guidance only

**£22**

# SUNLIGHT RECORDER

Sunlight duration is arguably the least quantitative of the meteorological factors under consideration. The problem arises from the difficulty of deciding just exactly what constitutes sunlight. Unobscured bright sun or, if not, then what degree of cloud obscuration?

The sunlight sensor used in the weather station allows calibration for whatever level of light the user regards as constituting sunshine. Three ORP12 light dependent resistors (l.d.r.), R1, R2 and R3, are used as the light sensors and the circuit diagram for the "sensor head" is shown in Fig. 2. The circuit diagram for the counter/display is also shown in Fig. 2.



## COMPONENTS

### SUNLIGHT SENSOR HEAD

#### Resistors

R1-R3 ORP12 light dependant resistor (3 off)

#### Potentiometers

VR1-VR3 100k min. cermet preset, horiz. (3 off)

#### Capacitor

C1 100n disc ceramic

#### Semiconductors

IC1 74LS14 HEX Schmitt trigger inverter

IC3 74LS32 quad 2-input OR gate

#### Miscellaneous

SK3/PL3 5-pin 180° DIN socket and plug

Printed circuit board available from *EE PCB Service*, code EE686; diecast metal box, approx. 115mm x 65mm x 50mm; 14-pin d.i.l. socket (2 off); solder pins (7 off); coloured connecting wire; nuts, bolts and washers; wooden block for mounting LDRs - see text.

Approx cost guidance only

**£12**

The use of three separate l.d.r. sensors allows some degree of compensation for the lower attitude of the sun in the morning and the evening. Each sensor may be individually calibrated so as to produce an output when the sunlight incident upon it reaches the level which is considered as constituting sunshine.

The outputs from the l.d.r.s are first applied to three inputs, IC1a, b and c, of a 74LS14 HEX Schmitt inverter to produce TTL logic level signals. These signals are

then fed to the inputs of two 2-input OR gates IC3a and IC3b. The output from IC3a is fed to one of the inputs of IC3b to make up a three input arrangement between IC3a and IC3b. Thus, if the light level at any one of the l.d.r.s reaches the preset value, the output of the OR circuit will go to logic "1". Preset variable potentiometers VR1 to VR3, wired as variable resistors, allow adjustment of each individual sensor.

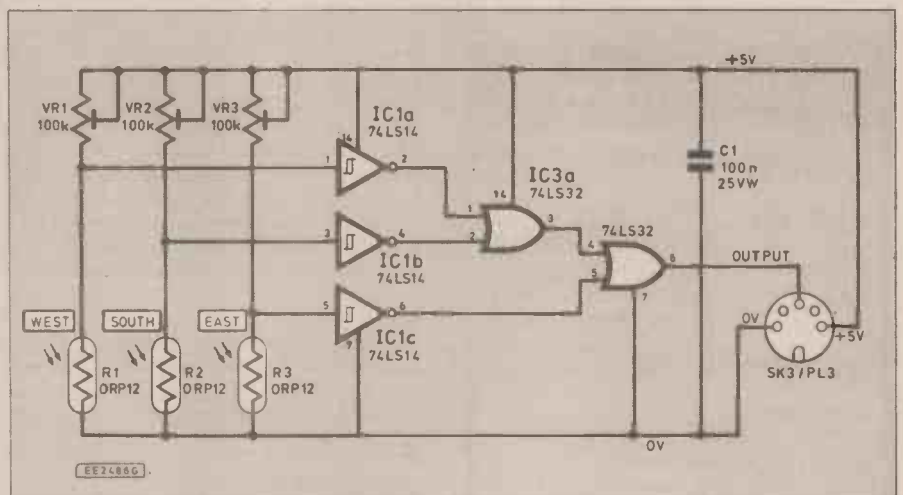
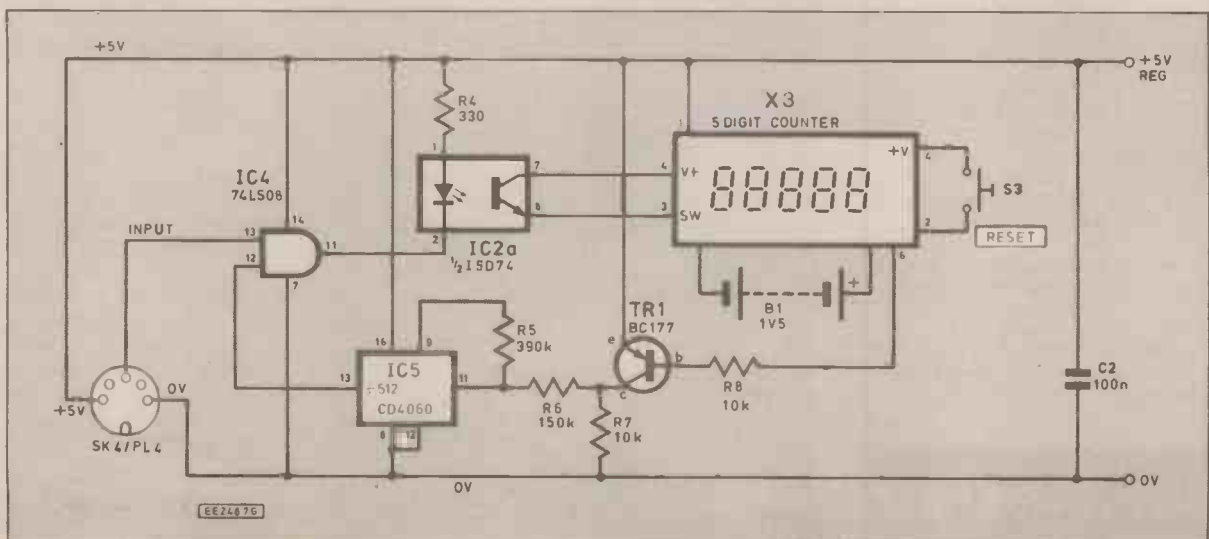

Fig. 2 Complete circuit diagram for the Sunlight Recorder. The sensor head section is shown above.



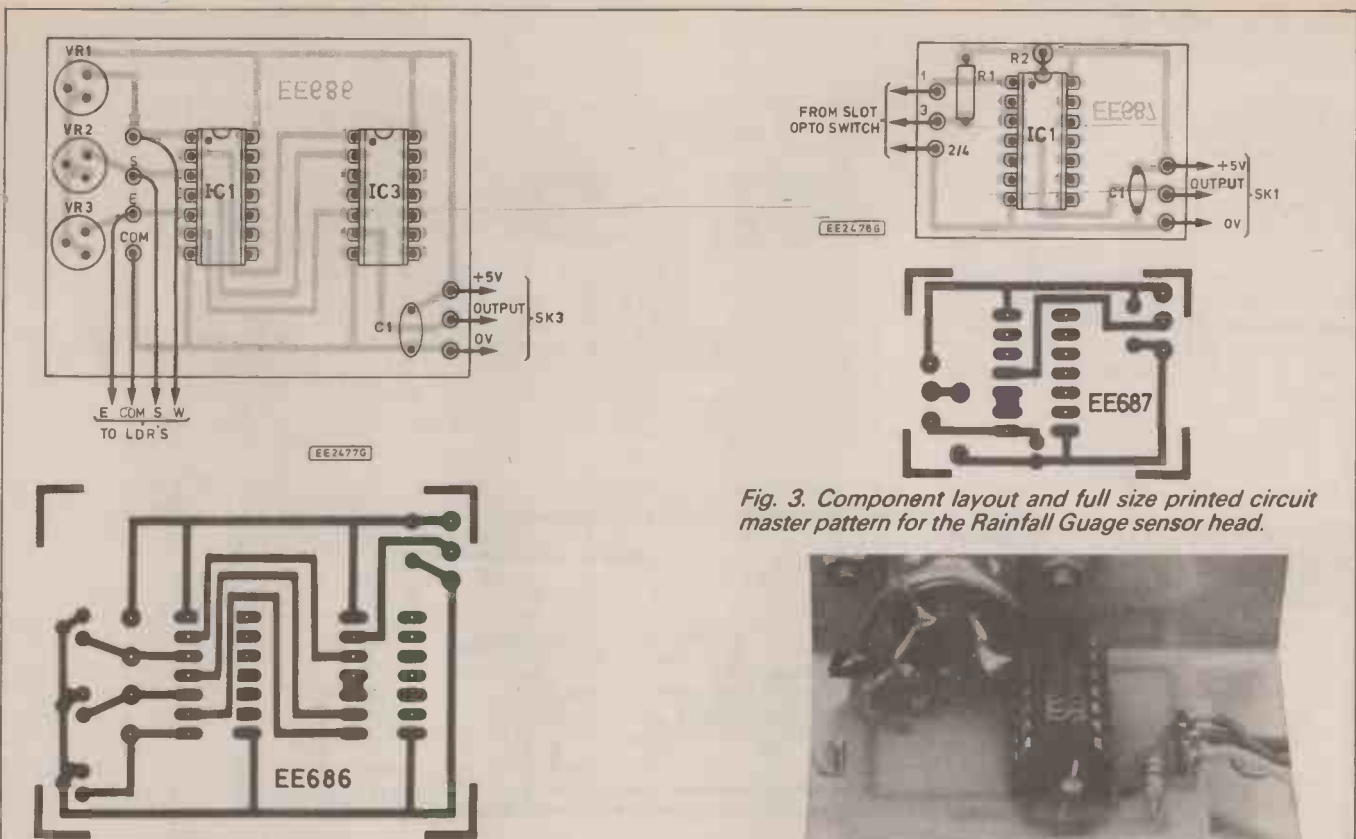



Fig. 3. Component layout and full size printed circuit master pattern for the Rainfall Gauge sensor head.

Fig. 4. Component layout and printed circuit master pattern for the Sunlight Recorder sensor head.

## COMPONENTS

### SUNLIGHT COUNTER DISPLAY

<b>Resistors</b>		 <p>See page 251</p>
R4	330	
R5	390k	
R6	150k	
R7	10k	
R8	10k	
All 0.25W 5% carbon film		
<b>Capacitor</b>		
C2	100n disc ceramic	
<b>Semiconductors</b>		
TR1	BC177 <i>nnp</i> silicon transistor	
IC2	Opto-isolator (ISD74)	
IC4	74LS08 quad 2-input AND gate	
IC5	CD4060 14-stage binary counter	
X3	5-digit counter/display module (Maplin FS 13P)	
<b>Miscellaneous</b>		
S3	Push-to-make switch	
SK4/PL4	5-pin 180° DIN socket and plug	

Printed circuit board available from *EE PCB Service*, code EE685 (this board is also part of the rainfall circuit and power supply); 14-pin d.i.l socket; 16-pin d.i.l socket; AA size battery for display; solder pins (6 off); coloured connecting wire, solder etc.

Approx cost guidance only **£19**

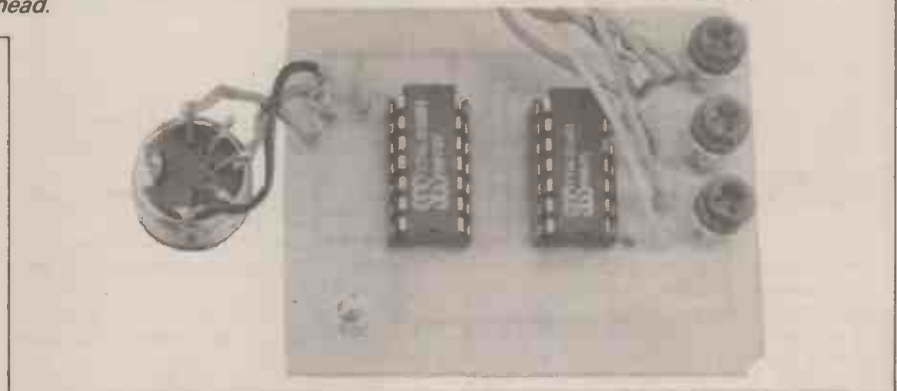

## COUNTER/DISPLAY

In order to measure the duration of the sunlight period, the logic "1" from the sensor is used to gate a clock which forms part of the display unit.

The counter section of the clock uses another 5-digit counter/display module and one second pulses are gated into this via the transmission AND gate IC4. The pulses will only be transmitted and hence the clock will only be incremented when the output signal from the sensing unit indicates the presence of sunlight on one of the sensors.

Pin 6 of the counter provides clock pulses at a frequency of 512Hz and these are divided by 512 by IC5, a 4060 CMOS 14-stage binary ripple counter. Once again, there is a minor interfacing problem between this device and the counter output. The latter consists of a negative going square wave of an amplitude of 1.5V.

The pulses are used to switch TR1, a *pnp* transistor which develops at its collector, positive going pulses of approximately five volts amplitude. These are then applied, through resistor R2 and R3 network, to the clock input (pin 11) of IC5.

As mentioned, IC5 can divide by various factors of up to  $2^{14}$ , but in this case, the  $2^9$  output at pin 13 is used. Pin 12 provides a reset facility and is held low (i.e. connected to 0V) in this application. The 1Hz pulses at the output of IC4 are coupled to the counter module input using an opto-isolator, as in the Rainfall Gauge.

## CONSTRUCTION

Three printed circuit boards are required and the component layouts and full size copper foil master patterns for these are given in Fig. 3, Fig. 4 and Fig. 5. These boards are available through the *EE PCB Service*, codes EE685, EE686 and EE687.

The boards should be prepared in the usual way and it is suggested that the i.c. sockets be inserted first to act as a guide for the rest of the components. This should be followed by the smallest component working up to the largest. It is most important that you check that polarity conscious components, such as diodes, transistor and electrolytic capacitors, are inserted on the boards correctly before soldering in place.

Finally, the i.c.s should be inserted in their holders, once again observing carefully the position of pin one of each i.c. The completed boards should be double

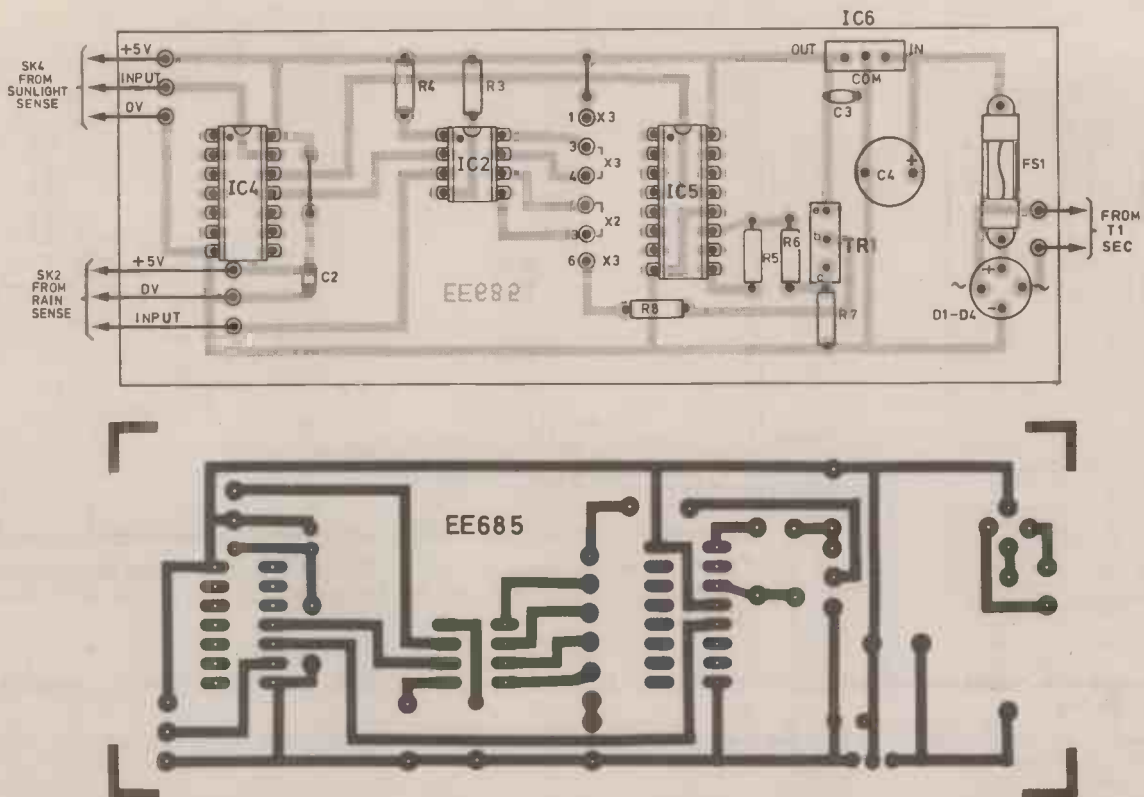

Fig. 5. Component layout and full size printed circuit master for the main display/counter board for the rainfall, sunlight and voltage regulator circuits. The mains transformer T1, DIN sockets and switches are mounted separately.

checked for any errors or solder slivers bridging any copper tracks. Once this has been done the boards should be put to one side until the mechanical construction of the sensor heads have been completed.

The rain gauge and sunlight sensor "heads" should be constructed following the details given in Fig. 6 and Fig. 8. The rainfall unit needs to be enclosed in a waterproof case and, in the prototype, this was formed from aluminium. It also carried the 127mm (5in.) funnel. One suggested method for fixing the funnel above the water collector bucket is shown in Fig. 7.

## RAINFALL SENSOR

Full mechanical details for the Rain-fall Sensor Head are shown in Fig. 6. Polythene waste piping of 36mm outside diameter is used for the "bucket", detailed dimensions of which are also shown in Fig. 6.

The full length of pipe (58mm) is first cut, care being taken to ensure that the ends are straight. The other cuttings are then marked out using a felt tipped pen and then carefully cut with a junior hacksaw.

The end piece was cut from 2mm thickness polythene sheet, but other plastics material such as Perspex or polystyrene would no doubt make suitable alternatives. Once the end piece has been cut and filed to the same outside diameter as the tube, it should be fixed to it by gluing all around the periphery with Superglue.

The remainder of the sensor unit employs largely plywood and dowel and is very easily assembled using Fig. 6 as a guide. The lever pivot should be as frictionless as possible and the simple arrangement of a

short length of Meccano rod mounted in an aluminium bracket worked well in the prototype.

A small counterbalance weight is necessary for calibration purposes and the prototype simply used two or three turns of 18s.w.g. solder wrapped around the lever arm. Calibration can be achieved by positioning this and the tipping limit stop so that 12.6ml of water poured *carefully*

into the bucket just causes it to tip and empty completely.

Power supplies to and output signals from the tipping bucket unit are carried via a 5-pin 240° DIN plug and socket and a suitable length of three core cable. Thin mains cable is quite adequate and the prototype used lengths of up to 20m without any apparent loss of integrity of the transmitted pulse.

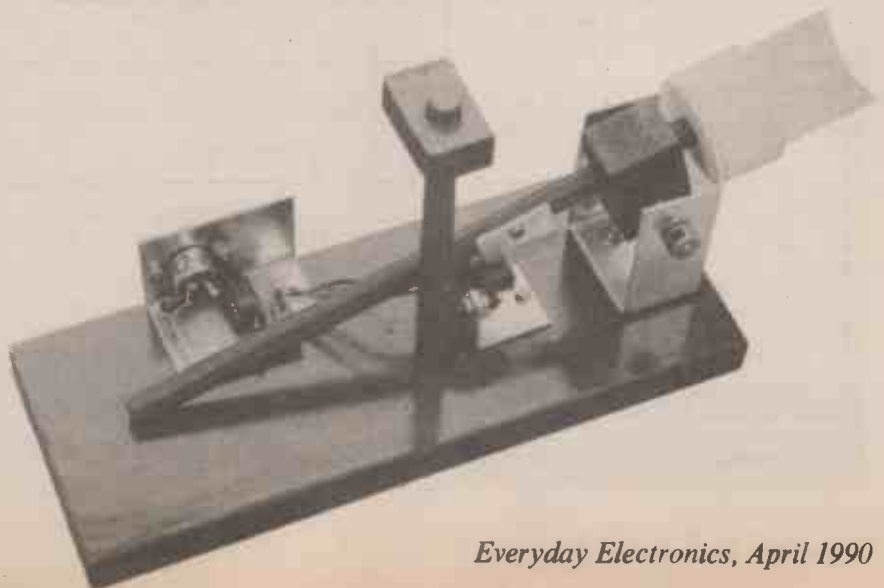
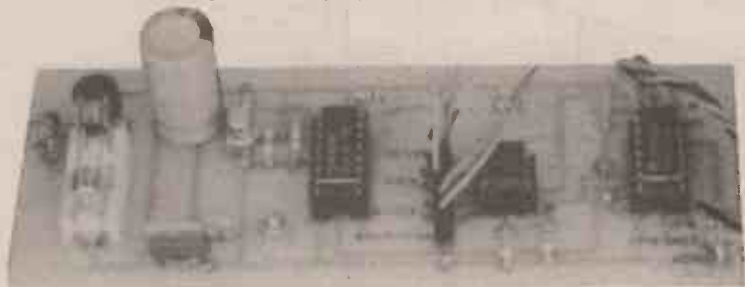

# RAINFALL GAUGE ASSEMBLY

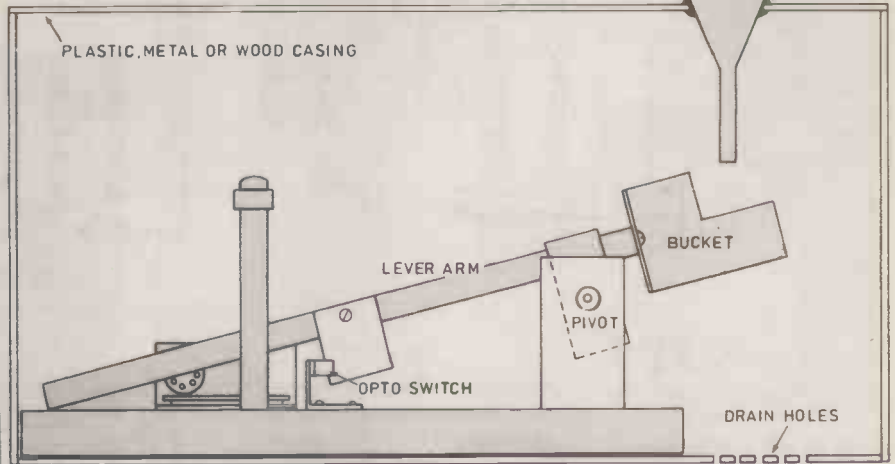
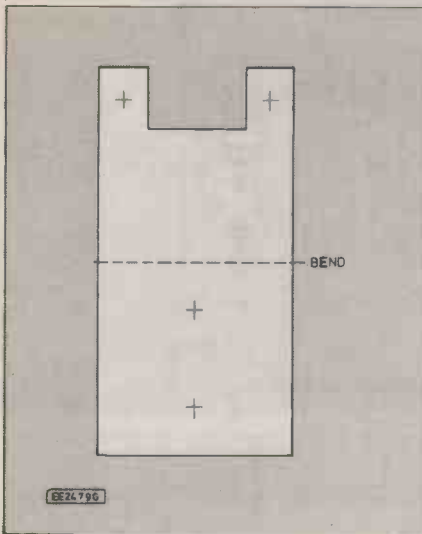
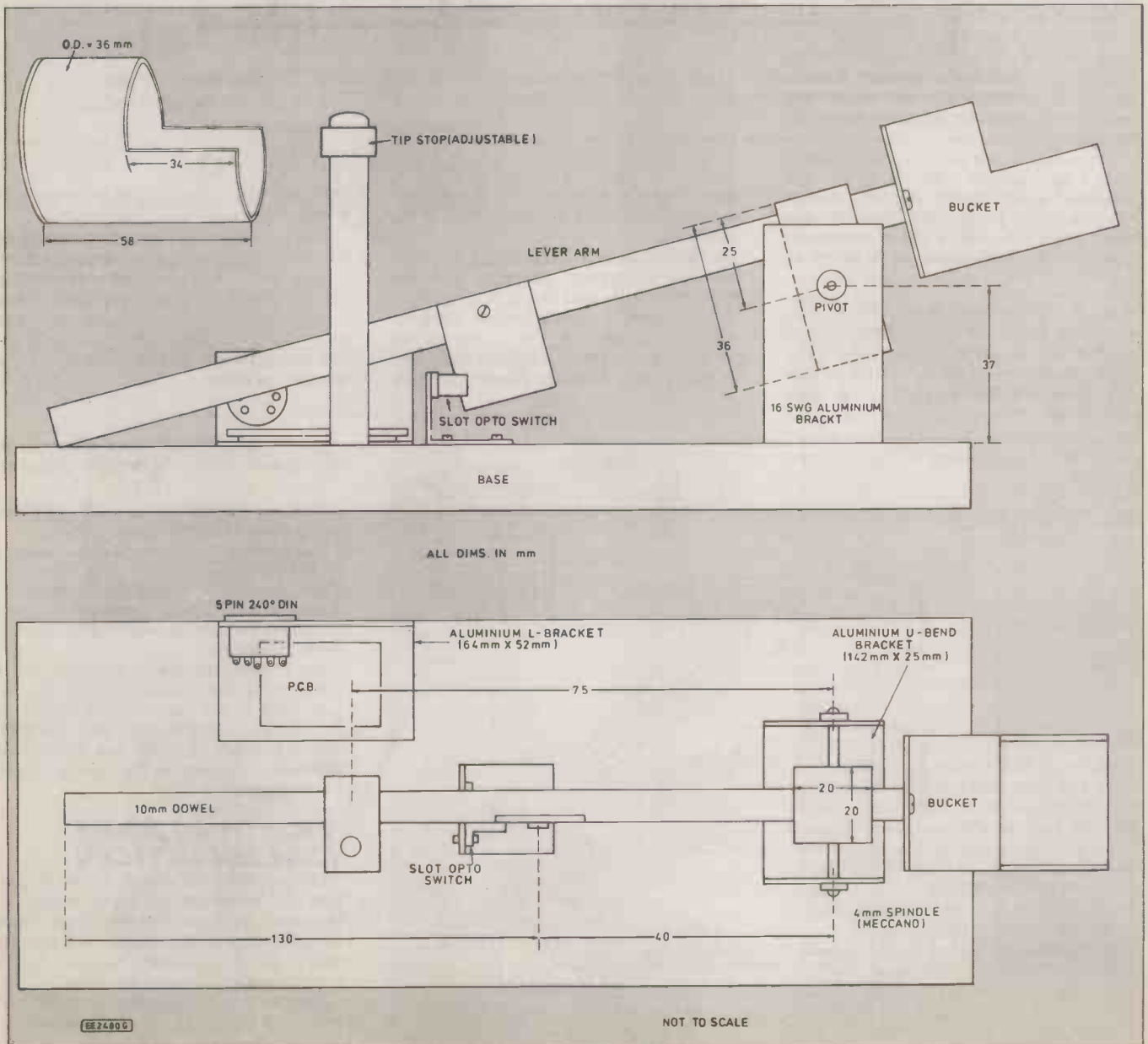

Fig. 7. Suggested arrangement for fixing the funnel above the collector bucket. The material for the "shroud" can be plastic, metal or wood; all joints should be made waterproof.

Fig. 6. Mechanical details and dimensions for the Rainfall Gauge. A full size template for the opto-switch mounting bracket is shown above left.



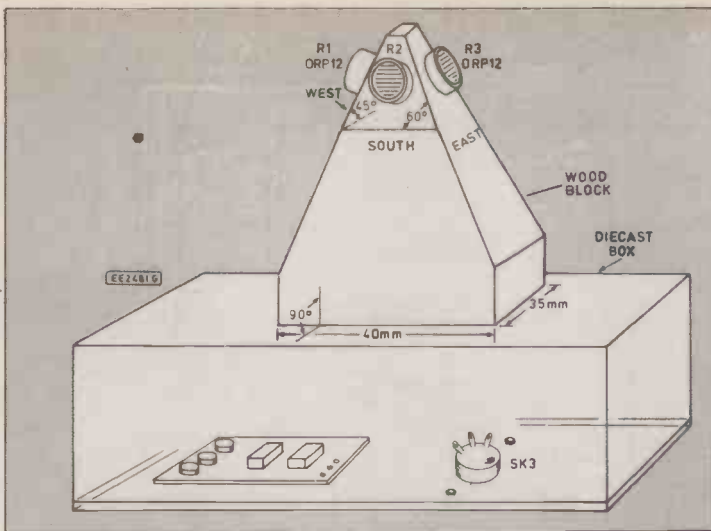

Fig. 8. Mounting set-up for the three light sensors.

## SUNLIGHT RECORDER

The mounting arrangement for the three l.d.r.s used in the Sunlight Recorder is shown in Fig. 7. The three ORP12 devices are mounted on the angled faces of the wooden block as shown.

The angles suggested allow some compensation for the angular elevation of the sun at different times of the day. Clearly, this varies between winter and summer and recalibration may be necessary from time to time.

The ORP12's are provided with connection leads (colour code these for convenience) which are first threaded through the holes in the block, each l.d.r. then being fixed to its face with a small quantity of Araldite. The completed assembly is at-

Fig. 9. Interwiring from the display circuit board to the other case mounted components. Note that the circuit board is mounted on the "wall" of the case and the mains on/off switch on the rear panel.

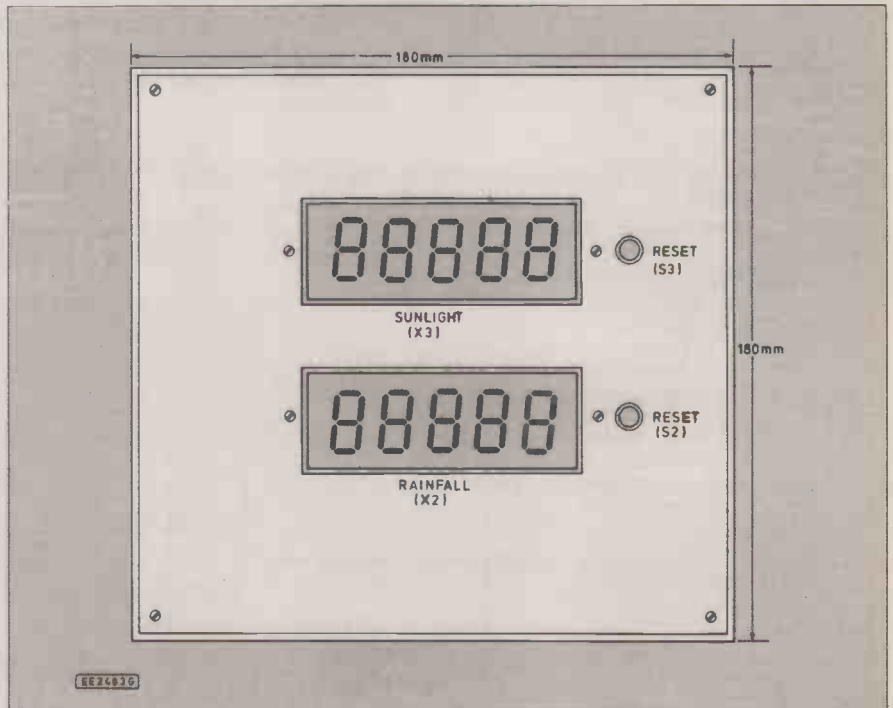
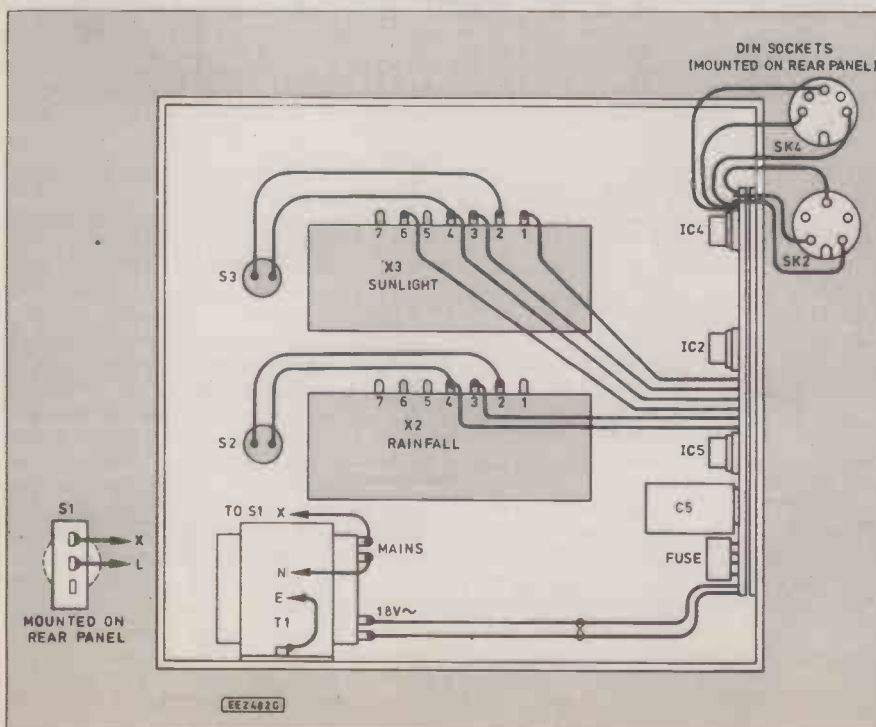

Fig. 10. Display/Counter front panel layout and overall dimensions of panel.



tached to the base of a small ABS box which houses the associated circuitry.

The Sunlight Recorder Head is connected to the main display unit via a 5-pin 180° DIN plugs, sockets and three-core cable. Again, a considerable length of interconnecting cable may be used without any apparent problems.

The boards may now be mounted on the appropriate sensor assembly or in the Display Unit as the case may be. Details of the prototype display unit and the interwiring between its board and the counter modules are shown in Fig. 9, Fig 10 and photographs.

## TESTING AND CALIBRATION

Connect up both sensors to the display unit and switch on the mains supply. At this point, the power supply voltage should be checked between COM (0V) and the output pin of the voltage regulator IC6. It should be approximately five volts.

Reset both of the counters using the push button switches S2, S3 and actuate the Rainfall Sensor by pushing the collecting

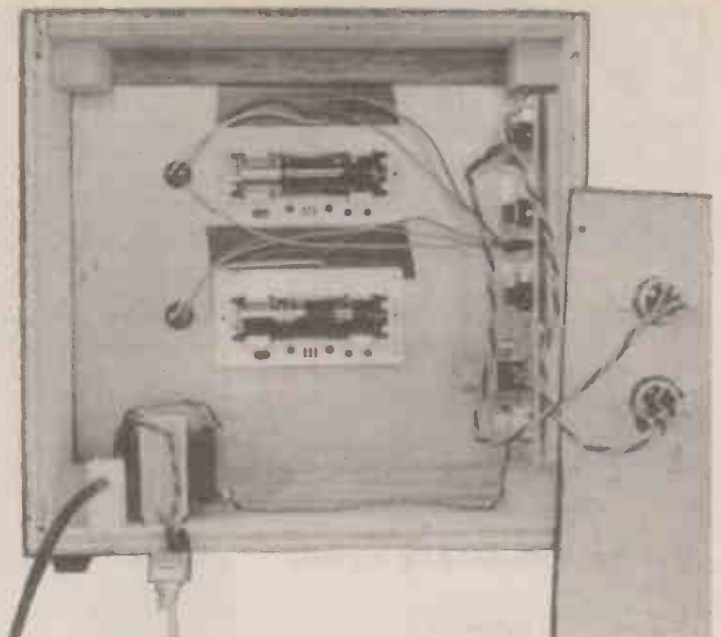

bucket down. A count of one should be recorded and, on allowing the lever to return to its rest position, the count should remain at one. Repeat this several times and check that the counter increments by one each time.

To test the Sunlight Recorder, set VR1 to VR3 at their mid-track positions and cover all of the l.d.r.s. The cover needs to be

effective in a normally lit room, so use black adhesive tape. The sunlight seconds counter should not be running.

Uncover each of the l.d.r.s in turn and check that each one causes the clock to count. The room should be well lit for this test.

The sensor unit can now be placed outside and orientated correctly. Calibration is

then achieved by adjustment of VR1 - VR3 so that the clock runs when it is considered that the light falling upon a particular sensor is sufficient to represent sunlight. □

Next month: We present an Electronic Barometer by Owen Bishop. Measures atmospheric pressure from 950 to 1050 millibars, with previous reading memory.

## OMNI ELECTRONICS

174 Dalkeith Road, Edinburgh EH16 5DX · 031 667 2611



Have you sent for your copy of our catalogue yet?

If not, simply send 2x 1st class stamps for a copy by return.

A COMPREHENSIVE RANGE WITH SERVICE SECOND TO NONE

Open: Monday-Friday 9.00-6.00  
Saturday 9.00-5.00



## CAMBRIDGE COMPUTER SCIENCE LIMITED

- ☆ 10MByte Winchester, used, 3 months Wty ..... £42.00 each
- ☆ 5.25" Disk Drives, 80 Tk, DSDD ..... £34.00 each
- ☆ 5.25" drive cases, room for drive, PSU & fan ..... £10.00 each
- ☆ Buy a case, winchester & PSU together for ..... £64.00 each
- ☆ Small cases, to fit 2 Half Ht 5.25" drives ..... £10.00 each
- ☆ 5.25" Drives, Used-untested-no warranty ..... £15.00 each  
(untested drives are sold on a strictly "as is" basis)
- ☆ 5.25" Disks, DSDD, 48 tpi boxes of 10 ..... £3.00 box
- ☆ 50W PSU 5V 6A, 12V 2.5A, -5V 0.5A, -12V 0.5A ..... £16.00 each
- ☆ Gould PSU 0-30V @5A Limited quantity only at ..... £45.00 each
- ☆ Dual Data lead (BBC Micro to 2 Disk Drives) ..... £4.00 each
- ☆ Power lead (BBC Micro to Disk Drive) ..... £2.00 each
- ☆ Dual power lead (BBC Micro to 2 Disk Drives) ..... £4.00 each
- ☆ 68000 CPUs (The first orders get 10MHz chips) ..... £3.50 each
- ☆ 280A CPU, CTC, PIO £1.20 each; DMA £2.00 ..... £4.50 all 4
- ☆ 74LS TTL, pick and mix, buy 10 or more for ..... £0.12 each  
Types available: '00 '02 '04 '08 '11 '13 '20 '21 '26 '27 '30 '32 '36 '42 '74 '83 '86 '107  
'109 '122 '132 '136 '139 '145 '151 '153 '157 '158 '163 '164 '191 '193 '298 '365 '670
- ☆ EPROMS 27128 ..... used £1.50 each; new 27128-25 £2.50 each
- ☆ 6264 8K Byte SRAM ..... -15 £3.00 each -12 £3.80 each
- ☆ 65256 32K Byte rams (selling out soon) ..... £7.00 each
- ☆ 8K Byte NV ram chips ..... £3.00 each £10.00 four
- ☆ 20 pin dll low profile IC sockets ..... £0.50/10 £4.00/100
- ☆ 40 pin dll low profile IC sockets ..... £0.60/10 £5.00/100
- ☆ Keyboard, 100 keys on board LCD & micro if ..... £8.00 each
- ☆ Toroidal mains transformer, 12V 4A & 0.4A, 12-0-12, 1A & 2A, 9-0-9, 2A ..... £4.00/1 £6.00/2 £8.00/3

All items new unless stated. Add 15% VAT to all prices. Prices include postage. Add 50p to orders below £5.00. (Please Note mail order only, no facilities for callers)

Send an SAE for our latest list or for more info.  
Dept EE, 374 Milton Road, Cambridge, CB4 1SU  
Tel: 0223 424602/0831 430496/0831 430552

continued from page 256.

Speech recognition has relied heavily on so-called template techniques. The name comes from analogy with a mechanical system. If you machine to recognise you could stamp out the shape of the word on a template (Fig. 2). By moving the

Fig. 2 In a template system, printed characters are scanned by a template containing the shape of one word. When what is seen through the template fits the shape the word is recognised. This is a mechanical analogy for an electronic word-recognition system.

In real life printed words occur in different type sizes and styles. This complicates the recognition process. In speech recognition, there are com-

parable complications. A speaker's rate of delivery may change according to his mood, state of fatigue and so on. Voice pitch may change as a result of excitement. Electronic template systems, which make frequency, amplitude and time analyses of a spoken word to provide electronic equivalents of words, in the form of binary numbers, must cope with these problems.

The trouble is that as the number of words to be recognised grows, the complexity of the recognition system increases very rapidly. This limits the capacity of even the best systems to a few thousand words and phrases. If the speaker joins up words into ordinary connected speech there is the added problem, for the system, of deciding where one word ends and the next begins.

### PHONETICS

At this point it becomes useful to take a

fresh look at the way in which human speech experts analyse spoken words. It is possible to write down the sound of a word by using a special phonetic alphabet. The result may look quite different from the ordinary printed forms of words, but it works. It turns out that to write down the sounds of spoken English, forty symbols are needed.

This is more than the letters of the alphabet but not too much for a machine system to cope with. To encode numbers 1 to 40 requires only a 6-bit code. A word made up of five basic sounds (called phonemes) then requires 30 bits, which isn't too bad. So if (and this is the hard part) it's possible to make a system which recognises phonemes, then spoken words can be encoded easily, and once encoded can be looked up in a phoneme-based dictionary (in computer memory form, of course) and so identified. Research and development is now proceeding along these lines.



*a regular  
feature for  
the Spectrum  
Owner...*

by Mike Tooley BA

**T**HIS month we shall be showing how readers can make maximum use of the powerful Philips SAA1099 stereo sound generator chip fitted to the MGT SAM Coupé. We begin, however, by attempting to dispel some of the myths and mysteries concerning the memory organisation of the Coupé.

### Memory Matters

A number of our regular readers have written recently to ask questions concerning the amount of memory fitted to the SAM Coupé. The most commonly asked question concerns the technique by which the Z80 microprocessor is able to address a 512K byte memory range (greater in excess of the 64K bytes which would normally be directly addressable by a processor of this type having 16 address lines).

The SAM Coupé uses "memory paging" to support very much more powerful applications than its humble predecessor. This technique allows the Coupé to access a memory range which is comparable with the Atari and Amiga machines.

Unfortunately, paging is a technique which is not very well understood. Essentially, the basic addressing range of the microprocessor forms a window within a very much larger area of memory which, for convenience, is divided into a number of blocks or "pages" which can be made to appear within the window.

The page of memory accessible by the microprocessor can be determined by writing data to a port address. This address constitutes a register which contains the number of the page which is to appear within the window. In the case of the Coupé, things are a little more difficult since the basic 64K bytes of memory addressing range are divided into four 16K byte blocks (A to D) whilst the total RAM available is divided into two banks (0 and 1) each of 256K bytes. The RAM thus constitutes 32 pages, each of 16K bytes (pages 0 to 31).

The first two 16K blocks within the CPU address range (A and B) occupy addresses 0 to 32767 decimal and are controlled by the Low Memory Paging Register (LMPR) at port address 250 decimal (FA hex.). The page (and bank) number is written to this I/O port address in order to determine which of the RAM pages appears in blocks

A and B. A single bit within the LMPR also determines whether block A is the ROM.

The second two blocks of 16K bytes (C and D) occupying addresses 32768 to 65535 decimal are associated with the High Memory Paging Register (HMPPR) at port address 251 decimal (FB hex.). The requisite page (and bank) number is written to this I/O port address in order to determine which of the RAM pages appears as blocks C and D.

### Sound Generation

Fortunately, the SAM Coupé is fitted with an extremely versatile sound generator chip in the form of the Philips SAA1099 stereo sound generator. Unfortunately, neither the "Advanced User Guide" nor MGT's excellent SAM Coupé manual deal with programming the sound generator in any detail and the user is left with remarkably few clues concerning its use based on the SOUND command.

The key to unlocking the tremendous power contained within the sound generator is that of understanding the internal operation of the device. Indeed, in order to make full use of the chip it is essential to have some understanding of its internal architecture and, in particular, the function and bit assignment of each of its internal registers. Simply experimenting with sending bytes of data to its various internal registers is not likely to produce any very meaningful results!

The SAA1099 can generate a very wide range of sound effects including simulations of musical instruments and the sounds which would normally be associated with arcade games. Whereas most integrated sound generators have only three frequency generators, the SAA1099 has six. Furthermore, the tones produced by these six generators (over an 8-octave range) can be mixed with a variety of different types of noise.

A stereo effect (adding an extra dimension to computer games) can be generated by duplicating the six sound components to form identical left- and right-hand channel signals, weighting the signals present in each channel, and then combining them to form a stereophonic signal. Besides the stereo sound facility, effects such as Doppler shifts can be imitated using fairly simple software routines.

The simplified architecture of the SA1099 device is shown in Fig. 1. The chip contains six identical frequency generating circuits, each of which can generate 256 tones in each of eight octaves from 31Hz to 7.81kHz. Each generator can be enabled or disabled individually, making it possible to preselect a tone and make it audible when desired.

To simplify the software, the frequency generators can be synchronized at start-up and when changing frequencies, octaves and envelopes using the "frequency reset" bit. In addition, the outputs of frequency generators 0 and 3 can each control a noise generator whilst the outputs of generators 1 and 4 can each control an envelope generator for special effects.

The two noise generators each have a programmable output controlled by the contents of register 16 which determines whether the tone is either:

- software-controlled via frequency generator 0 and 3 (which then produce no tone). The "colour" of the noise generated is derived from twice the frequency of the fre-

quency generator output (i.e. from 61Hz to 15.6kHz).

- one of three pre-defined noises based on clock frequencies of 7.8kHz, 15.6kHz, or 31.25kHz. In this case, the output of noise generator 0 can be mixed with the outputs of frequency generators 0, 1 and 2, and the output of noise generator 1 can be mixed with the outputs of frequency generators 3, 4 and 5. For mixing, the amplitude of the tone is increased relative to that of the noise.

Six mixers are used to mix the tone provided by each of the tone generators with noise. Each mixer can be set to either:

- mix the noise and tone
- pass the tone only
- pass the noise only
- pass neither tone nor noise.

The six amplitude controllers duplicate the signal from one of the noise/frequency mixers to form the left and right channel components and also assign one of sixteen amplitude levels to the signals. A stereo effect can be produced by adjusting the relative amplitude of the signals present on each channel output. As an example, when a source of sound moves from left to right across the screen, its amplitude can be reduced on the left channel and increased on the right channel. This can be very easily accomplished using just a few simple assembly language or BASIC statements.

The two envelope controllers enable control of the envelope shape of the output fed to each channel. Various options can be selected including single and repetitive attack and decay.

### Programming the SAA1099

The SA1099 is controlled by means of its 32 internal registers. The bit assignment for these registers is shown in Table 1 and the content of the registers can be easily modified from BASIC by means of statements of the form: SOUND r,b where r is the SA1099 register address (0 to 31 decimal) and b is the byte (0 to 255 decimal) which will be written to the register.

The frequency of the output of the tone generators is given by the formula:

$$f = \frac{15625 \times 2^m}{511 - n} \text{ Hz}$$

where  $m$  is the "octave number" and  $n$  is the "tone number" for the frequency generator concerned. The octave number must be loaded into bits 5, 6 and 7 (or 2, 1 and 0) of the appropriate octave number register whilst the tone number must be loaded into the appropriate tone number register.

As an example, the following lines of BASIC will produce summed tone outputs of 2kHz and 250Hz (from generators 0 and 1 respectively) at both the left and right hand sound channels:

```
10 SOUND 28,1
20 SOUND 8,11
30 SOUND 9,11
40 SOUND 16,54
50 SOUND 0,255
60 SOUND 1,127
70 SOUND 24,142
80 SOUND 25,134
90 SOUND 20,3
```

Line 10 enables the SA1099 (bit 0 is set). Lines 20 and 30 set the tone numbers ( $n$ ) for generators 0 and 1 respectively. Line 40 sets octave numbers ( $m$ ) of 3 and 6 for generators 1 and 0 respectively. Line 50 enables 100 per cent amplitude for gener-



**Notes:**

- R = amplitude setting bit (bit 7 = MBS)
- L = amplitude setting bit (bit 3 = MBS)
- T = frequency setting bit (bit 7 = MBS)
- X = unused/don't care (should be written as a logic 0)
- 5 = enable bit for generator 5 (logic 1 to enable)
- 4 = enable bit for generator 4 (logic 1 to enable)
- 3 = enable bit for generator 3 (logic 1 to enable)
- 2 = enable bit for generator 2 (logic 1 to enable)
- 1 = enable bit for generator 1 (logic 1 to enable)
- 0 = enable bit for generator 0 (logic 1 to enable)
- Y = noise generator clock frequency bits:
  - 0 0 = 31.25kHz
  - 0 1 = 15.6kHz
  - 1 0 = 7.8kHz
  - 1 1 = 61Hz to 15.6kHz\*

(\*frequency generator 0 or 3 controlling noise generator 0 or 1, respectively)

E = envelope select bits:

- Bit 0 (LSB) = 0 for identical left and right channel envelopes
- Bit 0 (LSB) = 1 for identical left and right channel envelopes

Bit position	Envelope shape
3 2 1	
0 0 0	zero amplitude
0 0 1	maximum amplitude
0 1 0	single decay
0 1 1	repetitive decay
1 0 0	single triangle
1 0 1	repetitive triangle
1 1 0	single attack
1 1 1	repetitive attack

**Table 1. Bit assignment for the SAA1099 internal register**

Register (hex)	(dec)	Bit number								Function
		7	6	5	4	3	2	1	0	
00	0	R	R	R	R	L	L	L	L	Amplitude setting — controller 0
01	1	R	R	R	R	L	L	L	L	Amplitude setting — controller 1
02	2	R	R	R	R	L	L	L	L	Amplitude setting — controller 2
03	3	R	R	R	R	L	L	L	L	Amplitude setting — controller 3
04	4	R	R	R	R	L	L	L	L	Amplitude setting — controller 4
05	5	R	R	R	R	L	L	L	L	Amplitude setting — controller 5
06	6	X	X	X	X	X	X	X	X	Reserved for possible expansion
07	7	X	X	X	X	X	X	X	X	Reserved for possible expansion
08	8	T	T	T	T	T	T	T	T	Tone number (n) — generator 0
09	9	T	T	T	T	T	T	T	T	Tone number (n) — generator 1
0A	10	T	T	T	T	T	T	T	T	Tone number (n) — generator 2
0B	11	T	T	T	T	T	T	T	T	Tone number (n) — generator 3
0C	12	T	T	T	T	T	T	T	T	Tone number (n) — generator 4
0D	13	T	T	T	T	T	T	T	T	Tone number (n) — generator 5
0E	14	X	X	X	X	X	X	X	X	Reserved for possible expansion
0F	15	X	X	X	X	X	X	X	X	Reserved for possible expansion
10	16	X	B	B	B	X	A	A	A	Octave numbers (m) — generators 1 and 0
11	17	X	D	D	D	X	C	C	C	Octave numbers (m) — generators 3 and 2
12	18	X	F	F	F	X	E	E	E	Octave numbers (m) — generators 5 and 4
13	19	X	X	X	X	X	X	X	X	Reserved for possible expansion
14	20	X	X	5	4	3	2	1	0	Frequency enable bits
15	21	X	X	5	4	3	2	1	0	Noise enable bits
16	22	X	X	Y	Y	X	X	Y	Y	Noise generator clock frequency select
17	23	X	X	X	X	X	X	X	X	Reserved for possible expansion
18	24	E	E	E	E	E	E	E	E	Envelope generator 0
19	25	E	E	E	E	E	E	E	E	Envelope generator 1
1A	26	X	X	X	X	X	X	X	X	Reserved for possible expansion
1B	27	X	X	X	X	X	X	X	X	Reserved for possible expansion
1C	28	X	X	X	X	X	R	S		Master reset and enable
1D	29	X	X	X	X	X	X	X	X	Reserved for possible expansion
1E	30	X	X	X	X	X	X	X	X	Reserved for possible expansion
1F	31	X	X	X	X	X	X	X	X	Reserved for possible expansion

Bit 4 = 0 for 4-bit envelope resolution  
 Bit 4 = 1 for 3-bit envelope resolution  
 Bit 5 = 0 for internal envelope clock  
 (frequency generator 1 or 4)

Bit 5 = 1 for external envelope clock  
 Bit 6 = X (don't care)  
 Bit 7 = 0 for reset (no envelope control)  
 Bit 7 = 1 enable envelope control

ator 0 whilst line 60 selects 50 per cent of the maximum amplitude for generator 1 (thus generator 0's output is twice as large as that from generator 1). Lines 70 and 80 select internal clock, four bit resolution, with repetitive attack (channel 0) and decay (channel 1). Finally, line 90 selects frequency outputs from channels 0 and 1.

**Next Month:** On Spec will be devoted to catching up with problems, hints and tips sent in by readers. We also hope to have some more information for those of you who may be interested in radio applications of the Spectrum and include some interesting demonstration software routines which put the SAA1099 tone generator through its paces! In the meantime, if you have any problems, queries or suggestions for inclusion in *On Spec*, please don't hesitate to drop me a line: Mike Tooley, Faculty of Technology, Brooklands College, Heath Road, Weybridge, Surrey KT13 8TT.

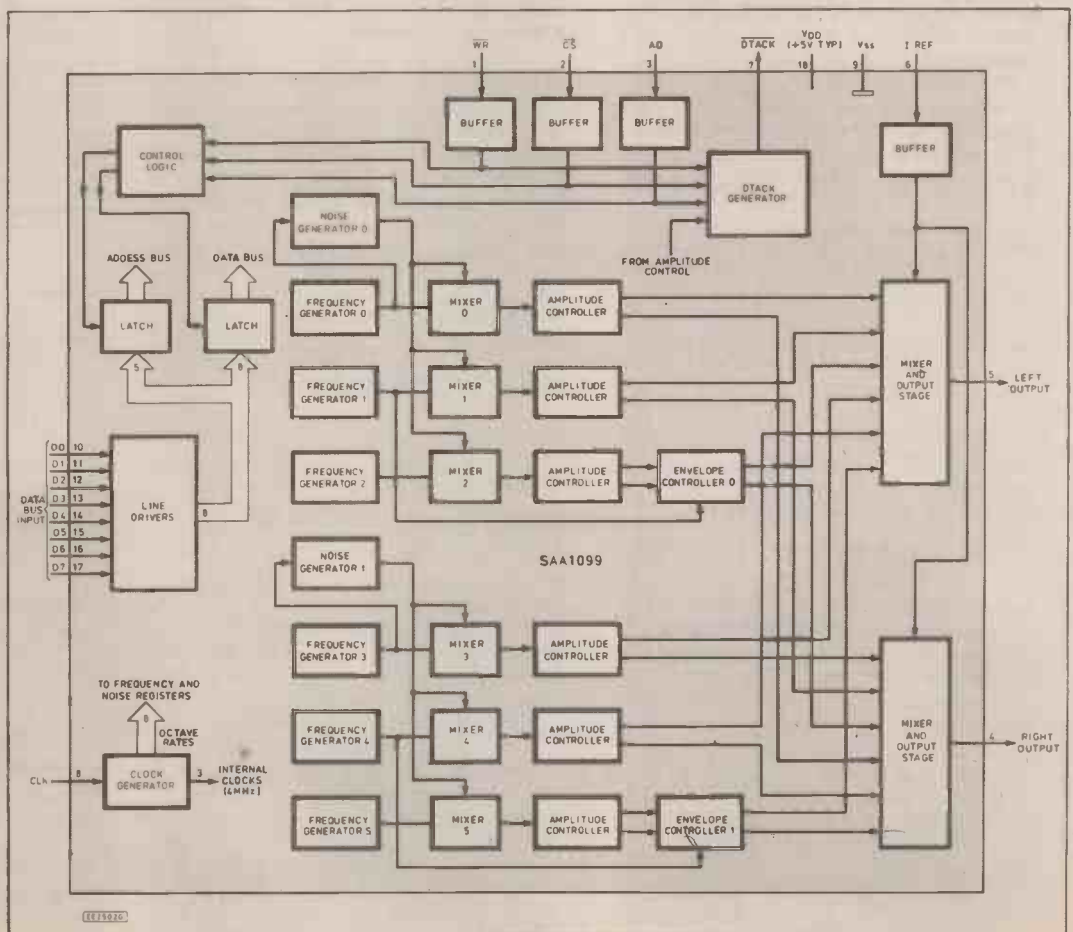
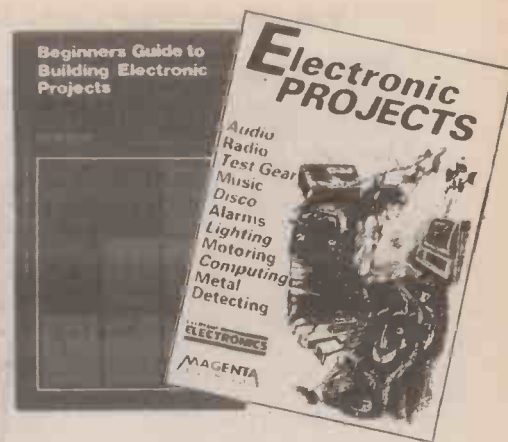

**Fig. 1. Internal architecture of the SAA1099.**

# DIRECT BOOK SERVICE

The books listed have been selected as being of special interest to everyone involved in electronics and computing. They are supplied by mail order direct to your door. Full details are given on the last book page.

For another selection of books see next month's issue.



## MORE BOOKS NEXT MONTH — MORE BOOKS NEXT MONTH

### PROJECT CONSTRUCTION

#### HOW TO GET YOUR ELECTRONIC PROJECTS WORKING

**R. A. Penfold**  
We have all built projects only to find that they did not work correctly, or at all, when first switched on. The aim of this book is to help the reader overcome just these problems by indicating how and where to start looking for many of the common faults that can occur when building up projects.

96 pages Order code BP110 £2.50

#### HOW TO DESIGN AND MAKE YOUR OWN P.C.B.s

**R. A. Penfold**  
Deals with the simple methods of copying printed circuit board designs from magazines and books and covers all aspects of simple p.c.b. construction including photographic methods and designing your own p.c.b.s.

80 pages Order code BP121 £2.50

#### BEGINNER'S GUIDE TO BUILDING ELECTRONIC PROJECTS

**R. A. Penfold**  
Shows the complete beginner how to tackle the practical side of electronics, so that he or she can confidently build the electronic projects that are regularly featured in magazines and books. Also includes examples in the form of simple projects.

112 pages Order code No. 227 £1.95

#### ELECTRONIC SCIENCE PROJECTS

**O. Bishop**  
These projects range in complexity from a simple colour temperature meter to an infra-red laser. There are novelties such as an electronic clock regulated by a resonating spring, and an oscilloscope with solid-state display. There are scientific measuring instruments such as a pH meter and an electro-cardiometer. All projects have a strong scientific flavour. The way they work, and how to build and use them are fully explained.

144 pages Order code BP104 £2.95

#### ELECTRONIC PROJECTS — BOOK 1

Published by *Everyday Electronics* in association with *Magenta Electronics*.

Contains twenty of the best projects from previous issues of *EE* each backed with a kit of components. The projects are: Seashell Sea Synthesiser, *EE* Treasure Hunter, Mini Strobe, Digital Capacitance Meter, Three Channel Sound to Light, BBC 16k Sideways Ram, Simple Short Wave Radio, Insulation Tester, Visual Guitar/Instrument Tuner, Stepper Motor Interface, Eprom Eraser, 200MHz Digital Frequency Meter, Infra Red Alarm, *EE* Equaliser Ioniser, Bat Detector, Acoustic Probe, Mainstester and Fuse Finder, Light Rider — (Lapel Badge, Disco Lights, Chaser Light), Musical Doorbell, Function Generator, Tilt Alarm, 10W Audio Amplifier, *EE* Buccaneer Induction Balance Metal Detector, BBC Midi Interface, Variable Bench Power Supply, Pet Scarer, Audio Signal Generator.

128 pages (A4 size) Order Code EP1 £2.45

### CIRCUITS & DESIGN

#### PRACTICAL ELECTRONIC BUILDING BLOCKS—BOOK 1

#### PRACTICAL ELECTRONIC BUILDING BLOCKS—BOOK 2

**R. A. Penfold**

These books are designed to aid electronic enthusiasts who like to experiment with circuits and produce their own projects, rather than simply following published project designs.

**BOOK 1** contains: Oscillators—sinewave, triangular, squarewave, sawtooth, and pulse waveform generators operating at audio frequencies. Timers—simple monostable circuits using i.c.s, the 555 and 7555 devices, etc. Miscellaneous—noise generators, rectifiers, comparators and triggers, etc.

**BOOK 2** contains: Amplifiers—low level discrete and op-amp circuits, voltage and buffer amplifiers including d.c. types. Also low-noise audio and voltage controlled amplifiers. Filters—high-pass, low-pass, 6, 12, and 24dB per octave types. Miscellaneous—i.c. power amplifiers, mixers, voltage and current regulators, etc.

**BOOK 1** 128 pages Order code BP117 £1.95  
**BOOK 2** 112 pages Order code BP118 £1.95

#### ELECTRONIC ALARM CIRCUITS MANUAL

**R. M. Marston**

One hundred and forty useful alarm circuits, of a variety of types, are shown in this volume. The operating principle of each one is explained in concise but comprehensive terms, and brief construction notes are given where necessary.

Aimed at the practical design engineer, technician and experimenter, as well as the electronics student and amateur.

124 pages Order code NE11 £9.95

#### DESIGNING DC POWER SUPPLIES

**G. C. Loveday C.Eng MIERE**

Covers all aspects of the design of regulated power units, using discrete, i.c. regulators and switched units. It also covers protection circuits and reference supplies. Many design examples and exercises all with fully worked solutions are given.

131 pages Order code BM2 £6.95

#### MODERN OPTO DEVICE PROJECTS

**R.A. Penfold**

In recent years, the range of opto devices available to the home constructor has expanded and changed radically. These devices now represent one of the more interesting areas of modern electronics for the hobbyist to experiment in, and many of these devices have useful practical applications as well. This book provides a number of practical designs which utilize a range of modern opto-electric devices, including such things as fibre optics, ultra bright l.e.d.s and passive IR detectors etc.

While many of these designs are not in the "dead simple" category, they should be within the capabilities of anyone with a reasonable amount of experience in electronics construction and some of the more simple designs are suitable for beginners.

104 pages Order code BP194 £2.95

#### DIGITAL LOGIC GATES AND FLIP-FLOPS

**Ian R. Sinclair**

This book, intended for enthusiasts, students and technicians, seeks to establish a firm foundation in digital electronics by treating the topics of gates and flip-flops thoroughly and from the beginning. This is not a constructor's book in the sense of presenting circuits to build and use, it is for the user who wants to design and troubleshoot digital circuitry with considerably more understanding of principles.

Topics such as Boolean algebra and Karnaugh mapping are explained, demonstrated and used extensively, and more attention is paid to the subject of synchronous counters than to the simple but less important ripple counters.

No background other than a basic knowledge of electronics is assumed, and the more theoretical topics are explained from the beginning, as also are many working practices. The book concludes with an explanation of microprocessor techniques as applied to digital logic.

200 pages Order code PC106 £8.95

#### HOW TO USE OP-AMPS

**E. A. Parr**

This book has been written as a designer's guide covering many operational amplifiers, serving both as a source book of circuits and a reference book for design calculations. The approach has been made as non-mathematical as possible.

160 pages Order code BP88 £2.95

#### MICRO INTERFACING CIRCUITS—BOOK 1

#### MICRO INTERFACING CIRCUITS—BOOK 2

**R. A. Penfold**

Both books include practical circuits together with details of the circuit operation and useful background information. Any special constructional points are covered but p.c.b. layouts and other detailed constructional information are not included.

Book 1 is mainly concerned with getting signals in and out of the computer. Book 2 deals primarily with circuits for practical applications.

**Book 1** 112 pages Order code BP130 £2.25  
**Book 2** 112 pages Order code BP131 £2.75

#### SENSORS AND TRANSDUCERS

**Keith Brindley**

There are a considerable number of transducers. Look through any electronic components catalogue and you'll find a wide variety of types, and each type has many variations. It's not easy to choose a transducer correctly for a particular function. In many specifications, terms and procedures are referred to which might deter you from using one that is, in fact, the best for the job. Yet, opting to use a transducer merely because it is easier to interface into the measuring system is not the answer. A greater knowledge of all types of transducers capable of doing the task is the ideal, and only then can a totally satisfactory decision be made to use one in particular.

176 pages Order code NE17 £12.95

#### ELECTRONIC CIRCUITS FOR THE COMPUTER CONTROL OF ROBOTS

**Robert Penfold**

Robots and robotics offer one of the most interesting areas for the electronics hobbyist to experiment in. Today the mechanical side of robots is not too difficult, as there are robotics kits and a wide range of mechanical components available. The micro controller is not too much of a problem either, since the software need not be terribly complex and many inexpensive home computers are well suited to the task.

The main stumbling block for most would-be robot builders is the electronics to interface the computer to the motors, and the sensors which provide feedback from the robot to the computer. The purpose of this book is to explain and provide some relatively simple electronic circuits which bridge this gap.

92 pages Order code BP179 £2.95

#### 50 SIMPLE LED CIRCUITS

**R. N. Soar**

Contains 50 interesting and useful circuits and applications, covering many different branches of electronics, using one of the most inexpensive and freely available components—the light-emitting diode (LED). Also includes circuits for the 707 common anode display.

64 pages Order Code BP42 £1.95  
**BOOK 2** 50 more l.e.d. circuits Order code BP87 £1.95

#### ELECTRONICS SIMPLIFIED —CRYSTAL SET CONSTRUCTION

**F. A. Wilson, C.G.I.A., C.Eng., F.I.E.E., F.I.E.R.E., F.B.I.M.**

Especially written for those who wish to participate in the intricacies of electronics more through practical construction than by theoretical study. It is designed for all ages upwards from the day one can read intelligently and handle simple tools.

80 pages Order Code BP92 £1.75



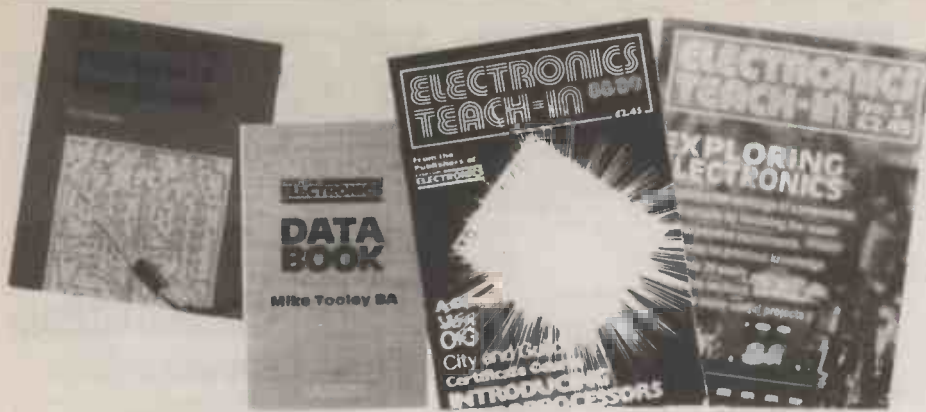

**ELECTRONICS TEACH-IN 88/89—INTRODUCING MICROPROCESSORS**  
**Mike Tooley BA** (published by *Everyday Electronics*)  
 A complete course that can lead successful readers to the award of a City and Guilds Certificate in Introductory Microprocessors (726/303). The book contains everything you need to know including full details on registering for assessment, etc.  
 80 pages (A4 size) Order code TI-88/89 £2.45

**FROM ATOMS TO AMPERES**  
**F. A. Wilson**  
 Explains in crystal clear terms the absolute fundamentals behind electricity and electronics. Really helps you to discover and understand the subject, perhaps for the first time ever.  
 Have you ever: Wondered about the true link between electricity and magnetism? Felt you could never understand the work of Einstein, Newton, Boltzmann, Planck and other early scientists? Just accepted that an electron is like a little black ball? Got mixed up with e.m.f. and p.d.? Thought the idea of holes in semiconductors is a bit much?  
 Then help is at hand with this inexpensive book, in as simple a way as possible and without too much complex mathematics and formulae.  
 244 pages Order code BP254 £3.50

**BEGINNERS GUIDE TO MICROPROCESSORS**  
**E.A. Parr**  
 An excellent grounding in microprocessors, this book is broadly relevant to the whole of our *Introducing Microprocessors* course. It is easy to read and well illustrated.  
 224 pages Order code NE03 £7.95

**ELECTRONICS—A "MADE SIMPLE" BOOK**  
**G. H. Olsen**  
 This book provides excellent background reading for our *Introducing Digital Electronics* series and will be of interest to everyone studying electronics. The subject is simply explained and well illustrated and the book assumes only a very basic knowledge of electricity.  
 330 pages Order code NE10 £4.95

**ELECTRONICS TEACH-IN No. 3 — EXPLORING ELECTRONICS** (published by *Everyday Electronics*)  
**Owen Bishop**  
 Another EE value for money publication aimed at students of electronics. The course is designed to explain the workings of electronic components and circuits by involving the reader in experimenting with them. The book does not contain masses of theory or formulae but straightforward explanations and circuits to build and experiment with.  
 Exploring Electronics contains more than 25 useful projects, assumes no previous knowledge of electronics and is split into 28 easily digestible sections.  
 88 pages (A4 size) Order code TI3 £2.45

**NEWNES ELECTRONICS POCKET BOOK**  
**E. A. Parr**  
 Newnes Electronics Pocket Book has been in print for over twenty years and has covered the development of electronics from valve to semiconductor technology and from transistors to LSI integrated circuits and microprocessors. To keep up to date with the rapidly changing world of electronics, continuous revision has been necessary. This new Fifth Edition takes account of recent changes and includes material suggested by readers of previous editions. New descriptions of op.amp. applications and the design of digital circuits have been added, along with a totally new chapter on computing, plus other revisions throughout.  
 315 pages (hard cover) Order Code NE02 £9.95

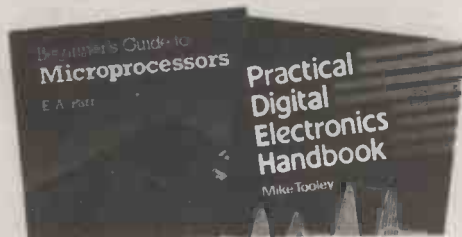

**EVERYDAY ELECTRONICS DATA BOOK**  
**Mike Tooley BA**  
 (published by EE in association with PC Publishing)  
 This book is an invaluable source of information of everyday relevance in the world of electronics. It contains not only sections which deal with the essential theory of electronic circuits but it also deals with a wide range of practical electronic applications.  
 It is ideal for the hobbyist, student, technician and engineer. The information is presented in the form of a basic electronic recipe book with numerous examples showing how theory can be put into practice using a range of commonly available "industry standard" components and devices.  
 † A must for everyone involved in electronics!  
 256 pages Order code DATA £8.95

**ELECTRONIC HOBBYISTS HANDBOOK**  
**R.A. Penfold**  
 Provides an inexpensive single source of easily located information that the amateur electronics enthusiast is likely to need for the day-to-day pursuit of this fascinating hobby. Covers common component colour codes. Details the characteristics and pinouts of many popular semiconductor devices, including various types of logic ICs, operational amplifiers, transistors, FETs, unijunctions, diodes, rectifiers, SCRs, diacs, triacs, regulators and SMDs, etc. Illustrates many useful types of circuits, such as timers and oscillators, audio amplifiers and filters, as well as including a separate section on power supplies. Also contains a multitude of other useful data.  
 88 pages Order code BP233 £4.95

**ESSENTIAL THEORY FOR THE ELECTRONICS HOBBYIST**  
**G. T. Rubarow, T. Eng (C.E.I.), Asso.I.E.R.E.**  
 The object of this book is to supply the hobbyist with a background knowledge tailored to meet his or her specific requirements and the author has brought together the relevant material and presented it in a readable manner with minimum recourse to mathematics.  
 128 pages Order Code 228 £2.50

**PRACTICAL DIGITAL ELECTRONICS HANDBOOK**  
**Mike Tooley** (Published in association with *Everyday Electronics*)  
 The vast majority of modern electronic systems rely heavily on the application of digital electronics, and the *Practical Digital Electronics Handbook* aims to provide readers with a practically based introduction to this subject. The book will prove invaluable to anyone involved with the design, manufacture or servicing of digital circuitry, as well as to those wishing to update their knowledge of modern digital devices and techniques. Contents: Introduction to integrated circuits; basic logic gates; monostable and bistable devices; timers; microprocessors; memories; input and output devices; interfaces; microprocessor buses. Appendix 1: Data. Appendix 2: Digital test gear projects; tools and test equipment; regulated bench power supply; logic probe; logic pulser; versatile pulse generator; digital IC tester; current tracer; audio logic tracer; RS-232C breakout box; versatile digital counter/frequency meter. Appendix 3: The oscilloscope. Appendix 4: Suggested reading. Appendix 5: Further study.  
 208 pages Order code PC100 £6.95

COMPUTING

**NEWNES COMPUTER ENGINEER'S POCKETBOOK (Second Edition)**  
**Michael Tooley**  
 An invaluable compendium of facts, figures, circuits and data, indispensable to the designer, student, service engineer and all those interested in computer and microcomputer systems. It will appeal equally to the hardware or software specialist and to the new band of "software engineers". This first edition covers a vast range of subjects at a practical level, with the necessary explanatory text. The data is presented in a succinct and rapidly accessible form so that the book can become part of an everyday toolkit.  
 205 pages (hard cover) Order code NE01 £9.95

**AN INTRODUCTION TO Z80 MACHINE CODE**  
**R. A. & J. W. Penfold**  
 Takes the reader through the basics of microprocessors and machine code programming with no previous knowledge of these being assumed. The Z80 is used in many popular home computers and simple programming examples are given for Z80-based machines including the Sinclair ZX-81 and Spectrum, Memotech and the Amstrad CPC 464. Also applicable to the Amstrad CPC 664 and 6128.  
 144 pages Order code BP152 £2.75

**A Z80 WORKSHOP MANUAL**  
**E. A. Parr, B.Sc., C.Eng., M.I.E.E.**  
 This book is intended for people who wish to progress beyond the stage of BASIC programming to topics such as machine code and assembly language programming, or need hardware details of a Z80 based computer.  
 192 pages Order Code BP112 £3.50

**COMPUTERS AND MUSIC — AN INTRODUCTION**  
**R.A. Penfold**  
 Computers are playing an increasingly important part in the world of music, and the days when computerised music was strictly for the fanatical few are long gone. Computer-based music systems in the past have tended to be either horrendously expensive, very crude, or both! These days, prices are much more modest and the potential of the equipment is much greater. Consequently a lot of musicians are being tempted into the unfamiliar territory of computer music systems.  
 If you are more used to the black and white keys of a synth keyboard than the QWERTY keyboard of a computer, you may be understandably confused by the jargon and terminology bandied about by computer buffs. But fear not, setting up and using a computer-based music making system is not as difficult as you might think.  
 This book will help you learn the basics of computing, running applications programs, wiring up a MIDI system and using the system to good effect. In fact just about everything you need to know about hardware and the programs, with no previous knowledge of computing needed or assumed. This book will help you to choose the right components for a system to suit your personal needs, and equip you to exploit that system fully.  
 174 pages Order code PC107 £7.95

**GETTING THE MOST FROM YOUR PRINTER**  
**J. W. Penfold**  
 Details how to use all the features provided on most dot-matrix printers from programs and popular word processor packages like Wordwise, Visawrite and Quill, etc. Shows exactly what must be typed in to achieve a given effect.  
 96 pages Order Code BP181 £2.95

**A CONCISE INTRODUCTION TO MS-DOS**  
**N. Kantaris**  
 This guide is written with the non-expert, busy person in mind and, as such, it has an underlying structure based on "what you need to know first, appears first". Nonetheless, the guide is also designed to be circular, which means that you don't have to start at the beginning and go to the end. The more experienced user can start from any section.  
 The guide covers versions 3.0, 3.1 and 3.2 of both PC-DOS and MS-DOS as implemented by IBM and other manufacturers of "compatible" microcomputers, including the AMSTRAD PC's. It covers both floppy disc-based systems and hard disc-based systems.  
 64 pages Order code BP232 £2.95

**AN INTRODUCTION TO 68000 ASSEMBLY LANGUAGE**  
**R. A. & J. W. Penfold**  
 Obtain a vast increase in running speed by writing programs for 68000 based micros such as the Commodore Amiga, Atari ST range or Apple Macintosh range etc., in assembly language. It is not as difficult as one might think and this book covers the fundamentals.  
 112 pages Order code BP184 £2.95

**THE ART OF PROGRAMMING THE ZX SPECTRUM**  
**M. James, B.Sc., M.B.C.S.**  
 It is one thing to have learnt how to use all the Spectrum's commands and functions, but a very different one to be able to combine them into programs that do exactly what you want them to. This is just what this book is all about—teaching you the art of effective programming with your Spectrum.  
 144 pages Order code BP119 £2.50

**BEGINNER'S GUIDE TO HI-FI**

Ian Sinclair

The *Beginner's Guide to Hi-Fi* will appeal to the audio enthusiast, whether newly won over by advances in technology or well established and wondering whether to update equipment. The book deals with the sound from its sources in the studio to its ultimate end in your ears, and shows what sound is, how it is recorded and how it is reproduced.

Every aspect of HI-FI, from pickup cartridges to loudspeakers, has been covered, and the emphasis has been on explaining design aims. Cassette systems have been given considerable prominence, including the more modern Dolby C and dbx noise reduction systems. The CD record has been covered in detail so that you can find out just why this system of sound reproduction is so superior.

194 pages

Temporarily out of print.

**DATA & COMPONENT IDENTIFICATION**

**HOW TO IDENTIFY UNMARKED ICs**

K. H. Recorr

Shows the reader how, with just a test-meter, to go about recording the particular signature of an unmarked i.c., which should enable the i.c. to then be identified with reference to manufacturers' or other data. An i.c. signature is a specially plotted chart produced by measuring the resistances between all terminal pairs of an i.c.

Chart

Order code BP101

£0.95

**INTERNATIONAL DIODE EQUIVALENTS GUIDE**

A. Michaels

Designed to help the user in finding possible substitutes for a large selection of the many different types of diodes that are available. Besides simple rectifier diodes, also included are Zener diodes, i.e.d.s, diacs, triacs, thyristors, OCIs, photo and display diodes.

144 pages

Temporarily out of print

**LINEAR IC EQUIVALENTS AND PIN CONNECTIONS**

A. Michaels

Shows equivalents and pin connections of a popular selection of European, American and Japanese linear i.c.s. Also includes details of functions, manufacturer and country of origin.

320 pages

Temporarily out of print

**RADIO AND ELECTRONIC COLOUR CODES AND DATA CHART**

B. B. Babani

Although this chart was first published in 1971 it provides basic information on many colour codes in use throughout the world, for most radio and electronic components. Includes resistors, capacitors, transformers, field coils, fuses, battery leads, speakers, etc. It is particularly useful for finding the values of old components.

Chart

Order code BP7

£0.95

**AN INTRODUCTION TO LOUDSPEAKERS AND ENCLOSURE DESIGN**

V. Capel

This book explores the various features, good points and snags of speaker designs. It examines the whys and wherefores so that the reader can understand the principles involved and so make an informed choice of design, or even design loudspeaker enclosures for him or herself. Crossover units are also explained, the various types, how they work, the distortions they produce and how to avoid them. Finally there is a step-by-step description of the construction of the *Kapellmeister* loudspeaker enclosure.

148 pages

Order Code BP256

£2.95

**MUSICAL APPLICATIONS OF THE ATARI ST's**

R. A. Penfold

The Atari ST's are now firmly established as the computers to use for electronic music applications. The range and sophistication of these applications are much greater than most people may realise, but there are still a lot of misconceptions about just what can and cannot be achieved. This book will help you sort out the fact from the fallacy and to get the most musically from the ST's.

A wide selection of topics are covered, including the internal sound chip; MIDI; applications programs such as sequencing and score writing, etc; simple but useful add-on projects and MIDI programming.

90 pages

Order code BP246

£5.95

**TESTING & TEST GEAR**

**TRANSISTOR RADIO FAULT-FINDING CHART**

C. E. Miller

Used properly, should enable the reader to trace most common faults reasonably quickly. Across the top of the chart will be found four rectangles containing brief description of these faults, viz—sound weak but undistorted, set dead, sound low or distorted and background noises. One then selects the most appropriate of these and following the arrows, carries out the suggested checks in sequence until the fault is cleared.

Chart

Order code BP70

£0.95

**HOW TO USE OSCILLOSCOPES AND OTHER TEST EQUIPMENT**

R. A. Penfold

You no longer need to be a millionaire in order to afford signal generators, digital measuring equipment, or an oscilloscope having a fair specification! But how do you set about using such equipment? Not all test equipment is simple, and oscilloscopes in particular tend to have vast numbers of knobs and switches. These can be a bit daunting for the uninitiated, but mastering a workshop oscilloscope is not really too difficult.

This book explains the basic function of an oscilloscope, gives a detailed explanation of all the standard controls, and provides advice on buying. A separate chapter deals with using an oscilloscope for fault finding on linear and logic circuits. Plenty of example waveforms help to illustrate the control functions and the effects of various fault conditions. The function and use of various other pieces of test equipment are also covered, including signal generators, logic probes, logic pulsers, and crystal calibrators.

104 pages

Order code BP267

£3.50

**NEW**

**PRACTICAL MIDI HANDBOOK**

R.A. Penfold

The Musical Instrument Digital Interface (MIDI) is surrounded by a great deal of misunderstanding, and many of the user manuals that accompany MIDI equipment are quite incomprehensible to the reader.

The Practical MIDI Handbook is aimed primarily at musicians, enthusiasts and technicians who want to exploit the vast capabilities of MIDI, but who have no previous knowledge of electronics or computing. The majority of the book is devoted to an explanation of what MIDI can do and how to exploit it to the full, with practical advice on connecting up a MIDI system and getting it to work, as well as deciphering the technical information in those equipment manuals.

128 pages

Order code PC101

£5.95

**COMPUTERS AND MUSIC**

— see computer section

**DIRECT BOOK SERVICE**

(A Division of Wimborne Publishing Ltd.)

**TO ORDER**

Please state the title and order code clearly, print your name and address and add the required postage to the total order.

Add 75p to your total order for postage and packing (overseas readers add £1.50 for countries in Europe, or add £2.00 for all countries outside Europe, surface mail postage) and send a PO, cheque or international money order (£ sterling only) made payable to *Direct Book Service* quoting your name and address, the order code and quantities required to **DIRECT BOOK SERVICE, 33 GRAVEL HILL, MERLEY, WIMBORNE, DORSET, BH21 1RW** (mail order only).

See next month's issue for another three page selection of books.

Although books are normally sent within seven days of receipt of your order, please allow a maximum of 28 days for delivery. Overseas readers allow extra time for surface mail post.

Please check price and availability (see latest issue of *Everyday Electronics*) before ordering from old lists.

Note — our postage charge is the same for one book or one hundred books!

**MORE BOOKS NEXT MONTH**



**RADIO, TV, SATELLITE**

**AN INTRODUCTION TO AMATEUR RADIO**

I.D. Poole

Amateur radio is a unique and fascinating hobby which has attracted thousands of people since it began at the turn of the century.

This book gives the newcomer a comprehensive and easy to understand guide through the subject so that the reader can gain the most from the hobby. It then remains an essential reference volume to be used time and again. Topics covered include the basic aspects of the hobby, such as operating procedures, jargon and setting up a station. Technical topics covered include propagation, receivers, transmitters and aerials etc.

150 pages

Order code BP257

£3.50

**INTERNATIONAL RADIO STATIONS GUIDE**

P. Shore

Provides the casual listener, amateur radio DXer and the professional radio monitor with an essential reference work designed to guide him or her around the ever more complex radio bands. This new edition has been completely revised and rewritten and incorporates much more information which is divided into the following sections:

Listening to Short Wave Radio; ITU Country Codes; World-wide Short Wave Radio Stations; European, Middle East and North African Long Wave Radio Stations; European, Near East and North African Medium Wave Radio Stations; Canadian Medium Wave Radio Stations; USA Medium Wave Radio Stations; Broadcasts in English; Programmes for DXers and Short Wave Listeners; UK FM Radio Stations; Time differences from GMT; Abbreviations; Wavelength/Frequency Conversion.

320 pages

Order code BP255

£4.95

**AERIAL PROJECTS**

R. A. Penfold

The subject of aerials is vast but in this book the author has considered practical aerial designs, including active, loop and ferrite aerials which give good performances and are relatively simple and inexpensive to build. The

complex theory and mathematics of aerial design have been avoided.

Also included are constructional details of a number of aerial accessories including a pre-selector, attenuator, filters and tuning unit.

96 pages

Order code BP105

£2.50

**AN INTRODUCTION TO SATELLITE TELEVISION**

F.A. Wilson

As a definitive introduction to the subject this book is presented on two levels. For the absolute beginner or anyone thinking about purchasing or hiring a satellite TV system, the story is told as simply as such a complex one can be in the main text.

For the professional engineer, electronics enthusiast, student or others with technical backgrounds, there are numerous appendices backing up the main text with additional technical and scientific detail formulae, calculations, tables etc.

There is also plenty for the DIY enthusiast with practical advice on choosing and installing the most problematic part of the system—the dish antenna.

104 pages

Order Code BP195

£5.95

**COMMUNICATION**

F. A. Wilson, C.G.I.A., C.Eng., F.I.E.E., F.I.E.R.E., F.B.I.M.

A look at the electronic fundamentals over the whole of the communication scene. This book aims to teach the important elements of each branch of the subject in a style as interesting and practical as possible. While not getting involved in the more complicated theory and mathematics, most of the modern transmission system techniques are examined including line, microwaves, submarine, satellite and digital multiplex systems, radio and telegraphy. To assist in understanding these more thoroughly, chapters on signal processing, the electromagnetic wave, networks and transmissions assessment are included, finally a short chapter on optical transmission.

256 pages

Order Code BP89

£2.95

## THE DREAM MACHINE ▷

Adjust the controls to suit your mood and let the gentle, relaxing sound drift over you. At first you might hear soft rain, sea surf, or the wind through distant trees. Almost hypnotic, the sound draws you irresistibly into a deep, refreshing sleep.

For many the thought of waking refreshed and alert from perhaps the first truly restful sleep in years is exciting enough in itself. For more adventurous souls there are strange and mysterious dream experiences waiting. Take lucid dreams, for instance, imagine being in control of your dreams and able to act out your most secret wishes and fantasies. With the Dream Machine anything is possible.

**DREAM MACHINE PARTS SET £22.77**

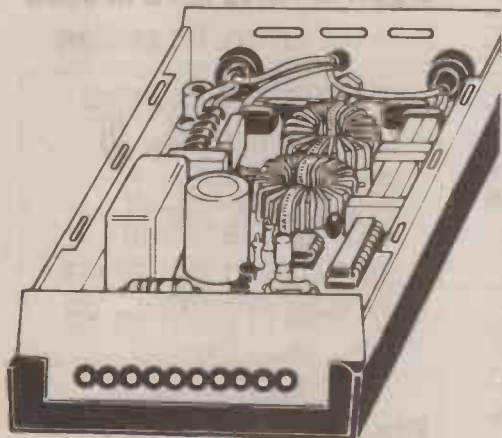
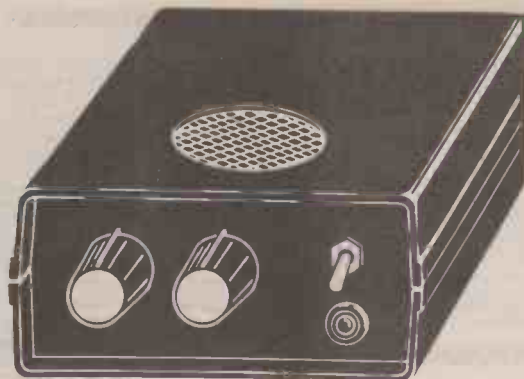

## ▷ POWER CONDITIONER

You don't have to be a hi-fi nut to notice the huge improvement in sound quality when you run your music system from a clean mains supply. How do you describe the difference? It's as if all this time your favourite artists have been playing and singing inside a wardrobe... and someone just opened the door and let them out. You could spend twenty times as much on special cables, plugs, mats and stuff without achieving a tenth of the difference. But don't take my word for it. Try it for yourself.

The sophisticated circuitry of the Power Conditioner begins with a bank of six VDRs to eliminate impulsive spikes. Then comes a massive filter with thirteen capacitors and two current-balanced inductors to smooth away every trace of noise and interference. A ten LED logarithmic display flicks up and down as each spike is eliminated, and gives a second by second account of the interference removed. Maximum load 1.5kW.

**POWER CONDITIONER PARTS SET £34.27**

## MAINS CONDITIONER ▷

A general purpose workhorse for cleaning up the mains supply to computers, hi-fi, television sets, and any other electronic equipment that might be disturbed by mains interference. The solid, no-nonsense circuit will handle loads up to 1kW, and the PCB can be built into the equipment to be protected or housed in the optional case.

**MAINS CONDITIONER PARTS SET (no case) £6.21**

**RUGGED CASE (optional) £2.07**

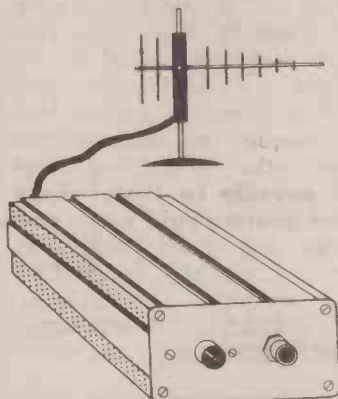
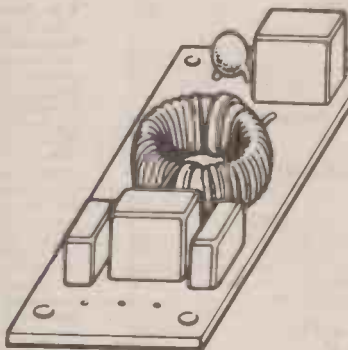

## ▷ AERIAL BOOSTER

Good TV pictures from an indoor aerial, from a caravan aerial, or in areas of poor reception. This booster ranks with the very best, giving wideband operation from 10MHz to 1.4GHz (it will boost FM radio signals too), mid-band gain of up to 26dB, and a wide supply voltage range of 9V to 26V. It will run from car batteries for caravanners, dry batteries for campers, or a battery eliminator for use in the home.

There are two parts sets for the project. AA1 gives you the PCB, hybrid amplifier, components and instructions. AA2 is the optional case set: rugged screened box, front and rear panels, waterproofing gaskets, feet, sockets and hardware.

**AA1 PARTS SET £14.72 AA2 PARTS SET £5.52**

## KNIGHT RAIDER ▷

The ultimate lighting effect for your car. Picture this: eight powerful lights in line along the front and eight along the rear. You flick a switch on the dashboard control box and a point of light moves lazily from left to right leaving a comet's tail behind it. Flip another switch and the point becomes a bar, bouncing backwards and forwards along the row. Now try one of the other six patterns. An LED display on the console lets you see what the main lights are doing.

The Knight Raider parts set contains the case and all components for the control box. The pattern generator and lamp driver is supplied as a PCB with all components for you to mount anywhere convenient. We supply the electronics, you supply the lamps (from any car accessories shop).

**KNIGHT RAIDER PARTS SET £28.52**



*Specialist*  
**SEMICONDUCTORS**

Tel: (0600) 3715

LIMITED

SALES DEPT., ROOM 111, FOUNDERS HOUSE, REDBROOK, MONMOUTH, GWENT.

### ORDERING

All prices include VAT  
UK orders: please add £1.15 postage and packing.  
Eire and overseas: please deduct VAT and add  
£5.00 carriage and insurance.



### ACCESS

Phone 0600 3715 for immediate  
attention to your Access order.

287

# PCB SERVICE

Printed circuit boards for certain constructional projects are available from the PCB Service, see list. These are fabricated in glass fibre, and are fully drilled and roller tinned. All prices include VAT and postage and packing. Add £1 per board for overseas airmail. Remittances should be sent to **The PCB Service Everyday Electronics, 6 Church Street, Wimborne, Dorset BH21 1JH.** Cheques should be crossed and made payable to **Everday Electronics (Payment in £ sterling only).**

*Boards for some older projects – not listed here – can often be obtained from Magenta Electronics, 135 Hunter St., Burton-on-Trent, Staffs DE14 2ST. Tel: 0283 65435 or Lake Electronics, 7 Middleton Close, Nuthall, Nottingham NG16 1BX. Tel: 0602 382509.*

**NOTE:** While 90% of our boards are now held in stock and are dispatched within seven days of receipt of order, please allow a maximum of 28 days for delivery – overseas readers allow extra if ordered by surface mail. Please check price and availability in the latest issue before ordering. We can only supply boards listed in the latest issue. Boards can only be supplied on a payment with order basis.

PROJECT TITLE	Order Code	Cost
Video Guard	FEB '87 556	£3.80
Spectrum I/O	557	£5.35
Computer Buffer/Interface	MAR '87 560	£3.32
Bulb Life Extender	APR '87 564	£3.00
Fridge Alarm	MAY '87 565	£3.00
Mini Disco Light	JUNE '87 567	£3.00
EE Buccaneer Metal Detector	JULY '87 570	£4.10
Monomix	571	£4.75
Noise Gate	SEPT '87 577	£4.41
Electronic Analogue/Digital Multimeter	579	£6.40
Transtest	OCT '87 580	£3.32
Accented Metronome	NOV '87 582	£3.77
BBC Sideways RAM/ROM	585	£4.10
Twinkling Star	DEC '87 588	£3.00
Audio Sine Wave Generator	589	£3.03
Capacitance Meter	JAN '88 590	£4.10
Transistor Curve Tracer	592	£3.00
Bench Power Supply Unit	FEB '88 593	£4.01
Game Timer	583	£3.55
Semiconductor Tester	MAR '88 594	£3.19
SOS Alert	595	£3.00
Guitar/Keyboard Envelope Shaper	596	£4.23
Stereo Noise Gate	APR '88 597	£6.65
Pipe & Cable Locator	598	£3.00
Inductive Proximity Detector	574	£3.00
Multi-Chan Remote Light Dim	MAY '88 599	£3.00
Transmitter	600	£3.07
Receiver	605	£3.00
Door Sentinel	606	£5.91
Function Generator – Main Board	607	£4.19
Function Generator – Power Supply		
Multi-Chan Remote Light Dim	JUNE '88 601	£4.86
Relay/Decoder	602	£3.07
Dimmer Board	603	£3.00
Power Supply	604	£7.76
Mother Board	611	£3.00
Headlight Reminder		
Video Wiper	JULY '88 612	£6.75
Isolink	613	£4.21
Tea Tune	AUG '88 609	£3.00
Time Switch	614	£4.84
Suntan Timer	610	£3.07
Car Alarm	615	£3.12
Breaking Glass Alarm	SEPT '88 617	£4.27
Amstrad PIO	618	£6.77
Eprom Eraser	OCT '88 620	£4.07
Doorbell Delay	NOV '88 616	£3.56
Micro Alarm	621	£3.12
Infra-Red Object Counter Trans	622	£4.61
Receiver	623	£3.23
Display	624	£3.05
Seashell Sea Synthesiser	625	£4.84

Reaction Timer Main Board	DEC '88 626	£3.46
Display Board	627	£3.00
Downbeat Metronome	629	£4.84
EPROM Programmer (On Spec)	630	£8.29
Phasor	631	£5.64
Monkey/Hunter Game	JAN '89 634	£3.36
Continuity Tester	FEB '89 619	£2.67
4-Channel Light Dimmer	635	£7.67
Mini PSU	636	£3.23
Sound-to-Light Interface	MAR '89 637	£6.24
Midi Pedal	639	£7.00
Midi Merge	640	£3.00
Audio Lead Tester	641	£5.77
Light Sentinel	APR '89 632	£9.20
Main Control Board	633	£4.59
Remote Interface (4 boards)	638	£6.64
Electron User Port	642	£6.80
4-Channel Auto-Fader Interface		
Pet Scarer	MAY '89 644	£3.00
Electron A/D Interface	645	£4.84
Spectrum EPROM Programmer	JUNE '89 628	£7.87
Bat Detector	647	£4.95
Programmable Pocket Timer	JULY '89 648	£3.82
Electronic Spirit Level	AUG '89 649	£3.85
Distance Recorder	651	£5.23
Treasure Hunter	652	£3.73
Xenon Beacon	SEPT '89 650	£4.13
Probe Pocket Treasure Finder	653	£4.12
Power Supplies { – Fixed Voltage	654	£4.08
{ – Variable Voltage	655	£4.48
Music on Hold	OCT '89 646	£3.85
Power Supplies – 25V 700mA	656	£4.35
– 30V 1A	657	£4.55
EE Seismograph – Control	658	£4.08
– Detector	659	£4.22
Logo/Logo & Spectrum	660	£6.49
Wash Pro	NOV '89 643	£3.83
Biofeedback Monitor – Front End	661	£4.52
– Processor	662	£4.56
Power Supplies – 1.5V–25V 2A	663	£4.78
Logo/Logo & Spectrum Interface	664	£5.60
EEG Electrode Impedance Meter	DEC '89 665	£3.98
Biofeedback Signal Generator	JAN '90 666	£4.08
Four-Channel Light Chaser	667	£6.70
Quick Cap Tester	FEB '90 668	£3.92
Weather Station		
Anemometer – Freq/Volt Board	670	£3.94
– Optional Display	669	£3.73
Wind Direction	673/674	£4.22
System Power Supply	675	£3.59
Prophet In-Car Ioniser	676	£3.18
EE Weather Station	MAR '90 671	£4.47
Display Driver	672 & 678	£4.22
Display & Sensor Boards	677	£4.28
Fermostat Mk2		
Superhet Broadcast Receiver	679/680	£4.22
Tuner/Audio Amp		
Stereo Noise Generator	APR '90 681	£4.24
Digital Experimenter's Unit		
Pulse Generator	682	£4.46
Power Supply	683	£3.66
Enlarger Timer	684	£4.28
EE Weather Station		
Rainfall/Sunlight Display	685	£4.27
Rainfall Sen(687)/Sunlight Sen(686)	686/687	£4.16

Please note it is important to give project title as well as order code.

## EE PRINTED CIRCUIT BOARD SERVICE

Please send me the following p.c.b.s.

Order Code	Project	Quantity	Price
.....	.....	.....	.....
.....	.....	.....	.....

I enclose cheque/PO for £.....

Name.....

Address.....

Please allow 28 days for delivery (see note above)

BLOCK CAPITALS PLEASE

### VARIABLE VOLTAGE TRANSFORMERS

INPUT 220/240V AC 50/60 OUTPUT 0-260V  
 200V 0.1 amp max £24.00 p&p £3.00 (£31.05 inc VAT)  
 0.5KVA 2.5 amp max £26.50 £3.75 (£34.75 inc VAT)  
 1KVA 5 amp max £34.00 £4.25 (£43.99 inc VAT)  
 2KVA 10 amp max £49.00 £5.50 (£62.68 inc VAT)  
 3KVA 15 amp max £65.00 £6.25 (£81.94 inc VAT)  
 5KVA 25 amp max £115.00  
 Carriage on request



**VOLTAGE CHANGING TRANSFORMER**  
 1250 Watt auto. Tapped 0-90V, 100, 110, 115, 120, twice to obtain voltages between 90 and 240V. Fitted in heavy duty louvered metal case. Fused input. Price incl VAT & p&p £39.50.

**COMPREHENSIVE RANGE OF TRANSFORMERS-LT. ISOLATION & AUTO (110-240V)** Auto transfer either cased with American socket and mains lead or open frame type. Available for immediate delivery.

**ULTRA VIOLET BLACK LIGHT FLUORESCENT TUBES**  
 4ft 40 watt £10.44 (£12.00 inc VAT) Caller only  
 2ft 20 watt £7.44 + £1.25 p&p (£9.99 inc VAT)  
 13in 10 watt £5.80 + 75p p&p (£6.39 inc VAT)  
 12in 8 watt £4.80 + 75p p&p (£5.12 inc VAT)  
 9in 6 watt £3.96 + 50p p&p (£4.32 inc VAT)  
 6in 4 watt £3.96 + 50p p&p (£4.32 inc VAT)

**230V AC BALLAST KIT** for either 6in, 9in or 12in tubes £5.50 + 55p p&p (£6.96 inc VAT)  
 For 13in tubes £6.00 + 75p p&p (£7.75 inc VAT)



**400 WATT UV LAMP**

Only £34.00 + £2.50 p&p (£41.98 inc VAT)  
**175 WATT SELF BALLASTED BLACK LIGHT MERCURY BULBS** Available with BC or ES fitting. Price incl VAT & p&p £19.84.



### 12 VOLT BILGE PUMPS

Buy direct from the importers  
 500 GPH 15ft head 3 amp £16.00 inc.  
 1750 GPH 15ft head 9 amp £20.18 + £2.00 p&p (£25.50 inc VAT)  
**EPROM ERASURE KIT**

Build your own EPROM ERASURE for a fraction of the price of a made-up unit kit of parts less case includes 12in 8 watt 2537 Angstrom Tube Ballast unit pair of bi-pin leads neon indicator on/off switch safety microswitch and circuit £14.00 + £2.00 p&p (£18.40 inc VAT)

### SUPER HY-LIGHT STROBE KIT

Designed for Disco, Theatrical users etc. Approx 16 Joules. Adjustable speed £48.00 + £2.00 p&p (£57.50 inc VAT)

Case and reflector £22.00 + £2.00 p&p (£27.60 inc VAT)  
 SAE for further details including Hy-Light and industrial Strobe Kits

Ample Parking Space  
 Showroom open Monday/Friday

## SERVICE TRADING CO

57 BRIDGMAN ROAD, CHISWICK, LONDON W4 5BB  
 01-995 1560  
 ACCOUNT CUSTOMERS MIN. ORDER £10



### WIDE RANGE OF XENON FLASH TUBES

Write/Phone your enquiries

**EXTENSIVE RANGE OF DIFFERENT TYPES OF GEARED MOTORS AVAILABLE FROM STOCK**

### WASHING MACHINE WATER PUMP

Brand new 240V AC fan cooled can be used for a variety of purposes. Inlets 1 1/2 ins. Outlet 1 inch. Price including p&p and VAT — £10.95 or 2 for £20 including p&p and VAT.

### SPECIAL OFFER AC CAPACITORS

1.5 MFD 440V £2.00 5 MFD 440V £4.00  
 2 MFD 440V £2.50 5.4 MFD 280V £2.00  
 4.1 MFD 440V £3.50 5 MFD 660V £3.00  
 12 MFD 400V £4.00  
 p+p 50p per unit plus VAT to be added to total.

### TORIN CENTRIFUGAL BLOWER

230V ac 2,900 RPM 0.9amp 130mm diameter impeller outlet 63 x 37mm overall size 195 x 160 x 150mm long Price £17.50 + £2.50 p&p (£23 inc. VAT)

### SHADED POLE GEAR MOTORS

In the following sizes:  
 9 RPM 12 RPM 80 RPM 160 RPM 110V AC or 240V AC with capacitors (supplied). Price incl VAT & p&p £12.85

### GEARED MOTORS

71 RPM 20lb inch torque reversible 115V AC input including capacitor and transformer for 240V AC operation. Price incl VAT & p&p £23.00.

### SOLID STATE EHT UNIT

Input 230/240V AC, Output approx 15KV. Producing 10mm spark. Built-in 10 sec timer. Easily modified for 20 sec, 30 sec to continuous. Designed for boiler ignition. Dozens of uses in the field of physics and electronics, eg supplying neon or argon tubes etc. Price less case £8.50 + £1.00 p&p (£10.99 inc VAT) NMS

### HEAVY DUTY MOTOR

Crouzet 115V/230V A.C. heavy duty 1RPM motor. Anticlockwise type 82015. Size 68mm diameter x 65mm long. Shaft 6mm diameter x 20mm long Price inc. VAT & p&p £18.40

### RHEOSTAT

50W 2ohm 5amp ceramic power rheostat. Price inc. VAT & p&p £10.35

### MICROSWITCH

Pye 15 amp changeover lever microswitch, type S171. Brand new. Price 5 for £6.90 inc. VAT & p&p.

### From stock at prices that defy competition

C/F Blowers Program Timers  
 Microswitches Synch Motors  
 write/phone your enquiries

NMS = NEW MANUF SURPLUS  
 R&T = RECONDITIONED AND TESTED

# SURVEILLANCE PROFESSIONAL QUALITY KITS

A range of high quality kits as supplied to leading UK security companies, all in-house designed and produced, not to be confused with cheap imports. All kits come fully documented with concise assembly and setting-up details, fibreglass PCB and all components. All transmitters are fully tuneable and can be monitored on a normal VHF radio or tuned higher for greater security. Build up service available if required.

- MTX. Micro-miniature audio transmitter. 17mm x 17mm. 9V operation. 1000m range ..... £12.95
- VT500. Hi-power-audio transmitter. 250mW output. 20mm x 40mm 9-12V operation. 2-3000m range ..... £15.95
- VOX75. Voice activated transmitter. Variable sensitivity. 30mm x 40mm. 9V operation. 1000m range ..... £18.95
- CTX900. Sub-carrier scrambled audio transmitter. Cannot be monitored without decoder fitted to radio. 30mm x 40mm. 9V operation. 1000m range ..... £21.95
- DSX900. Sub-carrier decoder unit for monitoring CTX900. Connects to radio earphone socket. Provides output for headphones. 35mm x 50mm. 9-12V operation ..... £21.95
- HVX400. Mains powered audio transmitter. Connects directly to 240V AC supply. 30mm x 35mm. 500m range ..... £18.95
- TR89. Crystal controlled audio transmitter. High performance. 100mW output. Supplied with xtal for 108MHz. Others available to 116MHz. 85mm x 28mm. 9V operation. 2-3000m range ..... £36.95
- TKX900. Tracker/Beeper transmitter. Transmits continuous stream of audio pulses. Variable tone and rate. Powerful 200mW output. 63mm x 25mm. 9V operation. 2-3000m range ..... £21.95
- ATR2. Micro size telephone recording interface. Connects between telephone line (anywhere) and cassette recorder. Tape switches automatically with use of phone. All conversations recorded. Powered from line 10mm x 35mm ..... £12.95
- TLX700. Micro miniature telephone transmitter. Connects to line (anywhere) switches on and off with phone use. All conversations transmitted. 20mm x 20mm. Powered from line 1000m range ..... £12.95
- XML900. RF bug detector. Variable sensitivity. Triggers LED and beeper when in presence of RF field. Detects MTX 15-20 feet. 55mm x 55mm. 9V operation ..... £26.95
- XL7000. Professional bug detector/locator. Variable sensitivity. Twin mode ten segment LED readout of signal strength with variable rate beeper. Second mode AUDIO CONFIRM distinguishes between localised bug transmission and normal legitimate signal such as pagers, cellular etc. 70mm x 100mm. 9V operation ..... £54.95

UK customers please send cheques, PO's or registered cash. Please add £1.50 per order for P&P. Goods despatched ASAP allowing for cheque clearance. Overseas customers send sterling bank draft or Eurocheque and add £5.00 per order for shipment. Credit card orders accepted on 0827 714476. Trade enquiries welcome.

Send 28p stamp for New 1990 Full Catalogue



The Workshops, 95 Main Rd  
 Baxterley, Nr. Atherstone  
 Warks CV9 2LE



0827 714476

## electronize Car Electronics

### MICRO-PRESSURE CAR ALARM

This new type of alarm is triggered by a unique pressure sensing system. As any vehicle door is opened, air is drawn out, causing a minute drop in air pressure. A sensor detects this sudden pressure change and sets off the alarm.

A sophisticated arrangement of electronic filters and timers provide features to match ultra-sonic systems but at a fraction of the cost.

- ☆ 1 Micro-Pressure intruder detection.
- ☆ 2 Operates on all doors and tailgate.
- ☆ 3 No door switches needed.
- ☆ 4 Automatically armed 1 minute after leaving vehicle.
- ☆ 5 10 second entry delay with audible warning.
- ☆ 6 Sounds horn intermittently for 1 minute.
- ☆ 7 Easy fitting - only 3 wires to connect - no holes to drill.
- ☆ 8 Compact design can be hidden below dashboard.
- ☆ 9 All solid state Power MOSFET output - on relays.

MICRO-PRESSURE ALARM KIT £12.95  
 ASSEMBLED READY TO FIT £18.95

### VOLT DROP CAR ALARM

Our latest alarm using the popular voltage drop method of triggering. Based on the timers of the micro-pressure alarm it offers features 4 to 9 above but relies on the existing door switch operation for triggering.

VOLT DROP ALARM KIT £11.75  
 ASSEMBLED READY TO FIT £17.75

### TOTAL ENERGY DISCHARGE IGNITION

Our long established Extended CDI system retains the contacts to allow easy fitting whilst the electronics removes the adverse effects. The unique spark generating system still out performs the latest all electronic systems.

TOTAL ENERGY DISCHARGE IGNITION £18.95  
 ASSEMBLED READY TO FIT £24.90

All Electronize kits include clear, easy to follow instructions, quality components and everything needed, right down to solder and heatsink compound.

Order direct (Please quote Ref. C05 and add £1 post and packing per item.)  
 or send for more details from:-

**ELECTRONIZE DESIGN** tel. 021 308 5877  
 2 Hillside Road, Four Oaks, Sutton Coldfield, B74 4DQ

When you need

# COMPONENTS

(C.W.O. Post Free U.K.)

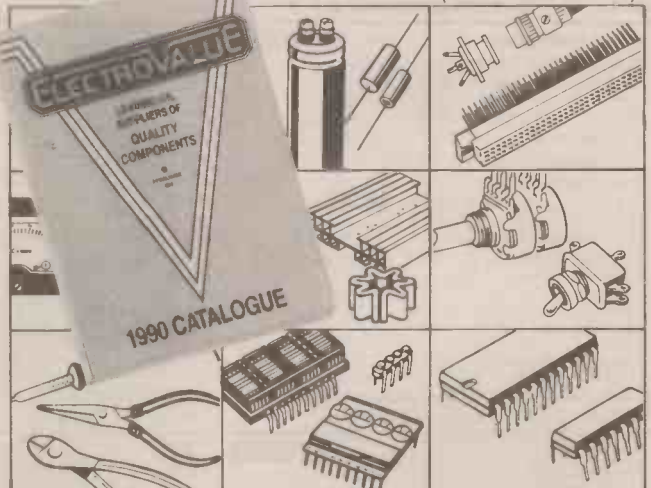

You need



for FREE CATALOGUE write phone or call

ELECTROVALUE LTD, FREEPOST, 28b St. Jude's Rd., Englefield Green, Egham, Surrey TW20 8BR  
 (No stamp required). Phone 0784 433 603. Fax 0784 435 216. Telex 264475.  
 Shop hours 9.0-5.30pm (Sat. 9.0-1.0pm)

NORTHERN BRANCH 680 Burnage Lane, Manchester M19 1NA. Phone 061-432 4945. Fax 061-432 4127.

The prepaid rate for semi-display space is £8.00 (plus VAT) per single column centimetre (minimum 2.5cm). The prepaid rate for classified advertisements is 30 pence (plus VAT) per word (minimum 12 words).

All cheques, postal orders, etc., to be made payable to Everyday Electronics. VAT must be added. Advertisements, together with remittance, should be sent to the Classified Advertisement Dept., Everyday Electronics, 6 Church Street, Wimborne, Dorset BH21 1JH. Tel: (0202) 881749.

### Kits

**FM MICRO TRANSMITTER KITS** 20mm x 28mm. £2.99 inc p&p. Cheques/PO to Minral, 39 Parkside, Orrell, Wigan, WN5 8LU.

**KITS.** Microtransmitter, VHF/FM, 14x25mm, including free microphone, £4.50. VHF/FM bleeper tracking transmitter, £7.99. Voice operated switch, £8.99. Telephone transmitter, VHF/FM, £4.99. Automatic telephone recording switch, £7.99. SAE list. ACE(EE). 99 Greenheath, Hednesford, Staffs. Access orders 05438 71902 (24 hrs).

**G.C.S.E. ELECTRONICS KITS.** Ten different £10.50 (+70p, p&p) or SAE for details. **SIR-KIT ELECTRONICS**, 70 Oxford Road, Clacton CO15 3TE.

**KITS! F.M.** £11.81, with P.A., £15.91. M.W. £18.90 inclusive. Payable to D. Davies, 33 Gwalodgyarth, Merthyr Tydfil, CF47 8YU.

### Miscellaneous

**PROTOTYPE PRINTED CIRCUIT BOARDS** one offs and quantities, for details send s.a.e. to B.M.A. Circuits, 38 Poynings Drive, Sussex BN3 8GR, or phone Brighton 720203.

**FOR SALE** Jackson NiCad battery chargers. Output d.c. 2-4V and 9V. £5.25 inc p&p. A.C.W. Computer Repairs, 2 Forge Cottages, High Street, Ewelme, Wallingford, Oxon OX10 6HQ.

**KIA** Easterfantastic freebie. Diodes, transistors, R&C giftpack plus audio wallchart! Return ad plus £1 p&p. 8 Cunliffe Road, Ilkley LS29 9EA.

**120 WATT** Stereoamps £12 inc case, sockets, controls. 4x2N3055 output and glass/PCB. 8 Cunliffe Road, Ilkley LS29 9EA.

**FOR SALE.** Robot 400 S.S.T.V. rx/tx, £300. Also Robot 800 S.S.T.V. c.w., ascii, rtty terminal £200. Both perfect, buyer collects. Ring Dave, 021-552 7560.

**TUNNEL DIODES**, 10mA, 270ps, £3.50; 60ps £5.50. 24-way gold plated 0.15 edge connectors 40p; 10-turn reliance 330ohm 0.25 shaft pots, £2. Plenty of cheap components. Tel 01-673 8696, days.

### HPGL PEN PLOTTING

HPGL FILES on your discs inc-plotted onto top quality film (for PCBs) from £5  
24hr turnaround. A5 to A1 sizes  
Send for details or 2x20p stamps for details plus disc mailer (state 5 1/2 / 3 1/2)

**White House Systems (Dept EE)**  
48 South Terrace, Esh Winning,  
Durham DH7 9PS

### AGE A & G ELECTRONICS LTD.

ELECTRONIC COMPONENTS MAIL ORDER COMPANY.

Electronic components, I.C.'s, diodes, LED's, capacitors, potentiometers, solar chargers, computer disks, video tapes, aerosols, etc.

Brand new quality components at unbeatable prices.  
1990 catalogue is out now

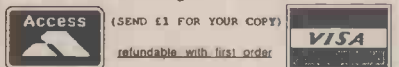

100 Park Avenue, London E6 2SR. Tel: 01-552 2386

### WALTONS OF WOLVERHAMPTON

Established since 1947 - offering a complete range - I.C.'s, transformers, switches, pots, capacitors, resistors, kits, speakers, test equipment, books and lots, lots more!

COME AND SEE US AT: MON-SAT 9-6.00 pm  
56A WORCESTER STREET, WOLVERHAMPTON TEL: 0902 22039

### ELECTRONIC COMPONENTS

EVERYTHING FOR YOUR NEXT PROJECT

THE BIGGEST DISPLAY IN THE SOUTH IS AT

### FRASER ELECTRONICS

42 ELM GROVE \* SOUTHSEA \* HANTS

Telephone 0705-815584

### NEW VHF MICROTRANSMITTER KIT

Tunable 80-115 MHz, 500 metre range, sensitive electret microphone, high quality PCB, SPECIAL OFFER complete kit ONLY £5, assembled and ready to use £8.95 post free. Access/Visa orders telephone 021 411 1821 (24hrs).

Cheques/P.O.s payable to:

**QUANTEK ELECTRONICS LTD**  
(Dept. EE), 45a Station Road  
Northfield, Birmingham B31 3TE

### SERVICE MANUALS

Available for Colour Televisions, Mono Televisions, Video Recorders, Audio equipment, Music Systems, Car Radio's, Cameras, Test equipment etc. etc.

Over 100,000 stocked, originals and photostats. LSAE Enquiries with Make/Model wanted.

FREE catalogue Unique Repair and Data Guides for LSAE.

### MAURITRON (EE)

8 Cherry Tree Road, Chinnor, Oxfordshire, OX9 4QY.

Telephone: (0844) 51694. Office Hours  
Fax: (0844) 52554 anytime.

### 240V AC POWER SUPPLIES

LARGE STOCKS - QUANTITY DISCOUNTS  
P.S.U.'s HAVE MANY OTHER USES

SINCLAIR PSU £9.95  
48K 9VDC 1.4 AMP - 128K 2.1 AMP  
QL £22.95

BROTHER PRINTER PSU £12.95  
TYPE 'C' 6VDC 2 AMP - TYPE 'D' 8.5VDC 1 AMP  
OBERON £14.95  
REGULATED 12VDC 1 AMP

**EEC LTD** Prices incl. VAT. Please add £2 P&P  
12 HIGH ST WATLINGTON OXON  
OX9 5PS TEL 049 161 3294

### Minral ELECTRONIC SERVICES

H52-2961	Alt Flashing Signal.....	£2.99
H52-2963	Electrifying Apparatus.....	£8.45
H52-2967	IC Radio.....	£9.45
H52-2968	Fog Horn.....	£5.95
H52-2971	Moving Light Tube.....	£28.95
H52-2976	Apple Radio.....	£8.45
H52-2982	Metal Detector.....	£5.95
H52-2988	Antenna Amp.....	£4.95
H52-2989	Speed Control.....	£18.95
H52-2994	Diode Receiver.....	£10.99
H52-2998	Lie Detector.....	£5.95
H52-3002	Electronic Dice.....	£10.95
H52-3005	Antenna Amp 30-850Mhz.....	£9.45
H52-3006	VHF Receiver.....	£10.95
H52-3021	MW Testing Transmitter.....	£4.99
H52-3022	Electronic Barking Dog.....	£19.45
H52-3033	Microwave Leak Detector.....	£6.95
H52-3112	Traffic Lights.....	£5.75
H52-3214	Test Oscillator.....	£6.75
H52-3236	Robot Voice.....	£9.49

SEND S.A.E. 9x6(24p) for catalogue. P&P per kit 60p  
12B HIGH ST, MILDENHALL, SUFFOLK  
IP28 7EQ Tel: 0638 713329

### RCS VARIABLE VOLTAGE D.C. BENCH POWER SUPPLY

1 to 24 volts up to 1/2 amp, 1 to 20 volts up to 1 amp, 1 to 16 volts up to 1 1/2 amps A.C. Fully stabilised. Twin panel meters for instant voltage and current readings. Overload protection.

Fully variable. Operates from 240V AC. Compact Unit size 9 x 5 1/2 x 3in. **£42 inc. VAT** + Post £2

### RADIO COMPONENT SPECIALISTS

337 WHITEHORSE ROAD, CROYDON SURREY, U.K. Tel: 01-684 1665

### TECHNICAL INFO SERVICES (EE)

76 Church St, Larkhall, Lanarkshire ML9 1HE  
Phone 0698 884505 Mon-Fri, 9-5.

any other time 0698 883334, FOR FAST QUOTES  
WORLD'S LARGEST COLLECTION SERVICE MANUALS - Most unobtainable elsewhere. Prices range from only £4.50 - large s.a.e. any quotation, no obligation to buy.

WORLD'S SOLE Suppliers of TV & Video Repair manuals, etc. from TV TECHNIC, also such publishers as Heinemann, Newnes, TV Technic, Thorn etc. Every published service sheet in stock, supplied full size, not bits & pieces. CTV's or any combination £3.50 plus LSAE; any other single item £2.50 plus LSAE. Complete Circuit Sets for most Videorecorders only £7 set (no serv. shits made).

LSAE for QUOTATIONS plus GIANT CATALOGUE - NEWSLETTERS - BARGAINS - FREE S2M as available  
Comprehensive TV Repair Manual £9.50 Complete Radio Service and Repair Course £9.50 Complete Repair & Service Manuals - Mono TV £12.50, CTV £17.00; Video £19.50 Complete Repair Data with circuit - Mono TV £9.50, CTV £12.50; Video £19.50  
£3.00 plus LSAE BRINGS THE ONLY COMPREHENSIVE SERVICE SHEETS & MANUALS, CATALOGUES plus FREE CHASSIS GUIDE and £4.00 OF VOUCHERS

### Manufacturers Original Spares

Available for many makes of TV, VIDEO & AUDIO EQUIPMENT. Also SINCLAIR, AMSTRAD & COMMODORE Computers. So whether it's a Custom Chlp, a Remote Control Handset or maybe just a Manual you require...

GIVE US A TRY!!!  
We also stock a range of Home Electrical Accessories, Tools, Soldering Equipment, Telephones, Aerials, Cables, Batteries and MUCH MORE WHY NOT SEND FOR OUR CATALOGUE!! Including our list of S. Offers & Component Clearance Bargains. Simply send 2x20 stamps (UK) for your copy NOW. Mail Order Only

### MARAPET (EED)

1 Hornbeam Mews, Gloucester GL2 0UE

### COMPONENT BARGAINS

Electronic components at LOW cost, resistors, capacitors, U, V, bulbs, Battery chargers, Boxes, Kits, and lots more.

To get your FREE catalogue send a S.A.E. to:

**CECIL ELECTRONICS**  
PO Box 6, EE, Usk, Gwent, NP5 2YG

### J.K.K.

Audio cassettes wound to specified lengths. Duplicating and labelling service available. Small orders welcome.

Visa cards accepted.  
For prompt reliable service ring:  
**01-478 0471**



Carbon Film resistors 1/4W 5% E24 series 0.51R to 10M0	1p
100 off per value—75p, even hundreds per value totalling 1000	£6.00p
Metal Film resistors 1/4W 10R to 1M0 5% E12 series—2p, 1% E24 series	3p
Mixed metal/carbon film resistors 1/2W E24 series 1R0 to 10M0	1 1/2p
1 watt mixed metal/Carbon Film 5% E12 series 4R7 to 10 Megohms	5p
Linear Carbon pre-sets 100mW and 1/4W 100R to 4M7 E6 series	7p
Miniature polyester capacitors 250V working for vertical mounting	
.015, .022, .033, .047, .068-4p, 0.1-5p, 0.12, 0.15, 0.22-6p, 0.47-8p, 0.68-8p, 1.0-12p	
Mylar (polyester) capacitors 100V working E12 series vertical mounting	
1000p to 8200p - 3p, .01 to .068-4p, 0.1-5p, 0.12, 0.15, 0.22-6p, 0.47/50V-8p	
Submin ceramic plate capacitors 100V w/kg vertical mountings. E12 series	
2% 1.8pf to 47pf - 3p, 2% 56 pf to 330pf - 4p, 10% 390p - 4700p	4p
Disc/plate ceramics 50V E12 series 1P0 to 1000P, E6 Series 1500P to 47000P	2p
Polystyrene capacitors 63V working E12 series long axial wires	
10pf to 820pf - 3p, 1000 pf to 10,000pf - 4p, 12,000 pf	5p
741 Op Amp - 20p, 555 Timer	22p
cmos 4001 - 20p, 4011 - 22p, 4017	40p
ALUMINIUM ELECTROLYTICS (Mfids/Volts)	
1/50, 2.2/50, 4.7/50, 10/25, 10/50	5p
22/16, 22/25, 22/50, 47/16, 47/25, 47/50	6p
100/16, 100/25 7p; 100/50 12p; 100/100	14p
220/16 8p; 220/25, 220/50 10p; 470/16, 470/25	11p
1000/25 25p; 1000/35, 2200/25 35p; 4700/25	70p
Submin. tantalum bead electrolytics (Mfids/Volts)	
0.1/35, 0.22/35, 0.47/35, 1.0/35, 3.3/16, 4.7/16	14p
2.2/35, 4.7/25, 4.7/35, 6.8/16 15p; 10/16, 22/6	20p
33/10, 47/6, 22/16 30p; 47/10 35p; 47/16 60p; 47/35	80p
VOLTAGE REGULATORS	
1A + or - 5V, 8V, 12V, 15V, 18V & 24V	55p
DIODES (piv/amps)	
75/25mA 1N4148 2p, 800/1A 1N4006 6p, 400/3A 1N5404 14p, 115/15mA OA91	6p
100/1A 1N4002 4p, 1000/1A 1N4007 7p, 60/1.5A S1M1 5p, 100/1A bridge	25p
400/1A 1N 4004 5p, 1250/1A BY127 10p, 30/15A OA47	8p
Zener diodes E24 series 3V3 to 33V 400 mW - 8p, 1 watt	12p
Battery snaps for PP3 - 6p for PP9	12p
L.E.D.'s 3mm, & 5mm. Red, Green, Yellow - 10p. Grommets 3mm - 2p, 5mm	2p
Red flashing L.E.D.'s require 5V supply only	50p
Mains indicator neons with 220k resistor	10p
20mm fuses 100mA to 5A Q/blow 5p. A/surge 8p. Holders pc or chassis	5p
High speed pc drill 0.8, 1.0, 1.3, 1.5, 2.0m - 30p. Machines 12V dc	£7.00
HELPING HANDS 6 ball joints and 2 croc clips to hold awkward jobs	£3.50p
AA/HP7 Nicad rechargeable cells 80p each. Universal charger unit	£6.50p
Glass reed switches with single pole make contacts - 8p. Magnets	12p
0.1" Veroboard 2 1/2" x 1" 9 rows 25 holes - 20p, 3 1/2" x 2 1/2" 24 rows 37 holes	60p
TRANSISTORS	
BC107/8/9-12p, BC547/8/9-8p, BC557/8/9-8p, BC182, 182L, BC183, 183L, BC184, 184L, BC212, 212L-10p, BC327, 337, 337L-12p, BC727, 737-12p, BD135/6/7/8/9-25p, BCY70-15p, BFY50/51/52-20p, BFX88-15p, 2N3055-50p, TIP31, 32-30p, TIP41, 42-40p, BU208A-£1.20, BF195, 197-12p	

## THE CR SUPPLY CO

127 Chesterfield Rd., Sheffield S8 0RN  
Tel: 0742 557771 Return posting

## MAKE YOUR INTERESTS PAY!

More than 8 million students throughout the world have found it worth their while! An ICS home-study course can help you get a better job, make more money and have more fun out of life! ICS has over 90 years experience in home-study courses and is the largest correspondence school in the world. You learn at your own pace. When and where you want, under the guidance of expert 'personal' tutors. Find out how we can help YOU. Post or phone today for your FREE INFORMATION PACK on the course of your choice.

GCSE/GCE/SCE	CAR MECHANICS
ELECTRONICS	COMPUTER
BASIC ELECTRONIC ENGINEERING (City & Guilds)	PROGRAMMING
ELECTRICAL ENGINEERING	TV, VIDEO & HI-FI
ELECTRICAL CONTRACTING/INSTALLATION	SERVICING
	RADIO AMATEUR LICENCE EXAM (City & Guilds)
Course of Interest	Name: _____
ICS	Address: _____ P.Code _____
	International Correspondence School, Dept. ECS40, 312/314 High Street, Sutton, Surrey SM1 1PR. Tel: 01-643 9568 or 041-221 2926 (24 hrs)



## WEATHER STATION FOR THE BBC MICRO

Simply plug interface unit into analogue socket for Data logging and/or live 4 channels of information i.e. wind speed and direction, temperature and pressure. Complete package hardware, software and installation ideas As sold to Schools and Colleges. Price £234 incl VAT and P&P. FREE compass with each order to assist setting up wind vane Also available Electronic Handheld Anemometer

£75 and Electronic Rainfall measure £40 order direct from:

EIFEL SYSTEMS, PO BOX 59, ASHFORD, KENT TN23 3EB.  
Tel 0233 637515

## SHERWOOD ELECTRONIC COMPONENTS

45 Rutland Street, Mansfield, Notts NG18 4AP

SPECIAL PACKS — All at £1.00 each

SP1 12x5mm Red LEDs	SP32 4xCmos 4077
SP2 12x5mm Green LEDs	SP33 4xCmos 4081
SP3 12x5mm Yellow LEDs	SP34 2xCmos 4510
SP4 10x5mm Amber LEDs	SP35 2xCmos 4511
SP5 36x5mm 1 part LED clips	SP36 20x10µF/25V Rad.Elect.Caps.
SP6 12x3mm Red LEDs	SP37 15x100µF/35V Rad.Elect.Caps.
SP7 12x3mm Green LEDs	SP38 20x47µF/25V Rad.Elect.Caps.
SP8 10x3mm Yellow LEDs	SP39 12x470µF/16V Rad.Elect.Caps.
SP9 40x3mm 1 part LED clips	SP40 15xBC237 Transistors
SP10 50x1N4148 signal diodes	SP41 25xmixed Transistors
SP11 25x1N4001 rectifier diodes	SP42 2xLM1458
SP12 25x1N4002 rectifier diodes	SP44 12x5mm Leds-4 each, Red, Green Yellow
SP13 25xRad.Elect.Caps. (1-1000µF)	SP45 25x1N4000 series rect. diodes
SP18 15xBC182 Transistors	SP46 15x400mW zeners — assorted values
SP19 15xBC183 Transistors	SP47 5xminiature push button switches
SP20 15xBC184 Transistors	SP101 15 metres of 22SWG 60-40 solder
SP21 15xBC212 Transistors	SP102 15x8 pin DIL sockets
SP22 15xBC214 Transistors	SP103 12x14 pin DIL sockets
SP23 15xBC549 Transistors	SP104 12x16 pin DIL sockets
SP24 5xCmos 4001	SP105 5x74LS00 I.C.s
SP25 5x555 Timer	SP106 5x74LS02 I.C.s
SP26 5x741 Op-Amp	SP107 20xmixed presets - Hor. +Vertical
SP27 5xCmos 4002	SP108 15xBC382 Transistors
SP28 5xCmos 4011	SP109 15xBC557 Transistors
SP29 3xCmos 4013	SP110 4x74LS13 I.C.s
SP30 5xCmos 4025	
SP31 4xCmos 4071	

1 pack of your choice FREE when you buy any 10 of the above £1.00 packs.

ADDITIONAL PACKS		RESISTOR PACKS	
SP50 25x5mm Red LEDs	£2.00	0.25W Carbon Film resistors 10R-10M	
SP51 25x5mm Green LEDs	£2.00	5 each value — total 365	£2.75
SP52 50xRad. Elec. Caps.	£1.95	10 each value — total 730	£4.50
SP53 30xDIL sockets 8, 14, 16	£2.00	1000 popular values	£6.00
SP54 1xTIL38+1xTIL100	£1.80	Individual resistors	2p ea.
SP57 100x1N4148 diodes	£1.75	10+ one value	1p ea.
SP65 60x3mm+5mm Leds	£4.80	100 one value	75p

CMOS			I.C.s			V. REGS.		
4000	25p	4070	27p	555	22p	78L05	25p	
4001	25p	4071	27p	556	75p	78L12	25p	
4002	25p	4072	27p	741	22p	78L15	26p	
4011	25p	4073	27p	747	70p	79L05	30p	
4012	27p	4075	27p	CA3140E	45p	79L12	30p	
4013	38p	4077	32p	CA3240E	£1.25	79L15	30p	
4017	55p	4081	27p	LM339	55p	1A		
4023	30p	4093	27p	LM380-14	£1.25	7805	35p	
4025	25p	4510	65p	LM723	60p	7812	35p	
4027	50p	4511	65p	LM1458	55p	7815	36p	
4040	70p	4514	£1.25	TL071	60p	7905	36p	
4047	65p	4515	£1.30	TL072	80p	7912	38p	
4049	40p	4516	65p	TL081	40p	7915	38p	
4066	40p	4528	70p	TL082	55p			

Cheques or P.O. to: SHERWOOD ELECTRONIC COMPONENTS  
Please add £1 P&P to orders under £20.00

This only a small sample of components stocked, send 75p for new 1990 catalogue, contains vouchers redeemable against orders over £5.00. NO VAT



NATIONAL COLLEGE OF TECHNOLOGY

## PACKAGED SHORT COURSES

The National College of Technology (NCT Ltd) offers a range of packaged short courses in analogue electronics, digital electronics and fibres & optoelectronics for study at home or at work. The advantages are that you may,

- commence at any time
- work at your own pace
- have a tutor (optional)

and there is no travelling involved. BTEC certificates are available subject to the conditions of the award. These highly popular packed courses contain workbooks, a cassette tape, circuit board and components necessary to provide both theoretical and practical training.

Whether you are a newcomer to electronics or have some experience and simply need updating, there is probably a packaged short course ready for you. Write or telephone for details, quoting Everyday Electronics, to:

NCT Ltd, Bicester Hall, 5 London Road, Bicester Oxon OX6 7BU

or telephone (0296) 613067 Ext. 202

## MULTI SOURCES

### SWITCH MODE POWER SUPPLY

30 watts, board size 180mm x 100mm. Dual Input 115/230V ± 15% Fully tested £6.50 each  
Reg output +5V at 3.5A, +12V at 1.5A, -5V at 0.3A 10+ £5.00 each

### COMPUTER GRADE CAPACITORS (mfd/volts)

10000/30 £1.50 each; 22000/10 £1.95; 22000/20 £2.25 each  
47000/48 £6.50 each; 68000/16 £3.25; 220/40 18p each  
150/60 9p each; 470/6.3 8p; 100/50 12p each  
9000/50 £1.80 each; 2.2/50 7p; 0.22/250 10p each  
Solid Tant 120/10 50p; 100/20 S.T. 60p; 2.2/20 15p each

### RELAYS HIGH QUALITY (coll voltage/no of poles/type)

IMO G4D 3.6-5V/2PCO/PCB £1.00; Schrack 24V DC/2PCO/high voltage contacts 75p  
NF4 24V DC/4PCO/PCB £1.20AC Relays 50V, 115V, 240V coil. SP, DP etc £1.20  
AZ535 12V DC/1PCO/PCB 75p; 4 Assorted relays, DC, AC coils £1.50

### POTENTIOMETERS

2 x 100Kohm with DPST switch 50p; 10Kohm linear 20p; 1Kohm linear 15p  
4K7 linear 20p; 5Kohm log 20p; Slider pots 100Kohm/Log 29p

### FUSEHOLDERS

PCB mounting 20 x 5mm 25p; 1 1/4" x 1/4" 27p; Open PCB mount 10p  
Belling heavy duty Size 1 with 15A fuse £1.20; Schurter fuseholder with 6 position switch 60p  
Page military type fuses 1 1/4" x 1/4" 25p

### FUSES

1" x 1/4" 1.5A Suitable for mains plug 12 for a £1; 1 1/4" x 1/4" Antisurge 62.5mA, 1.5mA, 3mA, 6 for a £1  
1 1/4" x 1/4" Quick blow 150mA, 750mA 10 for a £1; Subminiature (solder type) fuselinks 100mA 22p  
Soldering iron 240V with a spare element £8.50

### CONNECTORS

Amphenol (Series 57) free plug 36 way £1.20; Edge connectors D sided 0.156" 95p  
PCB mount, 8 way Barrier terminal blocks 50p; 4 way, 90 square header 9p  
Greenpar BNC sockets, panel mount 40p; 3m BNC co-ax cable with plugs £2.00  
16 pin DIL IC sockets 5p; Greenpar 4mm shrouded test leads 1m length 50p

THIS IS A VERY SMALL SAMPLE OF OUR STOCK. SIMPLY SEND SAE FOR OUR LIST

### NEW INSTRUMENTS

Uninterruptible power supply 1kVA on line with 4 hour back-up batteries.  
Batteries alone cost £938.00. Bargain price £850.00  
PS20 PULSE GENERATOR. Freq 1MHz-25MHz, crystal freq 10kHz-10MHz. 5 simultaneous outputs  
(+15V normal and complement, TTL normal and complement, 5V crystal output)  
independent width control. £345.00  
PS10 PULSE SOURCE. Selectable crystal frequencies 10MHz-10Hz  
TTL compatible outputs normal and complement, separate crystal output. £89.50

### SECOND USER INSTRUMENTS

Tektronix 422. Two channel portable scope. Immaculate condition. £395.00  
H.P. 1418 Storage scope with 3 plug ins. Very good condition. 1421 Time Base,  
1402 dual channel amplifier, 1400B diff amplifier. £525.00  
Comark 1601. Electronic thermometer -120 to +100°C without probe. £25.00  
Comark 1602. Electronic thermometer -80 to +100°C without probe. £25.00  
Grundig TR30. Resonance meter with internal battery 40kHz-30MHz. £40.00  
Tektronix 475 Scope. Dual channel 200MHz bandwidth. Needs repair. £395.00  
Carriage: Components £1.50; Equipment £10.00. Please check availability.

Unit 2, Stable Yard, Downs Barn, Milton Keynes, MK14 7RZ  
Tel: (0908) 666042 Fax: (0908) 691370

## ADVERTISERS INDEX

BK ELECTRONICS	.....	Cover (iii)
BLACKMORE ELECTRONICS	.....	272
BULL J & N	.....	COVER (ii)
CAMBRIDGE COMP. SCIENCE	.....	(281)
CIRKIT DISTRIBUTION	.....	253
CRICKLEWOOD ELECTRONICS	.....	265
CR SUPPLY COMPANY	.....	291
DALBANI CORPORATION	.....	241
EIFFEL SYSTEMS	.....	291
ELECTRONIC DESIGN	.....	289
ELECTROVALUE	.....	289
ELV FRANCE	.....	224/225
GRANDATA	.....	222
HART ELECTRONIC KITS	.....	241
HENRY'S AUDIO ELECTRONICS	.....	273
HIGHGRADE COMPONENTS	.....	226
HILLS COMPONENTS	.....	261
HOBBYKIT	.....	273
ICS	.....	291
JAYTEE ELECTRONIC SERVICES	.....	253
LONDON ELECTRONICS COLLEGE	.....	292
MAGENTA ELECTRONICS	.....	228/229
MAPLIN ELECTRONICS	.....	Cover (iv)
MARCO TRADING	.....	247
MULTI SOURCES	.....	292
NATIONAL COLLEGE OF TECH.	.....	291
OMNI ELECTRONICS	.....	281
RADIO & TV COMPONENTS	.....	227
RISCOM	.....	272
SERVICE TRADING CO.	.....	289
SHERWOOD DATA SYSTEMS	.....	261
SHERWOOD ELEC. COMP.	.....	291
SPECIALIST SEMICONDUCTORS	.....	287
STEWART OF READING	.....	292
SUMA DESIGNS	.....	289
TK ELECTRONICS	.....	230
TYPEFIT	.....	292

## BTEC ELECTRONICS TECHNICIAN FULL-TIME TRAINING

**2 YEAR**  
**BTEC National Diploma (OND)**  
**ELECTRONIC &**  
**COMMUNICATIONS ENGINEERING**  
(Electronics, Computing, Television, Video, Testing & Fault Diagnosis)

**1 YEAR**  
**BTEC National Certificate (ONC)**  
**ELECTRONIC ENGINEERING**  
**1—INFORMATION TECHNOLOGY**  
(Electronics, Satellite TV, Networks, Telecomms)

**2—ELECTRONIC EQUIPMENT SERVICING**  
(Electronics, Television, Video Cassette Recorders, CCTV, Testing and Fault Diagnosis)

**3—SOFTWARE ENGINEERING**  
(Electronics, Assembler, BASIC, Pascal, CAD/CAM)

**4—COMPUTING TECHNOLOGY**  
(Electronics, Computing Software/Hardware, Microelectronics)

**10 MONTHS**  
**BTEC Higher National Certificate (HNC)**  
**COMPUTING TECHNOLOGY & ROBOTICS**  
(Microprocessor Based Systems, Control, Robotics)

These courses include a high percentage of college based practical work to enhance future employment prospects

No additional fees for overseas students  
Shortened courses of from 3 to 6 months can be arranged for applicants with previous electronics knowledge

THOSE ELIGIBLE CAN APPLY FOR E.T. GRANT SUPPORT AN EQUAL OPPORTUNITIES PROGRAMME

**O.N.C. and O.N.D.**  
**Next Course Commences**  
**Monday 23rd April 1990**

FULL PROSPECTUS FROM

**LONDON ELECTRONICS COLLEGE**  
(Dept. EE), 20 PENYWERN ROAD  
EARLS COURT, LONDON SW5 9SU  
Tel: 01-373 8721

## WE HAVE THE WIDEST CHOICE OF USED OSCILLOSCOPES IN THE COUNTRY

H. P. 1740A Dual Trace 100MHz Delay Sweep Trig	£500
TELEQUIPMENT D83 Dual Trace 50MHz Delay Sweep	£200
GOULD OS3000A Dual Trace 40MHz Delay Sweep TV Trig	£300
TELEQUIPMENT D755 Dual Trace 50MHz Delay Sweep	£275
COSSOR CDU150 Dual Trace 35MHz Delay Sweep	£150
GOULD OS1100 Dual Trace 30MHz TV Trig	£210
S.E. LABS SM111 Dual Trace 10MHz	£130
TRIO CS1566A Dual Trace 20MHz	£250
H.P. 1220A Dual Trace 15MHz TV Trig	£175
GOULD OS255 Dual Trace 15MHz TV Trig	£180
PHILIPS PM3233 Dual Beam 10MHz TV Trig	£150
GOULD OS250B Dual Trace 15MHz TV Trig	£140

THIS IS JUST A SAMPLE - MANY OTHERS AVAILABLE

### TEKTRONIX 2215. DUAL TRACE 60MHz SWEEP DELAY. WITH MANUAL PROBES. FRONT COVER. POUCH ONLY £500

MARCONI TF2015 AM/FM 10-520MHz Sig Gen with TF2171	£450
MARCONI TF2015 without Synchroniser TF2171	£300
MARCONI TF2016 AM/FM 10MHz-120MHz Sig Gen with TF2173	£400
MARCONI TF2016 without Synchroniser TF2173	£250
MARCONI MOD Meters TF2200, TF2300B, TF2303	£100
DYNAMAR 1525 AM/FM 0.1-184 MHz Sig Gen	£200
H.P. 620B Signal Generator 7-11 GHz	£400
H.P. 618C Signal Generator 3.8-7.6 GHz	£400
H.P. 616B Signal Generator 1.8-4.2 GHz	£400
FERRUGRAPHI RTS2 Recorder Test Set	£275
WOLKE Wov & Filter Meter ME 108	£100
LEADER LMV 185A Two Channel Millivoltmeter 5Hz-500kHz; 100uV-300V	£100
FEEDBACK FG601 Sig Gen 0.001Hz-1MHz Sine/Sq/Tri	£150
MARCONI Automatic Distortion Meter TF237A 400Hz or 1kHz measures up to 0.01% LEVEL OSCILLATORS TG152/TG200 Series from £75	£75
MARCONI TF2700 UNIVERSAL LCR Bridge Battery	From £150

### TELEPHONES

YES! REAL DIAL TYPE TELEPHONES that don't slide around the desk. Type 746 with Standard BT Plug. ONLY £5 ea. With lead. £4 ea. P&P £4. Quantity discount.

SADELTA MC321 COLOUR BAR GENERATOR RF Bands 1/3 & Video 8 Functions. Sound Carrier. Unused (P&P £7)	£125
SADELTA COLOUR BAR GENERATOR PAL MC101. 8 patterns Pocket Size Rechargeable Batteries. Complete with Battery Charger Adapter Unused (P&P £4)	£50
LABGEAR Colour Bar Generator LGR 8 test patterns (P&P £4)	ONLY £40 ea.
LABGEAR CROSSHATCH GENERATORS Type CM6038-DB Cross-hatch/Grey Scale/Blank Raster. Mains or BATTERY. Unused	£18
Unused	£12 (P&P £3)
TRIO RF SIGNAL GENERATOR Type SG402 100kHz-30MHz Unused (P&P £7)	ONLY £50
ADVANCE S6528 AM Receiver 220MHz (P&P £7)	£30
MICROVITEX CUB MONITOR 14in colour	£90

USED EQUIPMENT - WITH 30 DAYS GUARANTEE. MANUALS SUPPLIED IF POSSIBLE. This is a VERY SMALL SAMPLE OF STOCK. SAE or telephone for Lists. Please check availability before ordering. CARRIAGE all units £16. VAT to be added to Total of Goods & Carriage.

### STEWART OF READING

110 WYKEHAM ROAD, READING, BERKS RG6 1PL Telephone: 0734 68041 Fax: 0734 351696

Callers welcome 9am-5.30 pm Mon-Fri (until 8.00 pm Thurs.)

TEKTRONIX OSCILLOSCOPE 2235 Dual Trace 100MHz Delay Sweep	£750
PHILIPS OSCILLOSCOPE PM3217 Dual Trace 50MHz Delay Sweep	£500
GOULD OS300 Oscilloscope Dual Trace 20MHz	£250
GOULD 1421 Digital Storage Dual Trace 20MHz	£750
THANDAR TA2080 Logic Analyser 20MHz, 8 Channel, 2375	£375
THURBY PL3200MD D-30V 2A Twice Quad Mode Digital Meters	£200
FEEDBACK FSG606 Sweep Function Generator 0.01MHz-1MHz (P&P £7)	£200
SOLARTRON 7045 Multimeter 4 1/2 digit LED 30 ranges Auto/Manual (P&P £7)	£125
LOGIC PROBE type 3300A TTL/Cmos (P&P £3)	£18
FARNELL Oscillator LFM3 10kHz-10MHz Sine/Square	£200
RACAL 9915 Freq Counter 10Hz-520MHz (Crystal Oven)	£150
RACAL 3900 Series Universal Counter Timers from	£150
MARCONI ATTENUATORS TF2162 DC-1MHz 600 Ohm 0-111dB (P&P £7)	£35
HATHFIELD ATTENUATORS 50 Ohm DC 250MHz 0-100dB 0.5-25W 50 Ohm 100MHz Manual	£100

### AVO MULTIMETERS (P&P £10 all Units)

AVO 85; 9s and Ministry Versions. With Batteries & Leads	From £50
TEST LEADS for AVOs. Red & Black with 2 croc Clips & 2 prods (P & P £3)	£5
Black EVER READY Case for AVOs. Un-used (P & P £4).	£15
BATTERIES 15 Volts	£3 each, 10 off £25 (P&P extra)
AVO TRANSISTOR ANALYSER Mk2 CT446 Sultcase style. With batteries and operating Instructions	£100
MARCONI AF Power Meter TF83A 20Hz-35kHz 20mW-10W With manual	ONLY £25 (P & P £7)
MARCONI RF POWER METER TF1152A/1 DC 500MHz 0.5-25W 50 Ohm 100m Manual	£100

### NEW EQUIPMENT

HAMEG OSCILLOSCOPE HM1005 Triple Trace 100MHz Delay Timebase	£720
HAMEG OSCILLOSCOPE HM804 Dual Trace 60MHz Delay	£375
HAMEG OSCILLOSCOPE HM203.6 Dual Trace 20 MHz Component Tester	£314
HAMEG OSCILLOSCOPE HM205.3 Dual Trace 20MHz Digital Storage	£575

All Other Models available

### BLACK STAR EQUIPMENT (P & P all units £5)

APOLLO 10 - 100MHz Counter Timer Ratio/Period/Time Interval etc	£222
APOLLO 100 - 100MHz (As above with more functions)	£295
METEOR 100 Frequency Counter 100MHz	£109
METEOR 600 Frequency Counter 600MHz	£135
METEOR 1000 Frequency Counter 1000Hz	£178
JUPITER 500 FUNCTION GENERATOR. 0.1Hz-500kHz Sine/Sq/Tri	£100
ORION COLOUR BAR GENERATOR PAUTV/Video	£209
All other Black Star Equipment available	
HUNG CHANG DMM 7030 3 1/2 digit. Hand held 28 ranges including 10 Amp AC/DC 0.1%. Complete with batteries & leads (P&P £4)	£39.50
As above DMM 6010 0.25%	£33.50
Carrying cases for above	£3 each
OSCILLOSCOPES PROBES. Switched x1; x10 (P&P £3)	£11

# Your own WYSIWYG typesetting — page make-up on your own computer — for just £150!

TYPEFIT is a desk top publishing program which runs on IBM PC's and compatibles. It's ideal for producing magazines, books, catalogues, price lists, leaflets, brochures, advertisements and the like.

- Easy to learn and use (mouse, menu and keyboard operated).
- Over 200 typefaces; sizes 1pt to 1,000pt.
- On screen and telephone help.

# Typefit

'EVERYDAY ELECTRONICS' IS PRODUCED ENTIRELY ON TYPEFIT

For further information ring us or send now for a demo disk.

PAGE MAKE-UP SOFTWARE & TYPESETTING BUREAU  
28-30 Southampton Road, Ringwood, Hants.  
Tel: (0425) 480880 Fax: (0425) 470069

**OMP POWER AMPLIFIER MODULES-TURNABLES-DIMMERS-LOUDSPEAKERS-19 INCH STEREO RACK AMPLIFIERS**

**OMP POWER AMPLIFIER MODULES**

Supplied ready built and tested.

**OMP POWER AMPLIFIER MODULES** Now enjoy a world-wide reputation for quality, reliability and performance at a realistic price. Four models available to suit the needs of the professional and hobby market, i.e., Industry, Leisure, Instrumental and Hi-Fi etc. When comparing prices, NOTE all models include Toroidal power supply, integral heat sink, Glass fibre P.C.B., and Drive circuits to power compatible VU meter. Open and short circuit proof.

**THOUSANDS OF MODULES PURCHASED BY PROFESSIONAL USERS**



**OMP100 Mk 11 Bi-Polar** Output power 110 watts R.M.S. into 4 ohms, Frequency Response 15Hz - 30KHz -3dB, T.H.D. 0.01%, S.N.R. -118dB, Sens. for Max. output 500mV at 10K, Size 355 x 115x65mm. PRICE £33.99 + £3.00 P&P.

**NEW SERIES II MOS-FET MODULES**

**OMP/MF 100 Mos-Fet** Output power 110 watts R.M.S. into 4 ohms, Frequency Response 1Hz - 100KHz -3dB, Damping Factor, >300, Slew Rate 45V/uS, T.H.D. Typical 0.002%, Input Sensitivity 500mV, S.N.R. -125dB. Size 300 x 123 x 60mm. PRICE £39.99 + £3.00 P&P.

**OMP/MF200 Mos-Fet** Output power 200 watts R.M.S. into 4 ohms, Frequency Response 1Hz - 100KHz -3dB, Damping Factor >300, Slew Rate 50V/uS, T.H.D. Typical 0.001%, Input Sensitivity 500mV, S.N.R. -130dB. Size 300 x 155 x 100mm. PRICE £62.99 + £3.50 P&P.

**OMP/MF300 Mos-Fet** Output power 300 watts R.M.S. into 4 ohms, Frequency Response 1Hz - 100KHz -3dB, Damping Factor >300, Slew Rate 60V/uS, T.H.D. Typical 0.0008%, Input Sensitivity 500mV, S.N.R. -130dB. Size 330 x 175 x 100mm. PRICE £79.99 + £4.50 P&P.

NOTE:- MOS-FET MODULES ARE AVAILABLE IN TWO VERSIONS. STANDARD - INPUT SENS. 500mV BAND WIDTH 100KHZ. PEC (PROFESSIONAL EQUIPMENT COMPATIBLE) - INPUT SENS. 775mV, BAND WIDTH 50KHZ. ORDER STANDARD OR PEC



**Vu METER** Compatible with our four amplifiers detailed above. A very accurate visual display employing 11 L.E.D. diodes (7 green, 4 red) plus an additional on/off indicator. Sophisticated logic control circuits for very fast rise and decay times. Tough moulded plastic case, with tinted acrylic front. Size 84 x 27 x 45mm. PRICE £8.50 + 50p P&P.

**LOUDSPEAKERS**



**LARGE SELECTION OF SPECIALIST LOUDSPEAKERS AVAILABLE, INCLUDING CABINET FITTINGS, SPEAKER GRILLES, CROSS-OVERS AND HIGH POWER, HIGH FREQUENCY BULLETS AND HORNS, LARGE S.A.E. (30p STAMPED) FOR COMPLETE LIST.**

**McKENZIE:- INSTRUMENTS, P.A., DISCO, ETC.**

- ALL MCKENZIE UNITS 8 OHMS IMPEDANCE**
- 8" 100 WATT C8100GPM GEN. PURPOSE, LEAD GUITAR, EXCELLENT MID. DISCO. PRICE £29.30 + £2.00 P&P
  - RES. FREQ. 80Hz. FREQ. RESP. TO 14KHz. SENS. 99dB.
  - 10" 100 WATT C10100GP GUITAR, VOICE, ORGAN, KEYBOARD, DISCO. EXCELLENT MID. PRICE £35.58 + £2.50 P&P
  - RES. FREQ. 70Hz. FREQ. RESP. TO 6KHz. SENS. 100dB.
  - 10" 200 WATT C10200GP GUITAR, KEYBOARD, DISCO. EXCELLENT HIGH POWER MID. PRICE £48.67 + £2.50 P&P
  - RES. FREQ. 45Hz. FREQ. RESP. TO 7KHz. SENS. 103dB.
  - 12" 100 WATT C12100GP HIGH POWER GEN. PURPOSE, LEAD GUITAR, DISCO. PRICE £37.59 + £3.50 P&P
  - RES. FREQ. 45Hz. FREQ. RESP. TO 7KHz. SENS. 99dB.
  - 12" 100 WATT C12100TC (TWIN CONE) HIGH POWER WIDE RESPONSE. P.A., VOICE, DISCO. PRICE £38.58 + £3.50 P&P
  - RES. FREQ. 45Hz. FREQ. RESP. TO 14KHz. SENS. 100dB.
  - 12" 200 WATT C12200B HIGH POWER BASS, KEYBOARDS, DISCO, P.A. PRICE £65.79 + £3.50 P&P
  - RES. FREQ. 40Hz. FREQ. RESP. TO 7KHz. SENS. 100dB.
  - 12" 300 WATT C12300GP HIGH POWER BASS LEAD GUITAR, KEYBOARDS, DISCO, ETC. PRICE £87.51 + £3.50 P&P
  - RES. FREQ. 45Hz. FREQ. RESP. TO 5KHz. SENS. 100dB.
  - 15" 100 WATT C15100BS BASS GUITAR, LOW FREQUENCY, P.A., DISCO. PRICE £55.05 + £4.00 P&P
  - RES. FREQ. 40Hz. FREQ. RESP. TO 5KHz. SENS. 99dB.
  - 15" 200 WATT C15200BS VERY HIGH POWER BASS. PRICE £75.10 + £4.00 P&P
  - RES. FREQ. 40Hz. FREQ. RESP. TO 4KHz. SENS. 99dB.
  - 15" 250 WATT C15250BS VERY HIGH POWER BASS. PRICE £82.54 + £4.50 P&P
  - RES. FREQ. 40Hz. FREQ. RESP. TO 4KHz. SENS. 99dB.
  - 15" 400 WATT C15400BS VERY HIGH POWER, LOW FREQUENCY BASS. PRICE £96.47 + £4.50 P&P
  - RES. FREQ. 40Hz. FREQ. RESP. TO 4KHz. SENS. 102dB.
  - 18" 400 WATT C18404BS EXTREMELY HIGH POWER, LOW FREQUENCY BASS. PRICE £172.06 + £5.00 P&P
  - RES. FREQ. 27Hz. FREQ. RESP. TO 3KHz. SENS. 99dB.

**EARBENDERS:- HI-FI, STUDIO, IN-CAR, ETC.**

- ALL EARBENDER UNITS 8 OHMS (Except EB8-50 & EB10-50 which are dual impedance tapped @ 4 & 8 Ohm)**
- BASS, SINGLE CONE, HIGH COMPLIANCE, ROLLED FOAM SURROUND**
  - 8" 50 WATT EB8-50 DUAL IMPEDANCE, TAPPED 4 & 8 OHM BASS, HI-FI, IN-CAR. PRICE £8.90 + £2.00 P&P
  - RES. FREQ. 40Hz. FREQ. RESP. TO 7KHz. SENS. 97dB.
  - 10" 50 WATT EB10-50 DUAL IMPEDANCE, TAPPED 4 & 8 OHM BASS, HI-FI, IN-CAR. PRICE £12.00 + £2.50 P&P
  - RES. FREQ. 40Hz. FREQ. RESP. TO 5KHz. SENS. 99dB.
  - 10" 100 WATT EB10-100 BASS, HI-FI, STUDIO. PRICE £27.76 + £3.50 P&P
  - RES. FREQ. 35Hz. FREQ. RESP. TO 3KHz. SENS. 96dB.
  - 12" 60 WATT EB12-60 BASS, HI-FI, STUDIO. PRICE £21.00 + £3.00 P&P
  - RES. FREQ. 28Hz. FREQ. RESP. TO 3KHz. SENS. 92dB.
  - 12" 100 WATT EB12-100 BASS, STUDIO, HI-FI, EXCELLENT DISCO. PRICE £38.75 + £3.50 P&P
  - RES. FREQ. 26Hz. FREQ. RESP. TO 3KHz. SENS. 93dB.
  - FULL RANGE TWIN CONE, HIGH COMPLIANCE, ROLLED SURROUND**
  - 5 1/2" 60 WATT EB5-60TC (TWIN CONE) HI-FI, MULTI-ARRAY DISCO ETC. PRICE £9.99 + £1.50 P&P
  - RES. FREQ. 60Hz. FREQ. RESP. TO 20KHz. SENS. 92dB.
  - 6 1/2" 60 WATT EB6-60TC (TWIN CONE) HI-FI, MULTI-ARRAY DISCO ETC. PRICE £10.99 + £1.50 P&P
  - RES. FREQ. 38Hz. FREQ. RESP. TO 20KHz. SENS. 94dB.
  - 8" 60 WATT EB8-60TC (TWIN CONE) HI-FI, MULTI-ARRAY DISCO ETC. PRICE £12.99 + £1.50 P&P
  - RES. FREQ. 40Hz. FREQ. RESP. TO 18KHz. SENS. 89dB.
  - 10" 60 WATT EB10-60TC (TWIN CONE) HI-FI, MULTI-ARRAY DISCO ETC. PRICE £16.49 + £2.00 P&P
  - RES. FREQ. 35Hz. FREQ. RESP. TO 12KHz. SENS. 86dB.

**TRANSMITTER HOBBY KITS**

PROVEN TRANSMITTER DESIGNS INCLUDING GLASS FIBRE PRINTED CIRCUIT BOARD AND HIGH QUALITY COMPONENTS COMPLETE WITH CIRCUIT AND INSTRUCTIONS

- 3W FM TRANSMITTER 80-108MHz. VARICAP CONTROLLED PROFESSIONAL PERFORMANCE, RANGE UP TO 3 MILES, SIZE 38 x 123mm, SUPPLY 12V @ 0.5AMP. PRICE £14.49 + £1.00 P&P
- FM MICRO TRANSMITTER (BUG) 100-108MHz VARICAP TUNED COMPLETE WITH VERY SENS FET MIC, RANGE 100-300m. SIZE 56 x 46mm, SUPPLY 9V BATT, PRICE £8.62 + £1.00 P&P



3 watt FM Transmitter

\* PRICES INCLUDE V.A.T. \* PROMPT DELIVERIES \* FRIENDLY SERVICE \* LARGE S.A.E., 30p STAMPED FOR CURRENT LIST.

**OMP VARISPEED TURNTABLE CHASSIS**



\* MANUAL ARM \* STEEL CHASSIS \* ELECTRONIC SPEED CONTROL 33 & 45 \* WRI PITCH CONTROL \* HIGH TORQUE SERVO DRIVEN DC MOTOR \* TRANSIT SCREWS \* 12" DIE CAST PLATTER \* NEON STROBE \* CALIBRATED BAL WEIGHT \* REMOVABLE HEAD SHELL \* 1/2" CARTRIDGE FIXINGS \* CUE LEVER \* POWER 220/240V 50/60Hz \* 390x305mm \* SUPPLIED WITH MOUNTING CUT-OUT TEMPLATE. PRICE £59.99 + £3.50 P&P.

**OPTIONAL MAGNETIC CARTRIDGES**

**STANTON AL500** PRICE £16.99 + 50p P&P  
**GOLDRING G650** PRICE £6.99 + 50p P&P

**OMP MOS-FET POWER AMPLIFIERS, HIGH POWER. TWO CHANNEL 19 INCH RACK**

**THOUSANDS PURCHASED BY PROFESSIONAL USERS**



**NEW MXF SERIES OF POWER AMPLIFIERS**  
**THREE MODELS:- MXF200 (100w + 100w)**  
**MXF400 (200w + 200w) MXF600 (300w + 300w)**

All power ratings R.M.S. into 4 ohms.

**FEATURES:** \* Independent power supplies with two Toroidal Transformers \* Twin L.E.D. Vu meters \* Rotary indexed level controls \* Illuminated on/off switch \* XLR connectors \* Standard 775mV inputs \* Open and short circuit proof \* Latest Mos-Fets for stress free power delivery into virtually any load \* High slew rate \* Very low distortion \* Aluminium cases \* MXF600 Fan Cooled with D.C. Loudspeaker and Thermal Protection.

**USED THE WORLD OVER IN CLUBS, PUBS, CINEMAS, DISCOS ETC.**

**SIZES:-** MXF 200 W19" x H3 1/2" (2U) x D11"  
 MXF 400 W19" x H5 1/4" (3U) x D12"  
 MXF 600 W19" x H5 1/4" (3U) x D13"

**MXF200 £171.35**  
**MXF400 £228.85**  
**MXF600 £322.00**

SECURICOR DELIVERY £12.00 EACH

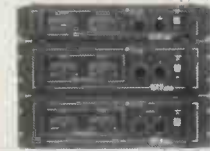

**OMP LINNET LOUDSPEAKERS**

THE VERY BEST IN QUALITY AND VALUE



MADE ESPECIALLY TO SUIT TODAY'S NEED FOR COMPACTNESS WITH HIGH OUTPUT SOUND LEVELS, FINISHED IN HARDWEARING BLACK VYNYDE WITH PROTECTIVE CORNERS, GRILLE AND CARRYING HANDLE INCORPORATES 12" DRIVER PLUS HIGH FREQ. HORN FOR FULL FREQ. RANGE. 45Hz-20KHz BOTH MODELS 8 OHM, SIZE H18" x W15" x D12"

CHOICE OF TWO MODELS

POWER RATINGS QUOTED IN WATTS RMS FOR EACH CABINET

**OMP 12-100 (100W 100dB) PRICE £159.99 PER PAIR**  
**OMP 12-200 (200W 102dB) PRICE £209.99 PER PAIR**

SECURICOR DEL:- £12.00 PER PAIR

**IN CAR STEREO BOOSTER AMPLIFIER**



**TWO SUPERB HIGH POWER CAR STEREO BOOSTER AMPLIFIERS**

150 WATTS (75+75) INTO 4 OHMS  
 300 WATTS (150+150) INTO 4 OHMS  
**FEATURES:-**  
 \* HIGH & LOW INPUT IMPEDANCES  
 \* HIGH & LOW INPUT SENSITIVITIES  
 \* VARIABLE INPUT GAIN CONTROL  
 \* SHORT CIRCUIT OUTPUT PROTECTION  
 \* POWER REQUIREMENT 12V. D.C.  
 PRICES: 150 WATT £43.00  
 300 WATT £95.00 + £3.00 P&P EACH

**PIEZO ELECTRIC TWEETERS-MOTOROLA**

**PIEZO ELECTRIC TWEETERS - MOTOROLA**

Join the Piezo revolution. The low dynamic mass (no voice coil) of a Piezo tweeter produces an improved transient response with a lower distortion level than ordinary dynamic tweeters. As a crossover is not required these units can be added to existing speaker systems of up to 100 watts (more if 2 put in series). **FREE EXPLANATORY LEAFLETS SUPPLIED WITH EACH TWEETER.**

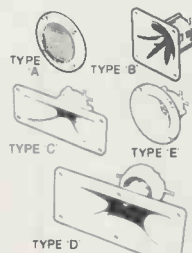

**TYPE 'A' (KSN2036A)** 3" round with protective wire mesh, ideal for bookshelf and medium sized Hi-fi speakers. Price £4.90 each + 50p P&P.  
**TYPE 'B' (KSN1005A)** 3 1/2" super horn. For general purpose speakers, disco and P.A. systems etc. Price £5.99 each + 50p P&P.  
**TYPE 'C' (KSN6016A)** 2" x 5" wide dispersion horn. For quality Hi-fi systems and quality discos etc. Price £6.99 each + 50p P&P.  
**TYPE 'D' (KSN1025A)** 2" x 6" wide dispersion horn. Upper frequency response retained extending down to mid range (2KHz). Suitable for high quality Hi-fi systems and quality discos. Price £9.99 each + 50p P&P.  
**TYPE 'E' (KSN1038A)** 3 1/2" horn tweeter with attractive silver finish trim. Suitable for Hi-fi monitor systems etc. Price £5.99 each + 50p P&P.  
**LEVEL CONTROL** Combines on a recessed mounting plate, level control and cabinet input jack socket. 85x85mm. Price £3.99 + 50p P&P.

**STEREO DISCO MIXER**

**STEREO DISCO MIXER** with 2 x 5 band L & R graphic equalisers and twin 10 segment L.E.D. VU Meters. Many outstanding features 5 inputs with individual faders providing a useful combination of the following:-  
 3 Turntables (Mag). 3 Mics. 4 Line including CD plus Mic with talk over switch Headphone Monitor. Pan Pot L & R. Master Output controls. Output 775mV. Size 360x280x90mm. Supply 220-240v.  
 Price £134.99 - £4.00 P&P

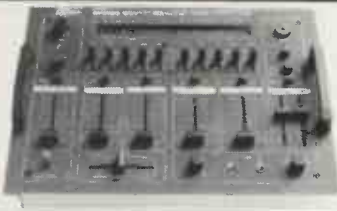

**B. K. ELECTRONICS** Dept EE  
 UNIT 5, COMET WAY, SOUTHEND-ON-SEA, ESSEX. SS2 6TR  
 TEL: 0702-527572 FAX: 0702-420243

POSTAL CHARGES PER ORDER £1.00 MINIMUM OFFICIAL ORDERS WELCOME FROM SCHOOLS, COLLEGES, GOVT. BODIES, ETC. PRICES INCLUSIVE OF V.A.T. SALES COUNTER. VISA ACCESS ACCEPTED BY POST, PHONE OR FAX



# Double Tops

DUAL BAND VHF (45W)/UHF (35W)

FM MOBILE TRANSCEIVER

When only the best is good enough - and

you still want something better...

- ★ **Cross Band Full Duplex**
- ★ **4 Scanning Modes**
- ★ **10 Function Memory Channels**
- ★ **Highly Visible Colour LCD Display**
- ★ **Illuminated Front Panel Controls**
- ★ **5 Channel Spacing Steps**
- ★ **Built-in Duplexer**
- ★ **Function Keys have Unique Audible Tone**
- ★ **Bell Function**
- ★ **Compact & Lightweight**

**ALINCO**  
from MAPLIN  
the authorised  
distributor

**Accessories Included:**

- ★ **Hand-held microphone**
- ★ **Mobile mounting bracket**
- ★ **Mounting hardware**
- ★ **Power cable**



This very high quality 2m/70cm FM dual band mobile transceiver has been specially designed to provide maximum performance and operating convenience in an ultra compact package. An impressive array of features gives maximum flexibility in mobile installations. The transceiver has an output power of 45W (VHF) 35W (UHF) and incorporates a high/low power switch. The unit is provided with 10 programmable memories. Channel spacing is in 5, 10, 12.5, 20 and 25kHz steps. There are four scanning modes:

1. VFO scanning of the entire band.
2. Memory scanning of selected memories.
3. Programmed band scanning of a selected segment of the band.
4. Priority scanning allows selection of a frequency, In VFO or memory, to serve as a priority frequency.

A duplexer is built-in so that when an antenna for both bands is in use, only one feeder cable for the transceiver is necessary.

The unit is supplied with a comprehensive instruction manual. It is illegal to transmit with this unit unless you hold a Radio Amateur's Class B (or A) licence.

Quote Reference **DBT20** £499.95

**PLUS TOP VALUE AMATEUR RADIO VHF FM Handheld 2m Transceiver**

- ★ **Ultra compact, lightweight design**
- ★ **6.5W Output Power (with optional 12V battery pack)**
- ★ **Simple Operation**
- ★ **Easy to See LCD Display**
- ★ **10 Channel Memories**
- ★ **Battery Save**
- ★ **Function Lock**
- ★ **Tone Burst**
- ★ **Amazing Compact Size Only 3x6x17 cm approx.**

A very high quality, lightweight, 2m handheld transceiver, incorporating many useful features. This transceiver is extremely simple to operate, most functions can be performed with one hand!

Quote Reference **AHT20** £219.95

**12V Ni-Cad Battery Pack**

For use with either above hand-held transceivers.  
A 12V 700mAh battery pack with integral DC-DC converter which allows the transceiver to be powered from a car cigarette lighter socket.  
A charger is also available for use with this pack.  
Battery Pack **NBP20** £59.95    Charger **NBC20** £14.95



**VHF/UHF FM Dual Band Handheld Transceiver**

- ★ **6W VHF/5W UHF Output Power (with optional 12V battery pack)**
- ★ **Cross Band Full Duplex Operation**
- ★ **Frequency selection by Direct Keyboard Entry or Step Up/Step Down**
- ★ **Automatic Battery Save Function**
- ★ **20 Memory Channels**
- ★ **Built-in DTMF Keypad and Encoder**
- ★ **Amazing Compact Size Only 3x6x19 cm approx.**

This unit is very compact and is one of the smallest dual band transceivers currently available. With the battery pack supplied output power is 2.5W for VHF and 2W for UHF. Frequency selection is either by direct keypad entry of the required frequency or by using step up/step down buttons in increments/decrements of 5kHz, 100kHz and 1MHz. An automatic battery save (ABS) function will extend battery life considerably. There are 20 memories (10 VHF and 10 UHF) for storing operating, offset and tone frequencies. The scanning facility has a priority function which has the ability to scan between chosen VHF and UHF frequencies. A 10dB RF attenuator is switch selectable and can be used in areas of high RF saturation.

Quote Reference **DHT20** £369.95



**Maplin ELECTRONICS**

P.O. Box 3, Rayleigh, Essex SS6 8LR.

**CREDIT CARD HOTLINE**

**0702 554161**



**PHONE BEFORE 5PM FOR SAME DAY DESPATCH**

or call in at a Maplin store in Birmingham, Bristol, Leeds, Hammersmith, Edgware, Manchester, Nottingham, Newcastle-upon-Tyne, Reading, Southampton and Southend-on-Sea.

Add 75p for carriage on all mail orders. If only ordering a catalogue, just add 50p carriage.  
Subject to availability. Prices may change after May 1st 1990.

**SEE THE COMPLETE RANGE OF TRANSCEIVERS AND LOTS MORE IN OUR BUMPER 580-PAGE CATALOGUE ON SALE NOW AT ALL BRANCHES OF WHSMITH - PRICE £2.25!**