

**EVERYDAY**

*29 Punnet Pl W3*

APRIL 1989

# ELECTRONICS

INCORPORATING ELECTRONICS MONTHLY

*Thain*

£1.40

**FREE! 32 PAGE GREENWELD  
SPRING CATALOGUE SUPPLEMENT**

**INTEGRATED AMPLIFIER**

**ELECTRON USER PORT**

**ROOM THERMOSTAT**

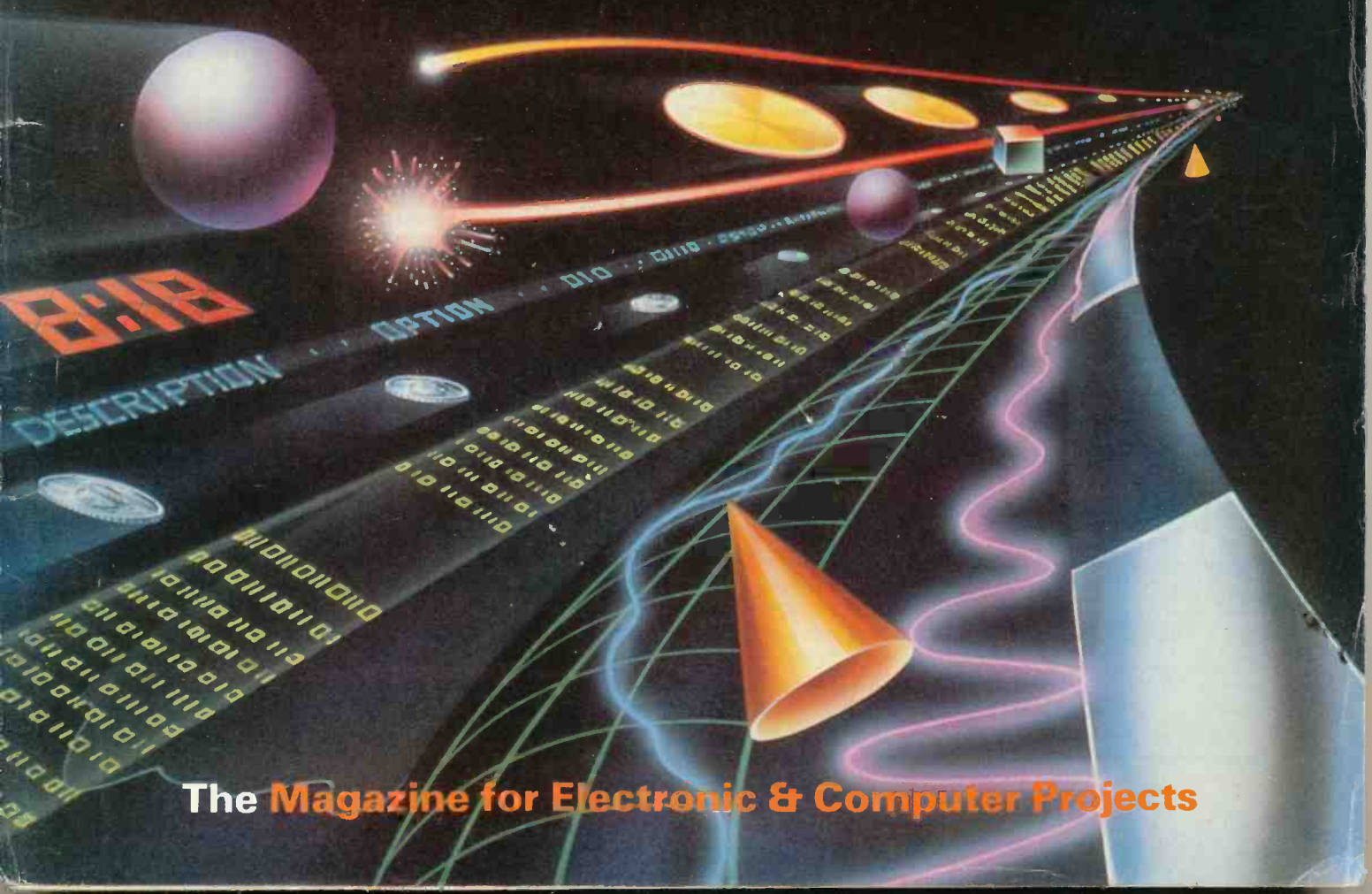

The Magazine for Electronic & Computer Projects



### No. 1 LIST BAKERS DOZEN PACKS

All packs are £1 each, if you order 12 then you are entitled to another free. Please state which one you want. Note the figure on the extreme left of the pack ref number and the next figure is the quantity of items in the pack, finally a short description.

- BD2 5 13A spurs provide a fused outlet to a ring main where devices such as a clock must not be switched off.
- BD7 4 In flex switches with neon on/off lights, saves leaving things switched on.
- BD9 2 6V 1A mains transformers upright mounting with fixed clamps.
- BD11 1 6 1/2in speaker cabinet ideal for extensions, takes our speaker. Ref BD137.
- BD13 12 30 watt reed switches, it's surprising what you can make with these—burglar alarms, secret switches, relay, etc., etc.
- BD22 2 25 watt loudspeaker two unit crossovers.
- BD29 1 B.D.A.C. stereo unit is wonderful value.
- BD30 2 Nicad constant current chargers adapt to charge almost any nicad battery.
- BD32 2 Humidity switches, as the air becomes damper the membrane stretches and operates a microswitch.
- BD42 5 13A rocker switch three tags so on/off, or change over with centre off.
- BD45 1 24hr time switch, ex-Electricity Board, automatically adjust for lengthening and shortening day. Original cost £40 each.
- BD49 10 Neon valves, with series resistor, these make good night lights.
- BD56 1 Mini unselector, one use is for an electric jigsaw puzzle, we give circuit diagram for this. One pulse into motor, moves switch through one pole.
- BD59 2 Flat solenoids—you could make your multi-tester read AC amps with this.
- BD67 1 Suck or blow operated pressure switch, or it can be operated by any low pressure variation such as water level in water tanks.
- BD91 1 Mains operated motors with gearbox. Final speed 16rpm, 2 watt rated.
- BD103A 1 6V 750mA power supply, nicely cased with mains input and 6V output leads.
- BD120 2 Stripper boards, each contains a 400V 2A bridge rectifier and 14 other diodes and rectifiers as well as dozens of condensers, etc.
- BD122 10m Twin screened flex with white pvc cover.
- BD128 10 Very fine drills for pcb boards etc. Normal cost about 80p each.
- BD132 2 Plastic boxes approx 3in cube with square hole through top so ideal for interrupted beam switch.
- BD134 10 Motors for model aeroplanes, spin to start so needs no switch.
- BD139 6 Microphone inserts—magnetic 400 ohm also act as speakers.
- BD148 4 Reed relay kits, you get 16 reed switches and 4 coil sets with notes on making c/o relays and other gadgets.
- BD149 6 Safety cover for 13A sockets—prevent those inquisitive little fingers getting nasty shocks.
- BD180 6 Neon indicators in panel mounting holders with lens.
- BD193 6 5 amp 3 pin flush mounting sockets make a low cost disco panel.
- BD196 1 In flex simmerstat—keeps your soldering iron etc. always at the ready.
- BD199 1 Mains solenoid, very powerful, has 1in pull or could push if modified.
- BD201 8 Keyboard switches—made for computers but have many other applications.
- BD210 4 Transistors type 2N3055, probably the most useful power transistor.
- BD211 1 Electric clock, mains operated, put this in a box and you need never be late.
- BD221 5 12V alarms, make a noise about as loud as a car horn. Slightly soiled but DK.
- BD242 2 6in x 4in speakers, 4 ohm made from Radiomobile so very good quality.
- BD252 1 Panostat, controls output of boiling ring from simmer up boil.
- BD259 50 Leads with push-on 1/4in tags—a must for hook-ups—mains connections etc.
- BD263 2 Oblong push switches for bell or chimes, these can mains up to 5amps so could be foot switch if fitted into pattress.
- BD268 1 Mini 1 watt amp for record player. Will also change speed of record player motor.
- BD283 3 Mild steel boxes approx 3in x 3in x 1in deep—standard electrical.
- BD293 50 Mixed silicon diodes.
- BD305 1 Tubular dynamic mic with optional table rest.

**VERY POWERFUL 12 VOLT MOTORS—1/3rd HORSEPOWER.** Made to drive the Sinclair C5 electric car but adaptable to power a go-kart, a mower, a rail car, model railway, etc. Brand new. Price £15.00 plus £2.00 postage. Our ref 15P8.

**WHITE CEILING SWITCH** 5 amp 2 way surface mounting with cord and tassel. Made by the famous Crabtree Company. Price £1 each. Our ref BD528.

**13A SWITCH SOCKETS** Top quality made by Crabtree, fitted in metal box with cutouts so ideal for garage, workshop, cellar, etc. Price £2 each. Our ref 2P37.

### POWERFUL IONISER

Generates approx. 10 times more IONS than the ET1 and similar circuits. Will refresh your home, office, workshop etc. Makes you feel better and work harder—a complete mains operated kit, case included. £12.50+£2 P&P. Our ref 12P51.

**ULTRA SONIC INTRUDER ALARM.** Small, nicely cased, will detect movement in a room upto 10m x 10m. Ingenious construction makes it independent of the mains; cannot be switched off, even with its on/off switch, until you know the secret, has delayed action enabling you to switch it on and leave the room; it has an inbuilt piezo sander which is very penetrating and high pitched and would frighten away most intruders. Has internal switching and could be coupled to an outdoor alarm if required.

It is the basis of a very efficient burglar alarm, or has other uses. For instance: you could disconnect the internal sander and using the internal switches you would know when somebody arrives without that person being aware that you know. Similarly, the unit could be used to operate other equipment ultra-sonically. It is brand new, guaranteed OK, complete but less battery (PP3 alkaline type). Price is £20 plus £3 insured delivery. Our ref 20P11.

**110 DECIBEL HORN.** For use with the ultra sonic intruder detector. Ideal for external positioning to attract the attention of neighbours should you have an intruder. This unit has its own mounting bracket and comes complete with good length of lead. Price £7. Our ref 7P9. Incidentally, this could also be used as a loudspeaker.

**THREE CAMERAS** All by famous makers, Kodak, etc. One disc and two different instant cameras. All in first class condition, believed to be in perfect working order but sold as untested. You can have them for £10 the three, including VAT, which must be a bargain—if only for the lenses, flash gear, etc. Our ref 10P58.



**ATARI 65XE COMPUTER** At 64K this is most powerful and suitable for home and business. Brand new, complete with PSU, TV lead, owner's manual and six games. Can be yours for only £45 plus £3 insured delivery.

**DATA RECORDERS** ACORN for Acorn Electron, etc., reference number ALF03, with TV lead, manual and PSU. Brand new. Price £10 plus £1.50 post. Order ref 10P44.

**ATARI XC12** for all their home computers. With leads and handbook. Brand new. Price £15 plus £2 post. Order ref 15P20.

**JOYSTICK FOR ATARI OR COMMODORE** for all Atari and Commodore 64 and Vic20. New. Price £5. Order ref 5P126.

**EXTRA SPECIAL OFFER** We will supply the Atari 65XE, data recorder XC12, joystick and six games for £57.50 plus £4 insured delivery.

**SUB-MIN TOGGLE SWITCH** Body size 8mm x 4mm x 7mm SBDT with chrome dolly fixing nuts. 4 for £1. Order Ref. BD649.

**SOUND TO LIGHT UNIT.** Complete kit of parts for a three channel sound to light unit controlling over 2000 watts of lighting. Use this at home if you wish but it is plenty rugged enough for disco work. The unit is housed in an attractive two-tone metal case and has controls for each channel, and a master on/off. The audio input and output are by 1/4in. sockets and three panel mounting fuse holders provide thyristor protection. A four pin plug and socket facilitate ease of connecting lamps. Special price is £14.95 in kit form.

**WALKMAN TYPE PERSONAL STEREO CASSETTE PLAYERS.** These are not second hand but are slightly rarer and may need some attention. All are complete with stereo headphones and are famous makes: Sanyo, Panasonic, Sony, etc. Stereo cassette type, no radio, £5 each. Our ref 5P132.

**SPECIAL OFFER** is ten of the cassette only version, our ref 5P132, for £40. This offer is our ref 40P3.

**RE-CHARGEABLE NICADS 'D' SIZE** These are tagged for easy joining together but tags, being spot welded, are easy to remove. Virtually unused, tested and guaranteed. £2.00 ref 2P141 or 6 wired together for £10.00 ref 10P47.

### LASER TUBE

Made by Philips Electrical. New and unused. This is helium-neon and has a typical power rating of 1.6mW. It emits random polarised light and is completely safe provided you do not look directly into the beam when eye damage could result. DON'T MISS THIS SPECIAL BARGAIN! Price £29.95 plus £3 insured delivery.

**POWER SUPPLY FOR PHILIPS LASER** available in kit form, Price £15 plus £2 postage.

**PAPST AXIAL FAN—MANUFACTURERS REF NO. TPY4580N.**

This is mains operated. 15 watt rating and in a metal frame with metal blades so OK in high temperatures. Body size approx. 4 3/4" square x 1 5/8" thick. £6.00 each, plus £1.00 postage. Our ref 6P6.

**VERY POWERFUL MAGNETS** Although only less than 1" long and not much thicker than a pencil these are very difficult to pull apart. Could be used to operate embedded reed switches, etc. Price 50p each, 2 for £1.00. Ref BD642.



**ORGAN MASTER** is a three octave musical keyboard. It is beautifully made, has gold plated contacts and is complete with ribbon cable and edge connector. Brand new, only £12 plus £3 postage. Our ref. 12P5.

**MUSIC FROM YOUR SPECTRUM 128** We offer the Organ Master three octave keyboard, complete with leads and the interface which plugs into your 128. You can then compose, play, record, store, etc., your own music. Price £19 plus £3 special packing and postage. Order ref. 19P1.

**20A DOUBLE POLE RELAY WITH 12V COIL** complete with mounting brackets, made by the Japanese Omron Company. Price £2 each. Our Ref. 2P173A.

**HAND-HELD VIDEO LAMP.** Mains operated and will enable you to take professional standard videos. Made by the famous Ferguson Company, this uses a 1000v halogen lamp in a fan cooled, hand-held and hand-switched metal housing. Comes complete with optional bar-door assembly and camera bar. Obviously intended to retail at over £60, we offer these at £30 each plus £3 insured delivery. Our ref 30P3.

**AN ALLADIN'S CAVE** We have opened another shop in Hove, the address is number 12 Boundary Road which is between Hove and Portslade fairly close to the seaford. When you want to see before you buy and when you want to browse around the special bargains available, this is where you should make for as the Portland Road shop in future will be just mail order. You can of course collect from Portland Road but you should bring in an order complete with reference numbers so that the stores can attend to it easily.

### J & N BULL ELECTRICAL

Dept. E.E., 250 PORTLAND ROAD, HOVE, BRIGHTON, SUSSEX BN3 50T

**MAIL ORDER TERMS:** Cash, PO or cheque with order. Orders under £20 add £1.50 service charge. Monthly account orders accepted from schools and public companies. Access and B/card orders accepted. Brighton (0273) 734648 or 203500

### POPULAR ITEMS

Some of the many items described in our current list which you will receive if you request it

**DOUBLE MICRODRIVES.** We are pleased to advise you that the Double Microdrives which we were offering at about this time last year as being suitable for the 'QL', 'OPD' and several other computers are again available, same price as before namely £5. Our ref 5P113.

**SOFTWARE FOR REMAKING.** Just arrived. Large quantity of mainly games. All are on normal tape spool in cassette holders and should be suitable for wiping out and re-making into games or programmes of your own design. We offer 5 different for £2 or 100 assorted for £20. Important note: We cannot say which titles you will get nor accept orders for specified titles or 'so many, all different', etc., so only order if you can take them as they come. Order ref 5 for £2 is 2P224, 100 assorted is 20P10.

**VERY USEFUL MAGNETS.** Flat, about 1in long, 1/2in wide and 1/4in thick. These are polarised on their faces which makes them ideal to operate reed switches in doors and windows or to hold papers or labels, etc., to metal cabinets, or even to keep cupboard doors firmly closed. Very powerful. 6 for £1. Our ref BD274(a).

**9in MONITOR** made for ICL, uses Philips black and white tube. Brand new and complete but uncased. £16.00 plus £5.00 post.

**ACORN COMPUTER DATA RECORDER REF ALF03** Made for the Electron or BBC computers but suitable for most others. Complete with mains adaptor, leads and handbook. £10.00. Ref 10P44.

**FREE POWER!** Can be yours if you use our solar cells—sturdily made modules with new system bubble magnifiers to concentrate the light and so eliminate the need for actual sunshine—they work just as well in bright light. Voltage input is 45—you join in series to get desired voltage—and in parallel for more amps. Module A gives 100mA, Price £1, Our ref. BD631. Module C gives 400mA, Price £2, Our ref. 2P199. Module D gives 700mA, Price £3, Our ref. 3P42.

**SOLAR POWERED NI-CAD CHARGER 4 Ni-Cad batteries AA (HP7) charged in eight hours or two in only 4 hours. It is a complete, boxed ready to use unit. Price £5. Our ref. 6P3.**

**SWITCH AC LOADS WITH YOUR COMPUTER** This is easy and reliable if you use our solid state relay. This has no moving parts, has high input resistance and acts as a noise barrier and provides 4kW isolation between logic terminals. The turn-on voltage is not critical, anything between 3 and 30V, internal resistance is about 1 ohm. AC loads up to 10A can be switched. Price is £2 each. Ref. 2P183.

**METAL PROJECT BOX** Ideal size for battery charger, power supply, etc.; sprayed grey, size 8in x 4 1/4in x 4 1/2in high, ends are louvred for ventilation other sides are flat and undrilled. Price £2. Order ref. 2P191.

**BIG SMOOTHING CAPACITOR.** Sprague powerlytic 39,000uF at 50V. £3. Our ref. 3P41.

**4-CORE FLEX CABLE.** Cores separately insulated and grey PVC covered overall. Each copper core size 7/32mm. Ideal for long telephone runs or similar applications even at mains voltage. 20 metres £2. Our ref 2P196 or 100 metres coil £8. Order ref. 8P19.

**6-CORE FLEX CABLE.** Description same as the 4-core above. Price 15 metres for £2. Our ref. 2P197 or 100 metres £9. Our ref. 9P1

**TWIN GANG TUNING CAPACITOR.** Each section is 0.005uF with trimmers and good length 1/4in spindle. £1 each. Our ref BD630.

**13A PLUGS** Pins sleeved for extra safety, parcel of 5 for £2. Order ref. 2P185.

**13A ADAPTERS** Takes 2 13A plugs, packet of 3 for £2. Order ref. 2P187.

**20V-0-20V Mains transformers** 2 1/2 amp (100 watt) loading, tapped primary. 200-245 upright mountings £4. Order ref. 4P24.

**BURGLAR ALARM BELL—6" gong OK** for outside use if protected from rain. 12V battery operated. Price £8. Ref. 8P2.

**VERY RELIABLE CAPACITOR** 4.7u 400v not electrolytic so not polarised, potted in all can, size 1 3/4x3/4x1 1/2in high. A top grade capacitor made for high class instrument work. Ideal for PCB mounting. 2 for £1. Our ref BD667.

**USEFUL MAINS TRANSFORMER** Upright mounting, normal tapped primary, has two secondaries. One gives 20v at 1.5amps if used alone, or the other gives 10V at 3amps if used alone. Join the two in series for 30v at 1 amp. Price £2. Our ref 2P214.

**CAPACITOR BARGAIN—axial ended, 4700uF at 25V.** Jap made, normally 50p each, you get 4 for £1. Our ref. 613.

**SINGLE SCREENED FLEX** 7.02 copper conductors, pvc insulated then with copper screen, finally outer insulation. In fact quite normal screened flex. 10m for £1. Our ref BD668. Ditto, but solid conductor. 10m for £1. Our ref BD668a.

**M.E.S. BULB HOLDERS** Circular base batten type fitting. 4 for £1. Our ref BD127a.

**SPRING LOADED TEST PRODS—Heavy duty,** made by the famous Bulgin company. very good quality. Price 4 for £1. Ref. BD597.

**TELEPHONES.** We have just received a consignment of desk telephones, rotary dial type, in good working order and in new condition. We offer these at £5 each plus £2 special packing and postage. This model would have the connecting lead with four tags for going into the old type junction box. Our ref 5P134. Or for £6 you can have the same telephone but with the new flat BT type plug fitted. Our ref 6P10.

**3-CORE FLEX BARGAIN NO. 1—Core size 5mm** so ideal for long extension leads carrying up to 5 amps or short leads up to 10 amps. 15mm for £2. Ref. 2P189.

**3-CORE FLEX BARGAIN NO. 2—Core size 1.25mm** so suitable for long extension leads carrying up to 13 amps, or short leads up to 25A. 10m for £2. Ref. 2P190.

**ALPHA-NUMERIC KEYBOARD—This keyboard has 73 keys** giving trouble free life and no contact bounce. The keys are arranged in two groups, the main area is a QWERTY array and on the right is a 15 key number pad, board size is approx. 13" x 4"—brand new but offered at only a fraction of its cost, namely £3, plus £1 post. Ref. 3P27.

**WIRE BARGAIN—500 metres** 0.7mm solid copper tinned and p.v.c. covered. Only £3 plus £1 post. Ref. 3P31—that's well under 1p per metre, and this wire is ideal for push on connections.

**1/8th HORSEPOWER 12 VOLT MOTOR** Made by Smiths, the body length of this is approximately 3in, the diameter 3in and the spindle 5/16th of an inch diameter. It has a centre flange for fixing or can be fixed from the end by means of 2 nuts. A very powerful little motor which revs at 3,000rpm. We have a large quantity of them so if you have any projects in mind then you could rely on supplies for at least two years. Price £6. Our ref 6P1, discount for quantities of 10 or more.

**FDD BARGAIN.** 3 1/2in made by Chinson of Japan. Single sided, 80 track, Shugart compatible interface, interchangeable with most other 3 1/2in and 5 1/4in drives. Completely cased with 4 pin power lead and 34 pin computer lead. Price £40. Our ref 40P1.

# EVERYDAY ELECTRONICS

INCORPORATING ELECTRONICS MONTHLY

ABC

MEMBER OF THE IEE

VOL 18 No 4 APRIL 1989

The Magazine for Electronic & Computer Projects

ISSN 0262-3617

PROJECTS... THEORY... NEWS...  
COMMENT... POPULAR FEATURES...

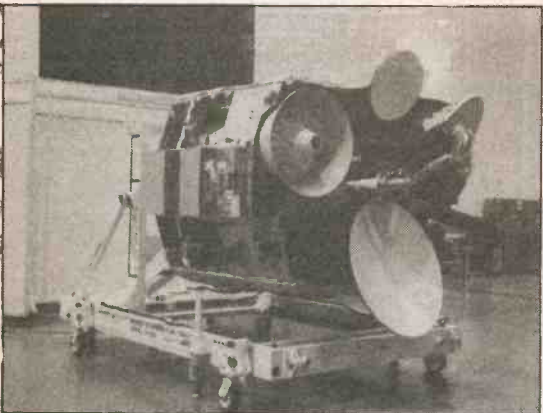
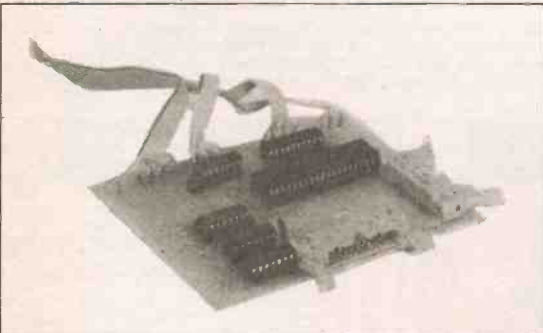
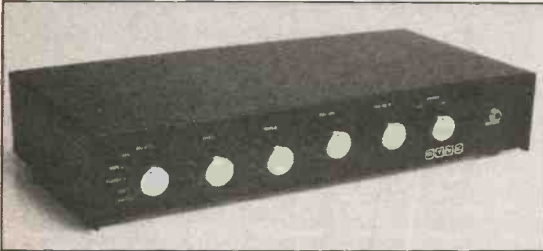

© Wimborne Publishing Ltd 1989. Copyright in all drawings, photographs and articles published in EVERYDAY ELECTRONICS is fully protected, and reproduction or imitations in whole or in part are expressly forbidden.

Our May '89 Issue will be published on Friday, April 7, 1989. See page 219 for details.  
Everyday Electronics, April 1989

## Projects

- INTEGRATED AMPLIFIER** 226  
A low cost, high quality amplifier providing up to 30W r.m.s. power output
- LIGHT SENTINEL** by Michael Perrow 232  
Discourage would-be intruders
- ROOM THERMOSTAT** by A. R. McCrae 246  
Improve the comfort of your home. Fully controllable from 10°C to 25°C
- AUTO FADER INTERFACE** by Andy Flind 256  
This final companion for the 4-Channel Light Dimmer will produce slow, continuous changes in the brilliance of coloured lamps automatically
- ELECTRON USER PORT** by Robert Penfold 266  
An easy to build expansion board that will accept many BBC Micro add-on projects

## Series

- INTRODUCING DIGITAL ELECTRONICS**  
by Michael Cockcroft 238  
Part Seven: Resistors and Resistance
- ON SPEC** by Mike Tooley 254  
Readers Sinclair Spectrum page
- ACTUALLY DOING IT** by Robert Penfold 262  
Finishing off
- BBC MICRO** by R. A. & J. W. Penfold 272  
Regular spot for BEEB fanatics
- ROBOT ROUNDUP** by Nigel Clark 278  
Investigating the world of robotics
- AMATEUR RADIO** by Tony Smith G4FA1 279  
Primary and Secondary Frequencies; AMTOR; High Marks

## Features

- EDITORIAL** 255
- SATELLITE BROADCASTING** by Barry Fox 250  
Report on the launching of Astra and Skynet commercial and military satellites
- FOR YOUR ENTERTAINMENT** by Barry Fox 261  
New Jargon; Installation Guide to the Stars
- PLEASE TAKE NOTE** 261  
Fire Alarm
- SHOPTALK** by David Barrington 264  
Product news and component buying
- DIRECT BOOK SERVICE** 274  
Special service to EE readers
- PRINTED CIRCUIT BOARD SERVICE** 280
- DOWN TO EARTH** by George Hylton 282  
Ultrasonic Transducers; Quartz Analogy
- MARKET PLACE** 283  
Free reader's buy and sell spot
- ADVERTISER'S INDEX** 288

## FREE

**GREENWELD 32-page SPRING CATALOGUE SUPPLEMENT**  
(between pages 252 & 253)

Readers' Services • Editorial and Advertisement Departments

# MAGENTA ELECTRONICS Ltd.

## A SELECTION OF OUR BEST PROJECT KITS

As usual these kits come complete with printed circuit boards, cases, all components, nuts, screws, wire etc. All have been tested by our engineers (many of them are our own designs) to ensure that you get excellent results.

### INSULATION TESTER

An electronic High Voltage tester for mains appliances and wiring. An inverter circuit produces 500 volts from a PP3 battery and applies it to the circuit under test. Reads insulation up to 100 Megohms. Completely safe in use.

**OUR KIT REF 444 £19.58**



### DIGITAL CAPACITANCE METER

Simple and accurate (1%) measurements of capacitors from a few pF up to 1,000 uF. Clear 5 digit LED display indicates exact value. Three ranges — pF, nF, and uF. Just connect the capacitor, press the button and read the value.

**£41.55  
OUR KIT  
REF 493**



### MOSFET VARIABLE BENCH 25V 2.5A POWER SUPPLY



**OUR KIT REF. 769 £49.73**

A superb design giving 0-25V and 0-2.5A. Twin panel meters indicate Voltage and Current. Voltage is variable from zero to 25V. Current-Limit control allows Constant Current charging of NICAD batteries, and protects circuits from overload. A Toroidal transformer MOSFET power output device, and Quad op-amp IC design give excellent performance.

### DIGITAL FREQUENCY 200 MHz METER

**KIT REF 563 £62.98**

An 8 digit meter reading from A.F. up to 200 MHz in two ranges. Large 0.5" Red LED display. Ideal for AF and RF measurements. Amateur and C.B. frequencies.



### 'EQUALISER' IONISER



**KIT REF 707 £15.53**

A mains powered Ioniser that produces a breeze of negative ions in the air. A compact, safe, simple unit that uses a negligible amount of electricity.

### 3 BAND SHORTWAVE RADIO



**OUR KIT  
REF 718 £26.53**

Covers 1.6-30 MHz in 3 bands using modern miniature coils. Audio output is via a built-in loudspeaker. Advanced design gives excellent stability, sensitivity and selectivity. Simple to build.

### SUPER SOUND- EFFECTS GENERATOR

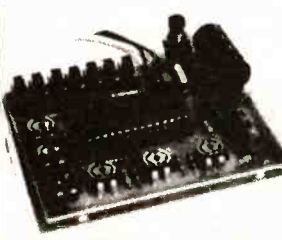

A wide range SN76477 sound effects board giving: Bird Chirps, Sirens, Helicopters, Explosions, Phaser Guns, Steam Train sounds, and more. Supplied without a case.

**KIT REF 781 £12.99**

### VISUAL GUITAR TUNER



Crystal controlled, with a super rotating LED display, indicates high, low, and exact degree of mistuning. Use with pick-up or mic. Also has audible output.

**KIT REF E711 £21.99**

## TOP KITS

**COMPONENTS, KITS, BOOKS, TOOLS,  
MOTORS, GEARS, PULLEYS, OPTICAL  
FIBRES, ROBOTICS, AND MUCH MUCH  
MORE—IN OUR  
NEW CATALOGUE £1.00**

## PROJECT KITS FOR E.E. (Just a selection more in our catalogue)

Magenta supply Full Kits: Including PCB's (or Stripboard), Hardware, Components, and Cases (unless stated). Please state Kit Reference Number, Kit Title, and Price, when ordering. REPRINTS: If you do not have the issue of E.E. which includes the project, you will need to order the instruction reprint as an extra: 80p each. Reprints are also available separately—Send £1 in stamps.

REF NO.	KIT-TITLE	PRICE	REF NO.	KIT-TITLE	PRICE
811	MIDI PEDAL Mar 89	£39.98	581	VIDEO GUARD Feb 87	£8.39
810	MIDI MERGE Mar 89	£11.59	584	SPECTRUM SPEECH SYNTH. (no case) Feb 87	£20.92
809	CALL ALERT Mar 89	£13.51	578	SPECTRUM I/O PORT less case Feb 87	£9.44
807	MINI PSU Feb 89	£22.71	569	CAR ALARM Dec 86	£12.47
806	CONTINUITY TESTER Feb 89	£10.28	563	200MHz DIG. FREQUENCY METER Nov 86	£62.98
505	4 CHANNEL LIGHT DIMMER Feb 89	£37.99	561	LIGHT RIDER LABEL BADGE Oct 86	£10.20
803	REACTION TIMER Dec. 88	£29.98	550	LIGHT RIDER DISCO VERSION	£19.82
802	PHASOR (Light Controller) Dec 88	£25.61	559	LIGHT RIDER 16 LED VERSION	£13.64
801	DOWNBEAT METRONOME Dec 88	£17.57	556	INFRA-RED BEAM ALARM Sept 86	£28.35
800	SPECTRUM EPROM PROGRAMMER Dec 88	£26.97	544	TILT ALARM July 86	£7.82
796	SEASHELL SYNTHESISER Nov 88	£24.99	542	PERSONAL RADIO June 86	£11.53
795	I.R. OBJECT COUNTER Nov 88	£29.83	528	PA AMPLIFIER May 86	£26.95
790	EPROM ERASER Oct 88	£24.95	523	STEREO REVERB Apr 86	£26.44
786	UNIVERSAL NICAD CHARGER July 88	£8.99	513	BBC MIDI INTERFACE Mar 86	£27.94
781	SUPER SOUND EFFECTS GENERATOR May 88	£12.99	512	MAINS TESTER & FUSE FINDER Mar 86	£8.82
780	CABLE & PIPE LOCATOR April 88	£15.35	497	MUSICAL DOOR BELL Jan 86	£18.72
775	ENVELOPE SHAPER Mar 88	£14.99	493	DIGITAL CAPACITANCE METER Dec 85	£41.55
769	VARIABLE 25V-2A BENCH POWER SUPPLY Feb 88	£49.73	481	SOLDERING IRON CONTROLLER Oct 85	£5.47
768	CAR LAMP CHECKING SYST. Feb 88	£7.10	464	STEPPER MOTOR INTERFACE FOR THE BBC	£11.68
763	AUDIO SIGNAL GENERATOR Dec 87	£13.64	COMPUTER less case Aug 85		£14.50
739	ACCENTED BEAT METRONOME Nov 87	£20.95	1D35 STEPPER MOTOR EXTRA		£5.14
740	ACOUSTIC PROBE Nov 87 (less bolt & probe)	£16.26	OPTIONAL POWER SUPPLY PARTS		£6.20
744	VIDEO CONTROLLER Oct 87	£29.14	461	CONTINUITY TESTER July 85	£6.20
745	TRANSTEST Oct 87	£9.70	455	ELECTRONIC DOORBELL June 85	£7.56
734	AUTOMATIC PORCH LIGHT Oct 87	£17.17	453	GRAPHIC EQUALISER June 85	£26.94
736	STATIC MONITOR Oct 87	£8.66	444	INSULATION TESTER Apr 85	£19.58
723	ELECTRONIC MULTIMETER Sept 87	£46.96	430	SPECTRUM AMPLIFIER Jan 85	£6.91
728	PERSONAL STEREO AMP Sept 87	£14.31	392	BBC MICRO AUDIO STORAGE SCOPE	£36.25
730	BURST-FIRE MAINS CONTROLLER Sept 87	£13.57	INTERFACE Nov 84		£5.53
724	SUPER SOUND ADAPTOR Aug 87	£38.39	387	MAINS CABLE DETECTOR Oct 84	£8.68
718	3 BAND 1.6-300MHz RADIO Aug 87	£26.53	362	VARI-CAP AM RADIO May 84	£13.15
719	BUCCANEER I.B. METAL DETECTOR inc. coils and case, less handle and hardware July 87	£26.45	337	BIOLOGICAL AMPLIFIER Jan 84	£24.14
720	DIGITAL COUNTER/FREQ METER (10MHz) inc. case July 87	£67.07	263	BUZZ OFF Mar 83	£5.68
722	FERMOSTAT July 87	£12.14	242	2-WAY INTERCOM no case July 82	£5.69
711	VISUAL GUITAR TUNER Jun 87	£22.99	240	EGG TIMER June 82	£6.86
715	MINI DISCO LIGHT Jun 87	£12.59	205	SUSTAIN UNIT Oct 81	£17.63
707	EQUALIZER IONISER May 87	£15.53	108	IN SITU TRANSISTOR TESTER Jun 78	£9.42
700	ACTIVE I/R BURGLAR ALARM Mar 87	£35.65	106	WEIRD SOUND EFFECTS GEN Mar 78	£7.82
			101	ELECTRONIC DICE Mar 77	£6.26



EE75 135 HUNTER STREET  
BURTON-ON-TRENT, STAFS DE14 2ST  
ADD £1.00 P&P TO ALL ORDERS

PRICES INCLUDE VAT  
SHOP OPEN 9-5 MON-FRI  
OFFICIAL ORDERS WELCOME

**0283 65435**

# 2 FREE CIRCUIT CARDS

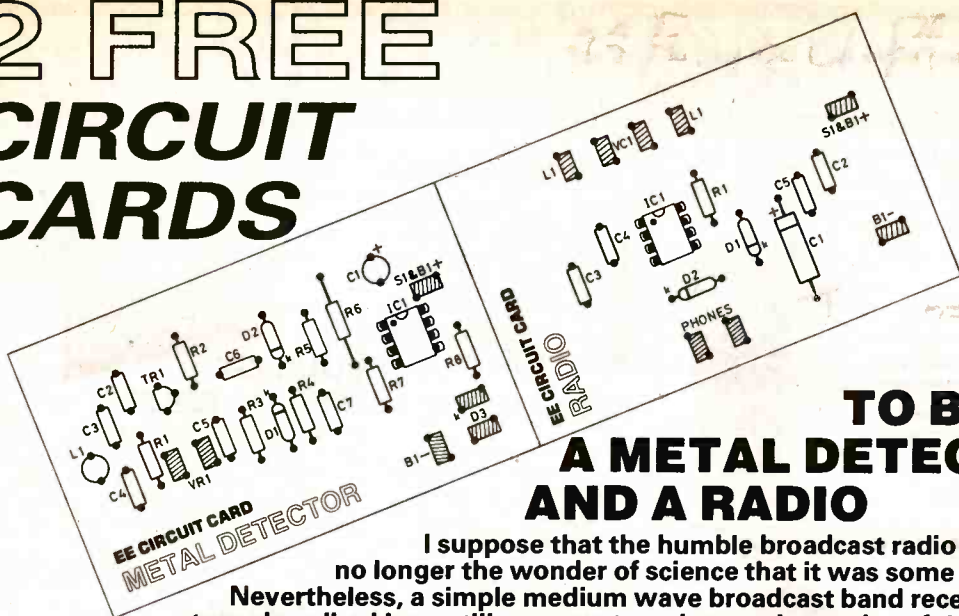

## TO BUILD A METAL DETECTOR AND A RADIO

I suppose that the humble broadcast radio receiver is no longer the wonder of science that it was some years ago. Nevertheless, a simple medium wave broadcast band receiver of the type described here still represents an interesting and useful project for the electronics hobbyist. This simple design is for use with medium impedance headphones (the type sold as replacements for personal stereo units) and should provide good reception of several stations in most areas.

Metal detectors have a multitude of uses, but I suppose that for the amateur user they are either "treasure" locators or used for detecting pipes, wires, screws, etc. in walls when doing a spot of do-it-yourself. This metal detector is intended for the second of these applications. Although it is extremely simple and can be constructed at very low cost, its level of performance is quite good.

## HI-FI SPEAKER DESIGN

Surprising though it is we have never published a hi-fi speaker design in EE. Next month we will put this right with a quite exceptional speaker system.

## PET SCARER

Keep the neighbours (or your own) pets off your seeds or away from you with this high power ultrasonic sound generator. It's inaudible to humans so creates no noise pollution problems.



# EVERYDAY ELECTRONICS

MAY ISSUE ON SALE APRIL 7

EE  
ELECTRONICS

# HIGH GRADE COMPONENT PARCELS

**EVERYTHING  
MUST  
GO!**

## UNIVERSAL EVERYTHING PARCEL

This one contains some of just about any component you care to name! There are passives (resistors, capacitors, tants, presets), oplo devices (couplers, LEDs of all shapes and sizes, infra-red components, 7-segment displays), semiconductors (transistors, diodes, ICs, rectifiers), and all kinds of other odds and ends (relays, VDRs, neons, battery connectors, mixed components packs). A stunning range of components – enough to get a workshop or lab. started – at a ridiculously low price.

The components are of excellent quality, in packs originally intended to sell at £1 each. To make sure you get a good variety, the 20-pack parcel will have no more than two of any one pack, the 100 pack parcel will have at most five of any one pack. Packs supplied as they come – our choice.

**PARCEL 1A: 20 PACKS for £10 + VAT**  
**PARCEL 1B: 100 PACKS for £39! + VAT**



## INTEGRATED CIRCUITS

This parcel contains nothing but ICs. The mixture offers TTL and CMOS logic, interface ICs, linear, data converters, op-amps, special functions, and so on. Some of the ICs are pre-packed with data sheets, some (TTL, CMOS, op-amps) we expect you to identify for yourself, others will be covered by the free *data pack* provided, and the rest you'll have to identify under your own steam. If you know your ICs you'll be in for a few nice surprises.

**PARCEL 3A: 100 ICs for £12! + VAT**  
**PARCEL 3B:  
500 ICs for £49!  
+ VAT**

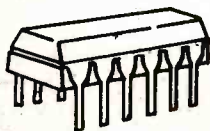

## ELECTROLYTICS

A first class selection of good, modern electrolytics. The mixture ranges from small coupling caps up to huge power supply electrolytics – you'll be hard pressed to find any value between 1 $\mu$ F and 2200 $\mu$ F that isn't represented. A wide range of very useful components. Go for it!

**PARCEL 5A:  
1000 ELECTROLYTICS for £8 + VAT**  
**PARCEL 5B:  
2500 ELECTROLYTICS for £16 + VAT**



## TANTALUM CAPACITORS

A nice range of tants in values up to 47 $\mu$ F. Lots of useful caps, and we're not mean with the most expensive ones. A fine selection.

**PARCEL 4A: 100 TANTS for £6.80 + VAT**  
**PARCEL 4B: 500 TANTS for £29! + VAT**



## TRANSISTORS

A mix of general purpose silicon transistors, mostly bipolar NPN and PNP, with a few FETs and unijunctions thrown in (when available) to spice the mixture. The contents vary from month to month – at the moment there are BC212s, BC213s, BC548s, BC238Bs, MTJ210s, and so on. Next month – who knows? All top quality components.

**PARCEL 6A:  
200 TRANSISTORS for £7.80! + VAT**



Unless otherwise stated, all the clearance parcels we offer contain brand new, top grade components. If some of the offers look too good to be true, all I can say is that the optimists will get some stunning bargains, the cynics will never know what they've missed, so everybody will be happy! All offers apply only while current stocks last – watch out for next month's parcels or, better still, be the first to hear about any new offers by putting your name on our mailing list. (Please write in, or phone Pete Leah on 0272 522703 after 6.30 pm).

## MASSIVE CLEARANCE SALE

Once again, a general purpose parcel containing a huge variety of components: resistors, capacitors, ICs, transistors, electrolytics, tants, triacs, LEDs, diodes, thermistors, trimmers, VDRs, all sorts. All new, top quality components. This is mostly remainders from our own stock – stuff we forgot to advertise, or have in too small a quantity to sell individually. Guaranteed to be worth at least eight times the price if valued from any standard component catalogue! What more can I say?

**PARCEL 2A: 1000+ top grade components for £12! + VAT  
(Value £100+)**  
**PARCEL 2B: 5000+ top grade components for £49! + VAT  
(Value £500+)**



## LEDs

All shapes, sizes and colours of LEDs. Round ones in various sizes, rectangular ones, red, green, amber and yellow ones, clear and tinted lenses, all sorts.

**PARCEL 7A: 100 LEDs for £5.90 + VAT**  
**PARCEL 7B: 500 LEDs for £24.90 + VAT**

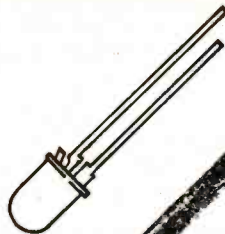

## CAPACITORS

An exciting selection of capacitors. There are ceramics for decoupling and general use, Polystyrenes for high performance circuits, dipped and moulded polyesters in values from a few nF up to 2.2 $\mu$ F (very expensive!), tants and aluminium electrolytics – just about any capacitor you'll ever need. Don't miss this one!

**PARCEL 8A:  
1000 CAPACITORS for £6.50 + VAT**

**PARCEL 8B:  
2500 CAPACITORS  
for £14.90 + VAT**



X

## UK Orders:

Please add £2.50 towards postage and packing and 15% VAT to the total

## Europe and Eire:

Please add £6.00 carriage and insurance. No VAT

## Outside Europe:

Please add £12.00 carriage and insurance. No VAT

# HIGHGRADE COMPONENTS LTD

Unit 111, 8 Woburn Road, Eastville, Bristol BS5 6TT

# HART

HART ELECTRONICS are specialist producers of kits for designs by JOHN LINSLEY-HOOD. All kits are APPROVED by the designer.

### LINSLEY-HOOD CASSETTE RECORDER CIRCUITS

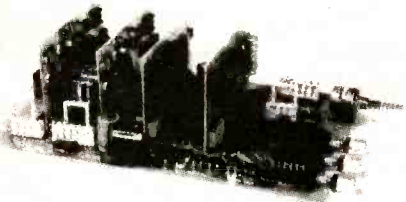

Complete record and replay circuits for very high quality low noise stereo cassette recorder. Circuits are optimised for our HS16 Super Quality Sendust Alloy Head. Switched bias and equalisation to cater for chrome and ferric tapes. Very easy to assemble on plug-in PCBs. Complete with full instructions.

Complete Stereo Record/Play Kit ..... £33.70  
VU Meters to suit ..... £2.30 each  
Reprints of original Articles ..... 75p no VAT  
Rc3X Stereo Mic Amplifier ..... £8.70

### LINSLEY HOOD 300 SERIES AMPLIFIER KITS

Superb integrated amplifier kits derived from John Linsley-Hood's articles in 'Hi-Fi News'. Ultra easy assembly and set-up with sound quality to please the most discerning listener. Ideal basis for any domestic sound system if quality matters to you. Buy the kit complete and save pounds off the individual component price.

K300-35 35 Watt Discount price for Complete Kit ..... £98.79  
K300-45 45 Watt Discount price for Complete Kit ..... £102.36  
RLH4&S Reprints of Original Articles from 'Hi-Fi News' ..... £1.05 no VAT

### LINSLEY-HOOD SUPER HIGH QUALITY AM/FM TUNER SYSTEM.

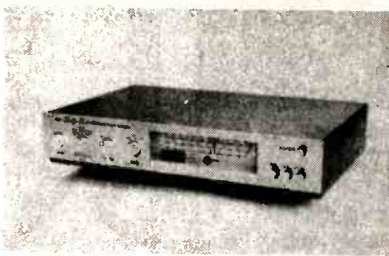

Our very latest kit for the discerning enthusiast of quality sound and an exotic feast for lovers of designs by John Linsley-Hood. A combination of his ultra high quality FM tuner and stereo decoder described in "ELECTRONICS TODAY INTERNATIONAL" and the Synchrodyne AM receiver described in "Wireless World". The complete unit is cased to match our 300 Series amplifiers. Novel circuit features in the FM section to include ready built pre-aligned front-end, phase locked loop demodulator with a response down to DC and advanced sample and hold stereo decoder together make a tuner which sounds better than the best of the high-priced exotica but, thanks to HART engineering, remains easy to build. The Synchrodyne section with its selectable bandwidth provides the best possible results from Long and Medium wave channels, so necessary in these days of split programming. If you want the very best in real HiFi listening then this is the tuner for you. Since all components are selected by the designer to give the very best sound this tuner is not cheap, but in terms of it's sound it is incredible value for money. To cater for all needs four versions are available with variations up to the top of the range full AM/FM model, with any unit being upgradeable at any time. Send for our fully illustrated details.

**DIGITAL ELECTRONICS COURSE**  
Send for your **FREE** list of the tools and components you will need for this exciting new series.

With every set of course components purchased we give a **free £5 discount voucher**, valid for six months.

### HIGH QUALITY REPLACEMENT CASSETTE HEADS



Do your tapes lack treble? A worn head could be the problem. Fitting one of our replacement heads could restore performance to better than new! Standard mountings make fitting easy and our TC1 Test Cassette helps you set the azimuth spot-on. We are the actual importers which means you get the benefit of lower prices for prime parts. Compare us with other suppliers and see! The following is a list of our most popular heads, all are suitable for use on Dolby machines and are ex-stock.

HC20 Permalloy Stereo Head. This is the standard head fitted as original equipment on most decks ..... £7.66  
HS16 Sendust Alloy Super Head. The best head we can find. Longer life than Permalloy, higher output than Ferrite, fantastic frequency response ..... £14.66  
HQ551 4-Track Head for auto-reverse or quadrophonic use. Full specification record and playback head ..... £14.60  
HX100 Stereo Permalloy R/P head. Special Offer £2.49  
MA481 2/2 Language Lab R/P head ..... £13.35  
SM166 2/2 Erase Head. Standard mounting, AC type ..... £8.85  
SM150 2/2 Erase Head. DC Type ..... £3.60  
HC751E 4/4 Erase Head for Portastudio etc. .... £6.60  
Full specifications of these and other special purpose heads in our lists.

### HART TRIPLE-PURPOSE TEST CASSETTE TC1

One inexpensive test cassette enables you to set up VU level, head azimuth and tape speed. Invaluable when fitting new heads. Only £4.66 plus VAT and 50p postage.

Tape Head De-magnetiser. Handy size mains operated unit prevents build up of residual head magnetisation causing noise on playback ..... £4.54  
Curved Pole Type for inaccessible heads ..... £4.85

Send for your free copy of our **LISTS**. Overseas please send 2 IRCs to cover surface Post of 3 IRCs for Airmail.

Please add part cost of post, packing and insurance as follows:

**INLAND**  
Orders up to £10 - 50p  
Orders £10 to £49 - £1  
Orders over £50 - £1.50

**OVERSEAS**  
Please send sufficient to cover Surface or Air Post as required.

# HART

HART ELECTRONICS LTD.  
8 PERRY LANE MILL  
OSWESTRY, SHROPSHIRE  
SY10 9AF

Personal callers are always very welcome but please note that we are closed all day Saturday

24hr SALES LINE  
(0691) 652894

ALL PRICES EXCLUDE VAT UNLESS STATED

## The Archer Z80 SBC

The SDS ARCHER - The Z80 based single board computer chosen by professionals and OEM users.

- ★ Top quality board with 4 parallel and 2 serial ports, counter-timers, power-fail interrupt, watchdog timer, EPROM & battery backed RAM.
- ★ **OPTIONS:** on board power supply, smart case, ROMable BASIC, Debug Monitor, wide range of I/O & memory extension cards.

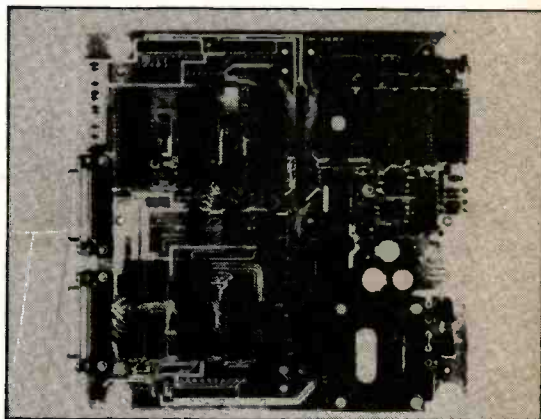

## The Bowman 68000 SBC

The SDS BOWMAN - The 68000 based single board computer for advanced high speed applications.

- ★ Extended double Eurocard with 2 parallel & 2 serial ports, battery backed CMOS RAM, EPROM, 2 counter-timers, watchdog timer, powerfail interrupt, & an optional zero wait state half megabyte D-RAM.
- ★ Extended width versions with on board power supply and case.

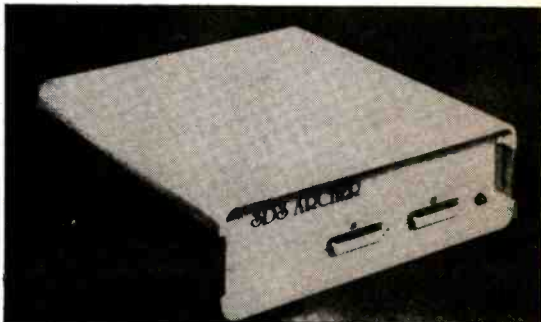

## Sherwood Data Systems Ltd

Sherwood House, Unit 6, York Way, Cressex Industrial Estate, High Wycombe, Bucks HP12 3PY. Tel: 0494 464264



## The UK Distributor for Standard Toroidal Transformers

- \* 106 types available from stock
- \* Sizes from 15VA to 625VA
- \* Dual 120v primaries allowing 110/120v or 220/240v operation

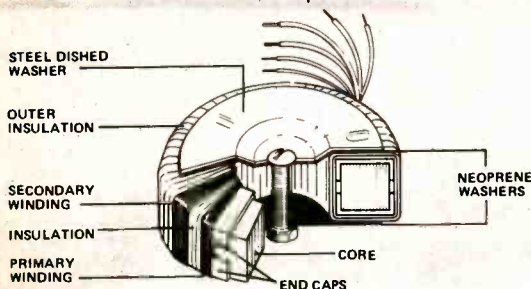

TYPE	SERIES NO.	SEC VOLTS	RMS CURRENT	TYPE	SERIES NO.	SEC VOLTS	RMS CURRENT
15VA £9.30	03010	6+6	1.25	160VA £16.85	53011	9+9	8.89
	03011	9+9	0.83		53012	12+12	6.66
	03012	12+12	0.63		53013	15+15	5.33
	03013	15+15	0.50		53014	18+18	4.44
	03014	18+18	0.42		53015	22+22	3.63
	03015	22+22	0.34		53016	25+25	3.20
	03016	25+25	0.30		53017	30+30	2.66
	03017	30+30	0.25		53018	35+35	2.28
30VA £10.60	13010	6+6	2.50	53026	40+40	2.00	
	13011	9+9	1.66	53028	110	1.45	
	13012	12+12	1.25	53029	220	0.72	
	13013	15+15	1.00	53030	240	0.66	
	13014	18+18	0.83	225VA £18.40	63012	12+12	9.38
	13015	22+22	0.68		63013	15+15	7.50
13016	25+25	0.60	63014		18+18	6.25	
13017	30+30	0.50	63015		22+22	5.11	
50VA £12.20	23010	6+6	4.16		63016	25+25	4.50
	23011	9+9	2.77		63017	30+30	3.75
	23012	12+12	2.08	63018	35+35	3.21	
	23013	15+15	1.66	63026	40+40	2.81	
	23014	18+18	1.38	63025	45+45	2.50	
	23015	22+22	1.13	63033	50+50	2.25	
	23016	25+25	1.00	63028	110	2.04	
	23017	30+30	0.83	63029	220	1.02	
	23028	110	0.45	63030	240	0.93	
	23029	220	0.22	300VA £20.10	73013	15+15	10.0
23030	240	0.20	73014		18+18	8.33	
80VA £13.50	33010	6+6	6.66		73015	22+22	6.82
	33011	9+9	4.44		73016	25+25	6.00
	33012	12+12	3.33		73017	30+30	5.00
	33013	15+15	2.66		73018	35+35	4.28
	33014	18+18	2.22	73026	40+40	3.75	
	33015	22+22	1.81	73025	45+45	3.33	
	33016	25+25	1.60	73033	50+50	3.00	
	33017	30+30	1.33	73028	110	2.72	
	33028	110	0.72	73029	220	1.36	
	33029	220	0.36	73030	240	1.25	
33030	240	0.33	500VA £26.55	83016	25+25	10.0	
120VA £14.35	43010	6+6		10.0	83017	30+30	8.33
	43011	9+9		6.66	83018	35+35	7.14
	43012	12+12		5.00	83026	40+40	6.25
	43013	15+15		4.00	83025	45+45	5.55
	43014	18+18		3.33	83033	50+50	5.00
	43015	22+22		2.72	83042	55+55	4.54
	43016	25+25		2.40	83028	110	4.54
	43017	30+30		2.00	83029	220	2.27
	43018	35+35		1.71	83030	240	2.08
	43028	110	1.09	625VA £29.30	93017	30+30	10.41
43029	220	0.54	93018		35+35	8.92	
43030	240	0.50	93026		40+40	7.81	
			93025		45+45	6.94	
			93033		50+50	6.25	
			93042		55+55	5.68	
			93028	110	5.68		
			93029	220	2.84		
			93030	240	2.60		



Prices include VAT and carriage

Quantity prices available on request  
Write or phone for free Data Pack

### Jaytee Electronic Services

143 Reculver Road, Beltinge, Herne Bay, Kent CT6 6PL  
Telephone: (0227) 375254 Fax: 0227 365104

## NEW THIS MONTH

## ★STAR BUY★

**Z8862** 10 game video unit—2 hand held controllers with joysticks, beautifully made. Requires 7.5V DC input (suitable PSU £2.95). Composite video and sound outputs (modulator + wiring details for direct connexion to TV £6).  
£9.95

**Z8863** KEYBOARD—High quality by Microswitch. 69 keys, 6 LED's, 15 various LS chips+socketed D8048 by Intel. Output via 7 way plug. Size 317x170mm  
£12.00

**Z8858** Hitachi Video Battery Charger BC60U for DP60 batts. used in GP7 camera. Extremely high quality unit  
£17.00

See also Currah Microspeech for additions

### GREEN SCREEN HI-RES 12in. MONITOR CHASSIS

Brand new and complete except for case, the super high definition (100 lines at centre) makes this monitor ideal for computer applications. Operates from 12V d.c. at 1.1A. Supplied complete with circuit diagram and 2 pots for brilliance/contrast, plus connecting instructions. Standard input from IBM machines, slight mod (details included) for other computers.  
Only £24.95+£3 carr.

### MONITOR INTERFACE KIT

Enables our hi-res monitor (above) and most others to be used with virtually any computer, PCB  
£3.00  
Complete set of on-board components plus regulator and heatsink  
£9.95  
Suitable transformer for interface and above monitor  
£5.31

## 1989 CATALOGUE

★ 100 BIG pages of components and equipment+32 Page Spring Supplement

- ★ Low, low prices
- ★ Fast "by return" service
- ★ 28 pages of Surplus Bargains
- ★ Only £1—send for yours now!

## HALF-PRICE KITS

Range of 'OK' Kits at half price! 5 diff. top quality kits containing all parts, inc. PCB, plastic case and comprehensive instructions!

**EK1** Quick Reaction £2.90  
**EK2** Electronic Organ £3.34  
**EK3** Digital Roulette £4.29  
**EK4** Electronic Dice £3.98  
**EK5** Morse Code Oscillator £1.99

### POWER SUPPLIES

**Z4113** BBC Computer PSU (early models). Steel case 158 x 72 x 55mm, 2m long mains lead, rocker switch, fused. Outputs: +5V at 2.5A; -5V at 100mA.  
£3.95

**Z975** Cased PSU 92x57x45mm with built-in 13A mains plug. Output 14V ac @600mA  
£3.00

**Siliconix** mains PSU 62x46x35mm with built-in cont. 2 pin plug. Output 4.5V dc 100mA to 3.5mm plug  
ONLY £1.00

**Aslec** type AA7271, PCB 50x50mm has 6 transistor cct providing current overload protection, thermal cut-out and excellent filtering. Input 8-24V dc. Output 5V 2A. Regulation 0.2%.  
£5.00

### EPSON SERIAL INTERFACES

**Model 8143** £15  
**Model 8148** with 2k buffer £25  
Just arrived—full details on next list together with other items in this parcel —ribbons, discs, other hardware add-ons

### CURRAH MICROSPEECH

We're bought up remaining stocks of this popular add-on to re-sell at a fraction of the original cost!

**Z4136** New complete and boxed set for the ZX Spectrum £8.95

**Z4140** As above, but unboxed—these were bulk packed £7.95

**Z4142** Speech 64 for the C64. No software needed! New and working, but no case. With full instructions. £6.00

**Z4138** Microslot. 'T' connector allowing peripherals to be connected to the Spectrum. New and boxed £2.00  
Also a quantity of 'returns' available. See Bargain List 43 for details



This exciting new series can lead to a worthwhile qualification—and we can supply all the components you need! The first six parts: Everything as listed in the booklet given free with EE.  
Just £12.95!

## GREENWELD ELECTRONIC COMPONENTS

443D MILLBROOK ROAD, SOUTHAMPTON SO1 0HX

All prices include VAT; just add £1.00 P&P; Min Credit Card £5. No CWO min. Official orders from schools welcome—Min invoice charge £10.00. Our shop has enormous stocks of components and is open 9-5.30 Mon-Sat. Come and see us!

### HOW TO CONTACT US

By post using the address below; by phone (0703) 772501 or 783740 (ansaphone out of business hours); by FAX (0703) 787555; by Email Telecom Gold 72:MAG36026; by Telex 265871 MOUNREF G quoting 72:MAG36026.

Only £7.95

## FREE!!!

With every Vero Easiwire kit purchased for £15, we're giving away, absolutely FREE, a complete set of components for the SIREN featured in Jan. issue. Limited supplies, so order NOW!

### PARTS FOR PROJECTS SO FAR

**IR Receiver** (inc. case) £6.00  
**IR Transmitter** (inc. case) £2.00  
**SIREN** (inc. case) £3.00  
**TILT ALARM** (inc. case) £5.30  
**MINIDRILL** for circuit cards (better than punching holes) £1.69

### AM/FM STEREO TUNER

**Z497** Complete radio chassis with push-button selection for LW/MW/FM and ON/OFF. Ferrite rod for LW and MW selection, co-ax socket for FM aerial. Supplied with mains transformer and rectifier/smoothing cap, and wiring details. PCB is 333 x 90mm.  
Only £7.95



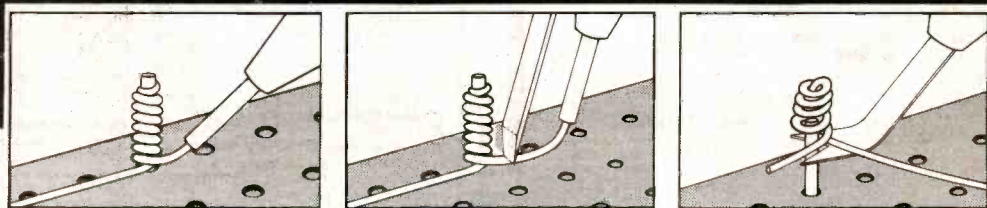

# EASIWIRES

## Circuit construction the easy way.

Solderless, quick and easy to learn. That's Circuigraph Easiwire from BICC-VERO. From now on you'll wonder why you ever used solder to construct your electronic circuits!

Consider the benefits Easiwire offers:

- You need no solder, no chemicals
- You simply wind the circuit wire around the pins
- You can re-use components
- It's easy to change
- The cost is low

What's more, Easiwire is ideal for circuit repairs.

In kit form, Easiwire comes complete with everything you need to construct circuits. That includes a wiring pen with integral cutter, two reels of wire, a component positioning and removal tool – and an instruction book. Of course kit items are available separately too.



Take advantage of the special offer price now. Complete the coupon below and send it to:

BICC-VERO Electronics Limited,  
Flanders Road,  
Hedge End,  
Southampton, SO3 3LG.

or phone 0489 788774 now with your credit card number  
(24-hour answering service)



Please rush me.....Easiwire kits.  
Special offer price £15. – (includes p & p and VAT).

I enclose cheque/postal order for .....  
made payable to BICC-VERO Electronics Limited.

Card number .....

Expiry date .....

Name .....

Address .....

.....Postcode .....

Signature.....Date .....

# KITS & COMPONENTS

## ELECTRONIC GUARD DOG



One of the best burglar deterrents is a guard dog and this kit provides the barking. Can be connected to a doorbell, pressure mat or any other intruder detector and produces random threatening barks. All you need is a mains supply, intruder detector and a little time.  
**XK125..... £24.00**

## DISCO LIGHTING KITS



DL8000K 8-way sequencer kit with built-in opto-isolated sound to light input. Only requires a box and control knob to complete..... **£31.50**  
 DL1000K 4-way chaser features bi-directional sequence and dimming 1kW per channel..... **£19.25**  
 DLZ1000K Uni-directional version of the above. Zero switching to reduce interference..... **£10.80**  
 DLA/1 (for DL & DLZ1000K) Optional opto input allowing audio 'beat' /light response..... **77p**  
 DL3000K 3-channel sound to light kit, zero voltage switching, automatic level control and built-in mic. 1kW per channel..... **£15.60**

## POWER STROBE KIT

Produces an intense light pulse at a variable frequency of 1 to 15Hz. Includes high quality PCB, components, connectors, 5Ws strobe tube and assembly instructions. Supply: 240V ac. Size: 80x50x45.  
**XK124 STROBOSCOPE KIT..... £13.75**

## SIMPLE KITS FOR BEGINNERS

Kits include all components (inc. speaker where used) and full instructions.  
**SK1 OODR CHIME** play a tune when activated by a pushbutton..... **£3.90**  
**SK2 WHISTLE SWITCH** switches a relay on and off in response to whistle command..... **£3.90**  
**SK3 SOUND GENERATOR** produces FOUR different sounds, including police/ambulance/fire-engine siren and machine gun..... **£3.90**

**SPECIAL OFFERS ON KITS FOR SCHOOLS AND TRAINING CENTRES**  
 - contact Sales Office for discounts and samples

## VOICE RECORD/PLAYBACK KIT

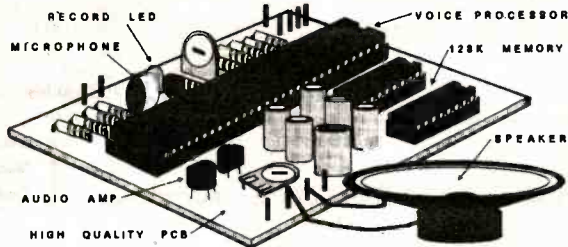

This simple to construct and even simpler to operate kit will record and playback short messages or tunes. It has many uses - seatbelt or lights reminder in the car, welcome messages to visitors at home or at work, warning messages in factories and public places, in fact anywhere where a spoken message is announced and which needs to be changed from time to time. Also suitable for toys - why not convert your daughter's £8 doll to an £80 talking doll!!

Size..... 78x60x15 mm  
 Message time..... 1-5 secs normal speed, 2-10 secs slow speed  
**XK129..... £22.50**

## TEN EXCITING PROJECTS FOR BEGINNERS

This kit contains a solderless breadboard, components and a booklet with instructions to enable the absolute novice to build ten fascinating projects including a light operated switch, intercom, burglar alarm and electronic lock. Each project includes a circuit diagram, description of operation and an easy to follow layout diagram. A section on component identification and function is included, enabling the beginner to build the circuits with confidence.  
**XK118..... £15.00**

## SOLID STATE RELAY BARGAIN



Zero voltage switching - no radio interference. 2.5KV input to output isolation. 4 KV terminals to heatsink isolation. 3V to 32V input voltage easily interfaced to TTL or CMOS logic. 24V to 240V rms load voltage. Inductive load switching. Built-in snubber network. 10A max. 4A with no heatsink at 40°C.  
**CD240/10..... £2.25**

## ELECTRONIC WEIGHING SCALES

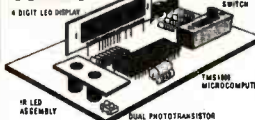

Kit contains a single chip microprocessor, PCB, displays and all electronics to produce a digital LED readout of weight in Kgs or Sts/lbs. A PCB link selects the scale - bathroom/ two types of kitchen scales. A low cost digital ruler could also be made.  
**ES1..... £6.50**

## SUPER-SENSITIVE MICROBUG

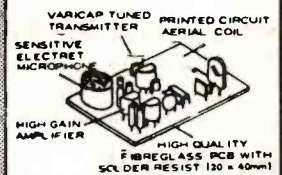

Only 45x25x15mm, including built-in mic. 88-100MHz (standard FM radio). Range approx. 300m depending on terrain. Powered by 9V PP3 (7mA). Ideal for surveillance, baby alarm etc..... **£5.50**

## VERSATILE REMOTE CONTROL KIT



Includes all components (+ transformer) for a sensitive IR receiver with 16 logic outputs (0-15V) which with suitable interface circuitry (relays, triacs, etc - details supplied) can switch up to 16 items of equipment on or off remotely. Outputs may be latched to the last received code or momentary (on during transmission) by specifying the decoder IC and a 15V stabilised supply is available to power external circuits. Supply: 240V AC or 15-24V DC at 10mA. Size (exc. transformer) 9x4x2 cms. Companion transmitter is the MK18 which operates from a 9V PP3 battery and gives a range of up to 60ft. Two keyboards are available - MK9 (4-way) and MK10 (16-way).  
 MK12 IR Receiver (inc transformer)..... **£16.30**  
 MK18 Transmitter..... **£7.50**  
 MK9 4-way Keyboard..... **£2.20**  
 MK10 16-way Keyboard..... **£6.55**  
 601133 Box for Transmitter..... **£2.60**

## ★ ★ ★ BARGAIN COMPONENT PACKS ★ ★ ★

Refill those empty component drawers at a fraction of the normal price and don't be caught out. All components supplied are to full spec, and are not seconds or surplus stock. Prices exclude VAT (15%).  
 Pack A: 650x25 watt resistor 47R-10M..... **£4.25**  
 Pack B: 60x Radial electrolytes 1uf-1000uf..... **£3.25**  
 Pack C: 30x Polyester capacitors a or 0.01uf-1uf..... **£4.50**  
 Pack D: 35x horizontal presets 1k-1M..... **£3.00**  
 Pack E: 30x IC sockets 8, 14, 16 pin..... **£2.00**  
 Pack F: 25x Red 5mm LEDs..... **£1.75**  
 Pack G: 25x Green LEDs..... **£2.00**  
 Pack H: 30x 5mm LEDs 10 Red, 10 Green, 10 Yellow..... **£2.50**  
 Pack J: 50x 1N4148 silicon diodes..... **£1.00**  
 Pack K: 40x npn/pnp transistors BC/548/558 General Purpose..... **£2.25**  
**FREE** Solderless Breadboard (verobloc type) when you buy all ten packs.

## MICROPROCESSOR TIMER

Kit controls 4 outputs independently switching on /off at 18 preset times over a 7-day cycle. LED display of time/day easily programmed. Includes box.  
**CT6000K..... £47.20**

XK114 Relay kit for CT6000 includes PCB, connectors and one relay. Will accept up to 4 relays. 3A/240V c/o contacts..... **£4.30**  
 701115 Additional relays..... **£1.80**

# TK ELECTRONICS

**TK ELECTRONICS**  
 13 Boston Road  
 London W7 3SJ  
 Tel: 01-567 8910  
 Fax: 01-566 1916

**ORDERING INFORMATION** All prices exclude VAT. Free p&p on orders over £50 (UK only), otherwise add £1+VAT. Overseas p&p: Europe £3.50 elsewhere £10.00. Send cheque/PO/Barclaycard/Access No. with order. Giro No. 529314002. Local authority and export orders welcome. Goods by return subject to availability.



## ORDERS: 01-5678910 24 HOURS

# EVERYDAY ELECTRONICS

INCORPORATING ELECTRONICS MONTHLY

The Magazine for Electronic & Computer Projects  
**VOL. 18 No. 4** April '89

**Editorial Offices**  
EVERYDAY ELECTRONICS EDITORIAL,  
6 CHURCH STREET, WIMBORNE,  
DORSET BH21 1JH  
Phone: Wimborne (0202) 881749  
FAX: (0202) 841692

See notes on **Readers' Enquiries** below—we regret that lengthy technical enquiries cannot be answered over the telephone

**Advertisement Offices**  
EVERYDAY ELECTRONICS ADVERTISEMENTS  
HOLLAND WOOD HOUSE, CHURCH LANE,  
GREAT HOLLAND, ESSEX CO13 0JS, Clacton  
(0255) 850596

## HEAVY METAL

I well remember building my first amplifier as an apprentice back in the mid sixties. It was a Mullard 5-10 design (five valves, ten watts, mono). Most of the construction work was in building two suitable aluminium chassis, one for the amp and one for the power supply. Each chassis measured about 250×200×100 mm. and each was constructed from 18 s.w.g. sheet aluminium with all the holes for pots, valve holders, etc., cut out before the bending took place.

After the "metal bashing" the wiring up was relatively simple, most components being mounted on the valve holders with hard wiring to everything else—no p.c.b. It sounded quite good and generated enough heat to keep you warm on a cold night. I guess the cost would have been around £15 (about a week's wages in those days).

How things have changed, 35 watts stereo with full input facilities and a good specification now cost under £40, and that price includes ready drilled case with printed front panel, etc. No metal bashing for hours before you can start the electronics. Perhaps a few readers will remember building our *Integrated Amplifier* design in 20 years' time.

## SOLDERING

These days you don't even have to be able to solder to build working projects—another two circuit cards will be given away next month. This time they are for a Metal Detector and a Radio—both use the Easiwire system to produce solderless projects.

Don't miss them—place an order for your copy now.

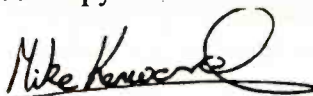

## SUBSCRIPTIONS

Annual subscriptions for delivery direct to any address in the UK: £15.70. Overseas: £19.00 (£36 airmail). Cheques or bank drafts (in £ sterling only) payable to Everyday Electronics and sent to EE Subscriptions Dept., 6 Church Street, Wimborne, Dorset BH21 1JH.

Subscriptions can only start with the next available issue. For back numbers see below.

## BACK ISSUES

Certain back issues of EVERYDAY ELECTRONICS are available price £1.50 (£2.00 overseas surface mail—£ sterling only please) inclusive of postage and packing per copy. Enquiries with remittance, made payable to Everyday Electronics, should be sent to Post Sales Department, Everyday Electronics, 6 Church Street, Wimborne, Dorset BH21 1JH. In the event of non-availability remittance will be returned. *Please allow 28 days for delivery. We have sold out of Sept., Oct. & Nov. 85, April, May & Dec. 86, Jan., Feb., April, May & Nov. 87, Jan., March, April, May, June & Oct. 88.*

## BINDERS

Binders to hold one volume (12 issues) are available from the above address for £4.95 (£6.95 to European countries and £9.00 to other countries, surface mail) inclusive of postage and packing. *Please allow 28 days for delivery. Payment in £ sterling only please.*

**Editor** MIKE KENWARD

**Secretary** PAMELA BROWN

**Deputy Editor**  
DAVID BARRINGTON

**Editorial Assistant**  
COLETTE MCKENZIE

**Editorial:** WIMBORNE (0202) 881749

**Advertisement Manager**  
PETER J. MEW Clacton (0255) 850596

**Classified Advertisements**  
Wimborne (0202) 881749

## READERS' ENQUIRIES

We are unable to offer any advice on the use, purchase, repair or modification of commercial equipment or the incorporation or modification of designs published in the magazine. We regret that we cannot provide data or answer queries on articles or projects that are more than five years old. Letters requiring a personal reply must be accompanied by a **stamped self-addressed envelope** or a **self-addressed envelope and international reply coupons**.

All reasonable precautions are taken to ensure that the advice and data given to readers is reliable. We cannot, however, guarantee it and we cannot accept legal responsibility for it.

## COMPONENT SUPPLIES

**We do not supply electronic components or kits** for building the projects featured, these can be supplied by advertisers.

## OLD PROJECTS

We advise readers to check that all parts are still available before commencing any project in a back-dated issue.

We regret that **we cannot provide data or answer queries on projects that are more than five years old.**

## ADVERTISEMENTS

Although the proprietors and staff of EVERYDAY ELECTRONICS take reasonable precautions to protect the interests of readers by ensuring as far as practicable that advertisements are *bona fide*, the magazine and its Publishers cannot give any undertakings in respect of statements or claims made by advertisers, whether these advertisements are printed as part of the magazine, or are in the form of inserts.

The Publishers regret that under no circumstances will the magazine accept liability for non-receipt of goods ordered, or for late delivery, or for faults in manufacture. Legal remedies are available in respect of some of these circumstances, and readers who have complaints should address them to the advertiser or should consult a local trading standards office, or a Citizen's Advice Bureau, or a solicitor.

## TRANSMITTERS/BUGS

We would like to advise readers that certain items of radio transmitting equipment which may be advertised in our pages cannot be legally used in the U.K. Readers should check the law before using any transmitting equipment as a fine, confiscation of equipment and/or imprisonment can result from illegal use.

The law relating to this subject varies from country to country; overseas readers should check local laws.





# INTEGRATED AMPLIFIER

*An easy to build stereo integrated amplifier with a good specification. The use of a ready made pre-amp module simplifies construction.*

**T**HIS stereo amplifier is designed as an "easy to build" project utilising a ready-made preamplifier module. To this end, most components are mounted on a single p.c.b.

## PREAMP

In the circuit diagram (Fig. 1) compo-

nents prefixed 100 are for one channel, equivalent components on the other channel are prefixed 200. Components that are not repeated for each channel carry no prefix i.e. C1, R1 etc.

The Mullard LP1183 is a ready built, two-stage stereo pre-amplifier module. The input stage is designed to process sig-

nals requiring a "flat" frequency response i.e. tuner, tape, aux/CD etc. The second stage provides comprehensive tone controls, and around 10dB boost and cut at 100Hz and 10kHz. This stage is followed by balance and volume controls.

A 14 pin dual-in-line i.c. (LM382) is used for amplifying the "phono" input to the required level before connection to the preamp module. By making use of its internal resistor matrix, components are kept to a minimum. The correct frequency equalisation (RIAA) is set by C103 (C203), C104 (C204) and R102 (R202).

## POWER AMP

In the power amplifier section, output transistors TR106 and TR107 (TR206 and TR207) are driven by complementary pair TR104 and TR105 (TR204 and TR205). Diodes D101, D102 and D103 (D201, D202 and D203) are included to ensure minimum crossover distortion at low power levels.

The voltage at the mid-point between the output transistors is set by R111 and R112 (R211 and R212) to give symmetrical clipping at maximum output levels. Transistor TR103 (TR203) provide bias for the output stage as well as thermal and voltage compensation. The quiescent current is set by VR101 (VR201).

High frequency stabilisation necessitated by the high value of negative feedback is effected by C111, C112, C107, C106 and R118 (C211, C212, C207, C206 and R218).

## POWER SUPPLY

A straightforward supply circuit is employed with D2 to D5 forming a bridge rectifier. Smoothing is supplied by C1 and C2 with d.c. fuses FS101 and FS201 protecting each channel. The l.e.d. indicates the unit is switched on.

## CONSTRUCTION

The p.c.b. is supplied with the preamplifier module and the first task is to mount the module in place (see Fig. 2)—it is essential to purchase these items to build the unit. The preamplifier circuit board design is the copyright of Mullard—now part of Philips Components—and probably could not be built by constructors for less than the cost of the ready made, tested module. Commence the remaining con-

## SPECIFICATION

### R.M.S. POWER OUTPUT

(At clipping)

Load=4 ohms	One channel driven	36W
	Both channel driven	30W
Load=8 ohms	One channel driven	25W
	Both channel driven	22W

### SENSITIVITY

(Load=8 ohms and at clipping)

*Phono	1.5mV	at 47k and 1kHz (RIAA)
Tape 1	150mV	at 1M
Tape 2	150mV	at 1M
Tuner	150mV	at 1M
CD	150mV	at 1M
Tape Output	150mV	(for above input sensitivity)
Headphone Output	150mV	into 8 ohm load

\*use a low output cartridge to avoid overload

### INPUT OVERLOAD 20db

### TONE CONTROLS

(Ref. 1kHz)

Bass	±12db	at 100Hz
Treble	+8db-12db	at 10kHz

### POWER BANDWIDTH

(-3db points in 8 ohms)  
20Hz to 40kHz

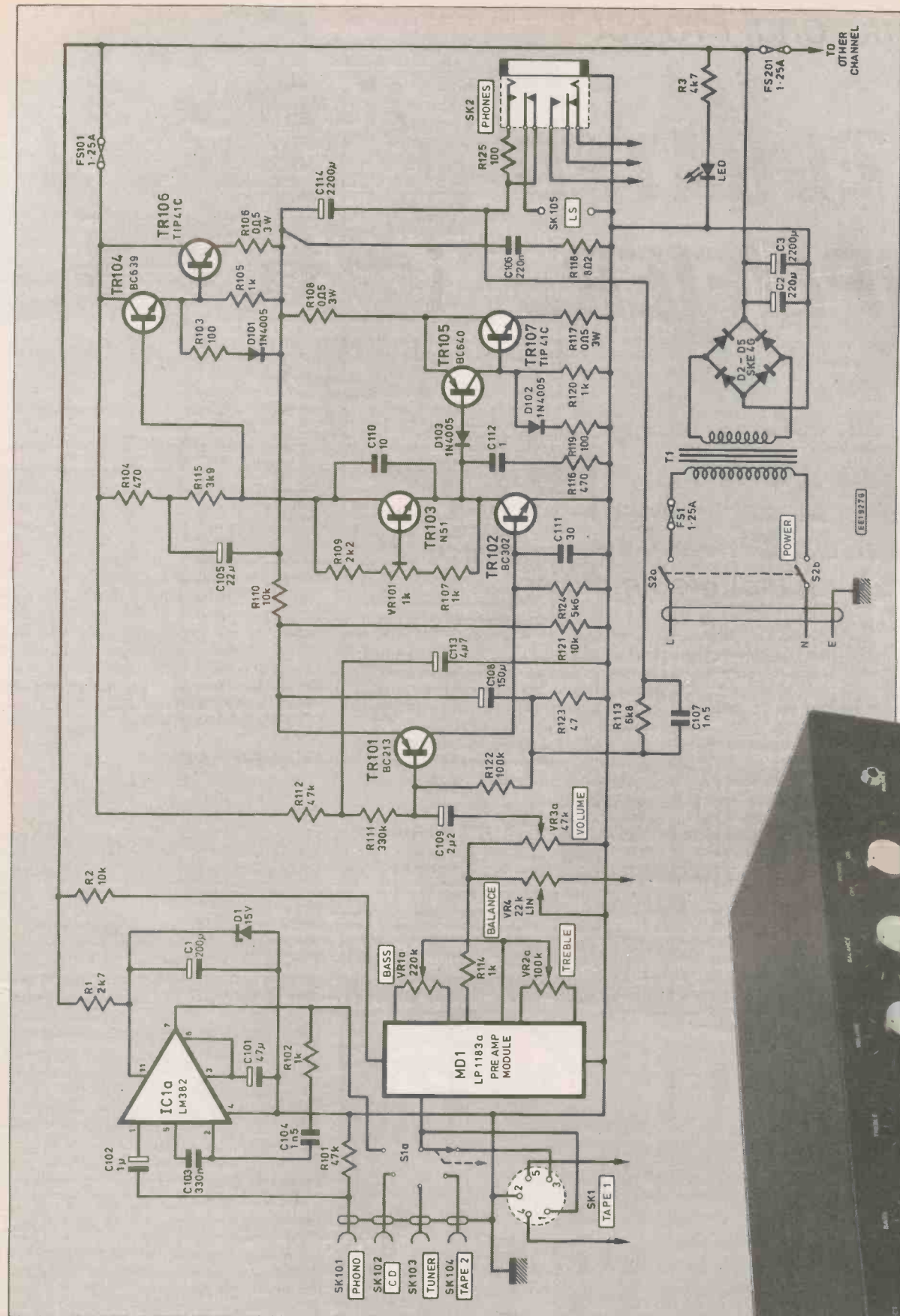
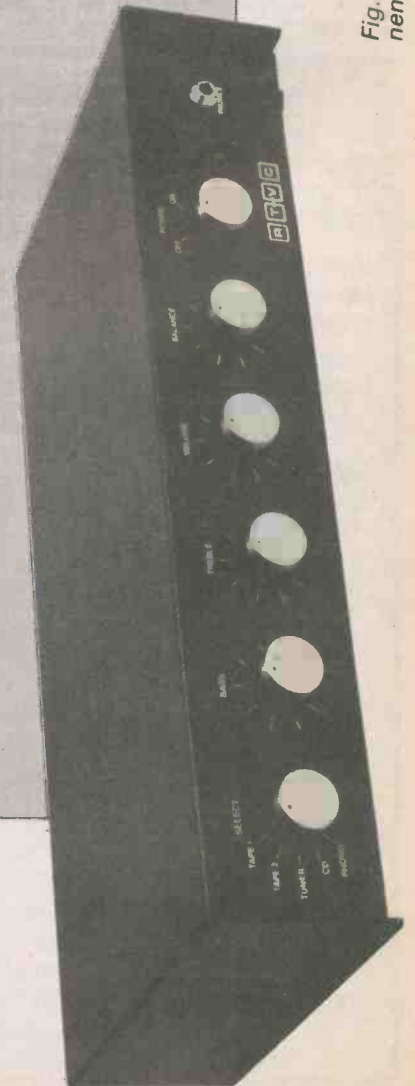

Fig. 1. Circuit diagram of the Integrated Amplifier—only one channel is shown. Components in the other channel are prefixed "200"; i.e. R201, C201 etc.

struction by mounting all components in size order, starting with the smallest and working up. Make sure you do not miss any of the five link wires and mount the six wirewound ( $0\Omega$ ) resistors a little above the p.c.b. Check component location and orientation carefully before adding the controls and output transistors.

### DUMMY PANELS

Note that the output transistors are mounted on a dummy panel which, together with the case—to which it is bolted, forms a heatsink. Each transistor is insulated from the panel with a mica



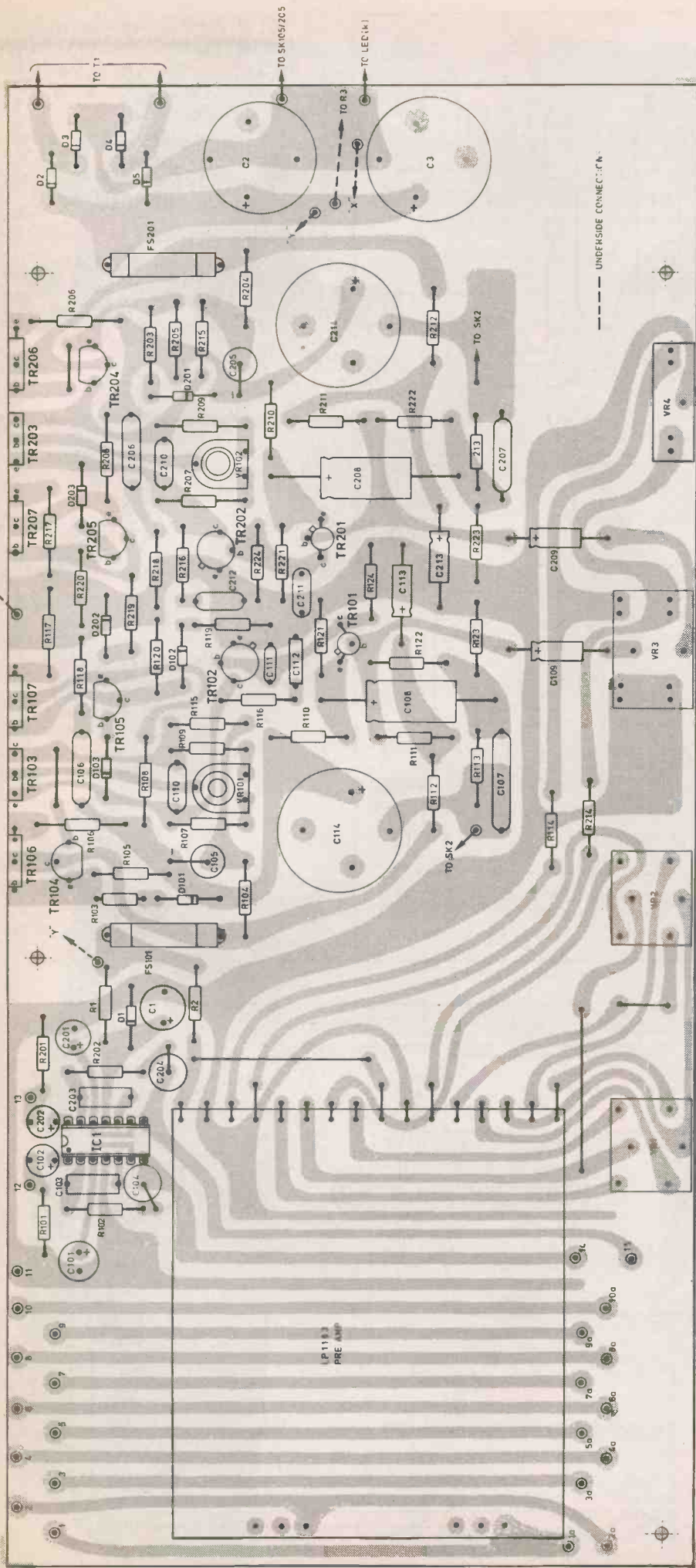
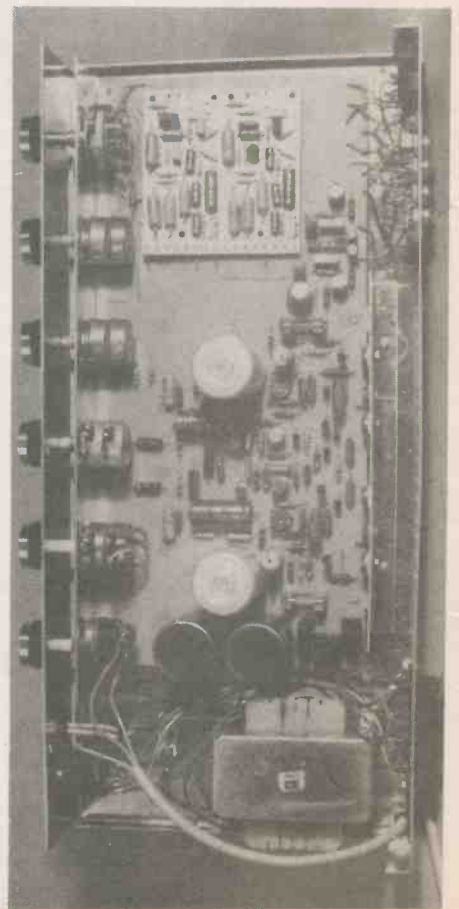

Fig. 2. P.C.B. layout and wiring. Use heavy wire for connections to SK2, SK105/205 and lines "X" and "Y".

The complete amplifier (left) showing the positions of the dummy control panel and the heat sink/mounting panel for the output transistors.

Wiring of the sockets (right) these leads should be insulated and kept short.



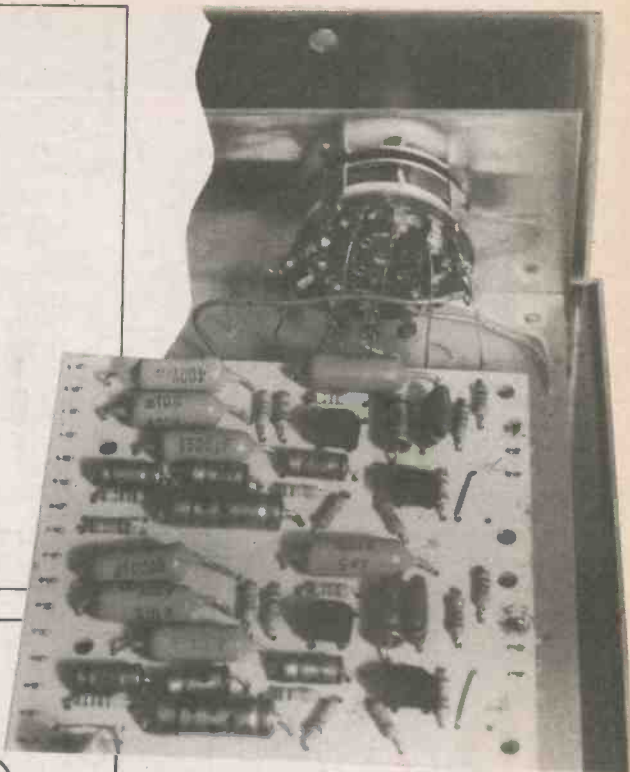
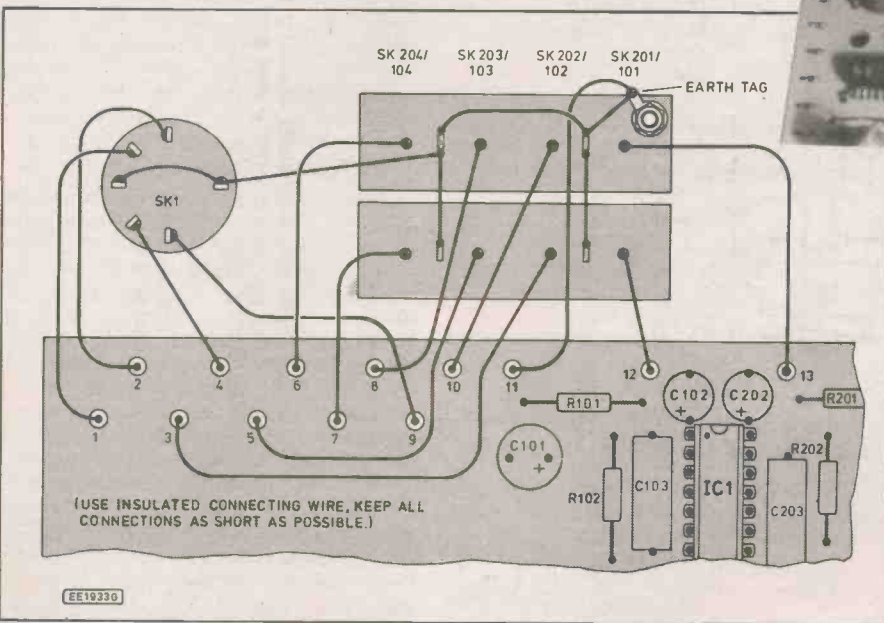
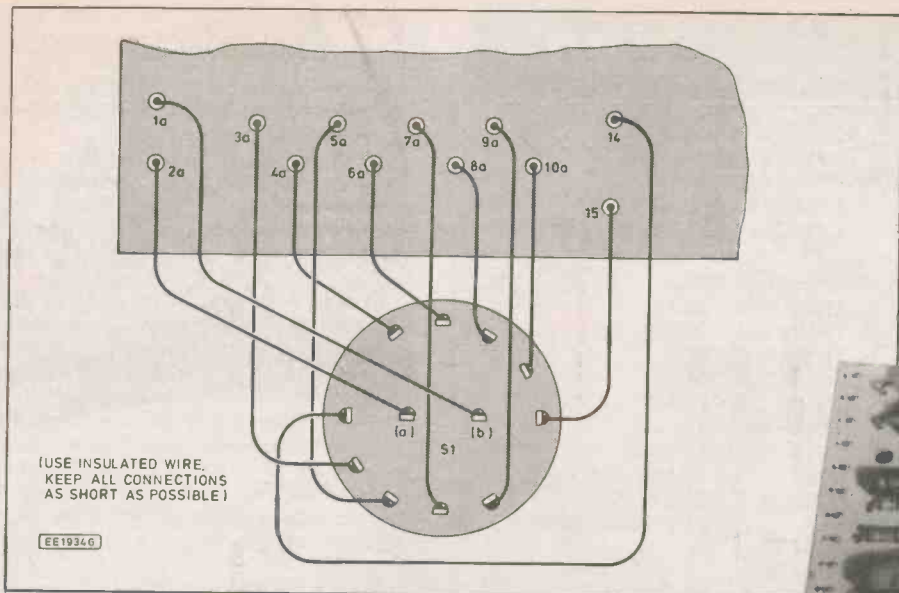
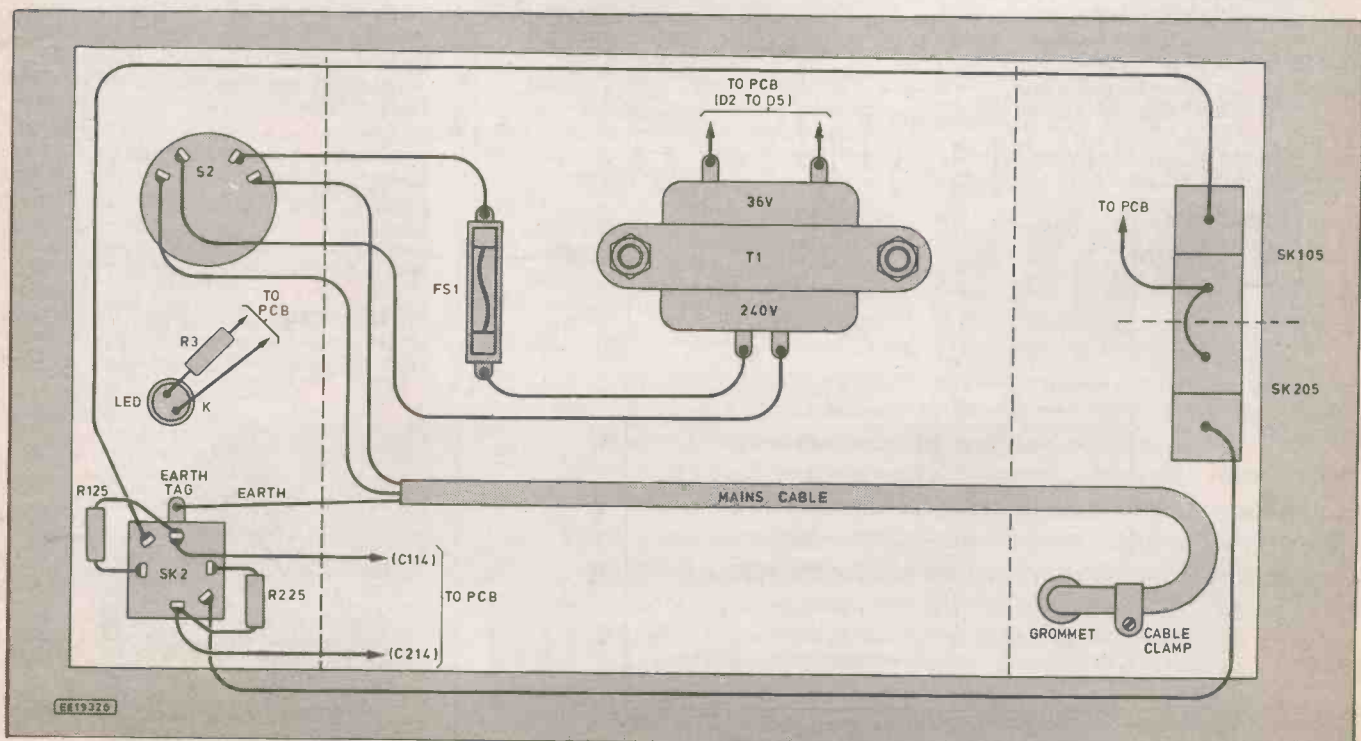

Fig. 3 (top). Selector switch wiring to the p.c.b.

Fig. 4 (left). Input socket wiring to the p.c.b.

Fig. 5 (below). Mains wiring and wiring to the headphone and speaker sockets.



# COMPONENTS

Approx. cost **£40**  
Guidance only

**NOTE** where components are marked 101/201 etc., two off are required of each type, one for each channel

## Resistors

R1	2k7
R2	10k
R3	4k7
R101/201	47k
R102/202	1k
R103/203	100
R104/204	470
R105/205	1k
R106/206	0Ω5 3W wirewound
R107/207	1k
R108/208	0Ω5 3W wirewound
R109/209	2k2
R110/210	10k
R111/211	330k 5%
R112/212	47k
R113/213	6k8
R114/214	1k
R115/215	3k9
R116/216	470
R117/217	0Ω5 3W wirewound
R118/218	8Ω2
R119/219	100
R120/220	1k
R121/221	10k
R122/222	100k 5%
R123/223	47 5%
R124/224	5k6
R125/225	100

All 1/4W carbon except where stated

## Potentiometers

PR101/201	1k preset
VR1	220k stereo
VR2	100k stereo
VR3	47k stereo
VR4	22k lin.

## Capacitors

C1	200μ radial elect. 16V
C2	2200μ elect. 63V
C3	2200μ elect. 63V
C101/201	47μ radial elect. 16V
C102/202	1μ radial elect. 50V
C103/203	330n
C104/204	1.5n
C105/205	22μ elect. 35V
C106/206	220n
C107/207	1.5n
C108/208	150μ elect. 40V
C109/209	2.2μ elect. 63V

**Shop  
Talk**  
see page 264

## Semiconductors

TR101/201	BC213
TR102/202	BC302
TR103/203	N51
TR104/204	BC639
TR105/205	B6640
TR106/206	TIP 41C
TR107/207	TIP 41C
D1	15V 400mW Zener
D2 to D4	SKE 4G 60V 2A rectifier (4 off)
D101/201, D102/202, D103/203	IN4005 (6 off) red l.e.d. with mounting clip or grommet
LED	LM382
IC1	LP1183 preamp. module
MD1	

## Miscellaneous

T1	2A 36V mains transformer
S1	5 way 2 pole selector switch
S2	d.p.d.t mains rotary switch
SK1	5 pin 180° DIN socket
SK2	1/4 inch switched stereo jack socket
SK101/201 to SK104/204	phono sockets— two 4 way strips
SK105/205	four way speaker socket
FS1	1.25A fuse and insulated panel mounting holder
FS101/201	1.25A fuse and p.c.b. mounting holder

Suitable case with control dummy panel and panel for transistor mounting/heatsink; knobs (6 off); mains lead; mains cable securing clip and grommet; p.c.b. (available from Radio and TV Components); p.c.b. pins; 6BA earth tag; 6BA and 4BA fixings; mounting kits for TR103/203, TR106/206, TR107/207; connecting wire etc.

washer and plastic bush. Check that there is no electrical contact between the transistor tab and the aluminium panel, using a multimeter if possible. TR103/203 are also mounted on the panel using nylon bolts and fibre washers to insulate them.

The front panel controls are also mounted on a dummy panel before being soldered to the p.c.b. Connecting wire should be added to the input switch and the balance control to connect them to the p.c.b.

Fix suitable lengths of wire for all the remaining connections to the p.c.b., then mount the p.c.b. and dummy panels into the bottom half of the case and fix the remaining components into position.

Mount resistor R3 on the anode lead of the l.e.d., cover with insulating sleeving and wire the l.e.d./R3 combination to the p.c.b. as shown, observing the correct polarity. Mount R125 and R225 on SK2 and connect this to the p.c.b. and the output sockets.

Finally connect up the remaining input and output sockets and wire up the connections to the switch, fuse and transformer. Make a careful check that everything is correct—time spent at this stage could be very valuable if something has been wrongly wired!

## TESTING

After checking that the amplifier is complete and has been correctly constructed proceed as follows.

Without the speakers connected, and with the d.c. fuses removed from both channels, connect a d.c. current meter in place of the fuse on the left hand channel; the fuse nearest to the preamplifier module. (The fuse tab nearest to the power transistors is the +ve connection on meter.) **To avoid damaging your meter, set it to its highest d.c. current range initially.**

Set both quiescent current presets (VR101 and VR201) to mid position, *turn the volume control to minimum*, switch on the amplifier. Then increase the sensitivity on the current meter to a suitable range and adjust the preset to read 10mA on the meter. Repeat the procedure for the right hand channel.

**It is VERY IMPORTANT that the quiescent current settings of 10mA be made while the unit is cold.**

Turn the amplifier off, insert the d.c. fuses, connect speakers and any other equipment that is to be used in conjunction with the amp, i.e. tuner, turntable, tape unit, C.D. etc. Select the required program and adjust the controls to suit. □

**NOTE.** D1 polarity is shown incorrectly on the actual p.c.b.s and R106 is marked R10. The diagrams are correct.





**OUT  
NOW!**

**CRICKLEWOOD**

**ELECTRONICS**

**1989 100 PAGE COMPONENT  
CATALOGUE PRICE £1**

**SEND OFF FOR YOUR COPY TODAY...**

- WE STOCK AN UNRIVALLED RANGE
- ALL OUR COMPONENTS ARE FIRST CLASS BRANDED ITEMS
- WE OFFER A SAME DAY SERVICE ON ALL STOCK ITEMS
- NO MINIMUM ORDER—IF YOU NEED ONE COMPONENT WE CAN SUPPLY ONE COMPONENT
- WE HAVE ADOPTED A NEW LOWER PRICING POLICY + QUANTITY DISCOUNTS
- FREE VOUCHERS WITH YOUR CATALOGUE—ORDER ONE NOW!..

JUST FILL IN THE COUPON OPPOSITE AND POST IT WITH YOUR £1 PAYMENT TO THE ADDRESS BELOW. YOU WILL RECEIVE NOT ONLY OUR SUPERB 100 PAGE CATALOGUE, BUT ALSO FREE VOUCHERS WHICH YOU CAN USE ON YOUR NEXT COMPONENTS ORDER.

CRICKLEWOOD ELECTRONICS LTD 40 CRICKLEWOOD BROADWAY LONDON NW2 3ET TEL: 01-450 0995/452 0161 FAX: 01-208 1441 TELEX: 914977

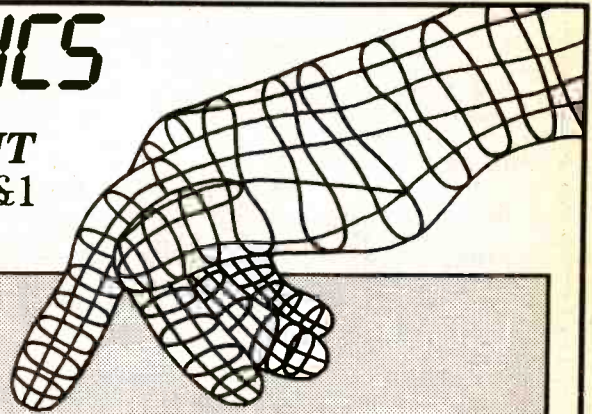

**FREE VOUCHERS!**  
SEND OFF FOR YOUR CATALOGUE AND VOUCHERS TODAY.

I WOULD LIKE TO RECEIVE.....  
COPY(COPIES) OF THE 1989  
CRICKLEWOOD ELECTRONICS  
COMPONENT CATALOGUE. I  
ENCLOSE £.....  
PLEASE ENCLOSE MY FREE  
VOUCHERS.

Tape your £1 coin here, or send a cheque or postal order for £1.00 for every catalogue you require.

NAME.....

ADDRESS.....



**£1 BARGAIN PACKS BUY 10 GET 1 FREE**

When ordering please state which pack you require.

The figure on the extreme left is the Order Number, the next column is Quantity/Pack.

No	Qty	Description
BP010	2	6½" Speaker 8Ω 10 watt
BP012	2	6½" Speaker 4Ω 10 watt
BP013	3	8"×5" Speaker 4Ω 6 watt made by E.M.I.
BP014	4	3½" Speakers 8Ω 8 watt JAPAN made
BP015	2	3½" Tweeters 8Ω 5 watt before crossover (30 watts after crossover)
BP016	6	2200µf can type Electrolytic 25V d.c. computer grade made in UK by PHILIPS
BP017	3	33000µf 16V d.c. electrolytic high quality computer grade UK made
BP018	3	2000µf 50V d.c. electrolytic high quality computer grade made in USA
BP019	20	20 ceramic trimers assorted values
BP020	4	Tuning capacitors, 2 gang dielectric a.m. type 3 position, 8 tag slide switch 3 amp rated 125V a.c. made in USA
BP021	10	10 125V a.c. made in USA
BP022	5	Push-button switches, push on push off, 2 pole change over. PC mount JAPAN made
BP023	4	2 pole 4 way rotary switch UK made by LORLIN
BP024	2	Right angle, PCB mounting rotary switch, 4 pole, 3 way rotary switch UK made by LORLIN
BP025	4	3 pole, 3 way miniature rotary switch with one extra position off (open frame YAXLEY type)
BP026	6	4 pole, 2 way rotary switch UK made by LORLIN
BP027	30	Mixed control knobs
BP028	10	Slide potentiometers (popular values)
BP029	6	Stereo rotary potentiometers
BP030	2	100k wire wound double precision potentiometers UK made
BP031	6	Single 100k multiturn pots, ideal for varicap tuners UK made by PHILIPS
BP032	4	UHF varicap tuner heads, unboxed and untested UK made by PHILIPS
BP033	2	FM stereo decoder modules with diagram UK made by PHILIPS
BP034	3	AM IF modules with diagram UK made by PHILIPS
BP035	6	All metal co-axial aerial plugs
BP036	6	Fuse holders, panel mounting 20mm type JAPAN made
BP037	6	In line fuse holders 20mm type UK made by BULGIN
BP038	20	5 pin din, 180° chassis socket
BP039	6	Double phono sockets, pasxion mounted
BP040	6	Single phono to phono screen leads 1.2m long JAPAN made
BP041	3	2.8m lengths of 3 core 5 amp mains cable
BP042	2	Large VU meters JAPAN made

BP043	30	4V miniature bulbs, wire ended, new untested
BP044	2	Sonotone stereo crystal cartridge with 78 and LP styli JAPAN made
BP045	2	Stereo cassette record and play heads JAPAN made
BP046	4	6-0-6 3VA mains transformers, P.C. mount UK made
BP047	1	24V 750mA mains power supply. Brand new boxed UK made by MULLARD
BP048	1	Car rear window heater/demister. Self adhesive panel, size 24"×9", complete with switch and cable UK made (Ideal for your old "Moggy 1000" etc)
BP049	10	OC44 transistors. Remove paint from top and it becomes a photo-electric cell UK made by MULLARD
BP050	30	Low signal transistors n.p.n., p.n.p. types
BP051	6	14 watt output transistors. 3 complimentary pairs in T066 case (Ideal replacement for AD161 and 162s)
BP052	8	3 watt audio output ICs. No TA7205P JAPAN made by TOSHIBA
BP053	5	5 watt audio ICs. No TBA800 (ATEZ)
BP054	10	Motor speed control ICs, as used with most cassette and record player motors
BP055	1	Digital DVM meter I.C. made by PLESSEY as used by THANDAR with diagram
BP056	4	7 segment 0.3 LED display (R.E.D.)
BP057	8	Bridge rectifiers, 1 amp, 24V

Hi-Fi stereo cassette deck transport mechanism, complete with 3 digit rev counter, 12V d.c. operation. Unused manufacturers surplus. JAPAN made  
**£6.20 +£1.50 P&P**

Garrard stereo record player deck, manual/auto operation, 3 speed (78, 45, 33½). 240V operation. Unused but store soiled  
**£6.50 +£2.00 P&P**

**RADIO and TV COMPONENTS ACTON LTD**  
21 HIGH STREET, ACTON LONDON W36 N9  
MAIL ORDER TERMS. POSTAL ORDERS and/or  
CHEQUES with orders. Orders under £20 add £3.00 service charge. Nett monthly accounts to Schools, Colleges and P.L.C. only. ACCESS + VISA.

Phone: 01-723 8432 or 01-992 8430  
Callers 323 Edgware Road, London W2

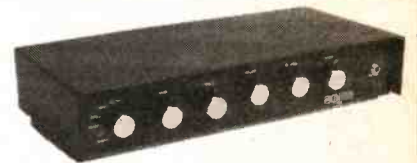

**EE STEREO INTEGRATED AMPLIFIER KIT**  
■ 30W×2 (Din 4 ohms) ■ CD/AUX input  
■ Separate Bass and Treble ■ LED power indicator  
■ Headphone jack.  
PROJECT INC. Pre-drilled case, back printed P.C.B. with ALL components.  
ALL YOU NEED IS solder, wire and £36.80 plus £3.50 for postage

(Full instructions in EVERDAY ELECTRONICS APRIL 1989 issue)

**AMPHONIC 125+ 125 POWER AMPLIFIER**



125 watt per channel stereo power amplifier with independent volume controls, professional 19" rack mount and silent running cooling fan for extra reliability.

Output power ..... 125W RMS max. per channel  
Output impedance ..... 4 to 16 ohms (max. power into 4 ohms)  
Sensitivity ..... 450mV @ 22k ohms  
Protection ..... Electronic short-circuit and fuses  
Power ..... 220-240Vac 50Hz  
Chassis dim ..... 435×125×280mm  
Weight ..... 10kg approx

Order Code 074  
**£124.99 +£7.00 P&P**

A full range of Velleman kits in stock.  
Send for catalogue

# LIGHT SENTINEL



**MICHAEL PERROW**

*Control up to five house lighting circuits and keep would-be intruders guessing as to whether the home is occupied or not.*

**D**OMESTIC security systems are taking a much higher priority these days because of the dramatic increase in home break-ins. Whilst an alarm system should of course be the first investment a device to deter the would be intruder could well prove its worth. Police also advise leaving a light on to give the impression that the home is occupied.

This is good advice but the idea can be enhanced with the Light Sentinel described here. The unit provides the means of remotely controlling up to five lighting circuits using the safety of low voltage switching signals which trigger a small interface unit fitted in each wall light switch.

The Light Sentinel monitors the ambient light level and activates at dusk. It then switches on one main light circuit and also sequences through up to four other circuits. The timing of the switching sequence can be adjusted from 10 to 40 minutes. The sequence is performed twice and then the

unit goes in to a "rest" state with all light circuits being extinguished.

This state remains until dawn when the unit is automatically reset. For example, if the timing is set for say half an hour intervals the sequence will last for four hours and hence if the unit is activated at 8pm, by the fall in light, the Sentinel will continue working until midnight. If the lighting circuits coupled to the unit include the bedroom, bathroom and stairs with the main circuit coupled to the lounge, then the impression can be given that there is movement from room to room within the house.

### POWER CONTROL

Because we are using the lighting as a deterrent we can economise on power if we wish by running the lights at half power using a SCR (thyristor) interface, however, this will then exclude the means of controlling any fluorescent lighting circuits. If nor-

mal brightness is preferred a solid state relay can be used for the interface.

Both these options provide a high degree of safety because only low level signals are sent out of the main unit using two-core cable and are isolated from the mains supply at the light switch. This ensures that no lethal voltages are present between the unit and the lighting circuits.

The system block diagram Fig. 1 gives the basic concept and shows how the unit is connected to the lighting circuits. As can be seen the optical isolator and associated components are mounted on a small printed circuit board within the existing lighting switch back box. If the solid state relay option is used then this relay is all that is required within the light switch box.

Note that it is not necessary to couple up all circuits for the unit to operate and the switching sequence can be preset using link wires. This will be described later.

An additional facility is built into the unit which will flash all circuits on and off if triggered by a main burglar alarm. This is achieved by shorting out the "Test" switch S1 with a pair of contacts from the main burglar alarm.

### CIRCUIT DESCRIPTION

The full circuit diagram of the Light Sentinel is shown in Fig. 2 and the Half Power Interface in Fig.3. When the unit is first switched on, during daylight conditions, the output from pin 3 of IC1 is low ("0"). This is coupled via IC5a to give a "1" (high) on pin 13 of IC4 and via IC5a and IC5d to give a "0" on pin 15 of IC4 which as a result is held in its reset state. At this point i.e. D3 is lit.

The oscillator IC2 is running and clocking pulses into IC3 which is a 14-bit binary counter. IC3, pin 7 is Q4 output and drives i.e.d. D2 to indicate that the oscillator is working. This output also has another use. If switch S1 is closed transistor TR1 is switched on and off as Q4 goes high and low. This is coupled via diodes D9 to D13 to the output circuits to enable a lamp test facility.

The unit is activated automatically due to R1, the light dependant resistor (l.d.r.), sensing the change in light level. As the light level falls so the resistance of R1 increases.

The point at which IC1, the light switching circuit, activates is set by potentiometer VR1. To provide protection from temporary increases and decreases of light, say

Fig. 1. System block diagram for the Light Sentinel.

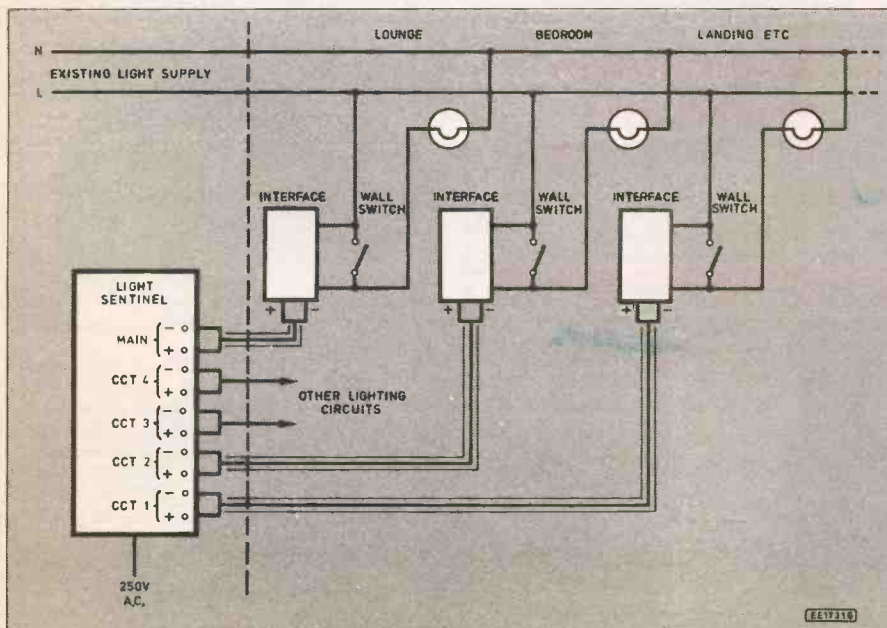

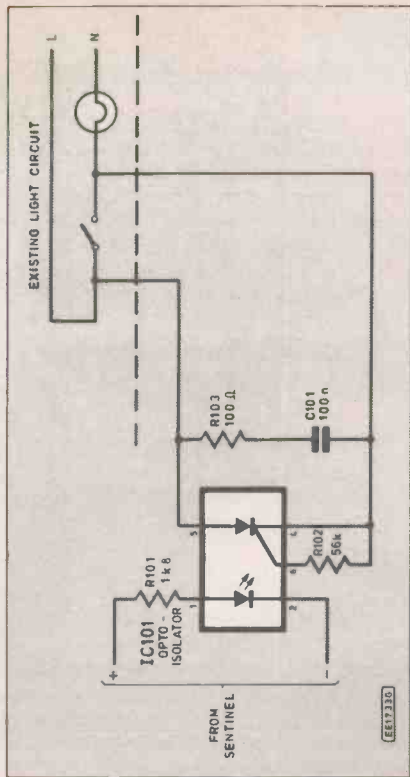

Fig. 3. Circuit diagram for the half power option.

from car head lights, a time delay of about 10 seconds is provided by resistor R4 and capacitor C1.

When the light level falls and causes IC1 to switch—pin 3 goes high, i.e. D1 lights and IC5a switches to give a “1” on pin 13 of IC4 and a “0” on pin 15 (via IC5d). This allows IC4 to be enabled and start counting the pulses from IC3.

For each pulse received IC4 clocks on one and each of its outputs in turn goes high. This is coupled via diodes D14-D21 and links to the output circuits. The lamp connected to the appropriate output circuit will now be lit. Also the lamp connected to the main output will also be directly activated via IC5b and this will stay lit until the complete cycle is completed.

The sequence will continue (providing it is still dark) until pin 11 of IC4 goes high, this happens on the tenth input pulse received at pin 14 of IC4. IC5a now switches and prevents IC4 clocking any more pulses due to the chip enable pin (13) being held high.

At this point all outputs are low and all external lights off. The circuit remains in this state until daylight when IC1 switches off and IC4 is reset automatically. The sequence restarts again at dusk.

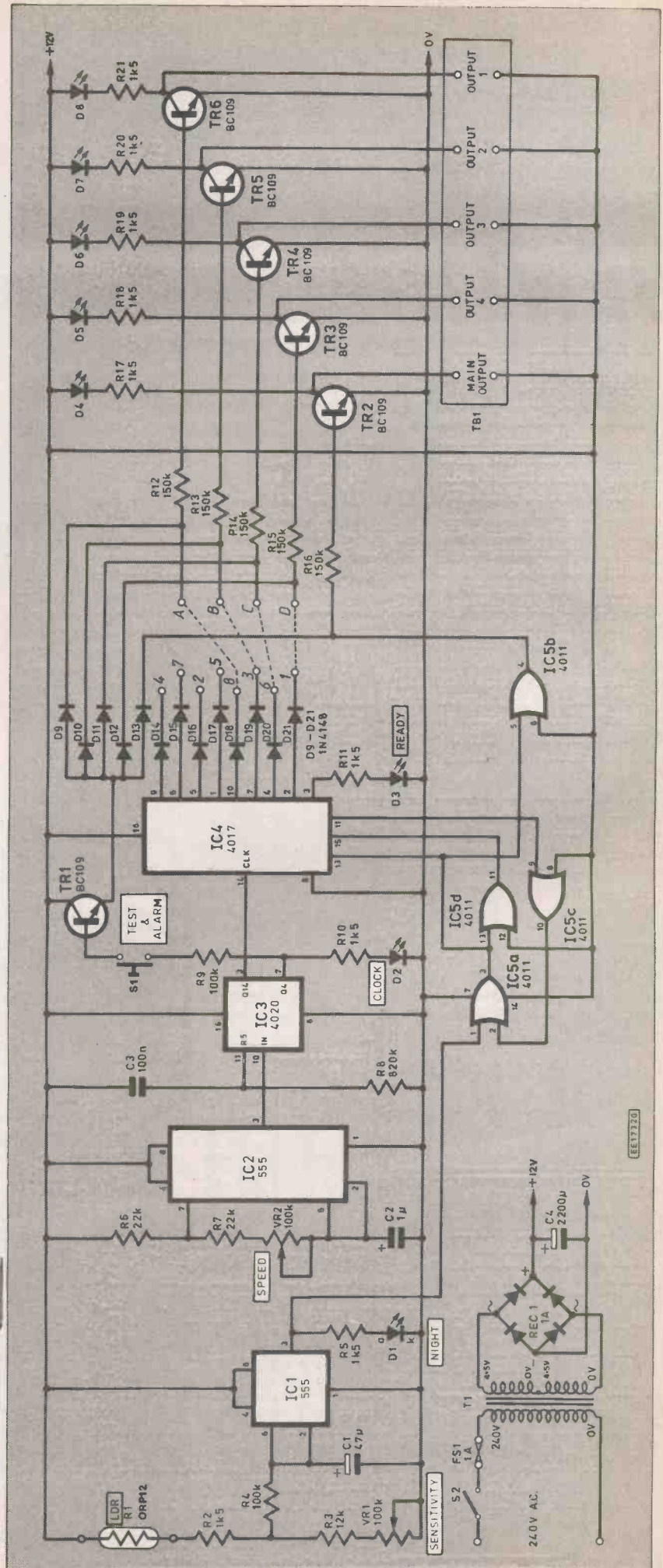
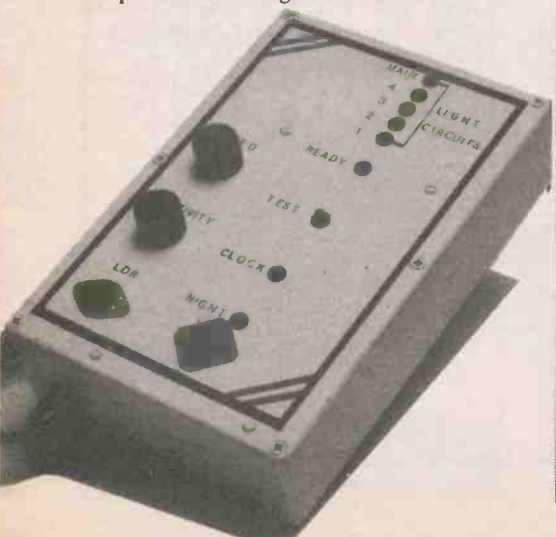
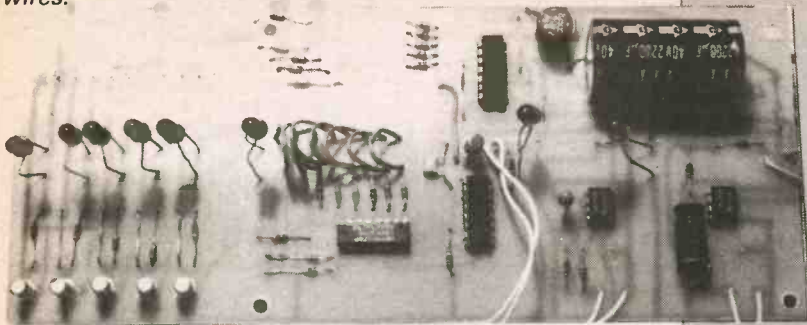

Fig. 2. Complete circuit diagram for Light Sentinel.



Completed circuit board showing the "program" link wires.



Completed half power lamp driver interface.

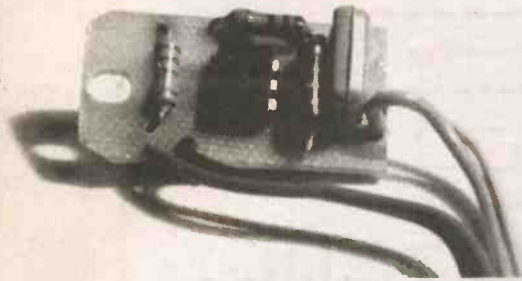

## CONSTRUCTION

The printed circuit board component layout and full size copper foil master pattern for the "master" control unit is shown in Figs. 4 and 5. The small, "opto-isolated", Half Power Interface printed circuit board component layout and copper master pattern is shown in Fig. 6. Both the boards are available from the *EE PCB Service*, order codes EE632 and EE633.

The main printed circuit board holds the majority of the components including the l.e.d.s. The mains transformer, fuse holder, switches and adjustable resistors are mounted directly onto the diecast box.

The cost of construction can be reduced if the alarm and test functions are not required. Just omit from the p.c.b. the following items: diodes D9 to D13, transistor TR1, switch S1 and resistor R9.

Start construction by mounting all the components on to the main board, Fig. 4, in the normal order:— links (11 off), resistors, capacitors and finally diodes, transistors and integrated circuits. The terminal block TB1 is mounted on the reverse side of the board.

If you refer to the component layout, Fig 4 you will see just below diodes D15 to D21 there are two sets of pads labelled 1 to 8 and A to D. These are to enable pre-programming of the switching sequence. Numbers 1 to 8 refer to the outputs from IC4 and one flying link should be connected to each. The letters A to D are the pads connected to the output circuitry and each one can accept up to three inputs from IC4.

For starters try straight forward sequencing by connecting the links in the following

manner: 1 and 5 to A; 2 and 6 to B; 3 and 7 to C and 4 and 8 to D. Experiment later!

## CASE

Now to the metal work—the bit I hate! Drill all the necessary holes, the front panel template (Fig. 7) should be used as a guide. Accuracy is essential for holes marked "A" as the l.e.d.s are offered into these directly from the p.c.b. which is mounted onto the front panel using four stand-off pillars.

The LDR (R1) is mounted remotely and wired into a speaker plug and plugged into a two-pin socket on the front panel. No layout is given for mounting of the mains transformer T1, fuse FS1 and mains switch S2. These are mounted in the main part of the metal case and are positioned so as to clear the main board when the lid is fitted.

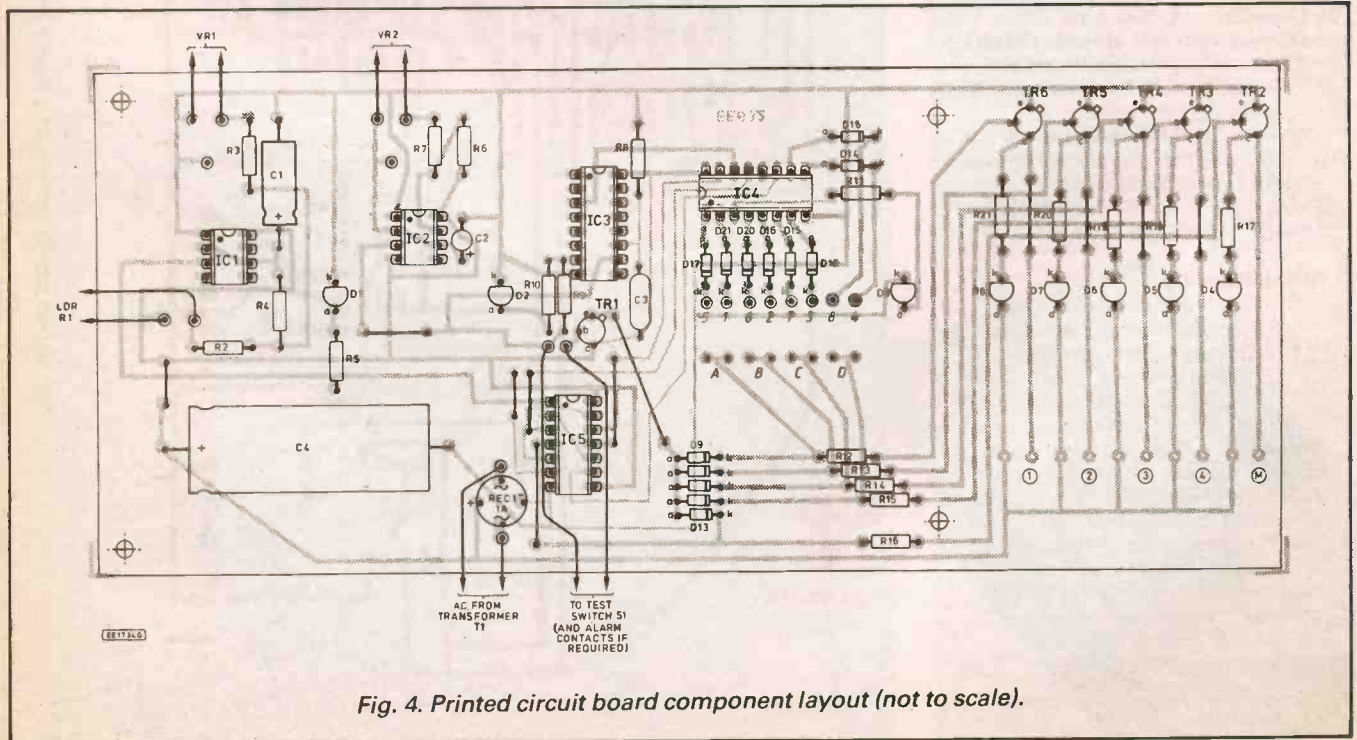

Fig. 4. Printed circuit board component layout (not to scale).

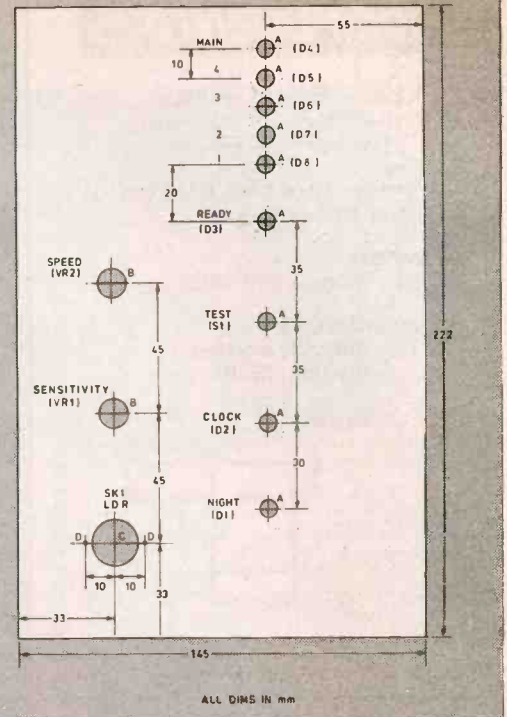

Fig. 7. Front panel drilling details.

# COMPONENTS

## REMOTE INTERFACE

(one set for each position)  
HALF POWER

### Resistors

R101 1k8 R102 56k R103 100  
All 0.25W 10% carbon

### Capacitors

C101 100n ceramic 400V

### Semiconductors

IC1 optically isolated  
thyristor (SCR)

### Miscellaneous

Printed circuit board available  
from *EE PCB Service* code EE633;  
connecting wire—see text; sol-  
der; etc.

## FULL POWER

RLA Solid state relay, mains  
rated switching

## MASTER CONTROL

### Resistors

R1 ORP12 light depend-  
ent resistor (LDR)  
R2, R5 1k5 (2 off)  
R3 12k  
R4, R9 100k (2 off)  
R6, R7 22k (2 off)  
R8 820k  
R10, R11 1k5 (2 off)  
R12—R16 150k (5 off)  
R17—R21 1k5 (5 off)  
All 0.25W 10% carbon

### Potentiometers

VR1 100k rotary carbon, lin  
VR2 100k rotary carbon, lin

### Capacitors

C1 47 $\mu$  axial elec. 25V  
C2 1 $\mu$  tantalum 10V  
C3 100n poly  
C4 2200 $\mu$  axial elec. 40V

### Semiconductors

D1—D8 Red l.e.d.s (8 off)  
D9—D21 1N4148 diode (13 off)  
REC1 1A bridge rectifier  
TR1—TR6 BC109 npn silicon (6 off)  
IC1, IC2 555 timer (2 off)  
IC3 4020 14-stage  
binary counter  
IC4 4017 decade counter  
IC5 4011 quad 2-input  
NAND gate

### Miscellaneous

S1 Push-to-make switch  
S2 Mains On/Off toggle switch  
T1 6VA mains transformer;  
250V primary,  
4.5V-0V-4.5V(0.6A) sec.

Printed circuit board available  
from *EE PCB Service*, code  
EE632; diecast aluminium box,  
222mm $\times$ 146mm $\times$ 55mm; TB1  
10-way p.c.b. screw terminal  
block; loudspeaker plug and sock-  
et; control knobs (2 off); 20mm  
long insulated standoffs (4 off);  
connecting wire; solder; etc.

Approx. cost  
Guidance Only **£35** incl. one  
Interface

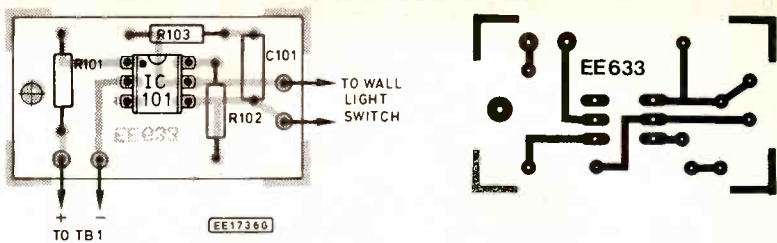

Fig. 6. Component layout and full size master pattern for the Half Power Interface.

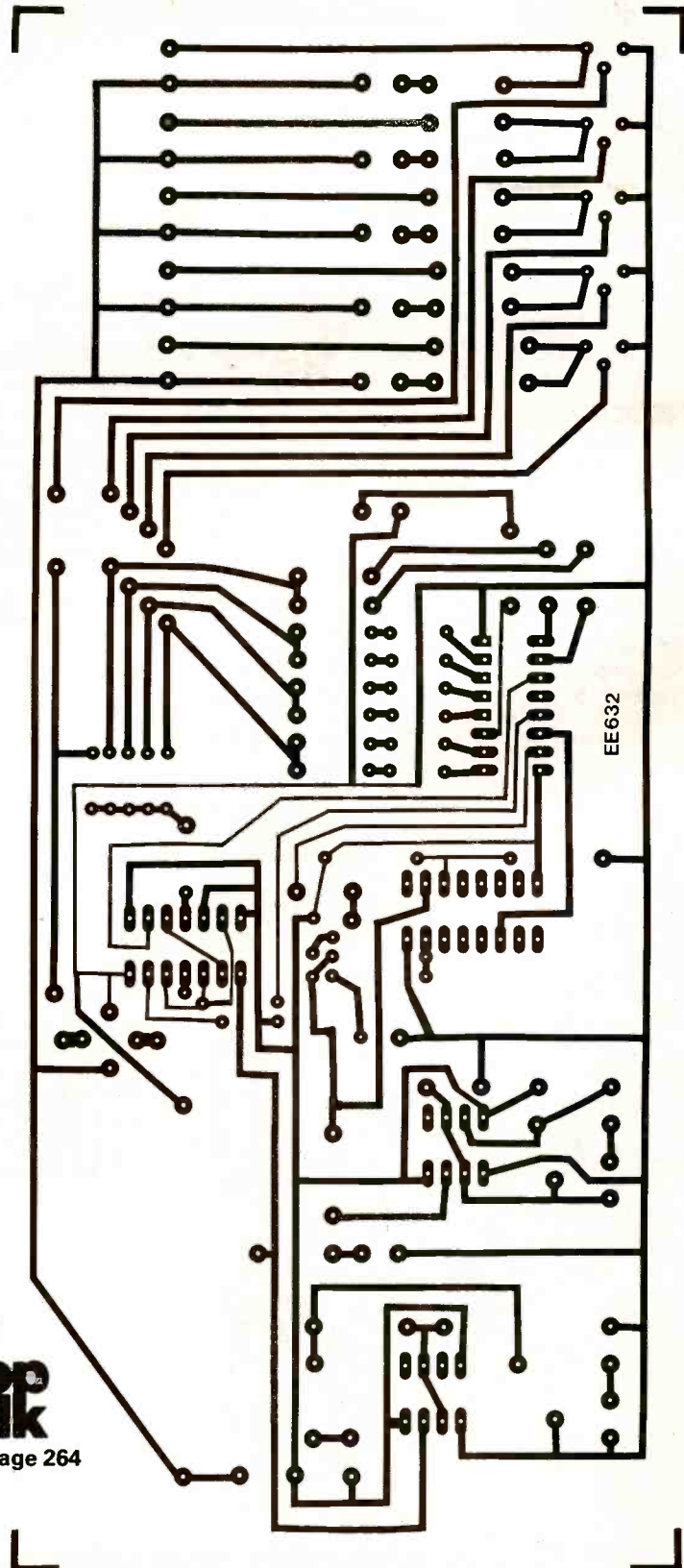

Fig. 5. Full size copper foil pattern for the master control. This board is available through the *EE PCB Service*.

**Shop  
Talk**  
see page 264

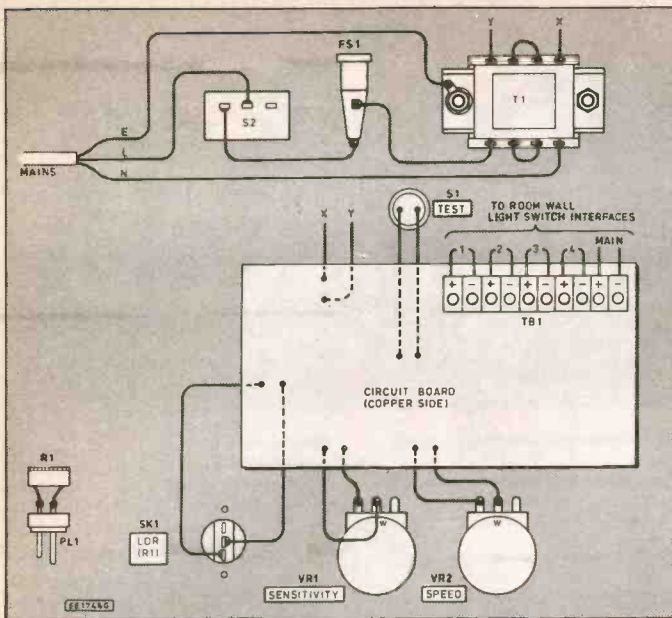

Fig. 8. Interwiring details from the main p.c.b. The LDR (R1) is mounted directly on PL1 during testing only. It should be wired remote from the unit.

When the box has been drilled, painted and components mounted the remaining wiring to the main p.c.b. should be carried out, see Fig. 8. This completes the construction of the main unit and all that remains are the modifications to the existing lighting switches.

## INTERFACE

For the full power switching interface there is no construction required as the solid state relay has internal components to ensure correct operation. All that is required is to mount the relay into the switch box and wire it up as shown in Fig. 1.

For the half-power switching, mount the components onto the small interface printed circuit board as indicated in Fig. 6, taking great care to ensure there are no shorts or bad soldering. After checking mount the board into the light switch box and wire it up as shown in Fig. 1.

The finished Sentinel, with board removed, showing power supply components, stand-off spacers and l.e.d. clips.

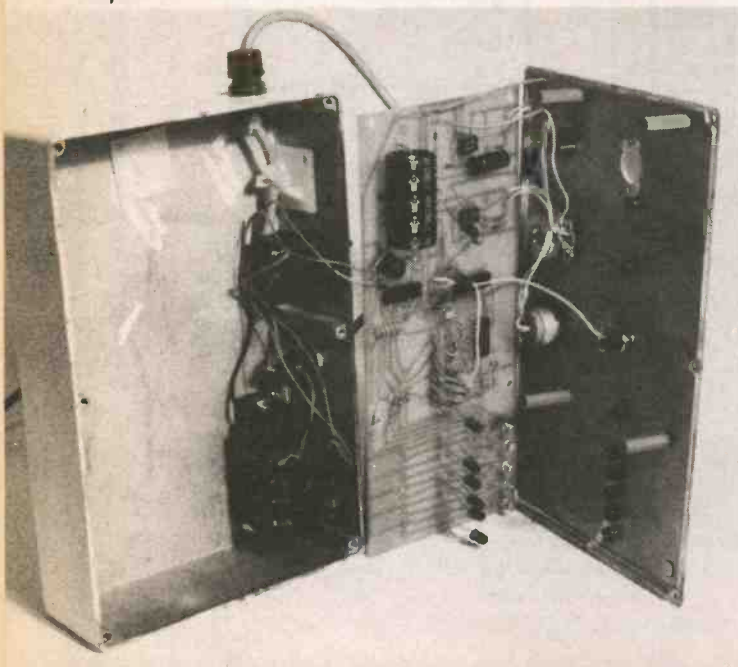

## SYSTEM CONNECTION AND TESTING

The majority of the information required for system connection and testing is also contained in Fig. 1. Mount the "master" control unit in a suitable position near to a mains supply. The LDR should be mounted near a window and should be shielded from any light that may be activated by the Sentinel.

Although only low level signals are transmitted from the unit to the interface it is advisable to use good quality mains cable for the interconnections ensuring correct polarity is observed. Recheck the installation before applying power. Set the Sensitivity control to maximum and the Speed control to minimum (quickest cycling speed).

On powering up the unit during daylight the following l.e.d.s should light: Ready, Night, Main and Clock. The speed of the

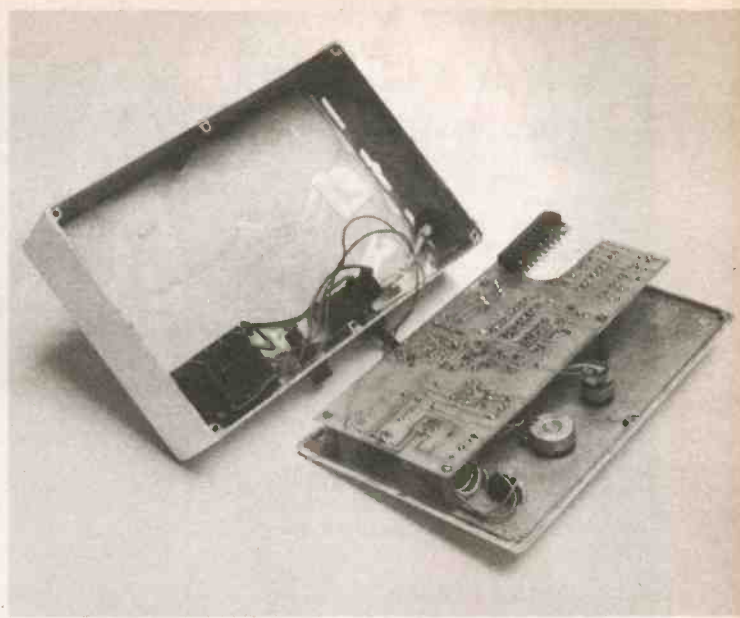

The completed unit showing the interface connecting block (TB1) mounted on the track side of the p.c.b.

Clock l.e.d. flash should be adjustable with the Speed control. After about 10 seconds the Night and the Main l.e.d.s will be extinguished.

Cover the LDR (R1) to cut off the light falling on it and after approximately 10 seconds the Main and Night l.e.d.s should illuminate. If they don't, adjust the Sensitivity control.

With the unit now activated the lighting circuit coupled to the main output should be lit. The sentinel has now begun its sequencing and after a predetermined time (set by the Speed control) the l.e.d.s numbered one to four and their associated lighting circuits should activate in turn. The unit goes back to the rest state when the sequence has been through two complete cycles.

As this testing process can be rather long winded it is possible to speed it up by substituting capacitor C2 with a 100nF capacitor during tests and reverting to the correct value when satisfied the unit is operating correctly. Normal light switching is not affected by the Light Sentinel except when that particular lighting circuit is triggered, hence the wall switch will have its normal response. □

Front panel layout for the Light Sentinel, the two interface modules and the light sensor (LDR).

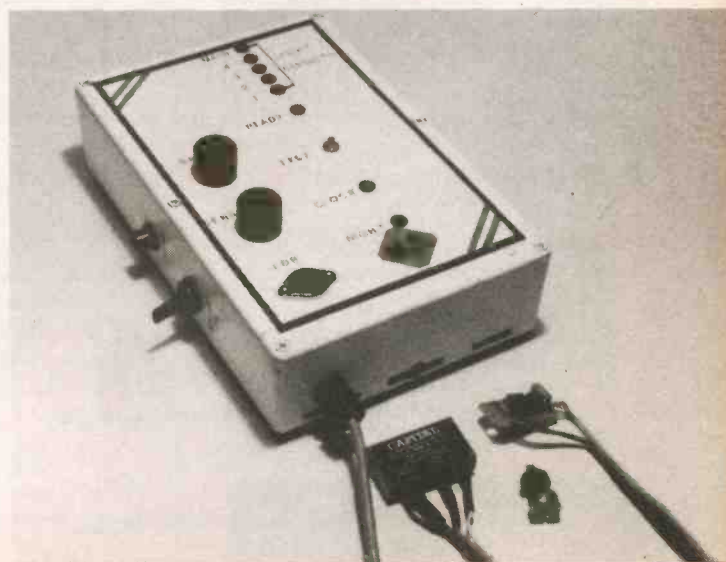

# New REALISTIC® PORTABLE SCANNING RECEIVER

- Frequency Synthesized - No Crystals To Buy
- 68-88 MHz VHF-Lo
- 108-136 MHz (AM) Aircraft
- 136.005-174 MHz VHF-Hi
- 380-512 MHz UHF
- 806-960 MHz

**Realistic Pro-34.** Catch all the action on this hand-held programmable scanner. Features extended frequency coverage, including the new 800 MHz band! Scan up to 200 channels in 10 bands or search for new bands. Store frequencies in a special monitor band for one-key transfer to permanent memory. Lock-out key temporarily bypasses unwanted channels.

## The Key To Better Listening

Also features large LCD display showing channels and frequencies being scanned, monitored or programmed and has a switchable backlight for night viewing. Squelch control, built-in speaker, 1/8" earphone socket, flexible aerial and belt-clip. Includes BNC jack for adding external aerial.

# Tandy®

*Tune in to Tandy TODAY!*

Over 400 Stores  
And Dealers Nationwide  
Prices may vary at Dealers. Offers subject to availability.

Tandy, Tandy Centre, Leamore Lane,  
Walsall, West Midlands. WS2 7PS



Realistic PRO-34 £249.95.  
Cat. No. 20-9135

# Introducing DIGITAL ELECTRONICS

## Part 7: Resistors and Resistances

By **Michael J. Cockcroft**  
Training Manager, Peterborough ITeC

**W**e are concerned mainly, this month, with the following City and Guilds objectives. I say "mainly" because, as we have done in previous parts where appropriate, we include some related theory from section 8 of the logbook. To keep things tidy, though, we will list the last section of the logbook in the last Part of the series, Part 12.

### 4.2 Resistors

4.2.1 Explain, in very simple qualitative terms, the action of a resistor.

4.2.2 Identify series and parallel modes of connection.

4.2.3 Describe the two most common applications of resistors as current limiting and potential dividing.

4.2.4. Explain the importance of using resistors of the correct power rating.

The first half of the course has attempted to achieve a major aim: that you, the reader, gain a general notion of what electronics is about. We have tried to help you understand the subject in this broad sense by keeping technical detail to an absolute minimum. At this introductory level we need not get too technical anyway, but it is time to be more specific about some of the issues brought up in previous parts.

We know that electronic systems, whether they are a simple bulb or a complicated computer, are operated by directing a current of electrons through them; and that the amount of current that flows

depends on the size of the voltage driving the current. But there is a third factor which determines the amount of current that flows: the amount of resistance to current flow put up by the component carrying the electrons. (The component leads and connecting wires in electric circuits also have resistance but this is usually very small compared to the resistances of the actual components, so small in comparison that, for most practical purposes, it can be ignored).

Resistance is very important in electronics and to be able to mentally visualise its effects in a circuit we need to know a little more about conductors and insulators than was previously discussed. The aim of the next few sections is to instil, in our keener readers, a deeper understanding of some of the concepts which emerged in Part 1. If you prefer to stay with the "general idea", you could skip some text and go to the section headed "Resistance".

### Conductors and Insulators

Materials which provide an easy path for electric current are called conductors. Metals such as copper and aluminium are most commonly used for wiring circuits, appliances, houses and the like because they are good conductors of electricity. Silver and gold are the best conductors, but are obviously too expensive to be used in the manufacture of electrical wire, par-

ticularly as copper is relatively cheap and almost as good a conductor.

Materials through which electric current will not easily flow are called insulators. An insulator, to be effective, must have a very high opposition to the flow of electrons. Most non-metals have this property. As you know, the insulation on electrical wires is usually rubber or plastic, these are very good insulators and are the two most commonly used materials for isolating conductors from each other.

There is no distinct margin between conductors or insulators. Copper is a very good conductor and rubber is a very good insulator. Between the two extremes there are materials which are neither good conductors nor good insulators; semiconductors, for example. There are other materials which cannot be classified as conductor, insulator, or semi conductor.

It is important to realise that any insulator will become a conductor if subjected to a high enough voltage. The insulators in Table 7.1 will remain insulators under normal 240 volt household supplies.

The way in which a material conducts electricity depends entirely on the atomic structure of the material. We touched on this subject in Part 1 when we compared a Helium atom to the solar system and illustrated how electrons can be moved



Table 7.1

**CONDUCTORS    INSULATORS**

silver	glass
gold	porcelain
copper	plastic
lead	rubber
tin	mica
brass	ice & snow (pure)
aluminium	nylon
bronze	bakelite
nickel	paper
iron & steel	wood
cadmium	paraffin
graphite	quartz
mercury	dry air

away from their original atoms by applying energy to the material to which they belong.

Let's compare the atomic structure of conductors and insulators and try to understand what it is about these two classes of material that makes one a path along which electrons can easily move and the other an obstacle to the same when energy is applied to them. To be able to do this we must first know something about the physical construction of materials in general.

**The Structure of Matter**

Any substance whether it is solid, liquid, or gaseous is made up of one or more basic substances called **elements**. There are just over 100 known elements and *all* matter is derived from these; substances are either pure elements (such as copper and silver) or they are mixtures of elements called **molecules**; for example, Sodium Chloride (salt) is made up of two elements—Sodium and Chlorine.

The absolute smallest particle of

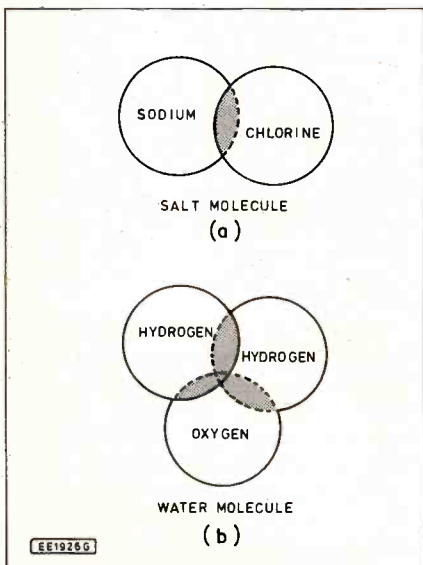

Fig. 7.1. Atoms bonded to form a salt molecule (a) and a water molecule (b).

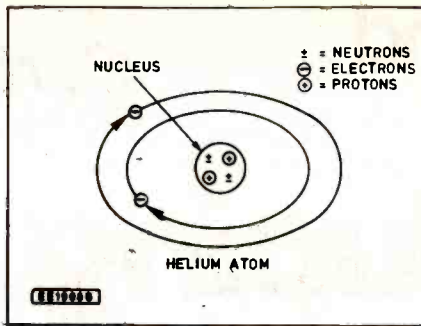

Fig. 7.2. Structure of a helium atom.

salt possible is called a salt molecule which is made up of the smallest possible particle of Sodium chemically bonded to the smallest possible particle of Chlorine. These "smallest possible particles" of elements are called atoms. Fig. 7.1 shows: (a) a Sodium atom bonded to a Chlorine atom to form a salt molecule, and (b) two Hydrogen atoms and an Oxygen atom (H<sub>2</sub>O) bonded together to form a water molecule.

**The Atom**

An atom in any material consists of protons, electrons, and neutrons; Fig. 7.2 shows the pictorial representation of a Helium atom reprinted from Part 1. The electron is the negative particle, and the pro-

ton is the positive particle. The proton has a positive electric charge and the electron has an equal, but opposite (negative) charge.

A body which holds an amount of electricity is termed a "charged body". If a certain body contains more protons than electrons, that body will hold a positive charge. The reverse is also true; a negatively charged body contains more electrons than protons.

A negative charged body placed near a positively charged body produces a force of attraction between them (unlike charges attract); One tries to contact the other in an attempt to balance the charge. Two charges of the same sign (both positive or both negative) will repel one another (like charges repel). When a charged body comes into contact with a neutral body, the charge will be divided equally between the two bodies. If the original charge is great enough, both bodies will acquire a like charge and repel one another (see Fig. 7.3).

Protons and neutrons are the largest part of the atom and are confined to the central nucleus of the atom. Electrons circle at high speeds in orbits of various sizes around the nucleus. The Helium atom in Fig. 7.2 has two electrons in orbit around a nucleus of two protons and two neutrons, indicating that the atomic number of helium is 2. Normally, electrons are kept in their orbits by the attractive charges (rather like magnetism) of the protons and electrons. In this state the atom is electrically neutral. The nucleus is positively charged and the electrons are negatively charged, but the atom as a whole is not charged.

All atoms under normal conditions are electrically neutral, this is because the numbers of protons and electrons are equal—the positive charge on the nucleus is neutralised by the opposite charge on the orbiting electrons.

**Ionisation**

If enough force or energy is applied to a material, electrons can break away from their atoms. When this happens, the atoms have an unequal number of protons and electrons and, having lost electrons, become positive (because there are now more protons than electrons). A charged atom (that is one with an imbalance of protons and electrons) is termed an **ion**; if it has an excess of protons it is a positive ion. When electrons move away from their original atoms, they can become attached to other atoms which, in turn, become negative ions.

The actual number of electrons orbiting an atom depends on the

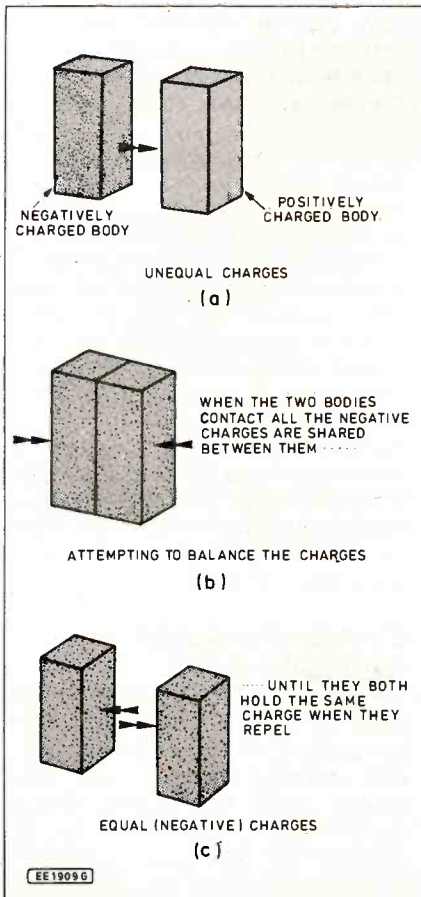

Fig. 7.3. Action of charged bodies.

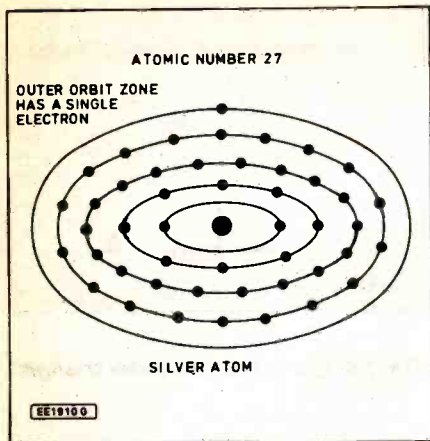

Fig. 7.4. Structure of a silver atom.

matter to which the atom belongs. This number, called the "atomic number", determines whether a material is a conductor, insulator, or something in-between the two. For each atom there are a number of orbit paths in which electrons fly around the nucleus. The number of orbit paths and the number of electrons in each path varies according to the atomic number of the particular element; for example, the Silver atom has 47 electrons (an atomic number of 47) in five orbit paths, as shown in Fig. 7.4.

The orbit path of particular interest to us in our investigation of what determines a material's resistance is the outermost orbit path. The fewer electrons in this "farthest away from the nucleus" zone, the better a conductor the material becomes because of the smaller required energy to part them from their parent atoms. Silver, with only one outer electron orbiting its atoms, requires very little energy to dislodge them. Copper has a similar atomic structure (see Fig. 7.5) and is almost as good a conductor; it also has only one outer electron but a different atomic number (29).

In contrast, air (the atmosphere) is a good insulator, it is composed

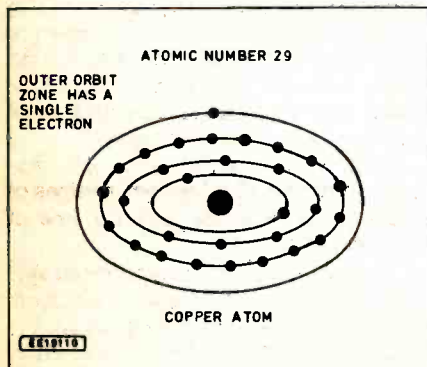

Fig. 7.5. The copper atom.

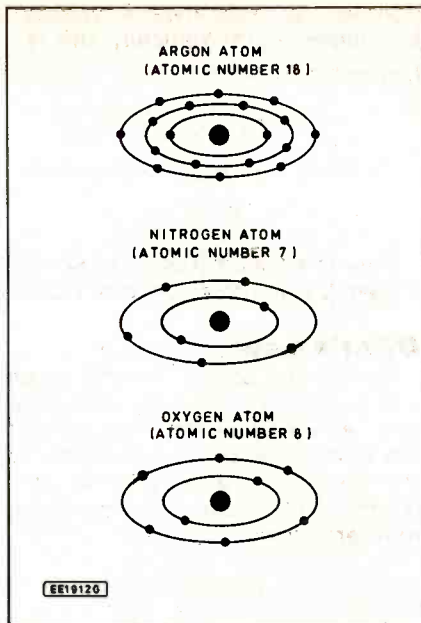

Fig. 7.6. The structure of the atoms in the air.

mostly of the elements Nitrogen, Oxygen, and Argon. These gases have five, six, and eight electrons, respectively, in their outer orbit zones (Fig. 7.6).

Since electric current is regarded as a flow of electrons, the amount of current depends on the number of electrons moving (called **free electrons**) in the circuit. The number of electrons free to move in a given material depends on the type of material it is; for example,

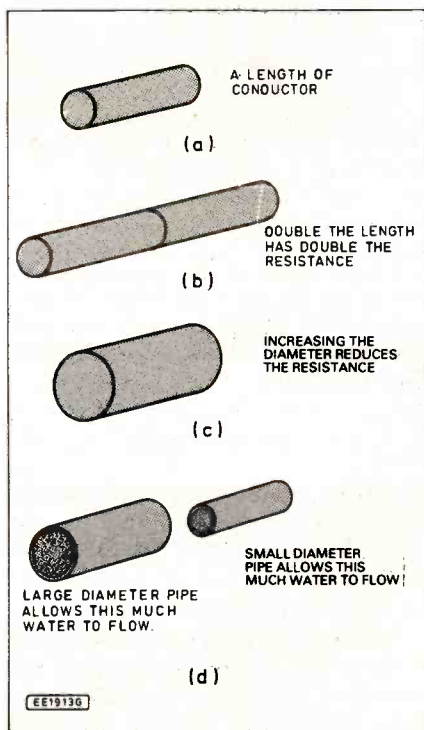

Fig. 7.7. Relationship between resistance, length and cross sectional area.

whether it is a conductor or an insulator. When we speak of conductors and insulators we are referring to the material's opposition to current flow. The term used to describe the opposition offered by a material to the flow of current is "resistance".

## Resistance

Resistance, then, is a physical property of all matter and is the property which determines the amount of current that will flow through a material when a given voltage is applied. Since the number of moving electrons determines the amount of current flowing in a material, the resistance of the material therefore depends on its size.

If one length of a uniform conductor (as in Fig. 7.7a) offers a certain resistance to the flow of current, adding another piece of the same length (as in Fig. 7.7b) will naturally double its resistance. So the resistance of a conductor is proportional to its length, the longer the conductor the greater the resistance. But if the diameter of the conductor is increased, as in Fig. 7.7c, the resistance is reduced; the material's resistance is inversely proportional to its cross-sectional area (the cross-sectional area means the area which would be exposed by cutting straight across the material. In the case of the conductor in the figure, it is the area of a circle of the same diameter as the wire).

Long, thin wire has more resistance to electron flow than short, thick wire for the same reason that long, thin pipes have more resistance to water flow than short, thick pipes. For the same length pipe, more water can move if a greater area is made available for it to move in (see Fig. 7.7d).

Resistance not only varies with different material types and sizes, it also varies appreciably as the temperature changes. This is because the temperature affects the motions of atoms and so affects the flow of free electrons. The resistance of conductors, for example, increases with a rise in temperature.

## In Summary

To take a superficial look at where we are at the moment, consider our "torch" circuit for the last time. This simple device reveals several important points concerning what we have learnt about electronic circuits:

- (1) Electronic components and devices are operated by placing them into a circuit and passing current through them.

- (2) Current is a measure of the quantity of electrons flowing past a given point in a circuit.
- (3) Any useful circuit requires a voltage source, components, and wires or other types of conductor to interconnect the various parts.
- (4) The amount of current that flows depends on the size of the voltage (the higher the voltage, the greater the current flow) and the type of material through which the current is flowing. (If the wire in the torch circuit were made of steel instead of copper, less current would flow and the bulb would be dimmer for the same supply voltage. Although steel is a conductor it is a poorer conductor than copper).
- (5) The size of voltage at the terminals of a voltage source or between two points in a circuit is a measure of the difference in the number of electrons at the two points. You will remember that a voltage source is an excess accumulation of electrons chemically (or otherwise) maintained between its two terminals.
- (6) Temperature affects the resistance of materials; for example, the resistance of the bulb filament in the torch circuit is different out of circuit than when it is on (don't try to measure its resistance with a meter while it is on!—take our word that this is true for the moment).

It is now appropriate to look at the mathematical relationships between electrical quantities so that we may predict the various voltages, currents etc., in circuits without having to physically measure them.

### Mathematical Relationships

Considering voltage (symbol V) is the driving force behind current (symbol I) flow and resistance (symbol R) limits the amount of current that flows, there must be some mathematical relationship between them.

We know that if the voltage to a circuit is increased the amount of current increases, we also know that if the resistance in a circuit is increased the amount of current is reduced. In fact, voltage and current are directly proportional to each other (they increase and decrease together by the same proportions), and current is inversely proportional to resistance (current decreases proportionately as resistance increases and vice versa—current increases propor-

tionately as resistance decreases). Expressed mathematically, this is:

Current in a circuit

$$= \frac{\text{Voltage applied to circuit}}{\text{Resistance of circuit}}$$

Or using mathematical symbols:

$$I = \frac{V}{R}$$

This is derived from a very well known law in physics—Ohm's Law.

### Ohm's Law

Ohm's law states "In any given conductor, provided the temperature remains constant, the ratio of the voltage across a conductor to the current established in the conductor is a constant". Or, putting it mathematically:

$$\frac{V}{I} = \text{constant.}$$

The constant is, of course, the resistance of the conductor. The equation can now be written:

$$\frac{V}{I} = R.$$

Ohm's law can be used to find current, voltage, or resistance if any two values of the three are known; for example, the equation to calculate the amount of voltage required to establish 2 amps through a load resistance of 50 ohms is derived by changing the subject of the above equation: We know:

$$R = \frac{V}{I}$$

is a formula for finding resistance when the values for voltage and current are known, but we need to find the voltage when resistance and current are known:

$$50 = \frac{?}{2}$$

Transposing, or changing the subject of an equation, is a simple matter of moving a quantity from one side of an equation to the other side by changing its sign. This is the same as performing like operations on both sides of the equation; for example, to get V by itself on one side of the equation, both sides of the equation need to be multiplied by I as follows:

$$(I) \times R = \frac{V \times (I)}{I}$$

The Is on the right side of the equation cancel, leaving  $I \times R = V$ . So  $V = I \times R$  or specifically (for the above problem):

$$V = 2 \times 50 = 100 \text{ volts}$$

The rule to remember is an equation is not altered by carrying out identical operations on both sides. The third form of the equation (when I is unknown) is derived by transposing  $V = IR$  to make I the subject. This is done by dividing both sides of the equation by R and can-

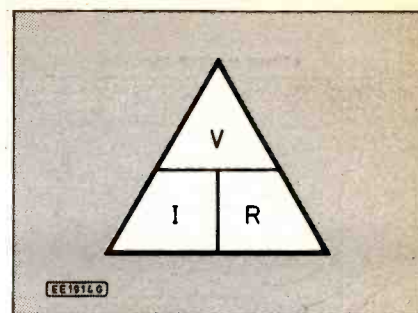

Fig. 7.8. Ohms law reminder triangle.

celling the Rs on the right hand side to get  $I = V/R$ , thus:

$$\frac{V}{(R)} = \frac{I \times R}{(R)}$$

The triangle in Fig. 7.8 may be used to help you to remember the three forms of the formula for Ohm's law. If the resistance is unknown place your finger over the R; this leaves V over (divided by) I visible and therefore  $R = V$  divided by I,  $(V/I)$ . To determine voltage cover the V; IR is visible and therefore  $V = I$  multiplied by R,  $(IR)$ . Finally, to find current, covering the I leaves V over R visible,  $(V/R)$ .

### Work, Energy and Power

One of the fundamental laws of physics is the conservation of energy law. Energy can neither be created nor destroyed; it can only be changed from one form to another. Energy is defined as the ability to do work. Work is being done only when there is movement against force or resistance; for example, when electrical energy is converted into light energy in a light bulb or when the chemicals stored in the body is converted into mechanical energy when a person moves an object from one place to another.

Work and power share the same unit of measurement—kilogram-metres (we are not concerned with kilogram-meters, but we need it as part of the example here). If you lift 2 kilograms 5 metres up in the air you do 10 kilogram-metres of work (the energy required to move an object is equal to the weight of the object multiplied by the distance moved), and since the work had been done on the weight you must have given it 10 kilogram-metres of energy (potential energy).

This weight would now be capable of doing 10 kilogram-metres of work in accordance with the law of conservation.

Power (symbol P [sometimes W]) may be defined as the rate at which work is done or the rate at which energy is converted from one form to another. If two people lift the above 2kg weight through 5

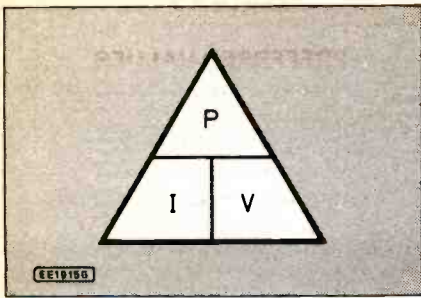

Fig. 7.9. Power formula triangle.

metres, then they both do the same amount of work, but if one person does it in a shorter time than the other, it is said that he has the greater power.

### Electrical Power

When voltage forces current through a resistance, heat is generated. Electrical energy is converted into heat energy. The rate at which this conversion takes place describes its electrical power (measured in watts). Power is determined by the current flowing through the device multiplied by voltage present across it:

$$P \text{ (power in watts)} = I \times V$$

In the same way that Ohm's law reveals an unknown quantity if two of the three factors V, I or R are known, the wattage rating of a device reveals the voltage or current if one or other of the values is known. A similar triangle to the one for Ohm's law is given in Fig. 7.9; it shows the formula for power in all three forms:

$$\begin{aligned} P &= IV \\ I &= P/V \\ V &= P/I \end{aligned}$$

This, including the Ohm's law set, gives us six formulae for finding four possible values—V, I, R and P. We can work out:

- (1) Voltage  
given current and resistance 1  
or current and power .....2
- (2) Current  
given voltage and resistance 3  
or voltage and power .....4
- (3) Resistance  
given current and voltage.....5
- (4) Power  
given current and voltage.....6

But this is not enough; for example, if we wish to know the power dissipation of a 100 ohm resistor with half an ampere flowing through it we are out of luck unless someone tells us what voltage is across the resistor. We need an expression like:

$$P = I \text{ something } R$$

In which the "something" box is any function that combines the two terms I and R to arrive at the result P. Happily, we can do this without

having to learn any more formulae (we only need to learn  $P=IV$  and  $V=IR$  parrot fashion, all other formulae involving V, I, R and P are derived from these); for example, to find the power dissipated in a resistor given only the value of the resistor and the current flowing through it, we use a combination of the two formulae  $P=IV$  and  $V=IR$ . Since P is the subject of the equation we start with:

$$P = IV$$

The value of I is known so all we need to do is exchange V for an equivalent expression involving the values we know (which, in this case, is I and R).  $V=IR$  so we can put IR in its place in the equation, thus:

$$P = I \times (I \times R).$$

All we have done is substitute the V in  $P=IV$  for another way of expressing V:  $V=IR$ . Now we have:

$$P = I \times I \times R = I^2 R.$$

The answer to the problem is:

$$P = 0.5 \times 0.5 \times 100 = 25 \text{ watts.}$$

### Illustrative Example

What power is dissipated in a 100 ohm resistor connected across a 9 volt battery?

$$P = IV$$

substitute I for V/R

$$\begin{aligned} &= \frac{V \times V}{R} \\ &= \frac{V^2}{R} = \frac{9 \times 9}{100} = 0.81 \text{ watts} \end{aligned}$$

Table 7.2 shows all forms of formulae for calculating V, I, R, or P providing any two are known. We leave it to you, as an exercise, to prove them.

### Resistors

Resistors are not new to us, we have identified a number of fixed and variable types and studied the value colour coding conventions in Part 2. We also mentioned, in the same part, the importance of using resistors of the correct power rating.

TABLE 7.2

V	$IR$	$\frac{P}{I}$	$\sqrt{PR}$
I	$\frac{V}{R}$	$\frac{P}{V}$	$\sqrt{\frac{P}{R}}$
R	$\frac{V}{I}$	$\frac{V^2}{P}$	$\frac{P}{I^2}$
P	$IV$	$I^2 R$	$\frac{V^2}{R}$

Resistors consume power. Electrical energy (current flowing through resistance) is converted to heat energy and lost to the atmosphere. We call this electrical loss *power dissipation*.

Excessive heat will destroy a resistor so we need to be able to calculate the amount of power that will be dissipated by a resistor operating in a circuit, and select a power rating accordingly. The power rating should be correct for reasons of economy too: it is uneconomic to provide excessively large resistors if they are not expected to dissipate a proportionate amount of heat energy, it may also be difficult to physically accommodate them in the circuit.

### Illustrative Example

What is the maximum current that is allowed to pass through a 100 ohm 5 watt resistor?

$$I = P/V$$

substitute V for IR:

$$= \frac{P}{IR}$$

multiply both sides by I:

$$I \times I = \frac{PI}{IR} \text{ or } I^2 = \frac{P}{R}$$

$$I = P/R \quad 5/100 = 0.233 \text{ amps}$$

Resistors are characterised by what material they are made from and by the way in which they are physically constructed in manufacture, Fig. 7.10 shows some of the most widely used types. One of the most economical and common is the *carbon composition* resistor. These usually range from 10 ohms to 10M (in a range of preferred values—see Table 7.3) at 1/4, 1/2, 1 and 2 watt power ratings. These resistors have very poor long term stability: their value can change by as much as 5% in one year.

High stability *film* resistors are also in wide use, there are three popular types: *carbon film*, *metal oxide film*, and *metal film*. In general, these resistors offer much better stability and are manufactured to better tolerances (as good as  $\pm 0.001\%$  for metal film). Film resistors cover the whole resistance range and the power rating range is quite large.

*Wire-wound* resistors are usually used for higher power applications. Typical types are *thin film*, *silicone*, *ceramic*, and *aluminium clad*. Power ratings range from less than one watt to several kilowatts.

### Series circuits

A series circuit, such as the series resistor circuit of Fig. 7.11, is a circuit in which all the components are connected end to end. In this type of circuit all the electrons which pass

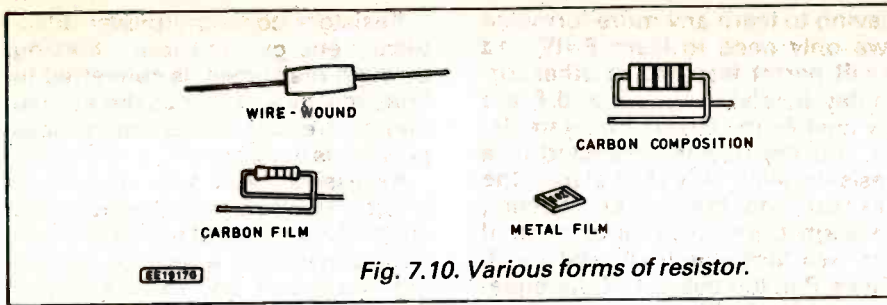
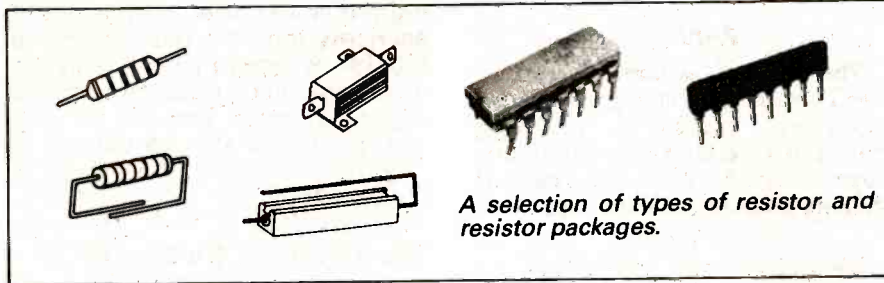

Fig. 7.10. Various forms of resistor.



A selection of types of resistor and resistor packages.

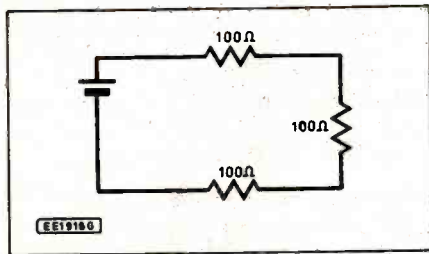

Fig. 7.11. Simple series circuit.

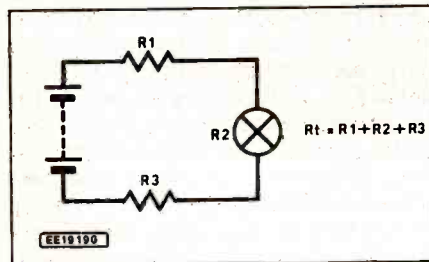

Fig. 7.12. Series circuit with a bulb.

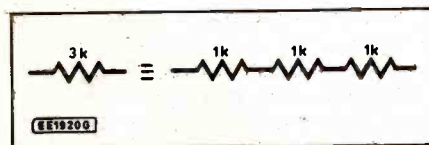

Fig. 7.13. Representing series resistors with one resistance.

through one component must also pass through all other components.

Current in a series circuit is determined by values of total resistance and total voltage. The total supply voltage is distributed proportionally across each of the series resistances, depending on their ratios to the total resistance. Total resistance ( $R_t$ ) in the circuit of Fig. 7.12 is the sum of all the individual resistance across the terminals of the source voltage:  $R_t$  will be equal to  $R_1 + R_2 + R_3$ .

The bulb shown in the figure does have a resistance (as do all electronic components) even though it is not a resistor; therefore, it is marked R for calculation purposes.

In analysing series circuits it is often necessary to represent all resistances by a single equivalent resistance for the purpose of making calculations; this is illustrated in Fig. 7.13.

### Fall in Voltage

All the source voltage is distributed proportionally across the resistances in a series circuit. The fall in voltage (usually called voltage drop) between any two points can be calculated by the ratio of the individual resistances to the total resistance of the circuit.

Consider three resistors connected across a 1.5 volt cell, as shown in Fig. 7.11. The resistors all have the same value of 100 ohms, or a total of 300 ohms for the circuit. Current flowing in the circuit will be 5mA ( $V/R$ ). The whole 1.5V will be dropped across the three resistors and as they are all the same value each resistor will have 0.5 volts across it (since each resistor represents one third of the total resistance). The voltage across each of the resistors, irrespective of their value (providing all three are the same), would be 0.5V. The current, however, would change according to the resistance.

The resistor leads and wires also have a resistance but, normally, the relatively small voltage drop of conductors is disregarded as the resistance of the wire is usually very small compared to the total load resistance.

The fact that a voltage drop is developed across a resistance when a current flows through it can be used to divide a source voltage into smaller values. We call such

TABLE 7.3

### PREFERRED VALUES

#### E12 Series

1.0	1.2	1.5	1.8
2.2	2.7	3.3	3.9
4.7	5.6	6.8	8.2

and their decades

#### E24 Series

1.0	1.1	1.2	1.3
1.5	1.6	1.8	2.0
2.2	2.4	2.7	3.0
3.3	3.6	3.9	4.3
4.7	5.1	5.6	6.2
6.8	7.5	8.2	9.1

and their decades

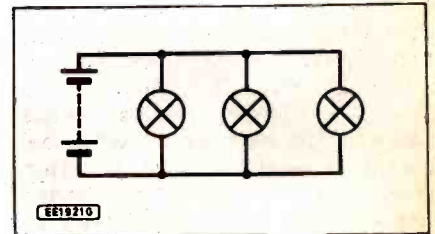

Fig. 7.14. Bulbs in parallel.

circuits potential dividers and we deal with these later in this article.

### Parallel circuits

A parallel circuit is a circuit in which all the components are connected to the same supply terminals. Two or more bulbs, for example, may be connected together across the same battery, as shown in Fig. 7.14.

In a series circuit all loads are connected end to end, the same current flows through all components and the source voltage is divided among the separate loads. In a parallel circuit the opposite happens to voltage and current; current in each branch of a parallel circuit must come from the same source. This means that each branch will have a different current if the resistance of each branch is different.

The source must supply current for each branch, so the total current is the sum of all branch currents. To find the amount of current in each branch of a parallel circuit Ohm's law must be applied ( $V/R$  for each branch). Consider Fig. 7.15; the total current  $I_t$  flowing in the circuit is equal to the sum of all the individual branch currents  $I_1$ ,  $I_2$ , and  $I_3$

$$I_t = I_1 + I_2 + I_3$$

The total resistance in this circuit, we will call this  $R_t$ , will be equal to  $V/I_t$ .

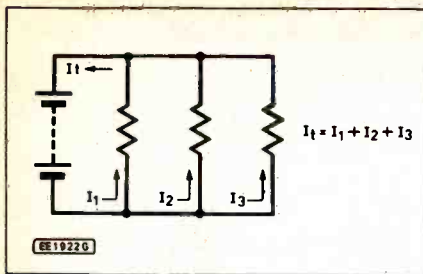

Fig. 7.15. Current flow in a parallel circuit.

Also:  $I_t = V/R_t$  and the current in any branch is  $V/R$  for that branch so:

$$I_1 = V/R_1, I_2 = V/R_2, \text{ and } I_3 = V/R_3$$

$$I_t = I_1 + I_2 + I_3$$

Therefore

$$V/R_t = V/R_1 + V/R_2 + V/R_3$$

The expression for calculating the total resistance in a parallel circuit is:

$$R = \frac{1}{1/R_1 + 1/R_2 + 1/R_3 + \dots + 1/R_n}$$

The expression can be simplified when there are only two resistors:

$$R = \frac{R_1 \times R_2}{R_1 + R_2}$$

We call this the "product over the sum" process of calculating parallel resistances.

### Series-Parallel Circuits

Electronic circuits are often a combination of series and parallel circuits. The diagram of Fig. 7.16 shows such a combination and is referred to as a series-parallel circuit.

You will recall that resistors in series can be represented by a single equivalent resistor. It follows that resistors in parallel can also be represented by a single equivalent resistor. Total resistance in a series-parallel circuit is calculated by reducing any parallel combinations of resistance to a single equivalent and then adding this equivalent up with any series equivalent: for example, consider the circuit in the Fig. 7.16. The first branch resistance is determined by finding an equivalent resistance for  $R_1$  and  $R_2$ . The second branch resistance is deter-

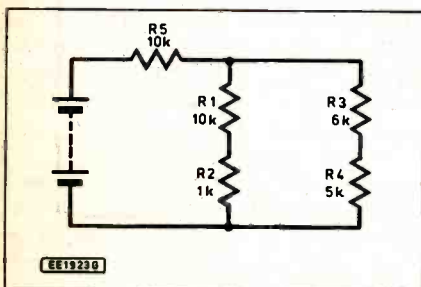

Fig. 7.16. A series/parallel circuit.

mined by the same process for  $R_3$  and  $R_4$ . The total resistance can then be determined by adding the parallel equivalent of the two branches to  $R_5$ .

Of course, there are many possible solutions to the same problem; by applying Ohm's law, for example, as we did earlier when calculating resistance in series and parallel circuits. These solutions may be applied to the problem of finding total resistance in the Fig. 7.11 circuit, if we feel it appropriate to do so. We may equally well (since there are only two parallel branches) prefer to calculate the equivalent resistance of the two parallel branches in the same circuit by the product-over-the-sum process:

$$R_{Bt} = \frac{R_{B1} \times R_{B2}}{R_{B1} + R_{B2}} = \frac{11k \times 11k}{11k + 11k} = \frac{121k}{22k} = 5.5k$$

In which:

$R_{Bt}$  is the total resistance for the two parallel branches.

$R_{B1}$  is the total resistance for branch 1 ( $R_1 + R_2$ )

$R_{B2}$  is the total resistance for branch 2 ( $R_3 + R_4$ )

The total resistance for the entire circuit becomes:

$$R_t = 5.5k + 10k = 15.5k$$

### The Potential Divider

The potential divider (Fig. 7.17) is a simple resistor series circuit which processes the voltage at its input to produce a different voltage at its output. The output voltage

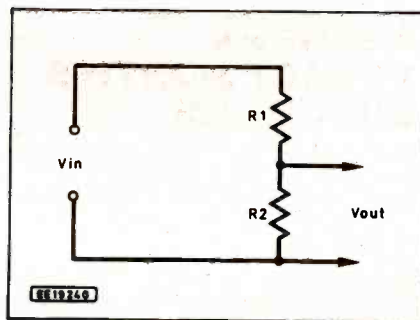

Fig. 7.17. The potential divider.

( $V_{out}$ ) will depend on the value of the input voltage ( $V_{in}$ ) but it also depends on the values of the two series resistors. If the input voltage and the values of the two resistors are known the output can be calculated thus:

$$V_{out} = V_{in} \times \frac{R_2}{R_1 + R_2}$$

The potentiometer is based on the principle of the potential divider; it allows a particular voltage to be "tapped off" by turning a knob to adjust the position of a wiper on resistive material. The resistance varies according to how much resistive material exists between the wiper (B) and another point (A or C)—see Fig. 7.18.

### The Current Limiting Resistor

Since the current flowing in a series circuit is determined by dividing the voltage by the sum of all the resistances present in the circuit, it stands to reason that the current will always be less than:

$$\frac{\text{Voltage}}{\text{Largest single resistance}}$$

Hence the current in the series circuit of Fig. 7.19 will be limited to 3mA. Therefore, it can be seen that a single resistor can be appropriately selected to limit current flow to a given value.

See the next page for questions etc.  
Next month: Capacitors.

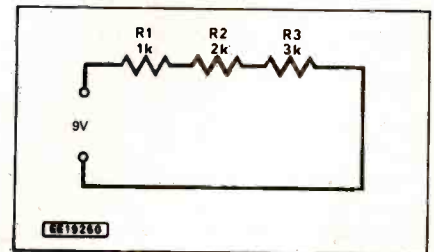

Fig. 7.19. Series circuit.

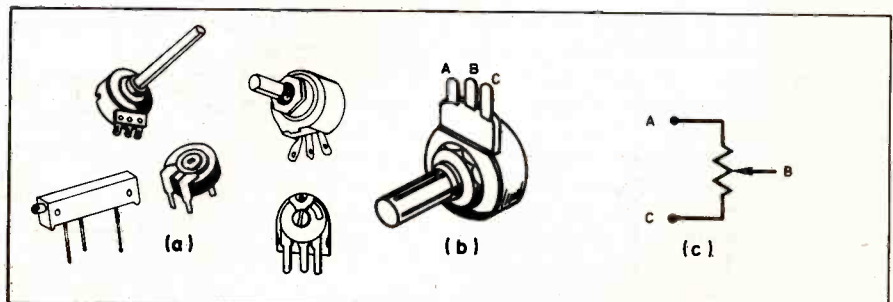
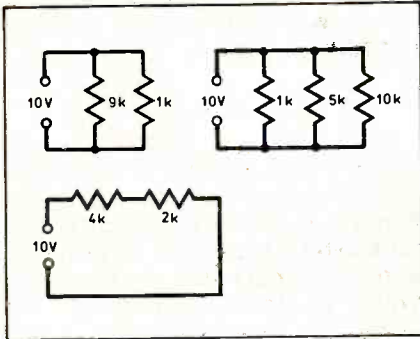

Fig. 7.18(a). A selection of potentiometers. (b) Physical connections of a potentiometer and (c) the circuit symbol.

## Questions

1. Calculate the total resistance and total current of the following circuits?



2. A conductor has a resistance of 1 ohm if a potential difference of 1 volt establishes a current of .....
3. According to Ohm's law, what will happen in each of the following cases. Answer "increase", "decrease" or "same" (meaning remain the same).
- (a) The voltage is increased  
Current will .....  
Resistance will .....
- (b) The voltage is decreased  
Current will .....  
Resistance will .....
- (c) Resistance is increased  
Voltage will .....  
Current will .....
- (d) Resistance is decreased  
Voltage will .....  
Current will .....
4. What would occur if a resistor rated at 1/4 watt were used to dissipate 800mW?
5. (a) Calculate the total resistance in the following circuit.

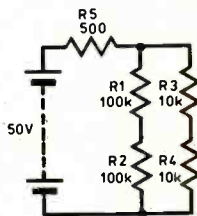

- (b) What is the total resistance in the same circuit when  $R_1=100k$ ,  $R_2=10k$ ,  $R_3=470$  ohms,  $R_4=1k$  and  $R_5=10k$ ?
- (c) Using the above values, what is the total current in the circuit.
6. Would the bulb in the circuit below dim or get brighter when the switch is made?

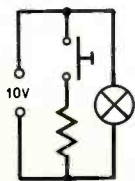

7. Employing the product-over-the-sum process, calculate the

total resistance for the following parallel combinations.

- (a) When  $R_1$  and  $R_2$  both equal 10k .....
- (b) When  $R_1$  and  $R_2$  both equal 100k .....
- (c) When  $R_1$  and  $R_2$  both equal 1k .....
8. Study your answers to a, b and c above and complete the following sentence:  
The total resistance may be reduced to ..... its former value by connecting a resistor of the same value in parallel.
9. Make the following calculations from the circuit below.

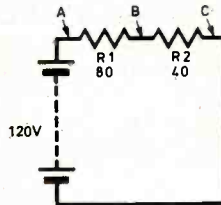

- (a) What is the voltage drop between A and C?
- (b) What is the voltage drop across  $R_1$ ?
- (c) How much power is dissipated in the total load
- (d) Calculate total current for the circuit.
10. Would  $I_1$  be less than or greater than  $I_2$  below?

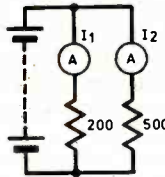

## ANSWERS TO LAST MONTH'S QUESTIONS

2. There would be no continuity if the switch is in the off position. If it is in the on position there would be continuity.
3. D.P.S.T. (you could also use a D.P.D.T., ignoring the N.C. contacts on both sides).

Answer to question 1.

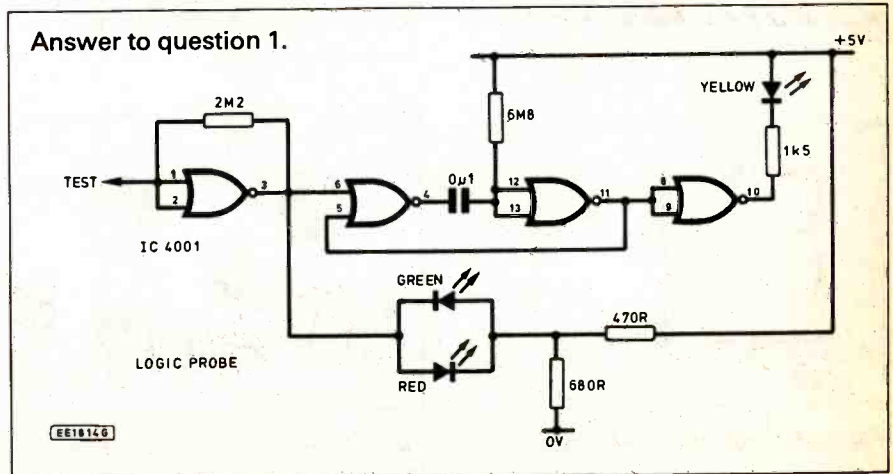

4. Fig. 6.7 shows the answer.
5. 1/ See Fig. 6.14(d).

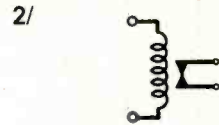

- 3/ See Fig. 6.14(b).
- 6.

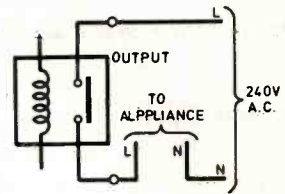

7. With the switch in the position shown one lamp will be on, when the switch is pushed that lamp will go off and the other one will come on.

**Please Note:** In Fig. 6.9 (last month) the bottom left hand terminal of the D.P.D.T. switch should be labelled NC1 also the last "Switch Type" in Table 6.1 should be D.P.D.T. We apologise for these errors.

Also in Fig. 6.2 track cuts should be made before mounting any components. These can be made with a hand held 5mm twist drill in the positions shown in Fig. 6.1. Make sure that each cut completely breaks the copper track. The breaks isolate the metal nuts retaining the bulb holder from the rest of the circuit.

**Recommended reading:** The book *Electronics* from the *Made Simple* books series will provide students with information relevant to this course and will also be an ongoing reference—see Direct Book Service pages for details.

Students will also find *Electronics Teach-In* (the first Teach-In book) provides a great deal of information relevant to this course. This book is published by EE and is also available through the Direct Book Service.

# ROOM THERMOSTAT



**A. R. McCRAE**

Improve the comfort of your home with this fully controllable, 10°C to 25°C, electronic thermostat. Uses low voltage control for added safety.

**T**HOSE WHO have, in recent years, bought houses which already have central heating will know all too well how the main thermostat tends to be installed in the wrong place, i.e. in a cool hall or at the top of the stairs, and to be unnecessarily insensitive, or obtrusive in its "click-on, click-off" operations.

This project enables the constructor to make his own thermostat and, if need be, to install it in a better site. For example, out of draughts or direct sunlight, away from the radiators and about four to five feet above floor level in the most frequently occupied room. Besides improving comfort, this system can result in noticeable economies of fuel.

## SYSTEMS

Most systems have thermostats operating on the bi-metal strip system, or the expansion and contraction of a capsule containing a volatile organic fluid. These work reasonably well but the electronic system detailed here works much better,

maintaining the temperature of the room almost imperceptibly within close limits around the set level and without making any audible sound.

It is usual for existing systems to have a full mains voltage at the thermostat on the wall, so it is recommended that some modifications be made for the sake of ease of installation and, of course safety. The electronic thermostat detailed here operates on the safe voltage of only 12V. *In case of ANY uncertainty, it is wise to consult an electrician or a friend with experience in mains wiring.*

If the existing 'stat, normally just an on-off switch, is disconnected, its function at the boiler can be taken over by an on-off relay switch. Excellent all-solid-state kits can be obtained for this purpose, employing opto-isolators for safety, and taking a mere 15mA when in operation.

A small 12V/50mA p.s.u., situated near the boiler, will be required to operate the new 'stat and its relay. Three leads from this p.s.u. to the site of the new 'stat will also be needed. Many existing 'stats

already use the three-wire system and, in such cases, no additional cabling will be needed. In any case, should new cables be needed, only very light wiring is required to cope with the small currents now involved.

## PRINCIPLE OF OPERATION

A simplified block diagram of the Room Thermostat is shown in Fig. 1 and the complete circuit diagram in Fig. 2. It is desirable to use a p.s.u. having a 12V regulator on its output; the 78L12 is an excellent choice for our purpose and suitable small p.s.u. kits are widely sold.

Only some 50mA (max.) output is necessary to run the thermostat and its attendant (distant) relay. A three-wire cable to the 'stat can thus be used both for the inward 12V power supply and the outward switched-positive lead to the relay.

Although most basic electronic project books give diagrams for "Thermostats" employing thermistors, these do not operate on a "straight line graph" principle and suffer from the disadvantage that the eventual scale on the adjustment dial is hopelessly compressed at one end. This results in difficulty in selecting the desired temperature with any precision and accurate adjustment is most essential when considerations of bodily comfort are involved.

Also, simple thermostats have a nasty habit of switching *on* and *off* repeatedly in a

Fig. 1. Simplified system block diagram for the Room Thermostat.

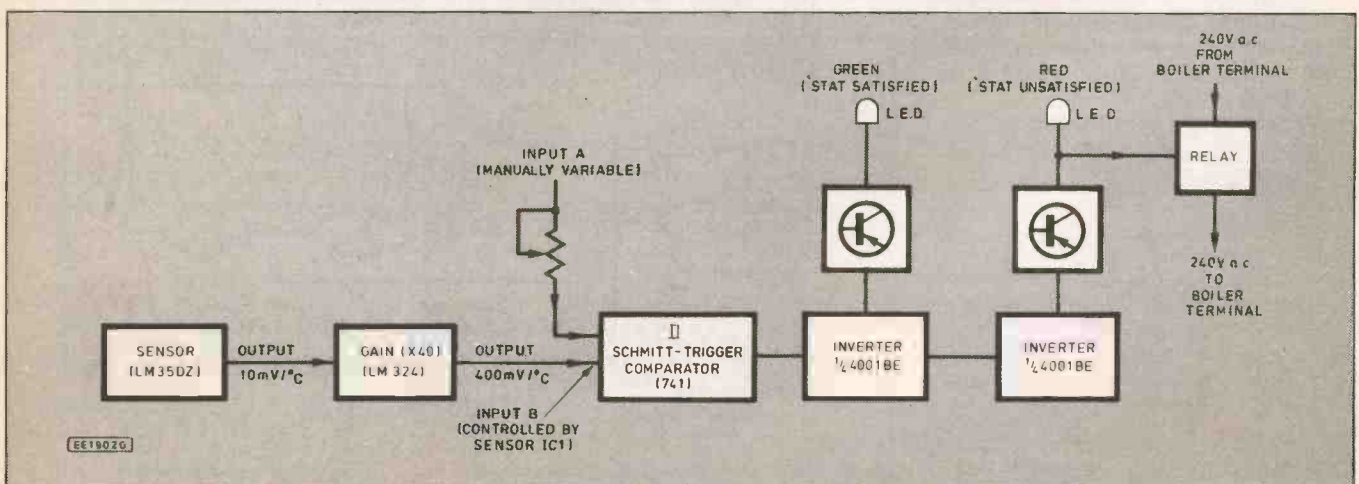



"chattering" manner when nearing their set point. This is highly undesirable and must be overcome, as in the present case, by using a Schmitt trigger arrangement. This allows the 'stat to cut *in* at a slightly lower temperature than it cuts *out*, so producing an "overlap" effect, or hysteresis, which can be controlled to suit the user's convenience.

## SENSOR

The main sensing element employed in the Room Thermostat is the LM35DZ i.c. which, over a range of almost 100°C, gives an output of precisely 10mV/°C. This voltage is rather small, so it is amplified by the non-inverting amplifier LM324 (IC2), which has the advantage of working happily on a normal +/- two-wire power supply. We use a gain of some forty times (x40), thus obtaining an output varying by 0.4V (400mV) for every °C of the ambient temperature.

The appropriate output from IC4 is taken to an output *pnp* transistor, a 2N3702, to switch on or off the current which will operate the relay at the boiler, as well as operating the l.e.d. indicator.

Although the sensing element IC1 is not the cheapest of components, this one is remarkably easy to use (see Fig. 3) and requires only to be connected across the supply lines, whereupon the third pin ( $V_{out}$ ) yields an output of precisely 10mV/°C.

The op. amp LM324 (IC2) actually contains four op. amps on its chip, but we employ only one of them in this circuit (see Fig. 2) and, by using the resistors shown, we obtain a gain of 40.

It may well be asked why, if the LM324 chip has spare op. amps, we need to use an additional 741 op. amp, IC3. The answer is that the 741, when used as a Schmitt trigger-comparator, gives a much crisper and sharper transition-point than the 324 op. amps can.

The variable resistor, VR1, acts as a

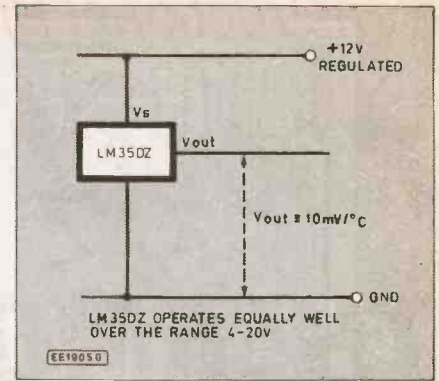

Fig. 3. Typical arrangement for connecting the LM35DZ temperature sensor i.c. in circuit. It will operate equally well over a range of 4V to 20V.

potential divider and we obtain a voltage from it of some 4V to 10V. As, after amplification, the sensor circuit gives 400mV/°C, this voltage corresponds to a

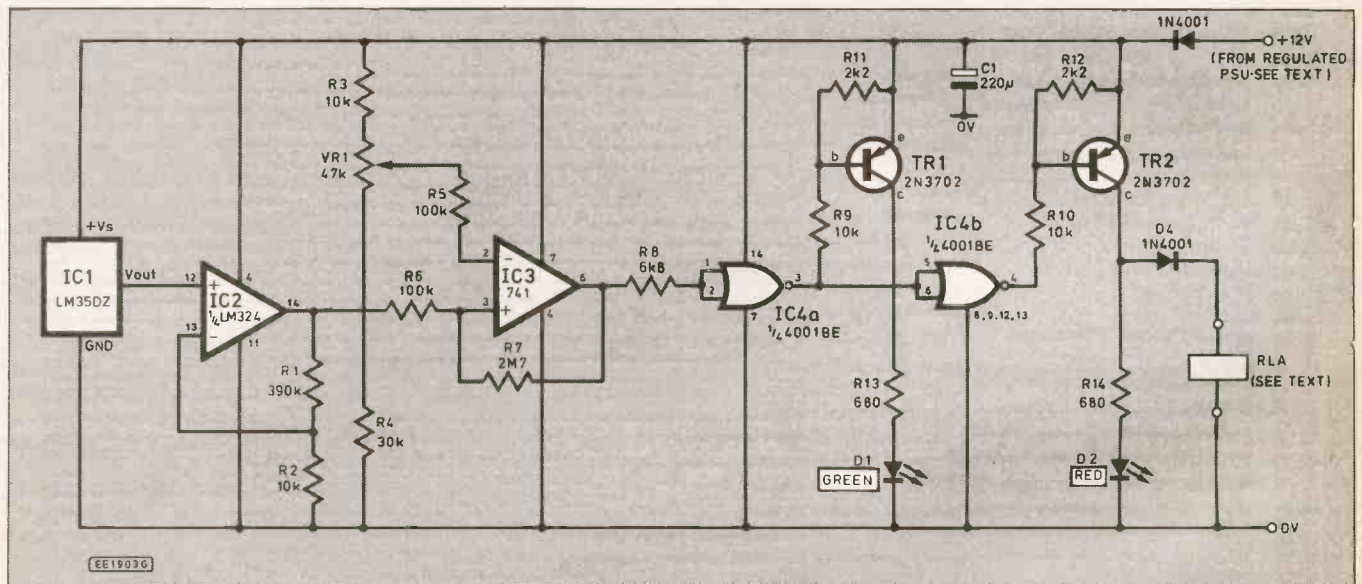

Fig. 2. Complete circuit diagram for the Room Thermostat. The connections to the "relay" are for the low voltage switching only.

## SCHMITT/COMPARATOR

To control the desired switching point and give the necessary hysteresis, this amplified voltage is fed into the non-inverting input (pin 3) of a 741 op-amp IC3, which doubles as a comparator and a Schmitt trigger. The other (inverting) input, pin 2, is fed from a potential divider which can vary its output voltage over the range 4-to-8V (approx.).

The 741 also has a resistor R7 connected between the output (Pin 6) and the non-inverting input (Pin 3) which supplies a degree of *positive* feedback, thus producing the desired hysteresis. In the present case, a value of 2.7 megohms for R6 usually gives satisfactory results, though it may be altered to suit the user's requirements if it is felt to be necessary.

Finally, though optionally, we may add a finishing touch by feeding the output voltage from IC3, (at pin 6), via R8 to IC4, a 4001 quad 2-input NOR gate i.c. configured as a double inverter. From this, we can run either a pair of l.e.d.s (one red, one green), or a single two-colour l.e.d. as an indicator(s) of the ON or OFF state of the thermostat.

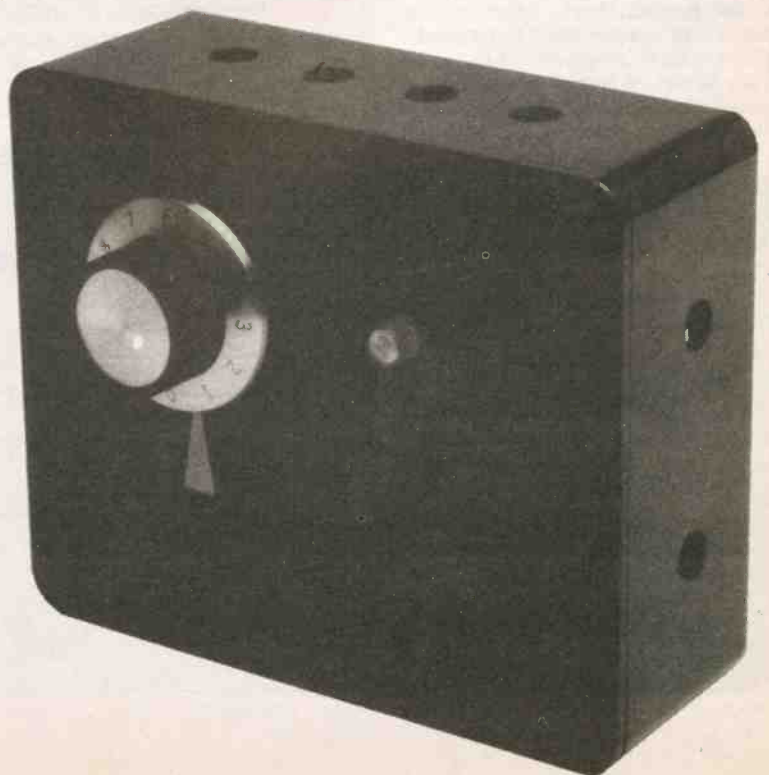

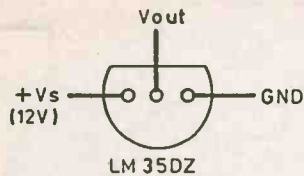

SEEN FROM "PIN SIDE"  
ie. BELOW

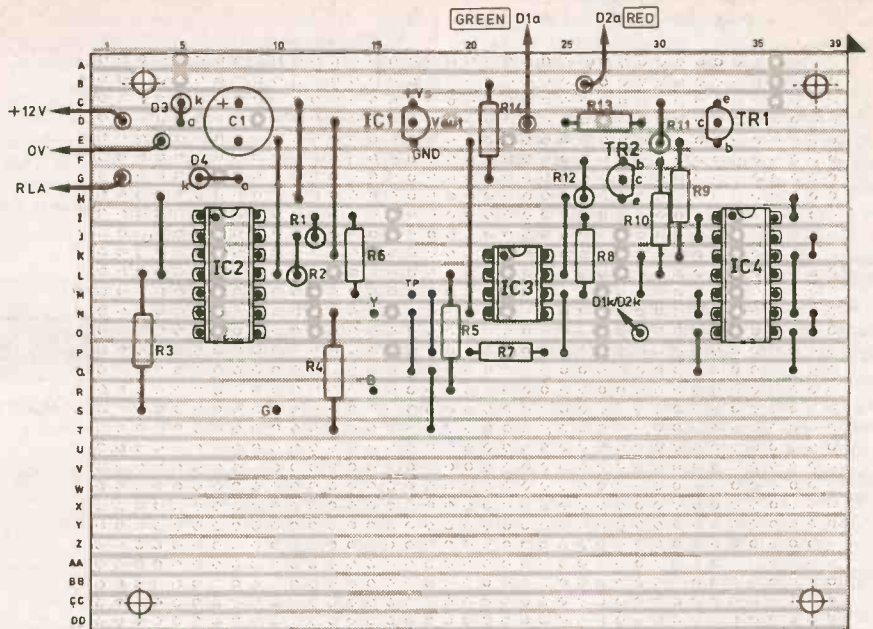
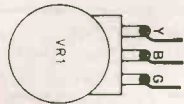
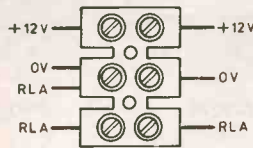

## COMPONENTS

### COMPONENTS

#### Resistors

R1	390k
R2, R3	10k (2 off)
R4	30k
R5, R6	100k (2 off)
R7	2M7
R8	6k8
R9, R10	10k (2 off)
R11, R12	2k2 (2 off)
R13, R14	680 (2 off)

All 0.25W  
5% carbon

**Shop  
Talk**  
see page  
264

#### Potentiometer

VR1 47k rotary  
carbon, lin

#### Capacitor

C1 220 $\mu$ p.c.b. mounting  
elec. 16V

#### Semiconductors

D1*	5mm green l.e.d.
D2*	5mm red l.e.d.
D3, D4	1N4001 1A 50V (2 off)
TR1, TR2	2N3702 <i>npn</i> silicon
IC1	LM35DZ Precision temp. sensor
IC2	LM324 Quad op. amp
IC3	741 Op. amp
IC4	CD4001BE CMOS quad 2-input NOR gate

#### Miscellaneous

RLA Solid state relay  
(see text)

Stripboard, 0.1in. matrix 30  
strips $\times$ 39 holes; ABS plastic  
case, 118mm $\times$ 98mm $\times$ 45mm;  
clear Cliplite l.e.d. covers (2 off);  
8-pin d.i.l. socket; 14-pin d.i.l. soc-  
ket (2 off); knob, with graduated  
skirt; quickstick pads; connecting  
wire; solder; etc.

\*A combined, 2-colour, 5mm  
l.e.d. may be used for D1/D2.



Fig. 4. Stripboard component layout and details of breaks required in the underside copper tracks.

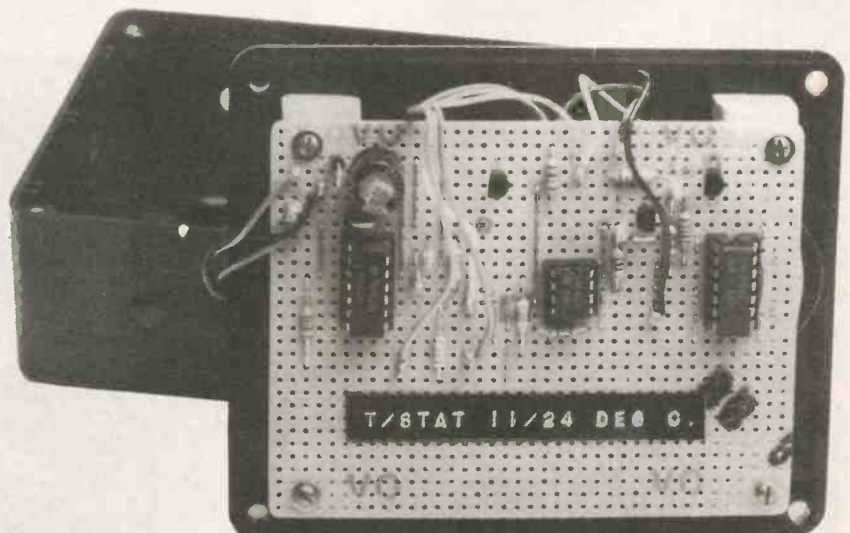

Approx. cost  
Guidance only

**£14**

temperature range of approximately 10°C to 25°C, covering the normal domestic comfort zone.

Finally, though not essential, we take the output of IC3, via resistor R8, to two gates of IC4, a 4001 configured as inverters (*The unused inputs on IC4 must be taken to ground.*) The outputs from these gates IC4a, IC4b, via TR1, TR2, can operate red and green l.e.d.s to indicate the state of the thermostat, which otherwise sits so quietly on the wall that it can be hard to believe it is doing its job! One of these transistors should also supply the output current to the distant relay RLA, via a safety diode to protect against unwanted back-e.m.f.s.

As the thermostat must necessarily be situated at some distance from its p.s.u., a sizeable capacitor, C1, is placed across its supply lines to protect against unwanted surges and pulses and help to maintain the desirable steady 12V input.

## CONSTRUCTION

The Room Thermostat stripboard component layout and details of breaks required in the underside copper tracks is shown in Fig. 4. Before mounting components on the board, double check that all breaks in the tracks have been made.

The whole circuit can readily be constructed on a piece of stripboard some 78mm by 100mm (30 strips of 39 holes). This is rather larger than the basic circuit requires but the extra board space allows for mounting holes to be drilled as required, without interfering with the wiring.

If this board is mounted within the lid of a plastic box approximately 115mm by 95mm by 43.5mm deep (internal), on suitable spacers or blocks, e.g. small pieces of wood of square section, attached by quick-stick pads to the box lid, space will be found between the circuit board and the lid for the necessary voltage-divider potentiometer VR1 and for the indicator l.e.d.s which mount very neatly in "Cliplite" fittings. These clip firmly into the panel when 6.25mm holes are drilled for them and the l.e.d.s then just push into the Cliplite holders from the rear.

The temperature sensor, LM35DZ (IC1), which in appearance closely resembles a T092-type transistor, should be mounted with long leads so that it stands 5mm to 9mm proud of the circuit board and thus allows free access to the surrounding air. The pin-out for this IC is also shown in Fig. 5.

It is desirable, of course, to allow for free circulation of the surrounding air through the box, so that it may have the maximum effect on the sensing element IC1 and this may be done without making the final effect untidy by drilling several holes of approximately 8mm diameter in the top and sides of the box, and a considerable number of such holes in the rear of the box, where, after mounting in on the wall, they cannot be seen. Then, if the box is mounted on the wall over two short strips of wood, approximately 25mm by 5mm and 35mm long, the plastic box is kept away from the wall sufficiently to allow circulation of air via the back of the casing as well as the sides.

## SETTING-UP

Little is needed in the way of final adjustment, other than to check that the completed circuit does not take more than

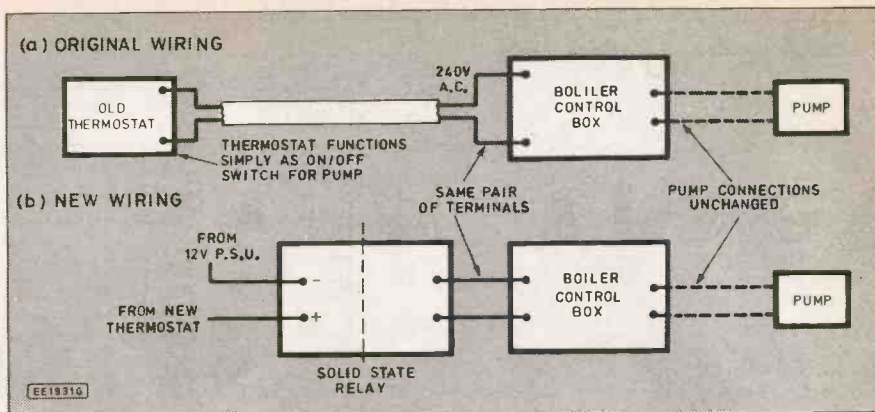

Fig. 5. Suggested set-up for connecting the thermostat unit to the relay and regulator p.s.u.

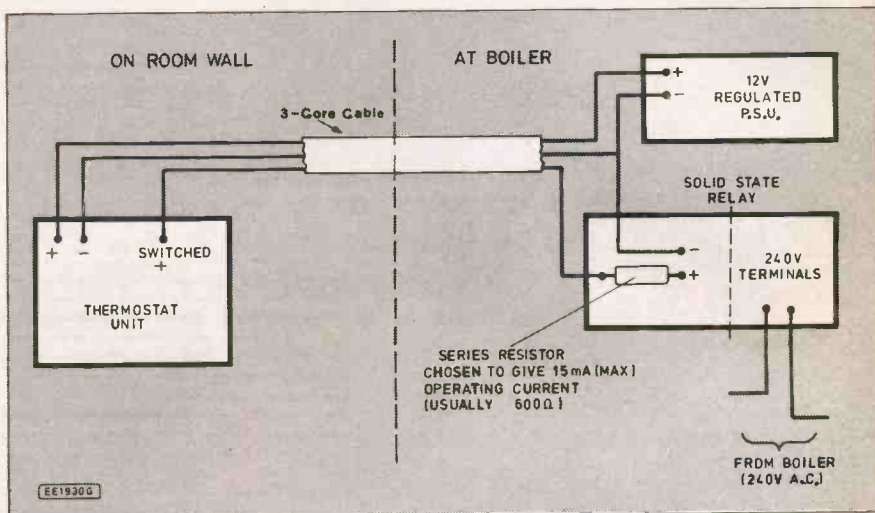

Fig. 6. Wiring the solid-state relay to the existing boiler control box.

30mA of current (without the relay being connected), and to see that its red and green l.e.d.s switch on and off in turn as the temperature varies; a finger held on the sensor, or even merely near the sensor, should cause a clear and speedy transition.

Experimentation will show that too *high* a value for the hysteresis resistor will give an "instant action" effect. This means that the 'stat turns on every time anyone walks near it, causing a draught, or every time anyone opens the room door.

Conversely, too *low* a value of hysteresis resistor will result in the room becoming noticeably cold and hot in turns, instead of maintaining an unobtrusively uniform temperature. In practice, of course, it can

never remain totally at a level temperature.

A small piece of adhesive coloured plastic on the case front can act as a pointer and then a calibrated knob can be fitted on the shaft of the potentiometer. The perfectionist could calibrate the knob in °C, but most users will be content to use a readily available calibrated knob bearing the figures 1 to 10 and then to remember the dial settings which give the desired level of comfort, a learning process which is surprisingly rapid.

Incidentally, if it is found that the knob, when rotated clockwise, produces a *fall* in the set temperature, rather than a rise, it is only necessary to transpose the two outer connections to the potentiometer tags. □

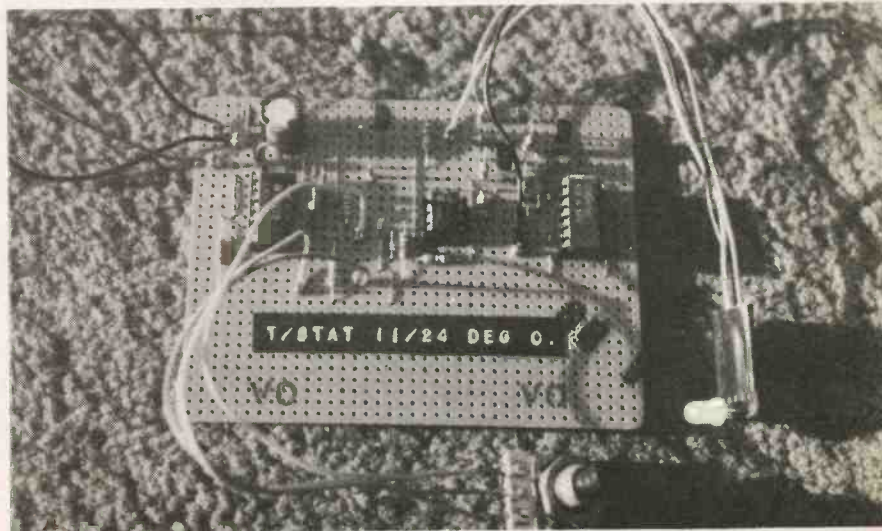

# SATELLITE BROADCASTING

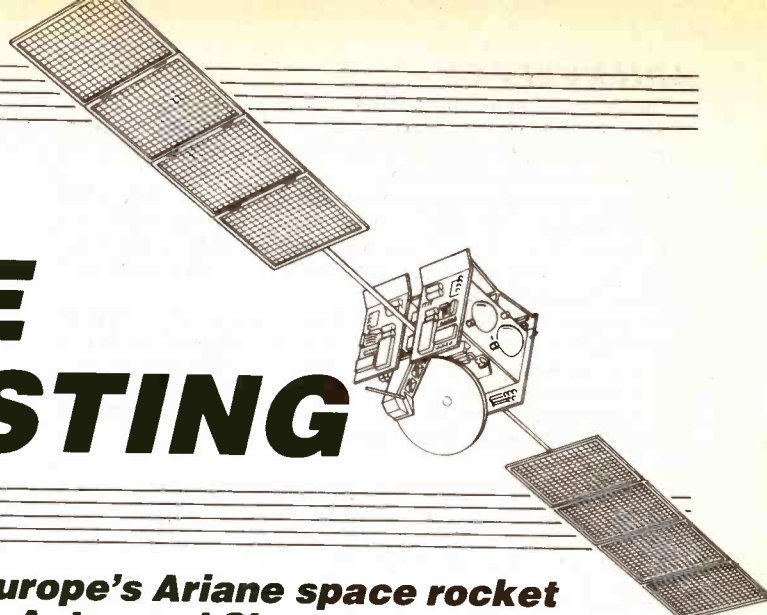

**The announcement that Europe's Ariane space rocket successfully launched the Astra and Skynet satellites on 11 December '88 gave no clue to the tensions surrounding the launch from Kourou in French Guiana.**

**Barry Fox was the only independent British journalist present at the launch of the Astra TV direct broadcasting satellite and Skynet, the military communications satellite. Here is his report on the behind the scenes activities, prior to and after launch.**

**B**Y NOW, direct satellite broadcasting into British homes should finally have begun—after nearly ten years of talking and promises.

All countries have been allocated five frequencies for a national DBS service. Britain's allocated orbital slot is at 31 degrees West. Originally the British Government had licensed the BBC to run a two channel service. But they added the proviso that the Corporation must buy a British satellite from Unisat, a consortium of British Telecom, British Aerospace and Marconi.

## HIGH COST AND A DARK HORSE

Unisat quoted the BBC such high prices that the Corporation got cold feet and backed out of the venture. There was then a plan to share responsibility between the ITV companies and private industry, but this too fell apart.

Finally the Government authorised the IBA to grant a three channel DBS franchise and this was won by British Satellite Broadcasting (BSB). The proviso, that the satellite must be British, was dropped. BSB is buying from Hughes in the USA, and plans to launch in August, with broadcasting to begin in October.

There has been some confusion because BSB initially talked about offering a four channel service; what they meant was that one of their three channels may be shared by two different types of programme. Then there was talk of putting *Channel 4* TV on the BSB satellite. After a predictable outcry, the daft plan was dropped. Now the Government is planning to franchise the other two channels, either to BSB or a rival company, later on.

This move follows the appearance of a dark horse in the race to win customers for programmes from space. A private company in Luxembourg, Astra, raised money (with backing from the Luxembourg Government) to launch a rival satellite, which will sit at 19 degrees East. Because Astra will broadcast across all Europe and at lower power than the national DBS birds (45 watts per channel instead of 100 or 200 watts) it has been allocated enough bandwidth for 48 channels—16 each on three satellites.

For a long time no-one took Astra seriously. Then the company emerged as a sound business venture. The first Astra satellite, made by RCA (now GE) was launched on Europe's *Ariane* rocket from Kourou in French Guiana last December.

Ten or eleven of Astra's first 16 channels will offer English language programming. At least some should already be operational.

*Astra satellite control centre near the Chateau de Betzdorf.*

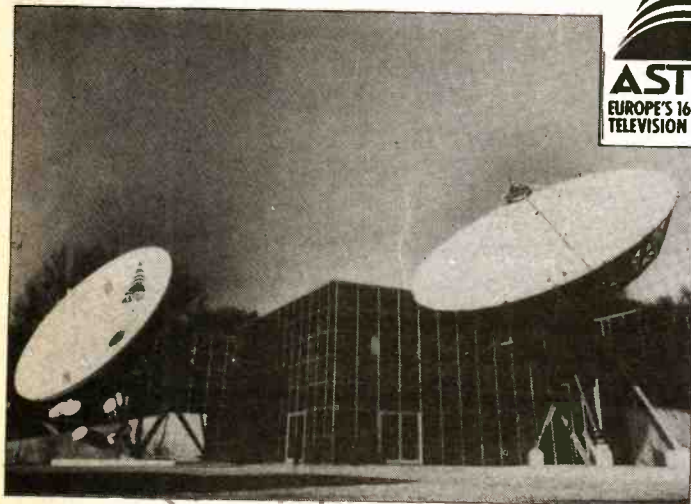

*'For a long time no-one took Astra seriously.'*



*The European reception or "footprint" area covered by the Astra bird.*

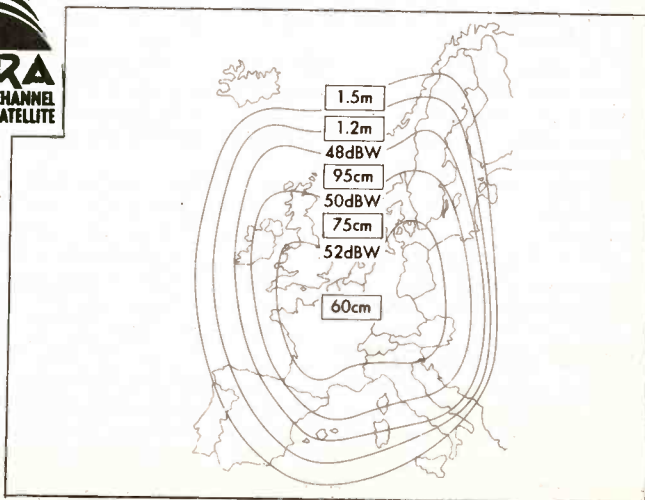

## ARIANESPACE

The bare news announcement that Europe's *Ariane* rocket successfully launched the *Astra* and *Skyнет* satellites half an hour after midnight (British time) on 11 December '88, gave no clue to the tension surrounding the launch.

Success was vitally important to Arianspace, the world's first commercial space transport company which was set up in 1980 and now claims 50 per cent of the commercial launch market. The European venture, over 58 per cent French, has staked its future on a new modular rocket design.

Six possible configurations for *Ariane 4*, each with a different combination of liquid and solid fuel boosters strapped to the first stage, cut production cost by 20 per cent. Launching from Kourou only five degrees off the Equator increases payload by 15 per cent. The modified nose cone, Spelda, lets one rocket dump up to three satellites into different orbital positions.

---

*'Never before has so much ridden  
on one rocket launch.'*

---

Arianspace has already ordered 21 *Ariane 4*s, and has just signed for 50 more. *Ariane* is now geared to launching nine rockets a year, from two launch sites. In Europe 10,000 jobs depend on the project.

The American space industry first treated *Ariane* as a joke. When the US launch programme turned sour, and went back to 25 year old moonshot technology, Arianspace adopted an arrogant attitude which annoyed many customers.

Then, when an *Ariane 2* failed and lost the *Intelsat* satellite, the Chinese and Russians went into competition. Arianspace emerged from what is now known as the "dark period" with some welcome humility—and the desperate need to impress customers, especially NATO which will need to put military satellites into orbit.

## MILITARY TRIALS

The British Ministry of Defence had booked space on the US shuttle for the first of its *Skyнет* military communication satellites. After the *Challenger* disaster in January 1986, the MoD hitched a ride on *Ariane Flight 27*, along with Luxembourg's *Astra* satellite.

The MoD has not been lucky in space. Its first *Skyнет* satellite was built by Philco Ford and launched in November 1969 to relay speech and data between ground stations. Within a year, *Skyнет*'s travelling wave tube amplifiers had failed. A replacement satellite was lost on launch when the boost motor, which kicks it from low to geostationary orbit, failed.

Marconi and Philco then won the contract for two new satellites. One was lost in January 1974 when its Thor Delta rocket failed but the other, *Skyнет 2B*, is still in service—albeit well past its planned useful life.

Plans for *Skyнет 3* were cancelled when the UK Government decided to lease from the US. In December 1981, after five years lobbying the MoD finally got the money to buy three *Skyнет 4* satellites from British Aerospace and Marconi. After *Challenger*, the first sat in a hangar for three years until its recent launch. Two more will go up on *Titan* and *Ariane* by 1990.

The *Skyнет* satellites handle u.h.f. transmissions, primarily for communication with submarines, and SHF transponders in the 7 to 8GHz or X band. A vocoder converts speech into data at a very low rate of 2.4kb/s. This is encrypted and "hopped" in frequency over a 500MHz band.

At the same time the aerial beam can be narrowed from full earth cover to three degrees. So the signal from the 40 watt transponder is very strong. The only way to jam the hopping narrow band would be to transmit impossibly high power over the entire frequency spectrum.

The narrow beam and low data rate also enable *Skyнет* to transmit to and receive from back pack terminals which foot soldiers plant on the ground. The next step is real time communication with aircraft. *Skyнет 4* also has an e.h.f. channel, at around 45GHz, for propagation experiments. The technology relies on gallium arsenide i.c.s made by Marconi.

## PRICE OF FAILURE

In Kourou Brian Day of the MoD coyly refused to say how much *Skyнет* is costing the British taxpayer. But a launch failure would have kissed goodbye to well over £50 million.

Failure of *Ariane 4* would also have been a catastrophe for SES, the Luxembourg company launching Europe's first commercial

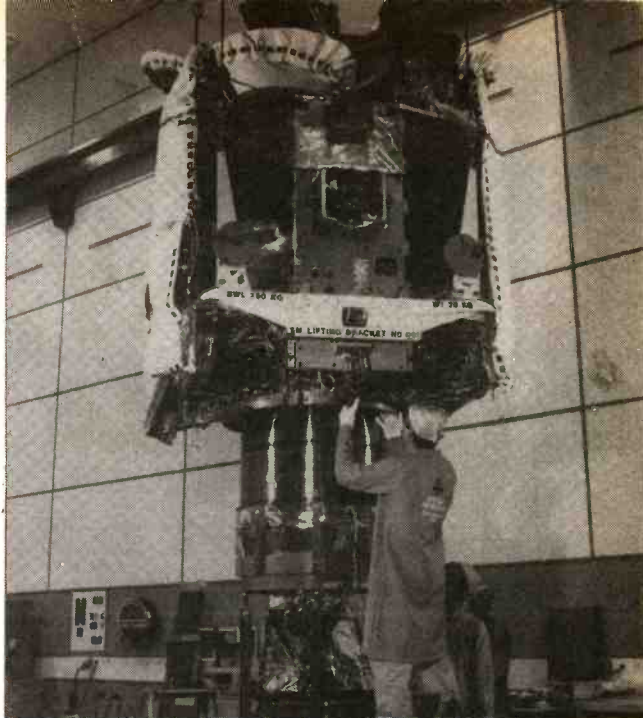

**A *Skyнет 4* military communications satellite being lowered onto a dummy Apogee Boost Motor. The integration check was performed in the satellite assembly hall at British Aerospace, Stevenage.**

TV broadcasting satellite, *Astra*. *Astra* has already sold 10 of its 16 channels, of which 11 are earmarked for English language programmes. At least half of these started broadcasting from the beginning of February.

The British satellite, *SBS*, is not due to start transmitting until October 1989. It will be at a quite different orbital slot (31 degrees West compared with *Astra*'s 19 degrees East) and will use quite different transmission standards (D-MAC and Eurocipher encryption, compared with PAL clear, or PAL with smartcard scrambling, or D-MAC with Eurocrypt on *Astra*).

So whoever starts first and wins an installed hardware base is likely to win all round. Early success for *Astra* could prevent BSB from raising enough money to launch a service. *Astra* cannot buy and launch a second satellite within two years. So failure of *Ariane 4* would effectively have put Luxembourg out of the frame and left BSB a clear run.

Never before has so much ridden on one rocket launch.

**Checking out that all is well on the *Astra* satellite prior to shipment to the launch site.**



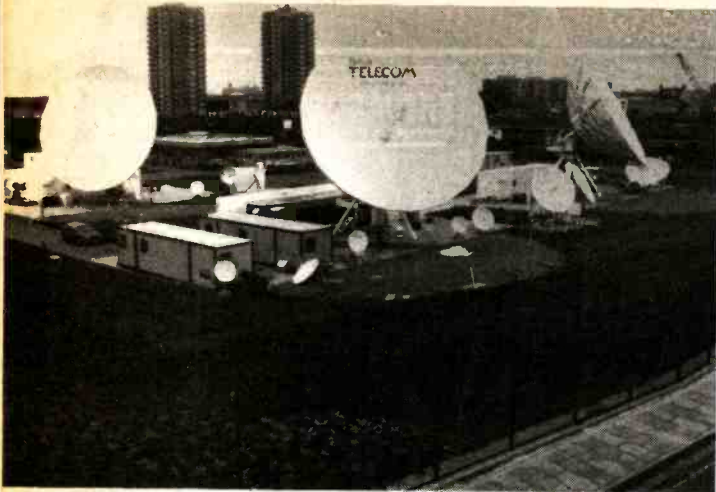

**London Teleport, the British Telecom's satellite reception centre is based in London's Dockland and was opened in 1984.**

## THE LAUNCH

The launch was originally scheduled for the night of December 9, but delayed because low cloud came within 10km of the site. The risk was of a lightning strike. If this happens as the rocket is taking off a surge of electric current, which can be greater than the electromagnetic pulse generated in a metal body when an atomic bomb explodes, will destroy the rocket's electronics guidance system. This would send the rocket off course and oblige the safety officer to destroy it in flight.

As the cloud cleared the control centre started to receive danger signals from the third stage of the rocket, which carries liquid hydrogen and liquid oxygen fuel. A check showed that the likely cause was a telemetry acquisition unit, which continually collects data from ten sensors. There is only one way to check the telemetry unit, and that is to drain off all the cryogenic fuel. — This takes all night.

Meanwhile, engineers at the mission control centre had lost the speech and data link between Kourou and Ascension Island. This is one of three earth tracking stations (at Natal, Ascension and Libreville) which track the rocket by radar as it appears over their horizon.

If the telemetry unit had not failed, preventing a launch, Ariane might well have taken off just before the Ascension Island link was lost—and it was lost for half an hour.

Arianespace says that loss of the link would not have jeopardized the mission because the trajectory of the rocket is controlled by a pre-programmed onboard computer. Data from the earth stations is used only for post mortem analysis. But the inescapable fact is that loss of Ascension would have created a real time radar tracking blind spot lasting up to 300 seconds.

**No, it's not a duet for "Pennies from Heaven". It's Alan Sugar MD of Amstrad asking Rupert Murdoch of Sky Television if he would accept the latest hi-tech dish aerial.**

**SKY  
Television**



## PAYPHONE LINK

After the successful launch 24 hours later, Arianespace engineers later admitted that the tracking radar signal does not travel direct from Ascension to Kourou. Instead it is routed to Washington, and from there by common carrier (i.e. public telephone line) to the Kennedy Space Centre and from there by submarine cable to Kourou. It was the common carrier link in America which failed. Was it AT and T? "We'd rather not say," says Arianespace.

Arianespace claims that the communications link has full redundancy, with signals able to travel along two quite separate routes. But clearly this was not the case, because two separate common carrier lines would not have failed at the same time, for the same period.

Arianespace admits that there have been similar problems with the Ascension Island link, "around ten times before".

Many of the VIPs which Arianespace had flown to Kourou by *Concorde* boggled when the word leaked out. Journalists conjured up the picture of the man in charge of the link in the US running out of dimes for his payphone.

---

**'A launch failure would have kissed good-bye to well over £50M of taxpayer's money.'**

---

British Telecom's Steve Maine was at the launch and "surprised" that there was no direct satellite link with the tracking stations. But Martin Peters, in charge of Skynet at the Ministry of Defence, could only bluster about "surprise not being the right word". Peters also says he accepts that it would not have been cost-effective to provide full redundancy on the link.

Hopefully his Skynet communications system does not cut corners in similar fashion.

## EXPLOSIVE SITUATION

The next day, in a casual conversation over lunch, I learned first hand why the German satellite *TV-SAT* failed after launch from Kourou a year ago.

Prior to launch all satellites are checked out in a dust free room. This involves extending the large solar panels and then folding them back like a bat's wing inside the satellite. The folded panels are held in place by explosive bolts. An engineer—whether German or French, no-one is saying—put the bolts in wrongly. So when the time came to fire the bolts in space, the panel stayed closed, making the satellite useless.

Astra were taking no chances. They sent an engineer over from Luxembourg to watch the job being done. And he had to telex back a signed confirmation on every bolt. The panels opened as planned and—barring last minute hitches—Astra is now 'on air'.

Launching the satellite and sending it into the required orbit was the easy part. The "last minute hitches" seem to be serving up the dish and receiver. □

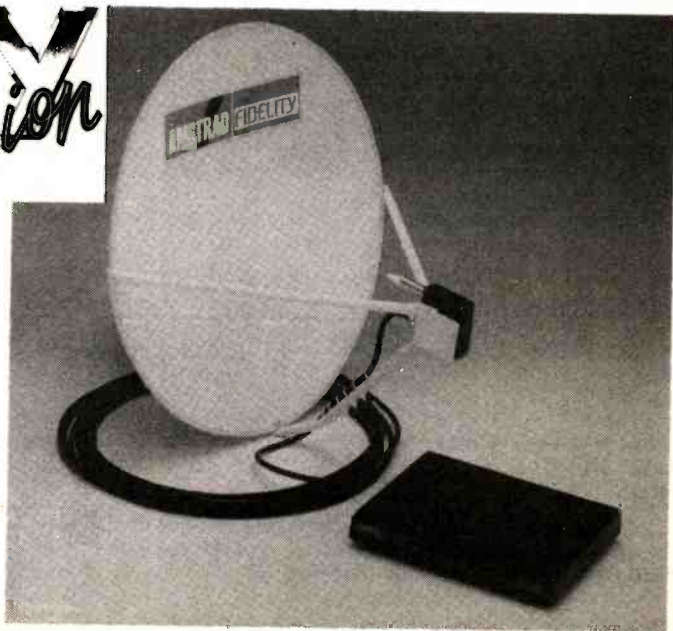

TEACH-IN SERIES

# TWO SPECIAL PUBLICATIONS

FROM EVERYDAY ELECTRONICS

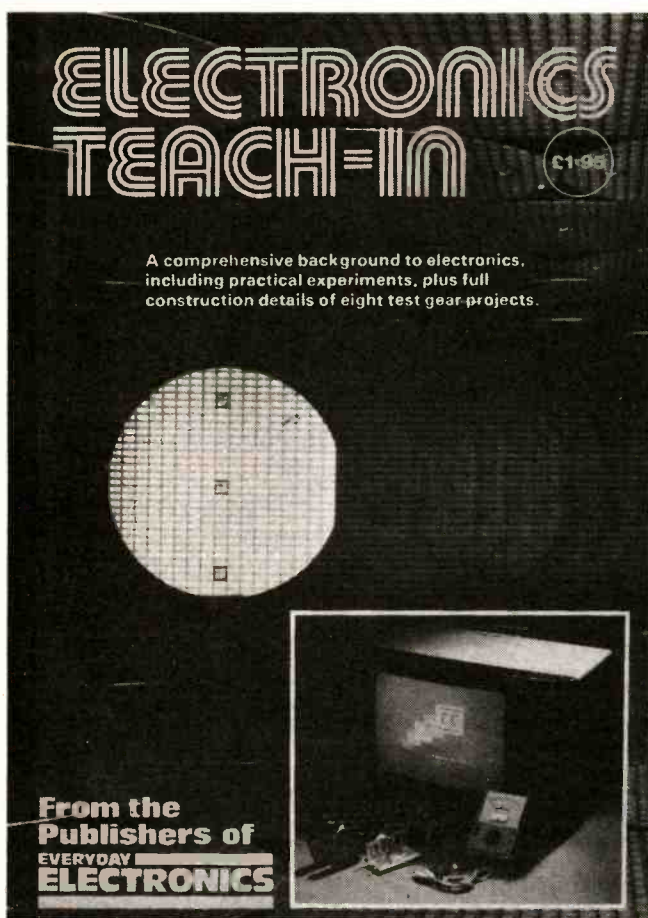
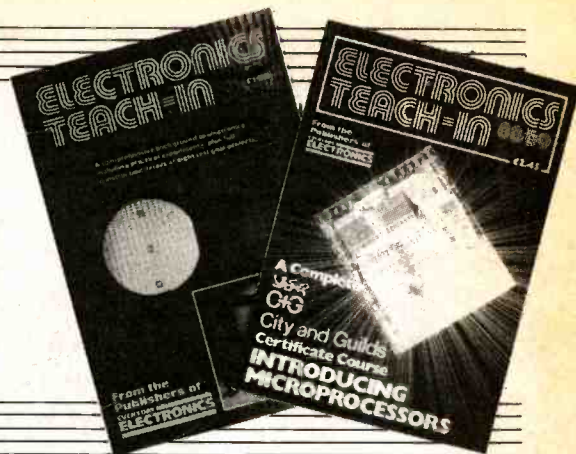

## THE FIRST "TEACH-IN" BOOK

**ONLY £1.95**

By Michael Tooley BA and David Whitfield MA MSc CEng MIEE

A comprehensive background to modern electronics including test gear projects. This 104 page, A4 size book forms a complete course in basic electronics; designed for the complete newcomer it will, however, also be of value to those with some previous experience of electronics. Wherever possible the course is related to "real life" working circuits and each part includes a set of detailed practical assignments.

This book is an excellent companion for anyone interested in electronics and will be invaluable for those taking G.C.S.E. or B.T.E.C. electronics courses. **ORDER CODE: EE/T-1**

**SEE DIRECT BOOK SERVICE pages—for full ordering details**

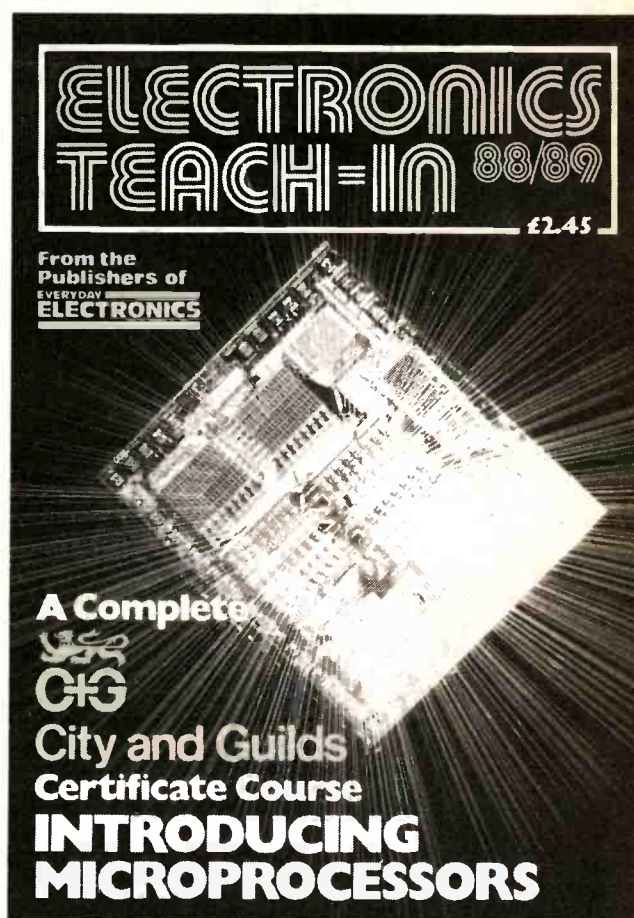

## TEACH-IN 88/89 BOOK

**£2.45**

**A complete City and Guilds Certificate Course for 726/303 Introductory Microprocessors**

Written by Mike Tooley BA this course can lead successful readers to a City and Guilds Certificate. Everything you need to know is included—even pre-test papers, etc.

From Terminology, Integrated Circuits and Logic Families in Part One, the course progresses in easy stages up to High- and Low-level Languages, Flow Charts and Assembly Language. Also featured is a range of eight Data Pages giving information on popular microprocessor chips. A comprehensive index is included, making this a valuable reference manual. **ORDER CODE: TI 88/89**

# ON... SPEC

*a regular  
feature for  
the Spectrum  
Owner...*

by Mike Tooley BA

LAST month we showed how a budget-priced monitor can be easily interfaced to a Spectrum of any vintage. This month, and still keeping a limited budget in mind, we shall take this one stage further and show how a disc drive can be easily added to a Plus-Two (or earlier) machine. Before we begin, however, there is just time to deal with two queries which are worthy of a wider audience.

## Protection Racket

John Weber writes from Bristol to ask if it is possible to include a line of BASIC within his programs which cannot be deleted or edited by others. John writes:

*"I have developed one or two useful statistical routines and I would like to circulate these together with a simple drawing package which I have developed. The programs are all written in BASIC and I believe that there may be some method of adding a line which cannot be deleted or edited which can contain my personal copyright information. Is this possible and how is it done?"*

*"I've tried entering a line 0 directly from the keyboard. The Spectrum, of course, will not have any of this nonsense and simply rejects my line with an unhelpful error message."*

Happily, this one is not too difficult, John. All you need do is enter your copyright message as line 1 (not line 0). Then edit the program line in memory so that the line number is changed from 1 to 0. This bypasses the BASIC editor (which would otherwise generate the "Nonsense in BASIC" error message).

The slight problem is that it is first necessary to locate the start of your program text before you can edit it. To do this, you can make use of the relevant system variable which is resident in memory at decimal address 23635.

This particular variable occupies two bytes; the low byte is at 23635 whilst the high byte is at 23636. The following BASIC command will do the job:

**PRINT (PEEK 23635+256\*PEEK 23636)**

The command will return the address of the first byte of your program. The first two bytes of your program (i.e. at the returned address and at address+1) represent the number of the first line of your program.

It is important to note, however, that the line number is stored in *conventional* order (i.e. high byte first). Hence, the byte stored at the address returned by the foregoing BASIC command should be 0 whilst that at address+1 should be 1.

All you now need to do is to replace the 1 with a 0! As an example, assume that the BASIC command return a value of 23755. You would then need to enter the following command:

**POKE 23756,0**

If you now LIST the program you will find that the first line is numbered 0 (not 1). Furthermore, you will not be able to edit the line nor will you be able to delete it! You should now SAVE your program (in the normal way) before copying it for distribution to your friends, safe in the knowledge that your copyright message will remain intact.

## Musical Connection!

Pat Lyon writes from Boston, Lincs., with a plea for help:

*"Please tell me how to go about getting my computer to analyse music from a tape or a record, then get it to print out the musical arrangements onto manuscript paper? I own a Spectrum Plus-Three and an Amstrad DPM 3160 printer."*

Sorry, Pat, this one is completely beyond me! A number of musical add-ons are available for the Spectrum but I doubt whether any of them can perform this particular task.

Furthermore, I suspect that this project would be expecting rather a lot from a humble Spectrum unless you are prepared to settle for a very basic specification. Perhaps another reader may be able to help?

## Disk Drive on a Budget

There can be nothing more frustrating than finding that your precious program tapes blankly refuse to load back into the machine on which they were created. Indeed, very few Spectrum owners will not have suffered from this particular bugbear!

The problem can, of course, be completely eliminated by moving to disc rather than cassette storage. Unfortunately, the cost of making such a change can be prohibitive. With this in mind, I recently spent some time researching the most cost-effective method of adding disc storage to one of my elderly Spectrums (an early Spectrum-Plus machine).

After much searching, I finally discovered a source of excellent low-cost drives (available from J and N Bull Electrical of Hove, Sussex). The drives in question are modern 3.5 in. units manufactured by Chinon. These units are extremely compact and, most important of all, are most attractively priced at £28.50 (plus £3 insured postage).

The drive supports 80-track single-sided operation which will provide an unformatted storage capacity of 500K bytes per disc (much in excess of that available from the internal drive fitted to the Plus-Three machine). The drive is supplied as a basic chassis which will require a case and power supply (+12V at 750mA max. and +5V at 400mA max.).

Doubtless a large number of readers will be happy to manufacture their own case and power supply. More adventurous readers might even consider re-packaging the entire system within a larger enclosure with integral disc drive. For the less adventurous, J. and N. Bull can supply a reasonably priced enclosure and power supply kit.

Connections for the Chinon drive are as follows (see Fig. 1):

Power Connector	
Pin No.	Supply
1	+12V
2	0V
3	0V
4	+5V

Interface Connector	
Pin No.	Signal
2	Unused
4	Unused
6	DRIVE SELECT 4
8	INDEX
10	DRIVE SELECT 1
12	DRIVE SELECT 2
14	DRIVE SELECT 3
16	MOTOR ON
18	DIRECTION SELECT
20	STEP
22	WRITE DATA
24	WRITE GATE
26	TRACK 00
28	WRITE PROJECT
30	READ DATA
32	Unused
34	READY

(NB: All odd numbered pins are connected to GND/0V).

## Interface

Having acquired a brand-new disc drive we now have to face up to another problem; connecting it to the Spectrum! The Plus-D interface from Miles Gordon Technology (reviewed in September 1988 *On Spec*) is probably the most cost-effective solution to this particular problem.

As a very definite bonus, the Plus-D incorporates a Centronics parallel printer interface. It also provides a "snapshot" facility which allows users to freeze the current program and either dump the screen to a Centronics printer (in either 32-column or "large size" modes), save the screen to disc, or save the entire contents of the Spectrum's memory as a 48K (or 128K) "snapshot" file.

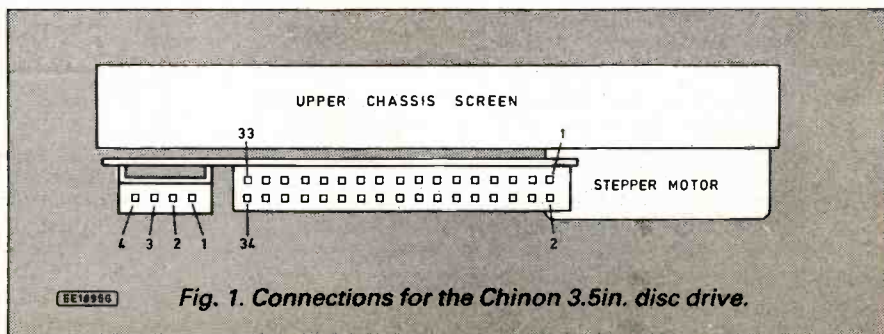

Fig. 1. Connections for the Chinon 3.5in. disc drive.



**Note:**

*J and N Bull Electrical\* are at 250, Portland Road, Hove, Brighton, Sussex, BN3 5QT whilst Miles Gordon Technology can be contacted at Lakeside, Phoenix Way, Swansea Enterprise Park, Swansea, SA7 9EH.*

*\*At the time of going to press we understand that J and N Bull have only 100 units left.*

The Plus-D interface mates with the expansion port at the rear of the Spectrum and is connected to the Chinon drive by means of a short length of 34-way ribbon cable—all very neat and simple. The complete cabling arrangements is shown in Fig. 2.

Fortunately, the Miles Gordon disc operating system (G+DOS) recognises commands which relate to Sinclair Microdrives and this will allow microdrive users to upgrade their microdrive-based software without having to make any changes.

Installing and customising the system software is extremely straightforward. The configuration and installation program (supplied by MGT on cassette) should be loaded, run, and the various questions answered. The relevant parameters for the Chinon drive are; 80 track, single-sided, and 6ms stepping time.

Finally, the installation program should be "backed-up" to disc (so that you can

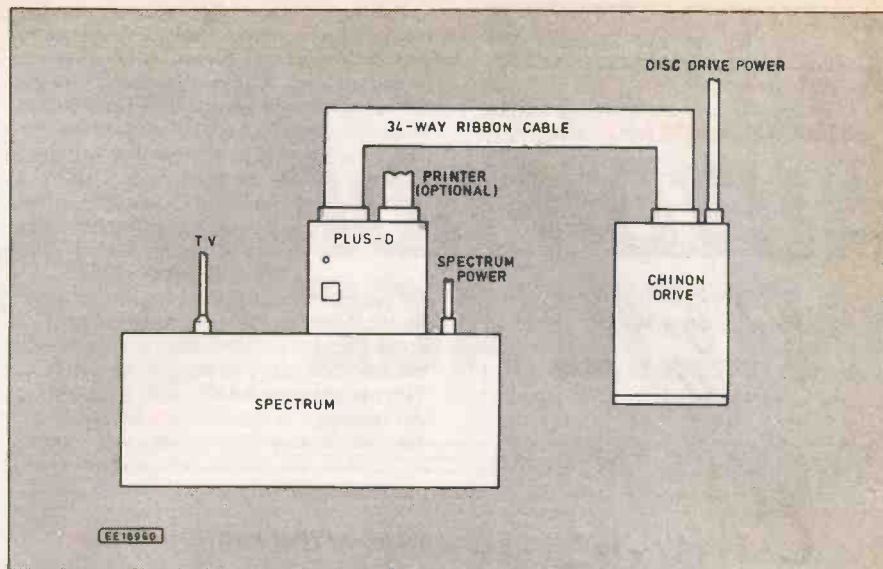

Fig. 2. Cabling arrangement for connecting the disc drive and plus-D to the Spectrum.

make future changes to the system without having to revert to the cassette-based program). The total cost for the entire project amounts to around £90—a much better bet than trading-in your Spectrum for a Plus-Three!

**Next month:** We shall be taking a look at software for designing circuit layouts. We also have some information which can be

instrumental in tracking down faulty Spectrum RAM devices. In the meantime, if you would like a copy of our 'On Spec Update', please drop me a line enclosing a large (250mm×300mm) adequately (i.e. 42p for UK postage) stamped addressed envelope. Mike Tooley, Department of Technology, Brooklands Technical College, Heath Road, Weybridge, Surrey, KT13 8TT.

## Z80A MICROCONTROLLER

A low cost single board micro-system providing all the requirements needed for many applications in industrial, experimental and educational fields

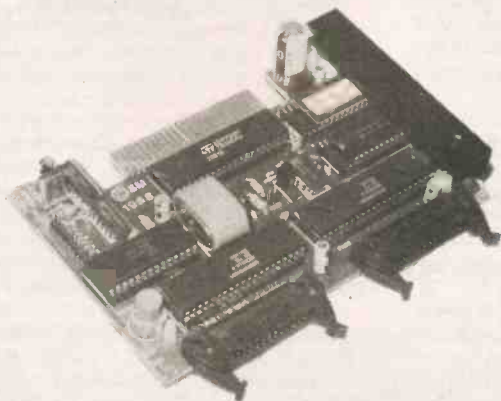

Just some of its extensive features include:

- \* Z80A CPU operating at 4MHz
- \* EPROM socket—jumper link selectable as 2, 4, 8, 16 or 32K accepts 2716/2732/2764/27128/27256 EPROMS
- \* RAM socket—jumper link selectable as 2, 8, 32K accepts 6116/6264/62256 CMOS static RAMS—battery back up included
- \* INPUT/OUTPUT—2 Z80A PIOs providing 32 programmable I/O lines
- \* HARDWARE COUNTER/TIMER—a Z80A CTC providing four independent counter/timer circuits
- \* Expansion boards available—DtoA, 8 channel AtoD, RS232 serial I/O etc
- \* Full documentation and user notes

**Z80A Single Board Controller fitted with 2Kx8 CMOS static RAM ONLY £94.95 + VAT—BUILT AND TESTED!!**

Specialising in microprocessor data logging and control applications, we provide a complete service covering any or all of the stages from initial hardware and software design through manufacture to final installation.

Phone/send for full details—OEM, trade and overseas enquiries welcome

**SM ENGINEERING**  
Telephone 0323-766262

'St Georges' Lion Hill, Stone Cross  
Pevensy, East Sussex BN24 5ED

## PCB DESIGNER

FOR THE 48K ZX SPECTRUM

Now you can produce high quality printed circuit boards/circuit diagrams/component layouts on your 48K ZX Spectrum. If you don't own one it's worth getting one just for this suite of programs! Comprehensive manual included with getting started tutorial.

FULL SUITE FOR ONLY £30.00 INC.

### PCB LAYOUT:

Produce quality printed circuits directly from your EPSON RX/FX or compatible dot matrix printer using a dense 1:1 printout on positive photoresist coated board. Or super quality using x2 printout and photoreduction. Many features such as 15 track widths; 15 pad sizes; 16 transistor/ic/corners; 20 connectors; large multiscreen WYSIWYG display gives a clear uncluttered view of pads, tracks and drill holes; 0.1in. grid on/off; Block move; copy; mirror; rotate; erase; area fill (ideal for earth plane); preview; undo; dimensionally accurate printer routine with quick print; 1:1 or 2:1 dumps. Custom pad design and library. Available separately for £20.00 inc.

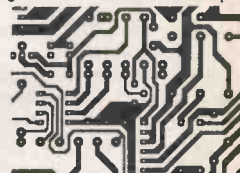

### COMPONENT LAYOUT

Draw component layouts directly or from existing pcb layouts using a unique track reducing facility. The following components are provided: resistors, capacitors, ics, diodes, transistors, line drawing, printout and block commands as above. Not available separately.

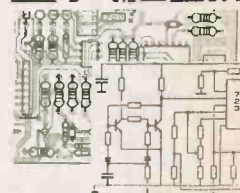

### CIRCUIT DIAGRAMS

Features similar to the above programs with a library of electronic symbols including resistors, capacitors, diodes, transistors, fets, op amp, switches, inductors, logic gates. Not available separately.

Version now available for EE Centronics Interface—see Jan issue. State version required from: Disciple/+D; Discovery; +3; Microdrive & Tape. Important! Tape and Microdrive users please state Centronics interface in use or send £1 for details.

**KEMSOFT** THE WOODLANDS, KEMPSEY, WORCESTER WR5 3NB. Tel. 0905 821088 after 6 p.m., or see us on A.I.X-386 BULLETIN BOARD 0905 52536/754127 on any computer with modem.

# AUTO-FADE INTERFACE

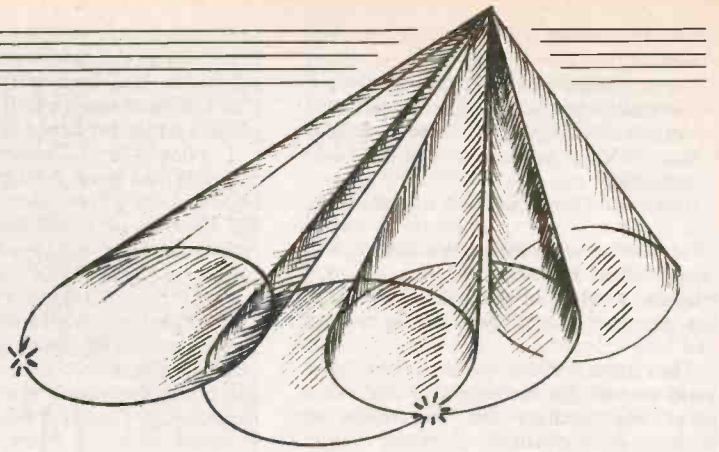

**ANDY FLIND**

*Produces slow, continuous changes in the brilliance of coloured lamps allowing creation of many fascinating effects for both domestic and commercial use. Interfaces with the 4-Channel Dimmer (Feb '89), via a single link cable.*

**T**HE SECOND (and final) interface project to accompany the *Four-channel Voltage Controlled Light Dimmer* (Feb '89 issue) is a *Four-Channel Auto-Fader Interface*. It produces slow, continuous changes in the brilliance of lamps driven by it through the dimmer.

The rate and "depth" of change and the average brightness are all independently adjustable for each channel, allowing creation of many different and fascinating effects with many uses, both domestic and commercial. It can be housed in the same case as the *Sound-to-Light Interface* (last month) with a switch for instant changeover, to make an extremely versatile control unit.

The fader circuit consists of a regulator to obtain a constant smoothed voltage from the Light Dimmer's "auxiliary" supply, and four identical circuits to generate the control signals. Each output consists of a variable d.c. voltage with a slow "sinewave" superimposed on it. The speed and amplitude of the sinewave are also variable, so that the overall brilliance of each lamp and the rate and depth of variation may be adjusted.

Depth control ranges from zero, where "average" acts as a dimmer, to overdrive, where the lamp virtually flashes on and off. Between these extremes a wide range of attractive auto-fading effects may be programmed. The speed can be varied between about a cycle every two seconds to one in twenty.

The output signal is shaped into something approaching a sinewave as this gives a more pleasant effect. A ramp is easier to generate, but the "corners" are clearly visible at most settings and spoil the impression.

A minor snag with this circuit is complexity, as there are twelve separate controls to wire up! However, as with the other projects in this series some options are available. If less than four channels are required the unwanted ones may be omitted, and if user control is not needed over some of the functions then preset potentiometers can be used.

## CIRCUIT DESCRIPTION

The circuit of the regulator and one of the four signal generators appears in Fig. 1. The supply regulator consists of IC1, a five-

volt regulator chip, with decoupling capacitors C1 to C4.

The 100n capacitors C2 and C3 decouple high frequencies where the internal inductance of the electrolytics limits their efficiency. These are often omitted in some designs, but a neighbour of the author is a CB enthusiast, and experience has shown them to be essential in the presence of strong r.f. fields! The regulator supplies all four signal generators.

For clarity only one signal generator is shown in Fig. 1. The other three are identical and have the same component numbering. In the component layout it will be noticed that there are, for example, four R1's, four IC2's, and four C5's.

From Fig. 1, the operation of each is as follows. A low-impedance source of a voltage midway between the supply rails is required at several points, so this is produced with IC2a. Resistors R1 and R2 split the five volt supply, and their output is buffered by the op-amp, one of the four present in IC2.

Op-amp IC2b, with capacitor C5 and resistor R3, forms an integrator whose output ramps up or down at a rate and direction set by the input to resistor R3. The output of this stage is fed to the input of IC3, connected as a "Schmitt trigger" with positive feedback through resistor R5. Its output changes state suddenly as the input to resistor R4 exceeds fixed positive and negative values.

Fig. 1. Circuit diagram for the Auto-Fader Interface. Components within the dotted area are repeated for each of the four channels.

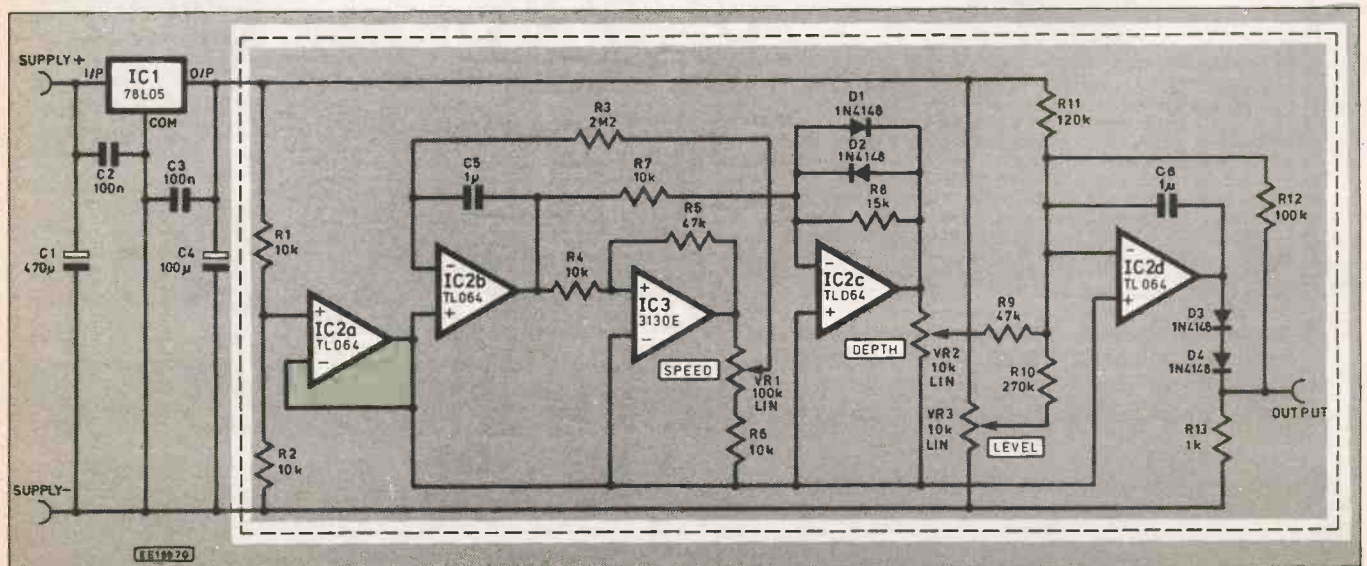

The 3130 device is used for IC3 as its output swings all the way to both supply rails, giving a symmetrical output signal. An adjustable fraction of this is returned to the integrator through the "Speed" potentiometer VR1, so creating a variable frequency oscillator.

The output from IC2a is a triangle wave but, as mentioned previously, a better effect is obtained with a sinusoidal control signal. The necessary shaping of the triangle is achieved through IC2c, which has non-linear feedback from diodes D1 and D2.

The output is not a pure sine, but is quite good enough for the intended use and a great improvement on the unaltered triangle. IC2d adjusts the average d.c. level of the signal and has controls for setting up various effects.

Potentiometer VR2 varies "Depth", or amplitude of the sinewave signal. A small, adjustable bias from potentiometer VR3 ("Level") and resistor R10 allows variation of the average brilliance of the lamp.

To control the 4-Channel Light Dimmer correctly, the outputs of this project must be able to reach negative supply voltage. The outputs of the TL064 quad op-amp cannot manage this, but the difficulty is overcome by diodes D3 and D4 and "pull-down" resistor R13.

The combined forward voltage drop of the diodes is a little over a volt, allowing the output of the amplifier to operate about a volt higher than the final output. Feedback for this stage (IC2d), through resistor R12, is taken after the diodes. Capacitor C6 removes any glitches and noise from preceding stages of the circuit.

## CONSTRUCTION

Before describing construction, some comment on the printed circuit board (p.c.b.) layout is in order. This consists of the regulator and its associated components to the left, and four self-contained signal generators. These can be seen quite clearly in the track pattern, and if less than four channels are needed and a more compact board would be an advantage, it is quite in order to cut off the unwanted portion of p.c.b.

Construction should be straightforward for most constructors. The component layout and full size copper foil master pattern is shown in Fig. 2. This board is available through the *EE PCB Service*, code 642.

The resistors and diodes can be fitted first, ensuring that the latter are correctly

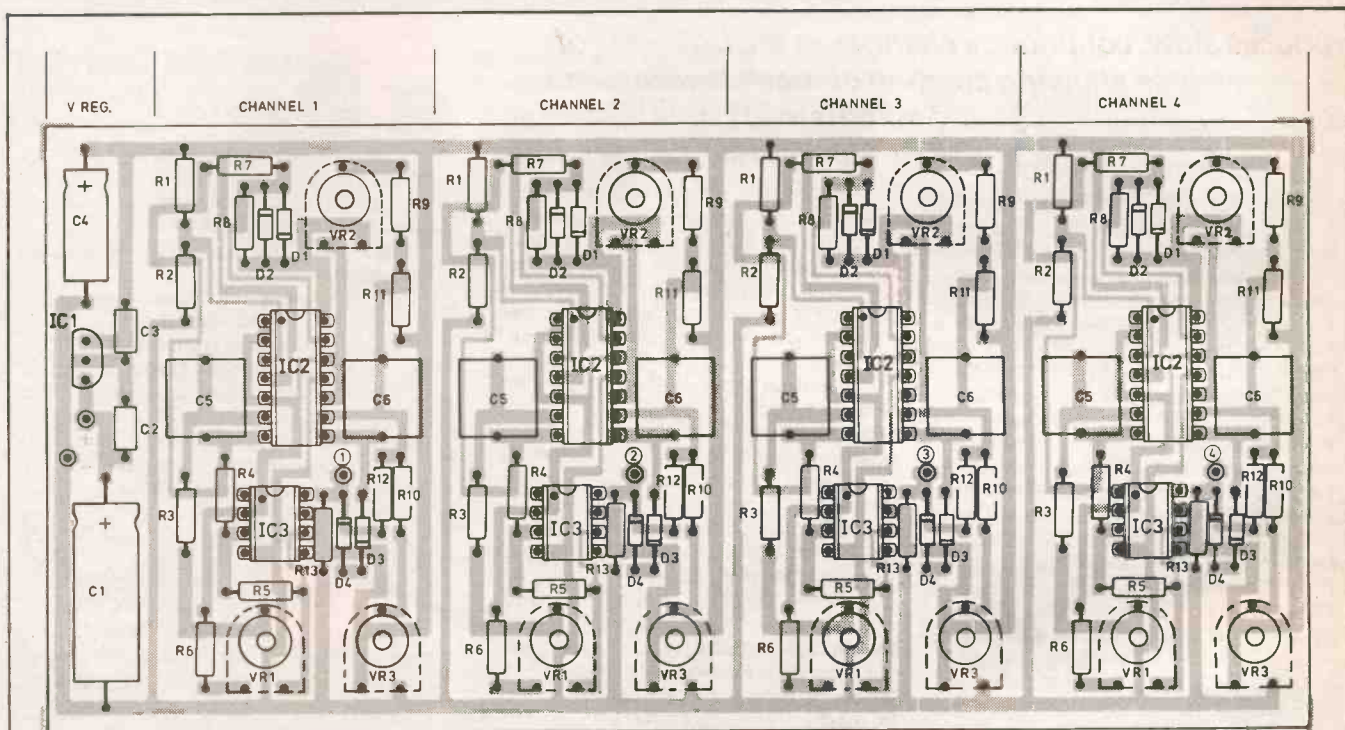
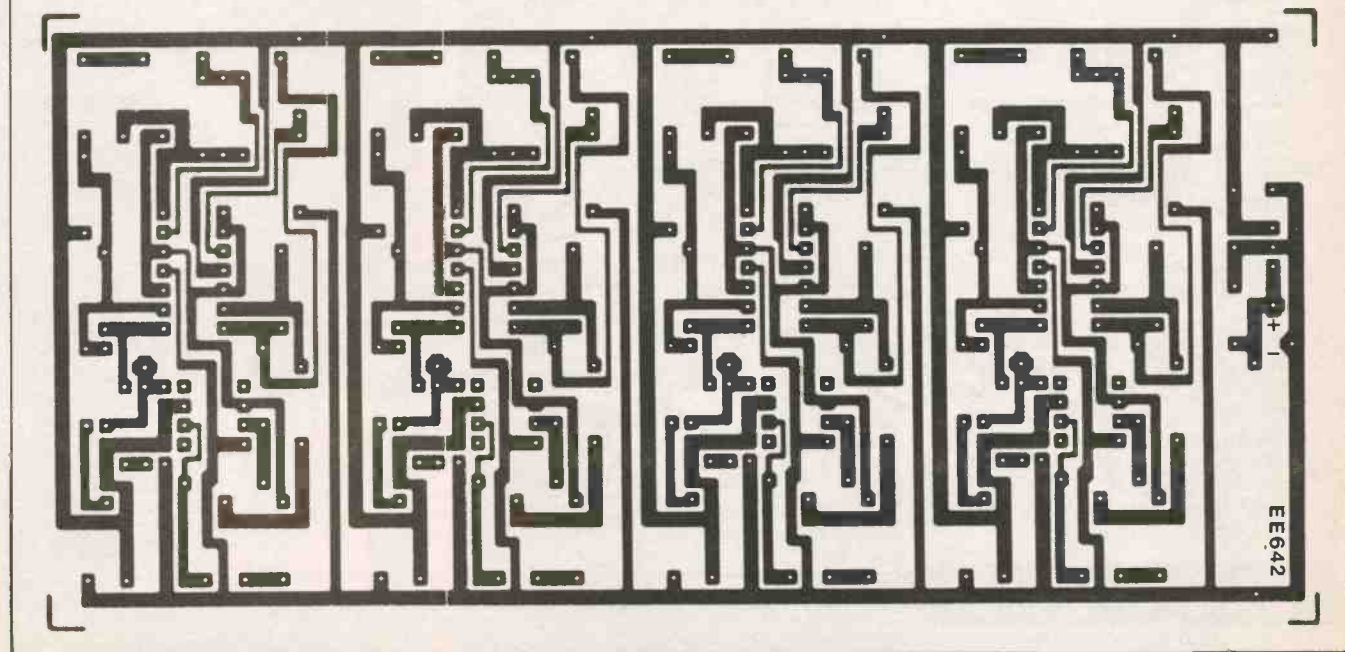

Fig. 2. Printed circuit board component layout and full size master pattern. The presets, shown dotted, are only required if "manual control" is NOT required and replace the case mounted controls. The leads from the 12 case mounted potentiometers should be wired in place of the presets, see Fig. 4.



# 4-CHANNEL AUTO-FADER INTERFACE

## COMPONENTS

### VOLTAGE REGULATOR

#### Capacitors

- C1 100 $\mu$  axial elec. 25V
- C2, C3 100n min. polyester layer (2 off)
- C4 470 $\mu$  axial elec. 10V

#### Semiconductor

- IC1 78L05 5V 100mA regulator

### SIGNAL GENERATOR

(multiply the following by the number of channels to be constructed—4-off for complete board)

#### Resistors

- R1, R2, R4, R6, R7 10k (5 off)
- R3 2M2
- R5, R9 47k (2 off)
- R8 15k
- R10 270k
- R11 120k
- R12 100k
- R13 1k

All 0.6W 1% metal film

**Shop  
Talk**

see page 264

#### Potentiometers

- VR1 100k rotary lin.
- VR2, VR3 10k rotary lin. (2 off)

#### Capacitors

- C5, C6 1 $\mu$  min. polyester layer

#### Semiconductors

- D1, D2, D3, D4 IN4148 silicon (4 off)
- IC2 TL064 quad op-amp (plus 14-pin d.i.l. socket)
- IC3 CA3130 op-amp (plus 8-pin d.i.l. socket)

#### Miscellaneous

(common to all channels)

Printed circuit board, available from *EE PCB Service* code EE642; case, ABS box 2006, 190mm $\times$ 110mm $\times$ 60mm; S1 4-pole 3-way rotary, break-before-make switch; knobs (12-off for all four channels); SK1 DIN chassis socket, 5-pin 240 degree; ribbon cable etc. for connections.

Approx. cost  
Guidance only

**£24**

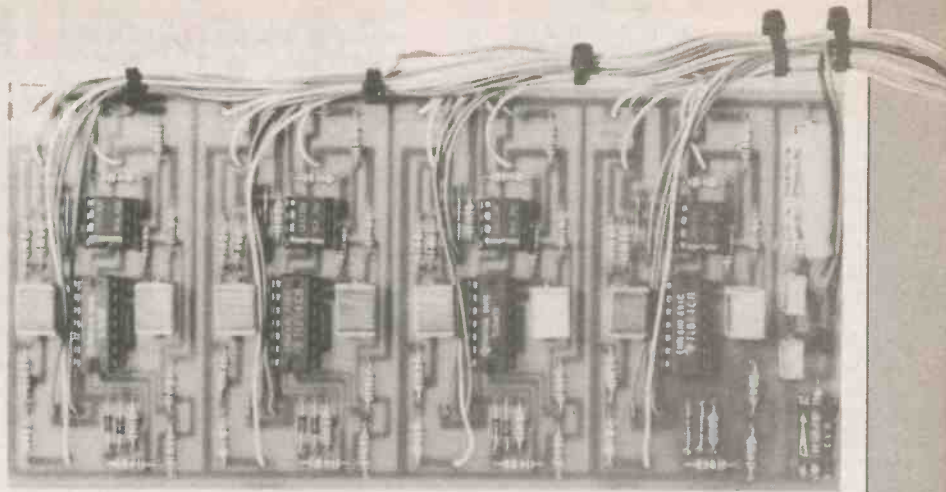

The completed board showing the wiring loom from the "effects" controls.



Fig. 3. Case drilling details and photograph of the finished unit.

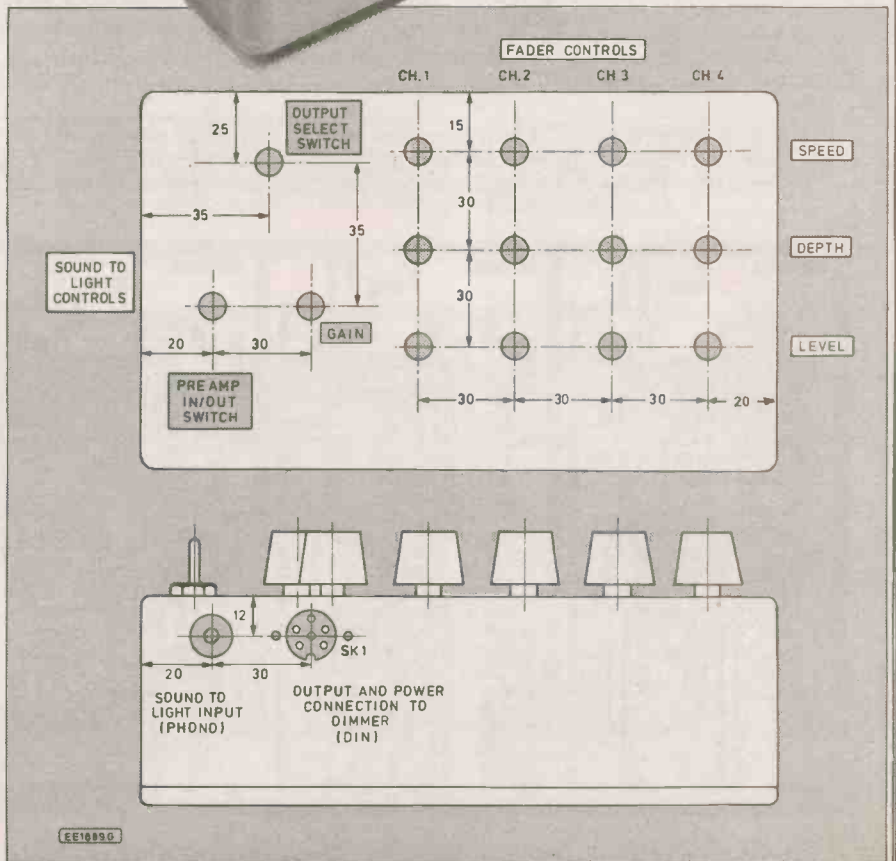

positioned. These should be followed by the non-electrolytic capacitors, which are all of the miniature silver-coloured polyester layer variety, and finally IC1 and the two electrolytic capacitors C1 and C4 can be added. Note that IC2 and IC3 are not fitted yet, as this should be done during testing. DIL sockets are recommended for them.

As mentioned earlier, presets may be used in place of the controls if preset effects are sufficient, they will fit directly to the board. However, if all controls are going to be panel mounted, the wiring for them should be added next.

More details will be given later, but for now the leads are required for testing. The use of coloured ribbon cable, split into strips of three cores each, helps to keep confusion to a minimum. A length of around 40cm should be sufficient to cover most final layouts.

## TESTING THE BOARD

Testing, after careful checking for errors, solder "bridges" between tracks etc., begins with a check of the supply regulator. Testing is best carried out with a temporary power supply; a PP3 battery will do nicely though a current-protected 10V bench power supply would be even better!

Either is preferable at this stage to running directly from the Dimmer's auxiliary supply, where a fault might damage both circuits. If all is well, the current drawn should be only two or three milliamps, though there will be a brief surge when the power is first turned on.

Assuming this is OK, the voltage across capacitor C4 should be 5V showing that the regulator is working. If so, temporarily connect the controls and add the first pair of IC2 and IC3's.

Turn the Depth control VR2 right down, measure the output voltage with a meter and try the effect of Level control VR3.

Fig. 4. Wiring to one set of channel controls, output switch and the supply socket. Other channels are identical. The supply is common to all channels.

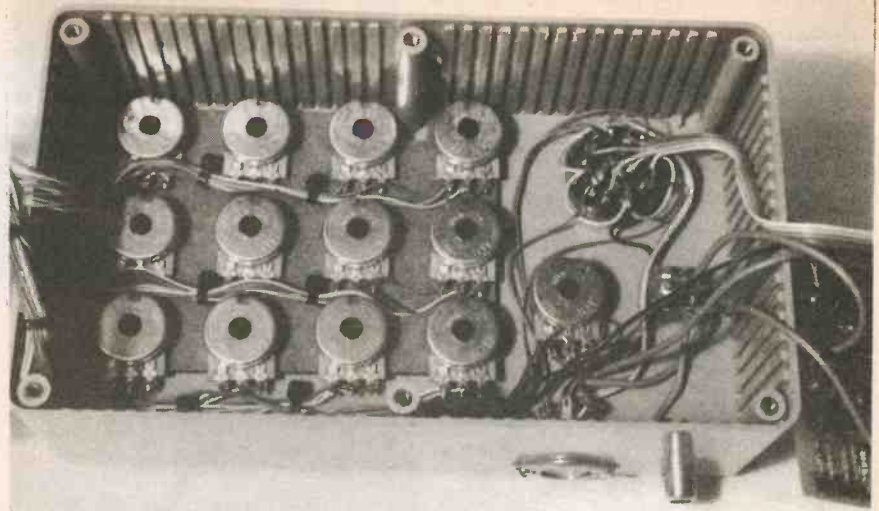
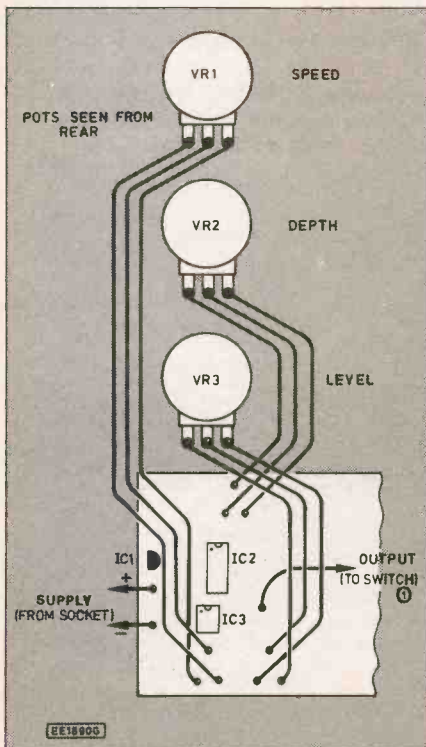

Layout of controls inside the case.

This should give adjustment from zero (negative rail) up to about 1.5 volts.

Next, the output should be set to about 0.5V with VR3 and the Speed control, VR1, turned right up. Advancing the Depth control should now produce the continuously changing voltage effect, swinging symmetrically about the original d.c. voltage setting. This procedure should be repeated for the remaining channels.

Some test points which may be helpful if problems arise are as follows. IC2's outputs are easy to locate as they are the four corner pins.

Top left (pin 1) is IC2a, which should be at 2.5 volts. Bottom left, (pin 7) is IC2b, and should be ramping slowly around a central point of 2.5 volts; about half a volt each way.

Top right (pin 14) is IC2c, with an overall swing of about 1.5 volts, again around the 2.5 volts, but it should now have been shaped into a "sinewave". With practice it

is possible to spot the difference on an analogue meter. Pin 9, bottom right, is IC2d output. The voltage here depends on the control settings, but should be about a volt higher than the final output.

## INTERWIRING

The prototype of this project is assembled into the same case as the *Sound-to-Light* project to make a really versatile control box. The case is the same as that used for the original *4-Channel Light Dimmer* project, a 190mm x 110mm x 60mm ABS plastic box, with non-slip feet stuck to the base so that it will sit on the Dimmer without slipping off.

In addition to the twelve fader controls the case was drilled to take the *Sound-to-Light's* level control, preamp switch and input socket, a four-pole switch to select the required outputs and a 6-way DIN socket for connections. The case drilling dimensions are shown in Fig. 3.

Fig. 5. Wiring details for the Auto-Fader/Sound-to-Light switch S1 and wiring to the DIN socket for connection to the Dimmer unit.

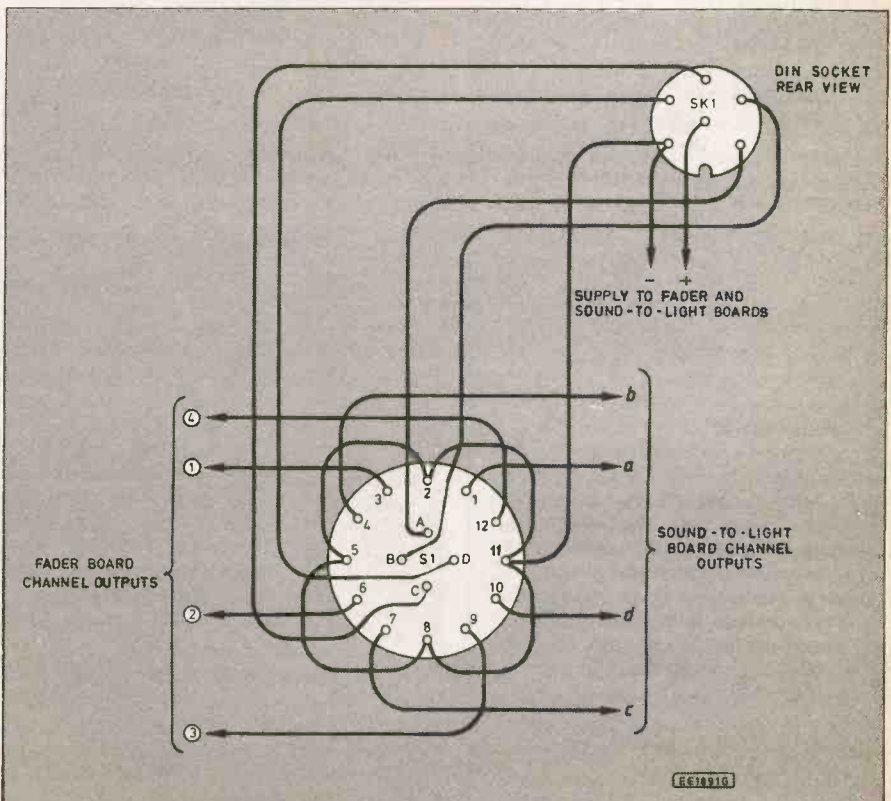



The 4-Channel Auto-Fader/Sound-to-Light Interface linked to the 4-Channel Light Dimmer (Feb '89) by a single connecting lead. Wiring to the "display" is made at a terminal block on the rear of the Dimmer case.

The wiring is not too complex but takes some time to complete. A problem for the author was that the boards had to lift out for photography and should not be obscured by wiring; a plate of "spaghetti" is not a very useful illustration! Overcoming this called for a miniature wiring loom.

Most constructors will not face this difficulty though, and the suggested procedure is to lay the board face up on the right of the upturned box and connect each potentiometer to the appropriate ribbon cable, after trimming to length. The control connections are not all shown as they are all the same, Fig. 4 showing the correct arrangement.

The completed wiring should allow the board to "fold over" into final position. As soldering is a trifle awkward within the confines of the box, an alternative is to place the controls in position on a piece of thick cardboard, wire them up and then transfer the assembly to the box.

A four-pole, three-way rotary switch selects outputs from either this or the *Sound-to-Light* board, and connects them to the DIN socket for transfer by cable to the *4-Channel Light Dimmer*. These switches have an adjustable stop for reducing them to two positions, but all three ways can be retained and the centre one used to connect a common input to all four channels.

On the prototype this is negative to turn the lights off, but two resistors might apply a couple of volts to turn them all fully on. The switch wiring is shown in Fig. 5.

Connections to the DIN socket should mimic those of the Dimmer as a simple, pin-for-pin connecting lead will then couple the units together. Both p.c.b.s are continuously powered, as there isn't a spare pole on the switch to select the supply. The combined load is well within the capabilities of the Dimmer's auxiliary output.

The completed Auto-Fader board showing the "sandwich" arrangement of the two boards. A piece of foam should be placed across the controls and the "lights" board folded into position followed by another piece of foam and finally the "fader" board. This method ensures that the boards and controls are adequately insulated from each other.

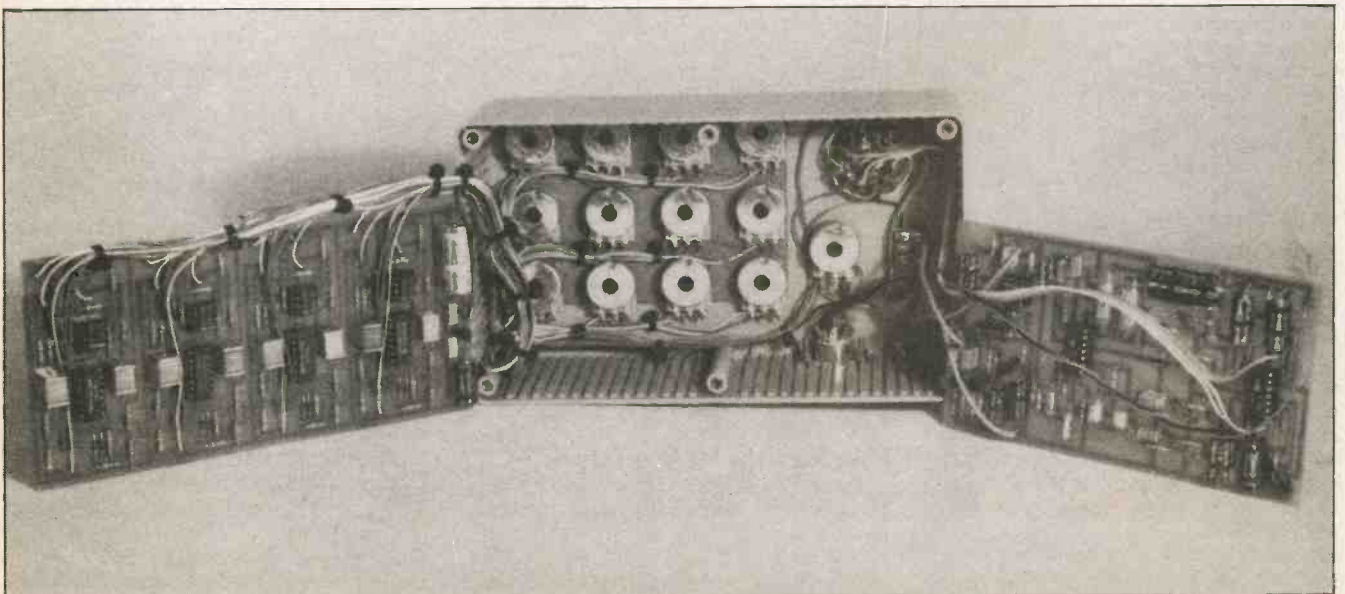

External wiring to the *Sound-to-Light* board is similar to the above, placing it to the left of the case whilst making connections so that it will fold into the case on completion. Wiring of the preamp switch, using screened lead, was shown in detail last month.

With the wiring completed, the two boards fold into place, spaced and insulated from each other and from other components with foam plastic. A piece of foam is placed behind the controls, the *Sound-to-Light* board rests on this component side downwards, then another piece of foam is placed over it, and finally the *Auto-Fader* board sits on this. When the cover is screwed home the foam and p.c.b. "sandwich" will all be held securely in place.

## SETTING UP

The controls of this project are best set up, initially at least, with the following procedure. It is best carried out one channel at a time.

To begin with, if the *Light Dimmer* has sensitivity controls these should all be set to maximum, as the *Auto-Fader* outputs are intended to operate between zero and one volt. Following this, the Depth control of the channel being adjusted should be turned right down, the Level control set to about half brilliance, then the Speed control should be turned right up so that the effect of the Depth can be easily seen and set.

Following this the Speed control can be adjusted to taste and minor modifications made as required. It really is great fun to play with, when four coloured lamps are driven some amazing effects can be produced.

Uses will range from Home Disco Lighting to Advertising Displays, to interesting and unusual room lighting. Two of the four channels controlled the "fairy lights" on the author's Christmas tree for the whole of the holiday, providing a useful reliability test for both the *Auto-Fader* and *Light Dimmer*. The effect obtained was far less irritating than plain flashing lights, placed less strain on the bulbs (especially the "fuse" bulb), and of course was practically unique. □

# FOR YOUR ENTERTAINMENT

BY BARRY FOX

## New Jargon

Barring last minute hitches the *Astra* satellite will by now be broadcasting direct into European homes with enough power for reception with a 60 cms aerial dish for which no planning permission is needed. High street shops which are now running out of customers for hi fi's, computers and videos hope to create a new market for small dish satellite systems.

So now customers have to learn a whole new jargon. On the face of things, a new book by Sandray Guest-Lee, *All You Need To Know About Satellite TV* (Mayflower Press £2.99, 28pp), is just what the customer needs; a lay language guide to the nuts and bolts of tuning in to satellite broadcasts.

I was passed a copy for review and regret to say I found it falls far short of the title promises—and underlines the considerable difficulty of trying to write in simple language about a complicated subject, without a full understanding of the technology.

The author has picked up some satellite jargon, stemming mainly from the now obsolete large dish systems which have been used by a few thousand people to pick up the cable programmes currently being relayed by low powered communication satellites. The author refers to the KU band, but does not say what it is. She describes the currently available channels in detail but does not say which satellites they come from.

None of this helps with the situation for 1989; a battle in the skies between *Astra* with 16 channels of varying transmission and scrambling format from 19 degrees East, and *BSB* with three channels in encrypted *MAC* from 31 degrees West.

There is a description of the new *MAC* TV transmission system but it is very muddled, and the reference to *BSB* offering a four channel service is wrong. *BSB* has a franchise for three of the five frequencies allocated to Britain for direct satellite broadcasting and the other two are soon going up for grabs.

## No Oracle

I don't wish to pick on the author of this book. The *Oracle* teletext service made exactly the same mistake in some pages broadcast about satellites broadcast over Christmas.

The error stems from some misleading publicity put out by *BSB* a while back, which referred to a four channel service on three frequencies—which is like saying *ITV* offers a three channel service on a single frequency, breakfast, day time and night hours programming.

My point is that in the satellite field a lot of enthusiasts will now be rushing in where wiser souls still fear to tread.

Ms. Guest-Lee's book has no glossary, which under the circumstances is perhaps fortunate. The reference section contains a very few addresses. One dealer is referred to as "Europe's major distributor in satellite receiver systems". Although the main company is reputable, it is only one of many.

No-one can write a useful book on the current satellite scene until vital decisions on transmission and scrambling standards have been taken. In the meantime, the best bet for anyone anxious to learn about satellite TV is to buy a few specialist magazines.

## Installation Guide to the Stars

Another book I saw for review, *Satellite Television Installation Guide*, by John Breeds (Swift TV Publications, Cricklade, Swindon) makes a good example of a reasonably readable book written by someone who obviously knows his trade. Breeds has previously written the very useful advice notes on satellite TV provided by *Salora*.

There is strong legal guidance pointing out to would-be fitters that they should obtain public liability cover in case a dish later comes loose in the wind. Dishes smaller than 90cm need no permission, but in theory every dish needs a one-time £10 licence from the DTI.

In practice the DTI will almost certainly drop this, because it costs more to administer than the revenue it brings in. Much more important, the Cable Authority is currently embarrassing both the DTI and Home Office by vigorously enforcing a section of the *1984 Cable and Broadcasting Act* which was designed to protect cable stations from unlicensed competitors wiring up blocks of flats and estates.

The Cable Authority now insists that it is a criminal offence (punishable by unlimited fine) for even two flats in the same building to share a dish aerial, even though they already share a u.h.f. aerial. The CA wants to charge flat dwellers £105 a year for a licence to operate as a cable station.

I was left in no doubt that the Home Office is deeply embarrassed about this when I phoned their Press Office for a comment. For the first time in twenty years of dealing with government Press Offices I was lied to—twice promised a comment if I could wait a few more hours for calls which never came.

## Footprints in the Rain

There are useful charts showing the position and footprint of communications satellites (*Intelsat* and *Eutelsat*) and DBS birds (*Astra* and *BSB*), with more charts showing the tilt angles needed for dishes in different parts of

the country. He explains hidden problems, like the difference between true south and magnetic south, and tells how to survey a site to tell whether it will be able to "see" a satellite.

There are practical tips, like how to bend warped dishes straight, and how to check that the waveguide assembly is accurately matched to the polarization angle of the incoming signal. Vertical polarisation will only be truly vertical, if the satellite is at the true south position, which in practice it won't be.

Breeds warns of the need to make cable joints completely water tight, to avoid loss of signal in wet weather. Even professionally installed, large dishes (like those used by TV studios) suffer poor pictures on wet days, so Heaven help the general public whose dishes will often have no "rain fade margin" i.e. be only just large enough to give acceptable results in dry weather.

The trick is to use a signal strength meter to optimize dish position, not just watch for the best picture. Another trick is to use thick cable. Although thin cable is cheaper it will lose signal at the frequencies of around 1GHz coming out of the dish.

"It is imperative that due consideration be given to the type of wall fixing", says the author, noting that wind gusts can considerably increase the apparent weight of a dish. "Avoid using cheap plastic wall plugs . . . (but) heavy duty wall plugs will not strengthen weak masonry."

I do hope members of the public, tempted to have a go at installing their own dishes, will read this book before setting foot on a ladder or risking life and limb on a roof.

## PLEASE TAKE NOTE

### FIRE ALARM

In the Fire Alarm project (Feb. '89) the circuit diagram, Fig. 1, shows TF3 to TR8 wrongly connected. The collectors and emitters should be changed over. The remaining diagrams are correct.

# ACTUALLY DOING IT!

by Robert Penfold

**W**HEN YOU reach the stage in the construction of a project where the circuit board is complete, you might think that most of the hard work is behind you. In reality this is often not the case. The delicate task of putting the circuit board together is behind you, and it is the harder work with drills, files, etc. that lies ahead.

So once you have your completed circuit board, how do you turn it into a finished project? I would recommend that you should not be in too much of a hurry to complete things. It would be very easy to make a mess of things and waste a lot of time and money in doing so.

Components that are connected in the wrong place on a circuit board can usually be removed and put in the correct position on the board without too much difficulty. Holes in cases cannot be undrilled!

## Preliminary Testing

A ploy that I have found useful over many years, and one which is well worth passing on, is to check that the circuit board works properly before fitting it into the case and finally wiring it to the rest of the unit. With a mains powered project this will probably not be something that can be achieved safely unless you have a bench power supply unit that can be used as a temporary power source for testing purposes.

With battery powered projects it does not take long to wire the battery connector, switches, potentiometers, etc. to the board and try it out. This wiring does not need to be very neat, but it must be right.

Crocodile clip leads are useful for making temporary connections for this type of testing. Obviously the practicality of all this depends very much on the size and nature of the project, but it is well worth trying it whenever possible.

One obvious advantage of doing this is that you have to wait less long to see if the project is working properly! A less obvious but (perhaps) greater advantage is that if the project should fail to work, it is generally much easier to locate and correct any mistakes at this stage than it would be once the unit was fully built and cased. In particular, you have full and easy access to both sides of the circuit board. Detailed checks for damaged components, solder bridges, etc. are easily made.

## Mounting Tension

Once you are ready to fit the board in the case, a suitable method of mounting must be selected. Do not simply use three or four nuts and bolts to fix the board to the appropriate panel of the case.

If the case is of metal construction, this would simply result in all the connections on the underside of the board being short circuited through the case. Even with a plastic or wooden case, this method of mounting is something that cannot be recommended.

You have to bear in mind that the connections on the underside of the board protrude about two to four millimetres below the bottom surface of the board. Simply bolting the board in place tends to buckle the board (or possibly the case).

While this might not prove disastrous, it will certainly do nothing to aid good reliability. With a board made from s.r.b.p. or a similar material there is a real risk of the tension causing the board to crack or, it could even shatter completely.

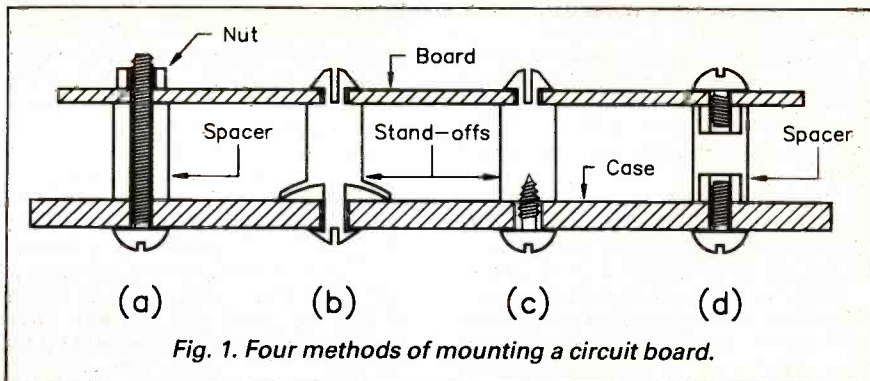

Fig. 1. Four methods of mounting a circuit board.

To avoid this problem it is normal for a board to be mounted on plastic stand-offs, or for some form of spacer to be used over each mounting bolt between the board and the case. Plastic stand-offs come in a wide variety of sizes, shapes and styles. I suppose that they boil down to two basic types, which are those that are a snap-fit to both the case and board, and those which are a snap-fit into the board but are fixed to the case via a self-tapping screw. These two types are shown in Fig. 1b and Fig. 1c respectively.

I have found the double snap-fit type a little difficult to use. You need to be very accurate with the diameters of the mounting holes in the board and case, and they still lack the security of the type which is screwed to the case.

A few stand-offs of the double snap-fit type seem unable to cope with some cases which have thick plastic base panels. In fairness, these cases can give problems with other methods of mounting that are perfectly adequate with thin panels.

## Spaced Out

Spacers are available in both threaded and non-threaded versions. With the

threaded type you screw them firmly onto the mounting bolts, drop the component panel into place, and then fit the mounting bolts. M3 or 6BA bolts, nuts, and spacers are about right. This is perhaps the best type of spacer to use, but you must be very accurate with the positioning of mounting holes in the case. The easiest and most accurate method of marking the positions of these holes is almost certainly to hold the board in position on the panel, and then to use it as a sort of template by marking through the holes in the board.

If you should be slightly lacking in accuracy with the positioning of the mounting holes, the board will not fit into place. Do not try to force it into position. Always avoid stress on circuit boards as this could result in damage to components and (or) cracked copper tracks. If the board will not fit it is a matter of removing the bolts and spacers, and then using a miniature round file to elongate one or more of the holes in the case to effectively correct their positioning.

The non-threaded spacers can be a bit awkward to use as you will have to hold three or four sets of bolts and spacers in position while you drop the board into place and fit the mounting nuts. This is bordering on the impossible unless you have some extra hands. A useful dodge is to use some blobs of Bostik Blue-Tack over the heads of all or some of the mounting bolts in order to hold them in place while you add the spacers, drop the board into position, and wind the fixing nuts a few turns into the bolts. With the Blue-Tack then

removed, the mounting nuts can be firmly screwed home.

With this method of mounting any lack of accuracy in the positioning of the fixing holes might go unnoticed. The mounting bolts will be something less than perfectly vertical in order to compensate for the error, but the small degree of list is unlikely to be noticed.

However, any gross error should become apparent as the mounting nuts are tightened, and must be corrected using the filing method mentioned above. Failure to do this could easily result in terminal damage to the circuit board!

A relatively new type of board mounting device is the plastic spacer having built-in threaded metal inserts. These are bolted to the case using short screws, and then the board is bolted onto them using a second set of short screws. Fig. 1a and Fig. 1d respectively show the standard method of using spacers and this modified arrangement.

This is a very neat solution which firmly fixes the board in place, but makes it easy to remove it when necessary. Its only disadvantage is that it is relatively expensive. I would presume that some threaded spacers



plus some short bolts would permit the same method of mounting to be adopted, but possibly at a much lower cost.

### On The Fiddle

Spacers and stand-offs are available in a range of heights from about 3 to 25 millimetres. For most purposes five millimetres is quite adequate, but if a board is carrying a high voltage and is mounted on a metal panel it would be better to use a spacing of about 10 to 15 millimetres.

Using long spacers where they are not really needed is quite acceptable from the electrical point of view, but might not be satisfactory mechanically. Many modern projects have to be almost shoe-horned into their cases, and anything that is larger than necessary can cause severe difficulties.

This rather fiddly nature of many recent projects can make it difficult to get mounting nuts and bolts into position in awkward corners. This seems to be a general trend in electronics. I have noticed that much commercial electronics can be removed from its case in a few seconds, but takes about an hour of precision work to reassemble everything (if you can get it all back together again at all!).

A useful ploy I have often used in the past is to use some Blue-Tack to stick a nut or bolt to the end of screwdriver while it is carefully manoeuvred into position. Another method is to take a screwdriver and repeatedly rub the end of a strong magnet along its length. Provided the screwdriver's blade is made from a ferrous metal this will magnetise it (most screwdrivers have steel blades).

Incidentally, some screwdriver blades seem to be slightly magnetised as supplied. Nuts or bolts that are also made from ferrous metal will then be attracted to it and will probably just adhere to the end of the blade.

A much better method than either of these is to use a "pearl catcher" tool. This is a pen-like tool which has a plunger at the top end which is operated with the thumb.

Pressing it causes four spring-loaded "claws" to extend and open out at the bottom end of the tool. These claws can be placed over a nut or the head of a screw, and will securely grasp it as the plunger is released (Fig. 2).

This tool lives up to its name, and will even grasp small, round objects having a slippery surface, such as pearls or ball-bearings. Apart from getting nuts and bolts into awkward corners, a pearl catcher can also be useful for retrieving small objects that have fallen into awkward places.

Fig. 2. The "pearl catcher" tool. Ideal for getting nuts and screws into awkward places, as well as retrieving them from the innards of a project.

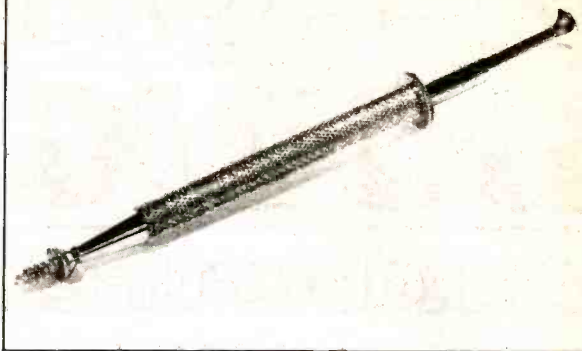

### Guide Lines

It has been assumed so far that you are not going to make use of any integral board mounting facilities the case might have. If you look at the interior of many project cases you will find that there is some form of built-in mounting facility for one or more boards. In its most common form there are tubular mounting pillars moulded into a plastic case. The board or boards are mounted on these via self-tapping screws.

In practice these mounting pillars are not as useful as you might think. They are intended for standard size boards (such as the Eurocard type) with the mounting holes drilled in the correct positions. Few home constructor projects use these standard size boards, and in most cases you will be unable to make use of these mounting pillars.

In fact they often seem to get in the way. It is not just a matter of them obstructing the circuit board, you can even find that it is impossible to get the lid on a case due to mounting pillars fouling controls, transformers, and other components.

Fortunately, removing these pillars is not a difficult job. They can usually be removed by drilling them out with a drill bit of about 8 to 10 millimetres in diameter (i.e. a slightly larger diameter than the pillars themselves). One word of warning though—go slowly and carefully. Otherwise there is a risk of drilling right through the case!

This is one job where a hand-drill is definitely preferable to a power type. If you do use a power drill, use a variable speed set to a very low operating speed. Of course, where these mounting pillars are usable, it only makes sense to utilize them.

Another form of built-in board mounting system is the guide-rail type. These are ridges moulded into some plastic cases, and

this system is also a feature of some diecast aluminium boxes. These rails are merely pairs of ridges on opposite sides of the case, into which a printed circuit board can be slotted. Again, these rails are something that are not usable with most projects as the circuit board will not have been designed to fit them.

Occasionally you might encounter a project that does require the use of a specific case so that the guide rails can be used. If you make your own printed circuit boards it might be possible to enlarge a board slightly by including a blank area at each end so that it can fit into guide-rails.

This is certainly a delightfully simple means of mounting printed circuit boards, and one which does not need any unsightly mounting screws showing on the exterior of the case. If you are making your own circuit board to fit into guide-rails, make quite sure that it is accurately cut to size.

Cutting it slightly too large will not be a major disaster as you can always file it down to size. The same is not true if it is cut marginally under-size. You will then be lucky to find any simple means of fixing the board in position reliably.

Usually with this type of case you have the option of having boards mounted vertically or horizontally. This tends to restrict the maximum board size, and multiple boards are not usually a very convenient method of construction. A better method would be to have the board mounted in the same plane as the front and rear panels.

With a few cases this is indeed possible, but only with the aid of four plastic clips which fit onto the board. It is then these clips that slide into the guide-rails. Once again, getting the board exactly the right size is important if this system is to provide a reasonably secure mounting for the board.

# RUGGED

LCD MULTIMETER PROJECT

- \* Full application notes
- \* Resolution 100 micro volts
- \* Minimum add on components

ONLY £16.04 inc VAT +p/p £1.25

Why not call us now



**RUGGED DISPLAYS LIMITED**

1 Mars House, Calleva Park,  
Aldermaston, Berks. RG7 4QW

LCD CLOCK PROJECT

- \* Full application notes and novel circuit ideas
- \* 12/24 Hour
- \* Snooze and alarm functions
- \* Tape counter/control timer

ONLY £10.34 inc VAT +p/p £1.25

Mail-Order Tel: (07356) 79521

# SHOP TALK

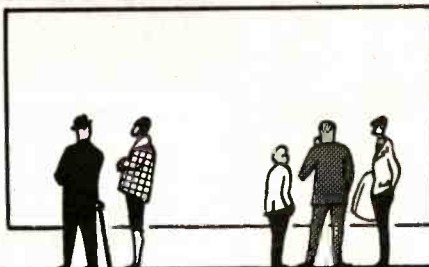

BY DAVID BARRINGTON

## In Brief

We just have space for a few snippets of news from around the "shops".

We often get calls from readers desperately seeking information or service details on specific equipment, including radios, TV's and video recorders. Until now we have been unable to advance any suggestions and been unable to help.

We have just heard that **Mauritron Electronics** (☎ 0844 51694) can supply manuals for "thousands" of different items, ranging from the earliest vintage wireless to the latest video recorders.

A new mail order company specialising in quality components has just been formed and is aimed at the electronic and computer enthusiast.

Called **Andor Electronics** (☎ 078 283642) they aim to provide a fast and friendly service. Their range of the 74 series i.c.s certainly seems very competitive and their general stock is continually changing.

For Spectrum owners who like designing their own printed circuit board, **Kemsoft** (☎ 0905 821088) are producing a PCB Designer package that allows the production of 1:1 and twice-up layouts to be produced.

Finally, we hear that **Everett Workshop Accessories** (☎ 0559 371226) have improved and added to the range of the various attachments for their Multi-Purpose work jigs.

## CONSTRUCTIONAL PROJECTS

### Integrated Amplifier

Although most of the components required to build the *Integrated Amplifier* seem, at first glance, to be straightforward enough, we have not come across or have any reference for the 60V diodes designated SKE4G or the N51 transistors. Also, as far as we have been able to establish, the ready-built Mullard pre-amplifier module is now only available from **Radio and TV Components Acton Ltd.**

The printed circuit board and the LP1183 preamplifier module is available from Radio & TV Components as a complete package for the sum of £10 plus VAT and 70p post and packing. A complete kit, including p.c.b., pre-drilled case and lettered front panel, dummy control panel and heatsink panel, may be purchased from **Radio and TV Components Acton Ltd., Dept**

**EE, 21 High Street, Acton, London, W36 N9** (☎ 01 723 8432) for the sum of £36.80. Add £3.50 for post and packing per order.

### Room Thermostat

One or two components required for the *Room Thermostat* need further comment, but the final choice must be left to individual constructors. *Please remember to switch off the mains when carrying out any installation work and double check before switching on again.*

There are many regulated power supply units on the market that should be suitable and provided they deliver about 1A at 8V to 12V the choice is fairly wide. However, as they have not been given a "soak test" only trial and error would show if they perform continuously over a long period without overheating.

The author suggests readers make their own p.s.u. and a neat little p.c.b. for a 0.5/1A regulated power supply from *Maplin* (order code YQ4OT), together with the necessary additional components, will make up a useful power unit. A transformer is also required, of course, and the *Maplin Bell Transformer* (code FL375—£6.95) gives a suitable 8V output at up to 1A and, claims the designer, runs cool for an indefinite spell of use.

Many of our regular advertisers should also be able to recommend a suitable transformer. They will certainly be able to supply a small plastics case to house both the p.c.b. and transformer.

A suitable solid-state relay should be available from most local component suppliers. Two "kits" from **TK Electronics**, the MK2 (needs the addition of a triac) and the XK104 (includes a triac) have both been used successfully in the prototype model. However, TK are currently offering their "ready made" CD240/10 solid state relay for just £2.25, plus VAT and £1 p&p, and may be a better buy.

All these relays can, with a control current of only some 15mA (arranged via a suitable series resistor), switch a mains current of up to 5A at 240V. This should be amply sufficient for the pump on a domestic radiator system, which, claims the author, needs only some 60W.

The LM35DZ temperature sensor i.c. and dual red/green l.e.d. are now widely stocked by most good component suppliers and should not prove too difficult to locate.

### Light Sentinel

A couple of items listed in the components list for the *Light Sentinel* could cause some local sourcing problems. This applies particularly to the opto-isolator and the solid-state relay for the interface modules.

The solid-state relay used in the prototype model for the full-power interface was a "Capital" device type SMT 2000/3 supplied by **Farnell** (☎ 0532 636311), code 175 783. Unfortunately, we have since learnt that they no longer carry this device. An alternative is a RS type available from **Electromail** (☎ 0536 204555) code 481-431; this "relay" has NOT been tried in the system.

Another possibility that may do the job, and mentioned earlier, is the Capital CD240/10 solid-state relay available at a "bargain" price (£2.25 plus VAT and £1 p&p) from **TK Electronics** (☎ 01 567 8910). This device has NOT been tried in the unit and, before ordering, the physical dimensions should also be ascertained to check that it will fit in the wall switch box.

The mains transformer is a 6VA type and a suitable type should be available from most stockists. If readers experience any difficulties, the one used in the prototype is a RS device and was purchased from **Electromail**, code 207 181 (£5.48).

The opto-thyristor (SCR) for the half power interface is also an RS device (code 308-001) and equivalent to the H11C4. The 6-pin d.i.l. device does not appear to have any special characteristics and most of our advertisers should be able to suggest a suitable alternative.

The master control and four small half power printed circuit boards are available through the *EE PCB Service*, codes EE632 and EE633 (see page 280).

### Auto Fader Interface

Looking through our many components catalogues, the TL064 quad low power op. amp used in the *Auto Fader Interface* appears in most of them and should not cause any undue purchasing problems. Indeed, all the components for this project are standard items.

When drilling the plastics case, it might be a good idea to tack a piece of thin protective card or paper on the "front panel" and mark the drilling points on the paper. Drilling through the paper and case should prevent the plastics surface from becoming marked or scratched. Once the drilling has been completed the paper can then be removed.

The printed circuit board for the *Auto Fader* is available from the *EE PCB Service*, code EE642 (see page 280).

### Electron User Port

We do not expect any component buying problems for the *Electron User Port* project. The computer ribbon cable and locking connectors are now accepted by most components stockists as standard lines and should be available generally. This also applies to the versatile interface adaptor (VIA) chip 6522. Prices do seem to vary quite a lot from one stockist to another.

The printed circuit board for this project is obtainable through the *EE PCB Service*, code EE638 (see page 280).

QUALITY...

# SECURITY SUPPLIES

FOR  
DIY &  
TRADE

...AT LOWEST PRICES

## CONTROL UNITS

- Automatic    ■ Modular
- Lighting     ■ Timer

## SENSORS

- Passive Infra-Red
- Ultrasonic
- Infra-Red Beam

## ACCESSORIES

- Contacts    ■ Pressure Pads

CARS &  
VANS

- Security Lighting
- Cable Etc. Etc.

HOMES &  
FACTORIES

## PRODUCT OF THE MONTH

### IR 1470 50' INFRA-RED BEAM SYSTEM



FOR SECURITY, INDUSTRIAL & PHOTOGRAPHIC APPLICATIONS

Starred features:

- 12V Operation
- ED Alignment Indicator
- Invisible Modulated Beam
- Easily Installed
- Size Only 82x52x57mm

ONLY £26.61 + VAT

The Security Specialist

## RISCOMP LIMITED

Dept. EE4.51 Poppy Road,  
Princes Risborough, Bucks.  
HP17 9PB

Callers by Appointment  
Office hours Mon-Fri  
9am-5pm



(084 44) 6326



electronize

## MICRO-PRESSURE CAR ALARM KIT

NEW

### CHECK THESE FEATURES

- ★ Micro-Pressure intruder detection.
- ★ Operates on all doors and tailgate.
- ★ No door switches needed.
- ★ Automatically armed 1 minute after leaving vehicle.
- ★ 10 second entry delay with audible warning.
- ★ Sounds horn intermittently for 1 minute.
- ★ Easy fitting - only 3 wires to connect - no holes to drill.
- ★ Compact design can be hidden below dashboard.
- ★ Low power drawn from horn circuit - no supply connections.
- ★ All solid state Power MOSFET output - no relays.

This new design employs a unique pressure sensing system to activate the alarm. As any vehicle door is opened, air is drawn out, causing a minute drop in air pressure. A sensor detects this sudden pressure change and sets off the alarm.

Fitting is extremely simple. Only two wires connect to the horn circuit, switching the horn and also powering the alarm. The low power circuit draws less than 2mA. A single control wire connects to the ignition circuit or hidden switch to arm the system whenever the vehicle is left.

As with all Electronize kits everything is included, high quality components and clear, easy to follow instructions, and all for the lowest possible price.

MICRO-PRESSURE ALARM KIT            £11.95    { Please add £1.00  
ASSEMBLED READY TO FIT           £17.95    { postage & packing

Also Available  
TOTAL ENERGY DISCHARGE ELECTRONIC IGNITION  
Extended CDI System

DIY PARTS KIT                                £17.95    { Please add £1.00  
ASSEMBLED READY TO FIT           £23.90    { postage & packing

**ELECTRONIZE DESIGN** Tel: 021 308 5877  
2 Hillside Road, Four Oaks, Sutton Coldfield, B74 4DQ

# ANDOR ELECTRONICS



### I.C.'s 74 LS

74LS00	20p
74LS02	20p
74LS04	20p
74LS08	20p
74LS10	20p
74LS13	30p
74LS14	35p
74LS20	20p
74LS27	20p
74LS32	20p
74LS42	45p
74LS74	25p
74LS75	35p
74LS86	28p
74LS90	38p
74LS93	38p
74LS95	55p
74LS125	30p
74LS138	40p
74LS155	45p
74LS157	45p
74LS163	50p
74LS164	55p
74LS175	50p
74LS193	60p
74LS240	70p
74LS244	70p
74LS257	48p
74LS373	60p
74LS390	60p
74LS393	60p

### I.C.'s 74 HC

74HC00	27p
74HC02	27p
74HC04	27p
74HC08	27p
74HC10	27p
74HC14	60p
74HC20	27p
74HC27	27p
74HC30	27p
74HC32	27p
74HC42	50p
74HC74	48p
74HC75	48p
74HC123	55p
74HC125	60p
74HC138	60p
74HC151	60p
74HC157	60p
74HC161	75p
74HC163	80p
74HC175	60p
74HC193	70p
74HC195	65p
74HC240	90p
74HC242	95p
74HC244	95p
74HC257	60p
74HC366	75p
74HC390	95p
74HC393	95p
74HC4016	110p
74HC4040	75p
74HC4051	90p
74HC4066	110p

### L.E.D.'s

3mm & 5mm	
Red	10p
Green	14p
Yellow	16p

### ZENNER DIODES

BZX55 500mW	10p
BZX85 1.3W	20p
C3V3    C7V5	
C3V6    C9V1	
C4V7    C12	
C5V1    C15	
C5V6    C24	
C6V2    C36	

### DIODES

1N4148	3p
1N4004 1A 400V	5p

### RESISTORS

Metal film 5%	
1 ohm - 1 Meg	
E12 range	
1	2p
10	17p
100	150p
Metal film 1%	
1 ohm - 1 Meg	
E24 range	
1	4p
10	35p
100	300p
Prices for same value not mixed	

### I.C.'s 74F

74F00	32p
74F02	32p
74F04	32p
74F08	32p
74F10	32p
74F20	32p
74F74	45p
74F86	45p
74F157	65p
74F161	140p
74F164	140p
74F175	90p
74F240	100p
74F244	100p
74F257	65p
74F373	100p

### IC SOCKETS

Low Profile	
6 Way	5p
8 Way	5p
14 Way	7p
16 Way	9p
18 Way	11p
20 Way	12p
24 Way	14p
28 Way	17p
40 Way	22p

### ANALOGUE I.C.'s

NE555 Timer	22p
LM741 OPA	22p
LM324 Quad	35p
uA733 Video	95p
ICL7660 Neg	220p
7805 5V Reg	35p
ZN426 8 bit D/A	250p
ZN429 8 bit D/A	220p
ZN449 8 bit A/D	375p

### NUTS & BOLTS

All steel & zinc plated	
Cheese Head Bolts	
6 BA 1/4in.	15p
6 BA 3/8in.	20p
4 BA 1/2in.	25p
4 BA 1in.	30p
Countersunk	
6 BA 1/4in.	15p
6 BA 3/8in.	25p
4 BA 1/2in.	25p
4 BA 1in.	30p
FULL NUTS	
6 BA	12p
4 BA	15p
Price for pack of 10	

### CAPACITORS

Min Radial lead	
0.033 50V	7p
0.1 63V	10p
4.7uF 16V	10p
10uF 16V	10p
22uF 25V	10p
47uF 16V	5p
100uF 16V	10p
220uF 16V	15p
470uF 16V	25p
Min Axial Lead	
0.1 decoupling	5p

### SOLDER 60/40

5 Metre 22 swg	95p
3 Metre 18 swg	95p
2 Metre 16 swg	95p

Ex Equipment I.C.'s

EPROMS	
27128 250nS	225p
2716	125p

### SPECIAL OFFERS

STATIC RAMS	
65256 200nS	400p

### ELECTROLYTICS

Miniature radial	
10uF 50V	5p
47uF 16V	5p

STOCK ITEMS BY RETURN. ADD 75p P&P.  
All prices include VAT. Send cheque or P.O. to  
**ANDOR ELECTRONICS, DEPT EE, 11 VICTORIA  
HOUSE, PAXTON STREET, HANLEY,  
STOKE-ON-TRENT ST1 3SD. TEL: 0782 283642**

# ELECTRON USER PORT

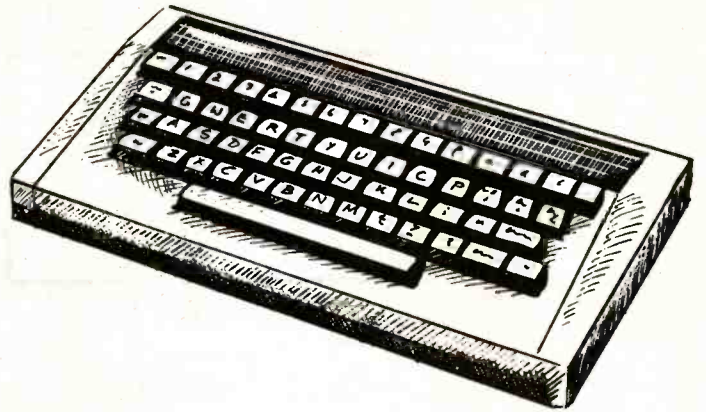

**ROBERT PENFOLD**

*An easy to build expansion for the Electron which will allow it to interface with many BBC Micro add-on projects.*

**T**HE Acorn Electron is essentially a cut down version of the popular BBC model B computer, and it has many features in common with the BBC machines. This includes BBC BASIC and the built-in assembler, but it lacks most of the ports. In particular, it lacks the user and analogue ports that are central to so many user add-on projects for the BBC computer. There are ready-made add-on ports available for the Electron, but it is not too difficult to produce your own interface at relatively low cost.

## ADDRESSING THE PROBLEM

This project provides a user port that has the same lines available as those on the BBC model B and master 128 computers. It enables the Electron to be used with

many projects designed for the BBC machines, but it has to be pointed out right from the start that this is not totally software compatible with the user port of the BBC machines. This would seem to be impossible to achieve, because the addresses used by the user port in the BBC machines (&FE60 to &FE6F) appear to be occupied by other hardware in the Electron. For instance, writing to the main user port address of &FE60 seems to have strange effects on the Electron's display (displacing it to the right for example)!

Although the Electron is very similar to the BBC machines in terms of the basic hardware, there are important differences. These mainly boil down to the Electron having a few custom chips instead of separate TTL chips, a lack of the mode 7 display circuit, and four 64K RAM chips used to provide 8 by 32K of memory. This seems to result in a lot of addresses that are vacant on the basic BBC machines being occupied

on the Electron. However, the whole of page &FC seems to be unused by the computer itself, and this area has been used for the user port described here.

Converting programs intended for the BBC computer and its user port is therefore very easy, and it is just a matter of using &FC0 as the first three digits instead of &FE6. Operation with commercial software/hardware that makes use of the BBC computer's user port is a different matter, and would probably prove to be non-convertible to operation with the Electron and this unit. The circuit was really only designed for home constructor projects though, and this factor is not a major drawback.

## THE VIA

The 6522 VIA (versatile interface adaptor) used to provide the user port actually has two ports, with port B acting as the user port. Port A plus some buffers is used to provide the printer port on the BBC computers. Here the unbuffered port A is made available. This gives an additional eight bit input/output port, plus two handshake lines.

Some add-ons for the BBC machines make use of the printer port to supply additional digital output lines, and port A should be usable in this role. Additionally, due to the lack of buffers, the eight data lines can be used as inputs if desired.

A separate analogue to digital converter can be added on to port A if preferred, and this is described in a separate article (*next month - Ed*). It is only an eight bit type, as opposed to the 12 bit resolution of the device used to provide the analogue inputs of the BBC machine. This is not such a drawback though, since noise problems reduce the effective resolution of this device to 10 bits, and in practice even this level of performance cannot always be achieved (not without the use of multiple readings and averaging techniques anyway).

Most user add-ons that make use of the analogue port have an effective resolution of only seven or eight bits, and with suitably modified software should work perfectly well with this converter. An advantage of this converter is that it can operate at over 100,000 conversions per second, which is about a thousand times as many as the BBC computer's analogue port. This makes it suitable for audio digitising and

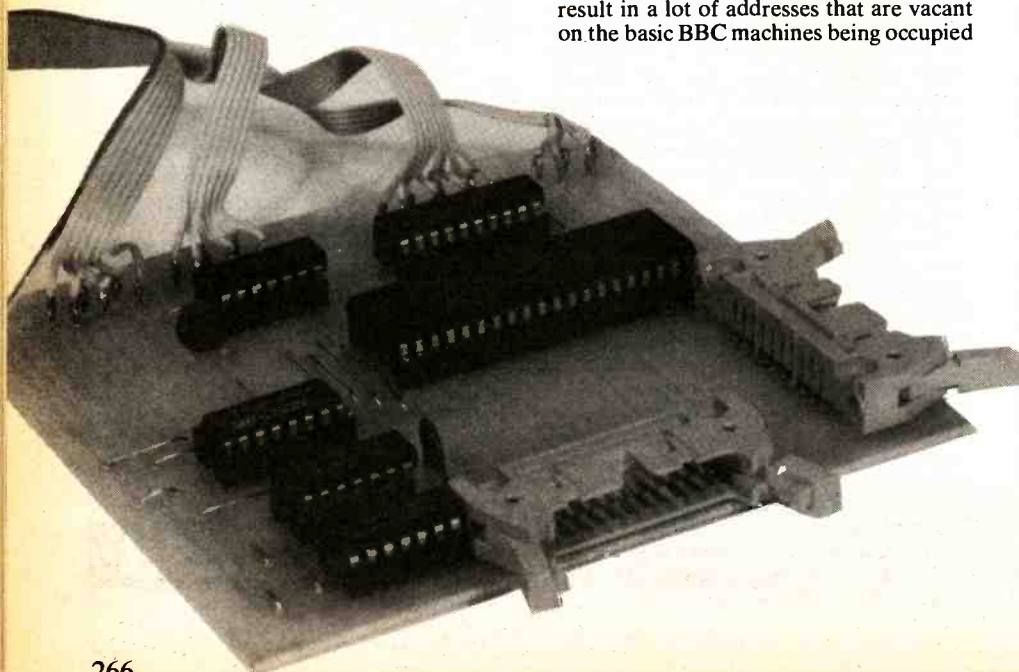

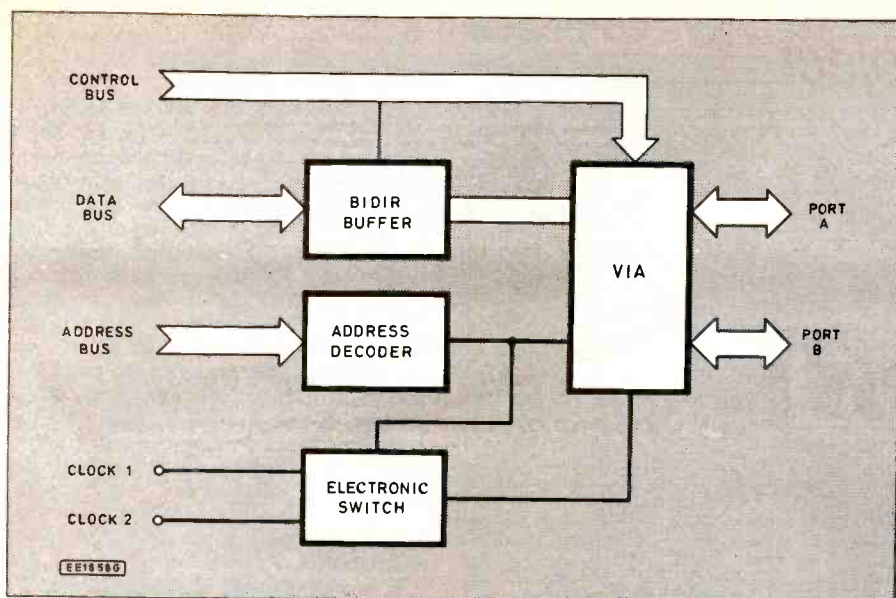

Fig. 1. Block diagram of the Electron User Port.

other medium speed applications that are outside the scope of the BBC analogue port.

## SYSTEM OPERATION

The Electron computer is based on a 6502 microprocessor, and on the face of it there should be no difficulty in interfacing it to a standard 65\*\* or 68\*\* series peripheral device such as the 6522. Unfortunately, matters are complicated by the "tricks" used in the Electron, with the microprocessor running at various speeds and stopping altogether periodically. This is done to enable various types of input/output device to be accommodated, and is a necessary part of the unusual memory arrangement used in the Electron.

Fig. 1 depicts this interface in block diagram form. To a large extent it is a standard 6502 type interface, with the control bus of the computer feeding into the relevant terminals on the VIA. The computer's data bus also connects to the corresponding terminals of the VIA, but there is a slight complication here in that the Electron's data bus seems to be difficult to drive properly. Some peripheral chips can manage it, but most 65\*\* series types (including the 6522) cannot. This problem is overcome by using an eight bit bidirectional buffer, or "octal transceiver" as it is often termed. This provides sufficient output to drive the Electron's data bus properly, and under control of the read/write ("R/W") line it is switched to send or receive data, as appropriate.

The address decoder provides only partial decoding, with the interface appearing at addresses from &FC00 to &FC0F, and then at "echoes" up to address &FCFF. This lack of full address decoding is largely of academic importance, but it does mean that this interface cannot be used at the same time as any other add-on which uses any addresses from &FC00 to &FCFF.

## CLOCKS

Interfacing the 6522 to the Electron is rather awkward in that the Electron provides three clock signals, but none of these are really suitable for the 6522. The three clocks are a 16MHz type, one at about 1.2MHz, and one which changes frequency

and periodically stops (sometimes referred to as the "MPU clock").

The 6522 requires the clock signal for two reasons. Firstly, it seems to require it in order to perform read operations, presumably to aid correct timing so that valid data is placed onto the data bus at the right time. The clock signal does not seem to be necessary for write operations incidentally. Secondly, it is sometimes required as the clock signal for the two sixteen bit timer/counters of the device.

In order to perform read operations correctly the MPU clock is required, but this is of little use for the counter/timer. It is what appears to be a random noise signal when displayed on an oscilloscope. With one of the timers used in the divider mode to provide an audio output signal, this gives an improved but still far from regular waveform. It renders the timer/counters useless for accurate frequency generation and timing applications.

The 1.2MHz clock signal is suitable for the counter/timers, and although it is not as convenient as the 1MHz clock of the BBC machine, it still permits accurate timing and frequency generation to be performed. It is possible that the higher clock frequencies could render the unit unable to produce long enough output times or low enough output frequencies when applied to add-ons that are intended for use with a 6522 plus 1MHz clock. However, in most cases it would just be a matter of using higher values in the timers to compensate for the higher clock frequency, or to have the computer perform some simple mathematics in order to adjust timings downwards by about 20 per cent.

Various ways around the clock problem were tried, but the only one that gave convincing results was to use a system of clock switching. Normally the 1.2MHz clock signal is used ("Clock 1"), but when the VIA is accessed by the computer a switch is made to the MPU clock ("Clock 2"). The address decoder provides the signal to control the electronic switch. This gives reliable read operations, and gives something close to a regular clock signal to operate the counter/timers.

Trying out the interface in a few simple applications certainly seems to give good results. I tried dividing the 16MHz clock by

sixteen and using this to give a 1MHz "normal" clock signal, but unfortunately this did not work well as it seemed to compromise reliability during read operations.

## CIRCUIT OPERATION

The full circuit diagram for Electron interface is shown in Fig. 2.

The top six address lines (A10 to A15) are decoded by IC1, which is an 8 input NAND gate. Its output is normally high, but it goes low when all eight inputs go high. In this case only six inputs are needed, and the two spare inputs are simply paired with two of the other inputs so that IC1's output goes low when the six address lines are high. This leaves A8 and A9 to decode, and the VIA (IC6) must only be activated when these are low. IC2 is a three to eight line decoder, and this decodes the remaining two address lines plus the output of IC1. Its "0" output activates IC6 when all three of its inputs are taken low.

Clock switching is provided by IC4 which is a quad tristate buffer. In this circuit only two of the buffers are needed, and the two spare sections are simply ignored. One control input is driven direct from the address decoder, but the other is driven via an inverter (IC3). IC3 is actually a quad 2 input NAND gate, but in this circuit only one section is used, and this has its inputs wired together so that it provides a simple inverter action. The inclusion of the inverter results in only one buffer or the other having its output enabled. Changing the state of the control input therefore gives, in effect, a switch from one clock signal to the other.

## COMPONENTS

**Shop  
Talk**

see page 264

### Capacitors

C1, C2 100n ceramic (2 off)

### Semiconductors

IC1 74LS30 TTL 8 input NAND  
IC2 74LS138 TTL 3 to 8 line decoder  
IC3 74LS00 TTL quad 2 input NAND  
IC4 74LS125 TTL quad tristate buffer  
IC5 74LS245 TTL octal transceiver  
IC6 6522 VIA

### Miscellaneous

Printed circuit board available from the *EE PCB Service*, order code 638; 26 way ribbon cable; 20 way IDC right angle (printed circuit mounting) plug (2 off); 2x25 way 0.1 inch pitch edge connector; 14 way d.i.l. holder (3 off); 16 way d.i.l. holder; 20 way d.i.l. holder; 40 way d.i.l. holder; 22 s.w.g. tinned copper wire, pins, solder.

Approx. cost  
Guidance only

**£19**

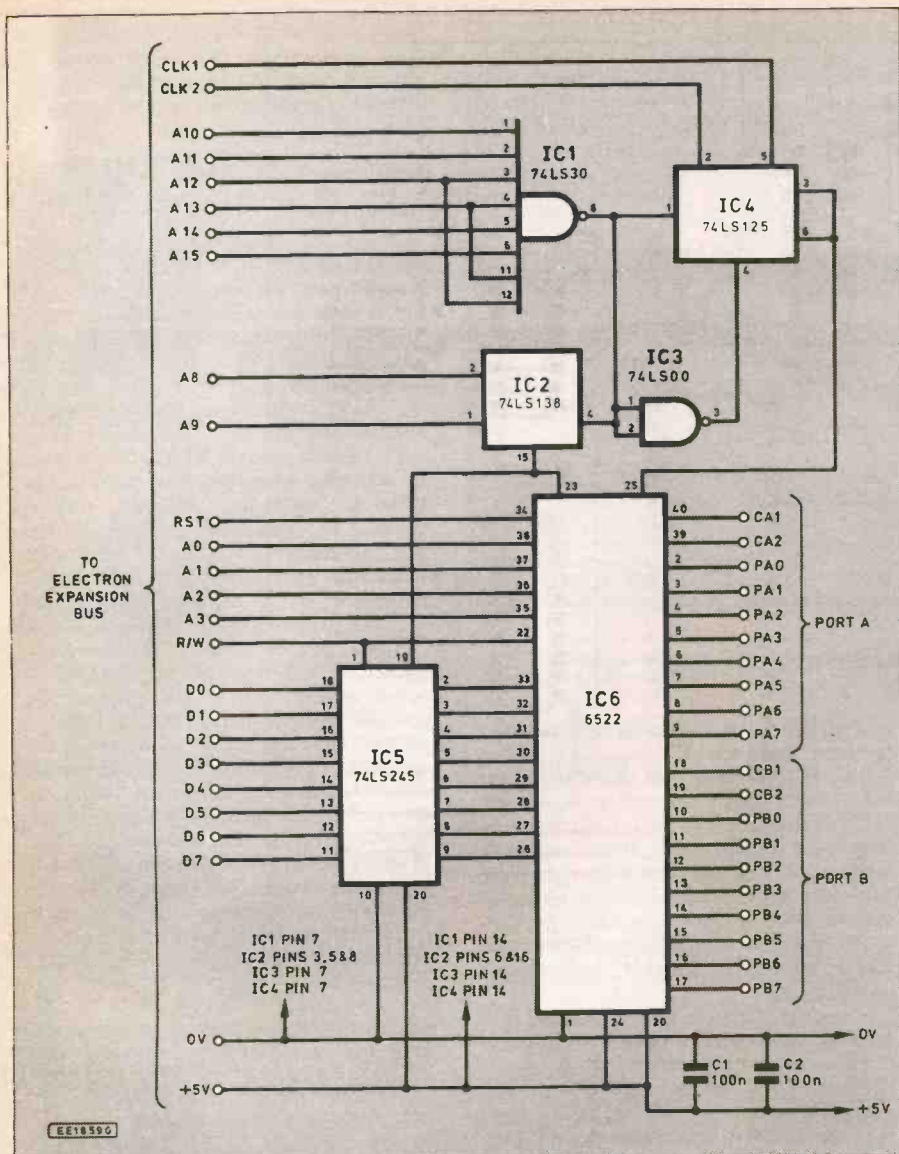

Fig. 2. Circuit diagram of the Electron User Port.

The control signal is taken from the output of IC1, and not from the output of the decoder as a whole. This gives a few changeovers other than when the interface is being accessed. This does not seem to have any detrimental effect on the accuracy of the counter/timer. It is necessary to arrange things this way as the interface otherwise seems to frequently malfunction on read operations (presumably due to the changeover being too sluggish). Controlling IC4 direct from IC1 seems to totally eliminate this problem.

IC5 is the octal transceiver, and its send/receive input is driven from the read/write line. Its chip enable input is driven from the output of the address decoder. IC6 is the 6522 VIA, and the unit seems to work properly using the standard (1MHz) version of this device. C1 and C2 are supply decoupling capacitors. The unit is powered from the +5 volt output on the Electron's expansion port.

### CONSTRUCTION

Refer to Fig. 3 for details of the printed circuit board. Some nineteen link wires are required, and these are made from 22s. w. g. tinned copper wire. IC6 is the only static sensitive chip used in the unit, and as this is not a particularly cheap device an

integrated circuit holder should be regarded as essential for this component. It is a good idea to use holders for the other integrated circuits as well.

The two ports are made available at separate 20 way i.d.c. header plugs. These must (of course) be of the printed circuit mounting variety, and the right-angled type are probably the most convenient type to use. Make sure that these are fully pushed down onto the printed circuit board before they are soldered in place. You should then find that they are firmly mounted on the board and that no additional fixing is needed. However, the connectors each have provision for two fixing screws, and they can be bolted in place if desired. If you do provide them with this additional fixing, be careful not to break or short circuit any of the tracks with the mounting screws.

### CONNECTION

Connection to the expansion port of the Electron is via a 26 way ribbon cable and a 2 by 25 way 0.1 inch pitch edge connector. This type of connector is readily available, but not fitted with a polarising key suitable for the Electron's expansion bus. You must therefore clearly mark the top edge of the connector as such, and take care not to fit it upside-down. Note that a 2 by 25 way edge connector fitted with a polarising key for the Amstrad CPC expansion port is not suitable for use with the Electron unless the polarising key is removed.

The connections to the printed circuit board are made via one millimetre diameter pins. Tin the ends of the leads and the pins with plenty of solder prior to connecting the cable to the board. There should then be no difficulty in making good, neat, and strong soldered joints. Similarly, tin the leads of the cable and the tags of the edge connector before connecting them together. Details of these connections are provided in Fig. 4.

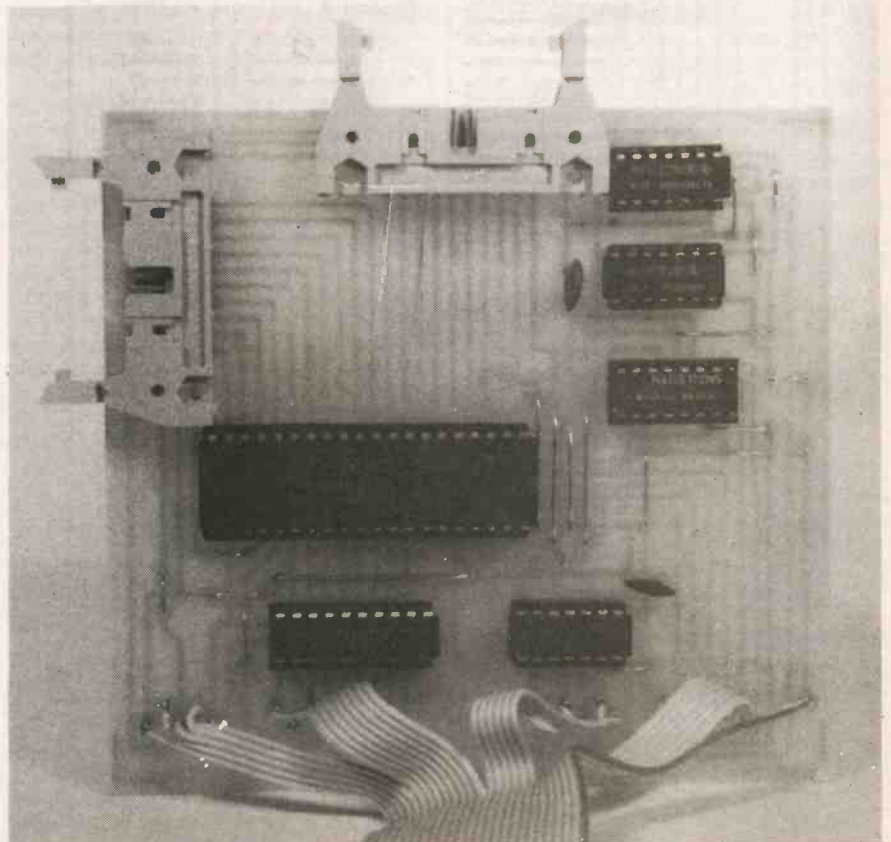

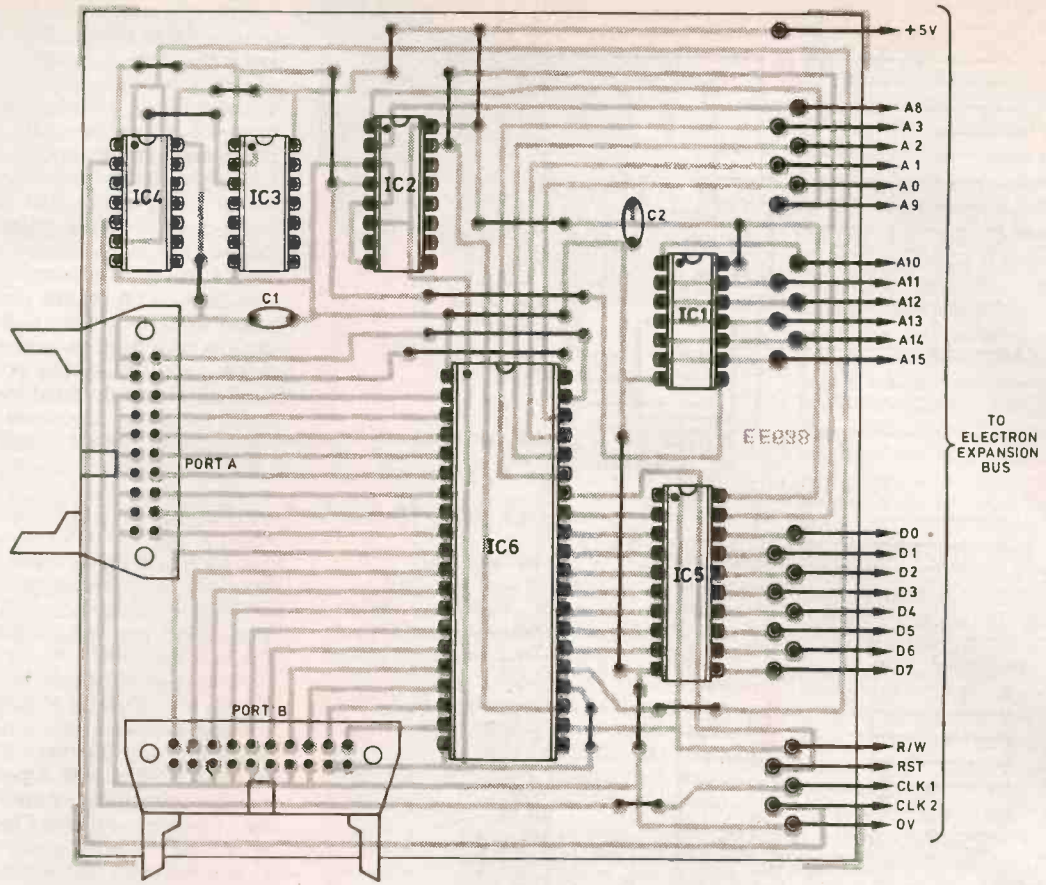

EE16800

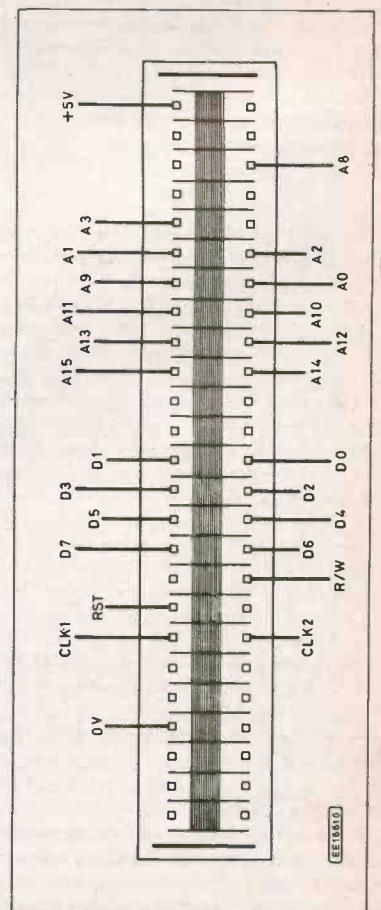
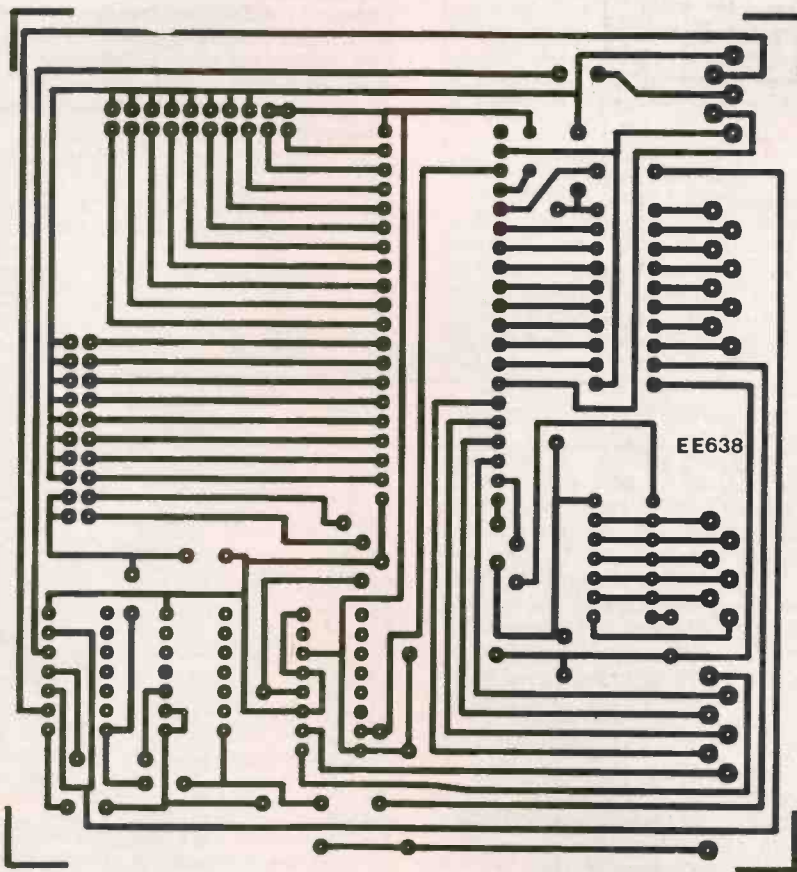

Fig. 3. Printed circuit board layout and connections.

Fig. 4 (right). Connections to the 2x25 way edge connector.

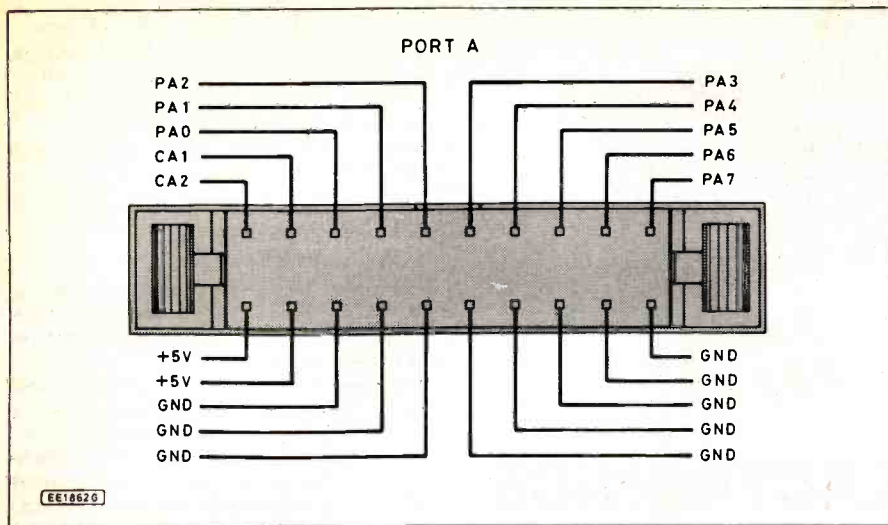

Fig. 5. Connection details for Port A.

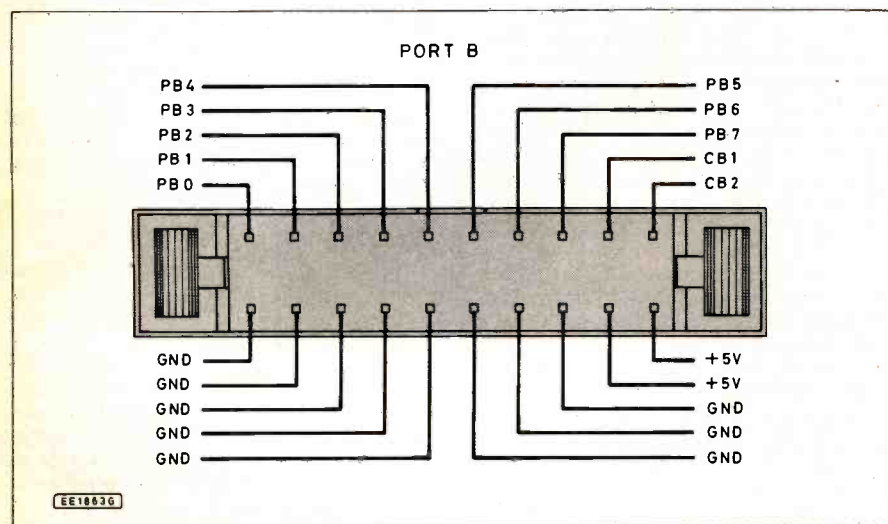

Fig. 6. Connection details for Port B.

The order of the connections on the printed circuit board has been designed to match up with the order in which they appear on the edge connector. This greatly simplifies the connections to the edge connector, but due care still needs to be exercised here. The use of "rainbow" type ribbon cable helps to reduce the risk of errors, although I found that the plain (grey) type was quite easy to use. Double check these connections before connecting the unit to the Electron and trying it out.

The original (breadboarded) prototype worked quite well with a cable about 0.8 metres long. The final prototype worked perfectly well with a short cable, but proved to be unreliable when a change to a cable about 0.5 metres long was made. In fact the unit worked perfectly well sometimes, and results varied according to the position of the unit and the connecting cable. Holding the connecting cable for instance, seemed to ensure perfect results!

Address line A10 seems to be the cause of this temperamental behaviour. Either the connecting cable must be kept quite short, or connecting A10 to the 0 volt rail via a 560 ohm resistor seems to provide a cure. Even with this resistor added I would still recommend that the cable should be limited to a length of about half a metre.

## TESTING

As for any add-on that connects direct to the buses of a computer, the unit must be connected to the computer prior to switch-on. When the computer is switched on, it should function normally with the usual start-up message being displayed. If it does not, switch off immediately and recheck all the wiring.

If all is well, try writing to port B, after first setting all the lines as outputs. For example, the commands:—

`?&FC02=255 RETURN`

`?&FC00=15 RETURN`

should set PB0 to PB3 high, and PB4 to PB7 low. The first instruction sets the lines as outputs, and the second sets the outputs to the desired logic levels. Next try reading port A using this command:

`PRINT ?&FC01 RETURN`

There is no need to set the port A lines as inputs as all lines are set as inputs by the reset signal at switch-on. This should return a value of 255 because both ports have internal pull-up resistors. Taking an input low and repeating the instruction should give a suitably modified result (e.g. taking PA7 low should give a returned value of 127).

Connection details for the two ports are given in Figs. 5 and 6. Note that port B has a similar method of connection to the BBC computer's user port, but it is not exactly the same. This slightly different method of connection needs to be taken into account when using the unit with a project designed for the user port of the BBC machines. Both ports make the +5 volt supply line available.

A detailed description of the 6522 goes beyond the scope of this article. Anyone intending to use this unit would be well advised to obtain the 6522 data sheet. A lot of information on the 6522 can be found in back issues of *Everyday Electronics*, and the "BEEB Micro" series has covered it in considerable detail. This series also includes some add-ons for the user port.

The table provided below should be useful. This is a list of the 6522 registers, together with their addresses in this interface and in the BBC model B computer. □

TABLE 1

Register	Address	Address (BBC B)
Port B	&FC00	&FE60
Port A	&FC01	&FE61
Date Direction B	&FC02	&FE62
Data Direction A	&FC03	&FE63
Timer 1 latch low byte	&FC04	&FE64
Timer 1 latch high byte	&FC05	&FE65
Timer 1 counter low byte	&FC06	&FE66
Timer 1 counter high byte	&FC07	&FE67
Timer 2 low byte	&FC08	&FE68
Timer 2 high byte	&FC09	&FE69
Shift register	&FC0A	&FE6A
Auxiliary control	&FC0B	&FE6B
Peripheral control	&FC0C	&FE6C
Interrupt flag	&FC0D	&FE6D
Interrupt enable	&FC0E	&FE6E
Port B (no handshaking)	&FC0F	&FE6F





## INTRO MICROELECTRONICS REVIEWED BY MIKE TOOLEY B.A.

**T**ECHNOLOGY is playing an increasingly important role in the school curriculum as new educational initiatives (including TVE) have an impact in the classroom. Microelectronics is fundamental to modern technology and many schools are currently developing courses with some microelectronics content. All of this is, of course, good news but it can pose something of a problem when the time comes for pupils to undertake practical work.

The requirement is for an understandable and clearly presented tutorial guide (filled with imaginative and interesting experiments and projects) supported by simple, yet robust and affordable, hardware.

As a governor of two state secondary schools (currently preparing for local financial management) and with a long-term personal involvement in education at a somewhat higher level, I was particularly pleased to learn of the *INTRO Microelectronics Course*. Low-cost packages of this type offer a solution to the problem of providing youngsters with their first taste of modern electronics without over-stretching a very limited budget!

### The INTRO package

The INTRO Microelectronics package comprises a comprehensive tutorial guide together with a circuit breadboard (the INTRO, supplied by Educational Electronics). In addition, a few other components are required in order to carry out the investigations described in the first two sections of the tutorial guide. The third section of the guide relates to a simple microcomputer board (not supplied as part of the INTRO package).

The emphasis is very much that of "learning by doing" and thus the two components of the package (book and INTRO circuit board) work extremely well together to provide a series of practical experiments. These range in complexity from a simple experiment on a light emitting diode to an investigation based on a semiconductor random access memory (RAM).

### Tutorial guide

The tutorial guide comprises a book written by David Thomson. This is entitled *Introducing MICROELECTRONICS* and is published by Thomas Nelson (ISBN 0-17-431283-0). The book contains 136 pages arranged in a handy 183 mm x 150 mm format.

The book is arranged in five sections; Introduction, Investigations, Introducing a Simple Computer, Computers in Control, and Case Studies. Sections are further subdivided into a total of twenty topic areas. The book is well thought out and extremely well illustrated with numerous line drawings. Experiment descriptions contain connecting diagrams for the INTRO board together with "link check", charts and paragraphs headed "What to do" and "More to do" and "How it works".

David Thomson's book is written at just the right level for a beginner and adopts a common sense approach coupled with a logical sequence of topics which range from identification of common components right through to using computers in control applications. By contrast, the information given in the two case studies is somewhat limited and it would be nice to see this expanded in any future edition.

### The INTRO board

The INTRO circuit board is of excellent quality and measures approximately 127 mm x 144 mm. The board is a much improved version of a circuit board which was originally developed for the use of David Thomson's own pupils at Perryfields High School whilst undertaking a "Microelectronics for all" module.

The central area of the INTRO board is designed to accommodate four 16-pin dual-in-line (d.i.l.) integrated circuits and associated wiring. The remaining area is devoted to a bank of six light emitting diodes (of various colours) together with associated drivers, a d.i.l. package containing four s.p.s.t. switches, a clock and a pulse generator (based on a CMOS 4093B device). The board also has a 10-way off-board connector which is designed to provide a means of connection to the I/O bus of a simple educational computer (more of this later).

The INTRO board derives its supply from a 9V PP3 battery. The board is, therefore, designed to accommodate CMOS devices (there is no on-board 5V regulator although the supply is reverse-polarity protected). Furthermore, in order to prevent floating input states, all of the i.c. pins are pulled high via 10k resistors. There are some obvious advantages in using CMOS devices in an educational board of this type (not the least of which is the ability to dispense with the usual 5V regulated power supply!).

The INTRO board is neat and uncluttered and the various areas of the board are clearly marked. The low-cost method of interconnection is perfectly adequate for use in the classroom where properly terminated jumper leads can be prohibitively expensive.

### INTRO and the Microprofessor

Sections Three and Four of *Introducing MICROELECTRONICS* describe experiments based on the popular Microprofessor computer board. The Microprofessor is well known in further and higher education and is based on the powerful Z80 8-bit microprocessor. *Introducing MICROELECTRONICS* barely scratches the surface as far as the potential of this little unit is concerned. It should not, therefore, be regarded as an essential part of the INTRO package.

Very little information is provided on the internal architecture of the computers and microprocessors and the author concentrates very much on using and programming the Microprofessor rather than attempting to explain the intricacies of the sophisticated VLSI chips of which it is composed. This is just as it should be. There is, after all, no need to get to grips with the complexity of the internal workings of a microcomputer in order to make effective use of it within a control system.

### In conclusion

The INTRO Microelectronics Course has already been used by a large number of secondary teachers and will undoubtedly become even more popular in the years to come. The package should also appeal to the enthusiast wishing to develop a basic understanding of microelectronics and digital circuits. Many E.E. readers must come into this latter category and, for them INTRO will certainly provide a sound basis for experimentation.

The INTRO package (comprising INTRO circuit board and tutorial guide) costs £45 (excluding carriage and VAT). At this price, the course should appeal to enthusiastic hobbyists as well as to secondary teachers working on a tight budget. The components required to carry out the practical experiments can be obtained from all of the usual suppliers however Educational Electronics can supply a ready-made kit (including prepared link wires) for an extra £18.50 (excluding carriage and VAT). Furthermore, *Introducing MICROELECTRONICS* can be purchased separately (direct from Educational Electronics or ordered through your local bookseller) for a very reasonable £6 (plus postage).

At the start of this review, I stated the essential requirements for a microelectronics learning aid for secondary pupils. I am happy to say that the INTRO Microelectronics Course succeeds on all counts. Not only is its tutorial guide understandable and clearly presented but it is presented in a form which will interest and stimulate secondary pupils. The supporting hardware is simple, robust, and moderately priced and fully complements the high-quality of the tutorial guide.

*Educational Electronics* are at 28, Lake Street, Leighton Buzzard, Beds., LU7 8RX, telephone: (0525) 373666. *Thomas Nelson* are at Nelson House, Mayfield Road, Walton-on-Thames, Surrey, KT12 5PL, telephone: (0932-246133).

## Frequency Response . . . A.C. Millivolt Meter Interface . . . Frequency

LAST month the topic of automatic frequency response measurement using the BBC micro was briefly discussed, and we continue with the same theme this month. The BBC micro controlled signal generators described in previous *Beeb Micro* articles are ideal for automatic frequency control measurement, but they need to be operated in conjunction with some form of a.c. millivolt meter in order to provide automatic frequency response testing. The obvious means of achieving this is to have a suitable interface fitted to the analogue port of the computer.

The basic setup is to have the output of the signal generator fed to the input of the amplifier, filter, or whatever, and the output of the device under test fed through to the input of the millivolt meter interface. Outputting a range of frequencies from the signal generator and taking a series of readings from the millivolt meter gives a set of test results which can be displayed in tabular form or converted into graph form and displayed on the screen.

### Millivolt Meter

The stages used in the very simple audio millivolt meter interface described here are shown in Fig. 1. At the input there is a three stage attenuator which gives the unit three measuring ranges with full scale values of 15 volts r.m.s., 1.5 volts r.m.s., and 150 millivolts r.m.s. The input is not the ideal place for the attenuator as it is in a high impedance part of the circuit, and stray capacitance can result in imperfections in the frequency response. However, in this case we are only interested in the audio frequency range up to about 20kHz or so, and the effects of stray capacitance should not be significant.

The next stage is an amplifier which has a voltage gain of about 20dB (ten times). The gain is adjustable for calibration purposes. The amplifier feeds into a precision rectifier which in this case is only a half wave type. This could compromise results on non-symmetrical waveforms, but it has to be pointed out that units of this general type only give truly valid results when measuring sinewave signals. In the current context the unit will only be fed with sinewave signals from one of the signal generator circuits, and half wave rectification should be perfectly adequate.

The output from the rectifier circuit is a form of pulsing d.c. signal. While this type of signal is perfectly suitable for an ordinary moving coil panel meter, for a computerised millivolt meter unit it is far from satisfactory. Unlike a panel meter, the computer's analogue inputs do not respond to the average input voltage.

The most likely result of feeding the unsmoothed signal to one of the BBC computer's analogue inputs is that it would operate as a sort of random number generator. The pulse signal is, therefore, smoothed to give a reasonably ripple-free

output to drive one of the computer's analogue inputs.

### The Circuit

The full circuit diagram for the Audio Millivolt Meter Interface appears in Fig. 2. Capacitor C1 provides d.c. blocking at the input and couples the input signal to the three stage attenuator. The latter also acts as the input bias resistance for the amplifier stage. For good accuracy on all ranges R1 to R4 should be one per cent or two per cent tolerance components.

The attenuator provides the circuit with a reasonably high input impedance of more than 500k. VR1 controls the amount of negative feedback applied to IC1 and hence also controls its voltage gain. The gain range is from unity to over 26dB (20 times).

IC2 acts as the basis of the precision rectifier which uses an unusual configuration. Basically IC2 is just a non-inverting mode amplifier having a voltage gain of about 12dB (four times). The rectifier action relies on the ability of the CA3140E to operate with a single supply rail. When used in this way, but with its inputs biased to the 0 volt rail rather than to the mid supply level, the device will operate normally on positive output half cycles. It cannot provide negative output half cycles though, since there is no negative supply rail to support them. Consequently, a simple but very effective rectifier action is obtained.

The linearity of this method seems to be excellent. VR2 is an offset-null control. The output of the circuit can tend to drift slightly positive under quiescent conditions, and VR2 trims out this offset.

### Lowpass Filter

Components R8 and C4 form the low-pass filter at the output of the unit. A single stage passive circuit seems to give perfectly adequate results. Any lack of consistency in readings from the unit are more likely to be due to the analogue port's familiar noise problem than any ripple on the output of the interface.

It is important to note that although the analogue inputs of the BBC computer have a full scale value of about 1.8 volts, when operating from a 5 volt supply this interface will only work properly with output voltages of up to about 1.4 to 1.5 volts. It may be possible to obtain an output of 1.8 volts, but only by driving the circuit into clipping (which will give inaccurate readings).

Provided this fact is taken into account by the software and (or) the user there is no great problem here, but if preferred the unit could be powered from the +12 volt output of the computer's power port instead of the +5 volt output available on the analogue port. The circuit will then be able to comfortably supply an output of 1.8 volts.

Note that the use of an operational amplifier other than a CA3140E for IC1 and IC2 is not recommended. This circuit requires operational amplifiers that can operate with a single supply and a supply potential of just 5 volts. Few types are capable of this. Note also that the use of a CA3240E (the dual version of the CA3140E) is not recommended. The 8 pin device does not provide the offset-null terminals for either amplifier, and there could be problems with instability.

Problems with instability and noise pick-

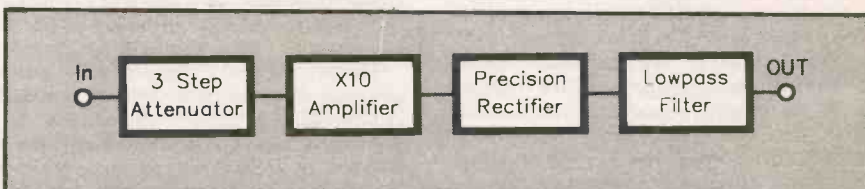

Fig. 1. Block diagram for the A.C. Millivolt Meter Interface.

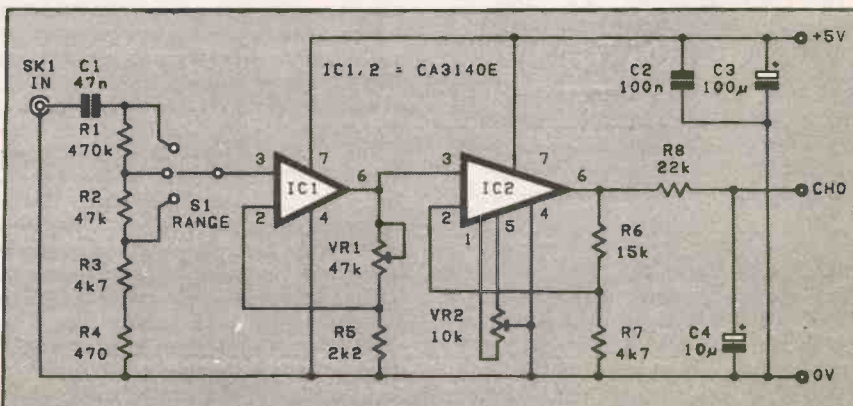

Fig. 2. Full circuit diagram for the A.C. Millivolt Meter Interface.

up need to be kept in mind when building the unit. The input wiring must all be either very short or screened. It is advisable to fit the unit in a metal case which should be earthed to the 0 volt supply rail.

## In Use

For checking the unit as an a.c. millivolt meter this simple program will suffice. It basically just reads channel 0 of the analogue port, divides readings by 32 to bring them into the range 0 to 2047.5, and then displays them on the screen as millivolt readings. This should be used with the unit switched to the 0 to 1.5 volt range, and for the reasons explained earlier, accurate results will not be obtained at readings beyond about 1.5 volts r.m.s. (i.e. readings beyond 1500 millivolts).

In order to calibrate the unit, first offset-null control VR1 must be given the correct setting. It should be found that adjustment of this control enables a fairly high reading to be obtained. It should be backed-off just far enough to reduce the reading under quiescent conditions to zero. Short circuit the input of the unit while doing this to avoid any problems with noise pick-up. It may not be possible to obtain a reading of zero, the minimum could be about 4. This is normally due to deficiencies in IC2 or the analogue port of the computer. In either

event, if this should happen the easiest solution is to have the software reduce readings by an appropriate amount in order to give zero as the minimum displayed reading.

Next inject an a.c. signal with a level of 1 volt r.m.s. to the input of the unit. A frequency of about 1kHz is suitable. The unit should be switched to the 1.5 volt range. VR1 is then adjusted for a reading of 1000 when running the test program. The unit is then ready for use.

The test program could be improved somewhat. The obvious omission is that it does not alter the scaling when the unit is switched to the 150 millivolt or 15 volt ranges. Methods of handling this sort of thing have been discussed in previous "BEEB micro" articles.

```
10 REM AC MILLIVOLT METER PROG
20 CLS
30 PRINTTAB (11,9) "MILLIVOLTS"
40 PRINTTAB (10,11) "ADVAL 1/32"
50 FOR D=1 TO 1000 :NEXT
60 GOTO 40
```

## Frequency Response

The main listing is for a simple frequency response testing program (which is intended for use with the v.c.f. based signal generator circuit). This checks the gain of the test circuit at a range of frequencies from 20Hz to 20kHz and provides results in

the form of a simple on-screen graph. Both the gain and frequency scales are the usual logarithmic types. In the case of the gain scaling, the grid provides 6dB divisions.

The program is self explanatory in use. When using it, be careful to select a suitable signal level. You do not want the signal too low in level as noise problems might then compromise results. On the other hand, setting the level too high could cause overloading of the circuit under test and a flattening of the response curve.

Of course, a much more sophisticated program should be possible. The obvious change would be to add some way of specifying the frequency limits covered, and the number of test frequencies to be used between those limits, with the program doing all the necessary calculations. This would make the unit more suitable for testing high Q narrow bandwidth filters.

A more simple but very worthwhile improvement would be to incorporate more test frequencies into the program but to leave it unchanged in other respects. There is plenty of scope here for any reasonably experienced BBC programmer to experiment with this type of equipment.

The system will always have its limitations, but the BBC computer plus some software and these simple add-ons provides the sort of automatic testing setup that would probably cost a few thousand pounds to achieve by other means.

```
10 REM Frequency Response Test Prg.
20 ?&FE62=128
30 ?&FE6B=192
40 MODE 1
50 CLS
60 VDU24,75;400;1275;1023;
70 VDU29,75;400;
80 PROCscale
90 VDU28,5,31,39,24
100 PROCbegin
110 REPEAT
120 PROCgrid
130 PROCbox
140 PROCgraph
150 PROCagain
160 UNTIL FALSE
170 END
180
190 DEF PROCbox
200 GCOL 0,2
210 MOVE 0,0
220 DRAW 0,540
230 DRAW 1200,540
240 DRAW 1200,0
250 DRAW 0,0
260 FOR X=400 TO 800 STEP 400
270 MOVE X,0
280 DRAW X,540
290 NEXT X
300 ENDPROC
310
320 DEF PROCgrid
330 CLG
340 MOVE 0,0
350 GCOL 0,1
360 FOR X=0 TO 1200 STEP 66.66
370 MOVE X,0
380 PLOT 21,X,540
390 NEXT X
400 MOVE 0,0
410 FOR Y=0 TO 540 STEP 54
420 MOVE 0,Y
430 PLOT 21,1200,Y
440 NEXT Y
450 ENDPROC
460
470 DEF PROCscale
480 RESTORE 550
490 FOR X=1 TO 38 STEP 12
500 READ fig$
510 PRINTTAB(X,21);fig$
520 NEXT X
530 ENDPROC
540
550 DATA 20H,200H,2K,20K
560
570 DEF PROCgraph
580 GCOL 0,3
590 RESTORE 710
600 MOVE 0,0
610 FOR X=0 TO 1200 STEP 66.66
620 READ ?&FE65,?&FE66
630 T=TIME:REPEAT UNTIL TIME>T+100
640 reading=ADVAL(1) DIV 32
650 IFreading>1000 THEN PROCrange:re
ading=1000 ELSE CLS
660 IF reading<>0 THEN reading=LOG(r
eading)
670 DRAW X,reading*180
680 NEXT X
690 ENDPROC
700
710 DATA 97,168,67,89,48,57,32,4,21,1
18
720 DATA 14,92,9,196,6,188,4,210,3,52
730 DATA 2,37,1,112,0,250,0,172,0,123
740 DATA 0,82,0,55,0,37,0,25
750
760 DEF PROCagain
770 CLS
780 PRINT "Press any key for new trace
"
790 REPEAT UNTIL GET
800 CLS
810 ENDPROC
820
830
840 DEF PROCbegin
850 CLS
860 PRINT "Press any key to start"
870 REPEAT UNTIL GET
880 CLS
890 ENDPROC
900
910 DEF PROCrange
920 PRINT "Reading out of range"
930 ENDPROC
```

# DIRECT BOOK SERVICE

## PROJECT CONSTRUCTION

### HOW TO GET YOUR ELECTRONIC PROJECTS WORKING

R. A. Penfold

We have all built projects only to find that they did not work correctly, or at all, when first switched on. The aim of this book is to help the reader overcome just these problems by indicating how and where to start looking for many of the common faults that can occur when building up projects.

96 pages Order code BP110 £2.50

### HOW TO DESIGN AND MAKE YOUR OWN P.C.B.s

R. A. Penfold

Deals with the simple methods of copying printed circuit

The books listed have been selected as being of special interest to everyone involved in electronics and computing. They are supplied by mail order direct to your door. Full ordering details are given on the last book page.

board designs from magazines and books and covers all aspects of simple p.c.b. construction including photographic methods and designing your own p.c.b.s.  
80 pages Order code BP121 £2.50

### BEGINNER'S GUIDE TO BUILDING ELECTRONIC PROJECTS

R. A. Penfold

Shows the complete beginner how to tackle the practical side of electronics, so that he or she can confidently build the electronic projects that are regularly featured in magazines and books. Also includes examples in the form of simple projects.

112 pages Order code No. 227 £2.25

### PRACTICAL ELECTRONIC BUILDING BLOCKS—BOOK 1 PRACTICAL ELECTRONIC BUILDING BLOCKS—BOOK 2

R. A. Penfold

These books are designed to aid electronic enthusiasts who like to experiment with circuits and produce their own projects, rather than simply following published project designs.

**BOOK 1** contains: Oscillators—sinewave, triangular, squarewave, sawtooth, and pulse waveform generators operating at audio frequencies. Timers—simple monostable circuits using i.c.s, the 555 and 7555 devices, etc. Miscellaneous—noise generators, rectifiers, comparators and triggers, etc.

**BOOK 2** contains: Amplifiers—low level discrete and op-amp circuits, voltage and buffer amplifiers including d.c. types. Also low-noise audio and voltage controlled amplifiers. Filters—high-pass, low-pass, 6, 12, and 24dB per octave types. Miscellaneous—i.c. power amplifiers, mixers, voltage and current regulators, etc.

**BOOK 1** 128 pages Order code BP117 £1.95  
**BOOK 2** 112 pages Order code BP118 £1.95

## CIRCUITS AND DESIGN

### ELECTRONICS SIMPLIFIED—CRYSTAL SET CONSTRUCTION

F. A. Wilson, C.G.I.A., C.Eng., F.I.E.E., F.I.E.R.E., F.B.I.M.

Especially written for those who wish to participate in the intricacies of electronics more through practical construction than by theoretical study. It is designed for all ages upwards from the day one can read intelligently and handle simple tools.

80 pages Order Code BP92 £1.75

### MICRO INTERFACING CIRCUITS—BOOK 1 MICRO INTERFACING CIRCUITS—BOOK 2

R. A. Penfold

Both books include practical circuits together with details of the circuit operation and useful background information. Any special constructional points are covered but p.c.b. layouts and other detailed constructional information are not included.

Book 1 is mainly concerned with getting signals in and out of the computer. Book 2 deals primarily with circuits for practical applications.

**Book 1** 112 pages Order code BP130 £2.25  
**Book 2** 112 pages Order code BP131 £2.75

### ELECTRONIC CIRCUITS HANDBOOK

Michael Tooley BA

This book aims to explode two popular misconceptions concerning the design of electronic circuits: that only those with many years of experience should undertake circuit design and that the process relies on an understanding of advanced mathematics. Provided one is not too ambitious, neither of these popularly held beliefs is true.

Specifically, this book aims to provide the reader with a unique collection of practical working circuits together with supporting information so that circuits can be produced in the shortest possible time and without recourse to theoretical texts.

Furthermore, information has been included so that the circuits can readily be modified and extended by readers to meet their own individual needs. Related circuits have been grouped together and cross-referenced within the text (and also in the index) so that readers are aware of which circuits can be readily connected together to form more complex systems. As far as possible, a common range of supply voltages, signal levels and impedances has been adopted.

As a bonus, ten test gear projects have been included. These not only serve to illustrate the techniques described but also provide a range of test equipment which is useful in its own right.

277 pages Order code NE05 £14.95

### Electronics Simplified - Crystal Set Construction



### 50 CIRCUITS USING GERMANIUM SILICON AND ZENER DIODES

R. N. Soar

Contains 50 interesting and useful circuits and applications, covering many different branches of electronics, using one of the most simple and inexpensive of components—the diode. Includes the use of germanium and silicon signal diodes, silicon rectifier diodes and Zener diodes, etc.

64 pages Order Code BP36 £1.50

### 50 Circuits Using Germanium Silicon & Zener Diodes



### A MICROPROCESSOR PRIMER

E. A. Parr, B.Sc., C.Eng., M.I.E.E.

Starts by designing a small computer which, because of its simplicity and logical structure, enables the language to be easily learnt and understood. The shortcomings are then discussed and the reader is shown how these can be overcome by changes and additions to the instruction set. In this way, such ideas as relative addressing, index registers, etc., are developed.

96 pages Order code BP72 £1.75

### COIL DESIGN AND CONSTRUCTION MANUAL

B. B. Babani

A complete book for the home constructor on "how to make" RF, IF, audio and power coils, chokes and transformers. Practically every possible type is discussed and calculations necessary are given and explained in detail. Although this book is now rather old, with the exception of torroids and pulse transformers little has changed in coil design since it was written.

96 pages Order Code 160 £2.50

### 50 SIMPLE LED CIRCUITS

R. N. Soar

Contains 50 interesting and useful circuits and applications, covering many different branches of electronics, using one of the most inexpensive and freely available components—the light-emitting diode (LED). Also includes circuits for the 707 common anode display.

64 pages Order Code BP42 £1.95  
**BOOK 2** 50 more l.e.d. circuits Order code BP87 £1.35



### AN INTRODUCTION TO LOUDSPEAKERS AND ENCLOSURE DESIGN

V. Capel

This book explores the various features, good points and snags of speaker designs. It examines the whys and wherefores so that the reader can understand the principles involved and so make an informed choice of design, or even design loudspeaker enclosures for him or herself. Crossover units are also explained, the various types, how they work, the distortions they produce and how to avoid them. Finally, there is a step-by-step description of the construction of the Kapellmeister loudspeaker enclosure.

148 pages Order Code BP256 £2.95

### How To Use Op Amps



### Popular Electronic Circuits Book 2



### HOW TO USE OP-AMPS

E. A. Parr

This book has been written as a designer's guide covering many operational amplifiers, serving both as a source book of circuits and a reference book for design calculations. The approach has been made as non-mathematical as possible.

160 pages Order code BP88 £2.95

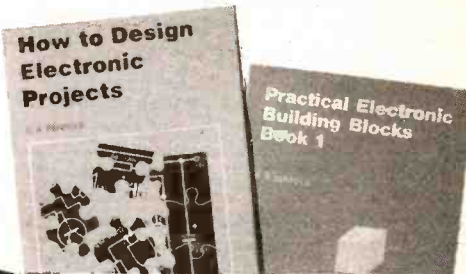

### HOW TO DESIGN ELECTRONIC PROJECTS

R. A. Penfold

The aim of this book is to help the reader to put together projects from standard circuit blocks with a minimum of trial and error, but without resorting to any advanced mathematics. Hints on designing circuit blocks to meet your special requirements are also provided.

128 pages Order code BP127 £2.25

### POPULAR ELECTRONIC CIRCUITS

—BOOK 1

POPULAR ELECTRONIC CIRCUITS

—BOOK 2

R. A. Penfold

Each book provides a wide range of designs for electronic enthusiasts who are capable of producing working projects from just a circuit diagram without the aid of detailed construction information. Any special setting-up procedures are described.

**BOOK 1** 160 pages Order code BP80 £2.95  
**BOOK 2** 160 pages Order code BP98 £2.95

### ELECTRONIC CIRCUITS FOR THE COMPUTER CONTROL OF MODEL RAILWAYS

R.A. Penfold

Home computers may easily be applied to the control of model railways and really quite sophisticated control, which needs only simple programming, is not too difficult to achieve. The main problem lies in interfacing the computer to the layout, but fortunately it is not too difficult or expensive to build suitable interfaces, and this book shows you how.

The projects consist of various types of controller, including a high quality pulse type, as well as circuits for train position sensing, signal and electric points control etc. The use of computers does not have to be restricted to massive layouts. Something as simple as an oval of track with a single siding can be given a new dimension by adding computer control and much fun can be had from these relatively simple setups.

88 pages Order code BP180 £2.95

### MODERN OPTO DEVICE PROJECTS

R.A. Penfold

In recent years, the range of opto devices available to the home constructor has expanded and changed radically. These devices now represent one of the more interesting areas of modern electronics for the hobbyist to experiment in, and many of these devices have useful practical applications as well. This book provides a number of practical

designs which utilize a range of modern opto-electric devices, including such things as fibre optics, ultra bright I.e.d.s and passive IR detectors etc.

While many of these designs are not in the "dead simple" category, they should be within the capabilities of anyone with a reasonable amount of experience in electronics construction and some of the more simple designs are suitable for beginners.

104 pages Order code BP194 £2.95

### ELECTRONIC CIRCUITS FOR THE COMPUTER CONTROL OF ROBOTS

Robert Penfold

Robots and robotics offer one of the most interesting areas for the electronics hobbyist to experiment in. Today the mechanical side of robots is not too difficult, as there are robotics kits and a wide range of mechanical components available. The micro controller is not too much of a problem either, since the software need not be terribly complex and many inexpensive home computers are well suited to the task.

The main stumbling block for most would-be robot builders is the electronics to interface the computer to the motors, and the sensors which provide feedback from the robot to the computer. The purpose of this book is to explain and provide some relatively simple electronic circuits which bridge this gap.

92 pages Order code BP179 £2.95



## DATA AND REFERENCE



## RECOMMENDED READING

### FOR INTRODUCING DIGITAL ELECTRONICS

#### ELECTRONICS—A "MADE SIMPLE" BOOK

G. H. Olsen

This book provides excellent background reading for our *Introducing Digital Electronics* series and will be of interest to everyone studying electronics. The subject is simply explained and well illustrated and the book assumes only a very basic knowledge of electricity.

330 pages Order code NE10 £4.95

#### PRACTICAL DIGITAL ELECTRONICS HANDBOOK

Mike Tooley (Published in association with *Everyday Electronics*)

The vast majority of modern electronic systems rely heavily on the application of digital electronics, and the *Practical Digital Electronics Handbook* aims to provide readers with a practically based introduction to this subject. The book will prove invaluable to anyone involved with the design, manufacture or servicing of digital circuitry, as well as to those wishing to update their knowledge of modern digital devices and techniques. Contents: Introduction to integrated circuits; basic logic gates; monostable and bistable devices; timers; microprocessors; memories; input and output devices; interfaces; microprocessor buses. Appendix 1: Data. Appendix 2: Digital test gear projects; tools and test equipment; regulated bench power supply; logic probe; logic pulser; versatile pulse generator; digital IC tester; current tracer; audio logic tracer; RS-232C breakout box; versatile digital counter/frequency meter. Appendix 3: The oscilloscope. Appendix 4: Suggested reading. Appendix 5: Further study.

208 pages Order code PC100 £6.95

### ELECTRONICS TEACH-IN

Michael Tooley BA and David Whitfield MA MSc  
CEng MIEE (published by *Everyday Electronics*)

This value for money *EE* book provides a comprehensive background to modern electronics including test gear projects. A complete course in basic electronics; designed for the complete newcomer it will however also be of value to those with some previous experience of electronics. Wherever possible the course is related to "real life" working circuits and each part includes a set of detailed practical assignments. Includes details of eight items of related test gear giving full constructional information and diagrams for each one. They are: Safe Power Supply; Universal LCR Bridge; Diode/Transistor Tester; Audio Signal Tracer; Audio Signal Generator; RF Signal Generator; FET Voltmeter; Pulse Generator. An excellent companion for anyone interested in electronics and invaluable for those taking G.C.S.E. and BTEC electronics courses.

104 pages (A4 size) Order code EE/T-1 £1.95

### PRACTICAL ELECTRONICS CALCULATIONS AND FORMULAE

F. A. Wilson, C.G.I.A., C.Eng., F.I.E.E., F.I.E.R.E., F.B.I.M.

Bridges the gap between complicated technical theory, and "cut-and-try" methods which may bring success in design but leave the experimenter unfulfilled. A strong practical bias—tedious and higher mathematics have been avoided where possible and many tables have been included.

The book is divided into six basic sections: Units and Constants, Direct-current Circuits, Passive Components, Alternating-current Circuits, Networks and Theorems, Measurements.

256 pages Order code BP53 £3.95

### ESSENTIAL THEORY FOR THE ELECTRONICS HOBBYIST

G. T. Rubaroe, T.Eng (C.E.I.), Assoc. I.E.R.E.

The object of this book is to supply the hobbyist with a background knowledge tailored to meet his or her specific requirements and the author has brought together the relevant material and presented it in a readable manner with minimum recourse to mathematics.

128 pages Order Code 228 £2.50

### MICROPROCESSING SYSTEMS AND CIRCUITS

F. A. Wilson, C.G.I.A., C.Eng., F.I.E.E., F.I.E.R.E., F.B.I.M.

A truly comprehensive guide to the elements of micro-processing systems which really starts at the beginning. Teaches the reader the essential fundamentals that are so important for a sound understanding of the subject.

256 pages Order Code BP77 £2.95

### CHART OF RADIO, ELECTRONIC, SEMICONDUCTOR AND LOGIC SYMBOLS

M. H. Banani, B.Sc.(Eng.)

Illustrates the common, and many of the not-so-common, radio, electronic, semiconductor and logic symbols that are used in books, magazines and instruction manuals, etc., in most countries throughout the world.

Chart Order Code BP27 £0.95

### ELECTRONICS TEACH-IN 88/89—INTRODUCING MICROPROCESSORS

Mike Tooley BA (published by *Everyday Electronics*)

A complete course that can lead successful readers to the award of a City and Guilds Certificate in Introductory Microprocessors (726/303). The book contains everything you need to know including full details on registering for assessment, etc.

80 pages (A4 size) Order code TI-88/89 £2.45

### ELECTRONIC HOBBYISTS HANDBOOK

R.A. Penfold

Provides an inexpensive single source of easily located information that the amateur electronics enthusiast is likely to need for the day-to-day pursuance of this fascinating hobby. Covers common component colour codes. Details the characteristics and pinouts of many popular semiconductor devices, including various types of logic ICs, operational amplifiers, transistors, FETs, unijunctions, diodes, rectifiers, SCRs, diacs, triacs, regulators and SMDs, etc. Illustrates many useful types of circuits, such as timers and oscillators, audio amplifiers and filters, as well as including a separate section on power supplies. Also contains a multitude of other useful data.

88 pages Order code BP233 £4.95

### AUDIO

F. A. Wilson, C.G.I.A., C.Eng., F.I.E.E., F.I.E.R.E., F.B.I.M.

Analysis of the sound wave and an explanation of acoustical quantities prepare the way. These are followed by a study of the mechanism of hearing and examination of the various sounds we hear. A look at room acoustics with a subsequent chapter on microphones and loudspeakers then sets the scene for the main chapter on audio systems—amplifiers, oscillators, disc and magnetic recording and electronic music.

320 pages Order Code BP111 £3.50

### HOW TO IDENTIFY UNMARKED ICs

K. H. Recorr

Shows the reader how, with just a test-meter, to go about recording the particular signature of an unmarked i.c. which should enable the i.c. to be identified with reference to manufacturers' or other data. An i.c. signature is a specially plotted chart produced by measuring the resistances between all terminal pairs of an i.c.

Chart Order code BP101 £0.95

### RADIO AND ELECTRONIC COLOUR CODES AND DATA CHART

B. B. Babani

Although this chart was first published in 1971 it provides basic information on many colour codes in use throughout the world, for most radio and electronic components. Includes resistors, capacitors, transformers, field coils, fuses, battery leads, speakers, etc. It is particularly useful for finding the values of old components.

Chart Order code BP7 £0.95

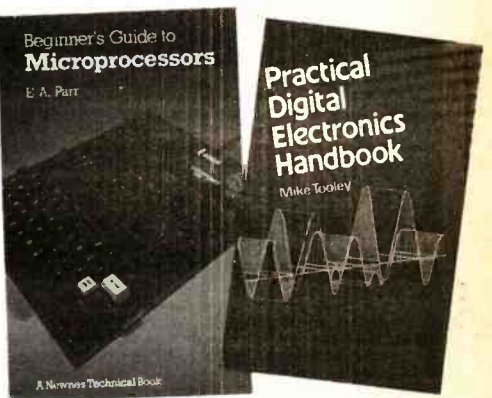

### BEGINNERS GUIDE TO MICROPROCESSORS

E. A. Parr

An excellent grounding in microprocessors, this book is broadly relevant to the whole of our *Introducing Microprocessors* course. It is easy to read and well illustrated.

224 pages Order code NE03 £5.95

### MICROELECTRONIC SYSTEMS 2 CHECKBOOK

R. Vears

The aim of this book is to provide a foundation in microcomputer hardware, software and interfacing techniques. Each topic is presented in a way that assumes only an elementary knowledge of microelectronic systems and logic functions. The book concentrates on 6502, Z80 and 6800 microprocessors and contains 60 tested programs, 160 worked problems and 250 further problems.

Now replaced by *Microelectronic Systems N2 Checkbook*  
Order code NE04N £6.95

## OSCILLOSCOPES: HOW TO USE THEM—HOW THEY WORK

Ian Hickman

Oscilloscopes are essential tools for checking circuit operation and diagnosing faults, and an enormous range of models is available. But which is the right 'scope for a particular application? Which features are essential, which not so important? What techniques will get the best out of the instrument?

Ian Hickman, experienced in both professional and hobbyist electronics, has revised this well-established book to help all oscilloscope users—and potential users.

133 pages Order code NE09 £6.95



## PRACTICAL ELECTRONICS HANDBOOK

Ian Sinclair

Ian Sinclair has now revised this useful and carefully selected collection of standard circuits, rules-of-thumb, and design data for professional engineers, students and enthusiasts involved in radio and electronics. Covering passive and active components, discrete component circuits (such as amplifiers, filters and oscillators) and linear and digital i.c.s, the book includes many items which are not elsewhere available in a single handy volume. The operation and functions of typical circuits are described, while mathematics is limited to that necessary for deciding component values for any application.

This revised edition contains more details on computers and microprocessors and has been brought up to date throughout.

199 pages Order Code NE06 £7.95

## BEGINNER'S GUIDE TO HI-FI

Ian Sinclair

The *Beginner's Guide to Hi-Fi* will appeal to the audio enthusiast, whether newly won over by advances in technology or well established and wondering whether to update equipment. The book deals with the sound from its sources in the studio to its ultimate end in your ears, and shows what sound is, how it is recorded and how it is reproduced.

Every aspect of Hi-Fi, from pickup cartridges to loudspeakers, has been covered, and the emphasis has been on explaining design aims. Cassette systems have been given considerable prominence, including the more modern Dolby C and dbx noise reduction systems. The CD record has been covered in detail so that you can find out just why this system of sound reproduction is so superior.

194 pages Order Code NE07 £5.95

## ELECTRONICS-BUILD AND LEARN

R. A. Penfold

The first chapter gives full constructional details of a circuit demonstrator unit that is used in subsequent chapters to introduce common electronic components—resistors, capacitors, transformers, diodes, transistors, thyristors, fetts and op amps. Later chapters go on to describe how these components are built up into useful circuits, oscillators, multivibrators, bistables and logic circuits.

At every stage in the book there are practical tests and experiments that you can carry out on the demonstrator unit to investigate the points described and to help you understand the principles involved. You will soon be able to go on to more complex circuits and tackle fault finding logically in other circuits you build.

120 pages Order Code PC103 £5.95

## COMMUNICATION

F. A. Wilson, C.G.I.A., C.Eng., F.I.E.E., F.I.E.R.E., F.B.I.M.

A look at the electronic fundamentals over the whole of the communication scene. This book aims to teach the important elements of each branch of the subject in a style as interesting and practical as possible. While not getting involved in the more complicated theory and mathematics, most of the modern transmission system techniques are examined including line, microwave, submarine, satellite and digital multiplex systems, radio and telegraphy. To assist in understanding these more thoroughly, chapters on signal processing, the electromagnetic wave, networks and transmissions assessment are included, finally a short chapter on optical transmission.

256 pages Order Code BP89 £2.95

## GETTING THE MOST FROM YOUR MULTIMETER

R.A. Penfold

This book is primarily aimed at beginners and those of limited experience of electronics. Chapter 1 covers the basics of analogue and digital multimeters, discussing the relative merits and the limitations of the two types. In Chapter 2 various methods of component checking are described, including tests for transistors, thyristors, resistors, capacitors and diodes. Circuit testing is covered in Chapter 3, with subjects such as voltage, current and continuity checks being discussed.

In the main little or no previous knowledge or experience is assumed. Using these simple component and circuit testing techniques the reader should be able to confidently tackle servicing of most electronic projects.

96 pages Order code BP239 £2.95

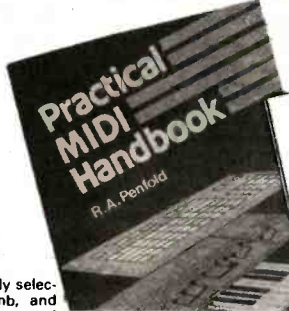

## PRACTICAL MIDI HANDBOOK

R.A. Penfold

The Musical Instrument Digital Interface (MIDI) is surrounded by a great deal of misunderstanding, and many of the user manuals that accompany MIDI equipment are quite incomprehensible to the reader.

The *Practical MIDI Handbook* is aimed primarily at musicians, enthusiasts and technicians who want to exploit the vast capabilities of MIDI, but who have no previous knowledge of electronics or computing. The majority of the book is devoted to an explanation of what MIDI can do and how to exploit it to the full, with practical advice on connecting up a MIDI system and getting it to work, as well as deciphering the technical information in those equipment manuals.

128 pages Order code PC101 £5.95

## INTRODUCTION TO DIGITAL AUDIO

Ian Sinclair

Digital recording methods have existed for many years and have become familiar to the professional recording engineer, but the compact disc (CD) was the first device to bring digital audio methods into the home. The next step is the appearance of digital audio tape (DAT) equipment. All this development has involved methods and circuits that are totally alien to the technician or keen amateur who has previously worked with audio circuits. The principles and practices of digital audio owe little or nothing to the traditional linear circuits of the past, and are much more comprehensible to today's computer engineer than the older generation of audio engineers.

This book is intended to bridge the gap of understanding for the technician and enthusiast. The principles and methods are explained, but the mathematical background and theory is avoided, other than to state the end product.

128 pages Order code PC102 £5.95



## INTERNATIONAL TRANSISTOR EQUIVALENTS GUIDE

A. Michaels

Helps the reader to find possible substitutes for a popular selection of European, American and Japanese transistors. Also shows material type, polarity, manufacturer and use.

320 pages Order code BP85 £3.50

## FROM ATOMS TO AMPERES

F. A. Wilson

Explains in crystal clear terms the absolute fundamentals behind electricity and electronics. Really helps you to discover and understand the subject, perhaps for the first time ever.

Have you ever: Wondered about the true link between electricity and magnetism? Felt you could never understand the work of Einstein, Newton, Boltzmann, Planck and other early scientists? Just accepted that an electron is like a little black ball? Got mixed up with e.m.f. and p.d.? Thought the idea of holes in semiconductor is a bit much?

Then help is at hand with this inexpensive book, in as simple a way as possible and without too much complex mathematics and formulae.

244 pages Order code BP254 £3.50



## TRANSISTOR RADIO FAULT-FINDING CHART

C. E. Miller

Used properly, should enable the reader to trace most common faults reasonably quickly. Across the top of the chart will be found four rectangles containing brief description of these faults, viz—sound weak but undistorted, set dead, sound low or distorted and background noises. One then selects the most appropriate of these and following the arrows, carries out the suggested checks in sequence until the fault is cleared.

Chart Order code BP70 £0.95

## DIGITAL IC EQUIVALENTS AND PIN CONNECTIONS

A. Michaels

Shows equivalents and pin connections of a popular selection of European, American and Japanese digital i.c.s. Also includes details of packaging, families, functions, manufacturer and country of origin.

256 pages Order code BP140 £5.95

## LINEAR IC EQUIVALENTS AND PIN CONNECTIONS

A. Michaels

Shows equivalents and pin connections of a popular selection of European, American and Japanese linear i.c.s. Also includes details of functions, manufacturer and country of origin.

320 pages Temporarily out of print

## INTERNATIONAL DIODE EQUIVALENTS GUIDE

A. Michaels

Designed to help the user in finding possible substitutes for a large selection of the many different types of diodes that are available. Besides simple rectifier diodes, also included are Zener diodes, l.e.d.s, diacs, triacs, thyristors, OCIs, photo and display diodes.

144 pages Order code BP108 £2.25

## NEWNES ELECTRONICS POCKET BOOK

E. A. Parr

Newnes Electronics Pocket Book has been in print for over twenty years and has covered the development of electronics from valve to semiconductor technology and from transistors to LSI integrated circuits and microprocessors. To keep up to date with the rapidly changing world of electronics, continuous revision has been necessary. This new Fifth Edition takes account of recent changes and includes material suggested by readers of previous editions. New descriptions of op.amp. applications and the design of digital circuits have been added, along with a totally new chapter on computing, plus other revisions throughout.

315 pages (hard cover) Order Code NE02 £9.95

## TRANSISTOR SELECTOR GUIDE

This unique guide offers a range of selection tables compiled so as to be of maximum use to all electronics engineers, designers and hobbyists.

Section 1: Covers component markings, codings and standards, as well as explaining the symbols used.

Section 2: Tabulates in alpha-numeric sequence the comprehensive specifications of over 1400 devices.

Section 3: Tabulates the devices by case type.

Section 4: Considers particular limits to the electrical parameters when compiling the tables.

Section 5: Illustrates package outlines and leadouts.

Section 6: Consists of a surface mounting device markings conversion list.

192 pages Temporarily out of print

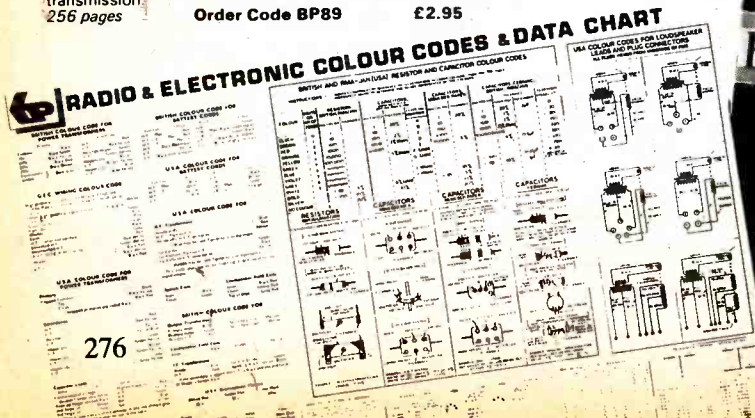

## RADIO/TELEVISION

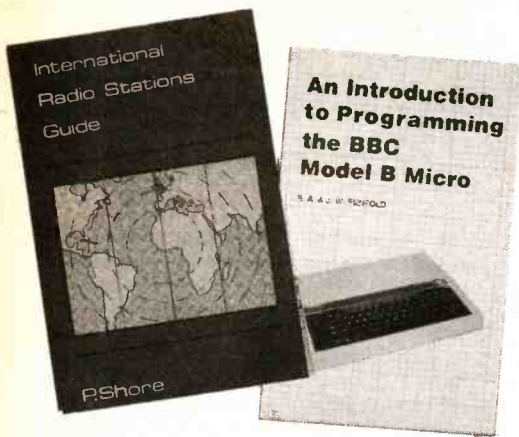

### AN INTRODUCTION TO RADIO DXING

R. A. Penfold

Anyone can switch on a short wave receiver and play with the controls until they pick up something, but to find a particular station, country or type of broadcast and to receive it as clearly as possible requires a little more skill and knowledge. The object of this book is to help the reader to do just that, which in essence is the fascinating hobby of radio DXing.

172 pages Order code BP91 £1.95

### INTERNATIONAL RADIO STATIONS GUIDE

P. Shore

Provides the casual listener, amateur radio DXer and the professional radio monitor with an essential reference work designed to guide him or her around the ever more complex radio bands. This new edition has been completely revised and rewritten and incorporates much more information which is divided into the following sections:

Listening to Short Wave Radio; ITU Country Codes; World-wide Short Wave Radio Stations; European, Middle East and North African Long Wave Radio Stations; European, Near East and North African Medium Wave Radio Stations; Canadian Medium Wave Radio Stations; USA Medium Wave Radio Stations; Broadcasts in English; Programmes for DXers and Short Wave Listeners; UK FM Radio Stations; Time differences from GMT; Abbreviations; Wavelength/Frequency Conversion.

320 pages Order code BP255 £4.95

### A TV-DXERS HANDBOOK

R. Bunney

Roger Bunney is probably one of the leading authorities in this country on the subject. Includes many units and devices which have been designed and used by active enthusiasts, and often, considerable ingenuity and thought have gone into the development of such units to overcome individual problems. A practical and authoritative reference to this unusual aspect of electronics.

128 pages Order code BP176 £5.95

### AN INTRODUCTION TO SATELLITE TELEVISION

F.A. Wilson

As a definitive introduction to the subject this book is presented on two levels. For the absolute beginner or anyone thinking about purchasing or hiring a satellite TV system, the story is told as simply as such a complex one can be in the main text.

For the professional engineer, electronics enthusiast, student or others with technical backgrounds, there are numerous appendices backing up the main text with additional technical and scientific detail formulae, calculations, tables etc.

There is also plenty for the DIY enthusiast with practical advice on choosing and installing the most problematic part of the system—the dish antenna.

104 pages Order Code BP195 £5.95

## COMPUTING

### NEWNES COMPUTER ENGINEER'S

POCKETBOOK

Michael Toolay

An invaluable compendium of facts, figures, circuits and data, indispensable to the designer, student, service engineer and all those interested in computer and microcomputer systems. It will appeal equally to the hardware or software specialist and to the new band of "software engineers". This first edition covers a vast range of subjects at a practical level, with the necessary explanatory text. The data is presented in a succinct and rapidly accessible form so that the book can become part of an everyday toolkit.

205 pages (hard cover) Order code NE01 £8.95

### GETTING THE MOST FROM YOUR PRINTER

J. W. Penfold

Details how to use all the features provided on most dot-matrix printers from programs and popular word processor packages like Wordwise, Visawrite and Quill, etc. Shows exactly what must be typed in to achieve a given effect.

96 pages Order Code BP181 £2.95

### A Z80 WORKSHOP MANUAL

E. A. Parr, B.Sc., C.Eng., M.I.E.E.

This book is intended for people who wish to progress beyond the stage of BASIC programming to topics such as machine code and assembly language programming, or need hardware details of a Z80 based computer.

192 pages Order Code BP112 £3.50

### AN INTRODUCTION TO 68000 ASSEMBLY

LANGUAGE

R. A. & J. W. Penfold

Obtain a vast increase in running speed by writing programs for 68000-based micros such as the Commodore Amiga, Atari ST range or Apple Macintosh range etc., in assembly language. It is not as difficult as one might think and this book covers the fundamentals.

112 pages Order code BP184 £2.95

### THE ART OF PROGRAMMING THE ZX

SPECTRUM

M. James, B.Sc., M.B.C.S.

It is one thing to have learnt how to use all the Spectrum's commands and functions, but a very different one to be able to combine them into programs that do exactly what you want them to. This is just what this book is all about—teaching you the art of effective programming with your Spectrum.

144 pages Order code BP119 £2.50

### AN INTRODUCTION TO PROGRAMMING THE

BBC MODEL B MICRO

R. A. & J. W. Penfold

Written for readers wanting to learn more about programming and how to make best use of the incredibly powerful model B's versatile features. Most aspects of the BBC micro are covered, the omissions being where little could usefully be added to the information provided by the manufacturer's own manual.

144 pages Order code BP139 £1.95

### THE PRE-BASIC BOOK

F. A. Wilson, C.G.I.A., C.ENG., F.I.E.E., F.I.E.R.E., F.B.I.M.

Another book on BASIC but with a difference. This one does not skip through the whole of the subject and thereby leave many would-be programmers floundering but instead concentrates on introducing the technique by looking in depth at the most frequently used and more easily understood computer instructions. For all new and potential micro users.

192 pages Order code BP146 £2.95

### AN INTRODUCTION TO

COMPUTER PERIPHERALS

J. W. Penfold

Covers such items as monitors, printers, disc drives, cassette recorders, modems, etc., explaining what they are, how to use them and the various types and standards. Helps you to make sure that the peripherals you buy will work with your computer.

80 pages Order code BP170 £2.50

### AN INTRODUCTION TO PROGRAMMING THE

ACORN ELECTRON

R. A. & J. W. Penfold

Designed to help the reader learn more about programming and to make best use of the Electron's many features. Adds considerably to the information already supplied in the manufacturer's own instruction manual.

144 pages Order code BP142 £1.95

### AN INTRODUCTION TO PROGRAMMING THE

ATARI 600/800 XL

R. A. & J. W. Penfold

Especially written to supplement the manufacturer's own handbook. The information supplied will help the reader to master BASIC programming and to make best use of the Atari's many powerful features.

128 pages Order code BP143 £1.95

### AN INTRODUCTION TO PROGRAMMING THE

SINCLAIR QL

R. A. & J. W. Penfold

Helps the reader to make best use of the fantastic Sinclair QL's almost unlimited range of features. Designed to complement the manufacturer's handbook.

112 pages Order code BP150 £1.95

### AN INTRODUCTION TO Z80 MACHINE CODE

R. A. & J. W. Penfold

Takes the reader through the basics of microprocessors and machine code programming with no previous knowledge of these being assumed. The Z80 is used in many popular home computers and simple programming examples are given for Z80-based machines including the Sinclair ZX-81 and Spectrum, Memotech and the Amstrad CPC 464. Also applicable to the Amstrad CPC 664 and 6128.

144 pages Order code BP152 £2.75

### AN INTRODUCTION TO 6502 MACHINE CODE

R. A. & J. W. Penfold

No previous knowledge of microprocessors or machine code is assumed. Topics covered are: assembly language and assemblers, the register set and memory, binary and hexadecimal numbering systems, addressing modes and the instruction set, and also mixing machine code with BASIC. Some simple programming examples are given for 6502-based home computers like the VIC-20, ORIC-1/Atmos, Electron, BBC and also the Commodore 64.

112 pages Order code BP147 £2.50

### HOW TO GET YOUR COMPUTER PROGRAMS

RUNNING

J. W. Penfold

Have you ever written your own programs only to find that they did not work! Help is now at hand with this book which shows you how to go about looking for your errors, and helps you to avoid the common bugs and pitfalls of program writing. Applicable to all dialects of the BASIC language.

144 pages Order code BP169 £2.50

### AN INTRODUCTION TO COMPUTER

COMMUNICATIONS

R. A. Penfold

Provides details of the various types of modem and their suitability for specific applications, plus details of connecting various computers to modems, and modems to the telephone system. Also information on common networking systems and RTTY.

96 pages Order code BP177 £2.95

### COMPUTER TERMINOLOGY EXPLAINED

I. D. Poole

Explains a wide range of terms that form the computer jargon used by enthusiasts. Includes a reference guide to the more commonly used BASIC commands.

96 pages Order code BP148 £1.95

# DIRECT BOOK SERVICE

(A Division of Wimborne Publishing Ltd.)

## TO ORDER

Please state the order code clearly, print your name and address and add the required postage to the total order.

Add 75p to your total order for postage and packing (overseas readers add £1.50 for countries in Europe, or add £2.00 for all countries outside Europe, surface mail postage) and send a PO, cheque or international money order (£ sterling only) made payable to **Direct Book Service** quoting your name and address, the order code and quantities required to **DIRECT BOOK SERVICE, 33 GRAVEL HILL, MERLEY, WIMBORNE, DORSET, BH21 1RW** (mail order only).

Although books are normally sent within seven days of receipt of your order, please allow a maximum of 28 days for delivery. Overseas readers allow extra time for surface mail post.

Please check price and availability (see latest issue of **Everyday Electronics**) before ordering from old lists.

Note—our postage charge is the same for one book or one hundred books!

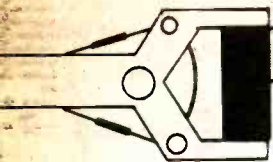

# Robot Roundup

## NIGEL CLARK

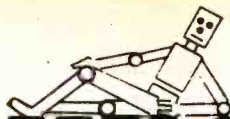

### RESOURCING FOR D AND T

PROPER resourcing will be an important part of making sure that the Design and Technology section of the proposed national curriculum can be introduced properly and effectively. This point is made in the interim report of the working group set up by the Department of Education and Science and the Welsh Office to investigate how the subject should be included in the curriculum in English and Welsh schools. The interim report was released at the end of last year and the final report is due at the end of April.

Although resources were not included in its terms of reference, members of the group, chaired by Lady Parkes, thought they were so important that comment should be made on them. "We feel, however, that it could be a serious omission if we did not at least give some indication about resources."

They said that the subject drew on, and linked with, a wide range of subjects and that would pose a challenge for teachers who would require training to meet it.

This is particularly so in secondary schools where teachers are used to working within their specialisations, but the group considered that primary teachers would also need some training. "For both primary and secondary teachers a considerable in-service training programme would be needed on a scale outweighing that for other foundation subjects.

The problem is not so great that D and T could not be implemented, as a number of schools were already doing a lot of development work in the area, but the committee warned that implementation would be slowed unless account was taken of the amount of training needed.

A further resource consideration is the availability of specialist accommodation and technological equipment, particularly in information technology. Despite the investment already made by schools, encouraged in various ways by government, the expected ratio in five years time of at least one microcomputer for every 60 primary school children and 30 secondary children would be insufficient.

### SUPPORT

The group's comments were accepted by Mr. Kenneth Baker, Secretary of State for Education. In welcoming the interim report he said that support for training and buying equipment would be available through educational support grants and the LEA training grants scheme, while the phased introduction of attainment targets and programmes of study would enable the resource implications for later stages of implementation to be monitored.

The Design and Technology Working Group was set up to advise on attain-

ment targets for children at 14 and 16 and the programmes of study needed to achieve them. Technology is defined as the designing and making of useful objects or systems. It is envisaged that it would involve drawing on skills and knowledge from a variety of subjects but always involving science and mathematics.

The terms of reference added: "Pupils should prepare for the world of work by learning how to work in teams as well as by themselves, by understanding the importance of functional efficiency, quality, appearance and market ability and about the importance of working within financial and technical constraints."

Information Technology is considered, in the terms of reference, to form a part of technology and it is deemed important to develop an awareness of the uses of IT at work. Technology is recognised as an area of study in its own right but it is pointed out that it does not need to be a separately-time-tabled subject, the school being left to decide how it should be taught.

### RESPONSE

In response the working party, which included representatives from a wide range of education, sent its interim report into the departments before Christmas and is now using it as the basis for consultation. The final report is due to be with ministers on April 30th.

In her covering letter Lady Parkes said that the working party is breaking new ground in education. Design and Technology required engaging in a broad range of activities at present covered in a number of different school subjects. Its implementation would require a greater degree of planning and cooperative working than occurred at present.

### TARGETS

The group said that it intended keeping the attainment targets simple and manageable, listing five provisionally—exploring contexts for D and T activities, formulating proposals and choosing a design for development, developing the design, making the artefact or system and finally appraising the processes, outcomes and effects of D and T activities.

In early years at primary schools these attainments should be simple with few contexts or constraints. As pupils got older the contexts and constraints would increase, demanding greater knowledge, skill, judgement and personal qualities. The personal qualities outlined in the terms of reference include self-reliance, self-discipline, a spirit of enterprise and a sense of social responsibility.

The targets are based, the group said, on the basic premise that the distinctive quality of D and T was the ability of

pupils to use their knowledge. They felt that the setting of knowledge-led targets would encourage the learning of knowledge as an end in itself rather than as a means to an end.

It is accepted, however, that a certain amount of core knowledge is needed. This is split into four groupings, media for D and T activities, influence on practice, characteristics of products and applications and effects. In addition it is expected that pupils would need to use knowledge outside those areas but members felt that it would be impossible to predict what that might be at the moment.

### SKILLS

There are also a number of skills which the group thought would be required, including exploring and investigating, imagining and speculating, organising and planning, making, communicating and presenting and finally appraising. However, it is explained that the skills meant nothing in the abstract. They were only meaningful when put into action on a specific subject.

The fundamental aspects of proper D and T courses, were, said the group, that they were practical and sufficiently broad, balanced and relevant to ensure that all pupils would be "engaged and their motivation for learning sustained".

Another important point is that the subject is holistic, not lending itself to the isolation and assessment of separate components. Therefore, pupils work should be assessed on the detailed observation of their work throughout the task set.

### IT CAPABILITY

Although not having completed its work in the IT area by the time of the report the group feel the development of an IT capability is an essential part of every pupils education. Through its use in D and T the group said that pupils would develop an understanding of its broader principles and processes.

Welcoming the report Baker urged group members to ensure that their final report gave teachers a sufficiently precise indication of what was required of them. "It is absolutely essential that teachers and others are left in no doubt about what is expected.

He again emphasised the need to show how real world contexts for problem sorting could help to develop "economic and career awareness and business understanding."

Two areas were considered by Baker to need further development—study programmes for children with special educational needs and the recommendations for stage four, between 14 and 16, where pupils should be allowed a choice between general and more specialised D and T courses.



# REPORTING AMATEUR RADIO

TONY SMITH G4FAI

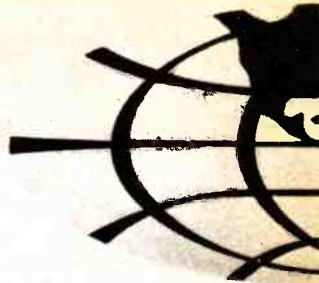

## PRIMARY AND SECONDARY FREQUENCIES

The DTI recently published a new colour coded bar chart covering frequencies from 1kHz up to 60GHz, divided into primary and secondary uses. The main uses shown are broadcasting, fixed services, mobile, amateur, radio location, navigation, astronomy, space, and the various maritime, aeronautical and satellite bands. Secondary uses are defined as those which do not have the same protection from interference given to the primary use of the same frequencies.

Amateur bands can be allocated on either basis. The 80m, 40m, 20m, 15m, 10m, part of 6m, 2m, and some u.h.f. bands are primary while other bands are either secondary or are available "on the basis of non-interference to other services".

It may sound from all this that primary users are protected from interference from other services, but individual amateurs do not have such protection. This is given by the regulations only to users whose frequencies have been registered nationally or internationally.

Amateurs, as both primary and secondary users, must not cause "Harmful Interference" or "Undue Interference" to stations to which particular frequencies are officially assigned. "Harmful Interference" is defined in the new Amateur Radio licence as "interference which endangers the functioning of a radio navigation service or of other safety services or seriously degrades, obstructs or repeatedly interrupts a radio communication service operating in accordance with the relevant governmental requirements."

Examination of the new frequency chart highlights the vulnerability of amateurs and other radio hobbyists. They occupy a very small percentage of a spectrum taken up mainly by commercial and governmental services, and inevitably can have little influence on the order of things.

The only benefit they do get is that some amateur operators develop remarkable skills in working through high interference levels, often making sense of signals which to non-amateurs are barely audible or intelligible. The "United Kingdom Radio Frequency Allocations Chart" is published by HMSO, ISBN 0 11 514637, price £2.50.

## AMTOR

Last month I described some of the activities covered by the British Amateur Teledata Group. As mentioned briefly, there are still many supporters of RTTY (radio teletype) but an alternative, error detecting, system known as AMTOR is becoming increasingly popular with teleprinter enthusiasts. This is an amateur system

adapted from Philips' TOR (Teleprinter Over Radio) developed in Holland in the early '70s for ship-to-shore communications, now known as SITOR.

An amateur operator, after hearing these signals on the air, programmed a microprocessor to send and receive TOR signals using four rather than five figures in the selective calling procedure and coined the name AMTOR. The first amateur QSO (contact) using the adapted system took place in 1978 between two stations 200km apart.

Since that time other amateurs have taken up AMTOR as converters have become available commercially, first enabling existing radio teletype stations to change to the new system, then allowing home computers, with specially written software, to interface with radio equipment for AMTOR operation.

## ERROR DETECTION

In AMTOR each seven-bit character has three data bits of one polarity and four of the other and any character received which does not have this ratio is detected and rejected as incorrect. A block of three characters is sent by the transmitting station and if all are valid the receiving station automatically clears the sending station to send the next three-character block. This mode is known as ARQ (Automatic Request repeat) and overcomes most of the problems of character corruption caused by poor radio conditions or interference from other stations.

An alternative mode, known as FEC (Forward Error Correction), sends all characters twice, giving the receiving station two chances to copy the character, but without the automatic signalling to and from the stations as in ARQ.

AMTOR operates within a very narrow bandwidth (300Hz) with a data rate of 100 bauds, although the real rate of data flow is about 50 bauds because of the repeats made. The tone shift is the same as with standard RTTY, namely 170Hz. The tones are 1445Hz for Mark, and 1275Hz for Space, and AMTOR is claimed to be far superior to Packet Radio (see this column, March 1987) for weak signal h.f. operation when fading and interference cause problems.

## FITTING EVERYTHING IN

From being an experimental mode in 1978, operated either illegally or on a special permit basis, AMTOR is now an accepted amateur mode formally recognised in the amateur radio licence, while around the world some 30 AMTOR mailboxes operate day and night. As new modes like AMTOR develop and expand however, and as more amateurs come into the hobby, a new problem arises—finding space in the bands for them all.

The International Amateur Radio

Union has allocated groups of frequencies in each band to different modes in an attempt to avoid chaos and misunderstandings between operators. These band-plans are compulsory in some parts of the world and voluntary in others (including IARU Region 1 of which the UK is a part).

The practitioners of every mode are very possessive about the parts of the band allocated to them and strongly object to any intrusion by other non-allocated modes. At the same time, users of expanding modes experience difficulty in finding suitable space in their own sections and look longingly at other users' allocations.

Such a situation arose recently when AMTOR users decided to apply to the Radio Society of Great Britain for a special licence to operate a mailbox on a frequency within the CW (Morse) section of the 40m band. This was because SSB (single sideband) users were causing interference in the RTTY section where AMTOR is supposed to operate.

On learning of this proposal CW clubs in the UK and across Europe, all members of the European CW Association, protested vigorously to the RSGB, to the IARU and to their national societies, with the result that the proposal was quietly dropped.

Apart from its experimental scientific reputation, amateur radio has always been noted for its fraternal nature. It was probably easier to be fraternal and idealistic in the past when the pressures were less, but the need for these qualities is greater than ever today. They possibly represent the only real hope of amicably accommodating the thousands of new amateurs, with their new modes, which national societies around the world feel they must recruit to ensure the continuing survival of amateur radio in the future.

## HIGH MARKS

Such recruits will find various ways to study for the necessary examinations before they finally get their "ticket" and go on the air. There are unlikely, however, to be many who come into the hobby like two of the crew members of the Soviet spacecraft *MIR*.

They received instruction in the appropriate subjects from ground-based Russian amateurs and then took their equivalent of the Radio Amateurs' Examination in space. To set up an amateur station you need an antenna, so when one of the crew made a spacewalk to repair a radio telescope he took the opportunity to fit an amateur antenna for the 2 metres band on the exterior of the spacecraft.

The astronaut hams now have the callsigns U1MIR and U2MIR and can be heard in the f.m. section of the 2m band between 145.400 MHz and 145.600MHz.

# PCB SERVICE

Printed circuit boards for certain constructional projects (up to two years old) are available from the PCB Service, see list. These are fabricated in glass fibre, and are fully drilled and roller tinned. All prices include VAT and postage and packing. Add £1 per board for overseas airmail. Remittances should be sent to: The PCB Service, *Everyday Electronics* Editorial Offices, 6 Church Street, Wimborne, Dorset BH21 1JH. Cheques should be crossed and made payable to *Everyday Electronics* (Payment in £ sterling only.)

**Readers are advised to check with prices appearing in the current issue before ordering.**

**NOTE: Boards for older projects—not listed here—can often be obtained from Magenta Electronics, 135 Hunter St., Burton-on-Trent, Staffs DE14 2ST. Tel: 0283 65435 or Lake Electronics, 7 Middleton Close, Nuthall, Nottingham NG16 1BX. Tel: 0602 382509.**

**NOTE: please allow 28 days for delivery. We can only supply boards listed in the latest issue. Boards can only be supplied by mail order and on a payment with order basis.**

PROJECT TITLE	Order Code	Cost
Light Rider—Lapel Badge - OCT '86 - —Disco Lights —Chaser Light	540 & 541 542 546	£2.97 £5.12 £4.04
Modem Tone Decoder - NOV '86 - 200MHz Digital Frequency Meter	547 548	£3.46 £5.14
- DEC '86 - Dual Reading Thermometer Automatic Car Alarm BBC 16K Sideways RAM (Software Cassette)	549 550 551 551S	£7.34 £2.93 £2.97 £3.88
Random Light Unit - JAN '87 -	552	£5.88
Car Voltage Monitor - FEB '87 - Mini Amp Video Guard Spectrum I/O Spectrum Speech Synthesiser	553 554 & 555 556 557 558	£2.48 £5.68 £3.80 £4.35 £4.86
- MAR - '87 Computer Buffer/Interface Infra Red Alarm : Sensor Head PSU/Relay Driver	560 561 562	£3.32 £4.19 £4.50
Alarm Thermometer - APR '87 - Experimental Speech Recognition Bulb Life Extender	559 563 564	£2.60 £4.75 £2.48
Fridge Alarm - MAY '87 - EE Equaliser-Ioniser	565 566	£2.40 £4.10
Mini Disco Light - JUNE '87 - Visual Guitar/Instrument Tuner	567 568	£2.93 £3.97
Fermostat - JULY '87 - EE Buccaneer Metal Detector Monomix	569 570 571	£3.34 £4.10 £4.75
-AUG '87 - Super Sound Adaptor Main Board PSU Board Simple Shortwave Radio, Tuner Amplifier	572 573 575 576	£4.21 £3.32 £3.15 £2.84
Noise Gate - SEPT '87 - Burst Fire Mains Controller Electronic Analogue/Digital Multimeter	577 578 579	£4.41 £3.31 £6.40
Transtest - OCT '87 - Video Controller	580 581	£3.32 £4.83
Accented Metronome - NOV '87 - Acoustic Probe BBC Sideways RAM/ROM	582 584 585	£3.77 £2.78 £4.10
Pseudo Echo Unit - DEC '87 - Dual Mains Light Flasher Twinkling Star Audio Sine Wave Generator	586 587 588 589	£4.60 £3.66 £2.61 £3.03
Capacitance Meter - JAN '88 - Bench Amplifier Transistor Curve Tracer	590 591 592	£4.10 £5.51 £2.84
- FEB '88 - Bench Power Supply Unit Game Timer	593 583	£4.01 £3.55

Semiconductor Tester - MAR '88 - SOS Alert Guitar/Keyboard Envelope Shaper	594 595 596	£3.19 £2.78 £4.23
Stereo Noise Gate - APR '88 - Pipe & Cable Locator Inductive Proximity Detector	597 598 574	£6.65 £2.72 £2.97
Multi-Channel Remote Light Dimmer Transmitter Receiver - MAY '88 - Door Sentinel Function Generator—Main Board Function Generator—Power Supply Super Sound Effects Generator	599 600 605 606 607 608	£2.78 £3.07 £2.60 £5.91 £4.19 £4.78
Multi-Channel Remote Light Dimmer Relay/Decoder Dimmer Board Power Supply Mother Board Headlight Reminder	601 602 603 604 611	£4.86 £3.07 £2.72 £7.76 £2.78
Video Wiper - JULY '88 - Isolink	612 613	£6.75 £4.21
Tea Tune - AUG '88 - Time Switch Suntan Timer Car Alarm	609 614 610 615	£2.56 £4.84 £3.07 £3.12
Doorbell Delay - SEPT '88 - Breaking Glass Alarm Amstrad PIO	616 617 618	£3.55 £4.27 £6.77
Eprom Eraser - OCT '88 -	620	£4.07
Doorbell Delay - NOV '88 - Micro Alarm Infra-Red Object Counter Transmitter Receiver Display Seashell Sea Synthesiser	616 621 622 623 624 625	£3.56 £3.12 £4.61 £3.23 £3.05 £4.84
Reaction Timer - DEC '88 - Main Board Display board Downbeat Metronome EPROM Programmer (On Spec) Phasor	626 627 629 630 631	£3.46 £2.67 £4.84 £8.29 £5.64
Monkey/Hunter Game - JAN '89 -	634	£3.36
Continuity Tester - FEB '89 - 4-Channel Light Dimmer Mini PSU	619 635 636	£2.67 £7.67 £3.23
Sound-to-Light Interface Midi Pedal - MAR '89 - Midi Merge Audio Lead Tester	637 639 640 641	£6.24 £7.00 £2.78 £5.77
Light Sentinel - APR '89 - Main Control Board Remote Interface (4 boards) Electron User Port 4-Channel Auto-Fader Interface	632 633 638 642	£9.20 £4.59 £6.64 £6.80

Please note that when ordering it is important to give project title as well as order code. Please print name and address in Block Caps. Do not send any other correspondence with your order.

EE PRINTED CIRCUIT BOARD SERVICE  
Please send me the following p.c.b.s.  
Make cheques/PO payable to: **Everyday Electronics**  
(payment in £ sterling only)

Order Code    Project    Quantity    Price

.....  
.....

I enclose cheque/PO for £.....

Name.....

Address.....

.....

Please allow 28 days for delivery

BLOCK CAPITALS PLEASE

# PROFESSIONAL SURVEILLANCE EQUIPMENT KITS

A RANGE OF HIGH QUALITY KITS AS SUPPLIED TO LEADING UK SECURITY COMPANIES. ALL KITS COME FULLY DOCUMENTED WITH CONCISE ASSEMBLY AND SETTING-UP DETAILS. FIBRE GLASS PCB AND ALL COMPONENTS. PLEASE ADD £1.50 TO COVER P&P. ALL UNITS AVAILABLE READY BUILT. DETAILS IN CATALOGUE.

**MTX** Micro-miniature VHF transmitter. The smallest kit on the market measuring an incredible 17mm x 17mm including on-board mic. Super sensitive. Fully tuneable over FM band. 9V operation with range up to 1000m. **£10.95**

**VOXTB** Voice-activated transmitter. Variable sensitivity trigger level switches transmitter on when sounds are detected. Stays on for time delay variable between 1-20 sec. Fully tuneable output covers all FM band. Very sensitive and low standby current through CMOS circuitry. 9V operation. Range up to 1000m. Measures 30mm x 40mm. **£15.95**

**VT800** High power version of the MTX with on-board PA stage providing 250mW of RF. Measures just 20mm x 40mm, power requirements 9-15V. Excellent sensitivity and stability. Fully tuneable over FM band. Ranges over 3000m can be expected. **£12.95**

**CTX900** Sub-carrier scrambled transmitter. Audio is double modulated providing very secure transmissions. Any unauthorised listener will not be able to demodulate signal without DSX900 Decoder unit. Fully tuneable output covering FM band. 9V operation. Range up to 1000m. Measures 30mm x 40mm. **£18.95**

**DSX 900** Decoder unit for CTX900. Connects to earphone output of receiver to descramble signal from CTX900 output to headphones. 9-12V operation. Measures 35mm x 50mm. **£17.95**

**TLX700** Micro size telephone transmitter. Connects onto line at any point and requires no batteries. Clearly transmits both sides of conversations on both incoming and outgoing calls. Undetectable by phone users. Fully tuneable output covering FM band. Range up to 1000. Measures just 20mm x 20mm. **£10.95**

**ATR2** Micro size telephone recording unit. Connects onto line at any point and connects into ANY normal cassette recorder having MIC and REM sockets. Requires no batteries. Switches recorder on silently when phone is used for incoming or outgoing calls, switches off when phone replaced. Clearly records both sides of conversations. Undetectable by phone user. Measures 10mm x 35mm. **£10.95**

**XAL800** RF Bug Detector/Locator. Wide band input circuitry detects presence of RF field and triggers flashing LED and piezo bleeper. Variable sensitivity enables source of transmission to be pinpointed to within 6 inches. Max sensitivity will detect MTX or similar transmitter at around 15-20 feet. 9V operation. Measures 55mm x 55mm. **£21.95**

**SUMA DESIGNS (Dept. EE), THE WORKSHOPS 95 MAIN ROAD, BAXTERLEY, Nr ATHERSTONE, WARKS CV9 2LE. TEL 0827 714476**

Send 28p stamp for new 1989 Catalogue including crystal transmitters, mains transmitters, surveillance receivers etc. PHONE ORDERS ON ACCESS OR AMEX ACCEPTED. Tel 0827 714476

## BARGAIN £1 COMPONENT PACKS

- 100 polyester Capacitors, Assorted values 10nF to 680nF.
- 2 Eich Resist Pens for making printed boards.
- 100 Silicon Diodes equivalent to 1N4148.
- 1 Surplus equipment panel containing lots of bits.
- 20 x 270 ohm Horiz Sub-miniature Preset Pots.

Order all 5 packs for £5 plus £1 p/p and receive a FREE mystery pack.

## FULL WORKSHOP SERVICE MANUALS SUPPLIED

Any Video recorder—£12 inclusive.  
Any Colour TV, Audio, Test, Amateur Radio, Vintage etc. £6.00 inclusive.

FREE catalogue with all orders or LSAE for your copy.

**MAURITRON ELECTRONICS LTD. (EE)**  
8 Cherrytree Road, Chinnor, Oxon OX9 4QY  
(0844) 51694



**MARCO TRADING**  
THE MALTINGS, HIGH STREET, WEM,  
SHROPSHIRE SY4 5EN DEPT EE4.  
Tel: 0939 32763 Telex 35565 Fax 0939 33800

Electronic Component Mail Order Company—Established 1972  
100 + PAGE CATALOGUE AVAILABLE—SEND £1 FOR YOUR COPY  
Including Discount Tickets—50p off £5 + order; £1 off £10 + order; £5 off £50 + order.

Tel: (0939) 32763. Telex: 35565. Fax: 0939 33800  
Please add 85p P&P & 15% VAT

### VISIT OUR RETAIL SHOPS

**WEM (MARCO),** The Maltings, High Street (0939) 32763  
**WOLVERHAMPTON (WALTONS),** 55A Worcester Street (0902) 22039  
**BIRMINGHAM (SUPERTRONICS),** 65 Hurst Street (021) 666 6504

**NI-CAD RECHARGEABLE BATTERIES**  
AAA — £1.25 (10+£1.20ea.)  
AA — 90p (10+ 85p ea.)  
A — £2.10 (10+£1.90ea.)  
C — £2.50 (10+£2.20ea.)  
PP3 — £4.10 (10+£3.90ea.)

**SOLDER 60/40**  
A 500g reel of 22 swg multicore solder  
60% tin 40% alloy  
non-corrosive. **ONLY £4.99**

**12V RECHARGEABLE UNIT**  
10 x D size Ni-Cads (4Ah) encapsulated in a black plastic case, fuse holder, gives 12V output when fully charged. Ex-equipment—fully tested and guaranteed. 245 x 75 x 75mm.  
**£7.99 plus £1.85 P&P plus 15% VAT**  
Charger for unit **£10.00**



**CHARGER FOR NI-CAD BATTERIES**  
Charges AAA, AA, C, D & PP3 NI-CADS  
**£4.50**



**JUST ARRIVED**  
High quality  
Desoldering Pump, European made  
**ONLY £2.99**  
(Normally £8.99). Spare tip 60p



**ANTEX SOLDERING**  
C Iron 15W £5.40 SK2 Kit £8.30  
CS Iron 17W £5.60 SK5 Kit £7.99  
XS Iron 25W £5.80 SK6 Kit £8.20  
ST4 Stand £2.20  
TCSU-O Soldering Station £72.50  
Spare Elements from £3.50  
Spare tips for above irons £1.20

**ORYX PORTASOL GAS SOLDERING IRON**  
Price (1+) £16.00 (5+) £15.30  
Spare tips: 1, 2.4, 3.2, 4mm £4

**LATEST CATALOGUE £1**

WE RESERVE THE RIGHT TO CHANGE THE PRICES WITHOUT PRIOR NOTICE

**TV ACCESSORIES**

1+	10+
Co-ax metal plug	20p 18p
Co-ax line socket	25p 22p
Co-ax line connector	12p 10p
Co-ax in line splitter	80p

**APRIL SPECIAL OFFER**  
1 in, 1 out antenna amplifier for colour and black/white TV. White plastic case with on/off switch. LED indicator and 1m lead.  
Band width ..... 300MHz—890MHz  
Gain ..... 7dB±1dB  
Impedance ..... 75Ω  
Power ..... 240Vac 50Hz  
Dims ..... 125x79x50mm  
**TV ANTENNA AMPLIFIERS ONLY £7.99**



**"CLOSED-CIRCUIT" TELEVISION SYSTEM**  
PRICES **£150.00**

COMPRISING: 1 x CAMERA 1 x MONITOR 1 x CAMERA BRACKET

USED USED NEW

COMPLETE WITH LENS



**12V Twin Fluorescent lamp 12" Double Tubes**

IDEAL FOR BOATS, CARAVANS, VANS, ETC.



**£5.99 EACH**  
**10 OFF £4.99**

**FM TRANSMITTER**  
Very High Quality  
"MINI-BUG"  
Ideal for Baby Alarm, etc!!  
**£8.50**



**FULL RANGE OF TRANSISTORS/IC'S-CMOS VALVES ETC**  
Boxes transformers  
Audio over 7,000 lines

**TV AERIAL ACCESSORIES**  
Co-ax Cable 75 Ohm 100 metre reel, brown & white **£12.50**

**SPECIAL OFFER**  
**UNIVERSAL P.C.B. ASSEMBLY JIG**  
TO ACCOMMODATE P.C.B. SIZE UP TO MAXIMUM—  
265 x 238mm



**OUR PRICE £15.00**  
(NORMAL PRICE OVER £50.00)

**MARCO KITS**

Ceramic 50V (125)	£3.50
Electrolytics Rad. (100)	£7.25
Fuse 20mm Q/B (80)	£3.75
Fuse 20mm A/S (80)	£7.50
Nut and Bolt (800)	£3.00
Pre-set Pots Horiz. (120)	£6.75
Pre-set Pots Vert. (120)	£6.75
Resistors	
0.25W Popular (1000)	£6.50
0.25W 5 off (305)	£2.95
0.25W 10 off (610)	£4.50
0.5W Popular (1000)	£7.50
0.5W 5 off (305)	£4.70
0.5W 10 off (730)	£7.75
1W 5 off (365)	£13.75
2W 5 off (365)	£21.75
Zener Diodes 5 off (55)£3.50	
0.25W Resistors 1+2p, 10+1.5p	
0.5W Resistors 1+2p, 10+1.5p	

**£3.99**  
**HELPING HANDS**  
with magnifier

**SERVISOL PRODUCTS**

Supa Freeze-it	£1.40
Switch cleaner	£1.24
Foam cleanser	£1.22
Super 40	£1.88
Fire extinguisher	£3.30
Tape head cleaner	£1.10
Anti-static spray	£1.20
Silicone grease	£1.38
Plastic seal	£1.35

# DOWN TO EARTH

BY GEORGE HYLTON

ULTRASONIC transducers have everyday domestic uses in remote controls for TVs, intruder alarms, etc. A reader notes that the types usually found on the hobby market are sold as matched pairs: one for transmitting and the other for receiving.

Why the need for matching? Why not just make identical transducers so that any two will match?

## PRODUCTION SPREADS

There are two answers. One is that it may be impossible to make identical transducers on a mass-production basis.

The common kinds are made from piezo-electric ceramic materials such as barium titanate. These materials have physical and electrical characteristics which tend to vary during manufacture, so that in a production batch the individual specimens may differ from one another sufficiently to impair use.

If, for instance, the resonant frequency is nominally 40kHz, in practice it may vary from specimen to specimen from, say, 38kHz to 42kHz. If the transducers are to be used in a system where precision of frequency is important then it will pay to sort them into groups with narrower spreads of frequency; such as 39kHz,  $\pm 1$ kHz and 41kHz  $\pm 1$ kHz.

## RESONANCE AND ANTI-RESONANCE

This, however, is not the whole story. It is easy to fall into the trap of assuming that a 40kHz transducer is just a simple vibrator which when excited resonates

Fig. 1. Internal arrangements of a ceramic ultrasonic transducer. (Case omitted.) The vibrating resonator moves a light metal horn which radiates the ultrasound.

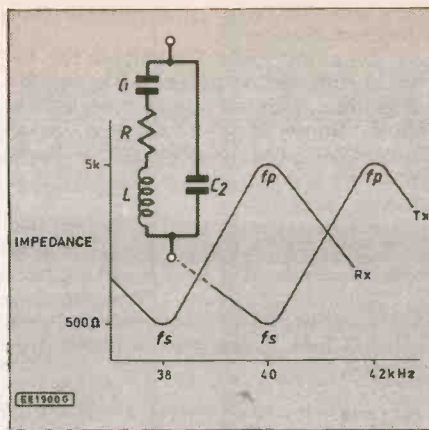
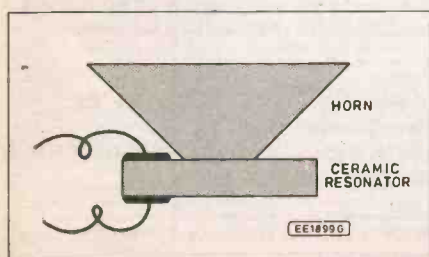

Fig. 2. Impedance/frequency curves for two transducers, and the equivalent circuit of a transducer.

at 40kHz, its one and only natural frequency.

The truth is that a transducer may have several natural frequencies. A quick test which I ran showed that a nominal 40kHz transducer absorbed power from my RC test oscillator at 38kHz and 76kHz. Evidently, this specimen has a strong response at the second harmonic.

To get the true picture of the response of a transducer around its nominal operating frequency calls for measuring its impedance as the frequency is varied. When this is done for the common (narrow band) type of transducer the result is something like Fig. 2. This shows a sharp dip in impedance at one frequency and a sharp rise at a slightly higher frequency.

This response can be explained by supposing that the transducer looks (to a source of electrical signals) like the LCR network shown inset in Fig. 2. This has a low impedance where L and C1

are series-resonant. This is the frequency where power is strongly absorbed from a low-impedance source.

The high-impedance peak requires a more subtle explanation. As the frequency is raised above the series-resonance value, L and C1 have a combined impedance which rises with frequency. Now, an inductance has this sort of impedance. So, above the series-resonance frequency ( $f_s$ ) the L, C1 branch acts as a sort of inductance.

However, C2 is in parallel with this pseudo-inductance. At some frequency C2 and the pseudo-inductance are parallel-resonant. Hence the high-impedance peak at  $f_p$ . (In some textbooks and data sheets the series resonance effect is named resonance, and the parallel resonance effect anti-resonance. The corresponding symbols for frequency then become  $f_r$  and  $f_a$ .)

## POWER MATCHING

The impedance values in Fig. 2 are typical of a rather high Q (by transducer standards) specimen. In this case, at  $f_s$ , the transducer looks like a resistance of 500 ohms. A voltage of 1V drives 2mA through it and the power is 2mW. At  $f_p$ , where the resistance is 5k, 1V drives only 0.2mA and the power is 0.2mW.

This explains why, in my rough test, I hadn't noticed  $f_p$ . My test oscillator has an output impedance of 600 ohms. When a load of 500 ohms is connected the voltage drops to less than half. This clearly reveals  $f_s$ . But at  $f_p$  where 600 ohms drives 5k the effect on oscillator output is small enough to be missed.

There's no reason why the transducer shouldn't be capable of absorbing lots of power at  $f_p$ . All that's required is to increase the drive voltage (with my values, by a bit more than threefold).

However, in a drive circuit whose supply voltage is low (such as Fig. 3a) it may be inconvenient to operate at  $f_p$

Fig. 3. (a) Transducer driven from CMOS oscillator and buffer. (b) Oscillator for high drive voltages. (c) Quartz-type oscillator circuit.

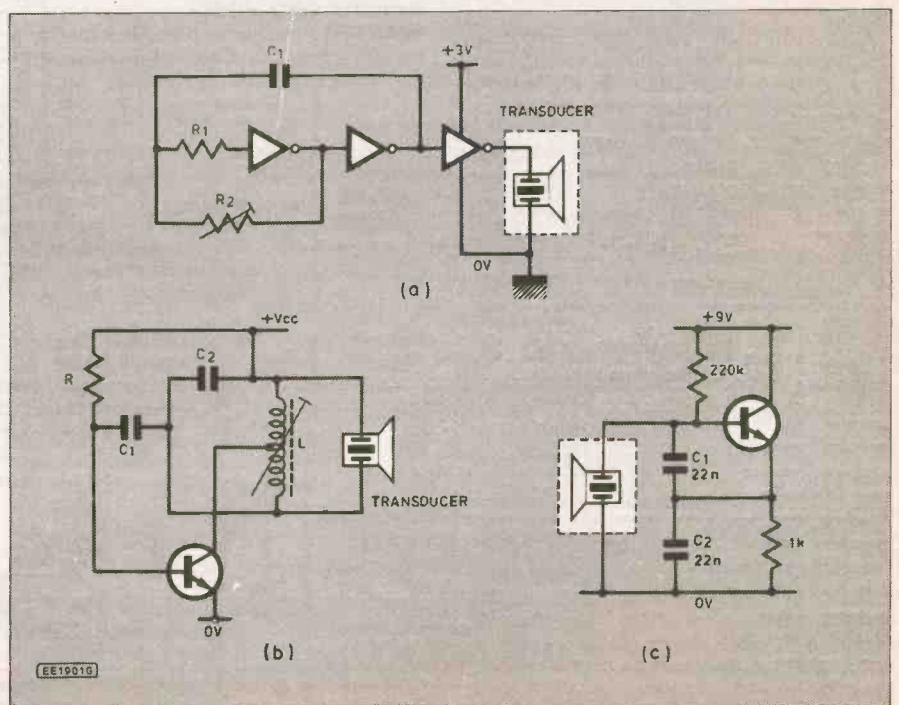

because the peak-to-peak output voltage can't exceed the supply voltage (in this case 3V), which seriously limits the drive power. Operation at  $f_s$  gives much more power.

At the receiving end, however, it may well be quite convenient to work at  $f_p$  because the transducer impedance is then quite compatible with the input impedance of the receiving amplifier. To get the best of both worlds, what's needed is a transmitting transducer operating at  $f_s$  and a receiving transducer whose  $f_p$  lies at the same frequency.

In other words, the manufacturer should make two lots of transducers, one for transmission, with  $f_s$  at say 40kHz and the other for reception with  $f_p$  at 40kHz, so that the  $f_s$  of the transmitters coincides with the  $f_p$  of the receivers, as in Fig. 2. It is in this sense that

matched pairs of transducers are required.

If the amount of drive voltage can be made sufficient to power a transmitter at  $f_p$ , then both transducers can be the same. Some form of step-up transformer can produce a high a.c. voltage from an oscillator powered by a low d.c. supply.

The sort of circuit required is depicted in Fig. 3b, where the inductance and capacitance tune to  $f_p$ . It may be possible to engineer the inductance so that the transducer's own capacitance (typically 2-3nF) gives the required frequency.

### QUARTZ ANALOGY

Readers familiar with quartz crystals will recognise from Fig. 2 that the general shape of the impedance-frequency curve is the same for a transducer and a

quartz crystal. This suggests that transmitting transducers might be usable in quartz-style oscillator circuits.

They can, but the much lower  $Q$  of the transducer makes things difficult. A possible type of circuit (Fig. 3c) places the operating frequency somewhere between  $f_s$  and  $f_p$ . Choice of capacitors C1, C2 gives some adjustment of frequency, but there's not much margin.

### RATINGS

Ceramic transducers will not withstand very large voltages and currents. There is usually a d.c. voltage limit (e.g. 10V) and an a.c. voltage limit.

The a.c. limit may be quite high (e.g. 50V rms) but this does not imply that the power output can be increased by increasing the a.c. drive. Overloading effects may set in at much lower voltages (e.g. 10V r.m.s.).

# MARKET PLACE

**WANTED E.E.** Jan. '87. Purchase or loan. All costs paid. G. Carress, 125 Saffrondale, Anlaby, N. Humberside HU10 6QB.

**CROTECH** 3132 20MHz dual trace oscilloscope with probes. Never used. Brand new. Offers around £250. Tel. 021 7449371. S. G. Carvell, 11 Himbleton Croft, Monks Path, Solihull, West Midlands B91 4UP.

**WANTED** oscilloscope, test gear, circuits, good working order. Will collect. Please state price. G. S. Bhakar, 93 Wiltshire Road, Chaddesden, Derby DE2 6FB. Tel. 0332 662363.

**WANTED** Babani's BP186 Walkie Talkie Projects book. Mohamad Lud Neu, Puspanti Complex, 43000 Kajang, Malaysia.

**WANTED** R.C.A. Receiving Tube manual. Frank Cosgrove. Tel. 0202 432973.

**SOLARTRON** CP1400 dual trace oscilloscope. Good Condition. £50. Tel. 0273 492159.

**ZX81** 16K RAM has failed. Replacement required. Any idea where obtainable. Please quote price. F. J. Pearce, Fieldways, Longridge, Sheepscombe, Stroud, Glos. GL6 7QU.

**PYE 5000** walkie talkie VHF hi-band DTI approved. Worth £100 or swap CCTV. Tel. 091 3732222.

**ALL** my surplus components for sale. Send s.a.e. for lists. J. Allen, 150 Magheralane Road, Antrim, Co. Antrim, BT41 2PD.

**8 FULLY BOUND VOLUMES** Radio Constructor 1966-1973, 1977-1978. Perfect condition £10 per volume. H. Jackson, 121 Cavalry Drive, March, Cambridgeshire PE15 9DP. Tel. 0354 57717.

**AMMETER**, never used. Perfect condition. Measures up to 10 amps. £120 o.n.o. Neil Porter. Tel. 0366 383380 (Downham Market).

**WANTED** circuit diagrams for burglar alarm control panels. P.I.R. detectors or any alarm related items. Paul Brown, 48 Lanndale Lawns, Springfield Tallaght, Dublin 24, Eire.

**DENCO COILS.** Green ranges 3, 4, 5. Three only. £1.00 each. M. Payne, 294 Whiteleas Way, South Shields, Tyne & Wear.

**WANTED** full set of valves for Telequipment 'scope model type D53. Cash paid 10 valves total. D. Randerson, 21 Edale Road, Sneinton Dale, Nottingham. Tel. 0602 503603.

**WANTED** instruction booklet for Commodore Program calculator model P50. K. Gilbert, 4/2 Gunnet Court, Muirhouse, Edinburgh EH4 4SG.

**WANTED URGENTLY:** ZX81 home computer at low price for school project. S. Fowler, 249 Kempshott Lane, Basingstoke, Hants RG22 5LZ.

**WANTED** information on where I can purchase cheap functional or non-functional video camera lens. J. Torley, 749 Bilsland Drive, Glasgow G20 9PA.

### FREE READERS ADS.

**RULES** Maximum of 16 words plus address and/or phone no. Private advertisers only (trade or business ads. can be placed in our classified columns). Pen pals or items related to electronics only. No computer software. EE cannot accept responsibility for the accuracy of ads, or for any transaction arising between readers as a result of a free ad. We reserve the right to refuse advertisements. Each ad. must be accompanied by a cut-out valid "date corner". Ads. will not appear (or be returned) if these rules are broken.

**HRO.** Bug-key. Marconi signal generators TF801A, TF144H. Bridge TF1313. Q-meter TF1245. Attenuator TF1073. Millivoltmeter TF899. Details Tel. 0293-885701 (Crawley, Sussex).

**FINALLY MOVED!** Lots of surplus components still to go. Dragons, transformers, repairs, c.p.u.'s 9900, 6800, Z80. N. Spiers, 20 Eaton Way, Gr. Totham, Essex CM9 8EE.

**WANTED** copies of E.E. from Jan. '84 to Aug. '87 inclusive. Must be complete. J. Benham, 2 Winnington, Fareham, Hants PO15 6HP. Tel. 0329 234522 (Fareham).

**He/Ne LASER** 1mW, built by physics undergraduate, £150. Also kit of parts and case £100. N. Humphrey Tel. 0243 375890.

**WANTED** Oscilloscope dual trace s'hand 20MHz. Ivan Walker, 193 Mowhan Road, Co. Armagh, N. Ireland BT60 2ED.

**BUSH A.C. MAINS** Radio Receiver purchased 1946. Type No. S.U.G.91, 3 valves, 12 in speaker, L, M, and S wave, floor standing, wood cabinet, working until few years ago. Information contact—R. Horwood, 144 Coleridge Way, West Drayton, Middlesex. UB7 9HS.

Name & Address:			

BLOCK CAPITALS PLEASE

Please read the **RULES** then write your advertisement here—one word to each box. Add your name, address and/or phone no. Please publish the following small ad. FREE in the next available issue. I am not a dealer in electronics or associated equipment. I have read the rules. I enclose a **cut-out valid** date corner.

Signature ..... Date .....

**COUPON VALID FOR POSTING BEFORE 7 APRIL '89**  
(One month later for overseas readers)

**SEND TO:** EE MARKET PLACE, EVERYDAY ELECTRONICS, 6 CHURCH STREET, WIMBORNE, DORSET BH21 1JH.

For readers who don't want to damage the issue send a photostat or a copy of the coupon (filled in, of course) with a **cut-out valid** "date corner"

# EVERYDAY ELECTRONICS

CLASSIFIED

Reach effectively and economically today's enthusiasts anxious to know of your products and services through our semi-display and classified pages. The prepaid rate for semi-display spaces is £8.00 (plus VAT) per single column centimetre (minimum 2.5 cm). The prepaid rate for classified advertisements is 30 pence (plus VAT) per word (minimum 12 words).

All cheques, postal orders, etc., to be made payable to Everyday Electronics. VAT must be added. Advertisements, together with remittance, should be sent to the Classified Advertisement Dept., Everyday Electronics, 6 Church Street, Wimborne, Dorset BH21 1JH. Tel: (0202) 881749.

## Electronic Components

### A & G ELECTRONICS LTD.

If you are buying Electronic Components elsewhere you are almost certainly paying too much! Write to us for a free 1989 catalogue and start saving money. (Please send two 19p stamps towards postage.)

100 Park Avenue, London E6 2SR  
Tel 01-552 2386

### WALTONS OF WOLVERHAMPTON

Established since 1947 - offering a complete range - I.C.s, transformers, switches, pots, capacitors, resistors, kits, speakers, test equipment, books and lots, lots more!

COME AND SEE US AT: MON-SAT 9-6.00 pm  
55A WORCESTER STREET, WOLVERHAMPTON TEL: 0902 22039

### ELECTRONIC COMPONENTS

EVERYTHING FOR YOUR NEXT PROJECT

THE BIGGEST DISPLAY IN THE SOUTH IS AT

### FRASER ELECTRONICS

42 ELM GROVE ★ SOUTHSEA ★ HANTS

Telephone 0705-815584

### DCS VARIABLE VOLTAGE D.C. BENCH POWER SUPPLY

1 to 24 volts up to 1/2 amp. 1 to 20 volts up to 1 amp. 1 to 16 volts up to 1 1/2 amps A.C. Fully stabilised. Twin panel meters for instant voltage and current readings. Overload protection.

Fully variable. Operates from 240V AC. Compact Unit. size 9 x 5 1/2 x 3in.



£39 inc. VAT + Post £2

### RADIO COMPONENT SPECIALISTS



337 WHITEHORSE ROAD, CROYDON SURREY, U.K. Tel: 01-684 1665

List, Large SAE. Delivery 7 days. Callers welcome. Closed Wednesday

### \*\*\*RESISTOR PACKS\*\*\*

1/4W 5% CARBON FILM  
10 of each E12 value  
10R to 10M  
Total 730 resistors

£8.00

RMOS P.O. BOX 3  
USK GWENT NP5 2YF

K.I.A. EASTER FREEBIE ...!! Assorted capacitor giftpack—op. amp—p.c.b.—enclose advertisement/£1 (p&p). 8 Cunliffe Road, Ilkley.

## Miscellaneous

### NEW VHF MICROTRANSMITTER KIT

Tuneable 88-115 MHz, 500 metre range, sensitive electret microphone, high quality p.c.b. SPECIAL OFFER complete kit ONLY £5 POST FREE. Access orders/telephone: 021-441 1821 (24 hrs.).

Cheques/P.O.s payable to:

QUANTEK ELECTRONICS LTD  
(Dept. EE), 45a Station Road  
Northfield, Birmingham B31 3TE

PRINTED CIRCUIT BOARDS made to own requirements. For details send s.a.e. to Mr. B. M. Ansbro, 38 Poynings Drive, Hove, Sussex BN3 8GR.

KITS. MINIATURE V.H.F. transmitter with microphone, size approx. 1 1/4in. x 1/2in., £3.99. Telephone transmitter, v.h.f. uses no batteries! £4.75. Automatic telephone recording switch, £8.99. Prices include P&P. Access cardholders telephone 05438 71902 (24 hr). S.A.E. catalogue. Cheque/P.O. to A.C. Electronics, Dept. EE, 99 Greenheath, Hednesford, Staffs.

**TECHNICAL INFO SERVICES (EE)**  
76 Church St., Larkhall, Lanarkshire ML9 1HE  
any other time 0830-0833. FOR FAST QUOTES  
Please 0830-0833 Mon-Fri. 9-5.  
WORLD'S LARGEST COLLECTION SERVICE MANUALS—Most unobtainable elsewhere. Prices range from only £4.50—large s.a.e. any quotation, no obligation to buy.  
WORLD'S SOLE Suppliers of TV & Video Repair manuals, etc. from TV TECHNIC, also such publishers as Heinemann, Newtons, TV Technic, Thorn etc. Every published service sheet in stock, supplied full size, not bits & pieces. CTV's or any combination £3.50 plus Lsae, any other single item £2.50 plus Lsae. Complete Circuit Sets for most Videorecorders only £7 set (no serv. chgs made).  
LSAE for QUOTATIONS plus GIANT CATALOGUE—NEWSLETTERS—  
BARGAINS—FREE S/Sht as available.  
Comprehensive TV Repair Manual £3.50. Complete Radio Service and Repair Course £3.50. Complete Repair & Service Manuals—Mono TV £12.50. CTV £17.00. Video £10.50. Complete Repair Data with circuit—Mono TV £9.50. CTV £12.50. Video £10.50.  
£3.00 plus LSAE BRINGS THE ONLY COMPREHENSIVE SERVICE SHEETS & MANUALS, CATALOGUES plus FREE CHASSIS GUIDE and £4.00 OF VOUCHERS

F.M. MICRO TRANSMITTER kit 20mm x 28mm. Long range, £3.99 inc. P&P. Cheques/P.O. to Minral, R/O 25 Orrell Road, Orrell, Wigan WN5 8EY.

ANY POWER SUPPLY YOU NEED! Modules and built-to-order PSU's. Write for details or quotation: CUSTOM POWER SUPPLIES, PO Box 558, Bristol BS99 1PN

GCSE ELECTRONICS KITS. 10 different £10.50 (+70p p&p) or SAE for details. EE Introducing Digital Electronics Kit £12 (+70p p&p). SIR-KIT ELECTRONICS, 70 Oxford Road, Clacton CO15 3TE.

SOFTWARE/LISTING wanted for Eprom programmer, EE June 1983. Allan Clarke, 1/47 Marsden St., Takapuna, Auckland, New Zealand.

## USE THIS SPACE TO

## SELL YOUR PRODUCTS

IT ONLY COSTS  
(see above for details) **£20** +VAT

## ORDER FORM PLEASE WRITE IN BLOCK CAPITALS

Please insert the advertisement below in the next available issue of **Everyday Electronics** for ..... Insertions. I enclose Cheque/P.O. for £..... (Cheques and Postal Orders should be made payable to Everyday Electronics)

The advertisement must include an address, box number, or phone number as part of the paid wordage. Please remember to add VAT.

NAME .....

ADDRESS .....

**EVERYDAY ELECTRONICS**  
Classified Advertisement Dept.,  
6 Church Street, Wimborne, Dorset BH21 1JH.  
Telephone (0202) 881749

RATE: 30p per word, minimum 12 words. VAT MUST BE ADDED.

## SHERWOOD ELECTRONIC COMPONENTS

45 Rutland St., Mansfield  
Notts. NG18 4AP

### RESISTOR PACKS

0.25W C.Film 10 each (610)	425p
0.25W C.Film: 5 each (305)	265p
0.25 C.Film Popular (1000)	600p
0.1W Min. Hor. presets 5ea (65)	385p
0.1W Min. Vert. presets 5ea (65)	385p

### SPECIAL PACKS All at £1 each

SP1 12x5mm Red LEDs	425p
SP2 12x5mm Green LEDs	425p
SP3 10x5mm Yellow LEDs	385p
SP4 10x5mm Amber LEDs	385p
SP5 30x5mm 1 part LED clips	385p
SP6 10x3mm Red LEDs	25p
SP7 10x3mm Green LEDs	25p
SP8 10x3mm Yellow LEDs	25p
SP9 40x3mm 1 part LED clips	30p
SP10 50x1N4148 signal diodes	25p
SP11 25x1N4001 rectifier diodes	50p
SP12 25x1N4002 rectifier diodes	65p
SP13 25xRad.Elec.Caps. (1-1000uf)	27p
SP14 10x5K Min. Hor. presets 0.1W	27p
SP15 24x2K2 Min. Hor. presets 0.1W	27p
SP16 24x4K7 Min. Hor. presets 0.1W	27p
SP17 24x100K Min. Hor. presets 0.1W	27p
SP18 12xBC182 Transistors	30p
SP19 12xBC183 Transistors	30p
SP20 12xBC184 Transistors	27p
SP21 10xBC212 Transistors	35p
SP22 10xBC214 Transistors	35p
SP23 10xBC549 Transistors	65p
SP24 5xCmos 4001 I.C.s	125p
SP25 5x555 Timer I.C.s	130p
SP26 5x741 Op. Amp I.C.s	65p
1 pack of your choice FREE when you buy any 10 of the above packs.	

### ADDITIONAL PACKS

SP50 25x5mm Red LEDs	200p
SP51 25x5mm Green LEDs	200p
SP52 50xRad. Elec. Caps.	195p
SP53 30xI.C. sockets - 8, 14, 16 pin	200p
SP54 1xTL38+1xTIL100	160p
SP55 250x0.25W Metal glaze 2% resistors	150p
SP56 36xRad. Polyester Caps.	180p

### VOLTAGE REGULATORS

78L05	25p	79L05	30p	7805	35p	7905	36p
78L12	26p	79L12	30p	7812	35p	7912	38p
78L15	26p	79L15	30p	7815	36p	7915	38p

### I.C.s

555	425p
741	22p
TL071	60p
TL072	80p
TL081	40p
TL082	55p
CA3140E	45p
CA3240E	125p

### Radial Elec. Caps

UF	V	P&P
1	16	5p
1	50	5p
1.5	50	5p
2.2	25	5p
2.2	63	5p
4.7	16	6p
4.7	25	6p
4.7	40	6p
4.7	63	6p
10	16	5p
10	25	6p
10	63	6p
22	16	6p
22	25	6p
22	63	7p
47	16	7p
47	25	7p
47	35	7p
47	63	7p
100	16	7p
100	25	8p
100	35	8p
100	50	8p
100	63	10p
220	16	10p
220	25	10p
220	63	11p
470	16	11p
470	25	11p
470	50	12p
470	63	12p
1000	16	15p
1000	35	20p

### Axial Elec. Caps.

UF	V	P&P
1	63	10p
2.2	63	10p
4.7	25	10p
10	35	11p
10	63	12p
22	25	12p
22	50	15p
47	50	15p
100	16	18p
100	40	20p
470	25	25p
470	50	27p
1000	16	27p

Cheques or P.O. to:  
**SHERWOOD ELECTRONIC COMPONENTS**

Please add £1 P&P NO VAT

## TRANSFORMERS

### EX STOCK

### MAINS ISOLATORS

Pri 120Vx2 or 220/240V or 415/440V. Sec 440 or 240V or 110V Centre Tapped Sec	£	P&P
20	8.33	2.51
60	13.67	2.70
100	15.87	2.92
200	22.49	3.52
250	29.20	3.82
500	41.91	4.34
1000	76.01	5.33
1500	98.04	6.54
2000	117.96	7.64
3000	165.41	O/A
6000	353.43	O/A

### 30/15V or 15-0-15V

2x15V Tapped Secs	£	P&P
0.5	1	4.55
1	2	6.19
2	A	10.01
3	M	11.60
4	P	13.84
5	S	17.72
6		19.41
8		25.94
10		29.94
12		34.42
15		37.43
20		51.10

### 50/25V or 25-0-25V

2x25V Tapped Secs	£	P&P
0.5	1	5.91
1	2	7.19
2	A	12.81
3	M	14.82
4	P	20.30
6	S	25.81
8		36.52
10		43.34
12		51.87

### 60/30V or 30-0-30V

2x30V Tapped Secs	£	P&P
0.5	1	6.72
1	2	10.25
2	A	13.17
3	M	19.05
4	P	21.72
5	S	27.46
6		31.32
8		44.04
10		51.28
12		59.09

### INVERTERS

12/24V DC to 240V AC  
Sine-Wave or Square Wave  
Outputs from 60VA

**TRANSFORMER WINDING SERVICE**  
3VA to 18KVA

**CONSTANT VOLTAGE TRANSFORMERS**  
For Spike-free Stable Mains  
Also Valve Mains Output & Matching Transformers

### STAND-BY LIGHTING OR POWER SYSTEMS, PLUS UPS SYSTEMS

PE OSCILLOSCOPE TRANSFORMER Y1  
£14.10 Inclusive

### TOROIDALS

Batches Wound to order  
Send Stamp for Lists  
Stock items by return  
Please add 15% to all items after P&P

24V	12V	£	P&P
0.15	0.03	3.44	1.87
0.25	0.5	3.64	1.90
0.5	1	4.36	1.98
1	2	6.08	2.09
2	A	7.01	2.20
3	M	12.08	2.36
4	P	8	12.87
6	S	12	15.62
8		16	18.59
10		20	25.02
15		30	31.10
20		40	44.40
30		60	63.75
41		83	73.41

### AUTOS

150, 115, 220, 230, 240V for step-up or down	80 VA	£	P&P
150	150	10.03	2.09
150	150	12.25	2.31
350	350	14.05	2.64
500	500	19.05	3.08
1000	1000	34.03	3.68
1500	1500	40.40	4.18
2000	2000	60.41	5.11
3000	3000	102.72	6.32
4000	4000	133.35	O/A
5000	5000	155.28	O/A
7500	7500	239.70	O/A
10kVA	10kVA	283.23	O/A

### CASED AUTOS

240V Cable Input 3-pin 115V USA Socket Outlet	20 VA	£	P&P
80	80	13.85	2.14
150	150	17.34	2.53
250	250	21.13	3.57
500	500	34.66	4.30
1000	1000	48.65	4.90
2000	2000	86.70	6.16
3000	3000	124.46	O/A

### 110V to 240V Cased Autos now available

USA 3-pin plug Input: 13A  
UK Socket Output  
AVOS & MEGGERS Full Range Available

UNIT 211  
STRATFORD WORKSHOPS,  
BURFORD ROAD  
LONDON E15 2SP

**BARRIE ELECTRONICS LTD**  
Tel: 01-555 0228 (3 lines)

## SWITCHING REGULATED POWER SUPPLIES

**Powerline Electronics, the UK's largest specialist distributor of power supplies offers the following state of the art power supplies at special prices:**

### SINGLE OUTPUT VERSIONS

zmj1701	5.0Vdc at 20A
zmj1702	12.0Vdc at 8A
zmj1703	24.0Vdc at 4A
zmj1704	48.0Vdc at 2A

**ONLY £19 EACH**

### MULTIPLE OUTPUT VERSIONS

zmj1705	5.0Vdc at 7A, +12.0Vdc at 2A and -12.0Vdc at 0.8A
zmj1706	5.0Vdc at 7A, +15.0Vdc at 2A and -15.0Vdc at 0.8A

**ONLY £19 EACH**

### FEATURES:

- √MOSFET design.
- √Parallelable for higher output power.
- √Short circuit proof.
- √Output voltage adjust by ±10%.
- √Very high efficiency.
- √High power density.
- √Reliable (MTBF at 25C is 75,000 hours).
- √Convection cooled.
- √Soft start circuit.
- √LED power-on indicator.
- √Available in several packages.

- \*Eurocassette
- \*PCB mounting
- \*Cased

GENERAL SPECIFICATION: Line regulation ±10%, ±0.2%. Load regulation 10-100%, ±0.5%. Transient response ±1% within 2 milliseconds. Dimensions Width 50mm, Height 100mm, Depth 160mm. Input-output isolation 3750VAC. Safety: Designed to meet IEC 380, IEC 435 and UL 478. power fail signal is available. Input voltage range 90-135 VAC or 184-264 VAC.

**POWERLINE**

5 Nimrod Way, Elgar Road, Reading, Berkshire RG2 0EB  
Tel. (0734) 868567 Fax (0734) 755172 Telex 847073

**EDU-SCOPE** Build your own solid state oscilloscope - complete kit of parts excluding case. . . . . £29.99  
**EDU-SCOPE CASE KIT** . . £10.95  
**LOW COST LEAD/PROBE**. £3.95

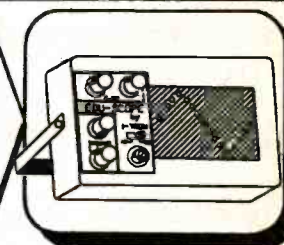

- BUG-89** Micro sized surveillance transmitter - can be received by any FM/VHS radio or our MICRO-FM - PCB size only 50x20mm. . . . £4.99
- MICRO-FM** A micro miniature personal FM receiver - High quality IC design (no alignment problems) - Great for surveillance work or for just listening to your favourite radio shows! (cased) . . . . . £7.99
- ROBO-VOX** Instantly transforms your voice into into Dalek/Robot type - also amazing feedback sound effects possible (cased) . . . . . £9.95
- ROBOT CIRCULAR** Unique radio controlled robot - can also be converted to control via computer. . . . . £16.95
- THERAMIN MUSIC GENERATOR** An electronic device based on an ancient legendary mystical instrument (cased) . . . . . £12.75
- SOLARTRONICS-88** Enter the exciting world of Solar Electronics with our Solar Designer's experimenter kit . . . . . £7.75
- SUPER SOUND-FX MICROCOMPUTER** An easy to use and program single chip sound effects Micro completely self contained - Incredible sound routines already masked programmed into the device - this is our most popular kit at present . . . . . £9.95
- SOUND-FX PRO CONSOLE CASE KIT** . . . . . £3.99

Please add 15% VAT and £0.95 per order for P&P. For FREE Datapack on all our Kits/ Products send SAE. - Allow up to 14 days for delivery - Make Cheques/Po's payable to :- ITRON U.K.

Castle Mill, Lower Kings Road  
BERKHAMSTED  
Hertfordshire HP4 2AD

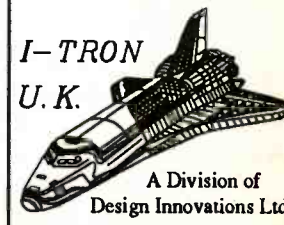

**I-TRON**  
U.K.

A Division of  
Design Innovations Ltd.

## NATIONAL COMPONENT CLUB

### SPECIAL OFFERS \* SPECIAL OFFERS

5	555 TIMER (IC's)	£1
5	741 OP-AMPS	£1
12	LED's (5mm red or green)	£1
25	GENERAL PURPOSE TRANSISTORS (BC 548, BC182 etc)	£1
15	BATTERY CLIPS (PP3)	£1
25	ASSORTED POTS & PRESETS	£1
70	ASSORTED CAPACITORS (Picofarads-2200uf)	£1
25	ELECTROLYTIC CAPACITORS (1uf-2200uf)	£1
1	6V 1.8VA POWER SUPPLY	£1
?	MYSTERY PACK	£1
10	CROCODILE CLIPS (5 red and 5 black)	£1
1	90db PIEZO SOUNDER	£1

**ANY SIX PACKS FOR A FIVER !  
ALL TWELVE FOR A TENNER !**

P.O. or Cheque to: NATIONAL COMPONENT CLUB, DEPT.EE,  
HIGHER ANSFORD, CASTLE CARY, SOMERSET BA7 7JG.  
Please add £1 P & P but do not add VAT.

**\* FREE CLUB MEMBERSHIP \***

## Need an extra pair of hands?

It's often the case that conventional methods just won't do. Fortunately there is now an alternative with the

### MULTI-PURPOSE JIG

It will hold a circuit board steady for assembly and wiring—  
It can hold things while glue sets—  
It can hold models for painting and repair—  
All its interchangeable heads rotate through 360 degrees so you can position your workpiece to best advantage—no need to take it out to turn it over either—just rotate it to where you want it.  
Precision spring loaded head for holding pressures of up to 5.5lbs.

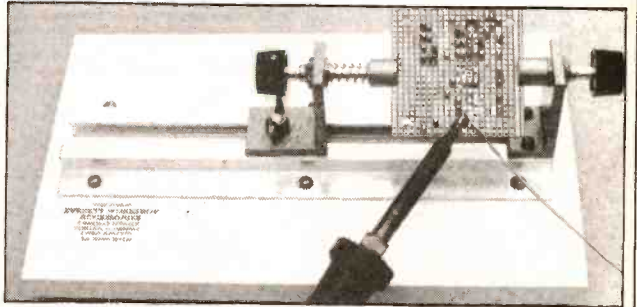

Each jig is hand built for a lifetime of use.

Due to improved production techniques we have also been able to reduce the prices!

Standard jig takes items up to 310 x 145mm **£19.50**  
Mini jig takes items up to 148 x 85mm **£16.50**  
inc. VAT and carriage

**EVERETT WORKSHOP ACCESSORIES**  
5 Railway Terrace, Henllan, Llandysul,  
Dyfed SA44 5TH

## SIGNAL GENERATORS

Two new  
AF and RF  
Signal  
Generators.

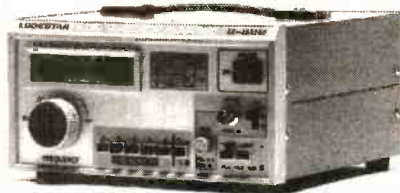

### Audio Signal Generator

Low distortion AF signal generator and frequency counter.

Frequency Range: 10Hz to 1MHz (in 5 ranges)

Output imp: 600Ω unbalanced

Output atten: 0, -20dB, -40dB and fine adjust

Output distortion: < 0.05% 500Hz to 50kHz

< 0.5% 50Hz to 500kHz

Square wave range: 10Hz to 20kHz (0.5μs rise time)

### RF Signal Generator

56-02603 **£183.65**

Signal generator and frequency counter covering 100kHz to 150MHz.

Frequency range: 100kHz-150MHz (upto 450MHz 3rd harmonic)

RF output: 100mV RMS (up to 35MHz)

Output atten: 0dB, -20dB and fine adjust

Int. modulation: 1kHz

Frequency counter: 10Hz to 150MHz (in 2 ranges)

PRICES INCLUDE VAT AND CARRIAGE.

56-04162 **£183.65**

AVAILABLE EX-STOCK.

# Cirkit



Cirkit Distribution Ltd.

Park Lane, Broxbourne, Herts EN10 7NQ.

Telephone (0992) 444111.

## MAKE YOUR INTERESTS PAY!

More than 8 million students throughout the world have found it worth their while! An ICS home-study course can help you get a better job, make more money and have more fun out of life! ICS has over 90 years experience in home-study courses and is the largest correspondence school in the world. You learn at your own pace. When and where you want, under the guidance of expert 'personal' tutors. Find out how we can help YOU. Post or phone today for your **FREE INFORMATION PACK** on the course of your choice.

GCSE / GCE / SCE ELECTRONICS	CAR MECHANICS COMPUTER PROGRAMMING	SEE ORACLE PAGE 871
BASIC ELECTRONIC ENGINEERING (City & Guilds)	TV, VIDEO & HI-FI SERVICING	
ELECTRICAL ENGINEERING ELECTRICAL CONTRACTING/ INSTALLATION	RADIO AMATEUR LICENCE EXAM (City & Guilds)	
Course of Interest _____		
Name: _____		
Address: _____ P.Code _____		
ICS International Correspondence Schools, Dept. ECS49 312/314 High Street, Sutton, Surrey SM1 1PR. Tel: 01-643 9568 or 041-221 2926 (24 hrs.)		

## OMNI ELECTRONICS

174 Dalkeith Road, Edinburgh EH16 5DX • 031 667 2611

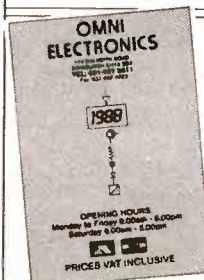

Have you sent for your copy of our catalogue yet?

If not, simply send 2 x 19p stamps for a copy by return.

**A COMPREHENSIVE RANGE  
WITH SERVICE SECOND TO  
NONE**



Open: Monday-Friday 9.00-6.00  
Saturday 9.00-5.00





## POWER CONDITIONER

FEATURED IN ETI  
JANUARY 1988

The ultimate mains purifier. Intended mainly for lowering the noise floor and improving the analytical qualities of top-flight audio equipment.

The massive filter section contains thirteen capacitors and two current balanced inductors, together with a bank of six VDRs, to remove every last trace of Impulsive and RF interference. A ten LED logarithmic display gives a second by second indication of the amount of interference removed.

Our approved parts set consists of case, PCB, all components (including high permeability toroidal cores, ICs, transistors, class X and Y suppression capacitors, VDRs, etc.) and full instructions.

PARTS SET £28.50 + VAT

A low cost (but high performance) mains conditioner is also available.  
MAINS CONDITIONER PARTS SET ES 40 + VAT  
RUGGED PLASTIC CASE £1.80 + VAT

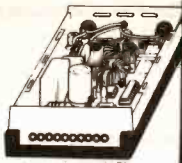

## KNIGHT RAIDER

FEATURED IN ETI JULY 1987

The ultimate in lighting effects for your Lamborghini, Maserati, BMW (or any other car, for that matter). Picture this: eight powerful lights in line along the front and eight along the rear. You flick a switch on the dashboard control box and a point of light moves lazily from left to right leaving a comet's tail behind it. Flip the switch again and the point of light becomes a bar, bouncing backwards and forwards along the row. Press again and try one of the other six patterns...

An LED display on the control box let's you see what the main lights are doing.

The Knight Raider can be fitted to any car (it makes an excellent fog light) or with low powered bulbs it can turn any child's pedal car or bicycle into a spectacular TV-age toy!

The parts set consists of box, PCB and components for control, PCB and components for sequence board, and full instructions.

Lamps not included.  
PARTS SET £19.90 + VAT

## RAINY DAY PROJECTS



All can be built in an afternoon!

JUMPIN' JACK FLASH (ETI March 1988)

Spectacular rock, stage and disco lighting effect! £6.90 + VAT

CREDIT CARD CASINO (ETI March 1987)

The wicked pocket gambling machine £5.90 + VAT

MAINS CONTROLLER (ETI January 1987)

Isolated logic to mains interface £6.20 + VAT

MATCHBOX AMPLIFIERS (ETI April 1986)

Listen: 50W of Hi-Fi power from an amp small enough to fit in a matchbox! £6.50 + VAT

Matchbox Amplifier (20W)

Matchbox Bridge Amplifier (50W) £8.90 + VAT

1.65V Power Amplifier IC, with data and circuits £3.90 + VAT

TACHO/DWELL METER (ETI January 1987)

Turn your Metro into a Porsche! £16.40 + VAT

HI-FI POWER METER (ETI May 1987)

Measures Hi-Fi output power up to 100W - includes PCB, components meters £3.90 + VAT

Mono power meter £7.20 + VAT



FEATURED IN ETI  
AUGUST 1988

There's nothing quite so encouraging as having a measurable result to show for your training efforts. If you are not particularly fit, your resting heart rate will be around 80 beats per minute. As your jogging, aerobics or sport strengthens your heart, the rate will drop dramatically - possibly to 60bpm or less. With the S101, you can watch your progress day by day.

Breathing is important too. How efficiently do you take up oxygen? How quickly do you recover from 'oxygen debt' after strenuous activity? The S101 will let you know.

The approved parts set consists of: case, 3 printed circuit boards, all components (including 17 ICs, quartz crystal, 75 transistors, resistors, diodes and capacitors), LCD, switches, plugs, sockets, electrodes, and full instructions for construction and use.

PARTS SET £33.80 + VAT

Some parts are available separately. Please send SAE for lists, or SAE + £2 for lists, circuit, construction details and training plan (free with parts set).

## THE DREAM MACHINE

FEATURED IN ETI  
DECEMBER 1987

Adjust the controls to suit your mood and let the gentle, relaxing sound drift over you. At first you might hear soft rain, sea surf, or the wind through distant trees. Almost hypnotic, the sound draws you irresistibly into a peaceful, refreshing sleep.

For many, the thought of waking refreshed and alert from perhaps the first truly restful sleep in years is exciting enough in itself. For more adventurous souls there are strange and mysterious dream experiences waiting. Take lucid dreams, for instance. Imagine being in control of your dreams and able to change them at will to act out your wishes and fantasies. With the Dream Machine it's easy!

The approved parts set consists of PCB, all components, controls, loudspeaker, knobs, lamp, fuseholders, fuse, mains power supply, prestige case and full instructions.

PARTS SET £16.50 + VAT

Don't forget! The best seller GROW RICH WHILE YOU SLEEP is now in stock.  
£2.95 (NOVAT)



## THE MISTRAL AIR IONISER

The best ioniser design yet - this one has variable ion drive, built-in ion counter and enough power to drive five multi-point emitters. For the technically minded, it has nine main drive stages, five secondary drives, and a four section booster to give an output capability of almost fifteen billion ( $1.47 \times 10^{10}$ ) ions every minute, or  $2.45 \times 10^{11}$  ions per second. With extra emitters this can be increased still further!

PARTS SET £24.80 + VAT

The parts set includes case, printed circuit boards, 126 top grade components, all controls, lamps, hardware, a multi-point phosphor-bronze emitter and full instructions.

Some parts are available separately - please send SAE for lists, or SAE + £1 for lists, circuit and construction details and further information (free with parts set).

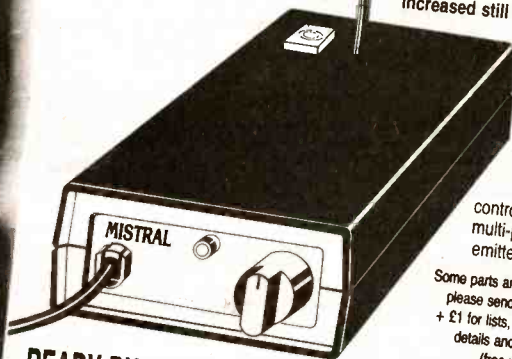

## READY-BUILT MISTRAL

The Mistral Ioniser (and most of our other projects) can now be supplied built, tested and ready to go. For details, please contact Peter Leah at P.L. Electronics, 8 Woburn Road, Eastville, Bristol BS5 6TT. Tel: 0272 522703. Evenings Only

INTERNAL EMITTER £2.69 + VAT

Can be used in place of the P-B external emitter, or both can be used together for the highest ion output. Parts set includes PCB, ion emitters, components and instructions.

## IPA BOARD CLEANER

Essential for removing grease and flux residues from the Mistral PCB to achieve peak performance. Applicator brush supplied.

£0.98 + VAT

## ION FAN

An almost silent piezo-electric fan, mains operated, to pump ions away from the emitter and into the room. Increases the effectiveness of any ioniser by five times!

£9.80 + VAT

## TV BOOSTER

Good TV pictures from poor aerials is what this project is all about. Keith Brimley's Aerial Booster gives a massive 23dB gain to ensure good viewing from campers and caravaners, from indoor aerials, or wherever a properly positioned high-gain antenna is not practical.

Based on the OM335 hybrid amplifier, the booster has specifications to rival the best, wideband operation from 100kHz to 1.4 GHz, mid-band gain of up to 26dB and a wide supply range of 9V to 26V (it will run from car batteries for caravanners, dry batteries for campers, or a mains 'battery eliminator' in the home). No special UHF construction skills are needed - the project could be made by a careful beginner.

There are two parts sets for the project. AA1 contains the printed circuit board, OM335 hybrid amplifier, components and instructions. AA2 is the optional case set: rugged screened box, front and rear panels, waterproofing gaskets, test, sockets and hardware.

AA1 PARTS SET £12.80 + VAT

AA2 PARTS SET £4.80 + VAT

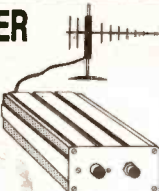

## ION DISPERSION METER

FEATURED IN ETI  
FEBRUARY 1989

The O-ion is a hand-held meter which alerts out ions in the air. It can tell the good ones from the bad! If you're thinking of buying a commercial ioniser, check the efficiency and output of one you've made yourself. help you set up ions and position the ioniser for best effect, do an ion-survey of your house or office - in short, it will tell you anything you want to know about ions in the air.

In direct mode the bar-graph readout will detect the presence of negative or positive ions and measure ion strength from  $5 \times 10^7$  to  $10^{10}$  ions per second, which covers the levels you can expect when an air purifier is in use. For the smaller concentrations of natural air ions, integrate mode will increase the sensitivity by far as you like.

Our approved parts set consists of: case, ion collector, printed circuit board, all components (including six ICs, diodes, LEDs, zener, 37 resistors and capacitors, LEDA, plug, socket, earth lead, etc.) and full instructions.

PARTS SET £16.40 + VAT

Some parts are available separately - please send SAE for lists, or SAE + £1 for lists, circuit, construction details and further information (free with parts set).



## BIO-FEEDBACK

FEATURED IN ETI  
DECEMBER 1986

Bio-feedback comes of age with this highly responsive, self-balancing skin response monitor! The pc-erful circuit has found application in clinical situations as well as on the bio-feedback scene. It will open your eyes to what GSR techniques are really all about. The complete parts set includes case, PCB, all components, leads, electrodes, conductive gel, and full instructions.

PARTS SET £15.80 + VAT

BIO-FEEDBACK BOOK £4.50 (no VAT)

Please note: the book, by Stern and Ray, is an authorised guide to the potential of bio-feedback techniques. It is not a hobby book, and will only be of interest to intelligent adults.



## POWERFUL AIR IONISER

FEATURED IN ETI  
JULY 1986

Ions have been described as 'vitamins of the air' by the health magazines, and have been credited with everything from curing hay fever and asthma to improving concentration and putting an end to insomnia. Although some of the claims may be exaggerated, there is no doubt that ionised air is much cleaner and purer, and seems much more invigorating than 'dead' air.

The DIRECT ION ioniser caused a great deal of excitement when it appeared as a constructional project in ETI. At last, an ioniser that was comparable with (better than?) commercial products, was reliable, good to build, and fun! Apart from the serious applications, some of the suggested experiments were outrageous!

We can supply a matched set of parts, fully approved by the designer, to build this unique project. The set includes a roller lined printed circuit board, 66 components, case, mains lead, and even the parts for the tester. According to one customer, the set costs about a third of the price of the individual components. What more can we say?

PARTS SET WITH BLACK CASE £11.50 + VAT

PARTS SET WITH WHITE CASE £11.80 + VAT



## BURGLAR BUSTER

Be safe from intruders with our Burglar Buster alarm system! It has all the features you'd expect from a high-tech alarm: entry and exit delay, anti-tamper loop, delay warning and control-box protection.

The parts set includes all four PCBs and all components to go on them. Other parts (case, switches, etc.) are available separately, if you haven't got anything suitable in your spare box. Set contains 4 PCBs, ICs, transistors, relays, capacitors, resistors, diodes, regulator, piezo sounder and full instructions.

BB1 PARTS SET £12.80 + VAT

## LEDs

Green rectangular LEDs for bar-graph displays.

50 for £3.50 500 for £25

100 for £6 1000 for £45

DIGITAL AND AUDIO EQUIPMENT LEDs  
Assorted 3mm LEDs: red, green, yellow and orange.  
25 of each (100 LEDs) for £6.80

U.K. Orders: please add 50p post and packing and 15% VAT to total.  
Eire and overseas:  
no VAT. Carriage and insurance £4.50.  
Please allow up to 14 days for delivery.

Specialist SEMICONDUCTORS LIMITED

Tel: (0600) 3715

SALES DEPT., ROOM 111, FOUNDERS HOUSE, REDBROOK, MONMOUTH, GWENT.

## BRAINWAVE MONITOR

FEATURED IN ETI  
AUGUST 1987

The most astonishing project ever to have appeared in an electronics magazine. Similar in principle to a medical EEG machine, this project allows you to hear the characteristic rhythms of your own mind! The alpha, beta and theta forms can be selected for study and the three articles give masses of information on their interpretation and powers.

In conjunction with Dr. Lewis's Alpha Plan, the monitor can be used to overcome shyness, to help you feel confident in stressful situations, and to train yourself to excel at things you're 'not good at'.

Our approved parts set contains case, two PCBs, screening can for bio-amplifier, all components (including three PMI precision amplifiers), leads, brass electrodes and full instructions.

PARTS SET £36.90 + VAT ALPHA PLAN BOOK £2.50

SILVER SOLUTION (for plating electrodes) £3.60 + VAT

Parts set available separately. We also have a range of accessories, professional electrodes, books, etc. Please send SAE for lists, or SAE + £2 for lists, construction details and further information (free with parts set).



Carbon Film resistors 1/4W 5% E24 series 0.51R to 10M0	1p
100 off per value—75p, even hundreds per value totalling 1000	£6.00p
Metal Film resistors 1/4W 10R to 1M0 5% E12 series—2p, 1% E24 series	3p
Mixed metal/carbon film resistors 1/2W E24 series 1R0 to 10M0	1 1/2p
1 watt mixed metal/Carbon Film 5% E12 series 4R7 to 10 Megohms	5p
Linear Carbon pre-sets 100mW and 1/4W 100R to 4M7 E6 series	7p
<b>Miniature polyester capacitors 250V working for vertical mounting</b>	
0.15, .022, .033, .047, .068-4p, 0.1-5p, 0.12, 0.15, 0.22-6p, 0.47-8p, 0.68-8p, 1.0-12p	
<b>Mylar (polyester) capacitors 100V working E12 series vertical mounting</b>	
1000p to 8200p - 3p, .01 to .068 - 4p, 0.1 - 5p, 0.12, 0.15, 0.22-6p, 0.47/50V-8p	
<b>Submin ceramic plate capacitors 100V wkg vertical mountings, E12 series</b>	
2% 1.8pf to 47pf - 3p, 2% 56 pf to 330pf - 4p, 10% 390p - 4700p	4p
Disc/plate ceramics 50V E12 series 1P0 to 1000P, E6 Series 1500P to 47000P	2p
<b>Polystyrene capacitors 63V working E12 series long axial wires</b>	
10pf to 820pf - 3p, 1000 pf to 10,000pf - 4p, 12,000 pf	5p
741 Op Amp - 20p, 555 Timer	22p
cmos 4001 - 20p, 4011 - 22p, 4017	40p
<b>ALUMINIUM ELECTROLYTICS (Mfds/Volts)</b>	
1/50, 2/2/50, 4/7/50, 10/25, 10/50	5p
22/16, 22/25, 22/50, 47/16, 47/25, 47/50	6p
100/16, 100/25 7p; 100/50 12p; 100/100	14p
220/16 8p; 220/25, 220/50 10p; 470/16, 470/25	11p
1000/25 25p; 1000/35, 2200/25 35p; 4700/25	70p
<b>Submin, tantalum bead electrolytics (Mfds/Volts)</b>	
0.1/35, 0.22/35, 0.47/35, 1.0/35, 3.3/16, 4.7/16	14p
2.2/35, 4.7/25, 4.7/35, 6.8/16 15p; 10/16, 22/6	20p
33/10, 47/6, 22/16 30p; 47/10 35p; 47/16 60p; 47/35	80p
<b>VOLTAGE REGULATORS</b>	
1A + or - 5V, 8V, 12V, 15V, 18V & 24V	55p
<b>DIODES (piv/amps)</b>	
75/25mA 1N4148 2p, 800/1A 1N4006 6p, 400/3A 1N5404 14p, 115/15mA OA91	6p
100/1A 1N4002 4p, 1000/1A 1N4007 7p, 60/1.5A S1M1 5p, 100/1A bridge	25p
400/1A 1N 4004 5p, 1250/1A BY127 10p, 30/1.5A OA47	8p
Zener diodes E24 series 3V3 to 33V 400 mW - 8p, 1 watt	12p
<b>Battery snaps for PP3 - 6p for PP9</b>	12p
L.E.D.'s 3mm, & 5mm. Red, Green, Yellow - 10p, Grommets 3mm - 2p, 5mm	2p
Red flashing L.E.D.'s require 5V supply only	50p
Mains indicator neons with 220k resistor	10p
20mm fuses 100mA to 5A Q/blow 5p, A/surge 8p, Holders pc or chassis	5p
High speed pc drill 0.8, 1.0, 1.3, 1.5, 2.0mm - 30p, Machines 12V dc	£7.00
HELPING HANDS 6 ball joints and 2 croc clips to hold awkward jobs	£3.50p
AA/HP7 Nicad rechargeable cells 80p each, Universal charger unit	£6.50p
Glass reed switches with single pole make contacts - 8p, Magnets	12p
<b>TRANSISTORS</b>	
BC547/8/9-8p, BC557/8/9-8p, BC182L/4L-10p, BC183, 183L-10p, BC212, 212L-10p,	
BC337, 337L-12p, BC727/737-12p, BD135/6/7/8/9-25p, BCV70-15p, BFY50, 52-20p,	
BFX88-15p, 2N3065-50p, TIP31, 32-30p, TIP41, 42-40p, BU208A-£1.20, BF195, 197-12p	
All prices are inclusive of VAT. Postage 25p (free over £5). Lists Free.	

**THE CR SUPPLY CO**  
127 Chesterfield Rd, Sheffield S8 0RN  
Return posting

## ADVERTISERS INDEX

ANDOR ELECTRONICS	265
BARRIE ELECTRONICS	285
BICC-VERO ELECTRONICS	223
B K ELECTRONICS	Cover (iii)
BULL, J. & N.	Cover (ii)
CIRKIT DISTRIBUTION	286
CRICKLEWOOD ELECTRONICS	231
CR SUPPLY CO.	288
ELECTRONIZE DESIGN	265
EVERETT WORKSHOP ACCESS	286
GREENWELD ELECTRONICS	222
HART ELECTRONIC KITS	221
HIGHGRADE COMPONENTS	220
I-TRON UK	285
ICS	286
JAYTEE ELEC. SERVICES	222
KEMSOFT	255
LONDON ELECTRONICS COLLEGE	288
MAGENTA ELECTRONICS	218
MAPLIN ELECTRONICS	Cover (iv)
MARCO TRADING	281
MAURITRON ELECTRONICS	281
NATIONAL COMPONENT CLUB	286
OMNI ELECTRONICS	286
PHONOSONICS	288
POWERLINE	285
RADIO & TV COMPONENTS	231
RISCOMP	285
RUGGED DISPLAYS	263
SHERWOOD DATA SYSTEMS	221
SHERWOOD ELECTRONIC COMPONENTS	285
SM ENGINEERING	255
SPECIALIST SEMICONDUCTORS	287
SUMA DESIGNS	281
TANDY	237
TK ELECTRONICS	224

## ELECTRONICS TECHNICIAN FULL-TIME TRAINING

(FULL TIME COURSES APPROVED BY THE BUSINESS & TECHNICIAN EDUCATION COUNCIL)

**2 YEAR**  
**BTEC National Diploma (OND)**  
**ELECTRONIC & COMMUNICATIONS ENGINEERING**  
(Electronics, Computing, Television, Video, Testing & Fault Diagnosis)

**1 YEAR**  
**BTEC National Certificate (ONC)**  
**ELECTRONIC ENGINEERING**  
1—INFORMATION TECHNOLOGY  
(Electronics, Satellite TV, CD, Networks, Telecomms)

2—ELECTRONIC EQUIPMENT SERVICING  
(Electronics, Television, Video Cassette Recorders, CCTV, Testing and Fault Diagnosis)

3—SOFTWARE ENGINEERING  
(Electronics, Assembler, BASIC, PASCAL, CAD/CAM)

4—COMPUTING TECHNOLOGY  
(Electronics, Computing Software/Hardware, Microelectronic Testing Methods)

**10 MONTHS**  
**BTEC Higher National Certificate (HNC)**  
**COMPUTING TECHNOLOGY & ROBOTICS**  
(Microprocessor Based Systems, Fault Diagnosis, ATE, Robotics) (Those eligible can apply for E.T. grant support)

*These courses include a high percentage of college based practical work to enhance future employment prospects. No additional fees for overseas students. Shortened courses of from 3 to 6 months can be arranged for applicants with previous electronics knowledge.*

**O.N.C. Monday 24th April 1989**  
**FULL PROSPECTUS FROM**

**LONDON ELECTRONICS COLLEGE**  
(Dept. EE), 20 PENYWERN ROAD  
EARLS COURT, LONDON SW5 9SU  
Tel: 01-373 8721

**\* LEARN BY BUILDING \* ENJOY BY USING \***

**PUBLISHED DESIGN FEATURES**

# PROJECT KITS

**\* BE CREATIVE \* RAISE YOUR SKILLS \* GET KITTED! \***

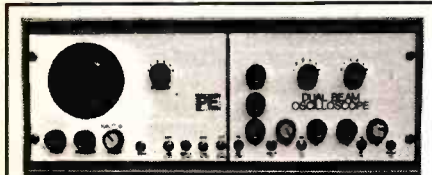

### DUAL BEAM OSCILLOSCOPE

2Y-amps, 6 ranges, variable level, DC to over 1MHz. 4 modes - Y1, Y2, Y1 & Y2, Y1 & Y2 to X. Time base variable from 0.05Hz to 20KHz. Variable sync level, polarity and source. Separate bright-line, brilliance and focus controls. Independent trace deflection controls. Details in catalogue.

### BURGLAR ALARM CONTROLLERS

#### MULTIZONE CONTROL SET280

£22.77

Two entry-zones, anti-tamper loop, personal attack, entry-exit timing, timed duration, automatic resetting, latching LED monitors.

#### SINGLE ZONE CONTROL SET279

£9.32

With timed duration control and latching LED monitor. Both units can be used with any standard detection devices, such as contact or magnetic switches, pressure pads, tremblers, ultrasonics, infrared etc., and will activate standard bells, strobes or sirens.

### COMPUTER KITS

The software listings published with the computer kit projects are for use with C64, PET and BBC computers.

**CHIP TESTER SET258F** £39.30

Computer controlled logic and chip analyser.

**EPROM PROGRAMMER SET277** £25.25

Computer controlled unit for 4K Eproms.

**MICRO-CHAT SET276** £64.50

Computer controlled speech synthesiser.

**MICRO-SCOPE SET247** £44.50

Turns a computer into an oscilloscope.

**MICRO-TUNER SET257** £55.32

Computer controlled, tuning aid and freq counter.

**MORSE DECODER SET269** £22.16

Computer controlled morse code-decoder.

SEND 9"x4" S.A.E. FOR CATALOGUE AND WITH ALL ENQUIRIES (OVERSEAS SEND £1.00)

### VARIOUS

**VOICE SCRAMBLER SET287** £42.22

32 switchable channels to keep your communications confidential.

**STORMS!** £29.50 each unit

Raw nature under panel control! Wind & Rain SET250W.

Thunder & Lightning SET250T.

**DISCO-LIGHTS SET245F** £62.50

3 chan sound to light, chasers, auto level.

**EVENT COUNTER SET278** £31.50

4-digit display counting for any logic source.

### ASTRONOMY



#### SIDEREAL CLOCK SET295

£49.50

Dual purpose star-time and solar-time digital clock with alarm.

### ENVIRONMENT

#### WEATHER CENTRE

Keep the Met Office in check and monitor the wind speed and direction, rain, temperature, soil moisture and sunny days.

Six detector circuits - KIT 275.1 £18.07

Automatic metered control monitor circuit - KIT 275.2 £40.95

Optional computer control circuit - KIT 275.3 £14.20

#### ELECTRONIC BAROMETER SET285

£35.55

Computer controlled unit for monitoring atmospheric pressure.

#### GEIGER COUNTER SET264

£59.50

A nuclear radiation detector for environmental and geological monitoring. With built in speaker, meter and digital output. This project was demonstrated on BBC TV.

### ORDERING

Send 9"x4" SAE for detailed catalogue, and with all enquiries (overseas send £1.00 or 5 I.R.C.'s). Add 15% VAT. Add P&P - Sets over £5 add £2.50. Others add £1.50. Overseas P&P in catalogue. Text photocopies - Geiger 264 and Weather 275 £1.50, others 50p, plus 50p post or large SAE. Insurance 50p per £50. MAIL ORDER, CWO, CHQ, PO, ACCESS VISA. Telephone orders: Mon-Fri, 9am - 6pm. 0689 37821. (Usually answering machine).

**PHONOSONICS, DEPT EE94, 8 FINUCANE DRIVE, ORPINGTON, KENT, BR5 4ED MAIL ORDER**

Published on approximately the first Friday of each month by Wimborne Publishing Ltd., 6 Church Street, Wimborne, Dorset BH21 1JH. Printed in England by Benham & Co. Limited, Colchester, Essex. Distributed by Seymour, 334 Brixton Road, London SW9 7AG. Sole Agents for Australia and New Zealand - Gordon & Gotch (Asia) Ltd., South Africa - Central News Agency Ltd. Subscriptions INLAND £15.70 and OVERSEAS £19 payable to "Everyday Electronics" Subscription Department, 6 Church Street, Wimborne, Dorset BH21 1JH. EVERYDAY ELECTRONICS is sold subject to the following conditions, namely that it shall not, without the written consent of the Publishers first having been given, be lent, resold, hired out or otherwise disposed of by way of Trade at more than the recommended selling price shown on the cover, and that it shall not be lent, resold, hired out or otherwise disposed of in a mutilated condition or in any unauthorised cover by way of Trade or affixed to or as part of any publication or advertising, literary or pictorial matter whatsoever.

**OVP POWER AMPLIFIER MODULES-TURNABLES-DIMMERS-LOUDSPEAKERS-19 INCH STEREO RACK AMPLIFIERS**

**OVP POWER AMPLIFIER MODULES**

Supplied ready built and tested.

**OVP POWER AMPLIFIER MODULES** Now enjoy a world-wide reputation for quality, reliability and performance at a realistic price. Four models available to suit the needs of the professional and hobby market, i.e., Industry, Leisure, Instrumental and Hi-Fi etc. When comparing prices, NOTE all models include Toroidal power supply, Integral heat sink, Glass fibre P.C.B. and Drive circuits to power compatible Vu meter. Open and short circuit proof.

**THOUSANDS OF MODULES PURCHASED BY PROFESSIONAL USERS**



**OVP100 Mk 11 Bi-Polar** Output power 110 watts R.M.S. into 4 ohms, Frequency Response 15Hz - 30KHz - 3dB, T.H.D. 0.01%, S.N.R. -118dB. Sens. for Max. output 500mV at 10K, Size 355 x 115x65mm. **PRICE £33.99 + £3.00 P&P.**

**NEW SERIES II MOS-FET MODULES**



**OVP/MF100 Mos-Fet** Output power 110 watts R.M.S. into 4 ohms, Frequency Response 1Hz - 100KHz -3dB, Damping Factor, >300, Slew Rate 45V/uS, T.H.D. Typical 0.002%, Input Sensitivity 500mV, S.N.R. -125dB. Size 300 x 123 x 60mm. **PRICE £39.99 + £3.00 P&P.**



**OVP/MF200 Mos-Fet** Output power 200 watts R.M.S. into 4 ohms, Frequency Response 1Hz - 100KHz -3dB, Damping Factor >300, Slew Rate 50V/uS, T.H.D. Typical 0.001%, Input Sensitivity 500mV, S.N.R. -130dB. Size 300 x 155 x 100mm. **PRICE £62.99 + £3.50 P&P.**



**OVP/MF300 Mos-Fet** Output power 300 watts R.M.S. into 4 ohms, Frequency Response 1Hz - 100KHz -3dB, Damping Factor >300, Slew Rate 60V/uS, T.H.D. Typical 0.0008%, Input Sensitivity 500mV, S.N.R. -130dB. Size 330 x 175 x 100mm. **PRICE £79.99 + £4.50 P&P.**

NOTE:— MOS-FET MODULES ARE AVAILABLE IN TWO VERSIONS, STANDARD — INPUT SENS. 500mV BAND WIDTH 100KHz, PEC (PROFESSIONAL EQUIPMENT COMPATIBLE) — INPUT SENS. 775mV, BAND WIDTH 50KHz, ORDER STANDARD OR PEC



**Vu METER** Compatible with our four amplifiers detailed above. A very accurate visual display employing 11 L.E.D. diodes (7 green, 4 red) plus an additional on/off indicator. Sophisticated logic control circuits for very fast rise and decay times. Tough moulded plastic case, with tinted acrylic front. Size 84 x 27 x 45mm. **PRICE £8.50 + 50p P&P.**

**LOUDSPEAKERS**



**LARGE SELECTION OF SPECIALIST LOUDSPEAKERS AVAILABLE, INCLUDING CABINET FITTINGS, SPEAKER GRILLES, CROSS-OVERS AND HIGH POWER, HIGH FREQUENCY BULLETS AND HORNS, LARGE S.A.E. (30p STAMPED) FOR COMPLETE LIST.**

**McKENZIE:— INSTRUMENTS, P.A., DISCO, ETC.**

**ALL MCKENZIE UNITS 8 OHMS IMPEDENCE**

- 8" 100 WATT C8100GPM GEN. PURPOSE, LEAD GUITAR, EXCELLENT MID., DISCO. RES. FREQ. 80Hz. FREQ. RESP. TO 14KHz. SENS. 99dB. **PRICE £28.59 + £2.00 P&P.**
- 10" 100 WATT C10100GP GUITAR, VOICE, ORGAN, KEYBOARD, DISCO, EXCELLENT MID. RES. FREQ. 70Hz. FREQ. RESP. TO 6KHz. SENS. 100dB. **PRICE £34.70 + £2.50 P&P.**
- 12" 200 WATT C10200GP GUITAR, KEYBOARD, DISCO, EXCELLENT HIGH POWER MID. RES. FREQ. 45Hz. FREQ. RESP. TO 7KHz. SENS. 103dB. **PRICE £47.48 + £2.50 P&P.**
- 12" 100 WATT C12100GP HIGH POWER GEN. PURPOSE, LEAD GUITAR, DISCO. RES. FREQ. 45Hz. FREQ. RESP. TO 7KHz. SENS. 98dB. **PRICE £36.66 + £3.50 P&P.**
- 12" 100 WATT C12100TC TWIN CONE HIGH POWER WIDE RESPONSE, P.A., VOICE, DISCO. RES. FREQ. 45Hz. FREQ. RESP. TO 14KHz. SENS. 100dB. **PRICE £37.63 + £3.50 P&P.**
- 12" 200 WATT C12200B HIGH POWER BASS, KEYBOARDS, DISCO, P.A. RES. FREQ. 40Hz. FREQ. RESP. TO 7KHz. SENS. 100dB. **PRICE £64.17 + £3.50 P&P.**
- 12" 300 WATT C12300GP HIGH POWER BASS LEAD GUITAR, KEYBOARDS, DISCO, ETC. RES. FREQ. 45Hz. FREQ. RESP. TO 5KHz. SENS. 100dB. **PRICE £85.79 + £3.50 P&P.**
- 15" 100 WATT C15100BS BASS GUITAR, LOW FREQUENCY, P.A., DISCO. RES. FREQ. 40Hz. FREQ. RESP. TO 5KHz. SENS. 98dB. **PRICE £53.70 + £4.00 P&P.**
- 15" 200 WATT C15200BS VERY HIGH POWER BASS. RES. FREQ. 40Hz. FREQ. RESP. TO 4KHz. SENS. 99dB. **PRICE £73.26 + £4.00 P&P.**
- 15" 250 WATT C15250BS VERY HIGH POWER BASS. RES. FREQ. 40Hz. FREQ. RESP. TO 4KHz. SENS. 99dB. **PRICE £87.53 + £4.50 P&P.**
- 15" 400 WATT C15400BS VERY HIGH POWER, LOW FREQUENCY BASS. RES. FREQ. 40Hz. FREQ. RESP. TO 4KHz. SENS. 102dB. **PRICE £94.12 + £4.50 P&P.**
- 18" 400 WATT C18400BS EXTREMELY HIGH POWER, LOW FREQUENCY BASS. RES. FREQ. 27Hz. FREQ. RESP. TO 3KHz. SENS. 99dB. **PRICE £167.85 + £5.00 P&P.**

**EARBENDERS:— HI-FI, STUDIO, IN-CAR, ETC.**

**ALL EARBENDER UNITS 8 OHMS EXCEPT EB8-50 DUAL 4 AND 8 OHM. BASS, SINGLE CONE, HIGH COMPLIANCE, ROLLED FOAM SURROUND**

- 8" 50 WATT EB8-50 DUAL IMPEDENCE, TAPPED 4/8 OHM BASS, HI-FI, IN-CAR. RES. FREQ. 40Hz. FREQ. RESP. TO 7KHz. SENS. 97dB. **PRICE £8.90 + £2.00 P&P.**
- 10" 50 WATT EB10-50 DUAL IMPEDENCE, TAPPED 4/8 OHM BASS, HI-FI, IN-CAR. RES. FREQ. 40Hz. FREQ. RESP. TO 9KHz. SENS. 99dB. **PRICE £12.00 + £2.50 P&P.**
- 10" 100 WATT EB10-100 BASS, HI-FI, STUDIO. RES. FREQ. 35Hz. FREQ. RESP. TO 3KHz. SENS. 96dB. **PRICE £27.50 + £3.50 P&P.**
- 12" 60 WATT EB12-60 BASS, HI-FI, STUDIO. RES. FREQ. 28Hz. FREQ. RESP. TO 3KHz. SENS. 92dB. **PRICE £21.00 + £3.00 P&P.**
- 12" 100 WATT EB12-100 BASS, STUDIO, HI-FI, EXCELLENT DISCO. RES. FREQ. 26Hz. FREQ. RESP. TO 3KHz. SENS. 93dB. **PRICE £32.00 + £3.50 P&P.**
- FULL RANGE TWIN CONE, HIGH COMPLIANCE, ROLLED SURROUND**
- 5 1/2" 60 WATT EB5-60TC (TWIN CONE) HI-FI, MULTI-ARRAY DISCO ETC. RES. FREQ. 63Hz. FREQ. RESP. TO 20KHz. SENS. 92dB. **PRICE £9.99 + £1.50 P&P.**
- 6 1/2" 60 WATT EB6-60TC (TWIN CONE) HI-FI, MULTI-ARRAY DISCO ETC. RES. FREQ. 38Hz. FREQ. RESP. TO 20KHz. SENS. 94dB. **PRICE £10.99 + £1.50 P&P.**
- 8" 60 WATT EB8-60TC (TWIN CONE) HI-FI, MULTI-ARRAY DISCO ETC. RES. FREQ. 40Hz. FREQ. RESP. TO 18KHz. SENS. 98dB. **PRICE £12.99 + £1.50 P&P.**
- 10" 60 WATT EB10-60TC (TWIN CONE) HI-FI, MULTI-ARRAY DISCO ETC. RES. FREQ. 35Hz. FREQ. RESP. TO 12KHz. SENS. 86dB. **PRICE £16.49 + £2.00 P&P.**

**TRANSMITTER HOBBY KITS**

**PROVEN TRANSMITTER DESIGNS INCLUDING GLASS FIBRE PRINTED CIRCUIT BOARD AND HIGH QUALITY COMPONENTS COMPLETE WITH CIRCUIT AND INSTRUCTIONS**

**3W FM TRANSMITTER 80-108MHz. VARICAP CONTROLLED PERFORMANCE, RANGE UP TO 3 MILES, SIZE 38 x 123mm, SUPPLY 12V @ 0.5AMP. PRICE £14.49 + £1.00 P&P**

**FM MICRO TRANSMITTER (BUG) 100-108MHz VARICAP TUNED COMPLETE WITH VERY SENS FET MIC, RANGE 100-300m, SIZE 56 x 46mm, SUPPLY 9V BATT, PRICE £8.62 + £1.00 P&P**



3 watt FM Transmitter



POSTAL CHARGES PER ORDER £1.00 MINIMUM. OFFICIAL ORDERS WELCOME FROM SCHOOLS, COLLEGES, GOVT. BODIES, ETC. PRICES INCLUSIVE OF V.A.T. SALES COUNTER. VIS A ACCESS CARD



\* PRICES INCLUDE V.A.T. \* PROMPT DELIVERIES \* FRIENDLY SERVICE \* LARGE S.A.E., 30p STAMPED FOR CURRENT LIST.

**OVP VARISPEED TURNTABLE CHASSIS**

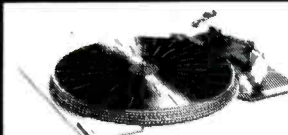

★ MANUAL ARM ★ STEEL CHASSIS ★ ELECTRONIC SPEED CONTROL 33 & 45 ★ VARI PITCH CONTROL ★ HIGH TORQUE SERVO DRIVEN DC MOTOR ★ TRANSIT SCREWS ★ 12" DIE CAST PLATTER ★ NEON STROBE ★ CALIBRATED BAL WEIGHT ★ REMOVABLE HEAD SHELL ★ 1/2" CARTRIDGE FIXINGS ★ CUE LEVER ★ POWER 220 240V 50/60Hz ★ 390x305mm ★ SUPPLIED WITH MOUNTING CUT-OUT TEMPLATE. **PRICE £59.99 + £3.50 P&P.**

**OPTIONAL MAGNETIC CARTRIDGES**

**STANTON AL500**  
PRICE £16.99 + 50p P&P

**GOLDRING G850**  
PRICE £6.99 + 50p P&P

**OVP MOS-FET POWER AMPLIFIERS, HIGH POWER, TWO CHANNEL 19 INCH RACK**

**THOUSANDS PURCHASED BY PROFESSIONAL USERS**

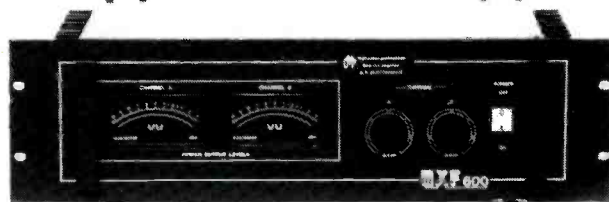

**NEW MXF SERIES OF POWER AMPLIFIERS**

THREE MODELS:— **MXF200 (100w + 100w)**  
**MXF400 (200w + 200w)** **MXF600 (300w + 300w)**

All power ratings R.M.S. into 4 ohms.

**FEATURES:** ★ Independent power supplies with two Toroidal Transformers ★ Twin L.E.D. Vu meters ★ Rotary indented level controls ★ Illuminated on off switch ★ XLR connectors ★ Standard 775mV inputs ★ Open and short circuit proof ★ Latest Mos-Fets for stress free power delivery into virtually any load ★ High slew rate ★ Very low distortion ★ Aluminium cases ★ MXF600 Fan cooled with D.C. loudspeaker and thermal protection.

**USED THE WORLD OVER IN CLUBS, PUBS, CINEMAS, DISCOS ETC.**

**SIZES:—** MXF 200 W19" x H3 1/2" (2U) x D11"  
MXF 400 W19" x H5 1/4" (3U) x D12"  
MXF 600 W19" x H5 1/4" (3U) x D13"

**PRICES: MXF200 £171.35**  
**MXF400 £228.85**  
**MXF600 £322.00**

SECURICOR DELIVERY £12.00 EACH



**OVP LINNET LOUDSPEAKERS**

THE VERY BEST IN QUALITY AND VALUE



MADE ESPECIALLY TO SUIT TODAY'S NEED FOR COMPACTNESS WITH HIGH OUTPUT SOUND LEVELS. FINISHED IN HARDWEARING BLACK VINYL WITH PROTECTIVE CORNERS, GRILLE AND CARRYING HANDLE INCORPORATES 12" DRIVER PLUS HIGH FREQ. HORN FOR FULL FREQ. RANGE. 45Hz-20KHz BOTH MODELS 8 OHM. SIZE H18" x W15" x D12"

CHOICE OF TWO MODELS

POWER RATINGS QUOTED IN WATTS RMS FOR EACH CABINET

**OVP 12-100 (100W 100dB) PRICE £159.99 PER PAIR**

**OVP 12-200 (200W 102dB) PRICE £209.99 PER PAIR**

SECURICOR DEL.— £12.00 PER PAIR

**OVP SLIDE DIMMER 1K WATT & 2.5K WATT**

CONTROLS LOADS UP TO 1KW & 2.5KW. SUITABLE FOR RESISTIVE AND INDUCTIVE LOADS. BLACK ANODISED CASE. READILY FLUSH MOUNTED THROUGH PANEL CABINET CUT-OUTS. ADVANCED FEATURES INCLUDE:—

- ★ FULL 65mm SLIDE TRAVEL
- ★ NEON MONITOR INDICATOR
- ★ FLASH OVERRIDE BUTTON
- ★ HIGH & LOW LEVEL PRESETS
- ★ FULLY SUPPRESSED TO BS 800

**SIZES:—** 1KW H128xW40xD55mm  
2.5KW H128xW76xD79mm

**PRICES:— 1K WATT £15.99**  
**2.5K WATT £24.99 + 60p P&P**

**PIEZO ELECTRIC TWEETERS—MOTOROLA**

**PIEZO ELECTRIC TWEETERS — MOTOROLA**

Join the Piezo revolution. The low dynamic mass (no voice coil) of a Piezo tweeter produces an improved transient response with a lower distortion level than ordinary dynamic tweeters. As a crossover is not required these units can be added to existing speaker systems of up to 100 watts (more if 2 put in series). **FREE EXPLANATORY LEAFLETS SUPPLIED WITH EACH TWEETER.**

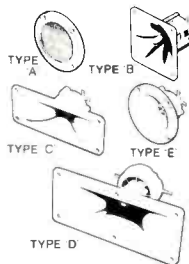

**TYPE 'A' (KSN2036A)** 3" round with protective wire mesh, ideal for bookshelf and medium sized Hi-Fi speakers. **Price £4.90 each + 50p P&P.**  
**TYPE 'B' (KSN1005a)** 3 1/2" super horn. For general purpose speakers, disco and P.A. systems etc. **Price £5.00 each + 50p P&P.**  
**TYPE 'C' (KSN6016A)** 2 1/2" x 5" wide dispersion horn. For quality Hi-Fi systems and quality discos etc. **Price £6.99 each + 50p P&P.**  
**TYPE 'D' (KSN1025A)** 2" x 6" wide dispersion horn. Upper frequency response retained extending down to mid range (2KHz). Suitable for high quality Hi-Fi systems and quality discos. **Price £9.99 each + 50p P&P.**  
**TYPE 'E' (KSN1038A)** 3 3/4" horn tweeter with attractive silver finish trim. Suitable for Hi-Fi monitor systems etc. **Price £5.99 each + 50p P&P.**  
**LEVEL CONTROL** Combines on a recessed mounting plate, level control and cabinet input jack socket. 85x85mm. **Price £3.99 + 50p P&P.**

**STEREO DISCO MIXER**

**STEREO DISCO MIXER** with 2 x 5 band L & R graphic equalisers and twin 10 segment L.E.D. Vu Meters. Many outstanding features 5 inputs with individual faders providing a useful combination of the following:—  
3 Turntables (Mag), 3 Mics, 4 Line including CD plus Mic with talk over switch Headphone Monitor, Pan Pot L & R, Master Output controls, Output 775mV. Size 360x280x90mm. Supply 220-240V.  
**Price £134.99 — £4.00 P&P**

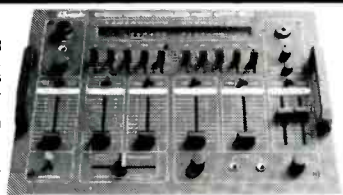

**B. K. ELECTRONICS Dept EE**

UNIT 5, COMET WAY, SOUTHDEN-ON-SEA, ESSEX. SS2 6TR  
TEL: 0702-527572 FAX: 0702-420243

# THE NEW MAPLIN CATALOGUE IT'S OUT OF THIS WORLD SEND FOR YOUR COPY TODAY

**ORDER YOUR COPY OF THE NEW MAPLIN CATALOGUE ON SALE NOW**

Pick up a copy from any W.H. Smith for just £1.95 or post this coupon now to receive your copy by post for just £1.95 + 50p p & p. If you live outside the U.K. send £3.40 or 15 International Reply Coupons. I enclose £2.45.

Name \_\_\_\_\_  
Address \_\_\_\_\_  
Post Code \_\_\_\_\_

Send to Maplin Electronics, P.O. Box 3, Rayleigh, Essex, SS6 8LR.

**AVAILABLE FROM 11th NOVEMBER 1988 IN ALL W.H. SMITH STORES**

EE 89



Evening on the planet Oldana, as the Maplin Juggernaut thunders along the highway; captured on canvas by galaxy famous artist Lionel Jeans and featured on the cover of the new Maplin Catalogue.