

EVERYDAY *GRAHAM 68 FOCUS DRIVE* DECEMBER 1988

ELECTRONICS

INCORPORATING ELECTRONICS MONTHLY

£1.30

FREE

CIRCUIT CARDS TO BUILD AN I.R. REMOTE CONTROL

PERSONAL CASSETTE AMPLIFIER

DOWNBEAT METRONOME

Special Oscilloscope Offer



PLUS FULL INDEX FOR 1988

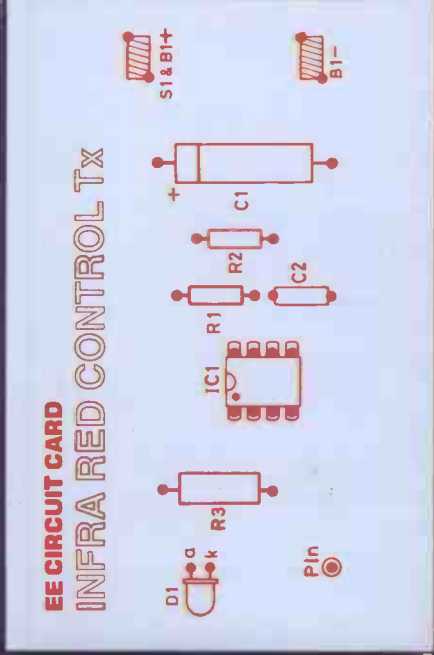
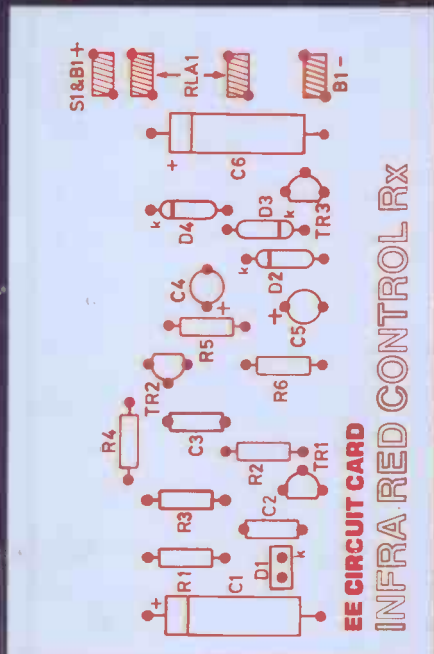

The Magazine for Electronic & Computer Projects



No. 1 LIST BAKERS DOZEN PACKS

All packs are £1 each, if you order 12 then you are entitled to another free. Please state which one you want. Note the figure on the extreme left of the pack ref number and the next figure is the quantity of items in the pack, finally a short description.

- BD1 5 13A junction boxes for adding extra points to your ring main circuit.
- BD2 5 13A spurs provide a fused outlet to a ring main where devices such as a clock must not be switched off.
- BD7 4 In flex switches with neon on/off lights, saves leaving things switched on.
- BD9 2 6V 1A mains transformers upright mounting with fixed clamps.
- BD11 1 6 1/2in speaker cabinet ideal for extensions, takes our speaker. Ref BD137.
- BD13 12 30 watt reed switches, it's surprising what you can make with these—burglar alarms, secret switches, relay, etc., etc.
- BD22 2 25 watt loudspeaker two unit crossovers.
- BD29 1 B.O.A.C. stereo unit is wonderful value.
- BD30 2 Nicad constant current chargers adapt to charge almost any nicad battery.
- BD32 2 Humidity switches, as the air becomes damper the membrane stretches and operates a microswitch.
- BD34 48 2 meter length of connecting wire all colour coded.
- BD42 5 13A rocker switch three tags so on/off, or change over with centre off.
- BD45 1 24hr time switch, ex-Electricity Board, automatically adjust for lengthening and shortening day, original cost £40 each.
- BD49 10 Neon valves, with series resistor, these make good night lights.
- BD56 1 Mini uniselector, one use is for an electric jigsaw puzzle, we give circuit diagram for this. One pulse into motor, moves switch through one pole.
- BD59 2 Flat solenoids—you could make your multi-tester read AC amps with this.
- BD67 1 Suck or blow operated pressure switch, or it can be operated by any low pressure variation such as water level in water tanks.
- BD91 2 Mains operated motors with gearbox. Final speed 16 rpm, 2 watt rated.
- BD103A 1 6V 750mA power supply, nicely cased with mains input and 6V output leads.
- BD120 2 Stripper boards, each contains a 400V 2A bridge rectifier and 14 other diodes and rectifiers as well as dozens of condensers, etc.
- BD122 10m Twin screened flex with white pvc cover.
- BD128 10 Very fine drills for pcb boards etc. Normal cost about 80p each.
- BD132 2 Plastic boxes approx 3in cube with square hole through top so ideal for interrupted beam switch.
- BD134 10 Motors for model aeroplanes, spin to start so needs no switch.
- BD139 6 Microphone inserts—magnetic 400 ohm also act as speakers.
- BD148 4 Reed relay kits, you get 16 reed switches and 4 coil sets with notes on making c/o relays and other gadgets.
- BD149 6 Safety cover for 13A sockets—prevent those inquisitive little fingers getting nasty shocks.
- BD180 6 Neon indicators in panel mounting holders with lens.
- BD193 6 5 amp 3 pin flush mounting sockets make a low cost disco panel.
- BD196 1 in flex simmerstat—keeps your soldering iron etc. always at the ready.
- BD199 1 Mains solenoid, very powerful, has 1in pull or could push if modified.
- BD201 8 Keyboard switches—made for computers but have many other applications.
- BD210 4 Transistors type 2N3055, probably the most useful power transistor.
- BD211 1 Electric clock, mains operated, put this in a box and you need never be late.
- BD221 5 12V alarms, make a noise about as loud as a car horn. Slightly soiled but OK.
- BD242 2 6in x 4in speakers, 4 ohm made from Radiomobile so very good quality.
- BD246 2 Tacho generators, generate one volt per 100 revs.
- BD252 1 Panostat, controls output of boiling ring from simmer up boil.
- BD259 50 Leads with push-on 1/4in tags—a must for hook-ups—mains connections etc.
- BD263 2 Oblong push switches for bell or chimes, these can mains up to 5 amps so could be foot switch if fitted into patress.
- BD268 1 Mini 1 watt amp for record player. Will also change speed of record player motor.
- BD275 1 Guitar mic—clip-on type suits most amps.
- BD283 3 Mild steel boxes approx 3in x 3in x 1in deep—standard electrical.
- BD293 50 Mixed silicon diodes.
- BD296 3 Car plugs with lead, fit into lighter socket.
- BD305 1 Tubular dynamic mic with optional table rest.

Most other packs still available and you can choose any as your free one.

VERY POWERFUL 12 VOLT MOTORS—1/2 HORSEPOWER Made to drive the Sinclair C5 electric car but equally adaptable to power a go-cart, a mower, a rail car, model railway, etc. Brand new. Price £15.00 plus £2.00 postage. Our ref. 1P58

OVER 400 GIFTS YOU CAN CHOOSE FROM

There is a total of over 400 packs in our Baker's Dozen range and you become entitled to a free gift with each dozen packs.

A classified list of these packs and our latest "News Letter" will be enclosed with your goods, and you will automatically receive our next news letter.



ATARI 65XE COMPUTER At 64k this is most powerful and suitable for home and business. Brand new, complete with PSU, TV lead, owner's manual and six games. Can be yours for only £45 plus £3 insured delivery.

DATA RECORDERS ACORN for Acorn Electron, etc., reference number ALF03, with TV lead, manual and PSU. Brand new. Price £10 plus £1.50 post. Order ref 10P44.

ATARI XC12 for all their home computers. With leads and handbook. Brand new. Price £10 plus £2 post. Order ref 10P53.

JOYSTICK FOR ATARI OR COMMODORE for all Atari and Commodore 64 and Vic20. New. Price £5. Order ref 5P126.

EXTRA SPECIAL OFFER We will supply the Atari 65XE, data recorder XC12, joystick and six games for £57.50 plus £4 insured delivery.

SUB-MIN TOGGLE SWITCH Body size 8mm x 4mm x 7mm SBDT with chrome dolly fixing nuts. 4 for £1. Order Ref. BD649.

EX GPD MULTI-RANGE TEST METER 12/C1 Complete in real leather case with carrying handle—this is a 20,000 OPU instrument, with 19 ranges including AC and DC volts-dc current 5mA to 1A 3 ohms ranges up to 20meg—the low ohms range is particularly useful, you will be able to read right down to one ohm and below. Not new but are in first class condition—tested and guaranteed. Price is £7.00. order ref 7P5.

RE-CHARGEABLE NICADS D' SIZE

These are tagged for easy joining together but tags, being spot welded, are easy to remove. Virtually unused, tested and guaranteed. £2.00 ref 2P141 or 6 wired together for £10.00 ref 10P47.

RECORD PLAYER DECK BRS, 12volt operated, belt driven with an 11in turntable, stereo cartridge. It will play 7in-10in or 12in individually at either 45rpm or 33rpm. Fitted speed selector and pick-up cueing lever. Price £12 plus £3 postage. Order ref 12P4.

2.5kw TABENTIAL BLOW HEATER has an approximate width of 8in (plus motor), elements made up of two 1.2kw sections so with switch available you can have 2.5kw, 1.2kw or cold blow. Over-heat cutout eliminates fire risk should fan stop or air flow be impeded. Fan blades are metal. Price £5 plus £2.50 post. Our ref 5P62. Switch 50p.

ALBA TWIN CASSETTE RECORDER AND PLAYER WITH STEREO RADIO This is a mains/battery portable made to sell, we understand, at about £50 but the ones we have are line rejects. They are brand new still in the manufacturers' boxes but have a slight defect associated with the cassette section. The radio and amplifier section, both mono and stereo, is perfectly OK. If you are handy at mending things then this should be for you. Price £20 or two for £38 plus £3 insured post, either package. Our ref 20P7 or 2 x 20P7.

LASER TUBE

Made by Philips Electrical. New and unused. This is helium-neon and has a typical power rating of 1.6mW. It emits random polarised light and is completely safe provided you do not look directly into the beam when eye damage could result. DON'T MISS THIS SPECIAL BARGAIN! Price £29.95 plus £3 insured delivery.

POWER SUPPLY FOR PHILIPS LASER is now available in kit form. Price £13 plus £2 postage, or make-up ready-to-use at £18 plus £2.50 postage. Our ref 13P1 for the kit and 18P1 for the made-up version.

PAPST AXIAL FAN—MANUFACTURERS REF NO. TYP4580N.

This is mains operated. 15 watt rating and in a metal frame with metal blades so OK in high temperatures. Body size approx. 4 3/4" square x 1 3/8" thick. £6.00 each, plus £1.00 postage. Our ref 6P6.

VERY POWERFUL MAGNETS Although only less than 1" long and not much thicker than a pencil these are very difficult to pull apart. Could be used to operate embedded reed switches, etc. Price 50p each, 2 for £1.00. Ref BD642.



ORGAN MASTER is a three octave musical keyboard. It is beautifully made, has gold plated contacts and is complete with ribbon cable and edge connector. Brand new, only £15 plus £3 postage. Order ref 15P15.

MUSIC FROM YOUR SPECTRUM 128 We offer the Organ Master three octave keyboard, complete with leads and the interface which plugs into your 128. You can them compose, play, record, store, etc., your own music. Price £28 plus £3 special packing and postage. Order ref 28P2.

20A DOUBLE POLE RELAY WITH 12V COIL complete with mounting brackets, made by the Japanese Omron Company. Price £2 each. Our Ref. 2P173A.

TORROIDAL MAINS TRANSFORMER with twin outputs. 6.3V 2A and 12V 600mA, so ideal for FDD power supply. Price £5. Our Ref. 5P122.

DOUBLE MICRO CASSETTE DECK made by the Japanese ABS company. This takes two micro cassettes and is complete with motors, solenoids to select the deck to use and record and playback heads. Price £10. Our Ref. 10P49.

QUICK FIX MAINS CONNECTOR A must for your workshop. Saves putting on plugs as you just push the wires under the spring clips. Automatically off when lid is up. Price £7.50. Our Ref. 7P51.

BT HANDSET with curly lead terminating with flat BT plug. Colour cream. Price £5. Our Ref. 5P123.

J & N BULL ELECTRICAL

Dept. E.E., 250 PORTLAND ROAD, HOVE, BRIGHTON, SUSSEX BN3 5QT

MAIL ORDER TERMS: Cash, PO or cheque with order. Orders under £20 add £1.50 service charge. Monthly account orders accepted from schools and public companies. Access and Bicard orders accepted. Brighton (0273) 734648 or 203500

POPULAR ITEMS

Some of the many items described in our current list which you will receive if you request it

3 1/2in FDD CHINON 80 track 500k. Shugart compatible interface. Standard connections, interchangeable with most other 3 1/2in and 5 1/4in drives. Brand new. £28.50 plus £3 insured post.

CASE NOW AVAILABLE FOR THE CHINON F353 This is the 80 track, single sided one which we have been selling at £28.50. The case is sheet metal, finished in hammer-beige with ample ventilation and rubber feet. Overall size 4 1/4in x 7in x 1 1/2in approx. Designed to take the ribbon cable and 3 core power lead. Price £8. Our ref 8P21.

3in FDD HITACHI HF305SXA Shugart compatible interface. 500k on 3in disc. Recommended for many Amstrads but interchangeable with most drives. £29.50 plus £3 insured post.

FDD CASE AND POWER SUPPLY KIT for the 3in or 3 1/2in. £11.00. Ref 11P2 for the Chinon, 11P3 for the Hitachi.

9in MONITOR made for ICL, uses Philips black and white tube. Brand new and complete but uncased. £16.00 plus £5.00 post.

ACORN COMPUTER DATA RECORDER REF ALF03 Made for the Electron or BBC computers but suitable for most others. Complete with mains adaptor, leads and handbook. £10.00. Ref 10P44.

POWERFUL IONISER Uses mains transformer. Generates approx. 10 times more ions than the normal diode/cap ladder circuits. Complete kit £11.50 plus £3.00 post.

FREE POWER! Can be yours if you use our solar cells—sturdily made modules with new system bubble magnifiers to concentrate the light and so eliminate the need for actual sunshine—they work just as well in bright light. Voltage input is .45—you join in series to get desired voltage—and in parallel for more cells. Module A gives 100mA, Price £1. Our ref. BD631. Module C gives 400mA, Price £2. Our ref. 2P199. Module D gives 700mA, Price £3. Our ref. 3P42.

SOLAR POWERED NI-CAD CHARGER 4 Ni-Cad batteries AA (HP7) charged in eight hours or two in only 4 hours. It is a complete, boxted ready to use unit. Price £6. Our ref. 6P3.

50V 20A TRANSFORMER 'C' Core construction so quite easy to adapt for other outputs—tapped mains input. Only £25 but very heavy so please add £5 if not collecting. Order Ref. 25P4.

SWITCH AC LOADS WITH YOUR COMPUTER This is easy and reliable if you use our solid state relay. This has no moving parts, has high input resistance and acts as a noise barrier and provides 4kW isolation between logic terminals. The turn-on voltage is not critical, anything between 3 and 30V, internal resistance is about 1K ohm. AC loads up to 10A can be switched. Price is £2 each. Ref. 2P183.

METAL PROJECT BOX Ideal size for battery charger, power supply etc.; sprayed grey, size 8in x 4 1/4in x 4in high, ends are louvred for ventilation other sides are flat and undrilled. Order Ref. 2P191. Price £1.

BIG SMOOTHING CAPACITOR. Sprague powerlytic 39,000uF at 50V. £3. Our ref. 3P41.

4-CORE FLEX CABLE. Cores separately insulated and grey PVC covered overall. Each copper core size 7/0.2mm. Ideal for long telephone runs or similar applications even at mains voltage. 20 metres £2. Our ref. 2P196 or 100 metres coil £8. Order ref. 8P19.

6-CORE FLEX CABLE. Description same as the 4-core above. Price 15 metres for £2. Our ref. 2P197 or 100 metres £9. Our ref. 9P1.

TWIN GANG TUNING CAPACITOR. Each section is 0005uF with trimmers and good length 1/4in spindle. Old but unused and in very good condition. £1 each. Our ref. BD630.

13A PLUGS Good British make complete with fuse, parcel of 5 for £2. Order ref. 2P185.

13A ADAPTERS Takes 2 13A plugs, packet of 3 for £2. Order ref. 2P187.

20V 0-20V Mains transformers 2 1/2 amp (100 watt) loading, tapped primary. 200-245 upright mountings £4. Order ref. 4P24.

BURGLAR ALARM BELL—6" gong OK for outside use if protected from rain. 12V battery operated. Price £8. Ref. 8P2.

24 HOUR TIME SWITCH—18A changeover contacts, up to 6 on/off per day. Nicely cased, interbbed for wall mounting. Price £8. Ref. 8P6.

CAPACITOR BARGAIN—axial ended, 4700uF at 25V. Jap made, normally 50p each, you get 4 for £1. Our ref. 613.

PIEZO ELECTRIC FAN—An unusual fan, more like the one used by Madame Butterfly than the conventional type. It does not rotate. The air movement is caused by two vibrating arms. It is American made, mains operated, very economical and causes no interference, so is ideal for computer and instrument cooling. Price is only £1 each. Ref. BD598.

SPRING LOADED TEST PRODS—Heavy duty, made by the famous Bulgin company, very good quality. Price 4 for £1. Ref. BD597.

ASTEC P.S.U.—Switch mode type. Input set for +230V. Output 3.5 amps at +5V, 1.5 amps at +12V, and 3 amps at +5V. Should be OK for floppy disc drives. Regular price £30. Our price only £10. Ref. 10T34. Brand new and unused.

APPLIANCE THERMOSTATS—Spindle adjust type suitable for convector heaters or similar. Price 2 for £1. Ref. BD582.

3-CORE FLEX BARGAIN No. 1—Core size 5mm so ideal for long extension leads carrying up to 5 amps or short leads up to 10 amps. 15mm for £2. Ref. 2P189.

3-CORE FLEX BARGAIN No. 2—Core size 1.25mm so suitable for long extension leads carrying up to 13 amps, or short leads up to 25A. 10m for £2. Ref. 2P190.

ALPHA-NUMERIC KEYBOARD—This keyboard has 73 keys giving trouble free life and no contact bounce. The keys are arranged in two groups, the main area is a QWERTY array and on the right is a 15 key number pad, board size is approx. 13" x 4"—brand new but offered at only a fraction of its cost, namely £3, plus £1 post. Ref. 3P27.

WIRE BARGAIN—500 metres 0.7mm solid copper tinned and p.v.c. covered. Only £3 plus £1 post. Ref. 3P31—that's well under 1p per metre, and this wire is ideal for push on connections.

INTERRUPTED BEAM KIT—This kit enables you to make a switch that will trigger when a steady beam of infra-red or ordinary light is broken. Main components—relay, photo-transistor, resistors and caps, etc. Circuit diagram but no case. Price £2. Ref. 2P15.

1/8th HORSEPOWER 12 VOLT MOTOR Made by Smiths, the body length of this is approximately 3in, the diameter 3in and the spindle 5/16th of an inch diameter. It has a centre flange for fixing or can be fixed from the end by means of 2 nuts. A very powerful little motor which revs at 3,000rpm. We have a large quantity of them so if you have any projects in mind then you could rely on supplies for at least two years. Price £6. Our ref 6P1, discount for quantities of 10 or more.

EVERYDAY ELECTRONICS

INCORPORATING ELECTRONICS MONTHLY

ABC

VOL 17 No 12 DECEMBER '88

The Magazine for Electronic & Computer Projects

ISSN 0262-3617

PROJECTS ... THEORY ... NEWS ...
COMMENT ... POPULAR FEATURES ...



© Wimborne Publishing Ltd 1988. Copyright in all drawings, photographs and articles published in **EVERYDAY ELECTRONICS** is fully protected, and reproduction or imitations in whole or in part are expressly forbidden.

Our January '89 issue will be published on Friday, 2 December 1988. See page 687 for details.

Everyday Electronics, December 1988

Projects

- PHASOR** by Andy Flind 694
Trip the light fantastic with this unusual project
- IR REMOTE CONTROL** by Robert Penfold 698
Simple solderless project using the Free Circuit Cards
- DOWNBEAT METRONOME** by Andy Flind 716
An accented beat metronome with sound and light output
- EPROM PROGRAMMER** 720
An On-Spec project for the Spectrum
- PERSONAL CASSETTE AMPLIFIER** by Richard Powell 724
Inexpensive in-car entertainment
- REACTION TIMER** by Paul Harding 732
A digital readout of your reaction time

Series

- INTRODUCING DIGITAL ELECTRONICS** 704
by Michael Cockcroft
City and Guilds 723/301 Certificate Course
Part Three: Materials and Tools
- ACTUALLY DOING IT** by Robert Penfold 712
Getting going with electronic construction
- ROBOT ROUNDUP** by Nigel Clark 714
Investigating the world of robots
- ON SPEC** by Mike Tooley BA 720
Readers' Sinclair Spectrum page
- AMATEUR RADIO** by Tony Smith G4FA1 728
To the South, PICPRO, Golden Jubilee, Nets
- BBC MICRO** by R. A. & J. W. Penfold 730
Regular spot for BEEB fanatics

Features

- EDITORIAL** 693
- SHOPTALK** by David Barrington 702
Product news and component buying
- USING THE FREE CIRCUIT CARDS** 703
- EASIWIRE OFFER TO READERS** 703
- PLEASE TAKE NOTE** 713
Seashell Sea Synthesiser
- FOR YOUR ENTERTAINMENT** by Barry Fox 726
Cryptology, Piracy Epidemic, Illegal Broadcasting
- SPECIAL 'SCOPE OFFER** 729
Two oscilloscopes at special discount prices
- DIRECT BOOK SERVICE** 736
Special service to *EE* readers
- PRINTED CIRCUIT BOARD SERVICE** 740
- INDEX** 741
Complete index for Volume 17 (1988)
- ADVERTISERS INDEX** 748

FREE

TWO CIRCUIT CARDS (Front cover mounted)
For solderless construction of the IR Remote Control

Readers' Services • Editorial and Advertisement Departments 629

685

1989 CATALOGUE

- ★ 100 pages of components and equipment
- ★ Low, low prices
- ★ Fast 'by return' service
- ★ Discount Vouchers
- ★ 28 pages of Surplus Bargains
- ★ Only £1 – send for yours now!



Introducing DIGITAL ELECTRONICS

This exciting new series can lead to a worthwhile qualification—and we can supply all the components you need! The first six parts: Everything as listed in the booklet given free with EE
 Just £12.95!

Low cost tool kit:
 25 Watt mains soldering iron, screwdriver, cutters, snipe nose pliers, wire strippers.
 All for £9.95

★ STAR BUY ★

GREEN SCREEN HI-RES 12" MONITOR CHASSIS

Brand new and complete except for case, the super high definition (1000 lines at centre) makes this monitor ideal for computer applications. Operates from 12V DC at 1.1A. Supplied complete with circuit diagram and 2 pots for brilliance/contrast, plus connecting instructions. Standard input from IBM machines, slight mod (details included) for other computers.
 Only £24.95+£3 carr.

MONITOR INTERFACE KIT

Enables our hi-res monitor (above) & most others to be used with virtually any computer. PCB £3.00
 Complete set of on-board components + regulator & heatsink £9.95
 Suitable transformer for interface and above monitor £5.31

Z8837 DUAL SHEET FEEDER. Brand new breakdown unit. Contains 3 x 12V stepper motors (48 step) plus driver panel with 4 x TIP115, 4 x TIP110, LM3302, 2 x 7407, 2 solenoids, buzzer, microswitches, control panel, 2 optocouplers plus lots of gears and mechanical bits. £24.95+£3 carr.

Z345 OPTICAL SHAFT ENCODER. Similar to RS631-632, but 80% cheaper! £8.50

NEW THIS MONTH

LCD DISPLAY

Z4115 8 digit 12.7mm high LCD by Data Image. 14 segment, so letters as well as digits can be formed.

List £15+ Our price £4.50

Z4117 Special low price switch mode PSU. 50W unit on PCB 160x100mm. Mains input, outputs 5V at 5A; +12V at 1A; -12V at 1A.

List £40+ Our price £9.50

Z4113 BBC Computer PSU (early models) Steel case 158x72x55mm, 2m long mains lead, rocker switch, fused. Outputs: +5V at 2.5A; -5V at 100mA. £3.95

Z4112 Another switch mode PSU. Same size as Z4117. Outputs 24V at 1.7A; 12V at 0.8A £9.95

KEYBOARDS

Z8848 Alpha numeric plus separate numeric keyboard. 104 keys plus 11 chips. 442x175mm £12.00

Z4116 24 way (8x3) membrane keypad. Large (200x90mm) area — they were used in a teaching aid. Overlay template and pinout supplied. £3.00

Z80 PANEL

Z494 Newbrain Motherboard. Microprocessor panel 265x155mm. Complete PCB for computer, Z80, EPROM, etc. 68 chips altogether plus other associated components, plugs, sockets, etc. Brand new in original packing £5.50

SOLDER SPECIAL!!

- ★ 15W 240V ac soldering iron
- ★ High power desolder pump
- ★ Large tube solder

ALL FOR
£7.95

FLASH UNITS

Z4100 Brand new, made for Hanimex. 56 x 30 x 18mm. Apart from xenon tube and driver circuitry, there is a sub-min 3V relay. £2.75

Z488 50 x 55 x 30mm. Complete assembly. 3V supply. Data supplied. £2.70

TELETEXT PANEL

Z037 265 x 145mm by GEC. Uses 8085A, 8165, 8255A, 8251, 8212 all by Intel. 2 x 2114, 2 x TC5501 + custom chips + 10 others. Nicad back up. New £9.90

NOTICE TO RETAILERS

Greenweld Electronics Ltd. have been appointed Official Wholesalers of Verobloc, Veroboard, Easiwire & Accessories by Vero. We will be only too happy to supply all your Veroboard requirements at Trade Price. Ring, write or fax us for full information and prices.



All prices include VAT; just add £1.00 P&P; Min Access £5. No CWO min. Official orders from schools welcome—min. invoice charge £10.00. our shop has enormous stocks of components and is open 9-5 Mon-Sat. Come and see us!

HOW TO CONTACT US:

By post using the address below; by phone (0703)772501 or 783740 (ansaphone out of business hours); by FAX (0703)787555; by Email Telecom Gold 72:MAG36026; by Telex 265871 M0NREF G quoting 72:MAG36026.

443D MILLBROOK ROAD, SOUTHAMPTON SO1 0HX

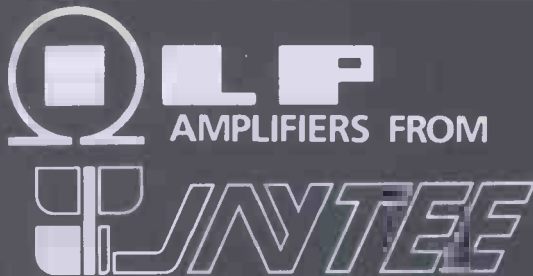

The UK Distributor for the complete ILP Audio Range



BIPOLAR AND MOSFET MODULES

The unique range of encapsulated amplifier modules with integral heatsink.

HY30	15W	Bipolar amp.	£11.30	HY248	120W	Bipolar amp (8ohm)	£24.15
HY60	30W	Bipolar amp	£11.30	HY364	180W	Bipolar amp (4ohm)	£36.00
HY6060	30W	Stereo Bipolar amp	£23.65	HY368	180W	Bipolar amp (8ohm)	£37.55
HY124	60W	Bipolar amp (4ohm)	£18.50	MOS128	60W	Mosfet amp	£40.70
HY128	60W	Bipolar amp (8ohm)	£18.50	MOS248	120W	Mosfet amp	£46.35
HY244	120W	Bipolar amp (4ohm)	£24.15	MOS364	180W	Mosfet amp	£75.75

POWER SUPPLIES

Comprising toroidal transformer and DC board to power the ILP amplifier modules.

Application	£ 9.75	PSU532	MOS128 (2)	£25.40
PSU30	Pre-amplifier	PSU542	HY248	£25.40
PSU212	1 or 2 HY30	PSU552	MOS248	£27.45
PSU412	HY6060, HY124, 1 or 2 HY60	PSU712	HY244 (2)	£29.20
PSU422	HY128	PSU722	HY248 (2)	£30.20
PSU432	MOS128	PSU732	HY364	£30.20
PSU512	HY244, HY128 (2)	PSU742	HY368	£32.20
PSU522	HY124 (2)	PSU752	MOS364, MOS248 (2)	£32.20

PRE-AMP and MIXER MODULES

These encapsulated modules are supplied with in-line connectors but require potentiometers, switches etc. Individual data sheets on request.

HY6	Mono pre-amp with bass & treble	£ 9.25
HY7	Mono mixer 8 channel	£ 8.75
HY8	Stereo mixer 5 channel	£ 8.75
HY9	Stereo pre-amp	£ 9.30
HY11	Mono mixer 5 channel with bass & treble	£ 9.75
HY12	Mono pre-amp 4 channel with bass, mid & treble	£ 9.30
HY13	Mono VU meter driver	£ 8.75
HY66	Stereo pre-amp with bass & treble	£15.00
HY67	Stereo headphone driver	£16.60
HY68	Stereo mixer 10 channel	£11.30
HY69	Mono pre-amp 2 channel with bass & treble	£15.40
HY71	Dual pre-amp	£14.95
HY73	Guitar pre-amp with bass & treble	£15.00
HY74	Stereo mixer 5 channel with bass & treble	£15.95
HY75	Pre-amp with bass, mid & treble	£15.40
HY76	Stereo switch matrix	£19.50
HY77	Stereo VU meter driver	£14.35
HY78	Stereo pre-amp	£14.70
HY83	Guitar pre-amp with special effects	£18.95
B6	Mounting board	£ 1.15
B66	Mounting board	£ 1.75

LOUDSPEAKERS

312B	350W 12" Bass loudspeaker	£78.65
312WB	200W 12" Wideband bass loudspeaker	£78.65

POWER SLAVES

These cased amplifiers are supplied assembled and tested in 60 and 120 watt Bipolar or Mosfet versions.

US12	60 watt Bipolar (4ohm)	£75.00	US32	60 watt Mosfet	£99.95
US22	120 watt Bipolar (4ohm)	£83.75	US42	120 watt Mosfet	£108.35

Prices include VAT and carriage

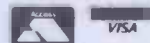

Quantity prices available on request
 Write or phone for free Data Pack

Jaytee Electronic Services

143 Reculver Road, Beltinge, Herne Bay, Kent CT6 6PL

Telephone: (0227) 375254 Fax: 0227 365104

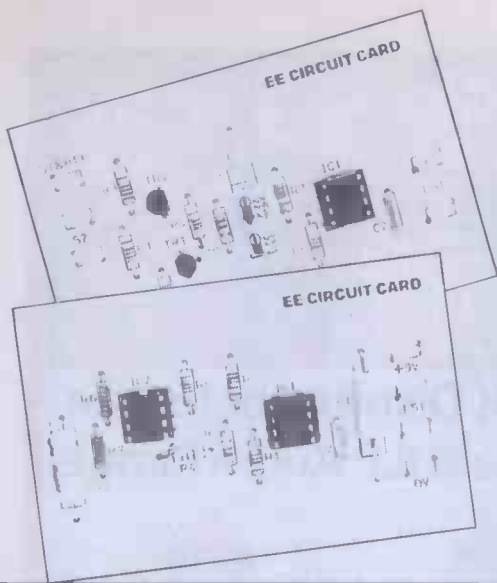

FREE CIRCUIT CARDS

Two more Circuit Cards will be attached to next month's issue of EE. These are similar to those that came with this issue but are for a Tilt Alarm and Siren. Once again they provide the chance to easily build a couple of simple solderless projects.

SPECTRUM PARALLEL PRINTER INTERFACE

A very simple interface—costing around £20 to build—that can link a Spectrum, Spectrum Plus or Spectrum 128 Plus 2 (in 48K mode) to most parallel printers. The article includes descriptions of parallel and serial systems, the functioning and timing of a parallel printer plus some user friendly software.

SATELLITE TELEVISION

Next year, small receiving dishes will begin to sprout on walls and roofs all over Europe to collect television programmes from space. Ian Graham reports on the technical progress and commercial competition in this new market-place. Has the dream of a single European system become a nightmare? Will the programmes be scrambled? Will Astra start and finish the race first?

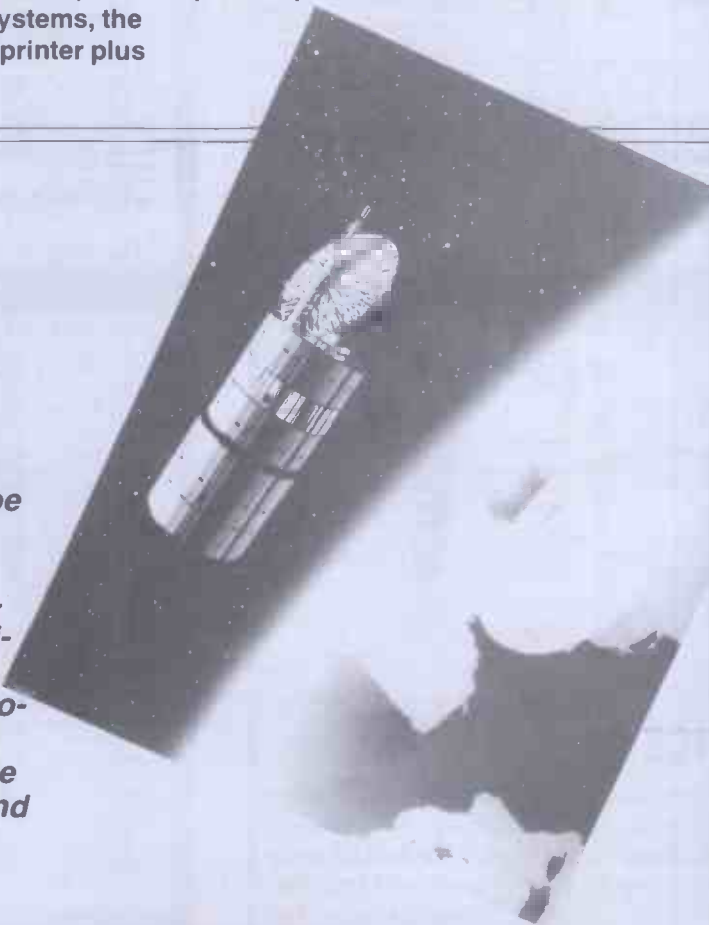

EVERYDAY ELECTRONICS

JANUARY '89 ISSUE ON SALE DECEMBER 2

EVERYDAY
ELECTRONICS

HARDWARE & SOFTWARE
CONSULTANT



kits

FOR POWER CONTROL

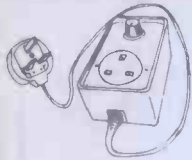

P.C.101 A.C. POWER CONTROLLER
1.5kW
Full phase control mains plug and socket kit that uses the Plessey TDA 2086A I.C. power controller ideal for universal motor control, heaters, lighting etc.

£16.90



P.C.102 A.C. POWER CONTROLLER
750W
Full kit that uses a 3 pin plug replacement module for phase control of mood lighting, heaters, universal motor control etc.

£11.95

M.P.C.01 A.C. SOLID STATE RELAY 1.5kW

Full kit for simple on/off control of mains loads from a logic signal (microcomputer output port etc.) optically isolated for maximum safety.

£9.80

M.P.C.02 A.C. (phase control) S.S.R. 1.5kW

Full kit for phase control of mains loads from the printer/output port of a micro computer as P.C.101 with additional p.c.b. circuitry.

£26.90

- ◆ ALL KITS ARE AVAILABLE READY BUILT. PLEASE SEND S.A.E. FOR FURTHER DETAILS.
- ◆ ALL KITS CONTAIN FULL INSTRUCTIONS AND CIRCUIT DIAGRAMS.
- ◆ ALSO HIGH QUALITY P.C.B.'s AND COMPONENTS.
- ◆ OFFICIAL SCHOOL AND COLLEGE ORDERS WELCOME.
- ◆ PLEASE ADD £1.50 p+p AND 15% V.A.T. TO ORDER TOTAL.

P.O. OR CHEQUES MADE PAYABLE TO:-

"MUTEX"

PO BOX 25

BILLINGHAM, CLEVELAND TS23 3FY

TELEPHONE (0642) 561181 (24 HOUR ANSWER SERVICE)

TWO GREAT HOBBIES

ONLY
£124.50
INC VAT



...IN ONE GREAT KIT!

The K5000 Metal Detector Kit combines the challenge of DIY Electronics assembly with the reward and excitement of discovering Britain's buried past.

THE KIT — simplified assembly techniques require little technical knowledge and no complex electronic test equipment. All stages of assembly covered in a detailed 36 page manual.

THE DETECTOR — features Analytical Discrimination & Ground Exclusion, backed by the proven pedigree of C-Scope, Europe's leading detector manufacturer.

A comprehensive instruction book is available @ £5 (deductable from order).

Ask at your local Hobby/Electronics shop or contact C-Scope for a copy of a published Field Test Report.



C-Scope International Ltd., Dept. EE86,
Wotton Road, Ashford, Kent TN23 2LN.
Telephone: 0233 29181.

THREE ACES FROM ALCON!

ELECTRO SUPER



20kΩ/V a.c. & d.c.
40 RANGES — FOOL PROOF!
plus 30A for the power man

Accuracy: d.c. ranges and ohms 2.5% a.c. 3% of f.s.d.
40 RANGES: d.c.V: 100mV, 300mV, 1.0V, 3.0V, 10V, 30V, 100V, 300V, 1000V; d.c.I: 50μA, 100μA, 300μA, 1.0mA, 3.0mA, 10mA, 30mA, 100mA, 1.0A, 6A, 30A; a.c.V: 10V, 30V, 100V, 300V; a.c.I: 3.0mA, 10mA, 100mA, 1.0A, 6.0A, 30A. Ohms: 0-10kΩ, 0-100kΩ, 30mA, 0-1MΩ. dB from -10 to +6 in 5 ranges.
Dimensions: 105x130x40mm.

ONLY £38.35

SUPER 20



20kΩ/V a.c. & d.c.

40 RANGES — INDESTRUCTIBLE

Electronically protected on all ranges but 30A
Accuracy: 2% d.c. -3% a.c. -1% centre scale on ohms.

40 RANGES: d.c.V: 100mV, 1.0V, 3.0V, 10V, 30V, 100V, 300V, 1000V; d.c.I: 50μA, 100μA, 300μA, 1mA, 3mA, 10mA, 30mA, 100mA, 1.0A, 10A; a.c.V: 10V, 30V, 100V, 300V, 1000V; a.c.I: 3.0mA, 10mA, 30mA, 100mA, 1.0A, 10A; Ohms: 0-5kΩ, 0-50kΩ, 0-500kΩ, 0-5.0MΩ, 0-50MΩ; dB from -10 to +61 in 5 ranges.
Dimensions: 105x130x40mm.

ONLY £36.00

MINI 20

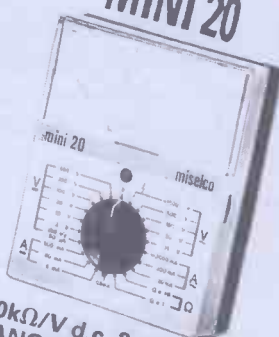

20kΩ/V d.c. & 4kΩ/V a.c.
28 RANGES with PROTECTIVE FUSE

Accuracy: 2% d.c. and ohms -3% a.c.
28 RANGES: d.c.V: 100mV, 3.0V, 10V, 30V, 100V, 300V, 600V; d.c.I: 50μA, 600μA, 6.0mA, 60mA, 600mA; a.c.V: 15V, 50V, 150V, 500V, 1500V; a.c.I: 30mA, 300mA, 3.0A; Ohms: 0-2kΩ, 0-2MΩ; dB from -10 to +62 in 6 ranges.
Dimensions: 105x130x40mm.

ONLY £25.30

3 HIGH QUALITY TEST INSTRUMENTS AT SUPERDEAL PRICES

EACH INSTRUMENT HAS A CLEAR MIRRORED SCALE AND COMES COMPLETE WITH A ROBUST CARRYING CASE, LEADS & INSTRUCTIONS. PRICES Our prices include VAT and postage and goods are normally despatched by return. Please write or telephone for details of these and the many other instruments in the Alcon range, including multimeters component measuring, automotive and electronic instruments.



Instruments Ltd.

P.O. Box 933 London SW10 9QN. Tel 01-352 8897. Telex: 268865.



**THE MALTINGS, HIGH STREET, WEM
SHROPSHIRE SY4 5EN
DEPT EE12**

**ELECTRONIC COMPONENT MAIL ORDER COMPANY - ESTABLISHED 1972
100 + PAGE CATALOGUE AVAILABLE - SEND £1 FOR YOUR COPY.**

INCLUDING DISCOUNT TICKETS -

50p OFF £5 + ORDER, £1 OFF £10 + ORDER, £5 OFF £50 + ORDER

VISIT OUR RETAIL SHOPS
BIRMINGHAM (SUPERTRONICS), 65 Hurst Street (021) 666 6504
WOLVERHAMPTON (WALTONS), 55A Worcester Street (0902) 22039
WEM (MARCO), The Maltings, High Street (0939) 32763

**PLEASE ADD
85p P&P
+15% VAT
TO ALL
ORDERS**
unless otherwise
stated.

**Tel (0939) 32763
Telex 35565
FAX: 0939 33800**

**24 HOUR
ANSWERING
MACHINE**

**MERRY CHRISTMAS TO ALL OUR CUSTOMERS OLD AND NEW. ALL OUR
BEST WISHES FOR '89. MARCO'S '89 CATALOGUE READY FOR
ONLY £1 JAN 1st 1989 ONLY £1**

INTEGRATED CIRCUITS (IC) EACH		TRANSISTORS + DIODES					
Type	Price (P)	Type	Price (P)				
741	0.16	BO222	0.80	BU103	0.90		
CA8100M	1.70	AC128	0.30	BD225	2.75		
CA3020	1.60	BC127	0.12	BD232	0.40	BR303	0.80
CA3065	1.50	AC141	0.58	BD234	0.30	BR359	0.42
HA1368W/R	1.60	AC142	0.40	BD235	0.30	BR366	0.40
LA4422	3.20	AL152	0.38	BD236	0.36	BSX20	0.70
IC1731	4.90	AL153	0.48	BD237	0.36	BSY52	0.35
LM2424	0.40	AL176K	0.32	BD237	0.38	BT59A	0.25
LM3809P	0.40	AC187	0.40	LA LB LC	0.12	BT100A/G2	0.90
LM3901M4	1.80	AC188	0.48	BC183A/B/C	0.10	BT101/500	2.75
LM1011N	3.20	AC189	0.48	LA LB LC	0.12	BT101/500	3.28
LM1458N	1.80	AC193K	0.40	LA LB LC	0.12	BT102/200	3.60
LM3900N	2.50	AD142	0.88	BC213A/B/C	0.10	BD441	0.85
MS1513L	0.30	AD149	0.95	BC213L	0.10	BD448	0.78
MS1515L	3.15	AJ151	0.28	LA LB LC	0.10	BD438	0.64
MC1307P	1.99	AJ155	0.15	A B C L E	0.20	BD441	0.85
MC1377P	1.50	AF114	0.88	BC213A/B/C	0.10	BD441	1.05
MC1378	2.30	AF121	0.70	A B	0.26	BD441	1.05
NE555	0.20	AJ124	0.64	A B	0.29	BD441	2.60
SAS5605	1.85	AJ124	0.70	A B	0.29	BD441	3.40
SAS5705	1.85	AJ125	0.50	BC301	0.36	BD441	3.40
SAS580	2.85	AJ126	0.50	BC302	0.36	BD441	3.40
SAS590	2.85	AJ127	0.50	BC303	0.36	BD441	3.40
SN74250N	1.75	AJ128	0.50	BC307A	0.16	BF177	0.50
SN74277N	1.10	AJ178	1.50	BC317B	0.15	BF180	0.27
SN7439	0.65	AF239	0.65	BC323	0.90	BF181	0.27
STR015	6.40	AF239	0.65	BC327	0.82	BF198	1.98
TA7103P	2.50	AS270	5.20	BC328	0.10	BY100	0.80
TA7104P	2.50	AS271	2.00	BC337	0.08	BY103	0.50
TA7205AP	1.75	AU110	2.90	BC338	0.10	BY122	0.60
TA7205AP	1.75	AX102	4.20	BC350A	0.24	BY126	0.10
TA7205AP	1.75	AX102	4.20	BC351	0.16	BY127	0.10
TA7205AP	1.75	AX102	4.20	BC351	0.16	BY127	0.10
TA7205AP	1.75	AX102	4.20	BC351	0.16	BY127	0.10
TA7205AP	1.75	AX102	4.20	BC351	0.16	BY127	0.10

**Over 7,000
items listed
in our '89
catalogue.
Bigger and
better. Look
out for our
special offer
every month**



HELPING HANDS WITH MAGNIFIER £3.99

FM TRANSMITTER

Very High Quality 'MINI-BUG' - Ideal for Baby Alarm, etc!
A very good range is obtainable - We have obtained over 1/2 mile, but it does depend on conditions. Simply insert battery - and you're ready to go. Reception can be obtained on any FM radio.
Frequency: 106-109 MHz FM
Power: PP3 9V battery (not included)
Dimensions: 4.25in x 2.25in x 0.75in

DECEMBER SPECIAL OFFER

4-WAY EXTENSION SOCKET



COMPLETE WITH 3 METRE CABLE, 13A PLUG, FUSE & NEON INDICATOR

ONLY £4.50
NORMALLY £5.75

NEW STANDARD SPECIFICATIONS

NI-CAD RECHARGEABLE BATTERIES
AAA - £1.25 (10+£1.20ea.)
AA - 90p (10+ 85p ea.)
C - £2.50 (10+£1.90ea.)
D - £2.50 (10+£2.20ea.)
PP3 - £4.10 (10+£3.90ea.)

SOLDER AT A RIDICULOUSLY LOW PRICE!
500gms reel of 22 SWG Multi-Core Solder 60% tin 40% alloy non-corrosive.
ONLY £4.99
Also 18 SWG £3.75

12V RECHARGEABLE UNIT
10 x D size NI-CADS (4Ah) encapsulated in a black plastic case, fuse holder. Gives 12V output when fully charged. Ex-equipment tested and guaranteed
245 x 75 x 75mm
£7.99
+£1.85 P&P + 15% VAT

CHARGER FOR NI-CAD BATTERIES
Charges AAA, AA, C, D & PP3 NI-CADS
£4.50

MARCO KITS
Ceramic 50V (125) £3.50
Electrolytics Rad. (100) £7.25
Fuse 20mm O/B (80) £3.75
Fuse 20mm A/S (80) £7.50
Nut & bolt (80) £3.00
Pre-set pots. horiz. (120) £6.75
Pre-set pots. vert. (120) £6.75
Resistors
0.25W Popular (1000) £6.50
0.25W 5 off (305) £2.95
0.25W 10 off (1000) £4.50
0.5W Popular (1000) £9.50
0.5W 5 off (365) £4.70
0.5W 10 off (730) £7.75
1W 5 off (365) £13.75
2W 5 off (365) £21.75
Zener diodes 5 off (55) £3.50
0.25W Resistors 1 + 2p 10 + 1.5p
0.5W Resistors 1 + 2p 10 + 1.5p

TV/video/computer combiner
£3.09

TV indoor amplifier improves signal 3 times £13.66

Second set amplifier improves signal to 2 sets 50% - £12.72

CB interference suppressor minimises CB interference on TV £4.45

TV/FM diplexer separates UHF TV signals from FM radio signals. £3.78

13A TEST PLUG - useful for testing 13A sockets.
PRICE: 99p ea. 10 off 90p ea.
TEST PRODS - fused - 99p pair

ENQUIRIES WELCOMED FROM SCHOOLS AND COLLEGES

LATEST CATALOGUE
£1

SERVISOL PRODUCTS
Supa Freeze-it £1.40
Switch cleaner £1.24
Foam cleanser £1.22
Super 40 £1.88
Fire extinguisher £3.30
Tape head cleaner £1.20
Anti-static spray £1.38
Silicone grease £1.38
Plastic seal £1.35

ANTEX SOLDERING
C IRON 15W £5.40 SK2 kit £8.30
CS IRON 17W £5.60 SK5 kit £7.99
XS IRON 25W £5.80 SK6 kit £8.20
ST4 stand £2.20
TCU-D soldering station £72.50
Spare tips for above irons £1.20

DESOLDERING PUMP
£2.99

SPARE NOZZLE FOR ABOVE - 60p

ORXYX PONTASOL GAS SOLDERING IRON
1+ Price £16.00
5+ Price £15.30
SPARE TIPS: 1, 2A, 3.2, 4.0mm £4

12V Twin Fluorescent lamp
12" Double Tubes

IDEAL FOR BOATS, CARAVANS, VANS, ETC.

ATTRACTIVE WHITE FITTING, RIBBED PERSEPEX DIFFUSER, ON/OFF SWITCH, 3M CABLE, TRANSISTORISED CIRCUITRY, KEYHOLE FIXING, 12V D.C. 8W TUBES. 368 x 67 x 43mm
£5.99 EACH
10 OFF £4.99

EQUIPMENT CASES

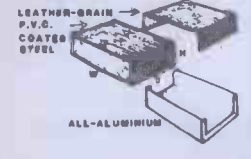

DIMENSIONS			Price
Height	Depth	Width	
2.0	2.25	4.5	1.50
2.0	4.0	6.0	2.00
2.0	5.5	8.0	2.70
2.0	11.0	11.0	4.70
2.5	3.0	4.0	1.70
2.5	3.0	6.0	2.10
2.5	4.0	8.0	2.60
2.5	5.25	8.0	3.00
3.0	6.0	5.0	2.70
3.0	6.0	8.0	3.20
3.0	8.0	8.0	3.80
3.0	6.0	11.0	4.20
3.5	7.5	11.0	4.90
3.5	7.5	17.0	7.20
4.0	4.0	8.0	2.70
4.0	6.0	8.0	3.20
4.0	9.0	6.0	4.20
4.0	7.0	8.0	4.20
5.0	6.0	8.0	4.30
5.0	6.0	11.0	5.20
5.0	6.0	15.0	6.20
5.0	11.0	8.0	5.90
5.0	11.0	11.0	7.50
5.0	11.0	15.0	9.40
7.0	10.0	7.0	6.80
7.0	10.0	10.0	8.40
7.0	10.0	17.0	11.90

STANDARD ABS BOXES High Impact ABS

Colour: black

Internal Dimensions (mm)

A	B	C	1+	10+
76	58	35	Box/MB1	£1.04 98p
95	71	35	Box/MB2	£1.14 £1.05
115	95	37	Box/MB3	£1.34 £1.24
140	90	55	Box/MB5	£1.88 £1.74
207	122	77	Box/MB4	£3.60 £3.40
213	142	57	Box/MB6	£2.70 £2.60

Order Code S0/034 Price £8.50

FULL RANGE OF BABANI BOOKS IN STOCK

BOOKS
Data Volume 1 - Trans data & drawings A-BUY £9.99
Data Volume 2 - as above C-Z £10.75
Data Volume 3 - 2N-2N6735 £10.20
Data Volume 4 - 2SA & on £13.50
Diodes Volume 1 £10.75
Diodes Volume 2 £10.85
Both volumes £20.60
I.C. CMOS £8.95
I.C. TTL £19.50
I.C. LIN Volume 1 £6.95
I.C. LIN Volume 2 £6.99
Both Volumes £13.00
Thyristors A-Z £10.45
Transistors A-Z £5.40
Transistors 2N-3N £5.50
Both Volumes £10.00

BT APPROVED EQUIPMENT

Master Socket (flush) £2.90
Master Socket (surface) £2.75
Secondary Socket (flush) £1.90
Secondary Socket (surface) £1.85
BT Cable (per metre) 15p
BT Cable 100 metres £12.00 reel
Line Jack Cord with plug £1.25
Extension lead, 5mtr £2.90
Wiring Tool 36p
Plug - 431A 25p
Shimtel Phone £17.35
Viscount Phone £26.04
Conversion kit & wiring diag. £6.90

"CLOSED-CIRCUIT" TELEVISION SYSTEM

PRICE £150.00
COMPRISING:
1 x CAMERA
1 x MONITOR
1 x CAMERA BRACKET

USED **USED** **NEW**

COMPLETE WITH LENS

MAGENTA ELECTRONICS Ltd

PROJECT KITS

Magenta supply Full Kits: Including PCB's (or Stripboard), Hardware, Components, and Cases (unless stated). Please state Kit Reference Number, Kit Title, and Price, when ordering.
REPRINTS: If you do not have the issue of E.E. which includes the project, you will need to order the instruction reprint as an extra: 80p each. Reprints are also available separately—Send £1 in stamps.

REF NO.	KIT-TITLE	PRICE	REF NO.	KIT-TITLE	PRICE
797	MICRO ALARM Nov 88	£8.81	546	CARAVAN BATTERY MONITOR July 86	£17.17
796	SEASHELL SYNTHESIZER Nov 88	£24.99	547	SQUEEKIE CONTINUITY TESTER July 86	£3.52
795	LR OBJECT COUNTER Nov 88	£29.63	548	ELECTRONIC SCARECROW July 86	£8.87
794	REAR SCREEN ONE-SHOT Nov 88	£11.92	549	PERCUSSION SYNTH June 86	£30.43
793	DOORBELL DELAY Nov 88	£10.28	542	PERSONAL RADIO June 86	£11.53
792	SOLDERING IRON TEMPERATURE CONTROLLER Oct 88	£9.50	543	WATCHDOG June 86	£8.24
790	EPROM ERASER Oct 88	£24.95	529	MINI STROBE May 86	£13.86
791	BREAKING GLASS ALARM Sept 88	£17.51	528	PA AMPLIFIER May 86	£26.95
789	AMSTRAD P10 Sept 88	£19.98	523	STEREO REVERB Apr 86	£26.44
788	TIME SWITCH Aug 88	£17.61	524	VERSATILE PSU Apr 86	£24.69
787	SPIKEATER July 88	£3.99	526	FRELOADER Apr 86	£3.48
786	UNIVERSAL NICAD CHARGER July 88	£6.99	513	BBC MIDI INTERFACE Mar 86	£27.94
785	ISOLINK July 88	£24.51	514	INTERVAL TIMER Mar 86	£18.87
784	VIDEO WIPER July 88	£33.59	515	STEREO HI-FI PRE-AMP	£49.19
783	HEADLIGHT REMINDER June 88	£7.99	512	MAINS TESTER & FUSE FINDER Mar 86	£3.82
782	DOOR SENTINEL May 88	£12.81	503	FUNCTION GENERATOR Feb 86	£24.84
781	SUPER SOUND EFFECTS GENERATOR May 88	£12.99	504	POWER SUPPLY FOR ABOVE	£7.62
780	CABLE & PIPE LOCATOR April 88	£15.35	497	MUSICAL DOOR BELL Jan 86	£18.72
779	STEREO NOISE GATE April 88	£26.98	493	DIGITAL CAPACITANCE METER Dec 85	£41.55
778	INDUCTIVE PROXIMITY DET. April 88	£8.63	481	SOLDERING IRON CONTROLLER Oct 85	£5.47
777	LOW FUEL ALERT April 88	£6.43	473	R.I.A.A. PRE-AMP Sept 85	£16.74
772	SEMICONDUCTOR TESTER Mar 88	£23.51	464	STEPPER MOTOR INTERFACE FOR THE BBC COMPUTER less case Aug 85	£11.68
776	LE DETECTOR Mar 88	£11.80		1035 STEPPER MOTOR EXTRA	£14.50
775	ENVELOPE SHAPER Mar 88	£14.99		OPTIONAL POWER SUPPLY PARTS	£5.14
774	SOS ALERT Mar 88	£9.36	461	CONTINUITY TESTER July 85	£6.20
769	VARIABLE 25V-2A BENCH POWER SUPPLY Feb 88	£49.73	459	AMSTRAD USER PORT July 85	£17.67
770	CAR LAMP CHECKING SYST. Feb 88	£7.10	455	ELECTRONIC DOORBELL June 85	£7.96
768	GAME TIMER Feb 88	£14.32	453	GRAPHIC EQUALISER June 85	£26.94
765	QUIZMASTER Jan 88	£18.96	444	INSULATION TESTER Apr 85	£19.58
767	TRANSISTOR CURVE TRACER (BBC)	£14.98	432	GAMES TIMER Jan 85	£9.11
763	AUDIO SIGNAL GENERATOR Dec 87	£13.64	430	SPECTRUM AMPLIFIER Jan 85	£6.91
764	DUAL MAINS LIGHTS FLASHER Dec 87	£20.98	417	DOOR CHIME Dec 84	£18.78
739	ACCENTED BEAT METRONOME Nov 87	£20.95	392	BBC MICRO AUDIO STORAGE SCOPE INTERFACE Nov 84	£36.25
740	ACOUSTIC PROBE Nov 87 (less bolt & probe)	£16.26	394	PROXIMITY ALARM Nov 84	£22.66
741	BBC SIDEWAYS RAM/ROM Nov 87	£27.53	387	MAINS CABLE DETECTOR Oct 84	£5.53
744	VIDEO CONTROLLER Oct 87	£29.14	386	DRILL SPEED CONTROLLER Oct 84	£8.68
745	TRANSTEST Oct 87	£9.70	381	GUITAR HEAD PHONE AMPLIFIER Sept 84	£13.15
734	AUTOMATIC PORCH LIGHT Oct 87	£17.17	363	VARICAP AM RADIO May 84	£23.58
735	CARAVAN FLOOD ALERT Oct 87	£5.44	364	SIMPLE LOOP BURGLAR ALARM May 84	£17.16
736	STATIC MONITOR Oct 87	£8.66	358	FUSE/DIODE CHECKER Apr 84	£4.35
723	ELECTRONIC MULTIMETER Sept 87	£46.96	356	QUASI STEREO ADAPTOR Apr 84	£13.73
729	NOISE GATE Sept 87	£23.25	344	SIGNAL TRACER Feb 84	£18.77
728	PERSONAL STEREO AMP Sept 87	£14.31	337	BIOLOGICAL AMPLIFIER Jan 84	£24.14
730	BURST-FIRE MAINS CONTROLLER Sept 87	£13.57	334	CONTINUITY TESTER Dec 83	£12.59
724	SUPER SOUND ADAPTOR Aug 87	£38.39	332	CHILDREN'S DISCO LIGHTS Dec 83	£10.48
718	3 BAND 1.6-30MHz RADIO Aug 87	£26.53	333	NOVEL EGG TIMER Dec 83 inc. case	£12.90
719	BUCCANEER I.B. METAL DETECTOR inc. coils and case, less handle and hardware July 87	£26.45	301	STORAGE SCOPE INTERFACE FOR BBC MICRO Aug 83 less software	£19.34
720	DIGITAL COUNTER/FREQ METER (10MHz) inc. case July 87	£67.07	299	HIGH POWER INTERFACE BOARD Aug 83 no case	£12.99
721	MONOMIX July 87	£21.00	292	USER PORT I/O BOARD less cable + plug	£13.22
722	FERROSTAT July 87	£12.14	293	USER PORT CONTROL BOARD July 83 less cable + plug + case	£31.67
711	VISUAL GUITAR TUNER Jun 87	£22.99	277	MW PERSONAL RADIO less case, May 83	£9.60
715	MINI DISCO LIGHT Jun 87	£12.59	270	MOISTURE DETECTOR May 83	£6.98
705	WINDSCREEN WASHER WARNING May 87	£5.12	270	NOVELTY EGG TIMER April 83 less case	£6.91
700	FRIDGE ALARM May 87	£9.88	263	BUZZ OFF March 83	£5.68
707	EQUALIZER (HONISER) May 87	£15.53	262	PUSH BIKE ALARM Feb 83	£14.77
705	BULB LIFE EXTENDER April 87 (less case)	£5.24	255	ZX TAPE CONTROL Nov 82	£8.98
703	EXP. SPEECH RECOGNITION April 87	£20.98	242	2-WAY INTERCOM July 82 no case	£5.69
700	ACTIVE I/R BURGLAR ALARM Mar 87	£35.65	243	REFLEX TESTER July 82	£9.79
581	VIDEO GUARD Feb 87	£9.29	240	EGG TIMER June 82	£6.86
583	CAR VOLTAGE MONITOR Feb 87	£12.58	237	CAR LED VOLT METER less case, May 82	£4.00
584	SPECTRUM SPEECH SYNTH. (no cd) Feb 87	£20.92	225	CAMERA OR FLASH GUN TRIGGER Mar 82 less tripod bushes	£17.20
578	SPECTRUM I/O PORT less case, Feb 87	£9.44	205	SUSTAIN UNIT Oct 81	£17.63
579	STEPPING MOTOR BOOSTER (for above) Feb 87	£5.45	206	TAPE NOISE LIMITER Oct 81	£5,976.27
575	STEPPING MOTOR MD200 Feb 87	£16.80	207	HEADS AND TAILS GAME Oct 81	£3.47
569	HANDS-OFF INTERCOM (per station) inc. case Jan 87	£10.49	209	PHOTO FLASH SLAVE Oct 81	£4.79
569	CAR ALARM Dec 86	£12.47	211	FUZZ BOX Oct 81	£10.05
571	RANDOM NUMBER GENERATOR Dec 86	£15.72	197	0-12V POWER SUPPLY Sept 81	£24.55
568	BBC 16K SIDEWAYS RAM Dec 86	£12.97	181	SOIL MOISTURE INDICATOR E.E. May 81	£5.66
564	CAR FLASHER WARNING Nov 86	£9.37	149	GUITAR PRACTICE AMPLIFIER Nov 80	£22.95
563	200MHz DIG. FREQUENCY METER Nov 86	£62.98	148	SOUND TO LIGHT Nov 80 3 channel	£29.38
562	10 WATT AUDIO AMPLIFIER Oct 86	£36.70	124	SPRING LINE REVERB UNIT Jan 80	£34.27
561	LIGHT RIDER LAPEL BADGE Oct 86	£10.20	122	UNIBOARD BURGLAR ALARM Dec 79	£8.38
560	LIGHT RIDER DISCO VERSION	£19.62	118	DARKROOM TIMER July 79	£4.03
559	LIGHT RIDER 16 LED VERSION	£13.64	113	MICROCHIME DOORBELL Feb 79	£21.99
558	SCRATCH BLANKER Sept 86	£55.83	111	SOUND TO LIGHT Sept 78	£10.98
556	INFRA-RED BEAM ALARM Sept 86	£28.35	108	IN SITU TRANSISTOR TESTOR Jun 78	£9.42
555	FREEZER FAILURE ALARM Sept 86	£15.50	106	WEIRD SOUND EFFECTS Gen Mar 78	£7.82
554	CAR TIMER Sept 86	£8.72	101	ELECTRONIC DICE Mar 77	£6.26
553	BATTERY TESTER Aug 86	£7.19			
544	TILT ALARM July 86	£7.82			

TOP KITS

MOSFET VARIABLE BENCH 25V 2.5A POWER SUPPLY



A superb design giving 0-25V and 0-2.5A. Twin panel meters indicate Voltage and Current. Voltage is variable from zero to 25V. Current-Limit control allows Constant Current charging of NICAD batteries, and protects circuits from overload. A Toroidal transformer MOSFET power output device, and Quad op-amp IC design give excellent performance.

OUR KIT REF. 769 £49.73

COMPONENTS, KITS, BOOKS, TOOLS, MOTORS, GEARS, PULLEYS, OPTICAL FIBRES, ROBOTICS, AND MUCH MUCH MORE—IN OUR NEW CATALOGUE £1.00

INTRODUCING DIGITAL ELECTRONICS COMPONENT PACK £13.99 INCLUDES BREADBOARD AND BATTERY

MOTOR-GEARBOX ASSEMBLIES

Miniature gearboxes complete with quality electric motor. Variable ratios by fitting 1 to 6 gears. 1.5-4.5v, 3-2200 rpm. Long 3mm shaft. Ideal for robots and buggies.

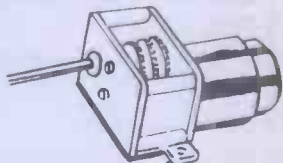

SMALL (MGS) £3.49 LARGE (MGL) £3.98

ADVENTURES WITH ELECTRONICS

An easy to follow book suitable for all ages. No soldering, uses an S DEC breadboard. Lots of clear diagrams and instructions to build 16 projects. Component pack includes S DEC and all components for the projects.

OPTICAL FIBRES TRIAL PACK OF 10 METRES. Nine assorted types & data. £1.99

LEGO Technic Sets

TEACHERS WE ARE STOCKISTS OF THE WHOLE RANGE. CONTACT US FOR BROCHURES. VERY COMPETITIVE PRICES AND QUICK DELIVERIES

STEPPING MOTORS 12 VOLT

48 STEPS 1035 £14.50	200 STEPS MD200 £16.80
----------------------------	------------------------------

MAGENTA ELECTRONICS LTD. SHOP NOW OPEN

— CALLERS WELCOME
**EE71, 135 HUNTER STREET,
 BURTON-ON-TRENT,
 STAFFS, DE14 2ST**
 Access/Barclaycard (Visa) by phone or post.
 24 hr Answerphone for credit card orders.

SHOP HOURS: 9-5 MON-FRI
 ADD £1 P&P TO ALL ORDERS.
 PRICES INCLUDE VAT.
 SAE ALL ENQUIRIES.
 OFFICIAL ORDERS WELCOME
 OVERSEAS: Payment must be sterling.
 IRISH REPUBLIC and BFPO, UK PRICES
 EUROPE: UK PRICES plus 10%.
 ELSEWHERE: write for quote.

0283 65435



FROM MAGENTA

A SELECTION OF OUR BEST PROJECT KITS

As usual these kits come complete with printed circuit boards, cases, all components, nuts, screws, wire etc. All have been tested by our engineers (many of them are our own designs) to ensure that you get excellent results.

INSULATION TESTER

An electronic High Voltage tester for mains appliances and wiring. An inverter circuit produces 500 volts from a PP3 battery and applies it to the circuit under test. Reads insulation up to 100 Megohms. Completely safe in use.



OUR KIT REF 444 £19.58

DIGITAL CAPACITANCE METER

Simple and accurate (1%) measurements of capacitors from a few pF up to 1,000 uF. Clear 5 digit LED display indicates exact value. Three ranges — pF, nF, and uF. Just connect the capacitor, press the button and read the value.



**£41.55
OUR KIT
REF 493**

3 BAND SHORTWAVE RADIO

Covers 1.6-30 MHz in 3 bands using modern miniature coils. Audio output is via a built-in loudspeaker. Advanced design gives excellent stability, sensitivity and selectivity. Simple to build.



OUR KIT REF 718 £26.53

DIGITAL FREQUENCY METER 200 MHz

An 8 digit meter reading from A.F. up to 200 MHz in two ranges. Large 0.5" Red LED display. Ideal for AF and RF measurements, Amateur and C.B. frequencies.

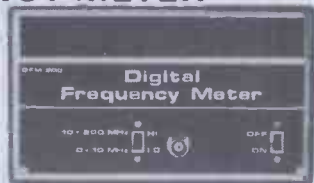

KIT REF 563 £62.98

'EQUALISER' IONISER



A mains powered Ioniser that produces a breeze of negative ions in the air. A compact, safe, simple unit that uses a negligible amount of electricity.

KIT REF 707 £15.53

SUPER SOUND-EFFECTS GENERATOR

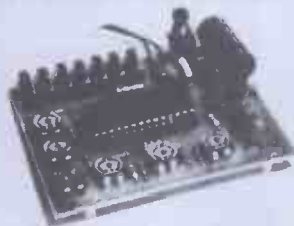

A wide range SN76477 sound effects board giving: Bird Chirps, Sirens, Helicopters, Explosions, Phaser Guns, Steam Train sounds, and more. Supplied without a case.

KIT REF 781 £12.99

ELECTRONICS TEACH-IN 88/89

£2.45

From the
Publishers of
EVERYDAY
ELECTRONICS

A Complete
City and Guilds
Certificate Course
**INTRODUCING
MICROPROCESSORS**

TEACH-IN 88/89 BOOK £2.45

★ NOW AVAILABLE ★

**A complete City and Guilds
Certificate Course for 726/303
Introductory Microprocessors**

Written by Mike Tooley B.A. this course can lead successful readers to a City and Guilds Certificate. Everything you need to know is included—even Pre-test papers, etc. Make sure of your copy, send in order with payment now.

Send to Direct Book Service, 33 Gravel Hill, Merley, Wimborne, Dorset BH21 1RW.

TEACH-IN 88/89—INTRODUCING MICROPROCESSORS, ORDER FORM

NAME _____

ADDRESS _____

Please send me copies of Teach-In 88/89—Introducing Microprocessors; I enclose cheque/PO £ sterling only for £ (overseas readers add £1 postage) made payable to Direct Book Service.

For KITS & COMPONENTS - Choose the easy way - with

refundable with first order

Send **50p* & SAE** for **CATALOGUE**

ORDERS: RING (01) 567 8910 - 24 HRS.

NEW THREE SIMPLE CONSTRUCTION KITS

Especially aimed for the beginner. Have fun with your project even after you have built it and also learn a little from building it. These kits include high quality solder resist print circuit boards, all electronic components (including speaker where used) and full construction instructions with circuit description.

- SK1 DOOR CHIME** - plays a tune when activated by a pushbutton £3.90
- SK2 WHISTLE SWITCH** - switches a relay on and off in response to whistle command. £3.90
- SK3 SOUND GENERATOR** - produces FOUR different sounds, including police/ambulance/fire - engine siren and machine gun. £3.90

SPECIAL OFFERS FOR SCHOOLS AND TRAINING CENTRES contact Sales Office for discounts and samples.

NEW SUPER-SENSITIVE FM MICROBUG

Highly sensitive FM transmitter measuring only 45x25x15mm, including the built-in microphone. Frequency 88-100MHz enabling reception on a standard domestic FM radio. Range approximately 300m depending on terrain. Powered by 9V PP3 (7mA). Its small size and highly sensitive electret microphone makes it ideal for surveillance, baby alarm, etc. £5.50

TEN EXCITING PROJECTS FOR BEGINNERS

This Kit has been specially designed for the beginner and contains a **SOLDERLESS BREADBOARD, COMPONENTS**, and a **BOOKLET** with instructions to enable the absolute novice to build TEN fascinating projects including a light operated switch, intercom, burglar alarm, and electronic lock. Each project includes a circuit diagram, description of operation and an easy to follow layout diagram. A section on component identification and function is included, enabling the beginner to build the circuits with confidence. **ORDER NO. XK118 £15.00**

DISCO LIGHTING KITS

DL1000K - This value-for-money 4-way chaser features bi-directional sequence and dimming. **1kW per channel £19.25**

DL21000K - A lower cost uni-directional version of the above. Zero switching to reduce interference. **£10.80**

DLA/1 (for DL & DL21000K) Optional opto input allowing audio 'beat/light' response. **£7.7p**

DL3000K - 3-channel sound to light kit features zero voltage switching, automatic level control and built-in microphone. **1kW per channel £15.60**

The **DL8000K** is an 8-way sequencer kit with built in opto-isolated sound to light input which comes complete with a pre-programmed EPROM containing **EIGHTY - YES 80!** different sequences including standard flashing and chase routines. The **KIT** includes full instructions and all components (even the PCB connectors) and requires only a box and a control knob to complete. Other features include manual sequence speed adjustment, zero voltage switching, LED mimic lamps and sound to light LED and a 300 W output per channel. And the best thing about it is the price.

ONLY **£31.50**



PROPORTIONAL TEMPERATURE CONTROLLER KIT

Uses "burst fire" technique to maintain temperature to within 0.5°C. Ideal for photography, incubators, wine-making, etc. Max. load 3kw (240V ac) Temp. range up to 90°C. Size: 7x4x2.5cms. **MK4 £7.80**

VERSATILE REMOTE CONTROL KIT

This kit includes all components (+ transformer) to make a sensitive IR receiver with 16 logic outputs (0-15V) which with suitable interface circuitry (relays, triacs, etc - details supplied) can be used to switch up to 16 items of equipment on or off remotely. The outputs may be latched (to the last received code) or momentary (on during transmission) by specifying the decoder IC and a 15V stabilised supply is available to power external circuits. Supply: 240V AC or 15-24V DC at 10mA. Size (excluding transformer) 9 x 4 x 2 cms. The companion transmitter is the MK18 which operates from a 9V PP3 battery and gives a range of up to 60ft. Two keyboards are available - MK9 (4-way) and MK10 (16-way), depending on the number of outputs to be used. **MK12 IR Receiver (incl. transformer) £16.30**

- MK18 Transmitter £7.50**
- MK9 4-Way Keyboard £2.20**
- MK10 16-Way Keyboard £6.55**
- 601 133 Box for Transmitter £2.60**

ELECTRONIC GUARD DOG KIT

One of the best deterrents to a burglar is a guard dog and this new kit provides the barking without the bite! The kit when assembled can be connected to a doorbell, pressure mat or any other intruder detector and will produce a random series of barking barks making the would be intruder think again and try his luck elsewhere. The kit is supplied complete with high quality PCB, transformer, all components and instructions. All you need is a mains supply, intruder detector and a little time. The kit even includes a horn speaker which is essential to produce the loud sound required. The "dog" can be adjusted to produce barks ranging from a Terrier to an Alsatian and contains circuitry to produce a random series of barks giving a more realistic effect. **XK125 Complete kit of parts £24.00**

HIGH SECURITY LOCK KIT

Designed for use with our lock mechanism (701 150) this kit will operate from a 9V to 15V supply drawing a steady current of only 50µA. There are over 5000 possible 4-digit combinations and the sequence can be easily changed. To make things even more difficult for an unauthorized user, an alarm can be sounded after 3 to 9 incorrect entries - selectable by means of a link. The alarm can sound for a few seconds to over 3 minutes during which time the keyboard is disabled preventing further entries. A latched or momentary output is available making the unit ideal for door locks, burglar alarms, car immobilisers, etc. A membrane keyboard or pushbutton switches may be used and a beep sounds when a key is depressed. Kit includes high quality PCB, all components, connectors, high power piezo buzzer and full assembly and user instructions.

- XK121 LOCK KIT £15.95**
- 350 118 Set of Keyboard Switches £4.00**
- 701 150 Electric Lock Mechanism 12 volt £16.50**

POWER STROBE KIT

Designed to produce a high intensity light pulse at a variable frequency of 1 to 15Hz this kit also includes circuitry to trigger the light from an external voltage source (eg. a loudspeaker) via an opto isolator. Instructions are also supplied on modifying the unit for manual triggering, as a slave flash in photographic applications or as a warning beacon in security applications. The kit includes a high quality pcb, components, connectors, 5Ws strobe tube and full assembly instructions. Supply: 240V ac. Size: 80 x 50 x 45. **XK124 STROBOSCOPE KIT £13.75**

BARGAIN COMPONENT PACKS

Refill those empty component drawers at a fraction of the normal price and don't be caught without that odd resistor or capacitor to complete your project. All components supplied are full specification and not seconds or surplus stock.

- PACK A:** 650x0.25W resistors 47R to 10M **£4.25**
- PACK B:** 60xElectrolytics 1uF-1000uF **£3.25**
- PACK C:** 30xPolyester Capacitors 0.01-1uF **£4.50**
- PACK D:** 36xHorizontal presets 1k-1M **£3.00**
- PACK E:** 30xIC sockets 8, 14 & 16 Pin **£2.00**
- PACK F:** 25xRed LEDs 5mm **£1.75**
- PACK G:** 25xGreen LEDs 5mm **£2.00**
- PACK H:** 30x5mm LEDs - red, green, yellow **£2.50**
- PACK J:** 50x1N4148 Si. diodes **£1.00**
- PACK K:** 40xNPN/PNP transistors BC182/212 General Purpose **£2.25**

10% OFF when you buy ALL 10 PACKS

Components for the new **EE INTRODUCING DIGITAL ELECTRONICS COURSE** (1st 6 parts) only **£11.95**

- Good quality tools selected to offer outstanding value for money:
- 650 004** 6in mini. Snipe Nose Pliers. Serrated jaws and return spring. **£2.10**
 - 650 005** 6in lap jointed side cutters. Insulated handles and return spring. **£2.10**
 - 650 006** Light duty cutters. Cutting capacity 0.22-1.2mm copper wire. **£1.60**
 - TOOL KIT** - Contains: side cutters, snipe nose pliers, wire strippers, flat blade screwdriver, philips screwdriver in black textured, reinforced and padded case which when opened out measures 240x205mm **£6.80**
 - 650 007** Self-adjustable automatic wire stripper with built-in cable cutter. **£3.95**
 - 650 018** Wire Stripper **£1.50**
 - 650 013** Screwdriver **£0.15**

- Soldering Irons**
- 650 018** Economy 15W Iron **£2.99**
 - 650 100** 15W ANTEX Iron **£6.80**
 - 650 103** 18W ANTEX Iron **£6.95**
 - 650 104** 25W ANTEX Iron **£7.10**

LOW COST MULTIMETER

A versatile meter with 19 ranges including 10A DC & BATTERY TEST. Case is tilted for easy reading. Supplied complete with batteries, test leads and a manual. Ideal meter for the beginner. Input impedance 20K ohm per volt. AC Volts: 0-10-25-100V 5%. DC Volts: 0-2.5-20-25-250 + 1000V + 5%. DC Current: 0-2.5-25m 250mA-10A + 4%. Resistance: 0-10K-100K-10MΩ Battery test: 9V-1.5V AA-1.5V C & D Protection: Fuse Dimensions: 154 x 77 x 43mm **£8.62**

RECHARGEABLE SOLDERING IRON

Powerful cordless iron complete with table-top/wall-mounting charging bracket. Reaches soldering temperature in 10 seconds. Includes lamp which lights when soldering. Comes with mains charging unit and 12V car battery adaptor. **Special offer £15.95**

HELPING HANDS

Magnifier and crocodile clips on ball and socket joints mounted on a heavy base. Ideal for holding and inspecting PCBs during soldering, fault finding, etc. (650 035) **£3.95**

SOLID STATE RELAY BARGAIN

*Zero Voltage Switching: No radio interference problems *2.5KV Input to Output Isolation: No risk of damage to your computer or driver circuits. *4KV Terminals to Heat-sink isolation: Simply bolt onto a heatsink. *3V to 32V Input Voltage: easily interfaced to TTL or CMOS Logic. *24V to 240V rms Load Voltage: Allowing mains loads to be switched. *Built in Snubber Network: Enabling switching of inductive loads. *10A Maximum Current: 4A with no heatsink fitted at 40 deg C. **CD240/10 £2.25**

GIANT SOLAR CELLS

NOW IN STOCK these giant size solar panels 12 x 12in will deliver 12 volts 200mA in bright sunlight and 11.5 volts 60mA on a typical British summer day (dull and overcast). **HUNDREDS OF USES** in the car or caravan, e.g. Charging NiCads, powering low voltage circuits where mains or battery supplies are inconvenient or coupled to a lead acid battery and a simple inverter you could build yourself a self contained mains supply for low power appliances. Stock No. 303 145. **£14.50** (plus £1.75 for p&p on total order).

HOME LIGHTING KITS

These kits contain all necessary components and full instructions and are designed to replace a standard wall switch and control up to 300W of lighting.

- TD300K** Touchdimmer **£9.30**
- T5300K** Touchswitch **£9.30**
- TDE/K** Extension kit for 2-way switching for TD300K **£2.95**
- LD 300K** Light Dimmer **£4.75**

SOLAR POWERED NICAD CHARGER

Takes up to 4 x AA size. Charges 2 batteries in 4-6 hrs. depending on strength of sunlight. Ideal for boating, caravaning, modellers, etc. **£6.50**

ELECTRONIC WEIGHING SCALES

This kit contains a Single Chip Micro-processor, PCB, displays and all electronics to produce a digital readout of weight in Kgs. or Sts. and Lbs. In normal use a toothed wheel (pattern provided) is made to rotate when a weight is placed onto the scales, interrupting two infra-red beams. The processor counts the number of teeth passing the sensor (up or down, depending on which beam is broken first), and shows the reading on the LED display in Sts. and Lbs., or Kgs. A PCB link selects the scale for labroom or two types of Kitchen Scales. A linear version of the toothed wheel could also be used. Other uses include up/down counters. A low cost digital ruler could be made by using a wheel with the correct tooth to diameter ratio. **ESI £6.50**

TR ELECTRONICS 13 BOSTON RD LONDON W7 3SJ Tel: 01-567 8910

SEND 9"x 6" S.A.E. & 50p FOR CATALOGUE OR CALL AT SHOP MON-FRI 9-5pm SATURDAY 10-4pm

ORDERING INFORMATION: ALL PRICES EXCLUDE VAT

FREE P&P on orders over £20 (UK only), otherwise add 75p + VAT. Overseas P&P: Europe £2.75. Elsewhere £6.50. Send cheque/PO/Barclaycard/Access No. with order. Giro No. 529314002.

LOCAL AUTHORITY AND EXPORT ORDERS WELCOME GOODS BY RETURN SUBJECT TO AVAILABILITY

EVERYDAY ELECTRONICS

INCORPORATING ELECTRONICS MONTHLY

The Magazine for Electronic & Computer Projects
VOL. 17 No. 12 December '88

CIRCUIT CARDS

EVERY so often a new constructional method comes along which changes the face of hobbyist projects. I well remember as an apprentice back in the early sixties when Veroboard came out. It revolutionised the hobby almost overnight. For the first time hobbyists could produce projects using a form of printed circuit board—actual p.c.b.s for hobbyists did not appear until many years later.

Now we have a solderless method of construction—again from Vero. Easiwire and various projects using this system are catching on fast—particularly in education where the absence of soldering is a particular advantage. Over the next few months we will bring you a range of eight projects designed to be built with the Easiwire system. You could of course build them up on plain matrix board with soldered connections if you so wish.

Obviously these projects will appeal particularly to those with little constructional experience since they eliminate one of the areas which can cause problems. We hope that our Free Circuit Cards will make construction of these projects virtually foolproof. To help a little further we have arranged a £1 off the Easiwire Kit from BICC-Vero—see page 703.

OFFERS

While on the subject of Special Offers to EE readers don't miss this month's 'Scope Offer (page 729). We know this type of equipment is rather expensive but this offer represents a good saving on the normal price and, of course, the 'Scope is one of the most useful and versatile items of equipment anyone interested in electronics could wish to own.

These Hameg 'Scopes are guaranteed for two years and should provide many, many years of reliable service to both hobbyists and professionals alike.

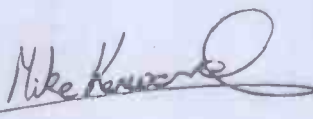

SUBSCRIPTIONS

Annual subscriptions for delivery direct to any address in the UK: £14.50. Overseas: £17.50 (£34 airmail). Cheques or bank drafts (in

£ sterling only) payable to Everyday Electronics and sent to EE Subscriptions Dept., 6 Church Street, Wimborne, Dorset BH21 1JH. Subscriptions can only start with the next available issue. For back numbers see below.

BACK ISSUES

Certain back issues of EVERYDAY ELECTRONICS are available price £1.50 (£2.00) overseas surface mail—£ sterling only please) inclusive of postage and packing per copy. Enquiries with remittance, made payable to Everyday Electronics, should be sent to Post Sales Department, Everyday Electronics, 6 Church Street, Wimborne, Dorset BH21 1JH. In the event of non-availability remittance will be returned. Please allow 28 days for delivery. We have sold out of Sept., Oct., & Nov. 85, April, May & Dec 86, Jan., Feb., April, May, Nov. 87, Jan., March & April 88).

BINDERS

Binders to hold one volume (12 issues) are available from the above address for £4.95 (£9.00 overseas surface mail) inclusive of p&p. Please allow 28 days for delivery. Payment in £ sterling only please.

Editorial Offices

EVERYDAY ELECTRONICS EDITORIAL,
6 CHURCH STREET, WIMBORNE,
DORSET BH21 1JH

Phone: Wimborne (0202) 881749
FAX: (0202) 841692

See notes on **Readers' Enquiries** below—we regret that lengthy technical enquiries cannot be answered over the telephone

Advertisement Offices

EVERYDAY ELECTRONICS ADVERTISEMENTS
HOLLAND WOOD HOUSE, CHURCH LANE,
GREAT HOLLAND, ESSEX CO13 0JS. Clacton
(0255) 850596

Editor MIKE KENWARD

Secretary PAMELA BROWN

Deputy Editor

DAVID BARRINGTON

Editorial Assistant

COLETTE MCKENZIE

Editorial: WIMBORNE (0202) 881749

Advertisement Manager

PETER J. MEW Clacton (0255) 850596

Classified Advertisements

Wimborne (0202) 881749

READERS' ENQUIRIES

We are unable to offer any advice on the use, purchase, repair or modification of commercial equipment or the incorporation or modification of designs published in the magazine. We regret that we cannot provide data or answer queries on articles or projects that are more than five years old. Letters requiring a personal reply must be accompanied by a **stamped self-addressed envelope** or a **self-addressed envelope and international reply coupons**.

All reasonable precautions are taken to ensure that the advice and data given to readers is reliable. We cannot, however, guarantee it and we cannot accept legal responsibility for it.

COMPONENT SUPPLIES

We do not supply electronic components or kits for building the projects featured, these can be supplied by advertisers.

OLD PROJECTS

We advise readers to check that all parts are still available before commencing any project in a back-dated issue.

We regret that we cannot provide data or answer queries on projects that are more than five years old.

ADVERTISEMENTS

Although the proprietors and staff of EVERYDAY ELECTRONICS take reasonable precautions to protect the interests of readers by ensuring as far as practicable that advertisements are *bona fide*, the magazine and its Publishers cannot give any undertakings in respect of statements or claims made by advertisers, whether these advertisements are printed as part of the magazine, or are in the form of inserts.

The Publishers regret that under no circumstances will the magazine accept liability for non-receipt of goods ordered, or for late delivery, or for faults in manufacture. Legal remedies are available in respect of some of these circumstances, and readers who have complaints should address them to the advertiser or should consult a local trading standards office, or a Citizen's Advice Bureau, or a solicitor.

TRANSMITTERS

We would like to advise readers that certain items of radio transmitting equipment which may be advertised in our pages cannot be legally used in the U.K. Readers should check the law before using any transmitting equipment as a fine, confiscation of equipment and/or imprisonment can result from illegal use.

The law relating to this subject varies from country to country; overseas readers should check local laws.



PHASOR

ANDY FLIND

A light effects unit (up to 100W) with a difference. Suitable for parties, games, meditation or just plain relaxing. Ideal companion for the "Seashell Sea Synthesiser" described last month.



OVER the last few months, the author has spent much time experimenting with electronic lighting effects. Up to four channels of coloured lights have been tried in various arrangements, operated by signal generators and filtered sound. During this work, it emerged that one of the most attractive effects consisted of a single bulb, either coloured or plain, placed inside one of those white translucent globes so often seen suspended from ceilings. The effect obtained is very pleasant and has so many possible uses that a special project especially for it seemed worthwhile.

With this project the globe is taken from its original fitting and placed "upside down" on a base, and the lamp is driven by a circuit that causes its brilliance to rise and fall slowly and continuously, at speeds from once every two seconds to once in twenty seconds or so. The speed of the effect, its depth and the overall brightness are all independently adjustable for a wide variety of possible effects. Apart from the attraction of the lamp itself, much fun can be had from simply playing with the controls.

BLOCK DIAGRAM

As the circuit is quite complex, the description will begin with a block diagram, Fig. 1,

which shows the general principle of operation. The well-known "phase-angle" power control method is used, similar to most dimmer switches, but it is voltage-controlled. A zero-crossing detector provides a short pulse each time the mains voltage crosses zero, and this resets a ramp generator. The ramp output is compared to the internally generated control signal, and the comparator controls the load through a triac.

As phase-angle dimmers produce a fair amount of r.f. noise, suppression is fitted to keep this from entering the mains wiring. Low-voltage power for the electronics is supplied from a capacitive "dropper" circuit. The control signal is a slow, approximately sine-shaped voltage as this gives the best effect. Whilst a triangular waveform is easier to generate, the "corners" are clearly visible in the light output and spoil the smoothness of the effect.

WAVEFORMS

The internal waveforms of the circuit are shown in Fig. 2. Diagram (a) shows the waveform of the 50Hz a.c. mains supply, (b) is the output from the zero crossing detector, though in practice the pulses are much shorter than shown. Note how they "straddle" the zero crossings so that drive to the triac is

removed just before zero, allowing it to turn off reliably. The ramp waveform appears at (c), and again at (d), this time together with a steady signal voltage, these two being the inputs to the comparator stage.

The outputs from comparator and triac are shown in (e) and (f). In this example the input signal at (d) and corresponding output power to the load at (f) are both about fifty percent of their range.

Like most really effective circuits, this one is fairly complex. None of the parts are particularly expensive though, and the completed board is fairly compact. A detailed description of the full circuit, Fig. 3, follows.

CIRCUIT

To begin with, a source of regulated power for the low-voltage electronics is necessary. The triac to be used, a C206D device, has been found by the author to trigger more reliably when operated with negative gate drive. Since this must be delivered with respect to the neutral side of the mains, a single negative supply rail is used instead of the more usual positive one.

The low voltage is obtained from the live side of the mains, using the reactance of C1 to limit current flow. Positive half-cycles pass through D1 to neutral, negative ones flow through D2 into C3. At about 12 volts, Zener D3 conducts, returning further current to neutral. The unused current in this type of "dropper" circuit is almost purely reactive; it doesn't cause heat as a resistor would, and should not increase the electricity bill.

IC1 is a 5 volt negative voltage regulator feeding decoupler C4. This is the power supply section of the circuit, providing negative supplies of about 12 volts with crude regulation for the output stage and a well-regulated 5 volts for everything else.

ZERO CROSSING

The zero-crossing detection is carried out by TR1 and IC2, a CMOS 4011B. A small current flows directly from live through R3 with a slight forward phase shift introduced by C2. During negative half-cycles it flows to neutral through the base-emitter junction of TR1, turning it on, during positive half cycles it flows through D4 and the transistor is turned off. The collector of this transistor is thus alternatively high and low, the changeovers

Fig. 1. Block diagram for the Phasor light effects "globe".

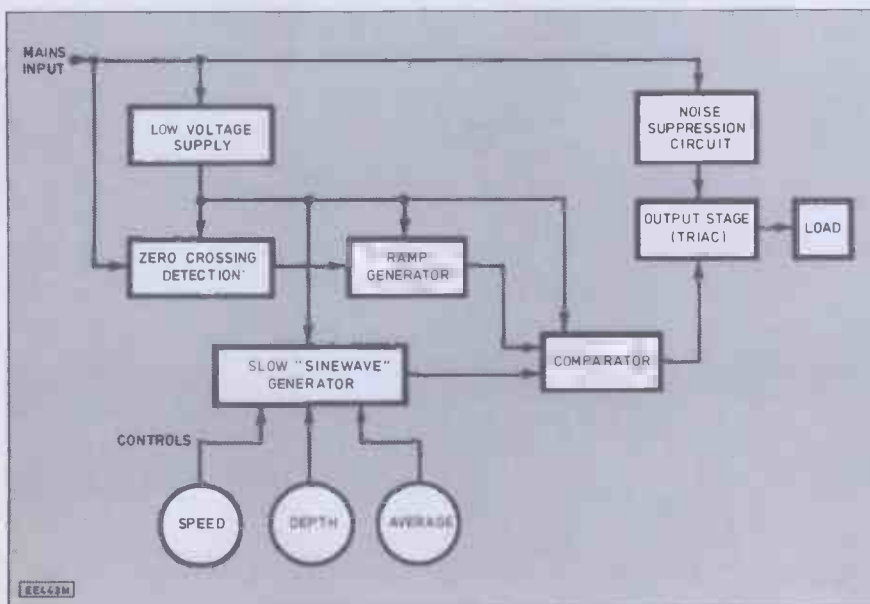

occurring just before the mains zero crossings. This signal drives IC2, a quad "NAND" gate device.

Gate "a" buffers (and inverts) the signal, gate "b" inverts it again. Each drives an input of gate "c" through a differentiator. The inputs of "c" are normally high, but each time the collector of TR1 changes state one of them is pulled briefly low, causing a short positive pulse to appear at the "c" output. This is inverted again by "d", giving a similar but negative-going pulse. With the component values shown the output pulses are theoretically about $400\mu\text{s}$ long and almost centred over the zero crossings.

These pulses turn on TR2, which charges C9. R8 discharges C9 by about a volt during the 10ms of each mains half-cycle. As this is only a small part of the C9/R8 time constant, the resulting ramp waveform is fairly linear. C10, R10, and R11 correct the d.c. voltage so that the average level of the ramp is half the supply voltage.

CONTROL SIGNAL

Ramp generation forms one side of the circuit, whilst the other is concerned with control signal generation. This is based around IC3, a TL064 quad op-amp. This particular device sports both low current consumption and high input impedance, both useful in this design. The first amplifier, "a", provides a low impedance mid-rail reference. "b" is an integrator, giving an output which ramps at a speed and direction depending on the input voltage to R17. It drives IC4, a "Schmitt trigger" with hysteresis of about 2 volts. The 3130 is used here instead of a TL064 amp because its output switches all the way to both supply rails.

Input for the integrator is taken from the 3130 through VR1, giving frequency adjustment from about one cycle per second to about one in every twenty seconds. The control is practically linear, making it easy to adjust. Output from this stage is a triangle wave but, as mentioned earlier, a sine wave is better for this application. IC3 "c" shapes the triangle, through non-linear feedback from diodes D5 and D6, into something similar to a sine wave in appearance, of about a volt peak to peak.

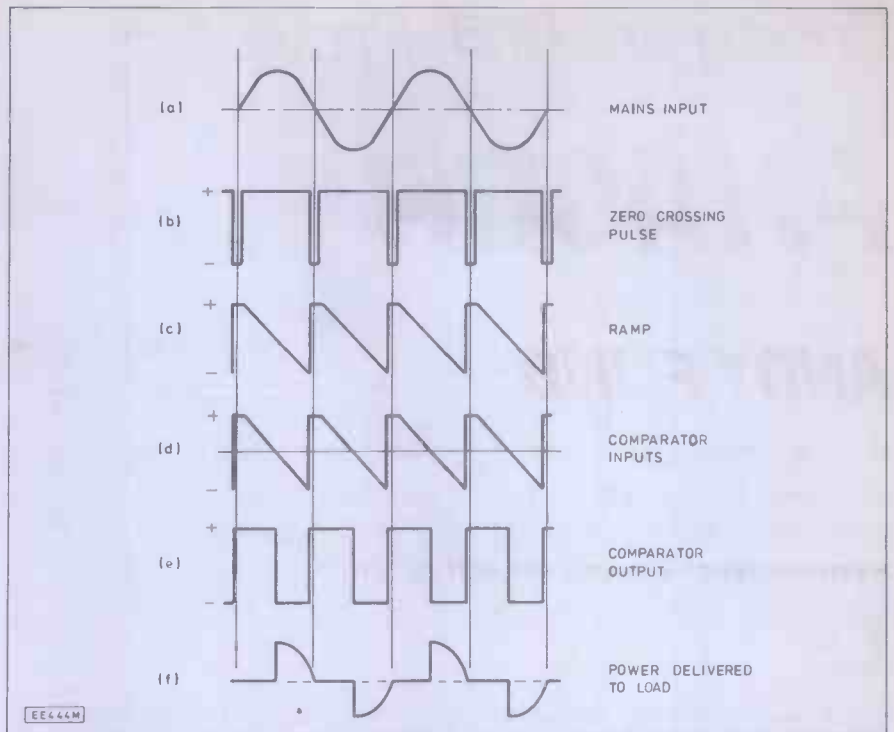

Fig. 2. Waveforms in Phasor circuit, at about half power.

The last of the four TL064 amps, IC3 "d", sets up the signal to the comparator. The "sinewave" input arrives via "depth" control VR3, allowing the fading effect to be varied from zero to overdrive, where the lamp virtually flashes instead of fading. An adjustable constant d.c. input from VR2 controls overall lamp brilliance. The outputs of this stage and the ramp generator go to comparator IC5 which drives the triac CSR1. IC5 is another 3130, they make excellent comparators. It is supplied directly from the 12 volt rail to improve the triac drive.

Suppression is supplied by choke L1 and capacitor C13 to keep r.f. radiation to a minimum, and a transient suppressor VDR1 is included to protect the triac from any high voltage spikes in the mains supply.

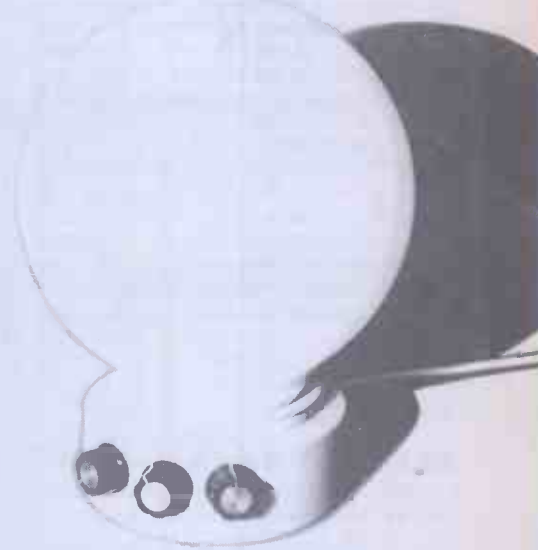
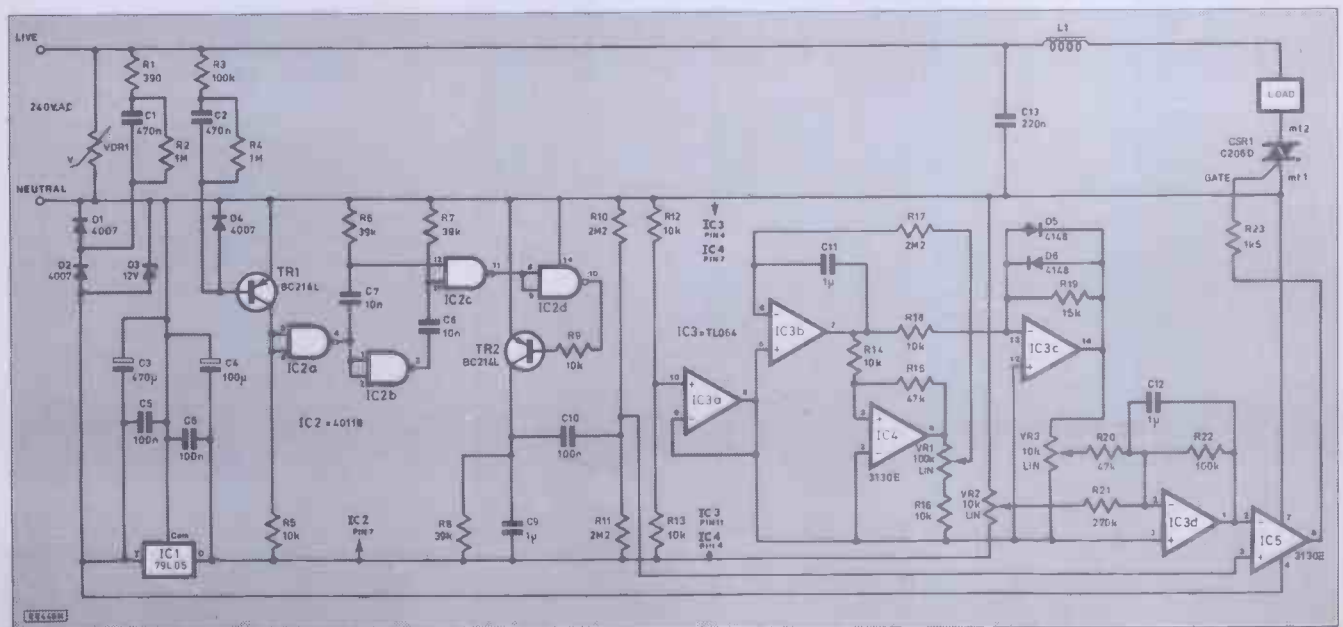

Fig. 3. Complete circuit diagram for the Phasor lamp driver.



COMPONENTS

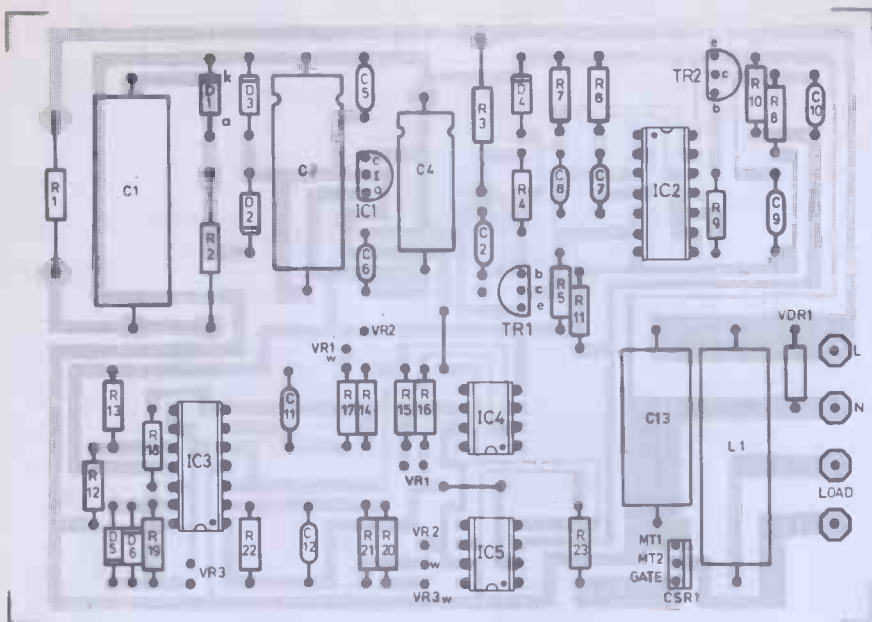
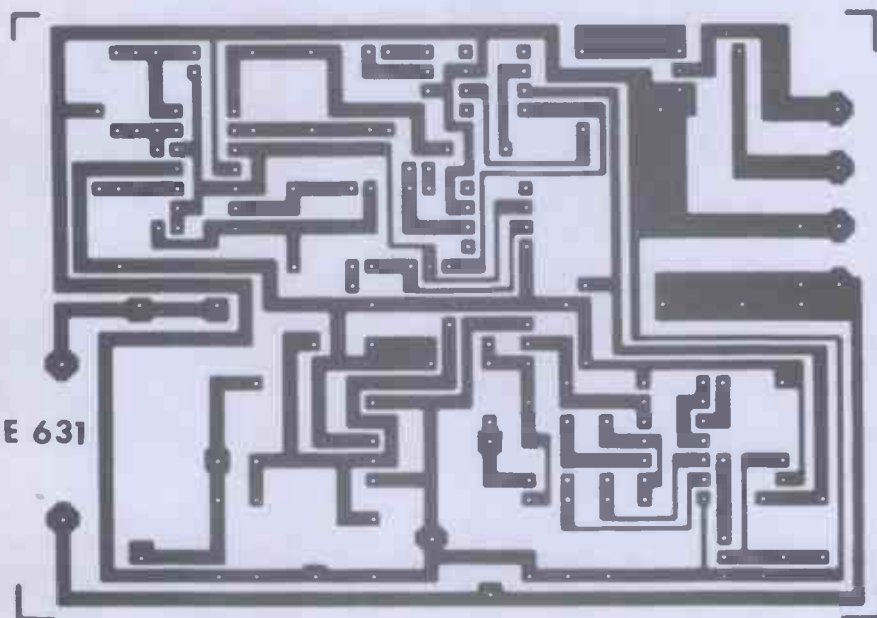
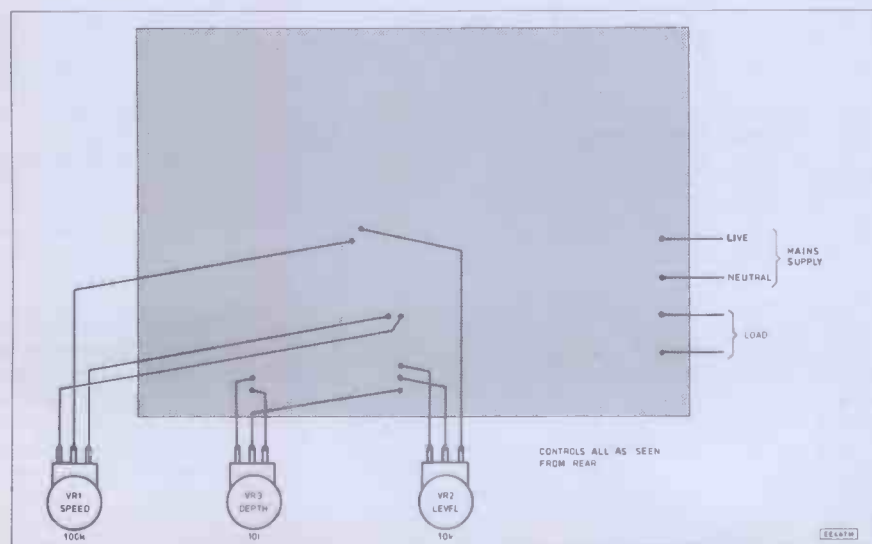

Fig. 4. Printed circuit board component layout and (below full size copper foil master pattern for the Phasor.



EE 631

Fig. 5. Interwiring from the circuit board to the "effects" controls.



Resistors

R1	390 1W
R2	1M 1W
R3	100k 1W
R4	1M
R5, R9, R12 to R14, R16, R18	10k (7 off)
R6 to R8	39k (3 off)
R10, R11, R17	2M2 (3 off)
R15, R20	47k (2 off)
R19	15k
R21	270k
R22	100k
R23	1k5

All 0.6 watt 1% except R1, R2, R3

Potentiometers

VR1	100k carbon lin. rotary
VR2	10k carbon lin. rotary
VR3	10k carbon lin. rotary

All plastic mounting bush and plastic spindle type

Shop Talk

See page 702

Capacitors

C1	0.47 μ 250V mains suppression type
C2	470n polyester layer
C3	470 μ axial lead elect. 25V
C4	100 μ axial lead elect. 10V
C5, C6, C10	100n polyester layer (3 off)
C7, C8	10n polyester layer (2 off)
C9, C11	1 μ polyester layer (3 off)
C12, C13	0.22 μ 250V mains suppression type

Semiconductors

D1, D2,	1N4007 silicon diode (3 off)
D4	BZX61C12 12V 1.3W Zener
D5, D6	1N4148 silicon diode (2 off)
TR1,	BC214L <i>pnp</i> silicon transistor (2 off)
TR2	transistor (2 off)
CSR1	C206D 3A 400V triac
IC1	μ A79L05 -5V 100mA regulator
IC2	4011B CMOS Quad 2-input NAND gate
IC3	TL064 Quad BI-FET op-amp
IC4	CA3130E CMOS
IC5	Op-amp (2 off)

Miscellaneous

VDR1 mains transient suppressor; suppressor choke, 3A; Printed circuit board available from the EE PCB Service, order code EE631; d.i.l. sockets 8-pin (2 off); d.i.l. sockets 14-pin (2 off); plastic control knobs (3 off).

Approx. cost Guidance only **£20**

CONSTRUCTION

Construction of this project is quite straightforward and should cause no special problems. Fig. 4 shows the component layout. The usual "height order" of component assembly is recommended, i.e. the tallest components go in last, simply because it makes things easier. Sockets should be used for all i.c.s except the regulator. Do not fit IC2 to IC5 or the triac at this stage. These will be fitted during testing.

Do PLEASE note that the i.c.s at the bottom of the board, that is numbers 3, 4 and 5, are positioned "head down", with pin one at the bottom. It's very easy to forget this when plugging them in later. Check the completed board carefully for errors, solder bridges etc., especially around the track that will carry mains live along the top.

TESTING

The following test procedure is strongly recommended. The infamous "Murphy's Law" often seems to be most active in the home constructor's workshop, so anything that helps thwart it should not be overlooked. In the prototype, the following checks revealed a faulty triac and incorrectly fitted TR2; even designers are not immune from Murphy!

Useful testing can be carried out safely with a low-voltage supply, but some checks must be made with the project connected to the mains. *When the mains supply is on, the whole must be treated with the greatest of care, all parts being treated as though they are LIVE. It is best to connect the test meter before plugging in.*

Testing should begin without i.c.'s (except regulator IC1) or the triac fitted. The transistors, however, should be in place, especially TR1. With no mains connection a 9 volt supply, such as a PP3 battery, can be connected across the 470 μ F capacitor C3. At this voltage Zener D3 should not conduct, so after a brief initial surge the drain should settle to about 2.5mA. Check the voltage across C6, which will be 5V if the regulator is working. If so disconnect the battery and connect the mains supply and (with care!) check the voltages across C3 and C4, about 11.5V and 5V respectively.

This completes the power supply tests, though a further useful check (again with care) whilst connected to mains is the voltage across R5, which should average 2.5V since this transistor is "on" half the time. Remember that the loading of your meter may have some effect, though.

With the board disconnected from the mains connect up the control pots as shown in Fig. 5 and plug in IC3 and IC4, the TL064 and the upper 3130. Note that these, and IC5, are orientated "upside-down". Reconnect the 9 volt battery supply to C3, and note the drain, which should now be about 3.5mA. If so, test between the negative side of C4 and pin 2 of IC5's empty socket, (second one up, right-hand side) with a meter on the 10 volt range. Turn the "depth" control VR3 right down (anti-clockwise), and observe the effect of "level" control VR2. This should allow adjustment of the voltage between about 1.5 and 3.5V. Set it to 2.5V, set the "speed" control VR1 somewhere near the top of its range, and advance the "depth" control VR3. The output should swing symmetrically about the original point, to a maximum of about 0.75V either way.

If all seems well disconnect the battery and fit the remaining two i.c.s (remember, the 3130 head down, the 4011 right way up), sol-

der in the triac, attach a suitable load, such as a 100W light bulb, and with care try the completed board. If all is well it will be possible to adjust the pots—do not touch any metal parts of the circuit or the pots as they must be treated as live at all times—to obtain various speeds and depths of auto-fading action.

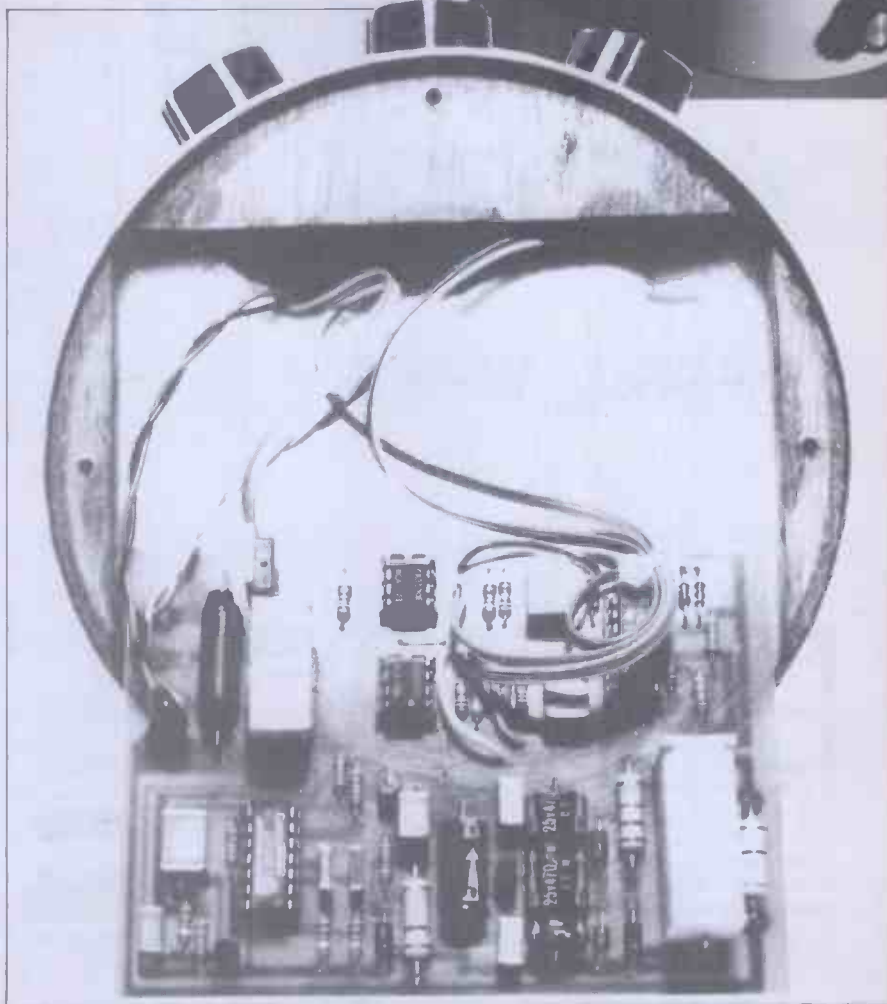

(above) The circuit board removed from the base of the "globe".

FAULT FINDING

Some tests that may help if it doesn't work follow. In the author's experience, triacs usually blow short circuit, so if the light will not dim this may be the problem. IC2 "a" and "b" should be switching in time with the signal from TR1, so their outputs, pins 4 and 3 respectively, can be checked for an average of 2.5V against the negative end of C4.

The output of "c" is a series of very short pulses, so it will measure only a fraction of a volt above negative. Output "d" is its inverse, and should, therefore, be a fraction below 5V. The voltage across C9 will be just below 4.5V. If these checks have to be made, take care as all parts of this circuit must be treated as "live" whilst connected to the mains.

At this point you will have, hopefully, a working Phasor circuit board. The maximum load should not exceed about 100W, resistive of course, such as a lightbulb, though the limit is set mainly by the lack of a heatsink for the triac. If this is moved off the board and fitted with a heatsink the specified device should be able to handle up to 500W with ease.

Applications for the board are limited only by imagination. It can be either boxed on its own with a socket outlet or incorporated into a lamp as an integrated unit.

It is essential that the unit is completely encased in a plastic or other fully insulated case and that the specified plastic style potentiometers and fixings are used. No part of the circuit should be exposed in any way.

IN USE

The prototype has a wooden base containing the board and controls, with a white globe on top as mentioned earlier. The effects obtainable range from a simple table lamp with dimmer control ("depth" turned right down) to something that appears straight out of "Dr. Who", enhancing the constructor's reputation as a "Mad Professor"! Sound effects help here, such as the stereo "wave sounds" of another of the author's projects (published last month).

For those who practise meditation, the slowly pulsating light can be very relaxing, and at the opposite end of this scale it could be used in eye-catching advertising displays. Parties might benefit from it as a form of simple disco lighting, in fact it might even find a use in commercial discos if the triac is mounted off-board with suitable heat sinking.

As a final suggestion, the author recently wandered into an exhibition of palm-readers, fortune-tellers and the like. Almost all of these worthies were equipped with desk lights consisting of small white globes, of the kind described here, in china mounts shaped either as hands or snakes. At the time this project was under development and the effect it could have added was easy to imagine. The possible uses for this project really are almost unlimited. □

I.R. REMOTE CONTROL

ROBERT PENFOLD

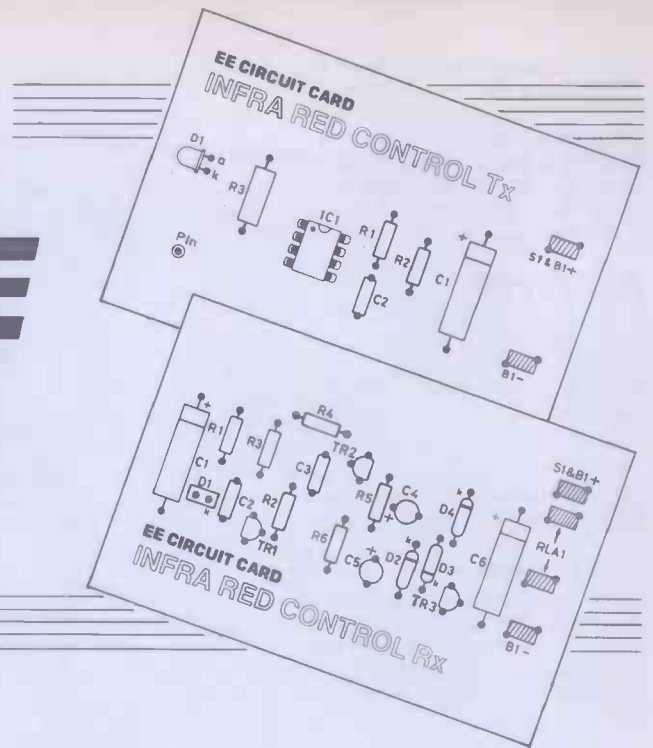

The first two projects in a set of eight that will use the Free Circuit Cards and BICC—Vero Easiwire solderless connection system.

A FEW years ago remote control systems were almost invariably of the ultrasonic variety, but these days infra-red systems are probably more common. They are generally less vulnerable to spurious triggering, and are less likely to annoy your pets! They can also carry quite complex forms of modulation. Their only real drawback when compared to ultrasonic systems is that the range is usually somewhat less, although for many applications a range of only a few metres is required. This is easily achieved using an infra-red system.

EASIWIRE

This infra-red remote control system has been kept as simple as possible so that it can easily be built using the BICC Vero Easiwire system (and the Free EE Circuit Cards supplied with this issue) by complete begin-

ners to electronics construction (see page 703 for information on using the Circuit Cards).

If you are not familiar with the Easiwire method of construction, its main claim to fame is that it is totally solderless. Despite the lack of any "proper" joints, it nevertheless provides neat and strong results that are suitable for most purposes. Refer to the June 1988 issue of *Everyday Electronics* for a full review of the Easiwire system.

CONTROL SYSTEM

The range of this control system depends on the emitter device used in the transmitter, and is around two to three metres using a wide-angle device, or about four to five metres using a narrow beam type. Although a narrow beam device gives better range, the aim of the transmitter must be quite accurate,

especially when the system is operated close to its maximum range.

The unit provides a basic on/off action, where opening and closing a switch on the transmitter results in the contacts of a relay in the receiver switching on and off in sympathy. The system is suitable for simple remote control applications such as control of a small model car or boat. The equipment could also be used as a broken-beam type sensor for a burglar alarm system.

THE SYSTEM

In theory it is possible to have a d.c. system, where the signal from the transmitter is detected by a photocell at the receiver, and the photocell drives an amplifier which in turn drives the relay. In practice such a system is unusable as it provides a totally inadequate range. Boosting the sensitivity to improve range simply results in frequent spurious operations of the system.

The main problem is that of a certain amount of background infra-red signal. This background level could easily be strong enough to swamp the signal from the transmitter. There is also a problem with the inevitable drift that occurs in high gain d.c. amplifiers. An inordinate amount of readjustment could be needed with a sensitive d.c. coupled circuit.

Infra-red remote control systems normally use some form of pulse signal, and this one is no exception. The block diagram of Fig. 1 shows the basic arrangement of the system.

TRANSMITTER

The basic transmitter signal is generated by an audio frequency oscillator. The exact operating frequency is not important, and anywhere in the upper regions of the audio range will suffice. Higher frequencies are less than ideal as the photocells and other parts of the unit will operate at less than optimum efficiency at these frequencies. Lower frequencies could make the equipment a bit sluggish in operation, and would make it relatively difficult to combat the background infra-red noise.

An l.e.d. converts the electrical pulses from the oscillator into pulses of infra-red radiation. This component is very much the same as the l.e.d.s used in clock displays etc., but its

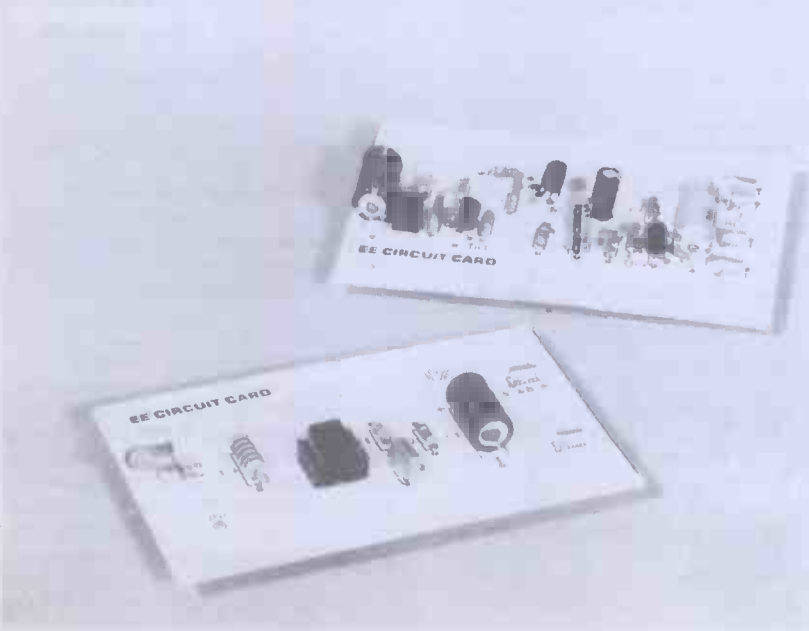

output is just outside the visible-red part of the spectrum and into the infra-red zone. It provides no significant visible light output, and does not noticeably glow when activated. In order to give an adequate output level the l.e.d. must be driven at a high current, and it is, therefore, driven from the oscillator via a buffer amplifier.

RECEIVER

The photocell at the receiver is a photo-diode. This is a type designed specifically for applications such as remote control systems. It has a spectral response that matches the output wavelengths of the l.e.d. at the trans-

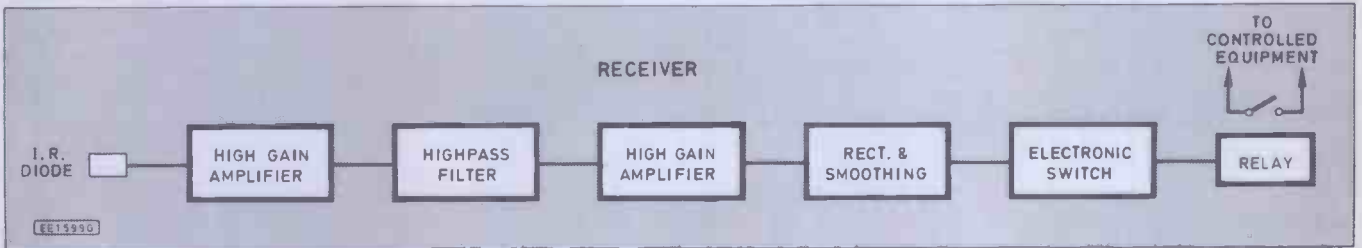
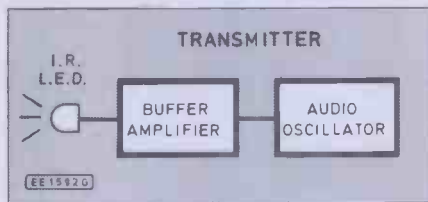

Fig. 1. Block diagram to show the operation of the IR Remote Control.

mitter, and it is a large area device that provides good sensitivity. At least, it provides good sensitivity by photo-diode standards.

It still only provides an extremely low level output signal which must be amplified by a considerable amount in order to give sufficient drive to operate a relay. Most of this gain is provided while the signal is still in pulse form, and it is provided by two high gain amplifier stages.

Under most circumstances the background infra-red noise level is not a problem. Reasonably constant infra-red signals will not affect the unit. It is only those that, like the signal from the transmitter, are amplitude modulated that will interfere with the unit by holding the receiver in the activated state.

The only likely source of such a signal is the 100 Hertz modulated signal produced by mains powered filament bulbs. As this is at a much lower frequency than the signal from the transmitter, some simple highpass filtering is all that is needed to remove any mains "hum" picked up by the photo-diode.

The output from the second high gain amplifier is fed to a rectifier and smoothing circuit. With a suitable input signal present, the output from rectifier circuit is a series of positive pulses. These are smoothed to produce a reasonably steady positive d.c. signal that can drive the relay.

The relay is controlled via an electronic switch that also provides a large amount of d.c. amplification. This enables the relatively weak output signal from the smoothing circuit to drive virtually any relay having a suitable coil voltage. A relay is merely a switch that is operated by an electromagnet, and its switch contacts are connected in one of the supply leads of the equipment which is to be controlled by the system.

Of course, in the absence of any signal from the transmitter, the output from the second amplifier is only a low level noise signal, and the d.c. output from the smoothing circuit is inadequate to drive the electronic switch properly. Consequently, the relay (and the controlled equipment) are only switched on when the transmitter is activated.

TRANSMITTER CIRCUIT

The transmitter circuit is shown in Fig. 2, and as will be apparent from this, it uses very few components. It is based on the indispensable 555 timer integrated circuit. In this case it is operated in the standard astable (oscillator) configuration, and its output frequency is controlled by timing components R1, R2 and C2. They give an output signal with a mark-space ratio of roughly 1:1. In other words, the "on" periods of the l.e.d. (D1) are roughly equal to the "off" periods.

Fig. 2. IR Transmitter circuit.

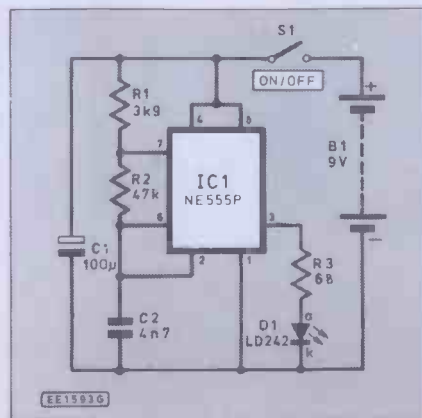

Resistor R3 controls the output current to D1, and it sets this current at a little under 100 milliamps. However, as D1 is switched off for about 50 per cent of the time the average

COMPONENTS

TRANSMITTER

**Shop
Talk**

See page 702

Resistors

- R1 3k9
- R2 47k
- R3 6B

All 0.25W 5% carbon except R3 (0.5W)

Capacitors

- C1 100 μ axial elect. 10V
- C2 4n7 polyester (7.5mm pitch)

Semiconductors

- IC1 NE555P timer
- D1 LD242 high power I.R.l.e.d.

Miscellaneous

- S1 s.p.s.t. sub-min toggle or push to make type (see text)
 - B1 9 volt (PP3 size)
- Battery connector; 8 pin d.i.l. i.c. holder; case (see text); EE Circuit Card or Easiwire board; wire; Easiwire connectors; etc.

Approx. cost **£3** plus case
Guidance only

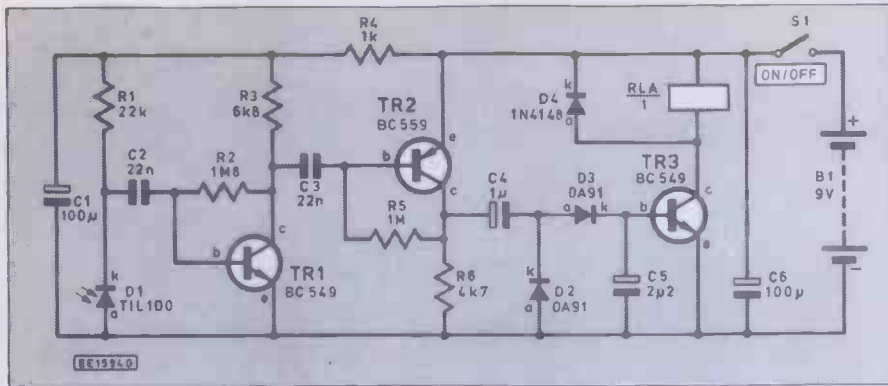

Fig. 3. IR Receiver circuit.

i.e.d. current is just under 50 milliamps. IC1 has a built-in output stage that enables these relatively high currents to be handled without the need for any external amplification.

RECEIVER CIRCUIT

The full circuit diagram for the receiver section of the system is shown in Fig. 3. D1 is the photo-diode, and it is used here in the reverse bias mode. R1 provides the reverse bias, and normally the current flow through D1 is only a minute leakage current. However, when it

receives each pulse of infra-red radiation from the transmitter a pulse of increased current flows through the circuit. This generates small voltage pulses at the junction of R1 and D1, and these are coupled to the input of the first amplifier by C2.

Transistors TR1 and TR2 act as the basis of the two high gain amplifiers, and these are both common emitter stages. They are a.c. coupled and use the same basic configuration, but the first amplifier uses an n.p.n. device whereas the second is based on a p.n.p. type. They each provide a voltage gain of more than 40dB (one hundred times). The highpass filtering is obtained by using fairly low values for coupling capacitors C2 and C3. This gives simple two pole filtering, which is adequate for present purposes.

Diodes D2 and D3 are the rectifier circuit, and C5 is the smoothing capacitor. The output of this circuit drives a common emitter switch (TR3) which has the relay coil as its collector load.

When the relay is de-energised a high reverse voltage can be generated across the coil. D4 effectively short circuits this voltage spike and prevents it from damaging any of the components in the unit. C1, R4, and C6 are a supply decoupling network. These prevent low frequency instability due to feedback through the supply lines.

CONSTRUCTION

Details of the transmitter board and small amount of hard wiring are shown in Fig. 4.

Equivalent details for the receiver unit are provided in Fig. 5. If the circuits are to be built on the EE Circuit Cards supplied with this issue rather than on pieces of the standard plastic Easiwire matrix board, then construction is much easier because the Cards are marked with component positions and the underside wiring. This makes it relatively difficult to make careless errors when constructing the boards. Despite this, you must still take reasonable care when fitting the components onto the boards. Make sure you read page 703 *Using The EE Circuit Cards* before starting construction.

Start with the transmitter board which is the more simple of the two. With Easiwire construction all the components are fitted onto the board and then they are wired up. Take care to fit C1 the right way round.

With the axial (horizontal mounting) electrolytics the correct orientation is shown by an indentation around the body of the component (which indicates the "+" terminal). The shorter leadout of D1 in the transmitter is its cathode ("k") terminal.

The LD242 gives optimum range but it is quite directional. Reduced range but a wider beam are obtained using an LD241 or a TIL38. Incidentally, some component suppliers sell these i.e.d.s simply as something like "high power infra-red i.e.d.s" rather than by type number.

An indentation at one end of IC1's body enables its orientation to be set correctly. Obviously there is no need to fit IC1 in a socket as there is no risk of heat damage with this method of construction. On the other hand, connections to it will be easier if they are made via a holder which has quite long pins.

Easiwire spring-like connectors are fitted to the board at the two points where connections to off-board components will be made. These connectors have their leads ready trimmed to length, but apart from IC1 the other components must have their leadouts cut so that only about three or four millimetres protrudes on the underside of the board.

WIRING UP

The wire which carries the negative supply rail must be routed around IC1. One way of keeping this wire in place is to fit a piece of the double-sided adhesive backing material onto the board. As only a single angle in the wire is needed, in this case an easier solution is to add a printed circuit pin to the board at the point

COMPONENTS

RECEIVER

Resistors

- R1 22k
- R2 1M8
- R3 6k8
- R4 1k
- R5 1M
- R6 4k7

All 0.25W 5% carbon film

Capacitors

- C1, C6 100µ axial elect. 10V (2 off)
- C2, C3 22n polyester 7.5mm pitch (2 off)
- C4 1µ radial elect. 63V
- C5 2µ2 radial elect. 63V

Semiconductors

- TR1, TR3 BC549 silicon n.p.n. (2 off)
- TR2 BC559 silicon p.n.p.
- D1 TIL100 IR photo-diode
- D2, D3 OA91 germanium signal diodes (2 off)
- D4 1N4148 silicon signal diode

Miscellaneous

- RLA1 6 volt relay with a coil resistance of 200 ohms or more, and contacts as required (see text)
 - S1 s.p.s.t. sub-min toggle switch
 - B1 9 volt battery (six HP7 size cells in plastic holder)
- Battery connector; case (see text); EE Circuit Card or Easiwire board; wire; Easiwire connectors; etc.

Approx. cost Guidance only **£8** plus case

Shop Talk

See page 702

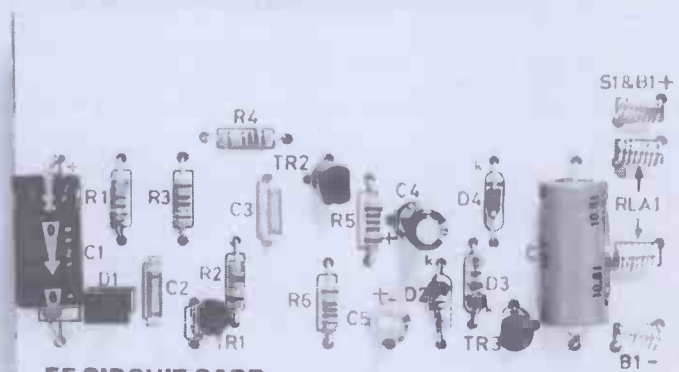

EE CIRCUIT CARD

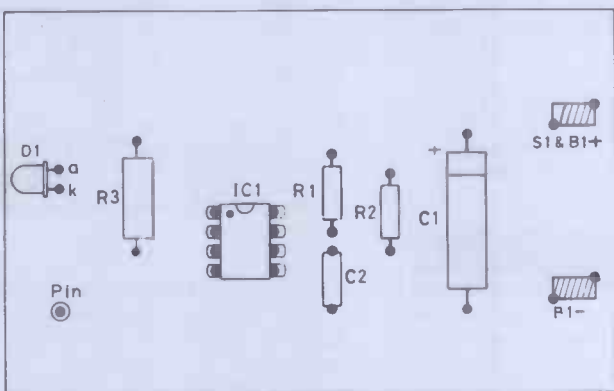
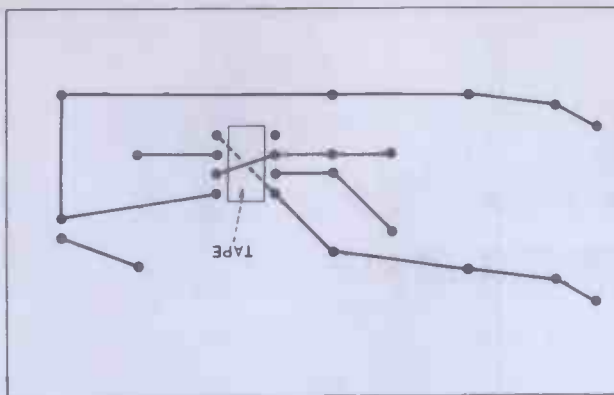

Fig. 4. Transmitter layout and wiring.

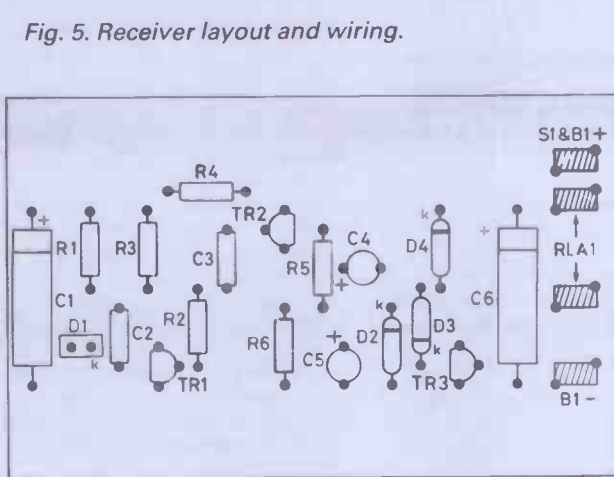
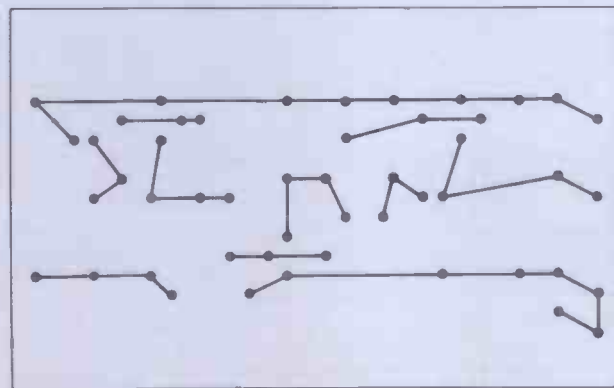

Fig. 5. Receiver layout and wiring.



indicated on the layout diagram/Card. In fact it does not even need to be a proper printed circuit pin, and a piece of wire trimmed from a resistor leadout is quite adequate.

Another minor complication to the underside wiring is that two wires must cross over one another. These are between IC1's two rows of pins. To avoid them short circuiting, add one wire, then cover it over with a piece of insulation tape, and then add the second wire.

The basic method of wiring up using the Easiwire "pen" is to first hold the end of the wire close to initial connection point. Then wind five or six turns of wire around the leadout, reasonably tightly, starting at the bottom and working upwards. Then repeat this process working from the top downwards. This process is repeated at subsequent connection points until a complete line of joints has been completed. It is important to keep the connecting wire quite taut. Otherwise there is a risk of short circuits and a greater risk of wires becoming broken.

The blade built into the "pen" tool is used to cut the wire close to the final connection point. It is a good idea to go back to the initial connection and trim off any excess wire. Leaving these "tails" of wire could lead to accidental short circuits.

There are a number of small plastic boxes that can accommodate the circuit board and battery, and an inexpensive 114 by 76 by 38 millimetre type should suffice. The component board is mounted on the base panel using M3 or 6BA fixings, including short spacers. Without these the components will be forced off the board as the mounting nuts are tightened. A window for D1 to "look" through must be made at a suitable position in one end of the case.

CONNECTIONS

The connections to the two connectors are made via the special Easiwire plugs. These are "crimped" onto the leads using a pair of pliers, and then they simply push into the on-board connectors. The connections to S1 can be soldered or made via miniature crocodile clips. A third option, and the one I favour, is to use the Easiwire "pen" to bind the bare ends of the leads to S1's tags. If the unit is to be used in an application where S1 will need to be closed for much of the time a miniature toggle switch is the best type to use. Otherwise, a push to make release to break push-button type is better.

A high power PP3 battery is adequate if the transmitter will only be used in short bursts. If it will be used for long periods a higher capacity battery such as six HP7 size cells in a plastic holder is preferable. These holders use a standard PP3 style connector incidentally. Note that the use of a high capacity battery might necessitate the use of a larger case.

RECEIVER CONSTRUCTION

A lot of the notes on transmitter construction apply equally well to the receiver, and will not be repeated here. Some of the electrolytic capacitors are radial (vertical mounting) types. The polarity of these is usually marked by "+" and "-" signs on the bodies of the components. D1 is mounted with the large surface that carries the type number (and possibly other markings) facing towards R1. Note that its sensitive surface is the one opposite this, and that the output from the transmitter must be directed towards this side of the device. A window must be made in the case adjacent to D1.

Make sure the other diodes are also fitted the right way round. A band at one end of the body indicates the cathode leadout, but these days some diodes have three or four bands. In this case, one band should be broader than the others and positioned right at one end of the diode's body. This is the one that indicates the cathode leadout wire.

The relay can be any type that has a coil resistance of about 200 ohms or more, will operate reliably on a six volt supply, and has contacts of adequate rating for the equipment that the unit will control.

A 6 volt, 410 ohm coil, printed circuit mounting relay is a good choice. Its relatively high coil resistance helps to keep down the current consumption and give good battery life. Unfortunately, it is slightly too large to fit onto the circuit board. It can easily be fixed inside the case though, using its metal top plate as a base plate for mounting purposes. It can either be glued in place using a good quality general purpose adhesive, or small bolts will fit into the holes ready-drilled in the metal plate.

The tags of this relay are large and well spread out, making it easy to complete wire-wrap connections to them using the Easiwire "pen". Connection details for this relay are

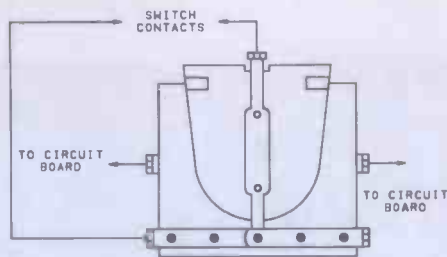

Fig. 6. Connections to the relay.

shown in Fig. 6. The two contacts are connected in place of the on/off switch in the controlled equipment. If you use a different type you will need to consult the retailers catalogue to determine the function of each tag, and the correct method of connection. For beginners it is probably better to use the specified relay. This has contacts that are rated at 50 watts for d.c. loads, and 1100 watts for a.c. loads.

Although the relay is capable of handling mains powered equipment, the unit should only be used in this way if it is built and installed in a fashion that is entirely safe. Those of

limited experience should only use the Remote Control with low voltage battery powered equipment.

IN USE

As with any projects, give the wiring a final and thorough check before switching on and testing the system. Try the system at close range initially. It can be tested even without having the relay contacts connected to the main item of equipment, as most relays produce a "click" sound as they switch on or off. The maximum range depends on the type of l.e.d. used, but should be at least a few metres.

If good range is important, use the high gain "C" suffice devices for TR1, TR2 and TR3. A simple infra-red system of this type is strictly a line of sight system, and anything opaque between the transmitter and the receiver will almost certainly prevent the system from working. This is put to good effect in broken beam intruder alarm systems. With the transmitter and receiver spaced a couple of metres or so apart, anyone passing between the two will briefly block the infra-red signal from the receiver. This will result in the relay contacts opening momentarily, which can be used to activate a burglar alarm system. □

SHOP TALK



BY DAVID BARRINGTON

Phasor

If any readers have difficulty in locating a source for the mains transient suppressor (VDR1), required for the *Phasor* project, this was purchased from Maplin, code HW13P. They also supplied the high current r.f. interference suppressor choke, code HW06G (RF Supp Choke 3A).

High voltage mains interference suppressor capacitors may prove troublesome to locate locally but most of our advertisers seem to stock "high voltage caps" that will do the job. However, if in doubt the ones used in the designer's model came from Maplin, code FF57M and FF58N.

The only people we have found who list a potentiometer with an all plastic mounting bush, body and spindle is Verospeed ☎ (0800 272555). This is entered under their type 16P and 16PS range, however, the fixing nut and washer are both of metal construction.

Provided ALL plastic control knobs are used, with well recessed fixing grub screws, we can see no reason why the more common "plastic" spindle potentiometers cannot be used here. The Phasor printed circuit board is available from the *EE PCB Service*, code 631.

In view of the presence of mains voltages, do NOT work on the unit with it connected to the mains unless absolutely necessary. Even then, take extreme care to touch only those points you wish to test.

Reaction Timer

One or two components called for in the *Reaction Timer* could cause local sourcing problems and may prove difficult to purchase.

The p.c.b. connectors and ribbon cable should be available from most component suppliers. However, any readers who do experience troubles locating these connectors, the ones used in the prototype model were purchased from Maplin and are listed under their "Minicon" range.

The only source we have been able to locate for the Celdis combined switch and l.e.d. and the 3-digit multiplexed common cathode display (IC7) is from **Silicon Sound, Dept. EE, 61 Ide Lane, Exeter, Devon, EX2 8UT**. Other types of combined switch/l.e.d. may be used but the display p.c.b. may have to be adapted. You can, of course, use a separate rocker switch and a l.e.d. (TIL209) in place of S1/D1.

The crystal X1 should be available generally, such as **Cirkit**, and the semiconductors all appear to be "off-the-shelf" devices, except, of course, the display mentioned previously. The red plastic filter material should not cause any buying problems.

The printed circuit boards for the *Reaction Timer* are available through the *EE PCB Service*, codes EE626 and EE627. The case is left to individual choice; the one used in the prototype was purchased from Maplin, code LH90X.

Personal Cassette Amplifier

When purchasing components for the *Personal Cassette Amplifier*, be sure to specify the 14-pin version of the LM380 audio power amp i.c. This is usually designated LM380N-14 and is capable of 2.5W output. The eight pin version is only rated at about 0.6W output.

The volume control should be of the "Log. law" type and the size of speaker used is left to individual choice. The size of loudspeaker, will, of course, also govern the size of case and mounting position if used in a car.

Metronome

It is not essential to use the sub-miniature enclosed preset potentiometers specified in the *Downbeat Metronome* you can, of course, use standard sub-miniature skeleton types. The enclosed types were purchased from Maplin and come from their CITEC range.

When buying the BC184L transistor, it is important to purchase one with the suffix L as pin connections for this device vary. The printed circuit board is available from the *EE PCB Service*, code 629.

EPROM Programmer

Most of our larger component suppliers carry stocks of the EPROMs and interface chip required for the *EPROM Programmer*—this month's *On Spec* subject. They are currently being listed by **Cirkit, Maplin, Omni and Greenweld Electronics**.

The printed circuit board may be obtained through the *EE PCB Service*, code 630 (see page 740).

I.R. Remote Control

We cannot foresee any component buying problems for the *I.R. Remote Control* project. The BICC-Vero "Easiwire" kit is now stocked by many of our advertisers.

The two circuit cards for the transmitter and receiver are attached to the front cover of this issue. Two new circuit cards will be given away with next month's issue—Why not place an order with your NEWSAGENT now!

USING YOUR CIRCUIT CARDS

THE CIRCUIT CARDS attached to the front cover of this issue have been specially designed for easy, solderless construction of projects using the BICC-Vero Easiwire system.

HOLE PUNCHING

Carefully remove your Circuit Cards from the cover taking care not to damage them, then cut them in half along the heavy line. Next, using the pointed end of the Easiwire unwrap tool, make holes through the board for the component leads. This is best done by placing the Circuit Card, component side up on a piece of thick cardboard or a pad of scrap paper then push the point through the Circuit Card at all the points marked with a "•".

Once all the holes are made you can use the Circuit Card, as described in the special articles in this issue, to build your projects. If you do not have a BICC-Vero Easiwire kit see the special offer below.

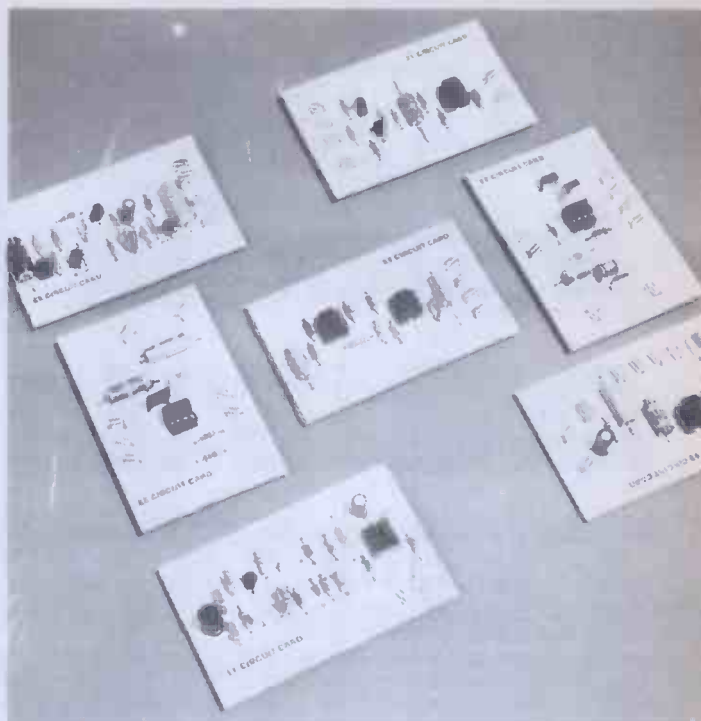

EASIWIRE SPECIAL OFFER

£1 OFF

FOR EE READERS

The BICC-Vero Easiwire kit allows you to build projects with a simple solderless wire wrapping system that is becoming very popular with hobbyists and in education. The system allows re-use of the components and it is easy to correct wiring mistakes with the special unwrap tool provided.

The kit contains a high quality wiring pen with spool of wire and a built-in spring loaded wire cutter, a double-ended unwrapping tool, a universal punched flexible injection moulded wiring board, plus a pack of spring loaded terminals, a spare spool of wire (approx. 40m long), instruction booklet and two sheets of self adhesive material to hold the wiring in place.

The system was reviewed by Robert Penfold in our June 1988 issue and has now been used as the construction medium for a range of eight projects for which Circuit Cards will be presented over the next few months.

To take advantage of our "£1 off offer to EE readers" you must send the coupon (correctly filled in) together with your payment of £14 (including VAT and postage) to: **BICC-Vero Electronics Ltd., (EE Special Offer Dept.) Flanders Road, Hedge End, Southampton, SO3 3LG.**



EE EASIWIRE OFFER—£1 OFF

Please send me one Easiwire kit price £14 inclusive

I enclose cheque/postal order for £..... made payable to
BICC-VERO Electronics Limited

Please debit my credit card as follows:



Card Number

Expiry Date

Name

Address

Signature



Introducing DIGITAL ELECTRONICS

Part 3: Materials and Tools

By Michael J. Cockcroft
Training Manager, Peterborough ITeC

This series of twelve articles has been designed as a complete course for the City and Guilds Introductory Digital Electronics syllabus (726 301). Full details on registering for C&G assessment, details of assessment centres, and information on the course in general were given in a booklet provided free with the October issue.

THIS month we investigate the raw materials and tools used for the purpose of assembling electronic systems. You will also learn how to make permanent electrical joints using a variety of connecting methods including soldering and crimping; and how to use the tools listed in the *Introducing Digital Electronics Booklet* given free with the October issue. Here are the City and Guilds objectives for this part of the course:

1.2 Materials

- 1.2.1 Identify at least six cable and wire styles selected from Appendix B of the Resource Document.
- 1.2.2 Identify at least six commonly available cable connectors and fuseholders selected from Appendix C of the Resource Document.

1.3 Tools

- 1.3.1 Identify at least ten of the common hand tools listed in Appendix E of the Resource Document.
- 1.3.2 Demonstrate the correct use, care, and storage of at least ten of the hand tools listed in Appendix E of the Resource Document.

- 1.3.3 Select, for a given application, appropriate tools and use suppliers catalogues to determine costs.

Table 3.1 lists the wires, cables, and wiring accessories from Appendix B of the City and Guilds Resource Document.

Wires

Most wire used in electronic systems consists of one (solid conductor) or more (multi-stranded) copper conductors sleeved in rubber or plastic insulation. The two p.v.c. insulated wires in Fig. 3.1 are taken from the table; the one in Fig. 3.1a has an identification code of 1/0.6 which is interpreted as single conductor (solid) of 0.6mm diameter; similarly, the wire of Fig. 3.1b (code 7/0.2) is interpreted as having seven conductors each 0.2mm in diameter.

When selecting wire for a particular purpose care must be taken not to exceed its current rating, some example wires and respective current carrying limitations are:

7/0.2	1 Amp.
10/0.2	3 Amp.
24/0.2	5 Amp.
32/0.2	10 Amp.

We must also choose according to how liable the wire is to be continually flexed and how susceptible the wire is to flexing. Solid conductor wire should never be used in applications where the wire will be bent back and forth, as this may fracture the conductor and cause it to break. Multi-stranded wire is able to bend more often without breaking and should be used in cases where the wire will be frequently flexed and moved. The more conductors in a wire the more bending it can withstand; a wire with a large number of small diameter strands (for example, 55/0.1) is obviously made to be moved and flexed.

The ideal application for the solid conductor wire is chassis and p.c.b. work; it can easily be shaped for neat positioning but, once in place, it will no longer be flexed.

Solid conductor wire is also available without an insulating sleeve; this is called tinned copper wire. Tinned copper wire is pre-coated with solder and supplied in sizes of the Standard Wire Gauge (s.w.g.). Table 3.2 shows the s.w.g. sizes and corresponding diameters for tinned copper wire.

Tinned copper wire is ideal for making wire links on stripboard (in places where there is no danger of touching other bare wires or component leads which should not be connected—the term used to describe superfluous connections like this is “shorting”) since time is saved by not needing to strip insulation from the wire.

Another type of solid conductor, with a more specialised application, is enamelled copper wire. This is also supplied in s.w.g. sizes and Table 3.2 shows the corresponding diameters

WIRES

Tinned copper

Table 3.1

1/0.6mm 356-331

Enamelled copper
PVC or PTFE insulated

1/0.6mm
1/0.6mm
7/0.2mm
16/0.2mm

CABLES

Mains PVC rubber 2 & 3 core 16/0.2mm;
3 cores 24/0.1mm;
3 core 40/0.2mm

Telephone

1, 2, or 3 pair

Ribbon

7/0.2mm
1/0.4mm

Screened

Single & multicore, lapped
or braided, various sizes

Coaxial

TV, video or RF types, various
wire sizes, cores insulations
& types of braid

ACCESSORIES

Spiral wrapping

3.2mm, 6.4mm

Sleeving, rubber

Hellerman—var-
ious sizes

Sleeving, heat shrink

Lacing cord

Rayon cord PVC or
waxed cord

Grommets

Various sizes

Cable ties

Releasable or
locking

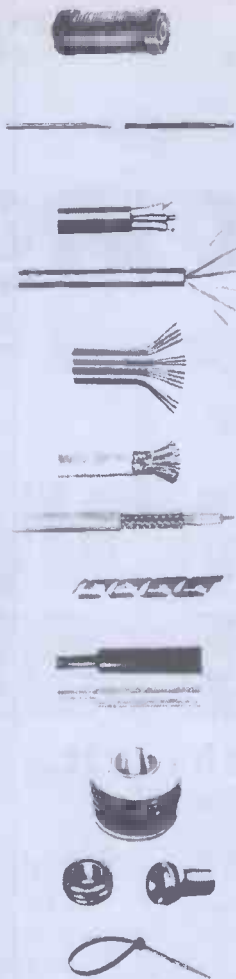

a wide variety of cable types are given in Table 3.1.

Wires, whether parts of cables or not, are usually soldered or screwed to terminals, plugs and sockets, p.c.b.'s etc. There are, however, tools available which use special techniques on special cables to speed up the process of connecting cables to connectors. Ribbon cable is one such special cable. A 40 core ribbon cable can be joined to a connector by a technique, called "insulation displacement", in seconds.

A coaxial cable is the type used to connect a television set to its aerial. It has a conductor sleeved in a polythene insulator, surrounded by an outer braided (plaited) conductor. The braided conductor is called a "screen" and, when connected appropriately, protects the inner conductor from outside interference.

Ordinary multicore cable may also be screened, the cable cores (wires) may be individually screened or collectively screened depending on the application. Screened cable is used in cases where there is a possibility of one circuit picking up signals from another circuit.

Wiring Accessories

A number of wiring accessories are listed in Table 3.1. These are various accessories for retaining wires and cables together in neat cable-forms. Lacing cord is the cheapest to buy but time consuming to apply; sleeves, wraps, and ties are all time saving alternatives to lacing.

Sleeving

Sleeves come in various shapes and sizes. In addition to the straight sleeves in the table, there are "T" junctions and multi-way junctions available. There are also small individual sleeves for covering plug and socket pins.

Heat shrink sleeving, in use, is slightly larger in diameter than the cable-form and when heated (by a powerful hairdryer or heat gun) the sleeve shrinks and grips the cable-form. Rubber sleeving, on the other hand, is selected to be smaller than the cable-form in order that it may be stretched over it using an application tool.

Spiral Wrapping

Spiral wrapping is a pre-formed plastic spiral which is wrapped around wires and/or cables by hand. The wrapping expands as it is applied, this exerts pressure on the wires to keep them in place.

Grommets

Grommets are used for safety and neatness where wires or cables pass through holes in equipment housings.

in millimetres. Enamelled copper wire is usually used for winding

transformers, chokes, etc.; the enamel coating provides insulation to prevent adjacent windings from shorting out on one another and must be scraped off with a knife (rather than stripped with wire strippers) to make an electrical connection.

Cables

Cables have a varying number of wires called cores; the cable attached to an electrical appliance, for example, is identified as two or three core mains cable. Signal cables, often called multicore cables, can contain fifty or more wires. A small selection from

TABLE 3.2

Standard Wire Gauge	Tinned Copper Wire	Copper Wire
16	1.62	1.73
18	1.22	1.31
20	0.91	1.01
22	0.71	0.73
24	0.56	0.63
26 (s.w.g.)	0.46	0.53

Fig. 3.1 Two different types of p.v.c. insulated wire.

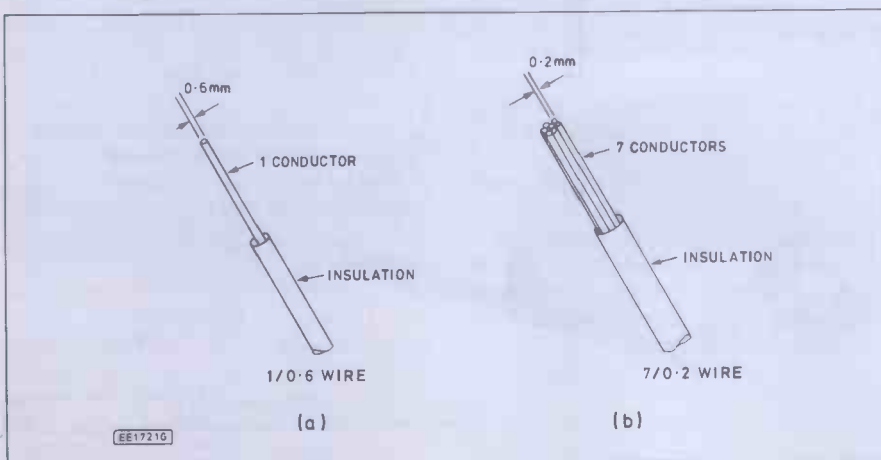

Table 3.3

PLUGS

DIN, Series 2-7 pin types

'D' types 9, 15 & 25 way types

DIL types 14 & 16 way

COAXIAL Standard Aluminium

MAINS British standard 13 Amp

BANANA 4mm

JACK 0.25"
2 or 3 Pole 3.50mm
2.50mm

PHONO PVC or metal case type

SOCKETS
SELECTION (for recognition) to match plugs, including multiway P.C.B. edge connectors

FUSEHOLDERS
Line Chassis Mounting 1", 1.25", 0.625", 20mm
Panel, PCB Mounting sizes

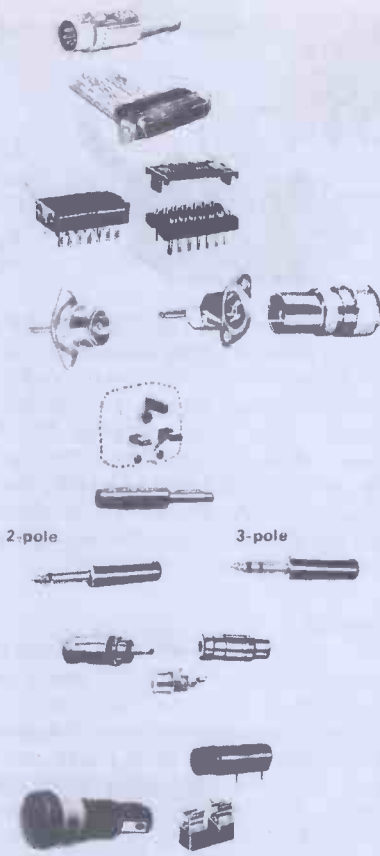

Applying heat to a join causes it to very quickly oxidise and so it is necessary to use a flux (an oxide remover), such as rosin, when making electrical solder joints. Although solder and flux may be purchased separately, most solder (such as that provided by Multicore) conveniently contains the rosin flux. Care should be taken not to buy solder containing corrosive flux.

Solder should be of a diameter appropriate to the particular task: it should be as thin as possible, without using too much length too quickly, and thick enough to solder the joint in a second or so. The 22 s.w.g. rosin cored type is ideal for stripboard work and any of the experiments in this course.

Soldering Iron

A typical soldering iron for professional use is shown in Fig 3.3a, this one is designed to have a long life (hence replacement parts—Fig 3.3b) and to be used for all applications.

In industry it is often economical to buy expensive irons, like this one, since they are suitable for most applications. The temperature control allows the iron to match the melting point of the solder to the application,

Connectors

Multipin connectors are used to interconnect items of equipment in cases where permanent connections are not wanted. Table 3.3 lists the connectors and fuseholders from Appendix C of the Resource Document.

There are different instructions for connecting cables and wires to each of the plugs and sockets in the table, and such detail is beyond the scope of this introductory course (you do, however, need to be able to identify all of these connectors by sight).

Suffice it to say, most of these connectors require soldered connections and it is advisable to insert a mating component during soldering (insert a plug/socket into the socket/plug being soldered) so that the heat of the soldering iron does not distort the shape of the connector. Also, don't let the joints get too hot so that the insulation on the wires melts.

Soldering

Soldering is the process of applying a material called solder to a mechanical joint between components, wires, or other metal parts. The solder is heated and melted over the join using a soldering iron.

Even firm mechanical wire-to-wire connections need the solder to make the joint permanent. This is because copper reacts with air after a time—a chemical reaction called oxidation—and prevents a good electrical path for current flow at the join (when cop-

per oxidises an insulating coat forms on its surface). Solder protects the join from oxidation.

Solder

Solder is a soft metal alloy of tin and lead and comes in reels as shown in Fig. 3.2a or dispensers as in 3.2b. The combination of tin and lead in the solder is usually about 60% tin to 40% lead to give it a low melting point and lessen the risk of damage to sensitive components like transistors and i.e.d.'s; however, the actual proportions vary in solders for different applications. Sometimes very small quantities of other elements like Arsenic, Bismuth, and Sulphur are also added to the alloy to alter the solders characteristics for particular applications.

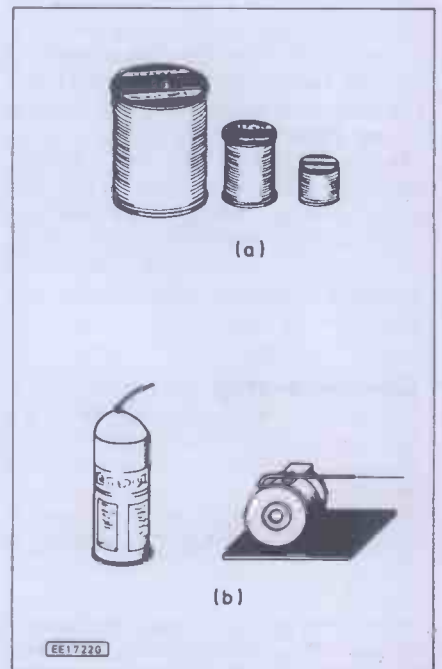
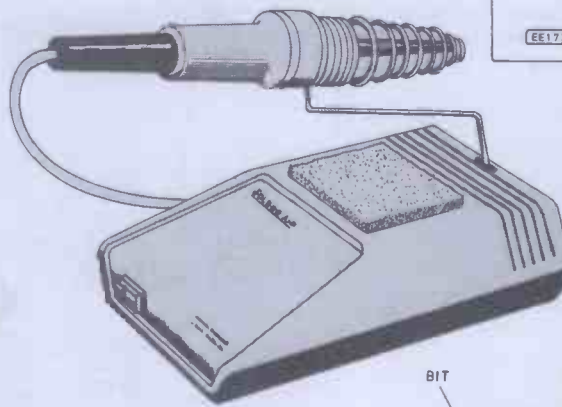
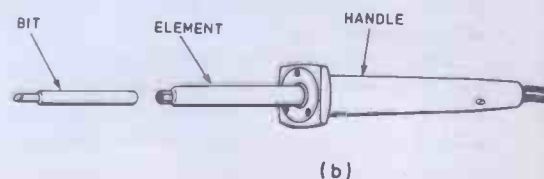

Fig. 3.2(a). Reels of solder (b) solder dispensers
Fig. 3.3(a). A typical temperature controlled "professional" iron (b) replacement parts of the soldering iron.



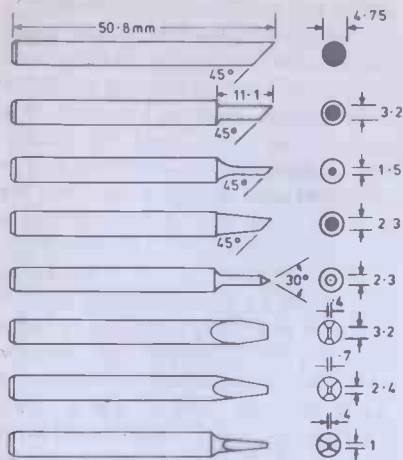

Fig. 3.4. A range of soldering tips or bits.

and a range of tips (Fig. 3.4) makes the iron suitable for tasks from intricate p.c.b. work to heavy solder tags and large components.

A variety of soldering irons are available. There are cordless soldering irons (gas or battery operated) for service engineers and other field professionals who may not have access to mains electricity, there are types which automatically feed solder wire, there are even special miniature irons for the purpose of soldering surface mount devices (s.m.d.'s) by hand.

You should choose one according to your budget and how serious you are about project work now and in the future. Because of the cost of an iron like the one of Fig. 3.3a, only a professional or serious hobbyist would consider buying one with similar features. A low cost miniature 15 or 25 watt mains soldering iron with a 2mm or 3mm bit will be adequate for this course.

Desoldering

Often it is necessary to remove a soldered component or wire from a printed circuit board or solder tag and there are tools—desoldering tools—available to allow an easy job of removing the solder. Desoldering is the process of removing solder from a joint. This can be done by sucking away the solder with a "solder sucker" (Fig. 3.5a) after first melting it with a soldering iron, or using the capillary action of desolder braid (Fig. 3.5b) when it is placed over the joint and heated with an iron. The solder sucker can be a bit harsh on fine p.c.b. tracks and care should be taken in this respect. Copper braid is much gentler on the p.c.b., but will very often damage sensitive components by overheating them; only use the braid on heat sensitive components if you are going to throw away the component after desoldering it.

Desoldering stations like the one in Fig. 3.6a are much used in industry, they have hollow bits connected to a solder collector and compressed air



Fig. 3.5a. (above) A solder sucker—when the plunger is released it springs back and sucks the molten solder away from the joint.

Fig. 3.5b. (left) Desoldering braid soaks up the molten solder when applied with the iron.

line. As shown in Fig. 3.6b, the bit is placed onto the joint to melt the solder, when melted the tip is moved in a circular motion (to prevent the component lead from sticking to the board while it cools) while the sucking action is activated (usually by a footswitch). As the solder is drawn into the glass collector the area about the joint is cooled.

Tools

For any kind of practical construction work, a number of tools are required. A minimal tool kit comprises a soldering iron, wire strippers, wire cutters, snipe nose pliers, and a small screwdriver (about 3mm with 50mm to 100mm long insulated blade). A more comprehensive set of tools is given in Table 3.4 (taken from Appendix E of the Resource Document). Readers must make sure that they can identify all of these tools and know how to use them all.

Making Connections

In order to solder (or otherwise join) wires or components together, there must be a good conductor-to-conductor contact to permit current flow. For this reason care should be taken that all insulation is removed from the parts to be joined and that the area be free from any grease, oil, or other foreign matter.

Stripping Wire

Wire stripping is the name given to the process of removing a length of insulation from a wire and is properly done with the aid of a pair of wire strippers such as those shown in Fig. 3.7.

Wire strippers like those of Fig. 3.7a are adjusted such that the jaws close enough to cut part way through the

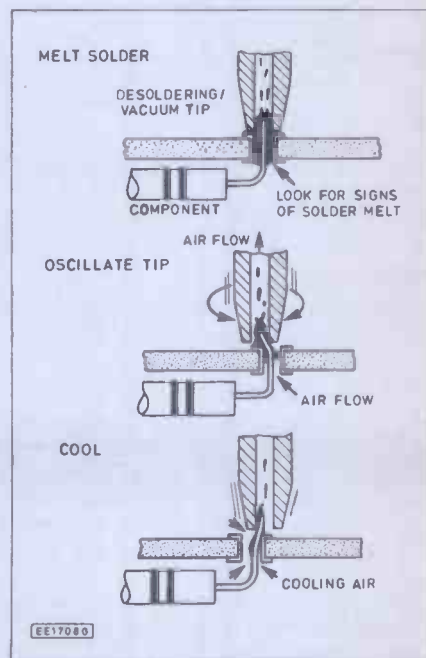

Fig. 3.6a. (below) A professional desoldering station. 3.6b. (right) desoldering process.

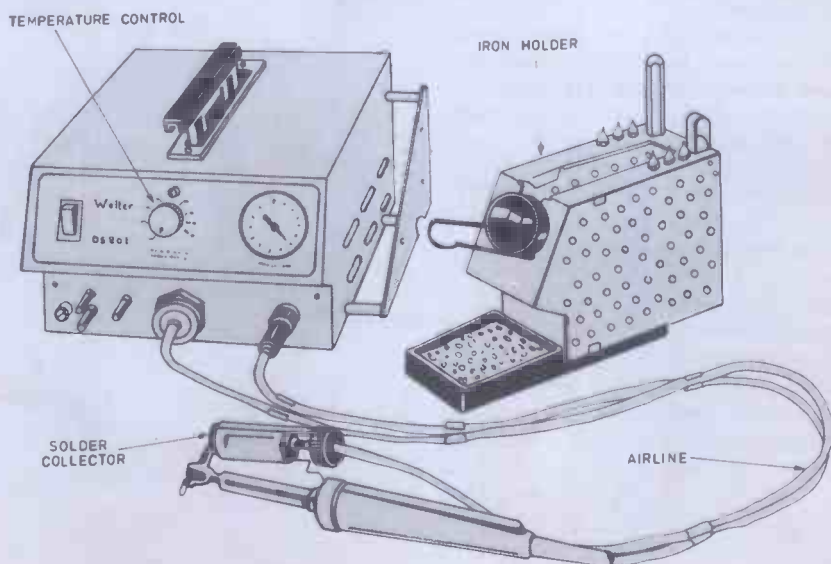

TABLE 3.4

INTRODUCTORY LEVEL TOOL SET

- ALLEN KEYS:** A/F 1.27mm, 2mm, 4mm, 8mm.
- CUTTERS AND PLIERS:** Wire Cutters, Wire Strippers, Pliers Plain, Pliers Pointed Nose, Pliers Combination, Crimping Tools.
- FILES:** Set Switch Files, 200mm Hand (fine cut); 6mm Round (fine cut).
- CLAMP AND GRIPS:** Pair G Clamps (50mm), Toolmakers Clamps, Mole Grips.
- STEEL RULE:** 300mm and 12 inch.
- HACKSAWS:** Junior Type 150mm Blade.
- HAMMERS:** 4 oz. (Ball Pein), Soft Faced (hide/plastic).
- HAND DRILL:** 8mm Chuck
- SCREWDRIVERS:** Plain Instrument Set, Plain 2mm, Plain 3mm, Plain 4mm, Plain 5mm, Phillips Small, Medium and Large. Pozidrive Small and Medium, Screw Hold Clips.
- SOLDERING IRONS:** Small Electrical Instrument, Large Instrument—Suction Desoldering Tool or Brain.
- SPANNERS:** One Small Metric Set, One Small BSF, One Small BA Set, Ring and Box-Selection, Two Adjustable—Small and Medium.
- TWIST DRILLS:** H.S.S. P.C.B. Set and 1/16 in. to 1/4 or Metric equivalent.

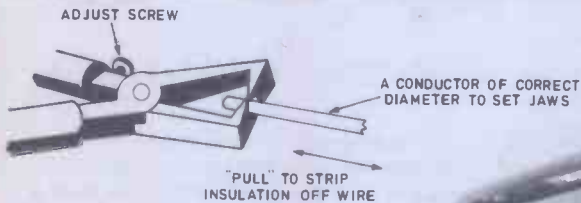

Fig. 3.7a. (above) Adjustable wire strippers.
Fig. 3.7b. (right) Automatic wire strippers.



insulation without cutting the conductor. When the tool is properly adjusted, tighten the locking nut.

To strip the wire place it between the jaws, inserting just enough to strip the right length of insulation, squeeze the handles firmly and pull. The strippers of Fig. 3.7b exemplify those professional tools in industry which automatically adjust to wire sizes within a range; the wire is placed between the jaws, the handles squeezed, and the insulation is removed without pulling on the part of the operator.

Connecting Wires to Terminals

Wire cutters and snipe nose pliers similar to those in Fig. 3.8 are essential to the electronics constructor. Cutters are used for cutting wire and trimming component leads, and snipe nose pliers are used to bend and shape wires and component leads when assembling p.c.b.'s and making terminal connections.



Fig. 3.8. Wire cutters—or side cutters—and snipe nose pliers.

Fig. 3.9. Connecting a wire to a terminal.

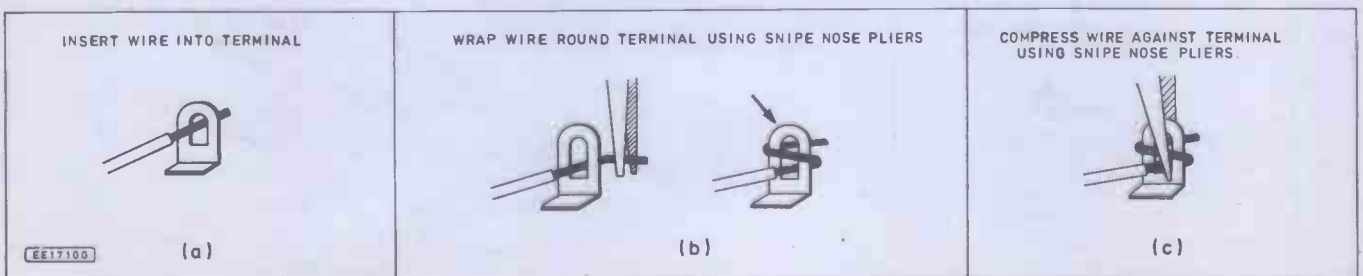

Although a joint needs solder to make it permanent (solder adds strength to the joint and prevents oxidation) the mechanical connection should provide sufficient contact for current to flow without solder. Here is how to connect a wire to a terminal prior to soldering:

- Step 1.** Remove 10 to 20mm of insulation from the the end of the wire depending on the size of the terminal. If the wire is dull or discoloured, it is probably oxidised. The oxidised film must be removed by scraping it off with a knife or sandpaper. The terminal must also be clean and shiny.
- Step 2.** Insert the bare conductor of the wire into the terminal as shown in Fig. 3.9a. Notice that the wire is positioned with the insulated part close to the terminal.
- Step 3.** Using snipe nose pliers, wrap the conductor round the terminal as directed in Fig. 3.9b and snip off the free end.
- Step 4.** Compress the conductor to the terminal with the pliers as shown in Fig. 3.9c. The terminal is now ready for soldering.

Screw Terminations

Some terminals do not require soldering. Even people lacking the

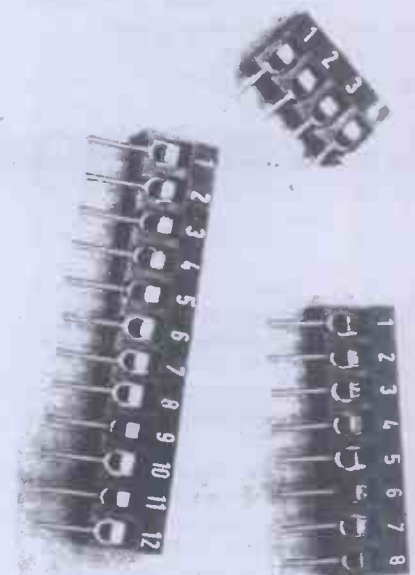

Fig. 3.10. P.C.B. mounting screw terminals.



Fig. 3.11. Various screwdrivers.

slightest interest in electricity know of the screw terminals within mains plugs, sockets, and junction boxes. There are also screw terminal strips available for mounting on p.c.b.'s; three such types are depicted in Fig. 3.10. A set of flat blades and Phillips screwdrivers which would be ideal for electronic work is shown in Fig. 3.11, although the 4mm flat blade would serve for most purposes.

Connecting wires to these terminals is quick and simple; wire is stripped of the required length of insulation, twisted (if multi-stranded) between thumb and forefinger into a neat spiral, inserted between the clamps of the terminal, and screwed down while holding the wire in place. It is important that there are no stray strands of conductor left unclamped. These can cause untold problems if they touch the wrong part of the circuit.

Stranded wires usually splay once stripped of insulation, hence the need for twisting. But just twisting doesn't always keep the strands together, especially when trying to clamp them in a screw-down terminal.

There are a number of ways to prevent conductor strands from going astray: One way is to strip twice the required length of insulation from the end of the wire, then bend the con-

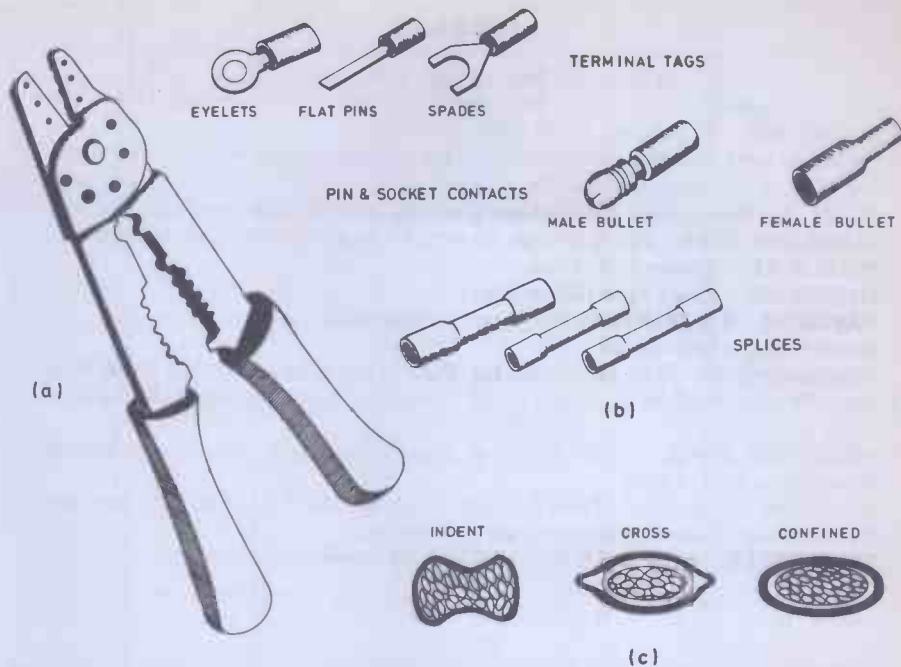

Fig. 3.13. A crimping tool, various crimp tags and the effect of various types of crimping.

ductor in half before insertion (Fig. 3.12a). Another way is to coat the end of the conductor with solder after twisting the strands together, a process called tinning the wire (Fig. 3.12b). A third method involves the use of a flat pin crimp tag (Fig. 3.12c).

Crimping

Crimping is the process of joining crimp connectors to wires using a crimping tool. A crimping tool which incorporates a wire cutting and stripping facility is depicted in Fig. 3.13a, and various crimp connectors (tag, pin & socket, and splice) are given in Fig. 3.13b.

Pin and socket connectors provide a neat termination to multi-stranded wires and are useful in applications where wires often need to be removed and replaced; terminal tag connectors provide a neat termination in the same way but are usually applied when the connection is expected to be more permanent; and splices make a neat permanent connection between wires.

A crimped joint is made by physically crushing connector to conductor using a crimping tool; Fig. 3.13c depicts the crushing effect at the join using various crimping tools. There are a number of specifications for

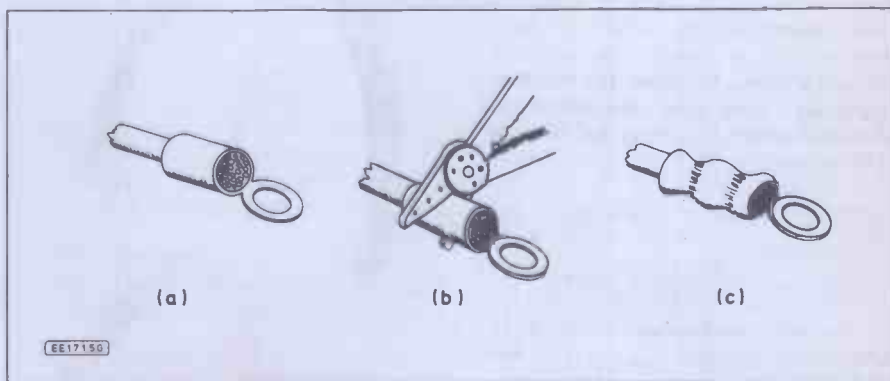
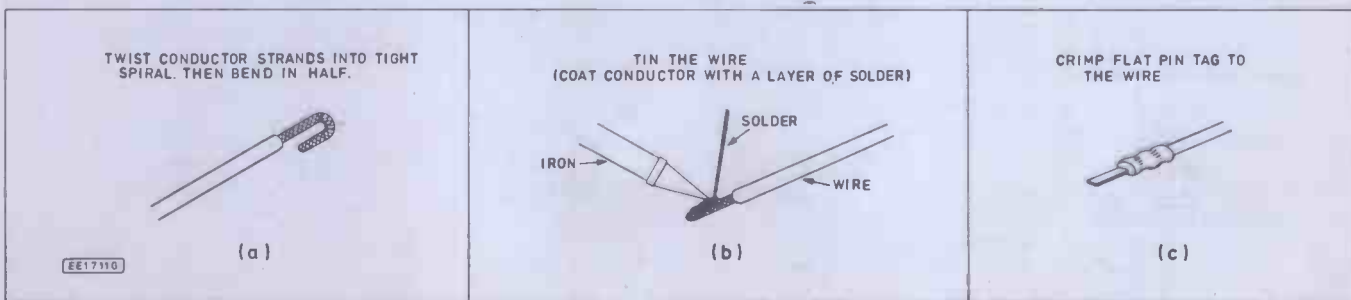

Fig. 3.14. Using a crimping tool.

Fig. 3.12. Preparing a wire for a screw terminal.



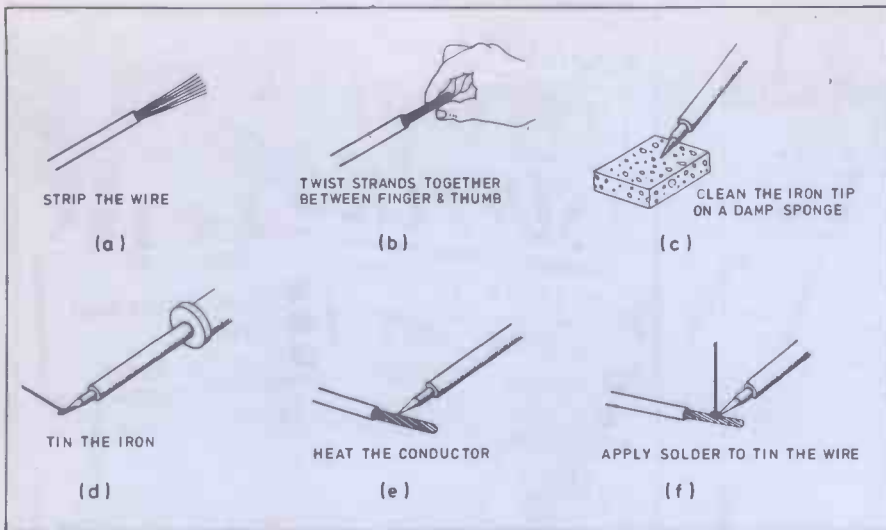

Fig. 3.15. Tinning the iron and the wire.

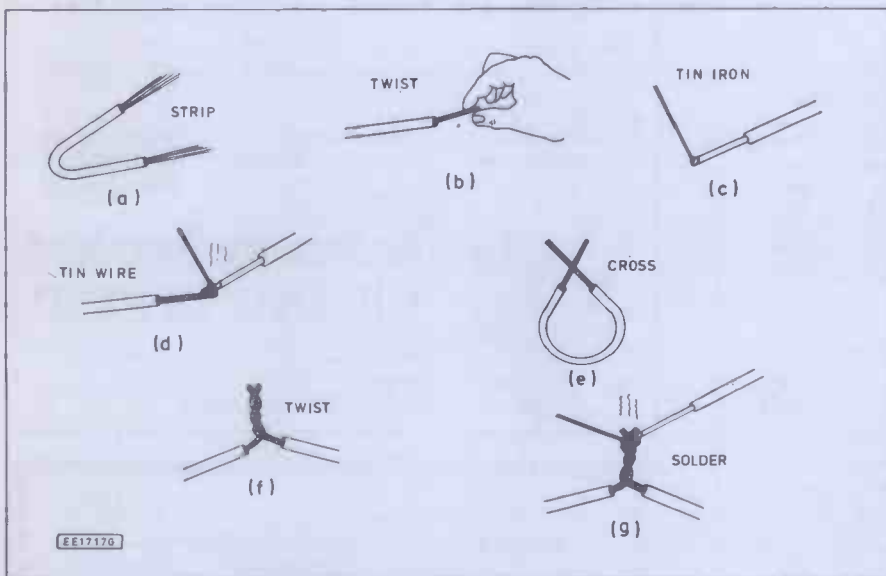

Fig. 3.16. Making a soldered joint.

crimping but, in general, after the wire is stripped, the bare conductor is inserted into the connector (Fig. 3.14a), placed between the jaws of the crimping tool (Fig. 3.14b), and crimped by squeezing the tool handles (Fig. 3.14c). There must be no loose strands of wire—these are a common cause of short circuits.

Making Soldered Joints

Soldering, like all manual skills, needs to be learned by actually doing it. The following exercise is designed to give you practice in soldering and in the use of hand tools:

Step 1. Strip 25mm of insulation from the end of a length of wire (Fig. 3.15a).

Step 2. Twist the strands of the bare conductor into a tight spiral (Fig. 3.15b).

Step 3. Dab the iron tip on a damp sponge to clean it (Fig. 3.15c).

Step 4. Touch rosin cored solder wire to the soldering iron tip very briefly to give it a thin coat of molten

solder as shown in Fig. 3.15d. This is called "tinning the iron".

Step 5. Touch the iron tip against the conductor to heat it up (Fig. 3.15e). The conductor must get hot enough to melt solder when it is applied.

Step 6. Apply solder to the conductor (*not* to the iron) until it has an even coat of shiny solder (Fig. 3.15f).

Always remove the iron after the solder when done. The wire is now "tinned".

Repeat this exercise a few times until you are able to tin a wire nicely at every attempt, then practice soldering the ends of a wire together by following the steps given in Fig. 3.16. There is more to be said about soldering when we begin assembling circuits in Part 5.

Questions

1. State the purpose of insulation on wires.
2. How many strands are contained in 32/0.2 wire?
3. State the overall diameter of 7/0.2 wire (not the diameter of each strand—you will need to consult a suppliers catalogue).
4. Identify the following plug and socket type.

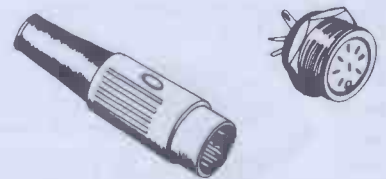

5. Which of the following does *not* represent a true "D" type connector?
 - 9 way
 - 15 way
 - 20 way
 - 25 way
 - 37 way
6. Use a suppliers catalogue to help name the "DIN" connectors shown below

NEXT MONTH—Answers to the questions above plus Measurement and Testing.

PLEASE NOTE

Answers to last's months questions are given on page 713

ASSESSMENT CENTERS

We have been contacted by a number of Assessment Centers and will publish a list with details next month.

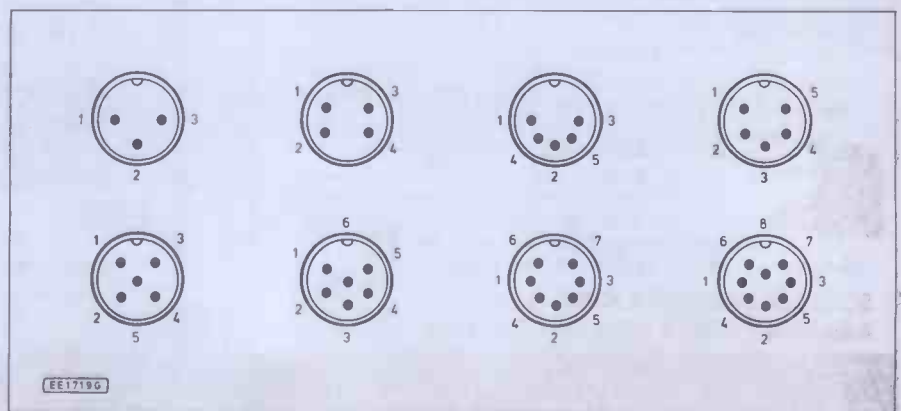

JOIN UP WITH LITESOLD

Professional Soldering Equipment at Special Mail-Order Prices.

EC50 Mains Electronic Iron. £29.99

proportional electronic temperature control inside the handle. Adjustable 280° to 400°C. Burn-proof 3-wire mains lead. Fitted 3.2mm Long-Life bit. 1.6, 2.4 and 4.7mm available. 240v a.c.

Features spike-free, solid state

SK18 Soldering Kit. £16.70

Build or repair any electronic project. LC18 240v 18w iron with 3.2, 2.4, and 1.6mm bits. Pack of 18 swg flux-cored 60/40 solder. Tweezers. 3 soldering aids. Reel of De-Solder braid. In PVC presentation wallet.

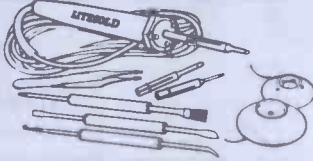

ADAMIN Miniature Iron £7.69

nylon handle with finger grip. Interchangeable bits available 1.2, 1.6, 2.4, 3.4 and 4.7mm. Fitted with 2.4mm. 240v 12w (12v available). Presentation wallet.

Possibly smallest mains iron in the world. Ideal for fine work. Slim

'L' Series Lightweight Irons. 12w £7.68

High efficiency irons for all electronic hobby work. Non-roll handles with finger guards.

Stainless steel element shafts. Screw-connected elements. Slip-on bits available from 1.6 to 4.7mm. LA12



18w £7.74

model, 12w, 2.4mm bit. LC 18 Model, 18w, 3.2mm bit. 240v Std - 12v available. Presentation wallet.

Soldering Iron

Stands 3&4

£6.06

No. 5

£6.28

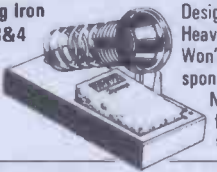

Designed specially for LITESOLD irons.

Heavy, solid-plastic base with non-slip pads. Won't tip over, holds iron safely. With wiping sponge and location for spare (hot) bits.

No 5 stand for EC50 iron No 4 stand for ADAMIN miniature iron No 3 stand for LA12 and LC18 Irons.

Replacement Bits

For all above irons. Non-stick designs, machined from special copper alloy, with Inconel retaining rings. Two types - Chromium plated with copper face (for economy and ease of use) and Iron plated with

Pre-tinned face (Long Life). State tip size, iron and type.

	Copper	L/L
EC50	-	£1.92
Adamin 12 and		
LA12	£1.06	£1.90
LC18	£1.20	£2.09

Yellow £1.38 Green £1.44



Blue £1.50 per Reel

For simple, safe and effective de-soldering of all types of joint, using a standard soldering iron. Handy colour-coded packs of 1.5 metres in 3 widths: Yellow - 1.5mm, Green - 2mm, Blue - 3mm.

De-Solder Pumps £7.71

High Quality version of increasingly popular type of tool. Precision made anodised aluminium body, plunger guard and high-seal piston. Easy



thumb operation. Automatic solder ejection. Conductive PTFE nozzle - no static problems.

Tool Sets

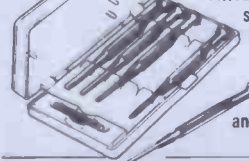

Top quality Japanese metric hardened and tempered tools. Swivel-top chrome plated brass handles. Fitted plastic cases. 113 set - 6 miniature screwdrivers 0.9 to 3.5mm £3.60

305 set 2 crosspoint and 3 hex wrenches

1.5 to 2.5mm £2.56

228 set 20 piece combination:

5 open, 5 skt spanners, 2 crosspoint, 3 hex and 3 plain drivers, scribe, handle/holder £8.46

Microcutters. £5.39 Light weight hardened and precision ground. Flush cutting. Screw joint, return spring, cushion-grip handles. Safety wire-retaining clip.



Soldering Aids.



Set of 3 £4.22

Scraper/Knife, Hook/Probe, Brush/Fork. 3 useful double-ended aids to soldering/desoldering/assembly. In plastic wallet.

ADAMIN Electric Stylus. £16.71

Writes like a ballpoint in Gold, Silver, Copper or 6 colours, on card, plastics, leather etc. Personalise wallets, bags, albums, books,

models... Operates at 4.5v from its own plug/transformer - totally safe. Supplied with coloured foils.



SEND FOR OUR ORDER FORM TODAY AND JOIN UP WITH THE PROFESSIONALS

Prices include p.p.a. and VAT. Send order with Cheque P.O. Ring for Access/Visa sales, or ask for order forms.

LIGHT SOLDERING DEVELOPMENTS LTD. DEPT. EE 97-99 GLOUCESTER ROAD, CROYDON CR0 2DN. 01 689 0574

QUALITY...

SECURITY SUPPLIES

FOR DIY & TRADE

...AT LOWEST PRICES

CONTROL UNITS

- Automatic
- Modular
- Lighting
- Timer

SENSORS

- Passive Infra-Red
- Ultrasonic
- Infra-Red Beam

ACCESSORIES

- Contacts
- Pressure Pads

CARS & VANS

- Security Lighting
- Cable Etc. Etc.

HOMES & FACTORIES

PRODUCT OF THE MONTH

CPU 9000 SELF-CONTAINED ALARM SYSTEM

Immediate Security Without Installation For homes storerooms, clubhouses, caravans etc...

- Detects intruders up to 30ft
- Penetrating 103db Siren with auto reset.
- Compact size only 203x180x78mm.
- Easily extended for coverage of additional rooms or large areas.
- Operates from 240V ac and 12V dc. Priced £67.72 +VAT



TELEPHONE OR SEND FOR FREE LITERATURE TODAY

The Security Specialist

RISCOMP LIMITED

Dept. EE12, 151 Poppy Road Princes Risborough, Bucks. HP17 9DB

Callers by Appointment Office hours Mon-Fri 9am-5pm

☎ (084 44) 6326



CATALOGUE



CATALOGUE

FREE

Send a stamped addressed envelope or up to 50p in coins to cover handling to:
BI-PAK CATALOGUE,
P.O. BOX 33, ROYSTON, HERTS. SG8 5DF
Please do not send cheques

ACTUALLY DOING IT!

by Robert Penfold

ALTHOUGH it is a hot and humid day in June as I write this piece, I would guess that by the time it gets into print a new electronics season will be well under way. Electronics construction is (of course) an all year round activity, but being primarily an indoor "sport" it tends to be pursued more vigorously in the non-summer months. The autumn is a time when most experienced electronics hobbyists start planning ahead for a busy winter of construction, and there are generally a lot of prospective newcomers to the hobby.

THE COMPONENTS

I suppose that I am stating the obvious when I say that electronics is a technical hobby. Even if you are only interested in the construction of projects and are not too bothered about how they work, the technicalities are not totally avoidable. Probably the best advice for those thinking about taking up electronics as a hobby is not to be put off by the intricacies.

The construction information in *Everyday Electronics* is very clear, but there are still likely to be points that you do not understand when reading through articles. Do not let this put you off. The types of project featured in *Everyday Electronics* are very diverse, as are the components they use. If you take the plunge and get underway with a project, the points that had you puzzled will almost certainly all become quite obvious once you have a complete set of bits.

If you are hesitating about electronics construction, do give it a try. It is a very interesting and rewarding hobby, and one that need not cost a great deal of money. You should start with a very simple project; not so that you are limiting your liability if things go wrong, but because this will give you a good chance of initial success. I mentioned previously that most problems will solve themselves once you have a complete set of components, but your first problem will be getting the right parts.

COMPONENT BUYING

When I first started electronics (the early 1960s) it was quite possible to take a trip to the local electronics shop and get all the components for practically any published project. The same is not true these days, even though my local electronics shop is now a Maplin's store and stocks many thousands of different components.

There is a vast range of electronic components now available, and it is unlikely that one store could hold stocks of all of them. There are a lot of specialised components that are only stocked by a few

suppliers, and it is surprising how many projects (even simple ones) require at least one unusual component.

The solution to the components problem is to obtain as many of the mail order catalogues as you can get. Some of these are free, or cost very little. Others will cost a pound or two, although some or all of this may be redeemable when an order is placed. Although it may seem that money would be better spent on components and tools than on component catalogues, this is a myopic attitude.

Apart from making it easy for you to locate the components you require, the beginner can glean a great deal of useful information from the larger component catalogues. There is often information on component colour coding and useful details of various semiconductors. Also of great help to the beginner are the photographs and drawings of components. This information, plus the article describing the project, will help you to order the right components, and to sort them out properly when they are delivered. A project stands little chance of working if you muddle-up the components!

If all else fails you can contact the publisher of the project for help in locating a hard to find component. However, before you do this take a good look at the article concerned, the components list, and advertisements in the magazine. In the case of *Everyday Electronics* projects you should also consult the *Shop Talk* feature which will give advice on sources of supply for any unusual components.

It is not unknown for enquiries to be received from irate readers claiming that components are unobtainable when sources of supply are named in the magazine, or the component concerned is advertised in the same issue as the one in which the project appears! Please read the magazine carefully before enquiring.

A RECENT PROJECT

As your first project choose one from a recent issue. Some people get hooked on electronics when they are given some electronics magazines from a few years ago. Possibly a lot more people who are given old magazines get put-off electronics for life. Getting all the components for a project which is more than just a few years old can be very difficult, or even impossible.

While many of the components in use today have been in existence in much the

same form for a long time, new components are always coming along while others become obsolete. In particular, many semiconductors that were popular five to fifteen years ago are no longer manufactured. The only chance of obtaining these is to look through the catalogues of retailers who deal in surplus components.

I still get the occasional enquiry on projects published ten to twenty years ago! It is unreasonable to expect much help with projects more than a few years old. Even if the relevant issue of the right magazine can be located, coming up with sensible answers to anything more than the most mundane of queries can be difficult.

You can, however, learn a great deal from old electronics magazines, and there should be no problem in building simple projects from them if all the components are still current items. Make sure that all the components can be obtained before ordering any of them, and start with some recent projects before attempting any older ones.

TOOLS OF THE TRADE

Many of the tools used in electronics construction are the type of thing that can be found in most households. Pliers and screwdrivers are the sort of general purpose tools that are needed for electronics work. You may need to buy some additional screwdrivers as you will often need very small types for electronics work. These are not to be found in every household, but generally cost a matter of pence and should not involve any major expenditure. Be sure to have at least one miniature cross point type. I have several pairs of pliers. Perhaps not surprisingly, the only pair I use to any extent are 'electricians' pliers (i.e. the short nosed, square ended type).

The main tool of the electronics constructor is the soldering iron, and this needs to be a small electric iron (about 15 to 25 watts) fitted with a miniature bit of about two to three millimetres in diameter. There is no need to go to great expense buying a temperature controlled type. A simple but good quality iron should only cost about £7 and this will be quite sufficient.

To go with the iron you will need a matching stand. A soldering iron stand should only cost about £2 to £3, and they usually include a sponge (which must be kept wet) on which excess flux and solder can be cleaned from the bit of the iron. You will also need some solder, and this should be a 60% tin/40% lead type having a multi-core non-corrosive flux. The 22 s.w.g. size is best for most electronic work, but it is handy to have some other thicker 18 s.w.g. solder for larger joints.

SOLDERING

Learning to solder is something you should do before you start your first project, rather than expecting to pick it up as you go along. The ability to produce good soldered joints is something that comes with experience, but you need to be reasonably competent before you start soldering in earnest. This is an important subject that we will return to next month.

A very important tool for the electronics hobbyist is a good pair of wire strippers and cutters. In fact this can be a combination tool or two separate tools. For many

years I used a combination cutter/stripper tool, and found this to be the most convenient way of doing things. In recent years I have used separate tools because the combination tools I obtained did not seem able to cut thin wires (they just put kinks in them). If at all possible I would recommend the use of good quality separates, but a good combination type should suffice if funds are limited.

Even a cheap combination tool is much better than trying to improvise using scissors, knives, etc. Apart from possibly being a bit dangerous, these other methods are not likely to be very effective.

When trimming wires on the underside of a circuit board you need something that will cut the wires close to the board. When stripping sleeving from wires you need a tool that will cut the sleeving but which will not nick the wire (which would leave it vulnerable to breaking at that point). The proper tool or tools are the only ones that are likely to do these jobs really well.

This is basically all you need for the electrical side of project construction. There are other tools which will make life much easier, such as a magnifying glass for inspecting circuit boards when searching for solder splashes. A good desoldering tool is also a decided asset. Some components are virtually impossible to remove from a circuit board without the aid of one of these.

You will also need some tools for the purely mechanical side of project construction. These are the types of tool that you will probably have already, such as a power or hand drill, a range of drill bits, a hacksaw or junior hacksaw, a modelling knife, a small hammer, and a centre-punch. Something you will probably have to buy and which is worth having right from the start is a set of miniature files. They will mostly be used on plastics and aluminium, neither of which are particularly hard. An inexpensive set of files should, therefore, be perfectly adequate.

ODDS AND ENDS

There are a few odds and ends which you are bound to need sooner or later, and it is probably best to obtain them at an early stage. Probably the most important of these is wire. For wiring up projects you will need some p.v.c. insulated connecting wire, and for general use the multi-strand type is the best. 7/0.2 wire (i.e. seven cores of 0.2 millimetre diameter wire) is suitable for most wiring. A heavier duty wire such as 16/0.2 or even 32/0.2 is needed for high current wiring, but initially you are unlikely to build any projects that merit either of these.

Tinned copper wire (which is not insulated) is useful for link wires on circuit

boards and short point-to-point style wiring. Either 22 or 24 s.w.g. wire should be suitable. Where a number of wires must run side by side it is generally easier to use ribbon cable than to tie several separate wires together. A couple of metres of 10 way multi-ribbon cable will be more than a little useful.

It is also helpful to have some p.v.c. sleeving. You are unlikely to use this very much, and a metre of 2 millimetre bore sleeving will probably last a few years. A roll of p.v.c. insulation tape is also worth having around.

A selection of M3 or 6BA nuts, bolts and spacers are needed for mounting circuit boards. You can buy these as you need them, but most constructors prefer to have a stock of these items. It can be very frustrating if you have a project that is complete apart from a few "out of stock" nuts and bolts! For the same reason it can be worthwhile laying in a small stock of resistors. I would estimate that two resistors of each value would only cost around £2, but could save a lot of frustration.

Last but by no means least, it is a good idea to have some grommets of various sizes. These are a sort of p.v.c. or rubber washer that fits into a hole drilled in a panel. It is advisable to always use grommets in holes that cables are threaded through, but with a metal panel and a mains cable they are mandatory.

Introducing DIGITAL ELECTRONICS

ANSWERS TO PART 2 QUESTIONS

- ±5%
- The package is a 14 pin d.i.l. and the pin numbering of this quad 2-input NAND gate chip is:

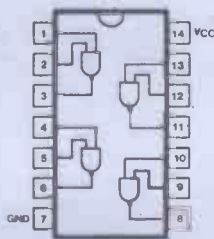

- Yes.
- 68k ±10%.
- Green, blue, black, black, yellow (reading from top to bottom).
- 250V.
- It would be written on the body of the resistor e.g. "2k2".
- 0.1A.

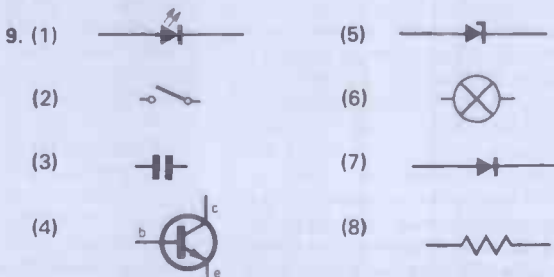

These are the basic symbols—there are of course variations to some of them).

- A *potentiometer* is a variable resistor.
- 4.7μF (4μ7) 35V (working voltage). The "+" indicates the +ve leadout.
- (a) 1Ω±5% (b) 22k±5% (c) 47k±2% (d) 33k±20%.
- dual-in-line.
- Pin 3.
- 47nF.

PLEASE TAKE NOTE

SEASHELL

(November 1988)

The gremlins, and the postal strike joined forces to create a few errors in the *Seashell* project published last month. Regular readers will know that we do not normally have this problem and we apologise for it—by the way we can normally spell capacitors unaided!

In the main circuit R30 (10k) is marked R38, C5 should be 470n (not 470k). There is a drawing error around D10/C24/R43/R45—this network should be similar to the channel above; the p.c.b. is correct.

The second paragraph under SOUND WAVES should read:

"Each output pulse discharges C3 and C4 through diodes D1 and D2. These capacitors charge again through R4 and R5,

taking about four seconds to reach half supply voltage where IC2a and IC2b switch, their outputs going low. These are differentiated by C5, R6 and C6, R7 so that the outputs from IC2c and IC2d each go high for about two seconds."

Below heading CONSTRUCTION, para. 4, 3rd sentence, should read "In particular, all the polyester capacitors are the miniature layer type, not the larger film variety." Same heading, para. 5, change C11 to C38. Same heading, last para., last sentence but one, should read "If the board is not cut, the power rails are completed by copper tracks so two of the connections shown will be unnecessary."

Basically all the construction details are correct as published so constructors should not have problems.

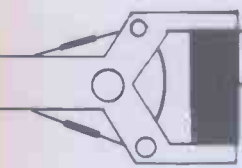

Robot Roundup



NIGEL CLARK

ROBOT ping pong has entered a new phase. It has left the low cost, high ingenuity area of the British and passed into the high cost, high powered area of the rest of Europe.

At the European finals in Zurich this year the deciding game saw a rally of four shots. That was a long way from the previous year's event which was decided by which machine was most likely to hit the ball on a service. This year the organisers were able to bring in more of the rules of human table tennis to decide the best machine.

The contrast between the winners in 1987 and 1988 could not have been greater. Last year John Knight's Charlie from Britain won with a system powered by an old Dragon computer, the software for which was stored on cassette. Charlie had a home-made vision system using a spinning mirror and phototransistors. The whole device cost less than £100. This year the Swiss entry, Toughy, by contrast was controlled by a MicroVax and a number of 68020 chips. The arm, operating around a central pillar, could move from point to point in a fraction of a second. Its total cost was far greater than that of Charlie.

This year's British entry (Charlie) was further hampered by being in the middle of a redesign. Last year the vertical movement of the bat on an X-Y frame was a problem and Knight's efforts to correct it were not complete, resulting in accurate horizontal movement but erratic vertical movement. However, the final score was relatively close at 21-13.

Regular followers of the ping pong contest over the years will be impressed that it has progressed to this relatively advanced state even if much of the scoring is still the result of failure by the server rather than positive action.

SCORING

The scoring follows that of table tennis in that a set is played until one player reaches 21 and is two points clear of the opponent. A player holds serve for five points when it automatically passes to the opponent.

In robot ping pong the ball is delivered by a mechanism attached to the top of the frame placed at the net and the server must hit it through a ½ metre square at the opponent's end of the table. The server has two attempts after which, if both are failures, a point goes to the receiver. If having made a successful shot the receiver fails to return it the server wins a point.

The two other contestants were from Sweden and Finland. The Finns' Byrokrat was driven to Zurich to prevent a repeat of the previous year when the finals were held in Venice. Unfortunately, they were then unable to get the machine through airport customs in time for the contest.

Both entries followed the high-powered path. Byrokrat used two 68008 micros, c.c.d. cameras and d.c. motors of up to 433

watts. The Swedes' GIRL had two interfaced cameras and "home-grown" 24-bit computers.

However, when they came face to face they both had an off day and neither was capable of making a scoring serve. The scoring reverted to that of previous contests with a touch being worth one point, two for a net clearance and five for a proper serve. On that basis the Finns took a 9-1 lead and the Swedes conceded.

The Finns then took on Knight's Charlie. Unfortunately for the British, Byrokrat was in better form and despite a few impressive serves from Charlie, Knight conceded when the score was 13-7.

GIRL also improved and was leading Toughy after a good start. However, the Swiss at last found the correct settings, coming back to win 21-16 and a place in the final against the Finns.

Byrokrat began the better with five good services from its first ten against five failures by the Swiss to lead 10-5 when the Swiss began their second set of serves. At that point Toughy began to get services in, but Byrokrat managed to return them, generating the first simple rallies seen since the contest began four years ago. At 6-10 the four hit rally occurred.

The Finns stayed in control and were leading at 17-12 but then the Swiss came back to draw level at 18-18 followed by three good serves to take the match. Next year the contestants are being invited to a practice match in Edinburgh in the spring.

All the events were witnessed by John Billingsley who thought up the contest and devised the rules between lecturing duties at Portsmouth Polytechnic. He has also been writing a book on control technology, *Controlling With Computers*, which is coming out soon, published by McGraw-Hill.

EDUCATION

Meanwhile British companies are still

trying to find the best way to service demand for robotics in education. The developers of the Robotech 1 arm kit, described in *EE* June 1988 have been making major changes to their product. The original kit included electronic and mechanical parts which, with the addition of wooden structural parts for which templates were included, an arm could be produced.

An interface for the BBC series is now almost ready. Tests are being carried out and it should be available by the end of the year. The arm has also been given sensors.

However, the original kit is being phased out to be replaced by three kits. George Walker, one of the Robotech creators, said that in response to reactions to Robotech 1 they were offering the series to give a range of options to teachers.

The first one contains plans for the robot arm, a mechanically indexed turntable and a wiring diagram for the BBC interface, all for about £80. The turntable is another new addition to the set, and works at a pre-set rate so that the arm has to be programmed to synchronise with it.

The second kit is the one nearest to the Robotech 1 with hardware suitable for building the plan in the first kit as well as photographs and notes showing how the items provided can be put together for other models. As with Robotech 1 the wooden structure still has to be provided by the builder. The final kit provides all the items, including the wooden parts and costs about £250.

Walker said that teachers notes were included with each pack so that they could decide how much of the available information could be given to students, allowing them to develop their own courses. He added that the plans were to build the Robotech 1 as there had not yet been time to make any alterations. However, a new design was being developed.

The Robotech 1 robot working with the mechanically indexed table.



SOLDERLESS WIRING EASIWIRE

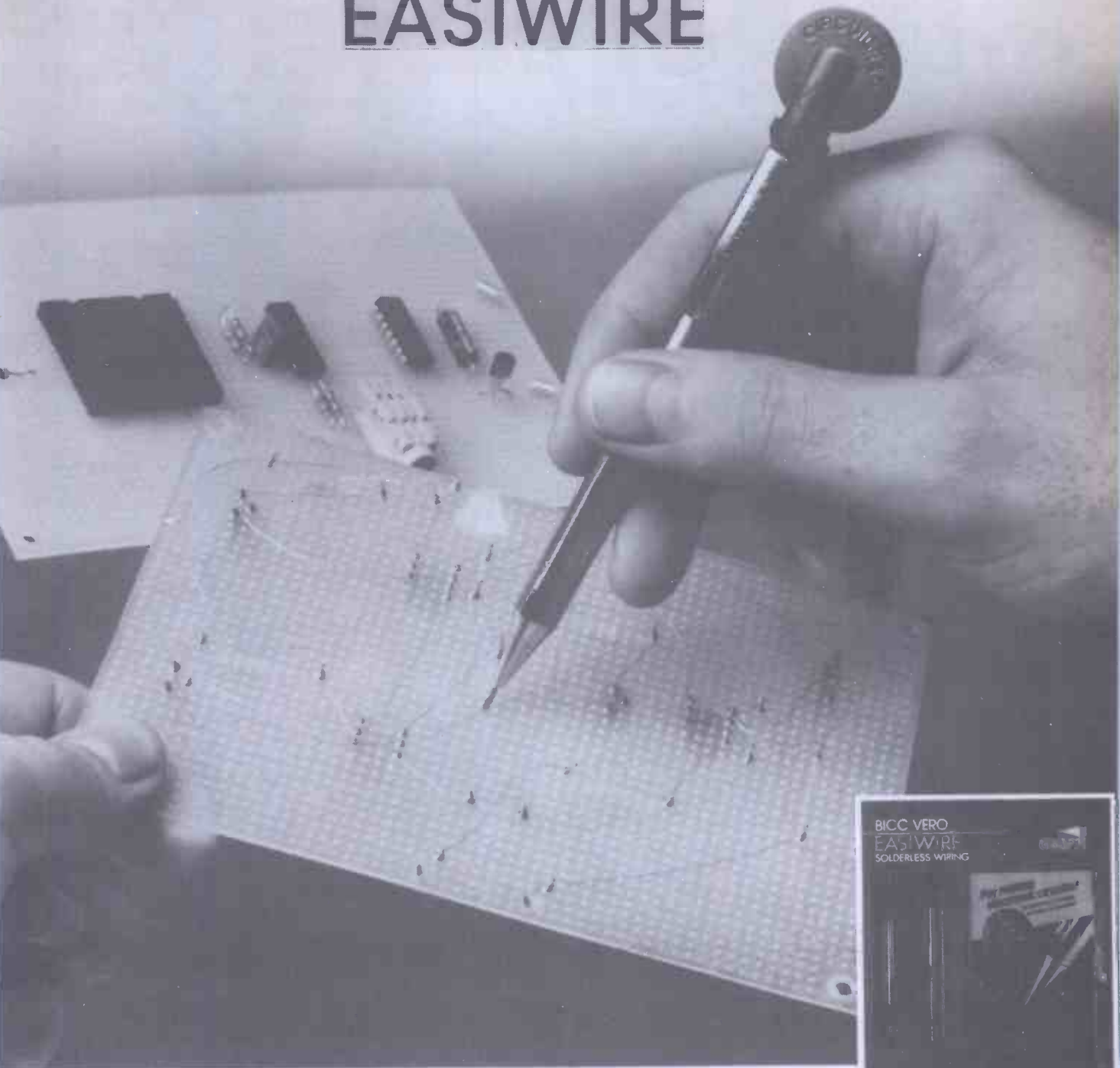

Construct your electronic circuits the new, quick and easy-to-learn way, **WITHOUT** solder: with Circuigraph Easiwire from BICC-VERO

With Easiwire all you do is wind the circuit wire tightly around the component pins. No soldering, no chemicals, no extras, simplicity itself. Circuits can be changed easily, and components re-used.

Easiwire comes in kit form. It contains all you need to construct circuits: a high-quality wiring pen with integral wire cutter, 2 reels of wire, a tool for component positioning and removal, a flexible injection moulded wiring board, double-sided adhesive sheets, spring-loaded terminals and jacks for power connections and an instruction book. Of course, all these components are available separately too.

To take advantage of the special introductory offer, complete the coupon on the right and send it to:

BICC-VERO ELECTRONICS LIMITED,
Flanders Road,
Hedge End,
Southampton, SO3 3LG



Please rush me.....Easiwire kits, retail price £18.-;
special introductory offer £15.-. (includes p & p and VAT).

I enclose cheque/postal order for....., made payable to
BICC-VERO Electronics Limited

Please debit my credit card as follows:



Card Number

Expiry Date

Name

Address

Signature

or phone 04892 88774 now with your credit card number
(24-hour answering service).

DOWNBEAT METRONOME



ANDY FLIND

**Master the art of good "time-keeping".
Build and practice with the aid of this pocket-sized low-cost, accented beat metronome and you should always be on cue.**

ALL BUDDING musicians eventually face a common problem; learning to keep time. A good teacher can help, but lessons are expensive and a great deal of practice can be needed to acquire the knack. A metronome provides a cheap and effective solution to this difficulty, giving a steady loud ticking to set the beat.

Better still is an "accented" metronome, with a "ping" every few beats to indicate the start of each bar. These are rather expensive to buy, but one may be built very cheaply from readily obtainable components. This one is also pocket-sized, so if your instrument is portable you can take it with you and practice anywhere.

BLOCK DIAGRAM

The heart of this project is a stable, slow-running oscillator built with an inverting integrator and a Schmitt trigger as shown in block diagram, Fig. 1. The integrator is the standard op-amp arrangement. Its reference is set to half the supply, so when the input to "R" is higher than this the output ramps downwards, when lower it ramps up. When it reaches the Schmitt threshold in either direction this rapidly changes state and the ramping direction is reversed.

The output of the op-amp is thus a triangle wave, with amplitude fixed by the Schmitt hysteresis, whilst complementary squarewave outputs are available from the Schmitt circuit used in this design. The frequency is determined by the values of R, C, the Schmitt threshold, and the voltage applied to R in each state.

To vary the tempo, one of the above parameters must be variable. C can be ruled out immediately, as suitable variable capacitors just don't exist. The frequency is inversely proportional to R and the threshold, so varying these results in an awkward non-linear scale on the control. It is directly related to the applied voltage, however, so if this is made adjustable the control will have evenly spaced calibrations. This was the reason for the choice of this oscillator circuit, which offers a considerable improvement over many earlier designs.

CIRCUIT

In the full circuit, Fig. 2, the oscillator consists of integrator IC1 with a Schmitt circuit formed by two NAND gates, IC2a and IC2b. VR3 offers adjustable attenuation of the Schmitt output before it is fed back to IC1.

The pulse needs current boosting, this being done by transistors TR1, TR2 and TR3. More "steam" is required in the positive direction than the negative, so two transistors are used here. This part of the circuit now produces a loud, steady ticking and a flashing light for the main beat.

The oscillator also drives the counter IC3. A minor problem was encountered here due to the slowly rising input to gate IC2a. The switching point is approached slowly and,

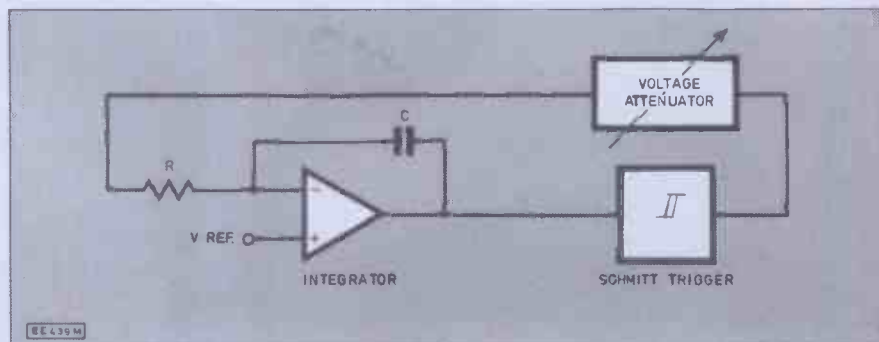

Fig. 1. Block diagram for the metronome oscillator.

The overall operating point is set by R1 and R2 to half the supply. As the whole circuit operates around this point, and the Schmitt output switches from rail to rail, the frequency is independent of the actual supply voltage, making regulation unnecessary.

The circuit in fact maintains excellent stability to below 5 volts, and is also very insensitive to changes in temperature. Most metronomes are required to produce 40 to 200 beats per minute, so the lower and upper limits are adjustable to these values with VR1 and VR2 respectively.

The Schmitt output is a squarewave which is differentiated by C4, R10 and C5, R9 and buffered by IC2c and d to produce positive-going pulses of suitable duration. From IC2c a pulse of about 33mS drives l.e.d. D1 to give a clearly visible flash. No series resistor is needed as the gate's internal resistance is sufficient to limit the l.e.d. current. Miniature loudspeakers produce loud clicks from pulses as short as 100µS, so the 330µS drive from IC2d is in fact rather generous.

despite the positive feedback from the following gate, it was still obviously managing a few output "glitches" as it changed, as the counter output was practically random. These pulses must have been very short, as the introduction of a 1µS time constant with R8 and C3 completely eliminated the problem. In fact it works with R8 alone, using the counter's input capacitance, but C3 ensures complete reliability.

IC3 can divide by zero up to ten, depending on which of its outputs is returned to "reset". It's a simple matter to select the appropriate one with a switch, and if reset is left high, with pull-up resistor R12, counting ceases altogether. The output is taken from pin 2 and pulses IC4 through a 47mS time constant set by C6 and R13.

Two of the gates flash the l.e.d. D2 for this period. The other two form an oscillator with a frequency of about 3kHz, which is enabled for the duration of the pulse. The output of this goes to the output along with the "tick", resulting in a short "ping" sound.

Resistors

- R1, R2, R6, R8, R11, R16 10k (6 off)
- R3 270k
- R4, R5 2k2 (2 off)
- R7 47k
- R9 330k
- R10 33k
- R12, R14 100k (2 off)
- R13 470k
- R15 18k

All 0.6W 1% metal film type

Potentiometers

- VR1 4k7 hor. preset
- VR2 220k hor. preset
- VR3 10k rotary carbon, lin

Capacitors

- C1 1n ceramic plate
- C2 1 μ poly layer
- C3 100p ceramic plate
- C4, C9 10n poly layer (2 off)
- C5, C6 100n poly layer (2 off)
- C7 100 μ axial elect. 10V
- C8 470 μ axial elect. 10V

Semiconductors

- D1, D2 L.E.D., High-brightness 3mm, red (2 off)
- D3 1N4001
- TR1 BC184L
- TR2, TR3 BC214L (2 off)
- IC1 3130 CMOS op-amp
- IC2, IC4 4011B CMOS quad NAND gate
- IC3 4017B CMOS divide-by-N

Miscellaneous

- S1, rotary 2-pole 6-way, break-before-make.
- S2, 1-pole 3-position slide-switch.
- LS1 Speaker, 45mm 8-ohm.
- Case, ABS plastic, 120x65x40mm; knobs (2 off); PP3 battery connector; 8 pin d.i.l. socket; 14 pin d.i.l. sockets (2 off); 16 pin d.i.l. socket; p.c.b. available from the *EE PCB Service*, order code EE629.

Shop Talk

See page 702

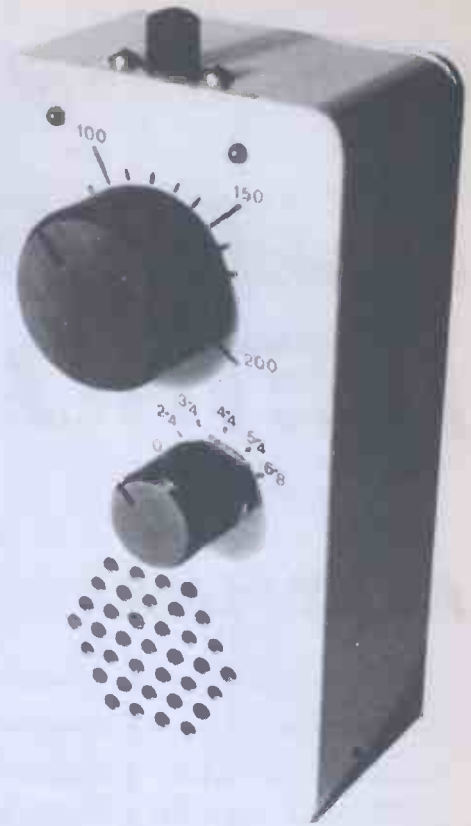

SOUND AND LIGHT

There may be occasions when the lights are required without sound so this is arranged through D3, with a 3-position switch in the negative battery supply. When set to "sound and light" negative goes directly to the circuit

rail and everything runs whilst D3 is reverse biased and has no effect.

When just lights are required, the supply is connected to the other end of D3, which also happens to be the input for the output stage. This holds the output low regardless of drive

through R11 or R16, so there is no sound. The negative rail is powered through D3 however, so the lights still operate. At first sight this may seem a strange arrangement, but it works well and keeps the switch wiring simple.

Fig. 2. Complete circuit diagram for the Downbeat Metronome.

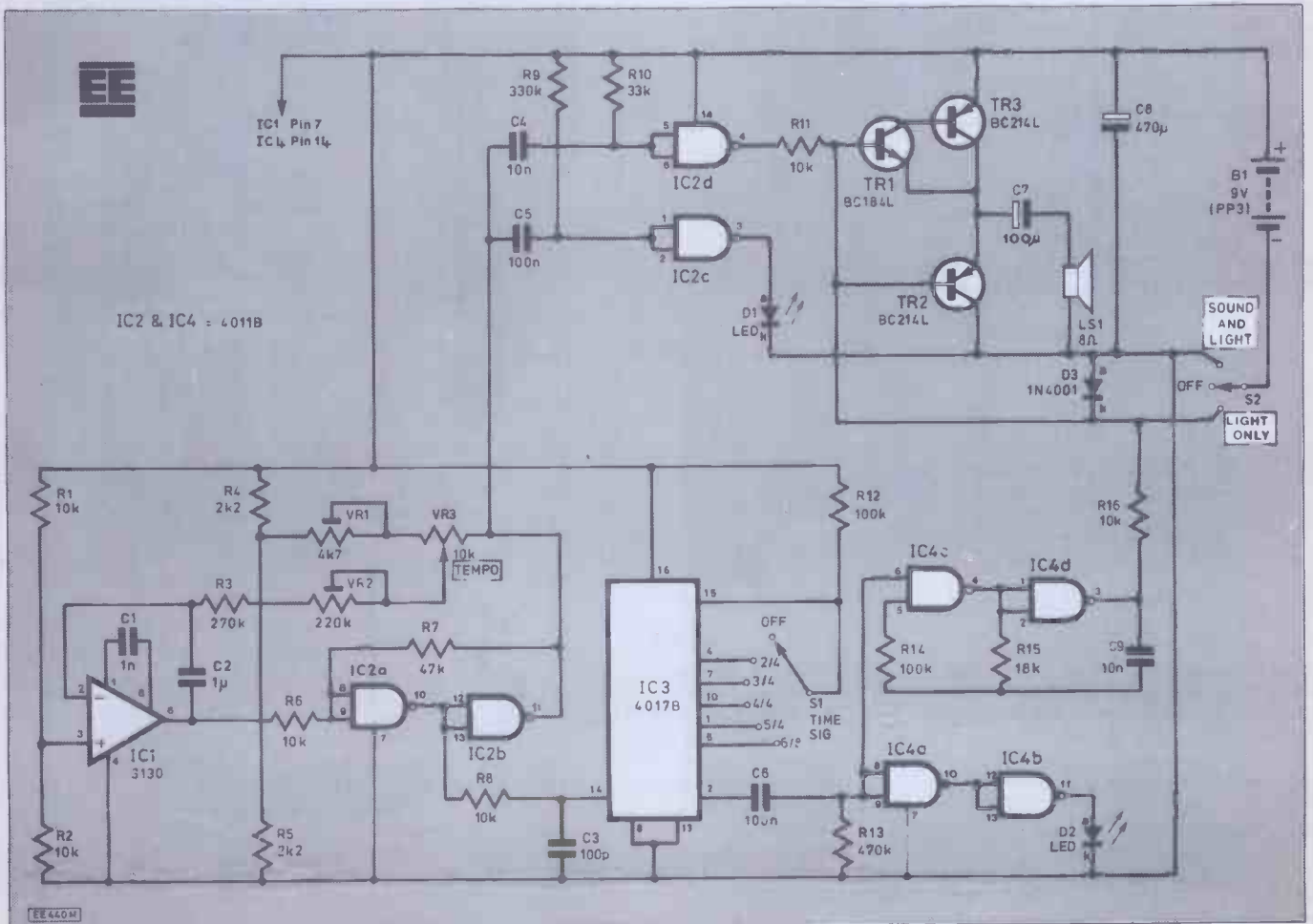

CONSTRUCTION

Earlier, it was stated that this project would be pocket-sized. Although it's not too tightly packed into the case, some care is necessary in construction and a fine-tipped soldering iron should be used. The choice of components is also of some importance. The "polyester layer" capacitors are the miniature, silver-coloured layer type, whilst the two ceramics, C1 and C3 are also miniature.

The switch is a standard plastic rotary type, which will fit directly to the board. The loudspeaker especially should be of the correct size; the prototype was fitted with one measuring 45mm diameter and 16mm deep.

Preparation of the printed circuit board should be complete before construction commences. If necessary the corner cutouts (to clear pillars in the box) and the hole for VR3's bush should be cut, and the holes for S1 terminals may need enlarging. The terminals are wire "stalks" about 5mm long, topped with "eyes" which should be cut off leaving the stalks as long as possible. After component fitting they are pushed through the holes and soldered. The holes will need to be about 1.5mm diameter, and it would be as well to check the switch fits.

Also, check that the board fits the case! Before construction it can be used as a template to mark the case for S1 and VR3. Note that whilst S1's bush passes through the case, VR3 is fitted to the board so clearance should be for the shaft only. This done, component assembly can be carried out as shown in Fig. 3. Everything except VR1 and VR2 can be fitted, though sockets are advisable for the i.c. points. Take care to place D3 correctly, with the marked (cathode) end connecting to the transistors.

The two presets are soldered to the copper side of the board. This leaves space for S2 on the component side, and allows adjustment when the project is complete. Miniature horizontal presets usually have legs which are thick near the body and narrower below, to create a gap when fitted to a board. These can be bent out at right angles and cut short, after which it will be easy to solder them to the tracks with a small-tipped iron, as shown in Fig. 4. Set them initially to half-scale.

After component assembly S1 can be fitted as described above, pushed fully home and soldered. The p.c.b. is secured by this switch; on the prototype a single thin washer between its body and the case produced the correct spacing, allowing the board to rest flat on top of the speaker, with the battery pressing it down from the other side for extra rigidity. It would be as well to check the fit with switch and speaker in position before finally soldering, though.

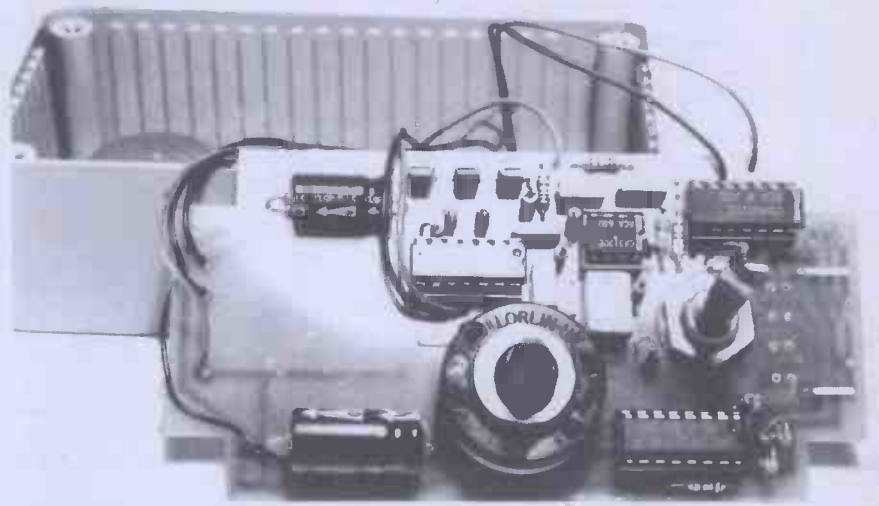

The completed circuit board showing the rotary "time" switch mounted on the component side and the "tempo" control VR3 spindle and bush protruding through from the copper side.

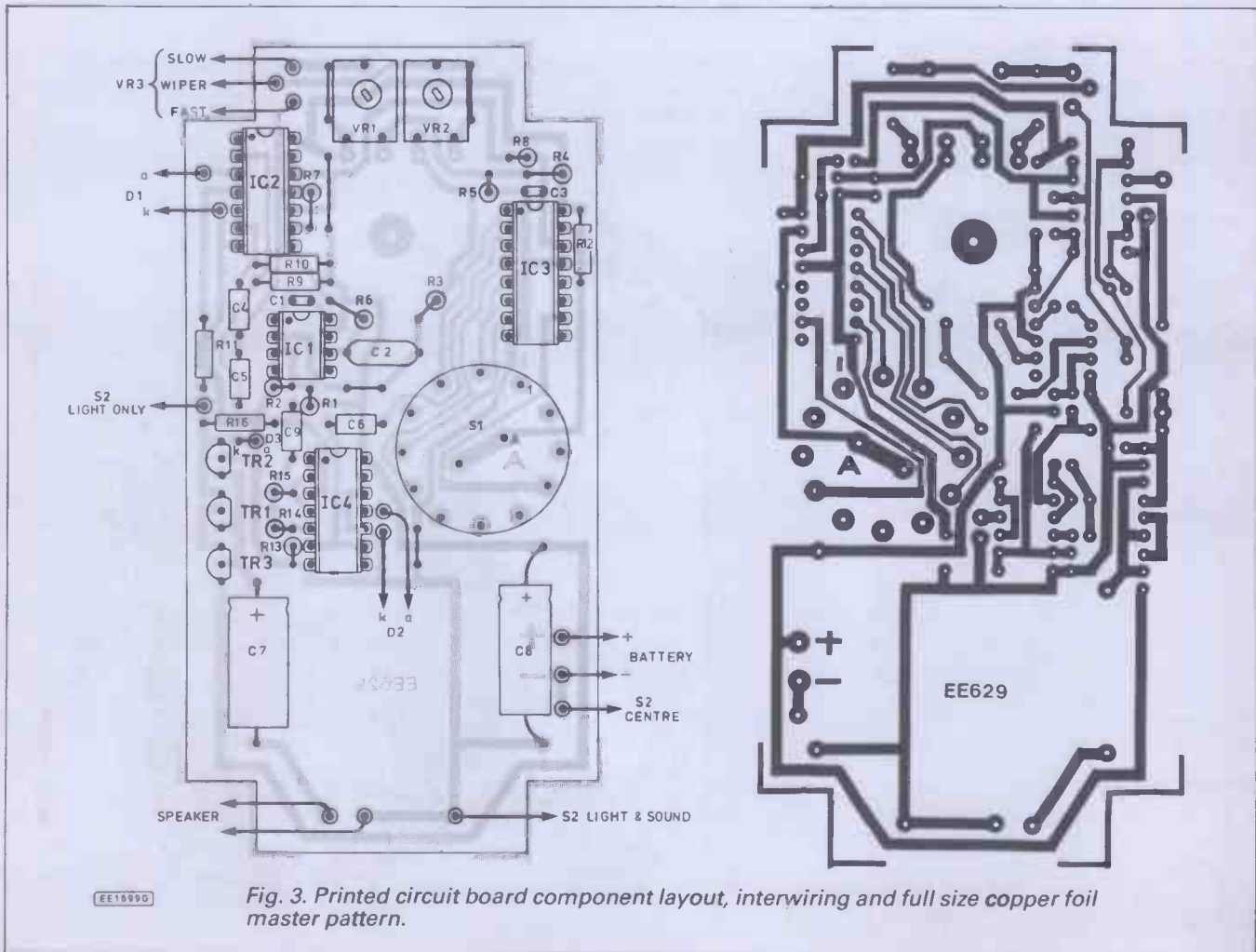

Fig. 3. Printed circuit board component layout, interwiring and full size copper foil master pattern.

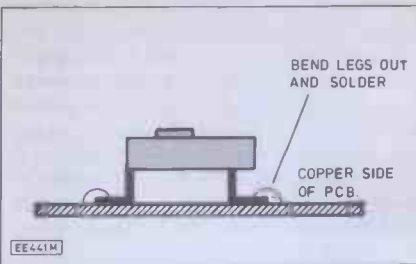

Fig. 4. Mounting the presets on the copper side of board.

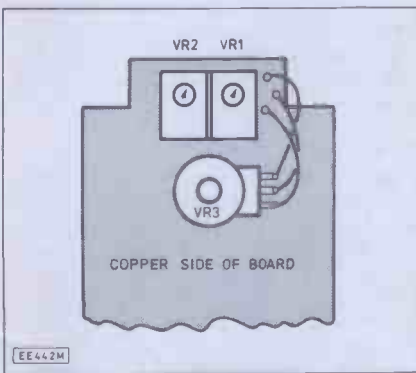
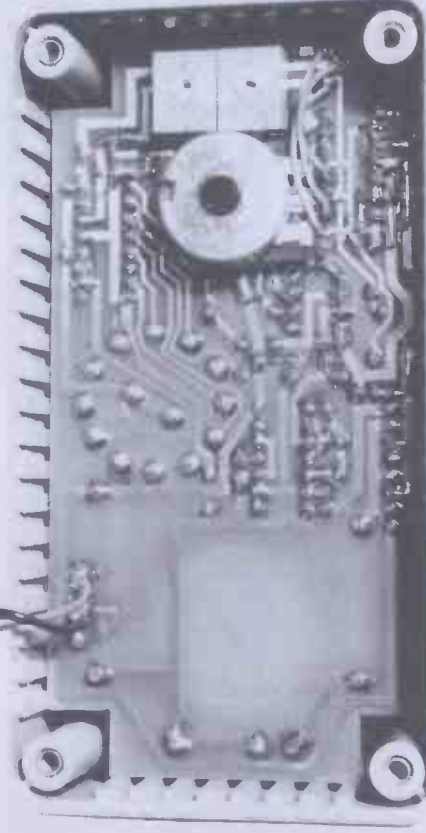

Fig. 5. Location and wiring of VR3.

VR3 is fitted to the copper side of the board and connected with short wires as shown in Fig. 5, a washer will give extra clearance between the body and the soldered joints if needed. Care should be taken to see that no metal parts short to the copper tracks. Leads can now be fitted to all external connection points, with the two l.e.d.'s D1 and D2 soldered to the ends of theirs, ensuring correct polarity.

The completed unit showing positioning of presets and control VR3 on the track side of the printed circuit board. A washer should be inserted between the board and VR3 to give clearance from the soldered joints.



TESTING

As an initial test, power can be applied before any of the four i.c.'s are inserted into their sockets. After the capacitor charging surge, the current drain should settle to about 5mA. If it takes much more than this, switch off and recheck the construction carefully. If all seems well, fit IC1, IC2 and temporarily connect the speaker. Power up again; D1 should flash and the speaker should tick. Adjustment of VR3 should alter the tempo.

If this works, switch off, fit IC3 and IC4 and try again. This time, providing the switch is not set to position 1, there should be a "ping" with every so many ticks, accompanied by a flash from D2.

Check that the switch selects the correct number of beats, every two in position 2, every three in 3, and so on up to six. The switch has an adjustment (at the base of the bush) to select the number of available positions, so check this is in the correct stop. The final task on the p.c.b. is to ensure the solder joints for the lower ends of C7 and C8 are low and smooth, so that they won't short against the case of the battery. If they have any sharp or projecting bits, file them down and run over them once more with the soldering iron.

The battery is insulated from the board by a small piece of foam plastic, which will also hold it firmly in place and press the p.c.b. down against the speaker. The battery connector should be soldered to the copper side of the board.

FINISHING

Switch S2 is fitted to the top of the case, as close to the front as possible, to clear the p.c.b. A hole is drilled to each side of it to take the l.e.d.'s, which are secured with a drop of

glue. The speaker is placed centrally at the very bottom of the case, where it will clear the board components around it; a pattern of holes makes a neat "grille". It is glued into place with "Evostik" or a similar adhesive.

Switch connections are made as shown, and the board secured in place by S1. This is spaced from the case with a plain washer wide enough to rest against its plastic body as pressure on the position adjuster may interfere with the action. Check none of the connecting wires are trapped before finally tightening the nut.

Calibration consists of adjusting VR2, with VR3 at its highest position, for 200 beats per minute, and VR1 with VR3 low, for 40 beats per minute. Make the adjustments in this order as VR2 alters the entire range, whilst VR1 alters only settings below maximum. VR3 can be scaled with patience and a stopwatch, but should prove to be more or less linear, depending on pot accuracy. Some pots seem to have "dead" areas at the ends of their scales.

Musical speeds, should these be needed on the scale, are "largo", below about 60 beats per minute, "Larghetto", 60 to 65, "Adagio", 65 to 75, "Andante", 75 to 105, "Moderato", 105 to 120, "Allegro" (nothing to do with BL cars!) 120 to 170, "Presto", 170 to 190, and "Prestissimo", above 190.

Practice with this simple device should improve the timekeeping of any musician, and it will be found invaluable by those who have to learn, for some of the time, alone. Beginners may also find it helpful in deciphering the timing of some written pieces, which can be extraordinarily difficult for those not used to sight reading.

Finished metronome with circuit board removed showing the loudspeaker glued to the "bottom" of the case and wiring to the slide switch S2, mounted in the "top" of the the case.

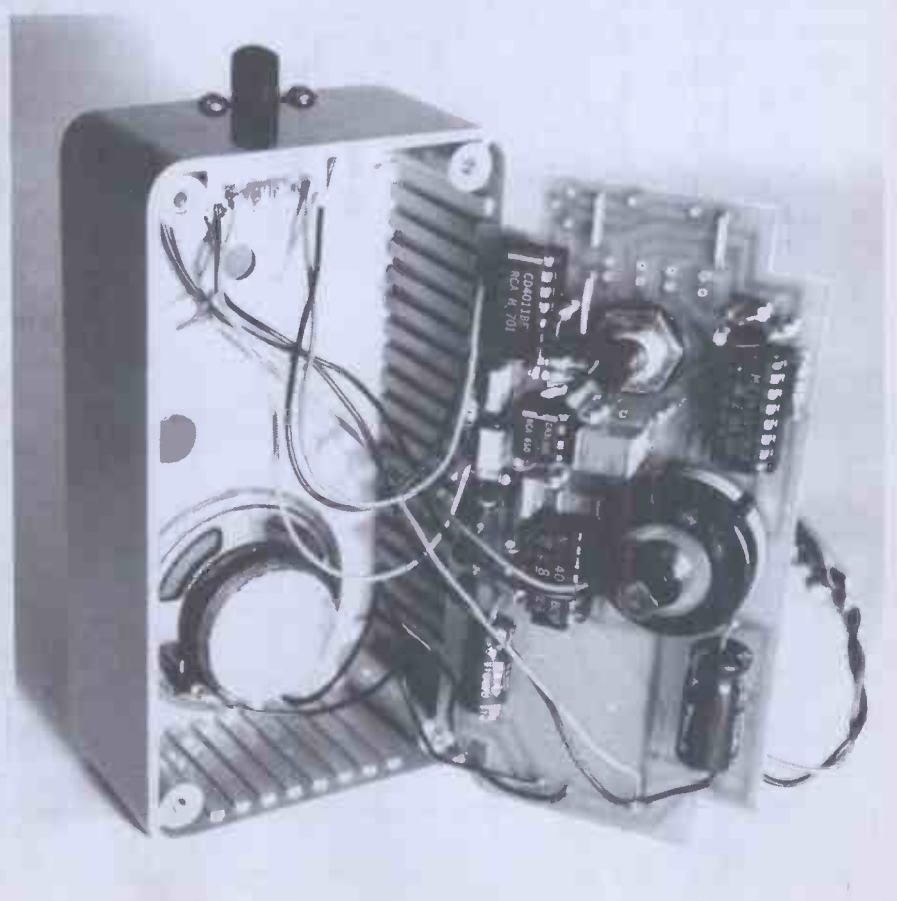



a regular feature for the Spectrum Owner...

by Mike Tooley BA

THIS month we shall be devoting the bulk of *On Spec* to another major project for Spectrum hardware enthusiasts. We begin, however, by attempting to provide a solution to a problem which is often raised by Spectrum programmers.

Disabling BREAK

Adrian Thomas, a regular reader of this column, complains that there is no obvious way of disabling the Spectrum's BREAK key. Adrian is developing some educational

software and he is anxious that the user is not able to exit from the program by means of the BREAK key.

The solution to this particular shortcoming of ZX-BASIC involves a straightforward POKE which should be added to the beginning of the program (e.g. line 1). The following line of BASIC will do the trick:

1 POKE 23613, (PEEK 23730)-5

To re-instate the BREAK key, the following line of code should be added at the end of the program:

9999 POKE 23613, (PEEK 23730)-3

Note that, in the event of an abnormal return to BASIC (i.e. one that does not involve the program executing line 9999), the BREAK key will be inoperative and the POKE should be entered in immediate mode directly from the keyboard (omitting, of course, the line number!).

EPROM programmer

In the past few months I have received an increasing number of requests for an EPROM programmer for use with the Spectrum. It was, therefore, particularly pleasing to learn that *Trevor Brown* (well known in amateur television circles) has produced just such a project for his own use and that this unit has been duplicated by several British Amateur Television Club (BATC) members.

Trevor's original design has appeared in the club's magazine, *CQ TV*, but I have taken the liberty of extending Trevor's basic design by adding a regulated 21V d.c. supply to provide the necessary EPROM programming voltage. Trevor writes;

Like it or not, EPROMs are becoming part of our everyday lives and the ability to look at the stored data, make backup copies, and in some cases store your own code in one is now

an every day need. This simple little unit can be made in a single evening.

A simple menu-driven program then provides the user with a variety of options, including loading data into memory from an EPROM (so that it can be examined) or copying data from memory into a blank (previously erased) EPROM. The unit has been designed to function with two of the most popular EPROM devices; the 2764 (8K byte) and 27128 (16K byte).

The programmer works well with Hisofi's Devpac assembler with the source code organised to run at any address and SAVED to tape or Microdrive for later transfer to EPROM. When programmed, the EPROM can be removed and installed into a microcomputer or microcontroller for testing and evaluation.

Circuit description

The complete circuit of the EPROM programmer is shown in Fig. 1. Trevor's design makes use of the 8255 PPI (Programmable Parallel Interface). This device was featured in an earlier *On Spec* and thus will need no further introduction to our regular readers. IC2, a 2764 or 27128, is the EPROM to be programmed. The unit will also program the low-power versions (27C64 and 27128A) in which case D3 should be omitted and replaced with a shorting link.

IC3a, IC3b and IC3d provide partial I/O address decoding such that IC1 is enabled whenever A7 goes low during an I/O read or write operation. IC3c simply inverts the Spectrum's RESET line to satisfy the active-high RESET input on IC2. The two inverters of IC4 are somewhat unusual and are used to activate the output enable (OE) and program (PGM) inputs of the EPROM.

Fig. 1. Complete circuit of the EPROM programmer

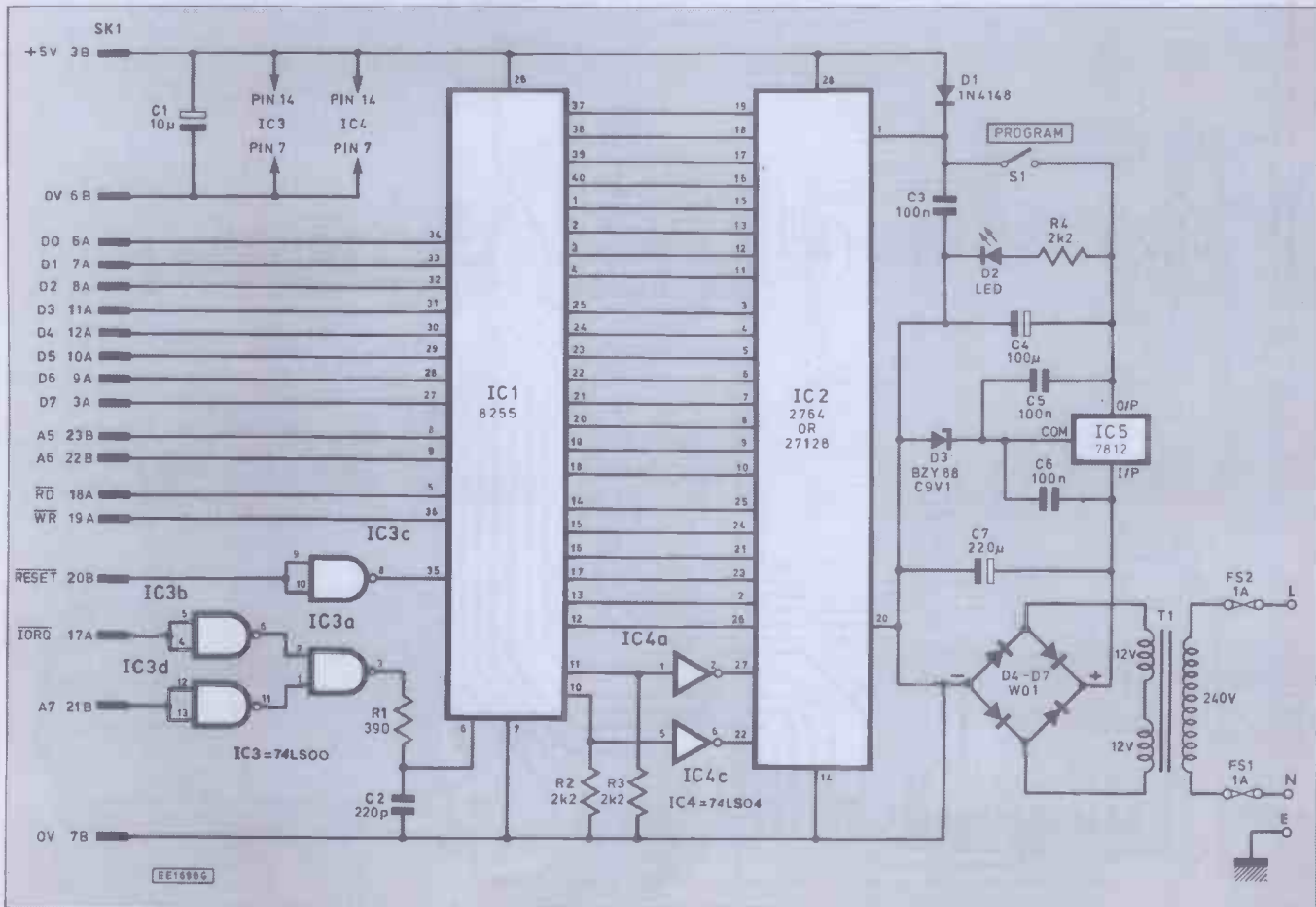

All three of ICI's ports default to inputs on power-up and hence the inputs of IC4a and IC4c are pulled-down by R3 and R2 to ensure that the EPROM's OE and PGM inputs both default to the inactive (high) state. Trevor's letter continues with this theme:

The PIO is often re-initialised by the programming part of the software in order to reverse the direction of the A-port between programming and reading. This change of direction will default the address carried by the B and C ports to zero and, if it was not for the inverters (IC4a and IC4c), the output enable would also be low which would cause a data clash along with a program pulse at address zero.

The machine code program will soon move things out of this undesirable default state but the inverters ensure that the EPROM data bus is in a tristate condition. The EPROM programmer's port assignment is as follows:

Port	Address (dec.)
A	31
B	95
C	63
Control	127

Construction

The EPROM programmer is assembled on a p.c.b. measuring approximately 120mm×135mm, the copper foil layout for which is shown (actual size) in Fig. 2. The p.c.b. is fitted with a 28-way double sided edge connector which mates directly with the expansion bus connector at the rear of the Spectrum.

The component layout on the upper (forward facing) side of the p.c.b. is shown in Fig.

3. Note that a total of six links are required on the upper (forward facing) surface of the p.c.b. The recommended sequence of locating and soldering components to the p.c.b. is as follows: edge connector, links, i.c. sockets, resistors, capacitors, diode, bridge rectifier, l.e.d. and regulator. Furthermore, constructors are advised to carefully check the orientation of all polarised components (including electrolytic capacitors, diode, bridge rectifier, l.e.d. and regulator).

When the p.c.b. wiring is complete, a careful visual inspection should be carried out, paying attention to checking for dry joints, inadvertent short-circuits between tracks and i.c. pins, and solder splashes. A few moments devoted to this task can often save many hours of frustration at a later stage!

After confirming that all is as it should be, the integrated circuits can be inserted into their sockets (taking care to ensure correct orientation) and the unit connected to the rear of the Spectrum, after first disconnecting the power supply. This latter precaution is essential since permanent damage can result if external circuitry of ANY sort is connected to, or disconnected from the Spectrum's expansion bus whilst power is applied.

When power is re-connected, the usual copyright message should be generated on the display. If this is not the case, disconnect the power, remove the EPROM programmer p.c.b. and carefully check again!

Software

Trevor's machine code program for the EPROM programmer is too long to reproduce in *On Spec*. However, to assist readers (and also to avoid the usual problems that can

result from simple typing errors), Trevor has kindly agreed to make the software available to constructors at a modest cost; £2 for readers in the U.K. and £4 for overseas readers. Both prices include cassette, postage and packing. Trevor Brown can be contacted at Tall Trees, 14 Stairfoot Close, Adel, Leeds, LS16 8JR.

The program provides the following five options:

1. Load an EPROM into memory
2. Blow a 2764 EPROM
3. Blow a 27128 EPROM
4. Examine memory
5. Enter BASIC

Trevor makes the following comments on the EPROM programmer software:

Option 1 will load either a 2764 or a 27128 into memory so that data can be examined using Option 4. 16K of data is moved so if a 2764 is loaded the data will repeat after 1FFF. This is not a problem and helps keep the program simple and small (less than 1K of code). When the program is first loaded, the memory is filled with FF (i.e. all bits are logic 1). This is useful for checking that an EPROM is erased.

Insert the EPROM and select Option 2 or 3 but do not switch the programming voltage (V_{pp}) "on". This "verify mode" compares the EPROM with the contents of memory; if all is well, the user will be returned to the menu, alternatively a failure message will be generated along with the address at which an error is detected. By this means, it only takes a few seconds to check an EPROM for erasure.

Fig. 2. P.C.B. foil layout for the EPROM programmer

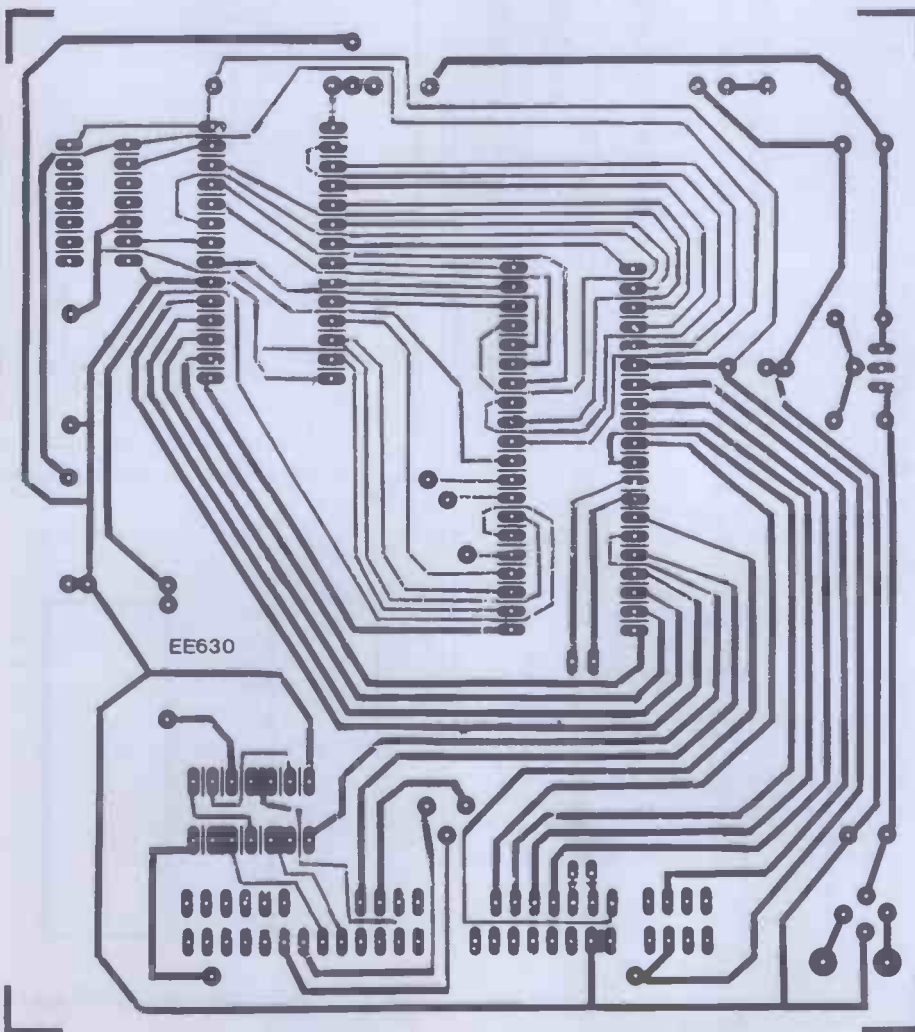

COMPONENTS

Resistors

- R1 390
- R2-R4 2k2 (3 off)
- All 0.25W 5% carbon

Capacitors

- C1 10 μ p.c. elect. 16V
- C2 220p polystyrene
- C3, C5, C6 100n polyester (3 off)
- C4 100 μ p.c. elect. 50V
- C7 220 μ p.c. elect. 50V

Semiconductors

- IC1 8255 PPI
- IC2 2764 or 27128 EPROM
- IC3 74LS00
- IC4 74LS04
- IC5 7812 12V 1A regulator
- D1 1N4148
- D2 red l.e.d.
- D3 BZY88
- C9V1 Zener
- D4-D7 WO1 (50V 1A bridge rectifier)

**Shop
Talk**

Miscellaneous

- S1 s.p.s.t. miniature toggle switch.
- 28-pin zero insertion force (ZIF) socket; 40-way low-profile d.i.l. socket; 14-pin low-profile d.i.l. socket (2 off); printed circuit board—available from the *EE PCB Service*, order code 630; 20mm fuse holders (2 off); 20mm 1A quick-blow fuses (2 off).
- T1 12 or 20VA mains transformer with 2×12V secondary windings; enclosure for transformer and fuses; mains connector; 28-way open end double-sided 2.54mm (0.1 inch) pitch edge connector (e.g. Veropart number 838-24826A).

Approx. cost
Guidance only

£29

Depending upon program size, programming may take up to 15 minutes. No short cut algorithms are used, but each byte is first read and the "blow" operation is skipped if not required.

Option 5 puts users into BASIC so that data resident in memory may be **SAVED** to, or **LOADED** from tape or Microdrive. The required syntax for a cassette tape **SAVE** is:

SAVE "filename"CODE,28000,8192
for a 2764 or

SAVE "filename"CODE,28000,16384
for a 27128

A microdrive **SAVE** requires the extra syntax of:

SAVE * "m";1;"filename"CODE,28000,8192
or

SAVE **"m";1;"filename"CODE,28000,16384
for 2764 and 27128 EPROM devices respectively.

Files may be loaded into memory for programming by using the commands:

LOAD "filename"CODE,28000
or

LOAD * "m";1;"filename"CODE,28000

(Note that the load address, 28000, may be omitted if a previous **SAVE** specified this address as a default).

Not all our readers will be familiar with the techniques used for data storage in an EPROM and Trevor has provided a few gen-

eral hints together with a warning which all constructors should carefully observe. Trevor continues:

For those who are not familiar with this means of data storage, the EPROM programmer can only change a logic 1 to a logic 0. An EPROM can be erased by exposure to ultra-violet light of about 2537 Angstrom. Exposure to a small 8W tube at a few inches for about 20 minutes will be required to erase a previously stored program. This process will fill the EPROM with logic 1's (or a byte of FFH at each address). Erasure can be checked by loading the EPROM into memory (using Menu Option 1) and then examining it (using Option 4).

WARNING: Ultra-violet light is dangerous to the eyes and skin and some form of opaque shielding should be used. Furthermore, Ozone can be produced and inhalation may cause respiratory irritation.

Clearly, there are a few important precautions to observe when erasing an EPROM. The best solution is with the aid of a specialised EPROM eraser in which the ultra-violet tubes are contained in a light-proof enclosure fitted with a timer. Such devices are available from several suppliers but they can be rather expensive. Since low-power ultra-violet tubes can be obtained quite cheaply, a possible alternative is that of building one's

own eraser, full details for such a unit were given in the *October '88 issue of EE*.

Finally, my own crude but quick method for erasing EPROMs involves nothing more than a common-or-garden sun-ray lamp! The particular unit in question will erase an EPROM in approximately 10 minutes when the EPROM is placed at a distance of 200mm from the lamp.

It is important to note, however, that over-exposure may effectively reduce the number of programming cycles that can be performed so exposure should be kept to the minimum that will ensure that all cells revert to logic 1. Furthermore, with a high-power ultra-violet source it is **ABSOLUTELY ESSENTIAL** to observe the precautions mentioned earlier, carefully following the recommendations of the sun-ray lamp manufacturer concerning skin exposure and eye protection.

Next month: we shall be tackling a seasonal *On Spec Project* in the form of a Christmas lights controller. In the meantime, if you would like a copy of our "On Spec Update", please drop me a line enclosing a large (250mm x 300mm) adequately stamped addressed envelope. Mike Tooley, Department of Technology, Brooklands Technical College, Heath Road, Weybridge, Surrey, KT13 8TT.

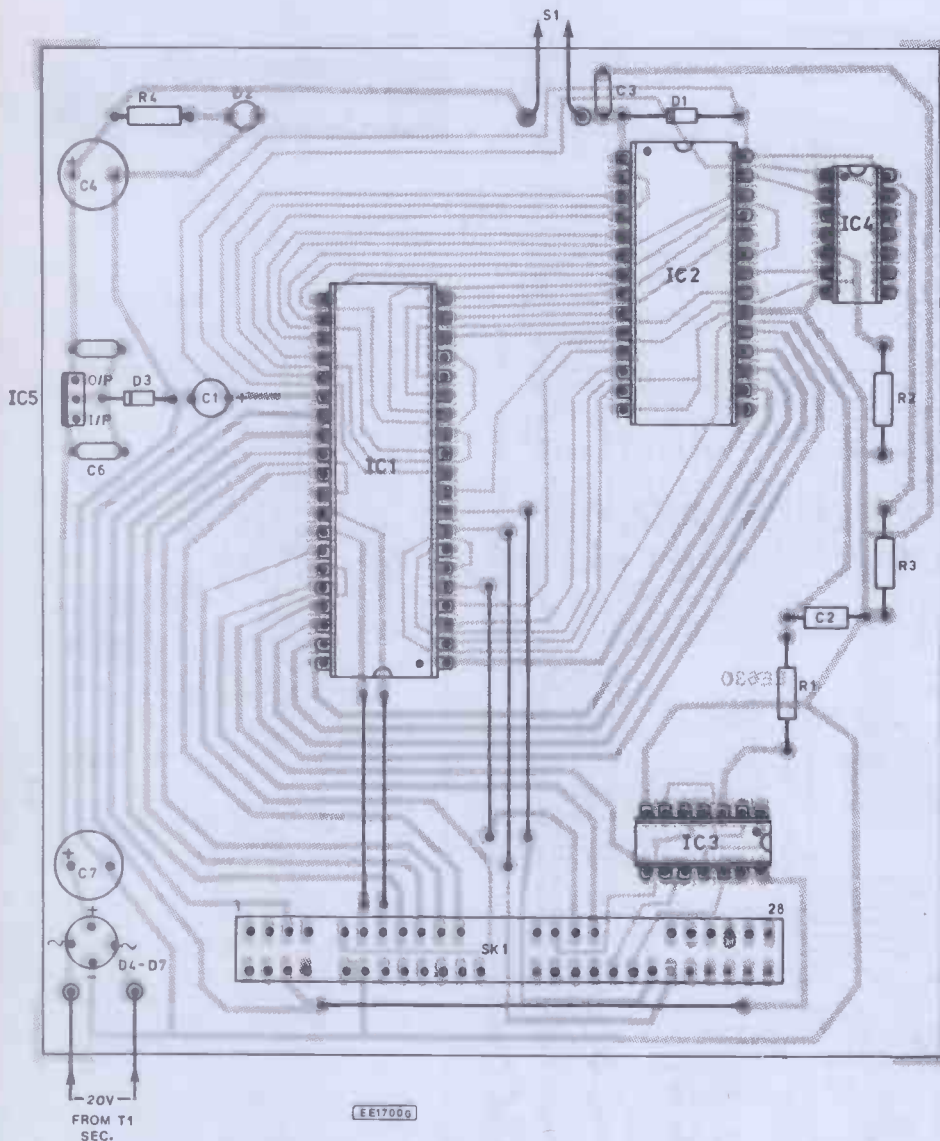

Fig. 3. P.C.B. component layout for the EPROM programmer

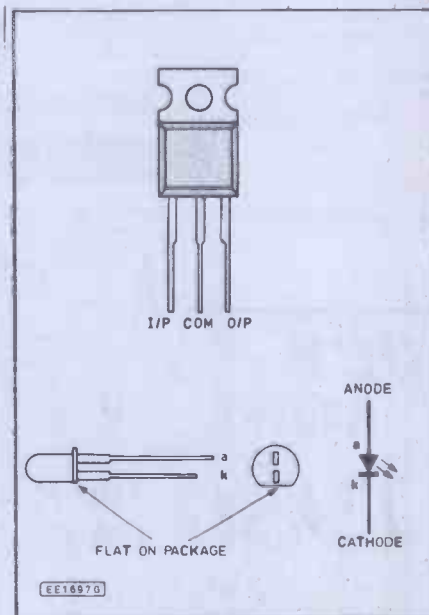

Fig. 4. Connections for the regulator and l.e.d.

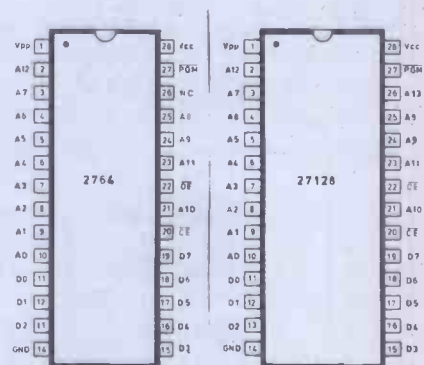

Fig. 5. Pin connections for 2764 and 27128 EPROM

TRANSFORMERS

MAINS ISOLATORS
Pri 120V x 2 or 220/240V or 415/440V, Sec 440 or 240V or 110V Centre Tapped Secs

20VA	£	7.58	P	2.28
60	12.37	8	2.45	
100	14.43	P	2.65	
200	20.45		3.20	
250	24.73		3.30	
500	38.10		3.85	
1000	69.10		4.85	
1500	89.13		5.95	
2000	107.24		5.95	
3000	150.38		O/A	
6000	321.20		O/A	

30/15V or 15-0-15V 2x15V Tapped Secs
Volts available: 3, 4, 5, 6, 8, 9, 10, 15, 18, 20, 27 or 30V

30V	15V	£	P&P
0.5	1	4.14	1.65
1	2	5.63	1.80
2	A	4	9.10
3	M	6	10.55
4	P	8	12.59
5	S	10	16.11
6	12	17.65	2.65
8	16	23.59	2.75
10	20	27.22	2.95
12	24	30.39	3.05
15	30	34.03	3.65
20	40	46.46	5.95

50/25V or 25-0-25V 2x25V Tapped Secs
Volts available: 5, 7, 8, 10, 13, 17, 20, 25, 33, 40, 50V or 20-0-20V or 25-0-25V

50V	25V	£	P&P
0.5	1	5.38	1.90
1	2	6.54	2.00
2	A	4	11.65
3	M	6	13.48
4	P	8	18.46
6	S	12	23.47
8	16	33.20	3.25
10	20	39.40	3.70
12	24	47.16	3.90

INVERTERS
1224V DC to 240V AC
Sine-Wave or Square Wave
From 60VA

TRANSFORMER WINDING SERVICE
3VA to 18KVA

CONSTANT VOLTAGE TRANSFORMERS
For Spike-free Stable Mains

Also Valve Mains Output & Matching transformers

UNIT 211, STRATFORD WORKSHOPS, BURFORD ROAD, LONDON E15 2SP

EX STOCK

24/12V or 12-0-12V 2x12V Secs Pri 240V

24V	12V	£	P&P
0.15	.03	3.13	1.70
0.25	.5	3.31	1.70
0.5	1	3.97	1.70
1	2	5.53	1.90
2	A	4	6.38
3	M	6	10.99
4	P	8	11.70
6	S	12	14.20
8	16	16.90	2.80
10	20	22.75	3.20
15	30	28.28	3.30
20	40	40.37	3.75
30	60	57.96	4.45
41	83	66.74	5.75

AUTOS
105, 115, 220, 230, 240V
For step-up or down

80VA	£	6.29	P&P	1.75
150	9.12		1.90	
250	11.14		2.10	
500	17.32		2.80	
1000	30.94		3.35	
1500	36.73		3.80	
2000	54.92		4.65	
3000	93.39		5.75	
4000	121.23		O/A	
5000	141.17		O/A	
7500	217.91		O/A	
10kVA	257.49		O/A	

CASED AUTOS

240V Cable Input
3-pin 115V USA Skt Outputs

20VA	£	8.96	P&P	1.85
80	12.17		1.95	
150	15.77		2.30	
250	19.21		3.25	
500	31.51		3.25	
1000	44.23		4.55	
2000	78.82		5.58	
3000	113.15		O/A	

110V to 240V Cased Autos
now available

Full range AVO's & MEGGERS

BARRIE ELECTRONICS LTD
Tel: 01-555 0228 (3 lines)

PROFESSIONAL SURVEILLANCE EQUIPMENT KITS

- MTX**
Micro-miniature VHF transmitter. The smallest kit on the market, measuring an incredible 17mm x 17mm including on-board mic. Super sensitive fully tuneable over FM band, 9V operation with range up to 1000m. **£10.95**
- VT500**
High power version of the MTX with on-board PA stage providing 250mW of RF. Measures just 20mm x 40mm, power requirements 9-15V. Excellent sensitivity and stability. Fully tuneable over FM band. Ranges over 3000m can be expected. **£12.95**
- VOX75**
Voice-activated transmitter. Variable sensitivity trigger level switches transmitter on when sounds are detected. Slays on for time delay variable between 1-20 sec. Fully tuneable output covers all FM band. Very sensitive and low standby current through CMOS circuitry. 9V operation, range up to 1000m. Measures 30mm x 40mm. **£16.95**
- CTX900**
Sub-carrier scrambled transmitter. Audio is double modulated providing very secure transmissions. Any unauthorised listener will not be able to demodulate signal without DSX900 Decoder unit. Variable modulation on-board. Fully tuneable output covering FM band. 9V operation, range up to 1000m. Measures 30mm x 40mm. **£18.95**
- DSX900**
Decoder unit for CTX900. Connects to earphone output of receiver to descramble signal from CTX900. Monitor using small speaker or headphones. Variable decode frequency on-board for best resolution. 9-12V operation. Measures 35mm x 50mm. **£17.95**
- TLX700**
Micro size telephone transmitter. Connects onto line at any point and requires no batteries. Clearly transmits both sides of conversations on both incoming and outgoing calls. Undetectable by phone users. Fully tuneable output covering FM band. Range up to 1000m. Measures just 20mm x 20mm. **£9.95**
- ATR2**
Micro size telephone recording unit. Connects onto line at any point and connects into ANY normal cassette recorder, standard or micro having MIC and REM sockets. Requires no batteries. Switches recorder on silently when phone is used for incoming or outgoing calls, switches off when phone replaced. Clearly records both sides of conversations. Undetectable by phone users. Measures 10mm x 35mm. **£10.95**
- XML900**
RF Bug Detector/Locator. Wide band input circuitry detects presence of RF field and triggers flashing LED and piezo bleeper. Variable sensitivity enables source of transmission to be pinpointed to within 6 inches. Max sensitivity will detect MTX or similar transmitter at around 15-20 feet. 9V operation. Measures 55mm x 55mm. **£21.95**

All kits come fully documented with concise assembly and setting-up instructions, high quality fibreglass PCB and all components necessary to complete the module. All prices are inclusive but please add £1.50 to cover P&P. Orders over £50.00 post free. Please state requirements clearly and enclose cheque or PO to cover.

Phone orders on ACCESS or AMEX accepted. Tel: 0827 714476

NOTE: It is illegal to operate a transmitter in the UK without a licence. Send 9x4 SAE for full catalogue of these and other surveillance kits

SUMA DESIGNS (Dept. EE), THE WORKSHOPS, 95 MAIN ROAD BAXTERLEY, Nr AHERSTINE, WARKS CV9 2LE. TEL. 0827 714476

OUT NOW!

CRICKLEWOOD ELECTRONICS

1989 100 PAGE COMPONENT CATALOGUE PRICE £1

SEND OFF FOR YOUR COPY TODAY...

- WE STOCK AN UNRIVALLED RANGE
- ALL OUR COMPONENTS ARE FIRST CLASS BRANDED ITEMS
- WE OFFER A SAME DAY SERVICE ON ALL STOCK ITEMS
- NO MINIMUM ORDER—IF YOU NEED ONE COMPONENT WE CAN SUPPLY ONE COMPONENT
- WE HAVE ADOPTED A NEW LOWER PRICING POLICY + QUANTITY DISCOUNTS
- FREE VOUCHERS WITH YOUR CATALOGUE—ORDER ONE NOW!...

JUST FILL IN THE COUPON OPPOSITE AND POST IT WITH YOUR £1 PAYMENT TO THE ADDRESS BELOW. YOU WILL RECEIVE NOT ONLY OUR SUPERB 100 PAGE CATALOGUE, BUT ALSO FREE VOUCHERS WHICH YOU CAN USE ON YOUR NEXT COMPONENTS ORDER.

CRICKLEWOOD ELECTRONICS LTD 40 CRICKLEWOOD BROADWAY LONDON NW2 3ET TEL: 01-450 0995/452 0161 FAX: 01-208 1441 TELEX: 914977

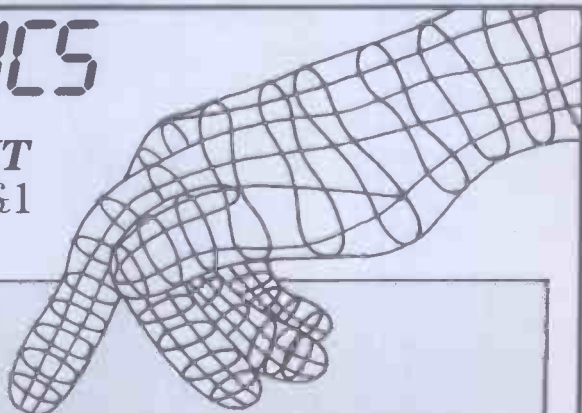

FREE VOUCHERS!

SEND OFF FOR YOUR CATALOGUE AND VOUCHERS TODAY.

I WOULD LIKE TO RECEIVE.....
COPY(COPIES) OF THE 1989
CRICKLEWOOD ELECTRONICS
COMPONENT CATALOGUE. I
ENCLOSE £.....
PLEASE ENCLOSE MY FREE
VOUCHERS.

Tape your £1 coin here, or send a cheque or postal order for £1.00 for every catalogue you require.

NAME.....

ADDRESS.....



PERSONAL CASSETTE AMPLIFIER

R. S. POWELL

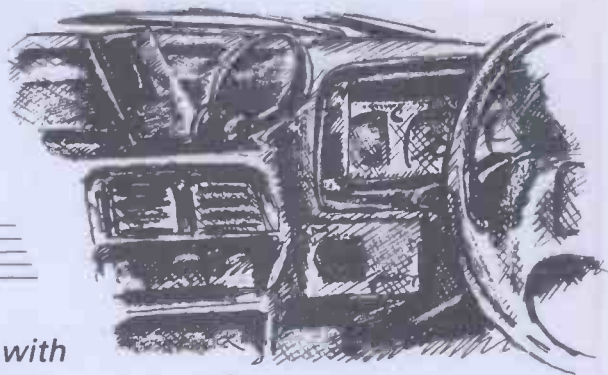

Budget-priced solution to providing in-car music, with the added advantage that personal cassettes are less renowned for damaging tapes than some cheap car players. Provides just over 2W output.

MANY car owners like to listen to music of some form whilst driving. be it from a car radio or cassette. Unfortunately car cassette players are either expensive or unreliable and tend to attract thieves. This article describes the construction of a simple little amplifier which may be used with a personal cassette player to enable tapes to be played in the car.

An amplifier of this type can be easily hidden, and the cassette player may be removed when one leaves the car. This simple system offers a low cost solution to providing in-car music with the added advantage that personal cassette units are less renowned for damaging tapes than cheap car players.

The amplifier can of course be used in a wide variety of other applications.

The Amplifier

The basic circuit for the amplifier is shown in Fig. 1. This may be used in either of two ways:

- (1) The circuit may be used with two resistors connected to the amplifier input—one to each channel of the stereo output from the player, as shown in Fig. 1.

alternatively:

- (2) Two of the circuits may be used to provide stereo by omitting R1 from each amplifier and connecting one circuit to each output channel. A dual-gang potentiometer should then be used for the volume control.

Circuit

The LM380 will deliver about 2 Watts into an eight ohm speaker, which is perfectly adequate for reasonable volume levels, even at motorway speeds. The actual circuit is very simple; R1, R2 and R3 constitute a passive mixer, forming a single signal from the left and right channels. As the headphone output usually matches impedances between 32 ohms and 11 kilohms, values of 100 have been chosen for R1 to R3. The signal developed across R3 is amplified by the LM380. VR1 varies how much signal is sent to the inverting input and hence determines the gain. The output is fed to the speaker via capacitor C3.

One should note C2 and R4 which are different from values usually used with the LM380. R4 helps prevent distortion and replaces the usual Zobel network, whilst C2 has been increased to 10 μ for the same reason.

Capacitor C4 is a decoupling capacitor and should be 1000 μ or more to stabilize the supply for the amplifier. The circuit will run from the car battery (or any other d.c. supply of 12 to 18V at about 500mA) and an i.e.d. indicates when the circuit is turned on. A short

length of screened cable should be used to link the amplifier input to a jack plug for the headphone socket on the cassette unit.

Construction

The unit is easily constructed on Veroboard as shown in Fig. 2. Note that pins 3, 4, 5, 7, 10, 11 and 12 of the LM380 are all earthed to help form a heatsink for this i.c. For stereo, two such boards may be produced omitting R1 from each. Take care to solder the capacitors the correct way around, and for the inexperienced constructor the use of an i.c. socket is recommended.

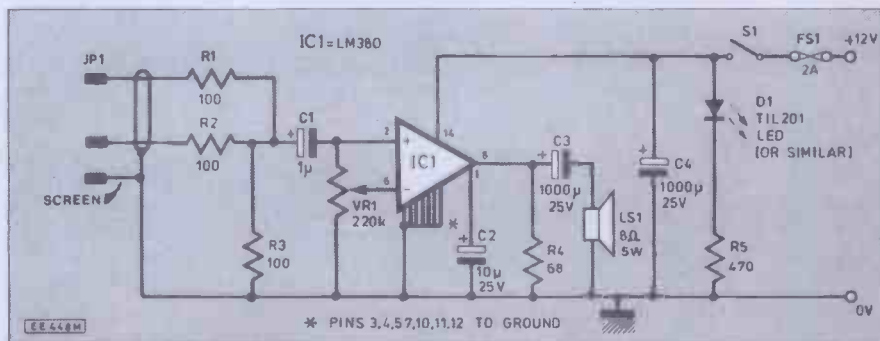
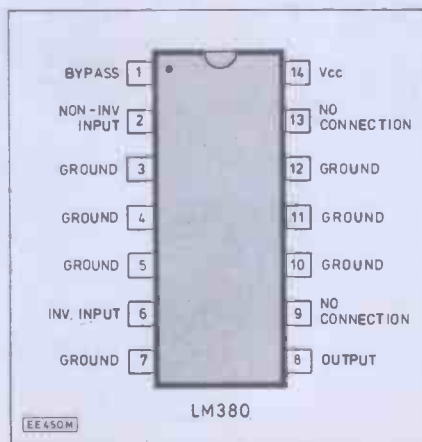

Fig. 1. Complete circuit diagram for the Personal Cassette Amplifier and below pinning details for the LM380 amplifier i.c.



A reasonable length of screened cable should be connected to the amplifier and terminated in a stereo 3.5mm plug suitable for the cassette unit in use. The only controls are the on/off switch and volume control, along with the "on" indicator i.e.d. if this is required. Remember the circuit should be powered via an in-line fuse as with all electrical circuits in the car. A two amp fuse as normally used with a car radio will suffice.

When fitting the unit into the car take care to check if the speaker/s are earthed and if so which lead. The unit may be mounted in a plastic box or, for example, in a console unit within the car. The author's unit is mounted behind the car-radio blanking cover along with an i.c.d. clock unit. From the outside there is no visual indication of any "audio" apparatus within the car which is ideal in helping prevent would be thieves from even attempting to enter the car.

COMPONENTS

Resistors

R1, (see text)
R2, R3 100
All 1/4W carbon

**Shop
Talk**

Page 702

Potentiometer

VR1 220k log. (see text)

Capacitors

C1 1 μ tantalum
C2 10 μ elect. 25V
C3, C4 1,000 μ elect. 25V
(2 off)

Semiconductors

D1 TIL201 l.e.d.
(or similar)
IC1 LM380 amplifier

Miscellaneous

JP1 3.5mm stereo jack
plug
FS1 2A in line fuse
and holder
LS1 8 ohm 5W speaker
Veroboard 16 strips by 28 holes,
screened stereo lead, connecting
wire etc.

Approx. cost **£7** inc. spk.
Guidance only

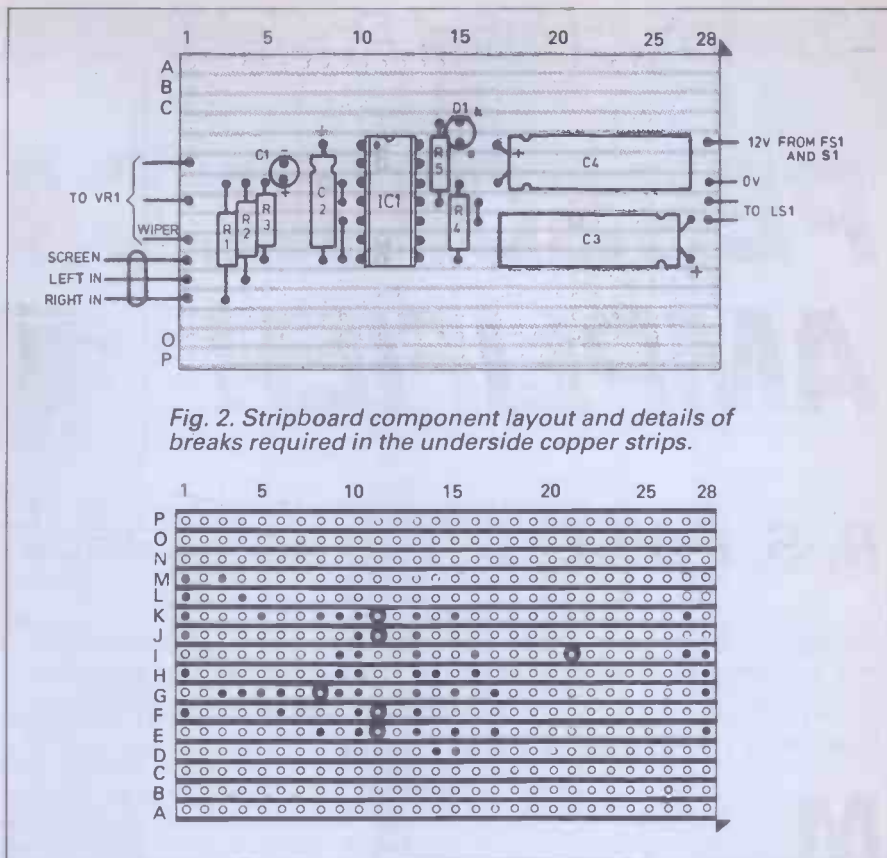

Fig. 2. Stripboard component layout and details of breaks required in the underside copper strips.

Using the Amplifier

Once the amplifier has been fitted into the car a small bracket to hold the cassette unit can be made by bending the end of a short length of metal rod and screwing this against a flat surface in the car. The author's unit mounts nicely on the car console.

The cassette player may be powered by ordinary batteries but a good alternative is to use rechargeable nickel cadmium cells available from many high-street stores. These rechargeable batteries are quite sufficient for even long journeys. If one is concerned at the

idea of the batteries running flat in the middle of a tape a simple circuit may be built to power the unit from the car battery using an LM317M. Details of such a circuit are readily available—most suppliers catalogues give details. □

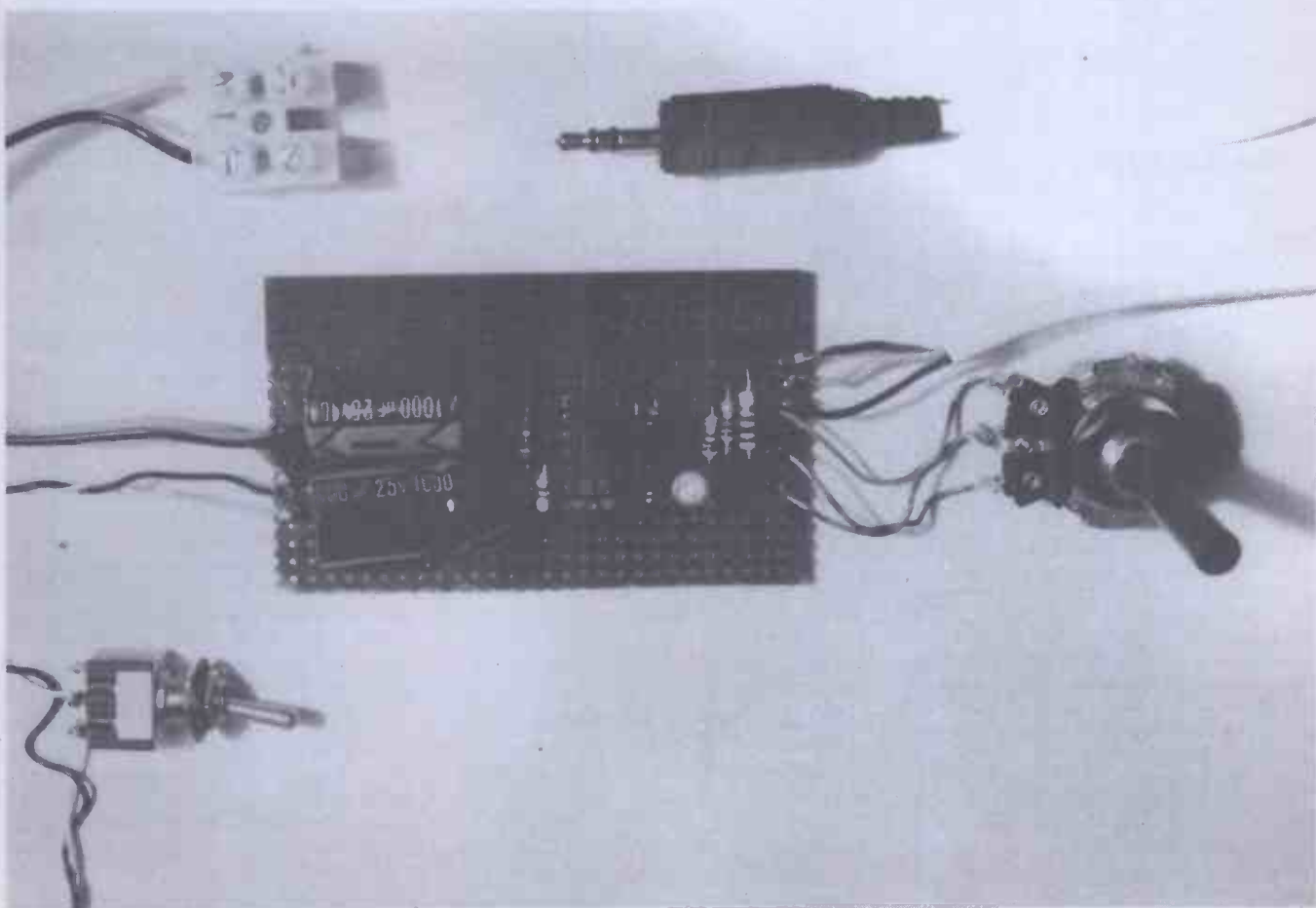

FOR YOUR ENTERTAINMENT

BY BARRY FOX

Encryptology

The satellite encryption system used in the US is called *VideoCipher*. The scrambler at the transmission end strips out the sync pulses which keep the pictures steady on screen, inverts the video signal by converting black to white, and alters the level of the burst signal used as a reference for colour information.

In addition, the sound is converted into digital code and slotted into the ends of the picture lines. The sound code is then encrypted by rearranging the digits—just as text messages are encrypted for security.

A set decoder, costing about \$400, generates digital sync pulses, decodes the digital audio and restructures the picture. But it can only do this when a code word burned into the decoder firmware matches a code word transmitted along with the signal. Otherwise the screen goes completely blank.

The transmitted codes are labelled so that they address only those decoders for which subscriptions, or pay-per-view payments, have been made. This technique is called "conditional access".

Pirates can't "hack" the codes controlling de-encryption because they follow the US Government's DES (Data Encryption Standard) which takes even the smartest computer a decade to unravel by trial and error. So the pirates buy a batch of legitimate decoders from GI's appointed manufacturers and pay a subscription on one of them.

So this one decoder gets an authorised code word burned into its firmware. The pirates then hack out the code and burn it into all the other decoders they have bought. So one subscription pays for viewing on dozens, or hundreds, of decoders.

EuroCipher

The system which GI is developing for BSB is called *EuroCipher*. The digital sound which accompanies the MAC picture signal is encrypted with DES codes. Also each line of the MAC picture is cut up into segments and the segments jugged so that each line ends up as a jumbled combination of several others.

De-encryption is under control of DES codes and an identifying word burned into the firmware, as in the US system. This will control subscription viewing.

For pay-per-view the set-top decoder will be connected to a central billing point by telephone line. For this an extra "side-car" with telephone modem will be needed, at an unspecified extra price.

There is a widespread problem in the US over piracy admits GI, with a total of 950,000 decoder units shipped to manufacturers, but only around 650,000 accounted for, i.e. owned by people who are paying subscriptions. Trade estimates in the US are that at least one-third, and perhaps as many as two-thirds, of all *VideoCipher* decoders sold so far are receiving television programmes for which they are not authorised.

Piracy Epidemic

So will there be a piracy epidemic here too?

They admit that the piracy boom in the US is the result of mistakes made in the original *VideoCipher* hardware design. The chips which store the user's personal identification number were too easily accessed by computer buffs who then produced replica chips for fitting in unauthorised decoders.

Even existing *VideoCipher* units in the US are prey to hackers, because signals running between four separate chips can be tapped. The next stage is to integrate all the electronics in a single chip.

But even this will not prevent hackers with access to an electron microscope, e.g. in a University lab, from shaving down the firmware chip and reading out the codes. To stop that, GI will have to use chips which are sealed in inert gas, rather than a plastics casing. They will then self-destruct when opened.

But all this puts up the price and reinforces doubts on BSB's £250 tag, they are paying GI £100 million up front to develop the system, in addition to £M50 to ITT for four million D-MAC chip sets.

Says Dr. Mark Medress of GI. "*EuroCipher is based on the lessons we have learned with VideoCipher over the last two and a half years since encryption began in the US. We now know how the pirates work and think.*"

Hair-Raising

The electronics industry moans about British safety regulations, and it is true that the bureaucracy is cumbersome. However, the Spanish way is much worse.

Hotels all round Europe have standardized on a neat hairdryer made in Switzerland. The Aliseo is designed for mounting on the wall of a bathroom. The motor and heating element are sealed

inside a plastic body, which connects with a hand-held air vent via a flexible plastic tube.

The user never needs to touch anything that is carrying an electric current. All that comes down the hand held tube is hot air; all electrical connections are hard wired inside the plastic casing.

In Barcelona recently I stayed at a posh hotel which had Aliseo's on the bathroom walls. But with wonderful naivety, the Spaniards had provided an open, unshuttered two-pin mains socket alongside the hair dryer and next to the bath and wash-basin. To run the hair dryer a guest with wet hands and bare feet has to push a bare, two-pin plug into the bare socket—thereby negating all the careful safety features built into the hair dryer.

Sound Track

People in North London were combing the streets this last summer, looking for the source of odd sounds like rolling, rhythmic thunder — and wrongly accusing neighbours of playing their hi-fi's too loud.

If you were one, look no further. It was the sound of new hi-tech sound equipment being used this year for concerts at Wembley stadium.

Brent council licences pop concerts at Wembley and has set a sound level limit of 98 decibels inside the stadium to keep Wembley residents happy. But this year Brent has been getting complaints from far further afield.

At first the council's health officers couldn't work it out. Now they have twigged. The concert promoters at Wembley have been using new sub-bass woofer loudspeakers which reproduce the full 98dB sound level right down to 20Hz.

These frequencies are so low that they roll around the whole of North London, cutting through walls like butter. At this pitch the human ear is non-directional so no-one knows where the sound is coming from.

On the Bank Holiday weekend the bass sound of Michael Jackson came close to drowning out the open air classical concert at Kenwood, a full 6 miles away — even though (and not a lot of people know this) the live sound from the Kenwood orchestra is always boosted by speakers hidden in the trees.

Illegal Broadcasting

Anyone watching ITV's *Telethon* fund raising event in June may have stumbled on an odd page of teletext; P169 on ITV contained lists of cryptic text and numbers. You will probably see the same page used during future ITV network marathon events.

There are already pages of teletext which carry coded secret messages which only "closed user group" recipients can read with special decoding equipment. They are used by large retail chains, to send price information round the country. Each branch has a modified TV set.

In doing this both the BBC and ITV are sailing very close to the wind legally. By law they are only allowed to broadcast—not carry private messages like British Telecom, Mercury or the Post

Office. But more of this when, as sure as night follows day, someone complains that closed user group teletext is by definition not broadcasting.

The *Telethon* page was not coded and not a Closed User Group. The plain English abbreviations identified regional ITV companies, like Tyne-Tees, Anglia, Central, London Weekend and so on. The numbers were times.

The page was being used to help regional producers slot their programmes together, following a precise timetable that could be instantly updated over the air. Once in a while they used it for messages too, for instance explaining that one producer's studio control link had gone wrong, so that he could hear incoming messages, but not say anything in reply!

OMNI ELECTRONICS

174 Dalkeith Road, Edinburgh EH16 5DX · 031 667 2611

The supplier to use if you're looking for
 ★ A WIDE RANGE of components aimed at the hobbyist ★
 ★ competitive VAT inclusive prices
 ★ mail order – generally by return of post ★
 ★ fast, friendly service ★

– by mail order, telephone order or personal call
NEW CATALOGUE NOW AVAILABLE

Send 2 x 19p stamps for a copy —

we do try to keep the goods we list in stock.

Whether you phone, write or call in we'll do our best to help you.



Open: Monday-Friday 9.00-6.00
 Saturday 9.00-5.00



BE POSITIVE !!

Positive working photoresist coated printed circuit boards, with full instructions, at a positively low price.
 All panels are 1/16" fibreglass, 1oz. copper, single-sided.

panel size (approx. in mm)	coated stock		uncoated stock	
	FR4	CMER(blue)	FR4	CMER(blue)
200x220	£4.20	£3.65	£2.60	£2.05
100x160	£1.68	£1.60	£1.05	£0.97

A number of panels (blue, uncoated) approx. 130x100mm are also available - £0.60

Prices are per panel, and include VAT.

Charges for post and packing: order value up to £5.00 - please add £1.00
 over £5.00 & up to £20.00 - please add £2.50
 over £20.00 - please add £5.00

Settlement terms: cheque with order



ADVANCED CIRCUITS LIMITED

Clarendon Road, Blackburn, Lancashire BB1 9SS
 (Tel 0254 680156)

THE CIRKIT WINTER '88-89 CATALOGUE IS OUT NOW!



Feature Project: Programmable Frequency Generator

£££s worth of discount vouchers

- New range PCs and peripheral
- Same day despatch
- Extended range

Easy to enter competition

and features many new products:

- Books - 12 Latest Titles
- Navico 2m Transceiver
- Miniature Mains Rocker Switches
- 8 Channel Logic Analyser
- Collet Knobs and Caps
- 2.4GHz Frequency Meter
- 10.7MHz Ceramic Filters
- Broadcast Band FM Tunersets
- RF Dip Meter
- IEC Mains Connectors
- Scanning Receivers - New Models
- 100MHz 3 Ch Oscilloscope
- RF and AF Signal Generators
- Pyropen - Cordless Gas Iron
- High Temp Elec Capacitors
- Miniature Analogue Multimeter

Plus discount vouchers, easy to enter competition and feature project. Available from your newsagent or directly from Cirkuit.

PRICE **£1.30**

Cirkuit



Cirkuit Distribution Ltd.

Park Lane, Broxbourne, Herts EN10 7NQ
 Telephone (0992) 444111 Telex: 22478

CIRCUIT BOARD ASSEMBLY/REPAIR JIG

It May Be A Little 'Lo-Tech'—But It's Incredibly Handy

Adjustable, rotating heads hold p.c.b.'s firmly but safely for easy assembly or repair. Insert components and simply flip over to solder leaves both hands free for a better job. Supplied with earthing lead for use with CMOS.

Interchangeable heads for holding many other items available.

Each jig hand made for a lifetime of use.

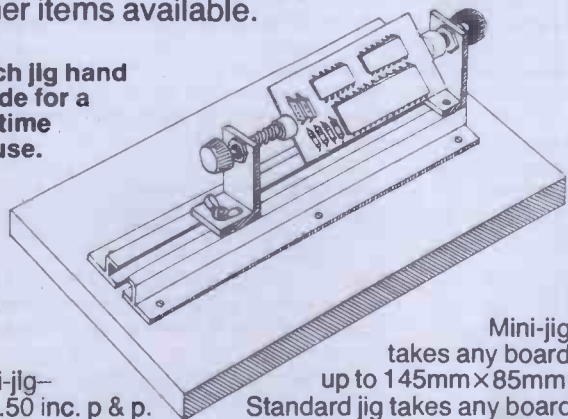

Mini-jig takes any board up to 145mm x 85mm.
 Standard jig takes any board up to 310mm x 145mm.

Mini-jig—£21.50 inc. p & p.
 Standard jig—

£24.50 inc. p & p. Cheque or P.O. only please:

EVERETT WORKSHOP ACCESSORIES

5 Railway Terrace, Henllan, Llandyssul, Dyfed, SA44 5TH, Wales

...REPORTING AMATEUR RADIO...

TONY SMITH G4FAI

TO THE SOUTH

I previously mentioned the Northern California DX Foundation, which provides substantial financial assistance for DXpeditions. These expeditions set up temporary amateur stations for extensive operating activity in unusual locations.

An example of such activity was the operation of stations 3Y1EE and 3Y2GV from Peter 1 Island in the Antarctic last year. The Norwegian Polar institute chartered a ship for a government sponsored mapping and research expedition to the island, and agreed that two radio amateurs, members of the LA(Norwegian)-DX-Group, could go as well provided they paid their own way.

A large sum of money was required for this purpose and contributions and support came from amateur radio groups and organisations interested in DX activities in a number of countries. Transceivers, amplifiers, antennas, tuners, rotors, and a generator, were provided by companies and individuals, and all were shipped to New Zealand for the start of the expedition.

NCDXF made the largest single grant in its history, \$30,000. They guaranteed \$10,000 for the trip, promising to pay that sum even if the amateurs were unable to get ashore and make any contacts. The full \$30,000 would be paid if they did get ashore and made over 15,000 QSOs (contacts on the air), which was the DXpedition's target.

In the event they made well over 16,000 QSOs during a period of 10 days, giving operators around the world the first ever opportunity of working this uninhabited, ice covered, volcanic island which, although first sighted in 1821, was not landed on until 1929.

Financial support for the DXpedition was so good that the LA-DX-Group have now been able to return \$10,000 to NCDXF as "seed money" for future expeditions to other rare locations. This was an outstanding example of yet another of the many facets of amateur radio. DXpeditions, some equally ambitious, others more modest, are taking place all the time, visiting other islands, deserts, mountains, or places which have little or no normal amateur radio activity. Wherever there is some isolated or exotic spot on the globe, you can be sure that if radio amateurs haven't got there yet it's only a question of time before someone mounts a DXpedition to reach it!

PICPRO

A recent article in CQ Magazine, in the USA, described a new aspect of packet radio communication (see this column, March 1987). This is PICPRO, a PICture PROgram for the PC and compatibles, written by Bob Slomka, WD4MNT, which displays a picture in colour as it is received via packet radio. This is automatically saved to disc and can be displayed later or be printed by a graphics printer.

The article, by Buck Rogers, K4BT, claims that the process is so different and spectacular that it ushers in a totally new era in packet and data communications. PICPRO functions as a terminal program operating in conjunction with the Kantronics MAXFAX weather facsimile receiving system. K4BT says he developed a packet picture passing technique a few years ago but the new technique could well have passed into oblivion but for its final evolution via the Kantronics system.

He claims that colour packet pictures are not subject to the noise and streaking found on slow-scan t.v. and that they are, as in the nature of packet itself, error free. *"Since frame checking is an integral part of the packet picture, just like standard text packet, the same error checking is performed as the picture is transmitted and received. This presents the receiving station with a picture identical to the picture at the transmitting station."*

Despite its success so far PICPRO is in a constant state of improvement, with WD4MNT re-writing and adding new features in the light of on-the-air trials between dedicated experimenters. It is an interesting area of activity, bringing together computer and radio interests, and this is the combination which many national radio societies see as the formula for continuing growth, attracting new entrants to amateur radio.

GOLDEN JUBILEE

The Royal Air Force Amateur Radio Society (RAFARS) celebrates its Golden Jubilee this year. The story was told, in *QRV*, (journal of RAFARS), winter 1947 issue, that although the Society was founded in 1938, amateur radio began in the RAF in 1924 when Flt. Lt. Durrant designed a 30 metres CW (Morse) transmitter. He sent constructional details to RAF Signals stations at Malta, Cairo, Jerusalem, Baghdad, Mosul and Delhi and suggested they keep a listening watch every evening for his own station at RAF Gosport.

He was quickly in communication with all these stations. Contacts with other amateur stations soon followed and the RAF overseas amateur network, operating from exotic locations, was in great demand.

An historic moment came when an urgent official message could not get through from Mesopotamia (now Iraq) on the regular long wave Inter-Command network, on 4,800 metres, and was relayed through the amateur stations instead. As a direct result of this the amateur Gosport to Hong Kong network became the official RAF short-wave W/T Inter-Command network!

In 1936 the Cranwell Amateur Radio Transmitting Society came into being, having its own callsign, G8FC, and in 1938 it published a CARTS journal, titled *QRV*.

As personnel were posted from Cranwell they wanted to keep in touch with the Society and soon there were members around the world. By 1938 it was realised that CARTS was, in effect, an RAF-wide organisation so in that year, with Air Ministry blessing, the Royal Air Force Amateur Radio Society, with headquarters at Cranwell, came into existence.

In 1951, headquarters were moved to No. 1 Radio School, RAF Locking, where it remains to this day, still producing *QRV* and operating G8FC. Its members are radio amateurs or short-wave listeners serving in, or retired from, the RAF or who have close connections with the Service. It has activities throughout the year.

Apart from G8FC, it can be heard with a number of other call-signs, all containing the suffix RAF. There is a daily UK "net" on 3.710MHz, at 1830 hrs, controlled by G2FIX, and a number of local weekly nets serving specific areas, where RAFARS members can meet on the air. Enquiries about membership of RAFARS should be made to the Admin Secretary, RAFARS, RAF Locking, Weston-super-Mare, BS24 7AA.

NETS

Mention of amateur "nets" calls for some explanation. The word is an abbreviation of "network", and a net is a group of amateurs, all transmitting and receiving on the same frequency. A "controller" is in charge to ensure net discipline, making a note of stations joining the net, calling them in turn to transmit and ensuring that no-one monopolises the proceedings. Listeners can hear all that is going on by tuning to a single frequency.

Some amateurs love nets and others can't abide them. If there are more than a few stations participating then each operator will only have the opportunity to transmit for a few minutes during the period of the net, which can be frustrating for some. On the other hand, regular participation in nets enables one to make and keep in touch with a number of friends and be up-to-date with the news of the organisation running the net.

In Australia, a group of Morse enthusiasts have been trying a different sort of net based on the American "traffic nets". In these nets, stations are paired off onto other frequencies for the purpose of passing greetings messages for the general public, coming back to the control frequency for fresh instructions when they have finished.

The Australians have adapted this system for chat nets so that the control frequency becomes a meeting point for stations to call in, with the controller then pairing them off using the same procedures and disciplines as in the traffic nets. The Aussies doing this think it is an improvement over the traditional net system, but I don't know if this idea has been tried in the UK.

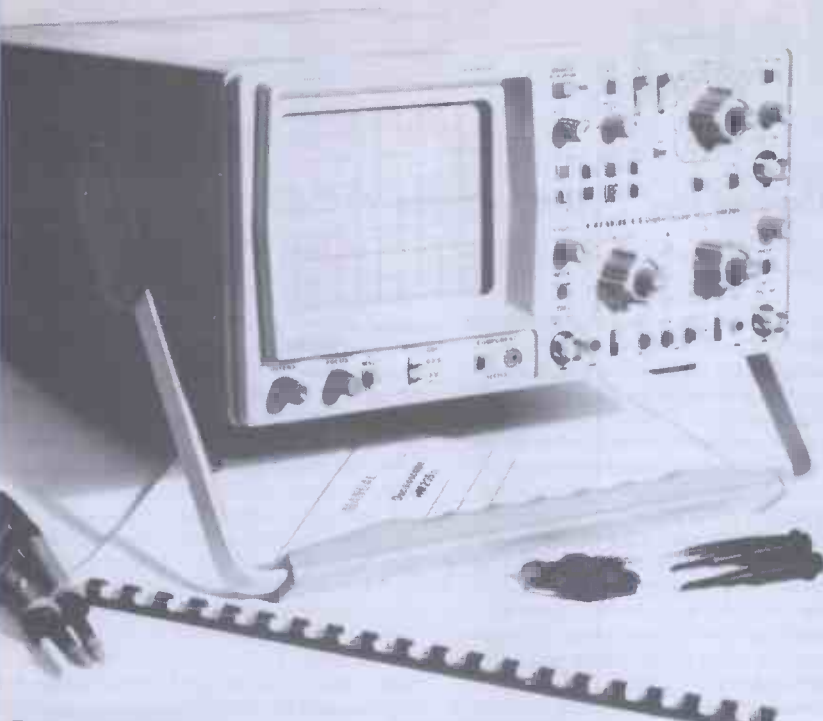

£547 incl. VAT and carriage (Securicor) **HM205-2**

Digital Storage Oscilloscope HM205-2
Analog: 2 channels d.c.-20MHz, max. 2mV/div, Comp-tester.
 Timebase 0.2s-20ns/cm, Trigger d.c.-40MHz.

Digital: Max. sampling rate 2x5MHz, Memory 2x1024x8 bit.
 Timebase 5s-2µs/div, Dot-Joiner.

With a digitizing rate of max. 5MHz, signal events between 0.05Hz and several 100kHz can be captured and displayed in a visually useful manner. Operating the storage functions is exceptionally easy. By simply pressing the "STORE" button, all signals at the 'scope input will be digitized and stored. In "Refresh" mode, the memory contents will be updated with every sweep. One-time events can be captured in the "Single" mode. Pressing one of the "Hold" buttons will "freeze" the respective memory contents for evaluation or output to a computer printer or X-Y plotter via optional interfaces.

The HM205-2 is equally feature-packed for realtime applications, including excellent transient response to above 20MHz, single button operated component tester, variable trigger hold off, and active TV-sync-separator.

Send coupon and payment to:
 BK Electronics (EE 'Scope Offer), Unit 5,
 Comet Way, Southend-on-Sea, Essex, SS2
 6TR. Tel. 0702-527572

EE 'SCOPE OFFER

Please supply one
 HM205-2 at £547 HM203-6 at £333
 (please tick box)

Send 'scope to:

.....

I enclose cheque/bank draft for £
 (make cheques payable to BK Electronics)
 OFFER CLOSING JAN. 13 1989

PRINT YOUR NAME AND ADDRESS

SPECIAL SCOPE OFFER

Once again *EE* is pleased to be able to offer all readers the chance to buy an oscilloscope at a discount price. We have joined forces with BK Electronics to offer two different oscilloscopes at exceptional prices.

As many readers will be aware a 'scope is one of the most versatile items of test gear and a digital storage oscilloscope can be particularly useful. These 'scopes come with a two year warranty which includes the c.r.t.—they are made in West Germany and can be serviced by Hameg in the U.K., should the need ever arise.

Each 'scope is supplied with two switchable (10:1 and 1:1) probes, a trimming tool for the probes and d.c. balance, plus a mains cable and an excellent manual, which includes detailed operating instructions and circuit diagrams etc.

Overseas readers please contact BK Electronics for an insured air-parcel quote.

OFFER CLOSING JANUARY 13, '89.

20MHz Two Channel Oscilloscope HM203-6

Two channels d.c. to 20 MHz, max. sensitivity 2mV/div., Component tester.

Timebase: 0.2s-20ns/div. incl. Mag.x10, Variable hold-off.
 Triggering d.c. to 40MHz, TV-sync-separator, Trigger-l.e.d.

The HM203-6 has been specifically designed for general production line and service applications. The many display modes, easy-to-learn front panel and operational simplicity also make it an ideal training 'scope for educational purposes.

For practical troubleshooting the built-in component tester enables quick characteristics tests of semiconductors and other components, in-circuit or discrete.

£333 incl. VAT and carriage (Securicor) **HM203-6**

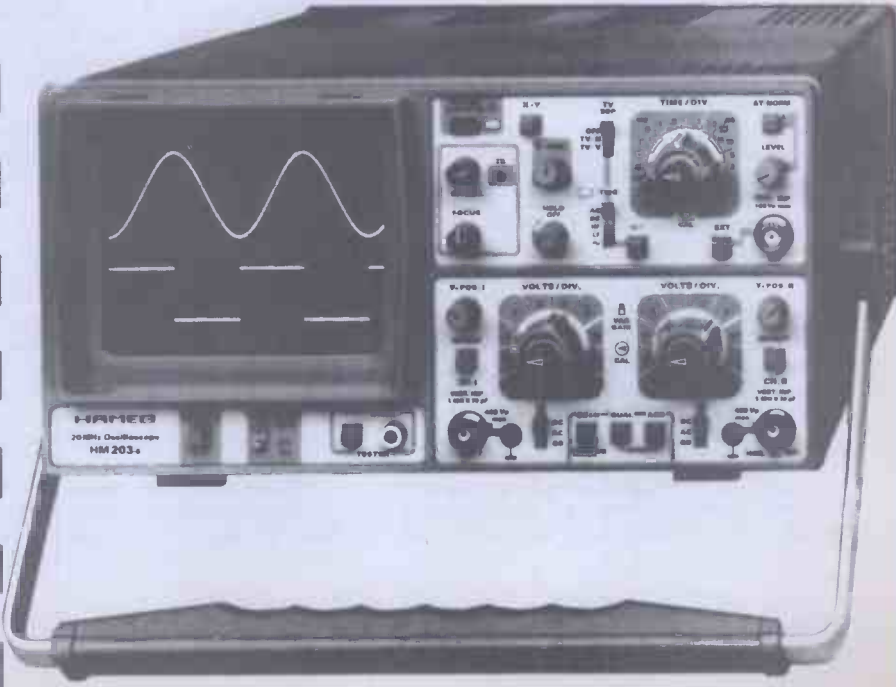

●●● Random Number Generation ●●●

IN THE *BEEB Micro* series we like to look at a mixture of serious applications for the BBC microcomputers and more lighthearted matters. This month we will be considering one of the less serious aspects of computing—random numbers. The RND function in BBC BASIC is used to generate random numbers. This function is mostly used in games, but it can also be used for other purposes, in particular to generate random data to test programs (for example, random numbers to test the efficiency of a sorting routine).

Random Number Generator

The numbers generated are not, in fact, truly random, being generated by a mathematical function. The series of numbers generated is, however, so long and so convoluted that the numbers may be considered random for all practical purposes. They are, however, more correctly termed pseudo-random.

If you turn on the computer and start generating random numbers, the series will always be the same. To avoid this, it is possible to "seed" the random number generator, giving it a starting value other than that provided by default. In some versions of BASIC there is a special statement to do this, usually RANDOMISE (or RAND), but in BBC BASIC the RND function is used, with a negative argument.

If the same argument is used each time, the same series will be produced, but it will be different to the default series. To produce a different series each time, an unpredictable seed value must be used.

The most common way of doing this is to use the BASIC TIME function. As this changes every 1/100 second, it is most unlikely that the RND function would execute twice when the TIME function returns exactly the same value. Even a difference of 1 in the seed will produce a totally different series of numbers. RND is a function, so it must always be on the right of an equals sign, or follow a PRINT statement, for example

```
dummy=RND(-TIME)
PRINT RND(-1)
```

The dummy variable will take the value of the argument to RND. In the second example—1 will be printed.

The ability to produce the same sequence of random numbers several times by using a constant seed can be useful, especially in testing the relative speeds of sort routines. However, you should always perform several comparative tests, using different data for each comparison, in case any one series of random numbers should favour one routine over the others.

If no argument to RND is given (e.g. $X=RND$), it will generate random numbers between -2147483648 and +2147483647. Giving a positive argument causes some processing of the random number generated so that it comes within a specific range.

$X=RND(1)$ will cause X to take a value between 0 and 0.999999. If you need non-integer numbers larger than 1, you must use RND(1) and multiply the result by a suitable factor. For example

$X=RND(1)*10$ will yield numbers between 0 and 9.99999. RND(0) will repeat the last number generated by RND(1).

If a value larger than 1 is given as the argument, random integers between 1 and the argument (inclusive of these values) will be generated. For example, to generate numbers from 1 to 6 for a dice simulation, you would use

$X=RND(6)$

If you need to generate a series of integers which could include 0, you must use an integer one more than the highest value you want to generate, and subtract 1 from the result returned by RND. For example, to generate digits from 0 to 9 you would use

$X=RND(10)-1$

A similar technique can be used to obtain starting values higher than 1. To generate random ASCII codes for capital letters, you could use

$code=RND(26)+64$
there being 26 letters in the alphabet, and the ASCII code for A being 65 (1+64).

Alternative Randomness

Probably most BBC micro programmers who require a random number turn to the RND function without giving a second thought to alternative methods. If you are programming in some other language there may well be no equivalent to the BBC BASIC RND function, and an alternative means then has to be sought.

Questions about methods of producing random numbers when programming in assembler or some other non-BASIC language seem to be quite commonplace in the letters pages of computer magazines. It is something that seems to be quite simple until you actually try to sit down and work out a method that will really work properly in practice.

There are solutions to the problem that only use software, but a hardware or semi-hardware solution is an equally valid way of doing things. As explained previously, a common ploy is to seed the BBC BASIC RND function from the timer so that a different set of numbers is obtained each time a program is run. Taking things a stage further, it is possible to use a timer as a form of random number generator.

The 6522 of the BBC computer that provides the printer and user ports includes two 16 bit timer counters. These are both available for user applications, and would seem to offer good scope for random number generation.

In order to use one of the timer/counters in this way it must be made to continuously count down at high speed. Reading the timer/counter then provides a number of between 0 and 65535. At least, it does if both the high and low bytes are read. For most purposes simply reading the low byte would probably suffice. This would give a number from 0 to 255 inclusive.

With the counter driven at high speed there is no way to predetermine what value will be read from it, and there is no obvious way in which there could be a bias towards any par-

ticular number or range of numbers. It is debatable as to just what constitutes a genuine random number and what is really a pseudo random number, but for most purposes the number read from the timer should be random enough.

Using Timer 2

Either of the two timer/counters are suitable for this application, but the more simple of the two (timer 2) is probably the best choice. This has only two modes of operation—the one where it is fed with the internal 1MHz clock signal and the one where it is driven from a clock signal fed to PB6 of the user port. These two modes are selected by writing a value of 0 (internal clock) or 32 (external clock) to ?&FE6B. For most purposes the internal clock signal should suffice.

The timer 2 registers are at addresses &FE68 (low byte) and &FE69 (high byte). Try this simple program which sets timer 2 for operation with the internal clock, and then reads the low byte and prints the value on the screen each time a key is pressed.

```
10 CLS
20 ?&FE6B=0
30 X=GET
40 PRINTTAB (10,10) ?&FE68
50 GOTO 30
```

Obviously it is unlikely that an application will require a random number in the 0 to 255 range provided by the low byte of timer 2, or the 0 to 65535 range provided by both bytes. However, some simple mathematics will normally be sufficient to convert the returned number to one that is suitable for a practical application.

As a simple example, assume that we wish to use the low byte of timer 2 to provide a number in the range 1 to 6 to act as a die for a games program. This short program demonstrates how this can be achieved. It merely prints a number from 1 to 6 on the screen each time a key is pressed.

```
10 CLS
20 ?&FE6B=0
30 X=GET
40 DIE=?&FE68
50 IF DIE > 251 THEN GOTO 40
60 DIE = DIE DIV 42
70 DIE = DIE + 1
80 PRINTTAB (10,10) DIE
90 GOTO 30
```

At line 40 the value in the low byte of timer 2 is placed in variable "DIE". For our present purpose we require a maximum number that provides an integer when divided by six, and 255 does not fit the bill. Line 50 effectively reduces the maximum figure for "DIE" from 255 to 251. If a value of more than 251 is placed in this variable, the program goes back and tries again, and keeps on doing so until an in-range value is obtained.

Although 251 does not provide an integer when divided by six, you have to bear in mind that the minimum number from the timer is 0 and not 1. Accordingly, there are 252 different values, and 252 divided by 6 is 42. Line 60 divides the value of "DIE" by 42 and discards any remainder. This gives a random number from 0 to 5, but 1 is added to this at line 70 so

as to give the required 1 to 6 range. Line 80 prints the value on screen and line 90 loops the program indefinitely.

When manipulating the numbers returned from the timer in order to obtain the desired range a certain amount of care needs to be exercised, as it is very easy to introduce a bias to certain numbers. Also, bear in mind that you cannot have more possible values in the final number range than the timer can produce.

If more than 256 different values are required, then both bytes of the timer must be used. BASIC is possibly a bit slow to read the timer properly, as it is likely that the count will move on in the time between the first and second bytes being read. As in this case it is not precise times we are after, but simply random numbers, this is not necessarily significant.

Using both bytes of timer 2 there are 65536 different values, which should be adequate for most purposes. However, if necessary timer 1 could be used as well, with the two values being added together to give a single large value, or multiple reads of timer 2 could be used to give much the same effect.

Improved Randomness

One way in which this means of random number generation could lack true randomness is that if the timer is read several times in rapid succession it will produce what is really a form of mathematical progression, rather than a series of truly random numbers. In practice it may well be read too infrequently for this to be noticeable, as it takes only about a fifteenth of a second for one complete down count of timer 2. Also, although it might seem that the timer was being read at regular inter-

vals, interrupts would tend to slightly randomise the times between readings.

It is possible to totally avoid problems with multiple reads of the timer by ensuring a relatively long delay between one reading and the next (say a second or more) and using a noise signal as the clock source. With the timer counting at a random rate, reading it at regular intervals will not provide a mathematical progression. Fig. 1 shows the circuit diagram for a simple random clock generator.

Noise Source

The noise source is a reverse biased base-emitter junction (TR1). The bias voltage is high enough to cause the junction to avalanche, like a Zener diode. Also like a Zener diode, it produces noise spikes, but most silicon transistors used in this mode provide a very much stronger output than a Zener diode. However, a Zener diode having an operating voltage of about 4.3 to 7.5 volts would probably work quite well in this circuit.

If a transistor is used, note that no connection is made to the collector terminal.

Whichever noise source is used, the output signal will still be quite low, and a large amount of amplification will be required in order to give a logic compatible output signal. This amplification is provided by two common emitter amplifiers. These drive a CMOS NOR gate (connected to act as an inverter) followed by a common emitter switch. The latter merely acts as a level shifter which gives an output at standard 5 volt logic levels.

The +5 volt and 0 volt supplies are taken from the user port, and the output of the unit connects to PB6 of this port. Remember to set ?&FE6B to a value of 32 to enable operation of timer 2 with a clock signal on PB6. 5 volts is insufficient to operate much of the circuit properly, and so a 9 to 12 volt supply is needed. This could be provided by a 9 volt battery, or the +12 volt output of the computer's power port could be used. The current consumption of the circuit is only a few milliamps from this supply.

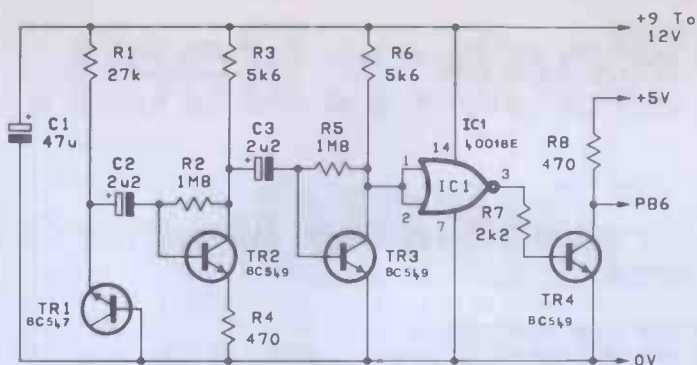
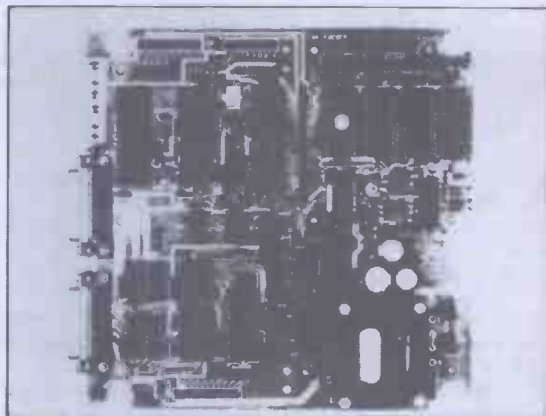

Fig. 1. The random clock generator circuit diagram

The Archer Z80 SBC

The SDS ARCHER – The Z80 based single board computer chosen by professionals and OEM users.

- ★ Top quality board with 4 parallel and 2 serial ports, counter-timers, power-fail interrupt, watchdog timer, EPROM & battery backed RAM.
- ★ **OPTIONS:** on board power supply, smart case, ROMable BASIC, Debug Monitor, wide range of I/O & memory extension cards.



The Bowman 68000 SBC

The SDS BOWMAN – The 68000 based single board computer for advanced high speed applications.

- ★ Extended double Eurocard with 2 parallel & 2 serial ports, battery backed CMOS RAM, EPROM, 2 counter-timers, watchdog timer, powerfail interrupt, & an optional zero wait state half megabyte D-RAM.
- ★ Extended width versions with on board power supply and case.



Sherwood Data Systems Ltd

Sherwood House, The Avenue, Farnham Common, Slough SL2 3JX. Tel. 02814-5067

REACTION TIMER

PAUL HARDING

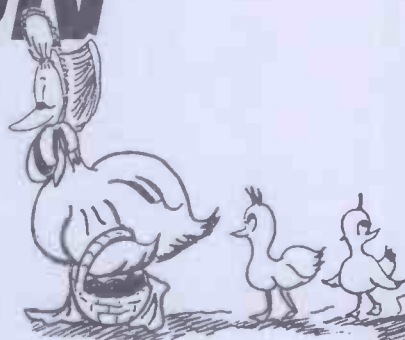

Just how good do you think your reactions are?

Build this pocket size, cheat proof unit and find out!

REACTION timers have long been popular as "party" type games; often a row of lights are used and these indicate the subject's reaction time, albeit in a rather crude fashion. The circuit presented here is a rather more sophisticated design; it features a digital display with a resolution of 1ms, and a crystal controlled oscillator, which removes any need for calibration—the prototype's oscillator has an accuracy of better than 0.1 per cent.

In use, the front panel pushbutton is pressed, an l.e.d. flashes to indicate the "set" state, and, a pseudo-random time later (ensuring that the circuit cannot be pre-empted) the display illuminates and starts incrementing. Pressing the pushbutton again will freeze the display, indicating the subject's reaction time. The display automatically blanks about five seconds later to conserve the battery.

Pressing the pushbutton before the display illuminates will return the circuit to its quiescent state. It is not possible to obtain an apparently very fast reaction time by holding the

pushbutton down after the initial press since the circuit is edge—and not level—sensitive. The display freezes at 999, and so, again, it is not possible to obtain a fast time by pressing the pushbutton on the counter's "second time around".

CIRCUIT DESCRIPTION

The overall block diagram for the Reaction Timer is shown in Fig. 1. The 1kHz oscillator constantly sends pulses to the counter, a three digit BCD multiplexed type. In the circuit's quiescent state, the counter is held Reset by the flip-flop, via the pulse delay/stretch element. While the counter is in this state its on-chip multiplex system is inhibited and no display results.

When the pushbutton is pressed, the debounced signal obtained causes the \bar{Q} output of the toggle to go low, removing the Reset condition from the flip-flop. Sometime later the output from the eight seconds (8s) oscillator goes high and Sets the flip-flop. The pulse delay/stretch is triggered, and about two seconds later the Reset on the counter is

removed. The display illuminates and starts counting upwards.

Pressing the pushbutton again returns \bar{Q} on the toggle high, which Resets the flip-flop, taking the counter's Latch EN input high, freezing the count, and hence displays the user's reaction time. This positive going edge on Latch EN is delayed by the pulse delay/stretch, to enable the reading to be seen before the counter is reset and the circuit returns to its quiescent state.

If the pushbutton is not pressed again the Overflow output of the counter will reset the toggle which then initiates the same sequence of events as described above, with the display showing 999. The l.e.d. is driven from the ANDed outputs of the 4Hz oscillator and the toggle, and indicates when the circuit is in its "Set" state.

Since the eight second (8s) oscillator runs continuously, it is almost impossible to predict when its output will next go high and so a degree of randomness in the switch on, of the counter is obtained.

CLOCK/COUNTER

Looking now at the complete circuit diagram for the Reaction Timer, Fig. 2, the 1kHz oscillator is configured around IC1, a 4060. This chip was specifically designed for use in crystal or R/C oscillators/dividers. In this application, the crystal frequency of 4.096MHz is divided by 2^{12} (i.e. 4096) to give 1kHz. This signal is further divided to give 250Hz, which is then fed to another binary divider, IC2, to generate the 4Hz and 8s clocks.

Resistor R3, capacitor C1, and IC4b act as the debounce circuit, driving the toggle element, IC3a, a D-type flip flop. Every press of switch of S1 rapidly discharges C1, which then takes a very much longer time to recharge via R3. IC4b "cleans up" the pulse's slowly ramping trailing edge.

When the circuit is in its quiescent state, pin 5 and pin 2 of IC3a are high, holding IC3b REset (pin 10), and so the latter's complementary output, pin 12, is also high. IC4c's output is low and capacitor C2 is discharged. IC5, the counter, is held REset.

If S1 is pressed pin 2 of IC3a swings low, and when, sometime later, pin 15, IC2 (the 8s oscillator's output) goes high, Q of IC3b is forced low. IC4c's output swings high and capacitor C2 starts to charge via D4 and R6. The LE (latch enable) signal on pin 10 is

Fig. 1. Block diagram for the Reaction Timer

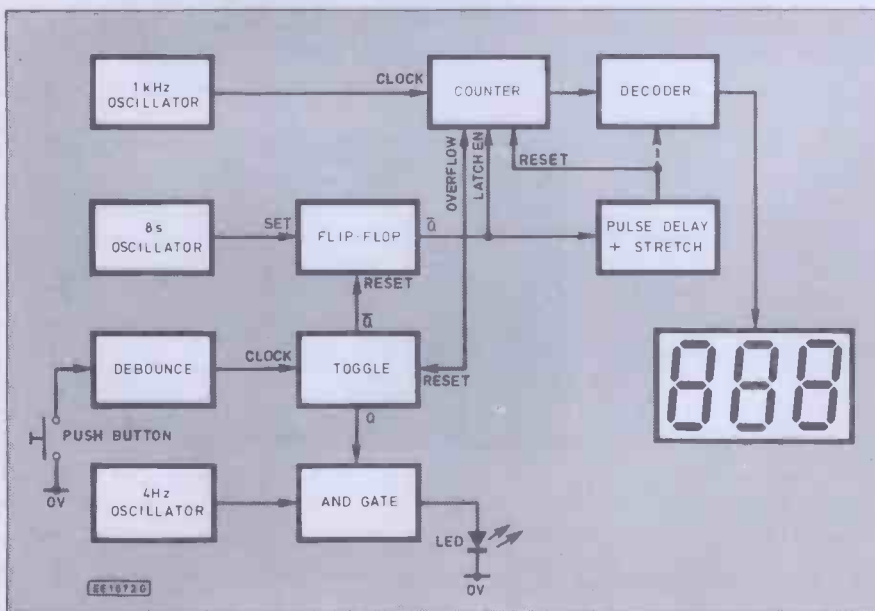

COMPONENTS



**Shop
Talk**
See page 702

Resistors

R1	10M
R2	820
R3, R4	100k (2 off)
R5	1M8
R6	220k
R7-13	560 (7 off)

All 0.25W 5% carbon

Capacitors

C1	0.47 μ radial elec. 16V
C2	10 μ radial elec. 16V
C3	1n Mylar
C4	47 μ radial elec. 16V

Semiconductors

D1	See switch S1 (orTIL209)
D2-4	IN4148
TR1-TR3	BC309 pnp (3 off)
IC1	4060B oscillator/divider
IC2	4040B binary divider
IC3	4013B dual D-type flip flop
IC4	4093B quad Schmitt NAND
IC5	4553B 3 digit BCD counter
IC6	4511B BCD-7 segment decoder
IC7	6203RVL red, 3 digit multiplexed, common cathode display

Miscellaneous

X1	4.096MHz crystal, HC18/U case style
S1/D1	B3J2 2100 combined switch and l.e.d.
S2	Ultra miniature slide switch

Minicon connectors:

- 8-way cable shell (1 off)
- 6-way cable shell (1 off)
- terminals (13 off)
- 8-way right angle header (1 off)
- 6-way right angle header (1 off)

Printed circuit boards, available from *EE PCB Service*, codes EE626 and EE627; plastic case, 65mm x 35mm x 120mm; 200mm ribbon cable, 7-way or greater; 14-pin i.c. sockets (2 off); 16-pin i.c. sockets (4 off); red filter plastic; PP3 battery and clips; p.c.b. guides; wire; solder; etc.

Approx. cost
Guidance only

£26

removed from IC5, but at this point it is still in its RESet state.

When the voltage across capacitor C2 crosses IC4d's upper input threshold, the latter's output goes low and the RESet on the counter is removed. The display, IC7, is illuminated, and IC5 starts counting.

Pressing S1 again RESets IC3b via IC3a causing the instantaneous count in IC5 to be latched on the display. Capacitor C2 starts to discharge, via the now low output of IC4c, through R5 and when the voltage across it falls below IC4d's lower input threshold, IC5 is RESet and the display blanks ready for the next attempt. The BCD data from IC5 is decoded by IC6 to a seven segment format suitable for displaying on the display module IC7.

DISPLAY

Moving on to the display stage of the circuit diagram, Fig. 2. The BCD counter IC5 also provides digit select outputs, and these drive the pnp emitter follower transistors, TR1 to TR3, to illuminate each digit at the correct time. Resistors R7 to R13 limit the drive current to IC7 to approximately 10mA to 12mA per segment.

The "set" l.e.d. (D1) is driven by the NOR gate resistor R4, diodes D2, D3, and IC4a, which, because of the logic used in the circuit, is functionally equivalent to the AND type shown in the block diagram. Capacitor C4 is a supply decoupling component and C3 sets the frequency of IC5's multiplex oscillator, its value is not critical.

Although only IC4b and IC4d are required to be Schmitt types, for reasons of space and cost efficiency all the NAND gates are in fact of this nature. This has no detrimental effect on circuit performance.

CONSTRUCTION

The component layout and full size copper foil master patterns for the Reaction Timer are shown in Fig. 3 and Fig. 4 respectively. These boards are available through *EE PCB Service*, codes EE626 and EE627.

Fig. 2. Complete circuit diagram for the Reaction Timer. Switch S1 and l.e.d. (D1) are mounted on the Display board.

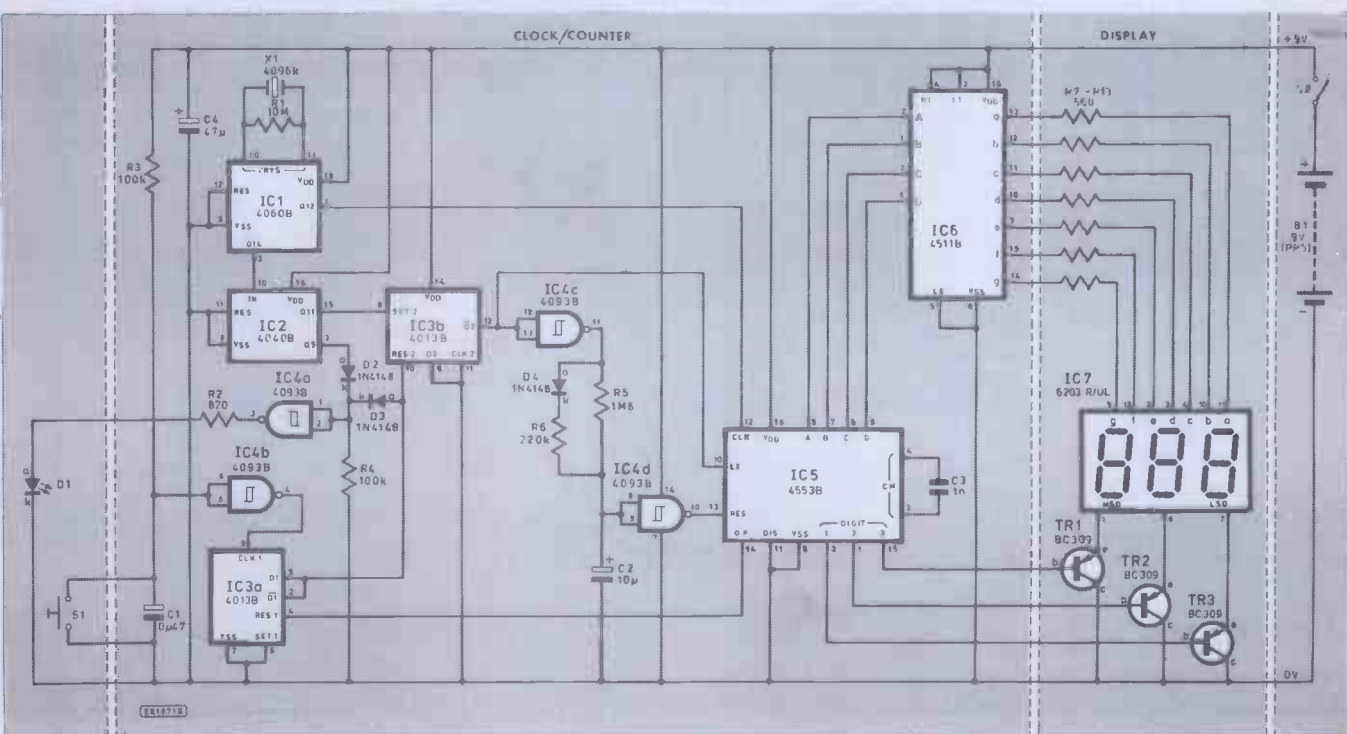

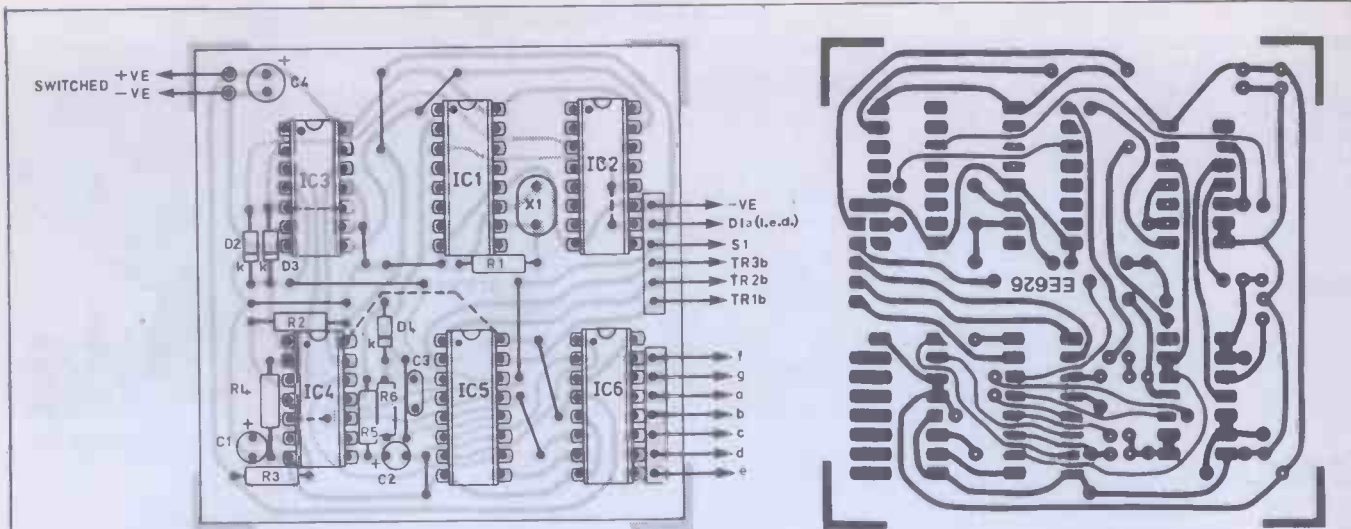

Fig. 3. Main printed circuit board component layout and full size copper foil master pattern.

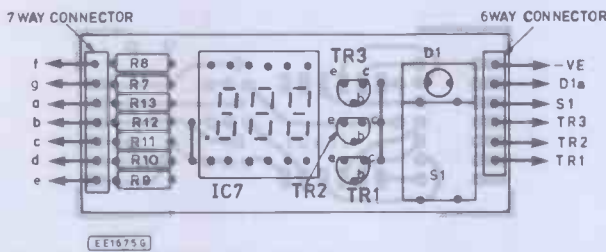

Fig. 4. Component layout and full size copper foil master pattern for the Display board.

Referring to the main circuit board component layout, Fig. 3, insert and solder the wire links (noting that four of the links, shown dashed, are under the board). The link adjacent to capacitor C3 may require insulating.

Next, insert and solder the resistors, diodes, i.e. sockets, capacitors and crystal, in that order. Ensure that the orientation of the diodes (cathode (k) shown as a black band on the overlay) and the polarised capacitors are correct.

It is preferable to use p.t.f.e. insulated wire for the underboard links because p.t.f.e. does not melt at normal soldering temperatures, thus reducing the risk of shorts. Note that capacitor C4 must have a lead pitch of 2.5mm or 0.1 in., so check before ordering. Do not insert the i.c.s yet.

Prepare two lengths of ribbon cable approximately 90mm/3.5 inches long, one 6-way and the other 7-way, as per Fig. 5. Be

The completed display board showing the 7-segment display and the combined switch and l.e.d.



careful not to put too much solder onto the joints of the terminals as this can prevent them from deflecting properly when they are plugged onto the p.c.b. header. Strip and tin the other end of the ribbon cables and solder them to the main p.c.b.

Since, 7-way p.c.b. headers and sockets are not available, 8-way parts need to be converted by cutting off the extra pole. This

is best done with a sharp craft knife. Similarly, the ribbon cable will require any additional wires to be stripped off.

Solder a length of thin insulated wire from the switched positive point on the p.c.b. to the centre pole of the On/Off slide switch, S2 and the red lead of the battery clip to one of its outside poles. The battery clip's black lead should be soldered directly to the negative point on the p.c.b.

The i.c.s can now be inserted into their sockets, taking care to observe the usual CMOS static precautions. Do not remove them from their conductive packaging until just before insertion, and do not touch their pins.

Fig. 5. Interwiring details for interconnecting the p.c.b.s.

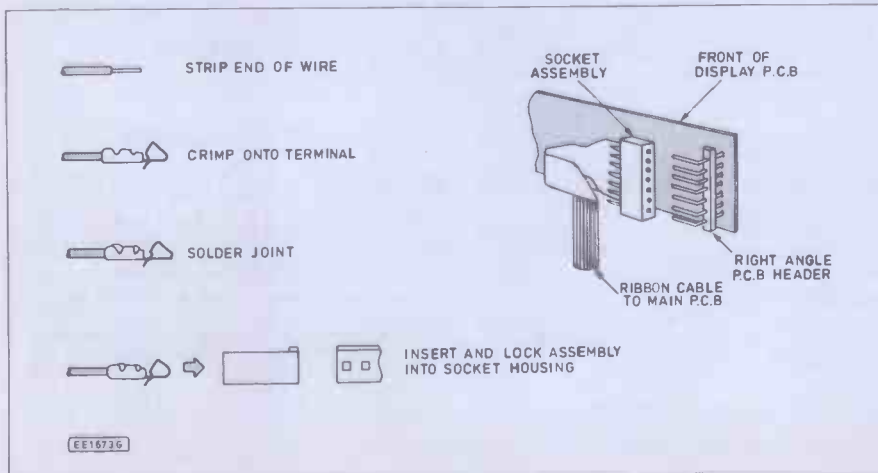

DISPLAY BOARD

Display p.c.b. construction: The same notes as above apply here, using Fig. 4 as the overlay diagram. When inserting the resistors, take care not to overstress their leads. Most 0.25W types will fit without too much difficulty.

Ensure that the transistors are mounted as close to the board as possible. This means bending the centre (base) lead quite sharply back along the transistor package. Solder the leads quickly to avoid heat damaging them. Also make sure that the display is inserted correctly.

Lastly, insert and solder the combined switch and l.e.d. if used, and solder the 6 and 7-way p.c.b. headers, with their pins pointing inwards, onto the back (copper side) of the display board. Connect the two p.c.b.'s together with the ribbon cables, connect a P3 battery, and give the unit a functional check.

CASE

Cut out the required holes in the case's front panel for the display and the switch. This can be done by chain drilling a series of, say, 1mm diameter holes around the required cutout, and then filing its edges smooth.

A piece of filter plastic can be glued across the display's aperture. Alternatively, cut a piece of filter plastic to the same size as the front panel, and use it as a replacement for the latter, this saves cutting a hole for the display and gives the front panel a more flush appearance. However, in practice it was found best to use the original front panel and glue the filter in place with an ABS solvent (used for "welding" plastic plumbing pipes).

The display board can be mounted by gluing short p.c.b. guides to the front panel. This needs to be done with the board inserted into the guides because the switch must protrude through its hole.

Cut a hole in the side of the case for the switch, ensuring that it will not foul any of the components on the main board. The main p.c.b. can be secured in the case with a couple of adhesive coated foam pads.

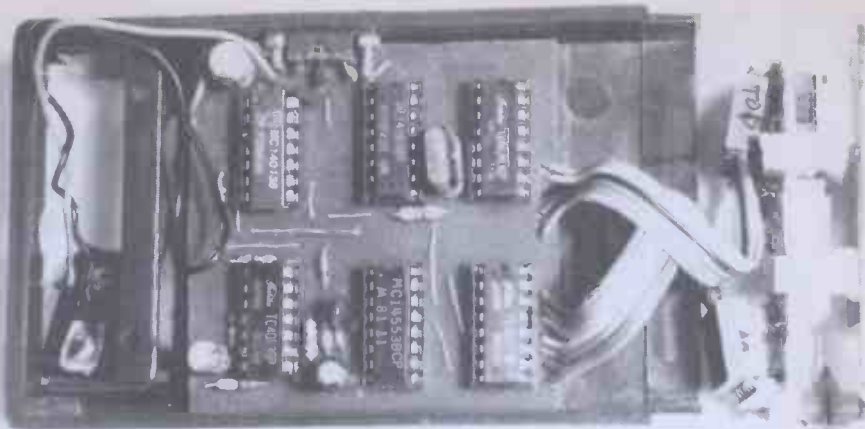

Completed timer showing the main printed circuit board, battery compartment and wiring to the on/off switch

FAULT FINDING

If the circuit does not work when it is tested, the circuit description should give some help as to where to look for the fault. Correct operation of the toggle, flip-flop, 8s and 4Hz oscillators, AND gate, and the output of the pulse delay/stretch can be checked with an ordinary voltmeter. The other sections of the circuit will probably need an oscilloscope for checking, although an audio signal tracer could be used on, say, the 1kHz clock.

Before taking any extensive circuit measurements, it is worth ensuring that all the i.c.s are receiving a supply voltage. Looking at the i.c. package with its pin one identi-

fication mark uppermost, the positive supply should be present on the top right hand pin, with respect to the "negative" (0V) supply at the bottom left hand pin.

The most common faults are incorrectly placed or orientated components, dry joints and solder splashes. In tracing the fault, look at the problem logically in conjunction with the block and circuit diagrams. For instance, if only one digit illuminates, the fault will probably be with the multiplex capacitor, C3, the driver transistors TR1 to TR3, or the latter's connecting leads.

Since the circuit is essentially clock driven, failure of the main oscillator (e.g. a dry joint on the crystal) will cause the entire circuit to appear dead. □

★LEARN BY BUILDING★ENJOY BY USING★

PROJECT KITS

★BE CREATIVE★RAISE YOUR SKILLS★GET KITTED!★

BURGLAR ALARM CONTROLLERS DETECTORS DETER DELINQUENTS

MULTIZONE CONTROL (PE) SET280 £22.77

Two entry-zones, anti-tamper loop, personal attack, entry-exit timing, timed duration, automatic resetting, latching LED monitors.

SINGLE ZONE CONTROL (PE) SET279 £9.32

With timed duration control and latching LED monitor.

Both units can be used with any standard detection devices, such as contact or magnetic switches, pressure pads, tremblers, ultrasonics, infrared etc, and will activate standard bells, strobes or sirens.

CHIP TESTER (PE) SET258F £39.30

Computer controlled logic and chip analyser

CHORUS-FLANGER (PE) SET235 £59.99

Mono-stereo. Superb dual-mode effects.

CYBERVOX (EE) SET228 £44.76

Amazing robot type voice unit, with ring-modulator and reverb.

DISCO-LIGHTS (PE) SET245F £62.50

3 chan sound to light, chasers, auto level.

ECHO-REVERB (PE) SET218 £57.66

Mono-stereo. 200ms echo, lengthy reverb, switchable multitracking.

EPROM PROGRAMMER (PE) SET277 £25.25

Computer controlled unit for 4K Eproms.

EVENT COUNTER (PE) SET278 £31.50

4-digit display counting for any logic source.

MICRO-CHAT (PE) SET276 £64.50

Computer controlled speech synthesiser.

MICRO-SCOPE (PE) SET247 £44.50

Turns a computer into an oscilloscope.

MICRO-TUNER (PE) SET257 £55.32

Computer controlled, tuning aid and freq counter.

MORSE DECODER (EE) SET269 £22.16

Computer controlled morse code-decoder.

POLYWHATSI! (PE) SET252 £122.69

Amazing effects unit, echo, reverb, double tracking, phasing, flanging, looping, pitch change, REVERSE tracking! 8K memory.

REVERB (EE) SET232 £27.35

Mono, with reverb to 4 secs, echo to 60ms.

RING MODULATOR (PE) SET231 £45.58

Fabulous effects generation, with ALC and VCO.

STORMS! (PE) £29.50 each unit

Raw nature under panel control Wind & Rain SET250W. Thunder & Lightning SET250T.

★COMPUTER KITS

The software listing published with the computer kit projects are for use with C64, PET and BBC computers.

MANY MORE KITS IN CATALOGUE

KITS include PCBs and instructions. Further details in catalogue. PCBs also available separately.



DUAL BEAM OSCILLOSCOPES (PE)

2y-amps, 6 ranges, variable level, DC to over 1MHz, 4 modes — Y1, Y2, Y1 + Y2m, Y1 + Y2 to X. Time base variable from 0.05Hz to 20kHz. Variable sync level, polarity and source. Separate bright-line, brilliance and focus controls. Independent trace deflector controls. Details in catalogue — See below.

VOICE SCRAMBLER (PE) SET287 £42.22

32 switchable channels to keep your communications confidential.

WEATHER CENTRE (PE)

Keep the Met Office in check and monitor the wind speed and direction, rain, temperature, soil moisture and sunny days.

Six detector circuits — KIT 275.1 £18.07

Automatic metered control monitor circuit — KIT 275.2 £40.95

Optional computer control circuit — KIT 275.3 £14.20

ELECTRONIC BAROMETER (PE) SET285 £35.55

Computer controlled unit for monitoring atmospheric pressure.

GEIGER COUNTER (PE) SET264 £59.50

A nuclear radiation detector for environmental and geological monitoring. With built in speaker, meter and digital output. This project was demonstrated on BBC TV.

MANY MORE KITS IN CATALOGUE

Send 9"x4" SAE for detailed catalogue, and with all enquiries (overseas send £1.00 or 5 I.R.C.'s). Add 15% VAT. Add P&P — Sets over £50 add £2.50. Others add £1.50. Overseas P&P in catalogue. Text photocopies — Geiger 264 £1.50, others 50p, plus 50p post or large SAE. Insurance 50p per £50. MAIL ORDER, CWO, CHQ, PO, ACCESS VISA. Telephone orders: Mon-Fri, 9am — 6pm. 0689 37821. (Usually answering machine).

PHONOSONICS, DEPT EE8D, 8 FINUCANE DRIVE, ORPINGTON, KENT BR5 4ED.

MAIL ORDER

DIRECT BOOK SERVICE

PROJECT CONSTRUCTION

HOW TO GET YOUR ELECTRONIC PROJECTS WORKING

R. A. Penfold
We have all built projects only to find that they did not work correctly, or at all, when first switched on. The aim of this book is to help the reader overcome just these problems by indicating how and where to start looking for many of the common faults that can occur when building up projects.

96 pages Order code BP110 £2.50

HOW TO DESIGN AND MAKE YOUR OWN P.C.B.s

R. A. Penfold
Deals with the simple methods of copying printed circuit

The books listed have been selected as being of special interest to everyone involved in electronics and computing. They are supplied by mail order direct to your door. Full ordering details are given on the last book page.

board designs from magazines and books and covers all aspects of simple p.c.b. construction including photographic methods and designing your own p.c.b.s.
80 pages Order code BP121 £1.95

BEGINNER'S GUIDE TO BUILDING ELECTRONIC PROJECTS

R. A. Penfold
Shows the complete beginner how to tackle the practical side of electronics, so that he or she can confidently build the electronic projects that are regularly featured in magazines and books. Also includes examples in the form of simple projects.

112 pages Order code No. 227 £1.95

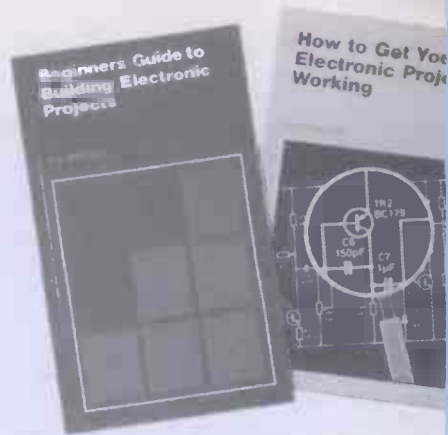

PRACTICAL ELECTRONIC BUILDING BLOCKS—BOOK 1 PRACTICAL ELECTRONIC BUILDING BLOCKS—BOOK 2

R. A. Penfold
These books are designed to aid electronic enthusiasts who like to experiment with circuits and produce their own projects, rather than simply following published project designs.

BOOK 1 contains: Oscillators—sinewave, triangular squarewave, sawtooth, and pulse waveform generators operating at audio frequencies. Timers—simple monostable circuits using i.c.s, the 555 and 7555 devices, etc. Miscellaneous—noise generators, comparators and triggers, etc.

BOOK 2 contains: Amplifiers—low level discrete and op-amp circuits, voltage and buffer amplifiers including d.c. types. Also low-noise audio and voltage controlled amplifiers. Filters—high-pass, low-pass, 6, 12, and 24dB per octave types. Miscellaneous—i.c. power amplifiers, mixers, voltage and current regulators, etc.

BOOK 1 128 pages Order code BP117 £1.95
BOOK 2 112 pages Order code BP118 £1.95

CIRCUITS AND DESIGN

ELECTRONICS SIMPLIFIED—CRYSTAL SET CONSTRUCTION

F. A. Wilson, C.G.I.A., C.Eng., F.I.E.E., F.I.E.R.E., F.B.I.M.

Especially written for those who wish to participate in the intricacies of electronics more through practical construction than by theoretical study. It is designed for all ages upwards from the day one can read intelligently and handle simple tools.

80 pages Order Code BP92 £1.75

MICRO INTERFACING CIRCUITS—BOOK 1 MICRO INTERFACING CIRCUITS—BOOK 2

R. A. Penfold
Both books include practical circuits together with details of the circuit operation and useful background information. Any special constructional points are covered but p.c.b. layouts and other detailed constructional information are not included.

Book 1 is mainly concerned with getting signals in and out of the computer; Book 2 deals primarily with circuits for practical applications.

Book 1 112 pages Order code BP130 £2.25
Book 2 112 pages Order code BP131 £2.75

ELECTRONIC CIRCUITS HANDBOOK

Michael Tooley BA
This book aims to explode two popular misconceptions concerning the design of electronic circuits: that only those with many years of experience should undertake circuit design and that the process relies on an understanding of advanced mathematics. Provided one is not too ambitious, neither of these popularly held beliefs is true.

Specifically, this book aims to provide the reader with a unique collection of practical working circuits together with supporting information so that circuits can be produced in the shortest possible time and without recourse to theoretical texts.

Furthermore, information has been included so that the circuits can readily be modified and extended by readers to meet their own individual needs. Related circuits have been grouped together and cross-referenced within the text (and also in the index) so that readers are aware of which circuit can be readily connected together to form more complex systems. As far as possible, a common range of supply voltages, signal levels and impedances has been adopted.

As a bonus, ten test gear projects have been included. These not only serve to illustrate the techniques described but also provide a range of test equipment which is useful in its own right.

277 pages Order code NE05 £14.95

Electronics Simplified - Crystal Set Construction



50 CIRCUITS USING GERMANIUM SILICON AND ZENER DIODES

R. N. Soar
Contains 50 interesting and useful circuits and applications, covering many different branches of electronics, using one of the most simple and inexpensive of components—the diode. Includes the use of germanium and silicon signal diodes, silicon rectifier diodes and Zener diodes, etc.

64 pages Order Code BP36 £1.50

50 Circuits Using Germanium Silicon & Zener Diodes



50 SIMPLE LED CIRCUITS

R. N. Soar
Contains 50 interesting and useful circuits and applications, covering many different branches of electronics, using one of the most inexpensive and freely available components—the light-emitting diode (LED). Also includes circuits for the 707 common anode display.

64 pages Order Code BP42 £1.95
BOOK 2 50 more l.e.d. circuits Order code BP87 £1.35

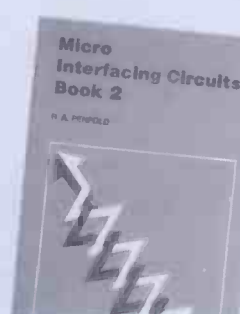

A MICROPROCESSOR PRIMER

E. A. Parr, B.Sc., C.Eng., M.I.E.E.
Starts by designing a small computer which, because of its simplicity and logical structure, enables the language to be easily learnt and understood. The shortcomings are then discussed and the reader is shown how these can be overcome by changes and additions to the instruction set. In this way, such ideas as relative addressing, index registers, etc., are developed.

96 pages Order code BP72 £1.75

A PRACTICAL INTRODUCTION TO MICROPROCESSORS

R. A. Penfold
Provides an introduction which includes a very simple microprocessor circuit which can be constructed so that the reader can experiment and gain practical experience.

96 pages Temporarily out of print

How to Design Electronic Projects

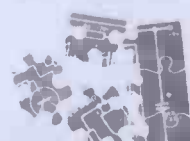

HOW TO DESIGN ELECTRONIC PROJECTS

R. A. Penfold
The aim of this book is to help the reader to put together projects from standard circuit blocks with a minimum of trial and error, but without resorting to any advanced mathematics. Hints on designing circuit blocks to meet your special requirements are also provided.

128 pages Order code BP127 £2.25

A Practical Introduction to Microprocessors



Coil Design and Construction Manual

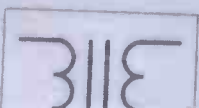

COIL DESIGN AND CONSTRUCTION MANUAL

B. B. Babani
A complete book for the home constructor on "how to make" RF, IF, audio and power coils, chokes and transformers. Practically every possible type is discussed and calculations necessary are given and explained in detail. Although this book is now rather old, with the exception of torroids and pulse transformers little has changed in coil design since it was written.

96 pages Order Code 160 £2.50

How To Use Op Amps



HOW TO USE OP-AMPS

E. A. Parr
This book has been written as a designer's guide covering many operational amplifiers, serving both as a source book of circuits and a reference book for design calculations. The approach has been made as non-mathematical as possible.

160 pages Order code BP88 £2.95

Popular Electronic Circuits Book 2



POPULAR ELECTRONIC CIRCUITS

—BOOK 1

POPULAR ELECTRONIC CIRCUITS

—BOOK 2

R. A. Penfold
Each book provides a wide range of designs for electronic enthusiasts who are capable of producing working projects from just a circuit diagram without the aid of detailed construction information. Any special setting-up procedures are described.

BOOK 1 160 pages Order code BP80 £1.95
BOOK 2 160 pages Order code BP88 £2.25

ELECTRONIC CIRCUITS FOR THE COMPUTER CONTROL OF MODEL RAILWAYS

A. Penfold
Some computers may easily be applied to the control of model railways and really quite sophisticated control, which needs only simple programming, is not too difficult to achieve. The main problem lies in interfacing the computer to the layout, but fortunately it is not too difficult or expensive to build suitable interfaces, and this book shows you how.

The projects consist of various types of controller, including high quality pulse type, as well as circuits for train position sensing, signal and electric points control etc. The use of computers does not have to be restricted to massive layouts, something as simple as an oval of track with a single siding can be given a new dimension by adding computer control and much fun can be had from these relatively simple setups.

3 pages Order code BP180 £2.95

MODERN OPTO DEVICE PROJECTS

A. Penfold
In recent years, the range of opto devices available to the home constructor has expanded and changed radically. These devices now represent one of the more interesting areas of modern electronics for the hobbyist to experiment with, and many of these devices have useful practical applications as well. This book provides a number of practical

designs which utilize a range of modern 'opto-electric' devices, including such things as fibre optics, ultra bright I.e.d.s and passive IR detectors etc. While many of these designs are not in the "dead simple" category, they should be within the capabilities of anyone with a reasonable amount of experience in electronics construction and some of the more simple designs are suitable for beginners.

104 pages Order code BP194 £2.95

ELECTRONIC CIRCUITS FOR THE COMPUTER CONTROL OF ROBOTS

Robert Penfold
Robots and robotics offer one of the most interesting areas for the electronics hobbyist to experiment in. Today the mechanical side of robots is not too difficult, as there are robotics kits and a wide range of mechanical components available. The micro controller is not too much of a problem either, since the software need not be terribly complex and many inexpensive home computers are well suited to the task.

The main stumbling block for most would-be robot builders is the electronics to interface the computer to the motors, and the sensors which provide feedback from the robot to the computer. The purpose of this book is to explain and provide some relatively simple electronic circuits which bridge this gap.

92 pages Order code BP179 £2.95

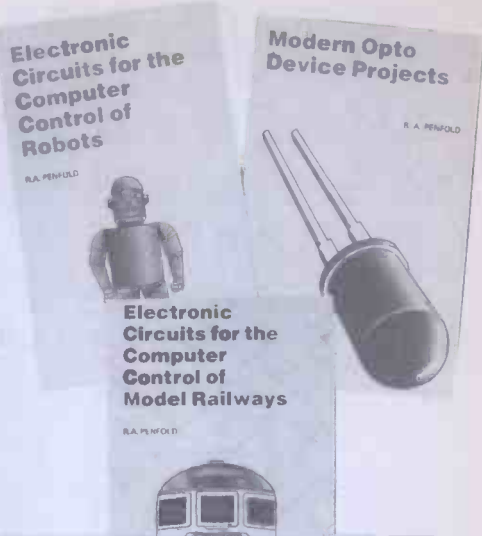

DATA AND REFERENCE

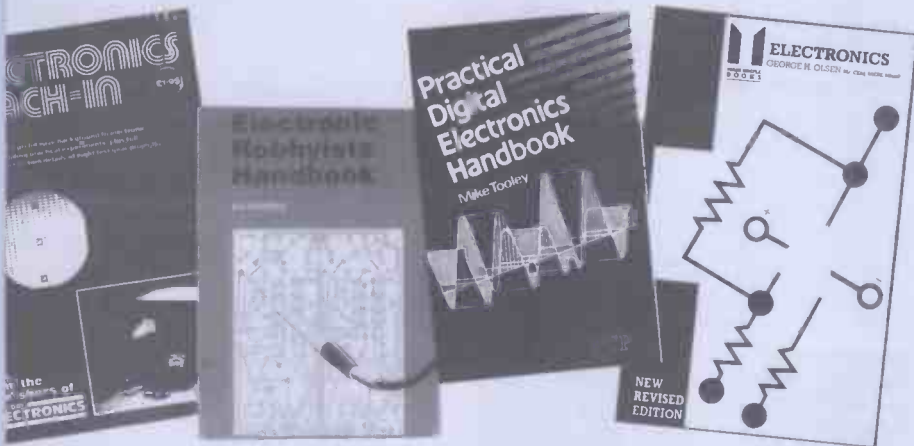

ELECTRONICS TEACH-IN

Michael Tooley BA and David Whitfield MA MSc Eng MIEE (published by Everyday Electronics)

This value for money EE book provides a comprehensive background to modern electronics including test gear projects. A complete course in basic electronics; designed for the complete newcomer it will however also be of value to those with some previous experience of electronics. Wherever possible the course is related to "real life" working circuits and each part includes a set of detailed practical assignments. Includes details of eight items of test gear giving full constructional information and diagrams for each one. They are: Safe Power Supply; Universal LCR Bridge; Diode/Transistor Tester; Audio Signal Tracer; Audio Signal Generator; RF Signal Generator; FET Voltmeter; Pulse Generator. An excellent companion for anyone interested in electronics and valuable for those taking G.C.S.E. and BTEC electronics courses.

144 pages (A4 size) Order code EE/T-1 £1.95

PRACTICAL ELECTRONICS CALCULATIONS AND FORMULAE

A. Wilson, C.G.I.A., C.Eng., F.I.E.E., F.I.E.R.E., B.I.M.

Bridges the gap between complicated technical theory and "cut-and-try" methods which may bring success in design but leave the experimenter unfulfilled. A strong practical bias—tedious and higher mathematics have been avoided where possible and many tables have been included.

The book is divided into six basic sections: Units and Constants, Direct-current Circuits, Passive Components, Alternating-current Circuits, Networks and Theorems, Measurements.

56 pages Order Code BP53 £2.95

ESSENTIAL THEORY FOR THE ELECTRONICS HOBBYIST

I. T. Rubaroe, T.Eng (C.E.I.), Assoc.I.E.R.E.

The object of this book is to supply the hobbyist with a background knowledge tailored to meet his or her specific requirements and the author has brought together the relevant material and presented it in a readable banner with minimum recourse to mathematics.

78 pages Order Code 228 £2.50

MICROPROCESSING SYSTEMS AND CIRCUITS

A. Wilson, C.G.I.A., C.Eng., F.I.E.E., F.I.E.R.E., B.I.M.

A truly comprehensive guide to the elements of micro-processing systems which really starts at the beginning, teaches the reader the essential fundamentals that are so important for a sound understanding of the subject.

56 pages Order Code BP77 £2.95

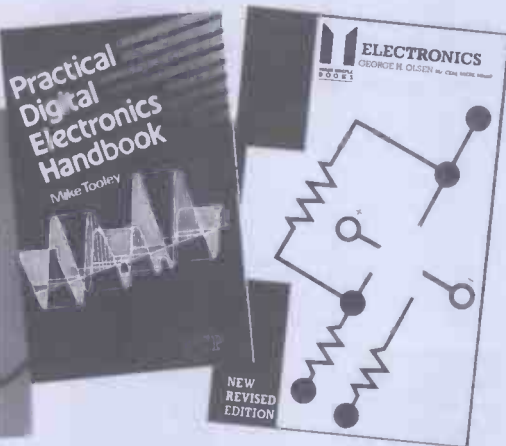

ELECTRONIC HOBBYISTS HANDBOOK

R.A. Penfold

Provides an inexpensive single source of easily located information that the amateur electronics enthusiast is likely to need for the day-to-day pursuance of this fascinating hobby. Covers common component colour codes. Details the characteristics and pinouts of many popular semiconductor devices, including various types of logic ICs, operational amplifiers, transistors, FETs, unijunctions, diodes, rectifiers, SCRs, diacs, triacs, regulators and SMDs, etc. Illustrates many useful types of circuits, such as timers and oscillators, audio amplifiers and filters, as well as including a separate section on power supplies. Also contains a multitude of other useful data.

88 pages Order code BP233 £4.95

AUDIO

F. A. Wilson, C.G.I.A., C.Eng., F.I.E.E., F.I.E.R.E., B.I.M.

Analysis of the sound wave and an explanation of acoustical quantities prepare the way. These are followed by a study of the mechanism of hearing and examination of the various sounds we hear. A look at room acoustics with a subsequent chapter on microphones and loudspeakers then sets the scene for the main chapter on audio systems—amplifiers, oscillators, disc and magnetic recording and electronic music.

320 pages Order Code BP111 £3.50

HOW TO IDENTIFY UNMARKED ICs

K. H. Recorr

Shows the reader how, with just a test-meter, to go about recording the particular signature of an unmarked i.c. which should enable the i.c. to then be identified with reference to manufacturers' or other data. An i.c. signature is a specially plotted chart produced by measuring the resistances between all terminal pairs of an i.c.

Chart Order code BP101 £0.95

RADIO AND ELECTRONIC COLOUR CODES AND DATA CHART

B. B. Babani

Although this chart was first published in 1971 it provides basic information on many colour codes in use throughout the world, for most radio and electronic components. Includes resistors, capacitors, transformers, field coils, fuses, battery leads, speakers, etc. It is particularly useful for finding the values of old components.

Chart Order code BP7 £0.95

CHART OF RADIO, ELECTRONIC, SEMICONDUCTOR AND LOGIC SYMBOLS

M. H. Banani, B.Sc.(Eng.)

Illustrates the common, and many of the not-so-common, radio, electronic, semiconductor and logic symbols that are used in books, magazines and instruction manuals, etc., in most countries throughout the world.

Chart Order Code BP27 £0.95

ELECTRONICS—A "MADE SIMPLE" BOOK

G. H. Olsen
This book provides excellent background reading for our *Introducing Digital Electronics* series and will be of interest to everyone studying electronics. The subject is simply explained and well illustrated and the book assumes only a very basic knowledge of electricity.

330 pages Order code NE10 £4.95

RECOMMENDED READING FOR INTRODUCING MICROPROCESSORS

PRACTICAL DIGITAL ELECTRONICS HANDBOOK

Mike Tooley (Published in association with Everyday Electronics)

The vast majority of modern electronic systems rely heavily on the application of digital electronics, and the *Practical Digital Electronics Handbook* aims to provide readers with a practically based introduction to this subject. The book will prove invaluable to anyone involved with the design, manufacture or servicing of digital circuitry, as well as to those wishing to update their knowledge of modern digital devices and techniques. Contents: Introduction to integrated circuits; basic logic gates; monostable and bistable devices; timers; microprocessors; memories; input and output devices; interfaces; microprocessor buses. Appendix 1: Data. Appendix 2: Digital test gear projects; tools and test equipment; regulated bench power supply; logic probe; logic pulser; versatile pulse generator; digital IC tester; current tracer; audio logic tracer; RS-232C breakout box; versatile digital counter/frequency meter. Appendix 3: The oscilloscope. Appendix 4: Suggested reading. Appendix 5: Further study.

208 pages Order code PC100 £6.95

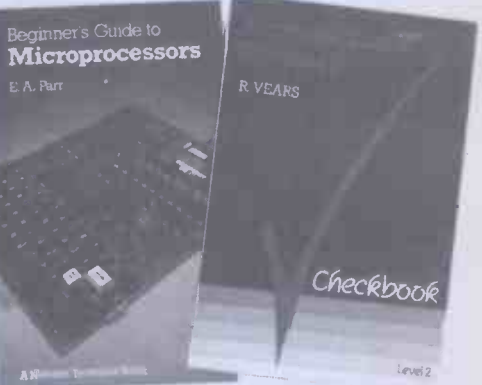

BEGINNERS GUIDE TO MICROPROCESSORS

E. A. Parr

An excellent grounding in microprocessors, this book is broadly relevant to the whole of our *Introducing Microprocessors* course. It is easy to read and well illustrated.

224 pages Order code NE03 £4.95

MICROELECTRONIC SYSTEMS 2 CHECKBOOK

R. Vears

The aim of this book is to provide a foundation in microcomputer hardware, software and interfacing techniques. Each topic is presented in a way that assumes only an elementary knowledge of microelectronic systems and logic functions. The book concentrates on 6502, Z80 and 6800 microprocessors and contains 60 tested programs, 160 worked problems and 250 further problems. Now replaced by *Microelectronic Systems N2 Checkbook*

Order code NE03N £6.95

OSCILLOSCOPES: HOW TO USE THEM—HOW THEY WORK

Ian Hickman

Oscilloscopes are essential tools for checking circuit operation and diagnosing faults, and an enormous range of models is available. But which is the right 'scope for a particular application? Which features are essential, which not so important? What techniques will get the best out of the instrument?

Ian Hickman, experienced in both professional and hobbyist electronics, has revised this well-established book to help all oscilloscope users—and potential users.

133 pages Order code NE09

£5.95



PRACTICAL ELECTRONICS HANDBOOK

Ian Sinclair

Ian Sinclair has now revised this useful and carefully selected collection of standard circuits, rules-of-thumb, and design data for professional engineers, students and enthusiasts involved in radio and electronics. Covering passive and active components, discrete component circuits (such as amplifiers, filters and oscillators) and linear and digital i.c.s, the book includes many items which are not elsewhere available in a single handy volume. The operation and functions of typical circuits are described, while mathematics is limited to that necessary for deciding component values for any application.

This revised edition contains more details on computers and microprocessors and has been brought up to date throughout.

199 pages Order Code NE06

£7.95

BEGINNER'S GUIDE TO HI-FI

Ian Sinclair

The *Beginner's Guide to Hi-Fi* will appeal to the audio enthusiast, whether newly won over by advances in technology or well established and wondering whether to update equipment. The book deals with the sound from its sources in the studio to its ultimate end in your ears, and shows what sound is, how it is recorded and how it is reproduced.

Every aspect of Hi-Fi, from pickup cartridges to loudspeakers, has been covered, and the emphasis has been on explaining design aims. Cassette systems have been given considerable prominence, including the more modern Dolby C and dbx noise reduction systems. The CD record has been covered in detail so that you can find out just why this system of sound reproduction is so superior.

194 pages Order Code NE07

£4.95

ELECTRONICS-BUILD AND LEARN

R. A. Penfold

The first chapter gives full constructional details of a circuit demonstrator unit that is used in subsequent chapters to introduce common electronic components—resistors, capacitors, transformers, diodes, transistors, thyristors, fets and op amps. Later chapters go on to describe how these components are built up into useful circuits, oscillators, multivibrators, bistables and logic circuits.

At every stage in the book there are practical tests and experiments that you can carry out on the demonstrator unit to investigate the points described and to help you understand the principles involved. You will soon be able to go on to more complex circuits and tackle fault finding logically in other circuits you build.

120 pages Order Code PC103

£5.95

COMMUNICATION

F. A. Wilson, C.G.I.A., C.Eng., F.I.E.E., F.I.E.R.E., F.B.I.M.

A look at the electronic fundamentals over the whole of the communication scene. This book aims to teach the important elements of each branch of the subject in a style as interesting and practical as possible. While not getting involved in the more complicated theory and mathematics, most of the modern transmission system techniques are examined including line, microwave, submarine, satellite and digital multiplex systems, radio and telegraphy. To assist in understanding these more thoroughly, chapters on signal processing, the electromagnetic wave, networks and transmissions assessment are included, finally a short chapter on optical transmission.

256 pages

Order Code BP89

£2.95

GETTING THE MOST FROM YOUR MULTIMETER

R.A. Penfold

This book is primarily aimed at beginners and those of limited experience of electronics. Chapter 1 covers the basics of analogue and digital multimeters, discussing the relative merits and the limitations of the two types. In Chapter 2 various methods of component checking are described, including tests for transistors, thyristors, resistors, capacitors and diodes. Circuit testing is covered in Chapter 3, with subjects such as voltage, current and continuity checks being discussed.

In the main little or no previous knowledge or experience is assumed. Using these simple component and circuit testing techniques the reader should be able to confidently tackle servicing of most electronic projects.

96 pages Order code BP239

£2.95

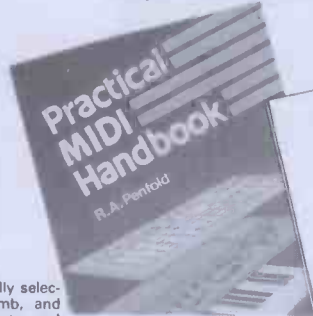

PRACTICAL MIDI HANDBOOK

R.A. Penfold

The Musical Instrument Digital Interface (MIDI) is surrounded by a great deal of misunderstanding, and many of the user manuals that accompany MIDI equipment are quite incomprehensible to the reader.

The *Practical MIDI Handbook* is aimed primarily at musicians, enthusiasts and technicians who want to exploit the vast capabilities of MIDI, but who have no previous knowledge of electronics or computing. The majority of the book is devoted to an explanation of what MIDI can do and how to exploit it to the full, with practical advice on connecting up a MIDI system and getting it to work, as well as deciphering the technical information in those equipment manuals.

128 pages Order code PC101

£5.95

INTRODUCTION TO DIGITAL AUDIO

Ian Sinclair

Digital recording methods have existed for many years and have become familiar to the professional recording engineer, but the compact disc (CD) was the first device to bring digital audio methods into the home. The next step is the appearance of digital audio tape (DAT) equipment.

All this development has involved methods and circuits that are totally alien to the technician or keen amateur who has previously worked with audio circuits. The principles and practices of digital audio owe little or nothing to the traditional linear circuits of the past, and are much more comprehensible to today's computer engineer than the older generation of audio engineers.

This book is intended to bridge the gap of understanding for the technician and enthusiast. The principles and methods are explained, but the mathematical background and theory is avoided, other than to state the end product.

128 pages Order Code PC102

£5.95

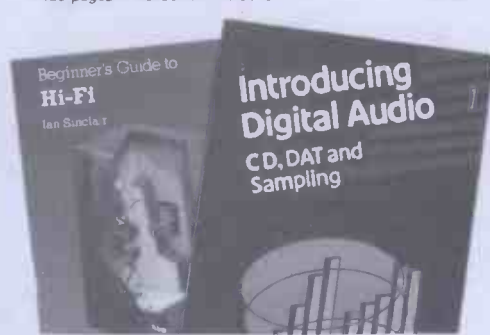

INTERNATIONAL TRANSISTOR EQUIVALENTS GUIDE

A. Michaels

Helps the reader to find possible substitutes for a popular selection of European, American and Japanese transistors. Also shows material type, polarity, manufacturer and use.

320 pages

Order code BP85

£2.95

TRANSISTOR RADIO FAULT-FINDING CHART

C. E. Miller

Used properly, should enable the reader to trace most common faults reasonably quickly. Across the top of the chart will be found four rectangles containing brief description of these faults, viz—sound weak but undistorted, set dead, sound low or distorted and background noises. One then selects the most appropriate of these and following the arrows, carries out the suggested checks in sequence until the fault is cleared.

Chart

Order code BP70

£0.9

DIGITAL IC EQUIVALENTS AND PIN CONNECTIONS

A. Michaels

Shows equivalents and pin connections of a popular selection of European, American and Japanese digital i.c.s. Also includes details of packaging, families, functions, manufacturer and country of origin.

256 pages

Order code BP140

£4.9

LINEAR IC EQUIVALENTS AND PIN CONNECTIONS

A. Michaels

Shows equivalents and pin connections of a popular selection of European, American and Japanese linear i.c.s. Also includes details of functions, manufacturer and country of origin.

320 pages

Order code BP141

£4.9

INTERNATIONAL DIODE EQUIVALENTS GUIDE

A. Michaels

Designed to help the user in finding possible substitutes for a large selection of the many different types of diode that are available. Besides simple rectifier diodes, also included are Zener diodes, i.e.d.s, diacs, triacs, thyristors, OCIs, photo and display diodes.

144 pages

Order code BP108

£2.2

NEWNES ELECTRONICS POCKET BOOK

E. A. Parr

Newnes Electronics Pocket Book has been in print for over twenty years and has covered the development of electronics from valve to semiconductor technology and from transistors to LSI integrated circuits and microprocessors. To keep up to date with the rapidly changing world of electronics, continuous revision has been necessary. This new Fifth Edition takes account of recent changes and includes material suggested by readers of previous editions. New descriptions of op.amp. applications and the design of digital circuits have been added along with a totally new chapter on computing, plus other revisions throughout.

315 pages (hard cover)

Order Code NE02

£9.9

TRANSISTOR SELECTOR GUIDE

This unique guide offers a range of selection tables compiled so as to be of maximum use to all electronic engineers, designers and hobbyists.

Section 1: Covers component markings, codings and standards, as well as explaining the symbols used.

Section 2: Tabulates in alpha-numeric sequence the comprehensive specifications of over 1400 devices.

Section 3: Tabulates the devices by case type.

Section 4: Considers particular limits to the electrical parameters when compiling the tables.

Section 5: Illustrates package outlines and leadouts.

Section 6: Consists of a surface mounting device marking conversion list.

192 pages

Order code BP234

£4.9

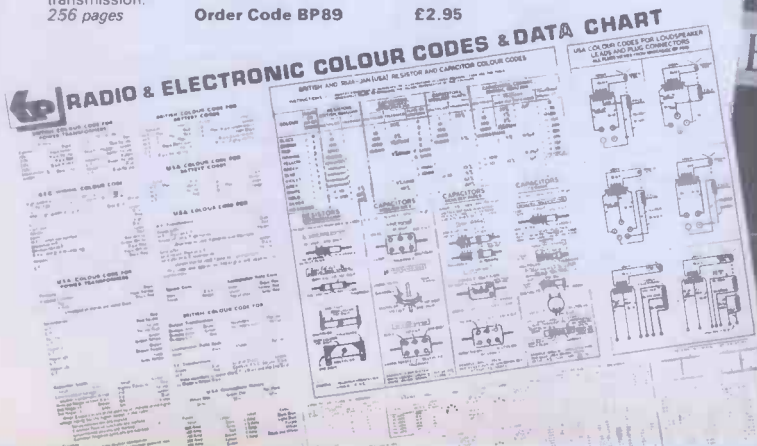

RADIO/TELEVISION

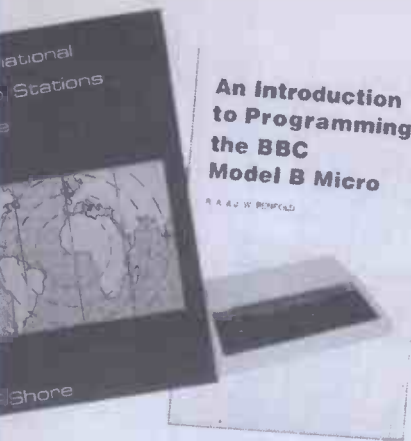

AN INTRODUCTION TO RADIO DXING

R. A. Penfold

Anyone can switch on a short wave receiver and play with the controls until they pick up something, but to find a particular station, country or type of broadcast and to receive it as clearly as possible requires a little more skill and knowledge. The object of this book is to help the reader to do just that, which in essence is the fascinating hobby of radio DXing.

112 pages Order code BP91 £1.95

INTERNATIONAL RADIO STATIONS GUIDE

P. Shore

Provides the casual listener, amateur radio DXer and the professional radio monitor with an essential reference work designed to guide him or her around the ever more complex radio bands. This new edition has been completely revised and rewritten and incorporates much more information which is divided into the following sections:

Listening to Short Wave Radio; ITU Country Codes; World-wide Short Wave Radio Stations; European, Middle East and North African Long Wave Radio Stations; European, Near East and North African Medium Wave Radio Stations; Canadian Medium Wave Radio Stations; USA Medium Wave Radio Stations; Broadcasts in English; Programmes for DXers and Short Wave Listeners; UK FM Radio Stations; Time differences from GMT; Abbreviations; Wavelength/Frequency Conversion.

320 pages Order code BP255 £4.95

BEGINNER'S GUIDE TO AMATEUR RADIO

F.G. Rayer Second edition revised by Gordon King G4VJV. Whether you are new to radio, or have become interested by way of CB, it is hoped that this book, will further whet your appetite and put you in good stead for passing the Radio Amateur's Examination and becoming a licensed radio amateur.

188 pages Temporarily out of print

AN INTRODUCTION TO SATELLITE TELEVISION

F.A. Wilson

As a definitive introduction to the subject this book is presented on two levels. For the absolute beginner or anyone thinking about purchasing or hiring a satellite TV system, the story is told as simply as such a complex one can be in the main text.

For the professional engineer, electronics enthusiast, student or others with technical backgrounds, there are numerous appendices backing up the main text with additional technical and scientific detail formulae, calculations, tables etc.

There is also plenty for the DIY enthusiast with practical advice on choosing and installing the most problematic part of the system—the dish antenna.

104 pages Order code BP 195 £5.95

COMPUTING

GETTING THE MOST FROM YOUR PRINTER

W. Penfold

Details how to use all the features provided on most dot-matrix printers from programs and popular word processing packages like Wordwise, Visawrite and Quill, etc. Shows exactly what must be typed in to achieve a given effect.

2 pages Order Code BP181 £2.95

Z80 WORKSHOP MANUAL

A. Parr, B.Sc., C.Eng., M.I.E.E.

This book is intended for people who wish to progress beyond the stage of BASIC programming to topics such as machine code and assembly language programming, need hardware details of a Z80 based computer.

2 pages Order Code BP112 £3.50

AN INTRODUCTION TO 68000 ASSEMBLY LANGUAGE

R. A. & J. W. Penfold

Obtain a vast increase in running speed by writing programs for 68000 based micros such as the Commodore Amiga, Atari ST range or Apple Macintosh range etc., in assembly language. It is not as difficult as one might think and this book covers the fundamentals.

2 pages Order code BP184 £2.95

THE ART OF PROGRAMMING THE ZX SPECTRUM

James, B.Sc., M.B.C.S.

This is one thing to have learnt how to use all the Spectrum's commands and functions, but a very different one to be able to combine them into programs that do exactly what you want them to. This is just what this book is all about—teaching you the art of effective programming with your Spectrum.

4 pages Order code BP119 £2.50

AN INTRODUCTION TO PROGRAMMING THE COMMODORE 16 & PLUS 4

A. Penfold

Helps you to learn to use and program these two Commodore machines with the minimum of difficulty by expanding and complementing the information supplied the manufacturer's own manuals.

8 pages Order code BP158 £2.50

AN INTRODUCTION TO PROGRAMMING THE BBC MODEL B MICRO

R. A. & J. W. Penfold

Written for readers wanting to learn more about programming and how to make best use of the incredibly powerful model B's versatile features. Most aspects of BBC micro are covered, the omissions being where it could usefully be added to the information provided the manufacturer's own manual.

4 pages Order code BP139 £1.95

THE PRE-BASIC BOOK

F.A. Wilson, C.G.I.A., C.ENG., F.I.E.E., F.I.E.R.E., B.I.M.

Another book on BASIC but with a difference. This one does not skip through the whole of the subject and thereby leave many would-be programmers floundering. It instead concentrates on introducing the technique by looking in depth at the most frequently used and more easily understood computer instructions. For all new and tentative micro users.

12 pages Order code BP146 £2.95

AN INTRODUCTION TO COMPUTER PERIPHERALS

W. Penfold

Covers such items as monitors, printers, disc drives, cassette recorders, modems, etc., explaining what they are, how to use them and the various types and standards. Helps you to make sure that the peripherals you buy will work with your computer.

2 pages Order code BP170 £2.50

COMPUTER TERMINOLOGY EXPLAINED

D. Poole

Explains a wide range of terms that form the computer jargon used by enthusiasts. Includes a reference guide to more commonly used BASIC commands.

2 pages Order code BP148 £1.95

AN INTRODUCTION TO PROGRAMMING THE ACORN ELECTRON

R. A. & J. W. Penfold

Designed to help the reader learn more about programming and to make best use of the Electron's many features. Adds considerably to the information already supplied in the manufacturer's own instruction manual.

144 pages Order code BP142 £1.95

AN INTRODUCTION TO PROGRAMMING THE ATARI 600/800 XL

R. A. & J. W. Penfold

Especially written to supplement the manufacturer's own handbook. The information supplied will help the reader to master BASIC programming and to make best use of the Atari's many powerful features.

128 pages Order code BP143 £1.95

AN INTRODUCTION TO PROGRAMMING THE AMSTRAD CPC 464 AND 664

R. A. & J. W. Penfold

The Amstrad CPC 464 or 664 running with Locomotive BASIC makes an extremely potent and versatile machine and this book is designed to help the reader get the most from this powerful combination. Written to complement rather than duplicate the information already given in the manufacturer's own manual. Also applicable to the CPC 6128.

144 pages Order Code BP153 £2.50

AN INTRODUCTION TO PROGRAMMING THE SINCLAIR QL

R. A. & J. W. Penfold

Helps the reader to get the best use of the fantastic Sinclair QL's almost unlimited range of features. Designed to complement the manufacturer's handbook.

112 pages Order code BP150 £1.95

AN INTRODUCTION TO Z80 MACHINE CODE

R. A. & J. W. Penfold

Takes the reader through the basics of microprocessors and machine code programming with no previous knowledge of these being assumed. The Z80 is used in many popular home computers and simple programming examples are given for Z80-based machines including the Sinclair ZX-81 and Spectrum, Memotech and the Amstrad CPC 464. Also applicable to the Amstrad CPC 664 and 6128.

144 pages Order code BP152 £2.75

AN INTRODUCTION TO 6502 MACHINE CODE

R. A. & J. W. Penfold

No previous knowledge of microprocessors or machine code is assumed. Topics covered are: assembly language and assemblers, the register set and memory, binary and hexadecimal numbering systems, addressing modes and the instruction set, and also mixing machine code with BASIC. Some simple programming examples are given for 6502-based home computers like the VIC-20, ORIC-1/Atmos, Electron, BCC and also the Commodore 64.

112 pages Order code BP147 £2.50

HOW TO GET YOUR COMPUTER PROGRAMS RUNNING

J. W. Penfold

Have you ever written your own programs only to find that they did not work? Help is now at hand with this book which shows you how to go about looking for your errors, and helps you to avoid the common bugs and pitfalls of program writing. Applicable to all dialects of the BASIC language.

144 pages Order code BP169 £2.50

AN INTRODUCTION TO COMPUTER COMMUNICATIONS

R. A. Penfold

Provides details of the various types of modem and their suitability for specific applications, plus details of connecting various computers to modems, and modems to the telephone system. Also information on common networking systems and RTTY.

96 pages Order code BP177 £2.95

THE PRE-COMPUTER BOOK

F. A. Wilson

Aimed at the absolute beginner with no knowledge of computing. An entirely non-technical discussion of computer bits and pieces and programming.

96 pages Order code BP115 £1.95

NEWNES COMPUTER ENGINEER'S

POCKETBOOK

Michael Tooley

An invaluable compendium of facts, figures, circuits and data, indispensable to the designer, student, service engineer and all those interested in computer and microcomputer systems. It will appeal equally to the hardware or software specialist and to the new band of "software engineers". This first edition covers a vast range of subjects at a practical level, with the necessary explanatory text. The data is presented in a succinct and rapidly accessible form so that the book can become part of an everyday toolkit.

205 pages (hard cover) Order code NE01 £8.95

DIRECT BOOK SERVICE

(A Division of Wimborne Publishing Ltd.)

TO ORDER

Please state the order code clearly, print your name and address and add the required postage to the total order.

Add 75p to your total order for postage (overseas readers add £1.50, surface mail postage) and send a PO, cheque or international money order (£ sterling only) made payable to Direct Book Service quoting your name and address, the order code and quantities required to DIRECT BOOK SERVICE, 33 GRAVEL HILL, MERLEY, WIMBORNE, DORSET, BH21 1RW (mail order only).

Although books are normally sent within seven days of receipt of your order, please allow a maximum of 28 days for delivery. Overseas readers allow extra time for surface mail post.

Nov '88

Please check price and availability (see latest issue of Everyday Electronics) before ordering from old lists.

Note—our postage charge is the same for one book or one hundred books!

PCB SERVICE

Printed circuit boards for certain constructional projects (up to two years old) are available from the PCB Service, see list. These are fabricated in glass fibre, and are fully drilled and roller tinned. All prices include VAT and postage and packing. Add £1 per board for overseas airmail. Remittances should be sent to: The PCB Service, *Everyday Electronics* Editorial Offices, 6 Church Street, Wimborne, Dorset BH21 1JH. Cheques should be crossed and made payable to *Everyday Electronics* (Payment in £ sterling only.)

Readers are advised to check with prices appearing in the current issue before ordering.

NOTE: Boards for older projects—not listed here—can often be obtained from Magenta Electronics, 135 Hunter St., Burton-on-Trent, Staffs DE14 2ST. Tel: 0283 65435 or Lake Electronics, 7 Middleton Close, Nuthall, Nottingham NG16 1BX. Tel: 0602 382509.

NOTE: please allow 28 days for delivery. We can only supply boards listed in the latest issue. Boards can only be supplied by mail order and on a payment with order basis.

PROJECT TITLE	Order Code	Cost
Infra Red Beam Alarm (Trans)	536	£4.16
Infra Red Beam Alarm (Rec) - SEPT '86 -	537	£4.16
Scratch Blanker	539	£6.80
- OCT '86 -		
10W Audio Amp (Power Amp)	543	£3.23
(Pre-Amp) £4.78 Pair	544	£3.97
Light Rider—Lapel Badge	540 & 541	£2.97
-Disco Lights	542	£5.12
-Chaser Light	546	£4.04
Modem Tone Decoder - NOV '86 -	547	£3.46
200MHz Digital Frequency Meter	548	£5.14
- DEC '86 -		
Dual Reading Thermometer	549	£7.34
Automatic Car Alarm	550	£2.93
BBC 16K Sideways RAM	551	£2.97
(Software Cassette)	551S	£3.88
Random Light Unit - JAN '87 -	552	£5.88
Car Voltage Monitor - FEB '87 -	553	£2.48
Mini Amp	554 & 555	£5.68
Video Guard	556	£3.80
Spectrum I/O	557	£4.35
Spectrum Speech Synthesiser	558	£4.86
- MAR - '87		
Computer Buffer/Interface	560	£3.32
Infra Red Alarm : Sensor Head	561	£4.19
PSU/Relay Driver	562	£4.50
Alarm Thermometer - APR '87 -	559	£2.60
Experimental Speech Recognition	563	£4.75
Bulb Life Extender	564	£2.48
Fridge Alarm - MAY '87 -	565	£2.40
EE Equaliser-Ioniser	566	£4.10
Mini Disco Light - JUNE '87 -	567	£2.93
Visual Guitar/Instrument Tuner	568	£3.97
Fermostat - JULY '87 -	569	£3.34
EE Buccaneer Metal Detector	570	£4.10
Monomix	571	£4.75
-AUG '87 -		
Super Sound Adaptor Main Board	572	£4.21
PSU Board	573	£3.32
Simple Shortwave Radio, Tuner	575	£3.15
Amplifier	576	£2.84
Noise Gate - SEPT '87 -	577	£4.41
Burst Fire Mains Controller	578	£3.31
Electronic Analogue/Digital Multimeter	579	£6.40
Transtest - OCT '87 -	580	£3.32
Video Controller	581	£4.83
Accented Metronome - NOV '87 -	582	£3.77
Acoustic Probe	584	£2.78
BBC Sideways RAM/ROM	585	£4.10
Pseudo Echo Unit - DEC '87 -	586	£4.60
Dual Mains Light Flasher	587	£3.66
Twinkling Star	588	£2.61
Audio Sine Wave Generator	589	£3.03

Capacitance Meter - JAN '88 -	590	£4.
Bench Amplifier	591	£5.
Transistor Curve Tracer	592	£2.
- FEB '88 -		
Bench Power Supply Unit	593	£4.
Game Timer	583	£3.
Semiconductor Tester - MAR '88 -	594	£3.
SOS Alert	595	£2.
Guitar/Keyboard Envelope Shaper	596	£4.
Stereo Noise Gate - APR '88 -	597	£6.
Pipe & Cable Locator	598	£2.
Inductive Proximity Detector	574	£2.
- MAY '88 -		
Multi-Channel Remote Light Dimmer		
Transmitter	599	£2.
Receiver	600	£3.
Door Sentinel	605	£2.
Function Generator—Main Board	606	£5.
Function Generator—Power Supply	607	£4.
Super Sound Effects Generator	608	£4.
- JUNE '88 -		
Multi-Channel Remote Light Dimmer		
Relay/Decoder	601	£4.
Dimmer Board	602	£3.
Power Supply	603	£2.
Mother Board	604	£7.
Headlight Reminder	611	£2.
Video Wiper - JULY '88 -	612	£6.
Isolink	613	£4.
Tea Tune - AUG '88 -	609	£2.
Time Switch	614	£4.
Suntan Timer	610	£3.
Car Alarm	615	£3.
Doorbell Delay - SEPT '88 -	616	£3.
Breaking Glass Alarm	617	£4.
Amstrad PIO	618	£6.
- OCT '88 -		
Eprom Eraser	620	£4.
- NOV '88 -		
Doorbell Delay	616	£3.
Micro Alarm	621	£3.
Infra-Red Object Counter		
Transmitter	622	£4.
Receiver	623	£3.
Display	624	£3.
Seashell Sea Synthesiser	625	£4.
- DEC '88 -		
Reaction Timer		
Main Board	626	£3.
Display board	627	£2.
Downbeat Metronome	629	£4.
EPROM Programmer (On Spec)	630	£8.
Phasor	631	£5.

Please note that when ordering it is important to give project title as well as order code. Please print name and address in Block Caps. Do not send any other correspondence with your order.

EE PRINTED CIRCUIT BOARD SERVICE
Please send me the following p.c.b.s.
Make cheques/PO payable to: **Everyday Electronics**
(payment in £ sterling only)

Order Code Project Quantity Price

.....

.....

.....

.....

.....

I enclose cheque/PO for £.....

Name.....

Address.....

.....

Please allow 28 days for delivery

BLOCK CAPITALS PLEASE

EVERYDAY ELECTRONICS

INCORPORATING ELECTRONICS MONTHLY



JANUARY 1988
TO DECEMBER 1988

Pages	Issue	Pages	Issue
1-64	January	377-440	July
65-128	February	441-496	August
129-192	March	497-552	September
193-256	April	553-620	October
257-312	May	621-684	November
313-376	June	685-748	December

The Magazine for Electronic & Computer Projects

VOLUME 17 INDEX

CONSTRUCTIONAL PROJECTS

ADDER, SIMPLE	154	HEADS OR TAILS	596
ALARM, BREAKING GLASS	504	HEART RATE MONITOR INTERFACE, BBC	508
ALARM, CAR	480,501	HEATED REAR SCREEN ONE-SHOT	632
ALARM, DOOR SENTINEL	284,360	HEAT SENSOR	458
ALARM, INFRA-RED BEAM	530	HOME SECURITY <i>by Owen N. Bishop</i>	350, 390, 458, 530
ALARM, LIGHT-TRIGGERED	368		
ALARM, MICRO	662		
ALERT, LOW FUEL	208		
ALERT, SOS	168		
AMPLIFIER, BENCH	6		
AMPLIFIER, PERSONAL CASSETTE	724		
AMSTRAD PIO	518		
AUDIBLE SMOOTHNESS TESTER <i>by A. H. Robson</i>	302,360		
AUDIO MINI-BRICKS <i>John Becker</i>	320, 406, 470, 536, 589, 501		
AUTO POWER-OFF <i>by T. R. de Vaux-Balbirnie</i>	242		
AUTO-WAGGLE JOYSTICK <i>by Richard Clark</i>	180		
BATTERY TESTER <i>by T. R. de Vaux-Balbirnie</i>	606		
BBC ECG MONITORING INTERFACE	658		
BBC HEART RATE MONITOR INTERFACE	508		
BBC SOUND-TO-LIGHT <i>by M. P. Horsey</i>	357		
BBC TRANSISTOR CURVE TRACER INTERFACE	42		
BENCH AMPLIFIER <i>by Andy Flind</i>	6		
BREAKING GLASS ALARM <i>by Robert Penfold</i>	504		
CABLE AND PIPE LOCATOR	200		
CAPACITANCE METER <i>by Andy Flind</i>	36		
CAR ALARM <i>by I. Coughlan</i>	480		
CAR COMPUTER, GTi	25		
CAR CONTROLLER, MODEL	580		
CAR HEADLIGHT REMINDER	326		
CAR LAMP CHECKING SYSTEM <i>by T. R. de Vaux-Balbirnie</i>	108		
CAR HEATED REAR SCREEN ONE-SHOT	632		
COMPUTER, GTi CAR	25		
CONTINUITY TESTER	52		
COUNTER, INFRA RED OBJECT	635		
DAC, SPECTRUM DUAL	404		
DATA LOGGER <i>by J. Phelan</i>	448, 501		
DELAY MODULE	589		
DETECTOR, LIE	140		
DIGITAL-TO-ANALOGUE CONVERTER	280		
DIMMER, MULTICHANNEL REMOTE LIGHT	268, 342		
DIODE/CAPACITOR LADDER	488		
DIODE PUMP	434		
DISCO LIGHT SEQUENCER <i>by Geoff Phillips</i>	100		
DOORBELL DELAY <i>by Steven Holland</i>	630		
DOOR SENTINEL <i>by A. R. Winstanley</i>	284, 360		
DOWNBEAT METRONOME <i>by Andy Flind</i>	716		
EASI-TRANSISTOR TESTER <i>by Robert Penfold</i>	333		
ECG MONITORING INTERFACE	658		
EMERGENCY LIGHTING SYSTEM <i>by T. R. de Vaux-Balbirnie</i>	76		
ENVELOPE SHAPER <i>by R. G. Payne</i>	160		
ENVELOPE SHAPER	470, 501		
EPROM ERASER <i>by Mark Stuart</i>	562		
EPROM PROGRAMMER, SPECTRUM	720		
FET TOUCH SWITCH	510		
FREQUENCY DOUBLER	470		
FREQUENCY-TO-VOLTAGE CONVERTER	536		
FUEL ALERT, LOW	208		
FUNCTION GENERATOR <i>by Mike Feather</i>	264		
FUZZ	470		
GAME TIMER <i>by S. Niewiadomski</i>	122		
GENERATOR, FUNCTION	264		
GENERATOR, SUPER SOUND EFFECTS	292, 360		
GTi CAR COMPUTER <i>by Steven Cousins</i>	25		
HALF ADDER	106		
HEADLIGHT REMINDER <i>by Paul Harding</i>	326		
INDUCTIVE PROXIMITY DETECTOR <i>by B. J. Frost</i>	230		
INFRA-RED BEAM ALARM	530		
INFRA-RED OBJECT COUNTER <i>by Roger Parsell</i>	635		
INTERFACE, BBC ECG MONITORING	658		
INTERFACE, BBC HEART RATE MONITOR	508		
INTERFACE, BBC TRANSISTOR CURVE TRACER	42		
I.R. REMOTE CONTROL	698		
ISOLINK <i>by Andy Flind</i>	416		
JOYSTICK, AUTO-WAGGLE	180		
LAMP CHECKING SYSTEM, CAR	108		
LIE DETECTOR <i>by T. R. de Vaux-Balbirnie</i>	140		
LIGHT DIMMER, MULTI-CHANNEL REMOTE	268, 342		
LIGHT EFFECTS UNIT	694		
LIGHT SEQUENCER DISCO	100		
LIGHT UP, SQUEAK UP, SHUT UP <i>by D. King</i>	52		
LIGHTING SYSTEM, EMERGENCY	76		
LOW FUEL ALERT <i>by T. R. de Vaux-Balbirnie</i>	208		
MAINS SUPPRESSOR	394		
METRONOME, DOWNBEAT	716		
METER, CAPACITANCE	36		
MICRO ALARM <i>by John Lewis</i>	662		
MIXER, 3-INPUT	320		
MOCK STEREO	406		
MODEL CAR CONTROLLER	580		
MONITOR, UNIVERSAL	236		
MULTI-CHANNEL REMOTE LIGHT DIMMER			
<i>by Barry Robinson</i>	268, 342		
Ni Cad CHARGER/POWER SUPPLY	422		
NOISE ATE, STEREO	222		
OBJECT COUNTER, INFRA-RED	635		
ONE VALVE RADIO <i>by P. E. Roberts</i>	92		
PERSONAL CASSETTE AMPLIFIER <i>by Richard Powell</i>	724		
PHASING	406		
PHASING <i>by Andy Flind</i>	694		
PIO FOR THE AMSTRAD <i>by M. Snook</i>	518		
PIPE AND CABLE LOCATOR <i>by Robert Penfold</i>	200		
POWER CONTROLLER <i>by A. R. Winstanley</i>	524		
POWER-OFF, AUTO	242		
POWER SUPPLY	422		
POWER SUPPLY, VARIABLE BENCH	70		
PROXIMITY DETECTOR, INDUCTIVE	216		
QUAD CAR CONTROLLER <i>by Chris Walker</i>	580		
QUAD-WAVEFORM VCO	320		
QUIZMASTER <i>by W. Hunter</i>	12		
RADIO, I.C.	230		
RADIO, ONE VALVE	92		
REACTION TIMER	46		
REACTION TIMER <i>by Paul Harding</i>	732		
REAR SCREEN ONE SHOT	632		
REVERB	589		
RING MODULATOR	406		
SAMPLE AND HOLD	536		
SEASHELL SEA SYNTHESISER <i>by Andy Flind</i>	651, 713		
SEMICONDUCTOR TESTER <i>by Andy Flind</i>	136		
SMOKE DETECTOR	458		
SMOOTHNESS TESTER, AUDIBLE	302		

SOLDERING IRON TEMPERATURE CONTROLLER <i>by Robert Penfold</i>	568	TIMER, GAME	122
SOS ALERT <i>Mungo Henning</i>	168	TIMER, MAINS OPERATED	242
SPETRUM DUAL DAC	404	TIMER, REACTION	46, 732
SPECTRUM EPROM PROGRAMMER	720	TIME SWITCH/SUNTAN TIMER <i>by Gary Calland</i>	466
SPIKEATER <i>by P. E. Roberts</i>	394	TRANSISTOR CURVE TRACER INTERFACE	42
STEREO NOISE GATE <i>by Robert Penfold</i>	222	TRANSISTOR TESTER, EASI-	333
SUNTAN TIMER	466	UNIVERSAL CHARGER/POWER SUPPLY <i>by Costas Calamookis</i>	422
SUPER SOUND EFFECTS GENERATOR <i>by Mark Stuart</i>	292, 360	UNIVERSAL MONITOR <i>by A. H. Robson</i>	236
SWITCH, FET TOUCH	510	VARIABLE BENCH POWER SUPPLY <i>by Mark Stuart</i>	70
SYNTHESISER, SEASHELL SEA.	651,713	VIDEO WIPER <i>by Robert Penfold</i>	384
TEA TUNE <i>by C. Walker</i>	476	VOICE-OPERATED FADER	536
TEMPERATURE SENSOR	476	VOLTAGE CONTROLLED FILTER (VCF)	406
TESTER, AUDIBLE SMOOTHNESS	302	8-CHANNEL EPROM LIGHT CONTROLLER	100
TESTER, BATTERY	606	1200W POWER CONTROLLER	524
TESTER, SEMICONDUCTOR	136		

SPECIAL SERIES

ACTUALLY DOING IT <i>by Robert Penfold</i> 50, 89, 186, 220, 272, 432, 514, 608, 664, 712		3-Materials and Tools	704
AMATEUR RADIO <i>by Tony Smith G4FA1</i> 49, 83, 142, 238, 298, 356, 425, 483, 602, 666, 728		INTRODUCING MICROPROCESSORS <i>by Mike Tooley</i> (C & G Certificate Course) 16, 84, 146, 212, 276, 337, 398	
BBC MICRO <i>by R. A. Penfold & J. W. Penfold</i> 42, 112, 172, 234, 274, 371, 412, 464, 508, 600, 658, 730		3-Fetching, decoding and executing instructions	16
CROSSWORD 125, 170, 210, 273, 317, 381, 665		4-System monitor in use; Practical Assignment; Reader's Forum	84
EXPLORING ELECTRONICS <i>by Owen Bishop</i> 46, 106, 154, 230, 280, 368, 434, 488, 510, 596		5-RAM and ROM devices; Practical Assignment	146
19-High speed Logic	46	6-Input/Output from Microprocessor-based systems	212
20-Doing Sums by Logic	106	7-Interfacing to the Parallel I/O Port of microprocessor systems	276
21-More Computer Maths	154	8-Flow Charts; Languages and Practical Assignment	337
22-Integrated Circuit Radio	230	9-Written Assessment; Practical Assignment; Reader's Forum	398
23-Op. Amp Sumer and Digital-to-Analogue Converter	280	ON SPEC <i>by Mike Tooley</i> 56, 120, 164, 250, 288, 354, 404, 491, 528, 614, 680, 720	
24-Op. Amp Comparator and Light-Triggered Alarm	368	ROBOT ROUNDUP <i>by Nigel Clark</i> 24, 114, 145, 204, 296, 348, 420, 463, 548, 603, 648, 714	
25-Using diodes	434	SPECIAL REPORT 330, 516, 668	
26-More Uses for Diodes	488	Vero Easiwire System <i>by Robert Penfold</i>	330
27-Field Effect Transistors	510	NCT Digital Circuits Vo. 1 <i>by Mike Tooley</i>	516
28-Shift Registers	596	Basic Electronics <i>by Mike Tooley</i>	668
INTRODUCING DIGITAL ELECTRONICS <i>by Michael Cockcroft</i> (C & G 726/301 Certificate Course) 572, 640, 704			
1-Important Concepts	572		
2-Component Identification and Coding	640		

GENERAL FEATURES

BOOK REVIEWS	670	PLEASE TAKE NOTE	360, 501, 713
CONSUMER ELECTRONICS <i>by Ian Graham</i>	656	Audible Smoothness Tester	360
DIGITAL SATELLITES <i>by John Wroe</i>	32	Audio Mini Bricks	501
DOWN TO EARTH <i>by George Hylton</i> 110, 188, 252, 308, 426, 546, 672		Car Alarm	501
EDITORIAL		Data Logger	501
5, 69, 135, 199, 263, 319, 383, 447, 503, 561, 629, 693		Digital Counter/Frequency Meter	360
FOR YOUR ENTERTAINMENT <i>by Barry Fox</i> 55, 91, 184, 240, 290, 366, 397, 465, 522, 584, 650, 726		Door Sentinel	360
GETTING RID OF HEAT <i>by Vivian Capel</i>	205	Seashell Sea Synthesiser	713
IT MANAGEMENT	144	Super Sound Generator	360
LONDON TO SYDNEY IN THREE HOURS <i>by Ian Graham</i>	96	SHOPTALK <i>by David Barrington</i> 40, 105, 158, 244, 295, 360, 415, 490, 527, 594, 660, 702	
MILITARY COMMUNICATIONS <i>by Ian Graham</i>	576	STREETWISE CARS <i>by Ian Graham</i>	454
NEW PRODUCTS	229, 300	SUPERCONDUCTORS <i>by George Hylton</i>	152
NEWS	167, 228	TRANSISTORS AS RECTIFIERS	287
		USING THE FREE CIRCUIT CARDS	703

SPECIAL OFFERS AND SERVICES

BOOK SERVICE 60, 116, 176, 246, 304, 362, 428, 484, 542, 610, 674, 736		HEADPHONES (Special Offer)	23
CIRCUIT CARDS (Cover Mounted) 1-I.R. Remote Control System Dec '88		INTRODUCING DIGITAL ELECTRONICS (C & G 726/301 Student Info Booklet) between 586/587	
CIRCUIT EXCHANGE (Booklet) between 160/161		MARKET PLACE 58, 95, 189, 239, 307, 601	
COMPONENTS CATALOGUE (Greenweld-Spring) between 224/225		PRINTED CIRCUIT BOARD SERVICE 62, 126, 190, 254, 373, 437, 493, 549, 616, 678, 740	
COMPONENTS CATALOGUE (100-page Greenweld) banded with Nov '88		OSCILLOSCOPES (Special Offer)	729
DATA CARDS		SOLDERING KIT (Special Offer)	157
3-Z80 Microprocessor and RAM devices Jan '88		TEST and TEST GEAR (Booklet) between 284/285	
4-Z80 Instruction Subset Feb '88		10-BAND IN-CAR GRAPHIC EQUALISER/BOOSTER (Special Offer)	11
5-6800 Microprocessor and EPROM Data Mar '88		1988 YEAR PLANNER Feb '88	
6-6800 Instruction Set and Programmable Parallel I/O Apr '88			
7-8085 Microprocessor and RS-232 May '88			
8-8085 Instruction Set and RS-232 Waveforms Jun '88			
EASIWIRE KIT (Special Offer) 703			
GAS SOLDERING IRON (Special Offer) 59			

Reach effectively and economically today's enthusiasts anxious to know of your products and services through our semi-display and classified pages. The prepaid rate for semi-display spaces is £8.00 (plus VAT) per single column centimetre (minimum 2.5 cm). The prepaid rate for classified advertisements is 30 pence (plus VAT) per word (minimum 12 words).

All cheques, postal orders, etc., to be made payable to Everyday Electronics. VAT must be added. Advertisements, together with remittance, should be sent to the Classified Advertisement Dept., Everyday Electronics, 6 Church Street, Wimborne, Dorset BH21 1JH. Tel: (0202) 881749.

Electronic Components

HUNDREDS of unusual items cheap! Send 80p for interesting samples and list. Grimsby Electronics, Lambert Road, Grimsby.

WALTONS OF WOLVERHAMPTON

Established since 1947 - offering a complete range - I.C.s, transformers, switches, pots, capacitors, resistors, kits, speakers, test equipment, books and lots, lots more!

COME AND SEE US AT: **MON-SAT 9-6.00 pm**
55A WORCESTER STREET, WOLVERHAMPTON TEL: 0902 22039

ELECTRONIC COMPONENTS

EVERYTHING FOR YOUR NEXT PROJECT

THE BIGGEST DISPLAY IN THE SOUTH IS AT

FRASER ELECTRONICS

42 ELM GROVE ★ SOUTHSEA ★ HANTS
Telephone 0705-815584

TOP QUALITY
INEXPENSIVE
ELECTRONIC
COMPONENTS AND TOOLS

TO OBTAIN OUR LATEST

CATALOGUE

SEND SAE AND £2.50 TO: P.O. BOX 10 ST. ANNES ON SEA LANCS FY8 1SA

ELECTRONICS SUCCESS

A & G ELECTRONICS LTD.

If you are buying Electronic Components elsewhere you are almost certainly paying too much! Write to us for a free 1988 catalogue and start saving money.
P.O. Box 443 London E15 6JU Tel: 01-519-6149

Miscellaneous

VHF MICROTRANSMITTER KIT

tuneable 88-115 MHz, 500 metre range, sensitive electret microphone, size 25mm x 20mm. SPECIAL OFFER complete kit ONLY £3.95 POST FREE. Access orders telephone 021-411 1821 (24 hrs).

Cheques/P.O.s payable to:
QUANTEK ELECTRONICS LTD
(Dept EE), 45a Station Road, Northfield, Birmingham B31 3TE

REPAIR YOUR OWN HI-FI SPEAKERS

send large stamped addressed envelope for catalogue of replacement drive units from stock to:

RTVCLTD.

21 High Street, Acton, London W3 6NG
Tel: 01-992 8430 and 323 Edgware Road, London W2. Tel: 01-723 8432

PRINTED CIRCUIT BOARDS made to own requirements. For details send sac to Mr. B. M. Ansbro, 38 Poynings Drive, Hove, Sussex BN3 8GR.

DCS VARIABLE VOLTAGE D.C. BENCH POWER SUPPLY

1 to 24 volts up to 1/2 amp. 1 to 20 volts up to 1 amp. 1 to 16 volts up to 1 1/2 amps A.C. Fully stabilised. Twin panel meters for instant voltage and current readings. Overload protection.

Fully variable.
Operates from 240V A.C.
Compact Unit, size 9 x 5 1/2 x 3in.



£36 inc. VAT
+ Post £2

RADIO COMPONENT SPECIALISTS

337 WHITEHORSE ROAD, CROYDON SURREY, U.K. Tel: 01-684 1665

List, Large SAE. Delivery 7 days. Callers welcome. Closed Wednesday

TECHNICAL INFO SERVICES (EE)
76 Church St. Larkhall, Lanarkshire ML9 1HE
Phone 0620 884585 Mon-Fri, 9-5.
any other time 0620 883334 FOR FAST QUOTES

WORLD'S LARGEST COLLECTION SERVICE MANUALS - Most unobtainable elsewhere. Prices range from only £4.50 - large s.a.e. any quotation, no obligation to buy.

WORLD'S SOLE Suppliers of TV & Video Repair manuals, etc. from TV TECHNIC, also such publishers as Heinemann, Newnes, TV Technic, Thorn etc. Every published service sheet in stock, supplied full size, not bits & pieces. CTV's or any combination £3.50 plus LSAE; any other single item £2.50 plus LSAE. Complete Circuit Sets for most Videorecorders only £7 set (no very sh's model).

LSAE for QUOTATIONS plus GIANT CATALOGUE - NEWSLETTERS - BARGAINS - FREE S/Sht as available

Comprehensive TV Repair Manual £9.50. Complete Radio Service and Repair Course £9.50. Complete Repair & Service Manuals - Mono TV £9.50, CTV £17.00, Video £19.50. Complete Repair Data with circuit Mono TV £9.50, CTV £12.50, Video £10.50.

£3.00 plus LSAE BRINGS THE ONLY COMPREHENSIVE SERVICE SHEETS & MANUALS, CATALOGUES plus FREE CHASSIS GUIDE and £4.00 OFF VOUCHERS

CIRCUIT DIAGRAMS

Most Makes, Models, Types, Audio, Music Systems, Colour, Mono Televisions, Amateur Radio, Test Equipment, Vintage etc. £3.50 plus LSAE. State Make/Model/Type with order.

Full Workshop Manual prices on request with LSAE

MAURITRON (EE), 8 Cherry Tree Road, Chinnor, Oxfordshire OX9 4QY

CIRCUIT BOARDS made to your design. 5p per square centimetre single sided. 10p per square centimetre double sided. All fibreglass boards. Contact Q.E.B. 6, Totternhoe Road, Dunstable, Beds LU6 2AG.

WANTED: Microprocessor Trainer and course books. Mr. Winfield, Glebe Cottage, Winsor Road, Winsor, Southampton SO4 2HJ.

SINCLAIR SPECTRUM 32K Eprom Card etc. £25. Circuit diagram £2.20 including software. To: D. Avery, 10 Alpha Place, Appledore, Bideford EX39 1QY.

P.C.B's 35p sq in s/sided. 10% discount for 10 off plus. Please add 75p p&p. Please send photocopy of oil pattern and cheque or P.O. to: D. T. Whitfield, 38 Patricia Avenue, Wolverhampton WV4 5AQ.

Kits

GCSE Physics, Technology, Electronics kits. S.A.E. for details. Sir-kit Electronics, 70 Oxford Road, Clacton, Essex. CO15 3TE.

ORDER FORM PLEASE WRITE IN BLOCK CAPITALS

Please insert the advertisement below in the next available issue of **Everyday Electronics** for Insertions. I enclose Cheque/P.O. for £..... (Cheques and Postal Orders should be made payable to Everyday Electronics)

The advertisement must include an address, box number, or phone number as part of the paid wordage. Please remember to add VAT.

NAME

ADDRESS

EVERYDAY ELECTRONICS

Classified Advertisement Dept.,
6 Church Street, Wimborne, Dorset BH21 1JH.
Telephone (0202) 881749

RATE: 30p per word, minimum 12 words. VAT MUST BE ADDED

POWER CONDITIONER

FEATURED IN ETI
JANUARY 1988

The ultimate mains purifier. Intended mainly for lowering the noise floor and improving the analytical qualities of top-flight audio equipment.

The massive filter section contains thirteen capacitors and two current balanced inductors, together with a bank of six VDRs, to remove every last trace of impulsive and RF interference. A ten LED logarithmic display gives a second by second indication of the amount of interference removed.

Our approved parts set consists of case, PCB, all components (including high permeability toroidal cores, ICs, transistors, class X and Y suppression capacitors, VDRs, etc.) and full instructions.

PARTS SET £28.50 + VAT

Some parts are available separately. Please send SAE for lists, or SAE + £1 for kits, circuit construction details and further information (free with parts set).

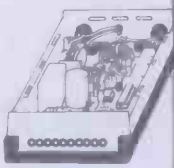

KNIGHT RAIDER

FEATURED IN ETI JULY 1987

The ultimate in lighting effects for your Lamborghini, Maserati, BMW (or any other car, for that matter). Picture this: eight powerful lights in line along the front and eight along the rear. You flick a switch on the dashboard control box and a point of light moves lazily from left to right leaving a comet's tail behind it. Flip the switch again and the point of light becomes a bar, bouncing backwards and forwards along the row. Press again and try one of the other six patterns. An LED display on the control box lets you see what the main lights are doing.

The Knight Raider can be fitted to any car (it makes an excellent fog light!) or with low powered bulbs it can turn any child's pedal car or bicycle into a spectacular TV-age toy!

The parts set consists of box, PCB and components for control, PCB and components for sequence board, and full instructions.

Lamps not included

PARTS SET £19.90 + VAT

RAINY DAY PROJECTS



All can be built in an afternoon!

JUMPIN' JACK FLASH (ETI March 1988)

Spectacular rock, stage and disco lighting effect! £6.90 - VAT

CREDIT CARD CASINO (ETI March 1987)

The wicked pocket gambling machine. £5.90 - VAT

MAINS CONTROLLER (ETI January 1987)

Isolated logic to mains interface. £6.20 - VAT

MATCHBOX AMPLIFIERS (ETI April 1986)

Listen 50W of Hi-Fi power from an amp small enough to fit in a matchbox!

Matchbox Amplifier (20W) £6.50 - VAT

Matchbox Bridge Amplifier £8.90 - VAT

L165V Power Amplifier IC, with data and circuits £3.90 - VAT

TACHO/DWELL METER (ETI January 1987)

Turn your Metro into a Porsche! £16.40 - VAT

HI-FI POWER METER (ETI May 1987)

Measures Hi-Fi output power: up to 100W

- includes PCB, components, meters

Mono power meter £3.90 - VAT

Stereo power meter £7.20 - VAT



FEATURED IN ETI
AUGUST 1988

There's nothing quite so encouraging as having a quantifiable result to show for your training efforts. If you are not particularly fit, your resting heart rate will be around 80 beats per minute. As your jogging, aerobics or sport strengthens your heart, the rate will drop dramatically - possibly to 60bpm or less. With the S101, you can watch your progress day by day.

Breathing is important too. How efficiently do you take up oxygen? How quickly do you recover from oxygen debt after strenuous activity? The S101 will let you know.

The approved parts set consists of case, 3 printed circuit boards, all components (including 11 ICs, quartz crystal, 75 transistors, resistors, diodes and capacitors), LCD, switches, plugs, sockets, electrodes and full instructions for construction and use.

PARTS SET £33.80 + VAT

Some parts are available separately. Please send SAE for lists, or SAE + £2 for lists, circuit construction details and training plan (free with parts set).



THE DREAM MACHINE

FEATURED IN ETI
DECEMBER 1987



Adjust the controls to suit your mood and let the gentle, relaxing sound drift over you. At first you might hear soft rain, sea surf, or the wind through distant trees. Almost hypnotic, the sound draws you irresistibly into a peaceful, refreshing sleep.

For many, the thought of waking refreshed and alert from perhaps the first truly restful sleep in years is exciting enough in itself. For more adventurous souls there are strange and mysterious dream experiences waiting. Take lucid dreams, for instance. Imagine being in control of your dreams and able to change them at will to act out your wishes and fantasies. With the Dream Machine it's easy!

The approved parts set consists of PCB, all components, controls, loudspeaker, knobs, lamp, fuseholders, fuse, mains power supply, prestige case and full instructions.

PARTS SET £16.50 + VAT

AVAILABLE WITHOUT CASE FOR ONLY £11.90 + VAT

ARMSTRONG 75W AMPLIFIER

FEATURED IN PE
JULY 1988



A. J. Armstrong's exciting new audio amplifier module is here at last!

Delivering a cool 75W (conservatively rated - you'll get nearer 100W), this MOSFET design embodies the finest minimalist design techniques, resulting in a clean, uncluttered circuit in which every component makes a precisely defined contribution to the overall sound. You can read all about it in the July issue of PE, but why bother with words when your ears will tell you so much more?

Parts set includes top grade PCB and all components

SPECIAL INTRODUCTORY PRICE FOR FULLY UPGRADED MODULES.

SINGLE PARTS SET £14.90 + VAT

STEREO PAIR £25.90 + VAT

Please send SAE + £1 for data and circuits (free with parts set), including diagrams for matching pre-amp and power supply. This amplifier will not be available from your usual audio supplier - we produce the only designer approved parts set.

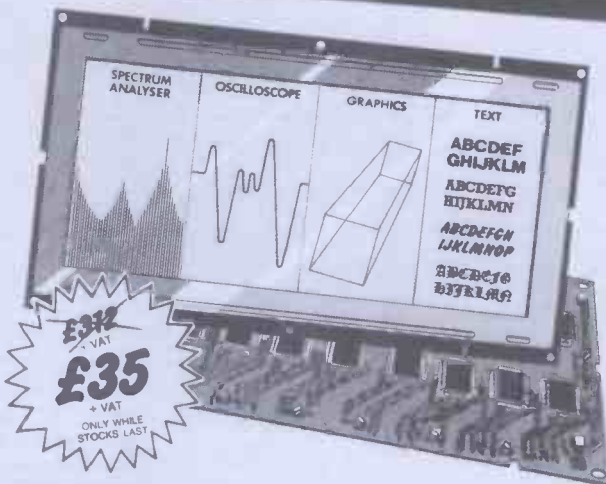

£312
VAT
£35
+ VAT
ONLY WHILE STOCKS LAST

GRAPHICS DISPLAY OFFER

These beautiful dot matrix LCDs were originally ordered from Hitachi by a top flight instrumentation manufacturer. Unfortunately their new product - a portable 'scope - was ditched before they even had a chance to open the cartons!

But it's an ill wind that blows nobody any good. Because of their bad management, you now have the chance to own a high grade graphics display module at a tiny fraction of the normal price. Hitachi distributors will charge £312 each for these displays. From us, while stocks last, the price is £35!

The LM236 display module has a 9 1/2" x 4" display area, made up of 640 x 200 pixels. Since each pixel can be accessed individually, the display is equally at home as a 'scope screen, a spectrum analyser display, a graphics monitor or a text screen.

To help organise the display, mounted on the back is a control board with 20 LSI ICs. This keeps track of all the individual dots and allows the screen to be filled via a simple eight-bit at-a-time interface.

To use the display, you will need to be fairly self-sufficient in logic design - you must know how to organise a frequency divider and serial data transfer. Apart from these basics, the data supplied with the module will tell you all you need to know to get it up and running.

MAINS CONDITIONER

FEATURED IN ETI
SEPTEMBER 1986

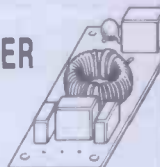

Cleans up mains pollution easily and effectively.

You'll hardly believe the difference in your Hi-Fi, TV, Video, and all other sensitive equipment.

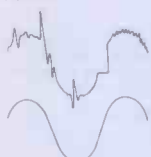

PARTS SET £4.90 + VAT

RUGGED PLASTIC CASE £1.65 + VAT

BIO-FEEDBACK

FEATURED IN ETI
DECEMBER 1986



Bio-feedback comes of age with this highly responsive, self-balancing skin response monitor! The powerful circuit has found application in clinical situations as well as on the bio-feedback scene. It will open your eyes to what GSR techniques are really all about. The complete parts set includes case, PCB, all components, leads, electrodes, conductive gel, and full instructions.

PARTS SET £13.95 + VAT

BIO-FEEDBACK BOOK £3.95 (no VAT)

Please note: the book by Stern and Ray is an authorised guide to the potential of bio-feedback techniques. It is not a hobby book, and will only be of interest to intelligent adults.

POWERFUL AIR IONISERS

Ions, the miraculous vitamins of the air, have been credited with almost magical powers.

They are said to improve concentration, reduce blood pressure, help you sleep better, and even to raise you IQ! Although some of the claims may be exaggerated, there's no doubt that ionised air is cleaner, purer and more invigorating than dead air. Anyone who has owned an ioniser would never again want to be without one!

The Direction caused a sensation when it appeared as a project in ETI. Two years later, in October 1988, the Mistral was unveiled. Which will you go for - the compact, powerful, value for money Direction Ion or the sophisticated, no compromise Mistral? The choice is yours!

MISTRAL IONISER PARTS SET £24.80 - VAT

DIRECTION PARTS SET (BLACK CASE) £11.50 - VAT

DIRECTION PARTS SET (WHITE CASE) £11.80 - VAT



LM2917 EXPERIMENTER SET

Consists of LM2917 IC, special printed circuit board and detailed instructions with data and circuits for eight different projects to build. Can be used to experiment with the circuit in the 'Next Great Little IC' feature (ETI, December 1986).

LM2917 EXPERIMENTER SET £5.80 + VAT

LEDs

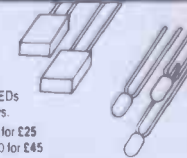

Green rectangular LEDs for bar-graph displays.

50 for £3.50 500 for £25

100 for £6 1000 for £45

DIGITAL AND AUDIO EQUIPMENT LEDs

Assorted 3mm LEDs: red, green, yellow and orange.

25 of each (100 LEDs) for £6.80

Prices shown are exclusive of VAT, so please add 15% to the order total. UK postage is 70p on any order. Carnage and insurance for overseas orders £4.50. Please allow up to 14 days for delivery.

Specialist SEMICONDUCTORS LIMITED

SALES DEPT., ROOM 111, FOUNDERS HOUSE, REDBROOK, MONMOUTH, GWENT.

BRAINWAVE MONITOR



FEATURED IN ETI
AUGUST 1987

The most astonishing project ever to have appeared in an electronics magazine. Similar in principle to a medical EEG machine, this project allows you to hear the characteristic rhythms of your own mind! The alpha, beta and theta forms can be selected for study and the three articles give masses of information on their interpretation and powers.

In conjunction with Dr. Lewis's Alpha Plan, the monitor can be used to overcome shyness, to help you feel confident in stressful situations, and to train yourself to excel at things you don't do well at!

Our approved parts set contains case, two PCBs, screening can for bio-amplifier, all components (including three PMT precision amplifiers), leads, brass electrodes and full instructions.

PARTS SET £36.90 + VAT ALPHA PLAN BOOK £2.50

SILVER SOLUTION (for pairing electrodes) £3.60 - VAT

Parts set available separately. We also have a range of accessories, professional electrodes, books, etc. Please send SAE for lists, or SAE + £2 for lists, construction details and further information (free with parts set).

SHERWOOD ELECTRONIC COMPONENTS

45 Rutland St., Mansfield
Notts. NG18 4AP

COMPONENT PACKS

0.25W resistors 10R — 1M0 10 each (610)	425p
0.25W resistors 10R — 1M0 5 each (305)	265p
0.25W resistors 10R — 1M0 Popular (1000)	600p
Min. Hor. Presets 100R — 1M0 5 each (60)	350p
Min. vert. Presets 100R — 1M0 5 each (60)	350p
Polyester Caps. Radial 0.01 — 1.5uF 3 each (42)	375p
12x5mm LESs Red or Green	100p
12x5mm LED Clips	40p
555 Timer x 5	100p
741 op-Amp x 5	100p
I.C. Sockets	
8 pin 8p each, 10 off	75p
14 pin 9 each, 10 off	85p
16 pin 10p each, 10 off	95p

Elect. Capacitors radial leads

uf			V			axial leads		
uf	V		uf	V		uf	V	
1	50	5p	47	35	7p	1	63	10p
1.5	50	5p	100	16	7p	4.7	25	10p
2.2	63	5p	100	50	8p	10	35	11p
4.7	16	6p	220	25	10p	47	50	15p
4.7	40	6p	220	63	11p	100	16	18p
10	25	6p	470	16	11p	100	35	20p
10	63	6p	470	50	12p	470	25	25p
22	63	7p	1000	16	15p	1000	16	27p
47	16	7p	1000	35	16p			

Cheque or P.O. to:
SHERWOOD ELECTRONIC COMPONENTS
Please add £1 P&P. NO VAT

OSCILLOSCOPES

TELEQUIPMENT D83 Dual trace 50MHz Delay sweep large tube with manual..... £350
 COSSOR OSCILLOSCOPE CDUI50. Dual trace 35MHz delay sweep, solid state. Portable 8 x 10cm display. With Manual..... NDW ONLY £180 each
 Optional front Protection cover containing 2 Probes & Viewing Hood..... £10
 S.E. LABS SM111 Dual trace 18MHz Solid State portable AC or external DC operation 8 x 10cm display with Manual..... £150
 ADVANCE DS250TV. Dual Trace 10MHz. With Manual..... £150
 SCOPEX 4D10A. Dual trace 10MHz with manual £150

TELEQUIPMENT S54A. Single Trace 10MHz. Solid State with manual..... £90
 SCOPEX 456. Single trace 6MHz with manual £65

TRIO OSCILLOSCOPES
 CS2150 4 Trace 150MHz Delay Sweep..... £1000
 CS1100 Dual Trace 100MHz Delay Sweep..... £700
 CS1065 3 Trace 60MHz Delay Sweep..... £500

MULTIMETERS

AVO 8 Complete with Batteries & Leads..... From £45
 AVO8 MIV Complete with Batteries & Leads £90
 AVO TEST SET No 1 (Military version of AVO 8) Complete with batteries & leads..... £65
 TEST LEADS suitable for AVO METERS Red & Black with 2 croc Clips & 2 Prods IP&P £31..... £5

BLACK 'EVER READY' CASES for AVOs, unused £20 P&P £4

LABGEAR CROSSHATCH GENERATOR CM6038 DB Crosshatch/Grey scale/blank raster. mains of Battery (P&P £3)..... Unused £18 Used £12

LABGEAR Colour Bar Generator KG1 8 Test Patterns (P&P £4)..... ONLY £40 each

ISOLATING TRANSFORMERS 240V INPUT

240V out 500VA £15 (p&p £5); 100VA £6 (p&p £3); 24V out 500VA £6 (p&p £5); 200VA £4 (p&p £4)

STEPPING MOTORS

Type 1. 200 Steps per rev 4 Phase 15 wire 12/24V. Torque 25oz inch, will run on 5V with reduced torque..... £15 ea.
 Type 2. 6/12 Steps per rev. 3 phase, 12/24V (will work on 5V)..... £2 ea 5 off..... £7.50
 Type 3. NORTH AMERICAN PHILIPS 24 Steps per rev. 4 wire 5V 3.3 Amps 0.250pm 0.200 PPs..... £6 ea.
 Type 4. 200 Steps per rev, 120V (3 wire) Torque 25 oz inch..... £4 ea.
 Type 7. WARNER 24 Steps per rev, 3 Phase (6 wire). 28V. Holding Torque 45oz inch..... £5 ea.

SPECIAL OFFER AT ONLY £300 ea.

TELEQUIPMENT D735 (NATO Approved version of D75) Dual Trace Delay Sweep 50MHz

TRIO RF SIGNAL GENERATOR type SG402 100kHz-30MHz. Unused... ONLY £75 (P&P £7)
 COLOUR BAR GENERATOR type PAL MC-101. 8 patterns pocket size. rechargeable batteries. Complete with battery charger/mains adaptor. Unused..... ONLY £35 (P&P £4)
 COLOUR BAR GENERATOR PAL MC321. 8 patterns video/sound output. Unused..... ONLY £175 (P&P £7)

AVO VALVE TESTER CT160. Suitcase style. 22 Bases. ONLY £25 each (p&p £7)

AVO TRANSISTOR ANALYSER MK 2 (CT446). Suitcase style. Complete with batteries & operating instructions. ONLY £25 each (P&P £7)

DISK DRIVE PSU 240V in 5V 1.6A & 12V 1.5A out. Size W125mm, H75mm, D180mm cased unused. FARNELL SWITCHED MODE PSU.

5V 40A +/- 12V 5A...£30 each. P&P £4
 OTHER SWITCHED MODE PSU available, please enquire.

MARCONI AF POWER METER TF833A 20Hz-35kHz, 20uW-10W. With Manual IP6P £71..... ONLY £35
 MARCONI RF POWER METER TF1152A/1 DC-500MHz. 0.5 to 25 Watts 50 Ohm. With Manual IP6P £71..... ONLY £45
 MARCONI ATTENUATOR TF2162. DC 1MHz 600 ohm, 0-111dB in 0.1dB steps (p&p £7)..... £35
 HATFIELD ATTENUATOR DC 250MHz 50 ohm 0-100dB (p&p £4)..... £60

NEW EQUIPMENT

HAMEG OSCILLOSCOPE 604. Dual trace 60MHz Delay Sweep. Component Tester & 2 Probes..... £375
 HAMEG OSCILLOSCOPE 203.6 Dual Trace 20MHz. Component Tester & 2 Probes..... £314
 All Other Models Available.

BLACK STAR FREQUENCY COUNTERS P6P £4
 Meteor 100 - 100MHz..... £99
 Meteor 600 - 600MHz..... £126
 Meteor 1000 - 1GHz..... £175
 BLACK STAR JUPITOR 500 FUNCTION GENERATOR. Sine/Square/Triangle. 0.1Hz-500kHz. P6P £4..... £110
 BLACK STAR ORION. PAL TV/VIDEO COLOUR PATTERN GENERATOR..... £199

HUNG CHANG DMM 7030. 3 1/2 digit. Hand held 26 ranges including 10 Amp AC/DC 0.1%. Complete with batteries & leads. P6P £4..... £39.50
 AS ABOVE. DMM 6010. 0.25%..... £35.50
 CARRYING CASE FOR ABOVE..... £3 each

OSCILLOSCOPES PROBES. Switched x1: x10 P&P £3..... x100..... £11

Used equipment - with 30 days guarantee. Manuals supplied if possible.
 This is a VERY SMALL SAMPLE OF STOCK. SAE or Telephone for Lists. Please check availability before ordering. CARRIAGE all units £16. VAT to be added to Total of Goods & Carriage.

STEWART OF READING
 110 WYKEHAM ROAD, READING, BERKS RG6 1PL
 Tel: 0734 68041 (Fax 351696) Callers welcome 9a.m. - 5.30p.m. Mon-Fri (8p.m. Thurs)



HART ELECTRONICS are specialist producers of kits for designers by JOHN LINSLEY-HOOD. All kits are APPROVED by the Designer.

LINSLEY-HOOD CASSETTE RECORDER CIRCUITS



Complete record and replay circuits for very high quality low noise stereo cassette recorder. Circuits are optimised for our HS16 Super Quality Sendust Alloy Head. Switched bias and equalisation to cater for chrome and ferric tapes. Very easy to assemble on plug-in PCBs. Complete with full instructions

Complete Stereo Record/Play Kit..... £33.70
 VU Meters to suit..... £2.30 each
 Reprints of original Articles..... 75p no VAT
 Hi-Fi Stereo Mic Amplifier..... £8.70

LINSLEY HOOD 300 SERIES AMPLIFIER KITS
 Superb integrated amplifier kits derived from John Linsley-Hood's articles in 'Hi-Fi News'.

Ultra easy assembly and set-up with sound quality to please the most discerning listener. Ideal basis for any domestic sound system if quality matters to you. Buy the kit complete and save pounds off the individual component price.

£300-35 35 Watt. Discount price for Complete Kit..... £98.79
 £300-45 45 Watt. Discount price for Complete Kit..... £102.36
 RLH485 Reprints of Original Articles from 'Hi-Fi News'..... £1.05 no VAT

LINSLEY-HOOD SUPER HIGH QUALITY AM/FM TUNER SYSTEM.



Our very latest kit for the discerning enthusiast of quality sound and an exotic feast for lovers of designs by John Linsley-Hood. A combination of his ultra high quality FM tuner and stereo decoder described in "ELECTRONICS TODAY INTERNATIONAL" and the Synchronyde AM receiver described in "Wireless World". The complete unit is cased to match our 300 Series amplifiers. Novel circuit features in the FM section to include ready built pre-aligned front-end, phase locked loop demodulator with a response down to DC and advanced sample and hold stereo decoder together make a tuner which sounds better than the best of the high-priced exotica but, thanks to HART engineering, remains easy to build. The Synchronyde section with its selectable bandwidth provides the best possible results from Long and Medium wave channels, so necessary in these days of split programming. If you want the very best in real Hi-Fi listening then this is the tuner for you. Since all components are selected by the designer to give the very best sound this tuner is not cheap, but in terms of it's sound it is incredible value for money. To cater for all needs four versions are available with variations up to the top of the range full AM/FM model, with any unit being upgradeable at any time. Send for our fully illustrated details

DIGITAL ELECTRONICS COURSE
 Send for your FREE list of the tools and components you will need for this exciting new series.

With every set of course components purchased we give a free £5 discount voucher, valid for six months.

HIGH QUALITY REPLACEMENT CASSETTE HEADS



Do your tapes lack treble? A worn head could be the problem. Fitting one of our replacement heads could restore performance to better than new! Standard mountings, make fitting easy and our TC1 Test Cassette helps you set the azimuth spot-on. We are the actual importers which means you get the benefit of lower prices for prime parts. Compare us with other suppliers and see! The following is a list of our most popular heads, all are suitable for use on Dolby machines and are ex-stock.

HC20 Permalloy Stereo Head. This is the standard head fitted as original equipment on most decks..... £7.66
 HS16 Sendust Alloy Super Head. The best head we can find. Longer life than Permalloy, higher output than Ferrite, fantastic frequency response..... £14.86
 HQ551 4-Track Head for auto-reverse or quadrophonic use. Full specification record and playback head..... £14.60
 HX100 Stereo Permalloy R/P head. Special Offer £2.49
 MA481 2/2 Language Lab R/P head..... £13.35
 SM166 2/2 Erase Head. Standard mounting, AC type..... £8.85
 SM150 2/2 Erase Head. DC Type..... £3.60
 HQ751E 4/4 Erase Head for Portastudio etc..... £46.80
 Full specifications of these and other special purpose heads in our lists.

HART TRIPLE-PURPOSE TEST CASSETTE TC1

One inexpensive test cassette enables you to set up VU level, head azimuth and tape speed. Invaluable when fitting new heads. Only £4.66 plus VAT and 50p postage.

Tape Head De-magnetiser. Handy size mains operated unit prevents build-up of residual head magnetisation causing noise on playback..... £4.54
 Curvad Pole Type for inaccessible heads..... £4.85

Send for your free copy of our LISTS. Overseas please send 2 IRCs to cover surface Post or 5 IRCs for Airmail.

Please add part cost of post, packing and insurance as follows:

INLAND
 Orders up to £10 - 50p
 Orders £10 to £49 - £1
 Orders over £50 - £1.50

OVERSEAS
 Please send sufficient to cover Surface or Air Post as required.

Personal callers are always very welcome but please note that we are closed all day Saturday

24hr SALES LINE
 (0691) 652894

ALL PRICES EXCLUDE VAT UNLESS STATED

HART ELECTRONIC KITS LTD.
 6 PENYLAN MILL
 OSWESTRY, SHROPSHIRE
 SY10 9AF

252A HIGH STREET, HARLESDEN, LONDON NW10 4TD

HURRY!
WHILE
STOCKS LAST

TEL: 01-965 5748

TELEX: 265871 MONREF G Quoting 72: MAG31197

OMEGA

OE

ELECTRONICS

SPECIAL STOCK CLEARANCE SALE

Table with multiple columns listing various electronic components such as CMOS, MEMORY DEVICES, LINEAR DEVICES, TAICOM LOW PROFILE IC SOCKETS, RECTIFIER DIODES, SIGNAL DIODES, and VOLTAGE REGULATORS. Each entry includes a part number, value, and price.

RESISTORS 0.25W 5% FROM 1.0 OHM - 10M OHM SAME VALUE 100PCS £0.35p.
PLEASE ADD 15% V.A.T. TO ALL PRICES, CARRIAGE IS FREE ON ORDERS OVER £20.00, ELSE ADD 75p+ V.A.T. TO TOTAL VALUE TO COVER CARRIAGE.
NOTE THAT THESE ITEMS ARE SUBJECT TO STOCK AVAILABILITY AND WHILE STOCKS LAST,
SO HURRY CALL US ON 01-965-5748 TO CHECK ON STOCK LEVELS.
ORDERS FROM GOVERNMENTAL AND EDUCATIONAL DEPTS. ARE WELCOME FOR LISTED OR ANY UNLISTED ITEMS.

ELECTRONICS TECHNICIAN FULL-TIME TRAINING

(FULL TIME COURSES APPROVED BY THE BUSINESS & TECHNICIAN EDUCATION COUNCIL)

2 YEAR
BTEC National Diploma (OND)
ELECTRONIC &
COMMUNICATIONS ENGINEERING
(Electronics, Computing, Television, Video, Testing & Fault Diagnosis)

- 1 YEAR
BTEC National Certificate (ONC)
ELECTRONIC ENGINEERING
1 - INFORMATION TECHNOLOGY
(Electronics, Satellite TV, CD, Networks, Telecomms)
2 - ELECTRONIC EQUIPMENT SERVICING
(Electronics, Television, Video Cassette Recorders, CCTV, Testing & Fault Diagnosis)
3 - SOFTWARE ENGINEERING
(Electronics, Assembler, BASIC, PASCAL, CAD/CAM)
4 - COMPUTING TECHNOLOGY
(Electronics, Computing Software/Hardware, Microelectronic Testing Methods)

10 MONTHS
BTEC Higher National Certificate (HNC)
COMPUTING TECHNOLOGY & ROBOTICS
(Microprocessor Based Systems, Fault Diagnosis, ATE, Robotics)
(Those eligible can apply for E.T. grant support)

THESE COURSES INCLUDE A HIGH PERCENTAGE OF COLLEGE BASED PRACTICAL WORK TO ENHANCE FUTURE EMPLOYMENT PROSPECTS
NO ADDITIONAL FEES FOR OVERSEAS STUDENTS
SHORTENED COURSES OF FROM 3 TO 6 MONTHS CAN BE ARRANGED FOR APPLICANTS WITH PREVIOUS ELECTRONICS KNOWLEDGE

O.N.C. Monday 9th Jan. 1989
FULL PROSPECTUS FROM

LONDON ELECTRONICS COLLEGE (Dept EE)
20 PENYVERN ROAD, EARLS COURT,
LONDON SW5 9SU. Tel: 01-373 8721.

MAKE YOUR INTERESTS PAY!

More than 8 million students throughout the world have found it worth their while! An ICS home-study course can help you get a better job, make more money and have more fun out of life! ICS has over 90 years experience in home-study courses and is the largest correspondence school in the world. You learn at your own pace, when and where you want under the guidance of expert 'distance' tutors. Find out how we can help YOU. Post or phone today for your FREE INFORMATION PACK on the course of your choice. (Tick one box only!)

Form with checkboxes for course interests: Electronics, Radio, Audio and TV Servicing, Basic Electronic Engineering (City & Guilds), Radio Amateur Licence Exam (City & Guilds), Electrical Engineering, Car Mechanics, Electrical Contracting/Installation, Computer Programming. Includes GCE level selection and a Name field.



Address: International Correspondence Schools, Dept. EGSC8 10,312/314 High St., Sutton, Surrey SM1 1PR. Tel: 01 643 9568 or 041 221 2926 (24 hrs)

SIR-KIT ELECTRONICS

G.C.S.E. Physics Technology Electronics

HOME STUDY KITS AT POCKET MONEY PRICES

First set available NOW covers simple switching circuits 10 modules from 60p each COMPLETE SET OF 10 ONLY £10.50 (+70p p&p) (builds over 40 circuit variations)

Cheques to:

SIR-KIT ELECTRONICS

70 Oxford Road
Clacton CO15 3TE
or S.A.E. for details

COMPUTER CONTROL

Interspec & Interbeeb multi-purpose interfaces

These compact cased units both offer the following facilities:
 ● 8 channel 8 bit analogue to digital converter (1mS conversion)
 ● 4 24V/1A relay outputs ● 4 switch or sensor inputs
 ● 8 bit TTL input port ● 8 bit TTL output port
 ● DCP BUS expansion system for adding extra accessories
 ● Easily programmed with single BASIC (or machine code) commands
 ideal for robotics, models, automation, test, research, etc, etc
Interspec is designed for connection to any model of Spectrum computer and is powered from the computers power supply.
 Special offer price £29.95 including VAT plus £1.95 p&p per order.
Interbeeb is designed for use with the Acorn BBC or Master computers & comes complete with ribbon cable for connection to the micro's 1MHz Bus socket & specially designed mains power unit. (Can also be used with an Archimedes if fitted with Acorn I/O Module.)
 Special offer price £49.95 including VAT plus £1.95 p&p per order.
Connector Packs are also available at £2.95 for use with above:
Connector Pack 1: Three plugs for both TTL ports & the DCP BUS.
Connector Pack 2: Ten 2mm plugs for analogue, switch & relay.
Remote control Buggy: This battery operated model incorporating twin motors & gearboxes forms an ideal introduction to computer robotics & is supplied complete with plugs, cable & detailed project booklet.
 Price £11.95 inc or special set including Interspec £39.95 inclusive.
Orders are normally despatched by return (cheques/P.O. payable to 'DCP Microdevelopments Ltd'). Trade & overseas enquiries welcome. We are established designers & manufacturers of computer control interfaces for home, industry and education use. This is just a small section from a large range of products compatible with many personal computers including Acorn, Amstrad, Apple, Commodore, IBM and Sinclair.

For full information please write, telephone or FAX:

DCP Microdevelopments Ltd,
 2 Station Close,
 Lingwood,
 Norwich, NR13 4AX
 Technical: (0480) 830997
 FAX: (0480) 830534



TOTAL ENERGY DISCHARGE ELECTRONIC IGNITION

IS YOUR CAR AS GOOD AS IT COULD BE ?

- ★ Is it **EASY TO START** in the cold and damp? Total Energy Discharge will give the most powerful spark and maintain full output even with a near flat battery.
- ★ Is it **ECONOMICAL** or does it "go off" between services as the ignition performance deteriorates? Total Energy Discharge gives much more output to fire lean fuel mixtures.
- ★ Has it **PEAK PERFORMANCE** or is it flat at high and low revs. where ignition output is marginal? Total Energy Discharge gives a more powerful spark from idle to the engines maximum (even with 8 cylinders).
- ★ Is the **PERFORMANCE SMOOTH?** The more powerful spark of Total Energy Discharge eliminates the near "misfires" whilst an electronic filter smoothes out the effects of contact bounce etc.
- ★ Do the **PLUGS AND POINTS** always need changing to bring the engine back to its best? Total Energy Discharge eliminates contact arcing and erosion by removing the heavy electrical load. The timing stays "spot on" and the contact condition does not affect the performance either. Larger plug gaps can be used, even wet or badly fouled plugs can be fired with this system.
- ★ **TOTAL ENERGY DISCHARGE** is a unique system and the most powerful on the market - 3.5 times the power of inductive systems - 3 times the energy and 3 times the duration of ordinary capacitive systems. Send for full technical details
- ★ **ALSO FEATURES**
EASY FITTING, STANDARD/ELECTRONIC CHANGEOVER SWITCH, STATIC TIMING LIGHT and DESIGNED IN RELIABILITY (14 years experience and a 3 year guarantee)
- ★ In **KIT FORM** it provides a top performance system at less than half the price of a comparable ready built unit. The kit includes: pre-drilled fibreglass PCB, pre-wound and varnished ferrite transformer, high quality 2µf discharge capacitor, case, easy to follow instructions, solder and everything you need to build and fit to your car. All you need is a soldering iron and a few basic tools.

TOTAL ENERGY DISCHARGE KIT £17.95 (Prices include VAT)
ASSEMBLED READY TO FIT £23.90 (Add £1.00 P&P)

ALSO AVAILABLE: Other Ignition systems and electronic car alarms

Order now or send for further details:

ELECTRONIZE DESIGN tel 021 308 5877
 2 Hillside Road, Four Oaks, Sutton Coldfield B74 4DQ

S.P.K ELECTRONICS

Please send large SAE for Comprehensive list of equipment & components that can be supplied.
 GOOD Discounts available for schools & colleges with multiple orders.

Westbury Mill, Westbury, Nr. Brackley, Northants
 NN13 5JS. Tel 0280-701691 or 0836 209923
 Telex: 94011054 (=Mill G)
 Fax: 0280 701228

Ordering: Please add £5 p&p. Add 15% VAT to this total. 24hr Answering Service on orders placed after 6pm.
 Cash, P.O. or cheque with order please. Visa, Access, Diners & American Express accepted.

ELECTRONIC TEST EQUIPMENT — CALIBRATION CERTIFICATES SUPPLIED AT EXTRA COST PHONE FOR DETAILS

This is just a small sample of our vast range of equipment. If the instrument you require is not listed please give us a call as we can probably help you.

BECHMAN Digital Multimeter model DM20L (we recommend this as excellent value for money) 3½ digit display, 28 RANGES, 20MHz logic probe built in, transistor gain testing. Direct reading 200-2000Mohm ranges. Continuity Bleeper 10Mohm input impedance, Pocket size. Ideal for the home constructor or experienced engineer, extremely versatile and exceptionally easy to use. **PRICE £46.00**

THANDAR Oscilloscope model SC110. Bench. Portable, low power, 10Mhz band width, 10mV, 10mV sensitivity, 12 attenuator/voltage settings, 21 time base ranges. Small screen (1in x 1¼in) but very useful instrument operates on batteries or mains. Comes with mains adaptor and x 1 probe. **PRICE £209.95**

ROBIN Analogue multimeter model OM20NB. 2000ohmp per volt multimeter DC Voltage to 1000V AC. Voltage to 500V DC current to 250mA. Resistance to 500Kohms. **PRICE £10.00**

FLOPPY DISKS Double sided, double density, 96 tpi, high quality. Pretested computer disks suitable for Amstrad and any other P.C.'s with 5¼in drives. **PRICE** per box of 10 disks **£7.00** Inclusive of price — **FREE** labels & Notch stickers & the box acts as a stand. Please add £1 for postage.

HITACHI Oscilloscope model V212. Large clear 6in screen DC to 20MHz Dual channel, max vertical sensitivity = 1mV/DIV, Fastest sweep rate = 100nS/DIV Calibrator output. This instrument has in our experience proved to be an exceptional piece of equipment, being very reliable and durable. We were impressed by its bright clear and crisp display making the instrument a pleasure to use. **PRICE** inclusive of 2 probes **£334.00**

Optional Extras
 Hard front cover price £16.
 Soft dust cover price £26.

 *
 * **CHRISTMAS IS NEARER THAN YOU THINK** *
 * **VHS VIDEO TAPES** *
 * **Kodak 3hr tape pack of 3 £8.25** *
 * **JVC 4hr tape pack of 3 £12.00** *
 *

ADVERTISERS INDEX

ADVANCED CIRCUITS 727	GREENWELD ELECTRONICS 686	OMNI ELECTRONICS 727
ALCON INSTRUMENTS 688	HART ELECTRONIC KITS 745	PHONOSONICS 735
ALPHA ELECTRONICS 748	ICS 746	RISCOMP 711
BARRIE ELECTRONICS 723	JAYTEE ELEC. SERVICES 686	SHERWOOD DATA SYSTEMS 731
BICC-VERO ELECTRONICS 715	LIGHT SOLDERING DEVELOPMENTS 711	SHERWOOD ELECTRONIC COMPONENTS 745
BI-PAK 711	LONDON ELECTRONICS COLLEGE 746	SIR-KIT ELECTRONICS SPECIALIST 746
B K ELECTRONIC Cover (iii)	MAGENTA ELECTRONICS 690	SEMICONDUCTORS 744
BULL, J. N. Cover (ii)	MAPLIN ELECTRONICS Cover (iv)	S.P.K. ELECTRONICS 747
CIRKIT DISTRIBUTION 727	MARCO TRADING 689	STEWART OF READING 745
CRICKLEWOOD ELECTRONICS 723	MUTEX 688	SUMA DESIGNS 723
C SCOPE INTERNATIONAL 688	NATIONAL COMPONENT CLUB 748	TK ELECTRONICS 692
DCP MICRODEVELOPMENTS 747	OMEGA ELECTRONICS 746	TUTORKIT PRODUCTS 748
ELECTRONIZE DESIGN 747		
EVERETT WORKSHOP ACCESS 727		

TUTORKIT MICROELECTRONICS TUTORS

OP AMP TUTOR OT1

A versatile teaching aid for Operational Amplifier fundamentals. Includes socketed 741, Mode Control Switch, Two Potentiometers and close tolerance components. Will solve simple Differential Equations and generate waveforms etc.

Op Amp Tutor OT1 (Kit) **£27.50** plus vat



TUTORKIT PRODUCTS
(Div. of Limrose Electronics Ltd.),
Llay Industrial Estate, Wrexham,
Clwyd, LL12 0TU, UK
Tel: 097 883 2285

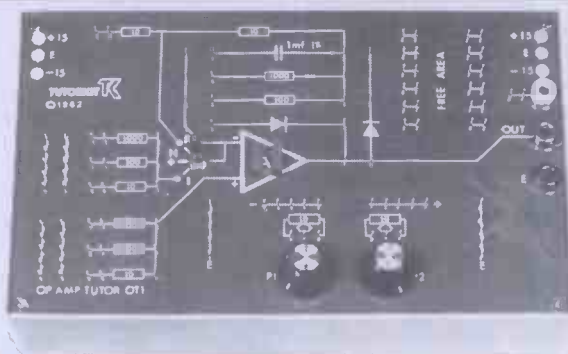

NATIONAL COMPONENT CLUB

SPECIAL OFFERS * SPECIAL OFFERS

5	555 TIMER (IC's)	£1
5	741 OP-AMPS	£1
12	LED's (5mm red or green)	£1
25	GENERAL PURPOSE TRANSISTORS (BC548, BC182 etc)	£1
15	BATTERY CLIPS (PP3)	£1
25	ASSORTED POTS & PRESETS	£1
70	ASSORTED CAPACITORS (Picofarads-2200uf)	£1
25	ELECTROLYTIC CAPACITORS (1uf-2200uf)	£1
300	MIXED RESISTORS (6R2-9M1)	£1
?	MYSTERY PACK	£1
10	CROCODILE CLIPS (5 red and 5 black)	£1
1	90db PIEZO SOUNDER	£1

**ANY SIX PACKS FOR A FIVER !
ALL TWELVE FOR A TENNER !**

P.O. or Cheque to: NATIONAL COMPONENT CLUB, DEPT.EE,
HIGHER ANSFORD, CASTLE CARY, SOMERSET BA7 7JG.
Please add £1 P & P but do not add VAT.

*** FREE CLUB MEMBERSHIP ***

THE BEST DEAL

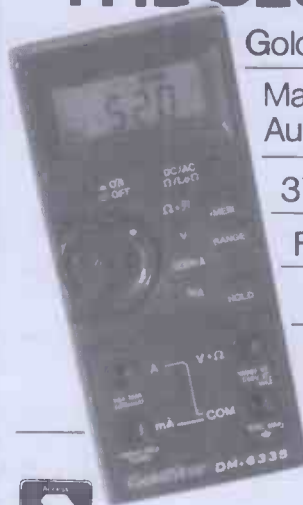

Gold Star from Alpha

Manual &
Autoranging DMMs

3½ Digit L.C.D.

Full 1 Year Guarantee

Best Value for Money

FROM
£39.00
(excl. VAT)



COMES FROM ALPHA



ELECTRONICS LIMITED

Unit 5 Linstock Way
Wigan Road, Atherton
M29 9CA
Tel: 0542 873434

Unit 6 Newbroom Park
Granton Park Ind. Estate
Edinburgh, Scotland EH5 1HS
Tel: 031 552 0753

26 Upper Stone Street
Maidstone, Kent
ME15 6EX
Tel: 0622 690187

MP POWER AMPLIFIER MODULES-TURNABLES-DIMMERS-LOUDSPEAKERS-19 INCH STEREO RACK AMPLIFIERS

* PRICES INCLUDE V.A.T. * PROMPT DELIVERIES * FRIENDLY SERVICE * LARGE S.A.E., 30p STAMPED FOR CURRENT LIST.

POWER AMPLIFIER MODULES

Supplied ready built and tested.
P POWER AMPLIFIER MODULES Now enjoy a world-wide reputation for quality, reliability and performance at a realistic price. Four models available to suit the needs of the professional and hobby market. i.e. Industry, Instrumental and Hi-Fi etc. When comparing prices. NOTE All models include Toroidal power supply, Integral heat sink, fibre P.C.B. and Drive circuits to power compatible Vu meter. Open and short circuit proof.

THOUSANDS OF MODULES PURCHASED BY PROFESSIONAL USERS

OMP100 Mk 11 Bi-Polar Output power 110 watts R.M.S. into 4 ohms, Frequency Response 15Hz - 30KHz -3dB, T.H.D. 0.01%, S.N.R. -118dB, Sens. for Max. output 500mV at 10K, Size 355 x 115x65mm. PRICE £33.99 + £3.00 P&P.

NEW SERIES II MOS-FET MODULES

OMP/MF 100 Mos-Fet Output power 110 watts R.M.S. into 4 ohms, Frequency Response 1Hz - 100KHz -3dB, Damping Factor, >300, Slew Rate 45V/uS, T.H.D. Typical 0.002%, Input Sensitivity 500mV, S.N.R. -125dB. Size 300 x 123 x 60mm. PRICE £39.99 + £3.00 P&P.

OMP/MF200 Mos-Fet Output power 200 watts R.M.S. into 4 ohms, Frequency Response 1Hz - 100KHz -3dB, Damping Factor >300, Slew Rate 50V/uS, T.H.D. Typical 0.001%, Input Sensitivity 500mV, S.N.R. -130dB. Size 300 x 155 x 100mm. PRICE £62.99 + £3.50 P&P.

OMP/MF300 Mos-Fet Output power 300 watts R.M.S. into 4 ohms, Frequency Response 1Hz - 100KHz -3dB, Damping Factor >300, Slew Rate 60V/uS, T.H.D. Typical 0.0008%, Input Sensitivity 500mV, S.N.R. -130dB. Size 330 x 175 x 100mm. PRICE £79.99 + £4.50 P&P.

NOTE:— MOS-FET MODULES ARE AVAILABLE IN TWO VERSIONS. STANDARD — INPUT SENS. 500mV BAND WIDTH 100KHz. PEC (PROFESSIONAL EQUIPMENT COMPATIBLE) — INPUT SENS. 775mV BAND WIDTH 50KHz. ORDER STANDARD OR PEC

Vu METER Compatible with our four amplifiers detailed above. A very accurate visual display employing 11 L.E.D diodes (7 green, 4 red) plus an additional on/off indicator. Sophisticated logic control circuits for very fast rise and decay times. Tough moulded plastic case, with tinted acrylic front. Size 84 x 27 x 45mm. PRICE £8.50 + 50p P&P.

LOUDSPEAKERS

LARGE SELECTION OF SPECIALIST LOUDSPEAKERS AVAILABLE, INCLUDING CABINET FITTINGS, SPEAKER GRILLES, CROSS-OVERS AND HIGH POWER, HIGH FREQUENCY BULLETS AND HORNS, LARGE S.A.E. (30p STAMPED) FOR COMPLETE LIST.

KENZIE:— INSTRUMENTS, P.A., DISCO, ETC.

- McKENZIE UNITS 8 OHMS IMPEDENCE**
- 30 WATT C8100GPM GEN. PURPOSE, LEAD GUITAR, EXCELLENT MID., DISCO. PRICE £28.59 + £2.00 P&P.
 - FREQ. 80Hz FREQ. RESP. TO 14KHz SENS. 99dB.
 - 100 WATT C10100GP GUITAR, VOICE, ORGAN, KEYBOARD, DISCO, EXCELLENT MID. PRICE £36.66 + £3.50 P&P.
 - FREQ. 70Hz FREQ. RESP. TO 6KHz SENS. 100dB.
 - 100 WATT C10200GP GUITAR, KEYBOARD, DISCO, EXCELLENT HIGH POWER MID. PRICE £47.48 + £2.50 P&P.
 - FREQ. 45Hz FREQ. RESP. TO 7KHz SENS. 103dB.
 - 100 WATT C12100GP HIGH POWER GEN. PURPOSE, LEAD GUITAR, DISCO. PRICE £47.48 + £2.50 P&P.
 - FREQ. 45Hz FREQ. RESP. TO 7KHz SENS. 98dB.
 - 100 WATT C12100TC TWIN CONE HIGH POWER WIDE RESPONSE, P.A., VOICE, DISCO. PRICE £37.63 + £3.50 P&P.
 - FREQ. 45Hz FREQ. RESP. TO 14KHz SENS. 100dB.
 - 200 WATT C12200B HIGH POWER BASS, KEYBOARDS, DISCO, P.A. PRICE £64.17 + £3.50 P&P.
 - FREQ. 40Hz FREQ. RESP. TO 7KHz SENS. 100dB.
 - 300 WATT C12300GP HIGH POWER BASS LEAD GUITAR, KEYBOARDS, DISCO, ETC. PRICE £85.79 + £3.50 P&P.
 - FREQ. 45Hz FREQ. RESP. TO 5KHz SENS. 100dB.
 - 100 WATT C15100BS BASS GUITAR, LOW FREQUENCY, P.A., DISCO. PRICE £53.70 + £4.00 P&P.
 - FREQ. 40Hz FREQ. RESP. TO 5KHz SENS. 98dB.
 - 200 WATT C15200BS VERY HIGH POWER BASS. PRICE £73.26 + £4.00 P&P.
 - FREQ. 40Hz FREQ. RESP. TO 4KHz SENS. 99dB.
 - 250 WATT C15250BS VERY HIGH POWER BASS. PRICE £80.53 + £4.50 P&P.
 - FREQ. 40Hz FREQ. RESP. TO 4KHz SENS. 99dB.
 - 400 WATT C15400BS VERY HIGH POWER, LOW FREQUENCY BASS. PRICE £94.12 + £4.50 P&P.
 - FREQ. 40Hz FREQ. RESP. TO 4KHz SENS. 102dB.
 - 400 WATT C18404BS EXTREMELY HIGH POWER, LOW FREQUENCY BASS. PRICE £167.85 + £5.00 P&P.
 - FREQ. 27Hz FREQ. RESP. TO 3KHz SENS. 99dB.

REBENDERS:— HI-FI, STUDIO, IN-CAR, ETC.

- REBENDER UNITS 8 OHMS EXCEPT EB8-50 AND EB10-50 DUAL 4 AND 8 OHM. SS, SINGLE CONE, HIGH COMPLIANCE, ROLLED FOAM SURROUND**
- 0 WATT EB8-50 DUAL IMPEDENCE, TAPPED 4/8 OHM BASS, HI-FI, IN-CAR. PRICE £18.90 + £2.00 P&P.
 - FREQ. 40Hz FREQ. RESP. TO 7KHz SENS. 97dB.
 - 50 WATT EB10-50 DUAL IMPEDENCE, TAPPED 4/8 OHM BASS, HI-FI, IN-CAR. PRICE £12.00 + £2.50 P&P.
 - FREQ. 40Hz FREQ. RESP. TO 5KHz SENS. 99dB.
 - 100 WATT EB10-100 BASS, HI-FI, STUDIO. PRICE £27.50 + £3.50 P&P.
 - FREQ. 35Hz FREQ. RESP. TO 3KHz SENS. 96dB.
 - 50 WATT EB12-60 BASS, HI-FI, STUDIO. PRICE £21.00 + £3.50 P&P.
 - FREQ. 28Hz FREQ. RESP. TO 3KHz SENS. 92dB.
 - 100 WATT EB12-100 BASS, STUDIO, HI-FI, EXCELLENT DISCO. PRICE £32.00 + £3.50 P&P.
 - FREQ. 26Hz FREQ. RESP. TO 3KHz SENS. 93dB.
 - L RANGE TWIN CONE, HIGH COMPLIANCE, ROLLED SURROUND**
 - 60 WATT EB5-60TC (TWIN CONE) HI-FI, MULTI-ARRAY DISCO ETC. PRICE £9.99 + £1.50 P&P.
 - FREQ. 63Hz FREQ. RESP. TO 20KHz SENS. 92dB.
 - 60 WATT EB6-60TC (TWIN CONE) HI-FI, MULTI-ARRAY DISCO ETC. PRICE £10.99 + £1.50 P&P.
 - FREQ. 38Hz FREQ. RESP. TO 20KHz SENS. 94dB.
 - 100 WATT EB8-60TC (TWIN CONE) HI-FI, MULTI-ARRAY DISCO ETC. PRICE £12.99 + £1.50 P&P.
 - FREQ. 40Hz FREQ. RESP. TO 18KHz SENS. 95dB.
 - 60 WATT EB10-60TC (TWIN CONE) HI-FI, MULTI-ARRAY DISCO ETC. PRICE £16.49 + £2.00 P&P.
 - FREQ. 35Hz FREQ. RESP. TO 12KHz SENS. 86dB.

TRANSITTER HOBBY KITS

SEVEN TRANSMITTER DESIGNS INCLUDING GLASS FIBRE TUBED CIRCUIT BOARD AND HIGH QUALITY COMPONENTS COMPLETE WITH CIRCUIT AND INSTRUCTIONS

- 3 WATT TRANSMITTER 80-108MHz, VARICAP CONTROLLED PROFESSIONAL PERFORMANCE, RANGE UP TO 3 MILES, SIZE 38 x 123mm. SUPPLY 12V IN 0.5AMP. PRICE £14.49 + £1.00 P&P.
- 3 WATT CRO TRANSMITTER (BUG) 100-108MHz VARICAP TUNED COMPLETE WITH SENS FET MIC. RANGE 100-300m. SIZE 56 x 46mm. SUPPLY 9V BATT. PRICE £8.62 + £1.00 P&P.



3 watt FM Transmitter

OMP VARISPEED TURNABLE CHASSIS

★ MANUAL ARM ★ STEEL CHASSIS ★ ELECTRONIC SPEED CONTROL 33 & 45 ★ VARI PITCH CONTROL ★ HIGH TORQUE SERVO DRIVEN DC MOTOR ★ TRANSIT SCREWS ★ 12 DIE CAST PLATTER ★ NEON STROBE ★ CALIBRATED BAL WEIGHT ★ REMOVABLE HEAD SHELL ★ CARTRIDGE FIXINGS ★ CUE LEVER ★ POWER 220 240V 50 60HZ ★ 390x305mm ★ SUPPLIED WITH MOUNTING CUT-OUT TEMPLATE.
PRICE £59.99 + £3.50 P&P.

OPTIONAL MAGNETIC CARTRIDGES

- STANTON AL500 PRICE £16.99 + 50p P&P
- GOLDRING G850 PRICE £6.99 + 50p P&P

OMP MOS-FET POWER AMPLIFIERS, HIGH POWER, TWO CHANNEL 19 INCH RACK



NEW MXF SERIES OF POWER AMPLIFIERS

THREE MODELS:— MXF200 (100w + 100w) MXF400 (200w + 200w) MXF600 (300w + 300w)

All power ratings R.M.S. into 4 ohms.
FEATURES: ★ Independent power supplies with two Toroidal Transformers ★ Twin L.E.D. Vu meters ★ Rotary indexed level controls ★ Illuminated on/off switch ★ XLR connectors ★ Standard 775mV inputs ★ Open and short circuit proof ★ Latest Mos-Fets for stress free power delivery into virtually any load ★ High slew rate ★ Very low distortion ★ Aluminium cases ★ MXF600 Fan Cooled with D.C. Loudspeaker and Thermal Protection.

USED THE WORLD OVER IN CLUBS, PUBS, CINEMAS, DISCOS ETC.

- SIZES:— MXF 200 W19" x H3 1/2" (2U) x D11" MXF 400 W19" x H5 1/4" (3U) x D12" MXF 600 W19" x H5 1/4" (3U) x D13"
- MXF200 £171.35
 MXF400 £228.85
 MXF600 £322.00
 SECURICOR DELIVERY £12.00 EACH

OMP LINNET LOUDSPEAKERS

THE VERY BEST IN QUALITY AND VALUE

MADE ESPECIALLY TO SUIT TODAY'S NEED FOR COMPACTNESS WITH HIGH OUTPUT SOUND LEVELS, FINISHED IN HARDWEARING BLACK VYNDIE WITH PROTECTIVE CORNERS, GRILLE AND CARRYING HANDLE, INCORPORATES 12" DRIVER PLUS HIGH FREQ. HORN FOR FULL FREQ. RANGE. 45Hz-20KHz BOTH MODELS 8 OHM. SIZE H18" x W15" x D12"

CHOICE OF TWO MODELS

- POWER RATINGS QUOTED IN WATTS RMS FOR EACH CABINET
- OMP 12-100 (100W 100dB) PRICE £159.99 PER PAIR
 - OMP 12-200 (200W 102dB) PRICE £209.99 PER PAIR

SECURICOR DEL.:— £12.00 PER PAIR

PIEZO ELECTRIC TWEETERS-MOTOROLA

Join the Piezo revolution. The low dynamic mass (no voice coil) of a Piezo tweeter produces an improved transient response with a lower distortion level than ordinary dynamic tweeters. As a crossover is not required these units can be added to existing speaker systems of up to 100 watts (more if 2 put in series). FREE EXPLANATORY LEAFLETS SUPPLIED WITH EACH TWEETER.

- TYPE 'A' (KSN2036A) 3" round with protective wire mesh, ideal for bookshelf and medium sized Hi-fi speakers. Price £4.90 each + 50p P&P.
 - TYPE 'B' (KSN1005A) 3 1/2" super horn. For general purpose speakers, disco and P.A. systems etc. Price £5.00 each + 50p P&P.
 - TYPE 'C' (KSN6016A) 2" x 5" wide dispersion horn. For quality Hi-fi systems and quality discos etc. Price £6.99 each + 50p P&P.
 - TYPE 'D' (KSN1025A) 2" x 6" wide dispersion horn. Upper frequency response retained extending down to mid range (2KHz). Suitable for high quality Hi-fi systems and quality discos. Price £9.99 each + 50p P&P.
 - TYPE 'E' (KSN1038A) 3 3/4" horn tweeter with attractive silver finish trim. Suitable for Hi-fi monitor systems etc. Price £5.99 each + 50p P&P.
- LEVEL CONTROL** Combines on a recessed mounting plate, level control and cabinet input jack socket. 85x95mm. Price £3.99 + 50p P&P.

STEREO DISCO MIXER

STEREO DISCO MIXER with 2 x 5 band L & R graphic equalisers and twin 10 segment L.E.D. Vu Meters. Many outstanding features 5 inputs with individual faders providing a useful combination of the following:— 3 Turntables (Mag), 3 Mics, 4 Line including CD plus Mic with talk over switch Headphone Monitor, Pan Pot L. & R. Master Output controls. Output 775mV. Size 360x280x90mm. Supply 220-240V.
Price £134.99 — £4.00 P&P

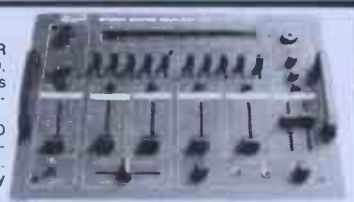

POSTAL CHARGES PER ORDER £1.00 MINIMUM. OFFICIAL ORDERS WELCOME FROM SCHOOLS, COLLEGES, GOV'T. BODIES, ETC. PRICES INCLUSIVE OF V.A.T. SALES COUNTER. VISA ACCESS ACCEPTED BY POST, PHONE OR FAX.

B. K. ELECTRONICS Dept EE
 UNIT 5, COMET WAY, SOUTHEND-ON-SEA, ESSEX, SS2 6TR
 TEL: 0702-527572 FAX: 0702-420243

ORDER YOUR COPY OF THE NEW MAPLIN CATALOGUE ON SALE SOON

Check up a copy from any W.H. Smith for just £1.95 or post this coupon now to receive your copy by post for just £1.95 + 50p p & p. If you live outside the U.K. send £3.40 or 15 International Reply Coupons. I enclose £2.45.

Send to Maplin Electronics, P.O. Box 3, Rayleigh, Essex SS6 8LR. Post Code EE 89

AVAILABLE FROM 11th NOVEMBER 1988 IN ALL W.H. SMITH STORES

**THE NEW MAPLIN CATALOGUE
IT'S OUT OF THIS WORLD
SEND FOR YOUR COPY TODAY**

