

Easy to build projects for everyone

NOV. 82
80p

Everyday ELECTRONICS

**SEDAC
Prize Winning
Project**
**OSCILLOSCOPE
COMPANION**



**DIGITAL METRONOME
COMBINATION LOCK
ZX TAPE CONTROL**

NEW SERIES
**it Information
Technology**

Electronic Hobbies Fair
FREE 50p
COUPON
INSIDE

electronize **ELECTRONIC IGNITION KITS**

Two years ago we launched the Total Energy Discharge System, we knew it could outperform any competing system and the sales have proved just how good it is. With thousands of systems sold in over 30 countries around the World, from the cold of Norway to the tropical heat of Singapore, the system is an outstanding success.

THIS IS WHAT MAKES TOTAL ENERGY DISCHARGE SO GOOD—

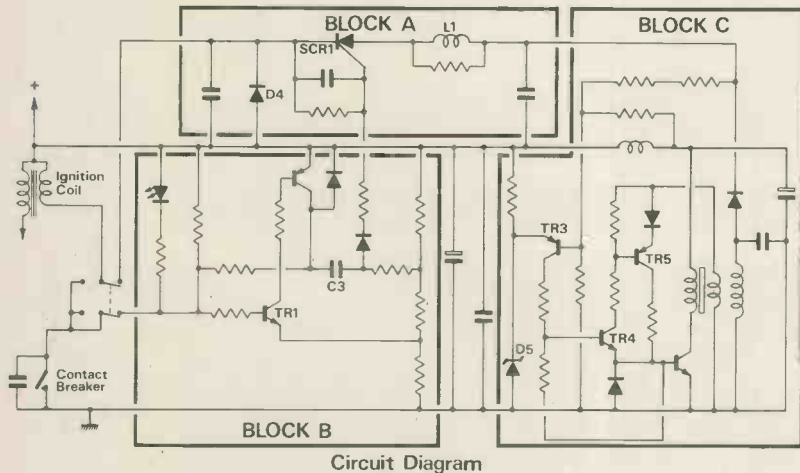

Circuit Diagram

The discharge circuit in block A is the heart of the system. It looks simple but outperforms any other by far. A 2 μ F storage capacitor (twice the usual size) charged to + 370 volts, is discharged into the ignition coil primary by SCR1, providing a high energy pulse of the correct polarity. Long after the storage capacitor is discharged, the current in the ignition coil is sustained by 'flywheel' diode D4, preventing energy flowing back to the capacitor and giving 3½ times the spark energy and duration. Instead of relying on the effects of coil 'ringing', inductor L1 commutates the SCR, giving complete freedom from the usual latching problems and allowing the storage capacitor to be recharged whilst the discharge current is still flowing in the coil.

Block B is the trigger circuit and provides faultless spark timing. The emitter of TR1 is biased from the supply to provide a variable trigger threshold, allowing triggering with the supply down to about 3.5 volts but rejecting noise and signals from contact shuffle and vibration. Capacitor C3 and its associated resistors provide a variable inhibit period, after the contacts close, which filters out extreme contact bounce on 4 cylinder engines yet still allows 8 cylinder operation to over 7500 rev/min. In effect the longer the contacts stay open the longer they must remain closed before the next spark can be triggered. (Be warned:- untimed sparks can seriously damage your engines health).

Block C is the inverter, the power behind the spark. It's a 'ringing choke' type. Well designed, this type can not only be regulated and charge the capacitor from zero volts, effectively a short circuit, but is also more efficient than the traditional push-pull type. Even though it provides around 3 times the power, it still doesn't need the usual finned heat sink. Transistors TR4 and TR5 regulate the inverter output, by controlling the amount of feedback, and are in turn controlled by TR3 which compares the voltage on the storage capacitor with the reference zener D5. The output voltage is set by the zener voltage so the full output is available over the whole supply voltage range, a powerful spark is produced even with the battery down to 4 volts.

These are the more obvious features, there are many more details like the absence of 'spikes' and low di/dt and dV/dt applied to the SCR, which together with top quality components make Total Energy Discharge not only a top performer but far more reliable.

This advanced circuitry gives all the well known advantages of the best capacitive discharge systems:

Peak Performance; Improved Economy; Fires Fouled Plugs; Accurate Timing; Smooth Performance;

PLUS

Super Power Spark; Better Starting; Optimum Spark Duration; Correct Spark Polarity; L.E.D. Static Timing Light; Low Radio Interference; Designed In Reliability.

Information disclosed above does not imply any freedom from patent or copyright of Electronize Design.



Electronize Total Energy Discharge Ignition is suitable for use with:

- ALL** 6 and 12 volt negative earth vehicles fitted with a conventional contact breaker and coil system.
- ALL** Ballast resistor (cold start/low voltage) systems.
- ALL** Voltage triggered electronic tachometers. (Some older current impulse types (Smiths pre 1974) require an adaptor)
- ANY** Number of cylinders up to & including 8.

SPECIFICATION

(using a typical ignition coil)

	TOTAL ENERGY DISCHARGE	ORDINARY CAPACITIVE DISCHARGE
Spark Power	140W	90W
Spark Energy	36mJ	10mJ
(stored energy)	135mJ	65mJ
Spark Duration	500 μ S	160 μ S
Output Voltage		
clean spark plug	38kV	26kV
fouled spark plug	26kV	17kV
Voltage Rise Time to 20kV	25 μ S	30 μ S

You can buy your Total Energy Discharge system as a ready assembled and tested unit ready to fit to your car or as a comprehensive kit of parts containing everything required, even a length of solder and a tube of heat sink compound. The kit comes complete with detailed, easy to follow instructions which enable even a beginner to assemble a kit in just a matter of hours.

The same top performance system is also available, in ready assembled or kit form, to suit cars and motorcycles fitted with twin ignition systems.

STANDARD UNIT	£26.70
Assembled and Tested	
STANDARD UNIT KIT	£15.90
TWIN OUTPUT UNIT	£36.45
Assembled and Tested	
TWIN OUTPUT KIT	£24.55

All systems are available direct from the manufacturer. Prices include VAT, postage and packing £1.00 extra. Access and Visa cards are welcome, just write or telephone quoting your number.



ELECTRONIZE DESIGN

Dept C · Magnus Rd · Wilneote
Tamworth · B77 5BY
tel 0827 281000

Everyday ELECTRONICS

VOL. 11 NO. 11 NOVEMBER 1982

PROJECTS . . . THEORY . . . NEWS . . .
COMMENT . . . POPULAR FEATURES . . .



Come along to this unique event for all electronics enthusiasts. Whatever your particular interests in the world of electronics, there will be much to see, to inform and entertain you. Components—equipments—books and magazines—plus special attractions to interest all the family.

Your 50p coupon is on page 753. Bring it with you on November 18, 19, 20 or 21.

Electronics Hobbies Fair is sponsored by Everyday Electronics, Practical Electronics and Practical Wireless and is organised by IPC Exhibitions Ltd.

SCHOOLS Electronic Design Award COMPETITION

YOUNG READERS PLEASE NOTE

Will your school be represented in this great National contest? Maybe your own project will win a valuable prize and bring honour to your school.

A school may be represented by either an individual or a team of pupils.

The usefulness and novelty of a project are prime matters for consideration during judging. The degree of circuit complexity is not of major importance, since good design implies efficient use of components. It follows therefore that a quite simple circuit could win.

Please turn to page 721 for details and then contact your science or physics teacher.

© IPC Magazines Limited 1982. Copyright in all drawings, photographs and articles published in EVERYDAY ELECTRONICS is fully protected, and reproduction or imitations in whole or in part are expressly forbidden.

Our December issue will be published on Friday, November 19. See page 741 for details.

PROJECTS

- COMBINATION LOCK** by C. Muten 700
Five-digit electronic security device
- TAPE CONTROLLER** by V. Terrell 704
For ZX81 and Spectrum users
- DIGITAL METRONOME** by S. Ibbs 713
Musicians' aid with frequency read-out
- OSCILLOSCOPE COMPANION** by S. Rainey 723
Expands the facilities of a basic single beam scope
- PHOTO FINISH** by A. P. Donleavy 734
Model racetrack accessory to determine the winner
- BEAT THE RELAY** by S. Dunn 736
A simple electronic game

SERIES

- INTRODUCING ELECTRONICS** by George Hylton 708
Part 2: Enter Capacitance
- THE ELECTRONICS OF INFORMATION TECHNOLOGY** 718
by T. E. Ivall
Part 1: Fundamental Concepts

FEATURES

- EDITORIAL** 699
Brave New World
- JACK PLUG AND FAMILY** by Doug Baker 703
Cartoon
- COUNTER INTELLIGENCE** by Paul Young 707
A retailer comments
- SCHOOLS COMPETITION** 721
Details of SEDAC 1983
- SHOP TALK** by Dave Barrington 722
Product news and components
- EVERYDAY NEWS** 732
What's happening in the world of electronics
- READERS' LETTERS** 738
Your news and views
- FOR YOUR ENTERTAINMENT** by Barry Fox 742
Cable Options, Grass Roots, The Wharfedale Story
- RADIO WORLD** by Pat Hawker G3VA 745
Legal Maze, Wadley Loop, Getting a Licence
- EXAMINATION PROJECTS** by C. Bowes 746
Constructive advice for students

Readers Services ● Editorial and Advertisement Departments

699

Beginners' luck

30% OFF
10 selected kits
for first-time
builders



Shortwave
Listener's
Receiver

With Heathkit, you're all set for a great deal. And not just big savings.

Whichever kit you choose, you'll find it easy to build. Simple, but detailed instructions take you through every stage. Everything is included. Even the solder you need is there.

Digital Clock

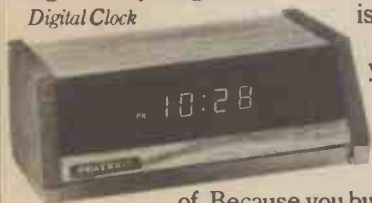

Follow the steps and you'll end up with a hand-crafted, well-designed piece of equipment. One you'll be proud of. Because you built it yourself.

There are 10 great kits to start you off. An interesting choice of kits from a digital clock to a metal locator, including a short wave listener's receiver, windspeed and direction indicator, digital readout electronic scale and five more useful kits.

All at 30% off to first-timers. Send for your catalogue right now for a start.



Windspeed and Direction
Indicator



Metal
Locator

To Heath Electronics
(UK) Limited, Dept (EE11),
Bristol Road, Gloucester GL2 6EE

To start me off, please send me
a copy of the new Heathkit catalogue.
I enclose 28p in stamps. EE/11

Name _____

Address _____

HEATH You build on our experience

HEATHKIT

PLASTIC CASES

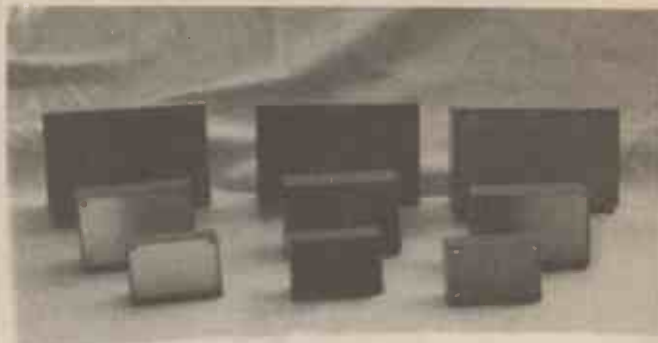

This attractive and durable range of small beige plastic cases offer a choice of front panels; grey plastic(P), silver metallised plastic(M) and aluminium(A) each secured by four self tapping screws (supplied). The case sides have moulded slots for PCB location and mouldings on two faces tilt the case by 10°. Vertically or desk style.

TYPE	EXTERNAL DIMENSIONS	PRICE EACH		
		P	M	A
10	85 x 60 x 40	0.99	1.16	1.22
20	110 x 75 x 50	1.20	1.49	1.72
30	155 x 95 x 60	2.10	2.51	2.74

SPECIAL OFFER Dpdt. C/Off, Chrome Dolly
only 99p
Miniature Toggle Switch
Including VAT and P&P

Mail Order only. All prices include VAT and P&P. Send large SAE for Catalogue of boxes, knobs, power supplies (from 5A to 150A), AC/DC controllers and more.

elec *trans*

DEPT. EE11, 2 THE WILLOWS,
HERSTMONCEUX, East Sussex,
BN27 4LE. TEL. 0323 832571.

ELECTRONICS IS A FINE HOBBY VELLEMAN-KIT



The Velleman range of electronic kits are designed using the latest technologies. They cover a wide field of applications and are graded by difficulty.

The range includes kits using microprocessors, infra-red systems, power supplies, dimmers, motor control units, amplifiers, sound and light units, digital counters, timers and many more including the very latest VELLEMAN HEATING CONTROLLER K2583 designed around a specially designed 'single chip microcomputer' and enabling time and temperature to be programmed as desired.

Full details and free illustrated catalogue and price list available on request from:

VELLEMAN (U.K.) LIMITED
P.O. Box 30,
St. Leonards on Sea,
East Sussex TN37 7NL
Tel: 0424 753246

Stocking distributors:

Baxol Tele Exports Ltd., Post Rathdrum, Co. Wicklow. Rep. of Ireland.
S & R Brewster Ltd., Union Street, Plymouth, Devon.
Marshalls Electronics Ltd., 85 West Regent Street, Glasgow.

You should see Ambit's new Autumn Catalogue...

IT SPEAKS FOR ITSELF

Another milestone in component supply...

If you've been wondering just what's been going on at Ambit lately, we are now taking the wraps off the most advanced and imaginative concept in component, tool, and information distribution since we launched WR&E last year.

We have included new items and information to plug a few gaps, and we are just starting to implement a new interactive computerised system of service and information that simply cannot be overlooked by anyone interested in the communications, electronics, video and computing business.

- ★ Price on the page
- ★ 24 Hour response -Guaranteed
- ★ Low prices
- ★ High quality
- ★ Export a speciality

No. 4. Autumn 1982

AMBIT INTERNATIONAL'S

WORLD of RADIO & ELECTRONICS

CONCISE PARTS CATALOGUE

128 PAGES

70 p

Some of the new items from this issue...

- Weller/Cooper: Soldering Irons & Tools
- You never regret buying the best!
- ★ TCP series
- ★ Tips & spares
- ★ Cutters/pliers
- ★ Toolkits

Motorola RF Power:
Transistors for manufacturing

- ★ 1W/30MHz to
- ★ 80W/150MHz
- ★ ...& beyond

Test equipment
A rapidly expanding range

- ★ Auto DMMs
- ★ Scopes
- ★ Bananas (?)
- ★ Sig gens

TOKO inductors
RM assemblies
Intelligent LCDs
Uni Crystal Filters
Coaxial relays
Micros & memories
Linears
Keyswitches
Panelware
Hardware

WR&E

LOWEST PRICE FULL SPEC. MCADS * * * MORE than PER E * * * 3 x \$1 vouchers inside

128 Pages of the broadest component range in the business

24 HOURS A DAY, 7 DAYS A WEEK

AUTUMN '82 WR&E 70p

AT YOUR NEWSAGENT - OR DIRECT FROM

AMBIT INTERNATIONAL BRENTWOOD ESSEX CM14 4SG

Telephone (0277)230909, telex 995194 AMBITG, data RS232/300 baud (0277)230959*

*Dial (0277)230959, hook in your low cost modem and terminal (most personal computers can be configured to access REWTEL, details are being published in R&EW over the next few months) and REWTEL will give you access to up to 5000 pages of background to the WR&E catalogue, equivalents, news, updates, hot off-the-press product news, information, jobs being advertised in the industry. It's computing at its most versatile and worthwhile: why be satisfied with a 64K MCU, when you can gain free access to the 70MByte+ of the REWTEL computer ??

HOME LIGHTING KITS

These kits contain all necessary components and full instructions & are designed to replace a standard wall switch and control up to 300w. of lighting.

- TDR300K Remote Control Dimmer **£14.30**
- MK6 Transmitter for above **£ 4.20**
- TD300K Touchdimmer **£ 7.00**
- TDEK Extension kit for 2-way switching for TD300K **£ 2.00**
- LD300K Rotary Controlled Dimmer **£ 3.50**



DISCO LIGHTING KITS

DL 1000K
This value-for-money kit features a bi-directional sequence, speed of direction and frequency of direction change, being variable by means of potentiometers and incorporates a master dimming control. **Only £14.60**



DL2100K
A lower cost version of the above, featuring unidirectional channel sequence with speed variable by means of a pre-set pot. Outputs switched only at mains zero crossing points to reduce radio interference to a minimum. **Only £8.00**

Optional opto input DLAT
Allowing audio ("beat")—light response. **60p**

NEW DL3000K
This 3 channel sound to light kit features zero voltage switching, automatic level control & built in m.c. No connections to speaker or amp required. No knobs to adjust—simply connect to mains supply & lamps. **Only £11.95** (1Kw/Channel)

DISPLAYS

- CQX87A 0.5" dual, c.a. Red **£1.80**
- DL340M 0.1" 4-Digit c.c. **£4.50**
- FND 500 0.5" c.c. **85p**
- FND 507 0.5" c.c. **85p**
- MP463 4-digit 0.5" multiplexed c.c. **£2.20**
- LED Clock Display..... **£2.20**

Liquid Crystal Display, 3 1/2 digit, 0.5" digits, d.i.l. package **£6.00**

KL901 9-digit, 7-seg. 0.1" c.c. LED calculator display with red filter **55p**

TEACH-IN '82

- EE MiniLab **£13.50**
- Parts 1-6 **£7.50**
- Parts 7-12 **£4.90**
- Special price for all kits purchased together **£23.50**

woodwork not included
The above kits include all the components specified in the Teach-in '82 projects parts 1—12 plus sockets for ICs specified.

LCD 3 1/2 DIGIT MULTIMETER
16 ranges including DC and AC voltage, DC current and resistance+PNP & PNP transistor gain and diode check. Input impedance 10M. Size 155x88x31mm. Requires PP3 9v battery. **ONLY £31.00**

REMOTE CONTROL

Published remote control systems tend to be quite complex & require a difficult-to-get components and a well-equipped lab to get them to work. If this has put you off making your own system we have just the kits for you. Using Infra-red, our KITS range from simple on/off controllers to coded transmitter/receivers with 16 on/off outputs or three analogue outputs for controlling, e.g. TV or Hi-Fi systems. The kits are easy to build and simple to set up—and they are extremely versatile, controlling anything from garage doors to room lighting just by adding the required output circuits, i.e. relays, tracs, etc. If you can design your own system we stock a wide range of remote control components at very competitive prices. We have compiled a booklet on remote control, containing circuits, hints, data sheets and details of our remote control kits and components. So don't control yourself—SEND US 30p and a stamped addressed envelope for your copy TODAY!

TRANSISTORS

- BC108 8p
- BC109 ... 15p
- BC182 ... 8p
- BC212 ... 3p
- BC212 ... 3p
- BC327 ... 12p
- BC337 ... 13p
- BFY50 .. 20p
- TIP31A .. 40p
- TIP32A .. 40p
- 2N3055 45p
- 2N3442
- 115w 140v
- 2N3819 90p
- 2N3819 N ch fet 20p

- VMOS POWER FETS**
- VN10KM 0.5A/60v 52p
 - VN66AF 2A/60v 88p

Add 55p postage & packing +15% VAT to total. Overseas Customers: Add £1.75 (Europe), £4.50 (elsewhere) for p&p. Send S.A.E. for further STOCK DETAILS. Goods by return subject to availability.

OPEN 9am to 5pm (Mon to Fri) 10am to 4pm (Sat)

CLOCK TOWER
LARGE NORTH CIRCULAR ISLAND

UXBRIDGE ROAD

CAR PARK

WELLS L1 GARAGE

24 HOUR CLOCK/APPLIANCE TIMER KIT

Switches any appliance up to 1kW on and off at preset times once per day. Kit contains: AY-5-1230 IC, 0.5" LED display, mains supply, display drivers, switches, LEDs, triacs, PCBs and full instructions.



- CT1000K Basic Kit **£14.90**
- CT1000K with white box (56/131 x 71mm) **£17.40** (Ready Built) **£22.50**

DVM/ULTRA SENSITIVE THERMOMETER KIT

This new design is based on the ICL7125 (a lower power version of the ICL7106 chip) and a 3 1/2 digit liquid crystal display. This kit will form the basis of a digital multimeter (only a few additional resistors and switches are required—details supplied), or a sensitive digital thermometer (-50°C to +150°C) reading to 0.1°C. The basic kit has a sensitivity of 200mV for a full scale reading, automatic polarity indication and an ultra low power requirement—giving a 2 year typical battery life from a standard 9V PP3 when used 8 hours a day, 7 days a week.



Price £15.50

3-NOTE DOOR CHIME
Based on the SAB0600 IC the kit is supplied with all components, including loudspeaker, printed circuit board, a pre-drilled box (95 x 71 x 35mm) and full instructions. Requires only a PP3 9V battery and push-switch to complete. AN IDEAL PROJECT FOR BEGINNERS. Order as XK102. **£5.00**

FREE SHORT FORM CATALOGUE—send SAE (6" x 9"). We also stock Vero, Books, Resistors, Capacitors, Semi-Conductors etc.

FAST SERVICE · TOP QUALITY · LOW LOW PRICES ALL PRICES EXCLUDE VAT

No circuit is complete without a call to -

TK ELECTRONICS EE

11 Boston Road
London W7 3SJ

ACCESS BY BARCLAYCARD

TEL: 01-567 8910 ORDERS
01-579 9794 ENQUIRIES
01-579 2842 TECHNICAL AFTER 3PM

TECHNICAL TRAINING IN ELECTRONICS, TELEVISION AND AUDIO

IN YOUR OWN HOME—AT YOUR PACE
ICS can provide the technical knowledge that is so essential to your success, knowledge that will enable you to take advantage of the many opportunities open to the trained man. You study in your own home, in your own time and at your own pace and if you are studying for an examination ICS guarantee coaching until you are successful.

- City & Guilds Certificates**
- Radio Amateurs**
- Basic Electronic Engineering (Joint C&G/ICS)**
- Certificate Courses**
- TV and Audio Servicing**
- Radio & Amplifier Construction**
- Electronic Engineering* and Maintenance**
- Computer Engineering* and Programming**
- Microprocessor Engineering***
- TV, Radio and Audio Engineering**
- Electrical Engineering,* Installation and Contracting** *Quality for IET Associate Membership

POST OR PHONE TODAY FOR FREE BOOKLET

Please send me your FREE School of Electronics Prospectus.

Subject of Interest _____

Name _____

Address _____

ICS Post to: Dept A268
ICS School of Electronics
160 Stewarts Road,
London SW8 4UJ

01-522 9911 (All Hours)

C.B. EXTRA! FABULOUS FRONTS

FRONT-END ADD-ON DIY KITS FOR GREATER FUN FROM YOUR RIG

- These are suitable for CB or standard audio use depending on socket type chosen (you will need two sockets—see below).
- COMPRESSOR.** Really helps avoid blasting your mods and adjacent channels! Preset it for the maximum that your rig will like and your signal strength won't top it. **SET-133-LS £12-37**
 - FUNNY TALKER MK2.** Modified ring modulator for fascinating metallic and modulated quality to your voice. Includes new high-gain pre-amp, voltage stabiliser, and output level control. **SET-99MK2-LS £19-06**
 - Add-on kit for MK1 users to convert to the MK2 (box not required).** **SET-99ADN £23-39**
 - MULTIPLEXER.** Are you using several front-end add-ons? This unit splits the microphone signal in up to 6 directions for feeding various extras, and also contains a six-input mixer for recombining the add-on signals onto one line. An extra two skts read for each to-from direction. **SET-132-LS £11-60**
 - MUSICAL CALL SIGN.** Programme your own individual 8-note call sign. Push button operated for use when you want. **SET-121-LS £14-23**
 - ROGER TWO-GONG.** Two-tone gong-like sound automatically activated at the end of transmission. **SET-126-LS £12-31**
 - SIGNAL COMPARATOR.** Uses special three-colour LEDs to give a visual indication of speech level. Also compares microphone level with levels from other units such as Roger Bleeps, etc. Helps avoid overmodulation and cross-channel break-through. **SET-129-LS £16-70**
 - SIMPLE REVERB.** Enhances the spacious quality of your transmission, and at full control can produce that 'Monster-from-the-Deep' effect. With control over balance, echo and duration. The response from listeners is astonishing! **SET-127-LS £20-39**
 - SINGLE ROGER.** Gives a single bleep of a preset duration and pitch when the microphone switch is released at the end of transmission. **SET-127-LS £10-07**
 - SPEECH PROCESSOR.** Dramatically improves the intelligibility of speech signals. We are making many sales on this directly because people have heard it on the air! **SET-110-LS £11-77**
 - VOICE FILTER.** For limiting the frequency band-width that reaches the rig from the microphone, helping to reduce background noise. Six selectable ranges plus by-pass. **SET-131-LS £12-75**
 - VOICE OPERATED SWITCH.** Avoid the danger and inconvenience of hand-held mobile transmission and let your voice do the switching for you! **SET-123-LS £13-60**
 - CB POWER SUPPLY.** From the mid-range of 13-8 volts, can be set anywhere between about 10v and 15v at approx. 300mA. Ideal for driving all these various CB add-ons! (Mic skts not reqd). **SET-130-LS £13-85**
 - CONNECTORS AVAILABLE**

- 4-pin chas skt **SKT-SC4** 46p
 - 4-pin line skt **SKT-LS4** POA
 - 4-pin chas plug **PLG-SP4** 46p
 - 4-pin line plug **PLG-LP4** 62p
 - 5-pin DIN 180° skt **SKT-KS** 16p
 - 5-pin DIN 180° plug **PLG-KP** 34p
 - Std jack skt mono **SKT-US** 20p
 - Std jack plug mono **PLG-UP** 18p
- If connectors ordered with kits no P&P charge, else add 60p to total.

Sets include electronic components, PCB, instructions, box. Prices incl. UK P&P, 15% VAT, E.A.O.E. Subject to stock. Terms C.W.O. mail order or collection by appointment. Access & Barclay accepted. Send S.A.E. (9 x 4 or bigger) for further details. Despatch usually 7 days on most items. Other kits in prep. Exports welcome, send £1 for Export list.

PHONOSONICS
DEPT E29, 22 HIGH STREET, SIDCUP,
KENT DA14 6EH. 01-302-6184 MON-FRI
FOUNDED 1972. A DECADE OF DESIGN AND DELIVERY!

Step-by-step fully illustrated assembly and fitting instructions are included together with circuit descriptions. Highest quality components are used throughout.

Sparkrite

BRANDLEADING ELECTRONICS
NOW AVAILABLE IN KIT FORM

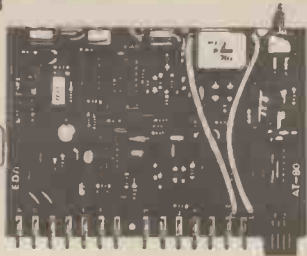
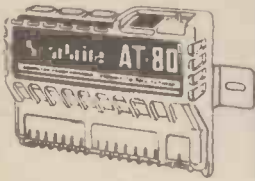

AT-80 Electronic Car Security System

- Arms doors, boot, bonnet and has security loop to protect fog/spot lamps, radio/tape, CB equipment
- Programmable personal code entry system
- Armed and disarmed from outside vehicle using a special magnetic key fob against a windscreen sensor pad adhered to the inside of the screen
- Fits all 12V neg earth vehicles
- Over 250 components to assemble

VOYAGER Car Drive Computer

- A most sophisticated accessory
- Utilises a single chip mask programmed microprocessor incorporating a unique programme designed by EDA Sparkrite Ltd.
- Affords 12 functions centred on Fuel, Speed, Distance and Time
- Visual and Audible alarms warning of Excess Speed, Frost/Ice, Lights-left-on
- Facility to operate LOG and TRIP functions independently or synchronously
- Large 10mm high 400ft-L fluorescent display with auto intensity
- Unique speed and fuel transducers giving a programmed accuracy of + or - 1%
- Large LOG & TRIP memories 2,000 miles, 180 gallons, 100 hours
- Full Imperial and Metric calibrations
- Over 300 components to assemble
- A real challenge for the electronics enthusiast!

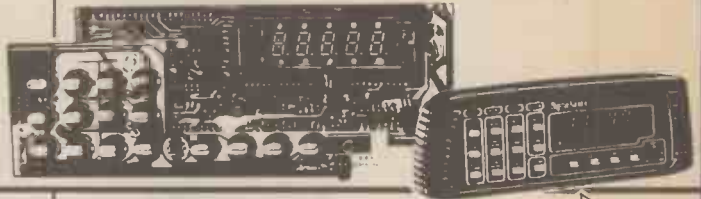

SX1000 Electronic Ignition

- Inductive Discharge
- Extended coil energy storage circuit
- Contact breaker driven
- Three position changeover switch
- Over 65 components to assemble
- Patented clip-to-coil fitting
- Fits all 12v neg. earth vehicles

TX1002 Electronic Ignition

- Contactless or contact triggered
- Extended coil energy storage circuit
- Inductive Discharge
- Three position changeover switch
- Distributor triggerhead adaptors included
- Die cast weatherproof case
- Clip-to-coil or remote mounting facility
- Fits majority of 4 & 6 cyl. 12V. neg. earth vehicles
- Over 145 components to assemble.

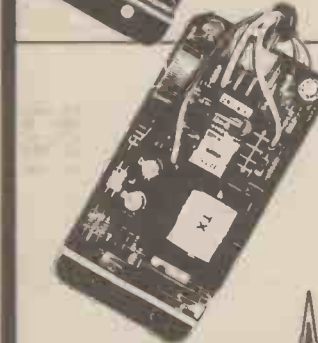

SX2000 Electronic Ignition

- The brandleading system on the market today
- Unique Reactive Discharge
- Combined Inductive and Capacitive Discharge
- Contact breaker driven
- Three position changeover switch
- Over 130 components to assemble
- Patented clip-to-coil fitting
- Fits all 12v neg. earth vehicles

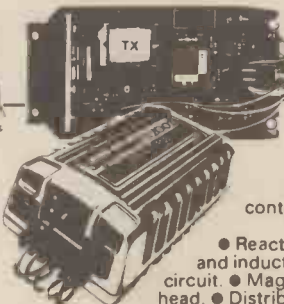

TX2002 Electronic Ignition

- The ultimate system
- Switchable contactless
- Three position switch with Auxiliary back-up inductive circuit
- Reactive Discharge. Combined capacitive and inductive.
- Extended coil energy storage circuit
- Magnetic contactless distributor triggerhead
- Distributor triggerhead adaptors included.
- Can also be triggered by existing contact breakers.
- Die cast waterproof case with clip-to-coil fitting
- Fits majority of 4 and 6 cylinder 12v neg. earth vehicles.
- Over 150 components to assemble

All SPARKRITE products and designs are fully covered by one or more World Patents

SPECIAL OFFER
"FREE" MAGIDICE KIT WITH
ALL ORDERS OVER £45.00



MAGIDICE Electronic Dice

- Not an auto item but great fun for the family
- Total random selection
- Triggered by waving of hand over dice
- Bleeps and flashes during a 4 second tumble sequence
- Throw displayed for 10 seconds
- Auto display of last throw 1 second in 5
- Muting and Off switch on base
- Hours of continuous use from PP7 battery
- Over 100 components to assemble

SPARKRITE 82 Bath Street, Walsall, West Midlands, WS1 3DE England

Tel: (0922) 614791 Allow 28 days for delivery

	SELF ASSEMBLY KIT
SX 1000	£12.95
SX 2000	£19.95
TX 1002	£22.95
TX 2002	£32.95
AT 80	£32.95
VOYAGER	£64.95
MAGIDICE	£9.95

PRICES INC. VAT. POSTAGE & PACKING

NAME _____ EE
ADDRESS _____

I ENCLOSE CHEQUE(S)/POSTAL ORDERS FOR

£ _____ KIT REF. _____

CHEQUE NO. _____

PHONE YOUR ORDER WITH ACCESS/BARCLAYCARD
SEND ONLY SAE IF BROCHURE IS REQUIRED

BRANDLEADING BRITISH ELECTRONICS
CUT OUT THE COUPON NOW! 697

Everyday ELECTRONICS

VOL. 11 NO. 11 NOVEMBER 1982

Editor
F. E. BENNETT

Assistant Editor
B. W. TERRELL B.Sc.

Production and News Editor
D. G. BARRINGTON

Projects Editor
G. P. HODGSON

Art Editor
R. F. PALMER

Assistant Art Editor
P. A. LOATES

Technical Illustrator
D. J. GOODING Tech. (CEI)

Secretary
JACQUELINE DOIDGE

Editorial Offices
KINGS REACH TOWER
STAMFORD STREET
LONDON SE1 9LS
Phone: 01-261 6873

Advertisement Manager
R. SMITH
Phone: 01-261 6671

Representative
R. WILLETT
Phone: 01-261 6865

Classified Supervisor
B. BLAKE
Phone: 01-261 5897

Make-Up and Copy Department
Phone: 01-261 6615

Advertisement Offices
KINGS REACH TOWER
STAMFORD STREET
LONDON SE1 9LS

Readers' Enquiries

We cannot undertake to answer readers' letters requesting modifications, designs or information on commercial equipment or subjects not published by us. All letters requiring a personal reply should be accompanied by a stamped self-addressed envelope.

We cannot undertake to engage in discussions on the telephone.

Component Supplies

Readers should note that we do not supply electronic components for building the projects featured in EVERYDAY ELECTRONICS, but these requirements can be met by our advertisers.

All reasonable precautions are taken to ensure that the advice and data given to readers are reliable. We cannot however guarantee it, and we cannot accept legal responsibility for it. Prices quoted are those current as we go to press.

BRAVE NEW WORLD

AN OFFICIAL view of the Brave New World soon to evolve has been given by the Minister for Information Technology. Speaking at the British Association in September, Mr Kenneth Baker MP painted a cheerful picture and was optimistic about what laid in store.

The central point of his story was that society would be greatly changed in its habits; the established life pattern of school, work, leisure and retirement would be broken. Learning would be an on-going process throughout life, in part dictated by necessity to re-train for new jobs created by advances in technology, and in part as purely recreational and cultural pursuits to help fill in those longer periods between work stints. For work would be performed in 2, 4, 6 or 8 hour "packages", according to individual preferences—at home on many instances.

The decentralisation of work was seen as a great advantage: socially—in helping to nurture family life; politically and economically—in encouraging smaller industrial units that will be more flexible and efficient than over-centralised bureaucratic hierarchies.

According to Mr Baker, one out of two of the present UK workforce come within the classification of "information operators". This means those who are employed in service trades or professions that involve the organisation, transmission, storage and retrieval, application or creation of information; plus engineers and factory workers who make electronic equipment for the information economy.

Can man live by information alone? But of course there remains the other half of the working population to grow the food, build the houses, make the motor cars and produce those other little necessities that keep body and soul together.

And what of this technology upon which all depends. Is it a new technology or is it merely an amalgamation of well known services that have been long available? Our new series *The Electronics of Information Technology* starting this month will endeavour to get to the truth of the matter.

It seems ironic that salvation from over-centralised industries and government agencies is to come via the most highly organised use of electronic based services, with their interdependence one on the other.

Are we to be released from one net to become ensnared in another?

The strands linking the information networks of the future may be gossamer-like optic fibres but their data carrying capability will be tremendous. They will constitute a powerful means to influence, as well as inform people inside their homes and elsewhere.

This is one aspect of the coming Information Economy that could give cause for concern.

Fred Bennett

Readers' Enquiries

We cannot undertake to answer readers' letters requesting modifications, designs or information on commercial equipment or subjects not published by us. All letters requiring a personal reply should be accompanied by a stamped self-addressed envelope.

We cannot undertake to engage in discussions on the telephone.

Component Supplies

Readers should note that we do not supply electronic components for building the projects featured in EVERYDAY ELECTRONICS, but these requirements can be met by our advertisers.

All reasonable precautions are taken to ensure that the advice and data given to readers are reliable. We cannot however guarantee it, and we cannot accept legal responsibility for it. Prices quoted are those current as we go to press.

Back Issues

Certain back issues of EVERYDAY ELECTRONICS are available worldwide price £1.00 inclusive of postage and packing per copy. Enquiries with remittance should be sent to Post Sales Department, IPC Magazines Ltd., Lavington House, 25 Lavington Street, London SE1 0PF. In the event of non-availability remittances will be returned.

Binders

Binders to hold one volume (12 issues) are available from the above address for £4.60 inclusive of postage and packing worldwide. Please state which Volume.

Subscriptions

Annual subscription for delivery direct to any address in the UK: £12.00. Overseas: £13.00. Cheques should be made payable to IPC Magazines Ltd., and sent to Room 2613, Kings Reach Tower, Stamford Street, London SE1 9LS.



THIS Combination Lock, unlike push-button versions, uses a rotary switch to enter the combination in a similar fashion to that found on mechanical safes. The combination is a five digit number and any incorrectly entered number will immediately reset the lock.

With nine numbers on the dial, there is over thirty six thousand different combinations of five numbers, enough to keep uninvited fingers busy for quite a long time!

CIRCUIT DESCRIPTION

The complete circuit diagram for the Combination Lock is shown in Fig. 1. R1 and R4 are used to bias pin 1 of IC2a to a high state (logic 1). When a high input is taken to connection PL1-1, pin 2 goes high. IC2a is an AND gate, so therefore under these conditions pin 3 will go high. As pin 3 and 2 are connected together the high output at pin 3 will keep pin 2 high even after the high input at PL1-1 is removed. IC2a is therefore latched "on" by this high input.

The output of IC2a is connected to pin 1 of IC1a thus making pin 1 of

IC1a high when IC2a is latched on. When a high input is taken to connection PL1-2 it will now have the same effect on IC1a as a high input at PL1-1 did on IC2a, that is, it latches on.

The same process occurs with high inputs at PL1-3, 4 and 5 on IC1b, c and d respectively, but only if the previous gate has been latched on. Thus making the five inputs at connections PL1-1 to 5 sequential, that is, PL1-1 high, PL1-2 high and so on.

DOUBLE CHECK

IC2b, c and d are used as a double check for a complete set of inputs. IC2b compares the outputs of IC1a and b. If they are both high then IC2b goes high. This output is then compared with the output of IC1c by IC2c. IC2d then compares the output of IC2c with the output of IC2c with the output of IC1d.

Therefore IC2b, c and d form a 4-input AND gate which will only output a high (logic 1) if IC1a, b and c and d have high outputs.

So together, IC1 and IC2 form a sequential five input logic system which could have many uses.

COMBINATION LOCK

BY C. MUTEN

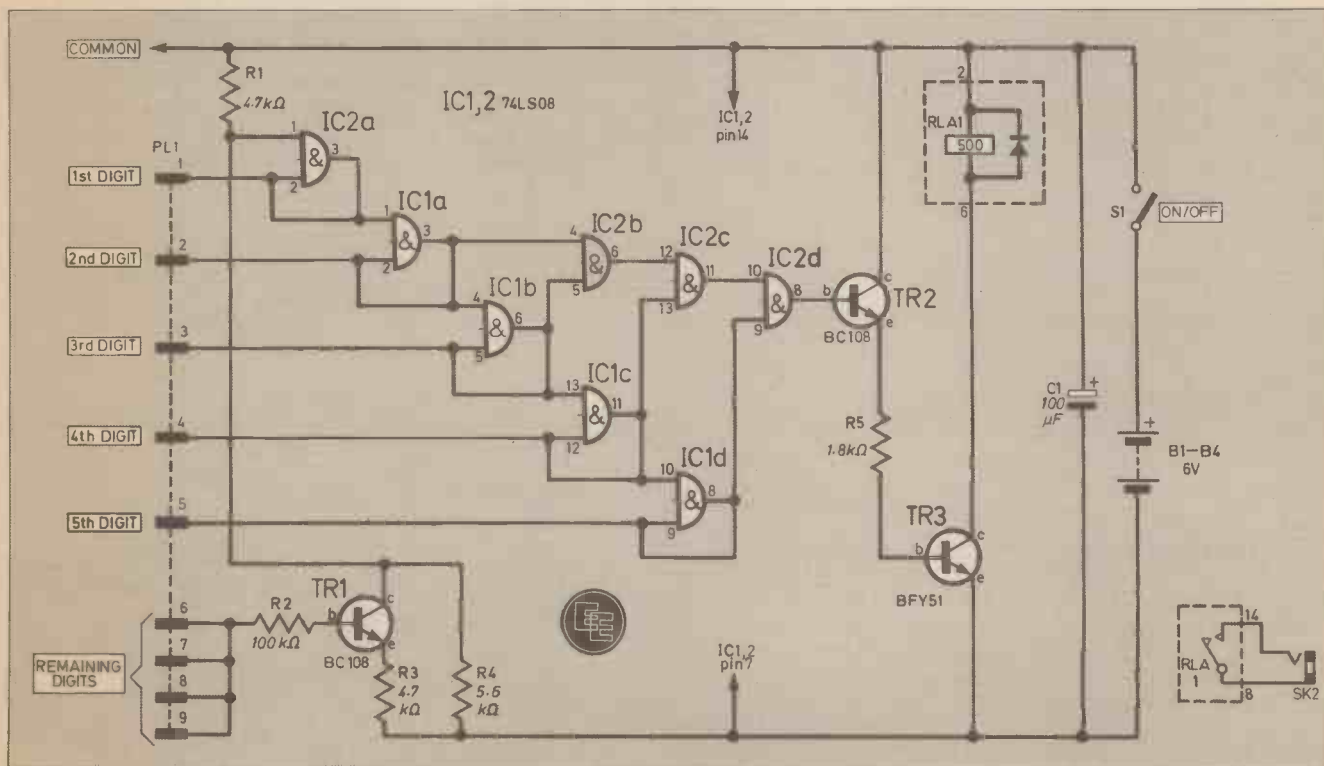

Fig. 1. Circuit diagram of the Combination Lock unit.

RESET

Inputs PL1-6, 7, 8 and 9 are used as a reset input, along with TR1, R2 and R3. When a high input is taken to one of these inputs, it goes via R2 to TR1 which is switched on and therefore puts R3 in parallel with R4. This changes the biasing on pin 1 of IC2a and causes it to go low (logic 0). If pin 1 is low then pin 3 will go low and also pin 2. As IC1a has an input connected to the output of IC2a then it will also produce a low output and so will each successive gate in the system until all outputs are low.

Therefore a high input at PL1-6, 7, 8 or 9 causes the whole logic system to be reset and await a high input at PL1-1 to restart the sequence again.

OUTPUT STAGE

Pin 8 of IC2d is the output of the logic system and is connected to the base of TR2. When pin 8 goes high, that is, when the combination input is correct and complete, TR2 is switched on. This causes a current to flow through R5 to the base of TR3 and therefore switch it on and in turn energise the relay coil.

An integral diode in the d.i.l. relay is used to protect TR3 from the back e.m.f. of the relay coil and C1 is used to decouple the supply voltage.

COMBINATION SWITCH

The circuit diagram of the combination switch unit is shown in Fig. 2. The +ve supply is brought in via and the ENTER switch, S2, to the pole of rotary switch S3. The number of the first digit of the combination must be connected to SK1-1, the second digit to SK1-2, and so on to the fifth digit connected to SK1-5.

The four unused digits are wired to SK1-6 to 9.

Fig. 2. Circuit diagram of the switch unit. Note that SK1 is attached via a length of 9-way screened cable, the screen forming the common connection.

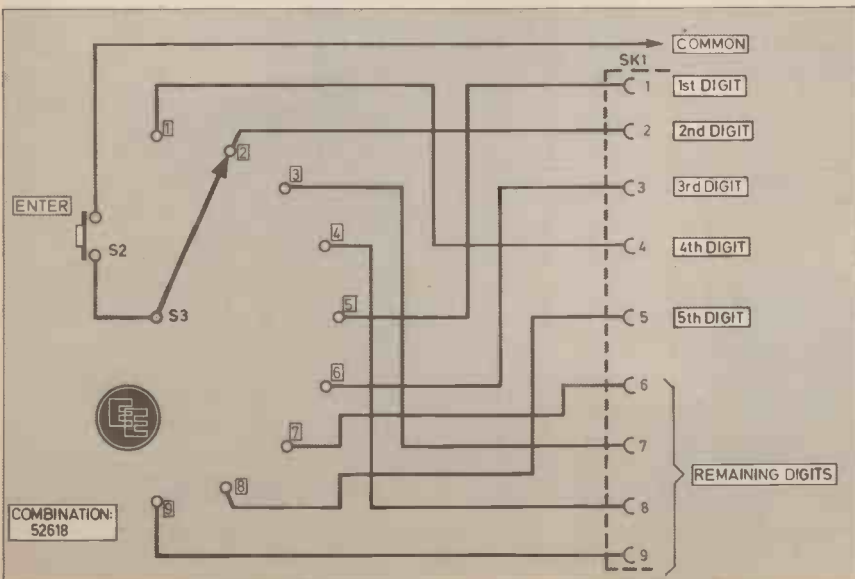

In this way, when the switch S3 is turned to the relevant number and the ENTER button is pressed, the logic high will be entered on the corresponding input on PL1 on the main unit.

Any combination can be set up, but the same number must not be used as consecutive digits and all numbers must be connected to SK1.



COMPONENT BOARD

The components were mounted on a printed circuit board measuring 95 x 36mm, as shown in Fig. 3. Start by inserting and soldering the Veropins and the 9-way minicon plug assembly, PL1, then the six short wire links. Resistors R1 to R5 can then be soldered in. Ensure correct orientation of C1 and also the relay RLA1 which is a special d.i.l. relay with its own internal protection diode, but an additional diode is required if a different relay is used, in which case it should be soldered across the coil terminals on the relay. Solder in TR1, 2, and 3 with care and also observe correct orientation of their leads.

IC1 and 2 can be soldered in but i.c. sockets are preferred.

CASE

The main unit was housed in an aluminium case measuring 100 x 40 x 74mm, as shown in the photographs.

COMPONENTS

Resistors

R1, 3	4.7k Ω (2 off)	See
R2	100k Ω	Shop Talk
R4	5.6k Ω	
R5	1.8k Ω	
All $\frac{1}{4}$ W	carbon $\pm 5\%$	

Capacitors

C1	100 μ F 10V elect
----	-----------------------

Semiconductors

TR1,2	BC108 silicon <i>npn</i> (2 off)
TR3	BFY51 silicon <i>npn</i>
IC1,2	74LS08 Low power Schottky TTL quad 2-Input AND gate (2 off)

Miscellaneous

S1	s.p.s.t. miniature toggle switch
S2	Push-to-make miniature keyboard switch
S3	Single pole, 9-way rotary switch
RLA	Miniature d.i.l. relay, 4-10V, 500 Ω coil
B1-4	1.5V HP7 cell (4 off)
SK1	9-way minicon socket, 0.1in. pitch
SK2	3.5mm jack socket
PL1	9-way minicon plug, 0.1in. pitch
PL2	3.5mm jack plug

Single sided p.c.b. 94 x 36mm; aluminium case, 102 x 70 x 38mm (type AB9); die cast box, 50 x 50 x 30mm; 9-way screened cable, 1m long; battery holder for 4 AA size cells; battery clip; P-clip; 14 pin i.c. holder (2 off); grommet (2 off); 7/0.2mm wire; knob; 6B Acounter-sunk screws, 10mm long (4 off); 6BA nuts (4 off); 6BA clearance spacers, 6.4mm long (4 off).

S1 and SK2, the relay output, were mounted on one end of the case along with a grommet for the 9-core cable to pass through.

The p.c.b. was mounted on one side of the case so that the 6BA counter-sunk screw heads would be covered by the lid of the case. The p.c.b. must be spaced away from the side to prevent the lid fixing screws from being obstructed by it.

The battery, made up of four HP7 (size AA) cells in a special holder, was held in place by an aluminium bracket made to suit the battery and case. This was fixed to the opposite





COMPONENTS
approximate
cost £9 excluding
 batteries

View inside the case showing the mounting of the p.c.b. on one side of the base. Spacers must be used to prevent short circuits.

Remote switch unit mounted in diecast box.

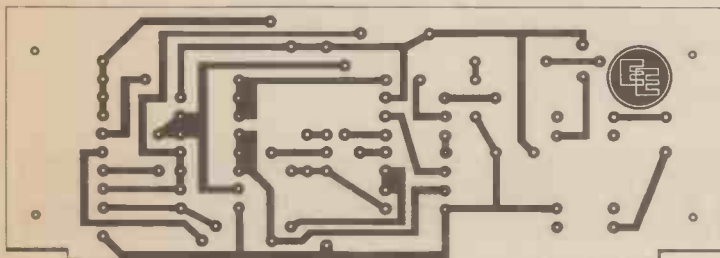
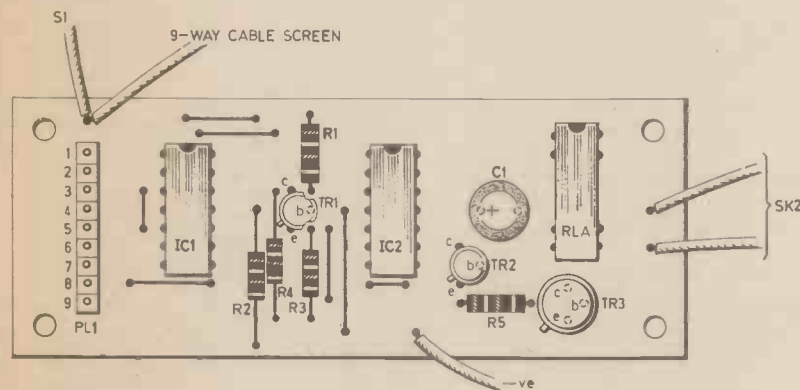

Fig. 3. Full size p.c.b. artwork and component layout. Note that corner cut-outs are only shown on track view. Photograph below shows the finished prototype p.c.b. assembly.

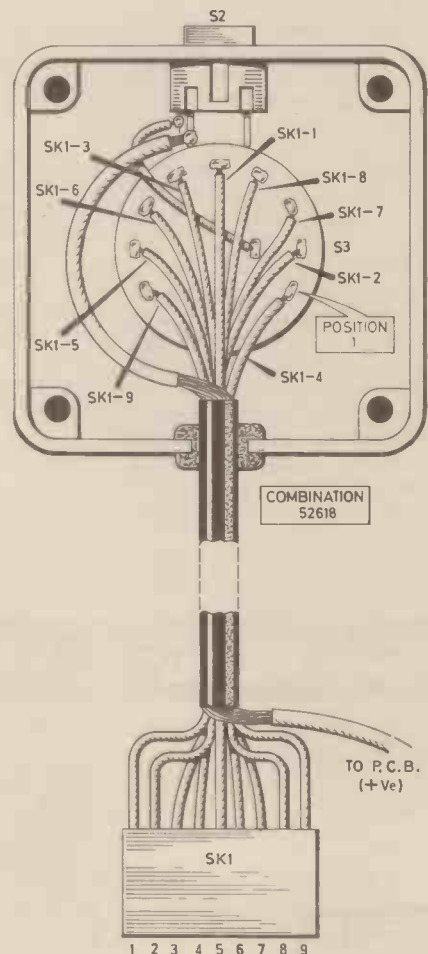
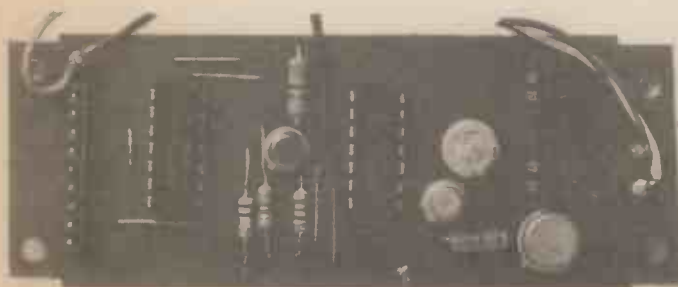
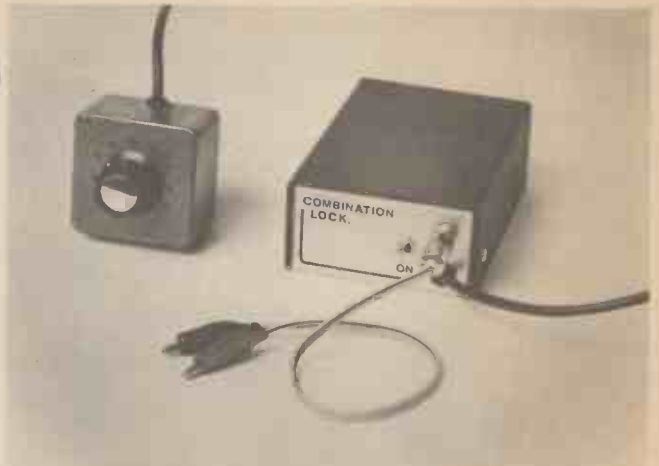

Fig. 4. Wiring of the remote combination switch for the number given. Any five figure number can be set up by re-arranging the connections to SK1. Note that if a different switch is used for S2, it may require more space.



Top view with cover removed clearly showing the battery pack retaining bracket.



Complete Combination Lock system with a test lead plugged into the relay output to connect it to a solenoid or similar device.

side of the case from the p.c.b. by a 6BA countersunk screw, nut and shakeproof washer.

This bracket was also used to hold the 9-core cable in place with a P-Clip. The 9 individual cores of the cable were connected to the p.c.b. by a 9-way minicon plug (PL1) assembly, cut from a 12-way. This could easily be unplugged from the p.c.b. and the combination changed as required. The screen of the 9-core cable was used as the +ve supply connection and this was soldered to the Veropin shown on Fig. 3, from which also a wire goes to the battery +ve via S1.

The 9-core cable goes to the remote switch unit, Fig. 4, which consists of a 1-pole 9-way rotary switch S3 and a non-locking push switch S2. The screen of the cable connects to the pole of S3 via S2. The other connections of S3 make up the numbers 1 to 9 for the combination input.

S2 and S3 were mounted in a small die cast aluminium box measuring 50 x 50 x 30mm. S2 was mounted on the underside edge of the box and its connections rest against the body of S3, therefore holding itself in place.

FINISH

The main unit and switch unit were lettered with rub-down lettering and covered with a spray-on varnish for protection.

The lid of the main unit was covered with cabinet covering cloth to enhance its appearance.

COMBINATION SETTING

By use of nine core screened cable all the necessary connections in the remote switch unit could be taken to the main unit. In the main unit the nine individual cores were connected

to the p.c.b. by a minicon plug and socket assembly. This means that the socket can be unplugged from the p.c.b. The contacts in it, which are connected to the nine cores, could then be swapped round, thus changing the combination as required.

In the nine core cable used on the prototype, the nine individual cores had different coloured sleeving so if it is noted to which number each colour connects to in the remote switch unit, it would make it easier to decide what the combination is when setting it in the main unit.

The combination is a five figure number and it must be remembered that the first figure connects to SK1-1, the second to SK1-2, the third to SK1-3, the fourth to SK1-4, and the fifth to SK1-5, and the remaining false numbers to SK1-6 to 9 on the minicon socket. □

JACK PLUG & FAMILY...

BY DOUG BAKER



TAPE CONTROLLER FOR THE ZX81 AND ZX SPECTRUM



BY V. TERRELL

THE unit described below has been designed to work in conjunction with the ZX81 Microcomputer and a standard cassette recorder to allow LOAD and SAVE operations to be carried out without the need to unplug leads whenever a program is saved or loaded. The unit may also, with slight modification be usefully employed by ZX Spectrum users.

TAPE LOADING

The normal procedure in loading a program from tape, is firstly, to judge roughly where the beginning of the program starts by using the cassette tape counter (if fitted) and then to pull the plug out of the "ear" socket thereby enabling the cassette internal speaker to operate. Now because the volume setting is normally kept at about three-quarters fully on (which is often forgotten) you are invariably blasted by a 1-2kHz tone everytime the plug is pulled. With the volume reduced the exact position is now found before the plug has to be put back and the volume level readjusted before making a load.

With some cassette recorders the volume setting is critical and having to repeat the whole procedure several times is not uncommon before a good

load is made. With this laborious and unsatisfactory method it is only a matter of time before the ear socket or plug connections become intermittent causing bad loads. The same can be said for the "mic." socket where if you name your programs using the cassette internal or external microphone, the mic. lead has to be removed and replaced everytime.

The ZX Tape Controller contains a microphone and loudspeaker to overcome these problems.

OTHER FACILITIES

Another useful feature that has been included is a switch to erase the tape when required.

The other plug that occasionally has to be pulled out is the 9 volt supply to reset the computer. This is necessary when you cannot break out of a loop or the program has crashed for some reason and the keyboard has no effect. The only way out of this problem is to disconnect the supply to the computer. The Controller is fitted with a switch to accomplish a reset. An l.e.d. lamp gives a visual indication that power is being applied to the unit from the ZX Power Supply.

CIRCUIT DIAGRAM

The complete circuit diagram for the ZX Tape Controller is shown in Fig. 1. The supply voltage for MIC1 and D1 are taken from the ZX Power Supply.

The microphone element MIC1 contains an amplifier fed by a sound pressure sensitive condenser. The device will operate from 2 to 10V and has been set to operate at 4.5 volts by the potential divider composed of R2 and R3.

Resistor R1 limits the current through D1, the light emitting diode power indicator. Smoothing capacitor C2 prevents hum while C1 couples the output of the microphone element to the 4-way selector switch S3. Switch S1, a momentary action push-to-break type disconnects the power to the computer when pressed and thereby effectively resets the system. The switch S2 when pressed shorts the recorder microphone input to earth allowing the tape to be erased with the minimum of noise.

MODE SELECTOR SWITCH

Only two poles of the three-pole rotary selector switch S3 are used. The 4-way action of the switch will select one mode at a time. In Fig. 1,

S3 is shown in the LOAD position where S3a connects the EAR socket SK1 to the EAR plug, PL1.

The next position on the switch is CUE. This allows you to listen to any instructions preceding the program and to set the tape in the correct position prior to loading (or saving). This connects the loudspeaker LS1 to the cassette recorder ear socket.

In spite of the small physical size of the speaker, and its low efficiency, the volume level produced by the speaker is adequate for such listening purposes with the cassette volume control set to about three-quarters fully on—normal setting. A larger speaker could be used with a 1 kilohm preset wired in series with the speaker to reduce the volume, but this would require a larger case than that specified.

The third position of S3 is SAVE, where S3b connects the MIC socket to the MIC plug. The last position, TALK, connects the microphone element to the cassette recorder mic. input allowing programs to be voice labelled, and any instructions regarding the program to be included.

SPECTRUM CONTROLLER

The lead from the Spectrum Power Supply is terminated in a different type of connector to that found on the ZX81 Power Supply. It is known as a cassette power connector and requires

a matching socket. Thus PL3 and SK3 specification will be different for the Spectrum—see Component List.

Also, the input sockets on the Spectrum are located in a different position to the ZX81 and spaced apart on the rear of the computer. The screened leads running to the plugs will need to be longer than specified below. The exact lengths will depend on the final position of the unit with respect to the computer.



NO BOARD

As very few of the components are not case mounted, it was not thought worthwhile using a circuit board. Instead, a point-to-point wiring technique was decided upon.

All the components fitted inside a plastic case measuring only 75x50x28mm. Details for drilling this case are shown in Fig. 2.

Start assembly by soldering two short lengths of connecting wire

COMPONENTS

Resistors

R1	1k Ω
R2	4.7k Ω
R3	4.7k Ω
All	$\frac{1}{4}$ W carbon $\pm 5\%$

See
**Shop
Talk**
page 722

Capacitors

C1, C2	10 μ F 16 volt elect. radial lead types (2 off)
--------	---

Semiconductors

D1	TIL220 0.2 inch dia. red l.e.d.
MIC1	Electret condenser microphone element (Tandy 270-092A)

Miscellaneous

S1	s.p.s.t. miniature press-to-break release-to-make, 1A d.c.
S2	s.p.s.t. miniature press-to-make, release-to-break
S3	3-pole 4-way rotary, midget wafer
SK1,2,3	3.5mm jack socket (3 off), chassis type
PL1,2,3	3.5mm jack plug (3 off)
LS1	8 Ω loudspeaker 28mm diameter (J. Bull)
Plastic case 75 x 50 x 28mm; pointer knob; screened cable; rubber feet (4 off); connecting wire; solder.	

ZX Spectrum

Components as above except:—	
SK3	2.5mm cassette power supply socket (Maplin HH62S)
PL3	2.5mm standard cassette power supply plug (Maplin HH86T)

Approx. cost **£6.00**
Guidance only

(about 50mm long) to each of the sockets SK1, 2 and 3 then fix the three sockets to the case. Now wire the three plugs PL1, 2 and 3 each with about 25cm of screened cable.

GLUED COMPONENTS

Next glue the loudspeaker in position with an adhesive such as Evo-Stik Clear.

The microphone sound aperture is only 2.5mm in diameter and is located in the centre at one end of the element and is masked by a disc of cloth. To fix it to the case spread a film of glue around the edge of the cloth only, then hold the element with its connections positioned as shown in Fig. 3 centrally over the hole until the glue sets.

Next glue D1 to the case with its anode lead facing towards the loudspeaker.

At this stage the assembly is best left for a few hours to allow the glue to harden.

When the glue has set, locate and secure the three switches and finally

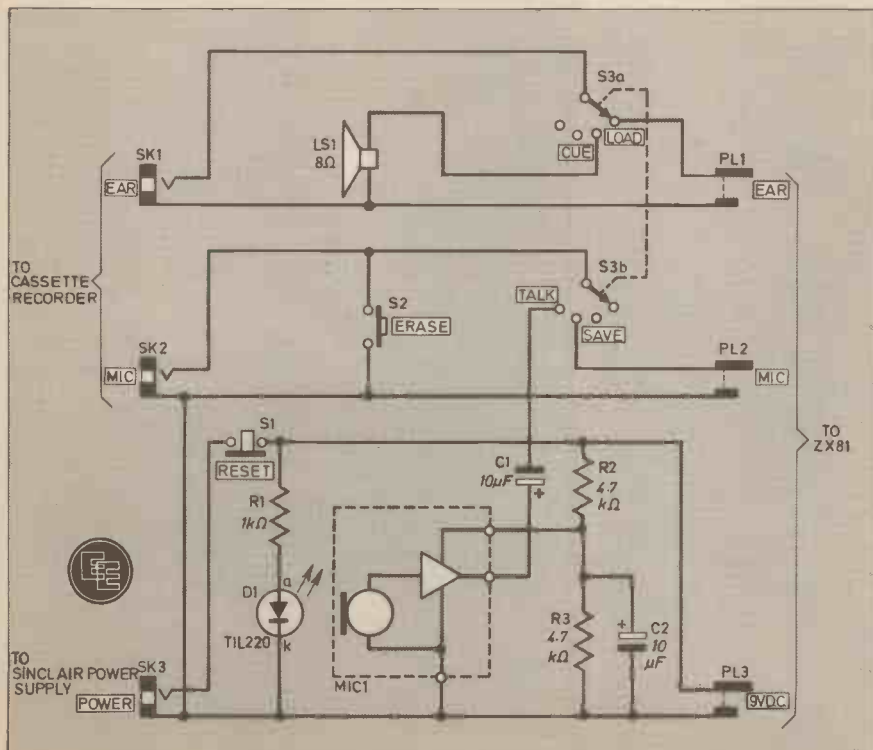

Fig. 1. Complete circuit diagram of the Tape Controller.



The Tape Controller in use with the ZX81 showing top panel labelling.



Close-up view of the internal construction of the prototype unit.

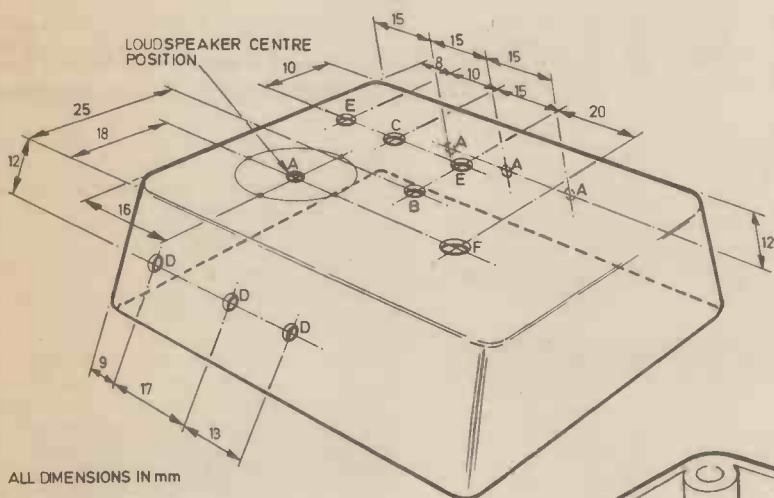

ALL DIMENSIONS IN mm

- 4 - HOLES 'A' 3mm DIA
- 1 - HOLE 'B' 3.5mm DIA
- 1 - HOLE 'C' 5mm DIA
- 3 - HOLES 'D' 6mm DIA
- 2 - HOLES 'E' 7.5mm DIA
- 1 - HOLE 'F' 9.5mm DIA

Fig 2. (above) Dimensions and drilling details for the plastics case specified.

Fig. 3. Shows all components in position in the case with complete interwiring. All interconnecting wire should be the insulated variety, and component leads sleeved where there is any likelihood of neighbouring leads touching.

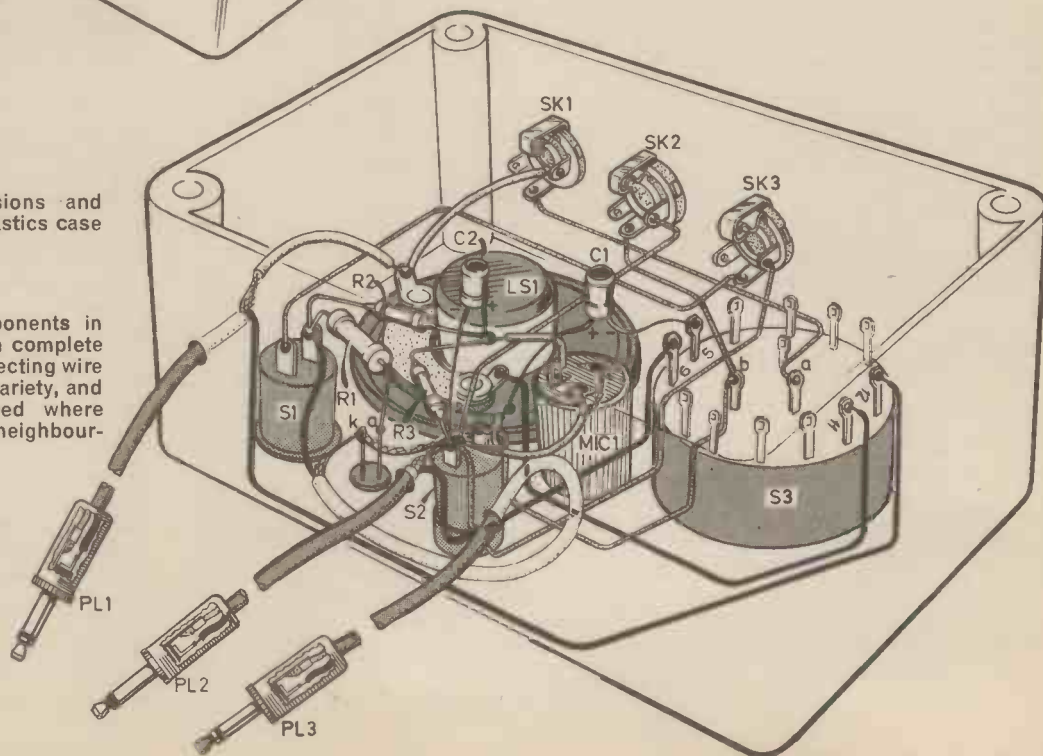

Labelling of the input sockets on the side of the Controller.

complete all the wiring as shown in Fig. 3. It is a good idea to trace each connection on the plan as it is made using a coloured pencil or felt-tip pen.

FINISHING OFF

The labelling of the Controller was made with dry transfer lettering (No. 1) onto coloured self adhesive labels (HP010) both obtainable from W. H. Smiths. See photographs for labelling details.

A rectangle of ribbed rubber matting was glued to the underside (the case lid) to prevent the unit from sliding around in use. Alternatively four self-adhesive rubber feet could be used.

With the labels attached, rotate and secure S3 so that when the pointer knob is fitted, it correctly aligns with the label marked positions.

TESTING

Carefully inspect all the connections and check that the unit is wired up correctly.

Connect the Sinclair Power Supply to the Tape Controller only and see that D1 lights up and is extinguished when S1 is pressed. If so, then plug the 9 volt lead (PL3) into the computer to check that power reaches the computer, and that S1 removes it. The computer will need to be plugged into the T.V. set in the normal manner to determine this.

Finally, plug the EAR and MIC leads into the computer and tape recorder and test all the functions.

CONTROLLER TIPS

1. Using the inbuilt microphone (TALK facility) to name and list

any instructions about your programs prior to the actual program itself is a good idea because what may be very clear when the program is first written may not be so clear a month or so later.

2. By pressing the ERASE for a short period after the save report code comes up on the screen will leave a clean section of tape and thus ready for your next save.
3. Save all your programs at least twice before re-loading to verify the save.
4. Reset the computer (by pressing RESET) only when you are certain the program has either crashed or gone into an endless loop. Remember once pressed all the memory is cleared. ☐

COUNTER INTELLIGENCE

By PAUL YOUNG

Ever the Optimist

The optimist is the fellow who says, "When one door shuts, another door opens"; while the pessimist says, "When one door shuts, another door closes". I belong to the former school of thought, although I am bound to admit that I must agree with Dr. Johnson when he said, apropos a friend of his remarrying after losing his wife, "A triumph of hope over experience".

I was therefore pleased to see that although Home Radio (Components) Ltd. had ceased business, T. Powell has just opened an electronics components shop in Edgware Road, London (see *Shop Talk* last month). If I may enlarge on that, T. Powell is handling the complete range of Cydon compression trimmers and the A.70 Short Wave aerial (designed very much on the lines of the original Eddystone Aerial). Both of these items were formerly stocked by Home Radio.

Enquiries about any other Home Radio items should be made to: Mr Alan Mason, Maydale Electronic Services, 2, Wellesley Parade, Godstone Road, Whyteleafe, Surrey CR3 0BL. I should add that the stock includes the "Universal Chassis".

London Scene

I know that a large number of our readers must live in or around the Capital and so for reasons that will be apparent later I decided to look at the London scene. I did this with a view to informing constructors what is available in the way of component suppliers.

I decided to start off with Lyle Street, just behind Leicester Square. Readers who know it will be aware that at one time, besides a large number of surplus shops, there were many other unusual trades.

I can now report that it is a respectable area, but alas the surplus electronic shops are reduced to three, namely "West End Radio", "Direct Electronics" and "Service Trading".

Next I turned my attention to Edgware Road, W1. Now here is a Mecca well worth exploring.

From the point where Praed Street crosses it and for the next half mile northwards towards Edgware, there are component shops and surplus shops on both sides of the road, literally dozens. I even noticed Henry's Radio back in business after their misfortune a few years ago.

Company Report

While I was in the Edgware Road I decided to call on Mr Leslie Cohen, son of the founder of Radio and TV Components Ltd. (RT-VC Ltd.), one of the real success stories in the electronics business.

Many a person has found fame and fortune because they were sacked, and this is the fate that overtook the founder of RT-VC, David Cohen. Unfit for war service he worked for E.M.I. for the whole of the war and was made redundant at the very end of it.

He said it turned out to be the biggest favour they ever did him. He worked for Jesse Bull and then early in 1950 opened a shop in Acton.

His lucky break came when the Burgoyne Soldering Iron Company's assets were auctioned. When this particular lot came up, all the other dealers had gone out for a smoke and there was only Mr Cohen left to bid and consequently he bought the whole quantity for a very low price. So low, in fact, that he was able to sell them to the public for 19/6 (97½p). The Burgoyne Iron was the first of the quick heat irons, the forerunner of the Weller.

When ITV started, RT-VC were quickly on the scene with a convertor kit, offering the aerial convertor kit and ten yards of cable for £2:19:6 (£2.97½).

Their next success came as the result of a tragedy; the De-Havilland Comet disasters. When all the Comets were grounded, David bought pieces of the airframe and converted them into TV aerials. They did have a slight setback with this, as initially the aerials would not work and it turned out that the metal was anodised and the anodising was a perfect insulator.

At this point I asked Leslie Cohen how long he has been interested in electronics himself, and he replied "All my life. When I was young, the war was on and there were no toys, so I played with bits and pieces of radio equipment."

Returning to the company history, after this came the transistor and a whole series of kits followed. Simple t.r.f. kits, superhets, and then battery portables. Also, RT-VC were the first firm to offer a stereo kit to the home constructor for under £25.

They opened their shop in Edgware Road in 1963, and in 1964 sold 50,000 car radio kits. David Cohen died in March 1978 and Leslie became managing director, his other two directors being his mother and Mr Nemes who is a technical genius.

Apart from being an astute business man Leslie Cohen is a skilled designer himself, and several designs which have appeared in the electronic magazines came from his drawing board.

When I tell you that since 1955 RT-VC have produced two and a half million kits I think you will agree that this is one of the most successful electronic businesses in the trade today.

I like to hear of new businesses starting up, but it takes a brave man to do it these days, especially if you consider the following statistics. "One business in three fails in the first year, and four out of five fail in the first five years". A sobering thought for the would-be entrepreneur!

Conundrum

Whenever I possibly can, I like to leave readers with a puzzle to solve. It is not entirely divorced from electronics, as electronics concerns communication and so does my conundrum.

Imagine being imprisoned as a spy and the occupant of the next cells knocks on the wall. How would you communicate with him? To make it more interesting, I will tell you that he doesn't know the Morse Code.

I await your replies with great interest. All will be revealed next month.

A NEW SERIES FEATURING A TEARLESS
TABLETOP TECHNIQUE BY GEORGE HYTON

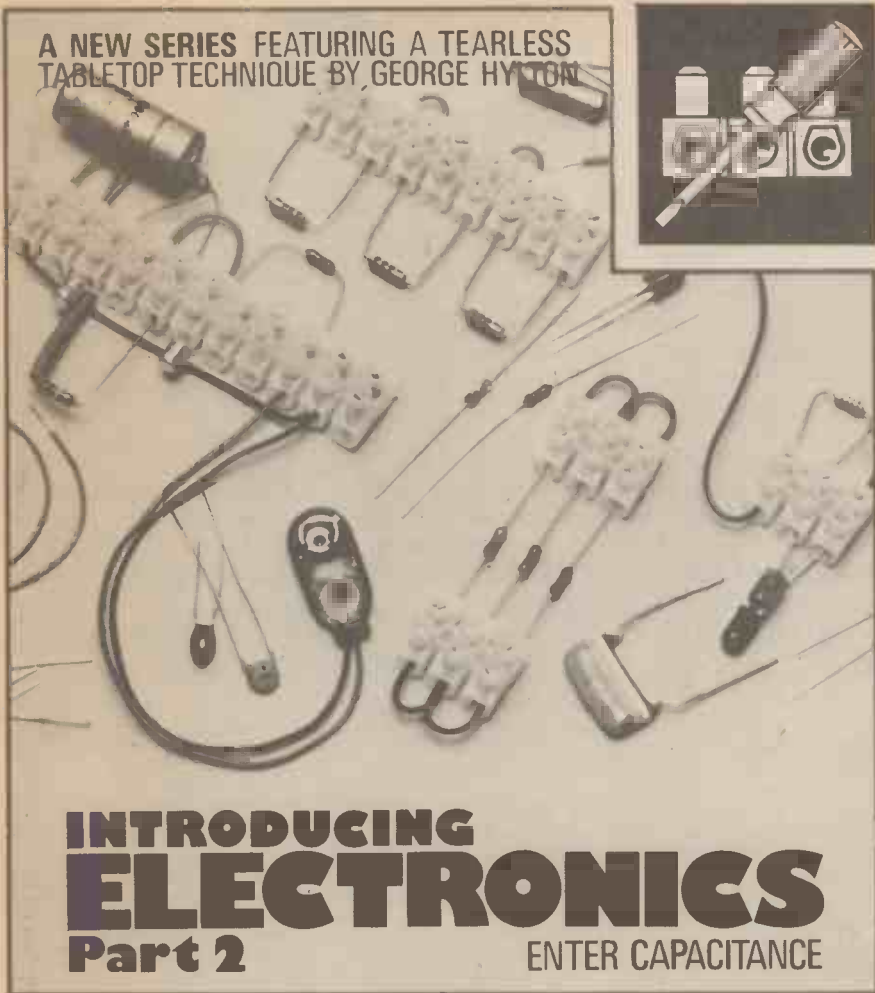

INTRODUCING ELECTRONICS Part 2

ENTER CAPACITANCE

LAST month we explored circuits which contained only resistance. This time we shall add capacitance. But first, a look at a special form of resistance which is one of the most useful devices in electronics.

You know it as a volume control. It is also referred to (not quite accurately) as a potentiometer, or "pot" for short. It is an adjustable device (Fig. 2.1a) with a resistive track which runs from A to B over which slides a moving contact C.

If a voltmeter ME1 is connected between slider (C) and one end of the track (B) as shown, then as C is slid from B to A slowly, the voltage indicated rises smoothly from zero to the full battery voltage (here 6V). The slider C can be set to "tap off" any voltage required, up to the full battery voltage.

POTENTIAL

The voltage at a point like C is often called a "potential". Potential means possible as opposed to actual. The voltage measured by the meter ME1 may be rather less than you expect. This is because the meter itself draws current.

This current, in flowing through the upper part (A-C) of the track, causes a fall in voltage which adds to the fall caused by the main flow from A to B. So the voltage registered by ME1 is less than the potential at C.

POTENTIOMETRY

In the second circuit (Fig. 2.1b) a cell of unspecified voltage (but less than 6V) is included. If C is moved to a point on the track where the voltage is exactly the same as the cell voltage then no current flows either

into or out of the cell. This is because the 6V battery is trying to push current into the cell via C, and the cell is trying to push current the opposite way, in at C and out at B. The two efforts cancel at this one point, the "balance point".

Since no current flows via C, the voltage at C must now be the same as the potential at C. This in turn must be the same as the potential of the cell itself. If the cell potential is known, the balance point shows where the corresponding potential occurs on the track. The cell can be used to indicate a "calibration point" on the track. If the whole track can be calibrated, then balancing the circuit against an unknown cell enables the cell potential to be measured.

It is from its use in true potential-measuring circuits that the 'volume control' type of variable resistance has acquired the name potentiometer, though in its ordinary applications it is used merely as a voltage-adjusting device not a measuring device.

BRIDGES

In Fig. 2.1c, the circuit can be balanced so that there is no potential difference (p.d.) between C and D. This arrangement is a "balanced bridge" and it has many uses, mostly in measurements.

In these examples the pot is used to adjust a steady voltage from a battery, that is a d.c. voltage. (d.c. really means direct current but engineers use it of voltages as well.) In its familiar role as a volume control the voltages are a.c. (alternating current) voltages, continually changing at audio frequencies.

CAPACITANCE AND CAPACITORS

At this point we'll look at our second circuit element, capacitance. Capacitance is the power to hold an electric charge and the component that provides it is a capacitor. Capacitors used to be called condensers, from their ability to concentrate a lot of charge in a small space.

A capacitor is an electrical sandwich. The bread layers are sheets of metal. The filling is insulating

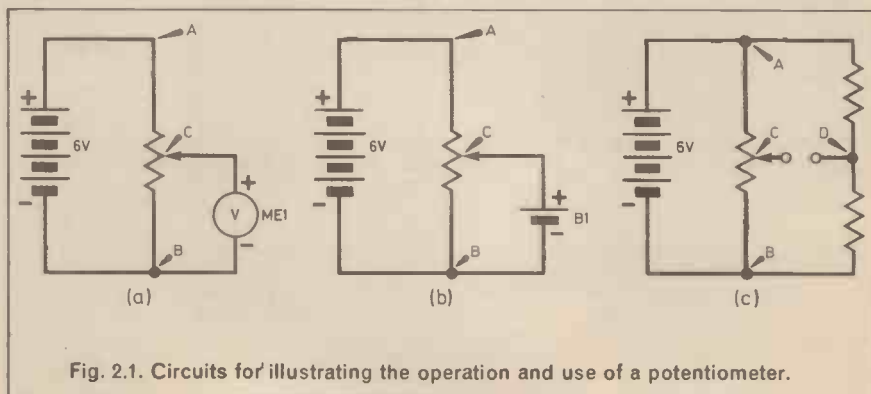

Fig. 2.1. Circuits for illustrating the operation and use of a potentiometer.

material, called in this case the dielectric. The sheets of metal are called the plates. Since in most capacitors their job is merely to conduct a charge to the dielectric they can be very thin.

In many capacitors the plates are just coatings of metal on the dielectric, which is often paper or plastic film.

The bigger the area of the plates the greater the chargeholding ability. More surprisingly, the capacity to store a charge also increases as the dielectric is made thinner. This is fortunate because it enables a lot of capacitance to be packed into a small space by using a very thin dielectric.

A favourite method nowadays is to take a long thin strip of plastic foil, coat the two sides with aluminium to form the plates, then roll it up and encapsulate it in wax or more plastic. Two lead out wires are provided, one in contact with each plate.

WORKING VOLTAGE

A snag about thin dielectrics is that they won't stand very high voltages. So every capacitor has a rated working voltage. You must not apply more than the rated voltage or the capacitor may be destroyed.

The unit of capacitance is the farad (after Michael Faraday the great Victorian physicist). For most practical purposes a farad (F) is far too large. The values you come across will be millionths of farads (microfarads, written μF), or thousand-millionths (nanofarads, written nF), or million-millionths (picofarads, written pF).

Very compact capacitors can be made by immersing plates of aluminium foil in a chemical solution and applying a voltage. This causes a very thin layer of oxide to form on the aluminium. Aluminium oxide is an insulator and acts as the dielectric. Low-voltage capacitors can be made

with very large capacitances. If you ever come across a 1F capacitor it will be of this type, which is called an electrolytic capacitor or just an electrolytic.

Unfortunately, if the voltage is removed the aluminium oxide slowly dissolves again so an electrolytic deteriorates when kept on the shelf. (If tantalum is used instead of aluminium the effect is not nearly so bad.) The oxide film dissolves very quickly if the voltage is reversed, positive to negative. The result can be quite explosive! So you must always observe polarity when using an electrolytic and connect it only in circuits where there is always a d.c. voltage across it, positive to positive plate, negative to negative plate.

For use in circuits where the d.c. is liable to reverse there are special reversible electrolytics which are really two normal ones connected back to back.

CHARGING AND DISCHARGING

For our experiments we'll start with an electrolytic of $1000\mu\text{F}$. Since our battery is 6V any working voltage above will do. (The one used by the author was rated at 16V.)

First, charge the capacitor through your l.e.d. indicator (Fig. 2.2a). A brief flash of the red lamp is all you should see, unless the $1000\mu\text{F}$ has been on the shelf a long time and has "de-formed" and gone leaky. In that case the red l.e.d. will stay on



The capacitor being charged up in circuit of Fig. 2.2.

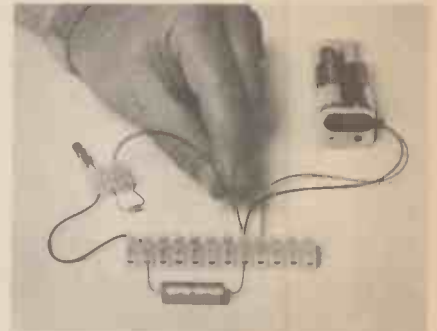

The capacitor is discharged by connecting the Indicator +ve lead to the battery -ve terminal. The green l.e.d. flashes.

until the oxide has "re-formed." (If it stays on more than a minute either the capacitor is beyond salvation or the polarity is wrong. In the latter

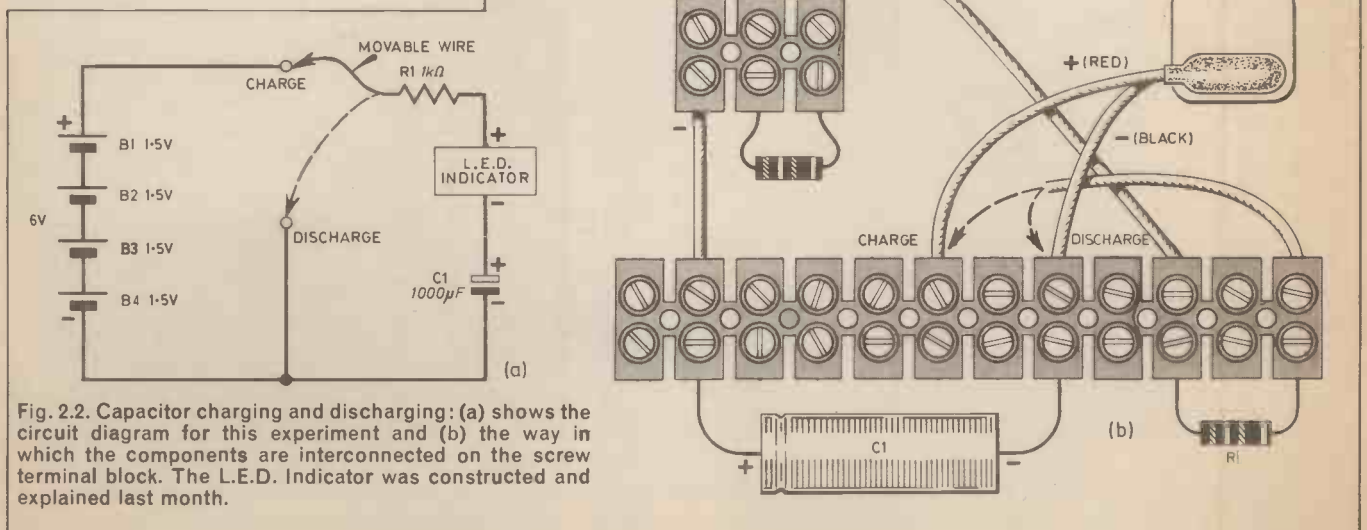

Fig. 2.2. Capacitor charging and discharging: (a) shows the circuit diagram for this experiment and (b) the way in which the components are interconnected on the screw terminal block. The L.E.D. Indicator was constructed and explained last month.

case reverse the battery connections and try again. The indicator will protect against excess current and there is no danger of an explosion.)

Having charged the $1000\mu\text{F}$, discharge it as shown by the dotted line. The green l.e.d. flashes as the current rushes out. Try repeating the experiment a few times. Evidently, from the briefness of the flashes, charging and discharging occur very rapidly.

The process can be slowed down by putting resistance in the path of the current (Fig. 2.3). Connecting $R1 (=1k\Omega)$ as shown increases the time to about a second. The l.e.d.s don't

glow so brightly now because the current is restricted to a few milliamps. Increasing the resistance slows down the process even more by allowing even smaller charging and discharging currents to flow. With a resistance ($R1$) of $100k\Omega$, the times are about 100 seconds, but the current is so small that the l.e.d.s can't be seen to glow.

TRANSISTORS

How can you tell that the capacitor is really charging when $R1$ is $100k\Omega$? You could charge it for a few minutes then discharge it through the Indicator directly, getting a flash. But we'll call in the aid of another device, the transistor.

A small current can turn on a transistor and make it pass a larger current, which can easily be 100 times greater. We can turn on the transistor with the small charging current and the Indicator with the larger, amplified current.

Connect up the circuit as shown (Fig. 2.4) but without the $1,000\mu\text{F}$ ($C1$). The small current through the $100k\Omega$ resistor $R1$ now passes from base (b) to emitter (e) and turns on the transistor. The amplified current passes through the collector (c) to the emitter. Both currents pass through the Indicator on their way to battery negative. The red l.e.d. lights.

Make sure $C1$ is discharged, then connect it as shown. The l.e.d. goes out, because the small current through $R1$ is now mostly diverted into the capacitor and not enough

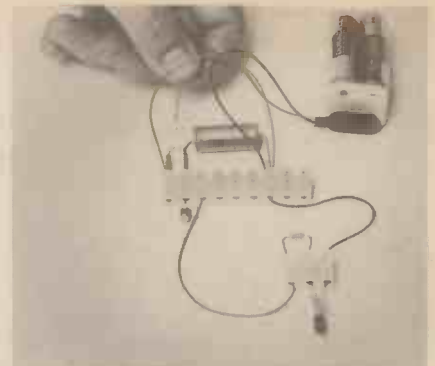

With the free wire not touching any other component, the capacitor will charge up and switch on the Indicator, see Fig. 2.4.

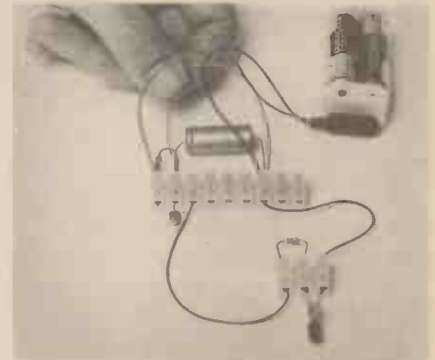

Shorting the capacitor with the wire as shown will discharge the capacitor and the Indicator will turn off (see Fig. 2.4).



Charging the capacitor through a resistor as in Fig. 2.3.



Discharging the capacitor in Fig. 2.3. There will be no green flash.

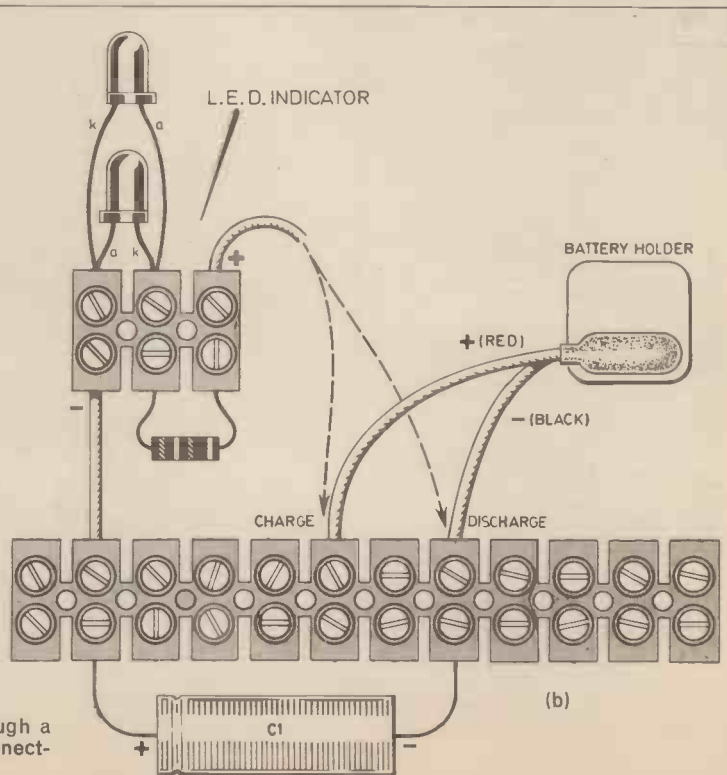
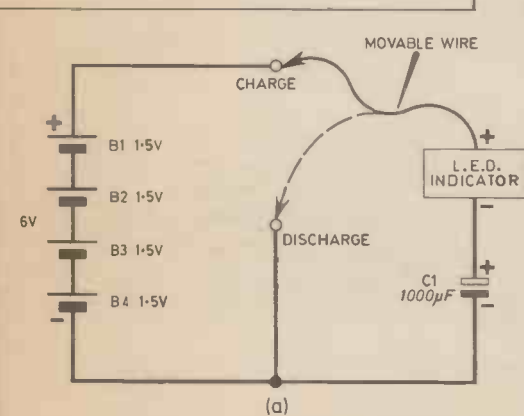

Fig. 2.3. Charging and discharging a capacitor through a resistor: (a) the circuit diagram (b) the method of connecting the components on the screw terminal block.

ADDITIONAL COMPONENTS REQUIRED FOR THIS MONTH'S EXPERIMENTS

Quantity	Description
1	Resistors
1	100Ω
1	10kΩ
1	100kΩ
	All 1/4W carbon ±5% tolerance
1	Capacitors
1	1000μF 6V elect.
1	100μF 6V elect.
1	100nF polyester, type C280
1	10nF ceramic disc
2	Semiconductors
	BC107, BC108, or BC109, or any other similar npn, silicon transistor
1	Miscellaneous
	crystal earphone

come on again and the red l.e.d. glows. If you short C1 as shown dotted, (Fig. 2.4a) the circuit is "reset" and a further half-minute blacking out of the red l.e.d. occurs. (The green l.e.d. does not glow when C1 is discharged because the current all goes through the dotted connection.)

RC TIMING CIRCUITS

Clearly, we have here the basis of a system for producing fixed time delays. RC timing circuits, that is, circuits in which a capacitance C is charged or discharged via a resistance R, are widely used.

The duration of the delay depends partly on the particular circuit (in our circuit, you'll have noticed, we get only about 30 seconds instead of the 100 seconds mentioned earlier). But

the periods are always related to what is called the RC time constant. This is R in ohms times C in farads and the answer is in seconds. So 1 ohm and 1 farad give 1 second.

Increasing the 1 ohm to 1 million ohms (1 megohm, 1M) enables C to be reduced a millionfold for the same result. So 1MΩ and 1μF also give 1 second.

Most of the timed periods in electronics are much less than a second because electronics often deals with

rapidly changing events like sound vibrations and radio waves which repeat many times per second. If we use RC circuits to generate such frequencies we need short time constants.

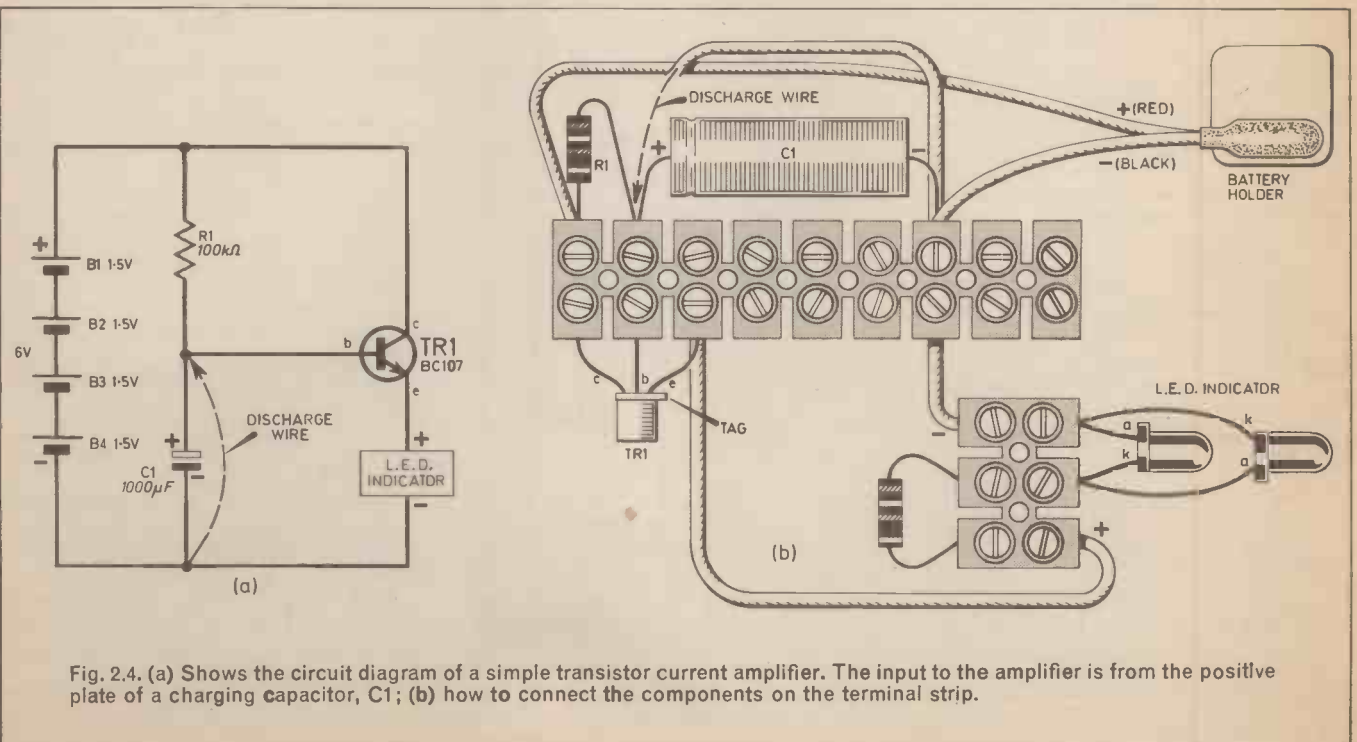
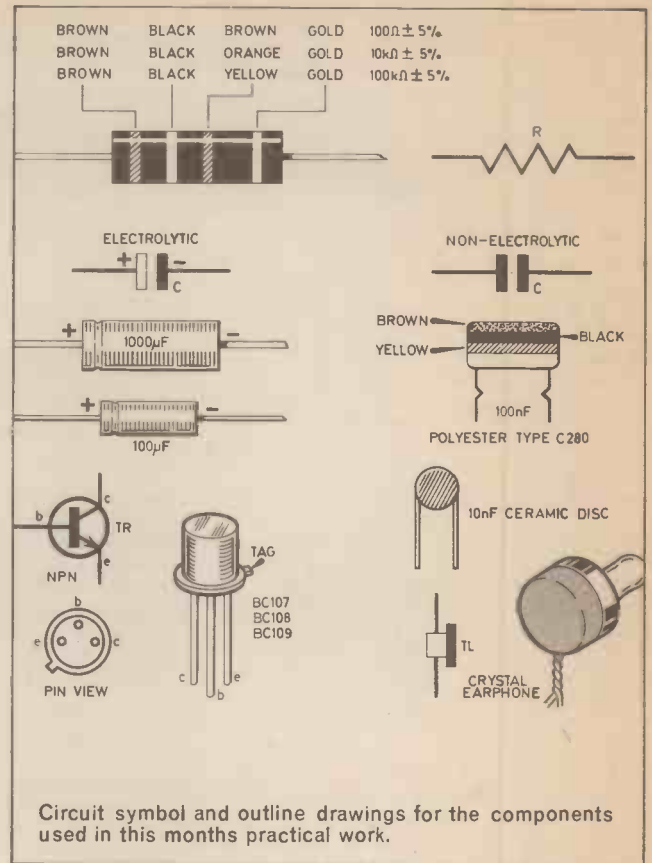

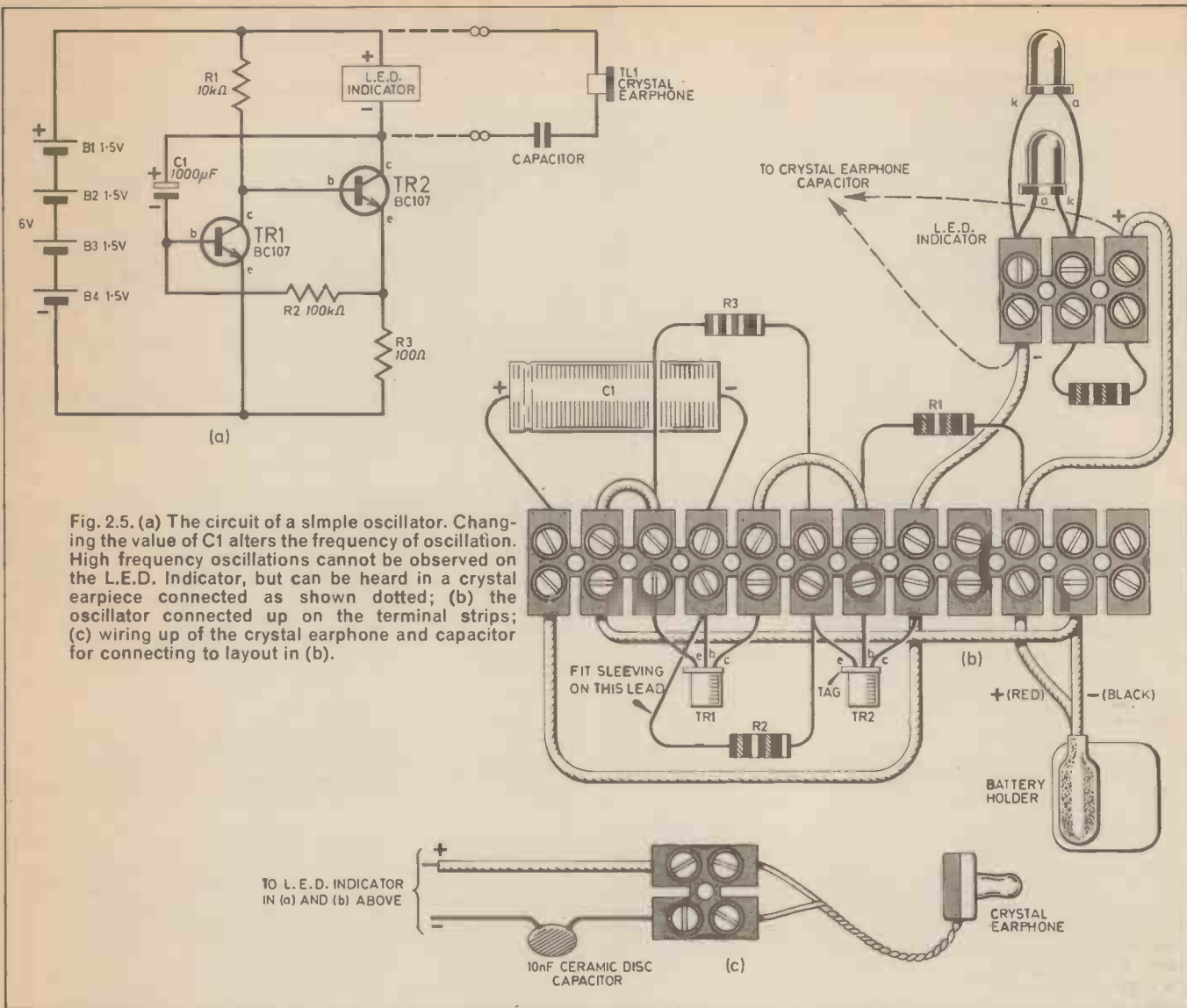

Fig. 2.5. (a) The circuit of a simple oscillator. Changing the value of C1 alters the frequency of oscillation. High frequency oscillations cannot be observed on the L.E.D. Indicator, but can be heard in a crystal earpiece connected as shown dotted; (b) the oscillator connected up on the terminal strips; (c) wiring up of the crystal earphone and capacitor for connecting to layout in (b).

RELAXATION TIME

Let's do it. We'll build an amplifier and turn it into an oscillator whose frequency is set by an RC circuit.

This time we use two transistors (Fig. 2.5). The second one amplifies the output of the first. So if each amplifies by 100 the overall amplification is 100 x 100.

Amplification is often called "gain". There are three kinds: voltage gain, current gain, and power gain. In any one circuit they are usually all different.

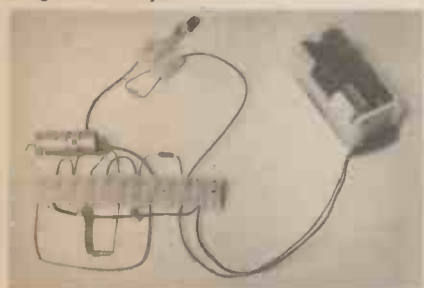

With C1 = 1000μF as shown the red l.e.d. lights for a few minutes then goes out for a while then comes on again and so on for ever, or until the battery runs down. By changing C1 to 100μF the process is speeded up about ten times. Much smaller capacitances such as 100nF (0.1μF) or 10nF (0.01μF) increase the frequency so much that the flicker of the l.e.d. is too fast to be seen. To prove that the circuit is still oscillating, connect a crystal earphone across the indicator as shown and listen to the oscillation. (If the l.e.d. goes out or dims when you connect the phone then it's not a crystal phone but a magnetic type. Get a real crystal earphone: they can be obtained for around 50 pence.)

Crystal earphones are usually supplied with a small moulded-on jack plug. Cut it off, leaving an inch or two of wire so you can use it again. Bare the ends of the phone leads and

connect to a piece of terminal block with two terminals. You can then connect your phone with ordinary thick wires instead of the awkward thin ones of its own cable.

This sort of oscillator is sometimes called a relaxation oscillator. What the transistors do, in effect, is turn the battery on and off regularly at the oscillating frequency. The resulting pulsating current is a mixture of a.c. and d.c. You know that the dielectric of a capacitor blocks d.c. because it is an insulator. You can now prove that it lets a.c. through.

To do so, all you need do is unhitch one phone lead and then remake the connection via a capacitor as shown dotted. (Any value from about 10nF upwards will do.) The oscillation still comes through at full strength.

Used in this way, a capacitor acts as a simple filter to separate a.c. from d.c. In this role it appears in many amplifier circuits.

To be continued

DIGITAL METRONOME

BY S. IBBS



HEAR THE BEAT-SEE THE BEAT-READ THE BEAT

ONE OF the most frequent and popular projects to appear in electronic magazines is the humble metronome, and readers may well buckle at the knees to see yet another . . . but be patient and think back. How many digital metronomes have you seen? Haven't they all required time consuming calibration of the main dial; haven't they been battery-powered so that sooner or later the frequency stability is suspect?

Being a music teacher by profession the author is well aware of these drawbacks, and this design aims to overcome these disadvantages. It takes about two minutes to calibrate, is always accurate, and provides a direct readout of the pulses per minute, updated automatically to register changes in tempo, caused by altering the main dial.

It is mains powered, which means there are no batteries to run down, and stability can be relied upon. The display can be blanked at any time without affecting the counting or the accuracy, and a flashing l.e.d. is incorporated as an alternative to the bleeper. It is inexpensive to build, and thus rivals many commercial units in terms of value for money.

HOW IT WORKS

The main problem when designing this project was how to read pulses per minute. To wait this length of time before the display registered

was obviously of no value, and the answer lay in speeding up the oscillator by a factor of 60 so that the counter read pulses per second. Altering the resistance of VR2 and 3 increases or decreases the frequency of the oscillator which is displayed by the digital counter. This frequency is then divided by 60 to give pulses per minute, which can either drive an l.e.d. or a gated audio oscillator, energising the transducer, WD1.

COUNTER

The full circuit diagram is shown in Fig. 1 over page.

The main counter i.c. is the 4553, a very useful CMOS device that provides binary coded decimal output, capable of controlling three 7-segment displays. This i.c. needs to be reset to zero before a count is made, and to do this a positive pulse is required at pin 13 (IC3). The gating for these functions is provided by IC2. When pin 12 (IC2) goes high, pin 13 (IC3) also goes high, resetting the counter.

On the return of pin 12 to a low state, the monostable formed by gates IC2c and d is triggered, and pin 10 will go low for a time determined by C1 and VR1. This low is inverted by IC2b to provide a high at pin 2, IC2a. When this occurs, any pulses on pin 1 (which is connected to the main oscillator) will be fed through to pin 3 and thus to the input of IC3 pin 12.

At the end of the monostable period, pin 10 goes high, pins 2 and

4 go low, preventing any more pulses reaching the counter. If this monostable period lasts for one second, adjusted by VR1, the counter will thus register how many oscillations occur in one second. This is the required count period.

COMPONENTS

Resistors

R1	10M Ω
R2,4,11	100k Ω (3 off)
R3	4.7M Ω
R5,6,7	100 Ω (3 off)
R8	1k Ω
R9	270 Ω
R10	680k Ω
All $\frac{1}{4}$ W	carbon $\pm 5\%$

See
**Shop
Talk**
page 722

Capacitors

C1	0.47 μ F polyester
C2	2.2 μ F 16V tantalum bead
C3,6	1,000pF ceramic (2 off)
C4	0.01 μ F polyester
C5	0.1 μ F polyester
C7	100 μ F 25V elect.
C8	10 μ F 25V elect, radial lead
C9	0.22 μ F polyester
C10	470 μ F 25V elect, radial lead

Semiconductors

D1	1N4148 silicon
D2	TIL220 red l.e.d.
D3,4	1N4001 silicon (2 off)
IC1,2	4011B CMOS quad 2-input NAND gate (2 off)
IC3	4553B CMOS 3 digit multiplexed b.c.d. counter
IC4	4511B CMOS b.c.d. to 7-segment decoder/driver
IC5	555 timer
IC6,7	4017B CMOS decade counter (2 off)
IC8	7812 12V, 1A regulator
XI-3	DL704 0.3in. high 7-segment. common cathode display (3 off)

Miscellaneous

S1	s.p.s.t. miniature toggle switch
S2	d.p.d.t. miniature toggle switch with centre off
WD1	PB2720 transducer
T1	Miniature mains transformer, 15-0-15V, 100mA secondary
VR1,2	1M Ω miniature horizontal preset (2 off)
VR3	1M Ω linear potentiometer
LP1	Neon mains indicator with integral resistor
FS1	500mA, 20mm long fuse
	Single sided p.c.b. 135 x 72mm and 65 x 30mm; Verocase type 202-21041C; 20mm fuse holder; red acetate display filter 60 x 30mm; l.e.d. mounting clip; 7/0.2mm stranded connecting wire; mains lead; grommet; cable clamp; control knob.

Guidance only
Approx. cost

£21

The high pulses at pin 12 of IC2 are provided by a pulse oscillator around IC1c and d, with its output connected to pin 12. This gives a very brief high pulse approximately every 2-3 seconds to automatically restart the counting sequence described above.

This oscillator is in fact a square wave generator with the duty cycle affected by the inclusion of D1, which makes the output low time decided by the 4.7 megohm resistor, and the high time by this resistor in parallel with the 100 kilohm; thus it will be high for a very short time, compared to the low state.

The binary coded decimal output from IC3 is fed into the decoder/driver, IC4, the outputs of which are connected to all three displays at once. However the cathode pins of the displays are fed back to IC3 which only switches on one display at a time. This switching speed is con-

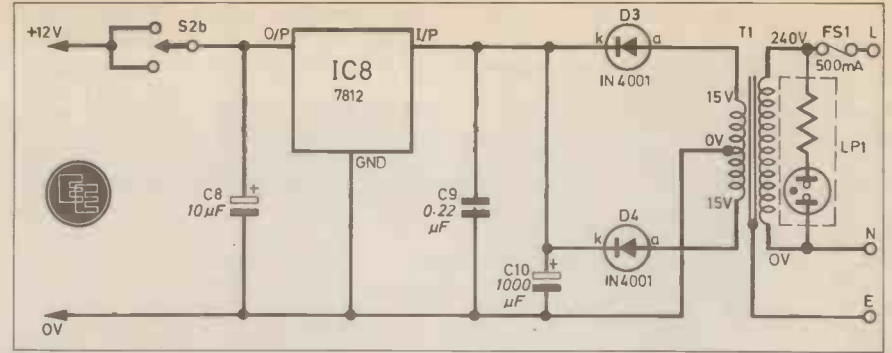

Fig. 2. Power supply for the Digital Metronome.

trolled by the capacitor between pins 3 and 4, and is so fast that the eye records a stable display. This technique is called multiplexing and saves interconnecting wires and power consumption.

DIVIDER

The output from the main oscillator also goes to the CLOCK pin of IC6, a CMOS decade counter whose ten outputs go high in turn on each incoming pulse. It divides the frequency by

Fig. 1. Circuit diagram of the Digital Metronome.

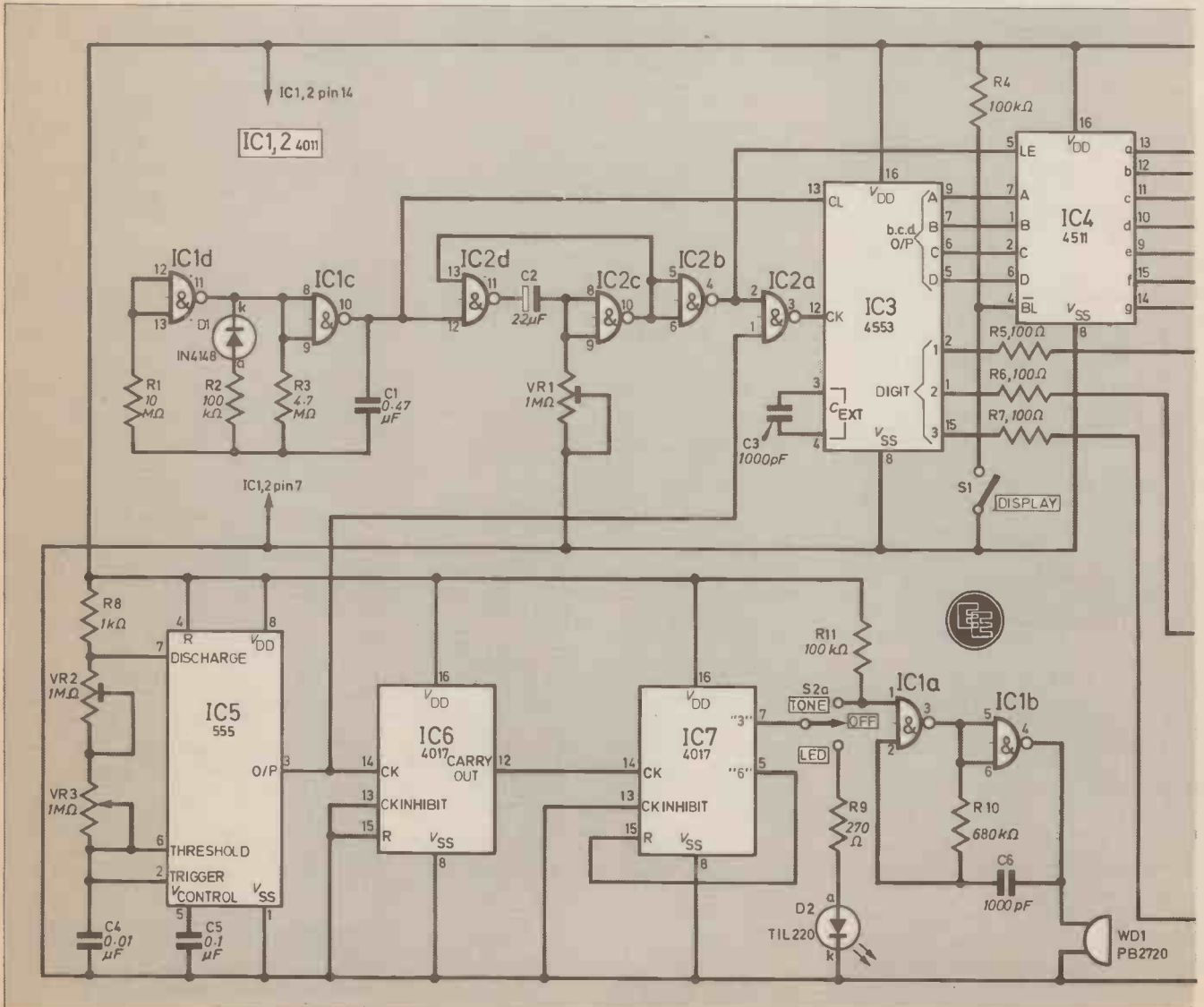

ten, and its output is connected to the input of another counter, this time connected as a divide-by-six counter. Thus pin 7 of IC7 goes high very briefly once for every 60 pulses coming in to IC6.

The output pulses go either to illuminate the l.e.d. D2, current-limited by R9, or to the gated audio IC1a and b driving WD1, the piezo transducer. With the values given, the frequency should be approx 1KHz, but constructors could well experiment with the values of R10 to find the resonant frequency of the particular transducer, when it is at its loudest.

POWER SUPPLY

Power supply circuit diagram is shown in Fig. 2.

The power supply consists of a 15-0-15V transformer (100 mA) rectified by D3 and D4, smoothed by C10, and regulated by a 12V regulator, IC8. This requires decoupling capacitors C8 and C9 for correct operation. C7

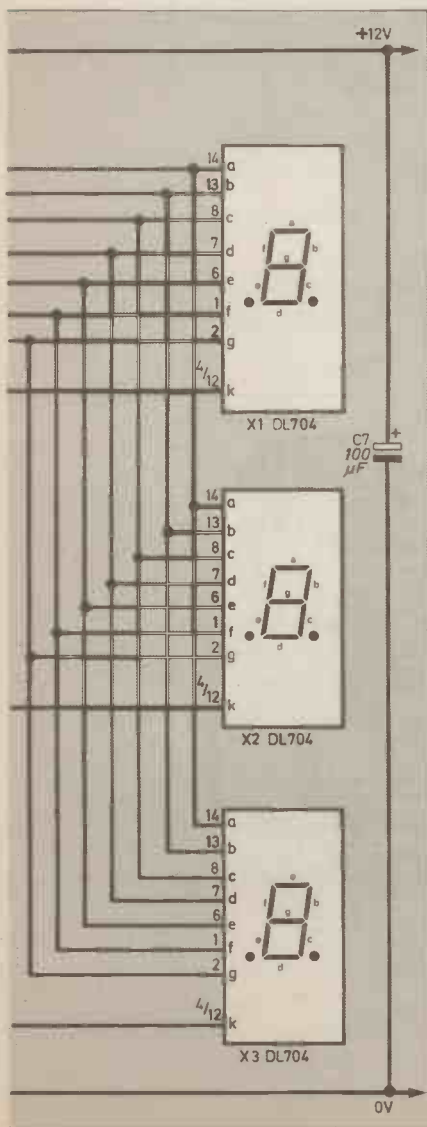

was also included because with so many pulses occurring, the counter may be affected, but it can be omitted if it proves to be unnecessary.



CIRCUIT BOARDS

All the components, including the transformer T1, are mounted on the main p.c.b, a design for which is given in Fig. 3. The three digit display was also mounted on a p.c.b, artwork shown in Fig. 4, as to mount the displays on stripboard requires a great number of link wires. An aperture was cut in the front aluminium panel of the verocase, and the display mounted behind it using epoxy resin, to avoid bolts showing on the front panel. A small piece of red acetate was included to improve contrast.

A double - pole, double - throw, centre-off switch was used, not only to switch the supply from the regulator to the board, but also to change from flashing l.e.d. to the transducer. This was mounted on one side of the

display, with the l.e.d. on the other side. Check the terminals on the l.e.d. before connecting it.

The potentiometer VR3, neon and DISPLAY ENABLE switch were mounted on the top panel, as was the transducer using two screws. Be careful with the leads of the device as they are quite fragile and can easily be pulled out.

If, like the author, constructors have struggled getting a neat pattern of holes for loudspeaker grilles, the following suggestion may help. The author used a rub-down transfer sheet of pads, intended for p.c.b. design and available from most electronic shops. This is laid on the panel, and a compass point pushed through the centre of the pads to give the desired pattern. The pads themselves aren't used and so are not wasted. Many different designs can be made this way, with a guarantee of regularity. The compass points then provide the starting point for the drill bit.

The mains lead is fed through a hole in the back panel, with a rubber grommet to protect the sheathing. Another hole must be drilled for the fuseholder.

GENERAL ASSEMBLY

The main p.c.b. is bolted to the bottom of the case, and connections made using lengths of insulated wire and Veropins. After checks have been

Prototype unit showing the wiring to case mounted components.

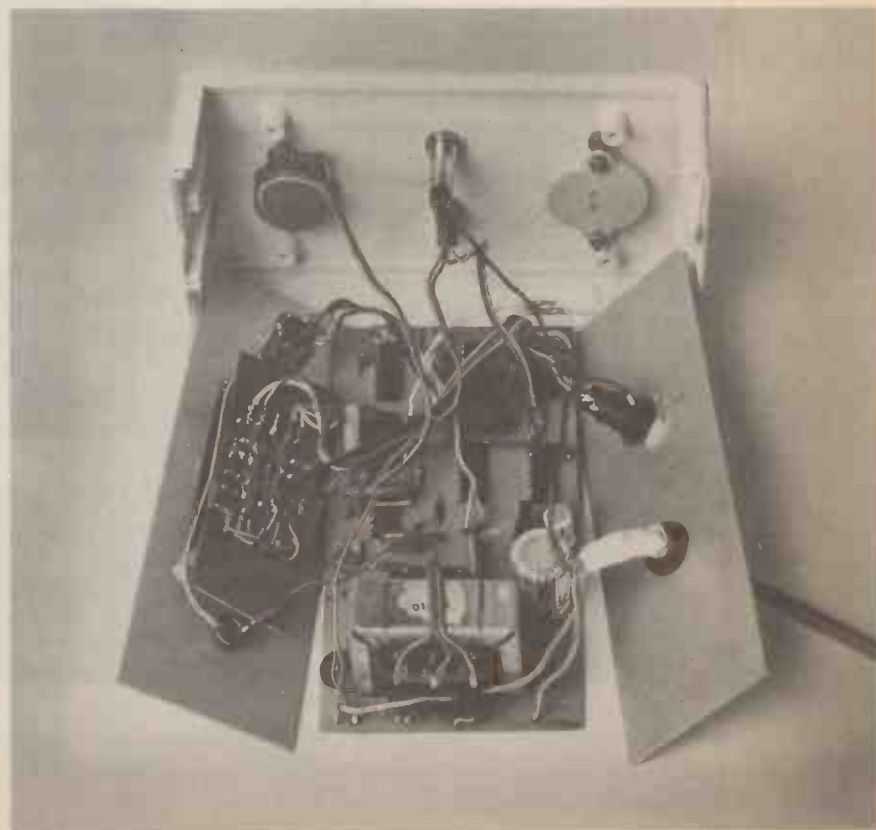

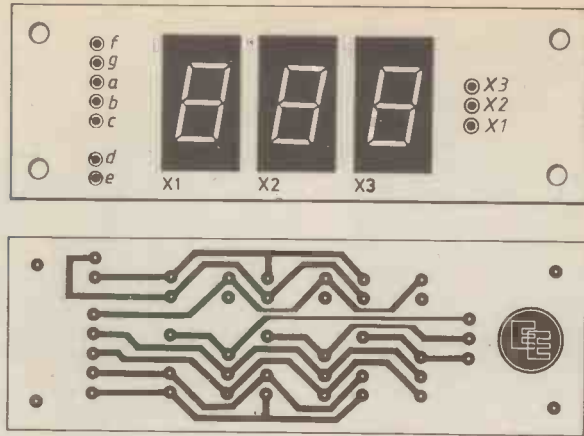

Fig. 4. Full size p.c.b. artwork and component layout for the display section.

⊙ = VEROPIN

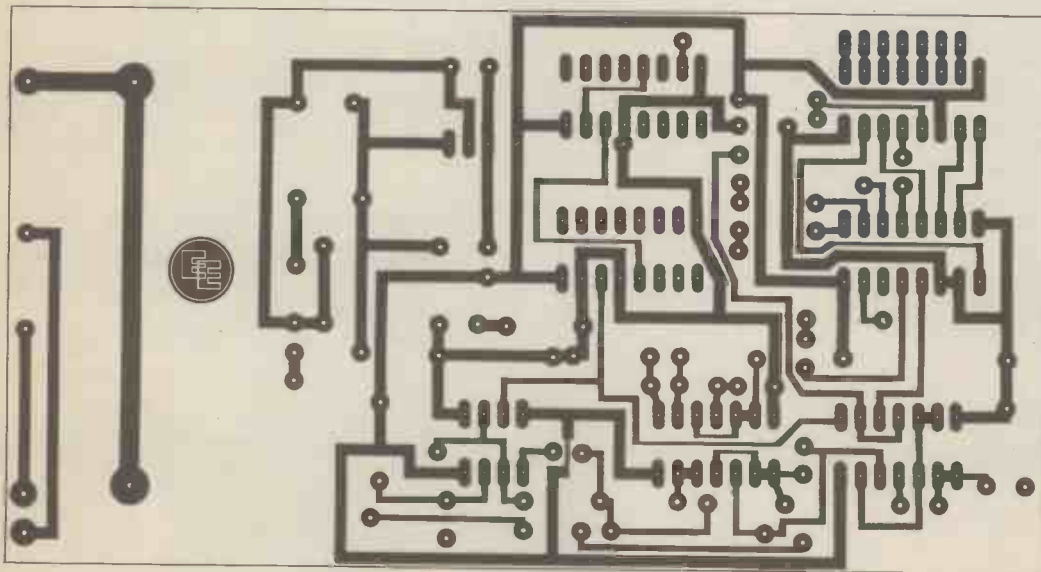
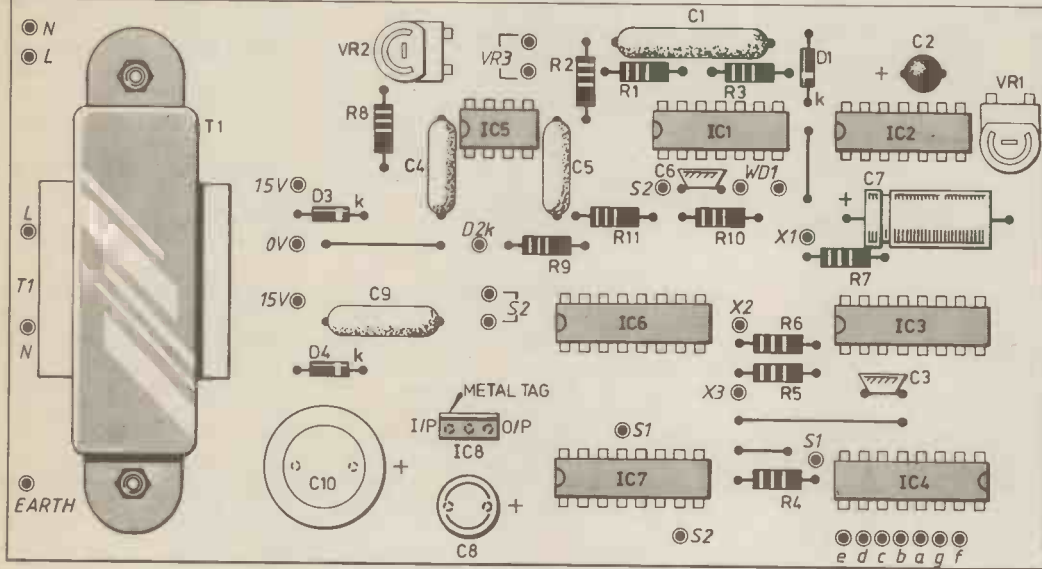

Fig. 3. Full size artwork of the main printed circuit board and component layout. Note that IC4 is inserted the opposite way round to all other i.c.s.

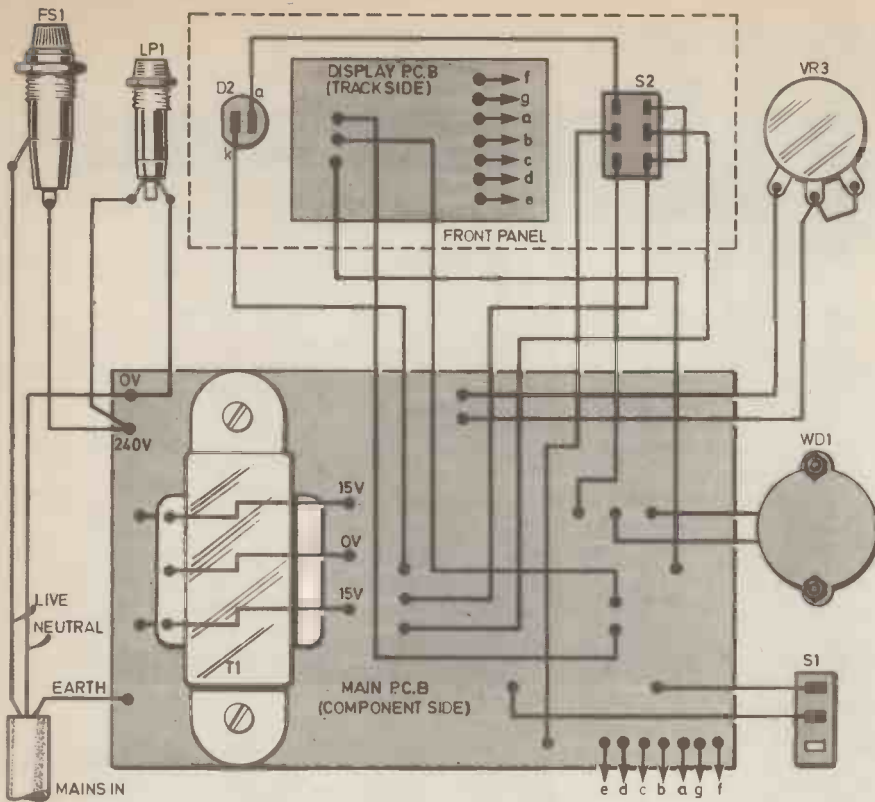

Fig. 5. Interwiring diagram. Allow enough wire to position components in the case.

made the unit is switched on and allowed to settle down (a couple of seconds for the capacitors to get fully charged; this should also be remembered when altering the dial).

Time a period of one minute and count the number of pulses, then adjust VR1 until the display shows this number. VR2 is then adjusted to give the maximum number of pulses, 120 on the prototype. This also affects the minimum count, being about 40. It would not be wise to go much lower than this figure, because the audio pulses become too long to be accurate (see end of article).

Constructors may like to add some numbers around the dial, but this was not thought to be necessary on the prototype. Using a 555 as the

main oscillator gives an almost linear frequency response so it is relatively easy to know the approximate position for a desired number, and the constantly updating display enables a highly accurate setting to be made. Because there will be some variation as to how the monostable period and

the main oscillator pulses coincide, the number may fluctuate by a digit either way.

R5, 6, 7 were selected to give a bright display in the prototype, but depending on the efficiency of the displays used these values could be increased or decreased, but do not omit them altogether.

Pin 5 of IC4 is connected to pin 2 of IC2 to give a reading of zeros between each reading, but if readers would prefer to see the counter actually counting, simply remove this connection, and connect pin 5 to earth via a 10 kilohm resistor.

CONCLUSION

As the lower limit of approximately 40 is reached, the audio pulses start to become long, and more unlike the short bleeps expected from a metronome. For those constructors who would like a lower limit, the circuit shown in Fig. 6 can be added enabling a much lower frequency limit, using just one more i.c. a 4001 quad NOR gate.

Two gates are connected together as a monostable, requiring a high input signal at pin 1 to give a high pulse at pin 4, whose duration is largely independent of the length of the input signal. The use of this i.c. also has an advantage in that two gates are still unused and can be placed after the gated audio oscillator to drive the piezo transducer in a bridge circuit to greatly increase the output power. It can be constructed on a small piece of stripboard and mounted above the p.c.b., powered from the same supply.

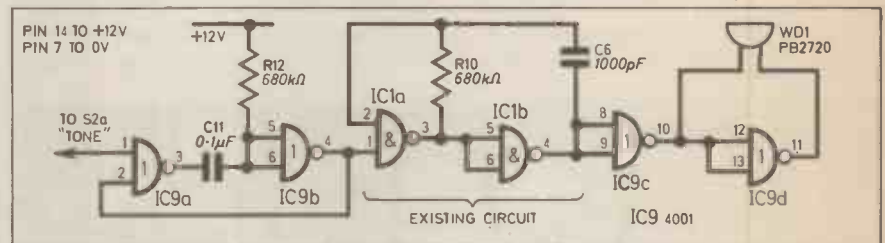
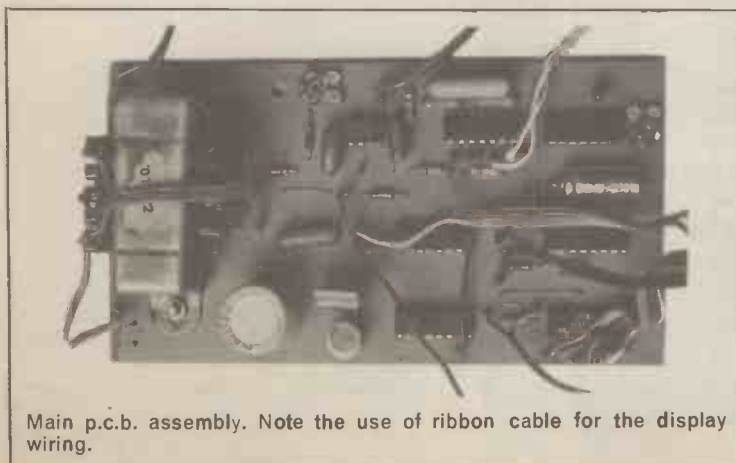

Fig. 6. Additional monostable circuit for use at lower frequencies.



Main p.c.b. assembly. Note the use of ribbon cable for the display wiring.



THE ELECTRONICS OF



INFORMATION TECHNOLOGY

BY T.E. IVALL C.Eng., M.I.E.R.E.

THE Government's "Information Technology Year", announced in the January issue of **EVERYDAY ELECTRONICS**, will soon be coming to its end. Has it all been just a publicity campaign—though with very legitimate commercial purposes? Or is Information Technology (**IT**) a genuinely separate engineering activity which we shall continue to recognise as such long after 1982 is over?

The editor was right to comment in that same issue that **IT** could be seen as something "newly labelled" rather than newly created. According to a report on the subject published in 1980 by the Government's Advisory Council for Applied Research and Development (**ACARD**), information technology "combines the technologies of computing and telecommunications" and "will perhaps be the most important area of application of microelectronics."

The report then goes on to list several examples of the hardware encompassed by this definition of **IT**, such as electronic telephone exchanges, word processors, electronic mail, video discs and viewdata systems.

Plessey PDF Digital Facsimile Machine. In the transmitting and receiving system of this facsimile equipment both light intensity and position in space are represented by electrical variables.

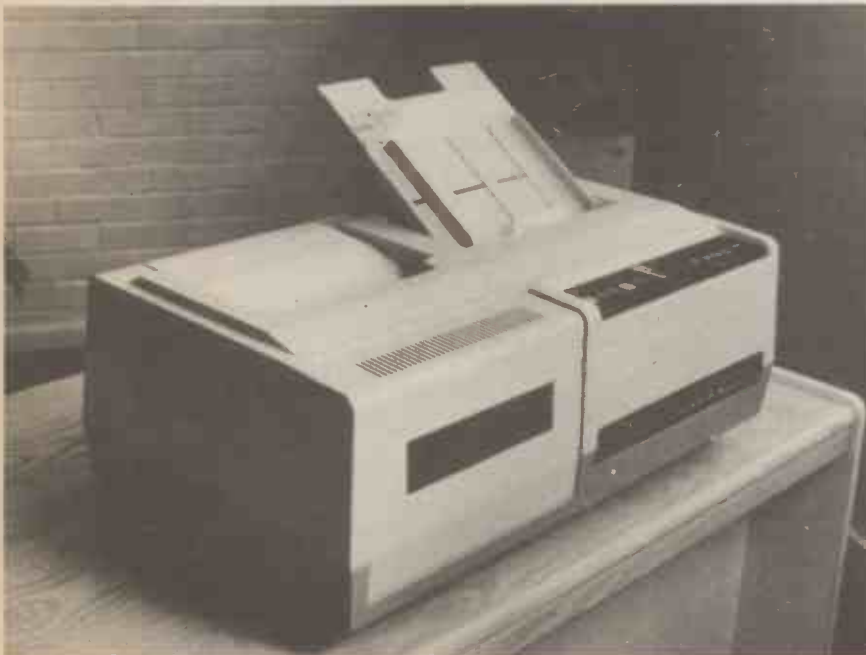

THIS IS THE QUESTION

This is a pretty big field! Is there really something essential which holds all these disparate elements together, to maintain a unity like that of an atom or a biological organism?

Whether the answer is yes or no, one would be quite right to point out that each of the separate products and systems will continue to go on its own sweet way, impelled largely by the commercial demand for this hardware. Engineers will continue to develop and manufacture electronic telephone exchanges and the public will continue to use them quite regardless of what is happening in video discs or word processors.

SHARING OF TECHNIQUES

However, we are all aware that there is a great deal of sharing of techniques between the different products and systems. One has only to think of how the electronic telephone exchange uses digital computing techniques that were originally developed for scientific, military and commercial applications.

The purpose of this series of articles, then, is to explore this

commonality of technique—to see if we can discover the message that runs through all of it, like the words running through a stick of rock.

Some electronics specialists would no doubt say: "well, its just electronics, nothing more." And they would be almost right. For if you look at the way electronic components, circuits and systems are actually applied to the world at large you find that their main function is to handle information — sensing, measuring, transmitting, processing, transforming, controlling, recording, displaying and so on.

NEW VIEW OF ELECTRONICS

But, nowadays, how electronic is electronics? The experimenter or engineer who puts together a collection of integrated circuits to do a certain job is scarcely interested in their internal functioning: he thinks in terms of their external functions and of the signals, logic states and information flows by which they are inter-related.

The arrival on the scene of specialists such as computer scientists and software engineers, needing to know little about electronic circuit design and probably caring even less, is altering our world view of electronics profoundly.

However, the readers of this magazine are by definition interested in electronics—whatever that is!—so we shall attempt to look at **IT** not from the point of view of the computer scientist or software engineer but from that of the electronics experimenter, technician or engineer.

ELECTRICAL QUANTITIES

The core of the approach is that what we call information is nothing to do with its semantic content (for example **s o s** sent by Morse code) but the symbols which represent it. These symbols are formed from electrical quantities. They may be static, as in a semiconductor memory, or dynamic, as in a signal.

Upon these electrical quantities representing information various operations are performed—coding, amplification, attenuation, comparison, integration and so on. The concepts of most of these operations will be already understood by the reader,

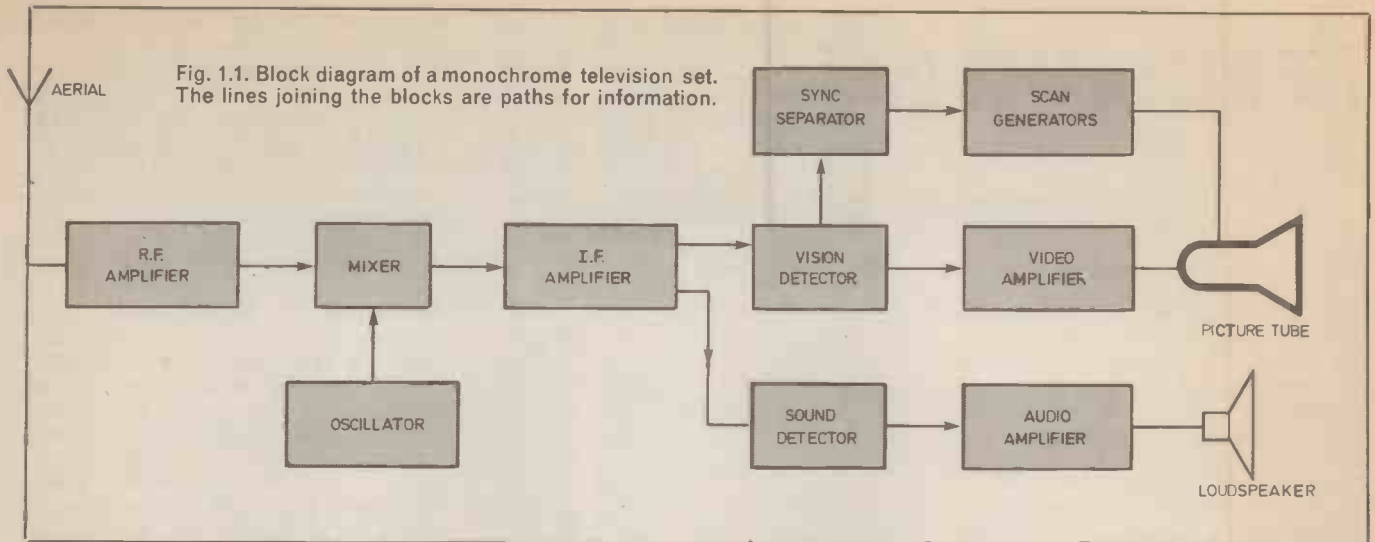

Fig. 1.1. Block diagram of a monochrome television set. The lines joining the blocks are paths for information.

at least intuitively if not in precise detail, so our approach will be to emphasise this operational aspect: what the electronic devices and systems do rather than what they are.

TWO-STATE LOGIC OPERATIONS

If there is indeed a common core to the multiplicity of IT systems it is probably the use of electronic devices to represent information by two-state or binary symbols. In electronic logic systems—from the simplest industrial controllers to advanced stored-program computers—the two states represent the “true” and “false” conditions of deductive logic.

In telecommunications the two states appear in binary codes—for example in pulse code modulation transmission systems—which may represent voice, music, vision, numerical data or any other type of information. Where two-state electronic logic operations result in the production of binary codes, the electronics of computing, control and communications merge into each other.

But any non-technical person who tries to get some idea of what information technology is about simply by examining pieces of its electronic hardware will end by being completely baffled and demoralised. The construction of the electronics, typically a printed-circuit board, gives hardly any clue to the function. It is better to forget the hardware, at least to begin with, and concentrate on the functions it performs.

BLOCK DIAGRAMS

This approach does, of course, correspond with the mental processes of electronics design engineers, who, before they get down to detail, think of the systems they are designing as groups of functions and draw block diagrams of them. Two well known examples are shown here, Fig. 1.1 and

Fig. 1.2—a monochrome television receiver and a microcomputer. Each block is labelled with the function it performs, while the lines connecting the blocks represent paths for information and show sketchily how the functions are acting on each other by means of this information.

REPRESENTING INFORMATION ELECTRICALLY

Information from the outside world goes into IT equipment as changes of physical quantities in space and time.

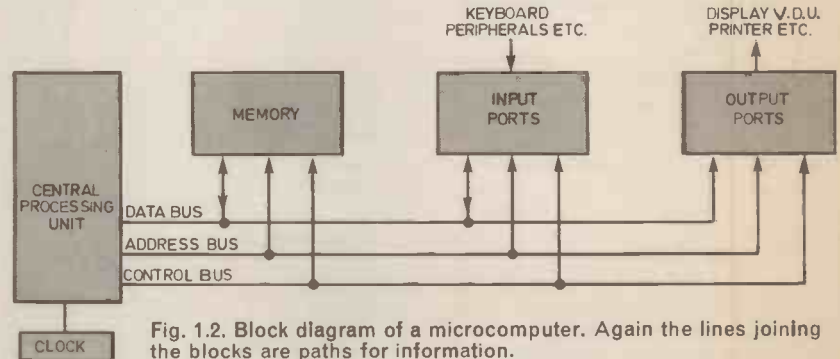

Fig. 1.2. Block diagram of a microcomputer. Again the lines joining the blocks are paths for information.

These changes might be in air pressure, light intensity, mechanical force, temperature, magnetic flux, velocity, flow rate, humidity or indeed any quantity that can be detected by an instrument.

All such changes are events occurring in time, but with some information the position of an event in space is the most significant thing about it—for example, the position of a selected key on a keyboard, the position of a part in an electronically controlled machine, the position of an element in an optically scanned pattern.

To represent these events in space and time by electrical symbols we can make use of three aspects of an electrical quantity: its magnitude (for example as charge, potential, or

current), its position (for example at a particular conductor or storage element among several) and the time at which it occurs.

ELECTRICAL STEP

Consider, for example, the electrical step shown in Fig. 1.3, which could be part of a sequence like a pulse train. Both the magnitude of the step (a) and the instant in time at which this step occurs (b) are variable. Either of these variations can represent a physical quantity

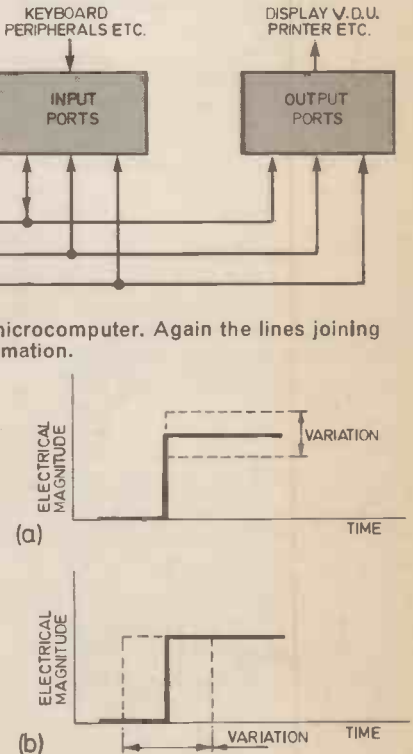

Fig. 1.3. Two properties of an electrical step that can represent events in the outside world: (a) variation of its magnitude; (b) variation of the time at which it occurs.

coming from the outside world. The particular conductor, say, on which (a) or (b) is occurring can represent a particular position in space.

Let us take a concrete example to illustrate these general points. Fig. 1.4 shows a simple system for counting objects moving along a conveyor in a factory. A light source produces a narrow beam of light which passes across the conveyor at such a level that the moving objects interrupt the beam. The light falls on a photodetector which converts its energy into electrical energy. Electric current from the photodetector passes into an electronic counter, which counts the interruptions of the light beam.

Fig. 1.5 shows in more detail what is taking place. At (a) is a graph of light energy reaching the photodetector over an interval of time. It will be seen that this energy falls to a very low value, practically zero, when the beam is interrupted by an object. (The small residual energy is the result of ambient light "leaking" into the detector.)

At (b) is a corresponding graph of the magnitude of the electrical

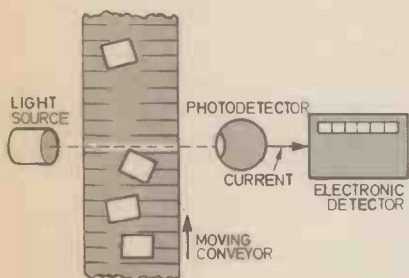

Fig. 1.4. In this simple industrial counting system information in electrical form is obtained about the interruptions of the light beam by objects on the conveyor.

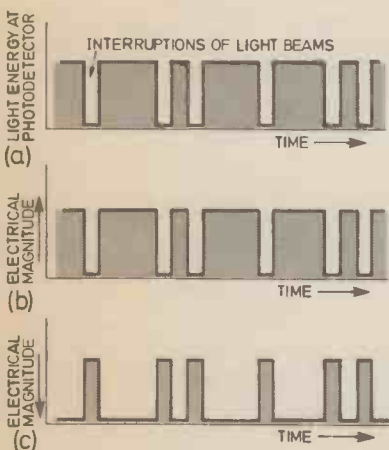

Fig. 1.5. Graphs showing events in the Fig. 1.4 counting system: (a) falls in light energy at the photodetector as objects interrupt the light beam; (b) corresponding falls in electrical energy from the photodetector; (c) inversion of (b) to show it more clearly as a sequence of pulses.

energy from the photodetector resulting from the incident light energy. It has the form of a sequence of falls in electrical magnitude, corresponding to interruptions of the light beam.

These events can be distinguished more clearly if we invert the graph as shown at (c). They then appear as a sequence of pulses.

STEP CHANGES

Within the electronic system the incoming information from the outside world—the passage of objects—is represented by the variation of the electrical magnitude shown in Fig. 1.5(c). These pulses, which are subsequently counted, illustrate the two general principles shown in Fig. 1.3. Variations of the electrical magnitude represent the strong-light/weak-light conditions at the photodetector while the occurrences of the pulses in time represent the presence of objects at the detection point.

CONTINUOUS VARIATION

Fig. 1.5(c) is, of course, an example of an electrical signal—a sequence of

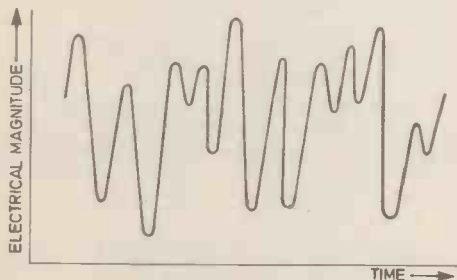

Fig. 1.6. Output of a microphone responding to sound waves—a signal with a continuous variation of electrical energy as distinct from the pulse signal in Fig. 1.5.

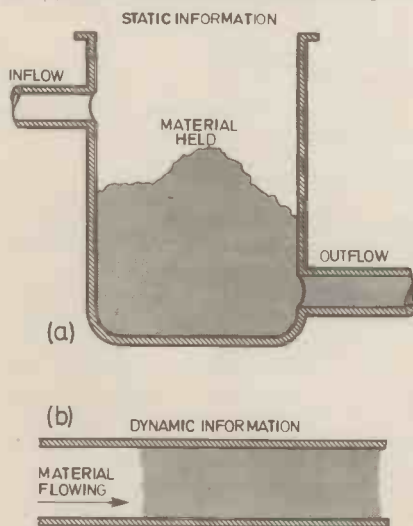

Fig. 1.7. Analogies for (a) static or stored information and (b) dynamic or conveyed information. In (a) the amount of material held represents some physical variable, while in (b) the flow rate of the material represents it.

events representing and conveying information. Another type of electrical signal is shown in Fig. 1.6, actually the output of a microphone responding to sound waves. The electrical magnitude here, of course, is proportional to the air pressure variations in the sound waves impinging on the microphone.

Although this graph or waveform shows a continuous variation of the electrical magnitude in contrast to the step changes in the pulses of Fig. 1.5(c), it can still be regarded as portraying a sequence of events because it consists of successive values of the electrical quantity—successive values that are infinitely close together.

In both examples the successive values are electrical symbols for the corresponding events in the outside world. As such they can be manipulated and processed in various ways. For example, they can be assigned numerical values by encoding techniques, as we shall see later.

STORED OR CONVEYED

In saying above that a signal represents and conveys information we make the point that it does both of these things. In certain IT processes, however, we may wish only to represent information without simultaneously conveying it—in other words, hold the electrical symbols at some place. The two functions are illustrated by analogy in Fig. 1.7.

At (a) the amount of material held in the container (which can be controlled by the inflow and outflow) may be used to represent some physical variable from the outside world. This is static information and the process of holding it is storage. At (b) the material is moving along a pipe—and this could be the inflow or outflow pipe in (a). Here we could use the flow rate of the material to represent the same physical variable.

So here we have two further ways of representing a given physical variable. In one case the information is static (stored), while in the other case it is dynamic (conveyed).

ELECTRIC CHARGE AND CURRENT

In the electronics of IT systems we can of course use electrons as the "material" in Fig. 1.7. In the static information case (a) these appear as a stored electric charge, while in the dynamic information case (b) the charge is moving and therefore appears as an electric current.

These are just two of the electrical quantities that can be used to represent information, but of course there are others such as voltage and power. And, as everyone with a tape recorder now knows, magnetism provides another way of storing information.

To be continued

1983 SCHOOLS Electronic Design Award COMPETITION

over
£2,000
in Prizes



Mullard Ltd—the largest electronic components company in the UK—and EVERYDAY ELECTRONICS join forces to present this rewarding challenge to Secondary Schools. . . .

DESIGN A PIECE OF ELECTRONIC EQUIPMENT HAVING A DIRECT PRACTICAL APPLICATION IN A SCHOOL'S SCIENCE LABORATORY

This competition is open to any United Kingdom Secondary School, State or Independent. Pupils of either sex in the age group 11-18 are eligible to participate in a team representing their school.

The competition will be conducted in two stages.

STAGE 1

Submission of Papers describing the proposed project with full circuit details.

Papers will be judged for novelty, ingenuity and viability. Particular attention will be given to originality and good circuit design technique.

Schools whose designs are adjudged to be the most promising will be asked to produce a working model.

STAGE 2

Models will be examined and prize winners selected on the basis of mechanical design, neatness of wiring and general assembly, plus operational performance.

All models will be exhibited at Mullard House, London, where the official presentation of prizes will be made at the end of June 1983. Representatives of finalists will be invited to stay overnight in London as guests of the SEDAC sponsors.

FIRST PRIZE The SEDAC Trophy
and £300*

SECOND PRIZE £200*

THIRD PRIZE £100*

* Plus a selection of components valued at £200

NINE RUNNERS UP a selection of components
valued at £100

In addition, all twelve finalists will receive a certificate and one year's subscription to EVERYDAY ELECTRONICS.

Science teachers of Secondary Schools are invited to apply for a Registration Form which contains full details of this competition.

Write to: Schools Competition, Room 2130, Kings Reach Tower, Stamford Street, London SE1 9LS.

Secondary School Pupils—make sure your school accepts this challenge and enters this contest. So bring this announcement to the attention of your science teacher or the head of your school.

Closing date for Registration : November 15 1982

Closing date for submission of Papers : January 31 1983



**SCHOOLS ELECTRONIC DESIGN AWARD COMPETITION (SEDAC)
SPONSORED BY MULLARD LTD AND EVERYDAY ELECTRONICS**





By Dave Barrington

Component Buying

Last month Paul Young gave some excellent advice on component buying and ordering.—See *Counter Intelligence* page.

The only addition we would make to his advice would be to look out for the "special bargain packs," sometimes Free (on certain orders), that are regularly offered by such advertisers as Bi-Pak, Rapid, Magenta and Chordgate. It also pays to browse through the Classified section. Here you will find such items as multi-packs of wires and service sheets on offer.

Bargain Time at The Fair

Talking of special bargains. We hear that exhibitors at the first **ELECTRONIC HOBBIES FAIR** will be offering special, once only, bargain prices on certain components throughout the run of the fair.

So, if you are still hesitant about visiting us on our stand why not come along and pick up some bargains from *the fair*?

The **ELECTRONIC HOBBIES FAIR** is being held from November 18 to 21 at the Alexandra Pavilion, Alexandra Palace, London. Opening times are 10.00 to 18.00 hours for the first three days and 10.00 to 17.00 hours on the final day.

Light Alternative

Earlier this year Anglia Components were one of the first component distributors to introduce *blue* l.e.d.s, now they are offering an alternative to the ubiquitous ORP12 light dependent resistor (l.d.r.).

Many variations of Cadmium Sulphide cells are available either in encapsulated or chip form, to special order.

One of the main rivals to RS, Anglia specialise in TV components and professional bodies and component traders will be most impressed with their components catalogue. This catalogue contains over 100-pages and covers such items as TV replacement parts to semiconductor and i.c. devices.

Further information can be obtained from Anglia Components, Dep EE, Burdett Road, Wisbech, Cambs, PE13 2PS.

Catalogues Received

With few exceptions, asking a musician to design and build a loudspeaker enclosure is like asking the housewife to repair the washing machine. They are both highly skilled and know whether the results are right, but the technical process that goes into creating the final result is a mystery to them.

With this concept in mind, Celestion International have recently published a Cabinet Handbook of system designs for the professional musician. This handbook will certainly appeal to the constructor, particularly the hi fi enthusiasts.

The 28-page handbook contains detailed design drawings, construction details and performance guide for more than a dozen cabinet styles. Included are several bass housings, guitar or bass guitar cabinet and tweeter and mid-range boxes.

Specialised units such as a tweeter wedge monitor that is used for "foldback", enabling musicians behind the main PA stacks to hear all instruments and vocals clearly, are also included.

The Celestion Cabinet Handbook costs £1 plus postage and is available from Celestion International, Dept EE, Ditton Works, Foxhall Road, Ipswich, IP3 8JP.

All products in the new 84-page Eagle Catalogue are guaranteed for two years. The catalogue is divided into six sections and includes colour photographs and brief technical specifications of each item.

Equipment listed includes intercoms and door phones, public address and paging systems, microphones and mixers, test equipment and power supplies, security units and audio equipment. The audio section lists portable units, hi fi and in-car entertainment accessories and sets.

Copies of the Eagle 1982/3 Catalogue and local stockists can be obtained from Semiconductor Supplies International Ltd., Dept EE, Dawson House, 128-130 Carshalton Road, Sutton Surrey, SM1 4RS.

The latest edition of the 1982/3 Babani Books technical books catalogue is now available. Books listed cover such subjects as; CMOS projects, using calculators, programming and long distance television reception (TV-DX).

Copies of the 1982/3 Babani Books catalogue may be obtained, free of charge, from Bernard Babani (Publishing) Ltd., Dept EE, The Grampians, Shepherds Bush Road, London, W6 7NF.

CONSTRUCTIONAL PROJECTS

Combination Lock

The dual-in-line relay used in the *Combination Lock* is a 500 ohm coil type with an internal protection diode. This device is available from any RS Components approved stockists and should be ordered as: s.p. form A, stock no. 349-383.

The device (purchased from another source) used in our prototype was supplied without the full complement of pins and the p.c.b. was designed around this particular relay. However, there is ample room on the circuit board for drilling the extra holes for the RS device. Alternatively, although not advisable if the relay is to be used for another project later, the unused pins can be bent back so that they "sit" on the topside of the circuit board.

When purchasing a relay make sure it is a device with an internal protection diode. If a diode is not included then one will have to be wired across the coil. The anode lead to TR3 collector and the cathode to the positive supply line.

The 9-way printed circuit board inter-connecting plug and socket assembly will have to cut from a 10-way version. These connectors are available from Amblt, Maplin, Watford, Magenta and any RS component supplier.

Digital Metronome

The 10 megohm resistor R1 called for in the *Digital Metronome* may prove troublesome to locate, but the $\frac{1}{2}$ W rating type seems to be fairly common and can be used here.

The physical size of the transformer T1 will obviously vary according to type used and may necessitate the use of a larger case. The piezoelectric transducer is now stocked by most advertisers.

Oscilloscope Companion

Most of the close tolerance resistors for the *Oscilloscope Companion* are readily available items from the E24 series. However, the 500 ohm type may cause troubles. It is suggested that readers follow the guide lines outlined in the article regarding the preferred value resistors.

The BZX61 Zener diodes D9 and D10 are stocked by Rapid Electronics. It would appear that most component stockists will be able to supply a 6.2V 1.3W equivalent for these diodes.

The 9-way rotary switches S3(103) and S4(104) will have to be made up from types with adjustable limit stops as these are non-standard items. This also applies to the 6-way types. Alternatively, 12-way and 2-pole 6-way switches could, but not recommended, be used and all unnecessary connecting tags wired together and fixed to the last switched or stop position.

The only source for the 10A rotary switch S3(103) that we have been able to locate are the high current types from RS Components. These are rated at 250V a.c. 6A, 30V d.c. 10A and have adjustable limit stops. The order code for this switch is RS 327-579—This switch is expensive.

Photo Finish

The detector phototransistors TIL78 used in the *Photo Finish* are now general "off-the-shelf" items and should not present purchasing problems.

It is not necessary to stick strictly to the case depicted in the article. Another suitable type would be one of the small plastic "diecast" moulded case.

Beat the Relay

The relay used on the prototype *Beat the Relay* game was a surplus GPO with a 125 ohm coil operating at 12V. However, any relay with 12V operation and a coil resistance of around 125 ohms with at least one set of normally open contacts will work here.

ZX Tape Controller

The miniature electret microphone needed for the *ZX Tape Controller* is available from most Tandy stores. This should be ordered as Microphone Element, stock number 270-092 and is listed as costing £1.29.

The 25mm loudspeaker is available from J. Bull and costs £1.75, including VAT and postage/packing.

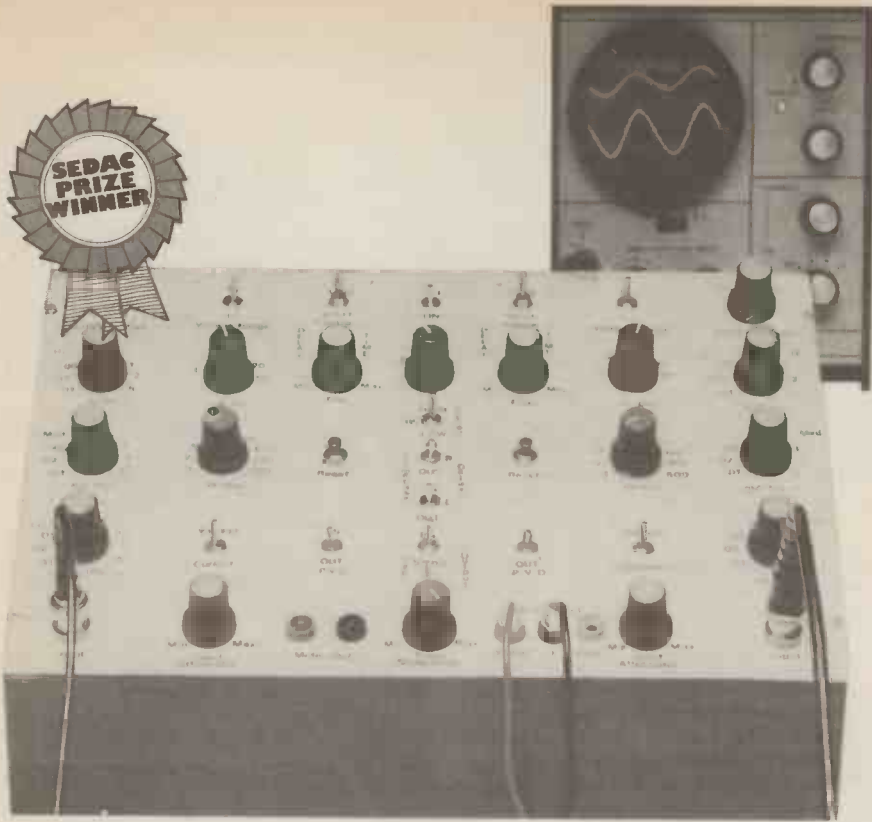

BY SIMON RAINEY

OSCILLOSCOPE COMPANION

THE OSCILLOSCOPE is one of the most useful pieces of laboratory equipment available and a desirable asset for any school. However, the price of even the simplest of 'scopes is high and therefore prohibitive for many secondary schools. It was for this reason that the author developed the Oscilloscope Companion.

This cheap addition to very basic or old oscilloscopes will enable them to measure very low currents and voltages as well as converting a single beam 'scope to a dual beam version.

The Oscilloscope Companion offers voltage ranges, current ranges, a beam splitter, a peak voltage detector, a timebase delay, and a precision rectifier/buffer which allows an ordinary voltmeter to be connected for more accurate measurements.

CIRCUIT DESCRIPTION

The overall circuit is complex and so may be divided into seven sub-circuits, these being the current ranging, voltage ranging, peak voltage detector, timebase delay, beam

splitter, output precision rectifier/buffer, and the power supply circuits. A detailed description of each is given.

CURRENT RANGING

The principle behind the current ranging is to measure the voltage across a resistor when a current is passing through it. The circuit diagram is given in Fig. 1. The resistors R1 to R27 are for this purpose and are switched into circuit by either S3, S4 or S5.

The values for resistors R1 to R9 have been calculated to give 1V across the required resistor when it is switched into circuit and the current stated per division is input. For example, R1 has a value of 100 ohms and is switched into circuit when the 10mA/division range is selected. Thus from Ohm's law, the voltage measured across the resistor with 10mA flowing is:

$$V = 0.01A \times 100 \Omega = 1V$$

Resistors R10 to R27 work on the same principle except the voltage produced is 10mV. This is too low for our needs and so a voltage amplifier with gain 100 is present in the form of IC1 and its associated components.

IC1 is a MOSFET operational amplifier with a very high input impedance so as not to affect the input. It has been configured as a non inverting amplifier with a gain of 100, the gain being determined by the ratio of R29 to R28 which in this arrangement are 390 kΩ and 3.9 kΩ. VR1 allows the voltage offset of the i.c. to be nulled out, which is necessary if the accuracy is to be refined. VR2 and R30 compensate for any impedance mismatching problems

Finally, S2 is used to select one of the three ranges and S1 is used to select whether CURRENT or VOLTAGE is to be measured.

VOLTAGE RANGING

The voltage ranging has two ranges and these are selected via S6, see Fig. 2. If the high range is

VOLTAGE RANGES	
Low Range	= 1mV, 2mV, 5mV, 10mV, 20mV, 50mV, 100mV, 200mV, 500mV
High Range	= 1V, 2V, 5V, 10V, 20V, 50V
INPUT IMPEDANCE	
10,000MΩ on all Low Ranges 10kΩ/volt on high range	
CURRENT RANGES	
Low Ranges	= 10nA, 20nA, 50nA, 100nA, 200nA, 500nA, 1μA, 2μA, 5μA
Middle Ranges	= 10μA, 20μA, 50μA, 100μA, 200μA, 500μA, 1mA, 2mA, 5mA
High Ranges	= 10mA, 20mA, 50mA, 100mA, 200mA, 500mA, 1A, 2A, 5A
INPUT IMPEDANCE	
Varies from 0.25Ω to 1MΩ depending on range. Has no significant effect on the accuracy.	
ACCURACY	
2% on all ranges	
BAND WIDTH	
5MHz on all ranges with no loss in accuracy. 20 MHz maximum	
OUTPUT	
Never exceeds range -4V to +4V. Will drive 500kΩ without loss in accuracy	
SYNC. OUTPUT	
Varies from -4V to +4V. Will trigger most oscilloscopes	

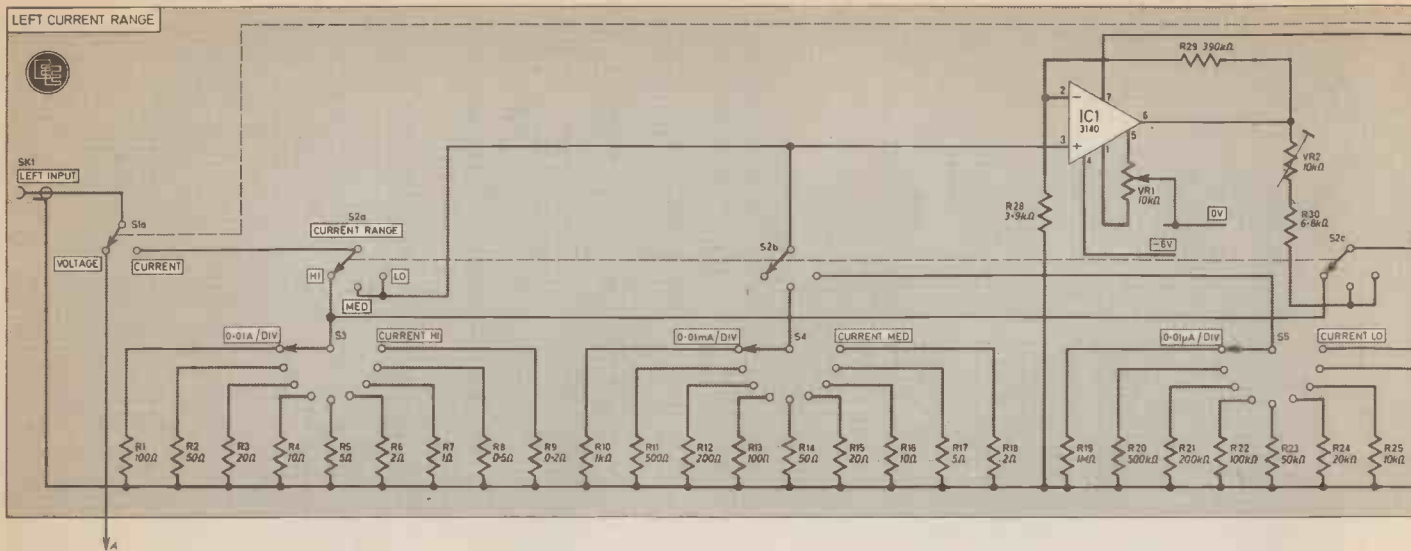

Fig. 1. (above) Circuit diagram of the left channel current range. Right channel identical except for all components prefixed with 100.

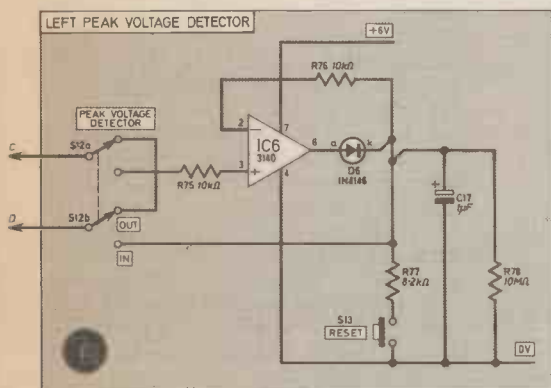

Fig. 4. Peak voltage detector circuit diagram. Left channel shown.

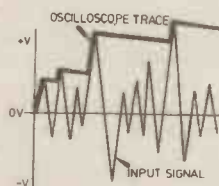

Fig. 3. Output produced by the peak voltage detector.

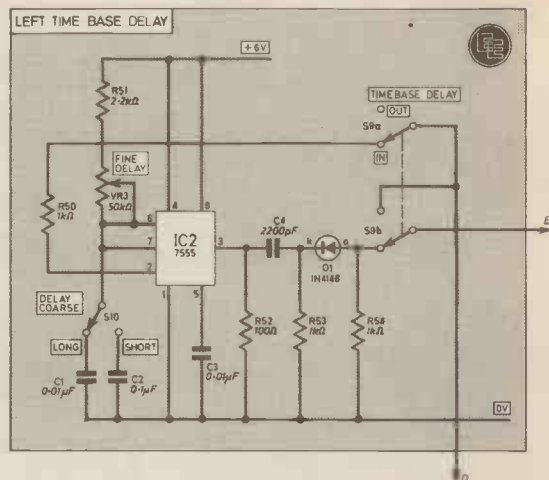

Fig. 5. Left timebase delay circuit diagram.

chosen, then the input voltage passes through one of the resistors R45 to R49 and through R44 to earth. The resistors R45 to R49 form five potential dividers with R44 and by selecting a different resistor, a different range is selected.

The basis of operation is that the output is tapped off at the junction of the two resistors forming the potential divider and that this output is always 1V when the input voltage is equal to the V/division range selected. For example, if the 20V/division range is chosen then R48 is switched into circuit.

The current which must flow through R44 for 1V to be developed is, from Ohm's law, 0.0001A. Now if 1V is dropped across R44, then $20 \div 1 = 19V$ must be dropped across R48 (20 because of a 20V input). From Ohm's law we see that the value of R48 is:

$$R = \frac{19}{0.0001} = 190000 \text{ or } 190 \text{ kilohms}$$

This form of circuit is very accurate but does tend to impose a relatively high load (100μA) on the input.

If the low range is chosen, the input passes to IC3. This is a MOSFET operational amplifier with an input impedance of 1.5×10^{12} ohms and so imposes virtually no load on the input. This is wired as a non-inverting voltage amplifier with unity gain and is used as a buffer for the input. VR4 is used to set the offset voltage at zero which would otherwise set the trace off centre.

R31 acts as a load resistor for IC4, another MOSFET op-amp. This is wired as an inverting voltage amplifier with variable gain. The gain is set by one of the resistors R32 to R40 on S7 and is calculated as the ratio of the selected resistor to R31.

For example, if the 2mV/division range (R33) is selected, the required output from IC4 is 100mV (not 1V yet) and so the gain must be $100/2 = 50$. Thus R33 divided by R39 (one kilohm) must equal 50. R33 is therefore $50/1 = 50$ kilohms. VR5 is used to offset the output voltage as in IC3.

R41 acts as a load resistor for IC5, another MOSFET op-amp. This is

wired as an inverting voltage amplifier with a gain of 10, the gain being set by the R42/R41 ratio. R43 is present to reduce inaccuracies in the output due to bias currents internal to the i.c. and a similar arrangement was not included with IC4 as the value of the resistor is dependent on R42 and R41 and this ratio varies with IC4. VR6 sets the offset as in IC3 and IC4.

The purpose of having two op-amps (IC4 and IC5) instead of one is to increase the bandwidth by reducing the gain of any one op-amp and to invert the inverse waveform from IC4.

PEAK VOLTAGE DETECTOR

The peak voltage detector detects the highest positive voltage peak displayed and remembers it for approximately 10 seconds. To understand the concept refer to Fig. 3.

The input waveform is irregular and so making its peak its amplitude hard to measure. However, by switching the peak voltage detector into circuit, the trace seen on the screen is that shown in Fig. 3.

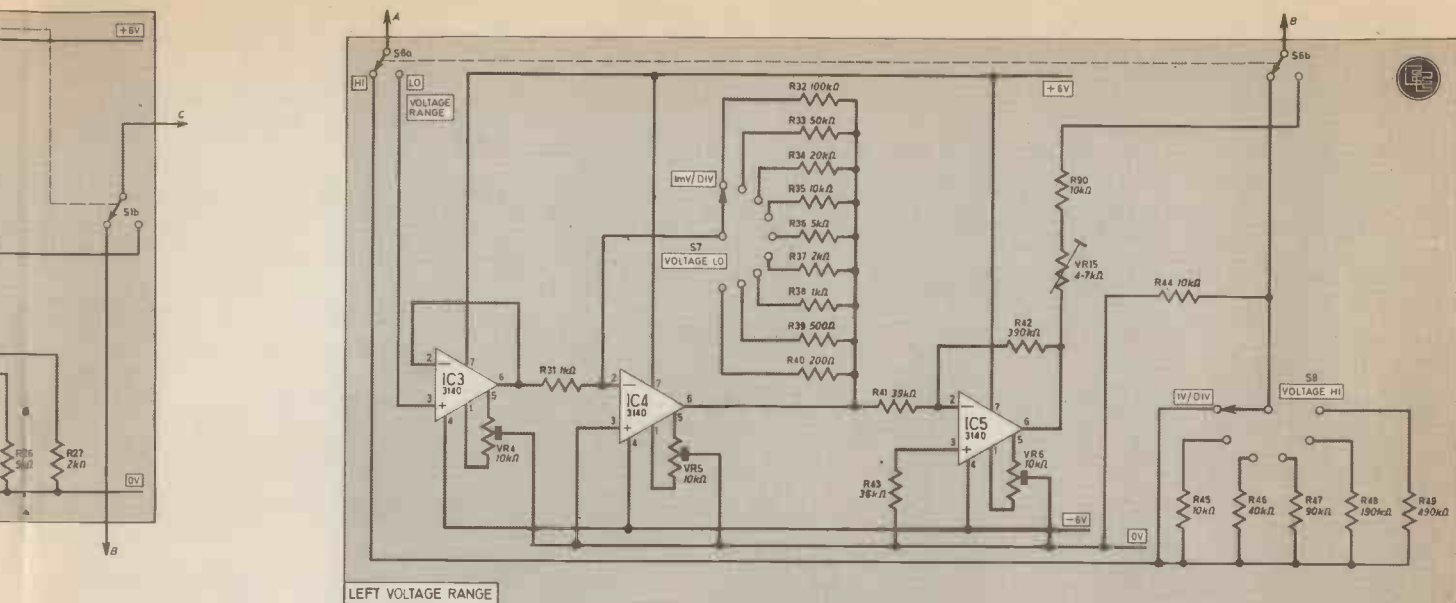

Fig. 2. Left voltage range selection circuit diagram. Again, the right channel is the same but with all component reference numbers prefixed with 100.

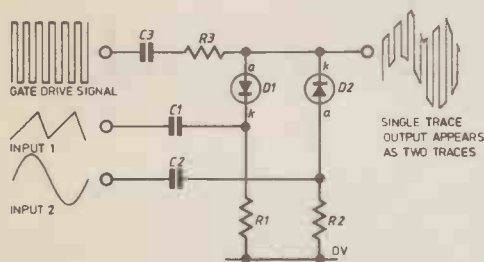

Fig. 6. Simple circuit showing the basic operation of the beam splitter section.

PEAK DETECTOR CIRCUIT

The peak voltage detector is built around IC6, see Fig. 4. If the non-inverting input (pin 3) goes negative then so does the output. However, under such circumstances diode D6 is reverse biased and no output is present. If the input goes positive, the output also goes positive and diode D6 is forward biased. The inverting input (pin 2) is now applied with a voltage identical to that of the input through resistor R76. At the same time C1 is charged to the same potential as the inverting input.

If the input (pin 3) now goes negative, diode D6 is again reverse biased and so the charge on the capacitor remains, being slowly discharged by the op-amp input bias current and resistor R78. The initial input voltage is therefore "remembered" and displayed as a slowly decaying trace (decaying because the capacitor is discharging).

The component values have been chosen to give a time constant or discharge time of roughly ten seconds but by depressing S13 the capacitor can be discharged immediately. S12 switches the peak voltage detector into circuit when required.

TIMEBASE DELAY CIRCUIT

The timebase delay is built around IC2, a CMOS 555 timer and the circuit is shown in Fig. 5. R50 limits the input current to the trigger input, pin 2. The 555 is a universal timer i.c. which can be configured as a monostable or astable multivibrator, the former is used here to produce a time delay. The RC network of R51, VR3 and either C1 or C2 sets the time delay and is variable from about $1\mu\text{s}$ to 1ms .

C3 sets the control voltage of the i.c., that is, the trigger voltage required to cause the output to change state. The order of events after a trigger voltage has been detected is as follows. The output immediately changes state and an internal short across C1 and C2 is removed, allowing it to charge through R51 and VR3. When the voltage at pins 6 and 7 reaches the trigger voltage, the output of IC2 changes state again and C1 or C2 is discharged via the internal short to earth.

The period the i.c. is in the "on" state is very short and so no problems should arise with regard to the trigger rate.

C4, D1, R52, R53 and R54 serve mainly to smooth the output and reduce transients and false triggering of the 'scope. S9 switches the delayed timebase in or out of circuit as required.

TRACE SEPARATION

The circuit description for this part of the circuit cannot be made complete unless the basic principle of operation is illustrated. The operation of the trace doubler is quite simple. The "heart" of the unit is the simple diode gate shown in Fig. 6.

Input 1 is capacitively coupled to the junction of D1 and R1, and input 2, to the junction of D2 and R2. The gate is operated by the square wave gate-drive signal which varies between zero and ten volts positive, but when this signal is a.c. coupled to the gate via C3, the d.c. component is eliminated and the signal at the top of R3 swings about zero volts as shown. Thus, on high points of the gate signal the top of R3 is 5V positive and on low points it is 5V negative.

Now, when the top of R3 is 5V positive, D1 is forward biased and forms an effective short circuit, so that R1 is virtually connected direct to R3 and input 1 to the output terminal. At the same time D2 is reverse biased and effectively open circuit, so that no part of the input 2 signal appears at the output.

By potential divider action, the output signal is imposed on a potential of 2.5V positive. Thus, under this condition the output consists of input 1 plus a bias potential of 2.5V positive.

When, on the next square wave half-cycle, the top of R3 goes 5V negative, D1 is reverse biased and isolates input 1 from the output, whilst D2 is forward biased and connects input 2 to the output. In this case, however, the output signal is imposed on a potential of 2.5V negative, so that under this condition the output consists of input 2 plus a bias potential of 2.5V negative.

Thus, the composite output signal of the gate consists of input 1 above input 2, as shown in the diagram, the two signals being separated by a potential proportional to the magnitude of the gate drive signal.

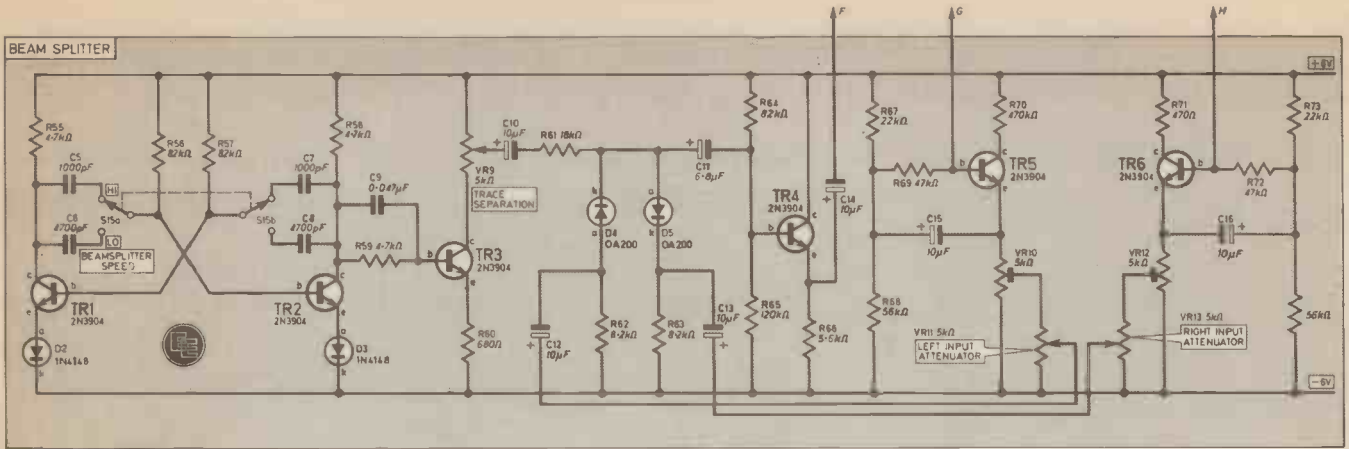

Fig. 7. (above) Circuit diagram of the beam splitter. This section of the circuit is common to both channels (see Fig. 10).

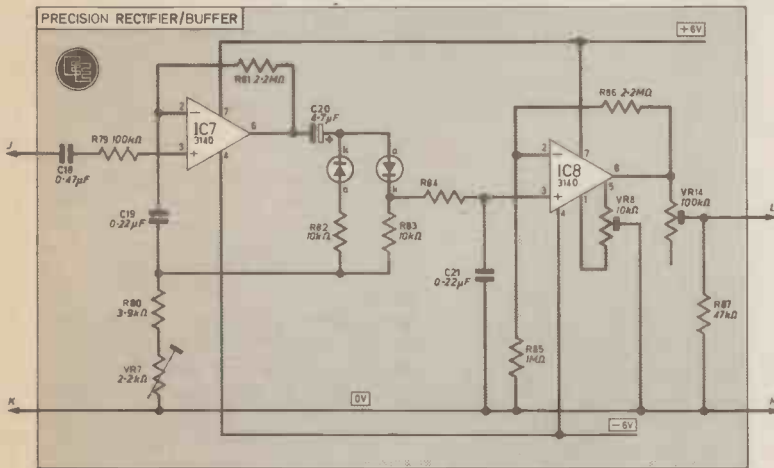

Fig. 8. Circuit diagram of the precision rectifier and buffer to drive the voltmeter output.

BEAM SPLITTER CIRCUIT

TR1 and TR2 form a free-running multivibrator which gives an approximate square wave signal at TR2 collector (see Fig. 7 for the circuit diagram). D2 and D3 prevent emitter-base reverse voltage breakdown on TR1 and TR2 and improve oscillator stability. S15 enables either Fast or Slow operating frequencies to be selected. The square wave from TR2 collector is direct coupled to TR3 which sharpens up the waveform and passes it on to the diode gate circuit (D4, D5) via VR9, which acts as a TRACE SEPARATION control. The output of the gate is fed to S14 and then to the oscilloscope output, SK3.

The inputs to the circuit are fed to bootstrap emitter followers TR5 and TR6. The 5 kilohm emitter loads of these circuits serve as infinitely variable attenuators (VR10, VR12) which are set to give unity gain, while VR11, VR13 can be adjusted to reduce the gain where necessary. The signals are thus passed at low impedance to the diode gates and, via S16, to the SYNC OUTPUT socket. R70 and R71

are placed in the collector paths of TR5 and TR6 to introduce a small degree of Miller feedbacks to prevent instability in the bootstrap circuitry.

S14 switches the beam splitter into circuit.

VOLTMETER OUTPUT

This circuit produces a d.c. voltage which is in unison with the output. See Fig. 8. IC7 is the basis of a precision rectifier which is an extension of a diode rectifier, but does not suffer from the 0.6V voltage drop associated with ordinary diodes.

When the input at pin 3 goes positive so does the output and D8 becomes forward biased and the voltage is passed on. If, however, the input goes negative then D7 becomes forward biased and the negative voltage thus applied the inverting input of the op-amp overrides the negative input at the non-inverting input and a positive output results. S20 acts as a smoothing capacitor and C19 improves the response. R80 and VR7 act as a variable path to provide a slight bias to

diode D7 and hence increase the accuracy.

IC8 forms a non-inverting voltage amplifier with unity gain which has a high enough input impedance so as not to affect the output of the precision rectifier. VR8 is used to set the offset voltage of the op-amp at zero. C20 gives further smoothing of the output so there is virtually no ripple present at meter terminals.

POWER SUPPLY

A mains power supply would be unsuitable in a circuit such as this because of the problems associated with producing a completely ripple free supply from a.c. As a result, a battery supply is used as shown in Fig. 9. The 9V produced by each battery is reduced to 6.2V by the action of zener diodes D9 and D10 and smoothed by C22 and C23 which also act as reservoir capacitors.

R88 and R89 are used so as not to short out the batteries when the Zener diodes conduct.

The battery voltage can drop by over 2V without affecting the supply voltage or the accuracy. S17 is the ON/OFF switch.

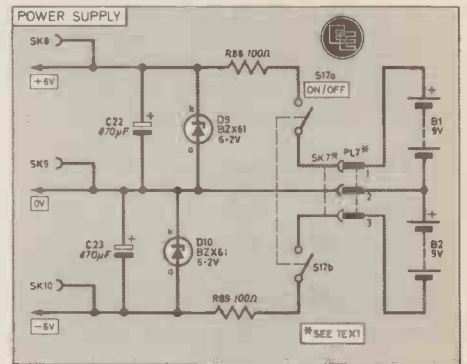

Fig. 9. Power supply circuit diagram. Note that PL7 and SK7 are only necessary if the batteries are housed externally in an additional case.

Precision Resistors

R1, 101, 13, 113	100Ω (4 off)
R2, 102, 14, 114	50Ω (4 off)
R3, 103, 15, 115	20Ω (4 off)
R4, 104, 16, 116	10Ω (4 off)
R5, 105, 17, 117	5Ω (4 off)
R6, 106, 18, 118	2Ω (4 off)
R7, 107	1Ω, 2W (2 off)
R8, 108	0.5Ω, 4W (2 off)
R9, 109	0.2Ω, 10W (2 off)
R10, 110, 31, 131, 38, 138	1kΩ (6 off)
R11, 111, 39, 139	500Ω (4 off)
R12, 112, 40, 140	200Ω (4 off)
R19, 119	1MΩ (2 off)
R20, 120	500kΩ (2 off)
R21, 121	200kΩ (2 off)
R22, 122, 32, 132	100kΩ (4 off)
R23, 123, 33, 133	50kΩ (4 off)
R24, 124, 34, 134	20kΩ (4 off)
R25, 125, 35, 135, 44, 144, 45, 145	10kΩ (8 off)

R26, 126, 36, 136	5kΩ (4 off)
R27, 127, 37, 137	2kΩ (4 off)
R46, 146	40kΩ (2 off)
R47, 147	90kΩ (2 off)
R48, 148	190kΩ (2 off)
R49, 149	490kΩ (2 off)

All 1/4 or 1/2W metal film ±1% unless otherwise stated. Where values are not in the E24 preferred series, the correct value should be made up from preferred values. See text.

R65	120kΩ
R66	5.6kΩ
R67, 73	22kΩ (2 off)
R68, 74	56kΩ (2 off)
R69, 72, 87	47kΩ (3 off)
R70, 71	470Ω (2 off)
R75, 175, 76, 176, 82, 83, 90, 190	10kΩ (8 off)
R78, 178	10MΩ (2 off)
R79	100kΩ
R81, 86	2.2MΩ (2 off)
R84	470kΩ
R85	1MΩ

All 1/4 or 1/2W carbon ±5%

All other Resistors

R28, 128, 80	3.9kΩ (3 off)
R29, 129, 42, 142	390kΩ (4 off)
R30, 130	6.8kΩ (2 off)
R41, 141	39kΩ (2 off)
R43, 143	36kΩ (2 off)
R50, 150, 53, 153, 54, 154	1kΩ (6 off)
R51, 151	2.2Ω (2 off)
R52, 152, 88, 89	100Ω (4 off)
R55, 58, 59	4.7kΩ (3 off)
R56, 57, 64	82kΩ (3 off)
R60	680Ω
R61	18kΩ
R62, 63, 77, 177	8.2kΩ (4 off)

Variable Resistors

VR1, 101, 2, 102, 4, 104, 5, 105, 6, 106, 8, 108	} 10kΩ miniature horizontal pre-set (12 off)
VR3, 103	
VR7, 107	50kΩ linear potentiometer (2 off)
VR9, 11, 13	2.2kΩ miniature horizontal pre-set (2 off)
VR10, 12, 15, 115	5kΩ linear potentiometer (3 off)
VR14	5kΩ miniature horizontal preset (4 off)
	100kΩ miniature horizontal preset

Capacitors

C1, 101, 3, 103	} 0.01μF polyester
C2, 102	
C4, 104	0.1μF polyester (2 off)
C5, 7	2,200pF polyester (2 off)
C6, 8	1,000pF polystyrene low leakage ±5% (2 off)
C9	4,700pF polystyrene low leakage ±5% (2 off)
C10, 12, 13, 14, 15, 16	} 0.047μF polyester
C11	
C17, 117	10μF 25V elect. (6 off)
C18	6.8μF 25V elect.
C19, 21	1μF 25V tantalum (2 off)
C20	0.47μF polyester
C22, 23	0.22μF polyester (2 off)
	4.7μF 25V elect.
	470μF 40V elect (2 off)

Switches

S1, 101, 6, 106, 15, 12, 112, 16, 116, 9, 109, 17	} d.p.d.t. miniature toggle (12 off)
S2, 102, 14	
S3, 103	3-pole, 3-way rotary (3 off)
S4, 104, 5, 105, 7, 107	} single pole, 9-way 10A rotary (2 off)
S8, 108	
S10, 11	single pole, 9-way midget rotary (6 off)
S13, 113	single pole, 6-way midget rotary (2 off)
	s.p.d.t. miniature toggle (2 off)
	push-to-make non-latching (2 off)

**See
Shop
Talk**
page 722

Semiconductors

D1, 101, 2, 3, 6, 106, 7, 8	} 1N4148 small signal silicon (8 off)
D4, 5	
D9, 10	0A200 germanium (2 off)
TR1, 2, 3, 4, 5, 6	BZX61 C6V2 6.2V 1.3W Zener diode (2 off)
IC1, 101, 3, 103, 4, 104, 5, 105, 6, 106, 7, 8	} 2N3904 silicon npn (6 off)
IC2, 102	
	CA3140 f.e.t. input op-amp (12 off)
	7555 CMOS timer (2 off)

Connectors

SK1, 101	b.n.c. coaxial socket (2 off)
SK2	4mm banana socket yellow
SK3	4mm banana socket red
SK4	4mm banana socket black
SK5	4mm insulated terminal red
SK6	4mm insulated terminal black
SK7	3-way DIN socket
SK8, 10	1mm test socket red (2 off)
SK9	1mm test socket black
PL7	3-way DIN plug

Miscellaneous

B1, 2	9V PP6 batteries (2 off)
	Single-sided p.c.b. 173 × 140mm; console case with front panel 300 × 220mm minimum (see text); case to house battery pack; knobs, 21mm diameter, 4 off red, 8 off blue, 2 off yellow, 2 off green, 2 off grey; 8-pin d.i.l. holder (14 off); Veropins; 7/0.2mm equipment wire.

COMPONENTS
approximate
cost £60
excluding
p.c.b. & case

CONSTRUCTION starts here

CIRCUIT BOARD

The main circuit is constructed on a single printed circuit board, 173 x 140mm, the full size artwork of which is given in Fig. 11. On the original prototype shown in the photographs, the p.c.b. was larger than that given in Fig. 11. However, due to restrictions imposed by the size of the page, the layout has been made more compact but with components still retaining their relative positions.

One benefit of this reduction in size (apart from a cheaper piece of board!) is that the two PP6 batteries can be fitted into the main console unit, thus eliminating the need for the three-way DIN plug and socket (PL7 and SK7) and the case for the battery pack.

The components are inserted into the board as shown in the p.c.b. assembly diagram, Fig. 12, and all the usual precautions concerning polarity of diodes, capacitors and semiconductors must be taken. It is recommended that Veropins are used for all flying lead connections.

FRONT PANEL

The rotary switches, toggle switches, control potentiometers, and input/output sockets are all mounted to the front panel as shown in Fig. 13. This panel is made from 1mm thick (20s.w.g.) aluminium sheet, 300 x 220mm.

The positions of the hole centres are given on this diagram but the diameters of the holes will depend upon the type of component used, so this should be measured carefully before drilling.

Fig. 14 shows the rear view of the front panel and this is to be used as a guide when finally wiring up. Note that the voltage and current range resistors are mounted directly onto the relevant switches.

COMPONENTS

Note that in the components list, the voltage and current range resistors are listed separately as Precision Resistors and that some of the values quoted are not in the E24 preferred series, for example, 500 ohms. Therefore, if the constructor wishes to maintain accuracy, these values must be made up from two E24 values, in our example, a 470 ohm resistor and a 30 ohm re-

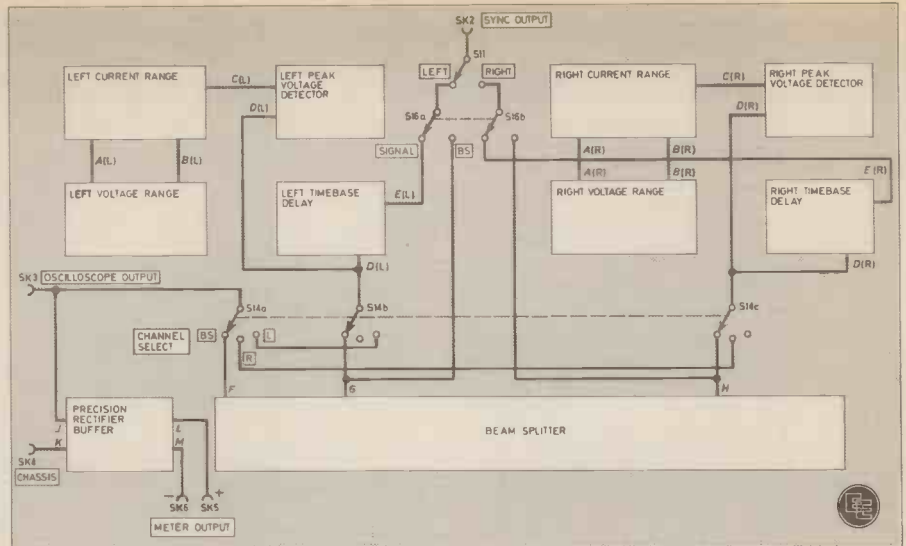

Fig. 10. System wiring diagram showing how the two channels are wired together. Letters in italics refer to the interconnections shown on the individual circuit diagrams (Figs. 1, 2 and 4 to 9). Power supply connections not shown.

sistor (both E24 preferred values) will equal 500 ohms.

However, in order to save on cost (at the sacrifice of accuracy), the nearest E24 value can be substituted. For example, the 5 kilohm resistor can be a 5.1 kilohm, the 2 ohm a 2.2 ohm and so on. If this course is chosen, then these resistors can all be ± 5 per cent tolerance types, if the subsequent drop in accuracy is acceptable.

It should also be noted that four sections of the circuit, the current range, voltage range, timebase delay and the peak voltage detector are duplicated for each channel. The circuit diagrams given are for the left channel and those for the right channel are identical but all components have been given the prefix 100 to assist identification. For example, R1 becomes R101, S13 becomes S113, and so on.

CASE

The prototype unit was built into a specially made console type case constructed from Perspex clear acrylic sheet, 6.4mm (1/4 inch) thick with an aluminium front panel. Plywood of the same thickness could also be used.

The dimensions of the case are: base 300 x 212mm, height, 120mm at the rear and 60mm at the front.

The base was butt jointed together with battens added to the corners for additional strength. The assembly is then glued together with epoxy adhesive (such as Araldite).

WIRING

The final wiring is carried out with the aid of the p.c.b. assembly drawing, the rear view of the front panel and the wiring list. All wire

used must be the multistranded type, a 7/0.2mm equipment wire is ideal.

When routing the wires, it is suggested that the p.c.b. assembly and front panel assembly are positioned so that when secured to the case assembly, the wiring acts as a kind of hinge to permit easy removal.

OPERATING INSTRUCTIONS

Power is supplied via the 3-pin DIN socket SK7 mounted on the rear panel (unless the batteries are mounted in the case).

The unit accepts two inputs via the b.n.c. sockets (standard 50 Ω) located on the front panel. The signal should be connected to these inputs via good quality screened leads only.

Two outputs are provided by the unit. To the right of centre on the front panel are three 4mm sockets. These are outputs for the oscilloscope and are connected up as follows — The red socket is connected to the signal input, the black socket to the earth and the yellow socket to the external sync input. To the left of centre are two 4mm sockets. These are provided for a meter and are connected, red to the positive meter terminal and black to negative.

Oscilloscope and Meter Settings

The following oscilloscope controls should be set as shown.

- Sync select — external
- Sync level — fully positive
- Input select — a.c.
- X shift, Y shift — as appropriate to centre trace
- Volts/division — 1V/div or 0.5V/div (see later)
- Timebase (Time/div) — as appropriate
- All other controls — as stated in the oscilloscope manual.

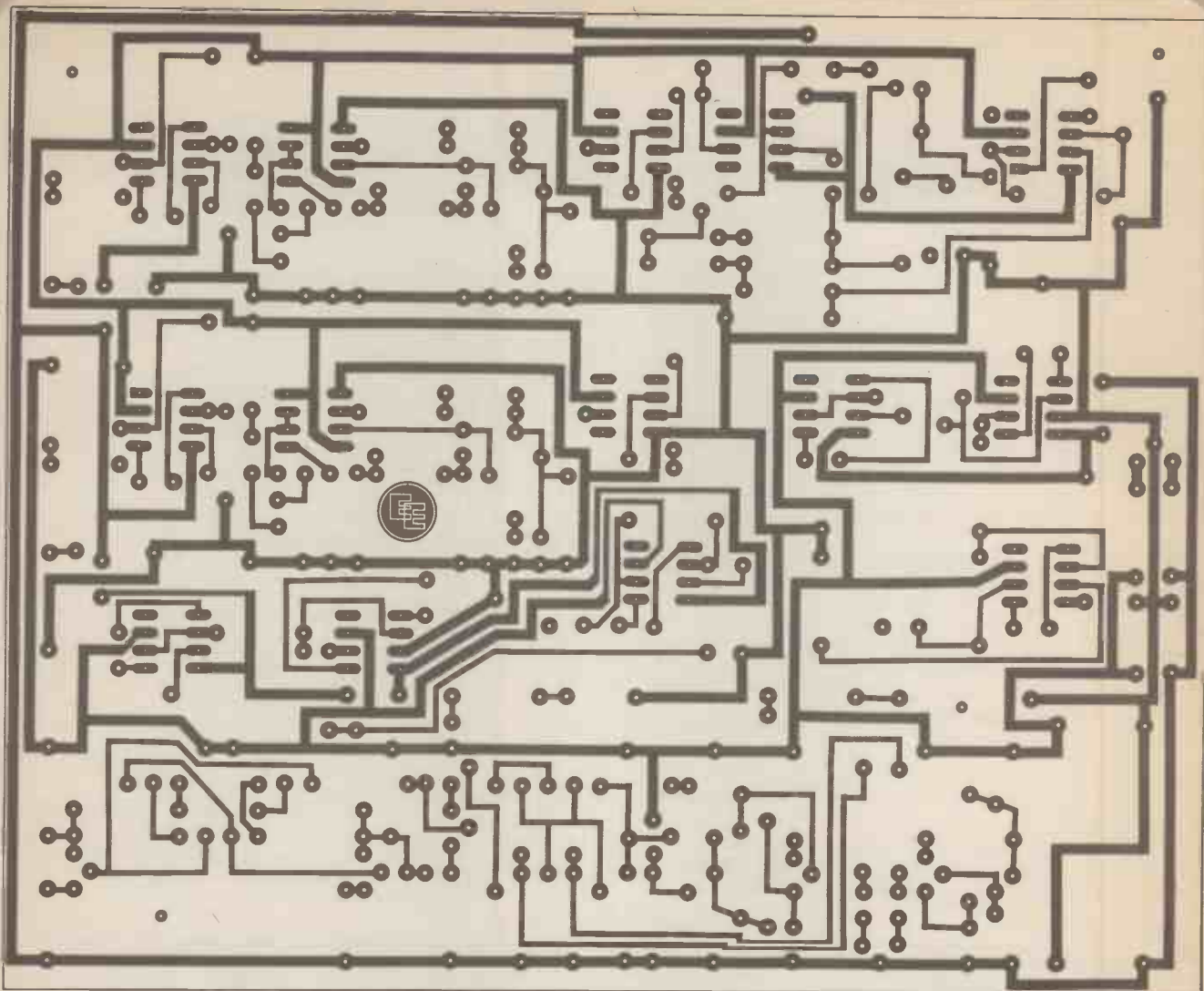
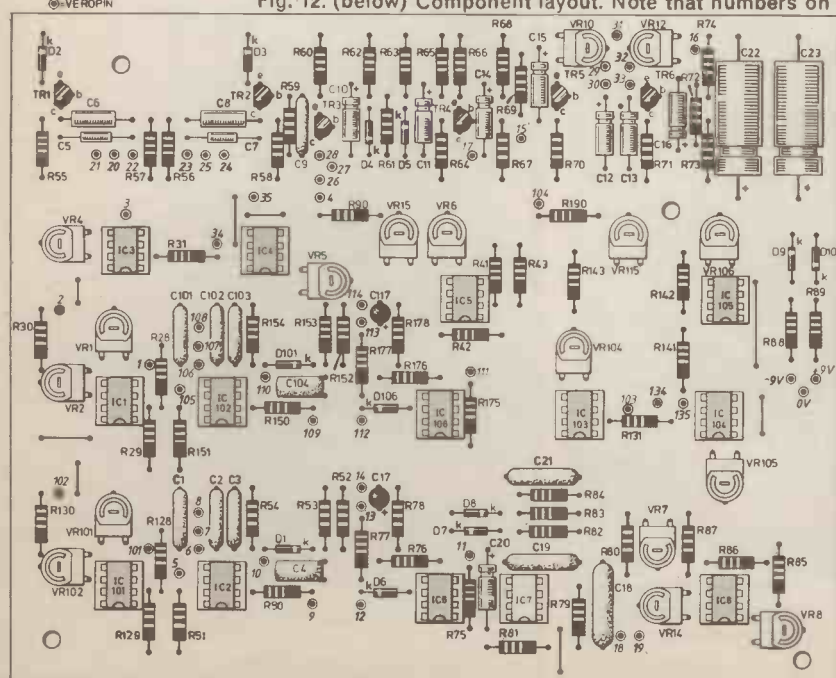

Fig. 11. Full size p.c.b. artwork for the Oscilloscope companion main component board. Photograph below shows completed assembly.

Fig. 12. (below) Component layout. Note that numbers on Veropins refer to numbers quoted on wiring list.



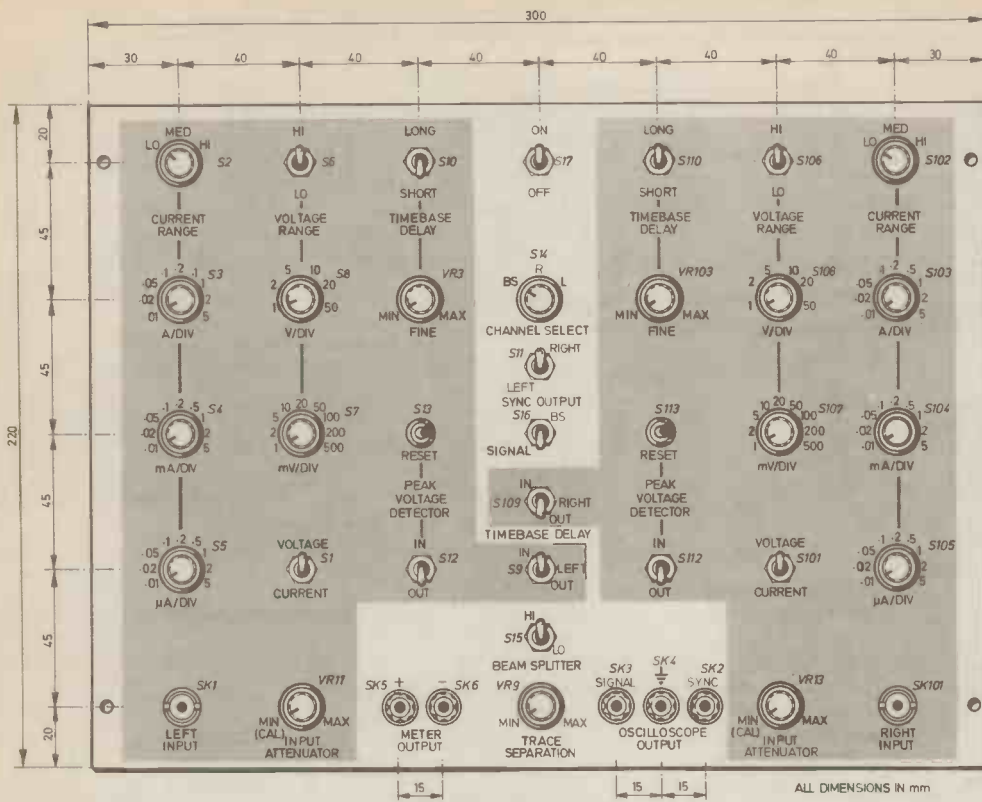

Fig. 13. Drilling drawing and assembly diagram for the front panel.

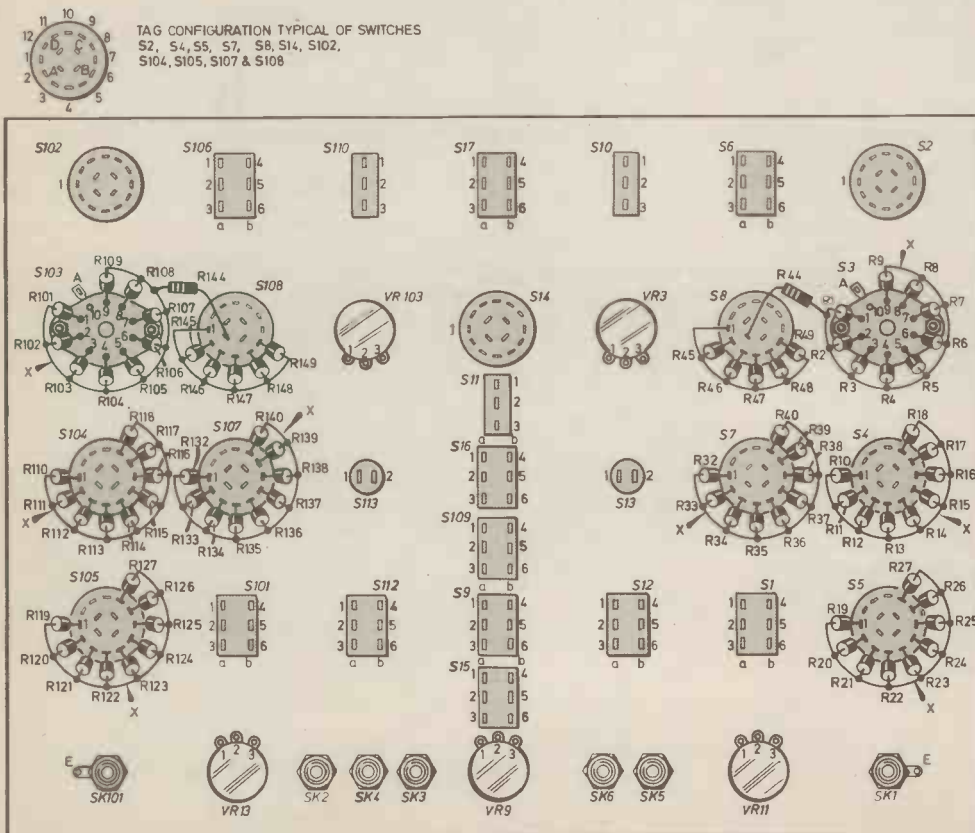

Fig. 14. Rear view of the front panel showing all switch terminal references and switch mounted components.

OSCILLOSCOPE COMPANION POINT-TO-POINT WIRING DATA

All wires to be multi-stranded, p.v.c. sleeved equipment wire. Use as many colours as possible to assist identification. Some terminals have more than one wire soldered to them so it is advisable to check the next wire link on the list before making the joint.

* Wire links marked thus are only required if a separate battery housing is used.

WIRE NO.	FROM	TO	WIRE NO.	FROM	TO	WIRE NO.	FROM	TO
001	S1-1	S2-A	043	S101-5	S112-2	085	S14-2	S14-8
002	S1-2	SK1	044	S101-6	S106-5	086	S14-3	S14-6
003	S1-3	S6-2	045	S102-1	S102-7	087	S14-A	SK3
004	S1-4	S2-C	046	S102-7	S103-A	088	SK3	PCB-18
005	S1-5	S12-2	047	S102-2	S102-3	089	SK5	PCB-19
006	S1-6	S6-5	048	S102-3	S102-B	090	S15-1	PCB-20
007	S2-1	S2-7	049	S102-B	PCB-101	091	S15-2	PCB-21
008	S2-7	S3-A	050	S102-5	S104-A	092	S15-3	PCB-22
009	S2-2	S2-3	051	S102-6	S105-A	093	S15-4	PCB-23
010	S2-3	S2-B	052	S102-8	S102-9	094	S15-5	PCB-24
011	S2-B	PCB-1	053	S102-9	PCB-102	095	S15-6	PCB-25
012	S2-5	S4-A	054	S106-1	PCB-103	096	VR9-1	PCB-26
013	S2-6	S5-A	055	S106-3	S108-1	097	VR9-2	PCB-27
014	S2-8	S2-9	056	S106-4	PCB-104	098	VR9-3	PCB-28
015	S2-9	PCB-2	057	S106-6	S108-A	099	VR11-1	PCB-29
016	S6-1	PCB-3	058	S107-A	PCB-134	100	VR11-2	PCB-30
017	S6-3	S8-1	059	S107-X	PCB-135	101	VR11-3	VR13-3
018	S6-4	PCB-4	060	VR103-1	PCB-105	102	VR13-3	PCB-31
019	S6-6	S8-A	061	VR103-2	VR103-3	103	VR13-1	PCB-32
020	S7-A	PCB-34	062	VR103-3	S110-2	104	VR13-2	PCB-33
021	S7-X	PCB-35	063	S110-2	PCB-106	105	SK1-E	SK6
022	VR3-1	PCB-5	064	S110-1	PCB-107	106	SK6	SK4
023	VR3-2	VR3-3	065	S110-3	PCB-108	107	SK4	SK101-E
024	VR3-3	S10-2	066	S109-2	S109-4	108	SK101-E	S103-X
025	S10-2	PCB-6	067	S109-4	S14-C	109	S103-X	S104-X
026	S10-1	PCB-7	068	S14-C	S112-5	110	S104-X	S105-X
027	S10-3	PCB-8	069	S109-3	PCB-109	111	S105-X	S5-X
028	S9-2	S9-4	070	S109-5	S16-4	112	S5-X	S4-X
029	S9-4	S14-B	071	S109-6	PCB-110	113	S4-X	S3-X
030	S14-B	S12-5	072	S112-1	S112-4	114	S3-X	PCB(0V)
031	S9-3	PCB-9	073	S112-3	PCB-111	115	S17-2	PCB(+9V)
032	S9-5	S16-1	074	S112-6	PCB-112	116	PCB(+9V)	SK8
033	S9-6	PCB-10	075	S113-1	PCB-113	117	S17-5	PCB(-9V)
034	S12-1	S12-4	076	S113-2	PCB-114	118	PCB(-9V)	SK10
035	S12-3	PCB-11	077	S16-2	S11-1	119*	S17-3	SK7-1
036	S12-6	PCB-12	078	S16-5	S11-3	120*	S17-6	SK7-3
037	S13-1	PCB-13	079	S11-2	SK2	121*	SK7-2	PCB(0V)
038	S13-2	PCB-14	080	S16-3	S14-4	122	PCB(0V)	SK9
039	S101-1	S102-A	081	S14-4	PCB-15	123	PL7-1	B1(+ve)
040	S101-2	SK101	082	S16-6	S14-7	124*	PL7-2	B1(-ve)
041	S101-3	S106-2	083	S14-7	PCB-16	125*	B1(-ve)	B2(+ve)
042	S101-4	S102-C	084	S14-1	PCB-17	126*	PL7-3	B2(-ve)

The oscilloscope is now set up and any adjustments will be detailed in the appropriate section of these instructions.

The meter, if connected, should be set to read d.c. voltage and should read 5V f.s.d. minimum.

Voltage Measurement (A.C. and D.C.)

Set the following switches on the unit as indicated —

VOLTAGE/CURRENT SELECT — VOLTAGE.
VOLTAGE RANGE — as required or HI if order of input not known.

Voltage range switches — as required or 50V/div if order of input not known.

PEAK VOLTAGE DETECTOR select — OUT

TIMEBASE DELAY — OUT

CHANNEL SELECT — the channel being used (L or R)

Any input will now be sent to the CRO, the trace being deflected as per the voltage range selected.

Peak Voltage detector

Set the oscilloscope to measure d.c. and 1V/div. With no input,

switch the PEAK VOLTAGE DETECTOR SELECT to the 'IN' position. Adjust the oscilloscope Y shift control to centre the trace. Any input will now have its peak value displayed as a straight line on the c.r.o. screen. The RESET button may be used to zero the trace after an input has been removed.

Timebase Delay

Switch the TIMEBASE DELAY switch to the IN position. With an input, adjust the DELAY TIME controls in conjunction with the oscilloscope's "Sync Level" control to produce a steady trace in a good position on the screen.

Beam Splitter

Set the controls of each channel as required. Set the CHANNEL SELECT switch to the BS position. Set the c.r.o. to read a.c. 0-5V/div. Adjust the TRACE SEPARATION control and the Y shift separation control to obtain two traces, one half way up the top half of the screen and one half way

down the bottom half. Both channels may now be displayed simultaneously.

If the traces appear too large to comfortably fit on the screen, use the INPUT ATTENUATORS. In the MIN position, the traces are accurate and readings may be taken from them.

Sync Outputs

The SYNC OUTPUT is selected via the appropriate switches and can be taken from left or right channel, beam splitter or signal or timebase delay. After setting, the "sync select" control of the oscilloscope should be adjusted to get a steady trace.

Reading the Meter

If a meter is connected then all that has to be done is read it as normal. The voltage will relate to the r.m.s. value of the waveform and can be changed into the correct value by multiplying the meter reading by the Units/div value. □

Everyday News

Lightlines

BRITAIN GETS WORLD'S LONGEST OPTICAL FIBRE . . .

The world's longest optical fibre telephone cable came into service recently (July 22) between London and Birmingham, the busiest trunk route in Britain. This is the latest addition to British Telecom's "Lightlines" optical fibre network.

British Telecom started laying the 204 kilometres (128 miles) of optical fibre cable in October last year. After only nine months the cable has begun carrying calls between the country's two major business centres.

The new fibre cable replaces the old metal cable London to Birmingham link first installed in about 1887. Then the cable consisted of seventy-six wires.

. . . And Martlesham Medal for Optical Fibre Pioneers

Two British Telecom scientists, who achieved the first vital breakthroughs in optical fibre technology, have received the Martlesham Medal.

Dr George Newns and Dr Keith Beales were key members of a small Telecom research team which in the late 1960s and early 1970s helped to steer Britain into a leading world position in optical communications.

An early picture, circa 1887, of an engineer working on the original London to Birmingham metal cable link. The cable consisted of seventy-six wires. In those days, once the cable had been joined, it was finally "wrapped and wiped" in molten lead.

UNDERGROUND FROM LONDON TO BIRMINGHAM



Figures from the German Patents Office in Munich indicate no shortage of invention and innovation. The office has archives of 22 million patents with new applications at a rate of 100,000 a year.



The Chairman of British Telecom, Sir George Jefferson, holds up a specimen of optical fibre cables at the opening of the world's longest optical communication route.

In particular, they took the double crucible method of making fibre from a crude laboratory concept to a highly successful production process which has been licensed to British, European and American companies and which has a waiting list of applicants.

Cable laying teams installing the new optical fibre cables keep in touch with distant teams by radio link. Optical fibres are hair-thin strands of glass cable capable of carrying thousands of simultaneous telephone calls and digital information down a single cable.



Demand for audio equipment is at a low level with even the Japanese complaining. The slump has forced the closure of Wharfedale, a top name in Britain for loudspeakers over the last 50 years. — See "For Your Entertainment!"



ANALYSIS

TOOL OR TOY?

In a world still reeling in trade recession the personal computer is an unquestioned star. It has fired the imagination of millions. The professional computers in the offices of successful manufacturers are overheating totting up the daily profits.

Beautifully produced brochures and other promotional aids bear all the hallmarks of high-powered marketing, presenting the personal computer as a fun thing, which it is, as an education, which it also is, and as a modern necessity for managing personal affairs which is very much a matter of opinion.

The publicity bandwagon should have had a further boost from a BBC Radio 4 Tuesday Call Phone-in. The two experts in the studio were enthusiastic on TV games, uncomfortable when pressed to reveal more serious and useful applications.

It all sounded so unconvincing that I was prompted to cast my mind back to the pre-computer era and recall how mother, head of a poor but happy family in a previous recession, managed her housekeeping budget within a cash income of £3 a week. She had never then heard of a computer (they hadn't been invented), was not mathematically minded, knew nothing of economics.

But she, too, had a computer of sorts consisting of a row of jam jars kept on a high shelf in the pantry. They were labelled Rent, Hire Purchase, Food, Coal, Gas, Electricity, Insurance, Clothes, Entertainment and so on.

On pay day the total incoming cash was divided and entered physically into the jam jar store in the various categories of outgoings and then withdrawn and disbursed as necessary during the week. The jam jars, being transparent, acted not only as a store (RAM) but also doubled as an instant visual display unit (VDU) showing at a glance the cash status of any liability at any time in the weekly economic cycle.

At the end of the week any surplus cash was "dumped" into a main bulk store called the Post Office where an obliging clerk would up-date her investment balance with a hand-written hard-copy print-out in her savings book.

The only snag was that mother's computer gave us kids no exciting electronic games. But my two sisters acquired needleworking and dressmaking skills out of surplus scraps for their dolls. We couldn't afford to buy a wireless set so I found out how to build one. It was my first step to a career in electronics.

Brian G. Peck

NEWS FROM SPACE

Twenty Years On

In the 20 years since Telstar, the world's first communications satellite to relay live TV pictures between the USA and Britain, the technology and usage have grown to today's 300 aerials at 200 earth stations with 13 geostationary Intelsat satellites handling two thirds of the world's intercontinental traffic.

Comet Study

British Aerospace is prime contractor in a team of nine from Europe in a £34 million project to study Halley's Comet when it comes near the earth in 1986.

The Giotto space satellite which will carry experiments by a number of European universities is to be launched in 1985, taking eight months to intercept the comet which passes close to earth every 76 years.

CB Probe

Suggestions that different CB technical standards in EEC countries are a barrier against trade, and therefore illegal under Common Market trade rules, could lead to harmonisation proposals on permitted power, frequencies and type of modulation.

British "breakers" may have to face yet another change of equipment if Common Market officials press for unification of standards throughout the Community.

ICL is to spend £350,000 in support of relevant research projects in British Universities. In total, ICL's R & D budget is of the order of £65 million per year.

Akio Wins Albert

The Royal Society of Arts prestigious Albert Medal has been awarded to Akio Morita, chairman and chief executive of Sony, for distinguished service in technological and industrial innovation. He is the first ever Japanese to win the medal.

KEEPING AHEAD

A first contribution of £6.9 million has been granted by the EEC to the European Strategic Research Programme in Information Technology (Esprit).

This programme is intended to keep Europe abreast, if not ahead, of similar programmes in the USA and Japan. Apart from central EEC funds, national governments and companies involved will also be investing large amounts. GEC, Plessey and ICL and nine other leading European companies are participating.

Next it's WCY

Hard on the heels of Britain's Information Technology Year is World Communications Year (WCY) in 1983 sponsored by the United Nations.

The All-Electronics/ECIF Show is changing its name to "The European All-Electronics/ECIF Show". The venue is to be the Barbican Arts and Conferences Centre and will run from April 19 to 21 1983.

SHIP RADIO

Although British shipbuilding is at a low ebb, Marconi International Marine remains a leading supplier of ship radio stations. The company's recent order book includes main installations in ten ships under construction in India, Japan and Korea.

The naval communications system ICS 3 developed by Marconi Communications Systems is now in use with five NATO navies and was the backbone of task force communications in the Falklands conflict.

SEDAC WINNERS VISIT MULLARD

The 1982 prize winners of the SEDAC Schools Competition enjoying their trip around the Mullard, Blackburn factory. Our picture shows the winning team from Peel Sixth Form College, Martin Lysejko and Anthony Hudson, watching Pat Wilson operating a scanning electron microscope in the works laboratory—For details of how to enter the 1983 SEDAC Schools Competition see page 721.





DESCRIBED here is the construction of a simple device for determining the first to pass the winning post on a slot car race track. It can be relied on to give an unbiased judgement. Although primarily designed for a model car race track, the constructor may well adapt the device for other purposes. The circuit uses a phototransistor buried on each track to detect the passing cars.

CIRCUIT DESCRIPTION

In the circuit diagram, Fig. 1, TR1 and 2 are two phototransistors and these are buried in the track so that when a car passes overhead it interrupts the ambient light falling on the transistors, causing the collector current to drop, hence the collector voltage to rise. These positive going pulses are fed into the CLOCK inputs of IC1 (pins 3 and 11).

IC1 is a CMOS 4013 containing two flip-flops connected together such that if one flip-flop changes its state, it prevents the other from doing so. This is done by connecting the Q output of one flip-flop to the D (DATA) input of the other. Whenever a positive pulse is applied to the clock input of a flip-flop, the Q output goes to the same state as the DATA input, and the Q to the opposite state.

Hence, if for example, the car detected by TR1 is the first to pass the post, the Q output of IC1a goes to 1 and the Q output goes to 0. The DATA input of IC1b is thus held at 0, so that when the second car passes the post as detected by TR2, the Q output of IC1b goes to 0; that is there is no change since the Q output of IC1a and IC1b started at 0, and the Q at 1.

Any further inputs to either flip-flop will cause no change in the output states until the flip-flops are reset by S1, which gives a momentary 1 to the reset inputs, pins 4 and 10.

The Q outputs 1 and 13 are connected to TR3 and TR4 respectively. When a flip-flop changes state the corresponding transistor is turned on, and hence drives the l.e.d. connected to it. R3 and R5 determine the current, and hence the brightness of the l.e.d.s. The l.e.d.s could be driven directly from the flip-flop outputs, but the current available does not give a very bright display, so TR3 and TR4 are therefore included to give more current drive.

The current used by the circuit is less than $1\mu\text{A}$ with no l.e.d. alight, and about 20mA when lit.

COMPONENTS

TR1 and TR2 were TIL78 phototransistors. Other types could be used, though R1 and R2 may need to be changed according to the sensitivity of the detectors. TR3 and TR4 may be any small signal npn transistors. The l.e.d.s may be any size or any colour, the prototype used one red and one green.

CONSTRUCTION

The prototype Photo Finish unit uses a plastic case, a PP3 battery and an ON/OFF switch. It may well be

that the constructor may be able to fit the circuit board into an existing piece of race track accessory and use the power supply of the race track. The circuit will function over a wide range of voltage up to 15V, however, it may be necessary to adjust R3 and R5 if the voltage is significantly lower than 9V.

If an external power source is used it may be necessary to use a diode and capacitor as shown in Fig. 2 to prevent electrical noise from the race cars from triggering the flip-flops.

A piece of stripboard 10 strips by 31 holes was used to mount the components. This size of board was chosen to fit the mounting slots of the box, size $85 \times 34 \times 56\text{mm}$, with an aluminium lid.

Fig. 3 gives the component layout on the board, the underside track breaks, and the wiring to the components mounted on the lid. Drill a straight piece of race track to enable the phototransistors to be a tight fit and choose a position such that the passing car will obscure the ambient light. Push them in from the underside and secure with glue. The connections to the unit may be by direct wiring or via terminal blocks (3-way required).

IN USE

In most cases the ambient light should be sufficient for the phototransistors to detect the cars. If not, place the piece of track with the detectors near a window or underneath a light. If no response is obtained from a cell, it may be that its connections are reversed.

Finally, it may be found that the shadow of someone passing nearby will trigger the photocell, if so, try to position the finish line away from such obstructions. □

photo finish

BY A.P. DONLEAVY



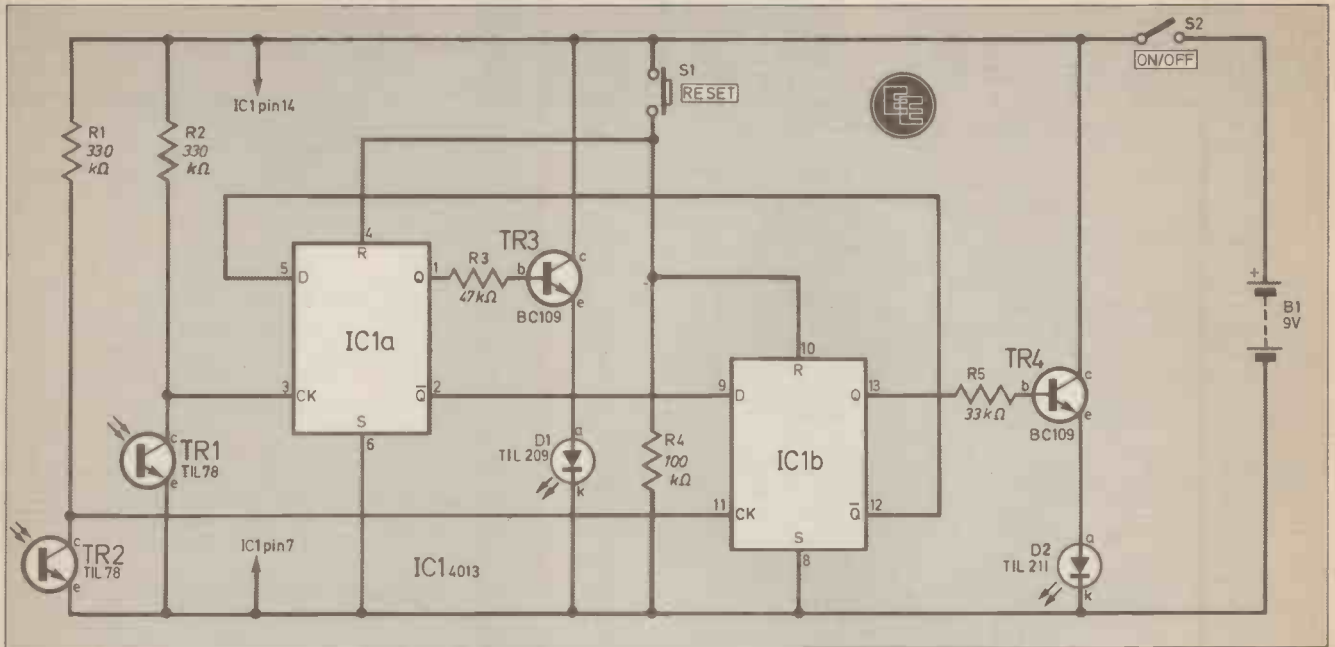

Fig. 1. The circuit diagram of the Photo Finish.

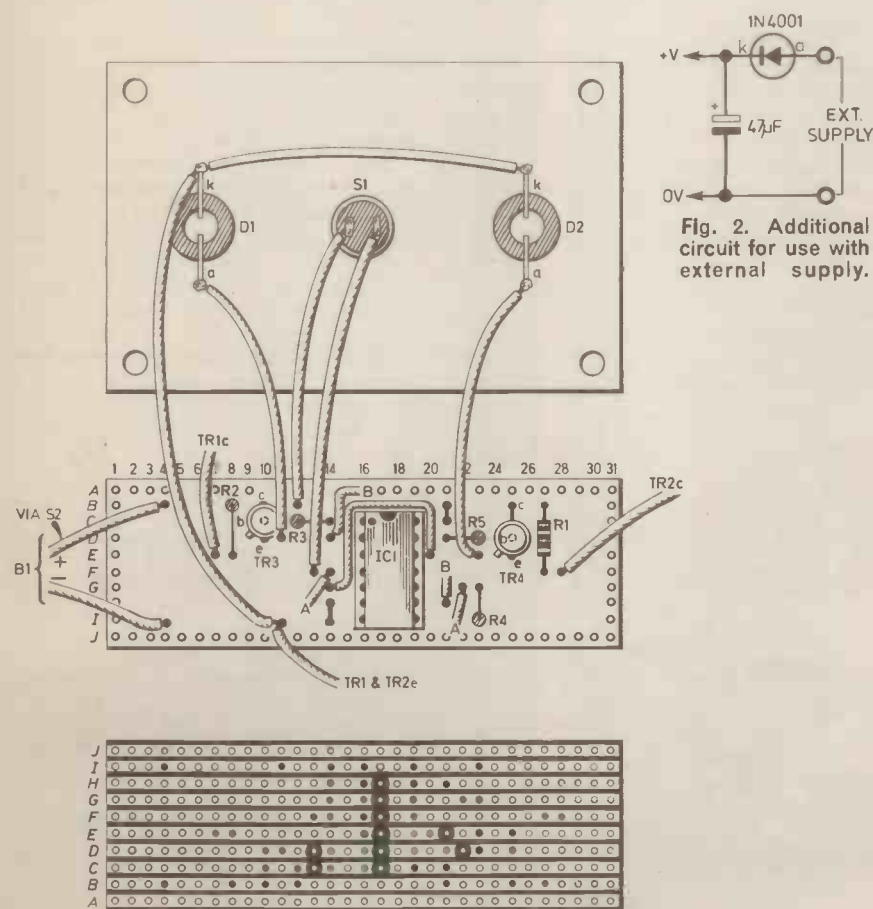

Fig. 3. Stripboard layout and external component wiring diagram. Note that the wires to the remotely mounted phototransistors TR1 and 2 can either go direct or via a 3-way terminal block.



COMPONENTS

Resistors

- R1,2 330kΩ (2 off)
- R3 47kΩ
- R4 100kΩ
- R5 33kΩ
- All 1/4W carbon ±5%

Semiconductors

- D1 TIL209 red l.e.d.
- D2 TIL211 green l.e.d.
- TR1,2 TIL78 phototransistor *npn* (2 off)
- TR3,4 BC109 silicon *npn* (2 off)
- IC1 4013B CMOS dual D-type flip-flop

Miscellaneous

- S1 Push-to-make miniature push button
- S2 s.p.s.t. miniature toggle
- B1 9V PP3 battery
- Stripboard, 0.1in. matrix, 10 strips by 31 holes; plastic case with aluminium lid, 85 × 55 × 35mm; battery clip; l.e.d. mounting clip (2 off); 3-way terminal block; 7/0.2mm wire.

Approx. cost
Guidance only

£5

See
**Shop
Talk**
page 722.

BEAT the RELAY

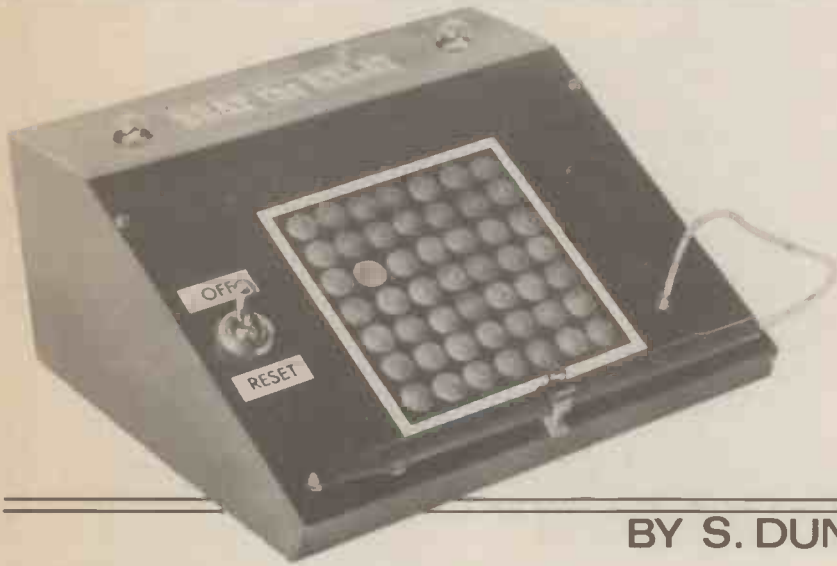

BY S. DUNN

ADVANCES in modern electronic games have rendered the humble board game a little old-fashioned, so here we describe a simple circuit to add a few flashing lights and new excitement to the basic board and counter type game.

Its uncomplicated construction and low cost make this project ideal for the beginner.

CIRCUIT DESCRIPTION

The basic concept of Beat The Relay is to have a panel on which there is a matrix of drawing pins, and some of these are wired so as to trigger two flashing lamps when touched by a probe.

The full circuit diagram is shown in Fig. 1. The prototype model has 49 drawing pins in a 7 by 7 matrix and the circuit diagram shows five of these wired so as to set the lamps off. However, any number may be used, so this is left to the constructor.

These "hot" drawing pins are connected together and then to the positive of the battery. When the probe makes contact with one of these pins, the relay coil, RLA/1 is energised, thus closing the normally open contacts, RLA/1. This in turn, keeps the relay coil energised and so acts as a latch circuit.

To release this latch, switch S1 has to be opened, in so doing it breaks the flow of current through the relay and RESETS the circuit. This switch is also the ON/OFF switch.

LAMP FLASHERS

Once the relay has latched, the positive power supply is fed to the flasher circuit. This circuit configuration is known as an *astable multivibrator* which will oscillate when energised.

To discuss how this type of circuit works, we first assume that transistor TR1 is "on" and TR2 is "off". This being the case, LP1 is on and LP2 is off. As TR1 is conducting, its collector (c) is almost at 0V potential so electrolytic capacitor C1 will charge up through resistor R2 and this increases the potential on the base (b) of TR2 until TR2 itself turns "on".

When this occurs, TR1 turns "off" as the collector of TR2 is now very close to 0V, this also appearing on the base of TR1. LP2 is now on and LP1 has gone off.

The whole process now reverses, with C2 charging through R3 until TR1 turns back "on" and the sequence repeats itself.

In this way the lamps flash on and off alternately, at a rate governed by the values of C1/R2 and C2/R3, when RLA is energised.

CIRCUIT BOARD

The multivibrator circuit was assembled on a small piece of strip-board, 11 strips by 12 holes, and the component layout is shown in Fig. 2 along with the interwiring details. Attention should be paid to the positions of the two track breaks and to the orientation of the electrolytic capacitors and transistors.

CASE ASSEMBLY

Before the final wiring of the electronic components is performed, the case must be made. The prototype model was assembled in a home-made wooden console, constructed from 6mm thick plywood as shown in the photographs. It measures 170mm wide by 150mm deep by 70mm high. The sloping front panel is 120mm from front to back.

The cabinet is butt-jointed and glued and then painted black. The front panel is secured with two screws to allow access for assembly.

The two lamp holders are glued beneath two holes in the top piece, S1 and the drawing pins are fixed into the front panel as shown. It is important that the points of the pins protrude through the back of the front panel. Finally add a small hole for the probe wire and mount the Terry clip holder.

Fig. 1. Circuit diagram of the Beat the Relay game.

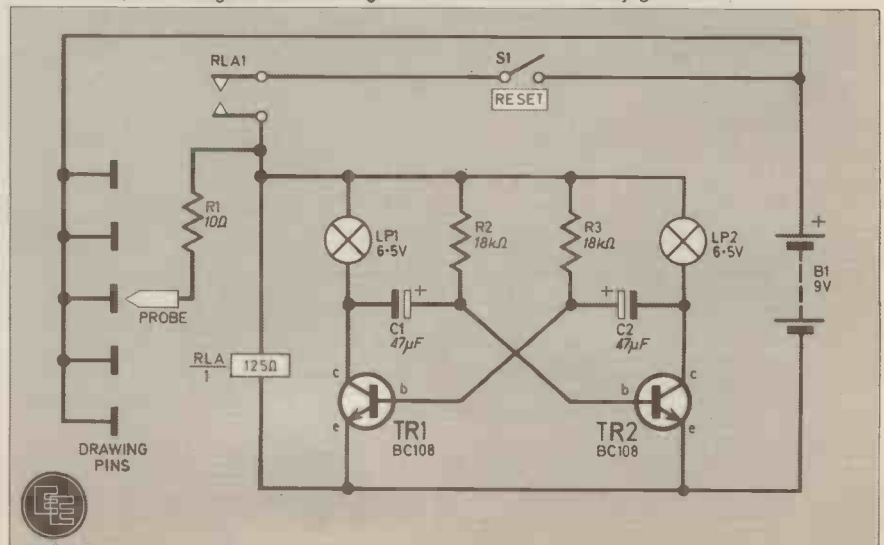

COMPONENTS

See
**Shop
Talk**
page 722

Resistors

R1 10 Ω
R2, 3 18k Ω (2 off)
All $\frac{1}{4}$ W carbon $\pm 10\%$

Capacitors

C1, 2 47 μ F 10V elect (2 off)

Semiconductors

TR1, 2 BC108 npn silicon (2 off)

Miscellaneous

S1 s.p.s.t. toggle switch
LP1, 2 6.5V, 0.15A filament lamp
(2 off)
RLA 12V, 125 Ω coil relay with normally open contacts
B1 9V PP6 battery
Stripboard, 0.1in. matrix, 11 strips by 12 holes; lamp holders (2 off, for LP1, 2); battery clips; 7/0.2 equipment wire; empty ball point pen holder (for the probe); drawing pins (49 off, must *not* be the plastic coated type); Terry clip (for the probe); 6mm ($\frac{1}{4}$ in.) thick plywood approximately 500 x 200mm (for the case); paint; glue.

Guidance only **£5** excluding case
Approx. cost

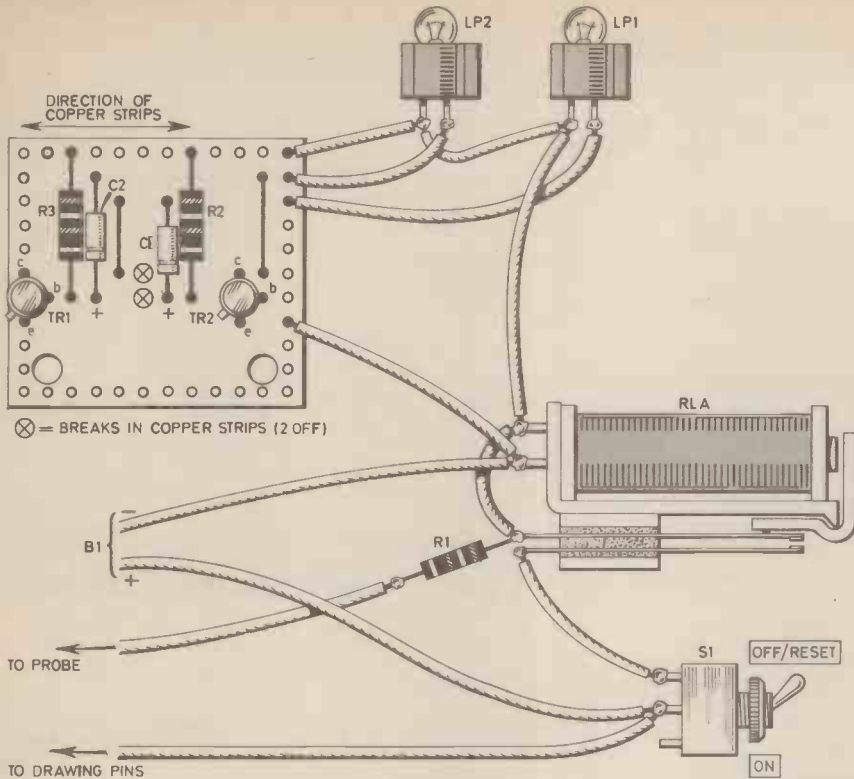

Fig. 2. Stripboard layout and interwiring diagram. Note that the "hot" drawing pins are all commoned up and connected to the wire from S1.

FINAL WIRING

The relay is glued to the base of the case and the board is then secured on two stand-offs alongside it. Leave enough space for the large PP6 type battery.

Wire up as shown in Fig 2 taking care to wire the relay correctly with the normally open contacts being used. Note that R1 is soldered to one of the relay terminals directly, with the probe wire connected to its other end.

The probe is made from an empty ball point pen tube with the wire threaded through it and soldered to a small screw, which is then pulled back to fit snugly in the pen holder.

The wire from S1 to the drawing pins is soldered to the point of one pin and then to all the other pins selected to be "hot". Choose these "hot" pins at random with perhaps one from each row with the occasional two together or a row with no "hot" pins at all. This all adds to the excitement.

TO PLAY

The basic idea of the game is to start at the bottom left hand corner of the matrix "board" and work along and up the board, in the same fashion as Spades and Ladders, with-



(Above) Photograph of the prototype circuit board before the mounting holes were made.

(Right) View inside the home-made case showing the basic layout and interwiring.



out landing on a "hot" pin. A die is used to decide how many moves the player makes each go.

If the player lands on a "hot" pin, he must pay some penalty like moving back a few pins or missing a go. The actual rules can be made up by the players themselves (before the game commences of course!).

Remember that when moving the probe according to the score on the die, do not actually touch all the pins along the way as this may set the lamps flashing unnecessarily. Only the last pin for each go need be touched.

An additional game for one or two players, is a memory game whereby each player takes it in turn to have a "stab" at the board to try and locate a "hot" pin and at the same time, trying to remember where all the previously discovered "hot" pins are. The winner is the player who can touch all the "hot" pins with the probe, without touching a single "cold" (one which doesn't set the lamps flashing) pin.

Using these two basic principles, many games can be devised to provide many hours of fun for the whole family. □

LETTERS

Soviet Diagnosis

I happened to read Paul Young's comments (*Counter Intelligence*—September '82 E.E.) on the use of electronics in Soviet medicine on the day I returned from a holiday in the Soviet Union during which I experienced it at first hand.

After being told by my own doctors that the stomach discomfort I had been experiencing for some time was due to gastritis or a small ulcer, tests taken at a holiday sanatorium in Yalta quickly diagnosed a hiatus hernia. The Medical Centres at Moscow and Yalta were full of electronic apparatus used for diagnosis and treatment... there was even an ECG on the beach where I stayed at Yalta for immediate tests on swimmers with suspect hearts!

A mention that I suffered from migraine quickly resulted in me being wired up to monitors in a room that looked like the control centre of a spacecraft! I'm afraid that when I was given daily inhalation treatment I was more interested in the apparatus than the treatment! Of course, such apparatus is also used in other countries, but the difference seems to be in the quantity and general availability.

Where Paul is wrong is in attributing the widespread use of electronics in the Soviet

Union to there being a shortage of doctors. With over a million doctors, it compared favourably with other advanced industrial countries, including Britain and the U.S.A.

However, there is a much greater emphasis on preventive medicine which involves people having a regular medical check-up. In this, electronics is proving a valuable tool, not as a substitute for doctors but to be used by them in order to ensure the most effective use of their knowledge and skill. Incidentally, their medical service is free.

Fred Westcott,
Chesterfield,
Derbys.

Library of Electronics

I am trying to accumulate a "library" of electronics reference books and I am having great difficulty in finding second-hand books.

Can your readers please suggest any bookshops that might sell secondhand electronics books.

P. A. Antcliff,
Hitchin,
Herts.

Model Train Chuffer

With reference to the *Model Train Chuffer* circuit described in the January 1982 issue, an effective modification is to replace the bridge rectifier and transistor TR1 of the v.c.o. with a light dependent resistor (LDR), illuminated with a 12 or 15V bulb (LP1) connected across the track, Fig. 1.

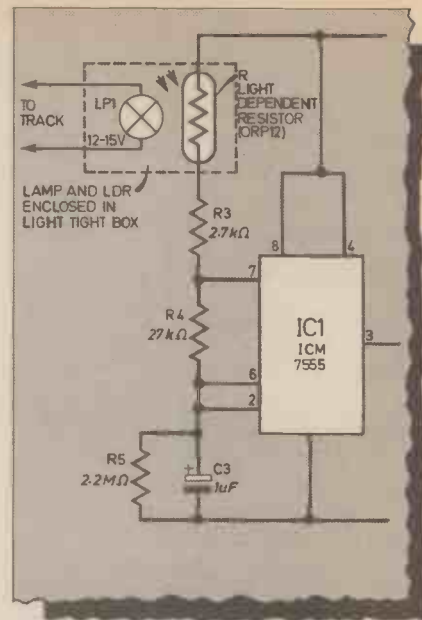

Fig. 1.

This system is also less affected by other chuffers and controllers on other tracks.

J. S. Rushton
Papakura
New Zealand

your future connection

Taking out a subscription for *Everyday Electronics* is the easiest and most convenient way of understanding tomorrow's world today. Regular features include easy-to-build projects for use in and around the home plus ideas for leisure... photography, games, motoring, music and many more.

Everyday Electronics is your introduction to a most stimulating hobby, so complete the form below today, and prepare to meet the challenge of tomorrow's technology.

OFFER CLOSES 31 DECEMBER 1982

SUBSCRIPTION ORDER FORM

UK	£12.00	£9.60
OVERSEAS	£13.00	£10.60

Please register my subscription for one year for which I enclose cheque/postal order value _____ made payable to IPC Magazines Ltd.

Name _____

Address _____

Send to: IPC Magazines Ltd, Room 2816, King's Reach Tower,
Stamford Street, London SE1 9LS

SPECIAL OFFER TO NEW SUBSCRIBERS
£2.40 OFF REGULAR
SUBSCRIPTION RATES
SAVE MONEY... ORDER NOW!

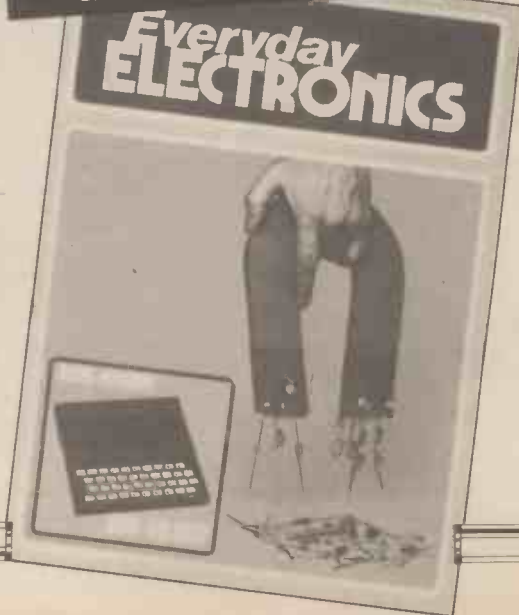

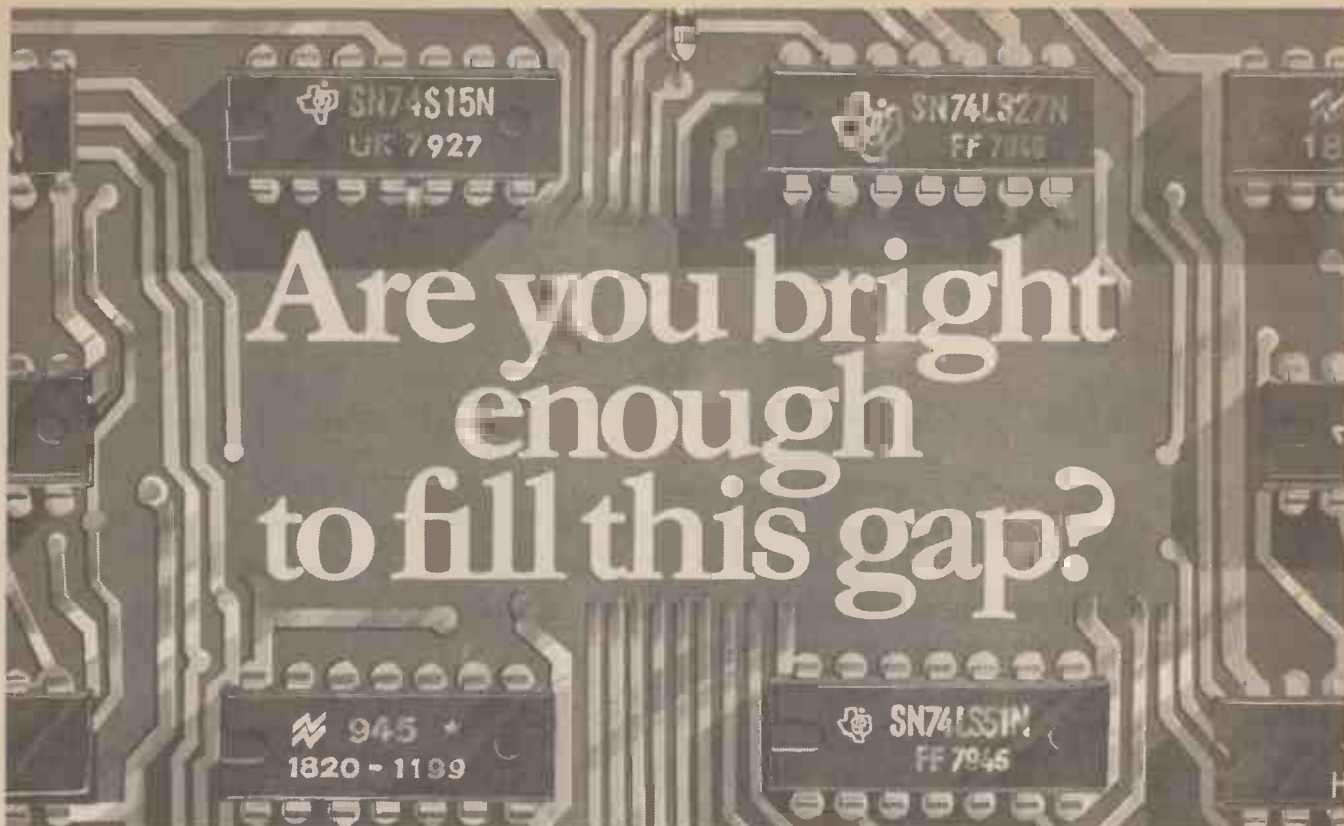

Are you bright enough to fill this gap?

Without fast and efficient communications, all the Army's modern technology and hardware would be useless.

Rather like rush-hour traffic in dense fog.

But with potentially much more disastrous consequences.

For this reason we're asking a lot from our Apprentice Technicians in the Royal Signals these days.

Right now we have a limited number of Technician Apprenticeships in Military Telecommunications.

You've got to have four 'O' levels, at grade C or better, including Maths, English and a Science subject before we'll be interested in you. We'll want to be sure that you're the right type, both physically and mentally, for such a crucial and exacting job.

And we'll want to be convinced that you've a real interest in Electronics.

Naturally, since we're asking this much of you, you'll expect quite a lot from us.

And you'll get it. If accepted, you'll go for two and a half years training at the Army Apprentices College in Harrogate, starting on January 6th next year.

There you'll receive a technical education in electronics equal to the best in the country, leading to a minimum of TEC Certificate.

And at the same time an academic and military training that will leave you in peak mental and physical form, ready for early promotion.

If you think you can handle this kind of challenge, and you'll be aged between 16 and 17½ in January, just fill in the coupon or call in at your nearest Army Careers Information Office, ideally before the end of the month.

You'll find our address in the 'phone book under "Army."

To: Major Martin Allington, M.O.D. DAR 2
(Dept EE1) Lansdowne House, Berkeley Square,
London W1X 6AA.

Name _____

Address _____

Date of birth: _____

EE 1

Junior Army 
Apprentice Technician. Royal Signals

BI-PAK BARGAINS

TRIACS — PLASTIC

4 AMP — 400v — TQ202 — TAG 136G.	
1 OFF	10 OFF
40p	£3.75
8 AMP 400v — TQ220 — TAG 425	50 OFF
60p	£17.50
	£30.00
	£50.00

SLIDER POTENTIOMETERS ALL AT 50p PER PAK

SX63 5 x 470 ohms Lin.	SX67 5 x 47k Lin
SX64 5 x 1k Lin	SX68 5 x 47k Log
SX65 5 x 22k Lin	SX69 5 x 100 Lin
SX66 5 x 22k Log	SX70 5 x 1 meg Lin

SX40 250 Silicon Diodes—Switching like 1N4148 DO 35. All good—uncoded	Worth double our price 45x75mA	£1.25
SX41 250 Silicon Diodes—General Purpose, like OA200/202, BA113/16. Uncoded.	30 100x200mA, DO-7.	£1.25

SX44 10 5A SCR's T064. 3 x 50v, 3 x 100v, 2 x 200v, 2 x 400v. Super value less than 1/2 price.	£1
SX45 10 5A SCR's T066. 2 x 50v, 2 x 100v, 4 x 200v, 2 x 400v. All coded. Brand new, a giveaway.	£1



MINIATURE TOOLS FOR HOBBYISTS

MINIATURE ROUND NOSE SIDE CUTTERS — Insulated handles 4 1/2 inch length. Order No Y043.

MINIATURE LONG NOSE PLIERS — insulated handles 5 1/2 inch length. Order No Y044.

MINIATURE BEND NOSE PLIERS — insulated handles 5 1/2 inch length. Order No Y045.

MINIATURE END NIPPERS — insulated handles 4 1/2 inch length. Order No Y046.

MINIATURE SNIP NOSE PLIERS with side cutter and serrated jaws — insulated handles 5 1/2 inch length. Order No Y042.

All with insulated handles

FLEXEY DRIVER

A flexible shaft screwdriver for those awkward to get at screws. Overall length 8 1/2 inch. Order No FS-1 Flat blade 4mm FS-2 Cross point no 1 £1.75 each.

GRIP DRIVER

Binch long screwdriver with spring loaded grip on end to hold screws in position while reaching into those difficult places. Order No SD-1 Flat blade 4mm SD-2 Cross point no. 0. 95p each.

INEXPENSIVE TOOLS OF IMMENSE VALUE

Combined wire stripper, cutter, crimping Incl. 25 ass't terminals for crimping. Order No WS2. Our low price £1.20 each.

BA NUT DRIVER SET
Set of 5 BA spanner shafts plus universal handle in roll-up wallet. Sizes 0BA 24-6-8BA
Order no: T192
£2.75 set

NEON SCREWDRIVER
7 1/2 inch blade order no NS1 £0.85p each
5 1/2 inch blade order no NS2 £0.65p each

Guarantee
Satisfaction or your money back has always been BI-PAK'S GUARANTEE and it still is. All these Sale items are in stock, in quantity and we will despatch the same day as your order is received.

EXPERIMENTOR BOXES — ALUMINIUM — PLASTIC ALUMINIUM BOXES

Made with Bright Aluminium folded construction with deep lid and screws

SIZE	L	W	H	Order No.	Price
5 1/2	2 1/4	1 1/2	159	83p	
4	2 1/4	1 1/2	161	83p	
4	2 1/2	2	163	83p	
3	2	1	164	57p	
8	6	3	166	£1.58	
6	4	2	167	£1.12	

All measurements for boxes are shown in inches. L = Length, W = Width, H = Height

Plastic Boxes
Coloured Black. Close fitting. Flanged Lid, fixing screws into brass bushes.

SIZE	L	W	H	Order No.	Price
4	2	1	141	£1.00	
4	2 1/2	1 1/2	143	£1.30	
6	3	2	144	£1.80	

Plastic as above but with aluminium top panel

SIZE	L	W	H	Order No.	Price
4	2 1/2	1	146	£1.40	

Plastic sloping front

SIZE	L	W	H	Order No.	Price
5 1/2	4 1/2	2 1/2	148	£2.14	

IC SOCKETS
The lowest price ever.

Pin	10 off	50 off	100 off
8 pin	85p	£3.50	£8.00
14 pin	90p	£3.75	£8.50
18 pin	95p	£4.00	£9.00

VOLTAGE REGULATORS T0220

	Positive +	Negative -	
7805	50p	7905	55p
7812	50p	7912	55p
7815	50p	7915	55p
7824	50p	7924	55p

BI-PAK'S OPTO 83 SPECIAL
A selection of Large & Small size LED's in Red, Green, Yellow and Clear, plus shaped devices of different types. 7 Segment displays, photo transistors, emitters and detectors. Types like MEL11, FPT100 etc. Plus Cadmium Cell DRP12 and germ. photo transistor OCP71.

0/N0 SX57A
Valued - Normal Retail £12.00
Our Price
£5.00

SEMICONDUCTORS FROM AROUND THE WORLD
100 A Collection of Transistors, Diodes, Rectifiers, Bridges, SCR's, Triacs, IC's both Logic and Linear plus Opto's all of which are current everyday usable devices.

Guaranteed Value over £10 at Normal Retail Price

Yours for only **£4.00** Data etc. in every pack Order No. SX56

MW398 NI-CAD CHARGER
Universal Ni-Cad battery charger. All plastic case with lift up lid. Charge/Test switch LED indicators at each of the five charging points

Charges	Power
PP3 (9v)	220-240V AC
U12 (1.5V penlite)	0ims
U11 (1.5V "C")	210 x 100 x 50mm
U2 (1.5V "D")	£6.95

POWER SUPPLY OUR PRICE £3.25
Power supply fits directly into 13 amp socket. Fused for safety. Polarity reversing socket. Voltage switch. Lead with multi plug. Input — 240V AC 50HZ Output — 3 4 5 6 7 5. 9 & 12V DC. Rating — 300 ma MW88

1 Amp SILICON RECTIFIERS
Glass Type similar IN4000 SERIES IN4001-IN4004 50 — 500v — uncoded — you select for VETS ALL perfect devices — NO odds Min 50v 50 for £1.00 — worth double ORDER NO SX76

Silicon General Purpose NPN Transistors TO-18 Case Lock fit leads — coded CV7644 Similar to BC147 — BC107 — Z789 ALL NEW! VCE 70v IC500mA Hfe 75-250 50 off 100 off 500 off 1000 off
PRICE £2.00 £3.80 £17.50 £30.00

Silicon General Purpose PNP Transistors TO-5 Case Lock fit leads coded CV9507 Similar ZN2905A to BF100 VC 60 IC 600mA Min Hfe 50 ALL NEW! 50 off 100 off 500 off 1000 off
PRICE £2.50 £4.00 £19.00 £35.00
Order as CV9507

Silicon NPN'L' Type Transistors
TO-92 Plastic centre collector Like BC182L — 183L — 184L VCBD 45 VCEO 30 IC200mA Hfe 100-400

ALL perfect devices — uncoded ORDER AS SX183L
50 off 100 off 500 off 1000 off
£1.50 £2.50 £10.00 £17.00

PNP SILICON TRANSISTORS:
Similar ZTX500 — ZTX214 — E-Line VCED 40 VCEO 35 IC 300mA Hfe 50-400

Brand New — Uncoded — Select Devices
50 off 100 off 500 off 1000 off
£2.00 £3.50 £15.00 £25.00
Order as ZTXPNP

DIGITAL VOLT METER MODULE
3 x 7 segment displays Basic Circuit 0-2V± instructions provided to extend voltage & current ranges. operating voltage 9/12v. Typ. Power Consumption 50mA 0/N0: SX99 Once only price £9.95

ELECTRONIC SIREN 92v DC
Red plastic case with adjustable tuning bracket. Emits high-pitched wailing note of varying pitch 100 cycles per minute. Dims. — 90mm (lax) 60mm (depth) Power: 12 v DC
Our Price: **£5.50**

8 Bit MICROPROCESSOR
National INS8080AN 40 Pin DIL N. Channel Silicon GATE MOS TECHNOLOGY AS used in Nationals M8080 Micro Computer Family Instruction Cycle Time 2 uS Supplied with functional Block Diagram

BRAND NEW — NOT seconds or reclaims
100% perfect ORDER NO SX8080
Normal Sell price £4.50 each
Our BI-PAK Special Price **£2.00**
SO HURRY — LIMITED STOCKS

40 Pin IC Socket to fit SX8080 Offer price
ORDER NO 1609 **30p**

MULTITESTERS
30,000 opv Including test leads and case AC volts — 0.2-5-10-25-100-250-500-1,000 DC volts — 0-0.25-1-2.5-10-25-100-250-1,000 DC current: 0-50ua 0-5ma-50ma 0-12amps. Resistance: 0-6K ohms-70K ohms-6meg ohms-60meg ohms Decibels — -20db to plus 56db. Short test: Internal buzzer. Dims: 160 x 110 x 50mm

1,000 opv Including test leads & Battery. AC volts: 0-15-150-500-1,000 DC volts: 0-15-150-500-1,000 DC currents: 0-1ma-150ma Resistance: 0-25 K ohms 100 K ohms Dims: 90 x 61 x 30mm

0/N0.1322.OUR PRICE £6.50 ONLY

0/N0. 1315. OUR PRICE ONLY £24.75

BI-PAK'S COMPLETELY NEW CATALOGUE
Completely re-designed. Full of the type of components you require, plus some very interesting ones you will soon be using and of course, the largest range of semiconductors for the Amateur and Professional you could hope to find.

There are no wasted pages of useless information so often included in catalogues published nowadays. Just solid facts: e. price, description and individual features of what we have available. But remember, BI-Pak's policy has always been to sell quality components at competitive prices and THAT WE STILL DO.

BI-PAK'S COMPLETELY NEW CATALOGUE is now available to you. You will be amazed how much you can save when you shop for Electronic Components with a BI-Pak Catalogue. Have one by you all the time—it pays to buy BI-PAK

To receive your copy send **75p** plus 25p p&p

BI-PAK Send your orders to Dept EE1 BI-PAK PJ BOX 6 WARE HERTS SHOP AT 3 BALDGCK ST WARE HERTS TERMS, CASH WITH ORDER SAME DAY DESPATCH ACCESS, BARCLAYCARD ALSO ACCEPTED TEL (0920) 3182 GIRO 388 7006 ADD 15% VAT AND 75p PER ORDER POSTAGE AND PACKING

Use your credit card. Ring us on Ware 3182 NOW and get your order even faster. Goods normally sent 2nd Class Mail. Remember you must add VAT at 15% to your order. Total Postage add 50p per Total order.

DESIGNS FOR DECEMBER

SECURITY VARI-LIGHT

Operates a mains lamp on an electronically randomly generated cycle and gives a naturally and realistic effect suggesting that premises are occupied. A timer is included to switch off the system after a predetermined delay of between two and seven hours. Further facilities are provided for: including the use of optically-coupled repeater units and lamps.



CAR INDICATOR SOUND BOOSTER

Simple add-on accessory gives audible warning at adequate strength for most driving conditions

ZX81 HALF PRICE 4K RAM

Further expansion on the cheap by simple mods to the 2K Ram Pack described in EE, April, 1982.

FIVE-VOLT REGULATED SUPPLY

Handy mains operated unit delivers up to 500mA d.c. Duplicate output terminals. Output voltage virtually unaltered for all load conditions.

VELOCITY MEASURER

Uses ultrasonics for determining velocity of the object based on the Doppler effect. Outputs can be directly displayed on the internal 7-segment readout, an oscilloscope or stored in a memory bank for ultimate feeding to a chart recorder to produce velocity-time graphs.

**SEDAC
WINNER**

SPECIAL OFFER ★
For Everyday Electronics Readers
**MISECO MINI 20
MULTIMETER**



Cable Options

The British Government is now pondering over what to do about cabling Britain. Its advisory panel, ITAP, said we should cable the country with wide bandwidth optical fibre trunk lines, but use only narrow bandwidth coaxial cables into individual homes with local switching from the trunk routes.

Some people (myself definitely included) believe this to be a disastrously short-sighted suggestion. It underestimates the future needs of homes which will have several TV sets, computers and two-way interactive data links, or wanting to use the same cable connection for different purposes at the same time.

The Wharfedale Story

OVER the last ten years I've watched the progress of the loudspeaker firm Wharfedale with special interest. It was founded by audio engineer Gilbert Briggs in 1932.

The Wharfedale Wireless Works built its first two speakers in an Ilkley cellar. The war nearly put an end to the firm because it was impossible to get the cloth needed to make the cone surrounds. But Briggs and his colleagues made do with rejected army dusters.

In 1955 Briggs booked the Royal Festival Hall to give a concert of live and recorded music. To everyone's surprise the concert was a sell-out. Peter Walker and John Collinson of Quad, operated the disc and tape equipment while Briggs, on stage, controlled four Wharfedale loudspeakers, each powered by its own 15 watt Quad valve amplifier.

The BBC, EMI and Decca all cooperated with recorded material, in both mono and stereo. The London Mozart Players under conductor Harry Blech, Denis Matthews piano, Campoli violin, Leon Goossens oboe, and Ralph Downes organ, all contributed live music, while the LPO conducted by Sir Adrian Boult appeared off disc through the Wharfedale loudspeakers.

There was no question of involving the audience scientifically or technically. The concert was just a concert, but with the difference that some of the music was live

An optical fibre link into each home would leave the options open for the future. Coaxial cable would close them. No-one wants to dig up Britain again when, as sure as night follows day, the limited bandwidth of a coaxial system proves inadequate.

British Telecom also argues in favour of optical fibre cabling, and not surprisingly also argues that BT, not private enterprise, should be given the contract. "British Telecom is uniquely qualified... to play a major role in the re-cabling of Britain" says Sir George Jefferson, Chairman of BT. "It has the experience and skills needed to install the new cable networks".

and some of it recorded. The object of the exercise was to prove that recorded sound could be directly comparable with live sound. Even in 1955 Briggs proved his point.

After the Festival Hall Briggs arranged similar concerts at Carnegie Hall in New York. Both Briggs and Wharfedale became famous names in audio.

In 1959 Briggs sold Wharfedale to the Rank Organisation. Major expansion began in 1967, at a factory site in Bradford. "The old man" as he was affectionately known worked on in Ilkley, writing books, until he died in 1978.

As the hi fi boom got underway and demand for loudspeakers grew, the Bradford factory added more workers and more production machinery. But this isn't the most efficient way to run a factory. Production techniques that work on a small scale won't work efficiently on a large scale.

At some stage you have to stop, and thoroughly re-design the production process to improve efficiency, and turn out more products at lower cost. Unfortunately Rank Wharfedale started to do this just as the hi fi bubble burst, and the recession started to bite.

For several years the Wharfedale factory in Bradford ran at a loss, and on Friday, July 23rd 1982 Rank finally shut it down. The staff of 350 were made redundant, on the day they went on annual holiday. To

Grass Roots

Without doubt British Telecom has more experience than anyone else in Britain of laying cables of all types, including optical fibre links. But at grass roots level, British Telecom has a very poor track record, for instance when it comes to installing new phones or repairing faults. You have only to read the correspondence columns of the popular press to know the problems suffered by some subscribers.

Recently I encountered these problems first hand. The real revelation was the yawning communication gap between the upper echelons of British Telecom, who make the decisions and the public statements, and the lower echelons, who deal with the public.

"There are 150 faulty phones in the queue for repair ahead of you in your area" I was told by the North London engineers when my phone developed a fault. I'd queued on the line for the best part of quarter of an hour to get through to the engineers.

I then queued as long again to get through to the single extension in the Telephone Manager's office that dealt with subscribers' problems. The best I could get from anyone was a vague promise of action in a day or so.

A succession of engineers finally arrived over the next week, diagnosed different faults inside the house and in the street cables, and then disappeared again leaving the phone still faulty. Engineers responsible for fixing faults inside the house weren't authorised to fix external faults and vice-versa.

All this time, people trying to call me got either unobtainable, engaged or ringing tones.

make matters worse, the Rank closure followed just one month after an Open Day of the Bradford factory to celebrate 50 years of Wharfedale and the launch of a new range of loudspeakers.

Sound Future

But all is not gloom. The Wharfedale name, factory and assets have now been bought by a British firm Tradewest. This is owned by a British businessman, Peter Newman, who makes and sells loudspeakers in Spain for other Continental manufacturers.

The new Wharfedale firm will re-employ around 60 of the old Wharfedale workers, but with single-union representation.

Ironically the main problem for Newman and Wharfedale is that the company's laboratories have become rightly famous over recent years for their acoustic research and original work in loudspeaker design. As soon as Rank announced the closure of Wharfedale, the ten skilled engineers in the Wharfedale research unit started to receive offers of employment from competitor firms.

Only time will tell whether Rank's decision to sever contact with Wharfedale has been the best thing that ever happened to the company, because it streamlined production, or the worst, because it marks the end of an era in British acoustic research and development.

Probably the fastest microcomputer in the universe

the **JUPITER ACE** only £89.95.



All inclusive Price

For £89.95 you receive your Jupiter Ace, a mains adaptor, all the leads needed to connect to most cassette recorders and T.V.s (colour or black and white), a software catalogue and a manual.

The manual is a complete introduction to the world of personal computing and a course in FORTH programming on the Ace.

Even if you are a complete newcomer to computers, the manual will guide you step by step from first principles to confident programming.

The price includes postage packing and V.A.T.

Key Features

- Revolutionary microcomputer language FORTH.
- Full-size moving-key keyboard.
- User-defined high-resolution graphics.
- Programmable sound generator.
- Floating point arithmetic.
- Fast cassette interface.
- Upper and lower case ascii character set.
- 24 x 32 character flicker-free display.

The Jupiter Ace uses FORTH

The Ace is set apart from all other personal computers on the market by its use of a revolutionary language called 'FORTH'. Some computer languages are easy for humans to understand, others are easy for computers; FORTH is most unusual in being both. Its underlying principles are so simple that it takes even a newcomer to computers only a few minutes to learn how to do calculations on the Ace, yet the very same principles are powerful enough to allow you to invent your own extensions to the language itself.

At the same time, the memory-saving coded form used to store your programs inside the Ace allows it to obey them very fast — typically in less than a tenth of the time it would take to do the same thing using a different language. Amongst other things, this makes the Ace ideal for games.

FORTH's unique combination of speed, versatility and ease of programming has already made it a prime choice for professional applications as diverse as pub games and radio telescopes, and gained it an enthusiastic national user group. Now the Jupiter Ace can bring this addictive language into your own home.

Designed by Jupiter Cantab

Leading computer Designers Richard Altwasser and Steven Vickers have a reputation for pushing technology forwards. After playing the major role in creating the ZX Spectrum they formed Jupiter Cantab to develop their latest brainchild the Jupiter Ace. Jupiter Cantab, 22, Foxhollow, Bar Hill, Cambridge, CB3 8EP

Everyday Electronics, November 1982

Technical Specification

Hardware

Processor/Memory
Z80A running at 3.25 MHz.
8K bytes ROM 3K bytes RAM.

Input

40 moving-key keyboard with auto-repeat on every key.

Output

Memory-mapped 32 x 24 character display with high resolution user graphics. Output to drive normal UHF TV set on channel 36.

Sound

Provided by internal loudspeaker.

Cassette

Load Save & Verify at 1500 baud, separate data storage.

Software, FORTH

Data Structures

Integer, Floating point and String data may be held as constants, variables or arrays with multiple dimensions and mixed data types.

Control Structures

IF-THEN-ELSE, DO-LOOP, BEGIN-WHILE-REPEAT, BEGIN-UNTIL, all may be mixed and nested to any depth.

Operators

Mathematical +, -, X, ÷.
Logical AND, OR, NOT, XOR.
Comparison <, >, =.

Program Editing

FORTH words may be listed, edited and redefined. Comments are preserved when words are compiled.

Order Form



The Jupiter Ace is available only by mail order. Please allow up to 28 days for delivery.

Send cheque or postal order with the form to:—
JUPITER CANTAB, 22 FOXHOLLOW, BAR HILL, CAMBRIDGE CB3 8EP

Please send me:—

JUPITER ACE MICROCOMPUTER(S) @ £89.95.

Name. Mr/Mrs/Miss

Address

EE

F

E.E. PROJECT KITS

I.C.s TRANSISTORS CAPACITORS TOOLS RESISTORS HARDWARE CASES KITS

MAGENTA

Make up your No. 1 SUPPLIER OF KITS AND COMPONENTS for E.E. Projects. We supply carefully selected sets of parts to enable you to construct E.E. projects. Kits include ALL THE ELECTRONICS AND HARDWARE NEEDED. Printed circuit boards (fully etched, drilled and roller tinned) or Veroboard are, of course, included as specified in the original article, we even include nuts, screws and I.C. sockets. PRICES INCLUDE CASES unless otherwise stated. BATTERIES ARE NOT INCLUDED. COMPONENT SHEET INCLUDED. If you do not have the issue of E.E. which includes the project—you will need to order the instruction reprint at an extra 45p each.

Reprints available separately 45p each + p. & p. 45p.

- CONTINUITY CHECKER** Sept 82, £4.97
SOUND SPLITTER Sept 82, £15.77
SOUND RECOMBINER Sept 82, £3.70
C.B. BATTERY CHARGER Sept 82, £2.65
- SCREEN WASH DELAY** Sept 82, £4.48
INSTRUMENT PRE AMP Aug. 82, £7.02
TWO TONE DOORBELL ALARM Aug 82, less case and bell transformer, £8.82
CB ROGER BLEEPER Aug 82, £8.47
BRAKE LIGHT RELAY July 82, £4.80
2-WAY INTERCOM July 82, £4.11
ELECTRONIC PITCH PIPE July 82, £4.91
REFLEX TESTER July 82, £7.07
SEAT BELT REMINDER June 82, £3.73
EGG TIMER June 82, £4.95
TWO TONE TRAIN HORN WITH REMOTE TRIGGER OPTION May 82, £11.26
CAR LED VOLTMMETER less case, May 82, £2.89
LIGHTNING CHESS BUZZER, May 82, £8.20
2k RAM PACK Apr 82 less case, £13.79
V.C.O. SOUND EFFECTS UNIT Apr 82, £11.56
- CAMERA OR FLASH GUN TRIGGER** Mar 82, £12.41 less tripod bushes.
POCKET TIMER Mar 82, £3.71
GUITAR TUNER Mar 82, £15.83
CAR OVERHEATING ALARM, Feb. 82, £8.81
SIMPLE STABILISED POWER SUPPLY, Jan. 82, £24.58
MINI EGG TIMER, Jan. 82, £3.94
SIREN MODULE, Jan. 82, less speaker, £5.57
MODEL TRAIN CHUFFER, Jan. 82, £8.27
SQUARE SIX, Dec. 81, £4.70
GUITAR ADAPTOR, Dec. 81, £3.76
REACTION METER, Dec. 81, £17.55
ELECTRONIC IGNITION, Nov. 81, £25.98
SIMPLE INFRA RED REMOTE CONTROL, Nov. 81, £18.98
PRESSURE MAT TRIGGER ALARM, Nov. 81, £6.27
EXPERIMENTER CRYSTAL SET, Nov. 81, Less aerial, £5.99
HEADPHONES, £2.98 extra.
CAPACITANCE METER, Oct. 81, £23.51
SUBSTAIN UNIT, Oct. 81, £12.76
"POPULAR DESIGNS", Oct. 81
TAPE NOISE LIMITER, £4.57
HEADS AND TAILS GAME, £2.52
CONTINUITY TESTER, £3.95
PHOTO FLASH SLAVE, £3.46
FUZZ BOX, £7.29
OPTO ALARM, £4.78
SOIL MOISTURE UNIT, £5.81
ICE ALARM, £7.85
0-12V POWER SUPPLY, Sept. 81, £17.98
CMOS CAR SECURITY ALARM, Sept. 81, £8.08
CMOS DIE, Sept. 81, £7.99
LED SANDGLASS, Aug. 81, £8.83
CMOS METRONOME, Aug. 81, £5.23
COMBINATION LOCK, July 81, Less case, £19.58
BURGLAR ALARM SYSTEM, June 81 less bell, loop & Mic's, £40.98
TAPE AUTO START, June 81, £12.79
LIGHTS REMINDER AND IGNITION LOCATOR E.E., May 81, £3.66
SOIL MOISTURE INDICATOR E.E., May 81, £4.95
GUITAR HEADPHONE AMPLIFIER E.E., May 81, £4.23
PHONE BELL REPEATER / BABY ALARM E.E., May 81, £5.65
INTERCOM, April 81, £22.23
SIMPLE TRANSISTOR & DIODE TESTERS, Mar. 81, Ohmmeter version £2.02, Led version £2.73
MINI SIREN, Mar. 81, £8.04
LED DICE, Mar. 81, £8.44
LED FLASHER, Mar. 81, £4.29
MODULATED TONE DOORBELL, Mar. 81, £8.64
BENCH POWER SUPPLY, Mar. 81, £53.47
THREE CHANNEL STEREO MIXER, Feb. 81, £18.69
SIGNAL TRACER, Feb. 81, £8.17 less probe.
NI-Cd BATTERY CHARGER, Feb. 81, £13.81
ULTRASONIC INTRUDER DETECTOR, Jan. 81 less case, £53.47
2 NOTE DOOR CHIME, Dec. 80, £10.32
LIVE WIRE GAME, Dec. 80, £11.70
GUITAR PRACTICE AMPLIFIER, Nov. 80, £12.82 less case, Standard case £3.88, High quality case £8.33
SOUND TO LIGHT, Nov. 80, 3 channel, £21.34
TRANSISTOR TESTER, Nov. 80, £11.63 Inc. test leads.
AUDIO EFFECTS UNIT FOR WEIRD SOUNDS, Oct. 80, £13.11
BICYCLE ALARM, Oct. 80, £10.35 less mounting brackets.
IRON HEAT CONTROL, Oct. 80, £5.86
TTL LOGIC PROBE, Sept. 80, £5.18
ZENER DIODE TESTER, June 80, £8.66
4 STATION RADIO, May 80, £19.28 less case.
LIGHTS WARNING SYSTEM, May 80, £4.88
BATTERY VOLTAGE MONITOR, May 80, £5.18
CABLE & PIPE LOCATOR, Mar. 80, £4.11 less coil former.
KITCHEN TIMER, Mar. 80, £14.65
STEREO HEADPHONE AMPLIFIER, Mar. 80, £18.15
MICRO MUSIC BOX, Feb. 80, £16.26, Grey Case £3.99 extra.
SIMPLE SHORT WAVE RECEIVER, Feb. 80, £25.86, Headphones £2.98
SLIDE/TAPE SYNCHRONISER, Feb. 80, £12.30
MORE PRACTICE OSCILLATOR, Feb. 80, £4.62
SPRING LINE REVERB. UNIT, Jan. 80, £25.86
UNIBOARD BURGLAR ALARM, Dec. 79, £8.03
BABY ALARM, Nov. 79, £8.60
CHASER LIGHTS, Sept. 79, £23.40
SIMPLE TRANSISTOR TESTER, Sept. 79, £7.30
DARKROOM TIMER, July 79, £2.89
ELECTRONIC CANARY, June 79, £5.86
MICROCHIME DOORBELL, Feb. 79, £15.85
THYRISTOR TESTER, Feb. 79, £3.78
FUSE CHECKER, Oct. 78, £2.31
SOUND TO LIGHT, Sept. 78, £8.42
CAR BATTERY STATE INDICATOR, Sept. 78, Less case, £2.09
R.F. SIGNAL GENERATOR, Sept. 78, £28.72
IN SITU TRANSISTOR TESTER, July 78, £8.77
WEIRD SOUND EFFECTS GENERATOR, Mar. 78, £5.59
AUDIO VISUAL METRONOME, Jan. 78, £5.98
ELECTRONIC TOUCH SWITCH, Jan. 78, £2.73 less case.
RAPID DIODE CHECK, Jan. 78, £2.74
PHONE/DOORBELL REPEATER, July 77, £7.46
ELECTRONIC DICE, Mar. 77, £5.88

SOLDERING/TOOLS

- ANTEX X5 SOLDERING IRON**
 25W £5.48
SOLDERING IRON STAND £1.98
SPARE BITS. Small, standard, large, 65p each. For X5 + X25
SOLDER. Handy size 99p
SOLDER CARTON £1.84
DESOLDER Braid 69p
HEAT SINK TWEEZERS 29p
DESOLDER PUMP £6.48
HOW TO SOLDER LEAFLET 12p
LOW COST CUTTERS £1.69
LOW COST LONG NOSE PLIERS £1.68
WIRE STRIPPERS & CUTTERS £2.69



MULTIMETER TYPE 2. (YN360TR) 20K o.p.v. with transistor tester. £14.75

HELPING HANDS JIG £6.30

Heavy base. Six ball and socket joints allow infinite variation of clips through 360°. Has 2 1/2" diameter (25 x 1 magnifier attached), used and recommended by our staff.

- VERO SPOT FACE CUTTER** £1.49
PIN INSERTION TOOL £1.98
VEROPINS (pk of 100) 0-1" 52p
MULTIMETER TYPE 1 (1,000 opv) £5.48
SET, 10 leads with 20 clips £1.99
RESISTOR COLOUR CODE CALCULATOR 21p
CONNECTING WIRE PACK TYPE ED. 11 colours 49p

ILLUMINATED MAGNIFIERS

- Small 2" dia. (5x mag.) £1.14
 Large 3" dia. (4x mag.) £2.40
CAST IRON VICE £2.88
SCREWDRIVER SET £1.98
POCKET TOOL SET £3.98
DENTISTS INSPECTION MIRROR £2.85
JEWELLERS EYEGLASS £1.50
PLASTIC TWEEZERS 69p
PAIR OF PROBES WITH LEADS (cc) 77p

TEACH IN 82

All top quality components as specified by Everyday Electronics. Our kit comes complete with FREE COMPONENT IDENTIFICATION SHEET. Follow this educational series and learn about electronics—Start Today.

- LIST 1** and **LIST 2** together £27.98. **LIST 3** £5.88.
 ★ ★ ★ SPECIAL OFFER ★ ★ ★
LISTS 1, 2 and 3 all bought together £33.48.

WOODEN CASE KIT also available £11.98—wood, formica, glue, screws etc. Cut to size.
 12 part series, reprints available of previously published parts. 45p each.

LISTS 1, 2, AND 3 ALL AVAILABLE NOW. ALSO WOODEN CASE KIT.

BOOKS

- SEMICONDUCTOR DATA BOOK**
 Newnes £5.90
ELECTRONIC PROJECTS FOR HOME SECURITY £3.35
ELECT. PROJECTS IN PHOTOGRAPHY £3.35
110 ELECT. ALARM PROJECTS £5.35
MODEL RAILWAY PROJECTS £1.95
BASIC ELECTRONICS. Theory and practice £7.98
BEGINNERS GUIDE TO BUILDING ELECT. PROJECTS £1.50

ADVENTURES WITH MICROELECTRONICS

Similar to 'Electronics' below. Uses I.C.s. Includes dice, electronic organ, doorbell, reaction timer, radio etc. Based on Bimboard 1 bread board.
Adventures with Microelectronics £2.55
Component pack £29.64 less battery.

ADVENTURES WITH ELECTRONICS

by Tom Duncan

An easy to follow book suitable for all ages. Ideal for beginners. No soldering, uses an S-Dec breadboard. Gives clear instructions with lots of pictures. 16 projects—including three radios, siren, metronome, organ, intercom, timer, etc. Helps you learn about electronic components and how circuits work. Component pack includes an S-Dec breadboard and all the components for the projects.
Adventures with Electronics £2.40. Component pack £18.98 less battery.

ADVENTURES WITH DIGITAL ELECTONICS

New book by Tom Duncan in the popular 'Adventures' series. This book of entertaining and instructive projects is designed for hobbyists and students. It provides a stepping stone to the microprocessor.
 The first part deals with the properties of some basic ICs used in digital electronics.
 The second part gives details of how to build eight devices—shooting gallery, 2-way traffic lights, electronic adder, computer space invaders game, etc.
 For each project there is an explanation of 'how it works' and also suggestions for 'things to try'.
 No soldering—all circuits built on 2 Bimboard 1 breadboards.
Adventures with Digital Electronics book £3.25. Component pack £42.50, ref. EEDC. All the components needed including 2 breadboards and hexadecimal keyboard. Available less breadboards £29.98, ref. EEDF. Both less battery.

MORE KITS AND COMPONENTS IN OUR LISTS
 FREE PRICE LIST
 Price list included with orders or send see (9 x 4)
CONTAINS LOTS MORE KITS, PCBs & COMPONENTS

1982 ELECTRONICS CATALOGUE

Illustrations, product descriptions, circuits all included. Up-to-date price list enclosed. All products are stock lines for fast delivery.
 Send 80p in stamps or add 80p to order.

MORE E.E. KITS PLUS H.E. and E.T.I. PROJECT KITS IN THE PRICE LIST.

MAGENTA gives you FAST DELIVERY OF QUALITY COMPONENTS & KITS. All products are stock lines and are new & full specification. We give personal service & quality products to all our customers—HAVE YOU TRIED US?

MAGENTA ELECTRONICS LTD.

EE45, 135 HUNTER ST. BURTON-ON-TRENT, STAFFS., DE14 2ST. 0283 65438. MON.-FRI. 9-5. MAIL ORDER ONLY.

ADD 45p P. & P. TO ALL ORDERS. PRICES INC. VAT



Normal despatch by return of post.
OFFICIAL ORDERS WELCOME.
 OVERSEAS: Payment must be in sterling.
 IRISH REPUBLIC AND BFPO: UK PRICES.
 EUROPE: UK PRICES plus 10%.
 ELSEWHERE: Write for quote.

RADIO WORLD

By Pat Hawker, G3VA

Legal maze

ONE thing is certain. Our legislation is lagging light-years behind modern technology. Office copying machines, audio and video tape recorders have stymied the intentions of the copyright laws and turned millions into lawbreakers.

CB radio with a.m. equipment, pirate broadcasting stations, public interception of distribution satellite television channels, cordless telephones have all combined to bring the existing Wireless Telegraphy Acts into disarray although new legislation is threatened. Governments show their contempt for the international Radio Regulations by "jamming" broadcasts they dislike or by operating powerful over-the-horizon h.f. radars that disrupt other services.

Some sections of the Official Secrets Act have been virtually abandoned. "Bugging" is sometimes illegal, sometimes legal.

Briefly-booming video cassette libraries including those of Woolworth and W. H. Smith, have been closed because they cannot compete with the many "pirated" cassettes, while for many years similar problems have hit the reputable recording industry.

Television programmes across international frontiers have already led to tangled lawsuits, for example in Belgium. The different restrictions on television advertising in different countries may also prove a minefield when Direct Broadcast Satellites (DBS) begin transmissions.

I was reminded of these problems recently when Oliver P. Ferrell sent me a copy of the 5th edition of his "Confidential Frequency List" (Gilfer Associates Inc, PO Box 239, 52 Park Avenue, Park Ridge, NJ 07656, USA, \$9.95). This book provides over 220 pages crammed with information including call signs and frequencies of thousands of what are described as "unusual" radio stations that can be heard in the shortwave spectrum, including many coast stations that pass traffic to and from ships, aeronautical stations, fixed "point-to-point" stations, diplomatic stations and the like.

To very few, if any, of these thousands of stations has a UK citizen any legal right to listen—let alone to divulge what he may "unintentionally" hear them transmit. He can, however, do this to a duly authorised officer of Her Majesty's Government, a person acting under the authority of the Secretary of State or a competent legal tribunal.

He may not reproduce in writing, copy, or make any use of such messages or allow them to be reproduced in writing, copied or made use of. So says the letter of the Law.

H.M. Government, it goes without saying, is not bound by such restrictions—if it were then unemployment in the Cheltenham area might rise dramatically. H.M. Government is even prepared to provide

facilities to foreign Governments to intercept our personal telephone conversations and telex circuits!

Bad Laws

It used to be assumed that laws that are unenforceable are bad laws. It is legal for me to have a copy of the Confidential Frequency List (at least I hope this is the case), it is legal for me to have a general coverage h.f. communications receiver, but apparently illegal for me to tune this outside of the bands allotted to broadcast stations, amateur stations and presumably CB stations (or do I need to have a CB licence to listen to CB transmissions?).

Altogether more sensible is the US Communications Act. This prohibits the divulging of the contents of any non-broadcast transmissions but does not specifically outlaw listening to such transmissions.

One day perhaps legislation will catch up with technology.

Wadley Loop

The other day a news release arrived on my desk from Racal Electronics casually announcing that this major electronics and communications group, made a net profit (before taxation) of over £73 million on a turnover that has reached a staggering £536 million.

A success story that began when, while still a relatively new and little known firm, they backed the radical ideas of

Dr Trevor Wadley, a genuinely-brilliant South African electronics engineer. He had devised a novel tuning system, based on three stages of mixing, that automatically cancelled out any oscillator drift and could readily be set to within 1kHz, anywhere up to 30MHz. An elegant (though extremely difficult to implement) system that preceded the full frequency-synthesis systems widely used for professional communications today. The Wadley loop system is still widely used and appreciated by short wave listeners.

In the 1950s, Dr Wadley brought his loop system to the UK and offered it to a number of well known British firms: all regarded it with great scepticism. Only the small firm of Racal were prepared to take the risk and so was born the RA17.

It is said that even Racal almost despaired at one stage in development until somebody found that by making a saw cut in the chassis the performance of the complex filters could be vastly improved. Such was the worldwide success of the RA17 that it rapidly took Racal to the top and made them a real force in all branches of h.f. communications.

Dr Wadley also invented the "Telluro-meter" system for measuring distances accurately by means of radio signals, a system adopted by surveyors in many countries. In 1979, the 25th anniversary of this invention was marked by a special South African stamp featuring Dr Wadley with his prototype instrument.

Dr Wadley, an engineer of brilliance and achievement, died recently in South Africa at the age of 61 years.

Getting a Licence

Criticisms of the long delays involved in obtaining an amateur licence are at last bearing fruit. The City & Guilds of London Institute has confirmed that in future it will hold at least three Radio Amateurs' Examinations each year. There will be examinations in December 1982, March 1983 and May 1983. This is a start, although still more needs to be done.

This year has also seen lengthy delays by the Home Office in progressing applications and then issuing the licence. At times this has taken a matter of months, but by the Autumn the period of waiting had been reduced to a few weeks. One problem has been that a peak of applications follow each R.A.E., so that more examinations should help even out the flow.

One sees that once again there are suggestions that the difference between Class A and Class B licences should be based on different-level technical examinations and that it should be possible to obtain a Class A licence without taking a Morse test.

While one can understand the feelings of those who believe (in my opinion wrongly) that Morse is an obsolete mode, some curious claims are being made. For instance that Japan has abandoned Morse tests (not true although it is possible to get a limited, low-power licence including some h.f. bands without Morse the more advanced licences still involve Morse tests) or that r.t.t.y. machine telegraphy is as effective as Morse and occupies an equally narrow bandwidth (again not true).

Examination Projects

C. J. BOWES

HELPFUL ADVICE TO CANDIDATES FROM A TEACHER AND EXTERNAL EXAMINER

There are now several examinations such as O-level Electronics, Control Technology and A-level Electronics and even Design examinations where the work required for the course includes a project to be designed and constructed by the candidate. And there is of course the Schools Electronic Design Award Competition (SEDAC) sponsored jointly by Mullard Ltd and this magazine.

There are a number of factors involved in designing and building projects which are applicable to constructors embarking on their first projects, either as part of such an examination course or competition, or for their own personal pleasure.

PERSONAL CHALLENGE

Irrespective of your reasons for taking the plunge, the design and construction of your own project presents an interesting challenge.

When you are designing and constructing a project of your own you will be the one who has to sort out the "bugs". If you are a fairly experienced constructor there is a good chance that you are unlikely to make any serious construction mistakes, but it is essential to check out your circuit design both in theory and on a breadboard very early on in the course of your project so that you can find out any problems and solve them before it gets too close to any deadlines.

Once you have accepted the possibility of errors occurring, the next thing to do is to realise that if a project fails to work first time this IS NOT FATAL, providing you have planned your strategy correctly, but is in fact normal luck.

PLAN YOUR STRATEGY

The key to success is in your approach and attitude towards your project. The first necessity which must be accepted is that if you are working towards a deadline then you cannot afford to leave everything to the last minute.

When you come to choose the project that you intend to build it is an advantage to choose one that you actually would like to do, either because you want to use the thing you make or because it includes a technique that you want to try out.

If you know that you are going to have to produce a project as part of an examination course it is useful to carry round with you a small notebook and jot into it project ideas as you think of them so that you will have a list of possible ideas to choose from when the time comes to select your project.

THE IDEAL PROJECT

A second factor to bear in mind is the difficulty of your project. A simple, easy to do project requiring no thought, is likely to be a bore to finish and, if it is too simple may not gain you many marks. The ideal project is one that is just a little harder to do than that which you could easily accomplish when you start. Preferably it should require a little research into a new component (to you) or circuit idea, BUT NOT TOO MUCH! This will provide you with a surmountable challenge and give you a pleasant feeling of satisfaction when it works.

ORIGINALITY

If your project is for an examination, the novelty of the circuit approach, if it is outside the course work but not too far removed from the course, will usually get you a slightly better mark; but you must be careful to ensure that not only is the design original and not copied out of a magazine or book of circuits, but that this will be clearly seen to be so by the examiner when he or she reads the report.

This does not mean that you will be expected to produce completely new circuit ideas (there is a limit to the "newness" of any project idea) but you will be expected to produce something which has something produced from your mind to alter or extend any published design that you may use as a starting point.

Examples are for instance different combinations of standard circuits or substantial modifications to a published circuit to tailor it to your specific requirements.

WRITE YOUR SPECIFICATION

Once you have chosen the title of your project, it is necessary to decide and write down, for future

reference, exactly what you want your project to do.

In your detailed specification you need to put down all the important features which you feel your project ought to contain. This will include details about any other equipment that you want your design to connect with, any particular components that you want to include, whether the device is to be battery or mains operated and the cost if this is important.

OUTLINE DESIGN

Once you have clarified your ideas by writing out your specification the next stage is to start on an outline design. Unless your project is extremely simple it is likely that you will need to divide it into a series of separate stages, each one of which can be achieved by a particular circuit.

A block diagram is sometimes useful here to sort out the stages and show how they interact with each other. At this stage you will only be concerned with the outline of the system and need not be concerned with the full detail of the actual circuitry contained in each block.

ALTERNATIVE SOLUTIONS

Before detailed circuit design begins you should consider how you could actually solve each of the problems posed by the individual sections of the design.

If you are producing a project for examination purposes, you will be expected to show that you have considered alternative methods of solving the problems posed by the sections of your project in addition to the one that you actually develop.

Even if your project is for your own pleasure it is useful to consider more than one method of tackling the problem so that if your first solution does not work you will have other ideas to fall back on. Again the possible solutions and your reasons for the final choice you make should be written down in your notes for future reference.

Practical aspects of circuit design and project building will be discussed in the second and concluding part of this article.

To be continued

You can't beat The System.

The Experimentor System™ — a quicker transition from imagination through experimentation to realization.

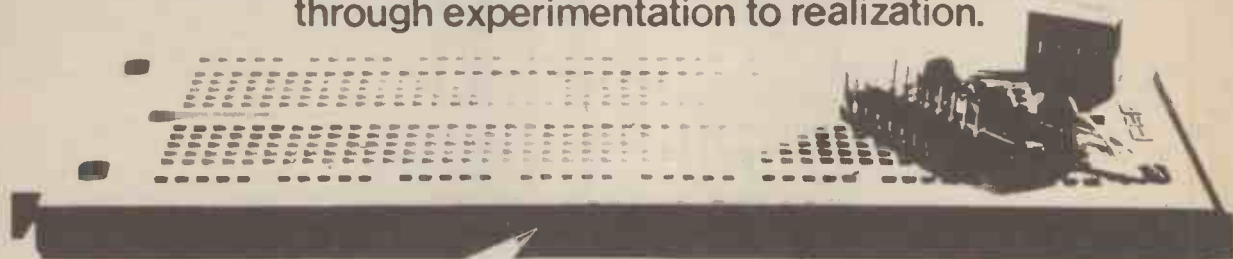

Experimentor solderless breadboard.

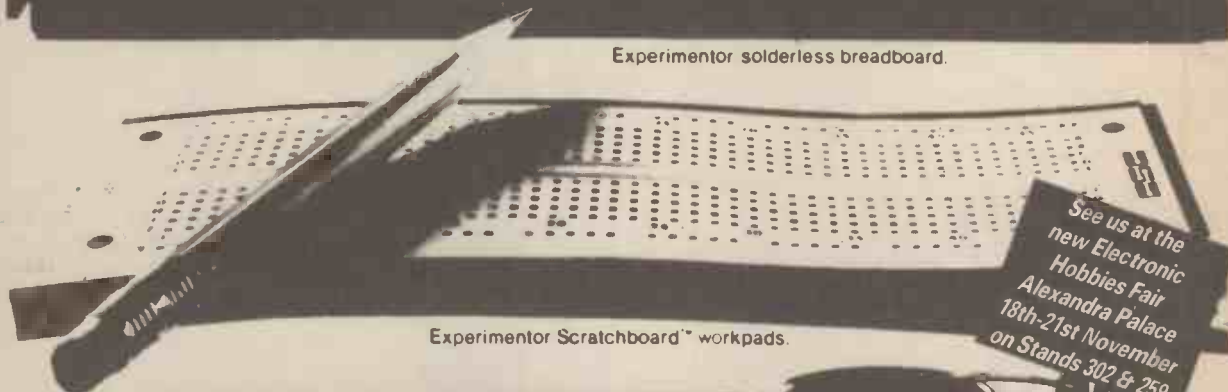

Experimentor Scratchboard™ workpads.

See us at the
new Electronic
Hobbies Fair
Alexandra Palace
18th-21st November
on Stands 302 & 259



Experimentor Matchboard™ pre-drilled PCBs

When you have a circuit idea that you want to make happen, we have a system to make it happen quicker and easier than ever before: The Experimentor System.

You already know how big a help our Experimentor solderless breadboards can be. Now we've taken our good idea two steps further.

We've added Experimentor Scratchboard workpads, with our breadboard hole-and-connection pattern printed in light blue ink. To let you sketch up a layout you already have working so you can reproduce it later.

With Experimentor Matchboard you can go from breadboard to the finished product nonstop! We've matched our breadboard pattern again, this time on a printed circuit board, finished and ready to build on. All for about £1.20

There's even a letter-and-number index for each hole, so you can move from breadboard (where they're moulded) to Scratchboard™ (where they're printed) to Matchboard™ (where they're silkscreened onto the component side) and always know where you are.

When you want to save time and energy, you can't beat The Experimentor System.

1. EXP-300PC, which includes one item. A Matchboard pre-drilled PCB £1.20	2. EXP-302, which includes three items. Three 50-sheet Scratchboard workpads £1.50	3. EXP-303, which includes three items. Two Matchboards and an EXP-300 solderless breadboard £7.60	4. EXP-304, which includes four items. Two Matchboards, an EXP-300 breadboard and a Scratchboard workpad £8.70
---	--	--	--

'As used in the Cambridge Learning Booklet'

GLOBAL SPECIALTIES CORPORATION



G.S.C. (UK) Limited, Dept.9W
Unit 1, Shire Hill Industrial Estate,
Saffron Walden, Essex. CB11 3AQ.
Telephone: Saffron Walden (0799) 21682
Telex: 817477

GLOBAL SPECIALTIES CORPORATION DEPT 9W
Unit 1, Shire Hill Industrial Estate, Saffron Walden, Essex

Name _____

Address _____

Inc P&P and 15% VAT

1 EXP 300PC £2.25	Qty Reqd _____	2 EXP 302 £2.58	Qty Reqd _____	FREE Catalogue tick box I enclose cheque PO for £ _____
3. EXP 303 £9.89	Qty Reqd _____	4 EXP 304 £11.15	Qty Reqd _____	

Phone your order with Access Barclaycard or American Express

Card No _____ Expiry date _____

Goods despatched within 48 hrs.

Sinclair ZX Spectrum

**16K or 48K RAM...
full-size moving-
key keyboard...
colour and sound...
high-resolution
graphics...**

**From only
£125!**



First, there was the world-beating Sinclair ZX80. The first personal computer for under £100.

Then, the ZX81. With up to 16K RAM available, and the ZX Printer. Giving more power and more flexibility. Together, they've sold over 500,000 so far, to make Sinclair world leaders in personal computing. And the ZX81 remains the ideal low-cost introduction to computing.

Now there's the ZX Spectrum! With up to 48K of RAM. A full-size moving-key keyboard. Vivid colour and sound. High-resolution graphics. And a low price that's unrivalled.

Professional power— personal computer price!

The ZX Spectrum incorporates all the proven features of the ZX81. But its new 16K BASIC ROM dramatically increases your computing power.

You have access to a range of 8 colours for foreground, background and border, together with a sound generator and high-resolution graphics.

You have the facility to support separate data files.

You have a choice of storage capacities (governed by the amount of RAM). 16K of RAM (which you can upgrade later to 48K of RAM) or a massive 48K of RAM.

Yet the price of the Spectrum 16K is an amazing £125! Even the popular 48K version costs only £175!

You may decide to begin with the 16K version. If so, you can still return it later for an upgrade. The cost? Around £60.

Ready to use today, easy to expand tomorrow

Your ZX Spectrum comes with a mains adaptor and all the necessary leads to connect to most cassette recorders and TVs (colour or black and white).

Employing Sinclair BASIC (now used in over 500,000 computers worldwide) the ZX Spectrum comes complete with two manuals which together represent a detailed course in BASIC programming. Whether you're a beginner or a competent programmer, you'll find them both of immense help. Depending on your computer experience, you'll quickly be moving into the colourful world of ZX Spectrum professional-level computing.

There's no need to stop there. The ZX Printer—available now—is fully compatible with the ZX Spectrum. And later this year there will be Microdrives for massive amounts of extra on-line storage, plus an RS232/network interface board.



Key features of the Sinclair ZX Spectrum

- Full colour—8 colours each for foreground, background and border, plus flashing and brightness-intensity control.
- Sound—BEEP command with variable pitch and duration.
- Massive RAM—16K or 48K.
- Full-size moving-key keyboard—all keys at normal typewriter pitch, with repeat facility on each key.
- High-resolution—256 dots horizontally x 192 vertically, each individually addressable for true high-resolution graphics.
- ASCII character set—with upper- and lower-case characters.
- Teletext-compatible—user software can generate 40 characters per line or other settings.
- High speed LOAD & SAVE—16K in 100 seconds via cassette, with VERIFY & MERGE for programs and separate data files.
- Sinclair 16K extended BASIC—incorporating unique 'one-touch' keyword entry, syntax check, and report codes.

um

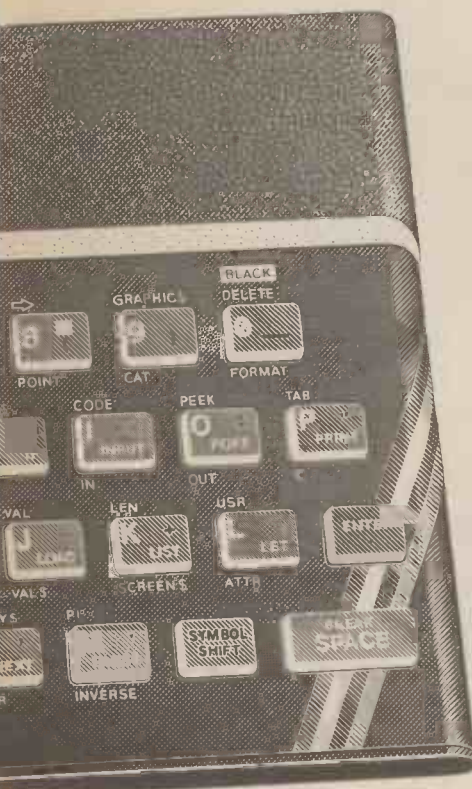

The ZX Printer – available now

Designed exclusively for use with the Sinclair ZX range of computers, the printer offers ZX Spectrum owners the full ASCII character set – including lower-case characters and high-resolution graphics.

A special feature is COPY which prints out exactly what is on the whole TV screen without the need for further instructions. Printing speed is 50 characters per second, with 32 characters per line and 9 lines per vertical inch.

The ZX Printer connects to the rear of your ZX Spectrum. A roll of paper (65ft long and 4in wide) is supplied, along with full instructions. Further supplies of paper are available in packs of five rolls.



The ZX Microdrive – coming soon

The new Microdrives, designed especially for the ZX Spectrum, are set to change the face of personal computing.

Each Microdrive is capable of holding up to 100K bytes using a single interchangeable microfloppy.

The transfer rate is 16K bytes per second, with average access time of 3.5 seconds. And you'll be able to connect up to 8 ZX Microdrives to your ZX Spectrum.

All the BASIC commands required for the Microdrives are included on the Spectrum.

A remarkable breakthrough at a remarkable price. The Microdrives are available later this year, for around £50.



How to order your ZX Spectrum

BY PHONE – Access, Barclaycard or Trustcard holders can call 01-200 0200 for personal attention 24 hours a day, every day. BY FREEPOST – use the no-stamp needed coupon below. You can pay by cheque, postal order, Access,

Barclaycard or Trustcard.

EITHER WAY – please allow up to 28 days for delivery. And there's a 14-day money-back option, of course. We want you to be satisfied beyond doubt – and we have no doubt that you will be.

To: Sinclair Research, FREEPOST, Camberley, Surrey, GU15 3BR.

Order

Qty	Item	Code	Item Price £	Total £
	Sinclair ZX Spectrum – 16K RAM version	100	125.00	
	Sinclair ZX Spectrum – 48K RAM version	101	175.00	
	Sinclair ZX Printer	27	59.95	
	Printer paper (pack of 5 rolls)	16	11.95	
	Postage and packing: orders under £100	28	2.95	
	orders over £100	29	4.95	
			Total £	

Please tick if you require a VAT receipt

*I enclose a cheque/postal order payable to Sinclair Research Ltd for £

*Please charge to my Access/Barclaycard/Trustcard account no.

*Please delete/complete as applicable

Signature

PLEASE PRINT

Name: Mr/Mrs/Miss

Address

EVE811

FREEPOST – no stamp needed. Prices apply to UK only. Export prices on application.

RS232/network interface board

This interface, available later this year, will enable you to connect your ZX Spectrum to a whole host of printers, terminals and other computers.

The potential is enormous. And the astonishingly low price of only £20 is possible only because the operating systems are already designed into the ROM.

ZX Spectrum

Available only
by mail order
and only from

sinclair

Sinclair Research Ltd,
Stanhope Road, Camberley,
Surrey, GU15 3PS.
Tel: Camberley (0276) 685311.

749

LOOK

Kit includes tape transport mechanism, ready punched and back printed quality circuit board and all electronic parts, i.e. semiconductors, resistors, capacitors, hardware, top cover, printed scale and mains transformer. You only supply solder and hook-up wire.

Self assembly simulated wood cabinet — only £4.50 + £1.50 p+p.

Featured in April issue of P.E. Reprint 50p. Free with kit.

ELECTRONICS ONLY!

Ideal for updating your existing cassette. Includes pcb diagram, all semiconductors, IC's, Capacitors, resistors. +£1.40p&p

£18-95

£32⁹⁵

+ £2.75 p&p.



P.E. STEREO CASSETTE RECORDER KIT

- NOISE REDUCTION SYSTEM
- AUTO STOP
- TAPE COUNTER
- SWITCHABLE E.O.
- INDEPENDENT LEVEL CONTROLS
- TWIN V.U. METER
- WOW & FLUTTER 0.1%
- RECORD/PLAYBACK I.C. WITH ELECTRONIC SWITCHING
- FULLY VARIABLE RECORDING BIAS FOR ACCURATE MATCHING OF ALL TAPES

STEREO AMPLIFIER KIT

- Featuring latest SGS/ATES TDA 2006 10 watt output IC's with in-built thermal and short circuit protection.
- Mullard stereo preamplifier module.
- Attractive black vinyl finish cabinet, 9" x 8" x 3 1/2" (approx).
- 10+10 stereo converts to a 20 watt disco amplifier.

To complete you just supply connecting wire and solder. Features include diode input sockets for ceramic cartridge, microphone, tape or tuner. Outputs — tape, speakers and headphones. By the press of a button it transforms into a 20 watt mono disco amplifier with twin deck mixing. The kit incorporates a Mullard LP1183 pre-amp module, plus power amp assembly kit and mains power supply. Also features slider controls, push button switches, fascia, knobs and contrasting case. Instructions 50p — supplied free with kit.

£16-50 + £2.90 p&p.

SPECIFICATIONS: Suitable for 4 to 8 ohm speakers. Frequency response: 40Hz - 20KHz. Input sensitivity: P.U. 150mV, Aux. 200mV, Mic. 1.5mV. Tone controls: Bass ± 12dB @ 60Hz, Treble ± 12dB @ 10KHz. Distortion: 0.1% typ. @ 8W. Mains supply: 220 - 250V 50Hz. **8" SPEAKER KIT**— Two 8" twin cone dome speakers. £4.75 a stereo pair plus £1.70 p&p.

KIT: £10-50 + £1.15 p&p
BUILT: £14-25 + £1.15 p&p

P.E. STEREO TUNER KIT

This easy to build 3 band stereo AM/FM tuner kit is designed in conjunction with P.E. (July 81 issue).

For ease of construction and alignment it incorporates three Mullard modules and an I.C. IF System. **FEATURES:** VHF, MW, LW bands, interstation muting and AFC on VHF. Tuning meter. Two back printed pcb's. Ready made chassis and scale. Aerial: AM

— ferrite rod, FM — 75 or 300 ohms. Stabilised power supply with "C" core mains transformer. All components supplied are to P.E. strict specification: Front scale size: 10 1/2" x 2 1/2" app. Complete with diagram and instructions. Self assembly simulated wood cabinet sleeve to suit tuner only. Finish size: 11 1/2" x 8 1/2" x 3 1/2". £3.50 Plus £1.50 p&p. Reprint 50p — FREE with kit.



£17-95 + £2.50 p&p.

SPECIAL OFFER! TUNER KIT PLUS:

- Matching I.C. 10 watt per channel Power amp kit.
- Mullard LP1183 built pre-amp, suitable for ceramic pickup and aux. inputs.
- Matching power supply kit with transformer.
- Matching set of 4 slider controls for bass, treble + vols. £21.95 + £3.50 p&p.

All mail to: 21A HIGH STREET, ACTON, W3 6NG. Note: Goods despatched to U.K. postal addresses only. All items subject to availability. Prices correct at 30/6/82 and subject to change without notice. Please allow 7 working days from receipt of order for despatch. RTVC Limited reserve the right to update their products without notice. Send S.A.E. for full list of products. Telephone or mail orders by ACCESS are welcomed.

ALL CALLERS TO: 323 Edgware Rd, London W2. Tel: 01-723 8432. 9.30 - 5.30, closed all day Thurs. ALL PRICES INCLUDE VAT AT 15%.



125W HIGH POWER AMP MODULE

SPECIFICATIONS. Max output power: 125w rms. Operating voltage (DC): 50-80 max. Loads: 4 - 16 ohms. Frequency response measured @ 100 watts: 25Hz - 20KHz. Sensitivity for 100 watts: 400mV @ 47K. Typical T.H.D. @ 50 watts: 4 ohms: 1%. Dimensions: 205 x 90 and 190 x 36 mm.

KIT: £10-50 + £1.15 p&p
BUILT: £14-25 + £1.15 p&p

MARSHALLS ELECTRONICS—(A. MARSHALL (LONDON) LIMITED) and BRADLEY MARSHALL LIMITED wish it to be known that there is no connection between them.

Each of the above-named Companies trade as separate entities and have no connection whatsoever.

A. MARSHALL (LONDON) LIMITED who also trade as **MARSHALLS ELECTRONICS** and **CONCORDE INSTRUMENT COMPANY LIMITED** will continue to advertise with their well-known logo and format and conduct their retail and industrial sales from their Glasgow Branch at 85 West Regent Street, Glasgow G2 2QD. **A. MARSHALL (LONDON) LIMITED** and **CONCORDE INSTRUMENT COMPANY LIMITED** have their Registered Offices situate at 27a Old Gloucester Street, London W1 and they also have an office in Monmouth.

BRADLEY MARSHALL LIMITED conduct their business from 325 Edgware Road, London W2 1BN, having purchased that business from **A. MARSHALL (LONDON) LIMITED**.

A. MARSHALL (LONDON) LIMITED

MARSHALLS ELECTRONICS

BRADLEY MARSHALL LIMITED

LIGHTNING

NEW SHOWROOM NOW OPEN

DO YOU NEED:- Electronic components, Tools, Test Equipment, Cases, Cabinets and Hardware etc. IN A HURRY?

THEN YOU NEED:-

LIGHTNING Electronic Components.

WHY?

Because **LIGHTNING** Strikes out where others fail:-

Express Despatch All Low Prices In Depth Stock
All New Guaranteed Goods from Leading Manufacturers

With all that going for us, going to you can you really afford to be without a copy of our brand new exciting CATALOGUE?

Many Prices Reduced — Many More Stock Lines

Send for YOUR Copy Now, ONLY 70p Post Paid

LIGHTNING ELECTRONIC COMPONENTS

Showroom and Mail Order Distribution Centre:
18 VICTORIA ROAD, TAMWORTH, STAFFS.
Telephone No. 0827 65767 Telephone Order now accepted

TITAN TRANSFORMERS AND COMPONENTS CENTRAL HALL CHAMBERS, GRIMSBY DN32 7EG

Mail Order only — Prices include 15% VAT

Inverters—high quality frequency stable 12/24 volts DC. to 240V AC at 100, 250, 500, 1,000 VA.

Voltage Stabilisers—Coarse or fine regulation. High speed Null switching 170/260V/50Hz. 100VA to 5KVA plus other sizes.

Adaptors—Switchable 6-7.5-9V 300MA unregulated.
6-7.5-9V 250 MA regulated.

Battery chargers—2 volts & 6 volts, power supplies and a full range of transformers.

BRIDGES, CAPACITORS ETC.

Send S.A.E. for details of product you are interested in.

MASTER ELECTRONICS NOW!

The PRACTICAL way!

This new style course will enable anyone to have a real understanding of electronics by a modern, practical and visual method. No previous knowledge is required, no maths, and an absolute minimum of theory.

You learn the practical way in easy steps mastering all the essentials of your hobby or to start or further a career in electronics or as a self-employed servicing engineer.

All the training can be carried out in the comfort of your own home and at your own pace. A tutor is available to whom you can write personally at any time, for advice or help during your work. A Certificate is given at the end of every course.

You will do the following:

- Build a modern oscilloscope
- Recognise and handle current electronic components
- Read, draw and understand circuit diagrams
- Carry out 40 experiments on basic electronic circuits used in modern equipment
- Build and use digital electronic circuits and current solid state 'chips'
- Learn how to test and service every type of electronic device used in industry and commerce today. Servicing of radio, T.V., Hi-Fi and microprocessor/computer equipment.

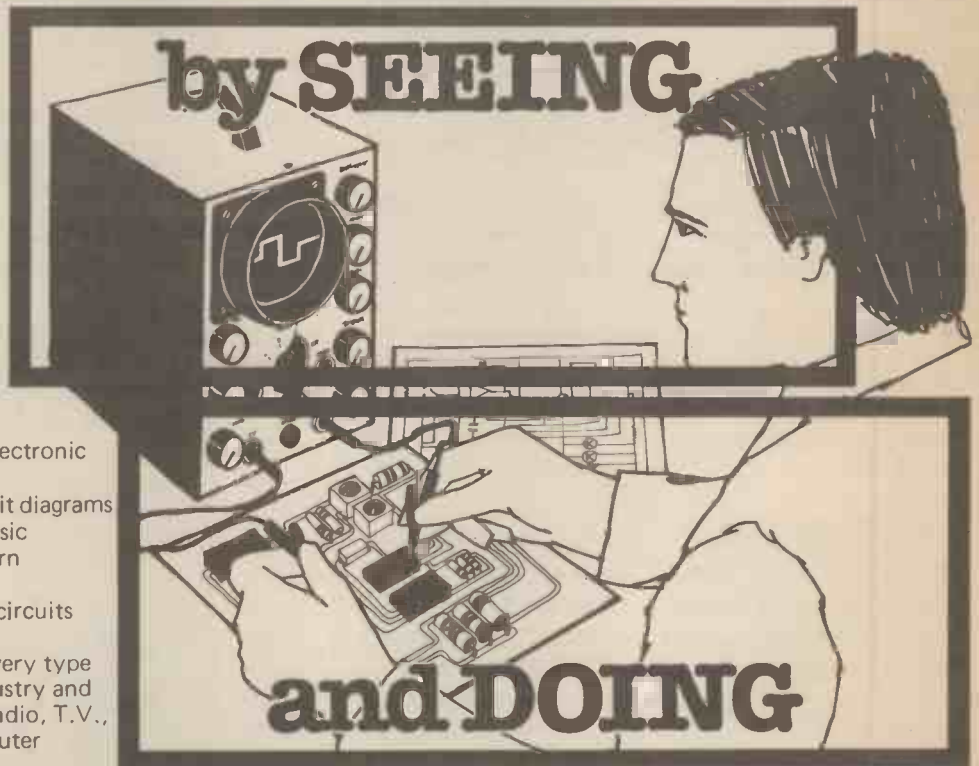

New Job? New Career? New Hobby? Get into **Electronics** Now!

FREE!

COLOUR BROCHURE



Please send your brochure without any obligation to

I am interested in:

NAME _____

COURSE IN ELECTRONICS as described above.

ADDRESS _____

RADIO AMATEUR LICENCE

MICROPROCESSORS

LOGIC COURSE

OTHER SUBJECTS _____

POST NOW TO:

BLOCK CAPS PLEASE

EE/11/820

British National Radio & Electronics School Reading, Berks. RG1 1BR.

TWO FABULOUS OFFERS FROM

ALCON

TESTER 20
20k Ω /V a.c. & d.c.

THE IDEAL INSTRUMENT FOR THE CONSTRUCTOR

With protective diodes and quick-acting 1.25A fuse.

ONLY £29.75

inc. VAT, P&P, complete with carrying case, leads and instructions.



The best instrument for the workshop, school, toolbox, TV shop and anywhere accurate information is needed quickly and simply.

Accuracy: d.c. ranges and Ω 2% a.c. 3% (of f.s.d.)
40 ranges: d.c. V 100mV, 1.0V, 3.0V, 10V, 30V, 100V, 300V, 1000V.
d.c. I 50 μ A, 100 μ A, 300 μ A, 1.0mA, 3mA, 10mA, 30mA, 100mA, 1A, 10A.
a.c. V 10V, 30V, 100V, 300V, 1000V.
a.c. I 3mA, 10mA, 30mA, 100mA, 1.0A, 10A.
 Ω 0-5.0k Ω , 0-50k Ω , 0-500k Ω , 5M Ω , 50M Ω .
dB from -10 to +61 in 5 ranges.

Dimensions: 105 x 130 x 40mm.

TESTER 50
39 ranges
50k Ω /V a.c. and d.c.
With protective diodes and quick-acting 1.25A fuse.

THE PROFESSIONAL SOLUTION TO GENERAL MEASUREMENT PROBLEMS

ONLY £36.30

incl. VAT, P&P, complete with carrying case, leads and instructions. Goods normally by return of post.

The best instrument for the workshop, school, toolbox, TV shop and anywhere accurate measurement is needed quickly and simply.

Accuracy: 50k Ω /V, a.c. and d.c.
39 ranges: d.c. V 150mV, 1V, 3V, 10V, 30V, 100V, 300V, 1000V;
d.c. I 20 μ A, 100 μ A, 300 μ A, 1mA, 3mA, 10mA, 30mA, 100mA, 1A, 3A.
a.c. V 10V, 30V, 100V, 300V, 1000V;
a.c. I 3mA, 10mA, 30mA, 100mA, 1A, 3A.
Ohms 5k Ω , 50k Ω , 500k Ω , 5M Ω , 50M Ω . dB from -10 to +61 in 5 ranges.

Dimensions: 105 x 130 x 40mm.

For details of these and the many other instruments in the Alcon range, including multimeters, components measuring, automotive and electronic instruments, please write or telephone:

ALCON Instruments Ltd.

19 MULBERRY WALK · LONDON SW3 6DZ · TEL: 01-352 1897 · TELEX: 918867



METERS: 110 x 82 x 35mm
30 μ A, 50 μ A, 100 μ A. £5.90.
Post 50p.

METERS: 45 x 50 x 34mm
50 μ A, 100 μ A, 1mA, 5mA, 10mA, 25v, 1A, 2A, 5A 25V.
£2.90. Post 30p.

METERS: 60 x 47 x 33mm
50 μ A, 100 μ A, 1mA, 5mA, 10mA, 100mA, 1A, 2A, 25v, 50v,
50-0-50 μ A, 100-0-100 μ A. £4.76.
VU meters. £5.32.
Post on above meters 30p.

Silicone grease 50g £1.32 Post 14p.

NI-CAD BATTERY CHARGER
Led indicators charge-test switch.
For PP3, HP7, HP11 & HP2 size batteries.
Price £5.85 Post 94p.

MULTI-METER

7N 360TR
20,000 ohm/volt
DC Volts: 0-1,
0-5, 2-5, 10-150-
250-1,000v.
AC Volts: 10-50,
250-1,000



RESISTANCE RANGES
X1, X10, X1K, X10K
£14-10
P.&P. 87p

TRANSFORMERS

240v Primary		
3-0-3v	100mA	82p
6-0-6v	100mA	87p
6-0-6v	250mA	£1.22
12-0-12v	50mA	92p
12-0-12v	100mA	£1.15
Post on above transformers 48p.		
9-0-9v	1A	£1.80
12-0-12v	1A	£2.40
15-0-15c	1A	£2.60
6-3v	1½A	£1.80
6-0-6v	1½A	£2.10
Post on above transformers 87p.		

All above prices include V.A.T. Send 80p for new 1982 fully illustrated catalogue, S.A.E. with all enquiries. Special prices for quantity quoted on request.

All goods despatched within 3 days from receipt of the order.

M. DZIUBAS

158 Bradshawgate, Bolton
Lancs. BL2 1BA

HOME CONSTRUCTOR TURNTABLE KITS

from

INPUT DESIGN LTD

THE LEADING MANUFACTURERS OF TURNTABLES IN KIT FORM

NORMAL RETAIL PRICE £49.50

SPECIAL INTRODUCTORY OFFER TO READERS OF EE

£44

inc VAT
(P & P £1.95)

This kit includes AC Synchronous motor (as used on £350 decks), Pulley, Belt, Drive Hub, Spindle, Bearing, Glass Platter, Felt Mat, Switch, Electronics, Cable and full instructions together with blueprint for plinth assembly.

Any other parts (ie Lid) available as optional extras.

5 YEAR GUARANTEE— MONEY BACK IF NOT SATISFIED

• KITDECK 2 Still £115 •

Pay by Barclaycard, Access or CWO. Export: Write for Pro-forma.



INPUT DESIGN LTD

Palace Street, Biggleswade, Beds. SG15 8DP.

Telephone: Biggleswade (0767) 316655 Telex: 826671

ELECTRONIC HOBBIES FAIR

Alexandra Pavilion November 18 – 21 1982

Launched in response to demand for a major national show of the highest quality, EVERYDAY ELECTRONICS, PRACTICAL ELECTRONICS and PRACTICAL WIRELESS are presenting the biggest and best event ever to be staged for the electronic hobbies enthusiast.

If your company is involved in the manufacture of electronic components, equipment, ancillary systems for

electronic projects, home computers, amateur radio, citizens band, video games, musical instruments – you should be there!

For further information about exhibiting contact: The Exhibition Manager, Electronic Hobbies Fair, IPC Exhibitions Ltd., Surrey House, 1 Throwley Way, Sutton, Surrey SM1 4QQ. Tel: 01-643 8040. Extn. 4873.

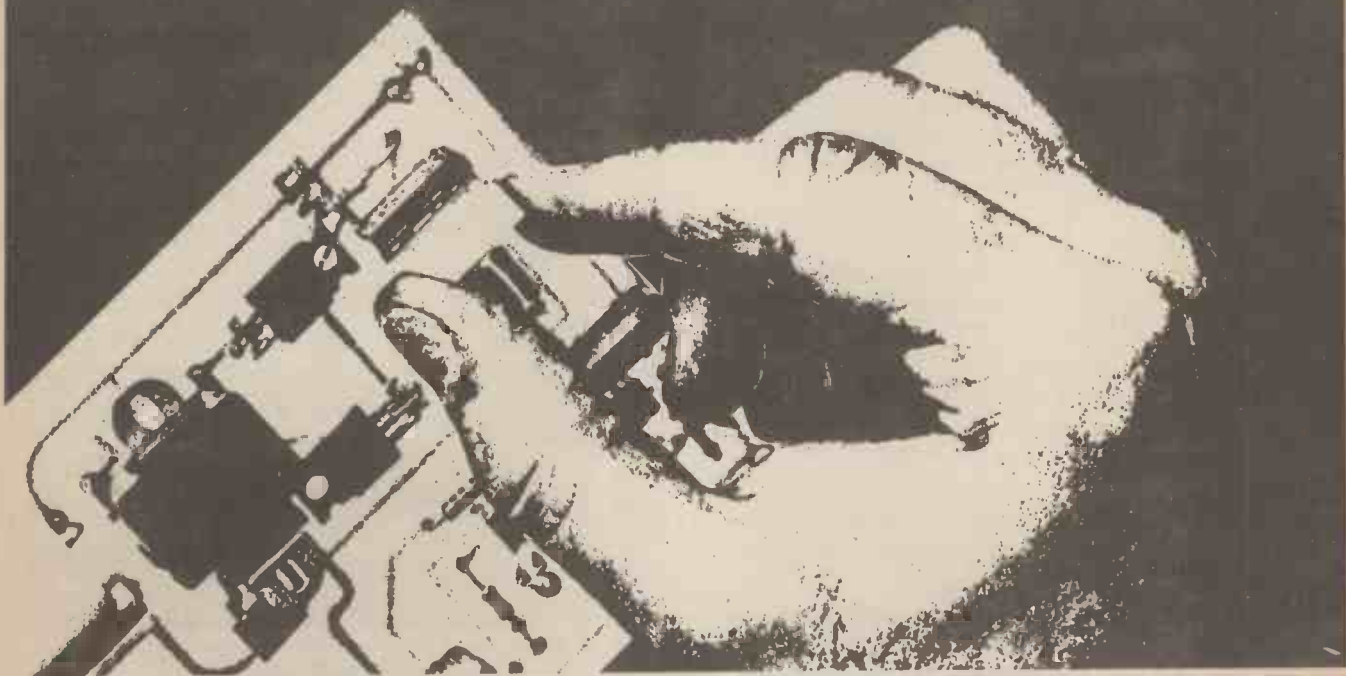

Please send me details about exhibiting at the



Name _____

Position in Company _____

Company _____

Address _____

Tel _____

Send to: The Exhibition Manager, Electronic Hobbies Fair, IPC Exhibitions Ltd., Surrey House, 1 Throwley Way, Sutton, Surrey SM1 4QQ.

THE BIGGEST NAME IN BRITISH BREADBOARDS

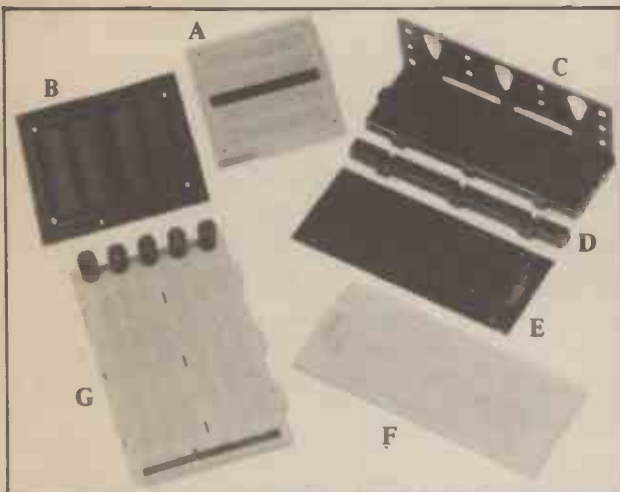

All BOSS Breadboards directly accept .3", .4", .5" & .6" pitch DIL IC's and have numbered and lettered rows and columns allowing exact location indexing.

- A. EuroBreadBoard. 500 contacts, ideal for schools and training establishments.
- B. EuroSolderBoard. Exact printed circuit board copy of 'A' enabling progression to permanent and rugged assembly.
- C. BIMBOARD 1. 550 contacts plus component support bracket. BIMBOARD's 2, 3 and 4 also available providing 1100, 1650 and 2200 contacts respectively.
- D. BIMBUSTRIP. 2 additional power lines, slot onto any 'C', 'G' or BIMBOARD DESIGNER.
- E. PC BIMBOARD. Exact printed circuit board copy of 'C' plus 'D' enabling permanent pcb circuits to be generated.
- F. Layout Pad. Exact paper copy of 'E' for planning or recording layouts.
- G. MPUroBreadBoards. 1422 contacts including power bus strips on all sides. Specifically for MPU circuits it is standard 160 x 100mm Eurocard size.

Adventures with Microelectronics. A beginners book based on BIMBOARD 1. Covers simple circuits, built step by step and includes component lists and sources.

Note: All BIMBOARD's 1, 2, 3 and 4, BIMBUSTRIP and MPUroBreadBoards slot onto each other thereby providing larger circuit development working areas.

**JUST RELEASED
BIMBOARD DESIGNERS.**
Incorporate 2 BIMBOARDS (4 to special order) plus integral fixed 5V and adjustable $\pm 5V$ to $\pm 15V$ power supplies.

BOSS

INDUSTRIAL MOULDINGS LIMITED

James Carter Rd, Mildenhall, Suffolk, IP28 7DE
Tel: Mildenhall (0638) 716101 Telex 818758

NO!

If you see an advertisement in the press, in print, on posters or a cinema commercial which you find unacceptable, write to us at the address below. (TV and radio commercials are dealt with by the I.B.A.)

**The Advertising
Standards Authority.**



ASA Ltd, Brook House, Torrington Place, London WC1E 7HN.



Constructor Series Speakers

IT'S
SO
EASY

Have fun, save money, building a Kef design with a Wilmslow Audio CS Total kit. No electronic or woodworking knowledge necessary and the end result is a proven top-quality design that you'll be proud of.



Each kit contains all cabinet components, accurately machined for easy assembly, speaker drive units, crossovers, wadding, grille fabric, terminals, nuts, bolts, etc. The cabinets can be painted or stained or finished with iron-on veneer or self adhesive woodgrain vinyl. Easy foolproof assembly instructions supplied. Set of constructor leaflets sent free on receipt of large S.A.E.

Prices: CS1 (As 101)	£110 pr. inc. VAT, plus carr./ins. £ 5.50
CS1A (simplified LS3/5A)	£103 pr. inc. VAT, plus carr./ins. £ 5.50
CS3 (as 103.2)	£129 pr. inc. VAT, plus carr./ins. £10.00
CS5 (as Carlton II)	£192 pr. inc. VAT, plus carr./ins. £15.00
CS7 (as Cantata)	£250 pr. inc. VAT, plus carr./ins. £18.00



0625 529599

35/39 Church Street, Wilmslow, Cheshire SK9 1AS

1982 Catalogue — £1.50 post free



Lightning service on telephoned credit card orders!



DIGITAL MULTIMETERS FROM ONLY £39

(plus VAT, p&p)



Get your hands on a low-cost, high-performance digital multimeter.

Choose from these three models:

EDM-101, at £39 (+VAT, p&p), has 5 functions and 19 ranges, plus diode test (200mV to 1000Vdc; 200 and 600Vac; 200µA to 2Adc; 200 Ω to 20M Ω).

T100 (illustrated), at £49 (+VAT, p&p), incorporates 7 functions and 29 ranges including diode test and a direct 10A input. (200mV to 1000Vdc or 750Vac; 200µA to 10Aac or dc; 200 Ω to 20M Ω).

T110, at £59 (+VAT, p&p), has an additional buzzer for fast continuity testing.
Send your order in today!

VAKO DISPLAY SYSTEMS LTD

Pass Street, Werneth, Oldham, Lancs OL9 6HZ
Tel: 061-652 5111 Telex: 668250

Please send me:

-EDM-101 multimeters at £46.60 (incl.VAT, p&p)
-T100 multimeters at £58.10 (incl.VAT, p&p)
-T110 multimeters at £69.50 (incl.VAT, p&p)

Cheque/P.O. enclosed payable to
Vako Display Systems Ltd. for: £

Name:

Address

Please allow 14 days for delivery.

TRADE COUNTER CALLERS WELCOME.



Bigger and Better for 1982
the colourful Wilmslow Audio brochure
– the definitive loudspeaker catalogue!

Everything for the speaker constructor – kits, drive units, components for HiFi and PA.

50 DIY HiFi speaker designs including the exciting new dB Total Concept speaker kits, the Kef Constructor range, Wharfedale Speakercraft, etc.

Flatpack cabinet kits for Kef, Wharfedale and many others.

- ★ Lowest prices — Largest stocks ★
- ★ Expert staff — Sound advice ★
- ★ Choose your DIY HiFi Speakers in the comfort of our ★
two listening lounges
(Customer operated demonstration facilities)
- ★ Ample parking ★

Send £1.50 for catalogue
(cheque, M.O. or stamps – or phone with your credit card number)

- ★ Access – Visa – American Express accepted ★
also HiFi Markets Budget Card.



0625 529599

35/39 Church Street, Wilmslow, Cheshire SK9 1AS



Lightning service on telephoned credit card orders!
Please allow 7 days for delivery



WHY USE STRIPBOARD?

Make your own PCB. It's easy:

"GET YOU STARTED" KIT

12V Mini Drill (takes 1/4A).
1mm Bit.
25 sq. ins. Copper Clad.
PCB Etchant for 1/2 ltr.
Tweezers and Dish.
Fine Etch Resist Pen.
Instructions. Only £6.00.
"SUPER" KIT As above with:
3 Pens, Fine-Med.-Thick.
75 sq. ins. Copper Clad.
3 Sheet Transfers—Etch Resist.
Only £8.50.

SIMPLE PCB DRILL

12V Motor with chuck attached with 3 collets 0.8 to 2.0mm. £4.50.

PCB ETCHANT

Double strength to make 1/2 ltr. solution. 90p.

ETCH RESIST PENS

Set of 3, Fine-Med.-Thick. £1.80.

COPPER CLAD BOARD

6" x 6" x 1mm on Pax. 25p sheet.

Prices are inclusive but add 60p P & P to each order.
Cheques & P.O.'s payable to POPS Components.

POPS COMPONENTS

38 Lower Addiscombe Rd,
Croydon CR0 6AA

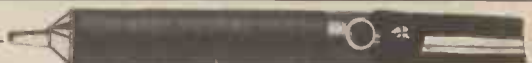

DESOLDERING TOOL. Make life easy with this superb anodised high suction desoldering tool. Essential for desoldering multi-lead devices from transistors to ICs. Especially handy for the experimenter and service engineer, eliminating damage to PCBs and components. £4.45 + VAT. SPARE TEFLON NOSE 85p + VAT.

JAPANESE TRANSISTORS: Equivalents available for most types. Please enquire.

LOW COST VERSTALVE MULTIMETER

THE MIGHTY MINI MULTI-TESTER. 2,000 ohms per volt. Ideal for the beginner and service engineer (fits into shirt pocket). DC & AC voltage ranges: 10v, 50v, 250v, 1,000v. DC current ranges 100mA. Resistance: 2 ranges 0-1Mohm (60 ohms centre scale). Decibels: -10 to +22db. Mirror Arc scale. Overload protection. Complete with battery, leads and instructions. £5.65 + VAT.

ORDER FORM (no need to cut magazine—order on plain paper)

Name

Address

.....Desoldering tools at £4.45 = £.....

.....Spare Teflon noses at 85p = £.....

.....Mighty Mini Testers at £5.65 = £.....

Postage, packing and insurance at 80p per one device, 25p for each additional device £.....

Sub total £.....

Add 15% VAT £.....

I enclose cheque no./P.O. no. £.....

Alternatively please credit my VISA/ACCESS/AMERICAN EXPRESS no.

Signature

This offer applies to UK only. Please allow 7-10 days delivery. Overseas customers please do not add VAT but allow to cover postage. TRADE ENQUIRIES WELCOME.

CRICKLEWOOD ELECTRONICS LTD.

40 Cricklewood Broadway, London NW2 3ET. Tel: 01-452 0161 Telex 914977

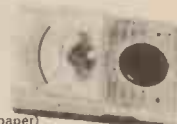

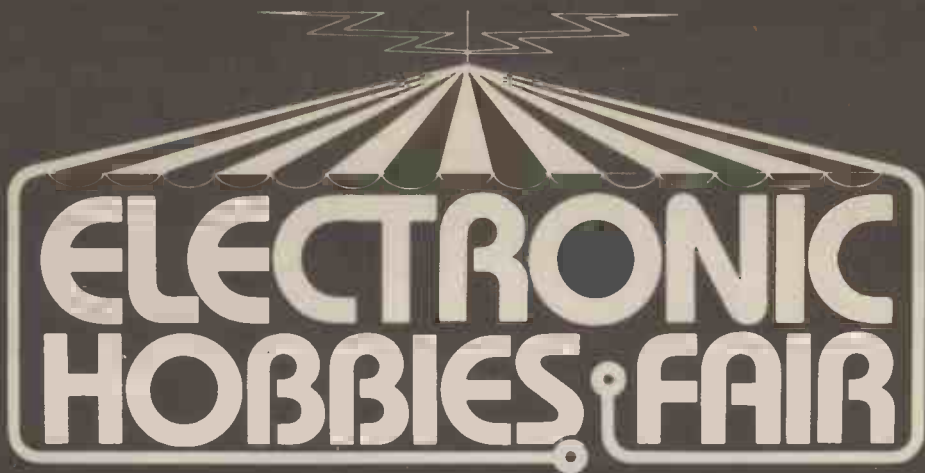

ELECTRONIC HOBBIES FAIR

Alexandra Pavilion London November 18 – 21 1982

The biggest and best event ever to be
staged for the
electronic hobbies enthusiast!

Walk into a whole world of electronic equipment. – Everything from resistors, IC's to home computers, transmitting and receiving units, citizens band radio and peripheral equipment, video games, musical instruments, radio control models. . . . In fact whatever your particular electronic hobby you'll find this show will be the most interesting and informative way to discover all the latest developments in your particular field.

Other attractions will include radio and TV transmission, electric vehicles, radio controlled models, and demonstrations by local and national organisations.

This is the age of the train – British Rail are offering a cheap rate rail fare from all major

stations in the country direct to Alexandra Palace – a bus will be waiting on your arrival to take you to the show. Ticket price also includes admission to the exhibition – so let the train take the strain to the Electronic Hobbies Fair.

Ticket prices at the door are £2 for adults, £1 for children but party rates are available for 20 people or more. To find out more, contact the Exhibition Manager, Electronic Hobbies Fair, IPC Exhibitions, Surrey House, 1 Throwley Way, Sutton, Surrey SM1 4QQ. Tel: 01-643 8040.

Electronic Hobbies Fair is sponsored by Practical Electronics, Everday Electronics and Practical Wireless and is organised by IPC Exhibitions Ltd.

OPENING TIMES

Thursday 18 Nov. – 10.00-18.00

Friday 19 Nov. – 10.00-18.00

Saturday 20 Nov. – 10.00-18.00

Sunday 21 Nov. – 10.00-17.00



50p OFF

admission if you produce this coupon
at the door of Electronic Hobbies Fair.
Valid one per person only any day.

EE1



CLASSIFIED

The prepaid rate for classified advertisements is 28 pence per word (minimum 12 words), box number 60p extra. Semi-display setting £7.24 per single column centimetre (minimum 2.5cm): All cheques, postal orders, etc., to be made payable to Everyday Electronics and crossed "Lloyds Bank Ltd." Treasury

notes should always be sent registered post. Advertisements, together with remittance, should be sent to the Classified Advertisement Department, Everyday Electronics Room 2612, IPC Magazines Limited, King's Reach Tower, Stamford St., London SE1 9LS. (Telephone 01-261 5942).

When replying to Classified Advertisements please ensure:

- (A) That you have clearly stated your requirements.
- (B) That you have enclosed the right remittance.
- (C) That your name and address is written in block capitals, and
- (D) That your letter is correctly addressed to the advertiser.

This will assist advertisers in processing and despatching orders with the minimum of delay.

Educational

COURSES—RADIO AMATEURS EXAMINATION. City and Guilds. Pass this important examination and obtain your licence, with an RRC Home Study Course. For details of this and other courses (GCE, professional examinations, etc) write or phone—**THE RAPID RESULTS COLLEGE, DEPT. JR2, Tuition House, London SW19 4DS.** Tel: 01-947 7272 (9 am-5 pm) or use our 24 hour Recordacall Service: 01-946 1102 quoting Dept JR2.

Service Sheets

ANY PUBLISHED, FULL-SIZE SERVICE SHEET by return £2 + LSAE. CTV/music centres £3. Repair data with all circuits, layouts, etc, your named TV or Video £8.50. Free 50p mag. All orders, queries—**T.I.S. (E.E.), 76 Churches, Larkhall, Lanarkshire.**

BELL'S TELEVISION SERVICE for service sheets on Radio, TV etc. £1.25 plus SAE. Colour TV Service Manuals on request. SAE with enquiries to **BTS, 190 King's Rd. Harrogate, N. Yorkshire.** Tel: 0423 55885.

Receivers and Components

PSU's 5V3A £18.99, 5V5A £25.99, 1.2-25V 1.2A £25.99, 3A £30.99, 5A £33.99, p&p included. EDWARDS ELECTRICS (J. C.), Unit 3, Mill Lane, Church Street, Bridgewater, Somerset.

COMPONENT BARGAINS, resistors, capacitors, transistors etc. Unused (45 diodes £1). SAE lists. BERMEL, Ellerslie Chambers, Bournemouth BH1 2EE.

Genuine Govt. Surplus Release ! HEADPHONES

AIRLITE HEADSETS with Boom Mike. Must have cost a fortune. Our price £4.50 per pair, postage £1. 2 pairs £9 post free. Less boom mike £4 per pair, £1 postage. 2 pairs £8 post free.
AMPLIVOX HEADSETS WITH BOOM MIKE £4.50 per pair, postage £1. 2 pairs £9 post free. Less boom mike £4 per pair, postage £1. 2 pairs £8 post free.
GENUINE AFV TANK HEADSETS and MIKE. £3.50, p.p. £1. 2 for £7 post free. Impedance of first two items 600Ω. All headphones in nice condition.
HAVE YOU SEEN THE GREEN CAT. 1000s of new components, radio, electronic, audio at unbelievably low prices. Send 50p and receive catalogue and **FREE RECORD SPEED INDICATOR.** Try a **JUMBO PACK,** Contains transistors, resistors, caps, pots, switches, radio and electronic devices. Over £50 worth for £11. Carriage £2.50. Mini Jumbo pack (£20 worth) for £5. p.p. £1.50.
MYERS ELECTRONICS, Dept. E.E. 12/14 Harper Street, Leeds LS2 7EA. Next to Union Jack Clothing store. Open 9 to 5, Mon. to Sat, Tel. 452045. Callers welcome.

TURN YOUR SURPLUS capacitors, transistors etc., into cash. Contact **Coles Harding & Co., 103 South Brink, Wisbech, Cambs.** 0945-584188. Immediate settlement.

AERIAL BOOSTERS trebles incoming signal, price £7.00. SAE leaflets. **VELCO ELECTRONICS, Ramsbottom, Lancashire BL0 9AG.**

BIG BARGAIN BOX

Our Big Bargain Box contains over a thousand components—resistors, capacitors, pots, switches, diodes, transistors, panels, bits and pieces, odds and ends. All useful stuff—would cost many times the price we are asking if bought separately. Approx weight 4lbs. **ONLY £5.00 inc. post—your'e bound to come back for another!** **ESP, 147G Foundry Lane, Southampton, SO1 3LS** Lots of surplus bargains on our latest list—send an s.a.e. for your copy now.

300 SMALL COMPONENTS, transistors, diodes. £1.70 7lbs assorted components £4.25 10lbs £5.75. Forty assorted 74 series ICs on panel £1.70. 500 capacitors £3.20. List 20p refundable. Post 60p. Optionable insurance 20p. J. W. B. RADIO, 2 Barnfield Crescent, Sale, Cheshire M33 1NL.

Veteran & Vintage

"SOUNDS VINTAGE"

The only magazine for all vintage sound enthusiasts, packed with articles by top writers, covering gramophones, phonographs, 78s, wireless, news, history, reviews, etc.
 Bi-monthly. Annual subscription £8.75 (airmail extra). Send 75p for sample copy.
212 Lower High St., Watford, Herts.

For Sale

OPTICAL FIBRES for use in communications, electrical isolation, remote sensing, illumination, etc. Introductory package contains five sample lengths of silica, glass and plastic fibres totalling ten metres plus a forty page fibre optics guide with theory, uses, practical circuits, etc. Send £5.95 to **Quantum Jump Ltd., 53 Marlborough Road, Tuebrook, Liverpool L13.**

ORDER FORM PLEASE WRITE IN BLOCK CAPITALS

Please insert the advertisement below in the next available issue of **Everyday Electronics** for.....
 insertions. I enclose Cheque/P.O. for £.....

(Cheques and Postal Orders should be crossed Lloyds Bank Ltd. and made payable to Everyday Electronics)

--	--	--	--

NAME

ADDRESS

EVERYDAY ELECTRONICS

Classified Advertisements Dept., Room 2612, King's Reach Tower, Stamford Street, London SE1 9LS Telephone 01-261 5942

Rate: 31p per word, minimum 12 words. Box No. 60p extra.

Company registered in England. Registered No. 83626. Registered Office: King's Reach Tower, Stamford Street, London SE1 9LS.

11/82

EUROPA ELECTRONICS

Mail Order to: 160 High Road, Willesden Green, London NW10.

Tel: 01-459-2480

Retail Shop: North Parade Electronics, 12 North Parade, Mollison Way, Edgware, Middlesex.

Post & Packing: Add 50p to all orders under £5.

VAT: All UK orders add 15% to total cost including p. & p.

All devices are new, full spec and guaranteed.

ELECTROLYTIC CAPACITORS (Axial & Radial) Values in uf.

63V: 1, 2-2, 3-3, 4-7, 6-8, 10 6p; 15, 22, 33 8p.
25V: 47, 100 8p; 220, 330 12p;
16V: 470 14p; 1000 20p;
10V: 1000 15p; 2200 25p.

POLYESTER CAPACITORS (Radial Lead) 250V. Values in nf.

2n2, 3n3, 4n7, 6n8, 10n, 15n, 22n, 33n, 47n 6p; 68n, 100n 8p; 150n, 220n, 330n 10p;
470n 15p; 680n 20p; 1000n 25p.

POLYESTER CAPACITORS (Radial Lead) 100V Values in nf.

1n, 1n5, 2n2, 3n3, 4n7, 6n8, 10n 6p; 15n, 22n, 33n, 47n 8p.

CERAMIC CAPACITORS 50V (Radial Lead).

22pF-47,000pF E12 Values 4p each.

POTENTIOMETERS: Carbon track, 0-25W log & linear values.

5K-2M single gang 30p
5K-2M single gang D/P switch 78p
5K-2M dual gang stereo 88p

PRESET POTENTIOMETERS Horizontal & Vertical.

0-1W 100R-1 Meg 7p
0-25W 100R-1 Meg 10p

RESISTORS 5% Carbon Film. E12 values.

0-25W IR-5MI 1p
0-5W 1R-5MI 1.5p

SWITCHES

Slide 1A DPDT 14p
DPDT c/off 15p

Sub-miniature Toggle

SPST on/off 54p
SP c/over 60p
DPDT 75p
DPDT c/off 88p

Push Button

Push to Make 15p
Push to Break 25p

VOLTAGE REGULATORS (PLASTIC) TO220

5V 1A 7805 40p 7905 45p
12V 1A 7812 40p 7912 45p
15V 1A 7815 40p 7915 45p
18V 1A 7818 40p 7918 45p
24V 1A 7824 40p 7924 45p

OPTO ELECTRONICS

2N5777 45p ORP60 120p
OC771 180p ORP61 120p
ORP12 120p TIL78 55p

LEDS

3mm 5mm Includ. clip
Red 11p 12p
Green 14p 14p
Yellow 14p 14p

7 Segment Displays

TIL321 115p DL704 99p
TIL322 115p DL707 99p

DIODES

0A47 8p
0A90 9p
0A91 9p
0A200 9p
0A202 9p
1N914 4p
1N916 7p
1N4148 4p
1N4001 5p
1N4004 6p
1N4007 7p

BRIDGE RECTIFIERS

1A 50V 19p
1A 100V 20p
1A 400V 25p
2A 100V 30p
2A 400V 45p

ZENER DIODES

2-7-33V
400mW 9p

DIL SOCKETS

Low Profile
8 pin 8p 20 pin 22p
14 pin 10p 24 pin 25p
16 pin 10p 40 pin 30p

VEROBOARDS 0-1in

2 1/2 x 3 1/2" clad 73p
2 1/2 x 5" 83p
3 1/2 x 3 1/2" 83p
3 1/2 x 5" 95p
3 1/2 x 17" 325p
4 1/2 x 18" 425p
Pkt of 100 pins 50p
Spot face cutter 118p
Pin insertion tool 162p

TRANSIS-TORS

AD161 42p
AD162 42p
BC107 10p
BC108B 12p
BC109 10p
BC109C 12p
BC177 16p
BC178 16p
BC179 20p
BC182L 10p
BC183L 10p
BC184L 10p
BC212L 10p
BC213L 10p
BC214L 10p
BC547 12p
BC548 12p
BC549C 14p
BC556 15p
BC557 15p
BC558 15p
BC559 15p
BFY50 23p
BFY51 23p
BFY52 23p
TIP29A 32p
TIP30A 35p
TIP31A 38p
TIP32A 38p
TIP33A 65p
TIP34A 74p
TIP41A 50p
TIP42A 55p
TIS43 32p
2N2646 45p
2N2905 25p
2N2906 26p
2N2907 26p
2N3053 26p
2N3055 48p
2N3702 10p
2N3703 10p
2N3704 10p
2N3705 10p
2N3706 10p
2N3707 10p
2N3708 10p
2N3709 10p
2N3819 22p
2N3903 15p
2N3904 15p
2N3905 15p
2N3906 15p
2N5457 30p
2N5458 30p
2N5459 30p

4000 CMOS

4000 10p
4001 10p
4002 12p
4002 24p
4011 10p
4012 16p
4013 20p
4015 40p
4017 32p
4018 45p
4019 25p
4023 13p
4024 32p
4030 15p
4047 40p
4068 14p
4069 13p
4070 13p
4071 13p
4072 13p
4073 15p
4075 13p
4077 13p
4078 15p
4081 13p
4082 13p
4093 20p
4095 95p
4096 70p
4501 28p
4506 35p
4507 35p
4510 46p
4512 42p
4518 40p
4520 70p

TTL

74 Series 74LS Series
7400 11p
7401 11p
7402 11p
7403 12p
7404 12p
7408 14p
7409 15p
7410 14p
7411 20p
7412 20p
7413 20p
7414 20p
7422 22p
7423 25p
7424 25p
7425 14p
7426 15p
7427 22p
7428 25p
7430 15p
7435 35p
7448 40p
7450 16p
7474 20p
7475 25p
7476 30p
7485 60p
7490 25p
7491 35p
7492 25p
7493 25p
7494 35p
7495 35p
7496 35p
7497 22p
74121 27p
74122 40p
74123 40p
74160 60p
74161 48p
74162 48p
74163 48p
74164 48p
74165 48p
74166 48p
74190 50p
74191 50p
74192 50p
74193 50p
74194 45p
74195 45p
74196 45p
74197 46p
74305 40p
74306 40p
74366 40p
74367 40p
74368 50p
74390 99p
74393 99p
74490 120p
200p

LINEAR IC's

741 14p
748 36p
CA3140 40p
LM301A 24p
LM380 75p
LM381N 145p
LM382 125p
NE555 16p
NE556 45p
NE565 120p
NE567 155p
NE567 140p
TBA800 80p
TBA810 95p
TBA820 80p
ZN423 135p
ZN425E 350p

INDEX TO ADVERTISERS

Alcon	752	Heathkit	694
Ambit	695	Input Design	752
Army Royal	739	I.C.S. Intertext	696
Audio Electronics	690	Jupiter Cantab	743
Bi-Pak	740	Lightning Components	750
B.K. Electronics	Cov. III	Magenta Electronics	744
B.N.R.&E.S.	751	Maplin Electronics	Cov. IV
Boss Industrial	754	Phonosonics	696
Bradley Marshalls	750	Pops Components	756
Bull J.	755	R&TVC	750
Carlton Nicholl	760	Radio Components Special-ists	759
Chordgate	759	Rapid Electronics	693
Cricklewood Electronics	691, 756	Sinclair Products	748, 749
Dziubas, M.	752	Titan Transformers	750
E.D.A.	697	T.K. Electronics	696
Electrains	694	Vako Display Systems	756
Electronize Design	Cov. II	Velleman U.K.	694
Electrovalue	692	Watford Electronics	698
Enfield Electronics	692	Wilmslow Audio	754, 756
Europa Electronics	760		
G.S.C.	747		
Greenweld	690		

CNC 10 PCB HOLDER

Ideal for small scale production, testing, research service engineers and the home constructor.

The CNC 10 has a board capacity of 8" x 8" and larger boards (maximum 8" wide) may be accommodated since they can project beyond the ends of the rails.

Adjustment of the board is extremely simple as they are locked in position by one central clamp. A further clamp enables the PCB, when in position, to be rotated through 360 degrees and locked in the required position.

An optional foam pad is available which enables a number of components to be inserted prior to soldering. Pad size 8" x 8".

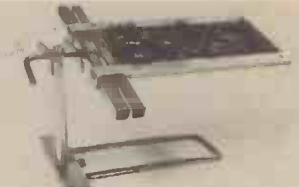

CNC 10 £15.10 inc. VAT
FOAM PAD & CLIP £5.84 inc. VAT
Please add £1.50 to cover postage.

Available direct from the manufacturer:
CARLTON NICHOL & CO. LTD., GOLDKEY INDUSTRIAL ESTATE, KELVEDON, COLCHESTER, ESSEX.

PLEASE MENTION EVERYDAY ELECTRONICS WHEN REPLYING TO ADVERTISEMENTS

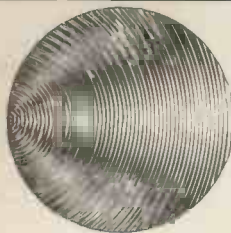

APPROVED
thandar
STOCKIST

B.K. ELECTRONICS

A SOUND CHOICE

APPROVED
thandar
STOCKIST

★ PROMPT DELIVERY ★ PRICES INCLUDE V.A.T. ★ AMPLE STOCKS
A PERSONAL SERVICE FROM A SMALL EXPANDING COMPANY



STEREO CASSETTE TAPE DECK MODULE.
Comprising of a top panel and tape mechanism coupled to a record/play back printed board assembly. Supplied as one complete unit for horizontal installation into cabinet or console of own choice. These units are brand new, ready built and tested.

Features: Three digit tape counter. Auto-stop. Six piano type keys, record, rewind, fast forward, play, stop and eject. Automatic record level control. Main inputs plus secondary inputs for stereo microphones. Input Sensitivity: 100mV to 2V Input Impedance: 68K. Output level: 400mV to both left and right hand channels. Output Impedance: 10K. Signal to noise ratio: 45dB. Wow and flutter: 0.1%. Power Supply requirements: 18V DC at 300mA. Connections: The left and right hand stereo inputs and outputs are via individual screened leads, all terminated with phono plugs (phono sockets provided). Dimensions: Top panel 5 1/2" x 11 1/4". Clearance required under top panel 2 1/2". Supplied complete with circuit diagram and connecting diagram. Attractive black and silver finish.

Price £26.70 + £2.50 postage and packing. Supplementary parts for 18V D.C. power supply (transformer, bridge rectifier and smoothing capacitor) £3.

6 piano type keys

NEW RANGE QUALITY POWER LOUD-SPEAKERS (15", 12" and 8"). These loudspeakers are ideal for both hi-fi and disco applications. Both the 12" and 15" units have heavy duty die-cast chassis and aluminium centre domes. All three units have white speaker cones and are fitted with attractive cast aluminium (ground finish) fixing escutcheons. Specification and Price:—

15" 100 watt R.M.S. Impedance 8ohm 59 oz. magnet, 2" aluminium voice coil. Resonant Frequency 20Hz. Frequency Response to 2.5KHz. Sensitivity 97dB. Price £32 each. £3.00 Packing and Carriage each.

12" 100 watt R.M.S. Impedance 8 ohm, 50 oz. magnet. 2" aluminium voice coil. Resonant Frequency 20Hz. Frequency Response to 4KHz. Sensitivity 95dB. Price £23.70 each. £3.00 Packing and Carriage each.

8" 50 watt R.M.S. Impedance 8 ohm. 20 oz magnet. 1 1/2" aluminium voice coil, Resonant Frequency 40Hz, Frequency Response to 6KHz, Sensitivity 92dB. Also available with black cone fitted with black metal protective grill. Price: White cone £8.90 each. Black cone/grill £9.50 each. P. & P. £1.25.

PIEZO ELECTRIC TWEETERS - MOTOROLA

Join the Piezo revolution. The low dynamic mass (no voice coil) of a Piezo tweeter produces an improved transient response with a lower distortion level than ordinary dynamic tweeters. As a crossover is not required these units can be added to existing speaker systems of up to 100 watts (more if 2 put in series). FREE EXPLANATORY LEAFLETS SUPPLIED WITH EACH TWEETER.

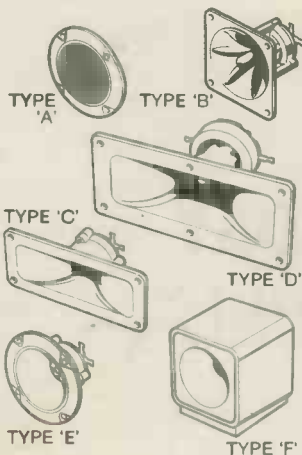

TYPE 'A' (KSN1036A) 3" round with protective wire mesh. Ideal for bookshelf and medium sized Hi-Fi speakers. Price £3.45 each.

TYPE 'B' (KSN1005A) 3 1/2" super horn. For general purpose speakers, disco and P.A. systems, etc. Price £4.35 each.

TYPE 'C' (KSN5016A) 2" x 5" wide dispersion horn. For Hi-Fi systems and quality discos, etc. Price £5.45 each.

TYPE 'D' (KSN1025A) 2" x 6" wide dispersion horn. Upper frequency response retained extending down to mid range (2,000 c/s). Suitable for Hi-Fi systems and quality discos. Price £6.90 each.

TYPE 'E' (KSN1038A) 3 1/2" horn tweeter with attractive silver finish trim. Suitable for Hi-Fi monitor systems, etc. Price £4.35 each.

TYPE 'F' (KSN1057A) Cased version of type 'E'. Free standing satellite tweeter. Perfect add on tweeter for conventional loudspeaker systems. Price £10.75 each.

U.K. post free (or SAE for Piezo leaflets).



1 K-WATT SLIDE DIMMER

- ★ Controls loads up to 1KW.
- ★ Compact Size 4 1/2" x 1 1/2" x 2 1/2".
- ★ Easy snap in fixing through panel/cabinet cut out.
- ★ Insulated plastic case.
- ★ Full wave control using 8 amp triac.
- ★ Conforms to BS800.
- ★ Suitable for both resistance and inductive loads. Innumerable applications in industry, the home, and disco's/theatres, etc.

Price £11.70 each + 50p P&P. (Any quantity.)



1000 MONO DISCO MIXER—completely built and tested employing modern I.C. circuitry. Can be mounted vertical or horizontal into cabinet, console, etc.

Two turntable inputs (ceramic) plus aux. (tape) and mic. inputs. Headphone monitor socket. Compatible with OMP100 Power Amp. (500mV O/P). Controls: Microphone talk over switch with separate volume, treble and bass. Three main fader (level) controls with master volume, treble and bass. Monitor selector switch with monitor level control. Mains On/Off switch. Smart black finish. Size: 535 x 110 x 60mm. Power requirements: 240V A.C. Price: £29.99 + £2.25 P & P.



B.S.R. P232 TURNTABLE

- P232 Turntable ★ 'S' shaped tone arm
- ★ Belt driven ★ Aluminium platter
- ★ Cueing lever. ★ 240 volt AC operation (50Hz)
- ★ Cut-out template supplied
- ★ Used as standard by HI-FI and Disco manufacturers
- ★ Fitted with either a magnetic or ceramic cartridge, please state cartridge required

Price £22.50 + £2.50 P & P.



POWER AMPLIFIER MODULES

100 WATT R.M.S. AND 300 WATT R.M.S. MODULES
Power Amplifier Modules with Integral toroidal transformer power supply, and heat sink. Supplied as one complete built and tested unit. Can be fitted in minutes. An LED Vu meter is available as an optional extra.

SPECIFICATION:
Max Output Power:
110 watts R.M.S. (OMP 100)
310 watts R.M.S. (OMP 300)
Loads: Open and short circuit proof. 4-16 ohms
Frequency Response: 20Hz—25KHz ±3dB.
Sensitivity for Max. Output:
500mV at 10K (OMP 100) 1V at 10K (OMP 300)
T.H.D.: Less than 0.1%
Supply: 240V 50Hz
Sizes: OMP 100 360 x 115 x 72mm
OMP 300 460 x 153 x 66mm
Prices: OMP 100 £31.50 each + £2.00 P&P
OMP 300 £89.00 each + £3.00 P&P
Vu Meter £6.50 each + 50p P&P.

A PURPOSELY DESIGNED 40 WATT R.M.S. 80HM SPEAKER SYSTEM RECENTLY DEVELOPED BY MULLARD'S SPECIALIST TEAM IN BELGIUM. Kit comprises a Mullard 3" Woofer with foam surround and aluminium voice coil. Mullard 3" high power dome tweeter. B.K.E. built and tested crossover, based on Mullard circuit combining low loss components, glass fibre board and recessed loudspeaker terminals. Recommended cabinet size 240 x 216 x 445 mm.

A superb sound at a relatively low cost. Complete with instructions. Price £14.50 + £1.50 p & p per kit.

New 5" 30 watt mini version of above now available. Recommended cabinet size 180 x 155 x 295 mm. Price £13.90 + £1.00 p & p per kit.

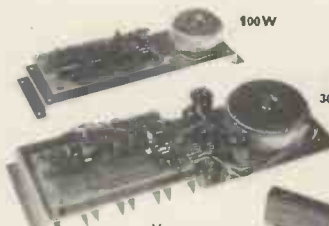

V.u. Meter

MULLARD SPEAKER KITS

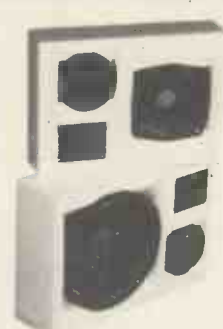

12" 80 watt R.M.S. loudspeaker.

A superb general purpose twin cone loudspeaker. 50 oz. magnet. 2" aluminium voice coil. Rolled surround. Resonant frequency 25Hz. Frequency response to 13KHz. Sensitivity 95dB. Impedance 8ohm. Attractive blue cone with aluminium centre dome.

Price £17.99 ea + £3.00 P & P.

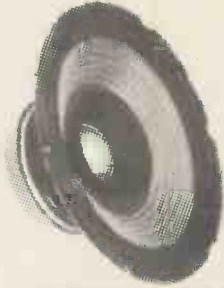

B.K. ELECTRONICS

DEPT E.E.

37 Whitehouse Meadows, Eastwood, Leigh-on-Sea, Essex SS9 5TY



★ SAE for current lists. ★ Official orders welcome. ★ All prices include VAT. ★ Mail order only. ★ All items packed (where applicable) in special energy absorbing PU foam. Callers welcome by prior appointment, please phone 0702-527572.

Make it with MAPLIN



KEYBOARD KIT WITH ELECTRONICS FOR ZX81

- * A full size, full travel 43-key keyboard that's simple to add to your ZX81 (no soldering in ZX81).
- * Complete with the electronics to make "Shift Lock", "Function" and "Graphics 2" single key selections making entry far easier.
- * Powered from ZX81's own standard power supply - with special adaptor supplied.
- * Two-colour print for key caps.
- * Amazing low price.

Full details in our projects book. Price 60p. Order As XA03D.

Complete kit (does not include case) for only £19.95 incl. VAT and carriage. Order As LW72P.
(Case-order as XG177 Price £4.95) (Ready-built in case-order as XG22Y Price £29.95)

MATINÉE ORGAN

Easy-to-build, superb specification. Comparable with organs selling for up to £1,000. Full construction details in our book. Price £2.50. Order As XH55K.

Complete kits available:
Electronics - £299.95,
Cabinet - £99.50 (carriage extra).
Demo cassette price £1.99. Order As XX43W.



25W STEREO MOSFET AMPLIFIER

A superb new amplifier at a remarkably low price.



- * Over 26W per channel into 8Ω at 1kHz both channels driven.
- * Frequency response 20Hz to 40kHz ±1dB.
- * Low distortion, low noise and high reliability power MOSFET output stage.
- * Extremely easy to build. Almost everything fits on main pcb, cutting interwiring to just 7 wires (plus toroidal transformer and mains lead terminations).
- * Complete kit contains everything you need including pre-drilled and printed chassis and wooden cabinet.

Full details in our projects book. Price 60p. Order As XA03D
Complete kit for only £49.95 incl. VAT and carriage. Order As LW71N

HOME SECURITY SYSTEM



Six independent channels - 2 or 4 wire operation. External horn. High degree of protection and long term reliability. Full details in our projects book. Price 60p. Order As XA02C.

MAPLIN'S FANTASTIC PROJECTS

Full details in our project books only 60p each.

In Book 1 (XA01B) 120W rms MOSFET Combo-Amplifier · Universal Timer with 18 program times and 4 outputs · Temperature Gauge · Six Vero Projects

In Book 2 (XA02C) Home Security System · Train Controller for 14 trains on one circuit · Stopwatch with multiple modes · Miles-per-Gallon Meter

In Book 3 (XA03D) ZX81 Keyboard with electronics · Stereo 25W MOSFET Amplifier · Doppler Radar Intruder Detector · Remote Control for Train Controller

In Book 4 (XA04E)* Telephone Exchange expandable up to 32 extensions · Ultrasonic Intruder Detector · Frequency Counter 100Hz to 500MHz · Remote Control for 25W Stereo Amplifier

*Projects for book 4 were in an advanced state at the time of writing, but contents may change prior to publication (due 14th Aug 1982).

MAPLIN'S NEW 1983 CATALOGUE

Over 350 pages packed with data and pictures and all completely revised and including over 1000 new items.

On sale in all branches of WHSMITH from November 19th

Price £1.25

MAPLIN

ELECTRONIC SUPPLIES LTD.

All mail to:

P.O. Box 3, Rayleigh, Essex SS6 8LR

Tel: Sales (0702) 552911 General (0702) 554155

Shops at:

159 King St., Hammersmith, London W6. Tel: 01-748 0926

284 London Rd., Westcliff-on-Sea, Essex. Tel: (0702) 554000

Lynton Square, Perry Barr, Birmingham. Tel: (021) 356 7292

Note: Shops closed Mondays

Maplin launches MAPCARD

A new way of buying from Maplin!

Now Maplin have their own credit card. You could have one too!

APPLY NOW!

Write to our Rayleigh address for details or pick up a leaflet in our shops.



NEW SHOP IN BIRMINGHAM

Visit our brand new shop in Birmingham for our complete range of electronic components and computers.

Come and see us at Lynton Square, Perry Barr, Birmingham (just off the junction of the Outer Ring Road A4040 and Birchfield Road A34). Tel: 021-356-7292. Excellent free parking.



See us at the
Electronics Hobbies Fair,
Alexandra Pavilion - London
November 18-21, 1982



Post this coupon now!

Please send me a copy of your 1983 catalogue as soon as it is available (at the end of November). I enclose £1.50 (inc p.p.). If I am not completely satisfied I may return the catalogue to you and have my money refunded. If you live outside the U.K. send £1.90 or 10 International Reply Coupons.

Name _____

Address _____

EE11/82