

An exciting hobby.... for everyone

everyday electronics

DEC. 75
30p



-  **Christmas Lights Flasher**
-  **Heads & Tails Game**
-  **Stereo Amplifier**



SPECIAL OFFER!
SOLDERING KIT

AN IDEAL CHRISTMAS GIFT



BI-PAK



BARGAIN BUNDLES

Send to: **BI-PAK SEMICONDUCTORS, DEPT. EE 2 P.O. BOX 6, WARE, HERTS**
 Bi-pak bring you, for 2 months only a fantastic inflation beating offer designed to help you, the customer. With every Pak comes a useful **FREE GIFT**. In addition to this, our star attraction is the **D.I.Y. Printed Circuit Kit**. With every kit sold during this offer comes a voucher to the value of £1.50 to be spent on any items from our Retail Catalogue.

I.C. BUNDLE

2 x 7400 2 x 7474
 2 x 74121 2 x 74141
 2 x 741

PLUS FREE
 2 x BPS8 and 2 x BPS16
 I.C. Sockets
ALL FOR ONLY £1.50
OFFER WORTH £3.27

PRINTED CIRCUIT KIT. Containing 6 sheets of 8in x 4in single sided laminate, a generous supply of etchant powder, etching dish, etchant measure, twee-ers, etch resistant marking pen, high quality pump drill with spares, cutting knife with spare blades, 8in metal ruler, plus full easy-to-follow instructions. £7.80p.



3 FOR THE PRICE OF 2

Buy 2 x C60 cassettes for 72p per pr. GET 1 x C58 absolutely FREE. Buy 2 x C90 cassettes for 96p per pr. GET 1 x C90 absolutely FREE.

DIODE + RECTIFIER BUNDLE

20 GERM G.P. DIODES DIRECT REPLACEMENTS FOR (0A81-85, 0A91-95)

2 x BY100 4 x IN4004 4 x 1.5A 400V
 4 x IN4001 4 x 1.5A 50V 4 x IN4148

PLUS FREE BOOK
 No. BPS "38 PRACTICAL TESTED DIODE CIRCUITS FOR THE HOME CONSTRUCTOR"

ALL FOR ONLY £1.50
OFFER WORTH £3.00

TRANSISTOR BUNDLE

2 x BC108C 2 x BC178
 2 x OC71 2 x BC107
 2 x BF115 2 x BC109
 2 x 2N3819 2 x BFX84
 2 x 2N3646 2 x BFX29

PLUS FREE
 ONE SHEET OF VEROBOARD
ALL FOR ONLY £1.50
OFFER WORTH £3.00

S.C.R. BUNDLE

2 x 0.6A 100V 2 x 1A 400V
 2 x 1A 50V 2 x 3A 50V
 2 x 5A 400V

PLUS FREE
 2 METERS OF 18SWG MULTI-CORE SOLDER **ALL FOR ONLY £1.50**
OFFER WORTH £3.00

CAPACITOR + RESISTOR BUNDLE

100 1/2W Resistors in assorted values ranging from 100 ohm to 1M ohm
 50 C280 Capacitors in assorted values ranging from 0.01µF to 2.2µF

PLUS FREE
 COLOUR CODE CHARTS
ALL FOR ONLY £1.50
OFFER WORTH £3.00

WATCH THIS SPACE FOR THE GREAT BI-PAK CHRISTMAS COMPETITION WITH A FIRST PRIZE OF A COLOUR T.V. PLUS 52 OTHER PRIZES

BURNEZE

Cools soothes and heals minor burns

Burneze unique aerosol first aid cools instantly, contains a fast-acting local anaesthetic plus antihistamine to control swelling. It deals with the lingering pain of a minor burn or scald and reduces the chance of a blister.

From Boots and other chemists. S.A.E. to Potter & Clarke, Croydon CR9 3LP, for intriguing leaflet

ENGINEERS

FREE

YOURSELF FOR A BETTER JOB WITH MORE PAY!

This 76 page FREE book shows how!

Do you want promotion, a better job, higher pay? "New Opportunities" shows you how to get them through a low-cost home study course. There are no books to buy and you can pay-as-you-learn.

This helpful guide to success should be read by every ambitious engineer. Send for this helpful 76 page FREE book now. No obligation and nobody will call on you. It could be the best thing you ever did.

POST NOW

CUT OUT THIS COUPON

CHOOSE A BRAND NEW FUTURE HERE!

Tick or state subject of interest. Post to the address below.

Electrical Engineering	<input type="checkbox"/>	Colour T.V. Servicing	<input type="checkbox"/>	CITY AND GUILDS Installations and Wiring	<input type="checkbox"/>
Electrical Installations and Wiring	<input type="checkbox"/>	C & G Radio, T.V. and Electronic Mechanics	<input type="checkbox"/>	CITY AND GUILDS Electrical Technicians	<input type="checkbox"/>
Electrical Draughtsmanship	<input type="checkbox"/>	General Radio and TV Engineering	<input type="checkbox"/>	CITY AND GUILDS Telecommunications	<input type="checkbox"/>
Electrical Mathematics	<input type="checkbox"/>	Radio Servicing, Maintenance and Repairs	<input type="checkbox"/>	Radio Amateurs' Exam. etc. etc.	<input type="checkbox"/>
Electronic Engineering	<input type="checkbox"/>	Transistor Technology	<input type="checkbox"/>		
Computer Prog.	<input type="checkbox"/>				

To: ALDERMASTON COLLEGE
DEPT. EEV 12 READING RG7 4PF
 Also at our London Advisory Office, 4 Fore Street Avenue Moorgate, London EC2Y 5EJ. Tel: 01-628 2721.

NAME (Block Capitals Please)

ADDRESS

POSTCODE

Other subjects Age

Accredited by C.A.C.C. Member of A.B.C.C.

HOME OF BRITISH INSTITUTE OF ENGINEERING TECHNOLOGY

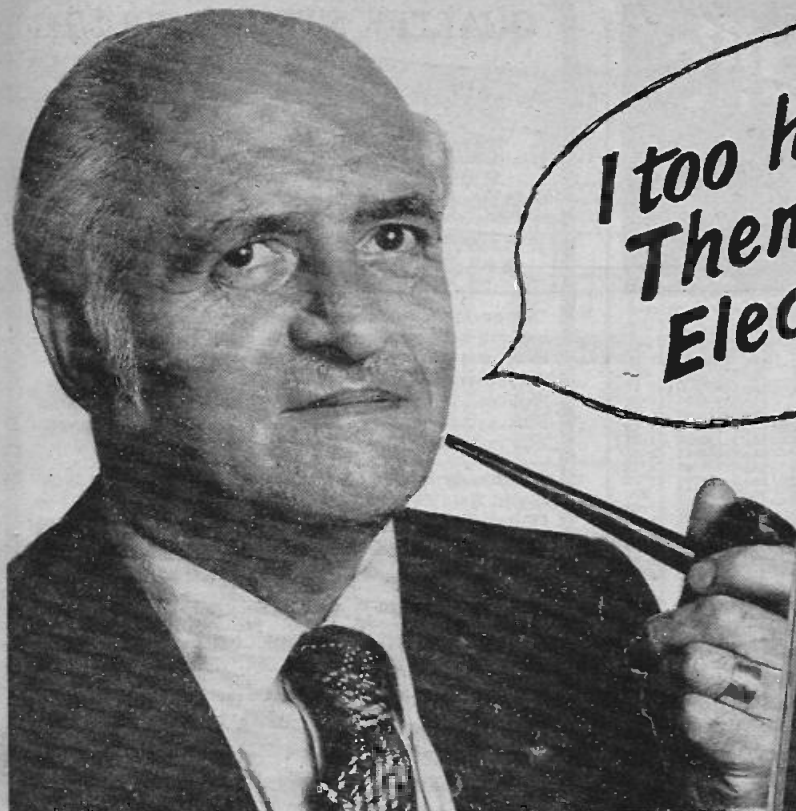

I too have a
Theme on
Electronics



As you may already know, the front cover of the Home Radio Components catalogue features a colour picture of the striking modern sculpture "Theme on Electronics" by the late Dame Barbara Hepworth. The original sculpture, incidentally, was commissioned in 1957 by Mullards for their Electronics Centre showroom.

If you asked me for *my* theme on electronics I'd say that experience has taught me that the simplest and most satisfactory way of getting electronic components is to buy them from Home Radio Components—either over the counter at their shop in Mitcham or by Mail Order. Ninety nine times out of a hundred they can supply just what you want immediately from stock—at very keen prices too. If you're likely to require bits and pieces fairly regularly it will be worth your while to make use of their Credit Account Service. This is a fairly new service provided by Home Radio Components, but they tell me that already about a thousand customers are using it. That doesn't surprise me. I for one have found that it saves me time and money in

several ways. No space to give details here, but full information and an application form are given in the catalogue. Whether or not you use the Credit Account Service, you'll certainly need the catalogue, and at £1.30 (85p plus 45p post & packing) it's a real bumper bargain. Its 240 pages list about 6000 components with nearly 2000 illustrations. What's more the catalogue contains Vouchers worth 70 pence when used against orders, so you can soon recover a good slice of your investment.

Send the coupon below with your cheque or P.O. for £1.30, and before long you too will be harping on the same theme on electronics!

Today's finest Components
Catalogue **85p** plus 45p POST & PACKING

POST THIS COUPON
with cheque or PO for £1.30

The price of £1.30 applies only to customers in the U.K. and to BFPO Addresses.

Please write your Name and Address in block capitals

NAME.....

ADDRESS.....

HOME RADIO (Components) LTD., Dept. EE,
234-240 London Road, Mitcham, Surrey CR4 3HD



(Regn. No
London 912966)

HOME RADIO (Components) LTD. Dept EE, 234-240 London Road, Mitcham, CR4 3HD Phone 01-648 8422

ASKYS FOR CHOICE

SEW PANEL METERS

STOCKED AT
481 Oxford Street 311 Edgware Road
42 Tottenham Court Rd. 3 Lisle Street
branches or by mail order.

USED EXTENSIVELY BY
INDUSTRY, GOVERNMENT
DEPARTMENTS, EDUCATIONAL
AUTHORITIES ETC.

Over 200 ranges in stocked—other ranges to
order. Quantity discounts available. Send
for fully illustrated brochure.

CLEAR PLASTIC MODEL SD640

Size: 85 x 64mm

50uA	£4.20	10V DC	£4.05
100uA	£4.15	20V DC	£4.05
200uA	£4.10	50V DC	£4.05
500uA	£4.05	150V DC	£4.05
50-0-50uA	£4.75	300V DC	£4.15
100-0-100uA	£4.70	15V AC	£4.15
1mA	£4.05	30V AC	£4.15
5mA	£4.05	50V AC	£4.15
10mA	£4.05	100V AC	£4.15
50mA	£4.05	150V AC	£4.15
100mA	£4.05	200V AC	£4.15
500mA	£4.05	300V AC	£4.15
1A DC	£4.05	VU Meter	£4.95
5A DC	£4.05		
10A DC	£4.05		
5V DC	£4.05		



CLEAR PLASTIC MODEL SW100

Size: 100 x 50mm

50uA	£3.85	150V AC	£4.90
100uA	£4.95	300V AC	£4.90
500uA	£4.75	VU Meter	£8.25
50-0-50uA	£4.95		
100-0-100uA	£4.90		
1mA	£4.75		
1A DC	£4.75		
5A DC	£4.75		
20V DC	£4.75		
50V DC	£4.75		
300V DC	£4.75		



MODEL E0107 EDUCATIONAL METER

Size: 100 x 90 x 150mm including terminals

A range of high quality moving coil instruments ideal for school experiments and other bench applications. 3" mirror scale. The meter movement is easily accessible to demonstrate internal working.

50uA	£9.35	20V DC	£8.40
100uA	£9.70	50V DC	£8.40
50-0-50uA	£9.70	300V DC	£8.40
1mA	£8.40	500mA/5A DC	£9.50
1.0-1mA	£8.40	5V/50V DC	£9.50
1A DC	£8.40	5V/10V DC	£9.50
5A DC	£8.40	1A/5A DC	£9.50
5V DC	£8.40		
10V DC	£8.40		
15V DC	£8.40		



CLEAR PLASTIC MODEL SD480

Size: 59 x 46mm

50uA	£3.85	5V DC	£3.65
100uA	£3.80	10V DC	£3.65
200uA	£3.75	20V DC	£3.65
500uA	£3.70	50V DC	£3.65
50-0-50uA	£3.80	300V DC	£3.65
100-0-100uA	£3.75	15V AC	£3.80
1mA	£3.65	30V AC	£3.80
5mA	£3.65	50V AC	£3.80
10mA	£3.65	100V AC	£3.80
50mA	£3.65	150V AC	£3.80
100mA	£3.65	200V AC	£3.80
500mA	£3.65	300V AC	£3.80
1A DC	£3.65	VU Meter	£4.85
5A DC	£3.65		
10A DC	£3.65		



*Items with asterisk are Moving Iron type, all others are Moving Coil

CLEAR PLASTIC MODEL SD830

Size: 110 x 83mm

50uA	£4.75	10V DC	£4.50
100uA	£4.65	20V DC	£4.50
200uA	£4.60	50V DC	£4.50
500uA	£4.55	300V DC	£4.50
50-0-50uA	£4.65	15V AC	£4.60
100-0-100uA	£4.60	30V AC	£4.60
1mA	£4.50	VU Meter	£5.60
5mA	£4.60		
10mA	£4.60		
60mA	£4.50		
100mA	£4.50		
500mA	£4.50		
1A DC	£4.50		
5A DC	£4.50		
1A DC	£4.50		
5A DC	£4.50		
10A DC	£4.50		
5V DC	£4.50		

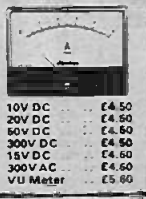

CLEAR PLASTIC MODEL MR 45P

Size: 60 x 50mm

50uA	£3.35	15V AC	£3.40
100uA	£3.50	30V AC	£3.40
200uA	£3.45	5 Meter 1mA	£3.75
500uA	£3.40	VU Meter	£4.30
50-0-50uA	£3.60	1A AC	£3.25
100-0-100uA	£3.45	10V DC	£3.25
500-0-500uA	£3.25	20V DC	£3.25
1mA	£3.25	50V DC	£3.25
5mA	£3.25	300V DC	£3.25
10mA	£3.25		
50mA	£3.25		
100mA	£3.25		
500mA	£3.25		
1A DC	£3.25		
5A DC	£3.25		
10V DC	£3.25		
20V DC	£3.25		
50V DC	£3.25		
300V DC	£3.25		



CLEAR PLASTIC MODEL MR 38P

Size: 42 x 42mm

50uA	£3.48	10V DC	£3.05
100uA	£3.40	15V DC	£3.05
200uA	£3.30	20V DC	£3.05
500uA	£3.10	30V DC	£3.05
50-0-50uA	£3.40	100V DC	£3.05
100-0-100uA	£3.25	150V DC	£3.10
500-0-500uA	£3.05	300V DC	£3.10
1mA	£3.05	500V DC	£3.10
5mA	£3.05	750V DC	£3.15
10mA	£3.05	15V AC	£3.16
50mA	£3.05	50V AC	£3.16
100mA	£3.05	150V AC	£3.16
500mA	£3.05	300V AC	£3.16
1A DC	£3.05	500V AC	£3.16
2A DC	£3.05	300V AC	£3.16
5A DC	£3.05	5 Meter 1mA	£3.60
10A DC	£3.05	VU Meter	£4.10
3V DC	£3.05		



CLEAR PLASTIC MODEL MR 85P

Size: 120 x 110mm

50uA	£6.00	50V DC	£5.75
100uA	£5.95	150V DC	£5.75
200uA	£5.90	300V DC	£5.75
500uA	£5.80	15V AC	£5.65
50-0-50uA	£5.95	30V AC	£5.65
100-0-100uA	£5.90	5 Meter 1mA	£6.65
500-0-500uA	£5.65	VU Meter	£7.10
1mA	£5.75	1A AC	£5.75
1.0-1mA	£5.75	10V DC	£5.75
5mA	£5.75	20V DC	£5.75
10mA	£5.75	50V DC	£5.75
50mA	£5.75	150V DC	£5.75
100mA	£5.75	15V AC	£5.75
500mA	£5.75	30V AC	£5.75
1A DC	£5.75	50V AC	£5.75
5A DC	£5.75	100V AC	£5.75
10A DC	£5.75	150V AC	£5.75
20V DC	£5.75	300V AC	£5.75



EDGWISE MODEL PE70

Size: 80 x 34mm

100uA	£4.55	5V DC	£3.65
200uA	£4.45	10V DC	£3.65
500uA	£4.30	20V DC	£3.65
50-0-50uA	£4.60	50V DC	£3.65
100-0-100uA	£4.45	300V DC	£3.65
1mA	£4.25	15V AC	£3.80
5mA	£4.25	30V AC	£3.80
10V DC	£4.25	50V AC	£3.80
30V DC	£4.25	100V AC	£3.80
50V DC	£4.25	150V AC	£3.80
300V DC	£4.25	200V AC	£3.80
VU Meter	£5.50	300V AC	£3.80



POSTAGE/PACKING & INSURANCE 15p

BAKELITE MODEL S80 Enlarged Window.

Size: 80 x 80mm

50uA	£4.85	10V DC	£4.60
100uA	£4.80	20V DC	£4.60
500uA	£4.60	50V DC	£4.60
50-0-50uA	£4.80	300V DC	£4.60
100-0-100uA	£4.85	15V AC	£4.60
1mA	£4.60	30V AC	£4.60
5mA	£4.60	VU Meter	£5.95
10mA	£4.60		
60mA	£4.60		
100mA	£4.60		
500mA	£4.60		
1A DC	£4.60		
5A DC	£4.60		
10V DC	£4.60		
20V DC	£4.60		
50V DC	£4.60		
300V DC	£4.60		
15V AC	£4.60		
30V AC	£4.60		
VU Meter	£5.95		



CLEAR PLASTIC MODEL MR 52P

Size: 60 x 60mm

50uA	£4.10	5 Meter 1mA	£4.20
100uA	£3.85	VU Meter	£4.85
500uA	£3.70	1A AC	£3.65
50-0-50uA	£3.95	5A AC	£3.65
100-0-100uA	£3.70	10A AC	£3.65
1mA	£3.85	20A AC	£3.65
5mA	£3.85	30A AC	£3.65
10mA	£3.65		
50mA	£3.65		
100mA	£3.65		
500mA	£3.65		
1A DC	£3.65		
5A DC	£3.65		
10V DC	£3.65		
20V DC	£3.65		
50V DC	£3.65		
300V DC	£3.65		
15V AC	£3.75		
30V AC	£3.75		



BAKELITE MODEL MR 65 Size: 80 x 80mm

Size: 80 x 80mm

50uA	£5.80	300V DC	£3.95
100uA	£4.40	50V AC	£3.95
500uA	£4.35	100V AC	£3.95
500uA	£4.40	150V AC	£3.95
50-0-50uA	£4.35	300V AC	£3.95
100-0-100uA	£4.05	500V AC	£3.95
500-0-500uA	£3.95	VU Meter	£5.20
1mA	£3.95	1A AC	£3.95
1.0-1mA	£3.95	5A AC	£3.95
10mA	£3.95	10A AC	£3.95
50mA	£3.95	20A AC	£3.95
100mA	£3.95	30A AC	£3.95
500mA	£3.95	50A AC	£3.95
1A DC	£3.95	500mA AC	£3.95
5A DC	£3.95	60mV DC	£4.15
10A DC	£3.95	100mV DC	£4.15
10V DC	£3.95		
20V DC	£3.95		
50V DC	£3.95		
150V DC	£3.95		



CLEAR PLASTIC MODEL MR 65P

Size: 85 x 78mm

50uA	£4.25	300V DC	£4.10
100uA	£4.25	15V DC	£4.20
200uA	£4.20	30V DC	£4.20
500uA	£4.15	10V DC	£4.20
50-0-50uA	£4.25	15V DC	£4.20
100-0-100uA	£4.20	20V DC	£4.20
500-0-500uA	£4.10	50V DC	£4.20
1mA	£4.10	180V DC	£4.20
1.0-1mA	£4.10		
5mA	£4.10		
10mA	£4.10		
50mA	£4.10		
100mA	£4.10		
500mA	£4.10		
1A DC	£4.10		
5A DC	£4.10		
10A DC	£4.10		
20A DC	£4.20		
30A DC	£4.10		
5V DC	£4.10		
10V DC	£4.10		
15V DC	£4.10		
20V DC	£4.10		
50V DC	£4.10		
150V DC	£4.10		



240° Wide Angle
1mA METERS
MWT-5.80 x 80mm
£7.45 P & P Ins 15p



ALL PRICES INCLUDE VAT

BATTERY/LEVEL PANEL INDICATOR

18mm x 18mm Panel mounting.
OUR PRICE 95p P/P & Ins 15p Discounts for quantity.



VU METER TYPE 3
250 uA Size: 33mm x 20mm.
£1.55 P/P & Ins 15p

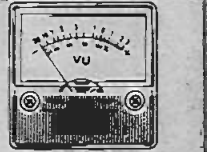

REDUCED TO CLEAR

YAMABISHI VARIABLE VOLTAGE TRANSFORMERS
Excellent quality at low cost. Input 230V 50/60Hz. Output 0-260V.
MODEL S260 BENCH MOUNTING

1A	£7.30-£1.50
2.5A	£10.35-£1.50
5A	£12.95-£1.50
8A	£19.45-£1.50
10A	£22.75-£1.50
12A	£25.90-£1.50
20A	£46.45-£1.50
25A	£64.75-£1.50
32A	£73.40-£1.50



MODEL C7202EN

20,000 o.p.v. DC.
10,000 o.p.v. AC
Mirror Scale.
5.25/50/250/500/
1000/2500 V. DC.
10/50/100/500/1000
V. AC. DC Resistance
x10, x1000 (30V
centre scale) DC
Current 30mA.
2.5

IT MAKES SENSE TO

TMK 200 MULTIMETER KIT

Build yourself a quality 20000 ovp. multimeter and save money. Complete kit with meter scale, movement and rotary range selector ready mounted in cabinet. All parts, batteries, test probes and instructions. Ranges: 0/0.6/6/30/120/600/1200V D.C. 0/0.8/8/6/60/600mA A.C. Current: 0/0.8/8/60/600mA. Resistance: 0/10/100K/1/10 Meg ohms. Decibels: -20 to +83dB. Size: 90 x 160 x 35mm



OUR PRICE £9.65 P/P & Ins 30p

U4324 MULTIMETER

High sensitivity. 20,000 ovp. Ranges: 0/0.1/1/10/100/1000/1200V DC. 0/0.1/1/10/100/1000/1200V AC. Current: 0.05/0.5/5/50/500mA/3A DC. 0.1/3/30/300mA A.C. Resistance: 25/500 ohms/0.5/5/50/500k ohms/5 Mohms. Decibels: -10 to +12dB. Size 167 x 95 x 63mm. Supplied complete with test leads, spare diode and instructions.

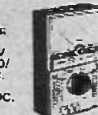

OUR PRICE £10.60 P/P & Ins 60p

HIOKI 750X VOLT-OHM-MILLIAMETER

43 ranges: 0-0.3/0.6/1.5/3/6/12/30/60/150/300/600/1200V DC. 0-3/6/15/30/60/120/300/600/1200V AC. Current: 0-30/60mA/1.5/3/15/30/150/300 mA/6/12A. Resistance: 0-3/300k/3/30Mohms. Decibels: -10 to +17dB. Output: 0-3/6/15/30/60/120/300V. Accuracy: $\pm 3\%$ DC, $\pm 4\%$ AC. Sensitivity: 50,000 ovp DC, 5,000 ovp AC, 4 inch meter. Built in protection. Size: 57 x 102 x 153mm



OUR PRICE £12.90 P/P & Ins 60p

U4312 MULTIMETER

extremely sturdy instrument for general electrical use. 5670 ovp. 0/0.3/1.5/3/15/30/60/150/300/600/1200V DC & 75mV. 0/0.3/1.5/3/15/30/60/150/300/600/1200V AC. 0/300mA/1.5/6/15/150/600/800mA/1/1.5/6A DC. 0/1.5/6/15/60/150/600mA. 1.5/6A 0/200/3/30k ohms. DC accuracy 1%. AC 1.5%. Knife edge pointer, mirror scale. Complete with sturdy metal carrying case, leads and instructions.



OUR PRICE £11.60 P/P & Ins 60p

U4315 MULTIMETER

Sturdy 43-range multimeter for current and voltage in DC. AC circuits with freq. 45-20kHz and DC resistance, capacitance, etc. Ranges: DC 50 μ A/100 μ A/1mA/5/25/100/500/2500. DC 75mV/1V/2.5/5/10/25/100/250/500/1000. AC 0.5mA/1.5/2.5/10/25/100/500/2500. AC 1V/2.5/5/10/25/100/250/500/1000. DC 300 Ω . DC 5k/10/50/500/5000. -15dB +2dB. Complete with steel carrying case and leads, manual.



OUR PRICE £10.80 P/P & Ins 60p

TMK MODEL TW50K

45 ranges. Mirror scale. 50kV/DC 50kV/AC. DC Volts: 0.125/0.25/1.25/2.5/5/10/25/50/125/250/500/1000. AC Volts 1.5/3/10/25/50/125/250/500/1000V. AC. 0/500A/5/50/500mA. 12A DC. 0/500A/5/50/500mA/1000V. 500mA. 12A DC. 0/500A/5/50/500megohms.



OUR PRICE £13.50 P/P & Ins 60p

U4313 MULTIMETER

High sensitivity. 120,000 ovp on DC and 2,000 ovp on AC and accuracy of 1.6% on DC and 2.6% on AC. Ranges: 0/0.2/2mA. DC current: 0.6mA. 3/15/60mA. 300/1.5A. DC and AC Voltage: 1.5V/3/7.5/15/30/60/150/300/600. DC resistance 1k/10k/100k/1M. Complete with steel carrying case and leads, manual.



OUR PRICE £14.90 P/P & Ins. 60p

KAMODEN 360 MULTIMETER

High sensitivity. DC 100k/ohm/V AC 10k/ohm/V. 5" mirror scale, overload protection. Ranges: 0.5/1/5/10/50/250/1000V DC. 5/10/50/250/1000V AC. DC current: 0.01mA/0.5/5/50/500mA/10A. Resistance: 0.1/1/10/100 ohms/10/100k ohms. Decibels: -20 to +62dB. Battery operated. Size: 180 x 140 x 80mm. Supplied complete with test leads etc.



OUR PRICE £18.90 P/P & Ins 60p

U4317 MULTIMETER

High sensitivity instrument for field and laboratory work. Knife edge pointer, 80mm mirror scale. Overload protection. Ranges: 100mV/0.5/1.5/10/25/50/100/250/500/1000V DC. 0.5/2/10/25/50/100/250/500/1000V AC. Current: 50mA/0.5/1.5/10/25/50/100/250mA/1.5A. DC Resistance: 0.5/10/100/200 ohms/1/3/30/300k ohms. Decibels: -5 to +10dB. Battery operated. Size: 210 x 115 x 90mm. Supplied in carrying case complete with leads.

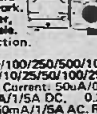

OUR PRICE £18.35 P/P & Ins 60p

MODEL AF.105 VOM

50,000 ovp. Mirror scale. Meter protection. 0/3/12/60/120/300/600/1200V DC. 0.5/3/10/30/300/800/1200V AC. 0/300A/6/60/300mA. 12Amp. 0/10K/1M/100 Ω DC. 0/250 Ohms. -20 to -17dB.



OUR PRICE £13.50 P/P & Ins 60p

ALL PRICES INCLUDE VAT

MODEL 500

30,000 ovp with overload protection. Mirror scale. 0/0.1/0.5/10/25/100/250/500/1000V DC. 0/2.5/10/25/100/250/500/1000V AC. 0/500A/5/50/500mA. 12A DC. 0/500A/5/50/500megohms.



OUR PRICE £15.05 P/P & Ins 60p

MODEL AS.1000 VOM

100,000 ovp. Mirror scale. Built-in meter protection. 0/3/12/60/120/300/600/1200V DC. 0/6/30/120/300/600V AC. 0/10A/6/60/300mA. 12Amp. 0/2K/200K/2M. 200 Meg Ohm. -20 to 17dB.



OUR PRICE £18.30 P/P & Ins 60p

MODEL HT1008A MULTIMETER

Overload protected. 9.9A Meter with mirror scale. Sensitivity 100kV. Polarity change switch. Ranges: 0.5/1.5/5/10/50/100/1000V DC. 2.5/10/50/250/1000V AC. DC resistance: 0-20/200K/2/20 Meg. ohms. DC current: 10/250uA/2.5/25/250mA/10A. AC current: 0-10A. -20 to +62dB. Operates from 2 x 1.5V batteries. Size: 180 x 134 x 79mm.

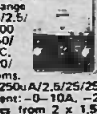

OUR PRICE £21.50 P/P & Ins 60p

KAMODEN HM720B FET VOM

Input impedance 10 Megohms. Ranges: 0/0.25/1/2.5/10/50/100/250/500/1000V DC. 0/2.5/10/50/250/500/1000V AC. DC current: 0.5/5/50/500/5mA/50mA/500mA/5M. 50 Megohms.



OUR PRICE £24.30 P/P & Ins 60p

U51 Clamp VOLT AMMETER

For measuring AC voltage and current without breaking circuit. Ranges: 0/0.5/1/2.5/5/10/25/50/100/250/500A. Accuracy 4%. Size 283 x 94 x 36mm. Complete with carrying case, leads and fuses.

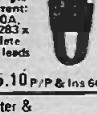

OUR PRICE £15.10 P/P & Ins 60p

U4341 Multimeter & Transistor Tester

27 ranges. 167,000 ovp. Overload protected. Ranges: 0.3/1.5/6/30/150/300/900V DC. 1.5/7.5/30/150/300/750V AC. Current: 0.06/0.6/6/60/600mA DC. 0.3/3/30/300mA AC. Resistance: 0.06/0.6/6/20/60/200k ohms/2 Mohms. Battery operated. Supplied complete with probes, leads and steel carrying case. Size: 115 x 215 x 90mm.

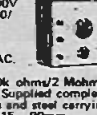

OUR PRICE £11.85 P/P & Ins 60p

KAMODEN IT35 TRANSISTOR TESTER

High quality instrument to test reverse leak current and DC current. Amplification factor of NPN, PNP, diodes, transistors, SCR's. Clear scale meter. Operates from internal batteries. Complete with instructions, leads carrying handle.



OUR PRICE £18.90 P/P & Ins 60p

SWR METER Model SWR3

Handy SWR meter for transmitter alignment, with built-in field strength meter. Accuracy 5%. Impedance 52 Ω . Indicator 100uA DC. Full scale 5 section collapsible antenna. Size 145 x 50 x 60mm.

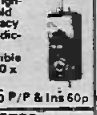

OUR PRICE £4.55 P/P & Ins 60p

S100TR MULTIMETER TRANSISTOR TESTER

100,000 ovp. Mirror scale. Overload protection. 0/0.12/0.6/3/12/60V DC. 0.6/3/12/60/120/600V AC. 0/10/100/1000V DC. 0.01-0.2 MFO. Transistor tester measures Alpha, Beta and ICG. Complete with instructions, batteries and leads.



OUR PRICE £22.65 P/P & Ins 60p

C15 PULSE OSCILLOSCOPE

For display of pulsed and periodic waveforms in electronic circuits. VERT. AMP Bandwidth: 10MHz. Sensitivity at 100kHz V/MS: 0.1-25. HOR. AMP Bandwidth: 500kHz. Sensitivity at 100kHz VRMS/mm: 0.3-25. Preset triggered sweep -3000usec. Free running 20-200 kHz in nine ranges. Calibrator pulse 220 x 360 x 430mm. 115-230V AC.



OUR PRICE £47.50 P/P & Ins. £1.50

370WTR MULTIMETER

Features AC current ranges: 0/0.5/2.5/10/50/250/500/1000V DC. 0/2.5/10/50/250/500/1000V AC. 0/50uA/1/10/100 mA/1/10A DC. 0/100mA/10A AC. 0/5k/50k/500k/5 Meg/50 Meg. Decibels: -20 to +62dB.



OUR PRICE £21.50 P/P & Ins 60p

KAMODEN 72.200 Multifester

High sensitivity meter. 200,000 ovp overload protection. Mirror scale. Ranges: -0/0.6/1.2/6/12/60/120V DC. 0/3/12/60/120V AC. 0/3/12/60/120V V.A.C. 0/8uA/1.2mA/120mA/600mA/12A DC. 0/12A AC. 20 to +63dB. 0/2K/20K/2 Meg/200 Megohms.



OUR PRICE £24.30 P/P & Ins 60p

TE-200 RF SIGNAL GENERATOR

Accurate wide range signal generator covering 120 kHz-500 MHz on 6 bands. Directly calibrated. Variable RF. Attenuator audio output. Xtal socket for calibration. 220/240V a.c. Brand new with instructions. Size 140mm x 215mm x 170mm.



OUR PRICE £24.30 P/P & Ins 60p

ARE 300 AF/RF SIGNAL GENERATOR

All transistorised compact fully portable. AF sine wave 100 Hz to 220 kHz. AF square wave 18Hz to 100 kHz. Output Square/Sine wave 10V. P-P RF 100kHz to 200MHz. Output 1V rms. 220/240V AC operation. Complete with instructions and leads.



OUR PRICE £40.50 P/P & Ins 60p

L84 TRANSISTOR TESTER

Tests PNP or NPN transistors. Audio indicator. Operates on two 1.5V batteries. Complete with instructions etc.



OUR PRICE £4.85 P/P & Ins 20p

SINCLAIR DM2 DIGITAL MULTIMETER

Will measure AC and DC volts, AC and DC current, and resistance in a total of 20 ranges. The large light emitting diode display will read up to 1999 and automatically indicate polarity, indication of positive and negative overload is also provided. The instrument is fitted with a combined carrying handle and bench stand and sockets are provided for the connection of an external power supply.



RANGES: DC VOLTS: 1v, 10, 100v, 1000v. AC VOLTS: 1v, 10v, 100v, 1000v. DC CURRENT: 1mA, 10mA, 100mA, 1000mA. AC CURRENT: 1mA, 10mA, 100mA, 1000mA. Resistance: 1k, 10k, 100k, 1000k.

OUR PRICE £63.70 P/P & Ins 50p

TRANSORISED L.C.R. A.C. BR/8 MEASURING BRIDGE

A new portable bridge offering excellent range and accuracy at low cost. Resistance: 6 ranges: 0.1 ohm-11.1 megohm $\pm 1\%$ Inductance: 6 ranges: 3 microhenry-111 henries $\pm 2\%$ Capacity: 6 ranges: 10pF-1110 mfd $\pm 2\%$ Turns Ratio: 6 ranges: 1:1/100/1:1100 $\pm 1\%$ Bridge Voltage at 1.000cps. Operated from 9-volt battery. 100 microamp meter indication. Size 7 1/2" x 5" x 2".

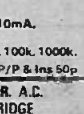

OUR PRICE £29.70 P/P & Ins 60p

TEZZ SINE SQUARE WAVE AUDIO GENERATOR

Size 200 x 200kHz on 4 bands. Square 20 cps to 20 kHz. Output impedance 500 Ω Ohms. 200/250V AC operation. Supplied brand new guaranteed with instruction manual and leads.

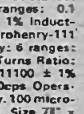

OUR PRICE £26.90 P/P & Ins 60p

MODEL TE20 RF SIGNAL GENERATOR

Six bands. 120kHz-260MHz. Dual output RF terminals. Separate variable audio output. Accuracy $\pm 2\%$. Audio output to 8V. Power requirements: 105-120V/220-240V AC. Size: 183 x 265 x 150mm. Complete with test leads etc.



OUR PRICE £20.45 P/P & Ins 60p

NEW GOLDRING G102 KIT

Belt-drive 2-speed turntable in kit form complete with pick up arm and head shell.

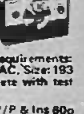

OUR PRICE £21.15 P/P & Ins £1.00



a service that makes sense!

EXPORT Personal exports arranged for overseas visitors. Goods specially packed, insured and despatched to all parts of the world at minimum cost exclusive of VAT. Payment by bank transfer, certified cheque, postal order or money order in any currency.

CUSTOMER SERVICES Our Customer Services Division at Head Office will answer all your enquiries - just ring 01-290 1321

BUY AT LASKYS

AUDIOTRONIC EXCLUSIVE TO LASKYS

AUDIOTRONIC HEADPHONES

LSH20 Individual volume controls. Mono/stereo switch. 40-19,000 Hz. 8 ohms.
OUR PRICE £8.50 P/P & Ins 50p

LSH30 Individual tone and volume controls. Mono/stereo switch. 30-20,000 Hz. 8 ohms.
OUR PRICE £10.50 P/P & Ins 30p

LSH40 Two-way speaker system. Individual volume controls. 20-20,000 Hz. 8 ohms.
OUR PRICE £12.95 P/P & Ins 30p



AUDIOTRONIC Model ATMI
Top value 1,000, super pocket multi-range. Range: 100/250/1,000 Hz AC and DC. DC current 0.1mA/100mA. Resistance: 3750Ω ohms. Switches: -10 to +12dB. Size 50 x 60 x 28mm. Complete with ear leads.
OUR PRICE £4.60 P/P & Ins 25p

AUDIOTRONIC Model ATMI
Top value 1,000, super pocket multi-range. Range: 100/250/1,000 Hz AC and DC. DC current 0.1mA/100mA. Resistance: 3750Ω ohms. Switches: -10 to +12dB. Size 50 x 60 x 28mm. Complete with ear leads.
OUR PRICE £4.60 P/P & Ins 25p

AUDIOTRONIC MODEL ATMS

Jewel movement, attractively moulded case with adjustable ohms adjustment. Range: 0-3/15/150/300/1200V AC. (5000 ohm). 0-5/30/300/600V DC. (6000 ohm). 0-300 uA/0-300mA DC. Resistance: x 10 & x 100. -10 to +16dB. Supplied with battery test leads and data booklet. Size: 121 x 73 x 29mm.
OUR PRICE £5.40 P/P & Ins 25p

AOC22 24-hour clock radio, covering MW/FM wavebands. 60-minute sleep timer, timer. Choice of Grey or White cabinet. P/P & Ins.
OUR PRICE £17.50 Ins £1.00

AUDIOTRONIC AHA101 Stereo Headphone Amplifier. All silicon, transistor amplifier operates from magnetic, ceramic or tuner inputs with twin stereo headphone outputs and separate volume controls for each channel. Operates from 9V battery. INPUTS: 6mV and 100mV. OUTPUT: 50mV per channel.
OUR PRICE £10.65 P/P & Ins 30p

AUDIOTRONIC LOW NOISE CASSETTES
MODEL 5 10 15
C60 £2.05 £3.88 £5.50
C90 £2.81 £5.34 £7.57
C120 £3.59 £6.80 £9.64

AUDIOTRONIC HIGH ENERGY LOW NOISE CASSETTES
MODEL 5 10 15
C60LN £3.59 £6.80 £9.94
C90LN £5.13 £8.72 £13.77
C120LN £6.15 £11.66 £18.52
P/P & Ins. 15p per order

MINIATURE ORGAN MUSIC MASTER AM100



Spanning nearly two octaves, including semi-tones. This instrument will give hours of enjoyment to all the family. Beautifully finished. The Keyboard range can be adjusted to be in tune with any instrument. Operates from internal 9V battery. Fitted with on/off switch, vibrato switch, earphone socket and external 9V D.C. socket. Size 228mm x 127mm x 64mm.
OUR PRICE £9.95 P/P & Ins 50p

ELECTRONIC CALCULATORS



We carry a tremendous range of both pocket and desk calculators by Sinclair, Hanimas, Texas, Hewlett, Packard, Novus, Casio, Unitex, Litronix, etc., etc. Owing to the demand it is not possible to include them in this advertisement, so send for our latest price list or call into any branch.



SPECIAL OFFER!
SINCLAIR 4000 AMPLIFIER AND FM TUNER
Slimline elegance and great performance from SINCLAIR - the 4000 amplifier gives 17W RMS per channel (both driven) into 8 ohms, phones jack, active switchable scratch filter, low noise and distortion, and much more. List Price £74.95 P/P & Ins.
OUR PRICE £33.95 P/P & Ins. £1.65

A perfect match for the 4000 amplifier is the 4000 FM tuner, which boasts a capture ratio of 3dB, sensitivity of 3µV for 30dB quieting, stereo beacon, etc. List Price £82.43 P/P & Ins.
OUR PRICE £29.95 P/P & Ins. £1.65

SINCLAIR Project 80 Modules

240 Power Amp. £5.60 P/P & Ins. 15p
260 Power Amp. £6.95 P/P & Ins. 18p
Stereo 80 Pre-Amp £13.10 P/P & Ins. 15p
Active Filter Unit £7.40 P/P & Ins. 15p
FM Tuner £3.10 P/P & Ins. 15p
Stereo Decoder £2.60 P/P & Ins. 15p
P25 Power Supply £8.40 P/P & Ins. 30p
P28 Power Supply £7.90 P/P & Ins. 30p
Transformer for P28 £5.10 P/P & Ins. 30p

SINCLAIR PROJECT 805

Now available at special low LASKYS prices - the famous project 805 no-solder amplifier kit. Included are all necessary wires, push-on connectors, P80 pre-amp, two 240 power boards giving 12w rms, P25 power supply, and a comprehensive manual. List Price £48.95
OUR PRICE £17.50 P/P & Ins. £1.65

WALKIE TALKIES SKYFON NV7

Super low cost transmitter/receivers. 100MW with call buzzer and on/off volume control. 7 transistors. Telescopic rod antenna.
OUR PRICE £43.60 per PAIR P/P & Ins 50p
NOT LICENSABLE IN THE U.K.



SENN-SOUND 4-CHANNEL ADAPTOR
Simple couple this unit to your existing stereo amplifier and add a pair of speakers, and enjoy the realism of the concert hall.
OUR PRICE £4.95 P/P & Ins. £1.35



BELTEK C6260 CAR AM/FM RADIO & 8-TRACK CARTRIDGE PLAYER
12v Neg. earth, has tone and balance controls, cartridge programme indicator, automatic head cleaning, and comes complete with installation kit, suppressors, and instructions. (No cartridge included).
OUR PRICE £22.50 P/P & Ins. £1.35



FANTAVOX FMT1 STEREO FM TUNER
9v Battery operated FM Stereo Tuner with A.F.C. FM88-108 MHz. Seven section telescopic aerial. Edgewise Tuning and volume controls. Size only 151x86x108mm. Socket for external power supply. Simple connections.
OUR PRICE £12.40 P/P & Ins. £1.65



ELIZABETHAN 8/LZ-1 8-Track Stereo Player. Home 8-Track player with automatic and manual programme change and illuminated channel indicators for use with your hi fi system. Size 71" x 12" D x 2 1/2" H. List Price £28.90.
OUR PRICE £14.90 P/P & Ins. £1.35

ALL PRICES INCLUDE VAT



FREE HI-FI BROCHURE
ABSOLUTELY FREE and available from any branch of LASKYS or by post (complete coupon below). Our brochure includes a complete price list, list of components, Calculators, Tapes, Cassette Decks, Tuners, Amplifiers, Televisions, Record Decks, Electronic Kits, Video, and a host of other accessories. A must for every hi-fi or electronics enthusiast.
COMING SOON! DON'T MISS OUR BUMPER 48-PAGE NOVEMBER/DECEMBER CHRISTMAS CATALOGUE. STUFFED WITH GREAT BARGAINS AND GIFT IDEAS!

your nearest store

CENTRAL LONDON	(01)	LEWISHAM	29 Riverside, Lewisham Centre <i>Opening Soon</i>
43 Colford Street, W1	493 8641	NORTH HAMPTON	75 Abington Street 35753
10 Tottenham Court Rd, W1	637 2232	HOTTINGHAM	5-7 Lower, Parliament St 48987
10 Tottenham Court Rd, W1	636 2605	OXFORD	16 Westgate Centre 722870
45 Tottenham Ct. Rd, W1	636 0845	READING	6 Friars Walk, Friar Street 0734 595459
5 Tottenham Ct. Rd, W1	580 0670	RICHMOND	32 Hill Street 948 1441
10 Tottenham Ct. Rd, W1	437 8704	ROMFORD	86 South Street 20218
10 Tottenham Ct. Rd, W1	723 9789	SLOUGH	Unit 65, Queensmere Centre <i>Opening Soon</i>
10 Tottenham Ct. Rd, W1	723 6211	SOUTHEND	205/206 Churchill West 612241
10 Tottenham Ct. Rd, W1	723 3271	TUNBRIDGE WELLS	53/57 Camden Road 23242
10 Tottenham Ct. Rd, W1	262 0387	WOLVERHAMPTON	30 Wulfrun Way 23384
10 Tottenham Ct. Rd, W1	723 4453	CHATHAM, DARTFORD, SWINDON	<i>Opening Soon</i>
10 Tottenham Ct. Rd, W1	723 4194	All prices correct at 30/9/75 but subject to change without notice E. & O. E.	
10 Tottenham Ct. Rd, W1	353 5812		
10 Tottenham Ct. Rd, W1	353 2833		
BRISTOL	021-236 3503		
GLoucester	20421		
GLoucester	681 3027		
GLoucester	546 1271		
GLoucester	537678		

TO LASKYS CUSTOMER SERVICES DIVISION (Dept EE 12)
Audiotronic House, The Hyde, London NW9 6JJ. Tel: 01-200 1321

Please send me the following items

Name _____

Address _____

Signature _____

TOTAL PURCHASE PRICE _____ (inc. P/P & Ins.)

Please send me your free 32-page Hi-Fi catalogue price list I enclose cheque postal order money order

I wish to pay by Barclaycard/Access and my number is _____

Registered in England No 347947 at 12 Lower Grosvenor Place, London SW1 0EX

PATENT PENDING



Sparkrite MK2

The tried, tested, proven, reliable, complete, professional, capacitive discharge,

Electronic Ignition Kit



"Sparkrite" was voted best of 8 systems tested by Popular Motoring Magazine

ORDER NOW

To ELECTRONICS DESIGN ASSOCIATES DEPT EE12
82 Bath Street, Walsall, WS1 3DE.
Phone 33652.

From Name
Address

- Qty.
- Sparkrite Mk 2 DIY Ass. kits @ £10.93
 - Sparkrite Mk 2 Ready Built Negative earth @ £13.86
 - Sparkrite Mk 2 Ready Built Positive earth @ £13.86
 - Ignition changeover switches @ £2.79
 - R.P.M. Limit systems in the above units @ £2.42

I enclose cheque/P.O.s for £.....
Cheque No.
(Send SAE if brochure only required)

Sparkrite MK2 is a high performance, high quality, capacitive discharge electronic ignition system. Because of the superb design of the Sparkrite circuit it completely eliminates problems of the contact breaker. There is no misfire because contact breaker bounce is eliminated electronically by a pulse suppression circuit which prevents the unit firing if the points bounce open at high R.P.M. Contact breaker burn is eliminated by reducing the current to about 1/50th of the norm. It will perform equally well with new, old, or even badly pitted points and is not dependent upon the dwell time of the contact breakers for recharging the system. Sparkrite incorporates a short circuit protected inverter which eliminates the problems of SCR lock on and therefore eliminates the possibility of blowing the transistors or the SCR. (Many capacitive discharge ignitions are not completely foolproof in this respect.) Sparkrite can therefore give you: up to 20% better fuel consumption. Instant all weather starting, cleaner plugs—they last up to 5 times longer without attention, faster acceleration, higher top speeds, longer coil and battery life, efficient fuel burning and less air pollution, smoother running, continual peak performance. **THE KIT COMPRISES EVERYTHING NEEDED.** Ready drilled pressed steel case coated in matt black epoxy resin, ready drilled base and heatsink,

top quality 5 year guaranteed transformer and components, cables, coil connectors, printed circuit board, nuts, bolts, silicon grease, full instructions to make the kit negative or positive earth, and 10 page installation instructions. **OPTIONAL EXTRAS** Electronic R.P.M. limitation. This can be included in the unit to prevent over revving, an advantage to most companies, hire firms, high performance drivers etc. Electronic/conventional ignition switch. Gives instant changeover from "Sparkrite" ignition to conventional ignition for performance comparisons, static timing etc., and will also switch the ignition off completely as a security device. Includes: switch, connectors, mounting bracket and instructions. Cables excluded. **PRICES** D.I.Y. assembly kit £10.93 incl. V.A.T. post and packing. Ready built unit £13.86 incl. V.A.T. post and packing. (Both to fit all vehicles with coil/distributor ignition up to 8 cylinders.) Switch for instant changeover from "Sparkrite" ignition to conventional ignition £2.79 incl. V.A.T. post and packing. R.P.M. limiting control £2.42 incl. V.A.T. post and packing. (Fitted in case on ready built unit, dashboard mounting on kit.) **CALLERS WELCOME**

L.R.S.



**DIGI
DICE**

OFF ON SPIN
BRITISH PATENT MADE IN ENGLAND

DIGITAL READ OUT DICE KIT

- ★ East to Build—Only 2 I.C.'s
- ★ Bright Minitron Readout
- ★ Runs from PP3 (included)
- ★ Small, only 3" x 2" x 1"

KIT ONLY £5.85 +15p post.

Two Kits for **£11.00** post free.

Parts List & Instructions 50p, refunded if kit bought.

Send now to

LRS ELECTRONIC SUPPLIES
3, CLIVESWAY, HINCKLEY, LEICS.

MAIL ORDER ONLY



become a RADIO-AMATEUR!

learn how to become a radio-amateur in contact with the whole world. We give skilled preparation for the G.P.O. licence

free! Brochure, without obligation to:

BRITISH NATIONAL RADIO & ELECTRONICS SCHOOL
Dept EEC 125 P.O. Box 156, JERSEY

NAME: _____

ADDRESS: _____

BLOCK CAPS please

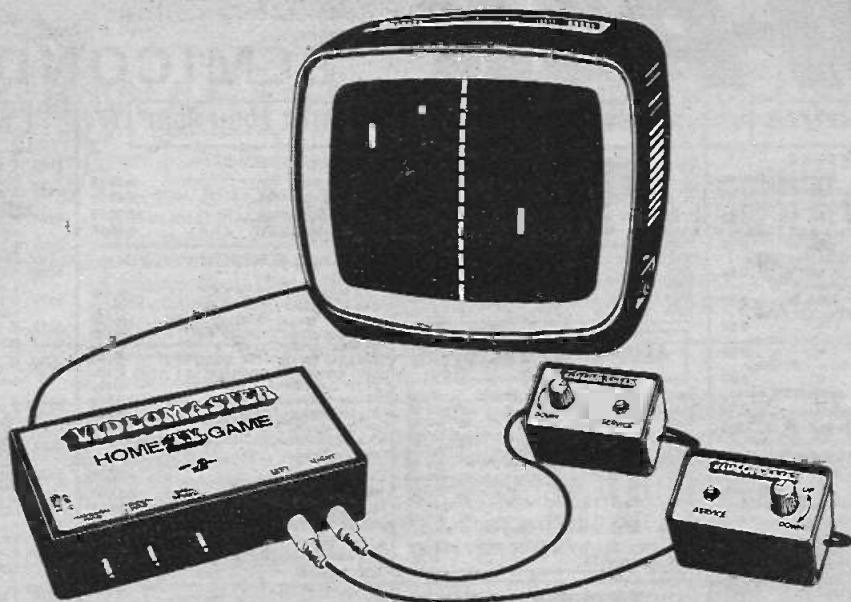

Videomaster urge all good electronics enthusiasts to play the game

The best thing about the Videomaster Home T.V. Game Mk. III is that the sheer pleasure of building it is immediately followed by the excitement of playing three fascinating games.

The famous Videomaster is now available for you to make. It plugs into any standard UHF 625 line TV set, and it shouldn't take you longer than a few hours to build.

In detail . . . The Videomaster Mk. III has eleven integrated circuits . . . four transistors . . . eleven diodes . . . is easy to build . . . with no alignment necessary because with ready-built and tested transistorized UHF modulator, is complete with all parts . . . including fully drilled and prepared p.c.b. . . . handsome plastic box . . . control leads . . . complete step by step assembly instructions . . . Runs on a PP7 9 volt battery . . . and has logic and analogue "state of the art" circuitry all with National Semiconductors CMOS devices . . . with full specification.

The cost? Only **£19.95** (+ VAT)

POST TODAY TO:

Videomaster Ltd

119/120 Chancery Lane, London WC2A 1QU

Please send me (insert no.) Videomaster Mk. III kits at £21.55 ea. inc. VAT. P & P

I enclose my cheque/money order for £

Tick if VHF Modulator required -£1 extra

NAME _____

ADDRESS _____



ALLOW 14 DAYS FOR DELIVERY

EE 1
Reg. No. 1115532

PO BOX 6 WARE HERTS

VISIT OUR COMPONENT SHOP
18, BALDOCK STREET, WARE, HERTS
Open Mon-Sat, 9-5.30 p.m.
Late night shopping till 7 p.m. Fri.

AL 60

50w. PEAK (25w. R.M.S.)

● Max Heat Sink temp 90°C. ● Frequency Response 20Hz to 100K Hz. ● Distortion better than 0.1 at 1KHz. ● Supply voltage 15-50 volts. ● Thermal Feedback. ● Latest Design Improvements. ● Load—3, 4, 5 or 16 ohms. ● Signal to noise ratio 80dB. ● Overall size 63mm x 105mm x 13mm. Especially designed to a strict specification. Only the finest components have been used and the latest solid state circuitry incorporated in this powerful little amplifier which should satisfy the most critical A.F. enthusiast.

ONLY £3.95

STABILISED POWER MODULE SPM80

SPM80 is especially designed to power 2 of the AL60 Amplifiers, up to 15 watt (r.m.s.) per channel simultaneously. This module embodies the latest components and circuit techniques incorporating complete short circuit protection. With the addition of the Mains Transformer BMT80, the unit will provide outputs of up to 1.5 amps at 35 volts. Size: 63mm x 105mm x 30mm.

These units enable you to build Audio Systems of the highest quality at a hitherto unobtainable price. Also ideal for many other applications including:—Disco Systems, Public Address Intercom Units, etc. Handbook available 10p.

TRANSFORMER BMT80 £2.68

PRICE £3.00

STEREO PRE-AMPLIFIER TYPE PA100

Built to a specification and NOT a price, and yet still the greatest value on the market, the PA100 stereo pre-amplifier has been conceived from the latest circuit techniques. Designed for use with the AL50 power amplifier system, this quality made unit incorporates no less than eight silicon planar transistors, two of these are specially selected low noise NPN devices for use in the input stages.

Three switched stereo inputs, and rumble and scratch filters are features of the PA100 which also has a STEREO/MONO switch, volume, balance and continuously variable bass and treble controls. **PRICE £13.20**

MK 60 AUDIO KIT

Comprising: 2 x AL60, 1 x SPM80, 1 x BTM80, 1 x PA100, 1 front panel, 1 kit of parts to include on-off switch, neon indicator, stereo headphone sockets plus instruction booklets.

COMPLETE PRICE: £27.55 plus 45p postage

TEAK 60 AUDIO KIT

Comprising: Teak veneered cabinet size 16½" x 11½" x 3½", other parts include aluminium chassis, heatsink and front panel bracket, plus back panel and appropriate sockets, etc.

KIT PRICE: £9.20 plus 45p postage

INCLUDE VAT
AT 25% TO ALL
★ADD 8%
NO VAT
 5p* overseas
 minimum order 75p

STEREO 30 COMPLETE AUDIO CHASSIS

7 + 7 WATTS R.M.S.

The Stereo 30 comprises a complete stereo pre-amplifier, power amplifiers and power supply. This with only the addition of a transformer or overwind, will produce a high quality audio unit suitable for use with a wide range of inputs, i.e. high quality ceramic pickup, stereo tuner, stereo tape deck, etc.

Simple to install, capable of producing really first class results, this unit is supplied with full instructions, black front panel, knobs, mains switch, fuse and fuse holder and universal mounting bracket, enabling it to be installed in a record plinth, cabinets of your own construction or the cabinet available.

Ideal for the beginner or advanced constructor who requires Hi-Fi performance with a minimum of installation difficulty. Can be installed in 30 mins. PRICE: £16.75 plus 45p postage and packing. TRANSFORMER: £2.45 plus 45p postage and packing. TEAK CAB: £3.95 plus 45p postage and packing.

AL 10/AL 20/AL 30

The AL10, AL20 and AL30 units are similar in their appearance and in their general specification. However, careful selection of the plastic power devices has resulted in a range of output powers from 3 to 10 watts R.M.S.

The versatility of their design makes them ideal for use in record players, tape recorders, stereo amplifiers and cassette and cartridge tape players in the car and at home. AL10 £2.30, AL20 £2.85, AL30 £2.95.

M.P.A. 30

Enjoy the quality of a magnetic cartridge with your existing ceramic equipment using the new M.P.A.30 which is a high quality pre-amplifier enabling magnetic cartridges to be used where facilities exist for the use of ceramic cartridges only.

Used in the construction are 4 low noise, high gain, silicon transistors. It is provided with a standard DIN input socket for ease of connection.

Supplied with full, easy to follow instructions. **PRICE £2.65**

STORAGE/CARRYCASES ★

RECORD CASES

7 In E.P. 18 3/4 in x 7 in x 8 in (50 records) *£2.48
 12 in L.P. 13 1/2 in x 7 1/2 in x 1 1/2 in (50 records) *£3.30

CASSETTE CASES

Holds 15. 10 in x 3 1/2 in x 5 in. Lock and handle. *£1.50

8-TRACK CARTRIDGE CASES

Holds 14. 13 in x 5 in x 6 in. Lock and handle *£2.20

Holds 24. 13 1/2 in x 8 in x 5 1/2 in Lock and handle *£3.20

CARTRIDGES

AC03
 GP91-18C 200mV at 1.2cm/sec £1.11
 GP93-1 280mV at 1cm/sec £1.48
 GP96-1 100mV at 1cm/sec £2.31

TTC
 J-2005 Crystal/Hi Output 97p
 J-2010C Crystal/Hi Output Compatible £1.21
 J-2005S Stereo/Hi Output £1.52
 J-2105 Ceramic/Med. Output £1.81
 J-2203 Magnetic 5mV/5cm/sec. Including stylus £4.78
 J-2203S Replacement stylus for above £2.38
 AT-55 Audio-technica magnetic cartridge 4mV/5cm/sec £3.06

DYNAMIC MIC'PHONE

TYPE B1223. 200 ohms impedance. Complete with stand, on/off switch and 2.5mm and 3.5mm plugs. Suitable for cassette tape recorders. **PRICE £1.67**

JUST OUT!
STEREO FM TUNER
 WRITE NOW FOR FULL DETAILS

GUARANTEED
 Satisfaction or your money refunded

Now...the most exciting Sinclair kit ever

The Black Watch kit

At £17.95, it's

★ **practical** – easily built by anyone in an evening's straightforward assembly.

★ **complete** – right down to strap and batteries.

★ **guaranteed**. A correctly-assembled watch is guaranteed for a year. It works as soon as you put the batteries in. On a built watch we guarantee an accuracy within a second a day – but building it yourself you may be able to adjust the trimmer to achieve an accuracy within a second a week.

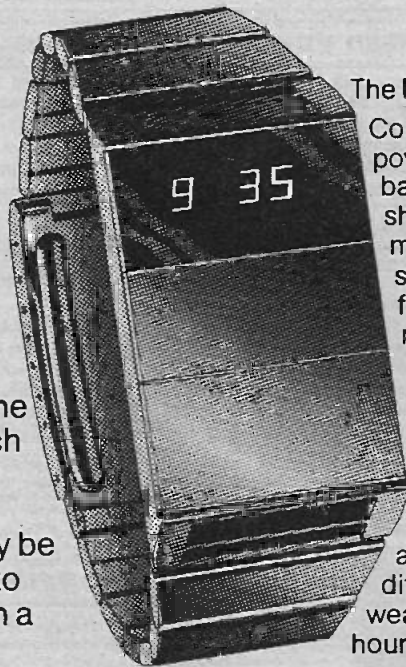

The Black Watch by Sinclair is unique. Controlled by a quartz crystal... powered by two hearing aid batteries... using bright red LEDs to show hours and minutes and minutes and seconds... it's also styled in the cool prestige Sinclair fashion: no knobs, no buttons, no flash.

The Black Watch kit is unique, too. It's rational – Sinclair have reduced the separate components to just four.

It's simple – anybody who can use a soldering iron can assemble a Black Watch without difficulty. From opening the kit to wearing the watch is a couple of hours' work.

The special features of The Black Watch

Smooth, chunky, matt-black case, with black strap. (Black stainless-steel bracelet available as extra – see order form.)

Large, bright, red display – easily read at night.

Touch-and-see case – no unprofessional buttons.

Runs on two hearing-aid batteries (supplied). Change your batteries yourself – no expensive jeweller's service.

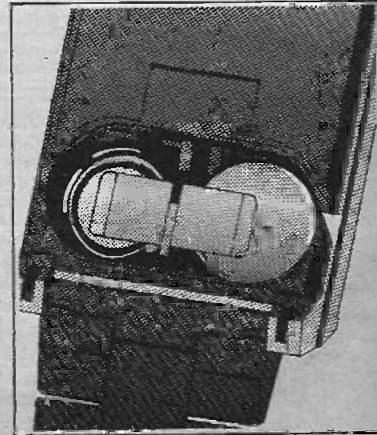
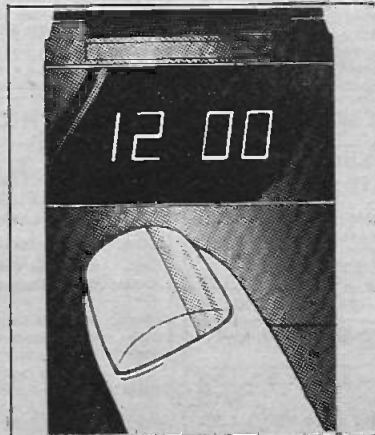
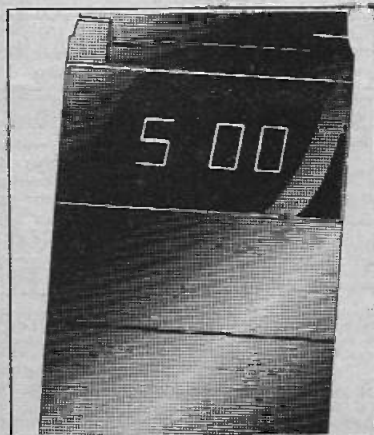

The Black Watch—using the unique Sinclair-designed state-of-the-art IC.

The chip...

The heart of the Black Watch is a unique IC designed by Sinclair and custom-built for them using state-of-the-art technology—integrated injection logic.

This chip of silicon measures only 3mm x 3mm and contains over 2000 transistors. The circuit includes

- a) reference oscillator
- b) divider chain
- c) decoder circuits
- d) display inhibit circuits
- e) display driving circuits.

The chip is totally designed and manufactured in the UK, and is the first design to incorporate all circuitry for a digital watch on a single chip.

...and how it works

A crystal-controlled reference is used to drive a chain of 15 binary dividers which reduce the frequency from 32,768 Hz to 1 Hz. This accurate signal is then counted into units of seconds, minutes, and hours, and on request the stored information is processed by the decoders and display drivers to feed the four 7-segment LED displays. When the display is not in operation, special power-saving circuits on the chip reduce current consumption to only a few microamps.

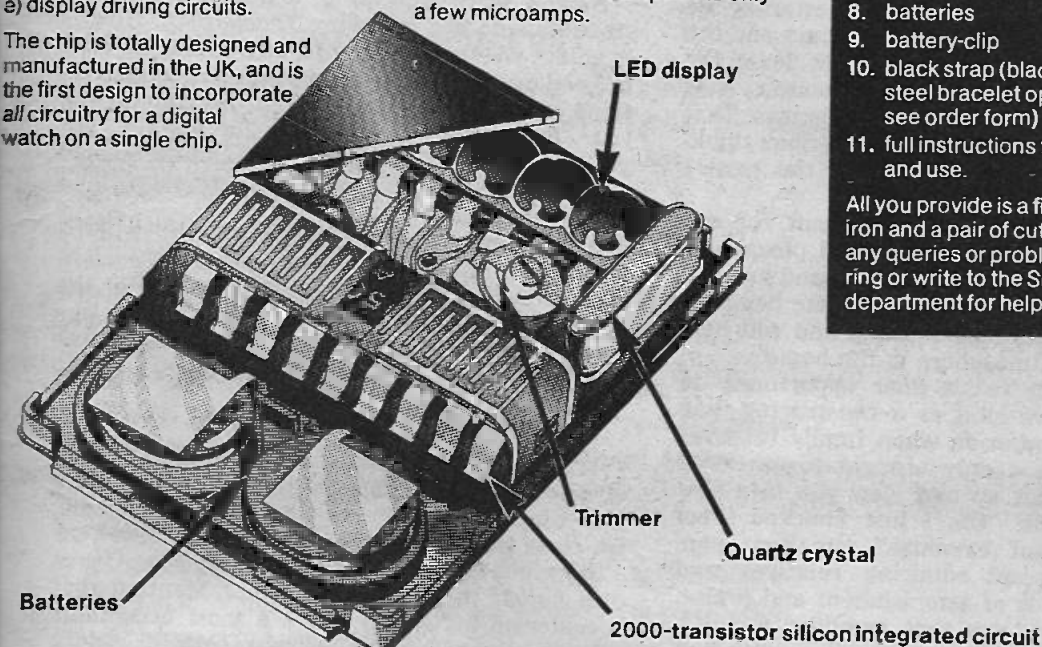

Complete kit £17.95!

The kit contains

1. printed circuit board
2. unique Sinclair-designed IC
3. encapsulated quartz crystal
4. trimmer
5. capacitor
6. LED display
7. 2-part case with window in position
8. batteries
9. battery-clip
10. black strap (black stainless-steel bracelet optional extra—see order form)
11. full instructions for building and use.

All you provide is a fine soldering iron and a pair of cutters. If you've any queries or problems in building, ring or write to the Sinclair service department for help.

Take advantage of this no- risks, money-back offer today!

The Sinclair Black Watch is fully guaranteed. Return your kit within 30 days and we'll refund your money without question. All parts are tested and checked before despatch—and correctly-assembled watches are guaranteed for one year. Simply fill in the FREEPOST order form and post it—today!

Price in kit form: £17.95 (inc. black strap, VAT, p&p).

To: Sinclair Radionics Ltd, FREEPOST, St Ives, Huntingdon, Cambs., PE17 4BR.

Please send me	Total £	
..... (qty) Sinclair Black Watch kit(s) at £17.95 (inc. black strap, VAT, p&p).	* I enclose cheque for £..... made out to Sinclair Radionics Ltd and crossed.
..... (qty) black stainless-steel bracelet(s) at £2.00 (inc. VAT, p&p).	* Please debit my *Barclaycard/Access/American Express account number

Name _____

Address _____

Please print. FREEPOST—no stamp required.

*Delete as required

sinclair

Sinclair Radionics Ltd,
London Road, St Ives,
Huntingdon, Cambs., PE17 4HJ.
Tel: St Ives (0480) 64646.
Reg. no: 699483 England. VAT Reg. no: 213 8170 88.

E E J2

everyday electronics

PROJECTS
THEORY...

TO AID THE PARTY

Time flies. Indeed, it seems but yesterday we were anticipating the coming of autumn and the delights that come in its train, not least the opening of the new constructing season. Now we are a mere four weeks from Christmas. That means time we got down to some serious thinking about projects for use during the festive season.

So right here and now we present for our readers' edification, amusement and pleasure—a novel flasher for decorative lights and an electronic version of that traditional game heads or tails. Both are quite easy to build and will help create the party atmosphere in the home.

And incidentally, what finer opportunity to show off one's own skill as a constructor than that once-a-year occasion when family relatives and friends are suddenly brought together? It may make them sit up and view you in a new and different light! "Oh, I just knocked them up in a couple of evenings" our hero nonchalantly replies as admiring relatives and friends utter words of astonishment and praise. "Now let me show you that amplifier I built."

But watch it. Be real canny or else you'll find yourself committed to building a baby alarm for cousin Sue, an egg timer for Aunt Judith, or a car intruder alarm for Uncle Jim. Even worse, saddled with the repair of innumerable radios.

NEW ENTRANTS

Now a word or two to our latest class of students who are following *Teach-In 76*. How is it going? Well, we trust. In any event, be sure to keep up the good work despite varied distractions which may appear around this time of the year. But should you succumb for a while, put your copies of EE in a safe place and then catch up with the series as soon as you are able. Don't skip an instalment.

Also, remember your "course tutor" will be pleased to help with any particular *Teach-In* queries if you write to him. It's just part of the EE service—a service we extend to all our readers through the several specialist contributors who make up our advisory team.

SPECIAL OFFER

We started this month writing about the constructor's contribution to the domestic scene this Christmas. Since charity begins at home, we close with the following thought.

Why not drop a gentle hint or two on your own behalf in the right quarter? Mention that a soldering kit would prove a most acceptable gift and casually deposit your copy of EE in some conspicuous place at home, open at page 651. Best of luck.

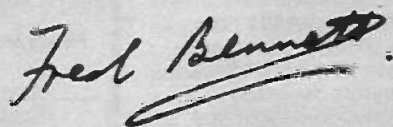

Our January issue will be published on Wednesday, December 17

EDITOR F. E. Bennett • ASSISTANT EDITOR M. Kenward • TECHNICAL EDITOR B. W. Terrell B.Sc.
ART EDITOR J. D. Pountney • P. A. Loates • K. A. Woodruff
ADVERTISEMENT MANAGER D. W. B. Tilleard

© IPC Magazines Limited 1975. Copyright in all drawings, photographs, and articles published in EVERYDAY ELECTRONICS is fully protected, and reproduction or imitations in whole or part are expressly forbidden.

All reasonable precautions are taken by EVERYDAY ELECTRONICS to ensure that the advice and data given to readers are reliable. We cannot, however, guarantee it, and we cannot accept legal responsibility for it. Prices quoted are those current as we go to press. Everyday Electronics Fleetway House, Farringdon Street, London, E.C.4. Phone: Editorial 01-634 4452; Advertisements 01-634 4202.

...EASY TO CONSTRUCT
...SIMPLY EXPLAINED



VOL. 4 NO. 12

DECEMBER 1975

CONSTRUCTIONAL PROJECTS

I.C. STEREO AMPLIFIER Easy to build unit by R. A. Penfold	634
CHRISTMAS LIGHTS FLASHER Provides variable flash rate by James A. Brett	639
HEADS AND TAILS A party game for all by Robert Goffin	648
PROBE TRACER For easy fault finding by F. G. Rayer	658

GENERAL FEATURES

EDITORIAL	632
TEACH-IN 76 Part 3 A new series for beginners by A. P. Stephenson	642
FOR YOUR ENTERTAINMENT Mail order buying by Adrian Hope	647
JACK PLUG AND FAMILY Cartoon	650
SPECIAL OFFER Soldering kit	651
PHYSICS IS FUN The Magnetic Effect of Current by Derrick Daines	653
SHOP TALK Component buying and new products by Mike Kenward	654
COUNTER INTELLIGENCE A retailer's reminiscence by Paul Young	657
YOUR CAREER IN ELECTRONICS Technical Publications by Peter Verwig	661
PROFESSOR ERNEST EVERSURE The Extraordinary Experiments of. by Anthony J. Bassett	664
DOWN TO EARTH Strange Goings on at the Receiving End by George Hylton	666
INDEX For Volume 4	667

We are unable to supply back copies of *Everyday Electronics* or reprints of articles and cannot undertake to answer readers' letters requesting designs, modifications or information on commercial equipment or subjects not published by us. An s.a.e. should be enclosed for a personal reply. Letters concerning published articles should be addressed to: The Editor, those concerning advertisements to: The Advertisement Manager, both at the address shown opposite.

Binders for volumes 1 to 4 (state which) and indexes for volume 1 and 2 available for £1.85 and 30p respectively, including postage, from Binding Department, Carlton House, Great Queen Street, London, WC2E 9PR.

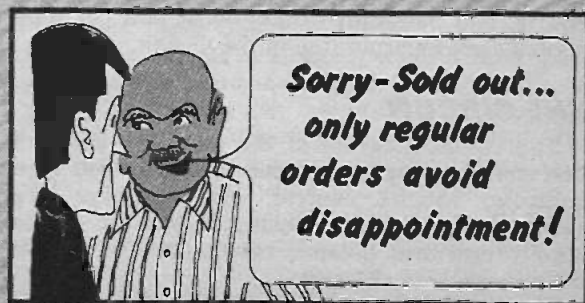

I.C. STEREO



An easy to build 4 + 4 watt stereo amplifier

By R.A. PENFOLD

THIS stereo amplifier uses two high performance integrated circuit audio amplifiers (one in each channel), and by considerably reducing the number of components required in the circuit when compared with a discrete component amplifier, the use of i.c.s greatly simplifies construction. This also helps to minimise the cost of the unit.

The TBA800 i.c.s used are capable of a maximum continuous output of 5 watts r.m.s., but in this application has been restricted to 4 watts r.m.s. per channel. This provides more volume than one might imagine, and although not very high by modern standards, it is more than adequate for most domestic purposes.

The prototype amplifier has been mainly used as a record player amplifier, and as such can be fed from either a crystal or ceramic cartridge, but not a magnetic type. However, the input sensitivity and impedance (250mV. r.m.s. into 350 kilohms), are such that the unit can be fed from most stereo tuners, tape decks, etc.

Output quality is very good, and the amplifier is suitable for the reproduction of classical, as well as pop music. The frequency response of the amplifier extends from about 40Hz to 50kHz, and bass and treble, boost and cut tone controls are incorporated in the design.

THE CIRCUIT

The circuit diagram of the amplifier showing one channel only is provided in Fig. 1. The tone controls, volume control, and amplifier are duplicated in the other channel, but the power supply unit and balance control are of course common to both channels.

The tone controls are situated at the input to

the circuit, and these use a well-known Baxandall configuration. Separate bass and treble controls are provided, and with reference to 1kHz, these provide about 12dB boost and cut at 100Hz and 10kHz respectively. The input signal is fed to the tone controls via VR1, which is the volume control.

Operation of the tone controls is possible by virtue of the fact that the reactance of a capacitor varies with frequency, and in fact reduces as frequency increases, doubling the frequency causing the reactance to be halved.

The tone control networks use a passive circuit, and therefore have no gain. Thus when the controls are set to give bass or treble boost, the boost is relative to other frequencies, and even at the boosted range of frequencies there are some losses in the networks.

The input sensitivity of the integrated circuit is significantly higher than the required input sensitivity of the amplifier as a whole, and so its extra gain is used to compensate for these losses.

The output of the tone controls is taken from VR2 slider, and connected to the input of IC1 at pin 8.

With this type of circuit, minute voltage drops in the power supply wiring can cause an increase in the distortion level, or can even cause the circuit to oscillate. In order to prevent this a supply decoupling capacitor must be connected physically close to the i.c., and this is the purpose

FOR
GUIDANCE
ONLY

ESTIMATED COST*
OF COMPONENTS
including V.A.T.

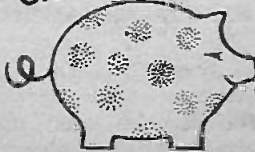

£13.50

excluding case

*Based on prices prevailing at time of going to press

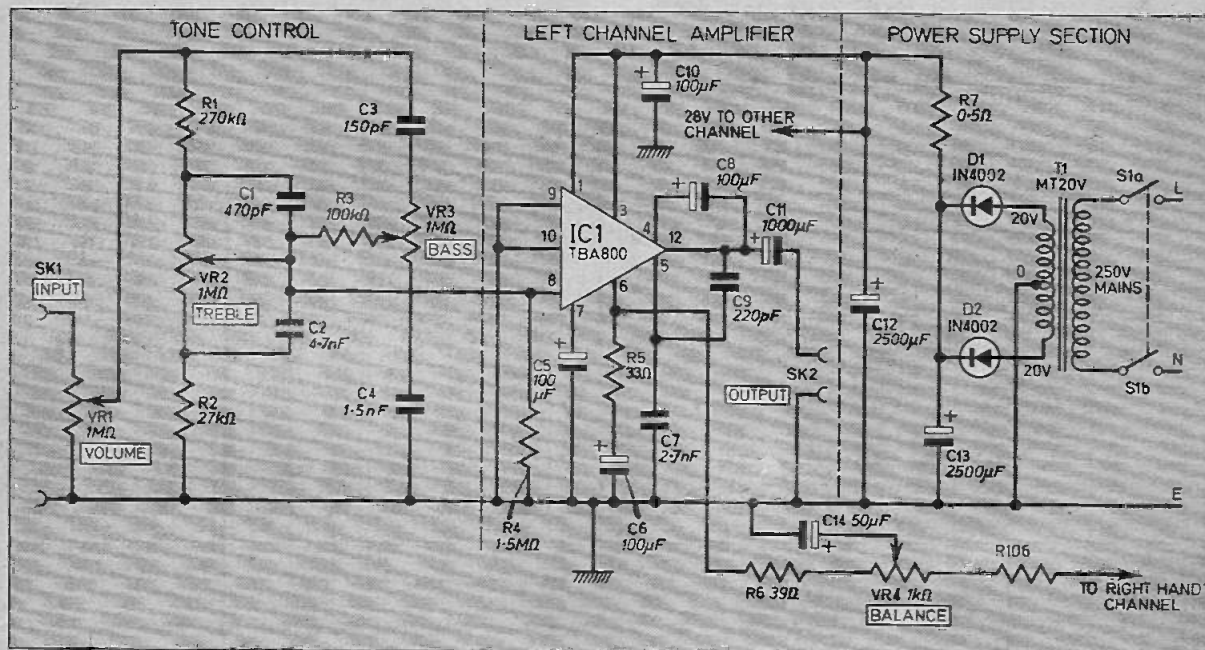

Fig. 1. The circuit diagram of the I.C. Stereo Amplifier.

of C10. Capacitor C5 smoothes the supply to the pre-amplifier section of the i.c., and ensures a low mains hum level at the output, even when a very simple mains power supply unit is used.

As the circuit uses quite a large amount of negative feedback, its frequency response would extend well into the r.f. spectrum with resulting instability, if precautions were not taken to limit the response. It is the purpose of C7 and C9 to provide this roll off in the r.f. response.

Capacitor C8 provides what is known as bootstrapping, which in this case consists of coupling some of the output signal back to the input of the output stage, in order to provide a greater maximum voltage swing on positive half cycles. This enables the i.c. to operate more efficiently from the available supply voltage. The output signal is coupled to the loudspeaker via C11 and provides d.c. blocking.

BALANCE CONTROL

Negative feedback is applied to pin 6 of the i.c. via its internal circuitry. The gain is set to the required level by decoupling the appropriate amount of feedback by connecting a decoupling capacitor in series with a limiting resistor, between pin 6 and the negative supply rail. This is the function of C6 and R5. The gain of the i.c. is determined by the value of the resistor, the lower its value, the more feedback which is decoupled, and the higher the gain.

The balance control, VR4, can be used to boost the gain of either channel by up to about 5dB, in order to compensate for any inequalities

in the amplifier gains, speaker efficiencies, etc., between the two channels. Control VR4 shunts a low value resistance, R6, across R5 to increase the decoupling effect on the feedback, and so achieve an increase in the gain of that channel. This is rather unconventional, but works well in practice.

POWER SUPPLY

A simple unregulated power supply is used, which is all that these i.c.s require for satisfactory operation. A centre tapped mains transformer, T1, feeds a fullwave push-pull rectifier using D1 and D2. The rough d.c. output of these is smoothed to a continuous d.c. by C13, R7, and C12. The on/off switch, S1, should be a double pole type. A potential of about 28 to 30 volts is developed across the output under quiescent conditions, but this drops to about 22 volts at full output.

CHASSIS

A ready made 230 x 180 x 50 mm 16 s.w.g. aluminium chassis was used, and drilling and cutting of this is shown in Fig. 2.

Start by drilling the mounting holes for the controls, T1, the loudspeaker sockets, and the mains input cable. Then drill the mounting holes for the input socket, which is a dual phono type. No dimensions are shown for these as they must be varied to suit the particular make of socket used. The large cut-out for the socket can be made using a fretsaw.

The approximate position in which the 5-way

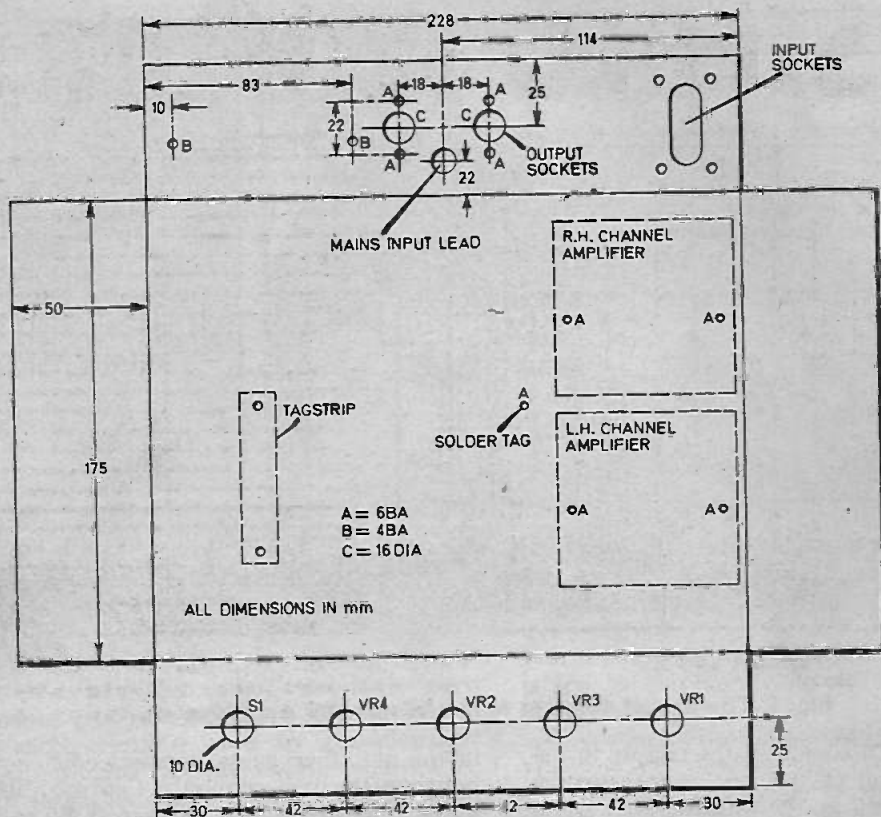

Fig. 2. Details of the chassis.

Components....

Note: Component reference numbers prefixed by 100 refer to right hand channel.

Resistors

R1, 101	270k Ω (2 off)
R2, 102	27k Ω (2 off)
R3, 103	100k Ω (2 off)
R4, 104	1.5M Ω (2 off)
R5, 105	33 Ω (2 off)
R6, 106	39 Ω (2 off)
R7	0.5 Ω 1 watt

All $\frac{1}{4}$ W carbon $\pm 10\%$ unless stated otherwise

Potentiometers

VR1, 101	1M Ω dual gang carbon log. (1 off)
VR2, 102	1M Ω dual gang carbon lin. (1 off)
VR3, 103	1M Ω dual gang carbon lin. (1 off)
VR4	1k Ω carbon lin.

Capacitors

C1, 101	470pF polystyrene (2 off)
C2, 102	4.7nF polystyrene (2 off)
C3, 103	150pF polystyrene (2 off)
C4, 104	1.5nF polystyrene (2 off)
C5, 105	100 μ F 25V elect. (2 off)
C6, 106	100 μ F 10V elect. (2 off)
C7, 107	2.7nF polystyrene (2 off)

WAV
TALK
SHOP
SEE

C8, 108	100 μ F 10V elect. (2 off)
C9, 109	220pF polystyrene (2 off)
C10, 110	100 μ F 40V elect. (2 off)
C11, 111	1000 μ F 16V elect. (2 off)
C12	2500 μ F 30V elect.
C13	2500 μ F 30V elect.
C14	50 μ F 25V elect.

Semiconductors

D1, D2	1N4002 or similar 100V 1A silicon rectifier diodes (2 off)
IC1, 101	TBA800 5 watt audio power amplifier integrated circuit (2 off)

Miscellaneous

S1	mains on/off switch d.p.d.t.
SK1, 101	phono sockets (2 off)
SK2, 102	DIN 2 pin loudspeaker sockets (2 off)
T1	MT20V mains/20-0-20V 750mA secondary (Osmabet)

Veroboard: 0.1 inch matrix 24 strips by 23 holes (2 off); aluminium chassis size 230 x 180 x 50mm; 5-way tagstrip; knobs (5 off); aluminium for heat radiators; screened wire; grommet; mains lead and plug; materials for outer casing.

I.C. STEREO AMPLIFIER

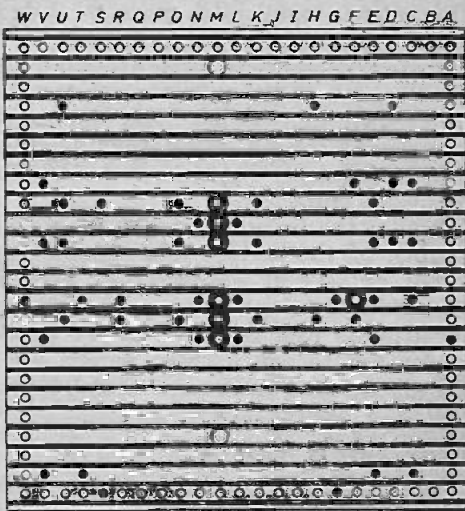
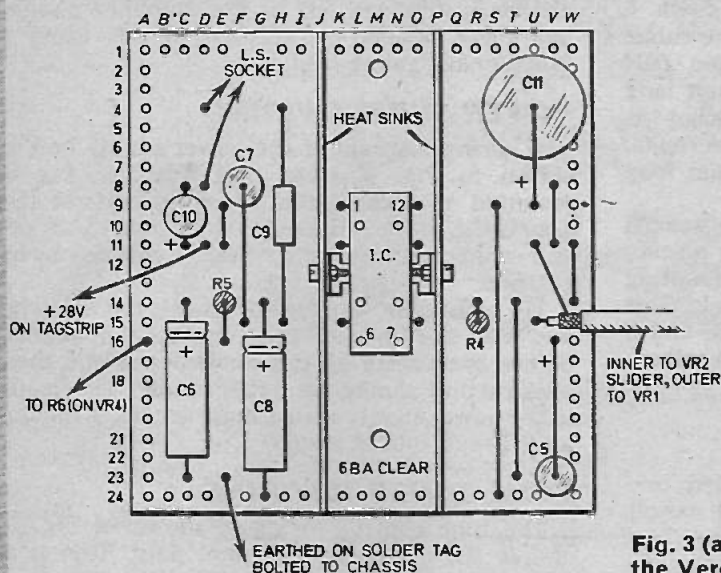

Fig. 3 (above). The layout of the components on the Veroboard and the breaks to be made on the underside. Two of these boards are needed.

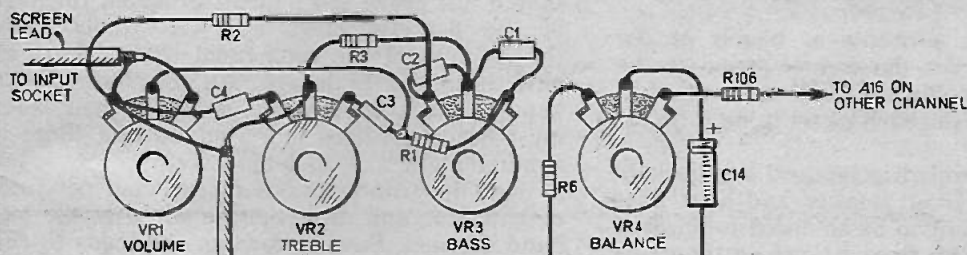

Fig. 5 (left). Wiring up details for the tone controls. Repeat for the other channel on the ganged potentiometers.

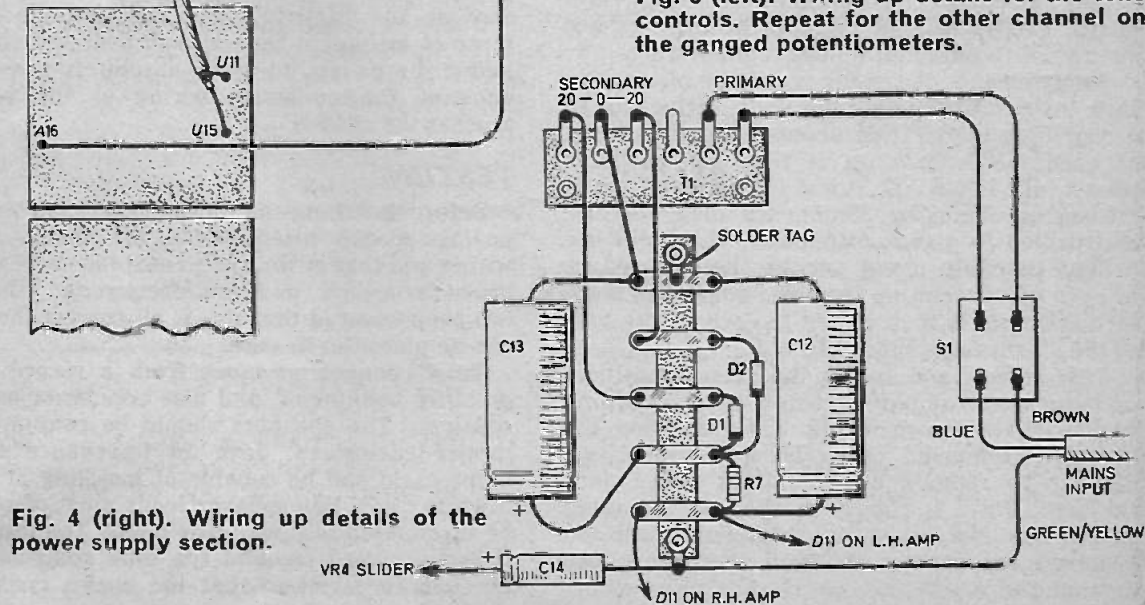

Fig. 4 (right). Wiring up details of the power supply section.

tagstrip on which the power supply circuitry is constructed, is mounted, is shown in Fig. 2, the exact position not being critical.

Having completed the drilling, the various components can then be mounted. The hole for the mains input lead must be fitted with a rubber grommet for the protection of the cable. The loudspeaker sockets are both 2-pin DIN sockets and these each require two 5mm long 6BA mounting bolts. The input socket is similarly mounted using four of these bolts. The transformer requires two 4BA 12mm long mounting bolts.

Mount the 5-way tagstrip so that it is spaced slightly off the bottom of the chassis, by placing a nut or several washers over each mounting bolt, between the tagstrip and the chassis. This tagstrip, as well as the amplifier panels, and a solder tag to which these panels are earthed, are all mounted using countersunk bolts.

AMPLIFIER PANELS

The wiring of the amplifier is divided into three sections, the amplifier panels, the power supply unit, and the controls. The amplifiers are constructed first, and are each built on 0.1 inch matrix Veroboard having 24 copper strips by 23 holes.

Start by cutting a couple of panels of the correct size. Then cut the copper strips at the points indicated in Fig. 3. Then drill the two 6BA mounting holes in each panel using a No. 31 twist drill.

The i.c.s are intended to be used on specially prepared printed circuit boards, and have heat tabs which are meant to be soldered to an area of copper laminate on the p.c.b. which then acts as a heat sink.

This obviously is not possible when using Veroboard, and so instead the tabs of the i.c.s are connected to aluminium heat radiators.

Bend the tabs flat using a pair of pliers, and then very carefully drill the ends of the tabs to accept 8BA bolts. Then about 5mm of the end of each tab is bent up at right angles. Four pieces of 18 to 22 s.w.g. aluminium, each measuring 65mm by 35mm, are then cut out, and drilled to accept 8BA bolts. The holes are drilled centrally along one of the long edges of each piece, 4mm up from the edge. One piece of aluminium is then bolted to each of the tabs of the i.c.s, using a short 8BA bolt.

Next mount and solder the i.c.s in position, and the other amplifier components, according to the layout shown in Fig. 3. Ensure that the i.c.s are connected correctly, as it would be difficult to remove one from its panel once soldered. Pin 1 is clearly marked on the cases of the i.c.s. Note that five short link wires are required for each panel, and that these use insulated wire.

When both amplifiers have been completed

and checked, they can be used as templates to mark the positions of the two 6BA mounting holes they each require. The positions in which the amplifiers are mounted is shown in Fig. 2. A solder tag is mounted on the bottom of the chassis just to the left of the amplifier panels, and these panels are earthed to this using a fairly heavy gauge lead.

POWER SUPPLY WIRING

A wiring diagram of the power supply unit is shown in Fig. 4. Note that a solder tag is mounted on each of the mounting bolts of the tagstrip. A proper three-pin mains plug (3A fuse) and cable must be used so that the chassis can be earthed.

Tin with solder the tags of T1, S1, the tagstrip, and also the ends of the component leadouts, before connecting up the components, and then construction should be quite simple. The leads in the power supply wiring must use wires having a fairly substantial gauge.

TONE CONTROL WIRING

The tone control wiring is shown in Fig. 5, and is shown for one channel only. This is a very simple point to point wiring system, and should not prove too difficult provided the tags of the potentiometers are well tinned; also tin the ends of the component leads once they have been cut to length. All leads should be kept as short as possible, and screened leads must be used where indicated, so that there is a minimum of stray pick-up.

Wire the front sections of the dual potentiometers first, and these can be wired in the left hand channel. Finally, connect the leads to the component panels, and then mount these boards on the chassis. They are mounted in the same way as the tagstrip, with the addition of a layer of insulation tape spread over the chassis under the panels, to make absolutely sure that none of the underside wiring of the panels touches the chassis.

TESTING

Before switching the unit on, check all wiring, paying special attention to the mains input wiring and that of the i.c.s, as mistakes here could prove expensive or even dangerous. When it has been ensured that this is all correct the unit can be placed in its case.

Then connect an input from a record deck or other equipment, and also connect a pair of speakers. The speakers should be contained in proper enclosures, have an impedance of 15 ohms each, and be capable of handling at least 5 watts r.m.s. The speaker leads must of course be terminated in 2 way DIN plugs. The unit can then be turned on, and the tone controls, etc. checked to ascertain that the entire system is operating properly. □

CHRISTMAS LIGHTS FLASHER

JAMES A. BRETT

THE flasher described is simple to make and costs little for the increased pleasure it can give when used with Christmas tree lights or other decorative lighting. The unit has an adjustable flash rate so that it can be set for the most pleasurable effect. A particular flash rate may give pleasure in one arrangement but be a source of annoyance in another.

The circuit is designed to be independent of load current and may be used to operate any lamp circuit up to 1 amp, i.e. 240 watts on the standard 240 volt mains.

THE CIRCUIT

The circuit shown in Fig. 1 uses the relaxation oscillator principle of a capacitor charging to the breakdown voltage of a neon lamp which fires, or more correctly ionises, with a visible glow, the voltage across the neon lamp being stabilised at a lower voltage.

In this circuit let us assume that the neon lamp LP1 is ionised and glowing, the voltage across LP1 is therefore fixed at approximately 80 volts. The capacitor C1 slowly charges up through VR1 and R2, the current also flowing through the neon lamp LP1 until the voltage

across LP2 rises to the breakdown value, some 120 volts. When LP2 fires the voltage across it falls immediately to the burning value of approximately 85 volts. Since the voltage across the capacitor C1 cannot change instantaneously the voltage across LP1 is depressed by about 35 volts to approximately 45 volts. This voltage is not sufficient to maintain ionisation and the neon lamp extinguishes and ceases to pass any current.

The capacitor C1 now starts to charge up, with a reversed polarity, via VR1 and R1. When the voltage across LP1 reaches the breakdown voltage the neon lamp LP1 fires, extinguishing LP2 and the cycle repeats.

When LP2 is ionised and passing current this current is fed to the gate of CSR1 causing it to conduct and light the lamp load. When LP2 deionises the triggering supply is removed from the gate of the thyristor and the CSR1 will cease to conduct at the end of the main half cycle.

Adjustment of VR1 alters the charging time of the capacitor C1 and hence provides control to set the flash rate. Resistor R3 is needed to ensure that when the neon lamp LP2 is deionised any internal leakage current in the thyristor between the anode and gate is allowed to flow away to the cathode without triggering CSR1 when it is in the non-conducting part of the flashing sequence.

The use of a full wave diode bridge and a thyristor instead of a triac, apart from being less costly, is necessary for two technical reasons: firstly a triac requires about twenty times more gate current than a thyristor and hence, to keep the same flash rate, the resistor values would have to be reduced by a factor of twenty and the capacitor value increased to some 40 μ F which is not very practical in a non

FOR
GUIDANCE
ONLY

ESTIMATED COST*
OF COMPONENTS
excluding V.A.T.

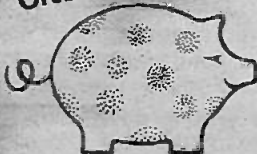

£1.60
excluding case

CHRISTMAS LIGHTS FLASHER

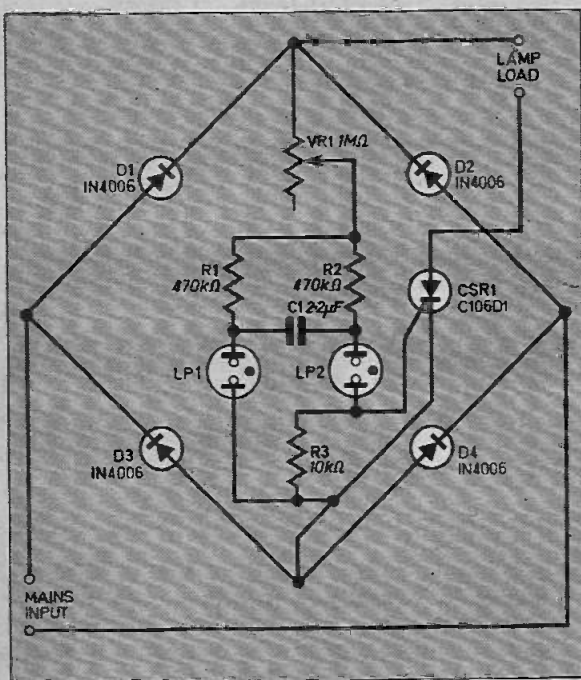

Fig. 1. Circuit diagram of the Christmas Lights Flasher.

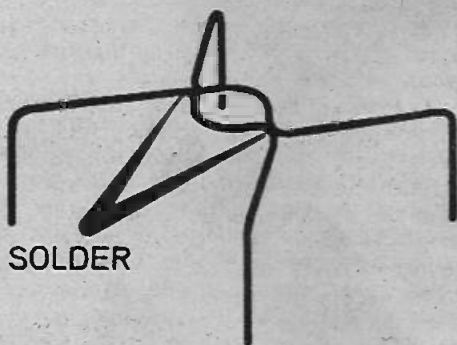

Fig. 3. Wire fixing for VR1 when it is not of the type shown.

Components

Resistors

- R1 470kΩ
- R2 470kΩ
- R3 10kΩ
- All ± 10% 1/2W carbon

**WIRE
SHOP**
SEE

Potentiometer

- VR1 1MΩ linear 1/2 watt composition (preferably with insulated spindle)

Capacitor

- C1 2.2μF 250V d.c. Mullard C280 type or similar non-electrolytic type

Semiconductors

- D1 1N4005/6
 - D2 1N4005/6
 - D3 1N4005/6
 - D4 1N4005/6
 - CSR1 General Electric C106D or Int. Rectifier IRC40
- or other 1A 600 p.i.v. silicon diodes

Miscellaneous

- LP1 miniature wire ended neon (90V type)
- LP2 miniature wire ended neon (90V type)
- Enclosure made from single MK moulded box and insulated blank cover plate, insulated knob.
- Veroboard, 0.15 inch matrix, 13 strips by 13 holes; two terminal blocks, each two way; two gromets, screws, nuts and wire.

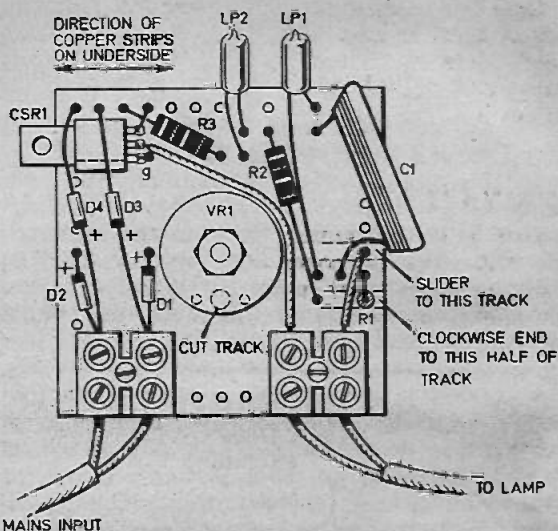

Fig. 2. Construction and wiring details of the flasher unit.

polarised non-electrolytic capacitor. Secondly rectification is needed to provide a d.c. supply for the neon timing circuit. The fact that the supply is not smoothed does not matter and in fact it increases the time for each flashing cycle without having to use an even larger capacitor.

CONSTRUCTION

Cut a piece of 0.15 inch matrix Veroboard to give 13 copper tracks by 13 holes. Check that this piece will fit squarely into the MK moulded box. Referring to Fig. 2 drill the two holes to mount the two terminal blocks.

If a potentiometer with end connections is used drill the Veroboard so that the potentiometer can be mounted with its shaft exactly over the centre of the board. If the potentiometer has side connections make a small supporting bridge using two pieces of 1.5mm or 18 s.w.g. tinned copper wire bent and soldered as shown in Fig. 3. After fitting this bridge over the shaft of the potentiometer and securing with a nut, insert the wire ends through holes in the Veroboard on unused tracks, such as track numbers 4 and 9 in Fig. 2, and solder in place. Wire links are fitted to make the connections between the clockwise end of the potentiometer and track 5 and between the slider and track 7.

The other components can now be mounted as shown in Fig. 2 ensuring that there are no short circuits by sleeving the component leads where necessary. Note that the heat sink tab of the thyristor is electrically internally connected to the anode and that the leads from D3 and D4 must be spaced off the tab even though they are insulated, as heat from the thyristor could soften the sleeve and cause a short circuit.

Drill two holes in the side of the MK moulded box of a size to suit the cable and gromets being used, slide in the ends of the two cables for input and output. Make off the ends of these cables in to the two terminal blocks.

INSULATION

Drill a 10mm diameter hole in the centre of the MK insulated cover plate and fit over the potentiometer shaft using a second potentiometer nut to hold the assembly to the plate. Offer up the plate to the box and screw together. Fit an insulated knob to the potentiometer shaft. For safety reasons this knob should be fitted with a well recessed screw or be fitted with an internal spring retaining clip. The knob should also be large enough to completely cover the potentiometer nut. These precautions must be taken to ensure a freedom from electric shocks.

Connect up the lamp circuit and the mains supply and if the assembly has been carried out correctly with fault free components the flasher is finished and ready for use. □

JAN. '76

Start the year—
right on time with
our easy to build

DIGITAL CLOCK

An easy to build all electronic digital clock using a "state-of-the-art" Large Scale Integrated chip and a 12mm high fluorescent display. Constructed in a slim line case giving a professional finish.

RADIO CONTROL TRANSMITTER

A single channel transmitter to match the receiver published last month. Simple inexpensive construction for model control.

TIME LAPSE CINE TRIGGER

London to Brighton in 5 minutes in your sitting room—it's possible with our time lapse trigger and your cine equipment, full constructional details next month.

everyday electronics

January issue on sale Wednesday December 17.

TEACH=IN 76

By A.P. STEPHENSON

Part Three

3.1 THE MULTIRANGE VOLTMETER

The voltmeter on the Circuit Deck was wired according to the theoretical diagram of Fig. 3.1a.

The common negative probe is connected to the negative terminal of the meter. The positive probe is connected to any of the four terminals according to the full scale voltage range required; R_4 has already been calculated as 250 kilohms. Using the same Ohm's law methods, we can now calculate the other three.

$$R_1 = 1 \text{ volt}/100 \text{ microamps} = 1/100 \text{ megohm} = 10 \text{ kilohm}$$

$$R_2 = 5 \text{ volt}/100 \text{ microamps} = 1/20 \text{ megohm} = 50 \text{ kilohms (} 2 \times 100 \text{ kilohms in parallel)}$$

$$R_3 = 10 \text{ volt}/100 \text{ microamps} = 1/10 \text{ megohm} = 100 \text{ kilohms}$$

$$R_4 = 25 \text{ volt}/100 \text{ microamps} = 1/4 \text{ megohm} = 250 \text{ kilohms (} 100 \text{ kilohm and } 150 \text{ kilohm in series)}$$

These calculations have neglected the resistance of the fine wire coil inside the meter which would probably be less than 1 kilohm. Since this "internal resistance" will always be in series with our external ones, we should, strictly, reduce all our values by about 1 kilohm to allow for this. The discrepancy, however, will be trivial, and for our standards absurd, the

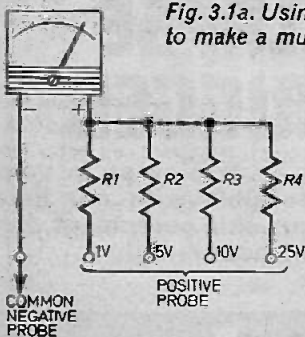

Fig. 3.1a. Using a bank of series resistors to make a multirange multimeter.



meter is about 5 per cent tolerance anyway, and we are not trying to compete with the National Physical Laboratory.

You may be puzzled to know why we are not going to use our meter to read current. There are two reasons:

(a) To measure current we cannot slap the probes across two points in circuit. A wire must be "broken" somewhere and the probes complete the circuit via the meter, this is a nuisance.

(b) The meter can easily be damaged if the current is much greater than you thought it should be. (A pointer hurtling across the face at supersonic speed and ending in a twisted wreck is a very depressing scene.)

Using the voltmeter, we are relatively safe because the highest voltage anywhere in the circuit is the battery voltage, so it is simply a case of using a range sufficient to cover this voltage. If the pointer only moves a small amount, it is safe to come down to the next lowest range. It is seldom necessary to directly measure current. Measure voltage drop and use Ohm's law.

3.2 THE VOLTAGE DIVIDER

If a certain component requires a lower voltage than the battery supply, a resistive **voltage divider** can be used, see Fig. 3.2a. Note we are labelling the battery voltage V_{IN} , ("input voltage"). Resistors R_1 , R_2 form

the voltage divider producing an "output" across R_2 .

There is a simple way to find V_{OUT} , based on the ratio $R_2/(R_1 + R_2)$. For example, since R_2 is 4 kilohms and R_1 is 6 kilohms, the output is 4/10 of the input.

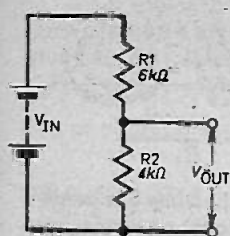

Fig. 3.2a. Using a resistive voltage divider to obtain a lower voltage.

This can be represented in equation form as shown below.

$$V_{OUT} = V_{IN} \left[\frac{R_2}{R_1 + R_2} \right]$$

Since the voltage divider idea is widely used, it is important that you develop an instinct for ratios so some examples are shown in Fig. 3.2b.

Notice that the actual resistor values are unimportant, only their ratios matter in these exercises.

For those that like juggling formulae around, try and prove the above equation using Ohm's law.

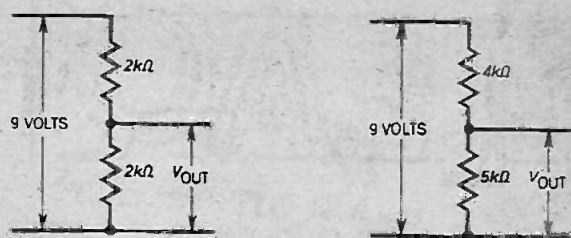

$$V_{OUT} = \frac{1}{2} \text{ INPUT} = 4.5\text{V} \quad V_{OUT} = \frac{5}{9} \text{ INPUT} = 5\text{V}$$

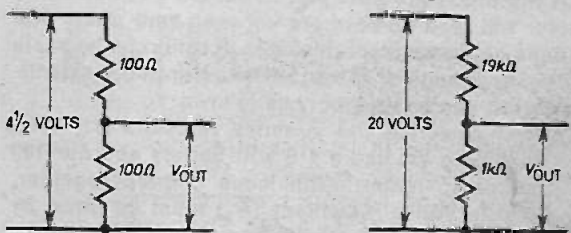

$$V_{OUT} = \frac{1}{2} \text{ INPUT} = 2.25\text{V} \quad V_{OUT} = \frac{1}{20} \text{ INPUT} = 1\text{V}$$

Fig. 3.2b. Examples illustrating the principle of the voltage divider.

3.3 VARIABLE RESISTORS

There are four variable resistors on the Circuit Deck in the form commonly known as "potentiometers" or simply "pots". The circuit symbol and physical construction are shown in Fig. 3.3a.

Rotating the knob moves the wiper arm which varies the resistance between A and B (and between B and C). The resistance across the "outer" connections AC remains constant. When we speak of say a "10 kilohm pot", we mean the resistance across AC.

If the knob is rotated to bring the wiper round to A the resistance between A and B will be zero, but the resistance between B and C will be maximum. If the

wiper is moved round to C the conditions are reversed.

There are two ways of using potentiometers:

- As a simple variable resistor, in which case only two of the terminals are used, the middle and one of the others (the other outer is left "up in the air").
- As a variable voltage divider using all three terminals:

V_{OUT} can be varied smoothly from zero volts (slider at bottom) to maximum volts (slider at top), see Fig. 3.3b.

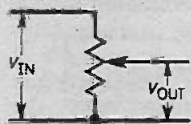

Fig. 3.3b. Using the potentiometer as a variable voltage divider.

On the Circuit Deck, each potentiometer has its three wires brought out to screw terminals for ease of connection which, in experiments, we shall refer to as "top" and "bottom". If top and bottom are reversed in an experiment, the knob will work "backwards". When the knob is rotated fully clockwise (looking at the knob), B is shorted to C. (Hold this page up to the light and look at wiper arm diagram from the back.)

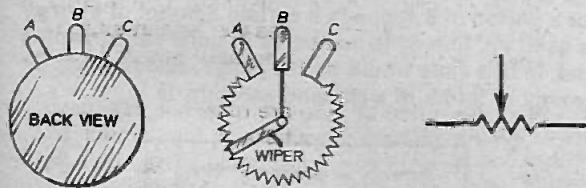

Fig. 3.3a. The physical construction (schematic) and circuit symbol for a variable resistor (or potentiometer).

3.4 MEASURING RESISTANCE

A simple arrangement to measure resistance is shown in (Fig. 3.4a).

The values of R_1 and VR_1 are calculated such that when the test prods are shorted together, the meter reads full scale, which corresponds to zero ohms

externally. The variable resistor is to enable this initial state to be adjusted accurately before attempting a measurement. With the test prods left open, there is no current so the meter reads zero, corresponding to infinite external resistance.

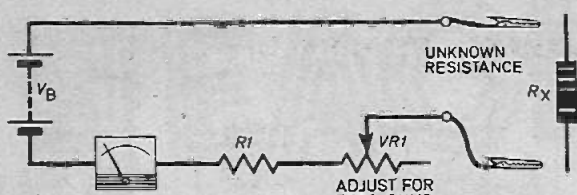

Fig. 3.4a. Theoretical circuit diagram of a simple arrangement to measure resistance.

If the prods are now placed across a resistor, the meter will read somewhere between zero ohms and infinite ohms, all that remains is to calibrate the scale by using a range of known resistors or (more scientifically) to use basic theory as follows:

- First calculate the in-series resistors R_1 , VR_1 , assuming we use a 4.5 volt battery and our 100 microamp meter. With leads shorted together, total in series resistance (R_T) must be given by $R_T = 4.5 \text{ volt}/100 \text{ microamps} = 45 \text{ kilohm}$, which allows us to choose say a 39 kilohm resistor and a 10 kilohm variable for R_1 and VR_2 respectively.
- To calibrate the scale in ohms is a little tricky because it will be "non-linear" (meaning the

values will not be evenly spaced over the dial).

Let I_{fs} be full scale deflection (zero external ohms) then $I_{fs} = V_B/R_T$. When an external resistor (R_X) is being measured, the current will then be $I = V_B/(R_T + R_X)$, so we have,
$$\frac{I}{I_{fs}} = \frac{V_B/(R_T + R_X)}{V_B/R_T} = \frac{R_T}{R_T + R_X}$$

Let us call I/I_{fs} the "full scale multiplying fraction"—(M) so as to write a more conventional equation

$$M = \frac{R_T}{R_T + R_X} \text{ which in percentage terms becomes}$$

$$M = 100 \left(\frac{R_T}{R_T + R_X} \right) \text{ per cent of full scale}$$

In our worked example, we had R_T equal to 45 kilohms, so if we were to measure say an external resistor of value 45 kilohms, M equals 50 per cent (meaning pointer reads half scale) a 250 kilohm resistor gives approximately 15 per cent full scale reading.

3.5 POWER, HEAT AND ENERGY

When current passes through a resistance, the electrons "bump" against atoms, causing them to vibrate and become hot. Since we can't get heat for nothing it follows that **power** is being consumed or "dissipated".

Power is measured in **watts** and is dependent both on the current through *and* the voltage across a resistor the equation being:

$$\text{Power} = \text{voltage} \times \text{current or } P = VI$$

Example

If the voltage across a resistor is 5 volts and it is passing 4 amps, the power is 5 volts \times 4 amps = 20 watts. However, since $I = V/R$ and $P = VI$, then $P = V^2/R$. Also, since $V = IR$ and $P = VI$ then $P = I^2R$, so we may use any of these equations to find the power. $P = VI$ or $P = V^2/R$ or $P = I^2R$.

Examples

- A 5 ohm resistor passing 2 amps consumes $2^2 \times 5 = 20$ watts.
- A 2 ohm resistor with 200 volts across it consumes $(200)^2/2 = 20,000$ watts or 20 kilowatts.

Heat is sometimes desirable, such as in electric fires, but in most electronic circuits it is a menace and every effort is made to operate components at low power levels to keep the temperature down.

The resistors specified for the Circuit Deck experiments are rated at $\frac{1}{4}$ watt, which means they will over-heat if this rating is exceeded. Larger power ratings

require resistors of larger physical size. Fortunately, the majority of resistors in circuits operate at milliwatt level, so heat is not a problem.

Be careful with your arithmetic when dealing with milli- or microamps. If we square milliamps, we get microamps.

Example

5 milliamps through a 4 ohm resistor dissipates a power equal to $(5\text{mA})^2 \times 4 \text{ ohm}$.
 $= 25 \mu\text{A} \times 4 \text{ ohm} = 100 \text{ microwatts}$.

If we operate a component at a power of 20 watts for a period of 5 seconds a certain amount of **energy** is used up. Energy is measured in units called **joules** and, in this case would be 100 joules. The formula for energy in terms of **watts** and **seconds**, is

$$\text{Energy} = \text{power} \times \text{time}$$

Note that 20 watts for 2 seconds burns the same energy as 10 watts for 4 seconds. A battery for instance has a certain amount of stored energy and we can please ourselves whether we use it at a high power rate for a short time, or a low power rate for a longer time.

Mains electricity is paid for in **kilowatt hours** known as "one unit". Thus we can burn one kilowatt for one hour, or $\frac{1}{2}$ kilowatt for two hours, and we shall still pay for one unit which from the above, is equivalent to 3.6 million joules.

TEACH-IN '76 EXPERIMENTS

EXPERIMENT 3A

Use of potentiometer as simple variable resistor.

PROCEDURE

1. Connect up as shown (Fig. 3A.1.) using the 50 ohm potentiometer terminals, switch, 4.5 volt battery and lamp.
2. Switch on and verify that brilliance can be varied by rotating the control knob of the potentiometer, switch off again.
3. Remove wire from top terminal of the potentiometer and refix it in the bottom terminal. Switch on and verify that control knob still varies brilliance but works backwards.
4. Turn knob to maximum brilliance of light. Measure voltage across battery terminal (using 5V meter range). Now switch off and measure battery voltage again. The voltmeter should read a little higher with switch off. This is because the battery itself has some internal resistance and its voltage will therefore drop when current is drawn.

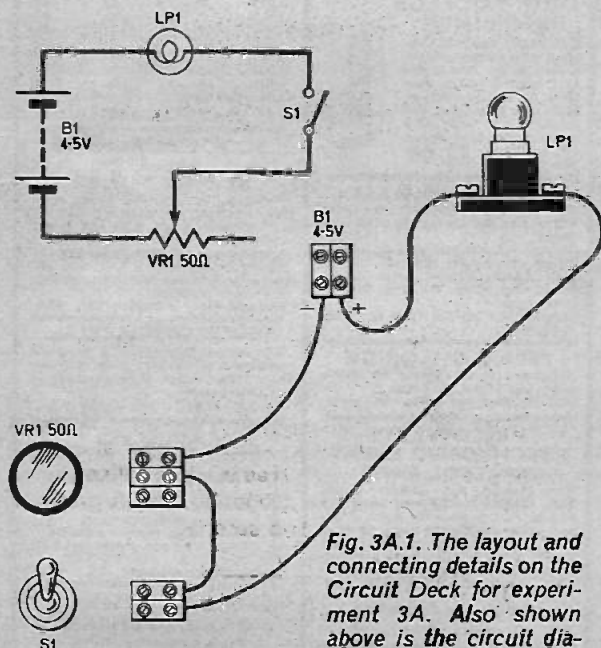

Fig. 3A.1. The layout and connecting details on the Circuit Deck for experiment 3A. Also shown above is the circuit diagram.

EXPERIMENT 3B

- (a) To show how a potentiometer can smoothly control a voltage.
- (b) To show the effect of the meter resistance on circuit behaviour.

PROCEDURE

1. Assemble the circuit shown in (Fig. 3B.1.) using the 1 kilohm potentiometer, the 9 volt battery and the

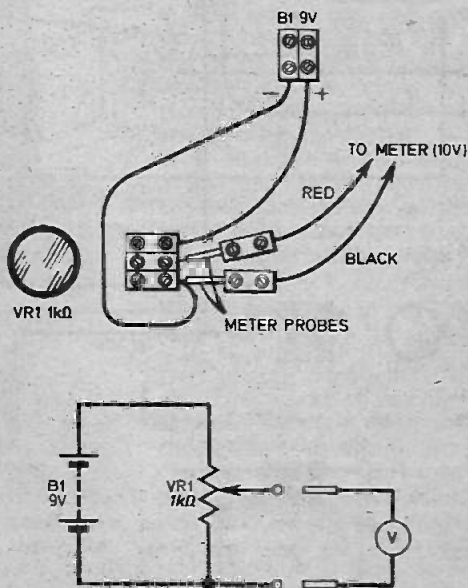

Fig. 3B.1. Shows the connections on the Circuit Deck for experiment 3B together with the theoretical circuit diagram.

meter on the 10V range. Set control fully anticlockwise.

2. Rotate the control slowly over its full extent and note the voltmeter reading will change smoothly from zero volts up to 9 volts. If the meter flickers or jumps erratically at certain positions of the control you have a poor potentiometer, the resistance track is probably dirty or worn. Replacement is the only cure.
3. Perform the same action all over again but using the 1 megohm potentiometer. Notice this time that the meter reading seems to lag behind the control (large movements of control near the zero volts end have only a small effect on the voltage). The reason for this is the meter and its resistance acting as a heavy parallel "load" of 100 kilohms which, although negligible with the 1 kilohm potentiometer, is appreciable with the 1 megohm potentiometer.

EXPERIMENT 3C

To construct and calibrate an ohmmeter.

PROCEDURE

1. Connect up as shown in (Fig. 3C.1) using the meter in the 1V range and set the 25 kilohm potentiometer fully anticlockwise.
2. Momentarily touch together the two crocodile clips. If all is well with the meter (needle does not rush at high speed across the face), leave the clips connected and adjust to read exactly full scale

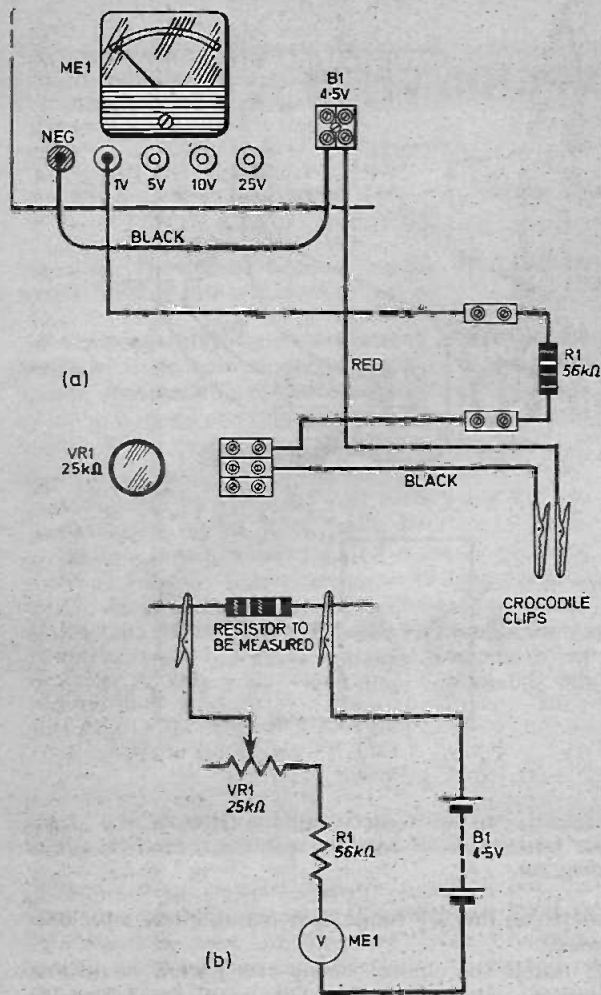

Fig. 3C.1. The layout and wiring details on the Circuit Deck for experiment 3C. Also shown is the theoretical circuit diagram.

(100 μ A) which is "zero ohms". Now separate the clips as the system is now "set up".

3. Cut a strip of white card 12mm wide and long enough to cover the scale of the meter and lay it on the glass ready for calibration. Extreme right, mark "0", extreme left mark " ∞ " (infinity).

4. Calibrate the scale between these extremes by either,

(a) Using your own stock of resistors and noting each reading when the clips are connected across each of them in turn.

(b) Using the theory, explained earlier. You will notice that the scale is very cramped at the right-hand side and resistors lower than a few kilohms read almost "zero ohms".

Save the calibrated card because this circuit can always be assembled again. Never attempt to measure ohms on a resistor already carrying current, it could destroy your meter!

CRESCENT RADIO LTD.

11-15 & 17 MAYES ROAD, LONDON N22 6TL
(also) 13 SOUTH MALL, EDMONTON, N.9

MAIL ORDER DEPT.

1 St Michaels Terrace Wood Green London N22 4SJ
Phone 888 3206 & MAIL ORDER 888-4474

ABS PLASTIC BOXES

Handy boxes for construction projects. Moulded extrusion rails for P.C. or chassis panels. Fitted with 1mm front panels.

1005 = 105mm x 73mm x 45mm = 55p.
1006 = 150mm x 74mm x 47mm = 72p.
1007 = 185mm x 124mm x 60mm = 81.88p.
1021 = 100mm x 74mm x 45mm = 65p. (sloping front) Plus 8% VAT

CLEAR PLASTIC PANEL METERS

Size 59mm x 46mm x 35mm these meters require a 38mm hole for mounting.

ME5 = 0 to 50 micro amp Full Scale
ME7 = 0 to 100 micro amp
ME8 = 0 to 500 micro amp
ME9 = 0 to 1mA
ME10 = 0 to 5mA
ME11 = 0 to 10mA
ME12 = 0 to 50mA
ME13 = 0 to 100mA
ME14 = 0 to 500mA
ME15 = 0 to 1 amp
ME16 = 0 to 50 volts
ME17 = 0 to 300 volts A.C. Full Scale
ME18 = "5" Meter
ME19 = "VU" Meter

OUR PRICE
£3.50
Plus 8% VAT

LOW VOLTAGE AMPLIFIER

5 transistor amplifier complete with volume control, is suitable for 9V d.c. and a.c. supplies. Will give about 1W at 8 ohm output. With high IMP input this amplifier will work as a record player, baby alarm, etc., amplifier. £2.00 Plus 8% VAT

P.C. ETCHING KIT

This kit contains all that the constructor will need to etch the circuits of his own design.

Contents—Plastic etching dish. Sample copper clad board. Laminator. 1 lb Ferric Chloride. Large Plastic Spoon. Etch Resist Pen. Full Etching Instructions.

Complete and Big Kit Value at £2.75p + 8% VAT.

FERRIC CHLORIDE

Anhydrous ferric chloride in double sealed one pound pld packs.

OUR PRICE — 65p + P.P. + 8% per lb.

3 KILOWATTS PSYCHEDELIC LIGHT CONTROL UNIT

Three Channel: Bass—Middle—Treble. Each channel has its own sensitivity control. Just connect the input of this unit to the loudspeaker terminals of an amplifier, and connect three 250V up to 100W lamps to the output terminals of the unit, and you produce a fascinating sound-light display. (All guaranteed.)

£18.50 plus 75p P. & P.
Plus 8% VAT

POWER PACKS

FP1 Switched 3, 4 $\frac{1}{2}$, 6, 7 $\frac{1}{2}$, 9 and 12 volt @ 500 m/s, with on/off switch and pilot light.
Size = 130 mm x 55 mm x 75 mm
ONLY = 94.00

FP2 Switched 6.7-9 volt Battery Eliminator. Approx size 2 $\frac{1}{2}$ " x 3 $\frac{1}{2}$ ". Ideal for cassette recorders. £3.25 each.

FP3 Car converter. From 12v Pos. or Neg to - 6.7-9 volt. Easy to fit and transistor regulated.
£3.90 each.

Plus 8% VAT

U.K. CARR.
50p unless otherwise stated

Send 50p for a CRESCENT CATALOGUE

LOW PRICE TRANSISTORS

BF303B—15p TIP42A—75p
AC142K—25p OC76—22p
BC149B—15p AA129—6p
Plus 25% VAT

IC EXTRACTION TOOL
Saves damage to valuable ICs.
Only 40p + 8% VAT

ANTEX SOLDERING IRONS AND SPARES

X25 25 watt £2.45
X25 Spare Element £1.20
X25 Spare Bits No. 50, 51, 52 44p each
C240/2 15 watt £2.45
C240/2 Spare Element £1.10
C240/2 Spare Bits No. 2, 3, 6 33p each
S.T.S. Soldering Iron Stand suitable for all models £1.10
Plus 8% VAT

ALUMINIUM BOXES

Metal Project Boxes give your work a professional finish.

	L	W	H	Price
AB7	21	5 $\frac{1}{2}$	1 $\frac{1}{2}$	54p
AB8	4	4	1 $\frac{1}{2}$	69p
AB9	4	2 $\frac{1}{2}$	1 $\frac{1}{2}$	59p
AB10	4	5 $\frac{1}{2}$	1 $\frac{1}{2}$	63p
AB11	4	2 $\frac{1}{2}$	2	54p
AB12	3	2	1	45p
AB13	6	4	2	62p
AB14	7	5	2 $\frac{1}{2}$	84p
AB15	8	6	3	99p
AB16	10	7	3	£1.35
AB17	10	4 $\frac{1}{2}$	3	£1.09
AB18	12	5	3	£1.20
AB19	12	8	3	£1.50

All size are approx and in inches.
Plus 8% VAT

SCOOP PURCHASE AM-FM STEREO TUNER

We supply an AM, FM, Stereo tuner fully wired and aligned on a 6" x 4" x 1 $\frac{1}{2}$ " Printed board, plus the ferrite aerial and a switch which you connect following our complete instructions. Now you only need a 9/12 Volt DC supply and you can feed this tuner into any stereo amplifier.

Fantastic Value at £7.00 + 25% VAT.

TELESCOPIC AERIAL

Nine section fully swivelling telescopic aerial with 4BA single bolt fixing or two hole fixing bracket. Fully extended — 43". Fully closed — 7".

Our Price — 50p + P/P + VAT @ 8%

CABLELESS SOLDERING IRON WAHL "ISO-TIP"

★ Completely Portable
★ Soldered up to 150 joints per charge
★ Re-charges in its own stand
★ Fine tip for all types of soldering
★ Only 8" long and weighs just 6 ozs.
Our Price £9.75. Plus 8% VAT
(Spare bits are available)

12-0-12 VOLT 500m/a 240 VOLT PRIMARY TRANSFORMER

Approx. size = 60mm x 40mm x 60mm. Fixing centres—75mm.
A REAL BARGAIN AT £1.20 each.
Plus 8% VAT

LOW NOISE LOW PRICE CASSETTES

Good quality tape in well made screw type cassettes. Presented in single plastic cases.
C60—£1p
C90—45p
C120—65p
10% discount on ten or more cassettes of one type Plus 8% VAT

All prices are excluding VAT. Please add to each item the VAT rate indicated to all orders

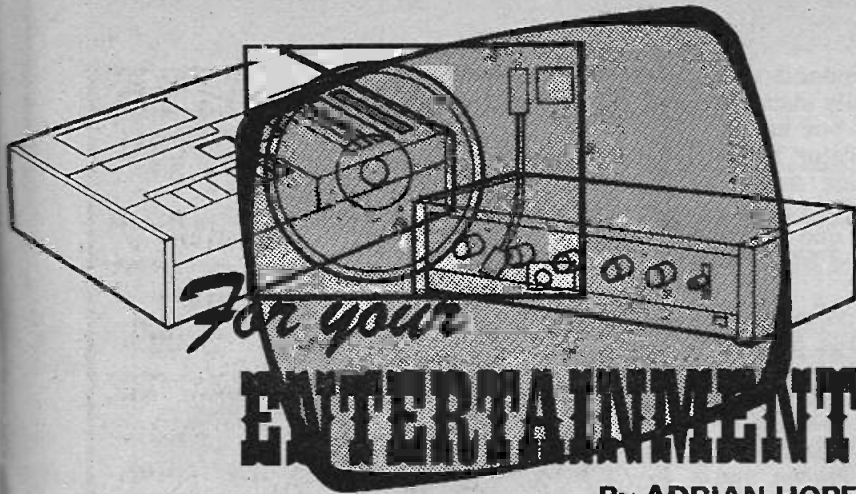

By ADRIAN HOPE

NEVITABLY, some readers will sooner or later order something electronic by mail order through an advert in this (or another similar) magazine, and suffer frustrating delays in delivery of the goods. It might help both readers and advertisers alike to have a few points clarified.

Placing An Advertisement

When a firm places an advert in a monthly magazine (EVERYDAY ELECTRONICS included), it could be up to eight weeks before that advert appears in print on the news-stands. In printing parlance, that eight weeks is referred to as "lag". Any firm worth its salt knows all about the pitfalls of "lag" and will try and make sure that he has plenty of the advertised goods in stock by the time the advert appears.

But a lot of unpredictable things can happen in that time. There may be an unprecedented run on the sale line, for instance as a result of other adverts in previous issues or other magazines, or perhaps in weekly or daily papers. And the line may either be unrepeatable at the advertised price or further stocks may be slow coming through from the manufacturer.

Sometimes the advert has been placed on the strength of a manufacturer's promise to provide stocks for sale by the date that the advert is due to appear. But in each case the result is the same; the poor chap who has sent in his money can't have his goods promptly. And this is where the problems really begin.

Having been in the position myself several times, I know only too well how infuriating it is to

have parted with your money but seen nothing through the post.

As the weeks roll by, one feels more and more worried about whether the firm in question has gone bust. So one writes off, demanding either the goods or money back. By now the mail order firm perhaps has a firm promise of the goods from the manufacturer, and thus is reluctant to write back when he hopes to be able simply to supply the goods very soon. But then, and it happens quite often, the manufacturer lets the mail order firm down, and promises another date for delivery. And so it goes on, the bad feeling growing.

Acknowledgements

Of course, in a perfect world the mail order firm would acknowledge every order and follow up with an apology letter if delivery is unavoidably delayed. But it is not a perfect world, and even a second-class acknowledgement costs not only secretarial time but also hard cash in postage.

Such costs may seem insignificant to the chap who has paid his money and has had no goods in return, but as a journalist who spends literally pounds every week replying to readers' letters, I can tell you it is not insignificant for the chap who is writing replies and paying for the postage.

Pay By Cheque

Let's try to be constructive. Firstly, readers should try always to pay for mail order goods by cheque. This way, you can obtain from your bank, in the form of a cancelled cheque, proof positive that you have paid. The mail

order firm knows this and thus knows also that the customer can, if he wishes, check whether or not his original order has gone astray.

Again, if it were an ideal world, a firm would not cash cheques until it could send out the goods. But often incoming cheques are handled by one employee as a routine, while outgoing orders are handled by another, perhaps in a separate warehouse. Also, people have been known to send cheques that bounce, so there is an incentive to cash a cheque before supplying the goods.

Waiting Time

It is probably reasonable to start getting impatient after two or three weeks of silence have elapsed. The first thing to do is check that your cheque has been cleared through your bank. Then write a polite note, confirming that you have not yet received any goods, and asking for information if nothing is likely to be sent off within the next week. That will take the time from ordering up to around a month.

If a month passes without any goods, any apology or any reply to your enquiry, and if your cheque has long since been cleared through your bank, it is reasonable to write again. This time firmly, but still politely, demanding either goods by return, or an explanation by return, or money back by return.

If that produces no reaction after a week or so, you should contact the magazine that ran the original advert. You owe this not only to yourself, but to the magazine and future readers of future adverts from the same firm. But bear in mind that it is usually a house rule that such queries will only be dealt with if they are in writing. This isn't red tape for the sake of it, but a precaution to safeguard everyone. It is not unknown for someone to claim non-delivery of goods when in fact they have received them, but fancy receiving another batch free. Although some people are prepared to tell lies over the telephone, they are usually unwilling to put them in writing.

One final point. Remember that although it may be frustrating not to receive acknowledgements from a firm prior to despatch of goods, it is only by cutting corners like these that the firm can keep its mail order prices down.

THIS simple little novelty device demonstrates how it is possible to electronically simulate the tossing of a coin. It consists of a box having a push button switch and two indicator lamps on the front panel, one lamp being marked heads, and the other being marked tails.

When the push button is pressed one of the lamps is illuminated, indicating either heads or tails.

The circuit is arranged so that it is purely a matter of chance whether the heads or tails lamp is illuminated when the push button is pressed, the circuit thus providing the same effect as tossing a coin.

A more serious side to the device is that it illustrates the operation of a well-known and extremely useful electronic building block—the bistable multivibrator.

CIRCUIT OPERATION

The theoretical circuit diagram of the Electronic Heads and Tails is shown in Fig. 1. The two indicator lamps are the two light emitting diodes (l.e.d.s), D1 and D2. These are protected against passing excessive currents by the series resistors R1 and R4. Diode D1 is illuminated when TR1 is turned on, and D2 will be illuminated when TR2 is turned on.

If VR1 is ignored for the time being, when the push button switch, S1, is depressed, the

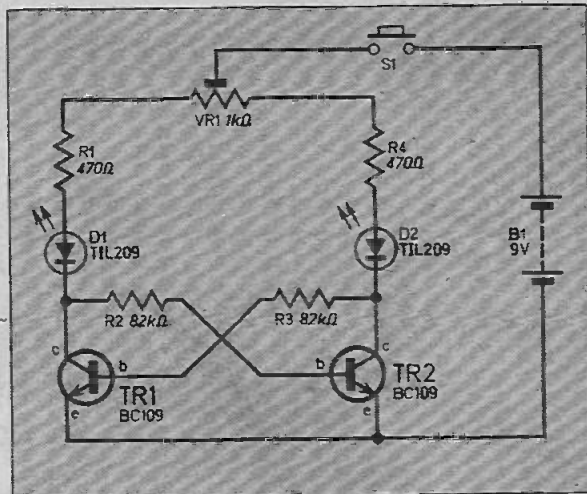

Fig. 1. The circuit diagram of the Heads & Tails Game.

positive supply will be connected to the circuit. The transistors will obviously both begin to turn on, TR1 receiving its base bias current via R4, D2, and R3, and TR2 receiving its base current via R1, D1, and R2.

It is, however, not possible for both transistors to turn hard on at the same time, as if TR1 is turned hard on, only a fraction of a volt will



A novel device which illustrates the operation of a basic circuit configuration



HEADS & TAILS GAME

By **ROBERT GOFFIN**
Everyday Electronics, December 1975

FOR
GUIDANCE
ONLY

ESTIMATED COST*
OF COMPONENTS
excluding V.A.T.

£1.30

excluding case

*Based on prices prevailing at
time of going to press

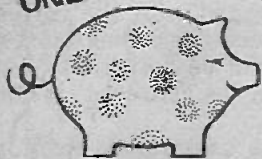

Components....

Resistors

R1 470 Ω
R2 82k Ω
R3 82k Ω
R4 470 Ω
All $\frac{1}{4}$ W carbon $\pm 5\%$

SEE

**SHOP
TALK**

Potentiometer

VR1 1k Ω horizontal skeleton preset

Semiconductors

TR1 BC109 silicon npn
TR2 BC109 silicon npn
D1 TIL209 or similar l.e.d. with holder
D2 TIL209 or similar l.e.d. with holder

Miscellaneous

S1 push-to-make, release-to-break push
button switch
B1 9V PP3 with connector
Veroboard: 0.15 inch matrix size 7 strips by
16 holes; case type Minos M2; connecting
wire

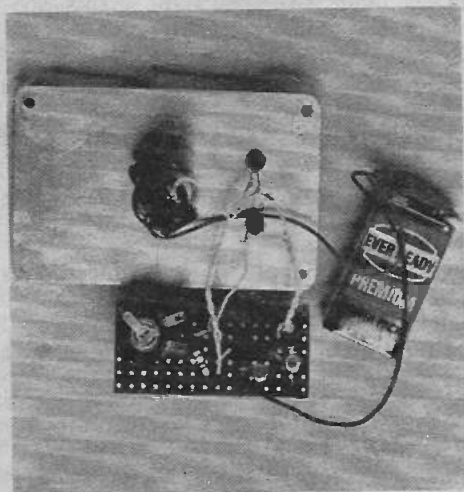

Photograph illustrating the construction of
the prototype unit.

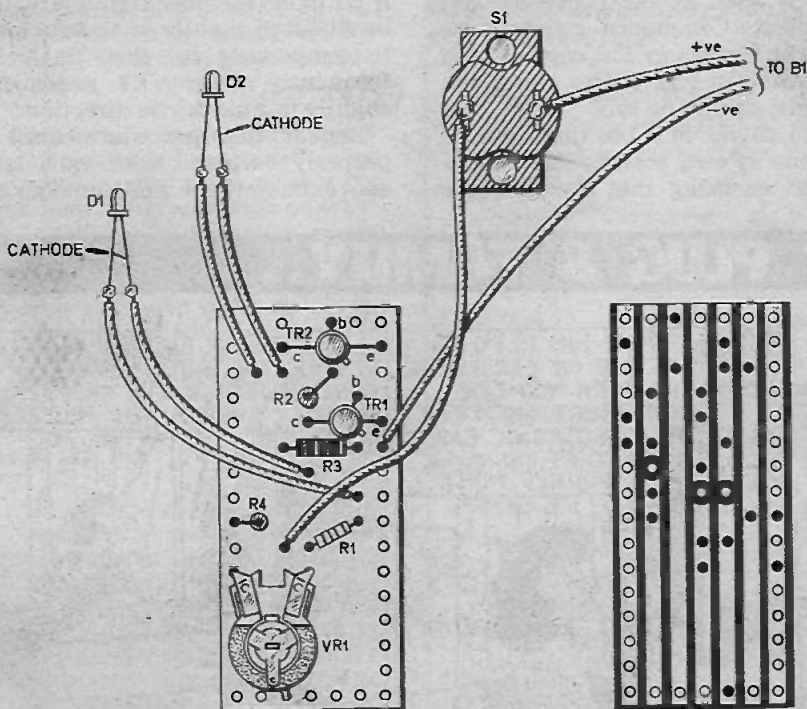

Fig. 2. Layout and wiring of the complete unit.

appear at its collector, and TR2 cannot receive the necessary bias current to turn hard on. If TR2 turns hard on then the same is true for TR1.

What happens when the supply is connected is that both transistors begin to turn on, but due partially to chance, and partially to a slight unbalance in the resistor values, transistor gains, etc. of each half of the circuit, one will begin to turn on faster than the other. In doing so it tends to starve the other transistor of base current as its own collector swings towards earth potential.

On the other hand this enables it to obtain a heavy base current from the collector of the other transistor, as this has its collector still at virtually the full supply potential. This regenerative action results in one transistor being biased to saturation, and the other being cut off. Obviously only one of the lamps will light up.

If the unbalance introduced by the component tolerances could be removed, it would obviously then be a matter of chance which of the lamps became illuminated. This is the purpose of VR1, which compensates for the component tolerances by supplying a higher supply voltage to one or other side of the circuit, and is adjusted by trial and error.

The action of the circuit is of course extremely fast, and it appears to the observer that the moment S1 is closed one of the lamps lights up.

CONSTRUCTION

Veroboard having 16 holes by 7 strips by 0.15 inch matrix is used as the constructional basis for the project. Commence construction by making the three breaks in the copper strip at the places indicated in Fig. 2. Use either the special tool or a twist drill to do this.

Then mount and solder into position each of the components, one by one, leaving the transistors until last and ensuring that an adequate

amount of solder is used for each joint. Also connect up the l.e.d.s and S1 using approx. 75mm lengths of thin insulated wire, and also connect the battery clip leads. Make quite sure that the l.e.d.s are connected with the correct polarity, as if they are incorrectly connected they will fail to light, and could be destroyed. With l.e.d.s type TIL209, the longer lead is the cathode.

The front panel of the case should next be drilled to take S1 and the diodes. Switch S1 is mounted in the centre of the panel, and the l.e.d.s are mounted to the right of this, one above the other, see photograph.

The case used in the prototype was a Mimos type size 100 x 65 x 50mm with runners to take the component board.

The light emitting diodes should be purchased together with the plastic panel holders in which they are mounted. The required dimensions for these holes will depend upon the type and make of components used.

The component panel is mounted vertically at the extreme left-hand side of the case in the slots moulded into the outer casing. There is a space for the battery, a PP3, beneath the two l.e.d.s.

ADJUSTMENT

Start with the slider of VR1 at a central position and then press S1 a number of times (25 or more). It will probably be found that one lamp lights up much more often than the other. If D1 lights up more frequently, then VR1 should be adjusted slightly in an anticlockwise direction to compensate for this. If D2 lights up more frequently, then VR1 needs to be adjusted slightly in a clockwise direction.

Repeat this procedure until the circuit is properly balanced with each lamp lighting up approximately the same number of times. □

JACK PLUG & FAMILY...



SPECIAL OFFER...

TO EVERYDAY ELECTRONICS READERS

£4.75

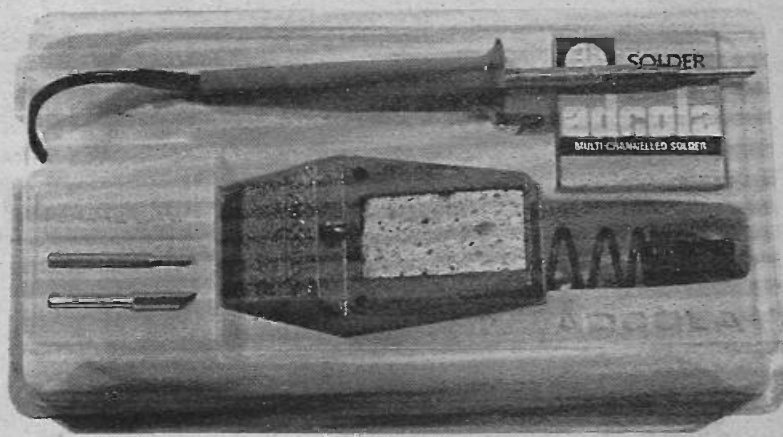

All the essentials for simple soldering are contained in this soldering kit produced by Adcola Products Ltd. The kit measures approx. 300mm x 160mm x 60mm and contains an Invader precision soldering instrument—approved by the Design Centre, a stand, flux cored solder, two spare soldering bits and an instruction card providing hints on soldering.

The Invader soldering instrument is thermally controlled to provide a constant level of the correct heat for soldering. It features a pencil slim handle for easy control and weighs less than 2ozs. The standard soldering tip provided is 4.75mm ($\frac{7}{16}$ in) diameter but two replacement bits of 3.2mm ($\frac{1}{4}$ in) and 6mm ($\frac{1}{4}$ in) diameter are included to provide complete versatility for the 25W soldering instrument.

The smaller bit is designed to undertake small detailed work and the larger for jobs calling for an increased heated area. These bits are merely inserted in the collet at the end of the Invader to convert it from one task to another.

An Invader stand is also contained in the kit to provide the user with a mobile and safe receptacle for the hot soldering instrument. The stand features an integral sponge for cleaning excess solder from the soldering bits and two holders to contain the spare bits. A spring holder is mounted on the base of the stand at an angle of about 45 degrees, and the soldering tool is simply inserted into the holder when not in use.

To complete the kit a packet dispenser of Adcola solder wire—which contains its own flux.

YOUR ORDER WILL NORMALLY BE DESPATCHED IN TIME FOR YOU TO RECEIVE IT WITHIN 28 DAYS, BUT PLEASE ALLOW AN ADDITIONAL 14 DAYS TO COVER ANY CARRIAGE DELAY.

REMITTANCES MUST BE BY POSTAL ORDER OR CHEQUE (NAME AND ADDRESS ON BACK OF CHEQUES PLEASE), CROSSED, AND MADE PAYABLE TO IPC MAGAZINES LIMITED. THIS OFFER IS OPEN TO READERS IN NORTHERN IRELAND, ENGLAND, SCOTLAND, WALES AND CHANNEL ISLANDS ONLY. IT IS NOT AVAILABLE IN EIRE OR OVERSEAS.

SOLDERING KIT

Please complete both parts of the coupon below in **BLOCK CAPITALS.**

To: Everyday Electronics,
Dept. EE2, Rochester X, Kent, ME99 1AA
Please send me the Soldering Kit(s) as indicated
at £4.75 each.

I enclose P.O./Cheque No. Value

No. of kits required

Name

Address

Tel. No. (Home or Work)

No. of kits required

Name

Address

From: Everyday Electronics,
Dept. EE2, Rochester X, Kent, ME99 1AA

Cut Round Dotted Line

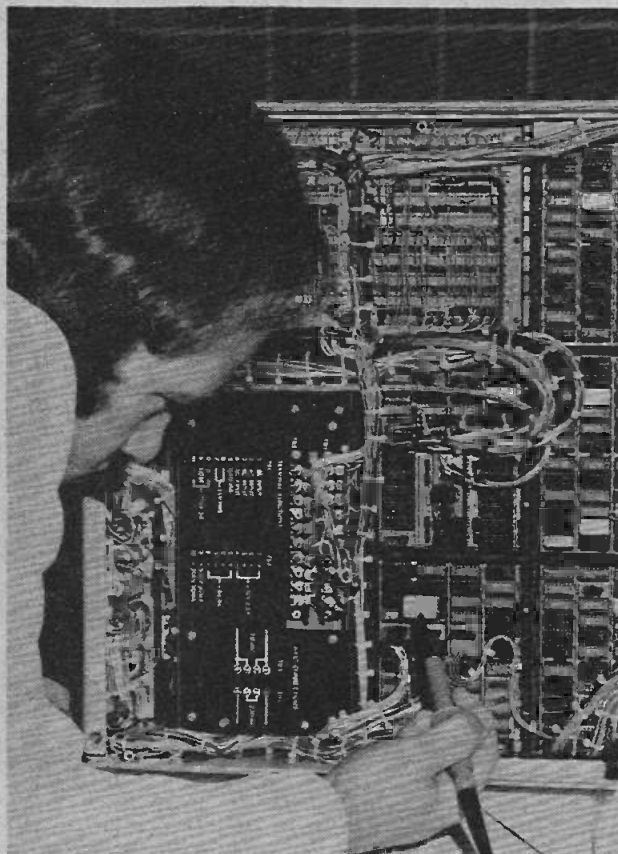

This hobby brings big rewards.

A soldering iron and a screwdriver. If you know how to use them, or at least know one end from the other, you know enough to enrol in our unique home electronics course.

This new style course will enable anyone to have a real understanding of electronics by a modern, practical and visual method. No previous knowledge is required, no maths, and an absolute minimum of theory.

You build, see and learn as, step by step, we take you through all the fundamentals of electronics and show you how easily the subject can be mastered and add a new dimension not only to your hobby but also to your earning capacity.

All the training is planned to be carried out in the comfort of your own home and work in your own time. You send them in when you are ready and not before. These culminate in a final test and a certificate of success.

1

Build an oscilloscope.

As the first stage of your training, you actually build your own Cathode ray oscilloscope! This is no toy, but a test instrument that you will need not only for the course's practical experiments, but also later if you decide to develop your knowledge and enter the profession. It remains your property and represents a very large saving over buying a similar piece of essential equipment.

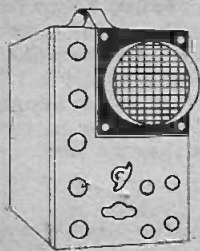

2

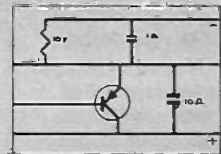

Read, draw and understand circuit diagrams.

In a short time you will be able to read and draw circuit diagrams, understand the very fundamentals of television, radio, computers and countless other electronic devices and their servicing procedures.

3

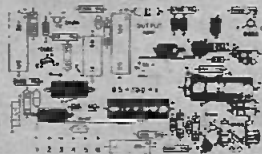

Carry out over 40 experiments on basic circuits.

We show you how to conduct experiments on a wide variety of different circuits and turn the information gained into a working knowledge of testing, servicing and maintaining all types of electronic equipment, radio, t.v. etc.

To find out more about how to learn electronics in a new, exciting and absorbing way, just clip the coupon for a free colour brochure and full details of enrolment.

PLUS FREE GIFT!

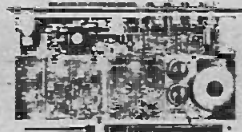

ALL STUDENTS ENROLLING IN OUR COURSES RECEIVE A FREE CIRCUIT BOARD ORIGINATING FROM A COMPUTER AND CONTAINING MANY DIFFERENT COMPONENTS THAT CAN BE USED IN EXPERIMENTS AND PROVIDE AN EXCELLENT EXAMPLE OF CURRENT ELECTRONIC PRACTICE

Brochure without obligation to:

BRITISH NATIONAL RADIO & ELECTRONICS SCHOOL, Dept P.O. Box 156, Jersey, Channel Islands.

NAME _____

ADDRESS _____

EEH 125 (Block caps please)

Physics is FUN!

By DERRICK DAINES

MAGNETIC EFFECT OF CURRENT

That an electric current causes a magnetic effect even in a straight wire can be demonstrated in a classic experiment which may easily be duplicated.

Take two stiff pieces of wire of about 1 metre in length and form a short right-angle at one end of each so that they may be suspended from the top of a suitable length of wood, (Fig. 1). The bottom ends of the wire should swing with perfect freedom, clear of the ruler and of the support.

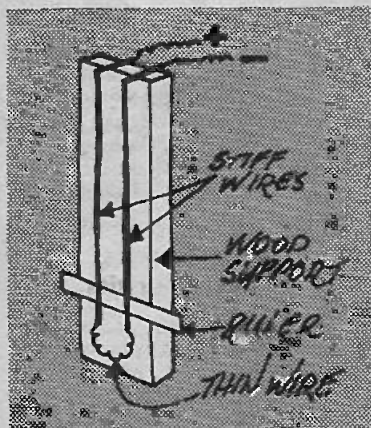

Fig. 1. Arrangement for demonstrating magnetic effect of a current.

In the classic form of the experiment, the ends were just immersed in a dish of mercury that provided a frictionless electrical connection between them, but an effective substitute is provided by a slack loop of extremely thin flexible wire; secure it to the bottom of each wire with a spot of solder. The same very thin wire

should be used to connect a battery to the top of the wires.

If a ruler is secured to the upright horizontally, a definite movement will be observed in the two wires. When the current is switched on they move away from each other. Switch off, and they return to their original positions.

The only force that can have caused such a movement is magnetism created when the current passed through the wire. Since the wires repelled each other, each wire must have offered the same polarity to the other.

We can investigate this phenomenon further by winding 20 turns of enamelled copper wire in a large rectangular shape, see Fig. 2. Bare the ends by scraping. Now cut a square of thick card and make a vee cut on opposite sides so that the coil fits into them. Sprinkle iron filings over the card before switching on

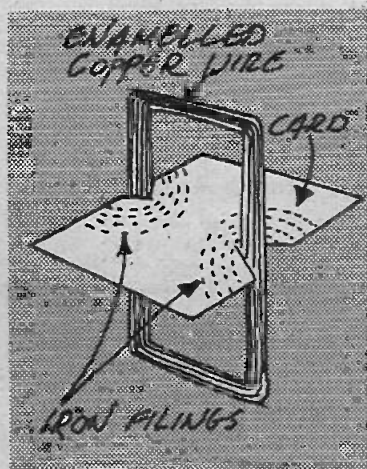

Fig. 2. Set up to investigate the magnetic field.

the battery. Tap the edge of the card very gently and the iron filings will arrange themselves in circles round the wires, as shown in Fig. 2.

The two experiments taken together give us a picture of a sheath-like magnetic field surrounding every wire that carries current and is a very important concept to hold. However, isn't there something very odd about those circles of iron filings? Regular readers will remember a similar experiment that we did with a permanent magnet; how the filings arranged themselves in arcs between the North and South poles. So what is odd? Simply this—in the sheath of magnetism round a wire, where are the poles?

Suppose we find out. Switch off the battery and remove the filings. Switch on the current again and "map" that magnetic field by means of a miniature compass. That is, place the compass near the wire and make a mark on the card by the North-seeking point.

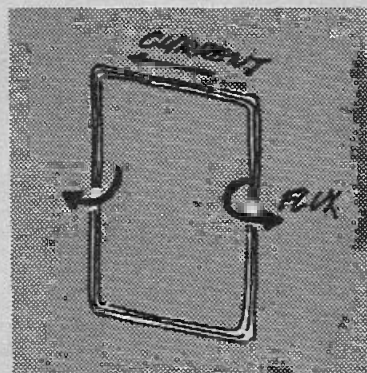

Fig. 3. Illustration of the screw-driver rule.

Move the compass and repeat several times. Soon the marks will be observed to form continuous circles; there are no North or South poles!

This single fact makes us stop and think about the nature of magnetism and what we think of as its "direction". Note the flow of the current and the flow of magnetism round the wire; it is easy to remember as the screwdriver rule (Fig. 3).

Imagine that you are holding a screwdriver in the right hand, pointing in the direction of current

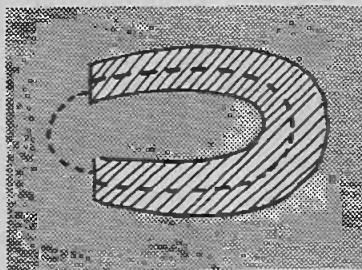

Fig. 4. Magnetic flux can exist only as a closed circuit.

flow. Then a twist of the screwdriver to the right gives the direction of the magnetic flux. If you change the polarity of the supply you will observe that the compass turns round and the mnemonic still holds good.

Like electrical currents, magnetic flux can exist only as a closed circuit and we may if we wish think of the circular form we have seen as the "pure" form that can exist only when it is contained in non-ferrous material, but distorted when near iron and completely conducted in iron, Fig. 4.

New products and component buying for constructional projects

SHOP TALK

By Mike Kerward

SINCE there are very few points to discuss concerning supplies of components for projects in this issue it gives us a bit more space to cover other things. A couple of new products of interest have appeared this month, the first is from Home Radio (Components) Ltd, and is a ready made signal injector case. The case consists of a 28mm internal diameter plastic tube 118mm long (may be easily cut down to about 70mm minimum—due to end stoppers) with two plastic push-in end stoppers, one with an 80mm brass probe fixed to it. Cost of the complete thing is 60p including V.A.T. plus 10p post and packing—Home Radio advertise in all our issues.

The second product is from GEC-Henley Ltd., and is a 65W Solon soldering iron with an adjustable bit. Just the job for heavier type work, say in the car where joints may be difficult to get at. The iron gives a choice

of straight or angled bit at the turn of a screw.

The recommended price for the iron—available through normal retail suppliers—is £3.77 plus V.A.T. at 8 per cent.

More news on the catalogue scene comes from Maplin Electronic Supplies. In addition to their 132-page catalogue which covers an extensive range of components, modules, cases, etc., and carries plenty of technical information and circuit data for i.c.s, they now send out a news-sheet free with the catalogue. A new news-sheet (try saying that quickly) is produced every two months. The sheet carries "up to the minute" information on new products, i.c. data, prices, etc.

The two they have sent us carry some great cartoons by a local "Leonardo", a nice piece about Mr. Healey's "add 25 per cent to everything" scheme and plenty of news of kits and new products not covered by their catalogue. In addition to all this the prices quoted in each sheet are guaranteed to stand for the two months' life of the sheet—not bad in this day and age when some suppliers say prices can only be quoted on the day of ordering.

I.C. Stereo Amplifier

One or two of the components specified for the I.C. Stereo Amplifier may not be available from all the suppliers but most of the larger ones should be able to cover them all. This is where catalogues come in handy. Readers must appreciate that to be fair to retailers we cannot quote one supplier unless he is the only supplier we know of, equally we cannot provide a long list of stockists for each item.

Heads and Tails

Once again no difficult to get components for the *Heads and Tails Game*. In fact the only part which may not be readily available is the Minos M2 case—this is one of the West Hyde Developments range. This, or a similar type and size case, should be available from most retailers.

Probe Tracer

This *Probe Tracer* has not been designed to fit the case mentioned earlier but could be modified in layout by anyone who knows what he is doing. However, the case described is neat, functional and very cheap.

The only part which needs some comment is the headphone, this must be of approximately the correct impedance—so check this when buying. Some surplus type phones would be suitable and probably much cheaper than new ones.

Christmas Lights Flasher

The circuit of the *Christmas Lights Flasher* is simple but unusual. However, none of the parts should be difficult to get, the neons should be the wire-ended type—not mounted in cases. Although these are harder to find they are much cheaper than the mounted type indicator, which would have to be dismantled for this application anyway.

One point to watch when buying is the insulation of the control knob; this must be fully insulated to protect the user and must cover the fixing nut of the control. It would also be an advantage if the pot. had a plastic spindle.

RECORD PLAYBACK TAPE HEADS

Individual prices of these are:
 2 track record playback heads 75p each.
 4 track record playback heads £1.10 each.
 Erase heads are also available separately—
 2 track 50p—4 track 85p.
 MV metal mounting shields 60p each.
 2 track heads already fixed on heavy mounting plate with shield £1.85. ALL PLUS 25% VAT



DRILL CONTROLLER

Electronically changes speed from approximately 10 revs. to maximum. Full power at speed by finger-tip control. Kit includes all parts, case, everything and full instructions. £2.50 plus 45p post & VAT. Made up model also available.

NEED A SPECIAL SWITCH

Double Leaf Contact. Very slight pressure closes both contacts 12p each. Plastic pushrod suitable for operating. 10p each, 10 for 88p.

1 R.P.M. MOTOR+GEAR BOX

Made by the famous Chamberlain & Hookham Ltd. These could be made to drive clock of similar. Really robust reliable unit. Price £1.50 + 30p Post & VAT

MINIATURE WAFER SWITCHES-

2 pole, 2 way—4 pole, 2 way—3 pole, 3 way—4 pole, 3 way—2 pole, 4 way—3 pole, 4 way—2 pole 6 way—1 pole, 12 way. All at 88p + 15p post & VAT each.

MULTI-SPEED MOTOR

Six speeds are available 500, 850 and 1,100 r.p.m. and 8,000, 12,000 and 16,500 r.p.m. Shaft is 1/8 in. diameter and approximately 1 in. long. 230/240v. 11.5 speed max. Further controlled with the use of our Thyristor controller. Very powerful and useful motor size approx. 2 in. dia. x 5 in. long. Price £1.40 + 45p post & VAT.

SLIDE SWITCHES

Slide Switch. 2-pole changeover panel mounting by two 6R.A. screws. Size approx. 1 1/2 x 1/2 in. rated 250V lamp. 15p + 7p post & VAT.

Sub Miniature Slide Switch. DPDT 18mm (4in approx.) between fixing centres. 28p + 9p post & VAT each. 10 for £1.90. SP Change over spring return 250V 1 amp. 25p + 6p post & VAT.

6 DIGIT COUNTER

Resetable. 440 ohm coil up to 25 impulses per second. Ex-equipment but guaranteed perfect. £3.80 + 40p Post & VAT each. † digit counter as specified for telephone charge calculator 88p.

PRESSURE SWITCH

Containing a 15 amp change over switch operated by a diaphragm which in turn is operated by air pressure through a small metal tube. The operating pressure is adjustable but is set to operate in approx. 10m. of water. These are quite low pressure devices and can in fact be operated simply by blowing into the inlet tube. Original use was for washing machines to turn off water when tub has reached correct level but no doubt has many other applications. £2.10 each + 25p post & VAT.

TELESCOPIC AERIAL

for portable, car radio or transmitter. Chroms plated—six sections, extends from 7 1/2 to 47in. 50p + 15p Post & VAT.

KNUCKLED MODEL FOR P.M. 80p + 17p Post & VAT.

LIGHT DIMMER KIT

For dimming up to 250w without heat sink or 750w with heat sink. This comprises quadrate variable control potentiometer, condenser, resistors, lag strip for mounting and data. Price £1.95 + 30p Post & VAT.

RELAY BARGAIN

Type 600 relay, 2-changeover one open and one closed contact. Twin 500 ohm coils make this suitable for closing off DC 6V, DC 12V, DC 24V or AC mains using resistor and rectifier. 40p each. Resistor and rectifier 20p extra... and Post VAT 20p.

TERMS

CASH DISCOUNTS
 25% on order over £500, 20% over £100. 15% £50, 10% £20.

SMALL ORDERS

Please add 30p H order under £5.

LARGE ORDERS

Deduct discounts as follows: £30-£50 deduct 10%; £60-£100 deduct 15%; £100-£499 deduct 20%; over £500 deduct 25%.

SWITCH TRIGGER MATS

So thin is undetectable under carpet but will switch on with slightest pressure. For burglar alarms, shop doors, etc. 24in x 18in £1.90. Post & VAT 30p. 18in x 0in £1.50. Post & VAT 25p



SMITHS CENTRAL HEATING CONTROLLER

Push button gives 10 variations as follows: (1) continuous hot water and continuous central heating (2) continuous hot water but central heating off at night (3) continuous hot water but central heating on only for 2 periods during the day (4) hot water and central heating both on but day time only (5) hot water all day but central heating only for 2 periods during the day (6) hot water and central heating on day time only then for summer time use with central heating off (7) hot water continuous (8) hot water day time only (9) hot water twice daily (10) everything off. A handsome looking unit with 24 hour movement and the switches and other parts necessary to select the desired programme of heating. Supplied complete with wiring diagram. Originally sold, we believe, at over £15—we offer these, while stocks last, at £5.65 each, VAT & Postage 85p each.

WALL THERMOSTATS (SMITHS)

Wall mounting and in a handsome plastic case. (Cream and beige). Adjustable by slider (lockable) and may be set to control temperatures from around freezing through to 50°C. The slide panel is engraved and indicates (frost), (warm), (very warm), etc. The thermostat will control heaters, etc., up to 15 amp at normal mains voltage and is ideal for living room, bedroom and greenhouse, etc. Price £1.95. VAT & Postage 80p. Don't miss this.

AUDIO AMPLIFIER

Part of the famous Reddione background music system, secondhand, but believed in good order. However, no guarantee; we are selling for spare-value only. These are 6 valve amplifiers, the output valves are 2 x EL 84 in push/pull, complete with mains transformer, rectifier and ample smoothing equipment. The mains transformer alone, today would cost at least £4. Size is 9 1/2" x 5 1/2" x 4 1/2". Price only £2.00 + postage and VAT £1.50.

15A ELECTRICAL PROGRAMMER

Learn to your sleep: Have radio playing and kettle boiling as you awake—switch on lights to ward off intruders—have a warm house to come home to. All these and many other things you can do if you invest in an electrical programmer. Clock by famous brand with 15 amp motor switch. Switch-on time can be set anywhere to stay on up to 6 hours. Independent 60 minute memory buzzer. A beautiful unit. Price £2.95. VAT & Postage 60p, or with glass front, chrome bezel. £1.50 extra.

SHORTWAVE CRYSTAL SET

Although this uses no battery it gives really amazing results. You will receive an amazing assortment of stations over the 10, 20, 31, 39 metre bands—KIT contains chassis front panel and all the parts. £1.60—crystal earphone 55p. VAT & Postage 75p.

THIS MONTH'S SNIP

Smiths 24 hr. timer heart, really the "Autoset" without its plastic case. This is a 24 hr. twice on, twice off, clock switch which will repeat until re-programmed. Switches rated at 15 amps. Limited supplies—£3.95 VAT & post 55p. each.

12 VOLT 1 1/2 AMP POWER PACK

This comprises double-wound 230/240V mains transformer with full wave rectifier and 2000 mfd smoothing. Price £3.75 plus VAT and Post 21.

Heavy Duty Mains Power Pack. Output voltage adjustable from 15-40V in steps—maximum load 250W—that is from 8 amp at 40V to 15 amp at 15V. This really is a high power heater unit with dozens of workshop uses. Output voltage adjustment is very quick—simply interchange push on leads. 8filcon rectifiers and smoothing by 3,000mF. Price £10.50 plus 25p VAT & post.

TANGENTIAL HEATER UNIT

This heater unit is most efficient, and quiet running. Is as fitted in Hoover and blower heater—costing 216 and more. Compresses motor, impeller. 2kW element and 1kW thermal allowing switching 1, 2 and 3kW and with terminal safety cut-out. Can be fitted into any metal line case or cabinet. Only needs control switch. £5.82 plus VAT & post £1.28W Model as above except 2kW £4-25 plus VAT & post 75p. Don't miss this. Control Switch 44p. P. & P. 40p.

INSTANT START FLUORESCENT LIGHTING BARGAINS

Starterless control gear, complete with tube ends and tube clips for window lighting, signs, fascias, etc. 4 ft. 40 w. £1.80; 5 ft. 65w. £2.00; 5 ft. 80w. £2.20; 6 ft. 80w. £2.45; and for pairs as follows—twin 2 ft. 20w. £2-55; twin 3 ft. 30w. £3-55; twin 4 ft. 40w. £3-25; twin 5 ft. 65w. £3-25; twin 5 ft. 80w. £3-95; twin 6 ft. 80w. £5-75. These are about one half of maker's current prices and can't be repeated once stocks are cleared. Please add 30p per piece to cover postage or carriage and 8% VAT.

MAINS TRANSFORMERS

All standard 230-250 volt primaries.	1 p	2 p
1v	2 amp (special)	1.75
2-4v	5 amp	.85
6-3v	2 amp	1.85
6-3v	3 amp	1.75
9v	1 amp	.95
12v	3-5 amp	2.80
12v	1 1/2 amp	1.60
12v	1 amp	1.40
6-5v-0-6-5v	1 amp	1.50
18v	1 amp	1.50
24v	2 amp	2.25
24v	3 amp	3.50
12-0-12v	50mA	1.20
6-0-6v	1 amp	2.00
8-0-8v	1 amp	1.50
18-0-18v	2 amp	3.50
25v	1 1/2 amp	1.85
60v 2 amp & 6-3v	1 amp	4.50
60v 3 amp & 3v	1 amp	7.50
27v	3 amp	4.50
30v	37 amp	22.00
80v tapped 75v & 70v	4 amp	5.50
230-0-230v	1.5 amps	1.75
275-0-275v at 90mA & 6-4v	3 amps	2.25

EHT Transformer 5000v 25mA (intermittent) 5.50
 Chassis Transformers
 6v and 12v 2 amps 1.50
 6v and 18v 3 amps 2.25
 6v and 12v 5 amps 3.50
 Add 30p per piece to cover postage and VAT 25%.

ONLY £1.50 FOR SEVEN ELECTRIC MOTORS

7 powerful batt. motors as used in racing cars & power models. Output & types vary for use in hundreds of different projects—Tools, toys, models, etc. All leads are reversible & for 1 1/2-15v. basis. Wiring diag. inc. VAT & Post 40p. FREE plan for min. power station.

BLACK LIGHT

As used in discotheques and for stage effects, etc. Virtually no white light appears until the rays impinge on luminous paint or white shirts, etc. We offer 9" 6v tubes complete with starter, choke, lamp-holder and starter-holder. Price £2.75 + 30p post. Tubes only £2. Post & VAT 60p.

MULLARD AUDIO AMPLIFIERS

All in module form, each ready built complete with heat sinks and connection tags, data supplied.
 Model 1153 500mW power output £2.10 + 40p post & VAT.
 Model 1172 1W. power output £1.35 + 45p post & VAT.
 Model EP9000 4 watt power output £2.40 + 50p post & VAT.
 EP 9001 twin channel or stereo pre amp. £2.50 + 50p post & VAT.

LIGHT SWITCH

Automatically switches on lights at dusk and off at dawn. Can also be used where light and dark is a convenient way to stop and start an operation. Requires only a pair of wires to the normal switch. In bakelite box, normal switch-plate size. 1 amp model £3.75. VAT and Postage 60p.

MAINS TRANSISTOR PACK

Designed to operate transistor sets and amplifiers. Adjustable output 6v, 8v, 12 volts for up to 500mA (class B working). Takes the place of any of the following batteries: PFI, PF3, PF4, PF5, PF7, PF9 and others. Kit comprises: main transformer rectifier, smoothing and load resistor condensers and instructions. Real snip at only £1.50. VAT & Postage 60p.

SOUND TO LIGHT UNIT

Add colour or white light to your amplifier. Will operate 1, 2 or 3 lamps (maximum 450w). Unit in Box all ready to work. £7.95 plus 30p VAT and postage.

MAINS MOTOR

Precision made—used in record decks and tapes recorders—ideal also for extractor fans, blower heaters, etc. New and perfect. Snip at 95p + VAT & Postage 20p. Postage 20p for first one then 10p for each one ordered.
 1 1/2 stackmotor £1.25 + VAT & postage 25p. 1 1/2 stackmotor £1.50 + VAT & Postage 30p.

EXTRACTOR FAN

Cleans the air at the rate of 10,000 cubic ft. per hour. Suitable for kitchens, bathrooms, factories, changing rooms, etc. It's so quiet it can hardly be heard. Compact, 5 1/2" casing with 5 1/2" fan blades. Kit comprises motor, fan blades, sheet metal casing, pull switch, mains connector and fixing brackets. £4.25 VAT & Postage £1.50.

J. BULL (ELECTRICAL) LTD.
 (Dept. E.E.), 103 TAMWORTH ROAD,
 CROYDON CRO 1XX

Don't miss your copy of HENRY'S CATALOGUE

only
50p
Plus 15p
P&P



- ★ OVER 5,000 ITEMS - largest UK range of electronic components for home constructors.
- ★ 200 PAGES - every aspect of electronics and components for amateurs and hobbyists - kits, projects, test gear.
- ★ DOZENS of new lines and new ranges.
- ★ MANY price reductions throughout the new Catalogue.
- ★ A Discount Voucher with every copy, worth 50p.

NEW ELECTRON STORES OPEN
94-96 UPPER PARLIAMENT ST., NOTTS. Tel: Nottingham 42668.
231 TOTTENHAM COURT ROAD, W1. Tel: 01-530 3459.

Write now for your copy, enclosing 65p remittance.

MIDLANDS:

New Electronics Store Open,
94/96 Upper Parliament Street,
Nottingham. Tel: (0602) 40403

HENRY'S

Electronic Centres

404-406 Electronic Components & Equipment 01-402 8381

354 PA Disco Lighting High Power Sound 01-402 5954

303 Special offers and bargains store

All mail to 303 Edgware Road London W2 1BW

Prices correct at time of preparation. Subject to change without notice. E & O E

Hi Fi and
Electronics
Centres Open
9am - 6pm

ELECTRONIC FOOTBALL & TENNIS

WITH THE FABULOUS VIDEO SPORT ON YOUR OWN TV

Play three exciting electronic ball games: FOOTBALL, TENNIS, HOLE IN THE WALL on your own TV! Just plug Video Sport into the aerial socket of your TV and away you go. Completely safe for you, your children and your TV. Mins operated. OUR INCREDIBLE PRICE £29.50 inc. VAT DEMONSTRATIONS NOW IN ALL CENTRES!



AM/FM MODULES LP1179 LP1171

Combined AM/FM tuner modules, together with a small number of R.C.'s Ferrite aerial, make up a sensitive FM/MV/LW tuner. 5v. Supply, supplied with data and circuit sheets. LP1171 COMBINED IF STRIP £4.60 LP1179 AM FRONT END AND AM GANG £4.60. £8.12 THE PAIR. Suitable Ferrite aerial 87p



UHF TV TUNERS

625 line receiver UHF transistorised tuners UK operation. Brand new. (Post/packing 25p each). TYPE B 4-button push button (edi.) £4.60. TYPE C variable tuning £2.90. TYPE D 6-button UHF/VHF tuner £5.20

ALL HENRY'S PRICES
INCLUSIVE OF VAT

Build the Texan & FM Tuner TEXAN 20 +20 W STEREO AMP

Features glass fibre PC board, Gerdners low field transformer, 8-1C's 10-transistors plus diodes etc. Designed by Texas Instruments engineers for Henry's and P.W. 1972. Overall size 151" x 23" x 62" mains operated. Free teak sleeve with every kit. £29.95 (built & tested £39.95) (Carr. 50p).

HENELEC STEREO FM TUNER

Features capacity diode tuning, lead and tuning meter indicators, mains operated. High performance and sensitivity. Overall size in teak sleeves 8" x 21" x 61". Complete kit with teak sleeve. £26.25 (built & tested £31.20) (Carr. 50p).

JOIN THE LARGE BAND OF CONSTRUCTORS!

SPECIAL OFFER

GARRARD CT4 STEREO CASSETTE TRANSPORT MECHANISM

- Stereo Heads
- Built in Motor Stabiliser
- Auto Stop+Eject
- Pause Control

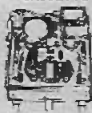

● 12V DC Operation. Robust, precision engineered mechanism based on the "STARR" patented design. Ideal for use in Car stereo cassette players, Hi-Fi stereo cassette recorders. Industrial and many other applications. Suitable for the 'PW' Ascot Stereo Cassette Deck.

£13.50 inc. VAT p & p 35p

AVO 9 MOVEMENTS New condition

£6.50 inc. VAT

FREE:

SEND NOW FOR OUR FREE LIST NO. 36 FOR OUR COMPLETE RANGE OF OVER 2,000 SEMICONDUCTOR DEVICES AT NEW LOW PRICES.

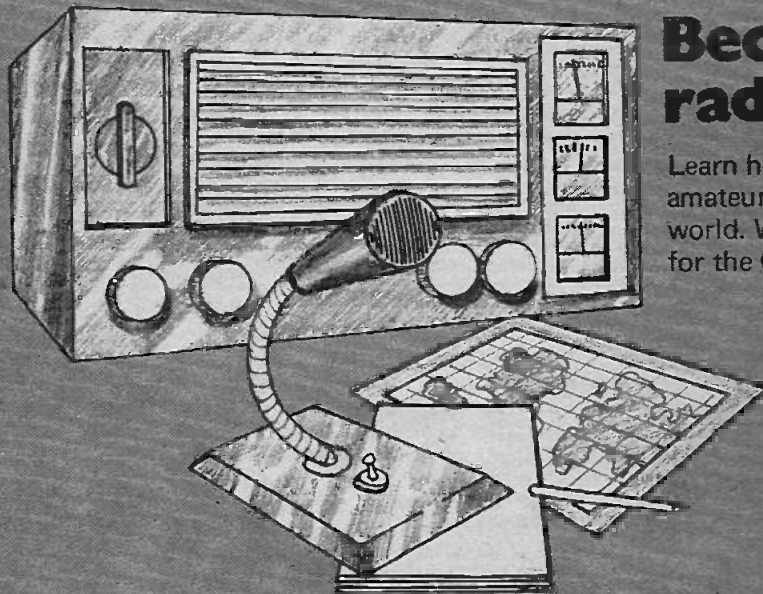

Become a radio amateur.

Learn how to become a radio-amateur in contact with the whole world. We give skilled preparation for the G.P.O. licence.

Free!

Brochure, without obligation to:

To: BRITISH NATIONAL RADIO & ELECTRONICS SCHOOL, Dept. EEB125,
P.O. Box 156, Jersey, Channel Islands.

NAME _____

ADDRESS _____

Block caps please

COUNTER INTELLIGENCE

By PAUL YOUNG



FOR the Christmas number our Editor kindly allows me to stray slightly from the straight and narrow. It follows that the tenor of this article will differ from the norm. I trust that if it does not instruct at least it will entertain. As they say in all the best serials, "Now read on".

In 1932 we were still in the grip of the depression. There were twenty men after every job, and to be jobless meant near starvation. I was searching for a job, when an advert caught my eye:

"Wanted radio engineer used to P.A. work, must be able to drive car, apply Alexander Black, The Wireless Doctor, 32 Ebury St, London SW1".

There was one little snag, I had never driven a car but I needed a job and anyway, I figured, I had driven a motorcycle and there could not be much difference. My friends still do not believe me when I tell them that my first experience of driving a car was from Victoria up to Marble Arch, down Oxford Street and along Tottenham Court Road to the Y.M.C.A., but the purpose of this story is not to tell you about a trip that still gives me nightmares, but about the job.

Much of the work consisted of putting in temporary public address systems in various London theatres and controlling them during the show. Needless to say our equipment was primitive by modern standards, big heavy valve amplifiers, feeding huge exponential horn speakers. The microphones, believe it or not were carbon granule, powered by a nine volt grid bias battery. Woe betide any singer, who in a moment of enthusiasm picked one up. The noise, sounded as if the roof was falling in.

After a short while I was asked to do the installation for a new play opening in London entitled "Whistling in the Dark". It would

also be my duty to travel round with it. It was an ingenious play and had a great success in America where it was made into a film, but in order that you appreciate the full flavour of my later predicament, I had better briefly explain the plot. Some gangsters capture a writer of "Who dunnits" and his girl friend. They threaten to torture the girl if he does not invent a way to kill the District Attorney without detection.

The writer explains how to put poison in his toothpaste. The gangsters rip the telephone out, remove it and leave the hero and heroine locked in the room while they go off to commit the perfect crime. Our hero has got to get a message to the outside world somehow. Being a resourceful man, and no doubt having been a regular reader of EVERYDAY ELECTRONICS, he has noted there is a radio set in the room, and he works out that by connecting the telephone leads to the output stage, he could utilize the speaker as a microphone and call the exchange, and then by changing the leads on the detector stage, he could hear their reply. After several attempts he succeeds and the D.A. is saved and all ends happily.

My job was to provide all the necessary sound effects. We played the Comedy Theatre, the old Fulham Shilling Theatre, and then we went to the Theatre Royal Chatham. I always used to get to a new location about two o'clock which gave me a good four hours to lay out the cables, plug in the mains and test. The last job was usually to connect the two wires to the microphone battery. The mains was a long way from the stage and I ran out my cable and connected up.

I switched on and bang went all the main fuses. Having ascertained the amplifier was alright I

looked at the cable and to my horror I found I had been given 1/044, the type of cable you use for permanent house wiring. I had already rolled it up and un-rolled it a few times and having only one copper wire in each lead, it was now beginning to break up. I could not possibly find any new cable in the short time left, so I had to search for the breaks with

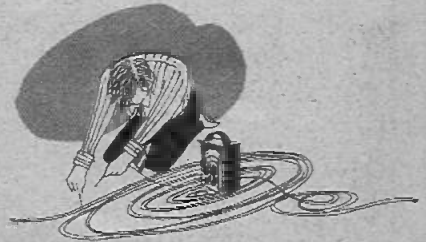

an Avometer and a pin connected to one test lead. As I found each break I had to repair it; there were four of them all told. By now they were ready to start Act I.

The stage manager was very understanding and so were the actors. They said they could stall in Act I (where the radio was just switched on to establish its presence) but if the outfit did not work at the appropriate time in Act II, they would have to return everyone's money. I should explain here, that at the right moment, a girl acting as a telephone operator, spoke into the microphone off stage and the result came out of the loud speaker of the radio.

You will never believe this, but it's true, I connected up the microphone battery with just two seconds to spare. I held my breath, and then to my utter relief, I heard a nasal feminine voice coming from the stage radio saying "Number please". You will now understand that I did not acquire all my white hair, through trying to advise you on component buying!

Happy Christmas.



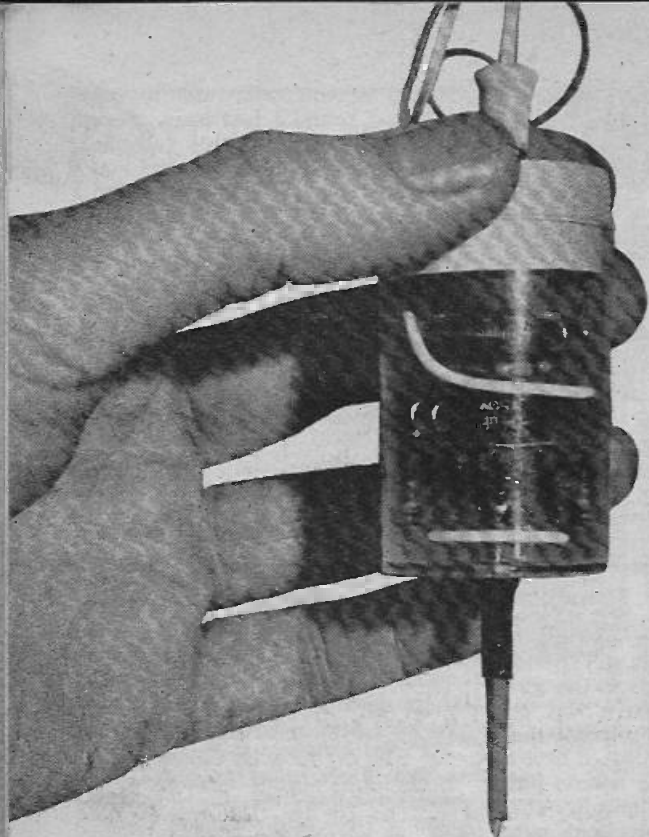

off when they are unplugged. Current drain is small, from a single dry cell in the unit and should therefore last a long time.

CASE AND BOARD

The tracer is constructed to fit in a plastic container 70mm long by 35mm in diameter. The container was originally used for holding confectionary decorations and spices. The exact dimensions are not important, provided all the components can be accommodated.

The prototype circuit board was 0.15 inch plain matrix board size 55 x 32mm and was cut so that it would slip inside the container. A little needed to be filed away each side near the lid, so that the latter could fit. If the container is not quite the same size as this, the board is cut to suit. It is not likely to be easy to fit the parts in a case which is very much smaller than that mentioned.

BOARD WIRING

The probe should be fitted first, and is a 6 BA threaded rod, about 65mm long. It is fixed with adhesive, and tied using thread passed through the holes in the board, using a needle, and similarly smeared with adhesive; C1 is best

PROBE TRACER

By F. G. RAYER

A SIGNAL tracer allows the presence of a signal to be followed through the various sections of a receiver, and can thus be of considerable aid in locating the site of a fault. The tracer shown here is contained within a small probe unit, to hold in the hand, with output to a single earpiece, or pair of headphones. It is suitable for radio frequency, intermediate frequency, and audio circuits.

THREE-STAGE CIRCUIT

The circuit diagram is shown in Fig. 1 and is basically a demodulator D1 followed by two audio amplifiers; C1 is an isolating capacitor, so that touching the probe upon various circuit points does not cause a short circuit, or upset d.c. working conditions in the receiver or other apparatus.

Capacitor C1 is rated at 150V, and the unit is intended for working on transistor equipment, where only low voltages will be present.

Capacitor C2 couples the demodulator to the first audio amplifier TR1, and C4 couples to the second stage TR2. Current for TR1 and TR2 base is obtained through R5 and the headphones. This allows the probe to be switched on or brought into use by plugging in the phones. It is switched

soldered to the probe before fixing it in this way.

As the battery rests along the underside of the board, no leads or joints occupy the centre rows of holes. Components R1, R6, TR1, and TR2 must be kept inwards so that the board can be placed in the container, see Fig. 2.

The battery will seldom need renewing, and leads are soldered to it, the outer case being negative. Though the HP7 cell can be fitted, the smaller HP16 cell would be satisfactory, if necessary.

CASE FITTING

The tracer can be tested before fixing it in the case. The probe passes through a hole drilled in the bottom. A washer and nut are put

FOR
GUIDANCE
ONLY

ESTIMATED COST*
OF COMPONENTS

excluding V.A.T.

£1.80

excluding case
and headphones

*Based on prices prevailing at
time of going to press



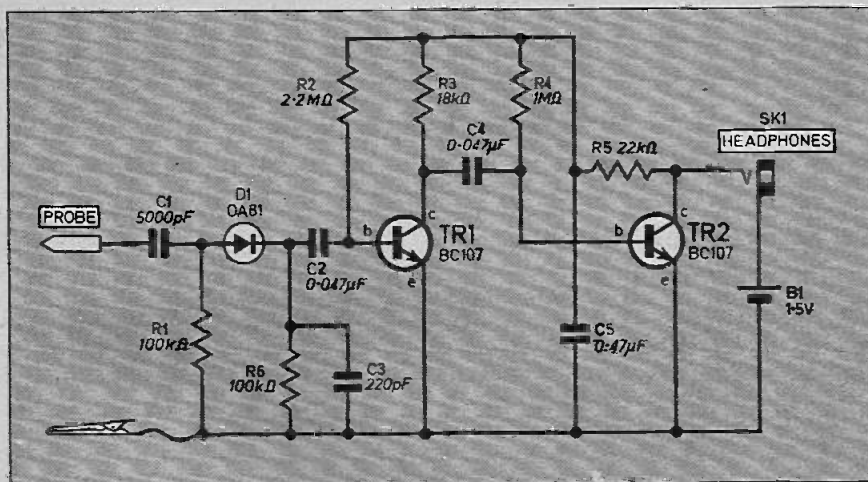
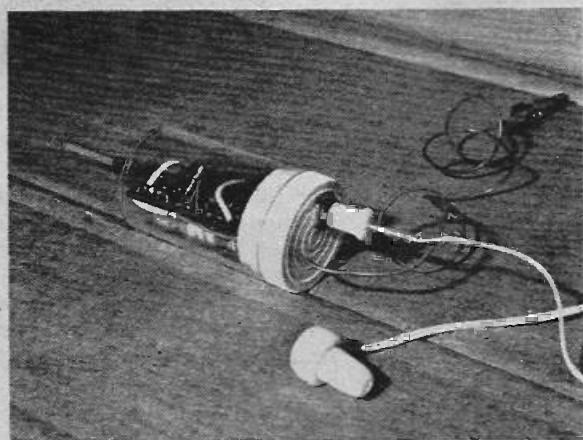

Fig. 1. The complete circuit diagram of the Probe Tracer.

on here, and insulated sleeving to cover the probe nearly to its point.

At the top of the case, a hole is made in the lid so that the jacket outlet bush passes through it. Run 300mm or so of thin flexible wire (from the emitter of TR1) through a small hole, and fit this with a crocodile clip. The lid can then be put on, followed by the outlet nut.

A surplus pair of 100 ohm headphones was found ideal for use with the probe, but phones of other resistance, or single personal type earpieces (except crystal) can be used instead.



Photograph of completed unit and earpiece. Alternatively headphones can be used.

METHOD OF USE

Tests begin at the earliest point in a receiver where signals can be heard, and proceed step by step through the circuit. When the point where a fault which prevents reception exists is passed, signals cease. Detailed checks are then made between this point and the earlier point, where signals were present.

The typical circuit for which the probe may be used is shown in Fig. 3. This a superhetrodyne circuit and will be helpful in understanding how the tracer can be employed.

The probe earth clip is attached to the receiver earth line. Referring to Fig. 3, the probe could be placed at some later point such as E, to check that TR1 and TR2 are operating. But assuming that the method of use is more easily followed if the circuit is taken from the beginning, a first test could be made with the probe at A. To obtain sufficient signal strength, a temporary aerial needs to be attached to the receiver. If there is no external aerial socket, it can be taken to A. If signals cannot be tuned in, L1, VC1 and T1 and connections to them are

Components....

Resistors

- R1 100kΩ
 - R2 2.2MΩ
 - R3 18kΩ
 - R4 1MΩ
 - R5 22kΩ
 - R6 100kΩ
- All $\frac{1}{4}$ W \pm 5% carbon

Capacitors

- C1 5000pF 150V working ceramic or plastic
- C2 0.047μF plastic or ceramic
- C3 220pF ceramic or polystyrene
- C4 0.047μF ceramic or plastic
- C5 0.47μF ceramic or plastic

Semiconductors

- D1 OA81 or similar germanium type
- TR1 BC107 silicon npn
- TR2 BC107 silicon npn

Miscellaneous

- SK1 3.5mm jack socket
 - B1 1.5V HP7
- Plain matrix board size 0.15 inch x 55 x 32mm; plastic tubular case, connecting wire; 65mm long 6BA bolt.

**SHOP
TALK**
SEE

PROBE TRACER

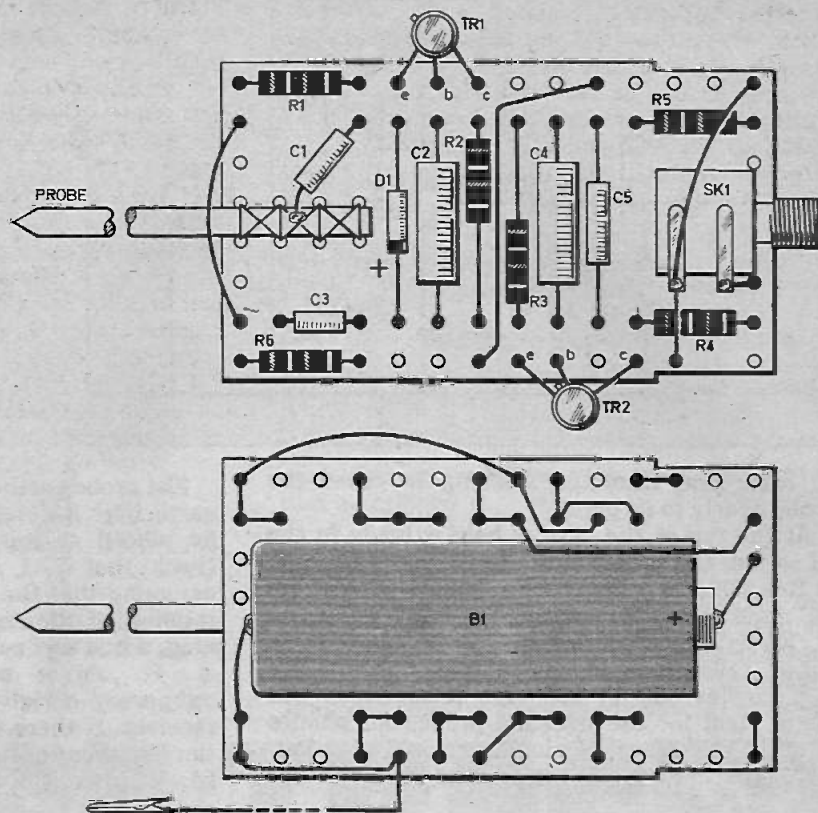

Fig. 2. The layout of components and wiring details on the component board.

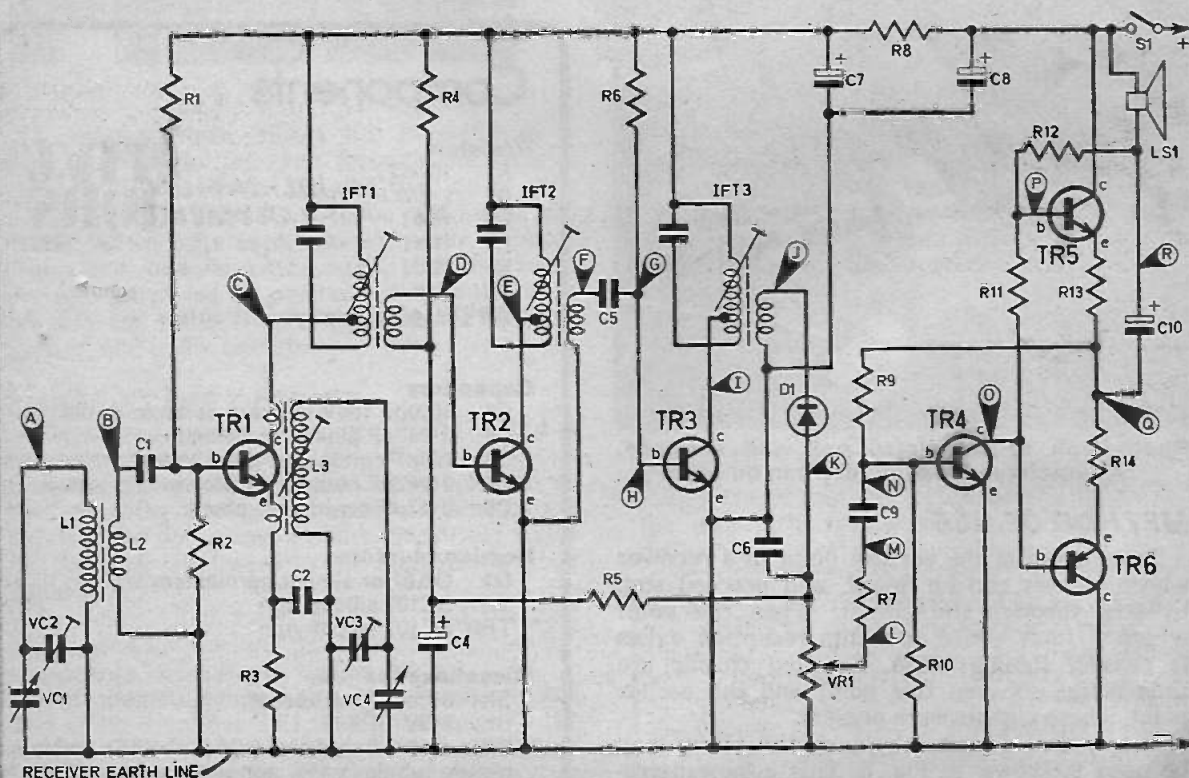

Fig. 3. The circuit of a typical superhetrodyne receiver with test points to illustrate the method of using the Probe Tracer.

suspected. Assuming signals are obtained, moving the probe to B checks L2. Volume will normally fall considerably, as L2 has few turns.

Signals should be received with the probe at C. If not, TR1 and its associated components R1, R2, R3, L3, C2, VC3 and VC4 are suspect.

Volume at D will again fall, due to the loss in IFT1. If signals are present at C, but not at D, IFT1 or its connections need checking.

Point E introduces TR2, and considerable gain should be apparent, compared with D. No signals at E (when obtained at D) suggest that TR2, R4, R5, VR1 and C4 need checking, and also IFT2.

Tests continue at F, then G. With a circuit board which may have a virtually invisible conductor crack, a test such as at G then at H will establish if the signal is lost in a typical foil conductor such as that from G to H.

Point I tests TR3 stage, and point J completes IF tests.

Audio circuit tests can be at K, and at L, to check VR1. Location M checks R7, and after this N checks C9. Point O checks TR4 stage. P, Q, and R are subsequent test points.

When moving ahead in this way through the receiver, volume may be expected to become too great. Up to point K this can be avoided by de-tuning or finding a weaker signal. After VR1, volume is controllable by this component.

Where sounds from the speaker are troublesome when tracing the source of an intermittent contact or some other fault which does not wholly prevent reception, the speaker can be temporarily disconnected. A resistor of about the same value is temporarily connected in its place.

When a defective stage has been located, some fault such as a poor joint, or short-circuit between conductors, may be obvious. If not, it is then necessary to check components and connections individually. There may only be a few items in the part of the circuit which has been found to be defective.

A voltmeter will show if the expected voltage is found across C8 (clearing the on/off switch, etc.) and across C7 (clearing C7 and R8), and at points such as C, E and I, to check any suspected winding here. Naturally detailed checks are only necessary over any part of the circuit which could cause the loss of signals between consecutive test points, as explained.

A resistor of about 1 megohm may be soldered directly to the probe tip, and can be included in the sleeving, to minimise the loading of any circuit by the probe. This does, however, reduce sensitivity to very weak signals, and normally any loading by the probe, or de-tuning produced by it, will not be of importance in circuit tests which are intended to locate a fault. □

Your Career in **ELECTRONICS**

By Peter Verwig

TECHNICAL PUBLICATIONS

EVERY item of electronic equipment and, indeed, most of the electronic components with which they are built, need backing up with user documentation of one sort or another. For a component such as a transistor or integrated circuit there is at least a specification and generally some application notes as a guide to the user on how to best use the component in practical electronic circuits and what pitfalls to avoid.

An equipment needs a user manual to instruct on the method of operation. This manual will often include a full description of how the equipment works and if so it will also include block

schematic diagrams. It may also include a section on fault finding and maintenance. If the equipment includes electro-mechanical equipment such as magnetic tape drive mechanisms which are subject to mechanical wear there may be a separate overhaul manual with detailed step-by-step instructions for dismantling, repair and re-assembly.

In the early days of electronics when equipment was simple in character the task of describing the equipment, how to operate it and what to do if it went wrong, was often left to the design engineer and was regarded as almost a part-time job. From a few jottings by the engineer a junior clerk might be expected to

knock the text into shape. A friendly draughtsman could produce the illustrations.

PUBLICATIONS DEPARTMENT

The situation is vastly different today. Even comparatively small companies have a technical publications department with full time authors and illustrators. In large companies such a department may number a hundred or more people on its staff. They produce technical manuals which can, for a big electronics system, run into hundreds of thousands of words bound in several volumes.

Even the typical technical handbook for an average piece of equipment will have some 15,000 words and perhaps 20 illustrations in 50 or so pages. Very small companies often have their technical publications produced by contractors specialising in such work.

The technical author and technical illustrator work behind the scenes but they are important, well respected, and have a good career structure with excellent



Illustrators co-relating drawings with equipment.

salaries. Moreover, because equipment is becoming ever more complex the demand for professional authors and illustrators is always increasing. It is a growth area offering job security as well as interest, the opportunity to be creative within certain limits and, at the end of each project, the satisfaction of seeing an end-product in which your own work is recognizable.

Note that I have stated in the preceding paragraph that there is opportunity to be creative *within certain limits*. There is, of course, no objection to a very creative person being employed in technical publications. But a good technical illustrator does not have to be an artist and a technical author does not have to be literary.

I once knew an illustrator who had water colours hung at the Royal Academy and whose postage stamp designs were adopted by a number of countries. A technical author of my acquaintance had a rising reputation as a novelist. These special skills were not, however, needed in their ordinary work. In the department, they exercised the same firm discipline as their fellow authors and illustrators in presenting facts plainly and simply, unembellished by their imaginations.

RACAL GROUP

As most readers of this series of career articles will have an

engineering rather than artistic interest, I shall concentrate on the technical author rather than the illustrator. For an up-to-date assessment of requirements I consulted the Technical Handbooks Manager of Racal Group Services Ltd., which is a central organisation serving all the UK-based manufacturing companies in the Racal Electronics Group which employs 6,000 people world-wide and has a turnover of £75 million a year.

The Group's business is founded on radio communications, instrumentation, data transmission and magnetic recording with a wide product range. The Technical Handbooks Section of the Group Publicity Department employs twenty technical authors and illustrators and may be regarded as typical. The general principles described are equally relevant to other manufacturers who may employ more or fewer people, and who may have their business in other sectors of the electronics manufacturing industry.

Unlike the other careers already outlined in this series, technical authorship is not open to the school-leaver. But if you are a school leaver intent on building a career in electronics read on. You could be a technical author in five years time and if you think you have ability and an aptitude for technical exposition, your "apprenticeship" will be all the more valuable if you have a definite target in mind.

QUALIFICATIONS

What qualifications do you need? Certainly the ability to express yourself clearly and concisely. Remember that your work as well as being clear to English-speaking operators and engineers may also have to be translated into French, German, Spanish, Arabic, Japanese or Chinese, and by translators who may have only a superficial technical knowledge. But far more important is engineering knowledge and experience.

Before you can write on any subject you must understand it. And if you are to be effective in writing on maintenance and overhaul of equipment you will need to have done some trouble-shooting and overhaul yourself although not necessarily on the equipment for which you are writing the manuals.

You will need a good personality because the actual writing of the text is the only solitary part of the total work and may take up only half or even less of your time. The rest is spent on discussion with design engineers, with the illustrators working on your project, with printers and with service engineers. You also need to be discreet and trustworthy. This is because the technical author is brought in at an early design stage of a new product so that the handbooks are printed and ready to accompany the first units leaving the factory.

You will need to preserve commercial security. No company wants to employ people who leak out confidential information. If you are working on military projects you will be bound by the Official Secrets Act and it may be that your section of the office will be isolated physically from that engaged on commercial projects.

The blend of qualities needed for a good technical author are both complex and considerable. There are very few really good handbooks produced in Europe or the United States and this is a reflection on the difficulties of finding good authors and why, when they are found, they are in such demand.

A fruitful field of recruitment is in test departments and in field engineering departments. Five years experience in either of these is a good foundation for a bud-

ding technical author. In either of these jobs a thorough knowledge of professional electronic products is obtained together with trouble-shooting experience and ability to use initiative and take responsibility.

You will have acquired a working knowledge of most techniques in electronics including analogue and digital circuits and logic. You will be capable of reading circuit diagrams and recognise the functions of each stage of a circuit. You will probably have acquired an Ordinary National or Higher National Certificate.

Given a good test engineer or field service engineer the rest can be taught. However brilliant you may be at English composition you will never get a job or hold a job as a technical author unless you have the technical knowledge appropriate to your subject. But the person with the right mix of experience and only reasonable competence in exposition can be successful.

INTERPRETER

Remember that the technical author is not writing advertising copy or a great work of literature. He is above all an interpreter. He gets notes, either written or verbal from design engineers and these are often scanty and incomplete. He may have to re-write them, expand them, compress them, edit them to make them comprehensible to the person new to the equipment. In conjunction with designers he may have to originate trouble-shooting charts and overhaul procedures.

It will be seen that this is a job for an engineer with writing ability rather than a writer with a little engineering knowledge. Given a good engineer, a technical publications department can train a newcomer in the craft of technical writing and this they are willing to do. A newcomer would generally work under supervision for his first few months, perhaps on amendments to existing manuals following product modification, or on the simpler sections of a large manual.

As experience is gained so his responsibilities will be enlarged so that he is not only meeting engineers and originating his own material but also instructing illustrators on the diagrams and other art work which will be used in support of his written matter. A senior technical author may

"employ" a junior author and a couple of illustrators. Some projects are so large that they need a group leader. Salaries for senior authors are currently in the £4,000 bracket and a junior may expect to start in a technical publications department at £2,500.

Publications dealing with defence equipment are almost invariably produced to a fixed specification in relation to layout and contents. These are currently laid down for the Army, Navy and Air Force, each of which differs in certain respects although there is a move to harmonisation. For commercial equipment most departments have their own internal standards so that most handbooks have a uniform appearance and structure of contents. But within the constraints of standardisation there is room for initiative in the art of engineering exposition.

PROMOTION

An author promoted to section leader status has additional administrative responsibilities. He will delegate tasks to authors under his control, arrange for equipments to be photographed, arrange printing orders and editorially check individual authors' drafts. At times when pressure of work is such that subcontractors may be called in, he will usually liaise with them and supervise the quality of their work.

To be a technical author is not a dead-end occupation. There is opportunity to rise to management status. Even at the bottom of the careers structure the technical author is generally regarded as being in the professional staff category on a monthly salary and entitled to additional benefits applicable to salaried staff in the company. At the least, these benefits will normally include a shorter working week and longer holidays than for shop-floor staff.

Technical authorship is a challenging occupation. It is not easy at any time and it can be very frustrating when, for example, late design changes or modifications involve re-writing or alterations to circuit diagrams or illustrations. But it can also be very rewarding. A good handbook enhances the product and although your name may not be printed on the cover it is still a book you have written or helped to write and in which you can take pride.

Technical authors may apply for membership of the Institute of Technical and Scientific Communicators who issue a diploma to those suitably qualified and experienced. The Institute has its own quarterly journal and monthly news letter, holds meetings in London, and arranges visits to industrial establishments and seats of learning. The address of the Institute is 17, Blue Bridge Avenue, Brookman's Park, Hatfield, Herts.

Engineer and Author discussing PCB circuit details.



The Extraordinary Experiments of Professor Ernest Eversure

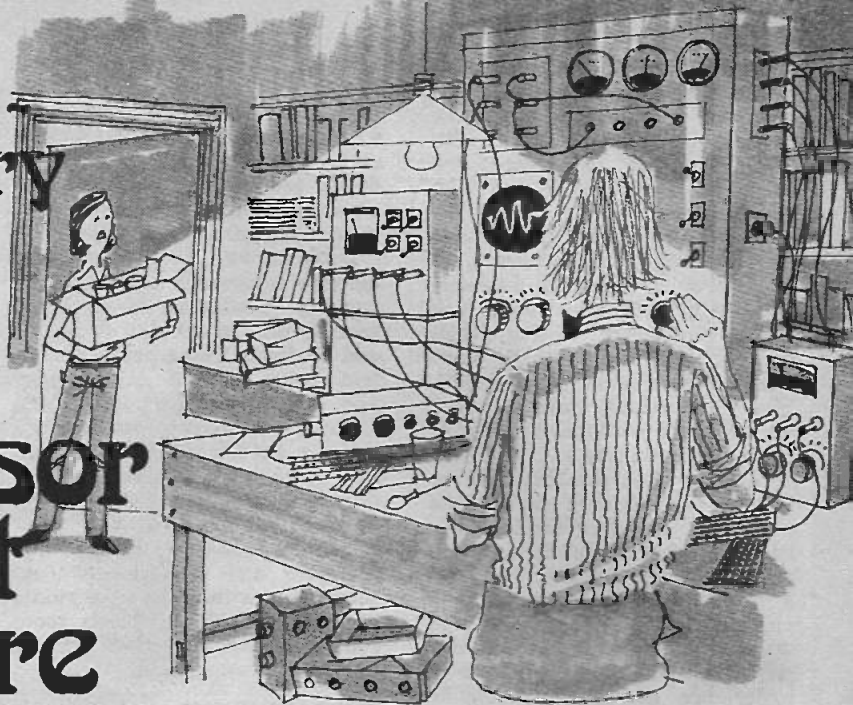

by Anthony John Bassett

NON-DESTRUCTIVE BREAKDOWN-VOLTAGE TESTER

Professor Ernest Eversure, or the Prof. as his friends call him, has been experimenting in electronics for more years than anyone can remember and we thought that you might like to hear of, and perhaps repeat, some of his extraordinary experiments. Anthony J. Bassett recounts some of these experiments every month so why not follow the Prof's work and learn along with young Bob, his friend.

FROM a safe distance Bob had seen how, with the Prof's own breakdown voltage tester, huge sparks flickered as thousands of volts flashed out to test components for his experiments. But the Prof. was now busily designing a miniature tester which would be safe for Bob to use himself. Soon he had produced a circuit-diagram for the tester (Fig. 1).

Bob collected together the necessary parts. For ME1 he used a small recording-level meter with a full scale deflection rating of 1mA. With the Prof's help, he measured the chassis, marked it and made holes to mount the meter, control, switches and terminals. (An aluminium or plastic case of about 200 x 150 x 60mm is suitable.)

After they had assembled the components onto the chassis, and carefully wired and soldered the assembly to form the circuit of Fig. 1, the Prof. carefully checked it over. In particular he checked

that C1 and C2 were firmly clamped into the capacitor clips, and sleeved with insulation to prevent any short-circuit to chassis.

When the Prof. was satisfied that the tester had been safely and properly constructed, he fixed the chassis base in place, and fitted four rubber feet.

TESTS

"This tester can be used for tests on a wide variety of components, Bob," the Prof. began, "and it can also be used to reform electrolytic capacitors, which is necessary when these have been in storage over long periods of time."

"Because the tester is likely to find most use in the testing and selection of transistors and diodes, it has been designed around this function and is therefore provided with a transistor socket and an npn/pnp polarity switch (S4).

"It can be used to test almost any type of junction transistor, and because the test-current is

limited by R1 to a very low level, the test delivers insufficient energy to damage the properties of the junction.

"Suppose we start with a BC109 transistor. To test this, beginning with S1 switched off, we will set the controls on the tester ready to begin.

"According to the specifications for a BC109, the maximum collector/emitter voltage is only 20 volts, so we can set S3 to the 300 volt range as this is the lowest available on the tester. The BC109 is an npn type, so S4 is set for npn.

"Now with S2 off, so that you do not touch the test-terminals whilst the test voltage is connected, insert the BC109 into the test socket; S2 can now be switched on. Leave S6 off; and make sure that VR1 is turned towards the S3 end so that when we switch on S1 the test voltage will start at zero.

"In order to measure the test voltage, we will connect a multimeter to the voltage-test terminals SK1 and SK2. It is best to use a high-resistance instrument of 20 kilohms per volt or more. This is because the test-current for the multimeter also flows through ME1, causing a very small error in the reading of ME1. If the multimeter is of sufficiently high

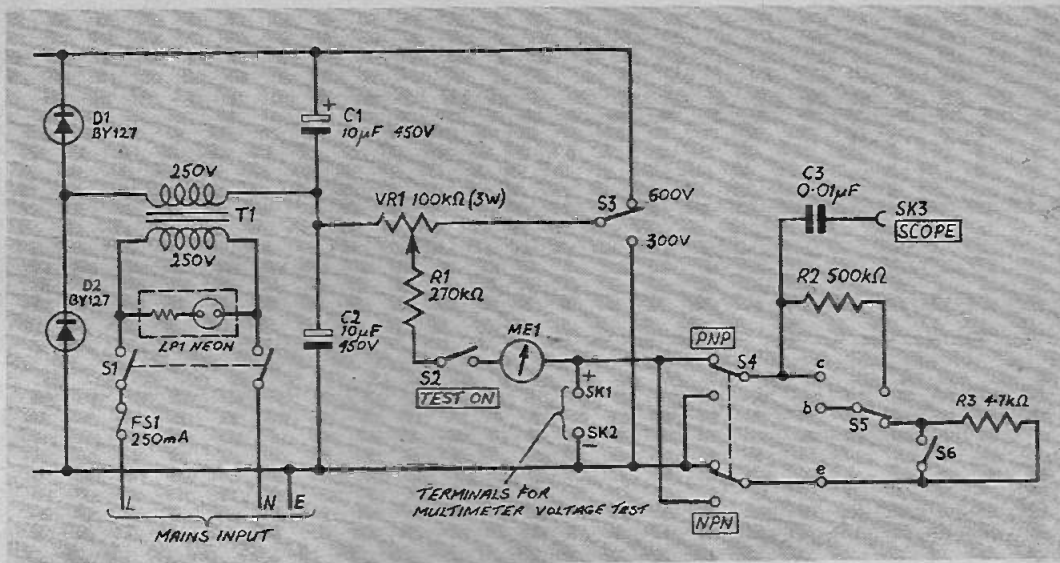

Fig. 1. Circuit diagram of the breakdown voltage tester.

resistance, the error will be so small as to be almost imperceptible, but if a low-resistance multimeter is used, the magnitude of the error would cause difficulty in using the tester."

After Bob had connected the multimeter to the terminals, he set it to the 50 volt range.

"I think the 50 volt range should be right for this test, Prof," he remarked, "as the transistor is rated at only 20 volts V_{CEO} rating."

Seeing that the multimeter was connected correctly, and that everything was ready to begin the test, the Prof. plugged the tester into the mains and switched S1 on.

The neon indicator came on, but nothing else seemed to happen until the Prof. carefully began to turn VR1. As he did so, the needle on the meter ME1 began to move across the scale, indicating that the transistor was conducting and allowing a small current to flow. The voltage indication on the multimeter, however, remained near zero.

"A small bias current is now flowing through R2, and this causes the transistor to conduct," the Prof. informed Bob.

"But if I operate the test switch S5, this disconnects R2, and connects R3 instead, and this provides zero bias. The transistor should then cease to conduct, and a voltage reading will appear on the multimeter."

The Prof. operated S5, and immediately the current reading

swung down almost to zero, and a reading of several volts appeared on the multimeter. The Prof. continued to turn VR1 clockwise, and as he did so, the reading on the multimeter rose until a voltage of 20 volts was indicated across the transistor.

SAFETY MARGIN

"This is the manufacturer's maximum rating for the transistor, Bob, but in giving this specification they always allow a margin between the voltage specified, and the voltage which the transistor will actually block or withstand. By using this tester we can find out practically how much higher we can go. This means that we can continue to turn the voltage up, using VR1, until the collector/base junction of the transistor fails to prevent a current flow through the transistor. When this happens, the current flowing will be shown on the meter ME1."

"I think I understand," said Bob; "If the makers have allowed a margin of 5 volts on their specification of 20 volts, then when we reach a reading of 25 volts a current should begin to flow. But if the margin is higher, say 10 volts, appreciable current will not begin to flow through the transistor until we reach 30 volts or higher."

"That is right," agreed the Prof., turning the voltage up first to 25 volts, then to 30 volts. Still no current was indicated.

"We have now reached another

of the manufacturer's rated maximum voltage levels, Bob. If you refer to the data once more, I think that you will find that 30 volts is given as the absolute maximum collector/base voltage in free air at 25 degrees centigrade."

The Prof., however, continued to turn the voltage up until the voltage had reached 50.

"I think that the maker's margin for maximum voltage is higher than you anticipated, Bob. We'd better change the meter range."

The Prof. switched off S2 so that the test voltage was removed whilst he changed the range on the meter. Then he switched S2 back on again and continued to turn the voltage up at a slow but steady rate. Only when the voltage reached nearly 60 volts did the needle of ME1 begin to stir to indicate a flow of current.

When this happened, as the Prof. continued to turn VR1, the current continued to rise, but the voltage remained around 60 volts.

"The actual maximum blocking voltage of this transistor has now been reached, Bob, at about 60 volts, which is far higher than the manufacturer's specification."

"Why is it, Prof., that the makers allow such an enormous margin?" enquired Bob, "Why don't they claim that this is, say, a 50 volt transistor and give the user only a 10 volt margin? Wouldn't this be sufficient?"

Answers and more tests next month.

DOWN TO EARTH

By GEORGE HYLTON

STRANGE GOINGS ON AT THE RECEIVING END

FROM time to time readers report peculiar reception of radio signals. Frequently it involves an audio amplifier which produces, unasked, a radio programme or TV sound. In these cases the explanation is nearly always that the reader who owns the audio gear lives near a radio or TV transmitter.

Strong r.f. signals get picked up on the input leads, or the wiring, or the mains connection, and so get into the amplifier, where they are rectified (detected) by a valve or transistor to produce the programme noises. (TV interference is generally accompanied by the buzz of the frame sync. pulses, which sound rather like mains hum.)

Occasionally, the interference is not present all the time. There are just short bursts of speech which disappear after a few seconds. People who experience this generally turn out to be living near roads used by vehicles with mobile radio telephones, such as the police or "radio taxi" services.

A much more unusual type of radio breakthrough is reported by a Portsmouth reader, S. G. Telford. He discovered by accident that his audio amplifier gave out Radio Sweden in English when he connected an electrolytic capacitor across the input. "The reception was perfectly clear", says Mr. Telford, "except for slight fading, but there was another station in the background."

The unusual thing about this case was that it involved long-distance reception. Usually, the signals from distant stations are too weak to break through audibly like this. Our reader thought that perhaps the particular 470 μ F capacitor he was using was tuning the equipment, so with great presence of mind he tried several others with different values. They all worked. But a short-circuit of the input silenced the programme.

What is the explanation? Well,

clearly, this is another case of r.f. breakthrough, but a most unusual one. Fortunately our reader managed, in the short time the effect lasted, to make some simple but useful tests. Shorting the amplifier input silenced the programme, so it seems clear that the transmission was coming in at the amplifier terminals, not through the mains or by direct pickup on the circuit wiring. Secondly, a capacitor—almost any capacitor—aided the breakthrough.

Now, the 470 μ F capacitance which first gave the effect has, in theory, such a low impedance at any short-wave radio frequency that it is virtually a short-circuit. In practice, however, many types of capacitor—including electrolytics—contain strips of conductor which are rolled up to form the usual cylindrical shape. A rolled-up conductor is a coil of sorts. It has inductance. Not much, but enough, perhaps, to tune the amplifier input very broadly to somewhere in the short-wave band.

It's quite possible for capacitors with very different values of capacitance to have similar values of inductance. This could explain why the radio programme was still heard when the capacitor was changed.

SELECTIVITY

Why the selectivity? Only Radio Sweden came in strongly. There's no need to assume that there was any special selectivity. This accidental reception could have been the result of freak radio propagation conditions which put a strong signal from one station into the amplifier, leaving others too weak to be heard except as background noises. It is just possible, however, that a more selective effect was at work.

For example, the mains wiring in the house could have formed an aerial tuned to Radio Sweden's frequency. The house—including

the amplifier—would then have been filled with an enhanced electromagnetic field which assisted breakthrough. Then again, the amplifier itself, though an audio amplifier, could have had stray internal feedback which made it operate as a selective short wave tuner of fixed frequency. But in this case one would have expected reception to happen frequently, not just once.

Another possibility is that the signals weren't coming directly from Sweden at all, but were being re-radiated accidentally by a receiver in the house next door, perhaps on a changed frequency.

FADING

Well, that's about as far as I can go, on the evidence, in explaining that problem. But another reader, M. P. Chamberlain of Thurnby, Leicestershire, says that the station he's listening to on his LW/MW radio starts fading in and out as soon as it gets dark, even with an outside aerial. He doesn't give any further details, but I'm placing a modest bet with myself (that way you don't lose) that it's a medium-wave station, probably near the high-frequency end of the MW band, that gives the trouble, and also that it's a fairly distant station, 100 miles away or more.

The fading happens because signals from such a transmitter can reach the receiver in two ways. During the day, they arrive by only one of these ways—the "ground wave", which is that part of the transmission which is bent round the curved surface of the earth by the process of refraction. By day, the rest of the energy from the transmitter goes off into space.

At night, on these frequencies, the ionosphere becomes a reflector, and the "sky waves" are reflected back to earth. So after dark the receiver picks up both waves—the ground wave and the sky wave. If they happen to be of equal strength, then they can either add together, giving a stronger signal, or cancel one another out. The ionosphere keeps changing all the time, so sometimes the signals add, and later they cancel, then they add again, and so on. The station "fades in and out". The only remedy is to live nearer to the station, where the ground wave is stronger all the time!

everyday electronics

VOLUME 4 INDEX

JANUARY 1975 TO DECEMBER 1975

<i>Pages</i>	<i>Issue</i>	<i>Pages</i>	<i>Issue</i>
1-56	January	341-396	July
57-112	February	397-452	August
113-168	March	453-508	September
169-232	April	509-564	October
233-288	May	565-620	November
289-340	June	621-676	December

We are unable to provide back numbers, or copies of articles.

CONSTRUCTIONAL PROJECTS

ADD-ON AMPLIFIER by R. A. Penfold	358	M.W./L.W. TUNER by R. A. Penfold	268, 316, 361
ALARM. CAR	260	MATCHBOX RECEIVER by F. G. Rayner	484
ALARM. INDICATOR AUDIBLE	468	MINSTREL. THE	244
ALARM. INTRUDER	406	MODULA 3 STEREO AMPLIFIER by Mike Kenward	66, 128, 262, 316
ALARM. RAIN	30	MOISTURE ALARM. SOIL	124, 211
ALARM. RAIN/WATER	578	MORSE PRACTICE UNIT by Mike Hughes	82
ALARM. SOIL MOISTURE	124, 211	MULTIMETER SENSITISER by R. A. Penfold	314
AMATEUR SHORT WAVE RECEIVER by F. G. Rayner	138	PRACTICE UNIT. MORSE	82
AMPLIFIER. I.C. STEREO	634	PROBE. SIGNAL INJECTOR AND LOGIC	204
AMPLIFIER. MODULA 3 STEREO	66, 128, 262, 316	PROBE TRACER by F. G. Rayner	658
AUTOMATIC GARAGE DOORS by P. H. Alley	350, 424	QUIZMASTER by R. A. Penfold	198, 262
BLEEPER. DOOR	540	RADIO CONTROL RECEIVER by R. A. Penfold	600
CAR ALARM by D. T. Goodwin	260	RAIN ALARM by L. Hardman	30
CAR RALLY INTERCOM by Mike Kenward	182	RAIN/WATER ALARM by Robert Goffin	578
CARS. ICE WARNING FOR	12	RECEIVER. AMATEUR SHORT WAVE	138
CELL CHARGER by George Hylton	372, 489	RECEIVER. MATCHBOX	484
CHRISTMAS LIGHTS FLASHER by James A. Brett	639	RECEIVER. SELF POWERED	368
CIRCUIT DECK by A. P. Stephenson	522	REMOTE CONTROL. ULTRASONIC	26
CONTINUITY TESTER by D. Andrews	478	SELF POWERED RECEIVER by R. N. Soar	368
CONTROL RECEIVER. RADIO	600	SENSITISER. MULTIMETER	413
CONTROL. ULTRASONIC REMOTE	26	SHORT WAVE RECEIVER. AMATEUR	138
COURTESY LIGHT DELAY by S. A. Money	536, 577	SIGNAL INJECTOR AND LOGIC PROBE by D. G. Ward	204
DECK. CIRCUIT	522	SOIL MOISTURE ALARM by R. A. Penfold	124, 211
DELAY. COURTESY LIGHT	536, 577	SONIC BOMBER GAME by F. G. Rayner	462
DELAYED ACTION SWITCH by J. B. Dance	74, 147	STEREO AMPLIFIER. I.C.	634
DOOR BLEEPER by A. Freed	540	STEREO AMPLIFIER. MODULA 3	66, 128, 262, 316
EGG TIMER by B. Cullen	574	SUPERHET TUNER. TWO-BAND	34
ELECTRONIC THERMOSTAT by Michael J. Holt	317	SWITCH. DELAYED ACTION	74, 147
FET VOLTMETER by Stephen Wedge	438	SWITCH. TOUCH	188
FLASHER. CHRISTMAS LIGHTS	639	TESTER. CONTINUITY	478
FUZZ BOX by C. F. Terrell	148, 211	THE MINSTREL by P. Mills	244
GAME. HEADS AND TAILS	648	THERMOSTAT. ELECTRONIC	317
GAME. SONIC BOMBER	462	TIMER. EGG	574
GARAGE DOORS. AUTOMATIC	350, 424	TOUCH SWITCH by A. Russell	188
GENERATOR. WHITE NOISE	410	TRACER. PROBE	658
GUITAR. HAWAIIAN	590	TRANSISTOR TESTER by R. A. Penfold	542
HAWAIIAN GUITAR by S. B. Browne	590	TREMOLO by M. G. Argent	518, 577
HEADS AND TAILS GAME by Robert Goffin	648	TUNER M.W./L.W.	268, 316, 631
I.C. STEREO AMPLIFIER by R. A. Penfold	634	TWO-BAND SUPERHET TUNER by F. G. Rayner	34
ICE WARNING FOR CARS by Malcolm Plant	12	ULTRASONIC REMOTE CONTROL by J. B. Dance	26
INDICATOR AUDIBLE ALARM by Malcolm Plant	468	VOLTMETER. FET	438
INTERCOM. CAR RALLY	182	WARNING FOR CARS. ICE	12
INTRUDER ALARM by D. H. Williams	406	WARNING. LIGHTING UP	96
LIGHT DELAY. COURTESY	536, 577	WARNING WINKER by George Hylton	250
LIGHTING-UP WARNING by David Smith	96	WHITE LINE FOLLOWER by Malcolm Plant	300
LIGHTS FLASHER. CHRISTMAS	639	WHITE NOISE GENERATOR by D. J. Fraser	410
LINE FOLLOWER. WHITE	300		

GENERAL FEATURES

BOOK REVIEWS	32	PLEASE TAKE NOTE	15, 147, 211, 262, 316, 361, 489, 577
BRIGHT IDEAS	43, 258, 312, 437, 532	PUBLISHERS ANNOUNCEMENT	437
COUNTER INTELLIGENCE by Paul Young	21, 90, 126, 197, 266, 309, 375, 413, 494, 532, 607, 657	READERS' LETTERS	39, 86, 160, 187, 312, 494, 535, 604, 606
EDITORIAL	10, 64, 122, 180, 242, 298, 348, 404, 460, 516, 572, 632	RUMINATIONS by Sensor	25, 137, 249
HELP!	44, 100, 152, 482	SHOP TALK by Mike Kenward	16, 87, 134, 212, 259, 316, 322, 370, 423, 483, 548, 598, 654
JACK PLUG AND FAMILY	16, 100, 206, 259, 433, 483, 545, 611, 650	WHAT DO YOU KNOW?	195

SPECIAL FEATURES

BRITISH AMATEUR ELECTRONICS CLUB	443	HOW RADAR WORKS by G. A. G. Brooke	17
COMPONENT CHECKING WITH A MULTIMETER	379	IT'S NOT MY FAULT by Phil Allcock	306
ECHO SOUNDING AND SONAR by G. A. G. Brooke	472	QUAD by Adrian Hope	77, 144, 147, 208
ELECTRONICS IN CAMERAS by J. B. Dance	414	THE FIELD EFFECT TRANSISTOR by J. B. Dance	549, 605
ELECTRONICS OFFSHORE by Bill Maconachie	381	THE UNIJUNCTION TRANSISTOR by J. B. Dance	430, 490
GUIDE TO SOLDERING	584		

SPECIAL SERIES

BEGIN HERE by Donald Maynard		Transistor Theory	275
2 Semiconductors	23	Class A Amplifier	326
3 Integrated Circuits	88	Transistor Switching Action	376
4 Testing and Construction Techniques	135	Testing and Selecting Components	434
DEMO CIRCUITS by Mike Hughes		Selecting Resistors	495
The Armstrong Oscillator	213	Souping up a Superhet.	553
DOWN TO EARTH by George Hylton		Test Gear	608
Biasing	48	Voltage Breakdown Tester	664
Loudspeaker Impedance	104	TEACH-IN 76 by A. P. Stephenson	
Capacitors	159	1.1 Electric Charge and Free Electrons	526
Power Dissipation in Transistors	222	1.2 Conductors, Insulators, and Electric Current	527
Loop Gain	280	1.3 The Battery	527
Multimeter Sensitivity	332	1.4 Resistance	528
Ohm's Law and the Golden Triangle	388	1.5 Colour Code	528
Resistors at V.H.F.	444	1.6 Circuit Diagrams	528
Transistor Substitution	500	1.7 Ohm's Law	529
Clicks and Crackles	612	Experiments and Exercises 1A, 1B and 1.1	530
Strange Goings on at the Receiving End	666	2.1 Resistors in Series and Parallel	580
FOR YOUR ENTERTAINMENT by Adrian Hope		2.2 Kirchoff's Law of Voltages	581
Calculators	47	2.3 Relative Potentials and Polarities	581
Computers	103	2.4 Kirchoff's Current Law	581
Repeatcorder and Discoust Buying	202	2.5 Conventional Current	582
Sensurround and "Flat" Batteries	265	2.6 Electromotive Force (e.m.f.)	582
Cars and Calculators	305	2.7 Measuring Voltage	582
Buying Abroad	357	Experiments and Exercises 2A and 2.1 to 2.5	583
Video Recording Equipment	432	3.1 The Multirange Voltmeter	642
Time Capsule and Video	471	3.2 The Voltage Divider	642
Professional Exhibitions	531	3.3 Variable Resistors	643
Interference and Wireless Intercoms	589	3.4 Measuring Resistance	643
Mail Order	647	3.5 Power Heat and Energy	644
PHYSICS IS FUN by Derrick Daines		Experiments 3A to 3C	645
Batteries	22	TEACH-IN 76 MATTERS ARISING	585
Magnetism	73	YOUR CAREER IN ELECTRONICS by Peter Verwig	
Faraday's Ice Pail Experiment	127	The Electronics Industry	196
Home Made Capacitors	203	The Importance of Qualifications	256
More on Home Made Capacitors	264	The Professional Institutions	310
Static Electricity	313	Apprenticeship	366
De-magnetising	387	The Post Office	420
A Magnetiser	419	The Marconi Company	486
Electrolysis	492	A Future in Valves	533
Pole Finding Paper	546	Britain's Technical Army	586
Electrolysis	599	Technical Publications	661
Magnetic Effect of Current	653	COMMENT ON CAREERS	588
PROFESSOR ERNEST EVERSURE by Anthony J. Bassett		WORKSHOP PRACTICE by Mike Hughes	
Musical Note Selector	41	Part 1 Cabinets and Enclosures	190
Experimental Microphone	92	Part 2 Professional Finish	252
Experimental Pick-up	153	Part 3 Professional Finish	323
Kazoo Pick-up	216	Part 4 Professional Finish	362
		Part 5 Professional Finish	488

SPECIAL INSERTS AND OFFERS

CONSTRUCTION TECHNIQUES WALL CHART	March 1975	INDEX FOR VOLUME 3	June 1975
CHOOSING AND USING MULTIMETERS—		CIRCUIT COMPONENTS—DATA CHART	October 1975
8 PAGE SUPPLEMENT	May 1975	SOLDERING KIT OFFER	651

The Sinclair DM2 Multimeter.

Comprehensive. Accurate. Portable.

And really rugged.

Yet only £59. (PLUS VAT)

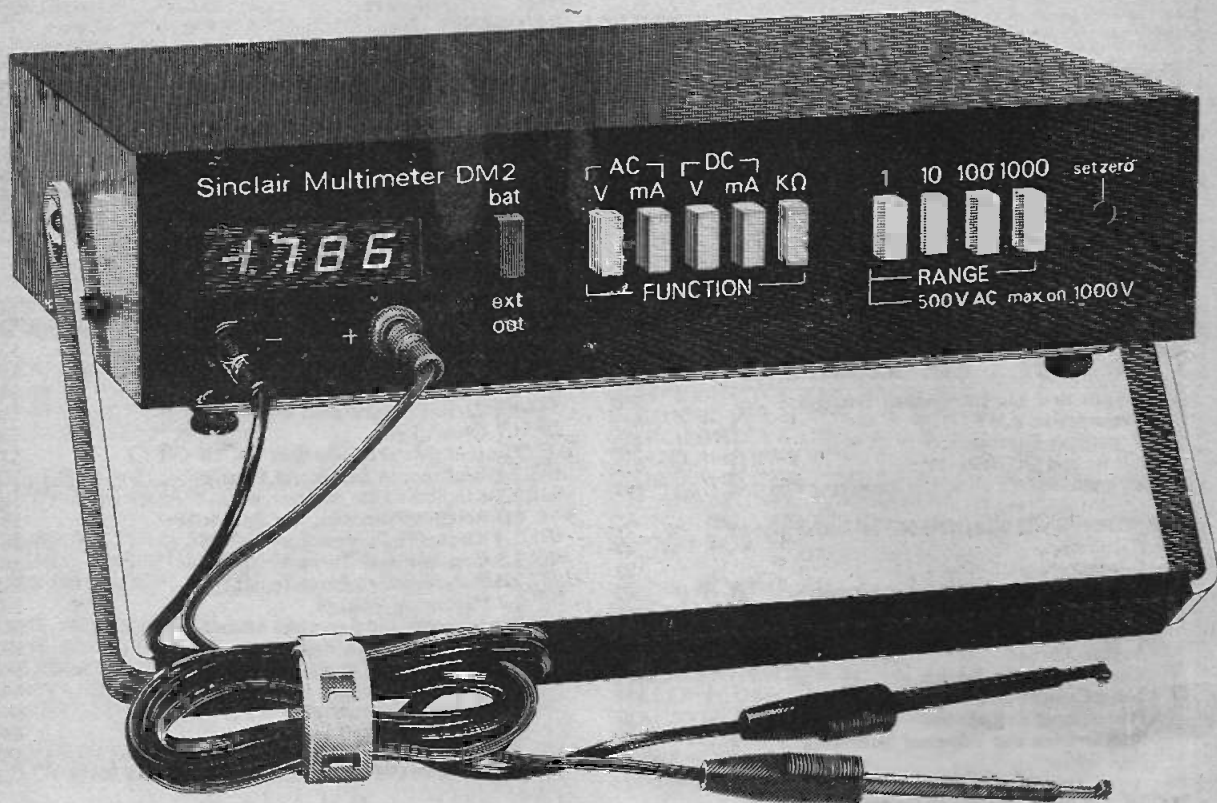

State-of-the-art circuit design, incorporating high-quality components, has resulted in a professional, $3\frac{1}{2}$ digit instrument of outstanding performance and reliability at a realistic price.

A custom-designed MOS LSI digital processing IC controls the auto-polarity dual-slope-integration A to D converter. The circuit built around this IC uses a MOSFET op-amp input buffer with 0.1% metal-film resistors. The result is excellent accuracy and stability with a very high basic input impedance.

The instrument reads to ± 1999 and has a basic accuracy on the 1 V DC range of $0.3\% \pm 1$ digit. Four 8 mm LED displays provide excellent legibility and angle of view. Battery operation allows complete independence of mains supply.

The Sinclair DM2 has all the capability you need. Just take a look at its features and compare them with higher-priced multimeters. You'll find the DM2 is their equal in virtually everything – except price!

Features of the Sinclair DM2

5 functions giving 22 ranges
 DC volts – 1 mV to 1000 V
 AC volts – 1 mV to 500 V
 DC current – 0.1 μ A to 1 A
 AC current – 1 μ A to 1 A
 Resistance – 1 Ω to 20 M Ω

Easy to use
 Automatic polarity, push-button selection for all ranges and modes from a single input terminal pair.

Easy to read
 Big, bright 8 mm LED display gives a quick, clear reading.

$3\frac{1}{2}$ digit display
 Display reads from 000 to 1999.

Overload indicator.

Protected
 Separate fuses for current and resistance circuits.

Accurate
 Dual slope integration. High stability.

Rugged construction
 Tough metal casing takes the roughest treatment – try standing on it!

Two power sources
 Supplied with a 9 V battery, giving 60-hour typical life. Mains adaptor also available.

Portable
 Weighs only 3 lb approx, including battery. Measures only 2 in x 9 in x 6 in approx.

Optional extras
 Mains adaptor – £3.19 inc VAT.
 Carrying case – £5.40 inc VAT.
 12-month no-quibble guarantee

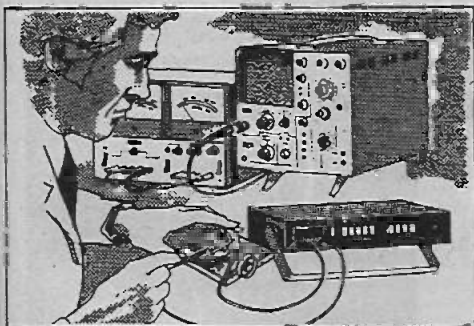

Use it in your laboratory. The DM2 sits rigidly on its combined carrying handle/stand.



Use it on the move. Keep the DM2 in its carrying case - it's always ready for use.

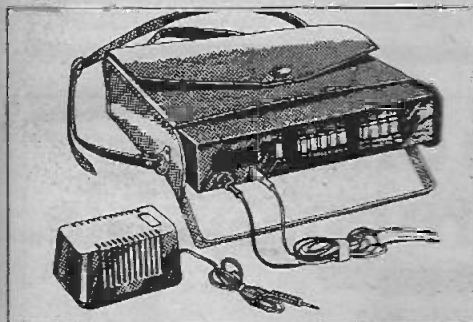

All you need to use the DM2... anywhere. Mains adaptor... carrying case... multimeter... you're ready for quick, efficient metering - whatever the situation.

Take advantage of this money-back, no-risk offer today

Test the Sinclair DM2 for yourself. Simply send us a cheque, your Access/Barclaycard number, or an official company order, with the coupon below. And in the unlikely event you find it's not what you need, return it to us within 10 days and we'll refund your money in full.

Interested in a quantity discount? Use the coupon to arrange a demonstration and get details of prices on 5 or more instruments.

Sinclair Radionics Ltd,
London Road, St Ives, Huntingdon,
Cams., PE17 4HJ.

Tel: St Ives (0480) 64646.
VAT Registration No: 213 8170 88.

sinclair

Everyday Electronics, December 1975

The Sinclair DM2 Multimeter: full technical story

DC Volts Range	Accuracy	Input Impedance	Resolution
1 V	0.3% ± 1 Digit	> 100 MΩ	1 mV
10 V	0.5% ± 1 ..	10 MΩ	10 mV
100 V	0.5% ± 1 ..	10 MΩ	100 mV
1000 V	0.5% ± 1 ..	10 MΩ	1 V

Maximum overload - 350 V on 1 V range
1000 V on all other ranges.

AC Volts Range	Accuracy	Input Impedance	Frequency Range
1 V	1.0% ± 2 Digits	10 MΩ/40 pF	20 Hz-3 KHz
10 V	1.0% ± 2 ..	10 MΩ/40 pF	20 Hz-3 KHz
100 V	2.0% ± 2 ..	10 MΩ/40 pF	20 Hz-3 KHz
1000 V	2.0% ± 2 ..	10 MΩ/40 pF	20 Hz-1 KHz

Maximum overload - 300 V on 1 V range
500 V on all other ranges.

DC Current Range	Accuracy	Input Impedance	Resolution
100 μA	2.0% ± 1 Digit	10 KΩ	100 nA
1 mA	0.8% ± 1 ..	1 KΩ	1 μA
10 mA	0.8% ± 1 ..	100 Ω	10 μA
100 mA	0.8% ± 1 ..	10 Ω	100 μA
1000 mA	2.0% ± 1 ..	1 Ω	1 mA

Maximum overload - 1 A (fused).

AC Current Range	Accuracy	Frequency Range
1 mA	1.5% ± 2 Digits	20 Hz-1 KHz
10 mA	1.5% ± 2 ..	20 Hz-1 KHz
100 mA	1.5% ± 2 ..	20 Hz-1 KHz
1000 mA	2.0% ± 2 ..	20 Hz-1 KHz

Maximum overload - 1 A (fused).

Resistance Range	Accuracy	Measuring Current
1 KΩ	1.0% ± 1 Digit	1 mA
10 KΩ	1.0% ± 1 ..	100 μA
100 KΩ	1.0% ± 1 ..	10 μA
1000 KΩ	1.0% ± 1 ..	1 μA
10 MΩ	2.0% ± 1 ..	100 nA

Overload protection - 50 mA (fused).

Readers outside the UK, please write for details of your local distributor to:

Sinclair Equipment International Ltd,
33 Beauchamp Place, London SW1 1NU.

To: Sinclair Radionics Ltd, FREEPOST, St Ives,
Huntingdon, Cambs., PE17 4BR.

Please send me:

..... Multimeters @ £63.72
inc VAT.
..... Mains adaptors @ £3.19
inc VAT.
..... Carrying cases @ £5.40
inc VAT.

*I enclose a cheque for £

*My Access/Barclaycard
number:

I am interested in 5 or more
multimeters.

..... Please arrange a
demonstration.
..... Please send details of
quantity discounts.

*I enclose an official company
order - signed and dated.

*Please complete or delete as
applicable.

Name

Address

Please print

FREEPOST - no stamp needed with address above.

E E 12



GIRO NO. 331 7056 Access & Barclay Cards accepted. C.W.O. only. P. & P. 25p Discount; £15-10% (except net items) Export Order enquiries welcome (£5 min. order)

Official Orders accepted from Educational & Government Departments
ALL PRICES INCLUDE VAT

LEIGHTON ELECTRONICS CENTRE

MULTIMETER U4323

22 Ranges plus AF/IF Oscillator 20,000 Ω/Volt.

Vdc—0.5—1000V in 7 ranges

Vac—2.5—1000V in 6 ranges

I_{dc}—0.05—500mA in 5 ranges

Resistance—5Ω—1MΩ in 4 ranges.

Accuracy—5% of F.S.D.

OSCILLATOR—1 KHz and 465 KHz (A.M.) at approx. 1 volt.

Size—160 x 97 x 40mm.

Supplied complete with carrying case, test leads and battery.

PRICE £8.64 net p & p 75p.



U4323

MULTIMETER U4324

34 Ranges. High sensitivity.

20,000 Ω/Volt. Overload protected.

Vdc—0.6—1200V in 9 ranges.

Vac—3—900V in 8 ranges.

I_{dc}—0.06—3A in 6 ranges.

I_{ac}—0.3—3A in 5 ranges.

Resistance—25Ω—5MΩ in 5 ranges.

Accuracy—dc and R—2½% of F.S.D.

ac and db—4% of F.S.D.

Size—157 x 98 x 63mm.

Supplied complete with storage case, test leads, spare diode, and battery.

PRICE £10.64 net p & p 75p.

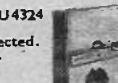

U4324

TEACH-IN SERIES COMPONENT KIT

KIT No. T12

ALL COMPONENTS AS SPECIFIED BY E.E.
FULLY GUARANTEED AND NEW STOCK

£15.50 + 60p p & p
NET.

INCLUDING VAT

* * * * *

WOOD KIT

Includes all wood as specified by E.E., cut to size, ready to assemble and includes adhesive and screws

£3 NET + 75p p. & p.

* * * * *

FULL LIST AVAILABLE. S.A.E. PLEASE
OR FREE WITH CATALOGUE

E. & O.E.

ALL STOCK SUBJECT TO AVAILABILITY



HAVE YOU GOT YOURS

CATALOGUE No. 4A
NEW CONVENIENT SIZE, AND FULLY ILLUSTRATED

CONTAINS MANY HARD TO GET ITEMS

20p

PAYS FOR ITSELF WITH DISCOUNT VOUCHERS WORTH **20p**

*DISCOUNTS

*ALL NEW STOCK

*SATISFACTION GUARANTEE

*DEPENDABLE SERVICE

S.A.E. FOR SUPPLEMENT NO. 1

B. H. COMPONENT FACTORS LTD.

(E.E.) LEIGHTON ELECTRONICS CENTRE,
39 NORTH ST., LEIGHTON BUZZARD, BEDS.
Tel. LEIGHTON BUZZARD 2316 (STD. Code 05253)

There's more than one way to make your time more enjoyable.



GC-1092AE Deluxe Alarm Clock

GC-1093 Car Clock/Timer

GC-1094 Digital Alarm Clock

Instead of just offering you one digital clock kit, Heathkit offer you four. Two alarms, a car model and a superb AM/FM clock-radio.

And, being Heathkit, they all come in easy to build kit form. Complete with a step-by-step instruction manual. So you should enjoy every second.

Post the coupon, enclosing a 10p stamp, and we'll send you a Heathkit catalogue with full details.

Heath (Gloucester) Ltd., Dept. EE-125, Bristol Road, Gloucester, GL2 6EE. Tel: (0452) 29451.

To: Heath (Gloucester) Limited, Dept. EE-125, Gloucester GL2 6EE.

Please send me a Heathkit catalogue. I enclose 10p for postage.

Name _____

Address _____

Postcode _____

HEATH
Schlumberger

Monthly budget plan available

CJL

CJL LTD. P.O. BOX 34, CANTERBURY, CT11 4YT

ALL PRICES INCLUDE P&P AND V.A.T.

AERIALS Telescopic, 15-120 cm £1.50	MINIATURE TRANSISTOR MODULES
KEYNECTORS Rapid connect to mains. Built-in fuses, neon & 13A fuse £3.50	Microphone pre-amplifier £2.45
MULTIMETERS Vdc/ac-10, 50, 250, 1,000. Idc-0.1A, R-150k £4.95	Power amplifier £2.70
PRINTED CIRCUIT KITS Contain all items necessary to produce printed circuits £3.95	STEREO HEADPHONES Superb stereo listening in comfort and privacy. 30-15kHz, 8 ohms £4.85
SIGNAL INJECTORS Audio through video signals, ideal servicing amplifiers, radio and tv £4.25	STEREO HEADPHONE JUNCTION BOXES 3 way unit selects phones only, speakers only or both £2.30
TEST SWITCHES 5 miniature push to test switches £1.00	SPEAKERS Miniature, 75mm dia, 8 ohms £0.95
AUDIO LEADS	BATTERY ELIMINATORS
5p din plug to 5p din plug, 1.5m £1.20	Miniature AC adaptor-9V at 50mA DC output from mains £4.35
2p din plug to 2p din skt, 10m £1.45	POWER SUPPLY UNITS P1
5 pin din plug to 2 phono plugs £1.20	Switchable 6 & 9V (200mA) ideal -most small radios etc. £4.85
BIB HI-FI ACCESSORIES	P2 Switchable to provide 6, 7.5, 9V at 400mA £7.15
Groov-Kleens /42 £1.95	SOLDERING IRONS Antex 25W, X25, 240V, Low leakage, 1/8" interchangeable long life bit £2.25
1" Tape Editing Kits /23 £1.50	3/32" 1/8; 3/16" bits each £0.47
Cassette Editing Kits /24 £1.65	X25 Elements £1.10
Cassette Head Cleaners /31 £0.65	Stands, ST3, High grade base, spring, sponges, accommodation spare bits £1.10
Hi-Fi Stereo Test Cassette £2.15	SOLDER -in handy Bib dispenser £0.43
Cassette Wallets (hold 6) £0.90	WIRE STRIPPERS & CUTTERS
CASSETTE HEAD DEMAGNETISER	Bib 8B, 8 gauge selector, automatic opening, easy grip handles £0.85
Shaped pole piece - saves time £3.65	TRANSFORMERS
EARPHONES Stethoscope style, 8 ohm dynamic £1.20	Mains (sub miniature)
Crystal earphone-lead & plug £0.65	6-0-6V RMS, 100mA £1.45
INTERCOMS 2-station, ideal for the home-baby alarm, office, with cable and staples £6.35	12-0-12V RMS, 50mA £1.45
MICROPHONES Dynamic, remote start/stop, 200 ohms, 100-10kHz 6mV output £2.15	

DENCO (CLACTON) LTD.

Dept. E.E.

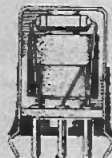
357-8-9 OLD RD., CLACTON-ON-SEA
ESSEX. CO15 3RH

Our components are chosen by technical authors and constructors throughout the world, for their performance and reliability, every coil being inspected twice plus a final test and near spot-on alignment.

General catalogue showing full product range 32p, post paid. Please enclose S.A.E. with all other enquiries.

TRADE ENQUIRIES WELCOME**PLEASE MENTION****EVERYDAY
ELECTRONICS****WHEN REPLYING TO
ADVERTISEMENTS**

Everyday Electronics, December 1975

**"I MADE IT MYSELF"**

Imagine the thrill you'll feel! Imagine how impressed people will be when they're hearing a programme on a modern radio you made yourself.

Now! Learn the secrets of radio and electronics by building your own modern transistor radio!

Practical lessons teach you sooner than you would dream possible.

What a wonderful way to learn—and pave the way to a new, better-paid career! No dreary ploughing through page after page of dull facts and figures. With this fascinating Technatron Course, you learn by building!

You build a modern Transistor Radio . . . a Burglar Alarm. You learn Radio and Electronics by doing actual projects you enjoy—making things with your own hands that you'll be proud to own!

No wonder it's so fast and easy to learn this way. Because learning becomes a hobby! And what a profitable hobby. Because opportunities in the field of Radio and Electronics are growing faster than they can find people to fill the jobs!

No soldering - yet you learn faster than you ever dreamed possible.

Yes! Faster than you can imagine, you pick up the technical know how you need. Specially prepared step-by-step lessons show you how to read circuits—assemble components—build things—experiment. You enjoy every minute of it! You get everything you need. Tools. Components. Even a versatile Multimeter that we teach you how to use. All included in the course. **AT NO EXTRA CHARGE!** And this is a course anyone can afford. (You can even pay for it by easy instalments).

So fast, so easy, this personalised course will teach you even if you don't know a thing today!

No matter how little you know now, no matter what your background or education, we'll teach you. Step by step, in simple easy-to-understand language, you pick up the secrets of radio and electronics.

You become a man who makes things, not just another of the millions, who don't understand. And you could pave the way to a great new career, to add to the thrill and pride you receive when you look at what you have achieved. Within weeks you could hold in your hand your own transistor radio. And after the course you can go on to acquire high-powered technical qualifications, because our famous courses go right up to City & Guilds levels.

Send now for FREE 78 page book - see how easy it is - read what others say!

Find out more now! This is the gateway to a thrilling new career, or a wonderful hobby you'll enjoy for years. Send the coupon now. There's no obligation.

POST TODAY FOR FREE BOOK**To: ALDERMASTON COLLEGE CEE 12 DEPT. CEE 12, READING RG7 4PF**

Also at our London Advisory Office, 4 Fore Street Avenue, Moorgate, London EC2Y 5EJ. Tel: 01-628 2721. Yes, I'd like to know more about your course. Please send me free details—plus your big, 78-page book that tells about all your courses.

NAME

ADDRESS

POSTCODE

**HOME OF BRITISH INSTITUTE OF ENGINEERING TECHNOLOGY**

Everyday Electronics Classified Advertisements

RATES: 12p per word (minimum 12 words). Box No. 35p. extra. Semi-display—£8.00 per single column inch. Advertisements must be prepaid and addressed to Classified Advertisement Department, "EVERYDAY ELECTRONICS," I.P.C. Magazines Ltd., Fleetway House, Farringdon Street, London EC4A 4AD. (01—634 4379)

CONDITIONS OF ACCEPTANCE OF CLASSIFIED ADVERTISEMENTS

The advertiser warrants that the advertisement does not contravene any of the provisions of the Trade Descriptions Act 1968/72. The Publishers reserve the right to refuse or withdraw any advertisement. Although every care is taken to avoid mistakes, the publishers cannot be liable for clerical or printer's errors or their consequences.

RECEIVERS AND COMPONENTS

COMPONENTS GALORE, pack of 500 assorted radio, TV and electronic components a real bargain at a realistic price, send only £1.50 C.W.O. This applies only to United Kingdom and Ireland. Overseas prices by arrangement. Caledonian Components, P. O. Box 3, Glenrothes, Fife, Scotland.

STEREO MAIN AMP. PANEL 2XB0865, 2XB0866 or RC sequitur. 6 other trans. requires 27V £2.25 (15p) circuit 20p. Not guaranteed. **BANK OF 20 NEONS** 75p (15p) 2M.C. plus M5 Meter. 3—£1.50 (50p). **T.V. CONVERGENCE PANELS** 2XAC128, 3 slugged coils, 3 slide switches, 11 W.W. pots, 3 carbon presets, 2 ferrite chokes etc. £1.30 p.p. **TALKING PAGE PANEL** 2 pots, 12 silicon trans. and SCR. 8 nice electrolytics 80p (15p). **THREE TRANSISTOR AUDIO AMP** Trans. equiv. to AC128, OC72, 40p (10p) 3—£1 p.p. **COPPER CLAD PAX PANELS** 5 1/2 x 5 1/2 6—75p. 12 x 12 75p. 16 x 12 75p. 8 x 9 1/2 3—£1.15. All C.P. 74 SERIES IC's **ON PANEL(S)** 10—85p (10p). **STABILISED POWER SUPPLY PANEL** 2 x 2N3702, 2 x AC153 Bridge rectifier 2 x 10/50V and 1000, 250 MFD 35V electrolytics 45p (10p). **VALUPAKS** 10 Silicon diodes 650V 1/4A on tapboard 50p (10p). 100 S/ MICA caps 35p (10p) 100 C280 polyester caps £1 (15p) Lists 15p. Refund on purchase.

3lbs Computer Panels £1.70 p.p.
7lbs Assorted Components £2.50 p.p.
J. W. B. Radio, 2 Barnfield Crescent Sale
Cheshire M33 1NL. Postage in brackets Mail order only.

VALVES, RADIO, TV, TRANSMITTING, INDUSTRIAL 1930 to 1975. 2,200 types in stock. Many obsolete. S.A.E. for quotation list 20p. Postal export service. We purchase new and boxed valves. Cox Radio (Sussex) Ltd, The Parade, East Wittering, Sussex. West Wittering 2023.

FOR SALE

FIRST NINE ISSUES "Everyday Electronics." Good condition. Offers (s.a.e.) to HAYES, 1 Trinity Drive, Newmarket, Suffolk.

MICROPHONES: AKG D202E1, £45.00; AKG D190C or 'E' £20.00; AKG D224, £60.00; Sennheiser MD211N, £45.00. All brand new and boxed. Please add 25% for VAT. All other AKG and Sennheiser mikes. SAE for quote to J. J. Francis (Wood Green), Ltd., Manwood House, Matching Green, Harlow, Essex. Tel: Matching 476.

ALL BACK NUMBERS of "Everyday Electronics," binders, Electronics Course, Radio Mains Unit, etc. Offers: WRIGHT, Flat 'C', 2 Park Quadrant, Glasgow G3 6BS.

WANTED

"**RADIO AND TELEVISION SERVICING**" books wanted, from 1963-1964 edition onwards. £2.00 paid per copy by return of post. BELL'S TELEVISION SERVICES, 190, Kings Road, Harrogate, N. Yorks. Tel: Harrogate 55885.

TAPE EXCHANGES

COMMUNICATE THROUGH YOUR RECORDER. Today's greatest hobby. Worldwide membership, all ages, all interests. Britain's largest, friendliest Tape-X-change: Established 1961: **WORLDWIDE TAPETALK**, 35 The Gardens, Harrow.

SERVICE SHEETS

SERVICE SHEETS for Radio, TV, Tape Recorders, Stereo, etc., with free fault-finding guide, 50p and SAE. Hamilton Radio, 47 Bohemia Road, St. Leonards, Sussex.

BELL'S TELEVISION SERVICES for service sheets, manuals & books on radio/TV etc. Service sheets 50p plus SAE. Service sheet catalogue 25p. Back issues of magazines from April 74 onwards cover price plus 12p post. Free booklists on request. SAE with enquiries please to:— B. T. S. 190, Kings Road, Harrogate, Yorkshire. Telephone Harrogate (Code 0423) 55885.

MISCELLANEOUS

BINOCULAR MAGNIFIER

FOR PRECISION CLOSE-UP WORK—LEAVES BOTH HANDS FREE



See close-up work with less eye strain & fatigue. Lightweight adjustable headband. Powerful optically ground lenses from Continental glass-works. Can be worn over normal glasses. An essential aid in industry, Home, Workshop, Collecting, Modelling, Jewellery, Watchmakers. Any fine work. 2 1/2 x mag. £8.50 + 40p p. & p. 3x mag. £9.50 + 40p p. & p. Also DE LUXE 2 1/2 and 3x models with superior quality lenses PLUS hinged lens mount £1.50 extra. Access accepted.

JOHN DUDLEY & CO. LTD., Dept. EES,
301 Cricklewood Lane, Finchley Road, London, NW2. Tel. 01-458 5917. (Callers welcome).

EXPERIMENTERS. Hundreds of items cheap. List 9p. Grimby Electronics, Lambert Road, Humberside.

LOUDSPEAKERS



Speakers, kits and cabinets for D.I.Y., HiFi, P.A., Disco, etc. by EMI, Fane, Goodmans, Baker, Kef, Elac, Richard Allan, Wharfedale, etc. Send stamp for free booklet "Choosing a speaker"

WILMSLOW AUDIO
Dept. EE, Swan Works, Bank Square,
Wilmslow, Cheshire SK9 1HF
Tel. Wilmslow 29599

LOWEST COST IC SOCKETS. Use Soldercon IC socket pins for 8 to 40 pin DIL's. 50p for strip of 100 pins, £1.50 for 3 strips of 100, £4 for 1000. 10p p&p for orders under £2. Add 8% VAT. Instructions supplied—send sae for sample. SINTEL, 53e Aston Street, Oxford. Tel: 0865 43203.

HOME SCIENTISTS

Get the key to a FANTASTIC WORLD of previously UNHEARD-OF-PROJECTS. The NEW Boffin catalogue lists LOTS of HIGHLY UNUSUAL, LOW-COST BARGAINS, READY-BUILT MODULES. Here are just a few examples. There are stacks more!

Dazzling MINI-STROBE (pocket size) £3.50

PEOPLE DETECTOR £4.20

Big-Ear SOUND-CATCHER £4.20

Mini DREAM LABORATORY £4.20

Don't take our word for it though! GET A COPY & SEE!

SEND ONLY 20p, and we'll RUSH YOU

A COPY (YOU'LL GET THE GOODIES'

JUST AS QUICKLY TOO!)

BOFFIN PROJECTS

4 Cunliffe Road, Stoneleigh,

Ewell, Surrey

(Mail Order U.K. Only)

NEED A DESIGN. We can produce a design for any project need. Send s.a.e. for realistic estimate to **DESIGN SERVICES**, 11 Crabtree Place, Norwood, Sheffield S5.

DIGITAL CLOCK COMPONENTS

For beginners: easy printed circuit board and components for digital clock, 4 x 0-3" digits (less case, switches, transformer): £9.95. Extra for 4 x 0-6" 'Jumbo' displays: £3.44.

Success guaranteed! See our free information etc. for details. (Can be converted to 4 range timer/stopwatch for use in e.g. darkrooms.)

Economy type displays DL-70M & DL-747E available separately, £5p & £1.70 each. AY-5-1224 clock chip £3.85, MK 50253 alarm clock chip £5.50.

Circuit diagrams available free on request (an S.A.E. would be a help to us). Add 10p per order and VAT @ 8%.

GREENBANK ELECTRONICS (Dept. ECE)
94 New Chester Road, New Ferry, Wirral,
Merseyside, L82 5AG.

TRIACS (Plastic) 10A/400V 72p (3+ 69p); 4A/400V 64p; DIAC 21p; 2N6027 PÜT 33p; NE555 48p; 13xBC148 £1; 10xBC158 £1; 300W Dimmer kit £2.10. VAT inclusive. P&P 15p. T. K. Electronics, 106 Studley Grange Road, London W7 2LX.

BUILD THE

TREASURE TRACER

MK III Metal Locator



- Variable tuning
- Britain's best selling metal locator kit
- Weighs only 22oz. Fitted with Faraday shield.
- Speaker and earphone operation
- Knocks down to only 17in.
- Prebuilt search coil assembly
- Thoroughly professional finish
- As seen on BBC1 and BBC2 TV
- You only need soldering iron, screwdriver, pliers and snips
- Five transistor circuit

Send stamped, addressed envelope for leaflet

Complete Kit £10.90 Built & tested £15.25
Post 60p - 92p VAT(8%) Post 60p - £1.27 VAT(8%)

MINIKITS ELECTRONICS
6b CLEVELAND ROAD,
LONDON, E15 2AN (Mail order only)

ALUMINIUM PROJECT BOXES

Box No.	Length"	Width"	Height"	Price
7	5½	2½	1½	47p
8	4	4	1½	48p
9	4	2½	1½	46p
10	5½	4	1½	49p
11	4	2½	2	49p
12	3	2	1	38p
13	6	4	2	58p
14	7	5	2½	75p
15	8	6	3	83p
16	10	7	3	£1-14

Prices include VAT (at 8%) but 18p should be added to the total order value for postage & packing.

8WATT 12VOLT FLUORESCENT LIGHT KIT
Complete Kit including all components, heatsink, channel, tube, etc.

ONLY £3-49 inc. VAT p. & p.

Ready Built £4-10 inc. VAT p. & p.
Diffuser 59p extra inc. VAT p. & p.
Send cheque or P.O.'s with your order direct to:—

ELECTRONICS DESIGN ASSOCIATES,
Dept. EE, 22 Bath Street,
Walsall, WS1 3DE
Phone: Walsall 33552

THE SCIENTIFIC WIRE CO

Copper - Nickel Chrome - Eureka - Manganin Wires.

Enamelled - Silk - Cotton - Tinned Coverings.

No minimum charges or quantities

Trade and Export enquiries welcome.

S.A.E. Brings List.

P.O. BOX 30, LONDON, E4 9BW

SUPERB INSTRUMENT CASES by Bazelli, manufactured from heavy duty PVC faced steel. Hundreds of people and industrial users are choosing the cases they require from our vast range, competitive prices start at a low 75p. Examples. Width, Depth, Height, 8in x 5in x 3in £1-55, 10in x 6in x 3in £2-20, 10in x 8in x 3in £2-75, 12in x 10in x 3in £3-60, 8in x 4in x 4in £1-80, 10in x 6in x 4in £2-70, 12in x 8in x 4in £3-60, 7in x 7in x 5in £2-65, 8in x 10in x 6in £3-60, 12in x 8in x 7in £4-12, 12in x 12in x 7in £4-40. Plus 8% Vat and 50p postage. Over 200 Models to choose from. Prompt despatch, Free literature, (stamp would be appreciated). Brazelli, Department No. 24, St. Wilfreds, Foundry Lane, Halton, Lancaster LA2 6LT.

MINI ACCUMULATORS



2 volt MULTI-USE Sealed Lead Acid Rechargeable Cells.
Size L450—1.4" x 1.1" x 0.44". 3 for £2-15. inc. P. & P.
Size GA2—1.7" x 1.3" x 0.5". 3 for £2-65 Suitable for Cords inc. P. & P.

GARFIELDS, 295 Rye Lane, London, S.E.15

COMPONENTS

D.P.D.T. Footswitch 140p
M218 Transformer 210p
R26/1 Jack socket 35p

EVERYDAY ELECTRONICS KITS

BETA FUZZ-TREBLE (Jan 73) 400p
(excl. selector switch and transformer)
WAA WAA (Aug 73) 250p
TREMOLO (Dec 73) 350p
FUZZ BOX (Mar 75) 350p

All kits less case and battery.

Price incl. p & p. Mail Order Only.

EXPRESS COMPONENTS

17 ALBERT SQUARE STRATFORD E15 1HJ

BLUE PCB INK

ONLY (ETCH ~ RESIST) USE WITH ANY 75p PEN! (30cc)

in UK VAT & Post FREE
CWO Please to
JFH SUPPLIES, 30 BAKER ST., LONDON W1M.

MULTIMETER

Type U4324

20,000Ω/V Overload protected.
Ranges: 0-6, 1-2, 3, 12, 30, 60, 120, 600, 1200V DC; 3, 6, 15, 60, 150, 300, 600, 900V AC; 0-06, 0-6, 6, 60, 600mA, 3A DC; 0-3, 3, 30, 300mA, 2A AC. 5 resistance ranges to 5MΩ dB's -10 to +62. Size 167 x 98 x 63mm. Supplied complete with test leads, clips, spare diode, batteries and instructions. Only £17-00.
Send 10p for illustrated brochure of meters.

71b BARGAIN PARCELS

Contains hundreds of resistors, pots, capacitors, switches, transistors, PC Boards and loads of odds and ends. Only £3-25.

CAPACITOR PACKS

200 mica ceramic poly caps £1-15; 100 polyester caps 0-01 to 1/2F £1-30; 200 mainly unmarked miniature electrolytics: Only £1-35. One of each pack £2-30.

Mains TRANSFORMERS

12-0-12V 50mA 85p; 6-0-6V 100mA 90p; 9-0-9V 100mA 95p; 12-0-12V 100mA £1; 6-0-6V 1A £2-00; 12-0-12V 1A £2-20; 30-0-30V 1A £3-30; 30V 1A tapped to give 3, 4, 5, 6, 8, 9, 10, 12, 15, 18, 20, 24 or 30V, or 12-0-12 or 15-0-15V £3-20. 2A version £4-30.

PC ETCHING KIT Mk II

Contains 1lb Ferric Chloride, DALO Etch resist pen, 100 sq ins copper clad board, etching dish, abrasive cleaner, instructions and now 2 miniature drill bits as well. Only £3-85.

GREENWOLD ELECTRONICS (EE12)

51 Shirley Park Road, Southampton SO1 4FX
All prices include VAT and Postage in UK
SAE List. Callers welcome 9-6 Mon-Sat
Telephone (073) 722501.

4-STATION INTERCOM



£17-25

Solve your communication problems with this 4-Station Transistor Intercom system (1 master and 3 Subs.) in robust plastic cabinets for desk or wall mounting. Call/talk/listen from Master to Subs and Subs to Master. Ideally suitable for Business, Surgery, Schools, Hospitals and Office. Operates on one 9V battery. On/Off switch. Volume control. Complete with 8 connecting wires each 50c. and other accessories. P. & P. 75p.

MAINS INTERCOM NEW MODEL

No batteries—20 wires. Just plug in the mains for instant two-way, loud and clear communication. On off switch and volume control. Price £31-24 per pair P. & P. 75p.

NEW! AMERICAN TYPE CRADLE

TELEPHONE AMPLIFIER



ONLY £12-95

VAT £1-04

Latest transistorised Telephone Amplifier with detached plug-in speaker. Placing the receiver on the cradle activates a switch for immediate two-way conversation without holding the handset. Many people can listen at a time. Increase efficiency in office, shop, workshop. Perfect for "conference" calls: leaves the user's hands free to make notes, consult files. No long waiting, saves time with long-distance calls. On/Off switch, volume. Direct tape recording model at £13-95 + VAT £1-12 P. & P. 70p, 10-day price-refund guarantee.

WEST LONDON DIRECT SUPPLIES (PW12)
169 KESBINGTON HIGH STREET, LONDON, W8

verobox®

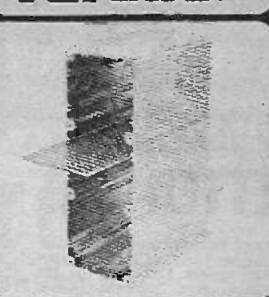

ALUMINIUM ENCLOSURES

- 6 standard sizes available from your local retailer.
- Made from precision extrusions with integral-board guide slots.
- Finned sides improve appearance and radiate heat.
- Parallel sides for ease of component mounting.



VERO ELECTRONICS LTD.

Eastleigh, Hants. SO5 3ZR

Tel: Chandler's Ford 2952 Telex: 47551

Subsidiaries and Agents throughout the World

ELECTRON-KIT

"EDUCATIONAL KITS OF EXCEPTIONAL QUALITY"

(Audio mag.)

"VALUE FOR MONEY" (Ev. Elec. mag.)

Build, dismantle and rebuild projects any number of times and design new circuits too.

16 PROJECT KIT £8-80 (1A) radios, amplifiers, mikes, alarms, Morse code, etc.

30 PROJECT KIT £10-45 (2A) as 1A plus similar more progressive experiments.

100 PROJECT KIT £20-45 (3A) as 2A plus electronic birds, cats, sirens, guns, organs, metronomes, light and sound, burglar alarms.

105 PROJECT KIT £25-25 (3AD) as 3A plus solar cell experiments and complete sophisticated controls.

150 PROJECT KIT £33-95 (4AD) as 3AD plus Relay and Meter

concentrations: Ion concentration - volume - output - field intensity - volt - resistance - ammeter, illuminometer, etc. and many, many more.

ADD-ON SETS & MANUALS build from one kit to another in easy stages.

VALUABLE MANUALS included with every kit.

Prices include Battery, VAT, p & p. Cheque/P.O. (or 10p for literature) to: E.E.

Satisfaction guaranteed

ELECTRON-KIT LTD. 408 St. John's Street, London, EC1. [01-278 4579]

ENGINEERS

FREE

YOURSELF FOR A BETTER JOB WITH MORE PAY!



Do you want promotion, a better job, higher pay? "New opportunities" shows you how to get them through a low-cost, Home Study Course. There are no books to buy and you can pay as you learn.

This easy to follow GUIDE TO SUCCESS should be read by every ambitious engineer. Send for this helpful 76-page free book NOW! No obligation, nobody will call on you. It could be the best thing you ever did.

CHOOSE A BRAND NEW FUTURE HERE



- | | | |
|----------------------------------------------------------------------|------------------------------------------------------------------|-------------------------------------------------------------|
| <input type="checkbox"/> ELECTRICAL and ELECTRONICS | <input type="checkbox"/> AUTO and AERO Motor Mechanics | <input type="checkbox"/> MECHANICAL A.M.S.E. (Mech.) |
| <input type="checkbox"/> Practical Radio & Electronics (with KIT) | <input type="checkbox"/> C. & G. Motor V. Mechanics | <input type="checkbox"/> General Mech. Eng. |
| <input type="checkbox"/> Electronic Engineering Certificate | <input type="checkbox"/> General Auto Engineering | <input type="checkbox"/> Inst. Engineers & Technicians |
| <input type="checkbox"/> General Elect. Eng. Certificate | <input type="checkbox"/> A.M.I.M.I. | <input type="checkbox"/> Maintenance Engineering |
| <input type="checkbox"/> C. & G. Elect. Installations | <input type="checkbox"/> Air Registration Board Certs. | <input type="checkbox"/> Welding |
| <input type="checkbox"/> Elect. Install. & Work | <input type="checkbox"/> M.A.A./I.M.I. Dip. | |
| <input type="checkbox"/> C. & G. Elect. Technicians | <input type="checkbox"/> CONSTRUCTIONAL | <input type="checkbox"/> MANAGEMENT and PRODUCTION |
| <input type="checkbox"/> RADIO and TELECOM-MUNICATIONS | <input type="checkbox"/> Heating, Ventilating & Air Conditioning | <input type="checkbox"/> Computer Programming |
| <input type="checkbox"/> Colour TV Servicing | <input type="checkbox"/> Architectural Draughtsmanship & Design | <input type="checkbox"/> Inst. of Cost & Managements Accts. |
| <input type="checkbox"/> C. & G. Telecoms. Technician's Cert. | <input type="checkbox"/> L.I.O.B. | <input type="checkbox"/> DRAUGHTS-MANSHIP and DESIGN |
| <input type="checkbox"/> C. & G. Radio, TV & Electronics Mech. Cert. | <input type="checkbox"/> Carpentry & Joinery | <input type="checkbox"/> General Draughtsmanship |
| <input type="checkbox"/> Radio & TV Engineering Course | <input type="checkbox"/> Plumbing Technology | <input type="checkbox"/> A.M.I.E.D. |
| <input type="checkbox"/> Radio, Servicing & Repairs | <input type="checkbox"/> General Building | <input type="checkbox"/> Electrical Draughtsmanship |
| <input type="checkbox"/> Radio Amateur's Exam. | <input type="checkbox"/> Painting & Decorating | |

POST NOW

G.C.E.
—58 'O' & 'A' Level Subjects
—over 10,000 Group Passes!

Aldermaston College

Dept. TEE12 Reading RG7 4PF.
also at our London Advisory Office, 4 Fore Street Avenue, Moorgate, London EC2Y 5EJ. Tel. 01-628 2721.

NAME (Block Capitals)

ADDRESS

..... Postcode.....

Other subjects of interest..... Age.....

Accredited by C.A.C.C. Member of A.B.C.C.

HOME OF BRITISH INSTITUTE OF ENGINEERING TECHNOLOGY

ELECTROVALUE

The good components service

In relatively few years, Electrovalue has risen to a position of pre-eminence as mail-order (and industrial) suppliers of semi-conductors, components, accessories, etc. There are wide ranges and large stocks to choose from as well as many worthwhile advantages to enjoy when you order from Electrovalue.

CATALOGUE 8 NOW READY

Enlarged to 144 pages. New items. Opto-electronics, Diagram of components, applications, I.C. circuits, etc. Better than even No. 7. Post free 48p, including voucher for 40p for use on order over £5 list value.

DISCOUNTS

On all C.W.O. mail orders, except for some items marked NETT.
5% on orders list value £5 or more 10% £10 or more

FREE POST & PACKING

On all C.W.O. mail orders in U.K. over £2 list value. If under, add 10p handling charge.

PRICE STABILIZATION POLICY

Prices are held and then reviewed over minimum periods of 3 months.

QUALITY GUARANTEE

On everything in our Catalogue—No manufacturers rejects, seconds or sub-standards merchandise.

ELECTROVALUE LTD

All communications to Section 3112, 28, ST. JUDES ROAD, ENGLEFIELD GREEN, EGHAM, SURREY TW20 0HB. Telephone Egham 3003, Telex 284475. Shop hours 9-5.30 daily, 9-1 pm Sats.
NORTHERN BRANCH: 630, Burnage Lane, Burnage, Manchester M19 1NA. Telephone (061) 432 4945. Shop hours Daily 9-5.30 pm; 9-1pm Sats.

VALVE BARGAINS

Any 5 64p, 10 99p, 50 £4.
Your choice from the following list: ECH84, ECC82, ECL80, EF80, EF183, EF184, PC86 PC88, PCF80, PCF802, PCL82, PCL84, PCL85, PCL805, PCL86, PFL200, PL36, PL504, PY33, PY81, PY800, PY88, EH90, 30FL1, 30FL2, 30PL14, 6F28

Colour Valves 25p each
PL508 PL509, PY500/A

Press 4 Button Transistor UHF Tuners £2.50

AERIAL BOOSTERS

We make three types of Aerial Boosters all for set top fitting, with Co-ax Plugs and Sockets.
B11—For Stereo and Standard VHF Radio
B12—For the older VHF Television, please state BBC1 and ITV Channels.
B45—For mon. or colour this covers the complete UHF band.
All Boosters are complete with Battery and take only minutes to fit.
Price £3.90 each

BARGAIN PACKS

All Components in the Bargain Packs are unused and marked.
Pack 1—Polyester (C280) Axial Leads Capacitors—250V/W & 400V/W, very good mixed selection from 0.01 UF to 2.2 UF. Price 100 £1.25, 1000 £10.00 (our choice).
Pack 2—Light Dimmers. 300 watt Light Dimmers complete with Plate (replaces existing switch. Takes only minutes to fit. Price £2.85.
Co-Ax Connectors 8p (70p).
Co-Ax Plug—8p (70p).
Jack Plugs—Standard 17p (£1.50). 2.5mm 10p (85p). 3.5mm 10p (85p).
Din Plugs—2 pin 12p (£1.00), 3 Pin 14p (£1.20), 5 Pin 18p (£1.50). (Price in brackets for Ten).

Prices include V.A.T. P. & P. under £1/15p, £1 to £3/20p, above £3/25p. Overseas at cost. Money back guarantee on all orders.

ELECTRONIC MAILORDER LTD., 62 BRIDGE ST., RAMSBOTTOM, BURY, LANCS. Tel. Rams. 3036.

Published approximately the third Friday of each month by IPO Magazines Ltd., Fleetway House, Farringdon Street, London E.C.4 4AD. Printed in England by Index Printers Ltd., Dunstable, Beds. Sole Agents for Australia and New Zealand—Gordon and Gotch (A/S) Ltd, South Africa—Central News Agency Ltd. Everyday Electronics is sold subject to the following conditions, namely that it shall not, without the written consent of the Publishers first given, be lent, resold, hired out or otherwise disposed of by way of Trade at more than the recommended selling price shown on cover, excluding Hire where the selling price is subject to V.A.T., and that it shall not be lent, resold, or hired out or otherwise disposed of in a mutilated condition or in any unauthorised cover by way of Trade, or affixed to or as part of any publication or advertising, literary or pictorial matter whatsoever.

BI-PRE-PAK

The people for component bargains



Makers of Stirling Sound

audio equipment

ORIGINATORS OF PRE-PACKED COMPONENTS IN BRITAIN — AND STILL LEADING!

XMAS OFFER!

BATT/MAINS STEREO F.M. TUNER/AMP

TO SHOW YOU A SAVING OF £12

if you buy all 4 units together. Bought singly you save 33½% off regular price of each unit

A Bi-Pre-Pak Super Special!

- ★ PRICES INCLUDE V.A.T. AND POSTAGE AND PACKING IN U.K.
- ★ TOTAL VALUE £30 — YOU PAY £18.00
- ★ SATISFACTION GUARANTEED
- ★ ORDER NOW — DELIVERY BY RETURN

1 F.M. TUNER FRONT-END

Ganged tuning; A.F.C. facility. Reduction-gear drive, 88-108 MHZ. Usual price inc. VAT £8.01

£5.34

2 I.F. BOARD

Using I.C. Designed for use with above front-end. Usual price inc. VAT £6.76

£4.50

3 STEREO DECODER, using I.C.

Designed for use with the above modules, can also be used with other mono F.M. tuners. Ready aligned. (L.E.D. for stereo beacon available at 20p) usual price inc. VAT £7.22

£4.82

4 5+5 WATT MUSIC POWER I.C. AMP

Useful stereo power amplifier with good performance, at economy price. Usual price inc. VAT £8.01

£5.34

TOTAL VALUE AT REGULAR ADVERTISED PRICE £30.00

3 SPECIAL OFFERS

LM 380 AUDIO IC (Marked SL80745). Brand new and to spec. 3 watts R.M.S. out. With data. £1.00

Three SN7490. Brand new I.C. to spec. decade counters only £1.20*

Five SN7400 Quad 2 input Nan gate ICs. Only 60p*

SUNDRY

P.1 PAK—Approx. 170 short-lead semi-conductors and components. PNP, NPN, diodes, rectifiers, etc. on PCBs. At least 30% factory marked. Some data supplied. £2.50

UHF 625 line tuner, rotary. £2.50

Rev Counter (for cars) (8%). £1.00*

Books by Bernard's Publications. Newnes-Butterworth's etc. No VAT.

THE FREE CATALOGUE

New edition better than ever. It's yours for free and well worth getting—only please send large S.A.E. with 10p stamp if we have to post it to you.

TERMS OF BUSINESS:

VAT at 25% must be added to total value of order except for items marked * or (8%), when VAT is to be added at 8%. No VAT on overseas orders. POST & PACKING add 25p for UK orders unless marked otherwise. Minimum mail order acceptable—£1. Overseas orders, add £1 for postage. Any difference will be credited or charged. PRICES subject to alteration without notice. AVAILABILITY All items available at time of going to press when every effort is made to ensure correctness of information.

BI-PRE-PAK LTD

Co. Reg. No. R271219

222 224 WEST ROAD, WESTCLIFF-ON-SEA, ESSEX SSO 90F.

TELEPHONE: SOUTHEND (0702) 46344.

WRITE ORDER SEPARATELY AND ATTACH COUPON IF REQUIRED

NEW RANGE TRANSISTOR & COMPONENT PACKS

TP SELECTION

- TP5 20 Transistors, PNP Germanium, Red Spot A.F.
- TP6 20 Transistors, PNP Germanium, White spot RF.
- TP7 1 2N174 150w 80Vce Power Transistor, with mounting assembly.
- TP19 100 diodes, mixed Germanium, Gold-bonded, etc. Marked/Unmarked.
- TP23 Twenty NPN Silicon uncodded T05. Similar to BFY50/2, 2N696, 2N1613, etc. Complementary to TP24.
- TP24 Twenty PNP Silicon, uncodded T05. Similar to BFP44, 2N2904/5
- TP29 8 power diodes 400V, 1-25A Silicon FST 3/4.

UT SELECTION

- UT1 50 PNP's Germanium, AF & RF.
- UT2 150 Germanium diodes, min. glass.
- UT4 100 Silicon diodes, min. glass, similar to IN914, IN916.
- UT5 40 250mW Zener diodes OAZ24 range; average 50% good.
- UT7 30 Silicon rectifiers 750mA, mixed voltages, Top Hats, etc.
- UT9 40 NPN Silicon planers. Similar to 2N3707-11 range. Low noise amps.
- UT12 25 2N3702/3 Transistors, PNP Silicon, Plastic to 92.

CP SELECTION

- CP1 Mixed bag of capacitors—Electrolytic, Paper, Silver Mica (Approx. 150—sold by weight).
- CP2 200 (approx.) Resistors, various types, values, watts. (Sold by weight.)
- CP3 40 Wire wound resistors, mixed.
- CP4 12 pots—pre-set, w/wound, carbon, dual, with/without switches—all mixed.
- CP7 Heat sinks, assorted. To fit SO-Z (OC72) TO-1 (AC128), etc.

ALL ABOVE PACKS—60p EACH.

TP Tested & Guaranteed; UT Untested, unmarked; CP Components.

CAPACITOR DISCHARGE IGNITION KIT

Simple to assemble and fit. Improves car performance, saves on fuel. P&P 30p. £7.50*

BI-PRE-PAK X-HATCH GENERATOR Mk.2

Four-pattern selector switch 3" x 5½" x 3"

Ready-built and tested in kit form

*£9.93

*£7.93

Please add 35p for postage and packing

Is invaluable to industrial and home user alike. Improved circuitry assures reliability and still better accuracy. Very compact, self-contained. Robustly built. Widely used by TV rental and other engineers. With reinforced fibreglass case. Instructions, but less batteries. (Three U2 type required.)

TV SIGNAL STRENGTH METER

Complete kit as described in "Television" £19.50 plus 40p* for P&P

SS300 POWER SUPPLY STABILISER

Add this to your unbalanced supply to obtain a steady working voltage from 15 to 50V for your audio system, workbench etc. Meters can be easily added. £3.25*

PLASTIC POWER TRANSISTORS

40 WATT SILICON*

Type	Polarity	Gain	VCE	Price
40N1	NPN	15	15	20p
40N2	NPN	40	40	30p
40P1	PNP	15	15	20p
40P2	PNP	40	40	30p

90 WATT SILICON*

Type	Polarity	Gain	VCE	Price
90N1	NPN	15	15	25p
90N2	NPN	40	40	35p
90P1	PNP	15	15	25p
90P2	PNP	40	40	35p

If you prefer not to cut coupon out, please mention EE 12 when writing

★ PHONE · WRITE · CALL

GIVE US YOUR ACCESS NO. and we will do the rest!

To BI-PRE-PAK, 224-226 WEST RD., WESTCLIFF-ON-SEA, ESSEX

Please send

for which I enclose inc. V.A.T.

Name

Address

EE12

RADIO EXCHANGE LTD.

ALL PRICES INCLUDE VAT
We regret we cannot for the time being accept Overseas Orders. Open to U.K. and Ireland residents only.

NEW EDU-KIT MAJOR

Completely Solderless Construction Kit. Build these projects without soldering iron or solder

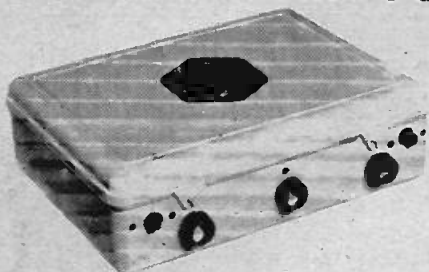

- ★ 4 Transistor Earpiece Radio.
- ★ 5 Transistor Push Pull Amplifier.
- ★ Batteryless Crystal Radio.
- ★ Signal Tracer.
- ★ 7 Transistor Loudspeaker Radio MW/LW.
- ★ One Transistor Radio.
- ★ Signal Injector.
- ★ 5 Transistor Short Wave Radio.
- ★ 3 Transistor Regenerative Radio.
- ★ Transistor Tester SPN-PNP.
- ★ Electronic Metronome.
- ★ 3 Transistor Regenerative Radio.
- ★ Audible Continuity Tester.
- ★ 4 Transistor Push Pull Amplifier.
- ★ Electronic Noise Generator.
- ★ Sensitive Pre-Amplifier.

Components include: 24 Resistors ● 21 Capacitors ● 10 Transistors ● 3 1/2" Loudspeaker ● Earpiece ● Mica Baseboard ● 3 12-way connectors ● 2 Volume controls ● 2 Slider Switches ● 1 Tuning Condenser ● 3 Knobs ● Ready Wound MW/LW/SW Coils ● Ferrite Rod ● 6 1/2 yards of wire ● 1 Yard of sleeving etc. ● Complete kit of parts including construction plans.

Total Building Costs £10-30

P & P 65p

ELECTRONIC CONSTRUCTION KITS

ECK 1

3 Transistor Easy Stage Earpiece Receiver Kit. Full Medium Wave Coverage. Complete with Ready Wound Ferrite Rod Aerial. High Efficiency Air Spaced Tuning Capacitor. Sensitive Crystal Earpiece and Gain Control. Operates from a 9 Volt P.P.7 Battery (not supplied with kit). This Electronic Construction Kit is a good starter for those interested in kit building and soldering. Complete kit of parts including construction plans.

£4-50 P.P. and Ins. 45p.

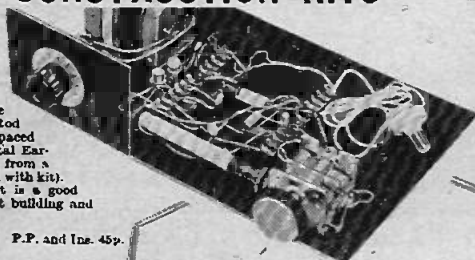

ECK 2

Self Contained Multi-Band V.H.F. Receiver Kit. 8 Transistors and 3 Diodes. Push/Full output. 3" Loudspeaker. Gain Control. Superb 9 section swivel ratchet and retractable chrome plated telescopic aerial. V.H.F. Tuning Capacitor. Resistors, Capacitors, Transistors, etc. Will receive T.V. Sound, Public Service Band, Aircraft, V.H.F. Local Stations, etc. Operates from a 9 Volt P.P.7 Battery (not supplied with kit). Complete kit of parts including construction plans.

£7-95 P.P. and Ins. 65p.

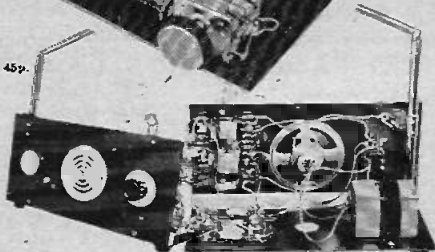

ECK 3

5 Transistor Medium Wave Receiver Kit. Class "A" Output with 3 1/2" Loudspeaker. Simple to operate with full Medium Wave Coverage. Ready Wound 8" Ferrite Rod Aerial. No external Aerial required. 7 stages, 5 Transistors and 2 Diodes, Tuning Capacitor. Gain Control, etc. Operates from a 4 1/2 Volt Battery (not supplied). Complete kit of parts including construction plans.

£5-40 P.P. and Ins. 45p.

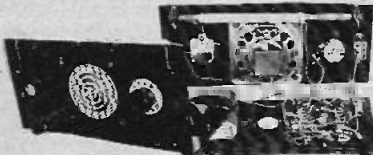

ECK 4

7 Transistors, 6 tuneable wavebands, MW, LW, Trawler Band, 3 Short Wave Bands. Receiver Kit. With 5" x 3" Loudspeaker. Push/Full output stage. Gain Control, and Rotary Switch. 7 Transistors and 4 Diodes. 6 section chrome-plated telescopic aerial. 8" Sensitive Ready Wound Ferrite Rod Aerial. Tuning Capacitor. Resistors, Capacitors, etc. Operates from a 9 Volt P.P. 7 Battery (not supplied with kit). Complete kit of parts including construction plans.

£7-25 P.P. and Ins. 65p.

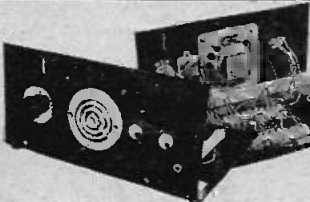

£7-50 P.P. and Ins. 45p

EDU-KIT JUNIOR

Completely Solderless Electronic Construction Kit. Build these projects without Soldering Iron or Solder.

- Crystal Radio Medium Wave Coverage:—No Battery necessary.
 - One Transistor Radio.
 - 2 Transistor Regenerative Radio.
 - 3 Transistor Earpiece Radio Medium Wave Coverage.
 - 4 Transistor Medium Wave Loudspeaker Radio.
 - Electronic Noise Generator.
 - Electronic Metronome.
 - 4 Transistor Push/Full Amplifier.
- All parts including Loudspeaker, Earpiece, MW Ferrite Rod Aerial, Capacitors, Resistors, Transistors, etc. Complete kit of parts including construction plans

VHF AIR CONVERTOR KIT

Build this Converter Kit and receive the Aircraft Band by placing it by the side of a radio tuned to Medium Wave or the Long Wave Band and operating as shown in the Instructions supplied free with all parts. Uses a retractable chrome plated telescopic aerial, Gain Control, V. H. F. Tuning Capacitor, Transistor, etc.



All Parts including Case and Plans. **£4-35** P.P. and Ins. 40p

ROAMER TEN MARK 2

With VHF including aircraft

Now with free earpiece and switched socket. 10 Transistors. Latest 4" 2 watt Ferrite Magnet Loudspeaker. 9 Tuneable Wavebands, MW1, MW2, LW, SW1, SW2, SW3, Trawler Band, VHF and Local Stations also Aircraft Band. Built in Ferrite Rod Aerial for MW/LW. Chrome plated 6 section Telescopic Aerial can be angled and rotated for peak short wave and VHF listening. Push/Full output using 600mW Transistors. Car Aerial and Tape Record Sockets. 10 Transistors plus 3 Diodes. Ganged Tuning Condenser with VHF section. Separate coil for Aircraft Band. Volume on/off. Wave Change and tone Controls. Attractive Case in black with silver blocking. Size 9" x 7" x 4". Easy to follow Instructions and diagrams. Parts price list and plans 50p free with parts.

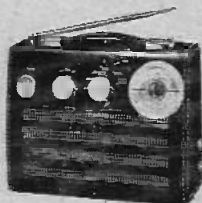

Total building costs **£11-87** P.P. and Ins. 65p

RADIO EXCHANGE LTD.

TO RADIO EXCHANGE LTD., 61A HIGH STREET, BEDFORD MK40 1SA. Tel: 0234 52367, REG NO. 788372

- Callers side entrance "Lavelis" Shop.
- Open 10-1, 2.30-4.30. Mon-Fri. 9-12 Sat.

I enclose £..... for
Name
Address