

Practical projects to build at home

everyday electronics

SEPT. 75
25p

PERFIT



MATCHBOX RECEIVER

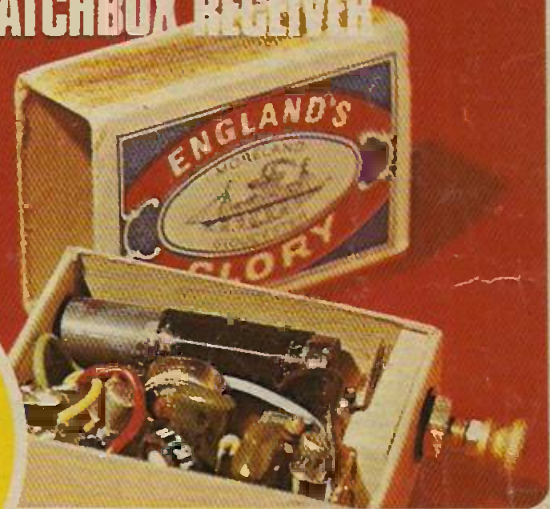

Get with it!

GET EVERYDAY
ELECTRONICS

**SONIC
BOMBER
GAME**

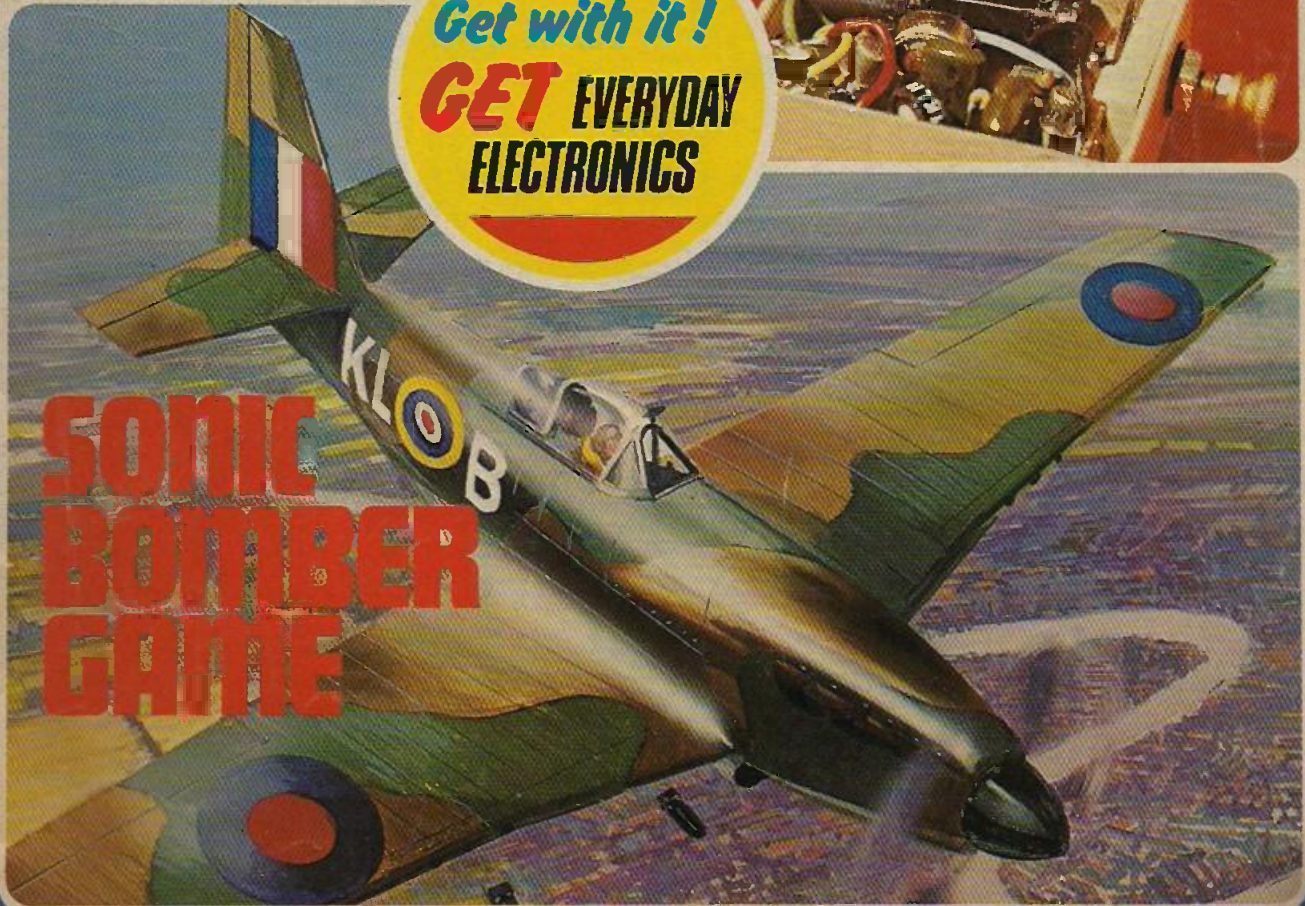

CHROMASONIC electronics

Dept. 3.56, Fortis Green Road,
Muswell Hill, London. N10 3HN.
telephone: 01-883 3705

C - MOS

74 TTL

LINEAR I.C.'s

C - MOS			74 TTL			LINEAR I.C.'s					
1-24	25-99	100up	1-24	25-99	100+						
CD4000AE	23p	19p	7400	14p	12p	555 (8 pin dip) V	55p	MC1303L	£1.84	SN76003N	£3.30
CD4001AE	23p	19p	7401	14p	12p	555 (14 pin) T	81p	MC1306P	80p	SN76013N	£1.98
CD4002AE	23p	19p	7402	14p	12p	703 (RF/IF Amp)	£1.29	MC1312	£2.42	SN76027N (MC1327)	£1.89
CD4006AE	£1.59	£1.33	7403	15p	12p		59p	MC1314	£4.13	SN76532N	£1.88
CD4007AE	23p	19p	7404	16p	13p	709 (8 pin dip)	38p	MC1327	£1.12	SN76544N	£1.81
CD4008AE	£1.75	£1.46	7408	16p	13p	709 (TO-99)	35p	MC1330P	85p	SN76550-2 (TAA550)	80p
CD4009AE	Use	CD4049	7409	16p	13p	709 (14 pin dip)	49p	MC1338P	£1.32		
CD4010AE	Use	CD4050	7410	16p	13p	BHA0002	£3.01	MC1350	64p	SN76552-2	81p
CD4011AE	23p	19p	7413	25p	24p	CA2111	£1.19	MC1351	88p	SN76660N (TBA120)	75p
CD4012AE	23p	19p	7417	27p	24p	CA3045	£1.69	MC1352	22p	SN76668N (CA3065)	£1.12
CD4013AE	69p	58p	7420	16p	13p	CA3048	88p	MC1357	£1.52		
CD4014AE	£1.75	£1.46	7427	27p	22p	CA3053	59p	MC1358 (CA3065)			
CD4015AE	£1.75	£1.46	7432	10p	13p	CA3065	£1.60	MC1375	£1.68	TAA263	£1.50
CD4016AE	69p	58p	7437	27p	22p	CA3075	£1.64	MC1455 (555T)	62p	TAA300	£2.17
CD4017AE	£1.75	£1.46	7437	27p	22p	CA3078	£1.26	MC1456CG	£1.98	TAA310A	£1.87
CD4018AE	£2.51	£2.09	7441	75p	65p	CA3080	59p	MC1458CPI	84p	TAA320	£1.44
CD4019AE	80p	66p	7442	65p	53p	CA3081	£1.98	MC1468B	£2.18	TAA350	£2.43
CD4020AE	£1.97	£1.64	7445	85p	71p	CA3082	£1.86	MC1495L	£4.24	TAA570	75p
CD4021AE	£1.75	£1.46	7447	95p	83p	CA3089E (TDA1200)	£2.43	MC1496G	96p	TAA570	£2.74
CD4022AE	£1.83	£1.53	7449	95p	83p	CA3097E	£1.67	MC1532P	£1.50	TAA700	£5.03
CD4023AE	23p	19p	7450	71p	57p	CA3123E	£1.76	MC3401P	74p	TB1205	£1.25
CD4024AE	£1.75	£1.46	7470	30p	25p	CA3401E (LM3900)	68p	MFC4000B	87p	TBA231	£1.02
CD4025AE	23p	19p	7472	25p	21p	748 (14 pin dip)	49p	MFC4060A	79p	TBA281 (723)	£2.59
CD4026AE	£2.79	£2.33	7473	30p	25p	753 (F.M. 1st. I.F.)	£1.08	MFC5030A	79p	TBA500Q	£3.18
CD4027AE	90p	82p	7474	32p	26p	75491	£1.08	MFC5040	98p	TBA520Q	£3.85
CD4028AE	£1.53	£1.28	7475	47p	39p	75492	£1.10	MFC5070	£1.56	TBA540Q	£3.72
CD4029AE	£1.12	£1.76	7476	32p	26p	Regulators 100mA		MM5314	£4.80	TGA550Q	£5.29
CD4030AE	71p	59p	7478	75p	65p	78105WC (TO-92)	80p	MVRSV (TO-3)	£1.45	TBA560CQ	£5.29
CD4032AE	£1.75	£1.17	7483	£1.30	£1.09	78121WC (TO-92)	80p	MVR12V (TO-3)	£1.45	TBA625A	£1.03
CD4034AE	£2.01	£1.68	7486	32p	26p	78151WC (TO-92)	80p	MVR15V (TO-3)	£1.45	TBA625C	£1.03
CD4040AE	£1.49	£1.24	7489	£3.56	£2.80	Regulators 100mA	85p	NE540L	£1.25	TBA851	£1.87
CD4049AE	69p	58p	7490	49p	40p	78105WC (TO-92)	80p	NE566A	£1.15	TBA720Q	£2.70
CD4050AE	69p	58p	7491	65p	55p	78151WC (TO-92)	80p	NE566B	£1.29	TBA750Q	£2.79
CD4051AE	£2.78	£2.32	7492	57p	46p	Regulators 500mA	90p	NE567	£5.06	TBA810A	£1.24
CD4052AE	£2.78	£2.32	7493	45p	32p	(TBA625A)	90p	NE568B	£5.06	TBA820	80p
CD4056AE	£2.12	£1.76	7495	67p	53p	78121A WC	90p	NE569	£2.96	TBA920Q	£4.71
CD4060AE	£2.51	£2.09	74100	£1.08	89p	(TBA625B)	90p	NE565N	£2.63	TCA270	£5.24
CD4066AE	£1.13	94p	74107	35p	28p	78151A WC	90p	NE566V	£1.87	TCA760	£2.16
CD4068AE	28p	24p	74121	34p	28p	Regulators 500mA	90p	NE567	£2.63	TCA800Q	£7.24
CD4069AE	28p	24p	74122	47p	39p	78M05HC	£1.35	NE568	£2.09	TCA830S	£1.04
CD4070AE	28p	24p	74141	78p	63p	78M12HC	£1.35	NE569	£2.09	TCA940	£2.25
CD4071AE	28p	24p	74145	68p	58p	78M15HC	£1.35	SL1414A	£2.75	TDA1054	£1.50
CD4077AE	71p	59p	74154	£1.75	£1.48	78M18HC	£1.35	SL437D	£2.50	TDA1200	£2.43
CD4081AE	28p	24p	74174	£1.00	83p	78M24HC	£1.35	SL440	£2.84	TDA1405	80p
CD4082AE	28p	24p	74180	£1.06	88p	Regulators 1A	80p	SL811C	£2.03	TDA1412	80p
CD4085AE	£1.28	£1.06	74181	£3.20	£2.50	7805KC (TO-3)	£2.09	SL812C	£2.03	TDA1415	80p
CD4086AE	£1.28	£1.06	74192	£1.35	£1.14	7815KC (TO-3)	£2.09	SL813C	£4.31	TDA2010	£3.00
CD4093AE	£1.56	£1.20	74193	£1.35	£1.14	7818KC (TO-3)	£2.09	SL820C	£3.06	TDA2020	£3.75
CD4099AE	£2.95	£2.46	74195	£1.64	£1.34	7824KC (TO-3)	£2.09	SL822C	£7.62	LJL8111A	£1.50
			74196	£1.64	£1.34	Regulators 1A	80p	SL823C	£5.57	ZN414	£1.28
						7825KC (TO-3)	£2.09	SL824C	£2.84		
						7818KC (TO-220)	£1.72	SL630C	£1.87		
						7815UC (TO-220)	£1.72	SL640C	£3.75		
						7818UC (TO-220)	£1.72	SL641C	£3.75		
								SL645C	£3.75		
								SL650C	£9.85		
								SN75491N	88p		
								SN75492N	£1.10		
								SN7601N	£1.82		

SIEMENS LCD's

LINE-O-LIGHT

LIQUID CRYSTAL DISPLAY complete with socket and removable reflective backing. Ref AN1028 13mm character height. Can be directly driven by National Semiconductor Alarm Clock chip MM5316. £13.99



NEW LED Linear Candles each device contains 10 light emitting diodes in a 20pin dual-in-line package. Ideal for solid state analogue meters or dials. Type 101 RED £2.26

20:59

PHOTO-DARLINGTON

SPECIAL PURCHASE

SEVEN SEGMENT DISPLAYS

2N5777
Vceo, Vcbo 25v. Vcbo B.
Vceo, Vcbo 25v. Vcbo B.
Ic 2500, Ie 250 mA **35p.**

enables
LIT707 0.3" 90p. LIT747 0.6" £1.99

litronix

Maxtron

Monsanto

I.C. SOCKETS
Dual-in-line TOS
Pins 8 14 16 24 26 36 40 8 10
Price 15p 15p 20p 30p 39p 44p 31p 35p

NEW
Litronix Double Digit Displays
0.5" Common Anode - 2 X H.
D.P.'s.
DL721 gives - 1, 9
DL727 gives 0, 10, 9, 9
Suitable for Clocks, Instruments;
T.V. Channel Indicator
Our Price £4.75 each.

L.E.D.'s
Free snap-on plastic retainer

0.125" dia. lens (TIL209) 1p- 10p- 100p-
0.16" dia. lens 1p- 10p- 100p-
0.2" dia. lens (MLE50) 1p- 10p- 100p-
Red 16p 15p 13p • 27p 24p 22p • 18p 16p 14p •
Green 27p 24p 22p • 33p 30p 27p • 30p 27p 25p •
Orange 27p 24p 22p • 33p 30p 27p • 30p 27p 25p •
Yellow 34p 31p 29p • 35p 32p 29p • 35p 32p 30p •

Low Cost Red GaAsP
Monorail MLED 500
In a TO9 package. 15p

NOTICE
Packaging & Packing Charges
With the recent increase in postal charges and a continuing increase in packaging cost we have been forced to review our policy.
Henceforward:
1. Orders valued at £5 or more will be post free.
2. All U.K. "small package" orders will go first class mail.
3. Minimum postage & packing charge will increase to 20p.

	COMMON ANODE R/H	COMMON ANODE L/H	COMMON CATHODE R/H	COMMON CATHODE L/H	Our Price
RED	DL70P	DL70P	DL701	DL704	£1.82
GREEN	MAN51	MAN57	MAN53	MAN54	£1.82
RED	MAN71	MAN72	MAN73	MAN74	£1.82
YELLOW	MAN81	MAN82	MAN83	MAN84	£1.82
ORANGE	MAN3610	MAN3620	MAN3630	MAN3640	£1.82
GREEN	XAN51	XAN52	-	XAN54	£1.49
RED	XAN71	XAN72	-	XAN74	£1.49
YELLOW	XAN81	XAN82	-	XAN84	£1.49
GREEN	MAN4510	MAN4520	MAN4530	MAN4540	£2.32
RED	MAN4710	MAN4720	MAN4730	MAN4740	£2.32
YELLOW	MAN4810	MAN4820	MAN4830	MAN4840	£2.32
ORANGE	MAN4610	MAN4620	MAN4630	MAN4640	£2.32
	C.A. L/H Dec. Pt.	C.A. L/H Dec. Pt.	C.C. L/H Dec. Pt.	C.C. L/H Dec. Pt.	
0.6"	RED DL7	DL7	DL7	DL7	£2.42

NOTE: MAN4000 series pinouts are 14 pin dit the same as MAN5070 & 80 series.

Items marked with a • include 8% VAT
Items unmarked include VAT at 25%

VAT INCLUDED

ADVERT. No.1. of Series B.

CALLERS WELCOME

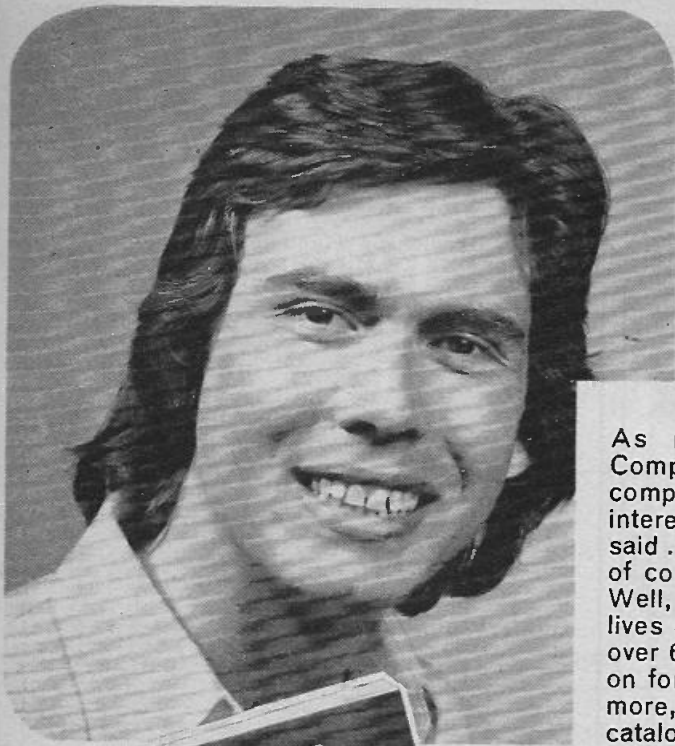

kom-pre-hense-iv

As no doubt you've noticed, Home Radio Components Ltd. are always going on about how comprehensive their catalogue is! So out of interest I looked up the word in a dictionary. It said . . . "KOM-PRE-HENSE-IV, having the quality of comprising much; extensive; full."

Well, on that definition, the catalogue certainly lives up to their claim. In its 240 pages there are over 6,000 items listed and there must be getting on for a couple of thousand illustrations. What's more, to make it easy to find your way around, the catalogue is most carefully indexed, with cross references where necessary. Recently someone at Home Radio Components told me that they've sold over 150,000 copies of the catalogue. I'm not surprised! They also mentioned that many professional people in the world of radio and electronics regard it as a standard reference work. I don't know about the professionals, but I know lots of we amateur freaks would be quite lost without it.

But perhaps you have managed to struggle along so far without this invaluable catalogue. Why hamper yourself any longer? *Send off the coupon below with cheque or P.O. for 98 pence.* (65p plus 33p postage & packing). Every catalogue contains 14 vouchers each worth 5p when used as directed. This means that you can recover 70 pence, the whole cost of the catalogue plus 5p towards the postage. Needless to say, the catalogue is backed by a really good Mail Order Service.



65p. plus 33p POST AND PACKING

Send off the coupon today. It's your first step to solving your component buying problems.

The price of 98p applies only to customers in the U.K. and to BFPO Addresses.

Please write your Name and Address in block capitals

NAME

ADDRESS

.....

.....

HOME RADIO (Components) LTD., Dept. EE,
234-240 London Road, Mitcham, Surrey CR4 3HD



(Regn. No
London 912966)

HOME RADIO (Components) LTD. Dept. EE, 234-240 London Road, Mitcham CR4 3HD. Phone 01-648 8422



become a RADIO-AMATEUR!

learn how to become a radio-amateur
in contact with the whole world. We give
skilled preparation for the G.P.O. licence

RAPY

free! Brochure, without obligation to:

**BRITISH NATIONAL RADIO & ELECTRONICS
SCHOOL** Dept EEB 95 P.O. Box 156, JERSEY

NAME: _____

ADDRESS: _____

BLOCK CAPS please

ELECTROVALUE

The best of all!

CATALOGUE 7 ISSUE 3

with 25p refund voucher

Up-dated Price & Product Information

112 pages plus cover As comprehensive and up-to-the-minute as possible. Thousands of items from vast ranges of semi-conductors including I.C.s to components, tools, accessories, technical information and diagrams are included as well as a refund voucher worth 25p for spending on orders list value £5 or more **SEND NOW FOR YOUR COPY BY RETURN 30p** paid it's an investment in practical money-saving and reliability!

PRICES as shown in our latest catalogue (No. 7, Issue 3) were due for review by April 1st. In fact these have remained unchanged since January, reviewed only at 3-monthly intervals as from July 1st next. This is instead of making day-to-day price changes.

DISCOUNTS apply on all items except the few where prices are shown **NETT. 5%** on orders from £5 to £14.99; **10%** on orders list value £15 or more.

FREE POST AND PACKING in U.K. for pre-paid mail orders over £2 (except Baxandall cabinets). If under there is an additional handling charge of 10p.

QUALITY GUARANTEE. All goods are sold on the understanding that they conform to maker's specification. No rejects, seconds or sub-standard merchandise.

ELECTROVALUE LTD

All communications to Section 2/5, 28, ST. JUDES RD, ENGLEFIELD GREEN, EGHAM, SURREY TW20 0HB. Telephone Egham 3603, Telex 264475. Shop hours: 9-5.30 daily, 9-1 pm Sats.

NORTHERN BRANCH: 680, Burnage Lane, Burnage, Manchester M19 1NA. Telephone (061) 432 4945. Shop hours: Daily 9-5.30 pm; 9-1 pm Sats.

Sparkrite mk2

The tried, tested, proven, reliable, complete,
professional, capacitive discharge,

Electronic Ignition Kit

"Sparkrite" was voted best of 8 systems tested by Popular Motoring Magazine

CALLERS WELCOME

ORDER NOW

To ELECTRONICS DESIGN ASSOCIATES DEPT EEP
82 Bath Street, Walsall, WS1 3D.
Phone 33652.

From Name _____

Address _____

Qty. _____

Sparkrite Mk 2 DIY Ass. kits @ £10.93

Sparkrite Mk 2 Ready Built Negative earth @ £13.86

Sparkrite Mk 2 Ready Built Positive earth @ £13.86

Ignition changeover switches @ £2.42

R.P.M. Limit systems in the above units @ £2.42

I enclose cheque/P.O. for £ _____

Cheque No. _____

(Send SAE if brochure only required)

Sparkrite Mk 2 is a high performance, high quality capacitive discharge, electronic ignition system.

Because of the superb design of the Sparkrite circuit it completely eliminates problems of the contact breaker. There is no misfire because contact breaker bounce is eliminated electronically by a pulse-suppression circuit which prevents the unit firing if the points bounce open at high R.P.M. Contact breaker burn is eliminated by reducing the current to about 1/50th of the norm. It will perform equally well with new, old, or even badly pitted points and is not dependent upon the dwell time of the contact breakers for recharging the system. Sparkrite incorporates a short circuit protected inverter which eliminates the problems of SCR lock on and therefore eliminates the possibility of blowing the transistors or the S.C.R. (Many capacitive discharge ignitions are not completely foolproof in this respect.)

Sparkrite can therefore give you:—
up to 20% better fuel consumption, instant all weather starting, cleaner plugs—they last up to 5 times longer without attention, faster acceleration, higher top speeds, longer coil and battery life, efficient fuel burning and less air pollution, smoother running, continual peak performance.

PATENT PENDING



THE KIT COMPRISES EVERYTHING NEEDED Ready drilled pressed steel case coated in matt black epoxy resin, ready drilled base and heat-sink, top quality 5 year guaranteed transformer and components, cables, coil connectors, printed circuit board, nuts, bolts, silicon grease, full instructions to make the kit negative or positive earth, and 10 page installation instructions.

OPTIONAL EXTRA

Electronic/conventional ignition switch Gives instant changeover from "Sparkrite" ignition to conventional ignition for performance comparisons, static timing etc., and will also switch the ignition off completely as a security device. Includes: switch connectors, mounting bracket and instructions. Cables excluded.

PRICES

D.I.Y. assembly kit £10.93 incl. V.A.T. post and packing. **Ready built unit** £13.86 incl. V.A.T. post and packing (Both to fit all vehicles with coil/distributor ignition up to 8 cylinders.) **Switch for instant changeover from "Sparkrite" ignition to conventional ignition** £2.79 incl. V.A.T. post and packing. **R.P.M. limiting control** £2.42 incl. V.A.T. post and packing. (Fitted in case on ready built unit, dashboard mounting on kit.)



I.L.P. (Electronics) Ltd

SHEER SIMPLICITY!

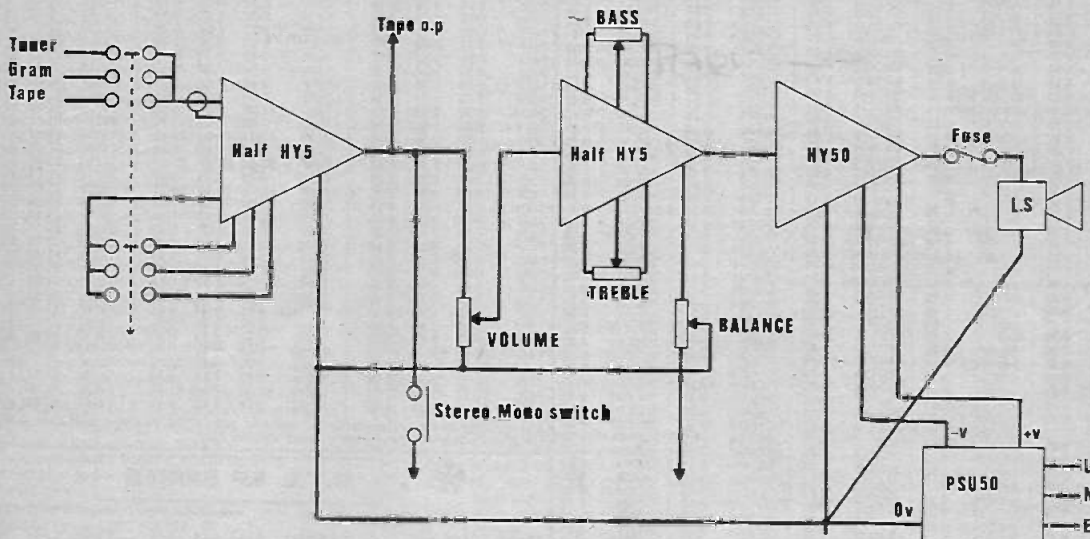

MONO ELECTRICAL CIRCUIT DIAGRAM WITH INTERCONNECTIONS FOR STEREO SHOWN
POWER CONNECTIONS FROM PFU50 TO HY5 NOT SHOWN FOR CLARITY OF DIAGRAM

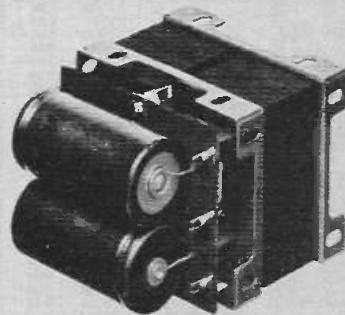
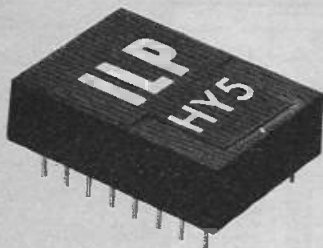

The HY5 is a complete mono hybrid preamplifier, ideally suited for both mono and stereo applications. Internally the device consists of two high quality amplifiers—the first contains frequency equalisation and gain correction, while the second caters for tone control and balance.

TECHNICAL SPECIFICATION

Inputs: Magnetic Pick-up 3mV RIAA; Ceramic Pick-up 30mV; Microphone 10mV; Tuner 100mV; Auxillary 3-100mV; Input Impedance 47kΩ at 1kHz. Outputs: Tape 100mV; Main output 0db (0-775V RMS). Active Tone Controls: Treble ± 12db at 10kHz; Bass ± 12db at 100Hz. Distortion: 0-5% at 1kHz. Signal/Noise Ratio: 68db. Overload Capability: 40db on most sensitive input. Supply Voltage: ± 16-25V.

PRICE £4.50 + 36p VAT
P. & P. free

The HY50 is a complete solid state hybrid Hi-Fi amplifier incorporating its own high conductivity heatsink hermetically sealed in black epoxy resin. Only five connections are provided, input, output, power lines and earth.

TECHNICAL SPECIFICATION

Output Power: 25W RMS into 8Ω. Load Impedance: 4-16Ω. Input Sensitivity 0db (0-775V RMS). Input Impedance: 47kΩ. Distortion: Less than 0-1% at 25W typically 0-05%. Signal/Noise Ratio: Better than 75db. Frequency Response: 10Hz-50kHz ± 3db. Supply Voltage: ± 25V. Size: 105 x 50 x 25mm.

PRICE £5.98 + 48p VAT
P. & P. free

The PSU50 incorporates a specially designed transformer and can be used for either mono or stereo systems.

TECHNICAL SPECIFICATIONS

Output voltage: 50V (25-0-25V). Input Voltage: 210-240V.
Size: L.70, D.90, H.60mm.

PRICE £6 + 48p VAT
P. & P. free

TWO YEARS' GUARANTEE ON ALL OUR PRODUCTS

I.L.P. Electronics Ltd.
Crossland House,
Nackington, Canterbury
Kent CT4 7AD
Registered Office
Tel (0227) 63218

Please supply,

Total Purchase price

I Enclose, Cheque Postal Orders Money Order

Please debit my Access account Barclaycard account EE9.

Account number

Name & Address

Signature

BI-PAK SEMICONDUCTORS

TRANSISTORS

BRAND NEW FULLY GUARANTEED

Type	Price	Type	Price	Type	Price	Type	Price	Type	Price
AC107	0.20	BC183L	0.15	2N2193	0.38	ORP61	*0.41	BC172	0.15
AC113	0.18	BC184	0.20	2N2194	0.38	P20	0.81	BF187	0.22
AC115	0.20	BC184L	0.20	2N2217	0.38	F446A	0.29	BF173	0.22
AC117K	0.30	BC186	0.29	2N2218	0.38	FS3	0.43	BF178	0.22
AC122	0.18	BC187	0.29	2N2219	0.38	ST140	0.18	BF177	0.22
AC125	0.18	BC207	0.11	2N2220	0.38	ST141	0.18	BF178	0.22
AC126	0.18	BC208	0.11	2N2221	0.38	TIF29	0.44	BF179	0.21
AC127	0.18	BC209	0.12	2N2222	0.38	TIF30	0.52	BF180	0.21
AC128	0.19	BC212L	0.13	2N2368	0.18	TIF31A	0.56	BF181	0.21
AC132	0.15	BC213L	0.13	2N2369	0.15	TN224	0.38	BF182	0.21
AC134	0.15	BC214L	0.13	2N2369A	0.15	TIF41A	0.68	BF183	0.41
AC137	0.15	BC225	0.36	2N2411	0.25	TIF42A	0.81	BF184	0.28
AC141	0.19	BC226	0.36	2N2412	0.25	TIS43	*0.31	BF185	0.21
AC141K	0.30	BC301	0.28	2N2646	0.48	UT46	*0.28	BF187	0.23
AC142	0.18	BC302	0.26	2N2712	0.21	ZN414	\$1.11	BF188	0.41
AC142K	0.38	BC303	0.31	2N2714	0.21	ZG301	0.19	BF194	0.12
AC151	0.19	BC304	0.37	2N2904	0.18	ZG302	0.19	BF193	0.15
AC154	0.20	BC340	0.81	2N2904A	0.21	ZG303	0.19	BF196	0.18
AC155	0.20	BC340	0.87	2N2905A	0.21	ZG304	0.25	BF197	0.15
AC156	0.20	BC350	0.26	2N2905	0.21	ZG306	0.41	BF200	0.46
AC157	0.25	BC351	0.27	2N2906A	0.21	ZG308	0.38	BF222	0.68
AC165	0.80	BC352	0.31	2N2906	0.19	ZN2926	0.15	BF227	0.46
AC166	0.20	BC353	0.25	2N2907	0.20	ZN2926 Y 0.11	0.11	BF258	0.61
AC167	0.20	BC354	0.26	2N2907A	0.20	ZN2926 O 0.10	0.10	BF259	0.61
AC168	0.25	BC370	0.28	2N2907A	0.20	ZN2926 B 0.10	0.10	BF262	0.68
AC169	0.15	BC371	0.15	2N2923	0.15	ZN2926 B 0.10	0.10	BF263	0.56
AC176	0.20	BC372	0.15	2N2924	0.15	ZN3010	0.71	BF270	0.88
AC177	0.25	BC3710	0.28	2N2925	0.15	ZN3011	0.15	BF271	0.81
AC178	0.20	BC371	0.20	2N2925	0.15	ZN3053	0.18	BF272	0.81
AC179	0.20	BC372	0.20	2N2926	0.15	ZN3054	0.47	BF273	0.88
AC180	0.20	BD115	0.62	2N2926	0.15	ZN3055	0.42	BF274	0.88
AC180K	0.30	BD116	0.61	2N3319	0.15	ZN3319	0.15	BF275	0.88
AC181	0.20	BD121	0.61	2N3391 A	0.17	ZN3404	0.29	BF276	0.88
AC181K	0.30	BD123	0.67	2N3392	0.15	ZN3405	0.29	BF277	0.88
AC187	0.22	BD134	0.70	2N3392	0.15	ZN3405	0.29	BF278	0.88
AC187K	0.30	BD135	0.71	2N3393	0.15	ZN3405	0.29	BF279	0.88
AC188	0.22	BD142	0.81	2N3394	0.15	ZN3405	0.29	BF280	0.88
AC188K	0.30	BD143	0.87	2N3395	0.18	ZN3405	0.29	BF281	0.88
AC189	0.22	BD155	0.81	2N3402	0.21	ZN3405	0.29	BF282	0.88
AC189K	0.30	BD156	0.81	2N3403	0.21	ZN3405	0.29	BF283	0.88
AC191	0.20	BFY53	0.18	2N3404	0.29	ZN3405	0.29	BF284	0.88
AC192	0.20	BKX19	0.18	2N3404	0.29	ZN3405	0.29	BF285	0.88
AC193	0.20	BKX20	0.18	2N3405	0.18	ZN3405	0.29	BF286	0.88
AC194	0.20	BKX21	0.18	2N3406	0.18	ZN3405	0.29	BF287	0.88
AC195	0.20	BKX22	0.18	2N3407	0.18	ZN3405	0.29	BF288	0.88
AC196	0.20	BKX23	0.18	2N3408	0.18	ZN3405	0.29	BF289	0.88
AC197	0.20	BKX24	0.18	2N3409	0.18	ZN3405	0.29	BF290	0.88
AC198	0.20	BKX25	0.18	2N3410	0.18	ZN3405	0.29	BF291	0.88
AC199	0.20	BKX26	0.18	2N3411	0.18	ZN3405	0.29	BF292	0.88
AC200	0.20	BKX27	0.18	2N3412	0.18	ZN3405	0.29	BF293	0.88
AC201	0.20	BKX28	0.18	2N3413	0.18	ZN3405	0.29	BF294	0.88
AC202	0.20	BKX29	0.18	2N3414	0.18	ZN3405	0.29	BF295	0.88
AC203	0.20	BKX30	0.18	2N3415	0.18	ZN3405	0.29	BF296	0.88
AC204	0.20	BKX31	0.18	2N3416	0.18	ZN3405	0.29	BF297	0.88
AC205	0.20	BKX32	0.18	2N3417	0.18	ZN3405	0.29	BF298	0.88
AC206	0.20	BKX33	0.18	2N3418	0.18	ZN3405	0.29	BF299	0.88
AC207	0.20	BKX34	0.18	2N3419	0.18	ZN3405	0.29	BF300	0.88
AC208	0.20	BKX35	0.18	2N3420	0.18	ZN3405	0.29	BF301	0.88
AC209	0.20	BKX36	0.18	2N3421	0.18	ZN3405	0.29	BF302	0.88
AC210	0.20	BKX37	0.18	2N3422	0.18	ZN3405	0.29	BF303	0.88
AC211	0.20	BKX38	0.18	2N3423	0.18	ZN3405	0.29	BF304	0.88
AC212	0.20	BKX39	0.18	2N3424	0.18	ZN3405	0.29	BF305	0.88
AC213	0.20	BKX40	0.18	2N3425	0.18	ZN3405	0.29	BF306	0.88
AC214	0.20	BKX41	0.18	2N3426	0.18	ZN3405	0.29	BF307	0.88
AC215	0.20	BKX42	0.18	2N3427	0.18	ZN3405	0.29	BF308	0.88
AC216	0.20	BKX43	0.18	2N3428	0.18	ZN3405	0.29	BF309	0.88
AC217	0.20	BKX44	0.18	2N3429	0.18	ZN3405	0.29	BF310	0.88
AC218	0.20	BKX45	0.18	2N3430	0.18	ZN3405	0.29	BF311	0.88
AC219	0.20	BKX46	0.18	2N3431	0.18	ZN3405	0.29	BF312	0.88
AC220	0.20	BKX47	0.18	2N3432	0.18	ZN3405	0.29	BF313	0.88
AC221	0.20	BKX48	0.18	2N3433	0.18	ZN3405	0.29	BF314	0.88
AC222	0.20	BKX49	0.18	2N3434	0.18	ZN3405	0.29	BF315	0.88
AC223	0.20	BKX50	0.18	2N3435	0.18	ZN3405	0.29	BF316	0.88
AC224	0.20	BKX51	0.18	2N3436	0.18	ZN3405	0.29	BF317	0.88
AC225	0.20	BKX52	0.18	2N3437	0.18	ZN3405	0.29	BF318	0.88
AC226	0.20	BKX53	0.18	2N3438	0.18	ZN3405	0.29	BF319	0.88
AC227	0.20	BKX54	0.18	2N3439	0.18	ZN3405	0.29	BF320	0.88
AC228	0.20	BKX55	0.18	2N3440	0.18	ZN3405	0.29	BF321	0.88
AC229	0.20	BKX56	0.18	2N3441	0.18	ZN3405	0.29	BF322	0.88
AC230	0.20	BKX57	0.18	2N3442	0.18	ZN3405	0.29	BF323	0.88
AC231	0.20	BKX58	0.18	2N3443	0.18	ZN3405	0.29	BF324	0.88
AC232	0.20	BKX59	0.18	2N3444	0.18	ZN3405	0.29	BF325	0.88
AC233	0.20	BKX60	0.18	2N3445	0.18	ZN3405	0.29	BF326	0.88
AC234	0.20	BKX61	0.18	2N3446	0.18	ZN3405	0.29	BF327	0.88
AC235	0.20	BKX62	0.18	2N3447	0.18	ZN3405	0.29	BF328	0.88
AC236	0.20	BKX63	0.18	2N3448	0.18	ZN3405	0.29	BF329	0.88
AC237	0.20	BKX64	0.18	2N3449	0.18	ZN3405	0.29	BF330	0.88
AC238	0.20	BKX65	0.18	2N3450	0.18	ZN3405	0.29	BF331	0.88
AC239	0.20	BKX66	0.18	2N3451	0.18	ZN3405	0.29	BF332	0.88
AC240	0.20	BKX67	0.18	2N3452	0.18	ZN3405	0.29	BF333	0.88
AC241	0.20	BKX68	0.18	2N3453	0.18	ZN3405	0.29	BF334	0.88
AC242	0.20	BKX69	0.18	2N3454	0.18	ZN3405	0.29	BF335	0.88
AC243	0.20	BKX70	0.18	2N3455	0.18	ZN3405	0.29	BF336	0.88
AC244	0.20	BKX71	0.18	2N3456	0.18	ZN3405	0.29	BF337	0.88
AC245	0.20	BKX72	0.18	2N3457	0.18	ZN3405	0.29	BF338	0.88
AC246	0.20	BKX73	0.18	2N3458	0.18	ZN3405	0.29	BF339	0.88
AC247	0.20	BKX74	0.18	2N3459	0.18	ZN3405	0.29	BF340	0.88
AC248	0.20	BKX75	0.18	2N3460	0.18	ZN3405	0.29	BF341	0.88
AC249	0.20	BKX76	0.18	2N3461	0.18	ZN3405	0.29	BF342	0.88
AC250	0.20	BKX77	0.18	2N3462	0.18	ZN3405	0.29	BF343	0.88
AC251	0.20	BKX78	0.18	2N3463	0.18	ZN3405	0.29	BF344	0.88
AC252	0.20	BKX79	0.18	2N3464	0.18	ZN3405	0.29	BF345	0.88
AC253	0.20	BKX80	0.18	2N3465	0.18	ZN3405	0.29	BF346	0.88
AC254	0.20	BKX81	0.18	2N3466	0.18	ZN3405	0.29	BF347	0.88
AC255	0.20	BKX82	0.18	2N3467	0.18	ZN3405	0.29	BF348	0.88
AC256	0.20	BKX83	0.18	2N3468	0.18	ZN3405	0.29	BF349	0.88
AC257	0.20	BKX84	0.18	2N3469	0.18	ZN3405	0.29	BF350	0.88
AC258	0.20	BKX85	0.18	2N3470	0.18	ZN3405	0.29	BF351	0.88
AC259	0.20	BKX86	0.18	2N3471	0.18	ZN3405	0.29	BF352	0.88
AC260	0.20	BKX87	0.18	2N3472	0.18	ZN3405	0.29	BF353	0.88
AC261	0.20	BKX88	0.18	2N3473	0.18	ZN3405	0.29	BF354	0.88
AC262	0.20	BKX89	0.18	2N3474	0.18	ZN3405	0.29	BF355	0.88
AC263	0.20	BKX90	0.18	2N3475	0.18	ZN3405	0.29	BF356	0.88
AC264	0.20	BKX91	0.18	2N3476	0.18	ZN3405	0.29	BF357	0.88
AC265	0.20	BKX92	0.18	2N3477	0.18	ZN3405	0.29	BF358	0.88
AC266	0.20	BKX93	0.18	2N3478	0.18	ZN3405	0.29	BF359	0.88
AC267	0.20	BKX94	0.18	2N3479	0.18	ZN3405	0.29	BF360	0.88
AC268	0.20	BKX95	0.18	2N3480	0.18	ZN3405	0.29	BF361	0.88
AC269	0.20	BKX96	0.18	2N3481	0.18	ZN3405	0.29	BF362	0.88
AC270	0.20	BKX97	0.18	2N3482	0.18	ZN3405	0.29	BF363	0.88
AC271	0.20	BKX98	0.18	2N3483	0.18	ZN3405	0.29	BF364	0.88
AC272	0.20	BKX99	0.18	2N3484	0.18	ZN3405	0.29	BF365	0.88
AC273	0.20	BKX00	0.18	2N3485	0.18	ZN3405	0.29	BF366	0.88
AC274	0.20	BKX01	0.18	2N3486	0.1				

PO BOX 6 WARE HERTS

SUPER UNTESTED PAKS

Pak No.	Description	Price Sp
U 1	120 Glass sub-min. General purpose Germ. diodes	0-60
U 2	50 Mixed Germanium transistors AF/BF	0-60
U 3	75 Germanium gold bonded sub-min. like OA5, OA47	0-60
U 4	20 Germanium transistors like OC81, AC128	0-60
U 5	60 200mA sub-min. silicon diodes	0-60
U 6	30 SiL Planar trans. NPN like B8Y95A, 2N706	0-60
U 7	16 8H. rect. TOP-HAT 750mA VLTG. RANGE up to 100	0-60
U 8	50 SiL planar diodes DO-7 glass 250mA like OA200/202	0-60
U 9	20 Mixed voltages, 1 Watt Zener Diodes	0-60
U10	20 PAV50 charge storage diodes DO-7 glass	0-60
U11	20 NPN SiL planar trans. TO-5 like 2N1132, 2N2904	0-60
U12	30 PNP-NPN SiL transistors OC200 & 2S104	0-60
U14	150 Mixed silicon and germanium diodes	0-60
U15	20 NPN SiL planar trans. TO-5 like 2N696, 2N697	0-60
U16	10 3AMP all. rectifiers stud type up to 1000 PIV	0-60
U17	30 Germanium PNP AP transistors TO-5 like ACY 17-22	0-60
U18	8 6 Amp sil. rectifiers BYZ13 type up to 600 PIV	0-60
U19	20 Silicon NPN transistors like BC 105	0-60
U20	12 1.5 Amp sil. rectifiers top hat up to 1000 PIV	0-60
U21	30 AD. Germ. alloy transistors 2G300 series & OC71	0-60
U23	20 MADT's like M8H series PNP transistors	0-60
U24	20 Germ. 1 Amp rectifiers GJM series up to 300 PIV	0-60
U25	25 300 MHz NPN silicon transistors 2N708, B8Y27	0-60
U26	30 Fast switching silicon diodes like IN914 Micro-Min	0-60
U29	10 1 Amp SCR's TO-5 can. up to 600 PIV CR81/25-600	*£1.20
U32	28 Zener diodes 400 mW DO-7 case 3-33 volts mixed	0-60
U33	16 Plastic case 1 Amp sil. rectifiers IN4000 series	0-60
U34	20 silicon PNP alloy trans. TO-5 BCY26 28302/4	0-60
U35	25 Silicon planar transistors PNP TO-18 2N2906	0-60
U36	20 Silicon planar NPN transistors TO-5 BFY50/51/52	0-60
U37	30 Silicon alloy transistors 80-2 PNP OC200, 82322	0-60
U38	20 Fast switching silicon trans. NPN 400 MHz 2N3011	0-60
U39	30 R.F. Ger. PNP transistors 2N1303/5 TO-5	0-60
U40	10 Dual transistors 6 lead TO-5 2N2060	0-60
U43	25 Silicon trans. plastic TO-18 A.F. BC113/114	0-60
U44	20 Silicon trans. plastic TO-5 BC115	0-60
U45	7 3A SCR. TO66 up to 600 PIV	*£1.20
U46	20 Unijunction transistors similar to T1843	0-60
U47	10 TO220AB plastic triacs 50V 6A	*£1.20
U48	9 NPN SiL power transistors like 2N3055	*£1.20
U49	12 NPN SiL plastic power trans. 60W like 2N5294/5296	*£1.20

Code No's mentioned above are given as a guide, to the type of device in the pak. The devices themselves are normally unmarked.

QUALITY TESTED PAKS

Pak No.	Quality Tested Paks	Price
Q 1	20 Red spot transistors PNP	0-60
Q 2	16 White spot R.F. transistors PNP	0-60
Q 3	4 OC 77 type transistors	0-60
Q 4	6 Matched transistors OC44/45/81/81D	0-60
Q 5	4 OC 75 transistors	0-60
Q 6	5 OC 72 transistors	0-60
Q 7	4 AC 128 transistors PNP high gain	0-60
Q 8	4 AC 128 transistors PNP	0-60
Q 9	7 OC 81 type transistors	0-60
Q10	7 OC 71 type transistors	0-60
Q11	2 AC 127/128 Complementary pairs	0-60
PNP/NPN		
Q12	3 AF 116 type transistors	0-60
Q13	3 AF 117 type transistors	0-60
Q14	3 OC 171 H.F. type transistors	0-60
Q15	7 2N2926 8H. Epoxy transistors mixed colours	0-60
Q17	5 NPN 2xST.141. & 3xST.140	0-60
Q18	4 MADT'S 2xMAT 100 & 2xMAT 120	0-60
Q19	3 MADT'S 2xMAT 101 & 1xMAT 121	0-60
Q20	4 OC 44 Germanium transistors A.F.	0-60
Q21	4 AC 127 NPN Germanium transistors	0-60
Q22	20 NKT transistors A.F. R.F. coded	0-60
Q23	10 OA 292 Silicon diodes sub-min	0-60
Q24	8 OA 81 diodes	0-60
Q25	15 IN 914 Silicon diodes 75PIV 75mA	0-60
Q26	8 OA95 Germanium diodes sub-min. IN69	0-60
Q27	2 10A 600 PIV Silicon rectifiers 18A425B	0-60
Q28	2 Silicon power rectifiers BYZ 13	0-60
Q29	4 SiL transistors 2x2N696, 1x2N697, 1x2N698	0-60
Q30	7 Silicon switch transistors 2N706 NPN	0-60
Q31	6 Silicon switch transistors 2N708 NPN	0-60
Q32	3 PNP Sil. trans. 2x2N1131, 1x2N1132	0-60
Q33	3 Silicon NPN transistors 2N1711	0-60
Q34	7 SiL NPN trans. 2N2369, 500MHz (code P397)	0-60
Q35	3 Silicon PNP TO-5 2x2N2904 & 1x2N2905	0-60
Q36	7 2N3846 TO-18 plastic 200 MHz NPN	0-60
Q37	3 2N3053 NPN Silicon transistors	0-60
Q38	5 PNP transistors 3x2N3703, 2x2N3072	0-60
Q39	5 NPN transistors 3x2N3704, 2x2N3705	0-60
Q40	5 NPN transistors 3x2N3707, 2x2N3708	0-60
Q41	3 Plastic NPN TO18 2N3904	0-60
Q43	5 BC 107 NPN transistors	0-60
Q44	5 NPN transistors 3xBC 108, 2xBC 109	0-60
Q45	3 BC 113 NPN TO-18 transistors	0-60
Q46	3 BC 115 NPN TO-5 transistors	0-60
Q47	4 NPN high gain transistors 2xBC 167, 2xBC 168	0-60
Q48	3 BCY 70 PNP transistors TO-18	0-60
Q49	3 NPN transistors 2xBFY 51, 1xBFY 52	0-60
Q50	7 B8Y 28 NPN switch transistors TO-18	0-60
Q51	7 B8Y 96A NPN transistors 300MHz	0-60
Q52	8 BY 100 type silicon rectifiers	*£1.20
Q53	25 SiL & Germ. trans. mixed all marked new	*£1.20
Q54	6 TIL 209 Red LED	*£1.20

MAMMOTH I.C. PAK

APPROX 200 PIECES
Assorted fall-out integrated circuits, including: Logic, 74 series, Linear, Audio and D.T.L. Many coded devices but some unmarked—you to identify.
OUR SPECIAL PRICE £1.20p

WORLD SCOOP

JUMBO SEMICONDUCTOR PAK
Transistors—Germ. and Silicon. Rectifiers—Diodes—Triacs—Thyristors—I.C.'s and Zeners. ALL NEW AND CODED

APPROX 1000 PIECES
Offering the amateur a fantastic bargain PAK and an enormous saving—identification and data sheet in every pak.
ONLY £1.85p

UNTESTED LIN PAKS

Manufacturers—Fall Outs' which include Functional and part Functional Units. These are classed as 'out-of-spec' from the makers' very rigid specifications, but are ideal for learning about I.C.'s and experimental work.

Pak No.	Contents	Price
ULIC708	= 10 x 709	0-60
ULIC710	= 7 x 710	0-60
ULIC741	= 7 x 741	0-60
ULIC747	= 5 x 747	0-60
ULIC748	= 7 x 748	0-60

C280 CAPACITOR PAK

Containing 75 of the C280 range of capacitors assorted in values ranging from 0.1µF to 3.2µF. Complete with identification chart.

FANTASTIC VALUE
ONLY £1.20p

SIL. G.P. DIODES

300 mW 40 PIV (min) SUB-MIN FULLY TESTED
Ideal for Organ builders
30 for 50p, 100 for £1.50, 500 for £5, £1000 for 9.

G.P. SWITCHING TRANS

TO18 8DM. TO 2N706/8 B8Y27/28/96A
All usable devices. No open and shorts. ALSO AVAILABLE IN PNP similar to 2N2906, BCY 70 for 20 for 50p, 50 for £1, 100 for £1.50, 500 for £5, 1000 for £14.
When ordering please state NPN or PNP

G.P. 100

30 WATT GERMANIUM TO3 METAL CASE
Vcbo 80V, Vcco 50V, IC 10A, Hfe 30-170 replaces the majority of Germanium power Transistors in the OC, AD NKT range.

1-24	25-99	100+
44p	41p	37p

G.P. 300

115 WATT SILICON TO3 METAL CASE
Vcbo 100V, Vcco 60V, IC 15A, Hfe 20-100 suitable replacement for 2N3055, BDT11 or BDT20

1-24	25-99	100+
50p	48p	46p

INDICATORS

3015F Minitron 7 Segment Indicator £1.11+
MAN 3M L.E.D. 7 SEGMENT DISPLAY
0.127" High Characters £1.75p+

ZENER DIODES

FULL RANGE IN STOCK
VOLTAGE RANGE 2-33V
400 mW 1.3V 10 w+
8p 17p 30p

EXCLUDE VAT
AT 25% TO ALL

* ADD 8%
NO VAT
add 20p overseas
Minimum order 75p

VOLTAGE REGULATORS

TO-3 Plastic Encapsulation	
ua.7805/L129 5V	(Equiv. to MVR5V) £1.25p
ua.7812/L130 12V	(Equiv. to MVR12V) £1.25p
ua.7815/L131 15V	(Equiv. to MVR15V) £1.25p
ua.7818 18V	(Equiv. to MVR18V) £1.25p

* THYRISTORS

PIV	0-6A	0-8A	1A	3A	5A	5A	7A	10A	16A	30A
	TO18	TO52	TO5	TO66	TO66	TO64	TO48	TO48	TO48	TO48
10	0-12	0-15	—	—	—	—	—	—	—	—
30	0-15	0-18	—	—	—	—	—	—	—	—
30	0-19	0-22	—	—	—	—	—	—	—	—
50	0-22	0-28	0-20	0-25	0-35	0-35	0-45	0-51	0-54	£1-18
180	0-25	0-30	0-25	0-25	0-48	0-48	0-51	0-57	0-58	£1-43
150	0-31	0-38	—	—	—	—	—	—	—	—
200	0-38	0-44	—	—	—	—	—	—	—	—
400	—	—	0-35	0-30	0-50	0-50	0-57	0-63	0-62	£1-73
500	—	—	0-30	0-30	0-55	0-57	0-52	0-71	0-77	£1-79
500	—	—	0-39	0-48	0-69	0-69	0-78	0-99	0-90	—
500	—	—	0-58	0-85	0-81	0-81	0-92	£1-22	£1-39	£4-07

DIODES

Type	Price	Type	Price	Type	Price	Type	Price
AA119	0-08	BY101	0-12	BYZ16	0-41	OA85	0-09
AA120	0-08	BY105	0-18	BYZ17	0-38	OA90	0-07
AA129	0-08	BY114	0-12	BYZ18	0-38	OA91	0-07
AA130	0-09	BY124	0-12	BYZ19	0-28	OA95	0-07
AAZ13	0-10	BY126	0-15	CG62	—	OA200	0-07
BA100	0-10	BY127	0-16	(OA91Eq) 0-08	—	OA202	0-07
BA116	0-21	BY128	0-18	CG451 (OA70)	—	8D10	0-06
BA126	0-22	BY130	0-17	OA79	0-07	8D19	0-06
BA148	0-16	BY133	0-21	OA5 Short	—	1N34	0-07
BA154	0-12	BY164	0-51	Leads	0-21	1N34A	0-07
BA155	0-15	BYX38/300 43	—	OA10	0-14	1N914	0-06
BA156	0-14	BYZ10	0-36	OA47	0-07	1N916	0-06
BA173	0-15	BYZ11	0-31	OA70	0-07	1N4148	0-06
BB104	0-15	BYZ12	0-31	OA79	0-07	1S021	0-10
BY100	0-16	BYZ13	0-38	OA51	0-07	1S061	0-07

* UNTESTED T.T.L. PAKS

Manufacturers—Fall Outs' which include Functional and part Functional Units. These are classed as 'out-of-spec' from the makers' very rigid specifications but are ideal for learning about I.C.'s and experimental work.

Pak No.	Contents	Price
UIC00	= 12 x 7400	0-60
UIC01	= 12 x 7401	0-60
UIC02	= 12 x 7402	0-60
UIC03	= 12 x 7403	0-60
UIC04	= 12 x 7404	0-60
UIC05	= 12 x 7405	0-60
UIC06	= 8 x 7406	0-60
UIC07	= 8 x 7407	0-60
UIC10	= 12 x 7410	0-60
UIC13	= 8 x 7413	0-60
UIC20	= 12 x 7420	0-60
UIC30	= 12 x 7430	0-60
UIC40	= 12 x 7440	0-60
UIC41	= 5 x 7441	0-60
UIC42	= 5 x 7442	0-60
UIC43	= 5 x 7443	0-60
UIC44	= 5 x 7444	0-60
UIC45	= 5 x 7445	0-60
UIC46	= 5 x 7446	0-60
UIC47	= 5 x 7447	0-60
UIC48	= 5 x 7448	0-60
UIC50	= 12 x 7450	0-60
UIC51	= 12 x 7451	0-60
UIC53	= 12 x 7453	0-60
UIC54	= 12 x 7454	0-60
UIC60	= 12 x 7460	0-60
UIC70	= 8 x 7470	0-60
UIC72	= 8 x 7472	0-60
UIC73	= 8 x 7473	0-60
UIC74	= 8 x 7474	0-60
UIC75	= 8 x 7475	0-60
UIC76	= 8 x 7476	0-60
UIC80	= 8 x 7480	0-60
UIC81	= 8 x 7481	0-60
UIC82	= 8 x 7482	0-60
UIC83	= 8 x 7483	0-60
UIC86	= 8 x 7486	0-60
UIC90	= 8 x 7490	0-60
UIC91	= 8 x 7491	0-60
UIC92	= 8 x 7492	0-60
UIC93	= 8 x 7493	0-60
UIC94	= 8 x 7494	0-60
UIC95	= 8 x 7495	0-60
UIC96	= 8 x 7496	0-60
UIC100	= 5 x 74100	0-60
UIC121	= 5 x 74121	0-60
UIC141	= 5 x 74141	0-60
UIC151	= 5 x 74151	0-60
UIC154	= 5 x 74154	0-60
UIC193	= 5 x 74193	0-60
UIC199	= 5 x 74199	0-60
UIC X1.25	Assorted 74's	£1-50

Sinclair IC20

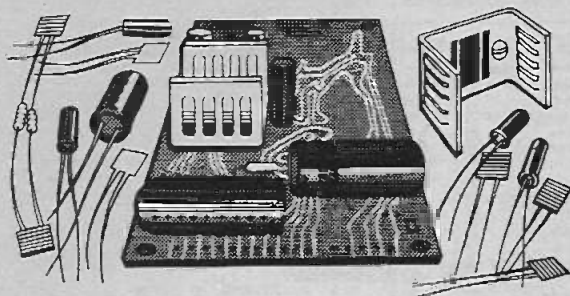

The watts...

The Sinclair IC20 is a revolutionary new 20 watts stereo amplifier kit.

It incorporates state-of-the-art integrated circuits - two monolithic silicon chips each containing the equivalent of over 20 transistors! These deliver 10 W per channel into 4Ω speakers.

And the IC20 has integral short-circuit protection and thermal cut-out - it's virtually indestructible. Use it for converting your mono record player to stereo... for upgrading your existing stereo... or for improving your car radio/tape player.

Its cost? Only £7.95 + VAT!

and the wherefores.



Get the full technical specifications...

See what impartial hi-fi journals thought of its performance...

And read up on the rest of the Sinclair hi-fi range...

It's all in the Sinclair hi-fi range fact-file.

Send for Sinclair's fact-file now!

See if the answer's here - the information on the component you've been looking for.

Simply cut the coupon and

send it to the no-stamp-needed FREEPOST address below.

We'll send you the Sinclair fact-file - giving you all you need to know about IC20, and the rest of the Sinclair hi-fi range.

Plus information about a few extras you're sure to find rather interesting.

You've plenty to gain... so cut the coupon - now!

Sinclair Radionics Ltd,
London Road, St Ives,
Huntingdon, Cambs., PE17 4HJ
St Ives (0480) 64646

Please send me the Sinclair range fact-file immediately

Name _____

Address _____

EE/9/1C

To: Sinclair Radionics Ltd,
FREEPOST, St Ives,
Huntingdon, Cambs., PE17 4BR

Please print

sinclair

QUALITY STEREO SOUND

ALMOST $\frac{1}{2}$ PRICE OFFER! SOLENT AUDIO SYSTEM

MADE TO SELL AT
DOUBLE THE PRICE
IN CABINET FORM
OUR
PRICE £59.95

£5.95
down

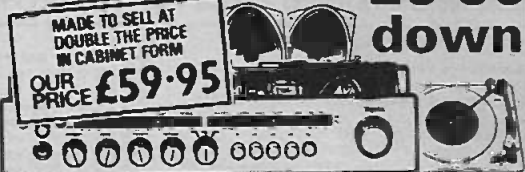

*Stereo Tuner Amplifier chassis with AM/FM radio covering long medium short and Stereo FM wavebands. Separate Base and Treble controls. 30 watts total power output (frequency response 25-20,000 Hz) Tape record and playback facilities. Dimensions 18" x 8 1/4" x 3 1/4". The very latest BSR automatic record deck with cue and pause control. Two matching elliptical speaker units.

Order early limited stocks available cash price £59.95. Credit Sale £5.95 deposit 9 monthly payments of £7.00 (Total Credit price £68.95). P. & P. £3.00. Send £8.95 today.

Chassis only available for cash at £42.00.

Full 12 months Guarantee.

CALLERS WELCOME.

Stereo headphones supplied with every complete order. 
LEWIS radio EE/9/75 100 CHASE SIDE SOUTHGATE
LONDON N14 5PL Telephones: 01-882-1644

ENGINEERS

FREE

YOURSELF FOR A

BETTER JOB WITH MORE PAY!



This 76 page
FREE book
shows how!

Do you want promotion, a better job, higher pay? "New Opportunities" shows you how to get them through a low-cost home study course. There are no books to buy and you can pay-as-you-learn.

This helpful guide to success should be read by every ambitious engineer. Send for this helpful 76 page FREE book now. No obligation and nobody will call on you. It could be the best thing you ever did.

CUT OUT THIS COUPON

CHOOSE A BRAND NEW FUTURE HERE!

Tick or state subject of interest. Post to the address below.

Electrical Engineering <input type="checkbox"/>	Colour T.V. Servicing <input type="checkbox"/>	CITY AND GUILDS Installations and Wiring <input type="checkbox"/>
Electrical Installations and Wiring <input type="checkbox"/>	C & G Radio, T.V. and Electronic Mechanics <input type="checkbox"/>	CITY AND GUILDS Electrical Technicians <input type="checkbox"/>
Electrical Draughtsmanship <input type="checkbox"/>	General Radio and TV Engineering <input type="checkbox"/>	CITY AND GUILDS Telecommunications <input type="checkbox"/>
Electrical Mathematics <input type="checkbox"/>	Radio Servicing, Maintenance and Repairs <input type="checkbox"/>	CITY AND GUILDS Radio Amateurs' Exam. etc. etc. <input type="checkbox"/>
Electronic Engineering <input type="checkbox"/>	Transistor Technology <input type="checkbox"/>	
Computer Prog. <input type="checkbox"/>		

TO: ALDERMASTON COLLEGE
DEPT. EEV 09 READING RG7 4PF
Also at our London Advisory Office, 4 Fore Street Avenue
Moorgate, London EC2Y 5EJ. Tel: 01-628 2721.

NAME (Block Capitals Please) _____

ADDRESS _____

POSTCODE _____

Other subjects _____

Accredited by U.A.C.C. Member of A.B.C.C.

HOME OF BRITISH INSTITUTE OF ENGINEERING TECHNOLOGY

NEW EDU-KIT MAJOR

Completely Solderless Electronic Construction Kit
Build these projects without soldering iron or solder

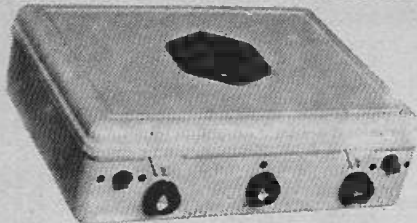

Total Building Costs

£9-03

PP & Ins. 58p
(Overseas Seamall
P & P £3-40)

- ★ 4 Transistor Earpiece Radio.
- ★ 5 Transistor Push Pull Amplifier.
- ★ Batteryless Crystal Radio.
- ★ Signal Tracer.
- ★ 7 Transistor Loudspeaker Radio MW/LW.
- ★ One Transistor Radio.
- ★ Signal Injector
- ★ 5 Transistor Short Wave Radio.
- ★ 2 Transistor Regenerative Radio.
- ★ Transistor Tester NPN-PNP.
- ★ Electronic Metronome.
- ★ 3 Transistor Regenerative Radio.
- ★ 4 Transistor Push Pull Amplifier.
- ★ Electronic Noise Generator
- ★ Audible Continuity Tester.
- ★ Sensitive Pre-Amplifier.

Components Include: 24 Resistors • 21 Capacitors • 10 Transistors • 3 1/2" Loudspeaker • Earpiece • Mica Baseboard • 3 12-way connectors • 2 Volume controls • 2 Slider Switches • 1 Tuning Condenser • 3 Knobs • Ready Wound MW/LW/SW Coils • Ferrite Rod • 6 1/2 yards of wire • 1 Yard-of sleeving etc. • Parts Price List and Plans 55p free with parts.

NEW ROAMER NINE

WITH V.H.F. INCLUDING AIRCRAFT

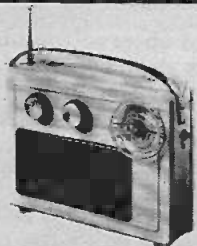

Nine Transistors, 9 Tunable wavebands as Roamer Ten. Built in ferrite rod aerial for VHF and SW. Push Pull output using 600mW transistors, 9 Transistors and 3 diodes, tuning condenser with V.H.F. section, separate coil for aircraft, moving coil loudspeaker, volume ON/OFF and wavechange controls. Attractive all white case with red grille and carrying strap. Size 9 1/2" x 7" x 2 1/2" approx. Parts Price List and Plans free with parts.

Total Building Costs **£8-70**

PP & Ins. 58p
(Overseas Seamall
P & P £3-40)

POCKET FIVE

NOW WITH 3" LOUD-SPEAKER

3 Tunable wavebands, M.W. L.W. and Trawler Band, 7 stages, 5 transistors and 2 diodes, super-sensitive ferrite rod aerial, attractive black and gold case. Size 5 1/4" x 1 1/2" x 3 1/4" approx. Plans and Parts Price List free with parts.

Total Building Costs **£3-70**

PP & Ins. 38p
(Overseas Seamall P & P £2-30)



TRANSONA FIVE NOW WITH 3" LOUDSPEAKER

Wavebands, transistors and speaker as Pocket Five. Larger Case with Red Speaker Grille and Tuning Dial. Plans and Parts Price List free with parts.

Total Building Costs **£4-00**

PP & Ins. 38p
(Overseas Seamall P & P £2-30)

TRANS EIGHT

8 TRANSISTORS and 3 DIODES

6 Tunable Wavebands: MW, LW, SW1, SW2, SW3 and Trawler Band. Sensitive ferrite rod aerial for M.W. and L.W. Telescopic aerial for Short Waves. 3in. Speaker. 8 improved type transistors plus 3 diodes. Attractive case in black with red grille, dial and black knobs with polished metal inserts. Size 9 x 6 1/2 x 2 1/2 in. approx. Push pull output. Battery economiser switch for extended battery life. Ample power to drive a larger speaker. Parts price list and plans free with parts.

Total building costs **£5-98**

PP & Ins. 50p
(Overseas Seamall P & P £2-50)

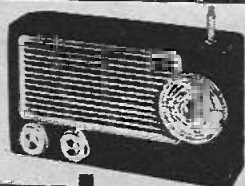

ROAMER SIX

CASE AND LOOKS AS TRANS-EIGHT

Trawler band plus an extra Medium waveband for easier tuning of Luxembourg, etc. Sensitive ferrite rod aerial and telescopic aerial for Short Waves. 3in. Speaker 8 stages—6 transistors and 2 diodes. Attractive black case with red grille, dial and black knobs with polished metal inserts. Total Size 9 x 6 1/2 x 2 1/2 in. approx. Plans and building parts price list free with parts.

Total building costs **£5-48**

PP & Ins. 50p
(Overseas Seamall P & P £2-50)

NEW Everyday Series

Build this exciting New series of designs E.V.5. 5 Transistors and 2 diodes. MW/LW. Powered by 4 1/2 volt Battery. Ferrite rod aerial, tuning condenser, volume control, and now with 3" loudspeaker. Attractive case with red speaker grille. Size 9" x 5 1/2" x 2 1/2" approx. Parts Price List and Plans free with parts.

Total Building Costs **£4-25**

PP & Ins. 50p
(Overseas Seamall P & P £2-30)

E.V.6. Case and looks as above. 6 Transistors and 3 diodes. Powered by 9 volt battery. Ferrite rod aerial, 3" loudspeaker, etc. MW/LW coverage. Push Pull output. Parts Price List and Plans free with parts.

Total Building Costs **£4-98**

PP & Ins. 50p
(Overseas Seamall P & P £2-30)

E.V.7. Case and looks as above. 7 Transistors and 3 diodes. Six wavebands. MW/LW, Trawler Band, SW1, SW2, SW3, powered by 9 volt battery. Push Pull output. Telescopic aerial for short waves. 3" Loudspeaker. Parts Price List and Easy Build Plans free with parts.

Total Building Costs **£5-60**

PP & Ins. 50p
(Overseas Seamall P & P £2-50)

ROAMER EIGHT Mk I

NOW WITH VARIABLE TONE CONTROL

7 Tunable Wavebands: MW1, MW2, LW, SW1, SW2, SW3 and Trawler Band. Built in Ferrite Rod Aerial for MW and LW. Chrome plated Telescopic aerial can be angled and rotated for peak short wave listening. Push pull output using 600mW transistors. Car aerial and Tape record sockets. Selectivity switch. 8 transistors plus 3 diodes. Latest 4" 2 watt ferrite magnet loudspeaker. Airspace ganged tuning condenser. Volume/on/off tuning wave change and tone controls. Attractive case in rich chestnut shade with gold blocking. Size 9 x 7 x 4 1/2 in. approx. Easy to follow instructions and diagrams. Parts price list and plans free with parts.

Total building costs **£8-73**

PP & Ins. £0-85



ROAMER TEN Mk 2

WITH VHF INCLUDING AIRCRAFT

Now with free earpiece and switched socket. 10 Transistors. Latest 4" 2 watt Ferrite Magnet Loudspeaker. 9" Tunable Wavebands, MW1, MW2, LW, SW1, SW2, SW3, Trawler Band, VHF and Local Stations also Aircraft Band.

Built in Ferrite Rod Aerial for MW/LW. Chrome plated 6 section Telescopic Aerial, can be angled and rotated for peak short wave and VHF listening. Push Pull output using 600mW Transistors. Car Aerial and Tape Record Sockets. 10 Transistors plus 3 Diodes. Ganged Tuning Condenser with VHF section. Separate coil for Aircraft Band. Volume on/off. Wave Change and tone Controls. Attractive Case in black with silver blocking. Size 9" x 7" x 4". Easy to follow instructions and diagrams. Parts price list and plans 60p free with parts.

Total building costs **£11-87**

PP & Ins. £0-65



"EDU-KIT"

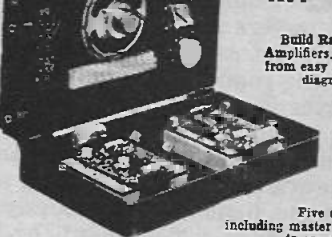

Build Radios, Amplifiers, etc., from easy stage diagrams.

Five units including master unit to construct

Components include:

Tuning Condenser: 2 Volume Controls: 2 Slider Switches: Fine Tone 3" Moving Coil Speaker: Terminal Strip: Ferrite Rod Aerial: Battery Clips: 4 Tag Boards: 10 Transistors: 4 Diodes: Resistors: Capacitors: Three 1" Knobs: Units once constructed are detachable from Master Unit, enabling them to be stored for future use. Ideal for Schools, Educational Authorities and all those interested in radio construction. Parts price list and plans free with parts.

Total building costs **£6-87**

PP & Ins. 50p
(Overseas Seamall P & P £3-40)

★ ALL PRICES NOW INCLUSIVE VAT ★

RADIO EXCHANGE LTD

★ Callers side entrance "Lavalla" shop
★ Open 10-1, 2.30-4.30, Mon.-Fri. 9-12 Sat.

To RADIO EXCHANGE CO., 61a HIGH STREET, BEDFORD, MK40 1SA
Tel.: 0234 52367. Reg. No. 783372.

I enclose £..... for
Name.....
Address.....
(Dept. EE9.)

everyday electronics

PROJECTS
THEORY..

THE EARS HAVE IT

Communication. That one word spells out pretty well what electronics is all about. Communication takes many forms; it may be between persons or between inanimate objects, or between one and the other. It's going on all the time and for the most part we are hardly conscious of it taking place.

Mediums used for communication are various, affecting different senses. Most of the human senses have their electronic equivalent, and electronics is very adept at converting one "sense" into another. Thus electronics can be used to provide that "eye in the back of the head" we all have fervently wished for sometime or another. Here are just a couple of examples.

You need all your wits about you when driving. Audible warning devices can supplement meters or lamps and give positive warning without causing any distraction of the eyes from the road ahead.

Anyone who has had to carry out wiring or circuit continuity checks will certainly have found himself sometime or another adopting the posture of a contortionist, squirming to get head and hands simultaneously behind a dashboard, under a floorboard, or into a most inaccessible region of some chassis or machine. Such gymnastics often end in frustration, for the severest test of one's agility comes when having made the vital contact with the meter

probes one tries to observe the ohmmeter scale. It is then that the desirability of an eye in the back of the head becomes truly apparent. The answer, again, is to use one's ears!

These two different "communication" problems are dealt with in simple and straightforward designs featured in this month's issue.

CALLING ALL BEGINNERS

Now, an advance mention of a very important event. Next month sees the start of a new beginner's series *Teach-In '76*. This series of articles has been prepared specially for those without previous knowledge of electronics. It provides an easy-to-follow course of instruction in theory and practical matters for anyone— young or old—who wishes to learn about electronics in the comfort of their own home.

Those readers who have no personal need for this basic instruction might like to consider whether there is anyone they know who would welcome this easy introduction to a fascinating and stimulating hobby. If so, they can share the enjoyment this hobby already brings them and acquire a grateful friend in the process.

And please note, it is most important to start at the beginning—and that means next month.

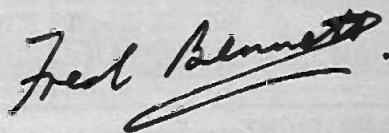

Our October issue will be published on Friday, September 19

EDITOR F. E. Bennett ● ASSISTANT EDITOR M. Kenward ● TECHNICAL EDITOR B. W. Terrell B.Sc.
ART EDITOR J. D. Pountney ● P. A. Loates ● K. A. Woodruff
ADVERTISEMENT MANAGER D. W. B. Tilleard

© IPC Magazines Limited 1975. Copyright in all drawings, photographs, and articles published in EVERYDAY ELECTRONICS is fully protected, and reproduction or imitations in whole or part are expressly forbidden.

All reasonable precautions are taken by EVERYDAY ELECTRONICS to ensure that the advice and data given to readers are reliable. We cannot, however, guarantee it, and we cannot accept legal responsibility for it. Prices quoted are those current as we go to press. Everyday Electronics Fleetway House, Farringdon Street, London, E.C.4. Phone: Editorial 01-634-4452; Advertisements 01-634-4202.

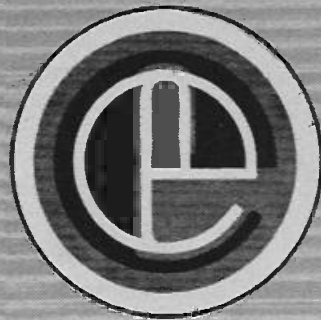

EASY TO CONSTRUCT SIMPLY EXPLAINED

VOL. 4 NO. 9

SEPTEMBER 1975

CONSTRUCTIONAL PROJECTS

SONIC BOMBER GAME <i>Fun for all the family</i> by F. G. Rayer	462
INDICATOR AUDIBLE ALARM <i>Car flasher warning</i> by Malcolm Plant	468
CONTINUITY TESTER <i>Dual range, audible-output, tester</i> by D. Andrews	478
MATCHBOX RECEIVER <i>Miniature integrated circuit receiver</i> by F. G. Rayer	484

GENERAL FEATURES

EDITORIAL	460
FOR YOUR ENTERTAINMENT <i>Time capsule and Video</i> by Adrian Hope	471
ECHO SOUNDING AND SONAR by G. A. G. Brooke	472
SHOP TALK <i>New products and component buying</i> by Mike Kenward	483
JACK PLUG AND FAMILY <i>Cartoon</i>	483
YOUR CAREER IN ELECTRONICS <i>The Marconi Co.</i> by Peter Verwig	486
WORKSHOP PRACTICE <i>Part 5 The Professional Finish</i> by Mike Hughes	488
PLEASE TAKE NOTE	489
THE UNIJUNCTION TRANSISTOR <i>Part 2</i> by J. B. Dance	490
PHYSICS IS FUN <i>Electrolysis</i> by Derrick Daines	492
COUNTER INTELLIGENCE <i>A retailer comments</i> by Paul Young	494
READERS' LETTERS <i>Colour code</i>	494
PROFESSOR ERNEST EVERSURE <i>The Extraordinary Experiments of.</i> by Anthony J. Bassett	495
DOWN TO EARTH <i>Transistor substitution</i> George Hylton	500

TOO GOOD TO MISS!

NEXT MONTH

New beginners series **TEACH-IN '76**

FREE CHART

Components Identified and Explained

See page 477

We are unable to supply back copies of *Everyday Electronics* or reprints of articles and cannot undertake to answer readers' letters requesting designs, modifications or information on commercial equipment or subjects not published by us. An s.a.e. should be enclosed for a personal reply. Letters concerning published articles should be addressed to: The Editor, those concerning advertisements to: The Advertisement Manager, both at the address shown opposite.

Binders for volumes 1 to 4 (state which) and indexes for volume 1 and 2 available for £1.85 and 30p respectively, including postage, from Binding Department, Carlton House, Great Queen Street, London, WC2E 9PR.

THIS game consists basically of a model plane carrying a "bomb" and travelling in a circular path on the end of a suspended boom. The player or bomb controller has a portable sonic transmitter, and when the button on this is pressed, the plane bomb is released.

It may fall onto a target board, players taking alternate turns and the highest score winning,

although it may be found that players in the younger age group will prefer to use the sonically controlled plane as a means of demolishing items they have constructed from light wooden or other building bricks etc.

The equipment is very light, and readily suspended from the ceiling. As the bomb has to be released while the plane is in motion, quite a test of skill is possible with older players.

SIMPLY

The receiver (including 3 volt dry battery and relay) plane and bomb carrier are fixed to a thin wooden lath, the battery and receiver at one end balancing the plane at the other. The pivot point for the lath was a hook at ceiling height, but could equally well be a pole such as a broom handle, fitted up-right in a wooden base.

The relay contacts are normally closed. The item forming the bomb must be ferrous (iron-like) and when it is placed in position, it bridges the poles of the electromagnet and "makes" the circuit. Current from the battery then flows through the relay contacts, electromagnet windings, and plane motor. Magnetic attraction holds the bomb in place. Thrust of the plane propeller moves the plane forward, the

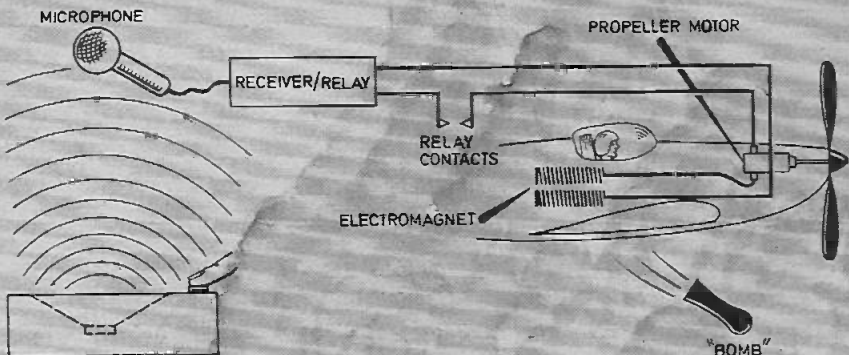

lath swinging round on its pivot.

The pick-up device of the receiver is a crystal microphone insert. When the push button on the transmitter is pressed, the transmitter produces an audio tone. This is picked up by the microphone and causes the relay contacts to open. The bomb thus falls, interrupting the circuit, and the plane motor stops. It is re-started by replacing the bomb.

PLANE

The plane used in the author's model was a "snap together" type with a wing span of about 225mm and about 200mm long. Various light plastic models of this kind are available, and are intended to run from a single 1.5 volt dry cell in the fuselage. The motor runs at high speed and the air current from the propeller easily gives the model enough forward speed. The bomb magnets are wound so that about 1.5 volts is present across the motor, and 1.5 volts across the magnet windings.

Actual details, or the type of plane, will not have much effect on the working of the model. Slightly smaller metal planes were considered too heavy here.

The model is assembled according to the instructions provided with it, except that its battery and switch are omitted. The motor leads are run out through small holes near the cockpit, and a small bolt is also locked in a hole here, to mount the plane.

Control could be by radio or other means, but the sonic control requires no licence or expensive components.

SOUND TRANSMITTER

Although the receiver can be operated from sounds from other sources, it is convenient to have an audio oscillator, generator or trans-

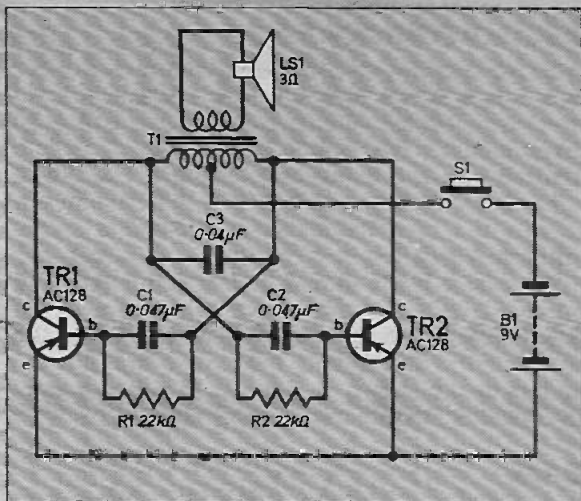

Fig. 1. The circuit diagram of the transmitter section of the game.

mitter for this purpose and controlled by a push switch. Pressing the transmitter switch then causes the receiver relay to function and release the bomb.

The circuit of the transmitter unit is shown in Fig. 1. The centre-tapped transformer T1 allows each transistor to drive the other in the correct phase. The note produced depends on T1, component values, transistors, and battery voltage. The actual frequency is not very important, provided it is not too low in pitch. It is probable that different transformers and transistors could be used, but in some cases it might be necessary to experiment with resistor and capacitor values to suit these.

Switch S1 should be a push-to-make release-to-break type. Current is only drawn for those brief intervals when S1 is depressed.

SONIC BOMBER GAME

BY F. G. RAYER

OSCILLATOR BOARD

In the prototype the oscillator component board used was a piece of unperforated Paxolin sheet size 37 by 55mm. Holes were drilled to accommodate the components using a 1.5mm drill bit and the fixing holes using a 5mm drill.

Begin by drilling the holes in the Paxolin cut to size and then mount the components as detailed in Fig. 2.

Transistor leads should be left full length and provided with sleeving. Note the cross-over of the transistor base lead-out wires. With the components assembled, next wire up on the underside as shown in Fig. 2. Finally, connect the speaker, switch and battery clips.

CASE

A plastic lunch box, 180×120×40mm was found to be a suitable size case in which to house the oscillator board, speaker and battery. This can be made to look quite attractive when coated with enamel paint.

It was found convenient in the prototype to mount the component board and battery on the lid and make the lid the base plate of the case. The speaker and switch are then mounted on the top panel of the case.

The upper section of the case should now be prepared to accept the speaker and switch. A series of holes need to be drilled where the speaker is to sit so that the speaker can be easily heard.

When S1 is depressed, a strong high pitched tone should emanate from the speaker indicating that all is well.

SOUND RECEIVER

The circuit of the receiver part of the system is shown in Fig. 3. A small crystal microphone insert MIC1 acts as the pick-up device, and

TR3 is the first amplifier, with base current through R3, and collector load R4. A few centimetres of screened lead allow the insert to be placed where required. Components R5 and C4 decouple the supply to this stage, to prevent feedback from later stages causing instability.

Transistor TR4 is the second audio amplifier, and C5 is very small in value for audio circuits, to help curtail possible response to low frequencies. The primary of the audio transformer T2 is the collector load for TR4.

The secondary of T2 connects to base and emitter of TR5. With no audio signal present, conductance by TR5 is negligible, so the base of TR6 is positive, and the emitter current of TR6 is very small. When an audio signal is present, T2 drives TR5 into conduction on positive peaks, so the voltage drop across R7 rises considerably, C6 maintaining this at an average level. The resulting negative base bias causes TR6 to conduct, to operate the relay, RLA thus opening the relay contacts and interrupting the supply to the motor and electromagnet.

A 3 volt supply was found adequate for the model, and is taken from the battery which supplies plane motor and electromagnet circuit. Quiescent current consumption is about 2 milliamps rising to 100 milliamps or so with the sound transmitter switched on 3 metres distant, its speaker facing the microphone.

The receiver can of course be actuated by sounds other than from the transmitter, if they are of sufficient intensity and suitable pitch, but this was not found to be of any practical disadvantage with the prototype.

RECEIVER BOARD

Plain matrix board, 0.1 inch pitch, size 20 by 11 holes was used to mount the components for the receiver circuit. The layout is shown in Fig. 4.

Fig. 3. The receiver section of the Sonic Bomber Game.

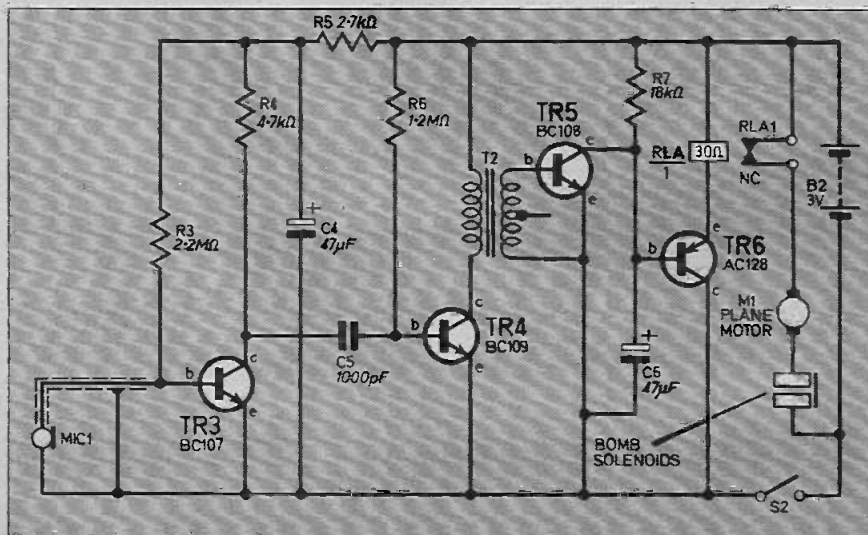

SONIC BOMBER GAME

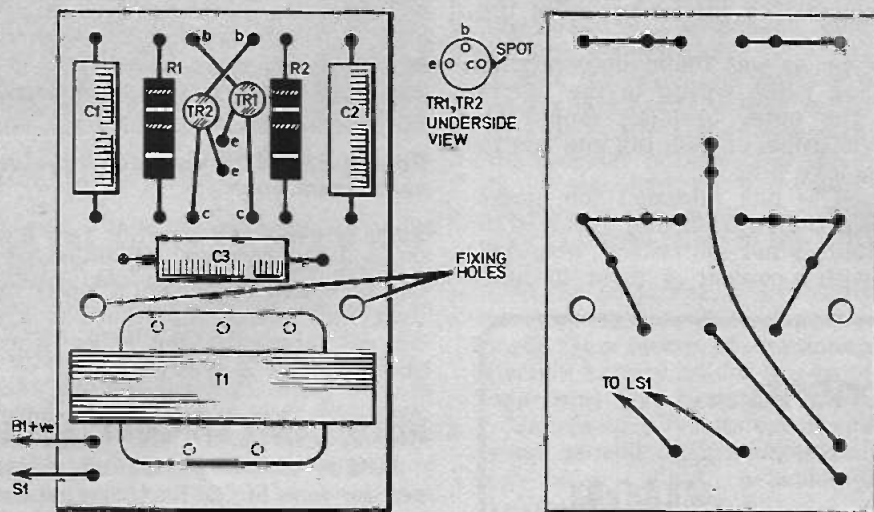

Fig. 2. Component layout and wiring details on the oscillator component board.

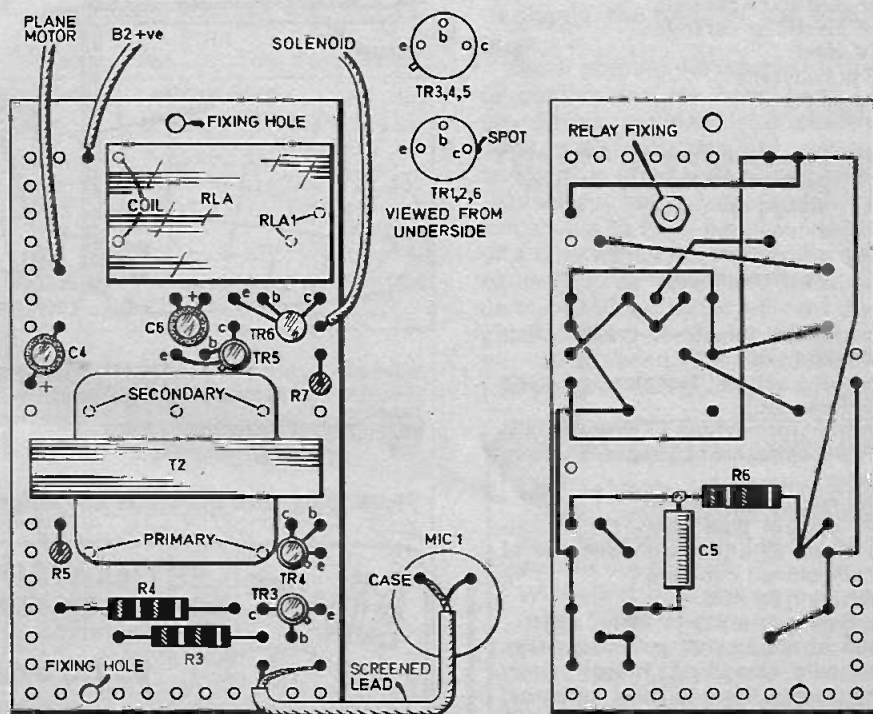
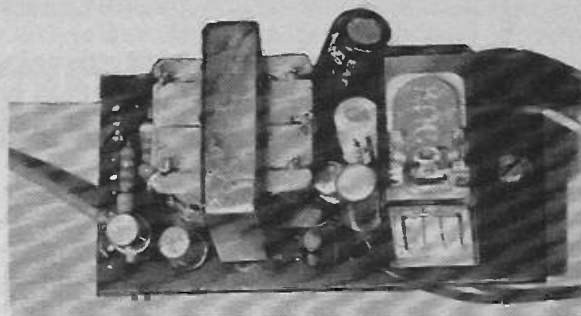

Fig. 4. The receiver component board. Shows the components mounted in position on the plain matrix board and wiring up details.

Drill the fixing holes and then mount the components as shown and wire up on the underside of the board as indicated in Fig. 4, paying attention to transistor leadout connections and capacitor polarities. A heatsink should be used when soldering the transistors. Note that there are two resistors mounted on the underside of the board.

In the prototype, it was found necessary to use screened lead when wiring in the microphone, MIC1. The outer braiding should be soldered to the microphone case tag and run to the receiver negative line.

The relay used is one intended for model control, and has a coil resistance of about 30 to 40 ohms. This item is not too critical, provided it will operate with a current of about 40 milli-



Photograph of the completed prototype receiver component board.

amps or over, and is not of very high resistance.

After carefully checking wiring, the receiver can be tested by placing a meter in one battery lead, and noting that there is a good rise in current, operating the relay, when the transmitter button is pressed.

Components . . .

Resistors

- R1 22k Ω
- R2 22k Ω
- R3 2.2M Ω
- R4 4.7k Ω
- R5 2.7k Ω
- R6 1.2M Ω
- R7 18k Ω

All $\frac{1}{2}$ W carbon \pm 10%

SEE
**SHOP
TALK**

Capacitors

- C1 0.047 μ F plastic or ceramic
- C2 0.047 μ F plastic or ceramic
- C3 0.047 μ F plastic or ceramic
- C4 47 μ F 6V elect.
- C5 1000pF polystyrene
- C6 47 μ F 6V elect.

Transistors

- TR1 AC128 germanium pnp
- TR2 AC128 germanium pnp
- TR3 BC107 silicon npn
- TR4 BC109 silicon npn
- TR5 BC108 silicon npn
- TR6 AC128 germanium pnp

Miscellaneous

- S1 push-to-make, release-to-break switch
 - S2 on/off slide switch
 - T1 push-pull output transformer type TT56 (Repanco)
 - T2 driver transformer type TT55 (Repanco)
 - LS1 3 ohm loudspeaker approx. 75mm diameter
 - MIC1 crystal microphone insert
 - RLA 3V battery control type relay, coil resistance 30 to 70 ohms with one set of normally closed contacts
 - B1 9V battery type PP6
 - B2 3V battery type HP11 [1.5V] (2 off)
- Plain Paxolin sheet size 37 x 55mm; 0.1in. plain matrix board, size 20 x 11 holes; battery clips for PP6; holder for two HP11 batteries; screened lead; case for transmitter, 180 x 120 x 40mm; 32 s.w.g. enamelled copper wire; 25mm long steel nails (2 off); snap-together motorised plane kit; lath.

PLANE AND MAGNET ASSEMBLY

Details of the plane and magnet assembly are shown in Fig. 5. Each magnet core is a 25mm long round-headed steel nail. The electromagnet is formed by winding each nail with 32 s.w.g. enamelled copper wire.

Start by soldering one end of the wire to the underside of the head and then wind on about

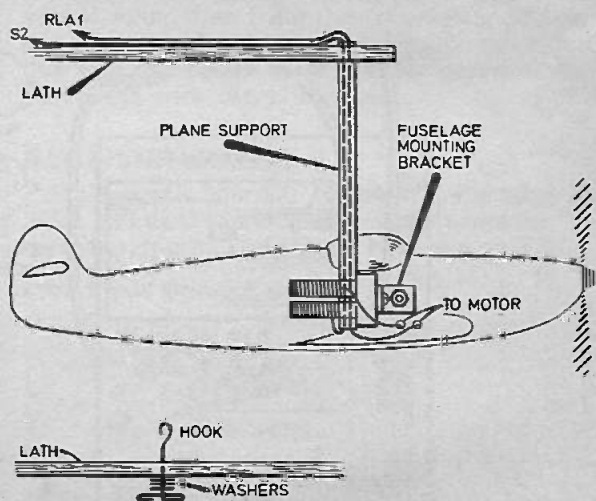
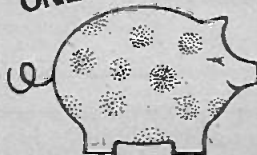

Fig. 5. Details of the plane and magnet assembly.

FOR
GUIDANCE
ONLY

ESTIMATED COST*
OF COMPONENTS
excluding V.A.T.

£5.00 excluding
case and plane



*Based on prices prevailing at time of going to press

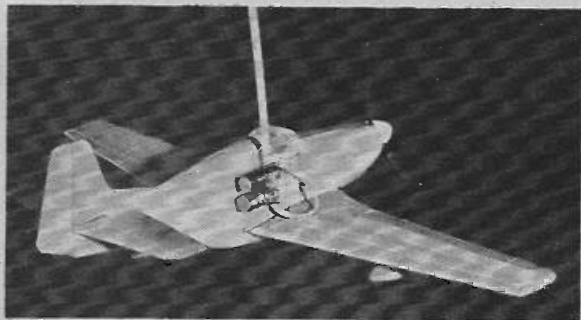

Photograph of the plane used by the author with electro-magnet fixed in place.

300 turns of wire so that the coil occupies about 15mm of the nail length from the head. Apply some adhesive or insulating tape to the coil to stop it coming unravelled and cut the wire to leave about 75mm projecting from the coil. This end is later soldered to one of the leads issuing from the motor via the fuselage. Now wind an identical second electromagnet and then hammer the nails side by side into a small block of wood about 15mm x 10mm x 10mm. Next fix a small right-angle bracket to this block so that it can be attached to the fuselage.

The upright fixing the plane to the lath was, in the prototype, the stem of a Bic pen with the leads running inside; alternatively a piece of dowel about 100mm long can be used. This upright can be glued or screwed to the block of wood and lath.

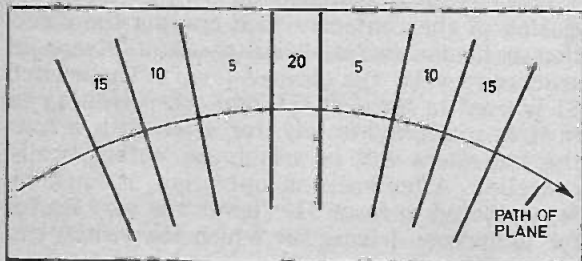

Fig. 6. A suggested target for "rolling" bombs. The dividers separating the score areas should be 12mm high card.

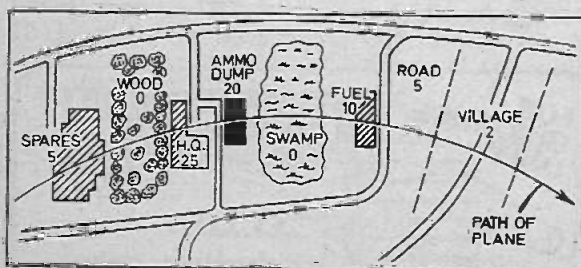

Fig. 7. Shows details of a pictorial target. The numbers refer to point value of target area.

Everyday Electronics, September 1975

ASSEMBLY

A lath about 1.5 metres was found suitable for mounting the plane at one end and the receiver at the other. A pivot hole should be drilled at 1 metre from the plane end and the battery and receiver positioned such that when the assembly is suspended from the pivot point the lath is horizontal.

With the plane and receiver board, switch S2, microphone and battery secured to the lath, wire up to the plane; ensure that the supply to the receiver is connected the right way round. If the propeller runs backwards reverse the connections to the motor. The wires joining the extremes can be taped to the lath to give a neater finish.

In the prototype, a cardboard tube was made to take the two HP11 batteries and terminals made from pieces of aluminium angle. Alternatively a battery holder can be purchased to take two HP11 type batteries.

Satisfactory results can be obtained with the plane moving in a smaller radius, so the lath can be any length between about 750mm to 1.5 metres.

BOMBS

Bombs must not be very heavy, but if too light may stay on the magnets when the current is interrupted due to residual magnetism. The ends of the magnets should be clean and bright, as should the parts of the bombs which bridge them.

Small pointed darts which will stick into a cork or similar surface have been used, but points are better avoided with children; 12mm 4BA bolts, each with one nut, were found suitable, and can be fitted with paper fins.

Ideas for some targets which have been used are shown in Figs. 6 and 7. Where the bombs are of a type which may bounce or roll and a real test of skill is in view, the score areas should be demarcated by strips of card about 12mm high glued to the board. If the plane quickly gains too much speed, the simplest cure is to reduce the pitch of the propeller by careful bending. □

PUBLISHERS ANNOUNCEMENT

The contents of EVERYDAY ELECTRONICS is fully protected by international copyright and reproduction of it in any form is prohibited without our consent.

With effect from this announcement any application for permission to reproduce, or use our material in any way or part of, must be made to the Editor. Under no circumstances will permission be given to reproduce material in a similar or competitive publication, without payment. No application need be made in the case of a private constructor, constructing one item for his/her own enjoyment and interest.

... are you winking?

INDICATOR AUDIBLE ALARM

By MALCOLM PLANT

Emits an audible tone when car indicator is operated.

ALL MODERN cars employ a device which automatically cancels a direction indicator after a turn is made. The device is mechanical and consists of a cam on the steering wheel column which rides freely over a trip during the turn but which flicks back the direction indicator lever on return of the steering wheel to the straight ahead position.

Unfortunately, turns are made frequently when the steering wheel does not rotate far enough for the cam to operate the trip such as when overtaking vehicles or leaving the kerb-side, for instance. And then the embarrassment and potential danger arises when the driver forgets to cancel the direction indicator, even though there is a visual indication on the car's dashboard.

What the driver requires is an audible warning that the direction flashers are operating. This article describes a simple circuit which does just that.

CIRCUIT DESCRIPTION

The circuit diagram of the unit is shown in Fig. 1 and was designed to produce a high pitched tone using the minimum number of components in order to keep down the cost of building the unit.

The circuit operates as a complementary pair audio frequency amplifier, the frequency of which

depends basically on the values of R1 and C1, although the impedance of the loudspeaker will have noticeable effect on the produced tone. While R1 should not be reduced below 220 kilohms, the value of C1 may be varied to suit the ear of the driver.

The circuit is switched on by the automatic closing of the contacts which operate the direction indicator lamps. Thus the unit bleeps in synchrony with the flasher lamps. The switch S1 is used to turn off the unit when waiting to turn at traffic lights, say, for after such a turn the indicators will invariably be automatically cancelled. After such an operation, it must be remembered to reset S1. The unit is very useful for motorway driving for which the switch can be kept closed.

CIRCUIT IN DETAIL

Commencing with both transistors off, TR1 will be turned on by R1 when the indicator switch is made. When this happens TR2 will be turned on which will cause TR1 to turn on yet faster due to the "regenerative" effect of C1

FOR
GUIDANCE
ONLY

ESTIMATED COST*
OF COMPONENTS
excluding V.A.T.

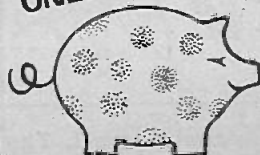

£1.20
excluding case

*Based on prices prevailing at
time of going to press

(i.e. TR2 switching on causes TR1 to switch on faster which in turn causes TR2 to switch on faster etc.).

However, C1 will only pass current to TR1 base whilst there is a changing voltage across it; hence when TR2 is saturated (fully on), there will be no change of voltage across C1 and base current for TR1 will be cut causing it to turn off.

Another regenerative effect occurs at this stage since as TR1 turns off, it causes TR2 to turn off which in turn causes TR1 to turn off yet faster resulting in a rapid fall in voltage at TR2 collector. This brings the circuit back to the original condition ready to re-start the cycle.

The result of this action is to produce a square wave at the collector of TR2 thus producing a tone in LS1, TR2 collector load.

Components....

Resistors

R1 220k Ω } $\frac{1}{4}$ W carbon $\pm 10\%$
R2 1k Ω }

Capacitor

C1 0.22 μ F plastic or ceramic

Transistors

TR1 ZTX300 silicon npn
TR2 ZTX500 silicon pnp

Miscellaneous

S1 push-to-make, push-to-break type switch

LS1 20 ohms Post Office type earpiece
0.1in Veroboard, 10 strips by 10 holes; solder tags (2 off); two-way terminal block; connecting wire; case.

SEE
**SHOP
TALK**

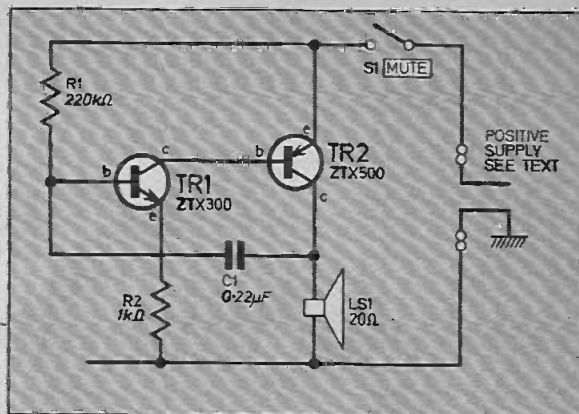
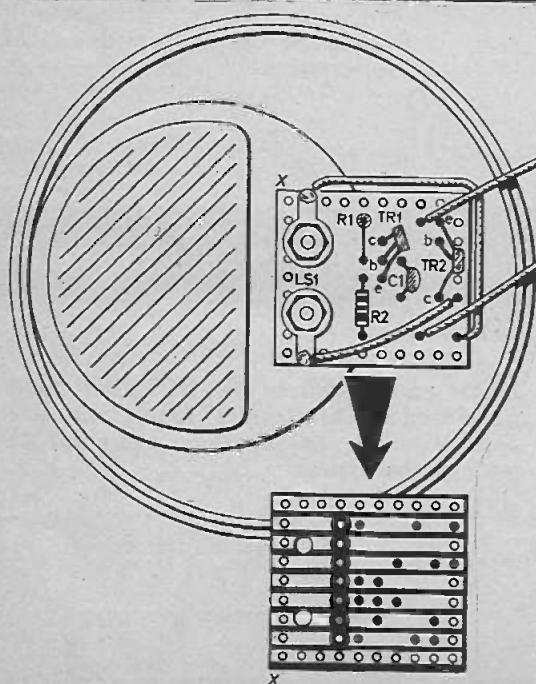
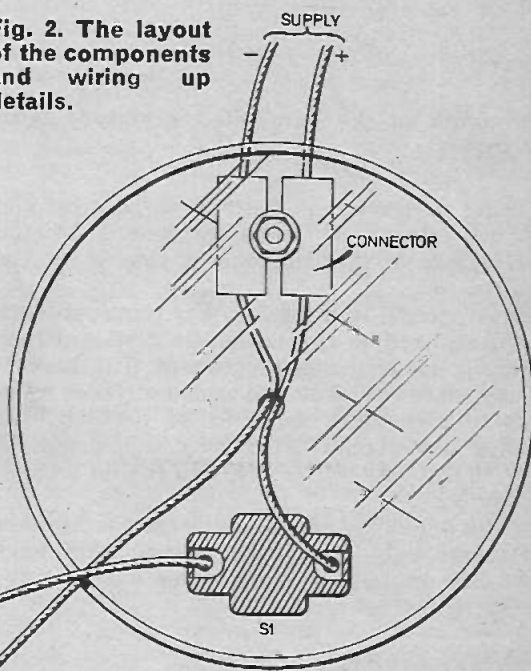

Fig. 1. The circuit diagram of the Indicator Audible Alarm shown for negative earth system.

Fig. 2. The layout of the components and wiring up details.



ASSEMBLY

The unit was designed to be positioned unobtrusively in the vehicle and this was achieved by assembling the speaker and circuit in a plastic typewriter ribbon case as illustrated in Fig. 2.

A piece of 10 strip by 10 hole 0.1 inch matrix Veroboard is suitable for assembling the circuit, the layout of which is shown in Fig. 2. Use a heat shunt when soldering the transistor in place.

The fixing holes are spaced so as to enable the Veroboard to be clamped by the fixing nuts of the speaker terminals. Under each of these terminals a solder tag is fixed so that connections from the speaker to the Veroboard can be made.

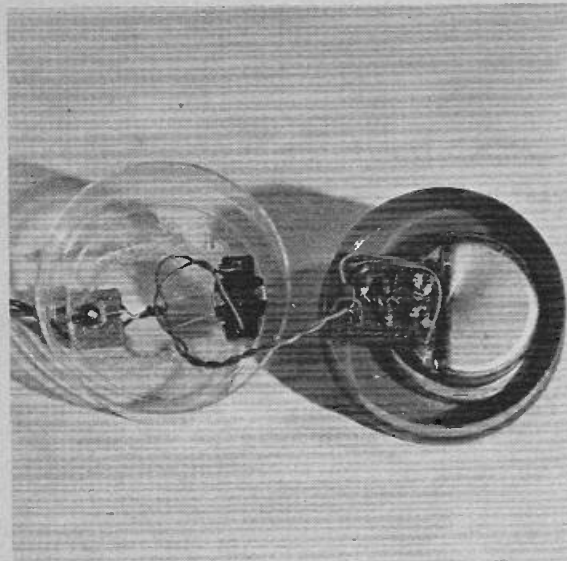

Photograph of the completed prototype with lid removed.

Layout of the components is not critical and will be determined to some extent by the physical size of the components chosen for the circuit.

The switch S1 and the two-way terminal block should be fixed to the lid of the case and then wired up to the component board. The base of the case needs to be drilled with a series of small holes to allow the sound to be emitted. The speaker and attached Veroboard should now be glued to the base of the case and the lid secured in position.

In the prototype the sound from the speaker was surprisingly loud; if the volume is too loud, it may be muted by taping over some of the speaker holes.

INSTALLATION

The complete unit should be placed in a convenient place for the driver to reach, and the appropriate lead (depending on whether the car is negatively or positively earthed) connected to a good earth point on the chassis/bodywork. The other lead needs to be connected to a point that goes 12 volts positive (negative earth system) or 12 volts negative (positive earth system) when the indicator control is operated. For cars with a single dashboard indicator lamp, this supply connection can be made to the non-earth side of this lamp. For cars with the double dashboard indicator lamp system, the supply connection will have to be made at the flasher unit itself at the tag whose voltage swings by 12 volts for either indicator lamps on. A voltmeter or 12V bulb will be necessary for determining this tag.



next month in PRACTICAL ELECTRONICS

HOW INVENTIVE ARE YOU?

OVER £500 IN PRIZES TO BE WON NEXT MONTH IN THE PLESSEY/PRACTICAL ELECTRONICS CHALLENGE COMPETITION

★ 1st Prize £250 ★ ★ 2nd Prize £100 ★
★ 3rd Prize £50 ★

Fifty runners-up prizes of ● 25 "Magispark" Gas Ignitors
● 25 One-year Subscriptions to Practical Electronics.

HOW EFFICIENT IS YOUR CAR?

Find out with the . . .

P.E. ENGINE ANALYSER

A portable tune-up tool for economy motoring.

Checks:

Revs - Dwell - Ignition Timing - Condenser, Ohms/
Continuity, Volts. And also includes a Battery Charger.

What are MICROPROCESSORS?

Learn about the latest circuit devices that herald a new revolution in electronic technology.

Also included with the October Issue is a FREE?
LINEAR I.C. IDENTICHART.

ORDER YOUR COPY ON THE FORM BELOW

TO
(Name of Newsagent)

Please reserve/deliver the OCTOBER issue of Practical Electronics (35p), on sale September 12, and continue every month until further notice.

NAME

ADDRESS

.....
.....

for your Entertainment...

By Adrian Hope

ONE of the most common occurrences in a science fiction novel is for someone to dig up a relic of an age and civilisation gone by. They then puzzle over what happened to the civilisation and how they destroyed themselves. Come to think of it, we do just that over the ancient Egyptians and South Americans. The basic question is always the same—how could a civilisation as primitive as this relic suggests have wiped itself out without trace?

Well, there is one possible answer—they were more advanced than the relic suggests. Then the question becomes—how far did they advance before self-destruction?

TIME THE GREAT CONFUSER

In 1938 the American electronics giant, Westinghouse, sunk a rocket-like "time capsule" made of corrosion-proof metal 15 metres into the ground at Flushing Meadow, New York, the site of that year's World Fair. The capsule was glass-lined and filled with nitrogen to protect a collection of microfilmed books, sound movie film and other clues to the technical and social state of the world in 1938.

At the same time Westinghouse sent 3,000 copies of a special book called "The Time Capsule" to libraries and monasteries round the world. The book doesn't detail the contents of the capsule, but it gives instructions on how to find it electromagnetically. Along with a notice engraved on the capsule itself, it begs future generations not to disturb or open the capsule until AD 6939.

Personally, I would have thought it better to carve instructions like these on a tablet of

stone, such as the 1927 carving of the Ten Commandments in rock at Buckland Beacon, Dartmoor, but that's beside the point. (If you want to look at the Time Capsule book yourself, you can find it in the British Library in Bloomsbury—shelf marked 20033.d.15.)

The Westinghouse book also carries an addendum which explains that in 1965 another time capsule was buried 3 metres away from the first, to update the 1938 information. Now think about what would have happened if the nuclear arms race that followed the last world war had wiped us all out before 1965. Think of how out-of-date the contents of that original 1938 capsule would have been to anyone who chanced on it a million years and several civilisations into the future.

STAGGERING ADVANCES

In other words, think of what technical advances the world saw between 1938 and 1965. It really is quite staggering. There never can have been a rate of technological development as dramatic and rapid as that in the period covering the second world war and the cold war years that followed it.

Radar, colour television, magnetic tape, the LP record, the atom bomb, the hydrogen bomb, the rocket missile, the moon rocket, the transistor, the linear motor, holography, video recording—all these were either conceived, invented or reduced to working practice in those years.

I cannot imagine that there will ever again in the history of our civilisation be a period of technological advance to compare with that which came between the planting of the two Westinghouse

time capsules. In fact it's doubtful whether civilisation could weather such a storm of upheaval again.

It's a sobering thought that all the major discoveries, and breakthroughs possible for our civilisation, may have now been made. If so, then we are condemned to a future of scuffling around for often pointless developments of basic concepts.

Certainly, there are signs that this is already happening in electronics. For example, there just isn't anything really new you can now do with an amplifier, other than design different types of transistor and paint the knobs on the front a different colour.

LETHAL VIDEO

Now, more than ever, I am convinced that the video recorder is a dangerous weapon. In the wrong hands it can bore people to death. Soon after writing my previous column on video, I was invited by the British Film Institute to view two "video studies" recorded in New Zealand by Darcy Lange.

These studies, which according to the producer are intended "to convey the image of work as an occupation, an activity, a creativity and as a time consumer", were being screened in the bar at the National Film Theatre for several hours a night.

On the night that I made my pilgrimage, two black- and white video monitors were installed on poles, one in each corner of the NFT bar. Presumably the New Zealand tapes were made without sound, because both the monitors were running silent. Each was displaying the same dribble of tedious video shots of cows being milked and walking round in circles past a sunset. Unfortunately, with monochrome video, it is often impossible to tell whether the scene depicted is sunny or cloudy, ugly or beautiful, and whether the ground is covered with grass, snow, mud or sand.

But what refreshed me most of all was the fact that absolutely no one was watching either of the monitor screens. They might just as well have been closed circuit security system monitors, for all the interest that anyone was showing in them. I don't doubt that the video films were made with skill and sincerity, but if no one wants to watch your efforts on the screen—why bother to put them there in the first place?

A PREVIOUS article (Everyday Electronics January 1975) described how radar works by means of the electronic timing of a radio frequency pulse that is sent out to and reflected back from a solid object. As the speed of the pulse is known it is not too difficult to calculate the distance. Sounding and ranging under water are basically, but only basically, similar to radar. A pulse is sent out, reflected and timed, but water being a very different medium to air, the pulse used is ultra-sonic frequency, rather than radio frequency. The timing is therefore much slower and the measuring device employed quite different.

It is necessary to talk about sounding and ranging separately; though closely related they do differ in practical if not electronic respects. Echo-sounding is the technique whereby pulses are sent vertically down from the ship to measure the depth of the water beneath or perhaps the distance to a fish shoal that may be in mid-water; in ranging (this is called sonar, an abbreviation of SOund NAVigation and Ranging) the pulse is emitted horizontally to be reflected off something often two miles from the ship. A complication is that in ill-informed quarters the word sonar is sometimes used for both methods.

ECHO-SOUNDING

Though historically junior, let us consider the

more common echo-sounding first. As was the case with radar the basic principles were discovered a very long time ago but not brought to the stage of practical efficiency until both money and brain power in large quantities had been brought to bear as a result of wartime pressure, in this case World War 1.

Leonardo da Vinci knew that sound travelled so well in water that if you put a long tube in the sea and listened on the other end you could hear ships—not power driven ships of course—at a great distance.

The speed of sound in water was measured accurately enough—it is about 1500 metres per second—in 1826.

In 1840 Joule noted that certain substances changed length when magnetised (the magnetostrictive effect) and in 1880 the Curies discovered that a voltage potential across the face of certain materials caused a change in length (the piezoelectric effect).

Both these phenomena are still at the basis of echo-sounding (and sonar) though they were not harnessed until the 1920's.

In 1909 a Fessenden oscillator was used in America to create a sonic pulse in water though the time measuring device to enable this to be called echo-sounding was very crude.

Though no electronics were concerned it should be mentioned that the first echo-sounder to supersede rope and wire leadlines in this



ECHO SOUNDING & SONAR

By G.A.G. BROOKE

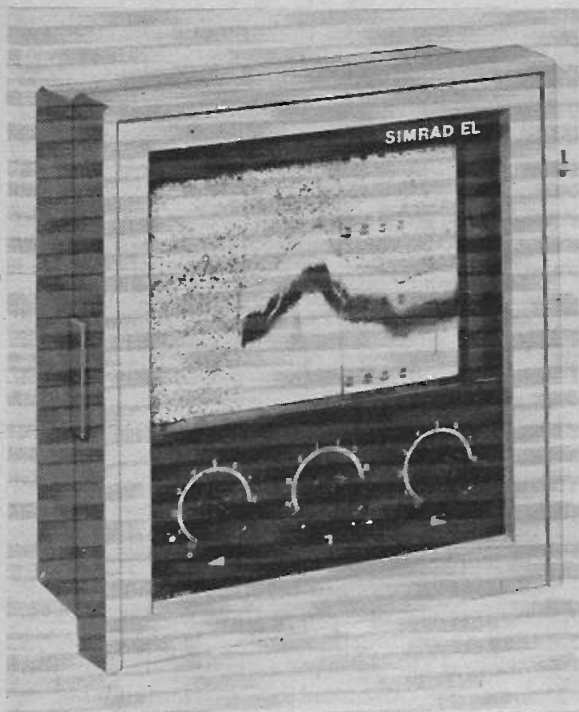

The Simrad EL echo-sounder showing the seabed on its chart.

country was the Royal Navy's (1921) device in which an electrically driven hammer hit a diaphragm causing it to emit a pulse of frequency about 500Hz. Such audible sound waves are known as *sonic*; the upper limit of normal hearing is about 20kHz and the useful range of ultrasonic frequencies, used for all underwater instruments today, extends from this to about 500kHz.

In the late 1920's the Curies' piezoelectric effect had been used for sonar (and in France for echo-sounding) but in this country Joules's magnetostriction principle was applied to echo-sounding with such success that the first British recording ultrasonic echo-sounder which appeared at sea in the early '30's has been little improved upon—as regards basic operation—to this day. From basic research by the Admiralty Research Laboratory this was manufactured commercially by Henry Hughes & Sons (now Kelvin Hughes) and was the first of a line of echo-sounders the latest of which is going strong today.

A TYPICAL RECORDING ECHO-SOUNDER

Including subsequent improvements, the functioning of a typical recording echo-sounder will now be described. The specifications of individual models naturally vary according to price and where necessary details of the Simrad 'EL' sounder found in hundreds of small vessels including large yachts and fishing boats, will be

quoted as typical. Sounders for fishing are ordinary navigational sounders with certain additional facilities.

The modern echo-sounder system, of which most designs will be entirely solid-state, consists of a recorder cabinet and a transducer. The cabinet displays a paper diagram (known as an echo-chart) of the column of seawater beneath the vessel and also houses all the transmitter and receiver circuits required. The transducer is let into the bottom of the ship so that its flat face—about 100mm square—is in direct contact with the sea.

An echo-chart is made of special paper which turns black at any spot where an electric current is passed through and comes in rolls several feet long by 150mm wide. The paper is wound, like camera film, from one vertical spool to another at a predetermined speed, only a 200 by 150mm portion being visible to the observer through a glass window. A pen, attached to a belt revolving over horizontal spools, runs vertically down the right hand side of the paper, returning out of sight to the top.

On switching on the system, four things occur simultaneously: the recorder paper starts to move very slowly from left to right, the belt revolves so that the pen begins to travel down the paper, and two circuits are energised by a contact on the belt situated in line with the pen. One circuit sends a current through the pen so that the paper is marked and the other (after completing certain other duties to be described later) 'fires' the transducer so that an ultrasonic pulse is sent down through the water. The mark made on the paper at this initial moment represents the surface of the water (actually the bottom of the vessel).

The ultrasonic echo that returns from the seabed—and possibly from fish in between—is received by the same transducer, changed into an electric current and applied to the pen.

The pen will have travelled down the paper since the first mark was made and the place at which the echo mark appears can be read off an adjacent scale representing the depth of water.

The process is then repeated automatically so that, as the paper moves, a broken but straight line is drawn joining the points that indicate the surface of the water and an undulating line is built up representing the contour of the seabed. Any fish in between are shown as tell-tale marks, fishermen usually being able to tell one species from another.

THE TRANSMITTER

This is an oversimplification and so let us go back for elaboration, looking first at the transmitter. The voltage pulse produced by the pen-belt is not itself in a form that can "fire" the transducer. Now a transducer is made up of layers of laminated nickel alloy, bound with

wire, and thanks to the principle of magnetostriction it will expand slightly when a suitable signal is applied to the coil, returning to its original size as soon as the signal is cut off. To effect this, the pen voltage pulse triggers a monostable circuit producing an output square wave lasting 0.7ms.

This waveform allows an oscillator, operating for this period of time only, to apply a 38kHz signal to the transducer windings. During every positive half cycle the laminations will expand, contracting during the negative half cycles. The alloy section will therefore vibrate at 38kHz and the water in contact with the face of the transducer will do the same; in other words an ultrasonic pulse of 38kHz is sent down to the bottom.

THE RECEIVER

Turning to the receiver: the pulse strikes the seabed and an echo returns, part of which, much attenuated, impinges on the transducer at the moment when it can be said to be acting as a microphone. Employing the reverse of the magnetostrictive process (causing the laminations to vibrate produces an a.c. current in the surrounding coil) the echo is passed to special receiver circuits.

Since the echo is weak these are very sensitive and must be protected from direct entry by the strong transmitted pulse. This is accomplished by causing the latter to induce a voltage in a transformer which in turn makes diodes go short circuit, earthing the input to the receiver (the received signals are too weak to cause these diodes to short).

All modern echo-sounder receivers are now "superhets" (i.e. superheterodyne) and in this case our 38kHz signal, being mixed with 48kHz from a local oscillator, produces an intermediate frequency of 10kHz. This is then passed to a filter circuit for removal of as much unwanted "noise" as possible, amplified again, and applied to the pen of the recorder. The resulting mark on the paper will, as we have seen, represent the echo from the bottom.

The paper can be made to represent different depths (i.e. 0 to 120, 0 to 240m) simply by altering the speed of the pen. The slower the speed the longer time is allowed for the pulse to go out and the echo to return from a greater depth.

FISHING APPLICATIONS

In fishing applications there are two other important circuits. One (really a set of circuits) is in the transmitter and allows for "phasing", a facility that enables different segments of the water under the vessel to be represented on the full extent of the paper and therefore on a larger scale than if the whole column (say from 0 to 180m) was shown. This is effected by having several trigger contacts on the pen-belt instead of only the one already mentioned. Each is located on the belt at different distances in

advance of the pen so that the one selected will fire the transducer before the pen arrives at the top of the paper. Thus if the 120 to 180m segment has been selected the pulse will travel 120m down and the echo 120m back before the pen starts down the paper. The pen will then start marking at 120 instead of zero, any one metre being of course on a larger scale.

The other important circuit is known as time varied gain, and ensures that fish nearer the surface do not appear larger on the recorder paper than those of the same size deeper down. The signal to the transmitter that fires the original pulse also goes to the t.v.g. circuit in the receiver which causes the receiver to go into a condition of low amplification. When the transmission ceases the receiver amplification will return to its normal level in a predetermined time, the result being that echoes received late in the cycle receive progressively greater amplification.

Yet more circuits are involved in the fact that the receiver can operate in three modes, normal, dynaline or contourline.

In normal the receiver is simply an amplifier which can be controlled by the gain setting, in the manner of any radio receiver.

Dynaline enables fish lying on the sea bottom to be distinguished from it on the echo-chart. Echoes returned by the bottom are much stronger than those from fish; this is measured and em-

Echo-sounder of a typical large inshore fishing vessel.





A fishing skipper studies his two echo-sounders. One is of a higher frequency than the other giving him a choice of accurate fish detection or ground discrimination.

ployed to produce a waveform which temporarily suppresses the receiver. The effect is to produce a blank (white) band immediately under the bottom which is thus reduced to a thin line; fish on the bottom are clearly visible against this thin line.

Contourline is simply a method of saving the somewhat expensive echo-chart paper. Echoes from the seabed often extend an inch or two below the actual bottom, depending on its nature. This is often of great assistance to the fishermen in locating good grounds, but if of no interest at the time, is a waste of paper. With contourline selected the larger bottom echo switches off the receiver completely, which is switched on again the next time the transmitter fires. This circuit is known as a bistable. The paper is clear below the bottom echoes and so can be reversed and used a second time.

Another way to economise on paper is to decrease the speed with which it moves across, but this must be considered in relation to the detail desired. A slow speed compresses the information making it more difficult to interpret the state of affairs beneath the ship. A compromise is of course reached and this is not the only one.

Turning to the transducer; the larger it is the more the beam can be concentrated which leads to greater depth penetration for the same power, but the transducer is an expensive item and so a compromise has to be made. Yet another has to do with pulse length. Discrimination, the ability to separate adjacent echoes, depends on the duration of the pulse, the shorter the pulse

the better discrimination. But the reverse is required for depth penetration and so the operator takes his choice.

Echo sounders designed principally for yachts are simpler than that described above. In the most common version there is no paper recorder but a speedometer-type dial with a flashing light to indicate the depth against a scale. The piezoelectric effect is employed, using a ceramic transducer which is much cheaper. Mechanical vibrations are produced when the crystalline structure of the material distorts under the influence of an electric field. From the circuit point of view the magnetostrictive type is electrically equivalent to an inductance with a parallel resistance representing the load, and the piezoelectric type is equivalent to a capacitor representing the load.

SONAR

The ultrasonic pulse of an echo-sounder is sent down in a cone-shaped beam of about 20 degrees, strength falling off rapidly towards the outside, and so it is only of use for telling you what is beneath the vessel; it will not pick up echoes any distance off. But many mariners want to have this information. The navigator or surveyor likes warning of a change of depth or an obstruction (such as a wreck), the naval officer needs to know what is below the surface ahead and the fisherman can profit by having more time to manoeuvre his net, towed astern, if he can locate fish still some way off.

Thus sonar, or sideways looking echo sounding, came into being. Actually it arrived before echo sounding, due to the pressure of anti-submarine research in World War I. The Royal Navy had the efficient "Asdic" as it was then called in 1930, the secret being well kept until World War II. The Americans and Japanese also had an equivalent in the '30's. The change of name to the American "Sonar" which took place in 1940 is often responsible for the erroneous notion that sonar was introduced from the U.S.A. at that time.

The working principles are virtually the same as for echo-sounding, in fact if angled downwards a sonar can stand in for an echo-sounder, though imperfectly. The transducer instead of being fixed in the hull is on the end of a cylindrical column, and is lowered through the ship's bottom for operation and retracted out of harm's way when not in use. It can be rotated—usually through 360 degrees—and tilted from the horizontal to the vertical. Its range is normally from about 1500 metres (nearly a mile) down to 250 metres, (the latter restriction making it unsuitable for echo-sounding).

The power required is somewhat greater than that in an echo-sounder in order to obtain the long range and for the same reason pulse width is 2 to 15 milliseconds (not 0.7 as with an echo-sounder).



The sonar cabinet of a large fishing vessel. The dial at the top shows which way the transducer is pointing, the chart beneath presenting horizontal range to the target.

The lowering, training and tilting arrangements, needing hydraulics and precision mechanics make a sonar about three times as expensive as an echo-sounder and for fishing it is usually encountered in the larger trawlers where their technique can make full use of its abilities. A paper recorder is employed in the way described above, except that the observer is presented with a plan view of the operation instead of one from the side.

Circuits for the transmitter and receiver are similar to those of an echo-sounder, except that the receiver—because of the longer ranges employed—does not have time varied gain. This is replaced by automatic gain control which boosts weak signals and attenuates strong ones.

REVERBERATION ECHO

An intriguing feature is the loudspeaker also provided which broadcasts the reverberation echo (explained below) as a "ping" and that from, say, fish as another "ping". With much experience the vessel can be steered by listening to these sounds. By constant training across the extent of a fish shoal its centre of density can be gauged and then its movement left or right; movement away or towards is discernible from the difference of note of the second echo to that of the first on the doppler principle (where the noise of an approaching train increases in pitch and then decreases as the train recedes).

With the more sophisticated sonar sets manipulation of the transducer can be entirely automatic, for example it can be set to traverse back and forth, either in steps or continuously between set limits, and there is even a computerised Simrad model that will follow the shoal automatically. Each of these models has its own controlling electronic circuit.

DOPPLER EFFECT

The Doppler effect, named after Christian Johann Doppler (died 1853), the Austrian physicist who discovered it, occurs whenever the distance between an observer and a source of constant vibration (light or sound) is changing. The wavelength is increased and therefore the frequency is reduced, whenever the source and the observer are moving away from one another, and vice versa.

In sonar however, the observer is aware of the change of pitch between the fish echo and the background of reverberation, not the pitch of the transmitted signal, which he cannot hear. Reverberation, made up of echoes from targets that are stationary in the water, consequently has a pitch that differs from the pitch of the transmission by the speed of the ship in the direction of the beam.

The Doppler shift heard by the operator is therefore a function of the speed of the target through the water, not relative to the ship. The actual amount of the shift is proportional to the transmitted frequency.

To take a concrete example, a movement of the target of 2 knots along the "line of sight" would cause a shift of 3.45 per cent for a 25kHz transmission. After heterodyning to an audible frequency of 1kHz this amounts to 34.5Hz, which is about half a semitone and just detectable to a trained ear.

It should be mentioned that both sonars and echo-sounders can be connected to c.r.t. displays with which the operator can gauge the strength of echoes, (in the case of sounders) and direction (sonars) often switching off the recorder meanwhile.

So the art of measuring under water has come a long way since the Royal Navy's mechanical hammer. Torpedoes can be fired on sonar information alone, some people say fish do not stand a chance (indeed world stocks are in danger of depletion) and a contour map of the Suez Canal can be printed automatically as a survey vessel steams down its contentious length. □

A Simrad inflatable rubber dome housing for a sonar transducer. When the sonar is not operating, the dome is retracted virtually flush with its housing.

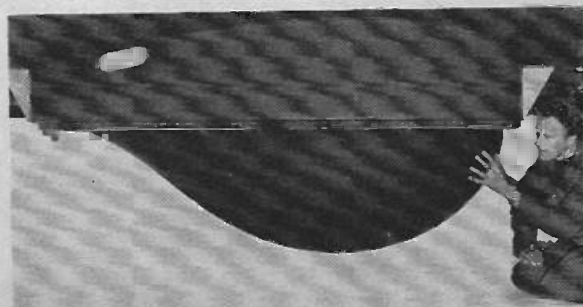

Don't miss
**NEXT
 MONTH'S**
issue!

can be employed.
 Other resistive transducers could also
 this circuit e.g. thermistors—resistance varies with
 temperature, some types of pressure transducer
 that employ a resistance change and gas detectors
 of specific types.

RESI

These
 carbon
 carbon
 ally
 toler
 are
 vari
 metal
 oxide
 type
 are
 virtu
 ally
 inde
 pendent
 and
 usually
 1%
 or
 2%
 at
 up
 to
 1W,
 they
 are
 typi
 cally
 used
 in
 power
 applications.
 Wirewound
 resistors
 are
 available
 in
 wattage
 ratings
 up
 to
 10W.
 Carbon
 and
 metal
 oxide
 resistors
 often
 use
 a
 colour
 code
 to
 indicate
 the
 value
 and
 tolerance.
 If
 a
 particular
 type
 is
 called
 for
 it
 should
 be
 used.
 Carbon
 resistors
 can
 be
 employed
 as

**FREE
 inside!**

DATA CHART...

**Circuit Components
 Identified & Explained**

COLOUR	NUMERICAL VALUE	MULTIPLIER
BLACK	0	X1
BROWN	1	X10
RED	2	X100
ORANGE	3	X1,000
YELLOW	4	X10,000
GREEN	5	X100,000
BLUE	6	X1,000,000
VIOLET	7	X10,000,000
PINK	8	X100,000,000
RED	9	X1,000,000,000
SILVER		X0.01
GOLD		X0.1
NO COLOUR BAND		X0.001

pink band signifies high tolerance not



TEACH-IN 76
 Start with the basics next month

This series has been specially written for the beginner in electronics. It takes you through the basic principles of electronics and backs up the theory with experiments to be performed on the Circuit Deck—which is easy to build.

- Plus**
Projects for you to build
- TREMOLO • TRANSISTOR TESTER • DOORBELL BLEEPER

Don't miss out - ORDER YOUR COPY NOW

**everyday
 electronics**

OCTOBER ISSUE
 ON SALE FRIDAY
 SEPTEMBER 19
 30p

*Keep both eyes
on the job!*

SOUND INDICATION of a SOUND CIRCUIT

with this...

CONTINUITY TESTER

By J. ANDREWS

A dual range, audible, warning tester.

THE simple, low cost Continuity Tester to be described in this article can be built in an evening and will adequately repay its construction cost. Its uses and applications range from kitchen to factory, from test bench to garage. Some of its uses and items that can be checked with the unit will be discussed later in the article.

You may ask, why an electronic continuity meter and why have an audible output? The electronic type of continuity meter has several advantages over say, a bulb and battery. First, its ease of use, when you are concentrating on a chassis or a circuit diagram, an audible indication of continuity is less distracting, and also because you can keep your eyes on the job in hand. The unit is also more mechanically robust than many ohm meters, a distinct advantage for service work.

DUAL RANGE

The main advantage of this unit lies, however, in its dual range. The design gives two continuity ranges, one for high resistance checks, and another for low. These are labelled on the prototype, Hi and Lo. The Lo output will only produce an output if the series resistance of the circuit under test is less than 500 ohms, this is probably the most useful range for general

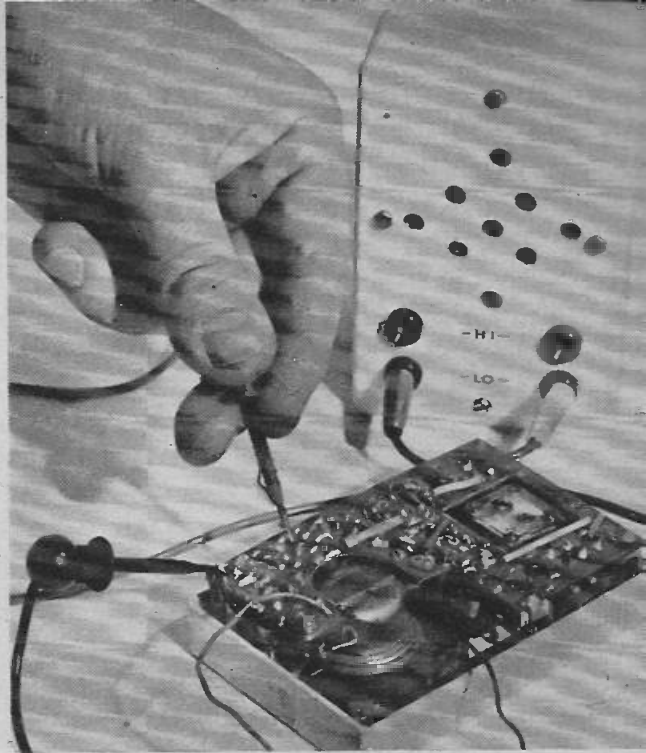

work. The unit will only give an output for direct connection.

On Hi, the series resistance can be as high as 200 kilohms (depending on the setting of the unit). This range can be used for checking insulation, leakage in capacitors, and general checks on circuits with high resistance. However, because of the low test voltage, insulation checks made with the unit should not be regarded as a substitute for a high voltage, megger type test; nevertheless, used with care the unit can give a useful indication of insulation condition.

CIRCUIT DESCRIPTION

The circuit diagram is shown in Fig. 1; TR2 forms with T1 and C1, a blocking oscillator. This

FOR
GUIDANCE
ONLY

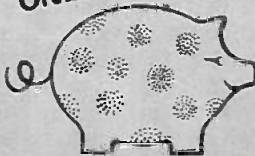

ESTIMATED COST*
OF COMPONENTS
excluding V.A.T.

£2.25

excluding case

*Based on prices prevailing at
time of going to press

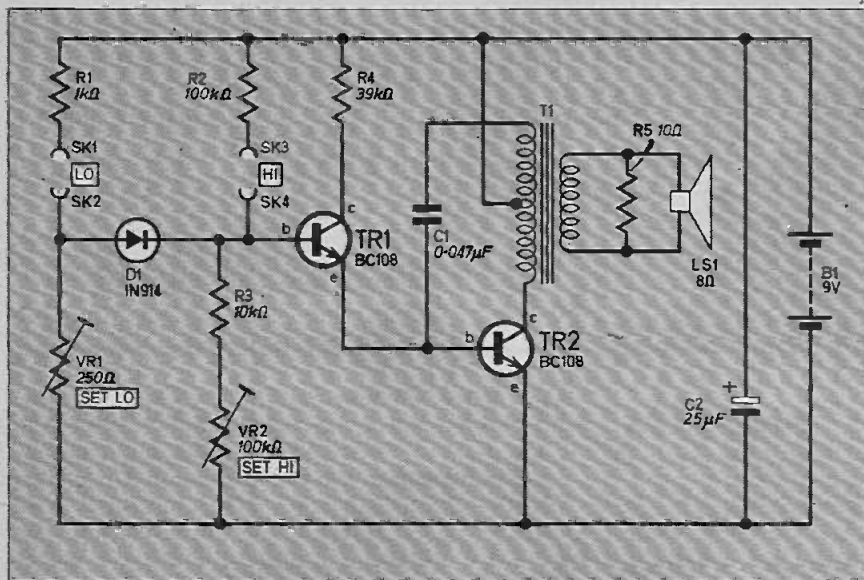

Fig. 1. The complete circuit diagram of the Continuity Tester.

is not as familiar a circuit as say, the multi-vibrator but in this application it is ideal as it uses fewer components and gives a high output.

Its operation is however not as simple as the number of components might suggest. To help understand the operation of the circuit let us consider TR1 is turned on: now base current flows via R4 into C1 which begins to charge; however, at about 0.6 volt TR2 base current starts to flow and the base voltage does not rise above 0.7 volt. The base current increases in TR2 as C1 charges, until the bias on TR2 is such that oscillation occurs. This oscillation is at a high frequency and is from the transformer, via C1 to TR2 base.

Because of the diode action of TR2 base and emitter junction, current flow in C1 is not uniform in both directions, and in a short time C1 is negatively charged with respect to TR2 base, biasing it off. With this circuit only about three or four cycles of this high frequency oscillation take place before TR2 is cut, or "blocked" off—hence its name.

With TR2 turned off, the potential across its base emitter junction is about minus 10 volts; this means that the voltage at the collector rises to almost 9 volts. Resistor R4 now appears in its primary context, as it is via R4 that C1 is discharged to the positive rail; when the voltage on the base of TR2 becomes positive TR2 turns on again and the cycle is repeated.

It can now be seen that the repetition rate is mainly determined by the time constant of C1R4, that is the time C1 takes to discharge to a given voltage; the value of these components has been selected to produce an agreeable tone in the loudspeaker. A ten ohm resistor is fitted across the transformer output terminals to help provide a constant load, thus preventing undesirable ringing effects which would affect the output.

In the circuit R4 has TR1 in series with it, TR1 functioning as a simple electronic switch. When TR1 is off no base current can flow to TR2 and so the oscillation cycle cannot start. Under this condition only leakage current flows in TR1 and TR2 which, for the transistors specified, is very small, so small in fact that it is not necessary to fit a battery on-off switch.

The resistor and diode network associated with TR1 requires some explanation as it is this group of components which give the dual range.

The terminals marked Lo are in series with a low resistance bias chain formed by R1 and VR1; if for instance a 1 kilohm resistor were connected across the Lo terminals, the reduction in bias (compared with a short) would be insufficient to turn on TR1 and no oscillation would occur in TR2. Connecting a 500 ohm or less would not reduce the bias current and TR1 would turn on, thus allowing TR2 to oscillate. Components R2 and VR2 form a high resistance bias chain, therefore connecting a 1 kilohm resistor across the Hi terminals would not reduce the bias current in the same ratio and TR1 would still be turned on. It is possible to connect circuits under test with resistance in excess of 300 kilohms to the Hi terminals and still receive full audio output from the continuity meter.

DIODE FUNCTION

The diode D1 is included to isolate the two bias networks; assume that there is a short across Lo terminals, a positive voltage appears at the junction of D1 and R1, this forward biases the diode which conducts. Current flows into TR1 base, turning it on and via R4 causing oscillations to occur. The effect of having VR2 and R3 connected from TR1 base to ground is negligible because the resistance here is approximately one hundred times greater than that of

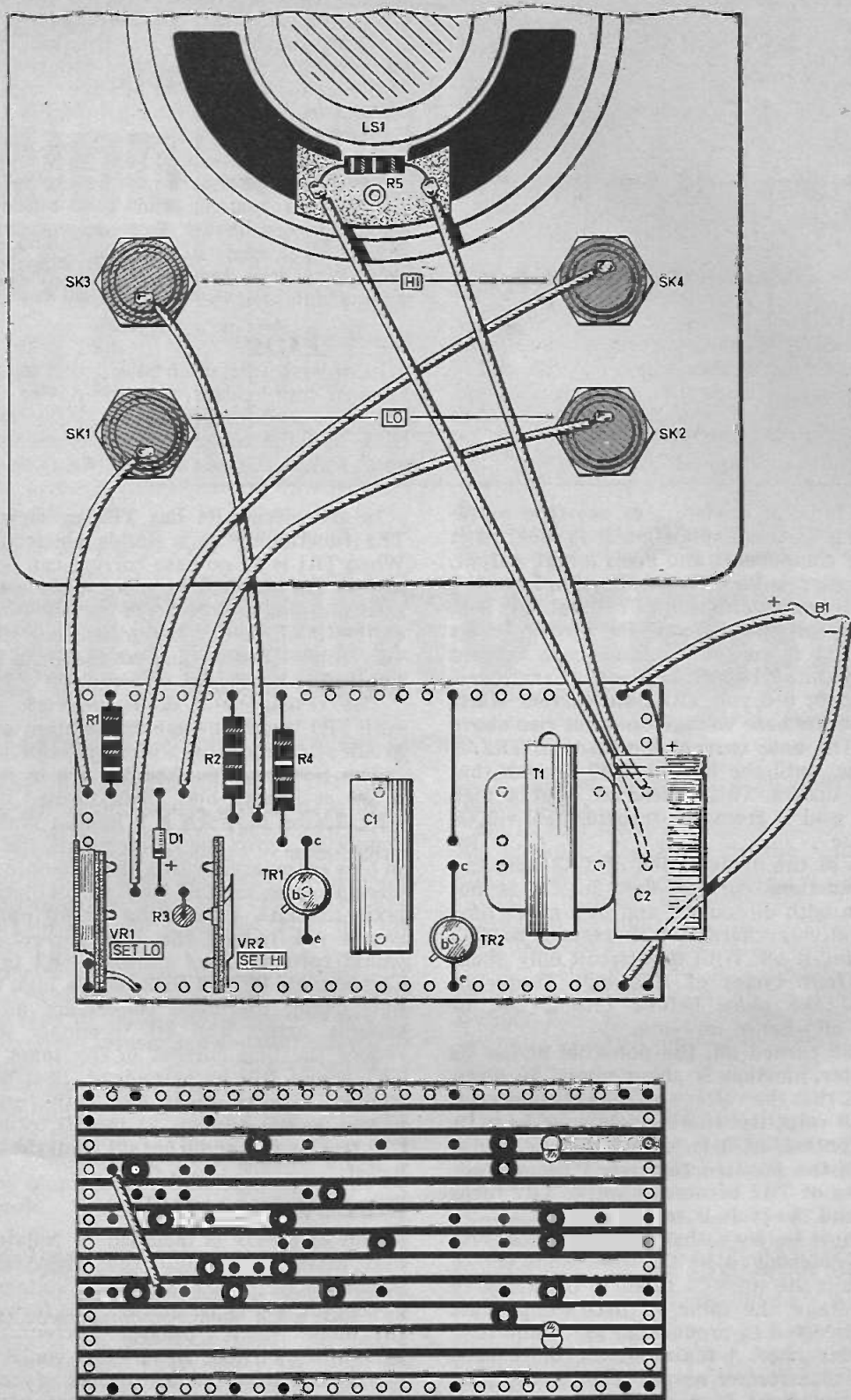
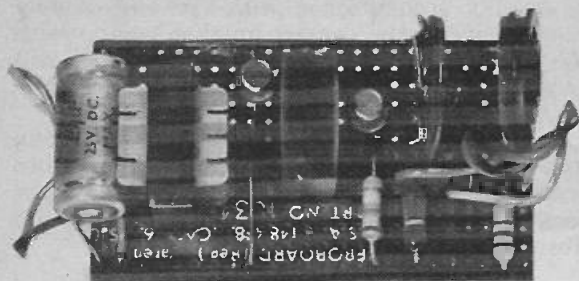

Fig. 2. Construction and wiring of the Continuity Tester.



Veroboard construction of the Continuity Tester.

the "Lo resistors". When the Hi sockets are used, the diode becomes reverse biased, its negative end held at zero volts, via VR1 and it does not conduct. This means that only VR2 and R3 are in circuit, the diode therefore acts as a switch between the two ranges.

The variable resistors VR1 and VR2, are included so that the ranges may be adjusted, details of this are given later. Basically the control VR1 is adjusted so that the oscillator will sound when a resistor of 500 ohms or less is applied to the Lo terminals. The resistance for the Hi range is set for a resistance up to 250 kilohms, thus giving two distinct ranges.

CONSTRUCTION

Begin construction by cutting the Veroboard to size, then with reference to Fig. 2 make breaks along the copper track as shown. Be sure to remove any metal swarf from this operation. Fit the components to the prepared board, and when soldering, take care not to create solder bridges on the copper strips, as these can be difficult to remove from 0.1 inch matrix board.

Use a heatshunt when soldering in the semiconductor.

The case used in the prototype was a commercially available plastic type measuring 115 x 75 x 35mm. The remainder of the components are mounted on the lid of the case. Prepare the lid to accept the wander sockets and then drill a series of holes in the lid to form a speaker grill, see photograph. A piece of speaker covering may be glued to the underside of the lid before the speaker is secured in position to prevent dust, crumbs, etc., from impairing the speaker performance.

With the sockets and speaker fitted in position, solder R5 in place and wire up the lid components to the component board. Finally connect a PP3 battery clip and the unit is ready for testing.

TESTING

Thoroughly check out the wiring and ensure that there are no solder bridges. If all is in order, connect the battery and short out the Lo sockets. This should cause the unit to oscillate. If it does, remove the short and then short out

the Hi sockets. The unit should again oscillate but at a slightly different frequency.

If the above results are obtained, then VR1 and VR2 may be adjusted as follows: connect a high resistor (about 200 kilohms) across the Hi sockets and adjust VR2 until oscillation begins. Replacing the 200 kilohms with a higher value resistor, oscillation should not occur.

The Lo range should now be shorted out with a 470 ohm resistor and VR1 adjusted until oscillation just begins. This completes the simple setting up procedure. Assemble the device in its case, label the front panel as shown in the photograph, and the unit is ready for use.

TEST LEADS

In order to get the best out of the unit, some form of test leads are required. For the prototype, two leads ending at one end with crocodile clips, and the other in test probes were made up as follows. Obtain two lengths of flexible PVC covered wire approximately a metre, fit wander plugs to one end and to the other ends of the leads fit crocodile clips.

USING THE CONTINUITY METER

At first sight, it may appear almost an insult to the constructor's intelligence to have a "using the continuity meter" chapter, however, a few words will show that the unit has applications outside the workshop. Its uses include automobile work, domestic appliances, TV and radio checks.

Components

Resistors

- R1 1k Ω
- R2 100k Ω
- R3 10k Ω
- R4 39k Ω
- R5 10 Ω

All $\frac{1}{4}$ W carbon $\pm 10\%$

Potentiometers

- VR1 250 Ω carbon preset
- VR2 100k Ω carbon preset

Capacitors

- C1 0.047 μ F plastic or ceramic
- C2 25 μ F 12V elect.

Semiconductors

- D1 1N914 or similar silicon diode
- TR1 BC108 silicon npn
- TR2 BC108 silicon npn

Miscellaneous

- T1 push-pull transistor output transformer (Eagle LT700 or similar)
 - LS1 8 ohm loudspeaker 60mm diameter (approx.)
 - SK1, 2, 3, 4 4mm wander sockets (4 off, 2 red, 2 black)
 - B1 9V battery type PP3 or similar
- Veroboard: 0.1in. matrix 13 strips x 24 holes; battery clips for B1; plastic case size 115 x 75 x 35mm; loudspeaker cloth.

SEE
**SHOP
TALK**

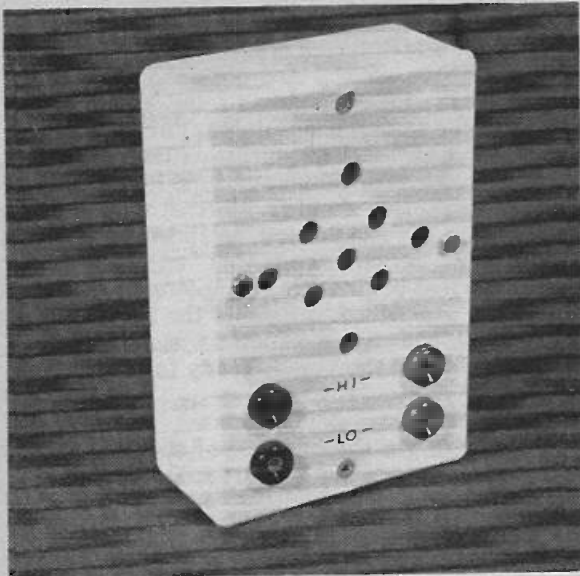

IN THE CAR

A unit such as this, carried as part of a tool kit, can prove very useful, as many car breakdowns are due, in one form or another to electrical failure.

The continuity meter can be used to quickly check, fuses, bulbs, continuity of coils, and motors of all types.

Setting the timing, and contact points may

be readily accomplished with the unit, simply connect across the contact breaker points (with the ignition off) and rotating the engine will cause the Continuity Tester to sound when the points close.

Other uses in the car include, tracing wiring in looms, testing control boxes, and pressure warning switches, such as oil pressure; these jobs are all simplified by using the Continuity Tester.

HOME AND DOMESTIC USE

The Continuity Tester should certainly find a place in an electrician's tool bag, as it has many applications in both domestic and industrial electrical work. In house wiring it will provide a good check of insulation (subject to the limitation of test voltage previously mentioned) and also of earth continuity, wiring identification, and switch operation. It can also be used to check the operation of thermostats, timers, cut outs, and other automatic contacts, the audible output giving a clear indication of contact closure.

On the bench the uses of the unit are probably limited only by the imagination of the user, and range from checking out wiring on a new project, to fault finding on other equipment.

These are just a few of the ideas for using this little project, others will no doubt be found. Whatever field it is used in, it should be found to be a useful tool. □



Diodes

I have acquired a lot of glass diodes that are unbranded and there is no polarity identification

on them. Is there any way of telling which way round they ought to be connected from the position of the crystal and "cats whisker" which can be quite clearly seen?



Yes. We assume that these are ordinary point contact germanium diodes—probably they are similar to OA91s but without a branding this is, of course difficult to say for sure. It is quite likely that they are outside manufacturer's specifications so will probably show high reverse leakage or low reverse breakdown voltage. Nevertheless you will probably find them useful for straightforward general purpose applications in low voltage circuits. The cats whisker is usually the *anode* end of the diode while the crystal (or chip) of germanium is the *cathode*.



"No it's not a prescription, its an explanation of diode action."

EVERYDAY ELECTRONICS

As from next month the price of EVERYDAY ELECTRONICS will be 30p.

New products and component buying for constructional projects

SHOP TALK

By Mike Kenward

AN unusual new product has found its way to our offices this month, it is an aerosol antiseptic from I.C.I.—why send it to E.E.? Well, it's supposed to be very good for minor burns as well as cuts, grazes and scalds although we have not yet had a chance to try it out, and do not intend to do a comprehensive test!

The product is called Disphex and has the action of iodine but without stinging. There is no need to touch the skin when applying it and the antiseptic forms a yellowish film over the wound, thus preventing infection whilst assisting healing. The film can be removed with water when required.

Available from chemists at 69p for a 55g aerosol it should last a long time, unless you are very careless with your soldering iron.



Sonic Bomber

Most of the parts for the Sonic Bomber Game should be easily obtainable, only one or two require special mention, these being the relay and transformer. The relay can be any small type with a coil resistance between about 30 and 70 ohms that will work on the 3V supply and has at least one set of normally closed contacts—this may not be readily available in some areas but the larger mail order suppliers or shops supplying parts for model control should be able to help.

The transformer is a Repanco type and should be available through larger suppliers, Repanco no longer supply one-offs to readers. Almost any type of cheap crystal microphone insert will probably be suitable—most suppliers carry some, usually the Eagle ones.

As far as the mechanics and the plane go there should be no problems—most of the larger model shops seem to sell the motorised type kits these days.

Continuity Tester

Only one part in the Continuity Tester requires special mention and that is the transformer, for

which we have not specified a particular type. Many different transistor push-pull output types are available and any of these will be suitable—buy the cheapest available.

The case can be any type of a suitable size—plastic ones are easier to work and usually cheaper than aluminium.

Matchbox Receiver

Parts for the Matchbox Receiver must of course all be small—remember this point when buying the capacitors in particular. The output socket also acts as the on/off switch and must be of a particular type which is modified—see text.

The trimmer used for tuning can be modified to provide a tuning “knob” or a special conversion spindle can be purchased from Home Radio. The short piece of ferrite rod required is not likely to be sold as such and will have to be cut from a larger piece; do this by filing a notch around the rod at the required point and breaking off the section over the edge of a table.

Indicator Audible Alarm

The earpiece used in the Indicator Audible Alarm is a P.O. type having a resistance of about 20 ohms; this is the most suitable for this project although a miniature 35 ohm speaker could be employed. The earpiece is available from a number of suppliers.

The original unit was housed in a typewriter ribbon case and this provides an excellent housing of compact dimensions and can be mounted in a convenient position under the car dashboard.

JACK PLUG & FAMILY...



MATCHBOX

RECEIVER



A miniature m.w. receiver using an integrated circuit to give good reception

A PORTABLE radio receiver able to give very good headphone reception from its internal ferrite aerial is nowadays quite easily constructed to fit inside a case the size of a matchbox due to miniaturisation of components. In fact the prototype receiver was fitted into an empty matchbox, assembly being in the tray and the outer part serving as a cover.

Tuning coverage is about 550 kilohertz to 1550 kilohertz, which is typical for the medium wave band.

CIRCUIT

The circuit diagram of the receiver is shown in Fig. 1. The ferrite aerial L1 forms a tunable parallel resonant circuit with compression trimmer C1. The output from this network (r.f.) is fed to integrated circuit IC1 which is a ZN414. This is a multistage amplifier and detector and processes the incoming modulated r.f. and extracts the audio signals making them available at the output lead. Resistor R1 is the necessary feedback resistor for IC1 and R2 and VR1 form the load for IC1.

The output from the integrated circuit is coupled, via C4, to audio amplifier TR1 which provides a considerable increase in volume.

Power is from a single 1.4V mercury battery. As there is no space for a conventional on/off switch, the output jack SK1 is so arranged that closure of the contacts B and C switches on the receiver. It is thus switched on by plugging in the headphones, and switched off by withdrawing the plug.

OUTPUT SOCKET

The output jack socket should be a switched type and can be 2.5mm or 3.5mm, but has to be

Components....

Resistors

R1 100k Ω

R2 470 Ω

R3 680k Ω

All $\frac{1}{4}$ W carbon $\pm 10\%$

SEE
**SHOP
TALK**

Capacitors

C1 450pF compression trimmer

C2 0.01 μ F plastic or ceramic

C3 0.1 μ F plastic or ceramic

C4 0.05 μ F plastic or ceramic

Semiconductors

IC1 ZN414 a.m. radio integrated circuit

TR1 BC107 silicon npn

Miscellaneous

VR1 1k Ω miniature carbon linear preset potentiometer

B1 MP675 1.4V mercury cell or similar

SK1 switched jack socket, 2.5mm or 3.5mm (see text)

Plain matrix board, 0.15in. 9 x 8 holes; ferrite-rod 37mm x 9mm ($\frac{1}{2}$ in) diameter; 32 s.w.g. enamelled copper wire; knob (see text).

FOR
GUIDANCE
ONLY

ESTIMATED COST*
OF COMPONENTS
excluding V.A.T.

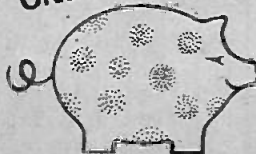

£2.40

*Based on prices prevailing at time of going to press

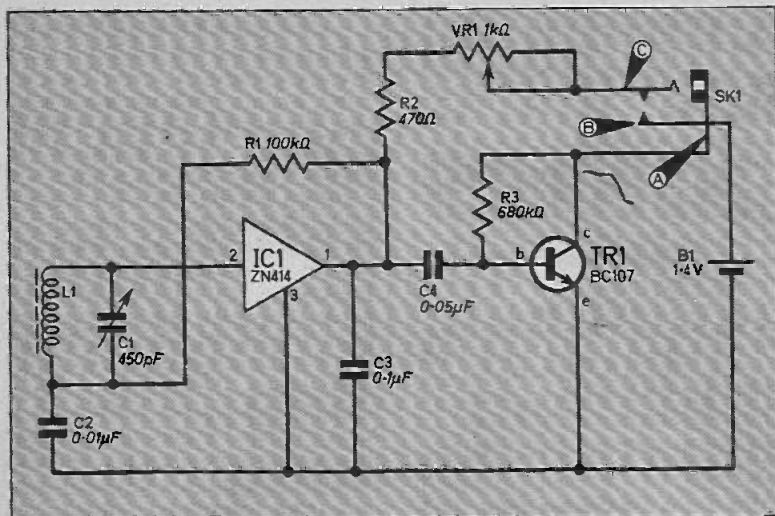

Fig. 1. Complete circuit diagram of the Matchbox Receiver

arranged so that the switchable contacts close when the plug is inserted. Jack sockets are normally made so that inserting the plug causes the contacts to open. If the required type is not readily available, the standard type should be modified. Some types of socket cannot be modified in this way so be alert when buying this component and inspect it to see if the modification can be carried out.

AERIAL AND TRIMMER

The winding L1 is 60 turns of 32 s.w.g. enamelled copper wire wound side by side on a ferrite rod 37mm long and 9mm (3/8in) in diameter. Winding should begin 3mm from one end of the rod, and the end turns secured with adhesive. (The whole winding should not be covered with adhesive.)

Trimmer C1 as supplied has an adjusting screw for setting by screwdriver. This should be replaced by a 6BA bolt (about 25mm long), taking care to retain the insulated and metal washers under its head. The bolt projects enough to take a 6BA lock-nut and knob or metal or insulated terminal head, see Fig. 3. This is for hand tuning.

The lock-nut is positioned so that the compression trimmer plates can spring fully open, or tuning coverage will be restricted and the high frequency end of the band cannot be reached.

COMPONENT BOARD

The prototype unit was built using 0.15 inch plain matrix board size 9 by 8 holes. The layout of the components on the board and the interconnecting wires on the underside of the board are shown in Fig. 2.

Begin by inserting a few components at a time, beginning with the resistors and capacitors and carrying out the underside wiring as you go along. Pay special attention to the lead-out con-

nections when soldering IC1 in position and use a heatshunt on the leads when soldering; similarly with TR1.

Joints and leads should be flat against the board so as to avoid raising the board more than about a millimetre or so above the base of the matchbox tray when mounted in position. Sleving is necessary on the lead on the underside from C3 to battery negative, see Fig. 2.

As the battery has a long life, connections are soldered directly to it; the case is the positive terminal. The ferrite rod assembly is secured to the component board with adhesive.

When all the board mounted components have been secured in position, SK1 and C1 should be wired in.

TESTING AND SETTING UP

Best results, and most comfortable listening, will be obtained with a complete headset, although a single miniature earphone is of course

Continued on page 493

Photograph showing the construction of the receiver.

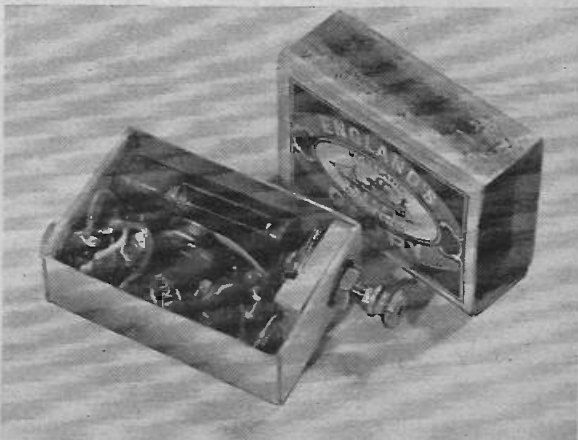

Your Career in **ELECTRONICS**

By Peter Verwig

A TESTING WAY TO SUCCESS

A career in electronics is an exciting prospect! Month by month our contributor Peter Verwig will explain what working in electronics is all about, how to prepare yourself for a rewarding career, and the job opportunities available in the world's fastest growing industry.

LAST month we examined career opportunities in the Post Office. This month we stay in communications by taking a look at a private enterprise commercial organisation and particularly at the role of the test engineer, one of the most important job functions in the whole chain of events from initial development of a new product through to its final delivery to the customer.

So although communications figures largely in this month's article much of what we shall be discussing from the testers viewpoint is generally applicable in other sectors of the manufacturing industry, for example in computer manufacture, or instruments, or medical electronics or radar. As we shall see, to enter the electronics industry as a production tester is not only comparatively easy but can be the gateway to many other careers in electronics.

The example we have chosen is Marconi Communication Systems Ltd., based at Chelmsford, Essex. It is one of the companies in GEC-Marconi Electronics which, in turn is a member company of The General Electric Company, which altogether employs more than 200,000 people and has a turnover of £1,500 million a year.

Like many other great organisations, GEC is divided into separate businesses. Marconi Communication Systems has annual sales of over £35 million and employs 5,000 people. Its specialities are radio and line communication, and sound and television broadcast equipment. The company is entirely autonomous. This means that it conducts its own affairs in product development, manufacture and marketing, and finan-

cially it is self-accounting and profit-seeking. Of course there is ultimate financial control from Group Headquarters and there are some shared facilities within GEC-Marconi Electronics such as Marconi College and Marconi Research Laboratories.

COMPANY STRUCTURE

This type of company structure is beneficial. It means that an operating company within a major grouping is of manageable size where employees are still recognisable as people, but large enough to provide a real career structure. And belonging to a large and successful group of companies gives extra financial stability and a better assurance of a long-term future.

If you already work at Marconi Communication Systems you might modestly admit that you had played your part in a company that has supplied 75 per cent of all the TV transmitters for the BBC and IBA and more than 500 overseas, now operating in 40 different countries. That more than 150 Marconi-built outside broadcast units are operating throughout the world, that TV viewers see their pictures through the lenses of thousands of monochrome and colour TV cameras built by Marconi. That in sound broadcasting nearly 100 countries use Marconi transmitters. That in civil radio transmission Marconi is in North Sea Oil, in the Post Office, in Cable and Wireless, and is a recognised world authority in the technique of troposcatter communication. That Marconi is big in satellite communications and has built giant earth stations throughout the world. That in military systems the company is

a major supplier to the British armed services, to NATO and to overseas defence organisations. And that in line communication the company is Europe's leading supplier of PCM (Pulse Code Modulation) systems.

If you join Marconi Communication Systems those are the sort of products on which you will work. Highly professional equipment built up to a standard rather than down to a price but able to compete in both price and quality in the world market place and do so successfully. This is no environment for the loafer, for the half-hearted, but for the keen entrant there are ample career opportunities in a company of world-class and one, moreover, which has the distinction of being the natural inheritor of the mainstream of activities of the original Marconi Wireless Telegraph Company Ltd., the first of its type in the world formed on February 23, 1900.

PLANNED TRAINING

Like most large companies Marconi has comprehensive technician and student apprenticeship schemes in electronics engineering and mechanical engineering with planned training over three-year or four-year periods. These schemes will lead to the acquisition of City and Guilds, Ordinary National or Higher National Certificates or, for student apprentices, a university degree. Entry is normally direct from school with age limits either 17 for City and Guilds streams or 17½ for National Certificate streams. An "accelerated" three-year course is available for those having completed a two-year sixth form "A" level course in Mathematics and Physics with a pass in either subject, plus two other subjects at "O" level. This is open to young people up to the age of 19 and involves a 25 weeks block-release course in the first year leading to ONC, and shorter block-release courses in the second and third years of the apprenticeship leading to HNC.

All the apprenticeships in electronics engineering include working in the test department as part of the practical training. This area is regarded as of the highest importance because it gives an excellent appreciation of many other aspects of design and production of electronic equipment.

THE TEST ENGINEER

In a sense, the test engineer has a function similar to that of a doctor in assessing the fitness of a patient and of curing ailments. The rule book is the specification of the equipment and the test engineer's job is to see that newly manufactured equipment meets the specification. He does this by taking measurements. He may also have to make adjustments to the equipment to bring it to operational specification. As his skills advance he will become more of a diagnostician, sorting out mysterious faults which elude less skilled testers. He becomes a "trouble-shooter". During his work he obtains a detailed knowledge of the equipment on which he works. Patterns of faults may emerge and the intelligent reporting of such faults can influence the design or production methods of the product, resulting in important modifications.

With complex modern equipment the units being tested can be worth many thousands of pounds and it is not uncommon for a test engineer to have, as the tools of his trade, test equipment of considerable complexity and cost. It is a responsible job for responsible people. The cost of testing has risen very steeply in recent years and this has led to the gradual introduction of automatic test equipment (ATE) first of all for simple repetitive jobs and later, with the addition of computers, to automatic testing of quite complex sub-assemblies and complete equipments. The more advanced ATE systems print out test results and often include diagnostic facilities. But automation will never put the test engineer out of work. It will, however, lighten the burden of his work and speed it up.

Can a young person get his start in electronics through the test department even if he is too old to qualify for the ordinary entry through an apprenticeship? Yes, he can.

Marconi, in common with many other manufacturers, are sympathetic to hobbyists. If you have a knowledge of electronics and show keenness to become a professional you have a good chance of making a start as a trainee. You might, for example, have some experience of radio and TV servicing and if, on top of this, you have shown a real desire to learn through attending evening

classes, an application for a job will be treated with sympathy and, of course, you will get on-the-job training. And you will make progress on your ability.

You would probably start work on repetitive tests, perhaps with the assistance of automatic test equipment. In Marconi Communications there are six grades of testers and as your experience rises, so will your grade. At first you may find the work boring but you will need to stick it out until you have shown that you have the ability to progress to more responsible and interesting work.

PERSONALITY COUNTS

Don't overlook the fact that you need personality as well as technical skill to become successful. This is because a tester also has liaison functions, some of them demanding a measure of diplomacy, like informing the production department of mistakes in assembly and especially if the mistake has escaped the attention of an intermediate inspector. In the case of consistent failure to meet a specification, which can happen in the early stages of production of a new equipment, it may be necessary to have consultation with the designers of the equipment. And where substantial export orders are concerned it is not uncommon for the customer to send one or more engineers to the manufacturing plant to observe the progress of the contract and such visiting engineers are always interested in seeing the equipment checked out and you may then expect to have to demonstrate and explain the pro-

cedures. So, as a test engineer, you will come into daily contact with people from other departments and quite often, the customer's representatives as well.

As a general rule a young engineer who has reached HNC standard should be doing diagnostic as well as routine testing within two to three years. The top of the tree is Quality Manager who may have as many as 50-60 test engineers and inspectors working for him. The reputation of the company and its equipment rests on his shoulders.

Because of the exceptional product knowledge that the test engineer acquires, the test department is a fruitful source of people for other departments. Many ex-test engineers find occupation in field installations, in the contracts department, in production and, not surprisingly, a number find their way into the development laboratories or become project engineers which virtually means managing a complete project.

At Marconi Communications nearly all unit managers have served some time in their careers as test engineers. Technical ability is highly rated and if you have management ability you will be given the opportunity of attending management courses.

Qualifications are important. Other things being equal a person with a degree might expect to reach a position of middle management in his early 30s, younger in exceptional cases. But it is by no means unknown for a person with HNC to catch up and pass degree people.

Things are buzzing in the telecine final test area at Marconi Communication Systems factory at Chelmsford. With sales approaching the £3 million mark in the first full year of production the test engineers have all the stops out in putting each finished equipment through its paces before delivery to the customer.



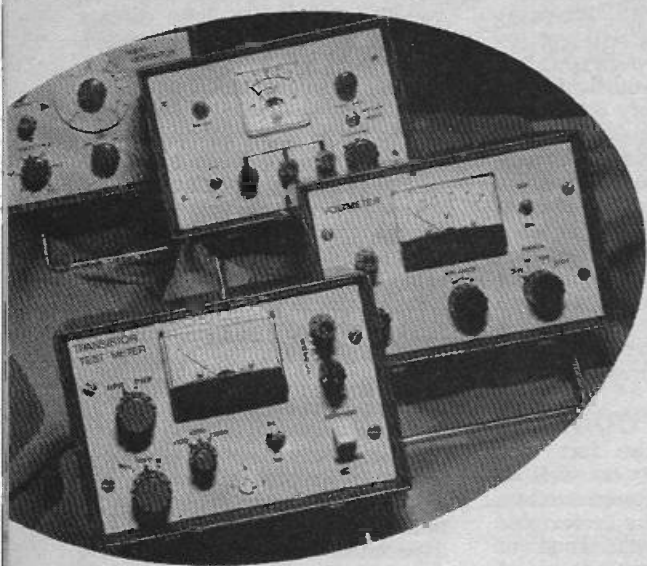

Workshop Practice

By MIKE HUGHES M.I.E.R.E.

PART FIVE

A Professional Finish

THIS month rounds off the section dealing with the Professional Finish.

DRY COLOUR

As you get more practice and experience in knowing what other draughting aids are available in rub-down form you can use the Sellotape transfer process to produce quite complex designs.

For the more ambitious who may want to introduce coloured backgrounds to the black (or other coloured) lettering, you can get some extremely interesting and satisfying results by using one of the Letraset products called "Dry Colour". This is a sheet of very thin tacky coloured film which is semi-transparent with a matt surface. There is a very wide range of colours.

The matt surface will take rub-on lettering and then you can knife round the edges of the word and remove the coloured backing with the word on it; the coloured backing can then be transferred to your front panel, burnished down into place and varnished to regain a glossy surface.

A large piece of Dry Colour burnished over the whole of a grained aluminium panel and then varnished gives a very good simulation of a coloured anodised finish.

BRISTOL BOARD

If you are not that good at handling metal work and producing the brushed finish (maybe your panel has a few defects in it!) you can use the principles of rub-down lettering described above but can carry out the work on a piece of good quality card. One- or two-sheet Bristol Board is one of the best types of card to use—it has a nice smooth surface and is free of

imperfections—although it is rather expensive, the chances are that a single sheet of it will last you a long time. It can be obtained from most art shops.

White card as a background is not very inspiring for a front panel so we suggest you first cover the surface with Dry Colour and then carry out your lettering in the way already suggested. When satisfied with the result give the surface of the job two or three coats of polyurethane varnish and when it is absolutely dry you can stick the card over the whole of the metal front panel.

The best way of sticking this permanently to a metal surface is with double-sided Sellotape but if you use this make sure that you apply the tape over the *whole* surface and not just round the edges—this prevents the card blistering as and when it absorbs moisture from the air and dries out.

Ideally the card should be slightly oversize for the metal panel so that you can trim the edges off absolutely flush with a sharp knife. Holes for the shafts of controls can be knifed out after the card is stuck on to the metal (you should, of course, make sure you drill the metal first!). Clearly the result is not as durable as a metal surface but you will be surprised how much protection a few coats of polyurethane will give.

This latter method is excellent for converting the appearance of wooden front panels but because of the poor adhesion of Sellotape to wood it would be better to use Evo-Stik to glue the card into place.

PERSPEX

Perspex, on the face of it, would appear to be an admirable front panel material. This is true but it presents lots of problems to the amateur when it comes to applying lettering. For a start rub-on lettering will not take to it and gummed transfers will not stick. The only



Fig. 1. Outlines the steps involved in using Dry Colour and double-sided Sellotape for putting legends on Perspex.

really satisfactory way of lettering is to engrave the front surface and fill the engraving with a contrasting colour. This is outside the scope of most enthusiasts.

There is a technique which the author has used successfully on transparent Perspex which requires the printing to be applied to the "rear side" of the panel so that the outside surface needs no treatment whatsoever.

The process is simple, but has to be done with care and is an extension of the Sellotape transfer method and is shown in Fig. 1. First, the Perspex should be fully drilled so that it requires no further mechanical operations. You should then rub down the words you require on to a piece of Bristol Board (or a post card) with light pressure and then lift them off using *double-sided* Sellotape.

If the tape has a protective siliconised paper on one side leave this in place for the time being; if it has none you can use a piece of the protective paper from the rub-down lettering as temporary protection to the top adhesive side.

When you have peeled the word off the card you can, if you wish, lay a piece of Dry Colour on the word (viewed the wrong way round). This will, of course, stick very easily to the Sellotape so make sure you get it in the right place first time with no air bubbles! You can now knife out a rectangle of the Sellotape containing the word and the Dry Colour and remove it from the backing paper.

The exposed "fresh" adhesive surface of the Sellotape should now be pressed into position on the *reverse* side of the transparent Perspex panel to which it will stick very well. The coloured background helps to prevent the Sellotape being very obvious. When you have positioned all the lettering you can now paint the reverse side of the Perspex with any enamel

paint. It will not adhere too well but as it is on the reverse side of the panel it will not suffer from any scratches. The lettering will have perfect protection and will stand out beautifully against the painted background. This latter method is very useful if you wish to make transparent tuning scales with graduations.

There are, of course, many other ways of putting lettering on to panels but we hope that the preceding suggestions will provide food for experimentation—by careful use of the modern draughting aids and a bit of ingenuity, there is almost no limit to what you can do at home on the dining-room table!

PLEASE
TAKE NOTE

We wish to apologise for an error in the article entitled *Warning Winker* published in the July 1975 issue. The formula given on page 373 to determine the charging current was shown inverted. It should read:

Cell capacity (mA H)
 10

The UNIUNCTION TRANSISTOR

By J. B. DANCE

THIS second and final part deals with applications and gives practical circuits to illustrate.

RELAXATION OSCILLATOR

The circuit of Fig. 5 shows one of the simplest types of circuit in which the unijunction transistor can be employed. It is the basis of most unijunction timer and oscillator circuits.

When the supply voltage is first connected, the capacitor C commences to charge through $R1$ and the voltage across this capacitor continues to rise with an exponential waveform until it becomes equal to the voltage V_p required to forward bias the emitter junction.

The capacitor then discharges through the emitter and the voltage across it falls to such a low value that the emitter junction ceases to conduct. The capacitor then commences to charge again and the cycle is continuously repeated until the power supply is interrupted.

This very simple circuit can operate at frequencies of up to the order of 100kHz. The frequency of oscillation is dependent on the time constant $C \times R1$, on the supply voltage from which C charges through $R1$ and on the value of η , since the latter determines the voltage to which the emitter must rise before the capacitor discharges.

A sawtooth waveform is obtainable from across the capacitor. The emitter of the unijunction transistor may be connected directly to the base of an *npn* transistor used in an emitter follower output circuit. Positive going output pulses can be obtained from across $R3$; they occur during the short time the device conducts when the capacitor is discharged. Negative going pulses can be obtained from base 2.

CONDITIONS FOR OSCILLATION

The circuit of Fig. 5 will oscillate only if certain conditions are satisfied.

The value of $R1$ must not be so great that it

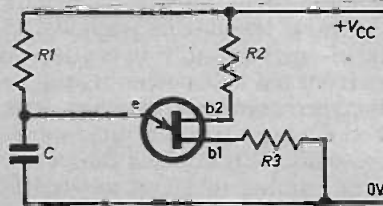

Fig. 5. A basic unijunction circuit for use as a timer or oscillator.

cannot pass enough current from the voltage supply line (V_{cc}) for the emitter peak current to be reached. In other words, using Ohm's Law:

$$\frac{V_{cc} - V_p}{I_p} > R1 \text{ (max)}$$

This condition limits the minimum frequency of oscillation which can be obtained with a given power supply voltage and a given capacitor. Typically one can obtain capacitor charging times of the order of one second per microfarad of the capacitor C if the power supply voltage exceeds 25 volts.

Another condition which must be satisfied is that the current flowing after the unijunction transistor has commenced to conduct must be smaller than the valley current. If this condition is not satisfied, the device will not return to the non-conducting condition after it "fires" during the first cycle. This condition may be written

$$\frac{V_{cc} - V_v}{I_v} < R1 \text{ (min)}$$

where $R1(\text{min})$ is the minimum value which may be used for $R1$.

In practice it is wise to choose a value of at least twice the minimum value to ensure that the unijunction circuit returns to the non-conducting state, since the variation of the emitter voltage with emitter current in the valley region of the emitter characteristic is very small (see Fig. 3 of last month).

The value of I_p is typically about 12 microamps and that of I_v about 8 milliamps, so it is not too difficult to satisfy the conditions for oscillation.

STABILITY

The frequency of oscillation varies with temperature. The main reason for this is that the voltage of the forward biased emitter diode varies with temperature. The frequency of oscillation can be stabilised against temperature variations by an appropriate choice of the resistor $R2$.

PRACTICAL CIRCUIT

A practical timer circuit designed by the Motorola Company is shown in Fig. 6. When $VR1$ has the maximum value of 10 megohms, $C1$ is 10 microfarads and the value of η is 0.8, the time for one complete period of oscillation

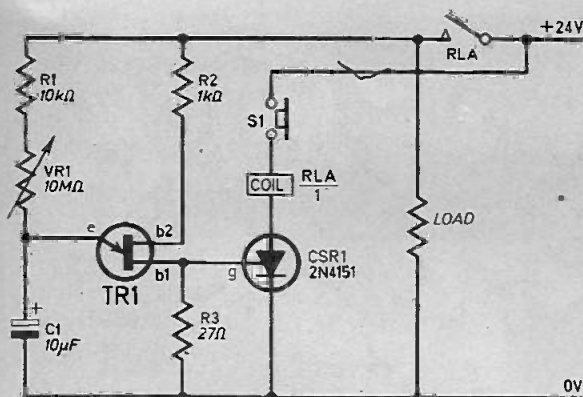

Fig. 6. A practical timing circuit.

can be calculated approximately from:

$$T \approx RI \times CI \log_e [1/(1-\eta)] \\ = 10^7 \times 10^{-5} \log_e [1/(1-0.8)] = 160 \text{ seconds}$$

If R2 is chosen as 1 kilohm, this produces good temperature compensation with the type of unijunction transistor shown.

The relay remains energised after the first cycle has occurred. Switch S1 is normally closed, but when it is pressed, the 2N4151 silicon controlled rectifier is turned off, as its anode current is interrupted. The relay is also de-energised, the relay contacts close and power is applied to the load and to the unijunction relaxation oscillator circuit.

The circuit remains in this state for a period of between about 1 second and 2.5 minutes (according to the setting of VR1), after which the unijunction transistor conducts and fires the silicon controlled rectifier. The relay is then energised and the power is removed from the load. The relay remains energised until S1 is pushed again.

This circuit is fairly typical of those using a unijunction transistor to fire a silicon controlled rectifier.

OTHER DEVICES

Photosensitive unijunction transistor

A photosensitive unijunction transistor has recently been introduced into the International General Electric range. In this type of device, incident light can reach the emitter junction where it forms charge carriers. The latter are attracted across the junction and trigger the device into conduction. Thus the operation is controlled by a beam of light.

Programmable unijunction transistor

Another type of interesting device is the International General Electric Company's programmable unijunction transistors, types D13T1 and D13T2. These are essentially low power general purpose triode type silicon controlled rectifiers in an economic type TO-98 encapsulation. They

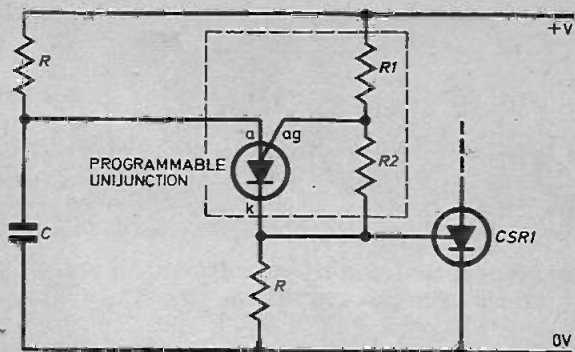

Fig. 7. The programmable unijunction and resistors R1 and R2 replace TR1 of Fig. 6.

are *pnpn* devices with a gate connection to the inner *n*-type electrode, but no connection is made to the inner *p*-type material.

The circuit of Fig. 7 is similar to that of Fig. 6 except that the programmable unijunction transistor and the resistors in dotted box have replaced the unijunction device. The values of R1 and R2 determine the voltage at which the anode to gate junction becomes forward biased.

Once conduction has commenced, the regeneration inherent in the *pnpn* device causes the conduction to continue until the supply voltage is interrupted.

If the resistors used in a circuit with the programmable unijunction device are suitably selected, the desired values of such parameters as η , I_p , I_v and R_{BB} can be obtained. When the resistors R1 and R2 are high, the values of I_p and I_v are low.

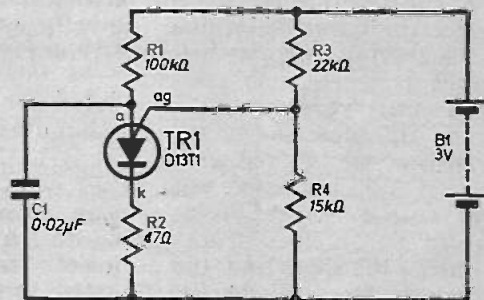

Fig. 8. A practical circuit using a programmable unijunction transistor.

Programmable unijunction transistors can be used in timers, relaxation oscillators, ring counters, etc.

A simple practical circuit designed by the manufacturers of the device is shown in Fig. 8. It consists of an oscillator operating at about 1 kilohertz from a 3 volt power supply.

The effective resistance between base 2 and base 1 of the equivalent unijunction device is about 37 kilohms. This enables the power supply current to be limited to about one-tenth of that which a normal unijunction transistor oscillator might take. □

Physics is FUN!

By Derrick DAINES

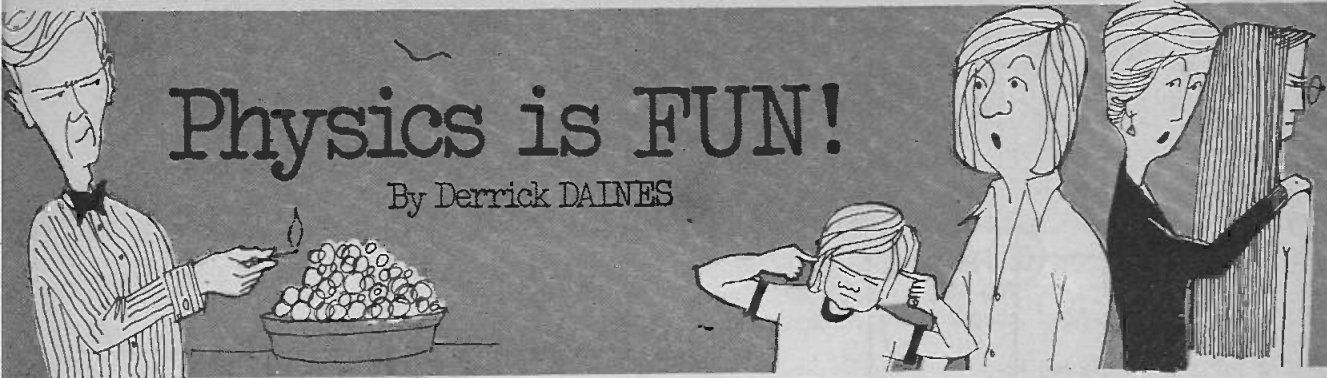

ELECTROLYSIS

Every schoolboy knows that the symbol for water is H_2O , meaning that water is composed of two molecules of hydrogen for every molecule of oxygen. We can separate water into its two constituent gases quite easily, as follows. Scrounge two short lengths of model railway track or any other sort of nickel-plated metal so as to make two electrodes each about 15mm long.

If nickel plate is unobtain-

most) out above the surface of the water without the water inside it falling out. Clip it to the side of the jar with the clothes peg.

Repeat with the other electrode and you will have the set-up illustrated in Fig. 1. If you manage it right, the clothes peg will grip both the tube and the electrode so that the latter does not fall to the bottom of the jar, although it won't matter a great deal if it does, so long as one end of it is inside the tablet tube.

Now we need a source of electricity. A power-pack is best, or a battery charger; notice that we need direct current, not alternating. A car battery is very good but failing all else even a 9V miniature battery as used in transistor radios will do. Connect one pole to one electrode and the other pole to the second electrode, using short pieces of wire and paperclips.

Bubbles will be seen to form on each electrode. In time—depending upon the current available—these bubbles will join together, burst free and float upwards. Hopefully, into the tablet tubes! The gases will be collected there, unable to escape. Soon it will be observed that the electrode connected to the positive terminal of the battery (known as the anode) has less collected gas than the other (the cathode). In the electrolytic decomposition of water, oxygen gathers at the anode and hydrogen at the cathode.

If your experiment does not work as well as it should, this might be because the water is too pure. Contrary to popular belief, pure water is an insulator; it is only when impurities are added (even in small amounts) that it becomes a good conductor. If necessary therefore, add a few

drops of sulphuric acid or a squeeze of lemon juice. Some side effects may result, but the basic principle as well as the end result remains the same.

It might also be worth while to insulate part of the electrodes immersed in the water so that all of the bubbles are formed immediately below the pill tubes (Fig. 2).

The presence of oxygen may be proved by inserting a few strands of red-hot steel wool into the smaller of the two gas collections

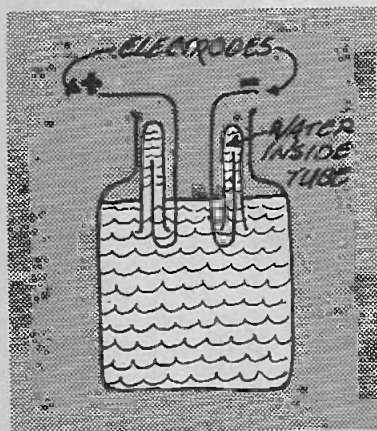

Fig. 1. Set up for basic electrolysis experiment.

able, thick copper wire will do almost as well. Carbon rods are quite unsuitable.

Bend each electrode in half and put one leg of each into a test tube or small tablet tube. Now get two spring-type clothes pegs and a glass jar or beaker three-quarters full of water. If you take each tablet tube in turn, with the electrode in it, and sink it into the jar before turning it upside down, you will be able to bring the bottom of the tube (now upper-

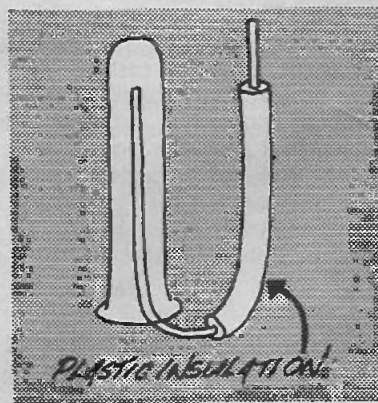
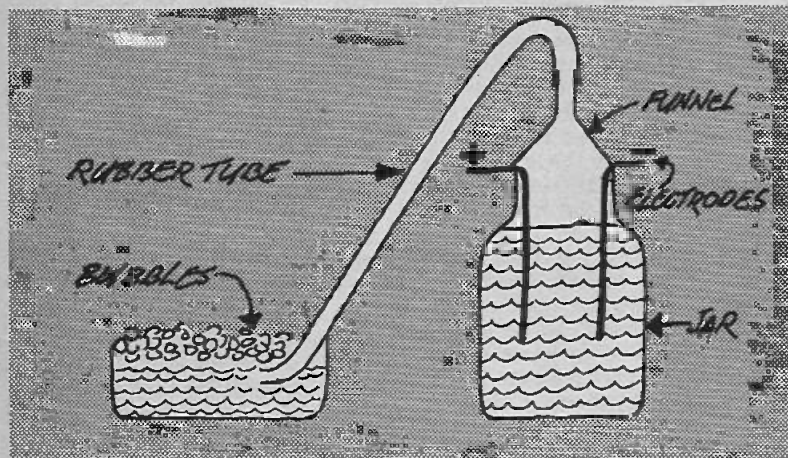

Fig. 2. Insulation of part of the electrodes.

(use pliers!). If you are lucky—and quick—you will see a definite increase in the red-hot glow and perhaps even a few flames. On no account try this with the larger of the two collections—that is, with the tube containing the hydrogen. Hydrogen is highly explosive.

A mixture of hydrogen and oxygen is called oxy-hydrogen. It may easily be collected by removing the tablet tubes and fitting a funnel upside down over the whole jar and sealing the edge

Fig. 3. Method of collecting oxy-hydrogen in bubbles.



with Sellotape. Fit a rubber tube to the funnel outlet and take it down to a dish of water to which a few drops of detergent have been added.

When the apparatus is connected to the power source, bubbles will form which are filled with oxy-hydrogen. Air will also be present—at least, with the first bubbles collected—from the funnel and tube. When a few bubbles have been collected, remove the dish to a safe distance away from the jar—preferably to another room—and the explosive nature of the mixture will be demonstrated by exploding the bubbles with a match or glowing cigarette (see Fig. 3). **Take great care with this experiment and explode only a few bubbles at a time.**

Each explosion turns the oxy-hydrogen into a tiny quantity of water. We might say that the energy put into separating the gases has been released as a single explosion.

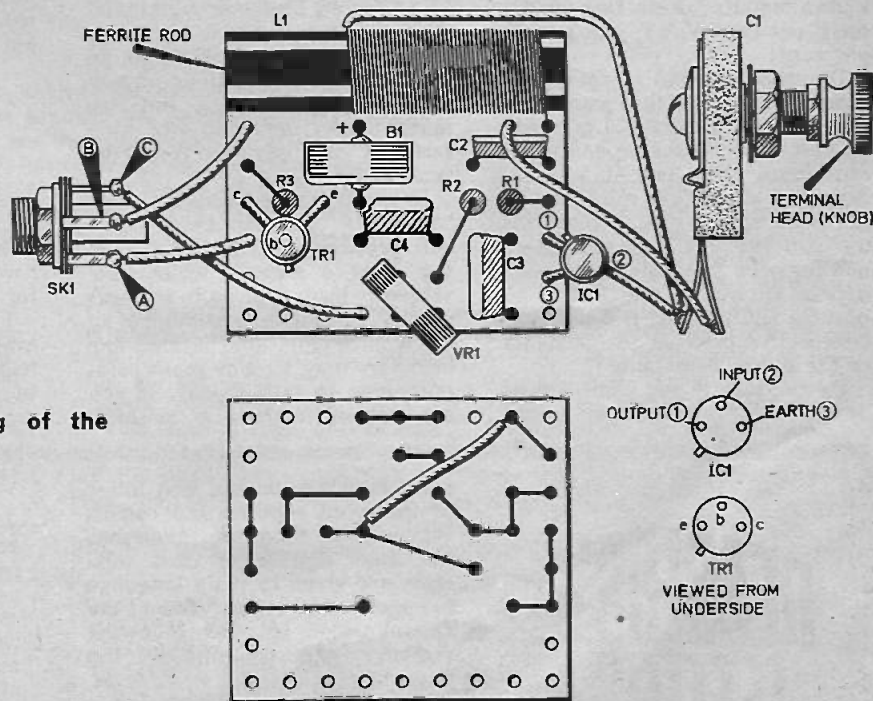

Fig. 2. Layout and wiring of the Matchbox Receiver.

Continued from page 485

easy to carry at other times. Medium or high impedance units, or headphones of about 2,000 ohms, are most suitable.

With the 'phones plugged in, adjusting C1 should tune in the stations which are best received in the locality. Some may be too loud, causing overloading, and this is corrected by turning the receiver to reduce signal pick up by the ferrite rod, if needed.

Potentiometer VR1 is adjusted with a small

screwdriver. When VR1 is at a low value, or zero, volume is greatest, but oscillation may accompany some signals. If so, turn VR1 to increase resistance so that oscillation ceases. The setting is not critical. Later readjustment of VR1 will give some extra life for a failing battery.

All that remains to be done is fit the assembly into a matchbox—or other case if you desire—and the receiver is complete and ready for use.



...Counter Intelligence

BY PAUL YOUNG

A retailer discusses component supply matters.

I HAVE already written two articles on the iniquities of V.A.T. and I will not try your patience by writing a third, even though it would take six more articles to explore fully the stupidities of it. I will, however mention in passing, two aspects of it. The definitions laid down by the V.A.T. men as to which items carry 8 per cent and which 25 per cent are so obscure as to be impossible to follow. Consequently many of us retailers are driven to falling back on the rate of V.A.T. we are charged by our suppliers. Unfortunately, even this has its pitfalls.

The other day I enquired the prices of International Octal Valve Holders from two well known manufacturers. One quoted me 8 per cent V.A.T. and one 25 per cent!

One success I can report in this direction. I found that some suppliers, were charging 25 per cent on postage and packing and when questioned they said it was because the goods they were supplying were 25 per cent. I took this up with the V.A.T. headquarters and for once they came back with a clear cut ruling, the V.A.T. on postage and packing is 8 per cent irrespective of what the contents of the parcel consists of!

By the way if you come across any V.A.T. "funnies" you might

let me know, I would like to publish a list of them later on.

The best we can hope for is a simplification of the V.A.T. system preferably back to one rate, but it does look as though we may be stuck for some time with a higher rate for electronic components.

To offset this increase, I can only urge you to look around for bargains. There are quite a number of good "buys" to be had, if you do a little diligent searching among the advertisements in the electronics magazines. I recently came across several adverts that demonstrate my theory. I will quote just two "100 $\frac{1}{4}$ - $\frac{1}{2}$ watt resistors, 100 Ceramic Capacitors, 100 Diodes". The whole bunch £1!! Oh! I agree that you might find all the resistors were the same value, but I do not think so. In any case a few cautious experiments, without laying out too much money, and you will soon sort out the genuine from the "catch penny".

In another advertisement I note "50 μ F 10V. 35p per dozen". You will probably tell me, "but I do not want a dozen", which conveniently brings me on to my next point. You may be a member of an electronics club, and perhaps the members may already make joint purchases to save money. If you are not, or if there is no local

club, why not start one?

What we all have to accept today, is that with high overheads, if we sell you a resistor at 4p we make a loss, whereas if we sell you five hundred for £6 we make a reasonable profit.

As a further economy measure, before you start on a project, why not analyse the parts list and try substitutions? The designer has not the time when specifying, perhaps a 100 kilohm resistor, to add the statement that any value could be used between 82 kilohm and 120 kilohm, and by making slight variations, you may be able to utilize parts you already have.

A little ingenuity can save the strain on your pocket. For example I noticed that the current price of a 310pF two-gang, variable capacitor made by a well-known manufacturer is £4.74p. There are a number of surplus 500pF two-gangs on the market, so why not use one of those and put a 1000pF silver mica in series with each section. If you work this out using the formula

$$C = \frac{1}{\frac{1}{C_1} + \frac{1}{C_2}}$$

where C equals the capacity in picofarads you will see that you finish up with about 330pF, which I would have thought near enough for all practical purposes.

I hope I have stimulated your interest in the various way of feating those twin bogeys "inflation" and V.A.T. Who knows, they may go away one day!

READERS' LETTERS

COLOUR CODE

Can you always remember the colour code? Although a necessity, the colour code follows no logic so many years ago I devised my own aide-memoir which may be of help to other readers. Either

plain language or the first letter of the word signifies the colour. Where more than one colour has the same first letter then sufficient are given in plain language to avoid ambiguity. From the second word of the following sentence start counting on the fingers.

"Bill Brown read Olaf Yellow's green book. Very good with gold and silver pages."

P. H. Alley,
Fleet, Hants.

Perhaps other readers would like to devise or suggest their own favourite mnemonic for the colour code.

The exercise will at any rate help impress the code firmly in the mind.

AIDE-MEMOIR

Word	Colour	Number	
Bill	Black	0	
Brown	Brown	1	
Read	Red	2	
Olaf	Orange	3	
Yellow's	Yellow	4	
Green	Green	5	
Book	Blue	6	
Very	Violet	7	
Good	Grey	8	
With	White	9	
Gold	Gold	± 5%	tolerance
and Silver	Silver	±10%	
Pages	Plain	±20%	

The Extraordinary Experiments of Professor Ernest Eversure

by Anthony John Bassett

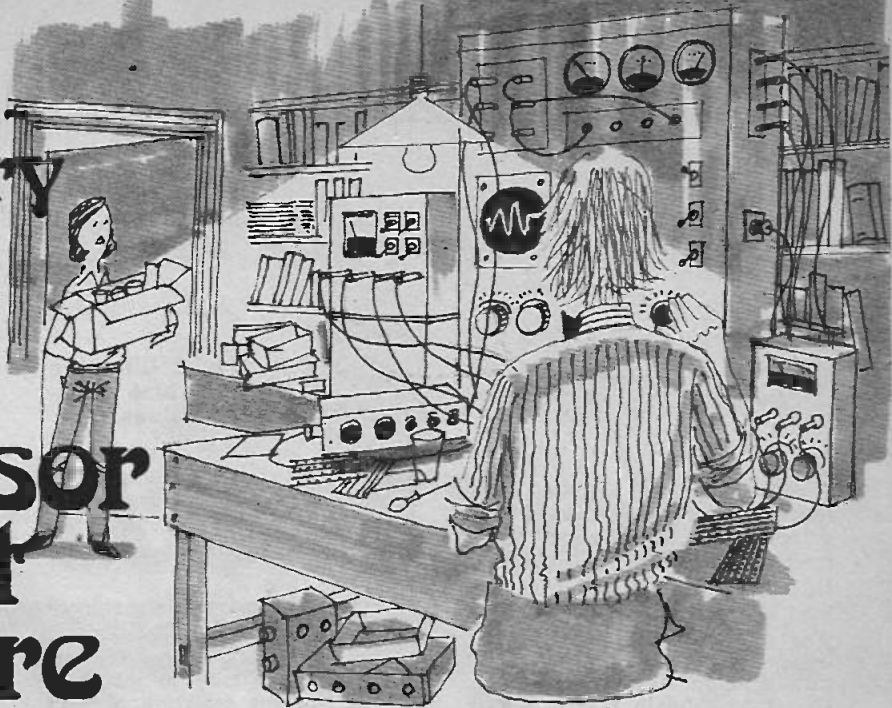

Professor Ernest Eversure, or the Prof. as his friends call him, has been experimenting in electronics for more years than anyone can remember and we thought that you might like to hear of, and perhaps repeat, some of his extraordinary experiments. Anthony J. Bassett recounts some of these experiments every month so why not follow the Prof's work and learn along with young Bob, his friend.

SELECTING COMPONENTS

"Whilst experimenting with the bias, it is better to disconnect the speaker and replace it with a fixed resistor 8 ohms 20 watts. A length of electric fire replacement element wire can be used if there is not a resistor of this rating available. This will carry a current of 15 amps quite safely if it is stretched slightly between two insulated terminals, and well ventilated to keep it cool. To check TR3 and find a bias resistor suitable for use with each individual transistor, you could use this circuit. The Prof. drew a diagram (Fig. 2).

"I CAN see that the selecting of components for particular circuits can be very interesting, Prof., and so far we have dealt mainly with selecting transistors. What about other components, say resistors. How can the selection of one resistor instead of another affect a circuit?"

"In many ways, Bob," the Prof. informed him; "I have a friend who is an audio enthusiast—and he has replaced most of the resistors in his stereo amplifier with preset potentiometers. Now whereas most hi fi enthusiasts are content to spend a considerable time and effort in comparing and adjusting the settings of balance and tone controls, he spends many a happy hour listening to his records and adjusting the value of almost every resistor in sight!

"However, we can approach the matter in a much more simple way by consideration of this circuit (Fig. 1) where there are only three bias resistors R1, R2, R3 to be taken into account.

Consider the bias requirements

of TR3. Let's assume that the maximum current which TR3 is required to pass is 1.5 amps. This is the maximum current through an 8 ohm load from a 12 volt supply. Then we can find out by trial the maximum value for R3 which will cause TR3 to pass this current."

Fig. 1. A three-stage class A amplifier (first described last month).

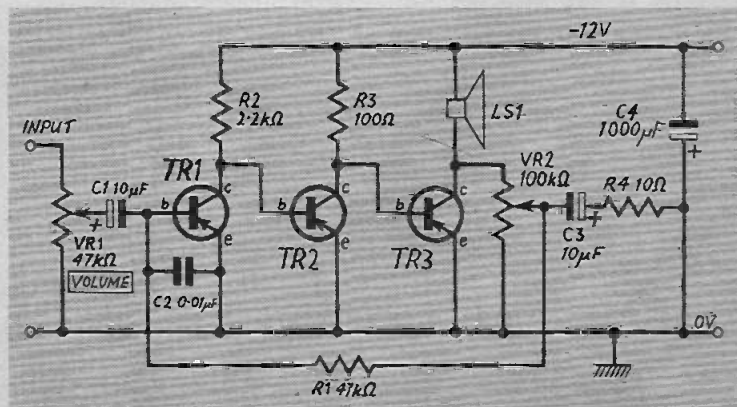

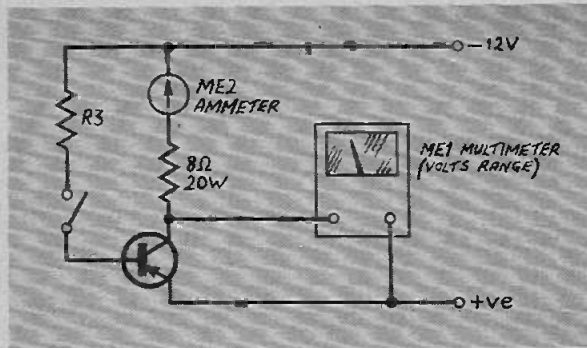

Fig. 2. Circuit to find bias resistor values.

Bob cut a length of coiled resistance wire to a length which gave a resistance of 8 ohms when stretched between two terminals. He made sure that the wire was well ventilated and could not come into contact with any inflammable materials, then built up the remainder of the circuit. He used a plug-in TO3 transistor socket mounted on a large heat sink.

One after another he plugged in the *pnp* power transistors from the bargain packs, and for each found the highest value of resistor R3 which could be used to bring the collector voltage down to its lowest value. For most of the transistors a value above 100 ohms could be used, and for some, 470 ohms or even more proved to be adequate. Bob found that it was necessary to use wire-wound resistors because, especially with their lower values, the resistors became quite hot.

There were one or two transistors where even a resistor of below 50 ohms in value gave insufficient bias to cause the transistor to pass a current of 1 amp. These transistors were obviously of low gain, and so unlikely to be of much value in the circuit. Bob put these to one side labelled

"low gain" and paired the remaining transistors off each with a suitable resistor.

The Prof. drew another set of diagrams (Fig. 3).

"Here, TR2 must be capable of absorbing all the current flowing in R3, so that TR3 becomes cut off. It is quite easy to set up a test circuit for selection of TR2 and R2.

If TR3 is a silicon transistor, the bias current flowing through the base of TR2 must be sufficient to bring the collector voltage of TR2 below about 0.5 volt. If TR3 is a germanium transistor, the collector voltage of TR2 must fall somewhat lower, preferably below 0.1 volt. Once you have selected TR3 and R3, R3 may be connected in the circuit in order that TR2 and R2 may be selected."

Bob built the circuit and tried one of the bargain pack *pnp* transistors in it. He found that the value of R2 could be raised to over 10 kilohms before the transistor failed to conduct enough to cause TR3 to become cut off. If TR2 was replaced with a BC478, the value of R2 could be raised even higher, and a resistor of value greater than 20 kilohms could be used!

Fig. 3. Test circuit for selection of TR2 and R2.

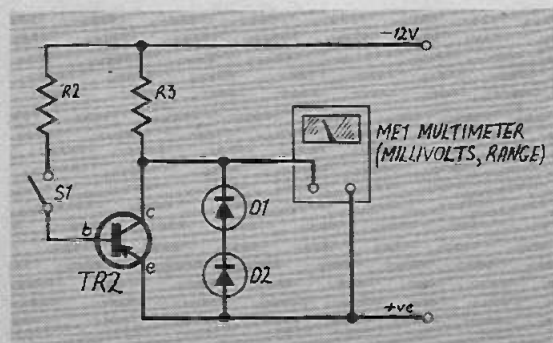

"It is better to use a resistor somewhat lower than the maximum, Bob, to allow for changes in the gain of the transistor due to temperature, and also to allow for changes in supply voltage. So it is a good idea to use a resistor of about half the maximum value which is indicated by this test.

To select R1, a similar circuit can be used, but, for test purposes we should connect one end of R1 to a source of supply at about half the battery voltage. This may be furnished by means of another battery, or by means of a potential divider consisting of two equal resistors."

Here the Prof. drew another circuit (Fig. 4; R5 and R6 form the potential divider).

"It is now possible to select a value for R1 which will enable TR1 to absorb all the current flowing in R2, thus cutting off the current flow in TR2. Because the value of R1 also determines the negative feedback over the entire amplifier circuit, and also has a great influence on the input impedance, the value selected will have a very large effect on the performance of the amplifier. The larger the value of the resistor which may be used, the greater the sensitivity of the amplifier. But if the resistor value you use for R1 is very high, you may find it necessary to decrease it in order to avoid distortion."

"Now I can see," said Bob, "how it is possible to select and test each of the components for a circuit individually by building test-circuits which imitate that part of the main circuit in which the component is to be used. If these test circuits were to be put

Fig. 4. Circuit to select resistor R1 and TR1.

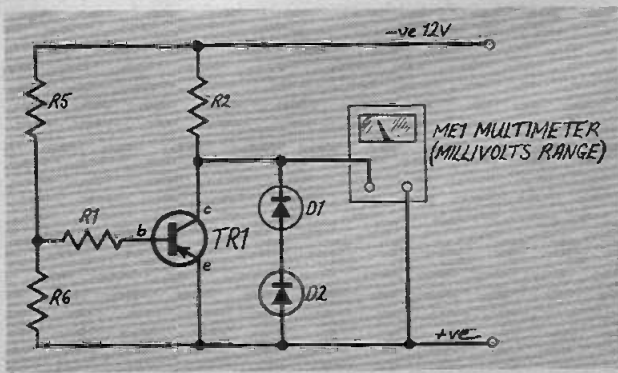

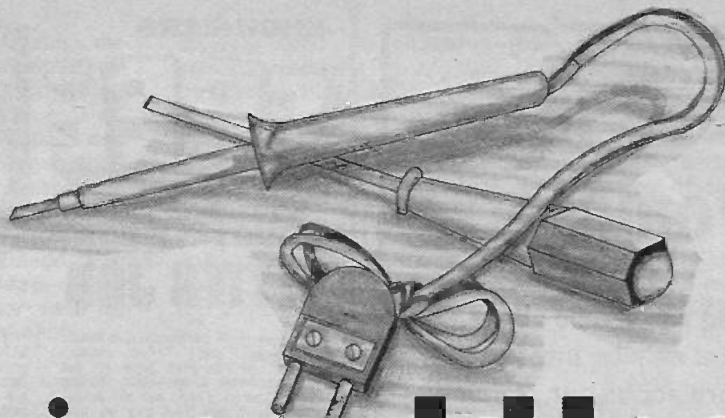

This could lead to something big.

A soldering iron and a screw driver. If you know how to use them, or at least know one end from the other, you know enough to enrol in our unique home electronics course.

This new style course will enable anyone to have a real understanding of electronics by a modern, practical and visual method. No previous knowledge is required, no maths, and an absolute minimum of theory.

You build, see and learn as, step by step, we take you through all the fundamentals of electronics and show you

how easily the subject can be mastered and add a new dimension not only to your hobby but also to your earning capacity.

This course is accepted by and used in a large number of schools and colleges and forms an invaluable grounding for professional training in the subject. All the training is planned to be carried out in the comfort of your own home and work in your own time. You send them in when you are ready and not before. These culminate in a final test and a certificate of success.

1

Build an oscilloscope.

As the first stage of your training, you actually build your own Cathode ray oscilloscope! This is no toy, but a professional test instrument that you will need not only for the course's practical experiments, but also later if you decide to develop your knowledge and enter the profession. It remains your property and represents a very large saving over buying a similar piece of essential equipment.

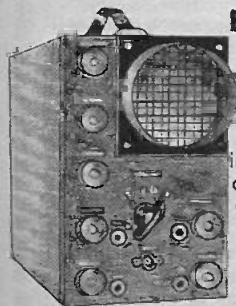

PLUS



FREE GIFT!

ALL STUDENTS ENROLLING IN OUR COURSES RECEIVE A FREE CIRCUIT BOARD ORIGINATING FROM A COMPUTER AND CONTAINING MANY DIFFERENT COMPONENTS THAT CAN BE USED IN EXPERIMENTS AND PROVIDE AN EXCELLENT EXAMPLE OF CURRENT ELECTRONIC PRACTICE

2

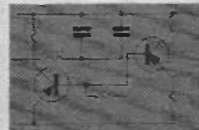

Read, draw and understand circuit diagrams.

In a short time you will be able to read and draw circuit diagrams, understand the very fundamentals of television, radio, computers and countless other electronic devices and their servicing procedures.

To find out more about how to learn electronics in a new, exciting and absorbing way, just clip the coupon for a free colour brochure and full details of enrolment.

WAA

Brochure without obligation to:
BRITISH NATIONAL RADIO & ELECTRONICS SCHOOL, Dept EEL95

P.O. Box 156, Jersey, Channel Islands.

NAME

ADDRESS

(Block caps please)

A career in Electronics

If you have read the article about us on page 486 you may be interested in learning more about our training schemes and about our company.

For further information write to:
The Senior Training Officer,
Marconi Communication Systems
Ltd., Marconi House, New Street,
Chelmsford, Essex.



IMPROVE PETROL CONSUMPTION

Fit the brilliant New Scorpio Mk II "Dual Polarity" Capacitive Discharge Electronic Ignition System. Suitable for all cars with coil/distributor ignition up to eight cylinders



- Genuine Improvement in overall petrol consumption (independent report claims at least 8 - 10%).
- Much easier cold weather starting, less strain on your battery.
- Less use of choke - increase engine life.
- Smoother running at lower revs. - makes your four cylinder car feel like a six cylinder.

TOGETHER WITH THE FOLLOWING "SCORPIO" MK II PLUS FEATURES NOT PREVIOUSLY AVAILABLE WITH OTHER MAKES:-

- * Only one model used for both positive (+) and negative (-) earth vehicles - If you change your car, you can certainly transfer your "Scorpio". No need to specify vehicle polarity when ordering.
- * There is a 6 volt model available.
- * Specially suppressed against radio interference (can be troublesome with electronic ignition systems).
- * Retains your original contact-breaker points, which last their mechanical life - no points burn.
- * Will drive electronic tachometers.

PRICE for complete "Scorpio" Mk. II unit, fully tested and ready for immediate installation, with easy to follow instructions - £17.50 (includes V.A.T., post and packing free - UK only) PLEASE STATE WHETHER 12 VOLT OR 6 VOLT REQUIRED.

For the D.I.Y. Man, there is a complete kit of parts available with easy to follow, comprehensive instructions, PRICE only £15.50 (includes V.A.T., post and packing free - UK only). THOUSANDS ALREADY IN USE, FULLY GUARANTEED.

Please forward stamped addressed envelope for our FREE interesting brochure - "Electronic Ignition - How it Works." containing circuit and itemised price list.

ELECTRO SPARES, Dept. E.E., 228 Eccleall Road, Sheffield S11 3PE.
Telephone: - Sheffield (0742) 66888.

ENGINEERS

FREE

YOURSELF FOR A BETTER JOB WITH MORE PAY!



Do you want promotion, a better job, higher pay? "New opportunities" shows you how to get them through a low-cost, Home Study Course. There are no books to buy and you can pay as you learn.

This easy to follow GUIDE TO SUCCESS should be read by every ambitious engineer. Send for this helpful 76-page free book NOW! No obligation, nobody will call on you. It could be the best thing you ever did.

CHOOSE A BRAND NEW FUTURE HERE

CUT OUT THIS COUPON
Tick or state subject of interest.
Post to address below.

- | | | |
|---|---|---|
| <input type="checkbox"/> ELECTRICAL ENGINEERING
City & Guilds Wiring and Installations
C. G. Electrical Tech-Primary
Gen. Electrical Eng. | <input type="checkbox"/> RADIO & TV Colour TV Servicing
C & G Radio, TV & Electronic Mechanics
Gen. Radio and TV Eng.
Radio Servicing, Maintenance and Repairs | <input type="checkbox"/> DRAUGHTSMANSHIP
Institute of Engineering
Draughtsmen & Designers
General Draughtsmanship
Architectural Draughtsmanship
Technical Drawing |
| <input type="checkbox"/> AERONAUTICAL ENGINEERING
Air Registration Board Certificates
Gen. Aero Engineering | <input type="checkbox"/> Practical Radio & Electronics (with self-build kit)
Radio Amateurs' Exam | <input type="checkbox"/> CONSTRUCTION & BUILDING
Institute of Building
Construction Surveyor's Inst.
Clerk of Works Diploma
C. & G. Building Quantities
General Building
General Civil Eng. |
| <input type="checkbox"/> AUTO ENGINEERING
City & Guilds Auto Engineering
Practice
Inst. Motor Industry
M.A.A./I.M.I. Management Diploma
Gen. Auto Engineering
Auto Diesel Maintenance
Motor Mechanics
Service Station and Garage Management | <input type="checkbox"/> ELECTRONIC ENGINEERING
Gen. Electronic Eng.
Practical Electronics (with kit) | <input type="checkbox"/> Heating, Ventilating & Air Conditioning
Carpentry & Joinery
Painting & Decorating
Plumbing
C.E.L. (Part 1)
Inst. Cost & Management
Accountants
Works Management etc. etc. |
| <input type="checkbox"/> TELECOMMUNICATIONS
City & Guilds Telecommunications | <input type="checkbox"/> REFRIGERATOR SERVICING
MECHANICAL ENGINEERING
Society of Engineers
Inst. Engineers and Technicians
General Mechanical Eng.
Welding
Maintenance Eng.
General Diesel Eng. | |



G.C.E.
—58 'O' & 'A' Level Subjects
—over 10,000 Group Passes!

Aldermaston College

Dept. TEE09 Reading RG7 4PF.
also at our London Advisory Office, 4 Fore Street Avenue, Moorgate, London EC2Y 5EJ. Tel. 01-628 2721.

NAME (Block Capitals)

ADDRESS

..... Postcode.....

Other subjects of interest..... Age.....

Accredited by C.A.C.C. Member of A.B.C.C.

HOME OF BRITISH INSTITUTE OF ENGINEERING TECHNOLOGY

together, it would become possible to match up individual sets of components for each of a number of amplifiers!"

"Yes", agreed the Prof. "and this would approach the method of 'in-circuit testing' where components are selected by testing them actually in the circuit in which they are to be used. I've got a really great idea—something that we can try next to show you just what I mean!"

SOUPING-UP A SUPERHET

"My idea," the Prof. told Bob, "is a simple low-cost method to boost the performance of almost any transistor radio. So that as well as giving a practical demonstration of in-circuit component testing, the result is that you end up with a better radio set! We will consider the circuit of an ordinary superhet radio. Did you know that the performance of most radios can be improved quite noticeably just by changing a few resistors?"

"The method is very easy, and it works with almost any superhet receiver. Let me explain this to you.

"When a radio receiver is designed for manufacture, it is designed to work with even the 'worst case' transistors which might come off the production line. This means that it is unlikely to give top-class performance from the transistors which are

actually used. By adjusting the bias on each of the r.f. and i.f. transistors individually, you'd be surprised how much improvement can be made in the performance."

Bob brought his radio and placed it on the workbench in front of the Prof. The Prof. carefully removed the back from Bob's radio. Inside was pasted a circuit diagram (Fig. 5) which the Prof. examined carefully for a few minutes.

"These are the resistors which we will alter Bob." The Prof. pointed out three resistors (which are marked "*" on the diagram).

"They are the 'bottom end' of the bias chain for each of the first three transistors in the set. Although there are quite a few other resistors in the set, alteration of these three is likely to have the required effect with the least risk of any side-effects on the performance of the set."

The Prof. tuned the set into a station which, though it did not provide a strong signal, was reasonably clear, steady and free from fading.

"I am deliberately not choosing a strong station, Bob, in order to avoid strong action from the automatic gain control circuit."

The Prof. switched the set off and replaced R3, which is the lower bias resistor for TR3, with a 10kΩ preset resistor (VR3) connected to the set by short lengths of wire.

"Try the effects of adjusting this potentiometer," he told Bob.

Bob switched on the radio, and began to carefully adjust the control. Soon he found that the performance of the radio seemed to be better than it had been previously, both in volume and in clarity of tone. At a certain setting, best performance was achieved.

"This is amazing, Prof.! Just by altering one resistor, the difference is already quite remarkable! I can hardly wait to hear the set after we've done the other two. Is each resistor likely to give a similar amount of improvement?"

"It is very difficult to predict, Bob" the Prof. told him, "because of the element of chance involved when the manufacturer assembles the set, some of the components will be better matched than the others. But there is usually a degree of mismatch present which is sufficient to give a perceptible improvement with each component we adjust. In some cases the improvement is more noticeable than with others. For each successive resistor you replace the effects are cumulative, and can add up to a considerable improvement overall."

Bob switched off the set again, and replaced R2, which is the lower bias resistor for TR2, using another 10kΩ preset resistor (VR2).

As he adjusted VR2, Bob noticed once again an improvement in the set's performance. But he also noticed some thing else. Continued next month

Fig. 5. The circuit diagram of the superhet receiver.

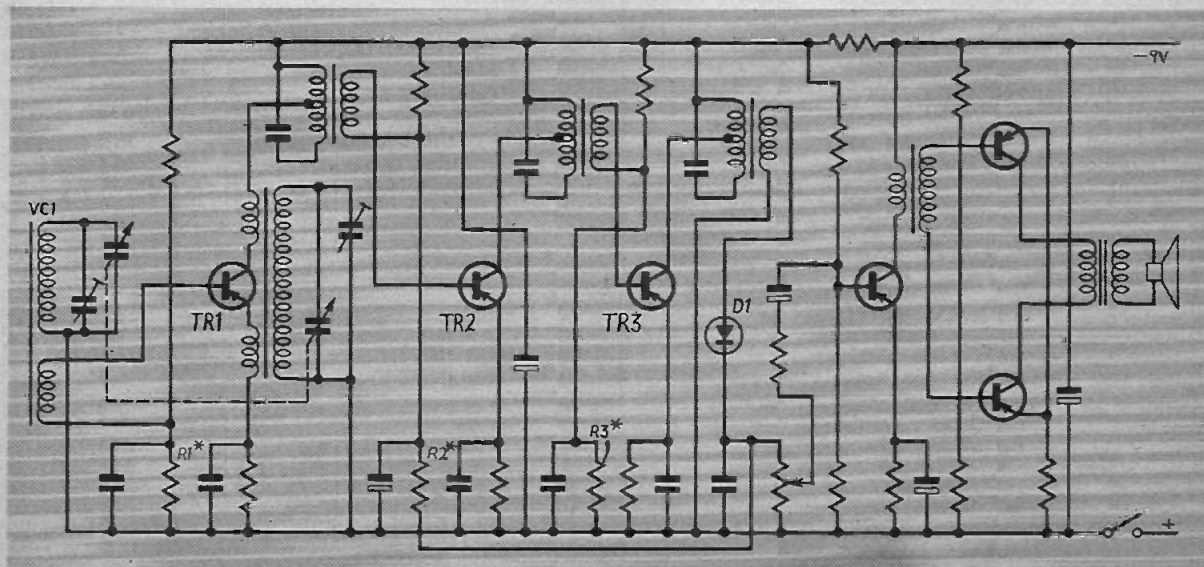

DOWN TO EARTH

By GEORGE HYLTON

READERS are often puzzled by the great variety of different transistor types specified in articles in this magazine. Often, it seems, two circuits which have the same function specify different transistors.

Reader D. A. Blakeman of Chichester suggests that contributors should be asked to explain *why* they choose particular kinds of semiconductor. Not a bad idea, though I fancy that in quite a few cases the answer would be: Because I tried this kind and the circuit worked!

TRANSISTOR ALTERNATIVES

Let's put the question another way: Is it possible to use one standard type of transistor in all circuits?

Looking through the circuits in a few numbers of *E.E.* will show that the answer is no. Some commonly-used circuits, such as complementary push-pull amplifier circuits (Fig. 1) exploit the fact that transistors can be made in two polarities, *pnp* and *npn*, and when both types are used together, as with TR2 and TR3 here, you must have at least *two* kinds of transistor.

But what about the many and varied circuits where only one polarity is required? Wouldn't it be possible to standardize on one type in all these? Or maybe use *two* standard types, one *pnp* and one *nnp*?

Here we are getting into the realm of the feasible. I think that it would be possible to use a standard *pnp* and a standard *nnp* for a very wide variety of circuits. What is more, if I had to choose I'd certainly pick something like BC107 for the *nnp*. Along with a roughly equivalent *pnp* type it could be used to build almost any type of circuit, within certain limits.

The limits, however, are important. They are imposed by the nature of the transistor itself. A BC107, for example, cannot safely

pass a collector current of more than about 100mA. If you need 500mA, you must use five transistors in parallel, and some means of ensuring that the current is shared equally by them.

There's also a collector voltage limit, and a high-frequency limit, and a power limit, and so on.

The upshot of it all is that while standard transistors could be made to operate, after a fashion, in most types of circuit (amplifiers, oscillators, switching circuits etc.) they certainly wouldn't work in *every* particular circuit. That is, you couldn't just take a circuit and substitute a BC107 for all the *nnp* transistors in it.

SWITCHING CIRCUITS

One limitation suffered by most silicon transistors is that the emitter-base junction, which should act as a high resistance when reverse-biased, breaks down when the reverse bias is more than a few volts, and conducts current freely.

This is usually of no importance in ordinary amplifier circuits where the base-emitter junction is always forward-biased, but it becomes important in some switching-type circuits such as the multivibrator.

Here, as a consequence of the way in which the transistors switch on and off alternately, the base-emitter junctions are subject to voltage impulses roughly equal to the supply voltage V_{cc} . If this is more than 6V, there is a serious risk that base-emitter junction breakdown will occur with silicon transistors.

This doesn't necessarily mean that the transistors will be damaged. (There is usually enough circuit resistance in series with the base-emitter junction to limit the current to a safe amount.) But it does mean that the circuit won't operate as simple theory predicts: in a multivibrator the waveform and frequency are affected.

This is why, in some circuits where there is likely to be a high reverse base-emitter voltage, designers specify germanium alloy transistors.

AMPLIFICATION FACTOR

It must also have a current amplification factor (h_{ie} or h_{FE}) which is compatible with the circuit. This is where a lot of substitutions come unstuck.

There are *some* circuits which will work with transistors of widely differing h_{ie} . In others, the value of h_{ie} is more critical.

Some transistor types have a very wide variation of h_{ie} . Take, for example the two much-used silicon planar *nnp* types, 2N2926 and BC108. These are rather similar in their voltage and current ratings and circuit applications, but 2N2926 has h_{ie} of 20-470 while BC108 has 125-900. (The values of h_{ie} given on some data sheets may differ from these because h_{ie} depends on makers' tolerances and on measuring conditions.)

A circuit which requires a transistor with $h_{ie}=100$ minimum will work with *any* BC108, but only with *some* 2N2926. On the other hand, a circuit which will work with any BC108 should also work with any BC107, since the only significant difference between these types is that the BC107 has a higher collector voltage rating.

With experience, the circuit builder gets to know what substitutions are possible. But the contributor to *E.E.* who wants to be helpful should always specify alternative types when these exist.

Fig. 1. Output stage of push-pull amplifier.

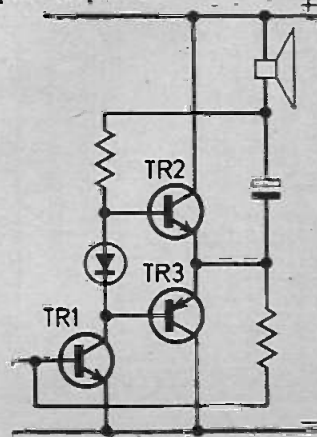

NEW ITEMS THIS MONTH

The bargains in this column are just some of the items which appeared in the April supplement to our catalogue. You can receive this catalogue and the next 12 supplements by sending £1.

Telephone cords, 4 core, curly cords as fitted to telephone handsets, made for the GPO so obviously very good quality. Standard length, 25p each. VAT & Post 15p each.

Fire alarm switches. In red cast iron case with break glass panel. These are engraved "In case of fire break glass" and have a hinged lid and second safety switch for testing purposes. £1.75 each. VAT & Post 45p each.

Tacho-motors. A precision motor made by Muirhead, when driven at 1000 rpm it generates 2V so it is the basis of a tacho-meter. It is a battery operated motor which can be used for precision work and within limits its speed can be brought to that desired by choosing the right voltage. Ex-equipment but fully guaranteed by us. 50p. VAT & Post 15p each.

Mains motor. Heavy duty made by Smiths with special long bearings for extra quiet running. This is a powerful (1/2") stack motor; good quality of these available at the price of £1.25 each. VAT & Post 30p each.

Crosscut motor. With gear box, mains input, final speed 12 revs per hour, fitted on mounting plate with on-off switch. £1.50 each. VAT & Post 30p.

3 1/2 r.p.m. mains motor. With gear box, ideal for driving clock wheels, etc. 95p each. VAT & Post 20p.

Battery motor. With gear box. Extremely well-made motor and gear box which with a 4 volt battery will rotate at 1 r.p.m. Speed can be adjustable up and down (within limits) by changing the battery volts. Price £3 each. VAT & Post 60p.

Multi-purpose relay. Work with coil volts from 6v to 24v or from the mains through diode and 150 lamp or relay in resistor. It has two sets of normal change-over contacts and a further two sets of change-overs which make before break. Supplied complete with mounting bracket. Price 50p. VAT & Post

5A power pack. Normal mains input, with a thermal safety device in primary of mains transformer and 4000 mfd of smoothing with full wave rectifier; completely enclosed in plastic box and with flex for mains, and terminal block for output. Price £1.75 + VAT & Post 55p. Pointer knob. With brushed aluminium embellishments, for 3/16 spindle. 10 for £1 + 40p VAT & Post.

500K Edgewise control. 1 1/2" diameter made by Morganite s/loc, ideal for light dimmer control or similar. 10 for £1 + 40p VAT & Post.

Battery charger. For nickel cadmium cells intended for small 1/2" diameter cells but suitable for other sizes using 400mA or external leads. This pushes straight into a 2-pin razor socket and is completely enclosed. 35p each + 20p VAT & Post. Permeability testers. Two stage ideal for use with ZN414 or similar circuit. Price 15p each + 15p VAT & Post.

47 nf 400v condensers by Eric. 10 for 50p + 20p VAT & Post.

8 switch disco lamp controller. This is a mains motor driving a rotating drum on which are 8 adjustable segments. These segments operate individual changeover 10 amp switches, so a total of 8 x 20 amps of lighting can be controlled enabling an unlimited variety of lighting effects to be achieved and changed with the minimum of effort. This is a real snip at £6.50 + 95p VAT & Post.

Wire ended neons. For incorporating in random lighting effects or simply as main indicators with long leads and resistors for working directly off mains. 10 for £1 + 20p VAT & Post.

Oven thermostat. Made by the famous Diamond H Company, this has a sensor joined by a capillary to a variable control and when fitted with a knob is ideal for controlling ovens or processes. 80p each + 25p VAT & Post.

150w auto transformer. 230-240v in, 115-150v out, very well made and dip sealed for quiet running, upright mounting with fixing legs. £2 each + 75p VAT & Post.

Immersion heaters. Standard screw-in fitting for normal tanks 23" KW - £2.50; 31" KW - £2.95; 10" KW - £2. Rod thermostats to suit. £1 each. Postage 40p per heater. VAT 8%. Mains transformer. 25v-0-25v 2 amps and 110v 100mA secondaries, normal tapped primary. Price £2.50 + 45p VAT & Post.

Instrument mains transformer. With 140v secondary tapped at 130, 120, 80 and 5v at 1 amp rating. Price £2 + 50p VAT & Post.

3 pole 3 way rotary change switch. Standard length 3" spindle. 20p + 15p VAT & Post. Panel meter. 24" 0-500mA, flush mounting. Price £1.50 + 25p VAT & Post.

Mercury batteries. Tube of 7 batteries connected together to give 10.7 volts offered some time ago at 5p per tube or 11 per carton of 20 tubes. A further large quantity of these enables us to offer at an even better price - 10 cartons making a total of 250 x 10.7 volt batteries for only £7.50 + £1.85 VAT & Postage per 10 cartons.

EHT transformer. American made, scaled in a steel case measuring 6 1/2" x 6" x 5 1/2" high with large porcelain stand-off insulators; it is extremely well-made, looks good enough to give 10 kv at 1 amp intended for American use, its primary would have to be fed through a variac or similar. With 90v input EHT output is 5.5v. Price £15 each + carriage and VAT £3.

MULLARD UNILEX STEREO SYSTEM

There is no doubt that it is a good system, we believe that for the money it is without comparison. We demonstrate gladly at our Tamworth Road depot. Prices of the individual items for this:

- 1 Unilex Amplifier Ref. EP.9000 £1.60
- 1 Unilex Amplifier Ref. EP.9004 £1.60
- 1 Unilex Pre-Amp Ref. EP.9001 £1.95
- 1 Unilex Power Unit Ref. EP.9002 £2.58
- 1 Control panel kit with spun aluminium faced knobs £3.80

Pair of 15 ohm speakers made by Goodmans are also available if required, price £3.30 the pair. No extra postage if ordered with the above, otherwise add 25p.

ALL SUBJECT TO 25% VAT

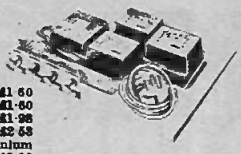

SMITHS CENTRAL HEATING CONTROLLER

Push button gives 10 variations as follows—(1) continuous hot water and continuous central heating (2) continuous hot water but central heating off at night (3) continuous hot water but central heating on only for 2 periods during the day (4) hot water and central heating both hot day time only (5) hot water all day but central heating only for 2 periods during the day (6) hot water and central heating on twice daily (7) hot water continuous (8) hot water day time only (9) hot water twice daily (10) everything off. A handsome looking unit with 24 hour movement and the switches and other parts necessary to select the desired programme of heating. Supplied complete with wiring diagram. Originally sold, we believe, at over £15—we offer these, while stocks last, at £5.95 each. VAT & Postage 85p each.

For 2 periods during the day time only—then for summer time use with central heating off (7) hot water continuous (8) hot water day time only (9) hot water twice daily (10) everything off. A handsome looking unit with 24 hour movement and the switches and other parts necessary to select the desired programme of heating. Supplied complete with wiring diagram. Originally sold, we believe, at over £15—we offer these, while stocks last, at £5.95 each. VAT & Postage 85p each.

WALL THERMOSTATS
Wall mounting and in a handsome plastic case. (Cream and beige). Adjustable by slider (lockable) and may be set to control temperatures from around freezing through to 50°C. The slide panel is engraved and indicates (frost), (warm), (very warm), etc. The thermostat will control heaters, etc., up to 15 amp at normal mains voltage and is ideal for living room, bedroom and greenhouse, etc. Price £1.95. VAT & Postage 20p. Don't miss this.

THIS MONTH'S SNIP
High power battery motor, 13v operated, strong enough to power a motor mower, go-cart or similar. Speed easily variable. These motors can also be used as a brake for any rotating machine, simply by coupling the spindle to the machine and short-circuiting the windings by a variable resistance, price £2.50. VAT & Postage 64p.
Even more powerful 4 1/2 volt model £3.50, VAT & Postage 92p.

BREAK-DOWN UNIT
Contains a whole range of most useful parts some of which are as follows—66 silicon diodes equivalent OA91, 68 resistors, mostly 1/4 watt 5% covering a wide range of values. 4 x .1 mfd 400v condensers. 5 x .01 mfd 100v condensers. 2 RF chokes. 8 x B9 valve holders. 1 x 4H choke. 1 x 115v transformer. 1 boxed unit containing 4 delay lines. Tag panels, trimmer condensers, suppressors, all mounted up on a useful chassis sized approx. 9" x 5" x 7". Offered at only 75p—the 66 diodes would cost at least 10 times this amount, so this is obviously a snip not to be missed. VAT & Postage 70p.

RADIO STETHOSCOPE
Easiest way to fault find, trace-signal from aerial to speaker, when signal stops you've found the fault. Use it on Radio, TV, amplifier, anything. Complete kit comprises two special transducers, a pair of ear pieces and all parts including probe tube and crystal earpiece, £2.80 twin stetho-set instead of carpiece 88p, VAT & Postage 45p.

DISTRIBUTION PANELS
Just what you need for work bench or lab. 4 x 13 amp sockets in metal box to take standard 13 amp fused plugs and on/off switch with neon warning light. Supplied complete with 6 feet of flex cable. Wired ready to work. £2.75, VAT & Postage 65p.

15A ELECTRICAL PROGRAMMER
Learn by your sleep! Have radio playing and Kettle boiling as you awake—switch on lights to ward off intruders—have a warm house to come home to. All these and many other things you can do if you invest in an electrical programmer. Clock by famous maker with 15 amp on/off switch. Switch-on time can be set anywhere to stay on up to 6 hours. Incredible 90 minute memory jogger. A beautiful unit. Price £2.90. VAT & Postage 60p, or with glass front, chrome bezel, £1.00 extra.

SHORTWAVE CRYSTAL SET
Although this uses no battery it gives really amazing results. You will receive an amazing assortment of stations over the 19, 25, 31, 39 metre bands! Kit contains chassis, front panel and all the parts, £1.50—crystal earphone 55p, VAT & Postage 75p.

INSTANT START FLUORESCENT LIGHTING BARGAINS
Startersless control gear, complete with tube ends and tube clips for window lighting, signs, fascias, etc. 4 ft. 40 w. £1.50; 5 ft. 65w. £1.60; 5 ft. 80w. £1.75; 6 ft. 80w. £1.95; and for pairs as follows:—twin 2 ft. 20w. £2.55; twin 3 ft. 30w. £2.75; twin 4 ft. 40w. £2.95; twin 5 ft. 65w. £3.25; twin 5 ft. 80w. £3.45; twin 8 ft. 125w. £4.50. These are about one half of maker's current prices and can't be repeated once stocks are cleared. Please add 30p per piece to cover postage or carriage and 8% VAT.

J. BULL (ELECTRICAL) LTD.
(Dept. E.E.), 103 TAMWORTH ROAD, CROYDON CRO IX

MAINS TRANSFORMERS

All standard 230-250 volt primaries	£	p
1v	1	amp (special) 1.75
2.4v	5	amp .85
6.3v	2	amp 1.00
6.3v	3	amp 1.50
9v	1	amp .85
9v	3.5	amp 1.35
12v	11	amp 1.50
12v	1	amp 1.00
6.5v-0.6v	1	amp 1.35
18v	1	amp 1.25
20v	1	amp 1.00
24v	1	amp 1.50
24v	3	amp 8.50
12-0-12v	50mA	1.20
6-0-6v	50mA	1.20
8-0-8v	1/2 amp	1.25
18-0-18v	2 amps	3.50
25v	11	amp 1.95
25v 2 amp & 6.3v	1	amp 4.50
60v 5 amp & 5v	1	amp 7.50
27v	8	amp 4.50
30v	37	amp 22.00
80v tapped 75v & 70v	4	amp 5.50
220v-60mA & 6.3v	1	amp 1.75
275-0-275v at 90mA & 6.4v	3	amp 2.85
EHT transformer 6000v 23mA	(intermittent)	6.50
Charger Transformers		
6v and 12v	2	amps 1.25
6v and 12v	3	amps 2.25
6v and 12v	5	amps 3.50
Add 30p per piece to cover postage and VAT 25%.		

ONLY £1 FOR SEVEN ELECTRIC MOTORS

7 powerful batt. motors as used in racing cars & power models. Output & types vary for use in hundreds of different projects—Tools, toys, models, etc. All brand new reversible & for 1 1/2-12v basic. Wiring diag. inc. VAT & Post 40p. FREE plan for min. power station.

RELAY BARGAIN
Type 600 relay, 2 changeover one open and one closed contact. Twin 500 ohm coils make this suitable or closing off DC 6v, DC 12v, DC 24v or AC mains using resistor and rectifier. 33p each. Resistor and rectifier 20p extra.

BLACK LIGHT
As used in discotheques and for stage effects, etc. Virtually no white light appears until the rays impinge on luminous paint or white shirts, etc. We offer 9" 6w tubes complete with starter, chokes, lamp-holders and start-holder. Price 22.75 + 30p post. Tubes only £2. Post & VAT 50p.

TAPE DECK
In metal case with carrying handle, heavy fly wheel and capstan drive. Tape speed 3 1/2. Mains operated on metal platform with tape head and guide. Not new but guaranteed good working order. Price £1.60 plus VAT and Postage 85p.

LIGHT SWITCH
Automatically switches onlights at dusk and off at dawn. Can also be used where light and dark is a convenient way to stop and start an operation. Requires only a pair of wires to the normal switch. In bakelite box, normal switch-plate etc. 1 amp model £2.95. VAT and Postage 60p.

MAINS TRANSISTOR PACK
Designed to operate transistor sets and amplifiers. Adjustable output 6v, 9v, 12v volts for up to 500mA (class B working). Takes the place of any of the following batteries: PP3, PP3, PP4, PP5, PP7, PP9 and others. Kit comprises: main transformer rectifier, smoothing and load resistor, condensers and instructions. Real snip at only £1.50. VAT & Postage 60p.

SOUND TO LIGHT UNIT
Add colour or white light to your amplifier. Will operate 1, 2 or 3 lamps (maximum 450w). Unit in Box all ready to work. £7.95 plus 90p VAT and postage.

MAINS MOTOR
Precision made—as used in record decks and tape recorders—ideal also for extractor fans, blower heaters, etc. New and perfect. Snip at 75p. Postage 20p for first one then 10p for each one ordered. 1 1/2" stackmotor £1.04. 1 1/2" stackmotor £1.20. VAT 8%.

EXTRACTOR FAN
Cleans the air at the rate of 10,000 cubic ft. per hour. Suitable for kitchens, bathrooms, factories, changing rooms, etc. It's so quiet it can hardly be heard. Compact, 5 1/2" casing with 5 1/2" fan blades. Kit comprises motor, fan blades sheet steel casing, pull switch, mains connector and fixing brackets. £3.75 VAT & Postage £1.25.

ELECTRONI-KIT

"EDUCATIONAL KITS of
EXCEPTIONAL QUALITY"
(Audio mag.)

"VALUE FOR MONEY"
(Ev. Elec. mag.)

Build, dismantle and rebuild projects any number of times and design new circuits too.

16 PROJECT KIT
£8.80 (1A) radios, amplifiers, mlkes, alarms, morse code, etc.

30 PROJECT KIT
£10.45 (2A) as 1A plus similar more progressive experiments.

100 PROJECT KIT
£20.45 (3A) as 2A plus electronic birds, cats, sirens, guns, organs, metronomes, light and sound, burglar alarms.

105 PROJECT KIT
£25.25 (3ADX) as 3A plus solar cell experiments and complete sophisticated controls.

150 PROJECT KIT
£33.95 (4ADX) as 3ADX plus Relay and Meter experiments: Ion concentration - , volume - , output - , field intensity - , volt - , resistance - , ammeter, Illuminometer, etc. and many, many more.

ADD-ON SETS & MANUALS build from one kit to another in easy stages.

VALUABLE MANUALS included with every kit.

Prices include Battery, VAT, p & d. Cheque/P.O. (or 7p for literature) to: E.E.

Satisfaction guaranteed
**ELECTRONI-KIT LTD, 408 St. John's Street,
London, EC1. (01-278 4579)**

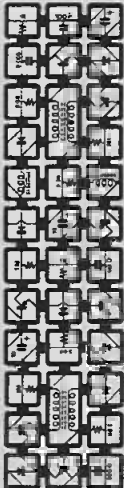

**HAVE YOU
GOT YOURS**

CATALOGUE No. 4
NEW CONVENIENT
SIZE AND FULLY
ILLUSTRATED

CONTAINS MANY
HARD TO GET
ITEMS

20p

PAYS FOR ITSELF
WITH DISCOUNT
VOUCHERS
WORTH
20p

*DISCOUNTS

*ALL NEW STOCK

*SATISFACTION
GUARANTEE

*DEPENDABLE
SERVICE

**B. H. COMPONENT
FACTORS LTD.**

(E.E.), LEIGHTON ELECTRONICS
CENTRE, 59 NORTH STREET,
LEIGHTON BUZZARD, LU7 7EG.
Tel.: Leighton Buzzard 2316 (Std. Code
05253).



Please
mention

*Everyday
Electronics*

when
replying
to

advertisements.

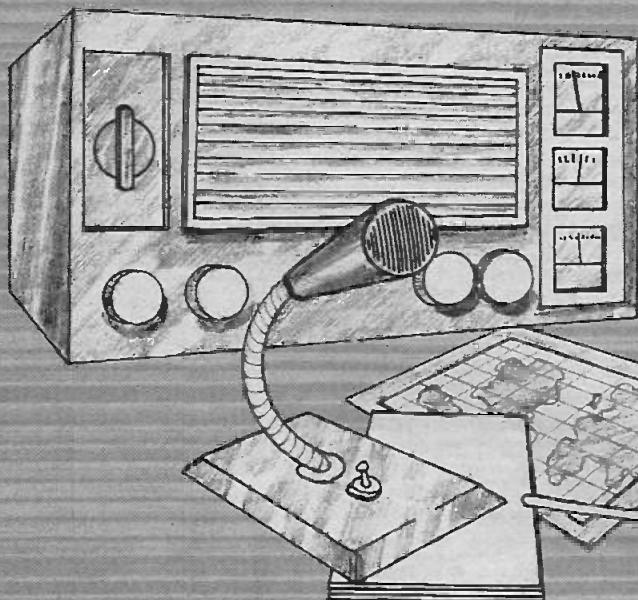

**Become a
radio amateur.**

Learn how to become a radio-amateur in contact with the whole world. We give skilled preparation for the G.P.O. licence.

Free!

Brochure, without obligation to:

To: **BRITISH NATIONAL RADIO & ELECTRONICS SCHOOL, Dept. EEB95,**
P.O. Box 156, Jersey, Channel Islands.

NAME _____

ADDRESS _____

Block caps please

Sinclair hi-fi

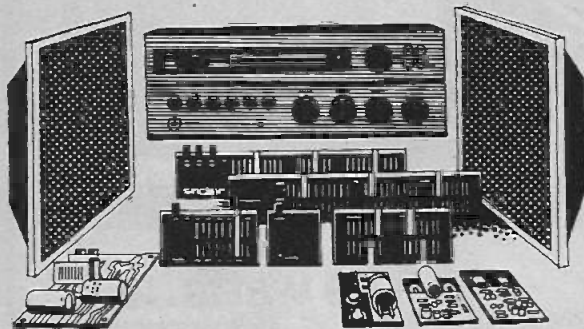

The watts...

The Sinclair range of hi-fi products. Three different ways of achieving hi-fi excellence - whatever area of hi-fi you're interested in.

And the Sinclair range fact-file gives you the full run-down on all of them.

On Project 80 - the build-as-you-please hi-fi module system.

On IC20 - the revolutionary integrated circuit amplifier kit.

And System 4000 - the luxury hi-fi amplifier and matching tuner.

and the wherefores.

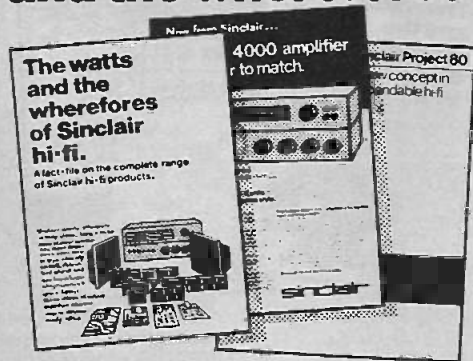

The Sinclair range fact-file shows you the whole story. Technical specifications... complete descriptions... big, clear pictures... and test reports by impartial hi-fi journals.

A real bundle of goodies.

Send for Sinclair's range fact-file - now!

See if the answer's here - the information on the component you've been looking for.

Simply cut the coupon and send it to the no-stamp-needed FREEPOST address below.

We'll send you the Sinclair fact-file - giving you all you need to know about Sinclair hi-fi. And information about a few extras you're sure to find rather interesting.

Sinclair Radionics Ltd,
London Road, St Ives,
Huntingdon, Cambs., PE17 4HJ
St Ives (0480) 64646

Please send me the Sinclair range fact-file immediately

Name

Address

EE/9/HF

To: Sinclair Radionics Ltd,
FREEPOST, St Ives,
Huntingdon, Cambs., PE17 4BR

Please print

sinclair

Join the Digital Revolution

Understand the latest developments in calculators, computers, watches, telephones, television, automotive instrumentation . . .

Each of the 6 volumes of this self-instruction course measures 11½" x 8½" and contains 60 pages packed with information, diagrams and questions designed to lead you step-by-step through number systems and Boolean algebra, to memories, counters and simple arithmetic circuits, and on to a complete understanding of the design and operation of calculators and computers.



£5.95

plus 50p packing and surface post anywhere in the world.

Payments may be made in foreign currencies.

Quality discounts available on request.

VAT zero rated.

Also available—a more elementary course assuming no prior knowledge except simple arithmetic.

in 4 volumes:

1. Basic Computer Logic
2. Logical Circuit Elements
3. Designing Circuits to Carry Out Logical Functions
4. Flipflops and Registers

£3.95

plus 50p P. & P.

Offer Order both courses for the bargain price £9.25, plus 50p P. & P.

**Designer
Manager
Enthusiast
Scientist
Engineer
Student**

These courses were written so that you could teach yourself the theory and application of digital logic. Learning by self instruction has the advantages of being quicker and more thorough than classroom learning. You work at your own speed and must respond by answering questions on each new piece of information before proceeding to the next.

Guarantee—no risk to you

If you are not entirely satisfied with Design of Digital Systems or Digital Computer Logic and Electronics, you may return them to us and your money will be refunded in full, no questions asked.

To: Cambridge Learning Enterprises
FREEPOST, St. Ives, Huntingdon, Cambs. PE17 4BR

*Please send me....set(s) of Design of Digital Systems at £6.45 each, p & p included

*or....set(s) of Digital Computer Logic and Electronics at £4.45 each, p & p included

*or....combined set(s) at £9.75 each, p & p included

Name

Address

*delete as applicable
No need to use a stamp—just print FREEPOST on the envelope.

EE9

Marshall's

A. Marshall (London) Ltd Dept: PW
 42 Cricklewood Broadway London NW2 3ET Tel: 01-452 0161/2
 Telex: 21452
 & 85 West Regent St Glasgow G2 2QD Tel: 041-332 4133
 & 1 Straits Parade Fishponds Bristol BS16 2LX
 Tel: 0272 554201/2
 & 27 Rue Danton Issy Les Moulineaux Paris 92 Tel: 642 2985
 Catalogue price 25p Trade and export enquiries welcome

Our range covers over 7,000 items. The largest selection in Britain
Top 200 IC's TTL, CMOS & Linear

CA3018A 85p	CD4043 £1-80	NE565 £4-48	SN7448 90p	SN74157 95p
CA3020 £1-80	CD4044 £1-80	SL414 £1-80	SN7450 16p	SN74160 £1-10
CA3028A 79p	CD4045 £2-65	SL610C £1-70	SN7451 16p	SN74161 £1-10
CA3035 £1-37	DC4046 £2-84	SL611C £1-70	SN7453 16p	SN74162 £1-10
CA3046 70p	CD4047 £1-65	SL612C £1-70	SN7454 16p	SN74163 £1-10
CA3048 £2-11	CD4049 81p	SK620C £2-60	SN7460 16p	SN74164 £2-01
CA3052 £1-62	CD4050 66p	SL621C £2-60	SN7470 33p	SN74165 £2-01
CA3089E £1-96	LM301A 46p	SL623 £4-59	SN7472 26p	SN74167 £4-10
CA3090Q £4-23	LM308 £2-50	SL640C £3-10	SN7473 36p	SN74174 £1-25
CD4000 36p	LM05TL £1-50	SN7400 16p	SN7474 36p	SN74175 90p
CD4001 36p	LM380 £1-10	SN7401 16p	SN7475 30p	SN74176 £1-44
CD4002 36p	LM381 £2-20	SN7401AN 38p	SN7476 35p	SN74180 £1-40
CD4006 £1-38	LM702C 75p	SN7402 16p	SN7480 30p	SN74181 £1-95
CD4007 £1-63	LM709 38p	SN7403 16p	SN7481 £1-25	SN74190 £2-30
CD4008 £1-63	BD1L 45p	SN7404 19p	SN7482 75p	SN74191 £2-30
CD4009 £1-18	14DIL 40p	SN7405 19p	SN7483 95p	SN74192 £1-15
CD4010 £1-18	LM710 47p	SN7406 45p	SN7484 95p	SN74193 £1-15
CD4011 36p	LM723C 90p	SN7407 45p	SN7485 £1-25	SN74196 £1-60
CD4012 36p	LM741C 40p	SN7408 19p	SN7486 31p	SN74197 £1-58
CD4013 66p	BD1L 40p	SN7409 22p	SN7490 45p	SN74198 £2-25
CD4014 £1-72	14DIL 38p	SN7410 16p	SN7491 85p	SN74199 £2-25
CD4015 £1-72	LM747 £1-05	SN7411 25p	SN7492 45p	SN76003N £2-92
CD4016 66p	LM748 60p	SN7412 28p	SN7493 45p	SN76013N £1-95
CD4017 £1-72	14DIL 73p	SN7413 35p	SN7494 82p	SN76023N £1-60
CD4018 £2-55	LM3900 70p	SN7416 35p	SN7495 72p	SN76033N £2-92
CD4019 86p	NE565 £2-00	SN7417 28p	SN7496 75p	TAA263 £1-10
CD4020 £1-91	LM7812 £2-50	SN7420 16p	SN74100 £1-25	TAA300 £1-80
CD4021 £1-72	LM7815 £2-50	SN7423 29p	SN74107 36p	TAA350A £2-10
CD4022 £1-66	LM7824 £2-50	SN7425 29p	SN74118 £1-00	TAA550 60p
CD4023 36p	MCI303L £1-50	SN7427 29p	SN74119 £1-92	TAA611C £2-18
CD4024 £1-24	MCI318P £2-59	SN7430 16p	SN74121 31p	TAA621 £2-03
CD4025 32p	MC6330P 90p	SN7432 28p	SN74122 50p	OC45 £2-20
CD4027 43p	MCI351P 80p	SN7437 35p	SN74123 60p	TAA651B £1-32
CD4028 £1-50	MCI352P 80p	SN7438 35p	SN74141 85p	TBA641B £2-25
CD4029 £3-50	MCI466L £3-50	SN7440 16p	SN74145 90p	TBA651 £1-69
CD4030 87p	MCI469R £2-75	SN7441AN 85p	SN74150 £1-50	TBA800 £1-40
CD4031 £5-19	NE555V 70p	SN7442 65p	SN74151 85p	TBA810 £1-40
CD4037 £1-91	NE556 £1-80	SN7443 95p	SN74173 85p	TBA820 £1-40
CD4041 £1-86	NE560 £4-48	SN7447 95p	SN84154 £1-50	TBA820 £1-15

BRISTOL

10% discount for callers at our new shop at 1 Straits Parade, Fishponds Bristol BS16 2LX, during August
 Tel: Bristol 654201/2.

POPULAR SEMICONDUCTORS

2N696 22p	2N3906 27p	AF139 65p	BD139 71p	MPSA56 31p
2N697 16p	2N4037 42p	AF239 65p	BD140 87p	OC28 76p
2N698 82p	2N4036 67p	AF240 90p	BF115 36p	OC35 60p
2N699 59p	2N4058 18p	AF279 70p	BF117 35p	OC42 50p
2N706 14p	2N4062 15p	AF280 79p	BF154 20p	OC45 22p
2N708 17p	2N4069 15p	AL102 61p	BF159 29p	TIP29A 49p
2N916 28p	2N4100 £1-10	BC107 14p	BF180 35p	TIP29C 58p
2N918 32p	2N4921 83p	BC108 14p	BF181 36p	TIP31A 62p
2N1302 184p	2N4923 £1-00	BC109 14p	BF184 30p	TIP32A 74p
2N1304 26p	2N5245 47p	BC147B 14p	BF194 12p	TIP33A £1-01
2N1306 31p	2N5294 48p	BC148B 15p	BF195 12p	TIP35A £1-51
2N1308 47p	2N5296 48p	BC149B 15p	BF196 13p	TIP35A £1-01
2N1711 45p	2N5457 49p	BC157A 16p	BF197 15p	TIP36A £2-90
2N2102 60p	2N5458 46p	BC158A 16p	BF198 18p	TIP42A £0-70
2N2147 78p	2N5459 49p	BC167B 15p	BF244 21p	TIP295S 98p
2N2148 94p	2N6027 45p	BC168B 15p	BF257 47p	TIP305S 98p
2N2181A 22p	3N128 73p	BC169B 15p	BF258 57p	TIS43 28p
2N219A 26p	3N140 £1-00	BC182 12p	BF259 35p	ZTX300 13p
2N2220 25p	3N141 81p	BC182L 12p	BF561 27p	ZTX301 13p
2N2221 18p	3N200 £2-49	BC183 12p	BF598 25p	ZTX500 15p
2N2222 20p	40361 40p	BC183L 12p	BF839 24p	ZTX501 13p
2N2369 20p	40362 45p	BC184 13p	BF879 24p	ZTX502 18p
2N2646 55p	40406 44p	BC184L 13p	BFX29 30p	IN814 7p
2N2904 22p	40407 35p	BC125A 16p	BFX30 27p	IN375A 15p
2N2905 25p	40408 50p	BC125A 16p	BFX84 24p	IN4007 10p
2N2906 19p	40409 52p	BC213LA 15p	BFX85 30p	IN4148 7p
2N2907 22p	40410 52p	BC214LB 18p	BFX88 25p	IN5404 22p
2N2924 20p	40411 £2-00	BC237B 16p	BFY50 22p	IN5408 80p
2N2926G 12p	40594 74p	BC238C 15p	BFY51 21p	AP108 8p
2N3053 25p	40595 84p	BC239C 15p	BFY52 20p	BA102 25p
2N3054 60p	40636 £1-10	BC257A 16p	BRY39 48p	BA145 18p
2N3055 75p	40673 73p	BC258B 16p	ME0402 20p	BA154 12p
2N3391 28p	AC162 20p	BC259B 17p	ME0412 18p	BA155 12p
2N3392 15p	AC127 20p	BC301 34p	ME4102 11p	BB103B 23p
2N3393 15p	AC128 20p	BC307B 17p	ME410 95p	BY126 12p
2N3440 59p	AC151 27p	BC308A 15p	MJ481 £1-40	BY126 12p
2N3442 £1-40	AC152 49p	BC309C 20p	MJ490 £1-05	BY127 15p
2N3638 15p	AC153 35p	BC327 23p	MJ491 £1-45	BYZ11 51p
2N3702 12p	AC176 30p	BC328 22p	MJ295S £1-00	BYZ12 51p
2N3703 13p	AC187K 35p	BCY70 17p	MJ340 48p	OA47 8p
2N3704 15p	AC188K 40p	BCY72 22p	MPS170 65p	CA48 18p
2N3706 15p	AD143 68p	BCY73 13p	MJ371 47p	CA48 18p
2N3708 14p	AD161 50p	BD121 £1-00	MJ371 47p	CA99 6p
2N3714 £1-38	AD162 50p	BD123 82p	MJ520 60p	CA91 6p
2N3716 £1-80	AF106 40p	BD124 67p	MJ521 70p	WO21A200 32p
2N3721 £2-20	AF109 40p	BD131 40p	MJ521 70p	BY164 57p
2N3773 £2-65	AF115 35p	BD132 50p	MPS113 47p	ST30ac 20p
2N3796 15p	AF116 35p	BD133 43p	MPI102 39p	40669 £1-00
2N3789 £2-08	AF117 35p	BD136 47p	MPSA05 25p	TIC44 29p
2N3819 37p	AF118 35p	BD137 55p	MPSA06 31p	CI06D 65p
2N3820 64p	AF124 30p	BD138 63p	MPSA55 31p	ORP12 60p

Prices correct at AUGUST 1975, but all exclusive of VAT. P. & P. 25p

Sinclair Project 80

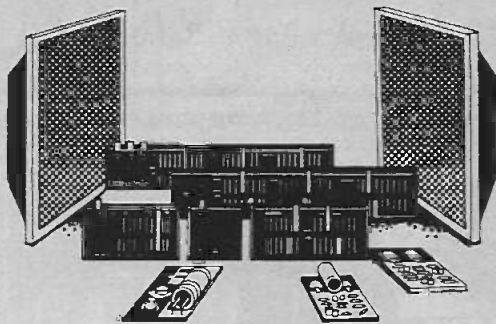

The watts...

14 different hi-fi modules. Between them they cater for every variety of hi-fi set-up, from a tuner amp to a full CBS SQ quadraphonic system. The value for money's amazing. A genuine 25W per channel quadraphonic amplifier for under £80... a 12W per channel stereo amp for around £30... And the satisfaction's even greater! If you can handle a soldering iron, you can handle Project 80. And if you can't... use Project 805 - the same modules but with solderless clip connections.

and the wherefores.



Take a look at some of the hi-fi systems you can build... Get the full technical specifications... See what impartial hi-fi journals thought of its performance... And read up on the rest of the Sinclair hi-fi range... It's all in the Sinclair hi-fi range fact-file. Send for Sinclair's fact-file - now! See if the answer's here - the information on the component you've been looking for. Simply cut the coupon and send it to the no-stamp-needed FREEPOST address below. We'll send you the Sinclair fact-file - giving you all you need to know about Project 80, and the rest of the Sinclair hi-fi range. Plus information about a few extras you're sure to find rather interesting. You've plenty to gain... so cut the coupon - now! Sinclair Radionics Ltd, London Road, St Ives, Huntingdon, Cambs., PE17 4HJ St Ives (0480) 64646

Please send me the Sinclair range fact-file immediately

Name _____

Address _____

EE/9/P8

To: Sinclair Radionics Ltd, FREEPOST, St Ives, Huntingdon, Cambs., PE17 4BR Please print

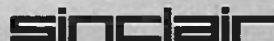

BI-PRE-PAK

The people for component bargains



Makers of Stirling Sound audio equipment

ORIGINATORS OF PRE-PACKED COMPONENTS IN BRITAIN — AND STILL LEADING!

AUDIO MODULES — today's most challenging values!

POWER AMPS



SS103

Compact I.C. amp. 3 watts R.M.S. Single channel. (mono). On P.C.B. size 3½" x 2". Needs 10-20V supply. £1.75

SS103-3

Stereo version of above. (Two I.C.s.) £3.25

NEW! SS105 Mk. 2

A compact all-purpose power amp. Can be run from 12V car battery. Size 3½" x 2". Useful 5W output (mono) into 32Ω using 12V. Excellent value. £2.25

SS110 Mk. 2

Similar in size to SS105 but will give 10W output into 4Ω using 24V (mono). Two in stereo give first-class results, suitable for many domestic applications. £2.75

SS140*

Beautifully designed. Will give up to 40W R.M.S. into 4Ω. Excellent S.N.R. and transient response. Fine for P.A., disco use, etc. Operates from 45V D.C. Two in bridge formation will give 80W R.M.S. into 8Ω. £3.60



PRE-AMP/CONTROL MODULES

SS100

Active tone control unit to provide Bass and Treble facilities (stereo). £1.60

SS101

Pre-amp for stereo ceramic cartridges, radio and tape. £1.60

SS102

Pre-amp for low-output stereo magnetic cartridges, radio and tape. £2.25

BUILD A STEREO F.M. TUNER

SS201

Front End assembly. Ganged tuning with well engineered slow-motion geared drive in robust housing. A.F.C. facility. Requires 6-16V. Excellent sensitivity. 88-108MHz. £6.25

SS202

I.F. Stage (with I.C.). Designed to use with SS201 uses I.C. Carefully checked before despatch. £5.25

SS203

Stereo Decoder. Designed essentially for use with SS201 and SS202, this excellent decoder can also make a stereo tuner of almost any single channel FM tuner. Supplied ready aligned. A.L.E.D. can easily be fitted. £5.62

Above 3 units together special price £12.12

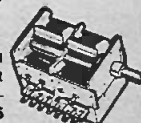

SPECIAL OFFERS

LM 330 AUDIO IC (Marked SL60745). Brand new and to spec. 3 watts R.M.S. out. With data. £1.00

2X SN7490. Brand new I.C. to spec. decade counters. £1.00*

3XSN 7400 Quad 2 input Nan gate ICs. 50p

SUNDRY

P.1 PAK—Approx. 170 short-lead semi-conductors and components. PNP, NPN, diodes, rectifiers, etc. on PCBs. At least 30% factory marked. Some data supplied. 50p

UHF 625 line tuner, rotary. £2.50

Rev Counter (for cars) (8%). £1.00*

Books by Bernard's Publications, Newnes-Butterworth's etc. No VAT.

THE FREE CATALOGUE

New edition better than ever. It's yours for free and well worth getting—only please send large S.A.E. with 10p stamp if we have to post it to you.

TERMS OF BUSINESS:

VAT at 25% must be added to total value of order except for items marked * or (8%), when VAT is to be added at 8%. No VAT on overseas orders. P.OST & PACKING add 22p for UK orders unless marked otherwise. Minimum mail order acceptable—£1. Overseas orders, add £1 for postage. Any difference will be credited or charged. PRICES subject to alteration without notice. AVAILABILITY All items available at time of going to press when every effort is made to ensure correctness of information.

NEW RANGE TRANSISTOR & COMPONENT PACKS

TP SELECTION

TP5 20 Transistors, PNP Germanium, Red Spot A.F.

TP6 20 Transistors, PNP Germanium. Write spot RF.

TP7 1 2N174 150w 80Vce Power Transistor, with mounting assembly.

TP19 100 diodes, mixed Germanium, Gold-bonded, etc. Marked/Unmarked.

TP23 Twenty NPN Silicon uncodded T05. Similar to BFY50/2, 2N696, 2N1613, etc. Complementary to TP24.

TP24 Twenty PNP Silicon, uncodded T05. Similar to BFY64, 2N2904/5

TP25 8 power diodes 400V, 1-25A Silicon FST 3/4.

ALL ABOVE PACKS—50p EACH.

UT SELECTION

UT1 50 PNP's Germanium, AF & RF.

UT2 150 Germanium diodes, min. glass.

UT4 100 Silicon diodes, min. glass, similar to IN914, IN916.

UT5 40 250mW Zener diodes OAZ24 range; average 50% good.

UT7 30 Silicon rectifiers 750mA, mixed voltages, Top Hats, etc.

UT9 40 NPN Silicon planers. Similar to 2N3707-11 range. Low noise amps.

UT12 25 2N3702/3 Transistors, PNP Silicon, Plastic to 92.

TP Tested & Guaranteed; UT Untested, unmarked; CP Components.

CP SELECTION

CP1 Mixed bag of capacitors—Electrolytic, Paper, Silver Mica (Approx. 150—sold by weight).

CP2 200 (approx.) Resistors, various types, values, watts. (Sold by weight.)

CP3 40 Wire wound resistors, mixed.

CP4 12 pots—pre-set, w/wound, carbon, dual, with/without switches—all mixed.

CP7 Heat sinks, assorted. To fit SO-Z (OC72) TO-1 (AC128), etc.

CAPACITOR DISCHARGE IGNITION KIT

Simple to assemble and fit. Improves car performance, saves on fuel. P&P 30p. £7.50*

BI-PRE-PAK X-HATCH GENERATOR Mk.2



Four-pattern selector switch 3" x 5½" x 3"

Ready-built and tested in kit form

*£9.33

*£7.93

Please add 35p for postage and packing. Is invaluable to industrial and home user alike. Improved circuitry assures reliability and still better accuracy. Very compact, self-contained. Robustly built. Widely used by TV rental and other engineers. With reinforced fibreglass case. Instructions, but less batteries. (Three U2 type required.)

TV SIGNAL STRENGTH METER

Complete kit as described in "Television" £19.50 plus 40p for P&P plus VAT at current rate.

SS300 POWER SUPPLY STABILISER

Add this to your unregulated supply to obtain a steady working voltage from 16 to 60V for your audio system, workbench etc. Money saving and very reliable. £3.25*

PLASTIC POWER TRANSISTORS

40 WATT SILICON*

Type	Polarity	Gain	VCE	Price
40N1	NPN	15	15	20p
40N2	NPN	40	40	30p
40P1	PNP	15	15	20p
40P2	PNP	40	40	30p

90 WATT SILICON

Type	Polarity	Gain	VCE	Price
90N1	NPN	15	15	25p
90N2	NPN	40	40	35p
90P1	PNP	15	15	25p
90P2	PNP	40	40	35p

If you prefer not to cut coupon out, please mention ETIP2 when writing

To BI-PRE-PAK, 224-226 WEST RD., WESTCLIFF-ON-SEA, ESSEX

Please send

for which I enclose Inc. V.A.T.

Name

Address

EE9

BI-PRE-PAK LTD

C. R. No. R/10019

222 224 WEST ROAD, WESTCLIFF-ON-SEA, ESSEX SSO 9DF.

TELEPHONE: SOUTHEND (0702) 46344.

WRITE ORDER SEPARATELY AND ATTACH COUPON IF REQUIRED

Everyday Electronics Classified Advertisements

RATES: 12p per word (minimum 12 words). Box No. 35p. extra. Semi-display—£8.00 per single column inch. Advertisements must be prepaid and addressed to Classified Advertisement Department, "EVERYDAY ELECTRONICS," I.P.C. Magazines Ltd., Fleetway House, Farringdon Street, London EC4A 4AD. (01—634 4379)

CONDITIONS OF ACCEPTANCE OF CLASSIFIED ADVERTISEMENTS

The advertiser warrants that the advertisement does not contravene any of the provisions of the Trade Descriptions Act 1968/72. The Publishers reserve the right to refuse or withdraw any advertisement. Although every care is taken to avoid mistakes, the publishers cannot be liable for clerical or printer's errors or their consequences.

FOR SALE

EVERYDAY ELECTRONICS. December 1971-April 1975, 33 issues. Any offers? S. Sherwin, Gomershay, Stalbridge, Dorset.

MICROPHONES: AKG D202E1, £45.00; AKG D190C or 'E' £20.00; AKG D224, £60.00; Sennheiser MD211N, £45.00. All brand new and boxed. Please add 25% for VAT. All other AKG and Sennheiser mikes. SAE for quote to J. J. Francis (Wood Green), Ltd., Manwood House, Matching Green, Harlow, Essex. Tel: Matching 476.

RECEIVERS AND COMPONENTS

COMPONENTS GALORE, pack of 500 assorted radio, TV and electronic components a real bargain at a realistic price, send only £1.50 C.W.O. This applies only to United Kingdom and Ireland. Overseas prices by arrangement. Caedonion Components. P. O. Box 3, Glenrothes, Fife, Scotland.

Four panels ex. F.M. Stereo Amp. 14 transistors 3 stereo pots, 7 way push button assembly coils and IFs etc £1.60 (40p). Bank of 20 Neons 74p (11p). Copper clad pax panels 5 1/2 x 5 1/2 in. 6-65p 10 x 6 in 3-£1. 12 x 12 in 65p all C.P. Talking page panel 2 pots 12 transistors and SCR plus 8 electrolytics etc 80p (15p). Mains transformer. Secs 24 and 6V £A. £1.25 (40p). Lists 12p. Refund on Purchase. 7lbs assorted components £2.20 C.P.

JWB RADIO

2 Barnfield Crescent, Sale, Cheshire M33 1NL. POSTAGE IN BRACKETS. MAIL ORDER ONLY

VALVES, RADIO, TV, TRANSMITTING, INDUSTRIAL 1930 to 1975. 2,200 types in stock. Many obsolete. S.A.E. for quotation list 20p. Postal export service. We purchase new and used boxed valves. Cox Radio (Sussex) Ltd, The Parade, East Wittering, Sussex. West Wittering 2023.

SERVICE SHEETS

SERVICE SHEETS for Radio, TV, Tape Recorders, Stereo, etc., with free fault-finding guide, 50p and SAE. Hamilton Radio, 47 Bohemia Road, St. Leonards, Sussex.

MISCELLANEOUS

LOWEST COST IC SOCKETS. Use Soldercon IC socket pins for 8 to 40 pin DIL's. 50p for strip of 100 pins, £1.50 for 3 strips of 100, £4 for 1000. 10p p&p for orders under £2. Add 8% VAT. Instructions supplied—send sae for sample. SINTEL, 53e Aston Street, Oxford. Tel: 0865 43203.

SUPERB INSTRUMENT CASES by Bazelli, manufactured from heavy duty PVC faced steel. Hundreds of people and industrial users are choosing the cases they require from our vast range, competitive prices start at a low 75p. Examples, Width, Depth, Height, 8in x 5in x 5in £1.55, 10in x 6in x 3in £2.20, 10in x 8in x 3in £2.75, 12in x 10in x 3in £3.60, 8in x 4in x 4in £1.80, 10in x 6in x 4in £2.70, 12in x 8in x 4in £3.60, 7in x 7in x 5in £2.65, 8in x 10in x 6in £5.60, 12in x 8in x 7in £4.12, 12in x 12in x 7in £4.40. Plus 8% Vat and 50p postage. Over 200 Models to choose from. Prompt despatch. Free literature, (stamp would be appreciated). Brazelli, Department No. 24, St. Wilfreds, Foundry Lane, Halton, Lancaster LA2 6LT.

I.C. EXPERIMENTER'S KITS

Learn about modern electronics with our new step-by-step kits. Use and understand digital logic techniques. Kits contain specially selected I.C.'s, Holders, Veroboard, L.E.D.'s, instructions and data. Kit One (Gates) and Kit Two (Flip-Flops) now available, £3.50 each. Bargain Offer—EXPERIMENTER'S PAK £3.80. Gates, Inverters, Flip-Flops, Counters. S.A.E. for further details to AUTOMATED HOMES, 69 High Street, Ryton, Coventry CV8 3FJ. Mail Order Only.

DIGITAL CLOCK CHIP, AY-5-1224, with data and circuit diagram, £3.66 plus VAT. "Jumbo" LED digits (16mm high), Economy type DL-747, only £2.04 each plus VAT, post free. Greenbank Electronics, 94 New Chester Road, Wirral, Merseyside L62 5AG.

ENAMELLED COPPER WIRE

S.W.G.	1/6 Reel	1/2 Reel
10-14	£2.95	£1.15
15-19	£2.15	£1.20
20-24	£2.20	£1.25
25-29	£2.25	£1.30
30-34	£2.30	£1.35
35-40	£2.35	£1.45

All the above prices are inclusive in U.K.

COPPER SUPPLIES

102 Parrwood Rd., Withington, Manchester 20
Telephone 061-445 8753

LIGHTING CONTROL UNIT

3 x 1kW per channel auto-to-light converter using isolated control circuitry for maximum safety. The unit comes in kit or ready built form and features individual sensitivity controls, sensitivity range switch and dimming switch. (Bypass controls as an optional extra.) Kit: £13.99. Ready built: £16.99. Details of dimmers, sequencers and other lighting control units available on request. Mail order or written enquiries only to:

SELEKTRON

21 Prior's Road, Windsor, Berks, SL4 4PD.

BEGINNERS, our two, large (33in x 25in) data sheets give the information you need on radio transmission, reception and components. Plus circuits, and crystal clear, full size plans for simple long, medium and short wave receivers. No soldering. Components easy to obtain. Send 65p + 10p P and P to: Tekna Data Sheets E. E. (Radio and Electronics) 11 Lawn Avenue, Doncaster, South Yorks. DNI 2JE. Mail order UK only.

AERIAL BOOSTERS—£3.30

We make three types of aerial boosters B45-UHF-TV, B12-VHF-TV, B11-VHF-Radio.

VALVES BARGAINS

ANY 5-50p, 10-75p, 30-£3.30. ECC82, EF80, EF183, EF184, PCC189, PCF80, PCF82, PCL82, PCL84, PCL85/805, PFL200, PL38, PL504, PY800, PY88.

COLOUR TV VALVES—PL508, PL509, PY600-25p each. Prices exclude VAT, P&P 10p, SAE—leaflet. Electronic Mail Order Ltd, 62 Bridge Street, Ramsbottom, Bury, Lancs. Tel RAMS 3638.

MULTIMETER



Type U4324
20,000Ω/V. Overload protected. Ranges: 0-5, 1-2, 3, 12, 30, 60, 120, 600, 1200V DC; 3, 6, 15, 60, 150, 300, 600, 900V AC; 0.06, 0.6, 6, 60, 600mA, 3A DC; 0.3, 3, 30, 300mA, 3A AC. 5 resistance ranges to SMD dB's—10 to +62. Size 167 x 98 x 63mm. Supplied complete with test leads, clips, spare diode, batteries and instructions. Only £11.00. Send 10p for illustrated brochure of meters.

71b BARGAIN PARCELS

Contains hundreds of resistors, pots, capacitors, switches, transistors, PC Boards and loads of odds and ends. Only £3.00.

CAPACITOR PACKS

200 mica ceramic poly caps £1.10; 100 polyester caps 0.01 to 1µF £1.30; 200 mainly unmarked miniature electrolytics, Only £1.35. One of each pack £3.30.

Mains TRANSFORMERS

12-0-12V 50mA 80p; 6-0-6V 100mA 90p; 9-0-9V 100mA 95p; 12-0-12V 100mA £1; 6-0-6V 1 1/2A £1.80; 12-0-12V 1A £2.00; 30-0-30V 1A £3.20; 30V 1A tapped to give 3, 4, 5, 6, 8, 9, 10, 12, 15, 18, 20, 24 or 30V, or 12-0-12 or 15-0-15 £2.80. 2A version £3.80.

PC ETCHING KIT MK II

Contains 1lb Ferric Chloride, DALO Etch resist pen, 100 sq ins copper clad board, etching dish, abrasive cleaner, instructions and now 2 miniature drill bits as well. Only £3.50.

GREENWELD ELECTRONICS (EES)

51 Shirley Park Road, Southampton SO1 4FX. All prices include VAT and postage in UK. SAE List. Callers welcome 9-6 Mon-Sat. Telephone (0703) 772501.

CONSTRUCTION AIDS. Screws, nuts, spacers, etc., in small quantities. Aluminium panels punched to spec. or plain sheet supplied. Fascia panels etched aluminium to individual requirements. Printed circuit boards—masters, negatives and boards, one-off or small numbers. Send 6p for list. **RAMAR CONSTRUCTOR SERVICES,** 29 Shelbourne Road, Stratford-on-Avon, Warks.

LOUD 6V D.C. MOTOR DRIVEN SIRENS, £1.25; BC108, 12p (5 for 48p); 3 digit counters, 15p; 4-0C84 on panels, 16p. Add 10p postage, list 10, 8p. Grimsby Electronics, 64 Tennyson Road, Cleethorpes, Humberside (callers to Lambert Road, Saturdays only).

THE SCIENTIFIC WIRE CO

Copper - Nickel Chrome - Eureka - Manganin Wires.

Enamelled - Silk - Cotton - Tinned Coverings. No minimum charges or quantities.

Trade and Export enquiries welcome.

S.A.E. Brngs List.

P.O. BOX 30, LONDON, E.4 9BW

ALUMINIUM PROJECT BOXES

Box No.	Length"	Width"	Height"	Price
7	5 1/2	2 1/2	1 1/2	47p
8	4	4	1 1/2	48p
9	4	4	1 1/2	46p
10	5 1/2	4	1 1/2	49p
11	4	4	2	46p
12	3	2	1	38p
13	6	4	2	58p
14	7	5	2 1/2	75p
15	6	6	3	95p
16	10	7	3	£1.14

Prices include VAT (at 8%) but 18p should be added to the total order value for postage & packing.

8 WATT 12 VOLT FLUORESCENT LIGHT KIT Complete Kit including all components, heatsink, channel, tube, etc.

ONLY £3.49 inc. VAT p. & p.

Ready Built £4.18 inc. VAT p. & p. Diffuser 59p extra inc. VAT p. & p. Send cheque or P.O.'s with your order direct to:—

ELECTRONICS DESIGNS ASSOCIATES, Dept. EE, 82 Bath Street, Walsall, WS1 3DE. Phone: Walsall 33652

BUILD THE TREASURE TRACER MK III Metal Locator



- Varicap tuning
- Brita's best selling metal locator kit
- Weighs only 22oz. Fitted with Faraday shield.
- Speaker and earphone operation
- Knocks down to only 17in.
- Prebuilt search coil assembly
- Thoroughly professional finish
- As seen on BBC1 and BBC2 TV
- You only need soldering iron, screwdriver, pliers and snips
- Five transistor circuit
- Send stamped, addressed envelope for leaflet

Complete Kit **£10-90** Built & tested **£15-25**
 Post 60p - 92p VAT(8%) Post 60p - £1-27 VAT(8%)

MINIKITS ELECTRONICS,
 65 CLEVELAND ROAD,
 LONDON, E18 2AN (Mail order only)

LOUDSPEAKERS



Speakers, kits and cabinets for D.I.Y., Hi Fi, P.A., Disco, etc. by EMI, Fane, Goodmans, Baker, Kef, Elac, Richard Allan, Wharfedale, etc.

Send stamp for free booklet "Choosing a speaker"

WILMSLOW AUDIO
 Dept. EE, Swan Works, Bank Square,
 Wilmslow, Cheshire, SK9 1HF
 Tel. Wilmslow 29599

HOME SCIENTISTS

Get the key to a FANTASTIC WORLD of previously UNHEARD-OF-PROJECTS. The NEW Boffin catalogue lists LOTS of HIGHLY UNUSUAL, LOW-COST BARGAINS, READY-BUILT MODULES. Here are just a few examples, there are stacks more!

Dazzling MINI-STROBE (pocket size) **£3-50**

PEOPLE DETECTOR **£4-20**
 Big-Ear SOUND-CATCHER **£4-20**
 Mini DREAM LABORATORY **£4-20**

Don't take our word for it though! GET A COPY & SEE!
 SEND ONLY 20p, and we'll RUSH YOU A COPY (YOU'LL GET THE GOODIES' JUST AS QUICKLY TOO!)

BOFFIN PROJECTS
 4 Cunliffe Road, Stoneleigh,
 Ewell, Surrey
 (Mail Order U.K. Only)

TELEVISIONS AND SPARES TO THE TRADE

MONOCHROME TELEVISIONS

BBC2 Dual Standard TVs (19in. 23in) in batches of 10-£2 each (makes include Bush, Thorn, Philips, Pye/Ekco, Baird). Many with transistorised tuners. GEC 2000, Thorn 950 series, Bush 141, Philips Style 70, Baird 600 and 700 series all at £8 each.

Thorn 1400, Bush 160/170 series, Philips 210, Pye-Ecko Olympic, etc., Baird 673, Push Button—all at £12-50 each.

20in and 24in square screen Dual Standard sets—Thorn, GEC, etc. 20in—£15, 24in—£16-50.

20in and 24in Single Standard Thorn 1500, GEC, Bush Acoustic, 20in—£17-50, 24—£19-50.

(1) Discounts for quantities. (2) All monochrome spares supplied free of charge. (3) All tubes guaranteed. (4) All cabinets very good. (5) All sets "walk and talk". (6) All sets guaranteed complete inside and out. (7) Delivery and VAT extra.

Portable TV: 16in Thorn UHF—£15 working. £12-50 untested.

COLOUR TELEVISIONS

Colour TVs: 19in and 25in. Makes include Thorn 2000, Bush CTV25, Decca CTV 19/25in, Pye-Ekco, Baird 700 and 710 series, Philips G6, GEC 2028. All sets guaranteed complete inside and out—cabinets first class and tubes guaranteed, complete inside and out—cabinets first class and tubes guaranteed. From £65 each.

20in and 22in Colour Televisions are always available in varying quantities—please telephone for availability and cost.

Please Note: (1) We deliver anywhere by our own transport. (2) All goods are blanket wrapped in our vans. (3) All orders with half deposit, balance on delivery after inspection. (4) Cheques most welcome. (5) Any quantity supplied. (6) We do not sell rubbish, and we stand by our guarantees. (7) We aim to please. (8) All spares supplied free of charge (mono only).

N.B. Special arrangement for delivery to North and South Ireland and world-wide exports orders welcomed.

TEST BENCH FACILITIES ALWAYS AVAILABLE

MISCELLANEOUS ITEMS

Large quantities of stereograms, fridges, deep freezers, Hoovermatics, radios, etc., always at hand—prices on request.

COLOUR SCAN COILS Mono
 All dual standard £5 plus £1 P. & P. All makes £2 inclusive.

VALVES
 All colour valves 40p each plus 5p All mono valves 10p each plus 2p each P. & P.

TUBES
 19in—£15, 22in—£22, 25in—£20 (post, insurance, packing, £5).
 19in £3, 20in—£4-50, 23in—£4, 24in—£8 (post, insurance, packing £3)

CABINETS
 19in—£12, 22in—£16, 25in—£14 (post, insurance, packing £5). All cabinets—£5 including post, insurance, packing.

LOPTs
 All dual standard colour £5-50 plus £1 P. & P. All makes available. All dual standard mono £2-20 plus £1 P. & P. All makes available.

Colour IF, Decoder and Convergence—frame IF, Line timebase £3 plus £1 P. & P.
 output for all dual standard models All dual standard models in stock.
 from £7-50 plus £1-50 P. & P. All models available.

SLOT METERS
 10p meters—£1-50 each including postage and packing.

SPEAKERS
 6in x 4in Round, 8in x 2in 30p each plus 10p P. & P.

MAIL ORDER SERVICES

BLACK/WHITE TELEVISIONS
 Working: 19in—£8-50, 23in—£12-50, 20in—£20, 24in—£24-50.
 Untested (but guaranteed complete with good tubes): 19in—£4, 23in—£5, 20in—£15, 24in—£19.
 (Postage, packing and Insurance £3-50 each, prices include VAT.)
 N.B. All tubes guaranteed.

COLOUR TELEVISIONS
 Working: 19in—£85, 22in—£125, 25in—£130.
 Untested (but guaranteed complete with good tubes): 19in—£70, 22in—£90, 25in—£95.
 (Postage, packing and insurance £9 each, prices include VAT.)
 Thorn 2000, Bush CTV25, Philips G6, GEC2028, Baird 700, Decca CTV25

PORTABLE BBC2 16in TELEVISIONS (MONOCHROME)
 Working £19-50. Untested £15. (Postage, packing and Insurance £3; prices include VAT.)

MAIL ORDER SPARES. Special Offer
 BRC 2000 panels, video, convergence and regulator—only £12-50 plus £1-50 P. & P.

Bush CTV 25 Line timebase—lower unit including LOPT and valves Mk. 1 and II only—£18 plus £3 P. & P.
 BRC single standard colour 4 button tuners colour and mono—£7-50 plus £1 P. & P.

UHF Vari-cap tuner units—£6-50 plus £1 P. & P.
 VHF Vari-cap tuner units—£7-50 plus £1 P. & P.
 Pye-Ekco CTV Tripler units—£6-25 plus 75p P. & P.
 Philips G8 Tripler units—£7-50 plus 75p P. & P.
 KB VC Series LOPT £2-50 including P. & P.
 Bush 125 and 135 IF PANELS—£3-50 plus 75p P. & P.
 Thorn 850 IF Panels—£2-50 plus £1 P. & P.
 GEC 2000 IF Panels—£3-50 plus £1 P. & P.

EX-EQUIPMENT TUNERS:
 Colour:
 All dual standard colour push button—rotary and integrated models in stock at £4-50 plus £1 P. & P.

Mono:
 All VHF tuners available at £2 plus £1 P. & P.
 All UHF tuners for dual standard models in stock. Push button—£3-50 plus £1 P. & P.
 Rotary—£2-50 plus £1 P. & P.

Integrated (UHF and VHF) £4-50 plus £1 P. & P.
 Comprehensive list of capacitors, resistors, etc., too numerous to mention. Prices on request.

PLEASE ALLOW 2 WEEKS DELIVERY. S.A.E. PLEASE FOR ENQUIRIES. ALL STOCK EX-EQUIPMENT
 BARCLAYCARD, ACCESS AND PROVIDENT WELCOME

TRADE DISTRIBUTORS

5 COMMERCIAL STREET, HARROGATE, YORKSHIRE

Telephone: (STD 0423) 3498 and 62347

Sinclair System 4000

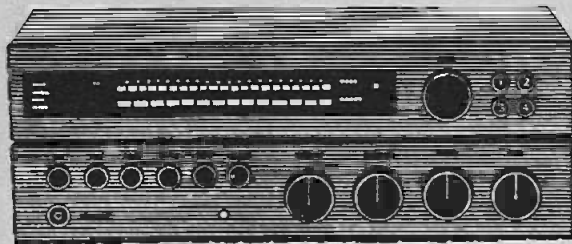

The watts...

Black, beautiful, and incredibly good value. Sinclair's two self-contained hi-fi units - in one handsome, elegant style.

A 17 watts per channel amplifier and a matching FM tuner.

The amplifier offers 17 W RMS per channel output... 0.05% total harmonic distortion... and a price tag

of around £50.

The System 4000 tuner completes a handsome, hard-working system.

Engineered and designed to accompany the System 4000 stereo amplifier, the FM tuner matches it in specification and design - and at around £40 completes a system of outstanding value.

and the wherefores.



Get the full technical specifications...

See what impartial hi-fi journals thought of its performance...

And read up on the rest of the Sinclair range...

It's all in the Sinclair hi-fi range fact-file.

Send for Sinclair's fact-file now!

See if the answer's here - the information on the component you've been looking for.

Simply cut the coupon and

send it to the no-stamp-needed FREEPOST address below.

We'll send you the Sinclair fact-file - giving you all you need to know about System 4000, and the rest of the Sinclair hi-fi range.

Plus information about a few extras you're sure to find rather interesting.

You've plenty to gain... so cut the coupon now!

Sinclair Radionics Ltd,
London Road, St Ives,
Huntingdon, Cambs., PE17 4HJ
St Ives (0480) 64646

Please send me the Sinclair range fact-file immediately

Name _____

Address _____

EE/9/4K

Please print

To: Sinclair Radionics Ltd,
FREEPOST, St Ives,
Huntingdon, Cambs., PE17 4BR

sinclair



"I MADE IT MYSELF"

Imagine the thrill you'll feel! Imagine how impressed people will be when they're hearing a programme on a modern radio you made yourself.

Now! Learn the secrets of radio and electronics by building your own modern transistor radio!

Practical lessons teach you sooner than you would dream possible.

What a wonderful way to learn—and pave the way to a new, better-paid career! No dreary ploughing through page after page of dull facts and figures. With this fascinating Technatron Course, you learn by building!

You build a modern Transistor Radio... a Burglar Alarm. You learn Radio and Electronics by doing actual projects you enjoy—making things with your own hands that you'll be proud to own! No wonder it's so fast and easy to learn this way. Because learning becomes a hobby! And what a profitable hobby. Because opportunities in the field of Radio and Electronics are growing faster than they can find people to fill the jobs!

No soldering - yet you learn faster than you ever dreamed possible.

Yes! Faster than you can imagine, you pick up the technical know how you need. Specially prepared step-by-step lessons show you how to read circuits—assemble components—build things—experiment. You enjoy every minute of it! You get everything you need. Tools. Components. Even a versatile Multimeter that we teach you how to use. All included in the course. **AT NO EXTRA CHARGE!** And this is a course anyone can afford. (You can even pay for it by easy instalments).

So fast, so easy, this personalised course will teach you even if you don't know a thing today!

No matter how little you know now, no matter what your background or education, we'll teach you. Step by step, in simple easy-to-understand language, you pick up the secrets of radio and electronics.

You become a man who makes things, not just another of the millions, who don't understand. And you could pave the way to a great new career, to add to the thrill and pride you receive when you look at what you have achieved. Within weeks you could hold in your hand your own transistor radio. And after the course you can go on to acquire high-powered technical qualifications, because our famous courses go right up to City & Guilds levels.

Send now for FREE 76 page book - see how easy it is - read what others say!

Find out more now! This is the gateway to a thrilling new career, or a wonderful hobby you'll enjoy for years. Send the coupon now. There's no obligation.

POST TODAY FOR FREE BOOK

To: ALDERMASTON COLLEGE CEE 09
DEPT. CEE 09, READING RG7 4PF

Also at our London Advisory Office, 4 Fore Street Avenue, Moorgate, London EC2V 5EJ. Tel: 01-623 7721. Yes, I'd like to know more about your course. Please send me free details—plus your big, 76-page book that tells about all your courses.

NAME _____

ADDRESS _____

POSTCODE _____



HOME OF BRITISH INSTITUTE OF ENGINEERING TECHNOLOGY

Complete the coupon and we'll send you our complete, new catalogue.

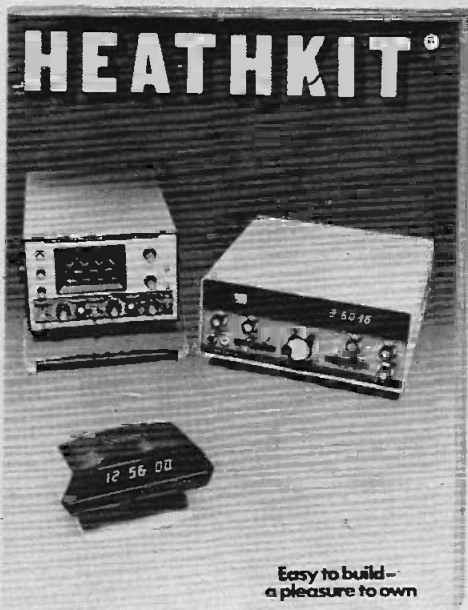

The new Heathkit catalogue is now out. Full as ever with exciting new models. To make building a Heathkit even more interesting and satisfying.

And, naturally, being Heathkit, every kit is absolutely complete. Right down to the last nut and bolt. So you won't find yourself embarrassingly short of a vital component on a Saturday evening—when the shops are shut.

You'll also get a very easy to understand instruction manual that takes you step by step through the assembly.

Clip the coupon now (enclosing a 10p stamp for postage) and we'll send you your copy to browse through.

With the world's largest range of electronic kits to choose from, there really is something for everyone.

Easy to build—
a pleasure to own

Including our full range of test equipment, amateur radio gear, hi-fi equipment and many general interest kits.

So, when you receive your catalogue you should have hours of pleasant reading.

And, if you happen to be in London or Gloucester, call in and see us. The London Heathkit Centre is at 233 Tottenham Court Road. The Gloucester showroom is next to our factory in Bristol Road.

At either one you'll be able to see for yourself the one thing the catalogue can't show you.

Namely, how well a completed Heathkit performs. Heath (Gloucester) Limited, Dept. EE-95, Bristol Road, Gloucester, GL2 6EE. Tel: Gloucester (0452) 29451.

DC-5 MHz, 100mV oscilloscope

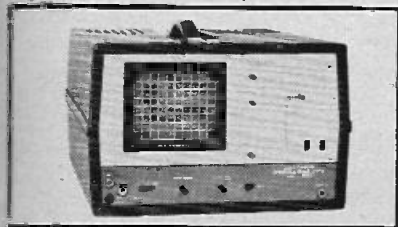

AM/FM 60 watt r.m.s. stereo receiver.

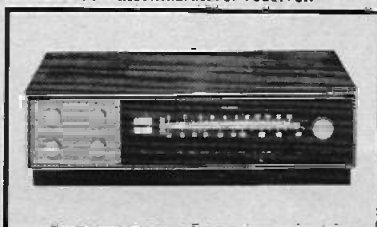

Deluxe digital alarm clock.



FREE
SOLDERING IRON
WORTH
£3.50
with all orders over £30

The new Heathkit catalogue. Out now FREE.

To: Heath (Gloucester) Limited, Dept. EE-95, Gloucester, GL2 6EE.
Please send me my Heathkit catalogue. I enclose a 10p stamp for postage.

Name _____

Address _____

Postcode _____

Full details in the catalogue. Offer available for limited period only.

HEATH
Schlumberger

Monthly budget plan
available

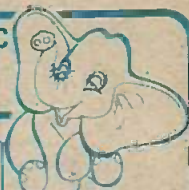

AMPLIFIERS with Controls

£1210	12 volt 2r + 2j watts 8 ohms	£9-34
SAC14	Mains 7 + 7 watts 8 ohms	£14-70
SAC30	Mains 15 + 15 watts 8 ohms	£18-90
CAO38	9 volt 1 1/2 + 1 1/2 watts 8 ohms	£8-58
CAO68	12 volt 3 + 3 watts 8 ohms	£13-12

MULLARD MODULES

LP1157	AM Type	£3-32
LP1185	10-7 LF Unit	£6-75
LP1196	10-7 FM Tuner	£7-30
Gorier Perm. FM Tuner		£5-25

FM and AM TUNERS and DECODERS

FM5231	(1u2) 6 volt fm tuner	£9-95
TU3	12 volt version (FM use with Decoder)	£9-95
SD4912	Stereo Decoder for Tu 3-12 volt	£9-95
SP62H	6 volt stereo FM tuner	£18-50
A1007	9 volt MW-AM	£6-18
A1018	9 volt FM tuner in cabinet	£17-45
A1005M (S)	9-12 volt Stereo decoder FM for above	£9-37
5475	Stereo decoder kit	£8-73

POWER SUPPLIES MAINS INPUT

(*chassis-rest cased)		£2-43
470C	6/7/9V 300 MA with adaptors	£4-00
PS20	9 volt 500 MA	£5-94
HC24R	3/5/7/9V, 100 MA stabilised	£5-94
*P11	2V 1 amp 3-30	£3-55
*P15	28V 1/2 amp	£5-87
*P1081	12V 1A	£8-42
*P1081	45V 0.9 amp	£7-77
P124	12V 0.2-1 amp	£13-77
SE101S	3/6/9/12V 1 amp stabilised	£4-50
P1076	3/4/6/7/9/12V 1/2 amp	£18-90
SE800A	1-15 VOLT 0-1/2 amp stabilised	£18-90

SINCLAIR MODULES & KITS

Sinclair Project 80		£18-05
ST80	Stereo preamplifier	£8-17
Audio Filter Unit		£6-40
Z40	15 Watt Amplifier	£8-17
Z60	25 Watt Amplifier	£5-72
P25	Power Supplies for 1 or 2 Z40	£8-18
P25	Power Supplies (S Tab) for 1 or 2 Z40	£4-86
TRANSFORMER FOR PZ5		£14-05
FM TUNER		£9-34
STEREO DECODER		£9-34
IC20	power amp kit	£5-88
P220	power supply for 1 or 2 IC20	£5-88

PACKAGE DEALS

2 x Z40	ST80 PZ5	(carr. packg. 35p) £29-32
2 x Z60	ST80 PZ6	£32-60
2 x Z60	ST80 PZ3-Lans	£40-42
805	KH	£42-25

SINCLAIR SPECIAL PURCHASES

*Project 60	stereo preamp	£7-94 (post 20p)
*Project 605	Kit	£23-44 (post 25p)

EMI SPEAKERS SPECIAL PURCHASE

13 in. x 8 in. chassis speakers (Carr. packg.)		£2-53
30p ea. or 50p pr. *150 TC 10 watts 8 ohms twin cone		£2-53
450A built in tweeter 8 ohms		£4-42
EW 15 watt 8 ohms with tweeter		£7-18
350 20 watt 8, 15 ohm with tweeter		£10-29
*Polished wood cabinet		£8-00
Carr. etc. 35p each or 50p pair		

PA-DISCOTHEQUE LIGHTING EQUIPMENT



Without doubt U.K.'s best range of modular and complete equipment. Lighting, mixing, microphones, accessories, speakers, amplifiers, lenses, etc., etc. FREE stock lists (Ref. No. 18) on request CALL IN AND SEE FOR YOURSELF at

HENRY'S DISCO CENTRE, 309 EDGWARE ROAD, TEL. 01-723 6963

EP27 LOW COST SEVEN SEGMENT INDICATOR DIGIT HEIGHT 1/3 inch £1 45 each p. & p. 15p

L450 RECHARGEABLE BATTERY 2V 4000mA/H 54p p. & p. 15p

PHILIPS 12V FLUORESCENT INVERTOR FOR 8W FLUORESCENT TUBE. SUPPLIED WITH INSTRUCTIONS AND TUBE £3-78 p. & p. 33p

STC & IIT MINATURE RELAYS

150R	6V	2pco	
180R	6/12V	2pco	
185R	12V	2pco	
1250R	12/25V	2pco	
1700R	18/24V	2pco	
1800R	24V	4pco	
2500R	18/24V	2pco	
4000R	24V	2pco	

BRAND NEW p.p. 15p

ALL HENRY'S PRICES ARE INCLUSIVE OF VAT

TAPE HEADS

Marriot XRPS/74	Track High	£3-17
Marriot XRPS/118	Track Med.	£4-00
Marriot XRPS/55	Track Med.	£5-25
Marriot XRPS/63	Track High	£2-00
Marriot Erase Heads for XRSP 17/18, 36 (KESI)		88p
Marriot BX12E 342	Track erase	28p
R/RPI Rec'd/Play	3 Track	48p
HRR Single Track Rec/Play		37p
Bogen Type UL290 Erase		£1-69
Miniature Stereo Cassette Rec/Play		£2-60

EXCLUSIVE 5 WATT IC AMPLIFIERS

Special purchase 5 watt output 8-16 ohm load. 30 volt max. DC operation, complete with data. Price £1-75 each or 2 for £3-30 Printed Circuit Panels 50p

8 DIGIT POCKET ELECTRONIC CALCULATORS

Sinclair Cambridge		£11-88
Cambridge Kit		£9-94
Cambridge Memory		
Built		£18-90
Scientific Built		£18-30
Scientific Kit		£14-90

GARRARD CT4 STEREO CASSETTE TRANSPORT MECHANISM

Features
• Stereo Heads
• Built in Motor Stabiliser
• Auto Stop & Eject
• Pause Control
• 12V DC Operation
Robust, precision engineered mechanism based on the "STARR" patented design. Ideal for use in Car stereo cassette players, Hi-Fi stereo cassette recorders, industrial and many other applications. Suitable for the "PW" Ascot Stereo Cassette Deck.
£13-50 inc. VAT p & p 35p

TEST EQUIPMENT MULTIMETERS

Carr/packg 35p		
U4324	20k Ω/V	
	with case	£10-30
U4313	20k Ω/V with steel case	£14-99
U4317	20 Ω/V with case	£18-36
U4341	33k Ω/V plus transistors	£11-88
	steel case	
U3223	20k Ω/V plus 1kHz OSC with case	£8-64
U4311	Laboratory meter	£56-16
U4312	20k Ω/V	£11-61
U4315	20k Ω/V with case	£10-80
U4317	20k Ω/V with case	£18-36
IT1-2	20k Ω/V 50k Ω/V	£6-42
THL330	(L33DX) 2k Ω/V	
Robust		£8-10
TP55N	20k Ω/V (case £2)	£11-61
TP105	20k Ω/V	£9-18
TW20S	20k Ω/V	£15-04
TW50K	50k Ω/V	£14-40
S100T	100k Ω/V plus transistor tester	£24-30

NEW REVOLUTIONARY SUPERTESTER 680R

680R	Multi-tester	£19-98
†TE40	AC Multivoltmeter	£21-33
†TE15	Grid dip meter	
	440Hz-28MHz	£21-06
†TE25	25 Range valve voltmeter	£24-30
†TE20D	RF Generator	
	120Hz-500mHz	£20-45
†TE220	AF Generator	
	20Hz-200kHz	£21-54
*HM35A	In circuit transistor tester	£21-06
*C3025	Deluxe meter	
	1-300mHz	£7-50
†TT145	Compact transistor tester	£15-93
†G3-36	R/C osc. 20Hz-200kHz	£21-33
*SE350A	De-luxe signal tracer	£13-98
*SE400	Mini-lab all in one tester	£16-74
*C1-1	S Scope 500,000Hz (Carr. £1-00)	£50-76
	Radio activity counter	£10-76
	0-10r (carr. £2)	
	Mains unit for above (carr. 50p)	£4-05

Don't miss your copy of

HENRY'S NEW 1975 CATALOGUE

only 50p Plus 20p P&P

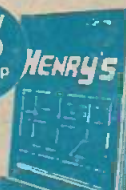

- ★ OVER 5,000 ITEMS - largest UK range of electronic components for home constructors.
- ★ 200 PAGES - every aspect of electronics and components for amateurs and hobbyists - kits, projects, test gear.
- ★ DOZENS of new lines and new ranges.
- ★ MANY price reductions throughout the new Catalogue.
- ★ A Discount Voucher with every copy, worth 50p.

ALL HENRY'S PRICES INCLUSIVE OF VAT

Write now for your copy, enclosing 70p remittance.

MIDLANDS: NEW ELECTRONICS STORE OPEN, 94/96 UPPER PARLIAMENT STREET, NOTTINGHAM, TEL: 40403
LONDON: 231 TOTENHAM COURT ROAD, W.1. (Lower Sates Floor).

Henry's

RADIO

Electronic Centres
404-406 Electronic Components & Equipment 01 402 8381
354 PA Disco-Lighting High Power Sound 01-402 5854
303 Special offers and bargains store
All mail to 303 Edgware Road, London W2 18W

Hi Fi and Electronics Centres Open 3pm - 6pm

Prices correct at time of preparation. Subject to change without notice. £ & 0.£

ELECTRONIC FOOTBALL & TENNIS WITH THE FABULOUS VIDEO SPORT

ON YOUR OWN TV
Play three exciting electronic ball games. FOOTBALL, TENNIS, HOLE IN THE WALL on your own TV. Just plug Video Sport into the aerial socket of your TV and away you go. Completely safe for you, your children and your TV. Mains operated.
OUR INCREDIBLE PRICE **£29-50 inc VAT**
DEMONSTRATIONS NOW IN ALL HI FI CENTRES!



AM FM MODULES LP1179, LP1171
Combined AM/FM tuner modules, together with a small number of R.C.'s Ferrite aerials, make up a sensitive FM/AM/LW tuner.
6 volts supply, supplied with data and circuit sheets.

LP1171	combined it strip	£4 60
LP1179	FM front end and AM gang	£4 60
	£8 62 the pair, Suitable Ferrite aerial 87p.	

UHF TV TUNERS

TYPE A	var. tun. slow motion drive	£3-50
TYPE C	variable tuning	£2-90
TYPE B	4-button (adj.)	£4 60
TYPE D	6-button UHF/VHF tuner	£5 20

TEXAN STEREO AMPLIFIER

Features glass fibre PC board, Gardners low field transformer, 6-IC's, 10-transistors plus diodes, etc. Designed by Texas instruments engineers for Henry's and P.W. 1972. Overall size 15 1/2" x 21" x 6 1/2" mains operated. Free teak sleeve with every kit (P&P 50p). (also built and tested £39.50).
£29-95

SPECIAL OFFER

TEXAN STEREO FM TUNER
Features capacity diode tuning, lead and tuning meter indicators, mains operated. High performance and sensitivity. Overall size in teak sleeve 8" x 22" x 6 1/2". Complete kit with teak sleeve. **£26-25** (P&P 50p) (also built and tested £31-20).

EXTRA DISCOUNTS
Semiconductors - Any one type of mixed SNT4 Series IC, 1z-extra 10%; 25-extra 15%; 100-extra 20%.

TRANSISTORS & INTEGRATED IC'S
TTL "7400 series" IC's from 18p each
Cosmos "4000 series" IC's from 28p each
Linear Op-Amps from 43p each
Signetics Phase Lock IC's; RCA Linear IC's; TO3 Power Devices in PNP and NPN; BC107 and "BC range" from 13p each
Range of OC Types 20p
Plastic Power Devices. Rectifiers, Zener Power Regulator IC's and many others.
Diodes up to 10 watts.