

An exciting hobby.... for everyone

everyday electronics

AUG. 75
25p



... Intruder
ALARM



WHITE
NOISE

WHITE
NOISE
GENERATOR



FET
VOLTMETER

... Plus all
the regular
features

NEW EDU-KIT MAJOR

Completely Solderless Electronic Construction Kit
Build these projects without soldering iron or solder

- ★ 4 Transistor Earpiece Radio.
- ★ Signal Tracer.
- ★ Signal Injector
- ★ Transistor Tester NPN-PNP.
- ★ 4 Transistor Push Pull Amplifier.
- ★ 5 Transistor Push Pull Amplifier.
- ★ 7 Transistor Loudspeaker Radio MW/LW.
- ★ 5 Transistor Short Wave Radio.
- ★ Electronic Metronome.
- ★ Electronic Noise Generator
- ★ Batteryless Crystal Radio.
- ★ One Transistor Radio.
- ★ 2 Transistor Regenerative Radio.
- ★ 3 Transistor Regenerative Radio.
- ★ Audible Continuity Tester.
- ★ Sensitive Pre-Amplifier.

Total Building Costs

£7-23 PP & Ins. 58p
(Overseas Seamail P & P £3-40)
(+25% VAT £1-80)

Components Include: 24 Resistors • 21 Capacitors • 10 Transistors • 31" Loudspeaker • Earpiece • Mica Baseboard • 3 12-way connectors • 2 Volume controls • 2 Slider Switches • 1 Tuning Condenser • 3 Knobs • Ready Wound MW/LW/SW Coils • Ferrite Rod • 6 1/2 yards of wire • 1 Yard of sleeving etc. • Parts Price List and Plans 55p free with parts.

NEW ROAMER NINE

WITH V.H.F. INCLUDING AIRCRAFT

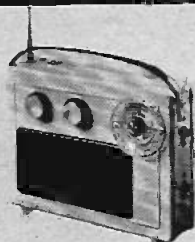

Nine Transistors, 9 Tunable wavebands as Roamer Ten. Built in ferrite rod aerial for MW/LW. Retractable chrome-plated telescopic aerial for VHF and SW. Push Pull output using 600 mW transistors, 9 Transistors and 3 diodes, tuning condenser with V.H.F. section, separate coil for aircraft, moving coil loudspeaker, volume ON/OFF and wavechange controls. Attractive all white case with red grille and carrying strap. Size 9 1/2" x 7" x 2 1/2". approx. Parts Price List and Plans free with parts.

Total Building Costs **£6-95** PP & Ins. 58p
(Overseas Seamail P & P £3-40)
(+25% VAT £1-75)

POCKET FIVE

NOW WITH 3" LOUD-SPEAKER

3 Tunable wavebands. M.W. L.W. and Trawler Band. 7 stages, 5 transistors and 2 diodes, supersensitive ferrite rod aerial, attractive black and gold case. Size 5 1/2" x 1 1/2" x 3 1/4" approx. Plans and Parts Price List free with parts.



Total Building Costs **£2-95** PP & Ins. 38p
(+25% VAT 75p)
(Overseas Seamail P & P £2-30)



TRANSONA FIVE

Wavebands, transistors and speaker as Pocket Five. Larger Case with Red Speaker Grille and Tuning Dial. Plans and Parts Price List free with parts.

Total Building Costs **£3-20** PP & Ins. 38p
(+25% VAT 80p.) (Overseas Seamail P & P £2-30)

TRANS EIGHT

8 TRANSISTORS and 3 DIODES

6 Tunable Wavebands: MW, LW, SW1, SW2, SW3 and Trawler Band. Sensitive ferrite rod aerial for M.W. and L.W. Telescopic aerial for Short Waves. 3in. Speaker. 8 improved type transistors plus 3 diodes. Attractive case in black with polished metal inserts. Total Building Costs **£4-78** PP & Ins. 50p
(+25% VAT £1-70)
(Overseas Seamail P & P £2-50)

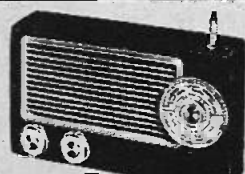

ROAMER SIX

CASE AND LOOKS AS TRANS-EIGHT

6 Tunable Wavebands: MW, LW, SW1 SW2 Waveband for easier tuning of Luxembourg, etc. Sensitive ferrite rod aerial and telescopic aerial for Short Waves. 3in. Speaker 8 stages—6 transistors and 2 diodes. Attractive black case with red grille, dial and black knobs with polished metal inserts. Total Building Costs **£4-38** PP & Ins. 50p
(+25% VAT £1-10) P & P £2-50

NEW Everyday Series

Build this exciting New series of designs E.V.5, 5 Transistors and 2 diodes. MW/LW. Powered by 4 1/2 volt Battery. Ferrite rod aerial, tuning condenser, volume control, and now with 3" loudspeaker. Attractive case with red speaker grille Size 9" x 5 1/2" x 2 1/4" approx. Parts Price List and Plans free with parts.

Total Building Costs **£3-40** PP & Ins. 50p
(Overseas Seamail P & P £2-30)
(+25% VAT 85p)

E.V.6, Case and looks as above. 6 Transistors and 3 diodes. Powered by 9 volt battery. Ferrite rod aerial, 3" loudspeaker, etc. MW/LW coverage. Push Pull output. Parts Price List and Plans free with parts.

Total Building Costs **£3-98** PP & Ins. 50p
(Overseas Seamail P & P £2-30)
(+25% VAT £1-00)

E.V.7, Case and looks as above. 7 Transistors and 3 diodes. Six wavebands. MW/LW, Trawler Band, SW1, SW2, SW3, powered by 9 volt battery. Push Pull output. Telescopic aerial for short waves. 3" Loudspeaker. Parts Price List and Easy Build Plans free with parts.

Total Building Costs **£4-48** PP & Ins. 50p
(Overseas Seamail P & P £2-50)
(+25% VAT £1-12)

ROAMER EIGHT Mk I

NOW WITH VARIABLE TONE CONTROL

7 Tunable Wavebands: MW1, MW2, LW, SW1, SW2, SW3 and Trawler Band. Built in Ferrite Rod Aerial for MW and LW. Chrome plated Telescopic aerial can be angled and rotated for peak short wave listening. Push pull output using 600mW transistors. Car aerial and Tape record sockets. Selectivity switch. 8 transistors plus 3 diodes. Latest 4" 2 watt ferrite magnet loudspeaker. Airspace charged tuning condenser. Volume on/off, tuning wave change and tone controls. Attractive case in rich chestnut shade with gold blocking. Size 9 x 7 x 4in. approx. Easy to follow instructions and diagrams. Parts price list and plans free with parts.

Total building costs **£6-98** PP & Ins. 40-65
(+25% VAT £1-70)



ROAMER TEN Mk 2

WITH VHF INCLUDING AIRCRAFT

Now with free earpiece and switched socket. 10 Transistors. Latest 4" 2 watt Ferrite Magnet Loudspeaker. 9" Tunable Wavebands. MW1, MW2, LW, SW1, SW2, SW3, Trawler Band, VHF and Local Stations also Alhralt Band. Built in Ferrite Rod Aerial for MW/LW. Chrome plated Telescopic Aerial, can be angled and rotated for peak short wave and VHF listening. Push Pull output using 600mW Transistors. Car Aerial and Tape Record Sockets. 10 Transistors plus 3 Diodes. Ganged Tuning Condenser with VHF section. Separate coil for Aircraft Band. Volume on/off. Wave Change and tone controls. Attractive Case in black with silver blocking. Size 9" x 7" x 4". Easy to follow instructions and diagrams. Parts price list and plans 50p free with parts.

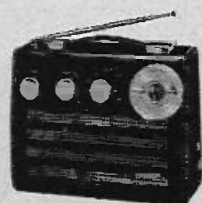

Total building costs **£9-50** PP & Ins. 20-65
(+25% VAT £2-37)

"EDU-KIT"

Build Radios. Amplifiers, etc., from easy stage diagrams.



Five units including master unit to construct

Components include:

Tuning Condenser; 2 Volume Controls; 2 Slider Switches; Fine Tone 3" Moving Coil Speaker; Terminal Strip; Ferrite Rod Aerial; Battery Clips; 4 Tag Boards; 10 Transistors; 4 Diodes; Resistors; Capacitors; Three 1" Knobs. Units once constructed are detachable from Master Unit, enabling them to be stored for future use. Ideal for Schools, Educational Authorities and all those interested in radio construction. Parts price list and plans free with parts.

Total building costs **£5-50** PP & Ins. 50p
(Overseas Seamail P & P £3-40)
(+25% VAT £1-37)

RADIO EXCHANGE LTD

★ Callers side entrance "Lavells" shop
★ Open 10-1, 2.30-4.30, Mon.-Fri. 9-12 Sat.

To RADIO-EXCHANGE CO., 61a HIGH STREET, BEDFORD, MK40 1SA
Tel.: 0234 52357, Reg. No. 788372.

I enclose £..... for

Name.....

Address.....
(Dept. EE8.)

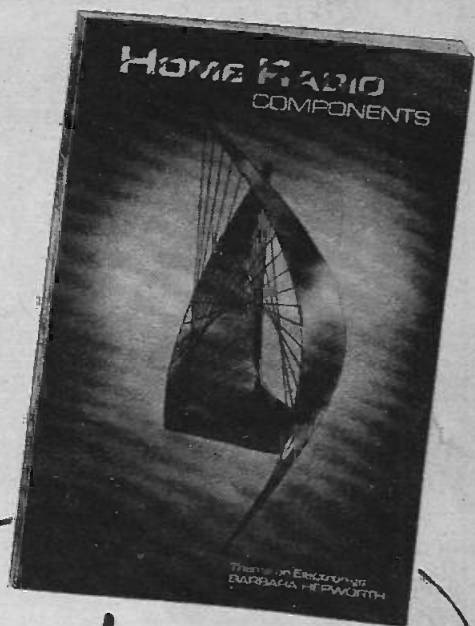
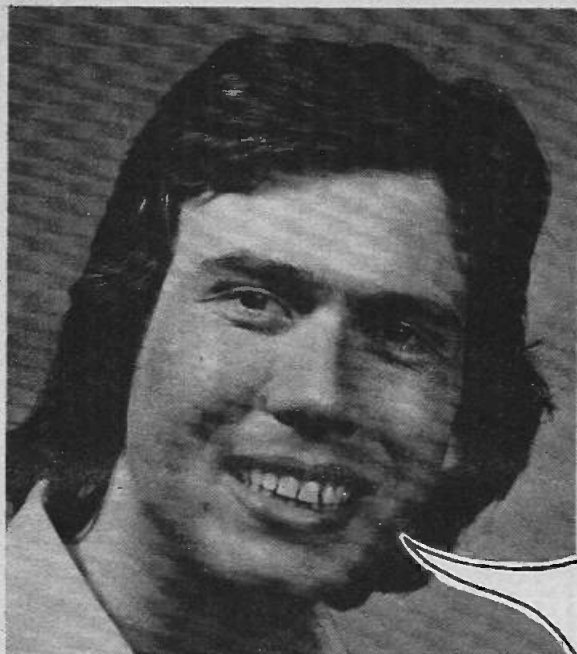

*It's the
LONG LIFE!
Catalogue!*

You have heard of "Long Life" batteries, milk and beer, so why not a "Long Life" catalogue? The thought struck me the other night when I visited a friend to chat about a joint project we were building. We needed a few bits and pieces, so he went to a drawer and pulled out a catalogue. Yes, it was the famous Home Radio Components catalogue alright, but at first I didn't recognise it. "Gracious! How old is it?" I exclaimed. "Oh" he said, "about 5 or 6 years". Fascinated, I said "Can you still use it? Surely, it's years out of date?" "No, not really" he said, "you see, many basic things like plugs, sockets, resistors, capacitors, switches, don't change much. Only the prices change, and Home Radio were wise enough to take all prices out of their catalogue many years ago and put them on a separate list. What's more, they were far sighted enough not to change their catalogue numbers, so all I have to do is to write or phone them occasionally and 'hey presto' along comes an up to date price list. Not a penny extra to pay!" "You really believe in getting your money's worth out of a catalogue" I said. "Sure thing" he replied, "but I might have bought four or five catalogues and still not ordered any more goods. These catalogues must cost Home Radio a bomb to produce, so I imagine they are quite pleased if one of their catalogues produces business for say two years or more. However I must admit it's about time I got myself a new one".

This conversation set me thinking, Home Radio Components really do produce a catalogue that will last and last, and a service to back it up. So if you are keen to save the pennies, send for a copy today. You may still be using it in 1977. On the other hand, if you really like to keep up with the latest developments, Home Radio will be happy to sell you a new one. Each year they spend at least 5 or 6 months revising it in order to bring the latest trends to your notice. Either way you cannot lose. Especially when you bear in mind, that although the initial cost is 65p plus 33p postage and packing, they enclose 14 vouchers each worth 5p if used as directed. Add to that the fact you could easily make it last two or three years... well, to borrow a phrase, "You never had it so good". Don't wait, send off the coupon today with your cheque or P.O. for 98 pence.

65p. plus 33p POST AND PACKING

POST THIS COUPON
with cheque or P.O. for 98p.

The price of 98p applies only to customers in the U.K. and to BFPO addresses.

Please write your Name and Address in block capitals

NAME.....

ADDRESS.....
.....
.....



HOME RADIO (Components) LTD., Dept. EE,
234-240 London Road, Mitcham, Surrey CR4 3HD

(Regn. No.
London 912966)

HOME RADIO (Components) LTD. Dept. EE, 234-240 London Road, Mitcham, CR4 3HD Phone 01-648 8422



become a RADIO-AMATEUR!

learn how to become a radio-amateur
in contact with the whole world. We give
skilled preparation for the G.P.O. licence

Free!

Brochure, without obligation to:

**BRITISH NATIONAL RADIO & ELECTRONICS
SCHOOL** Dept EEB 85 P.O. Box 156, JERSEY

NAME: _____

ADDRESS: _____

BLOCK CAPS please

IMPROVE PETROL CONSUMPTION

Fit the brilliant
New Scorpio Mk II
"Dual Polarity"
Capacitive Discharge
Electronic Ignition
System. Suitable for
all cars with
coil/distributor
ignition up to eight cylinders



- Genuine improvement in overall petrol consumption (Independent report claims at least 8-10%).
- Much easier cold weather starting, less strain on your battery.
- Less use of choke - Increase engine life.
- Smoother running at lower revs. - makes your four cylinder car feel like a six cylinder.

TOGETHER WITH THE FOLLOWING "SCORPIO" MK II PLUS FEATURES
NOT PREVIOUSLY AVAILABLE WITH OTHER MAKES:-

- Only one model used for both positive (+) and negative (-) earth vehicles - If you change your car, you can certainly transfer your "Scorpio". No need to specify vehicle polarity when ordering.
- There is a 6 volt model available.
- Specially suppressed against radio interference (can be troublesome with electronic ignition systems).
- Retains your original contact-breaker points, which last their mechanical life - no points burn.
- Will drive electronic tachometers.

PRICE for complete "Scorpio" Mk. II unit, fully tested and ready for immediate installation, with easy to follow instructions - £17.50 (includes V.A.T., post and packing free - UK only) PLEASE STATE WHETHER 12 VOLT OR 6 VOLT REQUIRED.

For the D.I.Y. Man, there is a complete kit of parts available with easy to follow, comprehensive instructions, PRICE only £15.50 (includes V.A.T., post and packing free - UK only). THOUSANDS ALREADY IN USE, FULLY GUARANTEED.

Please forward stamped addressed envelope for our FREE interesting brochure - "Electronic Ignition - How It Works," containing circuit and itemised price list.

ELECTRO SPARES, Dept. E.E., 288 Ecclesall Road, Sheffield S11 8PE.
Telephone: - Sheffield (0742) 688333.

MINI BLOWTORCH with the maxi uses

Just what the keen "Do it Yourself" enthusiast has been waiting for - a precision blow torch that puts the heat exactly where it's needed with a pencil point flame.

Invaluable for the amateur radio or electronic engineer, model maker etc.

Easy to hold - easy to use - no tool kit is complete without one.

- *PIN POINT FLAME UP TO 3500°F.
- *LIGHTWEIGHT *EASY AND SAFE TO USE
- *4-5 HOURS LIFE *BUTANE GAS *REFILLS READILY AVAILABLE *ADJUSTABLE HEAT INTENSITY

1. SPECIAL COOLING FINS
2. BRASS NOZZLE
3. PIN POINT FLAME
4. DETACHABLE SOLDER PENCIL

NEW



**ONLY
£6.25**
(incl. VAT P & P)

Longs

Reg England 68496.
Longs Ltd
Hanworth Lane
Trading Estate,
Chertsey,
Surrey KT16 9LZ
Tel: Chertsey 61241
Telex: 929811

Fill in this coupon now and send for your Mini Blow Torch. Money back guarantee if not satisfied.
Please send me Mini Blow Torch/es at £6.25 each
I enclose cheque/postal order for £.....

NAME _____ POSITION _____

COMPANY _____

ADDRESS _____

SIGNED _____

EE

Sinclair IC20

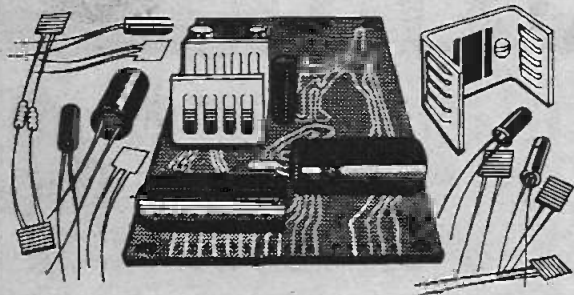

The watts...

The Sinclair IC20 is a revolutionary new 20 watts stereo amplifier kit.

It incorporates state-of-the-art integrated circuits - two monolithic silicon chips each containing the equivalent of over 20 transistors! These deliver 10 W per channel into 4Ω speakers.

And the IC20 has integral short-circuit protection and thermal cut-out - it's virtually indestructible. Use it for converting your mono record player to stereo... for upgrading your existing stereo... or for improving your car radio/tape player.

Its cost? Only £7.95 + VAT!

and the wherefores.



Get the full technical specifications...

See what impartial hi-fi journals thought of its performance...

And read up on the rest of the Sinclair hi-fi range...

It's all in the Sinclair hi-fi range fact-file.

Send for Sinclair's fact-file now!

See if the answer's here - the information on the component you've been looking for.

Simply cut the coupon and

send it to the no-stamp-needed FREEPOST address below.

We'll send you the Sinclair fact-file - giving you all you need to know about IC20, and the rest of the Sinclair hi-fi range.

Plus information about a few extras you're sure to find rather interesting.

You've plenty to gain... so cut the coupon - now!

Sinclair Radionics Ltd,
London Road, St Ives,
Huntingdon, Cambs., PE17 4HJ
St Ives (0480) 64646

Please send me the Sinclair range fact-file immediately

Name _____

Address _____

EE/IC/8

To: Sinclair Radionics Ltd,
FREEPOST, St Ives,
Huntingdon, Cambs., PE17 4BR

Please print

sinclair

We don't miss anything out, so you won't miss out.

Our 1214 Series stereo equipment comes to you in kit form. And, as you would expect, coming from Heathkit, they are absolutely complete kits. With nothing left out.

So you'll have all you need to build our superb AR-1214 stereo receiver. Or, if you'd prefer, a separate amplifier and tuner (the A A-1214 and AJ-1214).

The easy to understand instruction manual you'll get makes assembly beautifully straightforward.

And very enjoyable.

And the high performance of the 1214 Series means you won't miss out on listening pleasure in any way either.

From the stereo receiver, or separate amplifier, you'll get 15 watts r.m.s. a channel, with reproduction so good it makes many ready-made systems really sit up and listen.

For full details of the 1214 Series, the rest of our audio range, including speakers, and our many other kits, just post the coupon now for your free Heathkit catalogue.

Or call in at the London Heathkit Centre,
233 Tottenham Court Road.

Heath (Gloucester) Ltd., Dept. EE-85 Bristol Road,
Gloucester GL2 6EE. Tel: (0452) 29451.

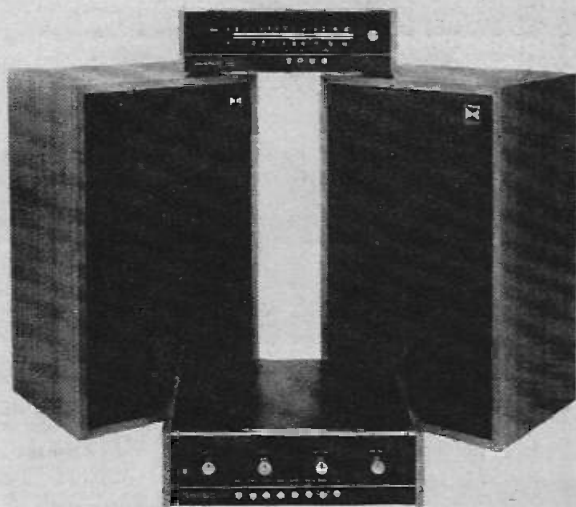
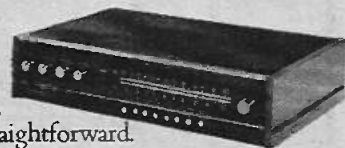

To: Heath (Gloucester) Limited, Dept. EE-85 Gloucester, GL2 6EE.
Please send me my free Heathkit catalogue.

HEATHKIT



Name: _____

Address: _____

Postcode: _____

HEATH

Schlumberger

Remember easy terms are available with the Heathkit Monthly Budget Plan.

ELECTROVALUE

Present

STABILIZED PRICE POLICY QUALITY COMPONENTS, KEEN PRICES AND DEPENDABLE SERVICE

112 page catalogue · attractive discounts · free postage & packing (U.K.)

A 100 OF THE BEST out of our latest catalogue

2N1307	47p	AF200U	40p	BD135	37p
2N2646	81p	AF239	60p	BD136	39p
2N3053	30p	B1906	35p	BDY20	83p
2N3054	64p	BA138	31p	BF194	15p
2N3065	70p	BB103	24p	BFR39	22p
2N3702	11p	BB104	40p	BFR99	28p
2N3703	11p	BB105	34p	BFY29	33p
2N3704	11p	BC107A	18p	BFY84	27p
2N3705	10p	BC107B	18p	BFY81	23p
2N3794	18p	BC108B	15p	BRY39	56p
2N3819	28p	BC108C	15p	BY184	41p
2N4082	11p	BC109B	18p	C106B1	42p
2N4443	30p	BC109C	18p	C106D1	53p
2N5052	42p	BC147A	14p	C1406	96p
2N5183	28p	BC147B	15p	MJ481	£1.20
2N5459	25p	BC148B	14p	MJ491	£1.35
40381	44p	BC149C	16p	MJ2955	80p
40382	44p	BC158B	19p	MJE371	£1.06
40602	44p	BC159A	19p	MJE321	96p
40636	£1.36	BC167B	13p	MJE2955	£1.12
40669	96p	BC168B	12p	MJE3955	88p
AC128	17p	BC169B	12p	QA91	8p
AC161R	34p	BC169C	13p	SD4	8p
AC183	27p	BC1795	28p	TIP31A	67p
AC153K	37p	BC182L	12p	TIP32A	77p
AC178	29p	BC184L	11p	TIP32A	77p
AC176K	38p	BC212L	12p	TIP41A	80p
AC187K	31p	BC214L	14p	TIP42A	82p
AC188K	29p	BC257A	14p	W02	30p
AD135	£1.82	BC259B	14p	ZTX300	14p
AD136	£1.11	BCY58	38p	ZTX304	23p
AD149	52p	BD130	70p	ZTX500	14p
AD161	42p	BD181	48p	ZTX504	45p
AD182	40p	BD132	56p	ZTX504	45p

ELECTROLYTIC CAPACITORS

Axial Lead	3V	6.3V	10V	16V	25V	40V	63V	100V
0.47	—	—	—	—	—	13p	9p	—
1.0	—	—	—	—	—	13p	9p	—
2.2	—	—	—	—	13p	—	9p	—
4.7	—	—	—	13p	—	9p	10p	9p
10	—	13p	—	—	9p	10p	9p	9p
22	—	—	9p	—	10p	9p	9p	12p
47	9p	—	9p	9p	9p	9p	12p	16p
100	10p	9p	9p	9p	10p	12p	15p	21p
220	9p	9p	10p	12p	13p	21p	34p	49p
470	10p	12p	12p	15p	16p	21p	36p	57p
1,000	13p	16p	16p	21p	25p	31p	52p	—
2,200	18p	—	—	32p	40p	52p	—	—
4,700	—	—	50p	56p	67p	—	—	—
10,000	54p	58p	—	—	—	—	—	—

RESISTORS

Code	Watts	Ohms	1 to 9	10 to 99	100 up
C	1/3	4.7-47K	1-3	1-1	0-9 nett
C	1/2	4.7-10K	1-3	1-1	0-9 nett
C	3/4	4.7-10M	1-3	1-2	0-97 nett
C	1	4.7-10M	2-2	2-5	1-92 nett
• MO	1/2	10-1M	4	3-3	2-2 nett
WW	1	0.22-0.47Ω	16	14	11 nett
WW	1	0.58-319Ω	12	10	6 nett
WW	3	1-10K	9	8	6 nett
WW	7	1-10K	11	10	8 nett

Codes:
C—carbon film, high stability, low noise.
MO—metal oxide, ElectroSil TR5 ultra low noise.
WW—wire wound, Pleassey.
Values: All E12 except C 1W, C 3W and MO 1W.
E12: 10, 12, 15, 18, 22, 27, 33, 39, 47, 56, 68, 82, and their decades.
E24: as E12 plus 11, 13, 15, 20, 24, 30, 36, 43, 51, 62, 75, 91 and their decades.
Tolerances:
5% except WW 10% ±0.05Ω below 10Ω and 1W MO 2%
Prices are in pence each for quantities of the same ohmic value and power rating. NOT mixed values. (Ignore fractions of one penny on total value of resistor order.) Prices for 100 up in units of 100 only.

all in the E.V. CATALOGUE 7 (issue 3)

112 pages of up-dated information and prices. More valuable than ever now that our price stabilizing has been introduced. Includes a 25p refund voucher for spending on orders for £5 or more list value. So before you even look at a screwdriver, make sure you have your E.V. Catalogue No. 7 issue 3 to hand. Price, post paid **30p**

PRICE STABILIZATION

Instead of changing prices from day to day with all the difficulties that brings, E.V. prices are now held for 3 monthly periods (as from July 1st) and then reviewed to see if changes are necessary for the next 3 months following.

DISCOUNTS

apply on all items except the few where prices are shown NETT. 5% on orders from £5 to £14.99; 10% on orders value £15 or more.

FREE POSTAGE & PACKING in U.K. for pre-paid mail orders over £2 (except Baxandall cabinets). If under, there is an additional handling charge of 10p.

QUALITY GUARANTEE

All goods are sold on the understanding that they conform to makers specifications. No rejects, seconds or sub-standard merchandise. We will refund or credit any balance due as requested.

V.A.T. @ 25% should be added to total value of orders. Every effort is made to ensure correctness of information at time of preparing and putting this advertisement to press.

• WAVECHANGE SWITCHES

1 pole 12 way; 2 pole 6 way; 3 pole 4 way; 4 pole 3 way each 33p
TAG STRIP 28 way 12p

• NUTS, SCREWS, etc.

In lots of 100 each
4BA NUTS 34p; 6BA NUTS 28p
1" 4BA Screws 30p; 1" 6BA Screws 24p
Threaded pillars 6BA, 1" hexagonal £1.46
Plain spacers 1" round £1.32
Other sizes available

CAPACITORS

DALY ELECTROLYTIC In cans, plastic sleeved
1000mF/25V 48p 2200/100 £1.91
5000/100 £3.85 5000/50 58p
5000/25V 86p 2000/50 78p
2000/25 58p 2000/50 £1.44
1000/100 86p

POLYESTER TYPE C.280. Radial leads for P.C.B. mounting. Working voltage 250V d.c.
0-01, 0-015, 0-022, 0-033, 0-047 ea. 3p
0-068, 0-1, 0-15 ea. 4p
0-22 5p; 0-33 7p; 0-47 8p; 0-68 11p; 1-0 14p; 1-5 21p; 2-2 24p

SILVERED MICA. Working voltage 500V d.c. Tolerance 1% or 0.5pF
Values in PFs—2-2 to 250 in 20 stages ea. 8p
470-820 in 5 stages, ea. 8p; 820 in 4 stages 16p
1000, 1500, 1800 12p; 2200, 2700 13p; 3600 17p; 4700, 1500 19p; 6800 24p; 8200 31p; 1000 33p

TANTALUM BEAD
0-1, 0-22, 0-47, 1-0 mF/35V, 1-5/20V, 3-3/16V ea. 18p
2-2/16V, 2-2/35V, 4-7/16V, 10/6-3V ea. 16p
4-7/35V, 10/16V, 22/6-3V ea. 23p
10/25V, 22/16V, 47/6-3V, 100/3V, 6-8/25V, 15/25V ea. 23p

POLYCARBONATE
Type-B.32540 Values in μF:
0-0047; 0-0068; 0-01; 0-015; 0-022 ea. 4p
0-018; 0-027; 0-033; 0-039; 0-047; 0-068; 0-1; ea. 5p
0-058; 0-082; 0-12; 0-15 ea. 8p
0-18; 0-22 7p; 0-27, 0-33 9p; 0-39, 0-47 11p; 0-58, 0-68 16p

CERAMIC PLATE
Working voltage 50V. d.c.
In 26 values from 22p to 6800pF. ea. 2p

POTENTIOMETERS

ROTARY, CARBON TRACK.
Double wipers for good contact and long working life
P.20 SINGLE linear 100 ohms to 4-7 meg ohms each 14p
P.20 SINGLE log. 4-7 Kohms to 2-2 megohms, each 14p
J.P.20 DUAL GANG lin. 4-7 Kohms to 2-2 megohms, each 48p
J.P.20 DUAL GANG log. 4-7 Kohms to 2-2 megohms, each 48p
J.P.20 DUAL GANG Log/antilog 10K, 22K, 47K, 1 ea. 48p
J.P.20 DUAL GANG antilog 10K only ea. 48p
2A DP mains switch for any of above 14p extra.
Decades of 10, 22 and 47 only available in ranges above.
Skeleton Carbon Presets, Type PR, horizontal or vertical 8p each.
SLIDER
Linear or log mono 4-7K to 1 meg. in all popular values each 36p
STEREO, matched tracks, lin. or log in all popular values from 4-7K to 1 meg. 66p
Escutcheon plates, mono, black or grey, each 18p
Control knobs. blk/whl/red/yel/gn/blue/dk grey/lt grey, each 7p

• MINITRON DIGITAL INDICATORS
3815F Seven segment filament compatible with standard logic modules. 0-9 and decimal point; 9mm characters in 16 lead DIL £1.28
Suitable BCD decoder driver 7447 £1.15
3815S showing + or - & 1 & dec. pt. £1.28

• LED'S (Light Emitting Diodes)
Photo Cells, cadmium sulphide each 48p

• ANTEX Soldering Irons
C2-240 £2.45 Spare bits 35p
CCN240 £2.96 Spare bits 45p

ELECTROVALUE LTD

28, ST. JUDES ROAD, ENGLEFIELD GREEN, EGHAM, SURREY TW20 0HB
Telephone Egham 3803 Telex 264475 Shop hours 9-5.30 daily; Sat. 9-1 p.m.

NORTHERN BRANCH: 680, Burnage Lane, Burnage, Manchester M19 1NA
Telephone (061) 432 4945 Shop hours 9-5.30 daily; Sat. 9-1 p.m.

U.S.A. CUSTOMERS are invited to contact ELECTROVALUE AMERICA, P.O. Box 27, Swarthmore PA 19081.

Sinclair hi-fi

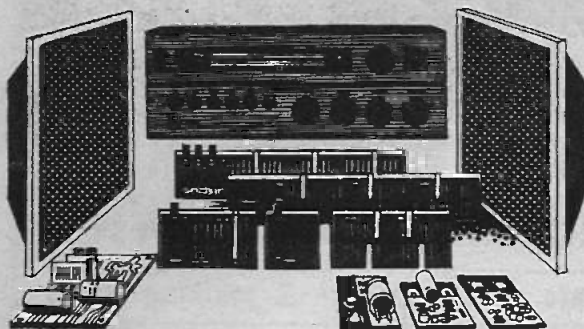

The watts...

The Sinclair range of hi-fi products. Three different ways of achieving hi-fi excellence - whatever area of hi-fi you're interested in.

And the Sinclair range fact-file gives you the full run-down on all of them.

On Project 80 - the build-as-you-please hi-fi module system.

On IC20 - the revolutionary integrated circuit amplifier kit.

And System 4000 - the luxury hi-fi amplifier and matching tuner.

and the wherefores.



The Sinclair range fact-file shows you the whole story. Technical specifications... complete descriptions... big, clear pictures... and test reports by impartial hi-fi journals.

A real bundle of goodies.

Send for Sinclair's range fact-file - now!

See if the answer's here - the information on the component you've been looking for.

Simply cut the coupon and send it to the no-stamp-needed FREEPOST address below.

We'll send you the Sinclair fact-file - giving you all you need to know about Sinclair hi-fi. And information about a few extras you're sure to find rather interesting.

Sinclair Radionics Ltd,
London Road, St Ives,
Huntingdon, Cambs., PE17 4HJ
St Ives (0480) 64646

Please send me the Sinclair range fact-file immediately

Name _____

Address _____

EE/HF/8

Please print

To: Sinclair Radionics Ltd,
FREEPOST, St Ives,
Huntingdon, Cambs., PE17 4BR

sinclair



"I MADE IT MYSELF"

Imagine the thrill you'll feel! Imagine how impressed people will be when they're hearing a programme on a modern radio you made yourself.

Now! Learn the secrets of radio and electronics by building your own modern transistor radio!

Practical lessons teach you sooner than you would dream possible.

What a wonderful way to learn—and pave the way to a new, better-paid career! No dreary ploughing through page after page of dull facts and figures. With this fascinating Technatron Course, you learn by building!

You build a modern Transistor Radio... a Burglar Alarm. You learn Radio and Electronics by doing actual projects you enjoy—making things with your own hands that you'll be proud to own! No wonder it's so fast and easy to learn this way. Because learning becomes a hobby! And what a profitable hobby. Because opportunities in the field of Radio and Electronics are growing faster than they can find people to fill the jobs!

No soldering - yet you learn faster than you ever dreamed possible.

Yes! Faster than you can imagine, you pick up the technical know-how you need. Specially prepared step-by-step lessons show you how to read circuits—assemble components—build things—experiment. You enjoy every minute of it! You get everything you need. Tools. Components. Even a versatile Multimeter that we teach you how to use. All included in the course. **AT NO EXTRA CHARGE!** And this is a course anyone can afford. (You can even pay for it by easy instalments).

So fast, so easy, this personalised course will teach you even if you don't know a thing today!

No matter how little you know now, no matter what your background or education, we'll teach you. Step by step, in simple easy-to-understand language, you pick up the secrets of radio and electronics. You become a man who makes things, not just another of the millions, who don't understand. And you could pave the way to a great new career, to add to the thrill and pride you receive when you look at what you have achieved. Within weeks you could hold in your hand your own transistor radio. And after the course you can go on to acquire high-powered technical qualifications, because our famous courses go right up to City & Guilds levels.

Send now for FREE 76 page book - see how easy it is - read what others say!

Find out more now! This is the gateway to a thrilling new career, or a wonderful hobby you'll enjoy for years. Send the coupon now. There's no obligation.

POST TODAY FOR FREE BOOK

To: ALDERMASTON COLLEGE CEE 08
DEPT. CEE 08, READING RG7 4PF

Also at our London Advisory Office, 4 Fore Street Avenue, Moorgate, London EC2Y 5EJ. Tel: 01-628 2721.

Yes, I'd like to know more about your course. Please send me free details—plus your big, 76-page book that tells about all your courses.

NAME _____

ADDRESS _____

POSTCODE _____



HOME OF BRITISH INSTITUTE OF ENGINEERING TECHNOLOGY



I.L.P. (Electronics) Ltd

SHEER SIMPLICITY!

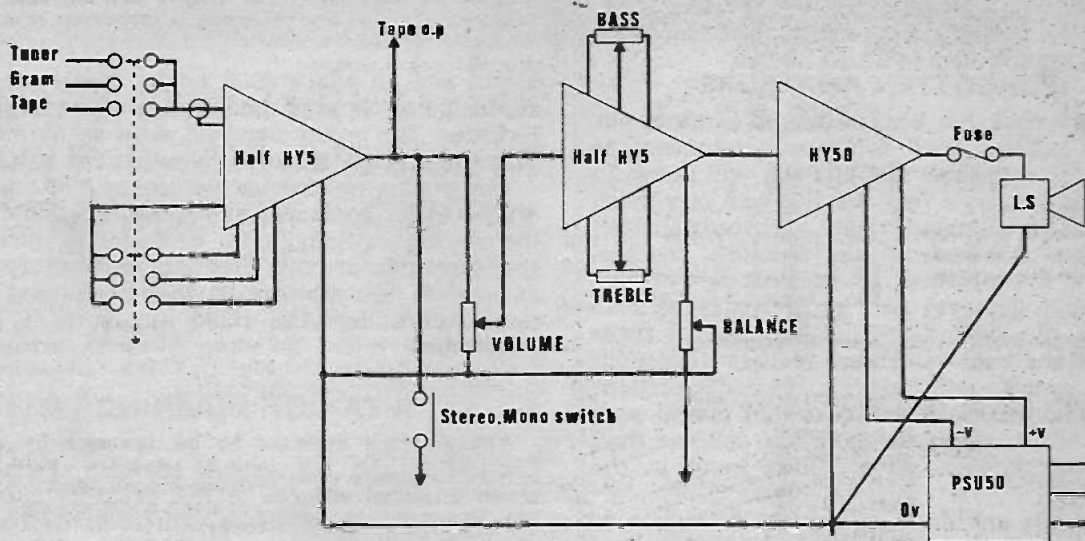

MONO ELECTRICAL CIRCUIT DIAGRAM WITH INTERCONNECTIONS FOR STEREO SHOWN
POWER CONNECTIONS FROM PFU50 TO HY5 NOT SHOWN FOR CLARITY OF DIAGRAM

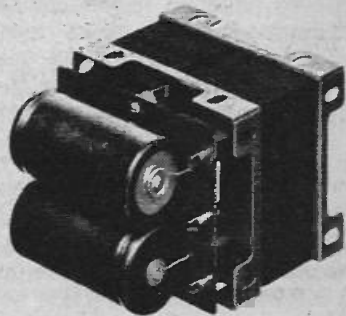
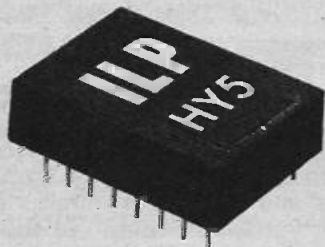

The HY5 is a complete mono hybrid preamplifier, ideally suited for both mono and stereo applications. Internally the device consists of two high quality amplifiers—the first contains frequency equalisation and gain correction, while the second caters for tone control and balance.

TECHNICAL SPECIFICATION
Inputs: Magnetic Pick-up 3mV RIAA; Ceramic Pick-up 30mV; Microphone 10mV; Tuner 100mV; Auxiliary 3-100mV; Input Impedance 47kΩ at 1kHz. Outputs: Tape 100mV; Main output 0db (0-775V RMS). Active Tone Controls: Treble ± 12db at 10kHz; Bass ± 12db at 100Hz. Distortion: 0-5% at 1kHz. Signal/Noise Ratio: 68db. Overload Capability: 40db on most sensitive input. Supply Voltage: ± 18-25V.

The HY50 is a complete solid state hybrid Hi-Fi amplifier incorporating its own high conductivity heatsink hermetically sealed in black epoxy resin. Only five connections are provided, input, output, power lines and earth.

TECHNICAL SPECIFICATION
Output Power: 25W RMS into 8Ω. Load Impedance: 4-16Ω. Input Sensitivity 0db (0-775V RMS). Input Impedance: 47kΩ. Distortion: Less than 0-1% at 25W typically 0-05%. Signal/Noise Ratio: Better than 75db. Frequency Response: 10Hz-50kHz ± 3db. Supply Voltage: ± 25V. Size: 105 x 50 x 25mm.

The PSU50 incorporates a specially designed transformer and can be used for either mono or stereo systems.

TECHNICAL SPECIFICATIONS
Output voltage: 50V (25-0-25V). Input Voltage: 210-240V. Size: L.70. D.90. H.50mm.

PRICE £4.50 + 36p VAT
P. & P. free

PRICE £5.98 + 48p VAT
P. & P. free

PRICE £6 + 48p VAT
P. & P. free

TWO YEARS' GUARANTEE ON ALL OUR PRODUCTS

I.L.P. Electronics Ltd.
Crossland House,
Nackington, Canterbury
Kent CT4 7AD
Registered Office
Tel (0227) 63218

Please supply,
Total Purchase price
I Enclose, Cheque Postal Orders Money Order
Please debit my Access account Barclaycard account E.E. £
Account number
Name & Address
Signature

everyday electronics

PROJECTS
THEORY...

FORGOTTEN AMATEURS

The amateur has always figured large in our national affairs. That is no over-statement, as those who remember the last war will know. In 1940 this country's very survival was very much in "amateur" hands. Private yachtsmen helped bring the B.E.F. from the Dunkirk beaches, weekend flyers formed a significant part of "the few" who defeated the air armadas sent to prepare the ground for the conquest of these islands, and radio amateurs in their thousands helped operate and maintain the radar stations and communications networks that played such a vital role in those dramatic late summer days when our survival as a nation hung in the balance.

Memories are short, of course. And none so short it seems as those of politicians and government administrators. Last April's Budget by strange irony managed to penalise today's amateurs engaged in certain leisure pursuits—including precisely those areas that proved crucial for our survival 35 years ago. Private flyers suffer from the higher V.A.T. imposed on their fees, yachtsmen have the same heavy tax on their craft and equipment, and the electronics enthusiast has to meet this same 25 per cent tax on the majority of his components.

Flying and yachting might with justification be called rich men's hobbies or spare time pursuits. Electronics cannot; its appeal is universal, and knows no social or class bounds. As both a

useful and an educational hobby it is open to all, including those of modest means and limited facilities. The outlay involved need be no more than the average schoolboy's pocket can sustain.

The young electronics enthusiasts of today are potential engineers and technicians, and in the continuous struggle for economic prosperity they have a future role that may prove every bit as vital to this country as that performed by their forerunners the radio amateurs of pre 1939 times.

A TAX ON LEARNING

Yet all this appears to be ignored by our Chancellor and his expert advisers. Perhaps those financial wizards of the Treasury should rub shoulders more often with their civil service colleagues in other ministries and departments dealing with such matters as defence, trade and industrial affairs, and education. They might even recall some basic truths, like you don't eat the seed corn unless you're hell-bent on self-destruction.

The higher V.A.T. on electronic components is a considerable blow to many, but especially to youngsters. It amounts to a tax on learning. What a thought to contend with as the economic situation worsens and the country braces itself to fight another "Battle of Britain" in the late summer of '75.

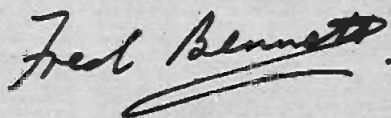

Our September Issue will be published on Friday, August 15

EDITOR F. E. Bennett ● ASSISTANT EDITOR M. Kenward ● TECHNICAL EDITOR B. W. Terrell B.Sc.
ART EDITOR J. D. Pountney ● P. A. Loates ● K. A. Woodruff
ADVERTISEMENT MANAGER D. W. B. Tilleard

© IPC Magazines Limited 1975. Copyright in all drawings, photographs, and articles published in EVERYDAY ELECTRONICS is fully protected, and reproduction or imitations in whole or part are expressly forbidden.

All reasonable precautions are taken by EVERYDAY ELECTRONICS to ensure that the advice and data given to readers are reliable. We cannot, however, guarantee it, and we cannot accept legal responsibility for it. Prices quoted are those current as we go to press. Everyday Electronics Fleetway House, Farringdon Street, London, E.C.4. Phone: Editorial 01-634-4452; Advertisements 01-634-4202.

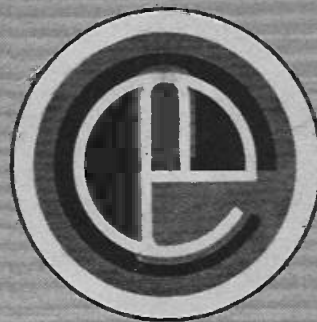

EASY TO CONSTRUCT SIMPLY EXPLAINED

VOL. 4 NO. 8

AUGUST 1975

CONSTRUCTIONAL PROJECTS

INTRUDER ALARM For the home. Informs you of uninvited guests by D. H. Williams	406
WHITE NOISE GENERATOR A source of musical and other effects by D. J. Fraser	410
AUTOMATIC GARAGE DOORS—Part 2 by P. H. Alley	424
FET VOLTMETER A high impedance voltmeter for a.c. and d.c. measurements -by Stephen Wedge	438

GENERAL FEATURES

EDITORIAL	404
COUNTER INTELLIGENCE A retailer comments on V.A.T. by Paul Young	413
ELECTRONICS IN CAMERAS by J. B. Dance	414
PHYSICS IS FUN A Magnetiser by Derrick Daines	419
YOUR CAREER IN ELECTRONICS The Post Office by Peter Verwig	420
SHOP TALK Component buying for constructional projects by Mike Kenward	423
THE UNIJUNCTION TRANSISTOR Theory and circuits by J. B. Dance	430
FOR YOUR ENTERTAINMENT Video recording equipment by Adrian Hope	432
JACK PLUG AND FAMILY Cartoon	433
PROFESSOR ERNEST EVERSURE The Extraordinary Experiments of. by Antony J. Bassett	434
BRIGHT IDEAS Readers' hints and tips	437
PUBLISHER'S ANNOUNCEMENT International copyright	437
BRITISH AMATEUR ELECTRONICS CLUB Members and club projects	443
DOWN TO EARTH Resistors at v.h.f. by George Hylton	444

Publisher's Annual Subscription Rate, including postage Inland £4.00, Overseas £3.90, USA/Canada \$11. International Giro facilities Account No. 5122007. State reason for payment "message to payee". Address to Everyday Electronics, Subscription Department, Carlton House, Great Queen Street, London, WC2E 9PR. Binders for volumes 1 to 4 (state which) and indexes for volume 1 and 2 available for £1.85 and 30p respectively, including postage, from Binding Department, at the above address.

We are unable to supply back copies of Everyday Electronics or reprints of articles and cannot undertake to answer readers' letters requesting designs, modifications or information on commercial equipment or subjects not published by us. An s.a.e. should be enclosed for a personal reply. Letters concerning published articles should be addressed to: The Editor, those concerning advertisements to: The Advertisement Manager, both at the address shown opposite.

**ARE YOU NEW TO ELECTRONICS?
BEGINNER'S SERIES**
COMING SOON ... Details Next Month
This is your BIG CHANCE-Don't miss it!

INTRUDER ALARM

Uses concealed magnetic switches to detect the opening of doors and windows.

By D. H. WILLIAMS

ANYONE wishing to install an intruder alarm in their own home has many decisions to make concerning the equipment used and the method of operation, for instance, the unit may be mains powered, battery powered, or mains powered with battery standby, each having its attendant advantages and disadvantages.

Mains powered equipment would not work should there be a power cut, and one is unable to leave the mains switched off during holidays. It is, however, cheap to run and should need no further attention. If fitted with a battery standby, interruption of the supply is catered for, but batteries deteriorate even when not in use, and therefore need regular replacement.

Equipment that is powered only by batteries is independent of mains and if the current drawn is very small the working life of the batteries would be almost as long as the shelf life. Another point is that being perfectly safe the beginner may build such a unit with confidence.

BASIC CIRCUITS

Basically there are two types of alarm, the normally open circuit, and the normally closed. A very simple alarm can be made using normally open switches, see Fig. 1. However, failure of one of the switches or a break in the wiring would prevent the alarm working.

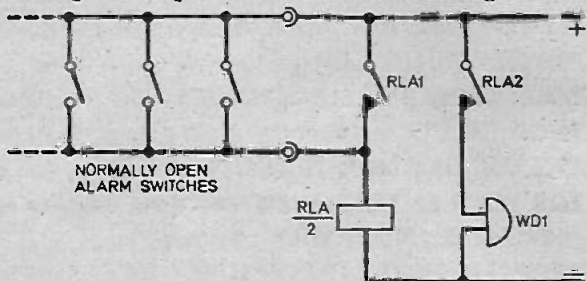

Fig. 1. Basic details of a normally open type alarm circuit.

If a closed circuit is used, as in Fig. 2, wiring and alarm switches are checked when switching on. A circuit of this type if wired in twin wire could be rendered inoperative by shorting the two conductors together. This being undesirable in a burglar alarm, further precautions must be taken.

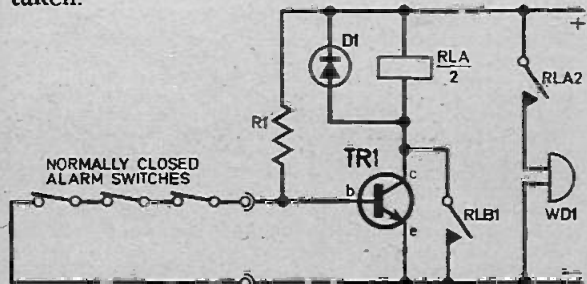

Fig. 2. Details of a normally closed type alarm circuit.

If a separate battery is placed at the furthest point from the control unit and a current from this battery is passed through the alarm switches to the control unit, then either a short-circuit or open circuit anywhere in the wiring will prevent this current reaching the unit and activate the alarm. The circuit shown in Fig. 3 is of this type.

CIRCUIT DESCRIPTION

The current from the remote battery, through the alarm switches, holds TR1 on, which switches TR2 off. Should one of the alarm switches be opened or a short circuit occur, no current flows in the base of TR1, which switches off, allowing R2 to switch TR2 on, the relay operates and is latched by one pair of contacts, the other pair providing voltage for the warning device.

A 10 kilohm resistor is connected in series with the remote battery so that a short across the wiring will not cause excessive current drain. This also enables the use of pressure mats (switch trigger mats) in the alarm wiring.

Switch S1 is pushed to test the circuit before switching the alarm on, in the event of a fault the light emitting diode D2 will light indicating an open door etc; S2 preferably a key operated switch, is the on/off switch.

Potentiometer VR1 adjusts the sensitivity of the unit and is set such that the unit will activate if the resistance of the alarm wiring increases by 10 kilohms or more. To set the sensitivity the 10 kilohm resistor in series with the remote battery is temporarily replaced by a resistance of 20 kilohms (two 10 kilohm resistors in series), VR1 is set to maximum resistance and the unit switched on; VR1 is slowly reduced in value until the alarm activates. The 10 kilohm

resistor is then reconnected.

The audible warning device WD1 provides internal alarm and the bell can be mounted in any convenient position externally if it is required.

Components....

Resistors

- R1 100k Ω
- R2 33k Ω
- R3 1k Ω
- R4 10k Ω
- R5 10k Ω (see text)
- All $\pm 10\%$ $\frac{1}{4}$ W carbon

SEE

**SHOP
TALK**

Switches

- S1 s.p.s.t. push to make
- S2 d.p.s.t. key operated
- Sa, b... etc, reed switches with operating magnets and pressure mats if required—see text.

Semiconductors

- TR1 2N2926G silicon npn
- TR2 2N2926G silicon npn
- D1 IN4001 or similar silicon diode
- D2 light emitting diode with panel mounting

Miscellaneous

- VR1 10k Ω skeleton preset—horizontal type
- RLA 430 Ω 12V relay with two sets of normally open contacts
- WD1 Audible warning device 12V (RS type)
- WD2 Friedland 150mm underdome bell, 6/12V or similar as required.
- Veroboard 0.1inch matrix 30 holes by 15 strips, 4 way connector block, case Norman AB17 or similar 250 \times 120 \times 75mm, connecting wire, 4BA fixings, etc.

Fig. 3. The complete circuit diagram of the Intruder Alarm.

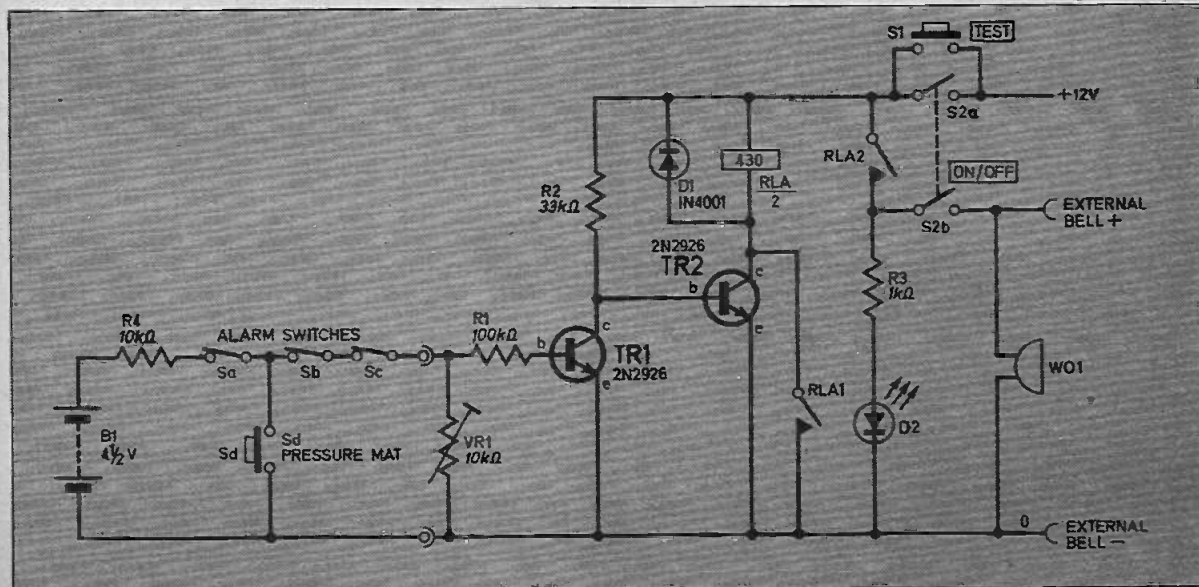

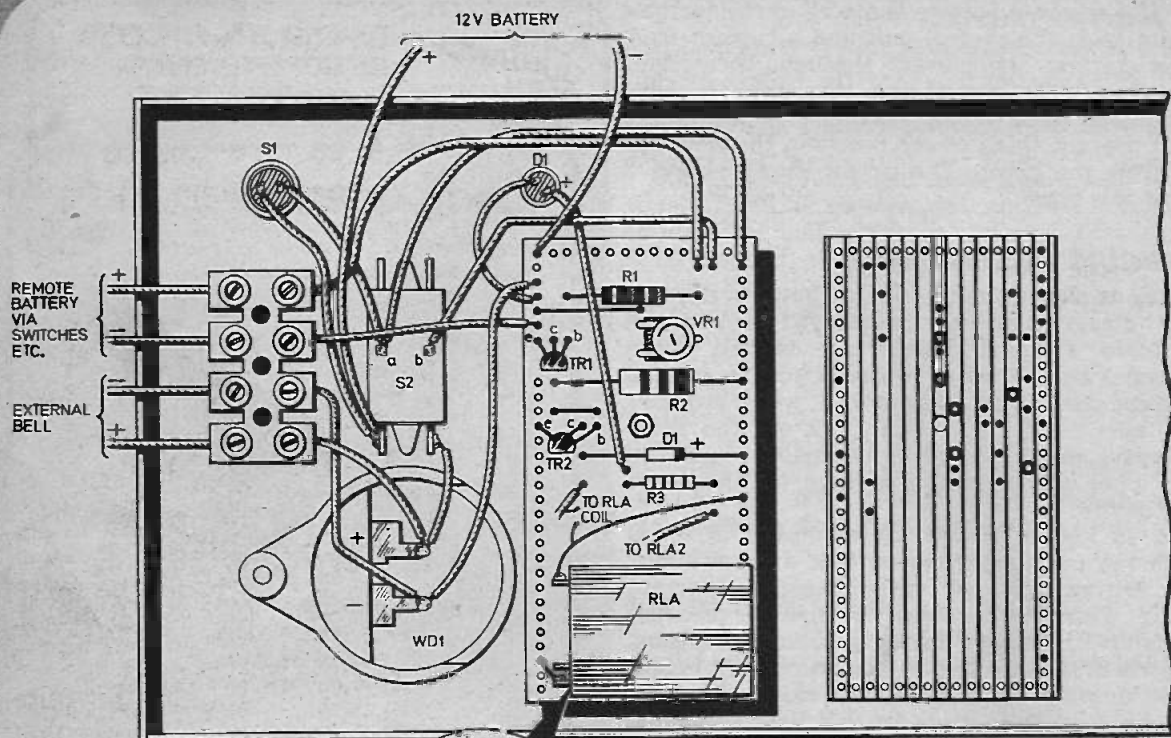

Fig. 4. The layout of the components on the Veroboard and complete wiring up details.

INTRUDER ALARM

By D. H. WILLIAMS

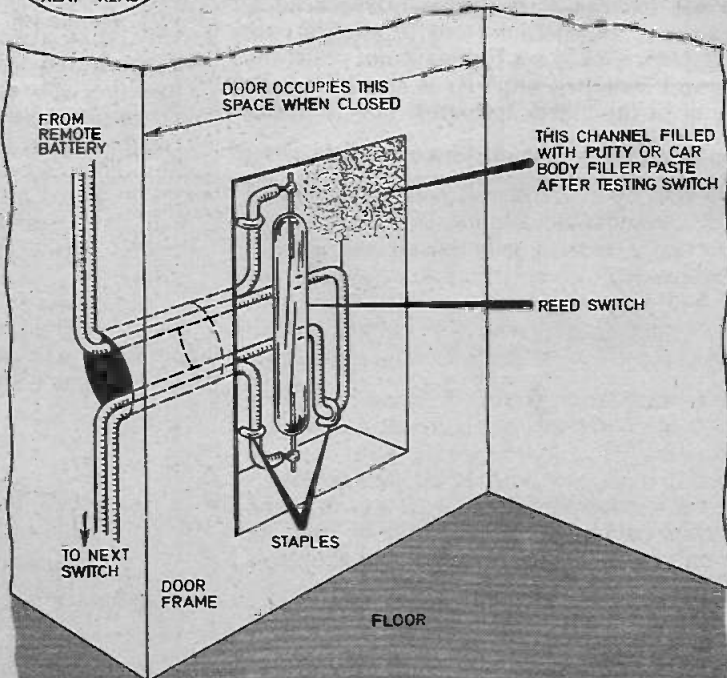

Fig. 6. Wiring and fitting a "concealed" magnetic switch in a door frame.

CONSTRUCTION

The prototype unit is housed in an aluminium box, using the lid as the front panel, all the components are mounted on the lid (Fig. 4) and there is enough space in the box for the two 6V batteries which power the unit. The supply leads are soldered directly to the springs on the batteries, excess length of spring should be cut off to prevent shorting to the case.

The basic circuit is built on a piece of Vero-board, as shown in Fig. 4, and provision made for the connection of an external bell, such as a Friedland 150mm underdome 6-12V, which can be mounted on the outside of the house, or in any convenient position.

SWITCHES

Nothing, so far, has been said of the type of switch used, this of course will depend on the individual, but the author recommends the use of magnetic reed switches mainly because of their reliability, but also because their small size makes them easy to conceal.

When setting the alarm and leaving the house one needs some method of by-passing the switches on the exit route, the obvious way of doing this is to mount a key operated switch outside the house, say in the door frame, which short-circuits the relevant switches, see Fig. 5.

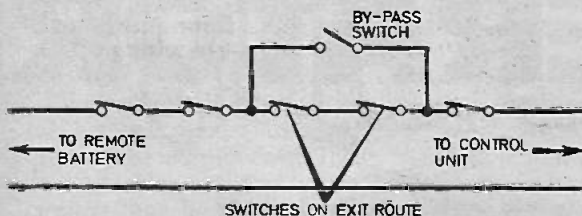

Fig. 5. Details of fixing a by-pass switch.

Use could also be made of a concealed magnetic reed, with a removable magnet.

The alarm is most easily wired using twin figure-8 stranded wire; all joints should be soldered and insulated for reliability.

WIRING

As far as the alarm wiring is concerned, one need not worry about concealing it from possible intruders as any tampering will activate the alarm. It is suggested that all outside doors and opening windows be fitted with a switch and also internal communicating doors, in case an intruder enters the house by removing the glass from a window.

In any situation where a switch and magnet are undesirable (valuable paintings, TV sets, audio equipment, etc.) pressure mats may be used, but these should be checked occasionally because they sometimes "creep" under the carpet and may be rendered ineffective. Care

FOR GUIDANCE ONLY

ESTIMATED COST* OF COMPONENTS
excluding V.A.T.

£3.70 excluding case and remote switches

*Based on prices prevailing at time of going to press

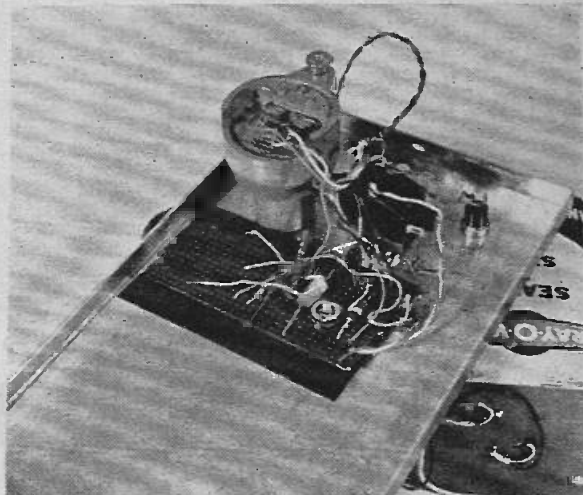

Photograph showing the prototype component board and wiring.

must be taken that there are no protruding nails, or other irregularities, under the pressure mat.

If the house has fitted carpets, the wiring can be concealed under the edge of the carpet (as close to the wall as possible) and the switches can be mounted by cutting a channel in the door frame, fitting the reed switch and filling the channel with putty or cellulose filler, as used in car repairs. The magnet should be fitted in the door in a similar manner, such that when the door is closed the reed switch and magnet are in line.

Connection to the switch is made by splitting the twin wire and cutting one of the conductors, the two ends are bared and then soldered to the lead-out wires (see Fig. 6). □

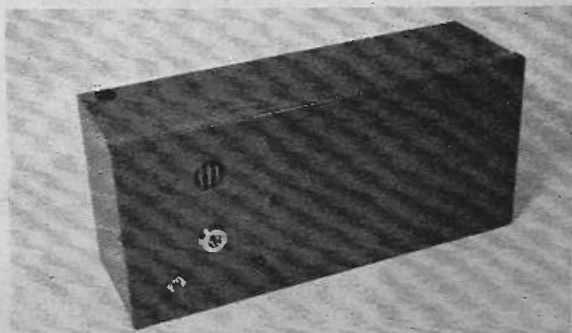

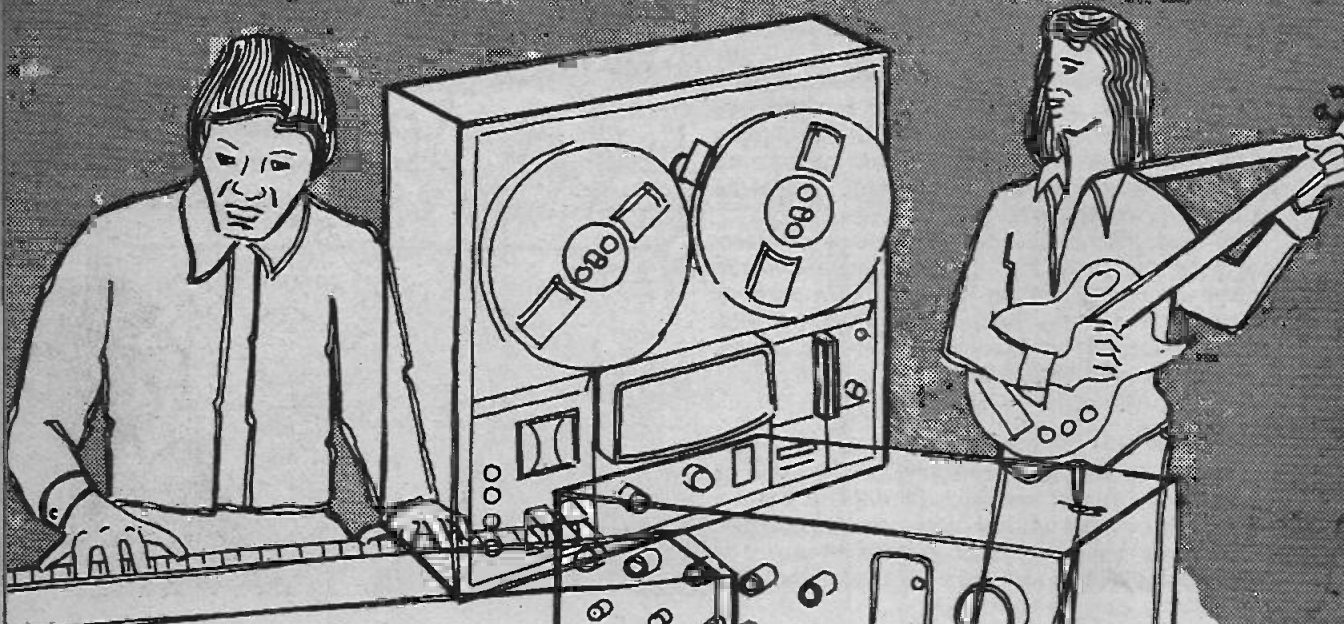

WHITE NOISE GENERATOR

By D. J. FRASER

Can be used alone or with other electronic equipment to produce a range of unusual effects.

A white noise generator is a very useful piece of electronic equipment in the field of sound effects as it can produce a wide variety of tones and easily be filtered. The range of sounds include natural sounds, such as wind, rain and hail, and unnatural sounds, such as an express train (especially effective in stereo) and a drum (used in conjunction with shaping circuits).

BASIC CIRCUIT

The basic circuit which produces the white noise is shown extreme left in Fig. 1. It is very simple consisting of a resistor and a germanium diode or one junction of a germanium transistor. This latter component will have to be experimented with to obtain the highest output level. The output from this circuit, however, is so low

HOW IT WORKS

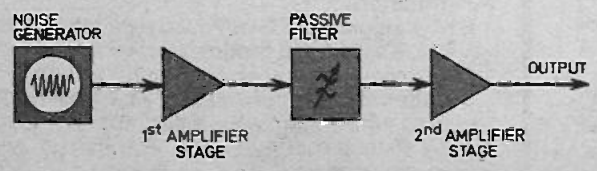

A diode is used as a noise generator and feeds an amplifier stage to provide reasonable voltage level. The signal is then passed to a filter stage that can be switched to provide various tones. Finally the signal is again amplified to produce an output suitable for feeding a variety of audio equipment.

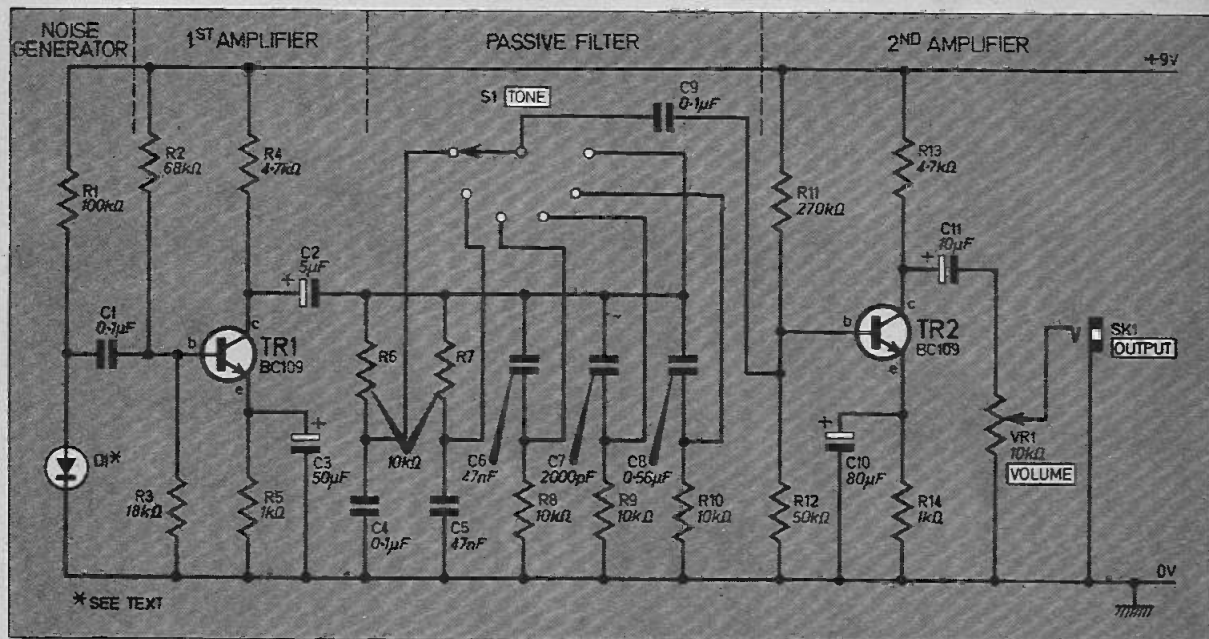

Fig. 1. The complete circuit diagram of the White Noise Generator.

that on putting the output into any normal amplifier, no sound will be heard. A single transistor amplifier is therefore used to increase this output to about 10mV and is shown in Fig. 1 as TR1 and its associated biasing resistors.

PASSIVE FILTERS

The output from this stage is fed to the filter stage which consists of several high and low pass filters. The output from these is fed to a switch to select the required tone. Active tone control circuits may be used, incorporating controls for bass and treble boost and cut, but this would entail extra circuitry and was felt unnecessary by the author.

The switch output may be fed directly into the input of a sensitive amplifier but as most commercial amplifiers are not sensitive enough an extra amplifier was designed to boost the output to a higher level. This is shown as TR2 in Fig. 1.

CONSTRUCTION

The main unit is built on a small piece of Veroboard which is shown in Fig. 2. As usual the resistors are mounted first then capacitors, noting polarity of electrolytics, and then the transistors, being careful not to overheat them whilst soldering. The tone circuit is best mounted on the switch tags, using an extra tag as a common earth terminal.

The board is bolted to the front panel using small bolts and spacers. A completely shielded metal case is advisable if the unit is likely to be near any source of mains hum. If a metal case is not used the metal switch parts and the poten-

Components . . .

Resistors

R1 100kΩ	R8 10kΩ
R2 68kΩ	R9 10kΩ
R3 18kΩ	R10 10kΩ
R4 4.7kΩ	R11 270kΩ
R5 1kΩ	R12 50kΩ
R6 10kΩ	R13 4.7kΩ
R7 10kΩ	R14 1kΩ
All ¼W carbon ± 10%	

Capacitors

C1 0.1μF plastic or paper
C2 5μF elect. 12V
C3 50μF elect. 12V
C4 0.1μF plastic or paper
C5 47nF plastic or paper
C6 47nF plastic or paper
C7 2,000pF plastic or paper
C8 0.56μF plastic or paper
C9 0.1μF plastic or paper
C10 80μF elect. 12V
C11 10μF elect. 12V

SEE
**SHOP
TALK**

Semiconductors

D1	any germanium diode or a junction of a germanium transistor (see text)
TR1	BC 109 silicon npn
TR2	BC 109 silicon npn

Miscellaneous

S1	single-pole 6-way rotary switch
VR1	10kΩ log. potentiometer
SK1	mono jack socket and plug to suit Veroboard 0.15 inch matrix, 24 holes by 20 strips, connecting wire, case approx. 150 x 100 x 60mm, knobs (2 off), 4BA fixings and spacers, screened lead, earth tag.

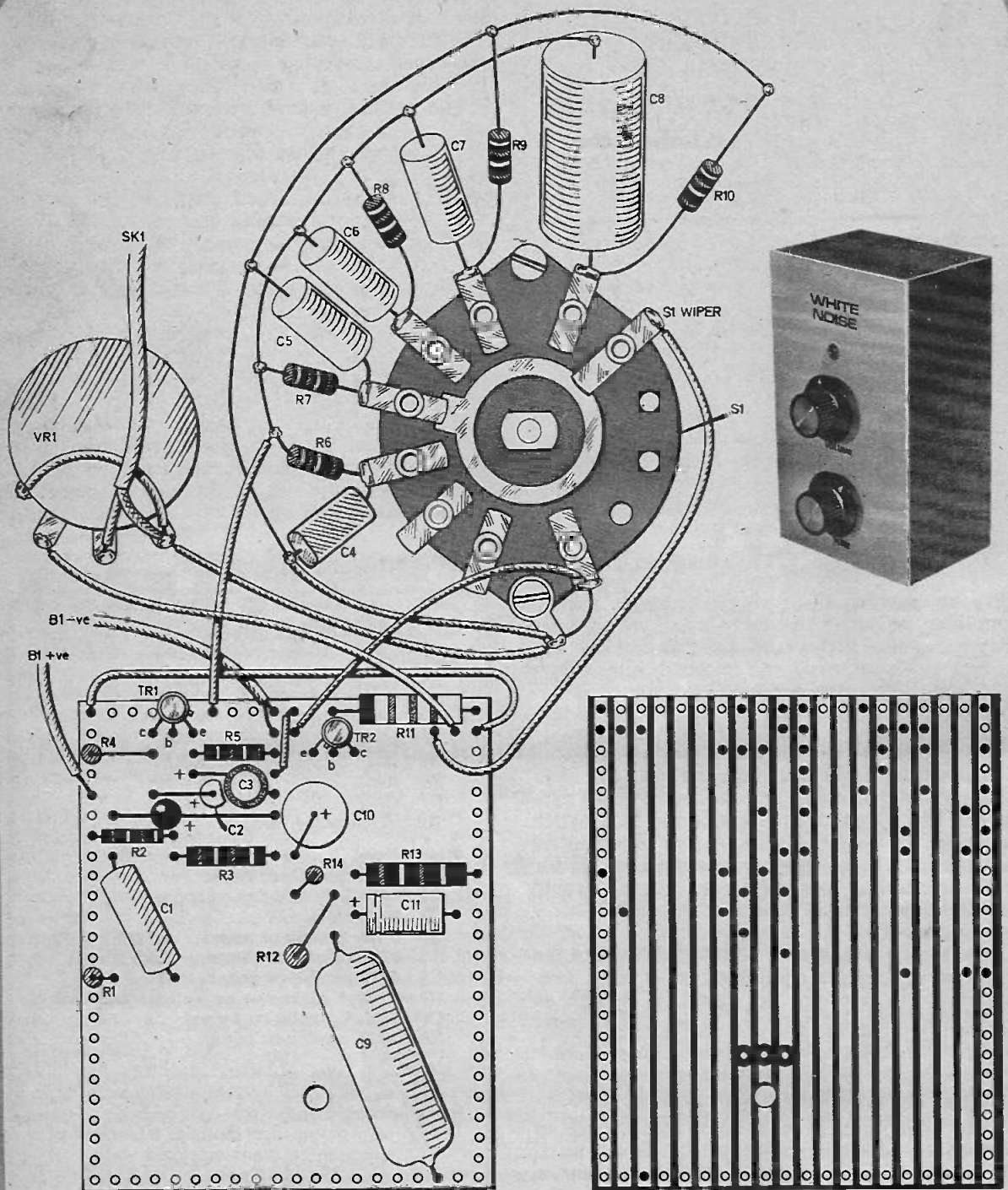
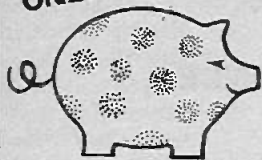

Fig. 2. The layout of the components on the Veroboard and complete wiring details.

WHITE NOISE GENERATOR

FOR
GUIDANCE
ONLY

ESTIMATED COST*
OF COMPONENTS
excluding V.A.T.



£2.10
excluding case

*Based on prices prevailing at
time of going to press

tiometer case should be earthed with the output socket. The unit is connected to the amplifier, tape recorder, etc., using a length of screened lead with a jack plug to suit SK1 on one end and a plug to suit the equipment on the other.

USE IN PRACTICE

The complete unit may be used by itself with a low powered amplifier to form a simple effects unit or it may be used with a tape recorder or in a simple synthesiser in conjunction with other units such as voltage controlled oscillators, fuzz units, tremolo and waa waa units as have been described in this magazine in the past (back issues are not available).

Effective train sounds can be produced using the unit in conjunction with a stereo amplifier. The train will seem to travel from one speaker to the other at varying speeds, this sounds best if the amplifier has a full range balance control.

The volume control is turned fully anticlockwise and the balance control fully anticlockwise. Then on cue the volume control is turned up slowly to the level wanted and left while the balance control is turned clockwise also slowly. The train image having moved to the right speaker, the volume control is turned down again and the train sound dies into the distance. The tone switch is best left on one of the lower tones for this effect.

The capacitor values in the tone shaper may be adjusted to give the required tone and the constructor is advised to buy several values and to experiment with them. Other switch positions include hail, light and heavy rain and many others can be devised by experimenting with bass and treble settings on the amplifier in use, and by feeding the output through various other units as mentioned above. □

Acknowledgement: We wish to thank Laskys for loaning us the tape recorder shown in the cover photograph.



...Counter Intelligence

BY PAUL YOUNG

A retailer discusses component supply matters.

IT IS not usual for me to write two consecutive articles on the same theme but I assure you in this case it is more than warranted. I refer to V.A.T.!

A well known politician once said that if you pass some legislation that does not have exactly the opposite effect of what you intended then that is a good piece of legislation. It is not hard to conclude what happens when bad legislation is passed, and the multi-rate V.A.T. scheme is the most diabolical and impossible scheme that I have witnessed in my thirty odd years in business.

A few weeks ago I went to the London Electronic Components Exhibition and took the opportunity to sound out several manufacturers on the subject, to find out what rate they would be charging us retailers. The results of my findings completely turned upside down all my previous notions on the subject.

All Bulgin's components were to be invoiced to us at 8 per cent; some switches were 8 per cent and others 25 per cent—and this

also applies to resistors and transformers. However, before you rush out and flay your supplier for overcharging, let me explain the catch.

The rate of V.A.T. we are charged has nothing to do with what rate we charge you, the customer (to quote from a high ranking Customs and Excise Officer). The whole thing revolves around the phrase "user intent". In other words if you come into my shop and buy a knob, and tell me it is for your cooker, I shall charge you 8 per cent, but if you say it is for your radio, then I shall charge you 25 per cent.

If only these Civil Servants had one grain of humour, they would see the situation in its true perspective, and I would then ask them (endeavouring to keep a straight face) whether, if a customer buys a knob and tells me it is for his cooker, and I am suspicious of his claim, should I accompany him home to check what he does with it? Alas, they have no sense of humour at all. If they had, they would find their

job intolerable.

Mr. Keith Riley of Mogul in an article in *Electronics Weekly* states "Certainly all the ingredients are at hand for, to say the least, a contentious situation to arise". I award that the first prize as the understatement of the year!

Since all the major manufacturers have told the Government this arrangement is completely un-workable and this has been echoed right down the chain, I think the Treasury are bound to take action to simplify it before much more water flows under Westminster Bridge.

In the meantime deal leniently with your components dealer and if he charges you 25 per cent and the rate subsequently turns out to be 8 per cent, remember that if the reverse procedure occurred, he would be called upon to make up the difference.

My big regret is that Gilbert and Sullivan are no longer with us, they could have written a whole comic opera around the retail electronics components trade, with some wonderful patter songs about V.A.T. Alternatively Shakespeare might have said something like:

"Out damned V.A.T., All the electronic computers of Japan, could not solve thy accursed riddle!"

ELECTRONICS



By J. B. DANCE

IN CAMERAS

A FEW years ago the use of electronic circuits in consumer products was confined almost entirely to radio and audio equipment. Nowadays, however, one finds electronic devices in many more consumer items such as washing machines, electronic watches, road vehicles, cameras, etc.

In the past it has not been an economical proposition to include fairly complex circuits in such products, since the labour charges involved with wiring in such circuits are very high. However, during the past two or three years many more new integrated circuits have been developed which are especially designed for use in consumer products. Such devices can be connected quite quickly to a minimum number of external components and reduce labour charges to a minimum. Most of the connections are inside the integrated circuit and these are all made automatically during the device manufacture.

CAMERA APPLICATIONS

The main application for electronics in camera design is for the control of the speed of mechanical shutters. In some types of camera the electronic circuit merely determines the time for which the shutter is open, but more and more cameras are employing automatic exposure control. In such cameras a photoconductive cell measures the light intensity and automatically adjusts the exposure time to produce the correct density of the negative after development.

In such cameras the setting of the lens aperture also adjusts a potentiometer which is connected to the shutter circuit so that the exposure time is correct at all apertures. A further potentiometer must be set by the user when the film is first inserted in the camera;

the setting of this potentiometer is dependent on the film sensitivity or speed and this latter variable is automatically taken into account in the determination of the exposure time.

Some cameras are produced with which an exposure can be made after an electronically controlled delay time. It is even possible for a film to be wound on automatically after each exposure and for a succession of exposures to be made at any desired intervals. Such electronic control is ideal for time-lapse photography.

In cine cameras one can control the speed of the film by electronic circuits connected to the motors. Other circuits may automatically adjust the aperture according to the amount of light entering the lens. Sophisticated cine cameras for professional work normally include more complex electronics.

HISTORY

The widespread use of electronics for camera shutter speed control is quite new. It is therefore somewhat surprising that the idea was put forward by Carl Eisner as long ago as 1902. Eisner suggested that the intensity of the light falling on a selenium cell could control the power fed to an electric motor when the shutter operating lever is actuated.

If the light intensity is high, the selenium cell has a low resistance and a large current flows through the motor causing rapid movement of the shutter mechanism.

SEMI-AUTOMATIC CAMERAS

In cameras employing the so-called "semi-automatic" exposure control systems, the light intensity is measured by a photoconductive cell and indicated by a meter. If the lens aperture

or the shutter speed are adjusted, an indicating scale moves past the meter needle and shows whether the exposure setting is satisfactory for the prevailing light conditions. For example, if the meter needle is in front of part of the scale which is green, the exposure is satisfactory, whilst if it is in front of a red part of the scale, either the aperture or the shutter speed setting must be adjusted.

Semi-automatic exposure systems may employ either mechanically or electronically timed shutters. Semi-automatic systems can be operated more quickly and with less trouble than when a separate exposure meter is employed. In addition, there is a smaller probability of error than if a separate meter is used.



The Minox C ultra-miniature camera produces 11 x 8mm negatives.

PHOTOCELLS

Selenium photocells have the advantage that they can convert the energy of the incident light directly into an electric current which can be used to deflect a meter. No battery is therefore required when such cells are used in semi-automatic exposure systems with mechanically timed shutters.

Nowadays, however, the use of cadmium sulphide photoconductive cells is far more common than selenium cells in cameras with built-in exposure control. Cadmium sulphide and selenium cells are the only types normally considered for this type of application, since they have a spectral response similar to that of the human eye and to modern photographic emulsions (which are manufactured to have a response similar to that of the eye). Silicon devices are quite unsuitable, since they show their main response to visible radiation in the red region and are even more sensitive in the infra-red.

The cadmium sulphide photocells found in cameras have the normal type of interleaved electrode structure found in similar cells used in other applications. They do have the disadvantage that they take a short time to respond to changes in light intensity.

An internal view of the Minox C. The electro-magnets which open and close the shutter are shown to the right of the batteries, whilst the circuit is near the centre.

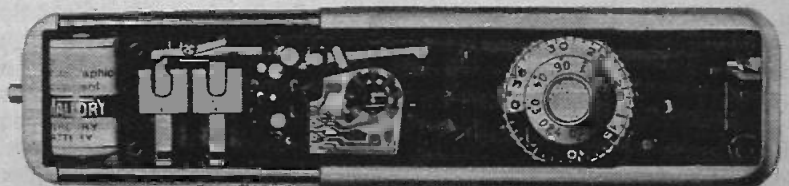

The Minolta Hi-Matic F camera with automatic shutter speed setting.

Current trends are for the cadmium sulphide photoconductive cell to measure the amount of light entering the camera *through-the-lens*. In such cameras through-the-lens is often referred to as TTL, but this must not be confused with the electronic use of TTL for transistor-transistor-logic.

The position of the cadmium sulphide cell in through-the-lens systems varies somewhat with the type of camera, but is generally somewhere at the back of the mirror of single lens reflex cameras. The mirror may be partially silvered so as to let a fraction of the incident light fall on to the photocell.

FULLY AUTOMATIC CAMERAS

Fully automatic electronically controlled shutters employ a timing circuit which switches off the power to an electro-magnet at the correct time after the opening of the shutter. The magnet then releases a metal blade which moves to close the shutter under the action of a spring.

The force exerted by an electro-magnet is much greater when the object being attracted is near to the magnet than when it is some distance away. A reasonable force is required in order that the shutter blades shall move quickly enough to give a suitable exposure. It is therefore much better to allow a small electromagnet to release a piece of soft iron attached to a shutter blade and allow a spring to do the actual work of moving the blade than to cause the electromagnet to pull a piece of soft iron into contact with the magnet.

Various timing circuits have been used in different cameras. They all depend on the time taken for a current passing through a resistor to charge a capacitor. This resistor consists in part of a photoconductive cell together with the preset potentiometers which are connected to the lens aperture setting and to the film speed setting control.

Circuits of this type can provide a very wide range of exposure times using only one capacitor. For example, a typical range of shutter speeds is 32 seconds to 1/250 second. Although the shutter speed is not automatically controlled by the light intensity in this type of circuit, the shutter speeds are much more accurate and reproducible than those which can be obtained from normal mechanically timed shutters. For example, the weakening of the springs with the age of the camera does not make a significant change to the exposure time. If the longest exposure time is checked with a stop-watch, all of the other times will have a similar percentage accuracy (typically ± 2 per cent).

ULTRA-MINIATURE CAMERA

One of the smallest cameras available at the time of writing is the Minox model "C"; it is only about 122 x 28 x 16mm in dimensions and weighs about 98gm (3 $\frac{1}{2}$ oz). It produces negatives 11 x 8mm in size.

The lens of this camera is always fully open, since the depth of field in this miniature model is such that everything from 20cm to infinity is in focus. Exposure times from 1/15 to 1/1000 second can be set manually, but the Minox C incorporates a fully automatic exposure system which can provide exposures of 1/1000 to 7 seconds. A warning light shows when exposures of over 1/30 second are required so that a tripod may be used.

The Minox shutter is interesting because two magnets are employed for controlling the shutter—one for opening it and one for closing it. This was found to be necessary in order to obtain the relatively high speed of 1/1000 second. The magnets take longer than this to operate, but as they are of similar design, the two operating delays are almost exactly equal. When the exposure time is very short, the impulse to close the shutter is produced by the

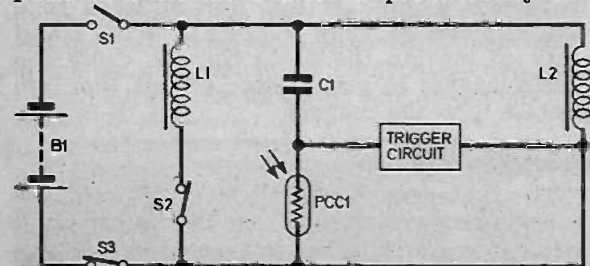
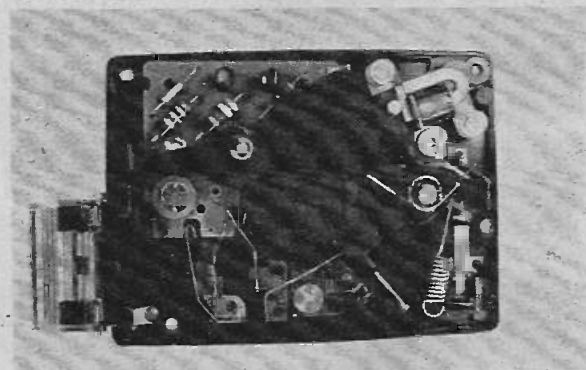

Fig. 1. The basic circuit used for the shutter speed timing in the Minox C camera.

amplifier before the shutter has even opened!

The basic circuit of the Minox C is shown in Fig. 1. When the shutter release lever is pressed, S1 closes and the electromagnet L1 is energised. It opens the shutter and also opens the contacts S2 so that it de-energises itself. After the capacitor C1 has charged to the threshold potential of the trigger circuit through the cadmium sulphide photoconductive cell PCC1, the circuit energises the electromagnet L2 which closes the shutter and opens the contacts S3. The trigger circuit used contains four transistors and two diodes.



The automatic shutter of a Polaroid camera.

MINOLTA CAMERAS

The Hi-Matic "E" and "F" cameras are manufactured by the Minolta Company of Japan. They use Seiko-ESF between-lens shutters which are timed electronically by means of the type of circuit shown in Fig. 2. A photoconductive cell with a centre tap, PCC1, is employed in this circuit to obtain the desired response curve in conjunction with R2 and R3.

Switch S6 is closed before the shutter is used. When the shutter is opened by the release button, S3 closes and renders TR1 non-conducting. The other transistor of this Schmitt trigger circuit, TR2, therefore conducts and the magnet L1 is energised. Switch S2 is also opened by the shutter operating lever.

The capacitor C1 now charges through the photoconductive cell PCC1. When the potential across C1 reaches the triggering value at the end of the exposure time, TR1 is switched to conduction and TR2 is switched off. The magnet therefore releases the armature and the shutter closes.

The circuit of TR3 serves as a battery voltage checking system. The potential of the base is controlled by R8 and R9; TR3 conducts and the lamp is illuminated when the base voltage exceeds a certain value. The same lamp is also used for warning purposes.

The Hi-Matic "F" (unlike the Hi-Matic "E") incorporates circuitry for automatically firing its electronic flash equipment only if the light

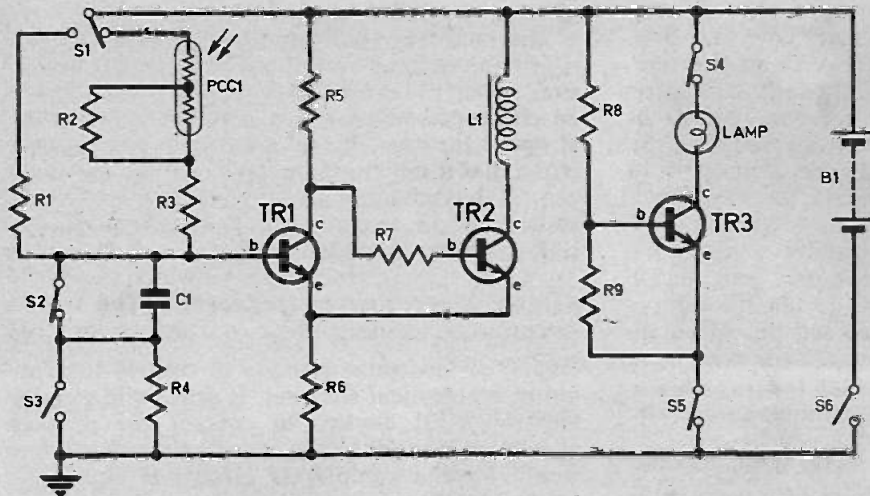

Fig. 2. The circuit used in the Minolta E and F cameras for automatic shutter speed control.

level is low enough for the flash to be required. Under such levels of lighting an indication is given in the viewfinder that the flash will be operated.

Another Minolta model, the "XM", incorporates a shutter using very thin titanium shutter blinds. The exposure is controlled by a through-the-lens cadmium sulphide metering system in conjunction with an integrated circuit over the range 4 seconds to 1/2000 second. A battery of silver oxide cells are used. A battery voltage checking warning lamp is included, but even if the battery fails, one still has an exposure of 1/100 second available.

The Minolta model "XE-1" also employs an integrated circuit for controlling a vertical traversing shutter mechanism which has been developed by the Leitz Company of Germany in collaboration with the Copal Company of Japan.

POLAROID CAMERAS

A range of Polaroid cameras are available with electronically timed shutters which can produce fully developed black and white photographs within half a minute of the exposure or colour photographs within one minute of the exposure. Some models employ a cadmium sulphide photocell which controls the charging time of a capacitor connected to the input of a Schmitt trigger circuit; the latter controls a magnet in the way discussed previously. These cameras do not employ sectors between the lenses, but the shutter consists of metal plates which operate near to the lens.

One Polaroid model has an electronic circuit for timing the development of the photographs immediately after exposure. Two integrated circuits are employed. A potentiometer sets the required development time and when the exposed film is pulled out of the camera, the timer is automatically actuated. After the preset development time has elapsed, a lamp is extinguished and an audio warning tone is emitted.

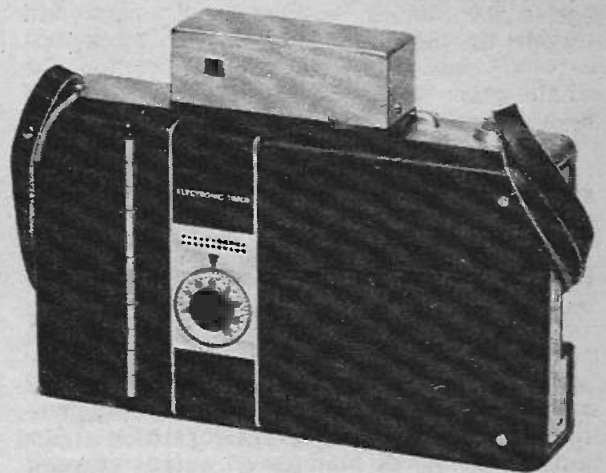

The model 350 Polaroid camera showing the electronic development timing adjustment.

YASHICA CAMERAS

The Yashica Company of Japan offer a number of semi-automatic and fully automatic cameras with electronically timed shutters. An interesting feature is the use of vertically running metal focal plane shutters. The semi-automatic "TL Electro-X" employs twin cadmium sulphide photocells with an integrated circuit, whilst the automatic "Electro AX" employs two integrated circuits including a memory system to store information on the light intensity.

This is required because the through-the-lens light metering system becomes inoperative immediately before the exposure when all of the light is falling on the film.

ASAHI PENTAX

The Japanese Asahi "Pentax ES" employs more complex electronics than most other single lens reflex cameras, the integrated circuit used containing some 50 transistors, diodes, etc.

The three pieces of information on which



The Asahi Pentax camera which incorporates a complex electronic exposure control circuit.

the exposure time is to be calculated, namely the light intensity, the aperture and the film speed, are fed by a photo-resistor and two variable resistors into the circuit. The current passing through each of these resistors is fed into separate logarithmic compression circuits which generate output signals proportional to the logarithm of the input currents. (The exponential current-voltage relationship across *pn* junctions is employed to generate the logarithmic functions.)

A memory circuit is incorporated in the light intensity channel so that the correct current can be fed into the computing circuits after the mirror has swung up and light no longer falls on to the photocell.

The logarithmic signals are suitably computed and the resulting signal is fed into an exponential expansion circuit (or anti-logarithmic current generator) to produce an output current, the value of which is proportional to the reciprocal of the required exposure time.

This current is fed into a capacitor from the instant when the shutter opens. When the potential across the capacitor reaches a certain value, the trigger circuit switches off the current to the electromagnet and the shutter closes.

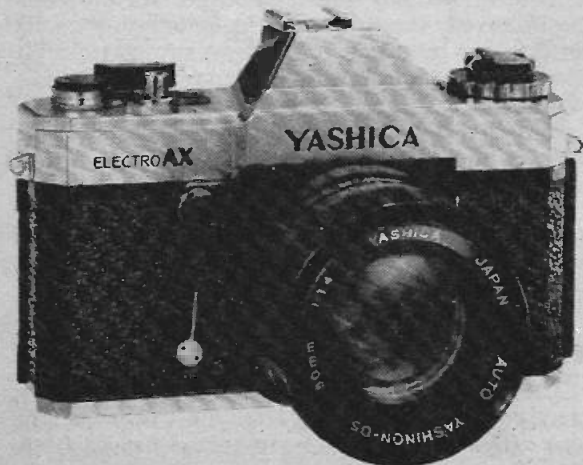

The Yashica Electro AX camera with automatic exposure control.

The meter in the view finder obtains its current from a point before the exponential expansion circuit so that it can display a wide range of exposure times over a short logarithmic scale. If the indicated shutter speed is unsatisfactory, one can change the aperture until an exposure in the desired range is obtained. The meter provides the unusually wide range of exposure times from 1/1000 second to 1 second.

FULLY ELECTRONIC SHUTTERS

All of the shutters discussed previously have employed electronic circuits to control the timing of mechanical shutters. If one could employ electro-optical devices to control the passage of a beam of light to the sensitive emulsion, one would have a completely electronic shutter.

Completely electronic shutters have been made, but unfortunately the present designs are suitable only for use in research laboratories and not in portable cameras. A Kerr cell with its associated power supply of about 50kV is required and the equipment is very heavy and expensive. In addition, a small amount of the incident light passes through this type of shutter even when it is 'closed', so a mechanical shutter must also be used which will limit the time for which the unwanted light can pass to the film.

Although Kerr cell shutters have the additional disadvantage that only a fraction of the incident light (perhaps 10 per cent) can reach the film when the shutter is open, one can obtain extremely short exposure times in the region of a few thousand millionths of a second.

In this type of shutter, light passes through a nicol prism which polarises it. The light then passes through the Kerr cell itself which contains two plates immersed in a liquid such as nitrobenzene. When a voltage pulse is applied to the plates, the plane of polarisation of the light is rotated so that it can pass through a second nicol prism to the film.

CONCLUSION

This review of current trends in camera electronics has not included the techniques used in cine cameras for the control of film speed or for camera aperture control to ensure correct exposure. Neither has it covered the ultra-high speed camera instrumentation where one may take up to 20,000 photographs per second. Such equipment may be used to photograph the explosion of gun powder, the light from a photographic flash bulb or the impact of two vehicles in a head-on crash.

Nevertheless, enough has been said to show the growing importance of electronics in a field which is relatively new. More and more manufacturers are producing cameras with electronic shutter speed control and doubtless electronics will find many other applications in photography in the coming years. □

Physics is FUN!

By Derrick DAINES

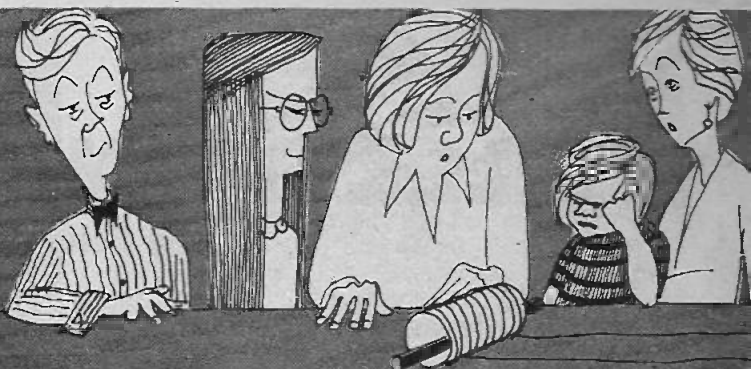

MAGNETISER

Last month in response to readers' requests, I illustrated a demagnetiser. Paradoxically, I have also had requests for a gadget to magnetise objects, so here goes.

Readers will have realised by now that the problem is one of realigning the molecules of iron and that this can be done slowly or quickly. One slow method involves stroking with another magnet; another less tedious, involves passing a current through a coil for a period of time. As far as the amateur is concerned, this is probably the best method, particularly for horse-shoe magnets or bulky items, Fig 1 shows the method.

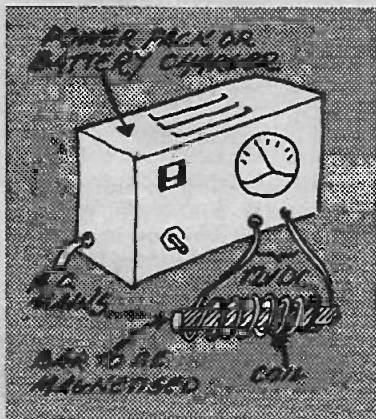

Fig. 1. Magnetising a bar of iron using a battery charger.

A power-pack such as a battery charger provides a 12 volt direct current to a coil, thereby setting up a steady magnetic field. The coil can be wound directly on the iron if it is insulated from it. As much current as can be comfortably provided is passed through the coil, as long as neither the coil nor the power-pack overheat. Tiny objects will magnetise in a few minutes;

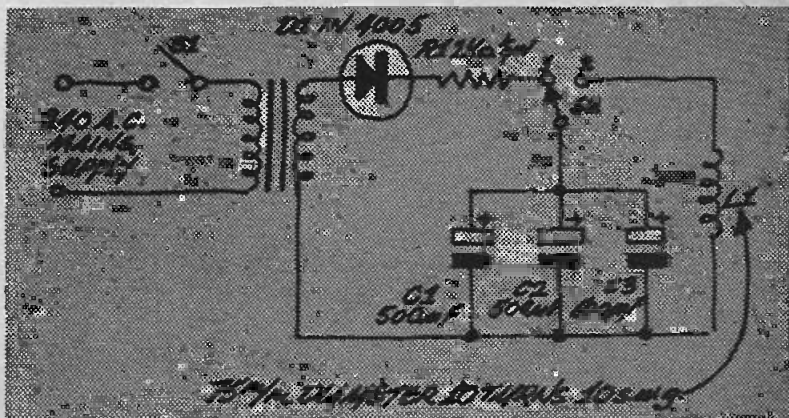

Fig. 2. The circuit diagram of an "instant" magnetiser. Note that S2 must be a knife switch.

larger objects will take an hour or so, while several days is not too long for very bulky articles.

Iron can be magnetised instantly however, if a very large voltage is available for a single moment of time (see Fig 2). A small transformer (T1) is used to isolate the mains from the unit. However since the turns ratio is 1:1, 240 volts is obtained on the output side. This is taken through diode D1, changing the alternating current to half-wave d.c. This diode should be 750mA rating, 500 p.i.v. The d.c. is used to charge a capacitor bank C1 to C3. These capacitors should be of any large capacity, but at least 250V d.c. working. Since they are in parallel, their total capacity is their sum, a quantity that affects the efficiency of the unit.

A few moments after switching on, the capacitors will be completely charged and the user then switches over the blade of S2, providing an instant discharge through the coil of L1. This instant surge of current provides a very intense magnetic field in and around the coil, instantly magnetising anything placed within it. The coil itself is simply

10 turns of 10 gauge wire wound on a cardboard tube 75mm in diameter, and the object to be magnetised is laid inside the tube.

The switch S2 should be a knife switch since the very heavy current flashing through it will simply weld together the blades of a smaller switch. It is for this reason that we must stress very strongly that this project is **definitely not** for the beginner; some severe burns can result from misuse. However there has been so much interest in the subject of magnetism that we make no apologies for including the item.

Readers capable of making and using this item will scarcely need the warning about adequate insulation and care in use, while beginners will learn quite a lot by a careful study of the diagram. In particular, the utilisation of the capacitors to store electricity. They are trickle-charged through the resistor when the blade of switch S2 is to the left; they retain their charge while the blade is being swung over, yet are instantly discharged through the coil when the blade is to the right.

Your Career in **ELECTRONICS**

By Peter Verwig

A career in electronics is an exciting prospect! Month by month our contributor Peter Verwig will explain what working in electronics is all about, how to prepare yourself for a rewarding career, and the job opportunities available in the world's fastest growing industry.

THE Post Office is Britain's largest employer—a vast organisation with well over 400,000 people on the pay-roll. But don't imagine that it is so big that it is cold and heartless. Many operating units are quite small and even the largest units are broken down into groups of people so that you quickly get to know your colleagues and they get to know you.

The very size of the Post Office gives it a career structure which is both varied and secure. You can join at almost any academic level and still have ample opportunity to make good progress. The Post Office is here to stay—it can never go-bust as some commercial firms can and do, and it has expanding opportunities for the young electronics engineer.

PUBLIC CORPORATION

In 1969 the Post Office became a public corporation charged with running its affairs on fully commercial lines. This means it has to operate profitably and one of the ways of achieving this is to improve efficiency by the installation of up-to-date equipment. This year the Post Office is spending £700 million, nearly £2 million every day, on its re-equipment programme.

The Post Office is a single public corporation but it runs four separate businesses; Telecommunications; Posts; Data Processing Services; and Giro. All these businesses have room for electronic technicians and engineers but the great bulk of them are in Telecommunications and it is to this area that we shall turn our attention. But before doing so, let us not forget the Posts business now has the go-ahead for full automation in letter sorting and this means more electronic equipment in sorting offices and even the installation of optical character recognition machines which will read the addresses on letters. So there are growing opportunities there, too.

Post Office Telecommunications employs some 250,000 people, more than half the total Post

Office pay-roll, operating the third largest telecommunications system in the world. The services include telegraphs, telephones, radiophones, TV, Telex, Datel, Facsimile and International Services.

A young person joining the Post Office today will find himself in the thick of a ten year period ahead which will be revolutionary in telecommunications technology. For the past 50 years the standard switching method has been the electromechanical relay. This will go and be replaced by all-electronic switching.

Sir Edward Fennessy, Deputy Chairman of the Post Office and Managing Director Telecommunications, gave some impressive forecasts recently. He said that electronic switching and other new developments would mean a massive swing to the use of integrated circuits. This year the Post Office will buy 2 million i.c.s. By 1980 the Post Office demand would have risen to 7 million i.c.s and by 1985 to 10 million i.c.s.

Annual demand would also include 50 million diodes, 14 million transistors, 50 million capacitors and 70 million resistors. Just let your mind dwell on what these astronomical figures mean in terms of equipment, installation, commissioning and maintenance!

As already mentioned, you can join the Post Office at any level appropriate to your present abilities. Let us assume that you are under 21, an enthusiastic amateur with a working knowledge of things electrical and electronic but with no specific educational qualifications.

The Post Office is now expanding its radiophone service for motorists under a £600,000 project. Car users can contact any telephone in the UK and most countries in Western Europe from the service areas which will number seven by next year.





New-look telephones. An experimental 'Trim-phone' instrument fitted with push-button dialing which has been subjected to test-marketing in selected areas to ascertain customer reaction and operational reliability.

ENTRANCE QUALIFICATIONS

It sounds a pretty desperate situation from which to start a career in high technology. But if you are keen the Post Office will help you. At the age of 18 you can join as a Trainee Technician Improver. Preference is given to applicants with some form of qualification but enthusiasm and willingness to learn should get you a start.

You will have an initial training course at a Regional Training Centre, then gain practical experience in the field for six months, then go on follow-up courses which will develop special skills, especially those for which you have shown aptitude. This is no easy ride.

Field experience is more likely to be up a telegraph pole or down a manhole rather than conducting elegant experiments in a laboratory. And it may have little to do with electronics in the first instance. The main thing is that it is a start, the first toe-hold in a career structure that can take you to the areas of activity and to the status you desire.

You will be encouraged to attend evening classes. If you are doing well you will get the opportunity of a day-release course for further study.

The Trainee Technician Improver who completes his training satisfactorily moves on to Technician IIA at the age of 21 with prospects of advancement to Technician I, Senior Technician and Technical Officer. The latter grade needs both theoretical knowledge and acquired skills. He may be in charge of installation and maintenance of large exchanges or transmission systems or even engaged on forward planning of new systems.

A new entrant can join in Technician IIA grade at any age between 21 and 45, again with-

out formal qualifications, although it is clearly an advantage to have some electrical or mechanical experience and, especially, an ONC or City and Guilds Certificate in Telecommunications.

You can also join directly as a Technician IIB if you are between 20 and 58. These technicians are of junior grade and often operate as assistants to the Technician IIAs. For young people especially, the Technician IIB is a training grade for a number of skills, and recruits are considered for up-grading to Technician IIA after 12 months.

It has been stressed in previous articles in this series that academic qualifications are the key to success. But in the Post Office grades so far mentioned you can get your start with none and learn while you earn. There are Post Office scholarships which enable bright people to study for a university degree.

ENGINEERS

It is possible for a Trainee Technician Improver who works hard and studies hard to compete for an appointment as Assistant Executive Engineer and finally as Executive Engineer. These positions are open to technicians after three years and five years, respectively, after joining.

Those who are academically qualified can move in directly as Assistant Executive Engineers, or in some special cases, as Executive Engineers in the management and professional career structure which broadly covers research and development, planning and management services, and supervisory duties in the regions and telephone areas.

If you are a school leaver with good 'A' levels in science subjects, or have a HND or are a graduate, you have a good chance of starting in Assistant Executive Engineer grade. Those with the lower academic qualifications will need to produce evidence of at least an overpowering urge and enthusiasm to work in telecommunications supported, if possible, by proven ability.

To join immediately as an Executive Engineer you must be an exceptionally well qualified graduate and possess the sort of personality able to accept responsibility at an early age.

For either of these grades you will be required to take tests and be interviewed by selection boards. Preliminary sessions may take place in the provinces but all final selection tests and interviews are in London. If you are accepted you will be offered a post in accordance with the recommendations of the selection board and within the natural limits of vacancies and, if possible, within the boundaries of your own stated preferences.

All engineering entrants have a one-week residential induction course at the Post Office College of Engineering Studies near Bletchley in Buckinghamshire, and then move to the regions

to gain appreciation of how the Post Office operates and is managed. They are assigned to appropriate departments for on-the-job training and there are specialised courses to be attended, both internally and externally. During career development you may expect from time to time to be sent on management courses.

MANAGEMENT

Note that if you are to get ahead you must be a manager as well as an engineer. Technical knowledge by itself is not enough. This doesn't necessarily mean you have to manage huge staffs. If you are in Post Office Research, for example, you would manage your own research project. In the Development Department you might manage a small team engaged in field trials of new equipment. On the other hand, in a large telephone area you may be responsible for up to 200 technicians working on installation and maintenance.

Here we have the perfect illustration of the advantage of having qualifications as early as possible. You start at a higher level and in the Post Office, for example, it is possible to rise to a position of real responsibility and enjoy the income and status that goes with it well before you are 30. You can still get there by joining as a virtually unqualified technician but generally it will take a little longer to achieve an equal position and you still need the academic qualifications in the end.

Always remember that it is easier to sit exams when you are young. Much harder to take them in maturity and especially so if you have other distractions such as a young family to bring up, a house to furnish and an outstanding mortgage.

RESEARCH AND DEVELOPMENT

The Post Office has its own research department based historically in Dollis Hill, North London and, more recently, at the new £9 million research complex at Martlesham Heath near Ipswich. But the Post Office is not a major manufacturer and so develops products and systems in conjunction with the telecommunications manufacturing industry and places contracts with industry for the supply of equipment. So if you are in Post Office engineering you may well find yourself working in close contact with equipment suppliers.

Don't be discouraged by the superficial impression that the Post Office is still technically dependent on electro-mechanical devices and run by people who don't know the difference between a transistor and a diode. Telecommunications chief Sir Edward Fennessy was leading the famous 60 Group RAF on Britain's crash radar programme in the Second World War. He then led Decca Radar to pre-eminence in marine radar and also headed Plessey Electronics Group before joining the Post Office. He is an electronics

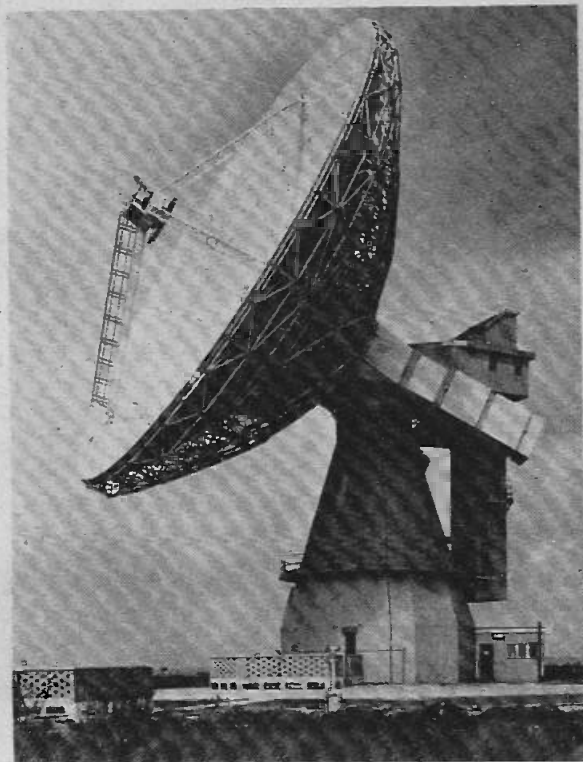

Goonhilly 3, the latest in the complex of Post Office earth satellite terminals at Goonhilly Downs, Cornwall.

man to his finger tips.

And if you look at some of the projects now in development you will see immediately that the Post Office in the 1980s will be an electronic engineer's dream. Such projects as computer-controlled exchanges, transmission through circular waveguides in the frequency range 40-120 GHz, transmission through optical fibres, millimetric wave systems to name but a few.

The first Post Office public radiophone service went on the air in 1959, the first transmissions from the Telstar satellite were received by the Post Office ground terminal at Goonhilly Downs in 1962, and it was also in this year that an experimental electronic exchange was opened at Highgate Wood. By 1964 the first PCM (Pulse-Code Modulation) system was in use, in 1965 the London Post Office Tower with its microwave telephone trunk and TV links was commissioned, in 1966 the first production electronic exchange came on line, in 1967 "Lincompex" radió telephony terminal equipment was being used on overseas routes.

If you are still at school your careers master will be able to give you some guidance.

Because availability of vacancies can vary from time to time and from place to place, others should contact the General Manager's Office of their local telephone area for the up-to-date position.



Lektrokit Ltd. have recently announced the availability of their low cost re-usable circuit assembly kit No.13.

The new kit, which is simple to assemble and quick to dismantle, comprises five plain double-sided circuit boards (the same type that Lektrokit supply to industry) together with 500 standard pre-tinned brass solder pins. At £4 a kit, plus V.A.T. it represents a real saving over the cost of having to buy the items individually.

The re-usable circuit boards are made of s.r.b.p. (synthetic resin bonded paper) and measure 120 by 100mm. They are perforated with holes on the international 0.1 inch matrix.

We would be pleased if you would mention E.E. when contacting advertisers or firms quoted editorially, for the supply of components.

Two new ignition systems have recently become available from Electronic Design Associates. The new systems, Sparkrite G.T. and GT3 are claimed to be the most powerful available in the U.K. Both systems are provided with an output socket to plug in a xenon timing or 8W fluorescent light—also supplied by E.D.A.

The GT3 includes a systems function light which shows all connections are correct and a static timing light for initial points adjustment. The GT3 also includes an automatic circuit to burn dirt off the contact points should they be dirty, however this system, unlike the G.T., is only available for negative earth cars.

Full details of these and other E.D.A. products are available from them at 82 Bath Street, Walsall, WS1 3DE.

The Sparkrite G.T. and G.T.3 ignition systems with the timing light and fluorescent light.

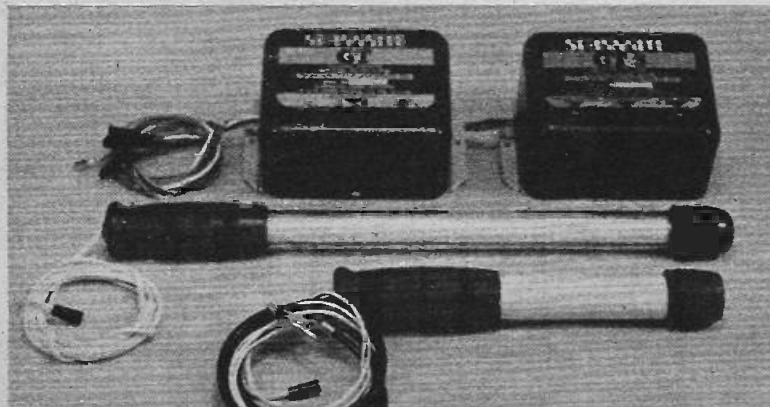

Intruder Alarm

One or two parts used in the *Intruder Alarm* require special mention. The audible warning device (12V type) is available from Doram Electronics Ltd., P.O. Box TR8, Wellington Road Industrial Estate, Leeds, LS12 2UF. The bell warning can be provided by any suitable bell mounted so that it is not easily disconnected or tampered with, most electrical shops should be able to supply this.

Key operated switches should be available from most larger suppliers the price depends to some extent on the quality of security-type of key used. The case used for the prototype was a simple aluminium one but any type of a suitable size will do.

F.E.T. Voltmeter

The notes on the use of the *F.E.T. Voltmeter* should be carefully followed, this applies to the a.c. ranges and particularly high voltage. The high voltages appearing at the input must also be kept in mind when constructing the unit and an insulated plastic case and knobs are recommended. Also because of this high voltage, switch ratings must be as specified. Although the switches should never have to actually switch high voltages they do have to provide insulation at voltages up to 1000V d.c.

If you are likely to put the unit to a great deal of use we suggest you invest in a good pair of probes and "extra-flexible wire", available from Doram (see above for address) for about 5p per metre (plus V.A.T. etc.)

Garage Doors

We hope that all the supply problems concerning parts for the *Automatic Garage Doors* were ironed out last month! All that remains to be purchased are the parts for the motor mounting board and cover and these should provide no problems.

The reversing switch mounted on the garage ceiling carries mains voltage to the motor and lamp and must be insulated—any small plastic box can be used for this with the back screwed to the ceiling, the switch in one side and the lid facing downwards so that the box can be screwed on.

White Noise Generator

There should be no buying problem with parts for the *White Noise Generator* but one or two components may need selection when the unit is operating. This applies to the noise diode which can be selected from any diode or the forward biased junction of a transistor—even a "dud" transistor might be used if an intact junction can be found.

Also some experimentation with the capacitors in the filter circuit could be useful—try any values between about 1,000pF and 1µF. Plastic types—meaning polyester, polystyrene, polycarbonate or mixed dielectric—are the best to buy, but if you have others available try them, anything will do—even electrolytic in this application.

IN this the second and final part of the Automatic Garage Doors we deal with circuit construction, wiring and the motor mechanics used to raise the door.

COMPONENTS

Components T1, D2, D3 and C5 provide a rectified and smoothed d.c. supply. The current requirement is moderate, about 30mA if the specified relay is used. Also the reverse voltage requirements are low so small signal diode types can be used for D2 and D3. Resistor R8 is included to protect the rectification diodes against excessive current surge on initial switch on, yet causing negligible reduction of voltage to the negative rail. Capacitor C1 ensures that TR1 is turned on when the unit is switched on, the system may otherwise be triggered on 50 per cent of occasions when TR1 and TR2 are deciding which one will conduct first. Also C1 passes any line interference to the base of TR1, again tending to switch it on and it is possible on very rare occasions for the door to stop in mid travel, to overcome this simply flash the headlights again.

Now to the reason for the PCC1, R1, C2 and R2 configuration which is the result of a host of statistical evidence built up over the years for practically all garage locations using different types of car headlight in conjunction with a Mullard ORP12 photocell. The basic problems are:

(1) To provide sufficient light in order to trigger the bistable under the worst conditions. This occurs at night with the car outside the garage and shining its headlight through the door. This can be further compounded by having a build-up of dirt on the door and the headlight.

(2) Having set the bistable to be triggered under the conditions in (1) to ensure that under the best conditions of ambient light, occurring during the day in the summer months, with the car away from the garage and the door open, the ambient light will not trigger the system.

(3) Having achieved conditions (1) and (2) the extra light provided by the car's headlight will be sufficient to trigger the system during daylight. Although adding R1 in series with PCC1 requires a greater intensity of light necessary to trigger the system by d.c. action. The rate of increase in light intensity when the lights are flashed is catered for by C2. Resistor R2 is to limit the maximum effective resistance of PCC1, which under night conditions can exceed one megohm, and avoids the tendency to switch TR1 back on when the headlight is extinguished or when one walks past the photocell, shielding it momentarily from the ambient light during strong sunlight. Meanwhile the time constant of R1 and C5 is long enough to keep TR1 off whilst TR2 struggles to switch on against the opposition

AUTOMATIC GARAGE DOORS

(PART TWO)

By B. H. ALLEY



of the relay coil inductance, which though negligible in the case of the specified relay is significant in many other relays.

After S2 is switched mechanically to its alternate position the base of TR2 is momentarily grounded to the positive rail by the appropriate capacitor C3 or C4 which in turn has already been discharged by its paralleled resistor since the last operation, C2, 3 and 4 should be the specified capacitance ± 20 per cent.

The values listed for R3, 4 and 6 are to suit the relay specified, and will have to be changed for different relays, the coil resistance should not exceed 1.5 kilohms. Make R3 equivalent to the coil resistance, increase R6 to a maximum of 12 kilohms (for a 1.5 kilohm coil) and increase R4 so as to give the quiescent voltages (i.e. TR1 on TR2 off) as shown in Fig. 9.

If the relay used has more than one set of contacts parallel them to reduce contact wear. Diode D1 is to protect TR2 against momentary high collector voltage caused by the inductive voltage generated across the relay coil when switching, and can be any signal diode of no particular specification other than a peak inverse voltage of greater than 25V.

Some reversible motors are more powerful in one direction than the other. The most powerful direction should be used for raising the door. The Parvalux SD8 gives the same power in both directions and incidentally C6 is supplied with the motor but should you buy one second hand and the capacitor is missing the value for the SD8 is $2.5\mu\text{F}$, at least 250 V a.c. and definitely not an electrolytic type.

CIRCUIT CONSTRUCTION

The low voltage circuit can be soldered on to the Veroboard (Fig. 11) but for convenience VR1 should be put in such a position that it can be adjusted for initial setting up with a small screwdriver without having to take off the cover (to be described later). This is the only adjustment catered for and should cover all situations.

If you have a switched mains outlet in the garage then wiring up should be straightforward. If you have a recently installed light circuit it is standard practice now to have an earth wire and again there should be no problem with wiring up the system other than ensuring the motor current is not excessive and in any case should not exceed 1 amp in a 5 amp circuit (the SD8 takes approx 300mA).

If the lighting circuit has no earth wire you should either earth the metal parts independently or surround them with an insulated cover. Fusing requirements are taken care of if coming through a "ring mains plug" in which you fit your own cartridge fuse of 2 amps for the SD8. Otherwise it is advisable to fit the optional fuse shown in Fig. 9.

The motor and Veroboard are fixed to a baseplate made out of 20mm thick chipboard of a

size for convenient screwing to the roof joists. A length of twin flex connects the trigger circuit to the ORP12 fixed at the end of a 100mm tube and in turn fixed by an adjustable bracket on the rear garage wall so as to line up with one of the car's headlights; Fig. 12 shows the wiring.

DRIVE SYSTEM

A small pulley, 30mm diameter, with integral fixing bracket is screwed to the rear of the architrave in line with and at the same height as the centre of the closed door.

Attached to the 9mm motor output shaft is a 100mm long 25mm diameter, aluminium round bar drilled to slip over the motor shaft and then fastened to it by a grub screw. The necessary drilling on the prototype was done by hand, though not of the machine shop quality. The low rotational speed of the winding shaft lends to wide tolerances all round and a little eccentricity can be tolerated, though naturally if it is possible to get the job done on a lathe it makes for a better and more easily obtained finish. Two tangential holes, 4mm diameter are drilled at either end together with two coincident holes at right angles which are tapped to 2BA and pinch screws inserted for securing the two ends of the nylon cord. See Fig. 13.

Screw the winding shaft to the motor shaft. Insert one end of the cord through the tangential hole nearest the motor and tighten it down by means of a pinch screw. Make sure the cord is threaded into the hole the correct way round so that when the motor rotates to lift the door the cord winds on to the bottom of the shaft.

Rotate the shaft two or three turns by closing the relay contacts manually with an insulated screwdriver, or better still have an assistant switch it on and off from the mains switch. Having two or three turns of cord on the shaft before lifting the door removes the strain from the pinch screw. Thread the other end of the cord through a wire joiner of the cord tensioning device, put a 75mm nail through the 5mm hole in the top strengthening tube and, keeping

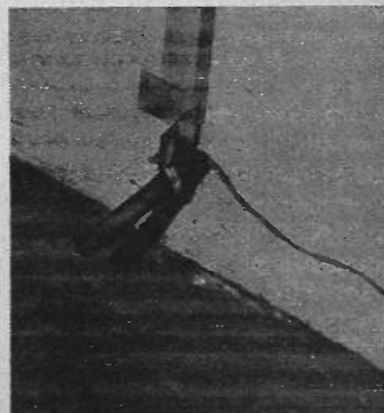

Photograph of the photocell mounting tube fixed to the garage door.

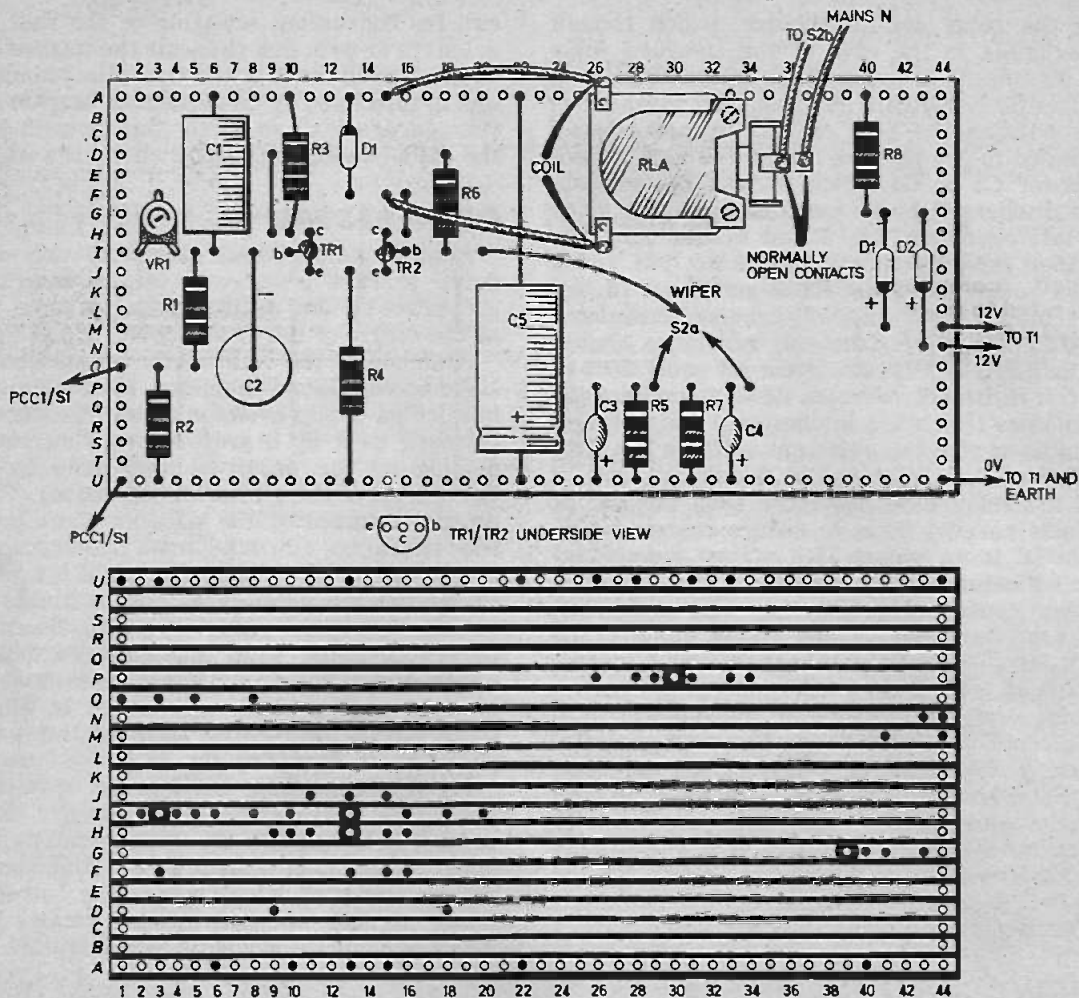

Fig. 11. Veroboard layout and wiring for the Automatic Garage Doors.

the cord taut, secure it in a knot round the head of the nail. Now thread the other wire joiner onto the pulley, pass the cord through the bottom of the pulley and locate it on the pulley.

Connect the switch cord to the head of the nail and secure it in a knot to both the nail and the switch. Holding the free end of the winding cord, ensuring it is correctly located on the pulley, press the door switch and let the motor haul up the door, allowing the cord to slip through your fingers as it winds onto the shaft but maintaining sufficient tension to ensure it doesn't slip off the pulley.

When the door is fully up the switch cord will ensure the motor is switched off. Now switch off at the mains. Wind the residue of cord round the winding shaft two or three times, keeping it taut before threading the remaining tangential hole in the shaft and retaining with the pinch screw.

Thread each end of the tensioning spring through its respective wire joiner, stretching it as required either side of the nail to maintain

the cord taut, then tighten down the wire joiner screws. Switch on and lower the door using the motor.

As an optional extra the door can be counter-balanced to any required degree by drilling another hole in the top strengthening tube close to the centre one and hooking in a "rubber bungee" the other end hooked into an eye screw placed in a convenient position in the ceiling or joist so as to exert an upward pull to the door. This feature not only helps the motor and gives assistance in the case of manual operation but also helps to obviate slight buckling of the door when in the lowered position.

The safety feature of the nail connection is as follows. Assuming the door is coming down and it is physically obstructed, the top of the door tends to curl upwards under the influence of the motor drive. In so doing the nail is pulled out of its hole, the motor finally being brought to rest when the nail reaches what would normally be the door closed position. Meanwhile the door is left resting on the obstruction.

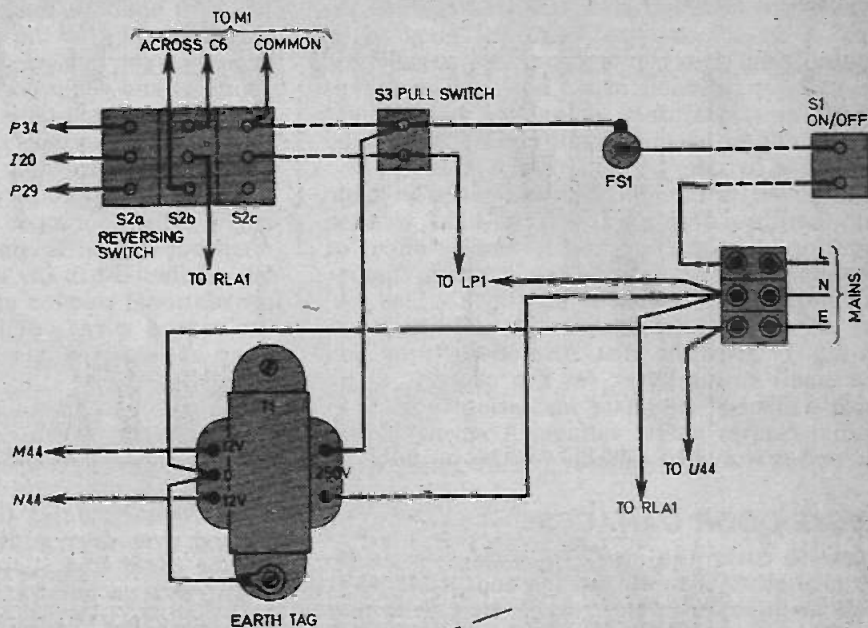

Fig. 12. Wiring of the circuit components not fitted to the Vero-board. Switches S1 and S2 will be remote from the motor unit.

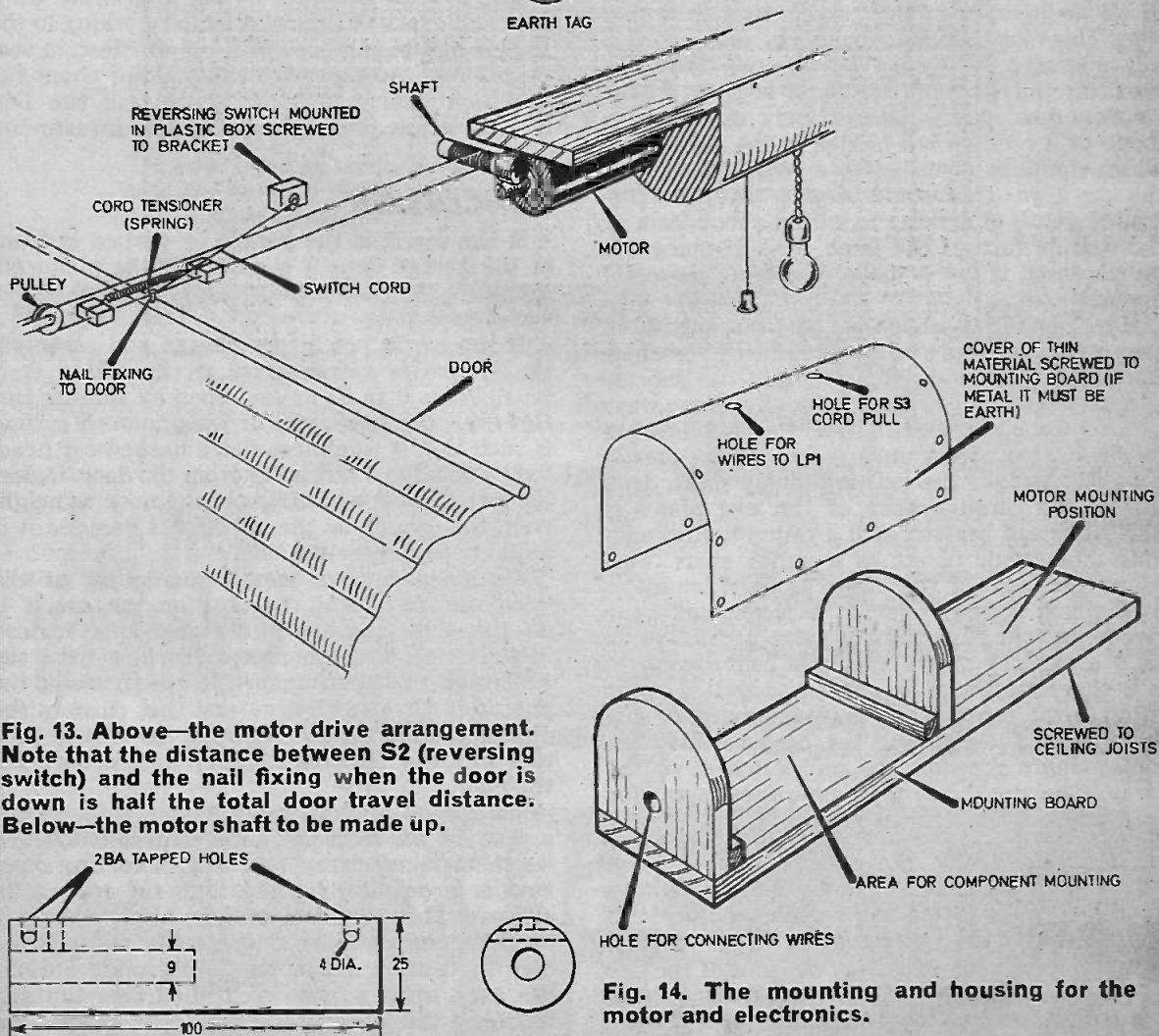

Fig. 13. Above—the motor drive arrangement. Note that the distance between S2 (reversing switch) and the nail fixing when the door is down is half the total door travel distance. Below—the motor shaft to be made up.

Fig. 14. The mounting and housing for the motor and electronics.

Once the obstruction is removed (lifting the door a few inches to facilitate removal if required) the door can be lowered manually and the nail repositioned in its hole, which makes it fully functional once again. The door is light enough not to harm a small child should it be obstructed by one.

The cover for the motor assembly can be made from hardboard supported by a light wooden frame or as in my own case, from an offcut of Respatex, the trade name for a much thinner and more flexible type of "Formica". Size will vary according to the size of motor and baseboard but Fig. 14 gives the idea. Also ensure provision of a small strong cover for the contacts of S2 which will need adequate insulation bearing in mind it carries mains voltage. A strong plastic case or box would be suitable for this purpose.

SINGLE DOOR GARAGES

Now to cover the aspect of garages with no entrance other than the garage door itself. First of all we must open the garage door from outside. This can be accomplished by making S1 a key operated switch, an old ignition switch is ideal for this purpose. It should be fixed in the wooden door jamb. Alternatively use may be made of a reed switch hidden in the door jamb which would be operated by a magnet kept with the car keys. This would require carefully controlled depth of drilling to within about 3mm of the outside face of the jamb. This distance can be increased if use is made of a more powerful magnet.

How can the door be opened from outside in case of power failure or motor failure? Somehow the drive must be disengaged from the door so that the door can be raised manually. Many ways can, no doubt, be devised for this but bearing in mind it *must be simple* the following idea is suitable. Remove the existing pulley shaft, drilling a hole through each of the end plates if necessary and replace with a round nail of suitable dimensions to act as a pulley shaft. Tied round the head of the nail is a short length of cord which is hung over an adjacent nail hammered into the rear of the wooden architrave, in such a manner that a specially bent length of self supporting wire is needed to pull it down through the narrow gap between the door and architrave. Then pulling the cord releases the pulley shaft allowing the pulley wheel to fall away. The door can then be raised manually using the corrugations as handholds.

Refitting the pulley and shaft present no problems.

DAMAGE

A few days after installing the first of the two doors a person, who shall be nameless, pressed the switch in the garage to open the door, jumped into the brand new car and, forgetting the door

was still opening, backed the car out. The noise was deafening as the door was forced from its grooves, yet within the hour the door was repaired and replaced in working condition.

That door is still in good condition today having had footballs kicked at it from close range, bricks thrown at it, and has been deflected up to 15cm by being rammed with the car. Not only has the door stood up to that kind of punishment but the car is completely unmarked. Work out all the cost in car repairs if that had been a conventional wooden or metal door! Meanwhile the second garage door, installed a few weeks later, has suffered no accidents and is as good as new.

Other advantages have been a garage filled with daylight, because the door rises vertically there are no problems with snow drifting up against the door and no allowance has to be made for positioning the car outside, unlike an up and over door or hinged door, which would hit the car if due allowance was not made.

No rust, no painting, no rot and above all a noticeable lack of draughts whilst working in the garage due to the door making an effective seal in its slides. Add to this a total cost of about £12 for each door and slides, excluding the Pop riveter, it has proved a worthwhile investment.

CONCLUSION

If the car is in the garage or parked in front of the garage door it is shielding the photocell, therefore the door cannot be opened by another car's headlights.

If the car is not in the garage and assuming the system is switched on at the mains, it is possible for it to be flashed open by another car. However, the sensitivity of the photocell system is such that it would require a flashed car headlight some 3 to 4 feet away from the door. Unless the intruder car's headlights are the same height from the ground as the car that is garaged it is unlikely to trigger the door.

An inclined drive means positioning of the headlight is critical. To position the car it is necessary to stop opposite a particular feature in the drive. Much nearer or further from the door than this spot means the beam misses the photocell. Driving slowly—and that close to the door it must be slowly—through the critical position with the headlights full on does not trigger the door.

Naturally the whole concept of security is that, unless the car is in the garage there is nothing worth stealing! Very few locks and doors are burglar proof, if a burglar is intent on gaining entrance there is little to stop him breaking a window, picking a lock, wrenching a handle or door or using a master key. An erudite burglar can even open a radio controlled door without touching the door. Nevertheless it is still unauthorized entry. □

NEXT MONTH...



SONIC BOMBER GAME

Try your hand at being a bomber pilot with our realistic game. You can actually bomb a target area and score points according to what you hit. Any number can play.

MATCHBOX RECEIVER

In these days of miniature components a sensitive receiver with earphone output can be made small enough to fit inside a matchbox—we show you how.

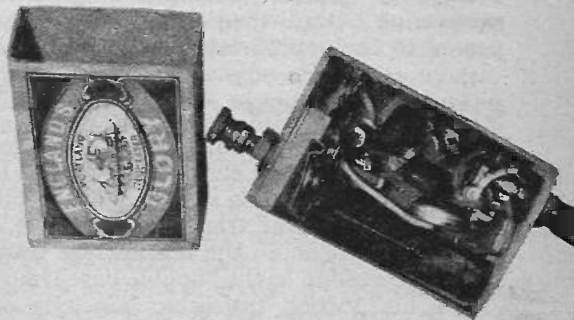

ARE YOU WINKING?



INDICATOR Audible Monitor

Do you ever forget to switch off the indicators or does the automatic return ever fail? Yes! Then you need our audible monitor.

everyday electronics

SEPTEMBER ISSUE
ON SALE FRIDAY
AUGUST 15

The UNIUNCTION

TRANSISTOR

By J. B. DANCE

ALTHOUGH the unijunction transistor is a miniature device with many applications, it is not nearly so well-known as the ordinary bipolar transistor. The basic principles of the unijunction transistor were formulated by H. Welker of France in 1948, whilst the first commercially produced devices became available in the 1950s.

Unijunction transistors can be used in simple relaxation oscillator circuits, timing circuits, etc., but one of their most important applications is for the triggering of silicon controlled rectifiers. Although circuits can be constructed for these applications which do not employ unijunction transistors, the use of these devices enables much simpler and more economical circuits to be designed.

In some applications the unijunction transistor bears a resemblance to the silicon controlled rectifier in that the device is switched to the conducting state when a suitable current is passed to the appropriate electrode.

CONSTRUCTION

The unijunction transistor has three connecting leads, namely the emitter, base 1 and base 2. The two bases have no resemblance to the base of a normal bipolar transistor. In some of the early publications on the unijunction transistor, it was referred to as the "double base transistor".

The unijunction transistor has only one *pn* junction, as its name implies. Most types of unijunction transistor comprise a bar of *n*-type silicon with a *p*-type electrode known as the emitter, as shown in Fig. 1. The emitter connection

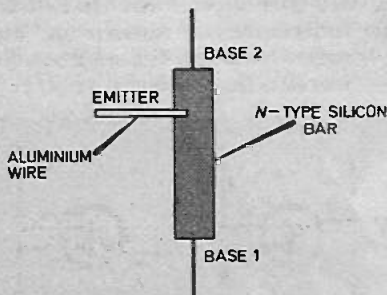

Fig. 1. Shows a schematic of the basics of a unijunction transistor.

may consist of an aluminium wire alloyed into the silicon.

The emitter junction is normally placed nearer to base 2 than to base 1. The device is therefore not asymmetrical and the two base connections are not interchangeable. Although symmetrical devices can be fabricated, they do not have the optimum electrical characteristics for most applications.

PRINCIPLES OF OPERATION

The operation of the unijunction transistor is dependent upon the modulation of the conductivity of the silicon between the emitter junction and the base 1 electrode.

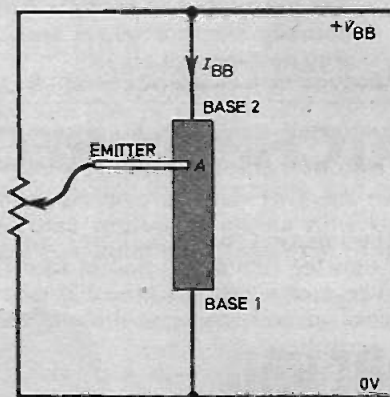

Fig. 2. The current flows through the silicon bar from base 2 to base 1.

A voltage V_{BB} is applied between the two bases, base 2 being positive with respect to base 1, as shown in Fig. 2. A current will flow from base 2 to base 1 along the resistive silicon bar. If the effective resistance between the two bases is r_{BB} , the current flowing into base 2, I_{BB} , is given by

$$I_{BB} = \frac{V_{BB}}{r_{BB}}$$

A fraction of the voltage V_{BB} will appear in the silicon bar at point A near the emitter. This fraction is known as the intrinsic stand-off ratio and is denoted η (pronounced "eta"). Thus the potential in the silicon bar at point A is ηV_{BB} with respect to base 2.

If the emitter is connected to base 1, the *pn* junction is reverse biased, since the *p*-type emitter will be negative with respect to the potential in the bar at point A. Only a minute emitter leakage current will therefore flow.

EMITTER POTENTIAL

If the potential of the emitter is increased, a point will be reached at which it becomes equal to the voltage at point A plus the voltage of a forward biased silicon diode (the latter is about 0.5 volt). A current then flows from the emitter into the silicon bar through the forward biased diode. The emitter voltage required to cause this current to pass is known as the peak point voltage, V_p . This is shown on the emitter characteristic of Fig. 3 together with the peak point current, I_p , which flows when V_p is applied.

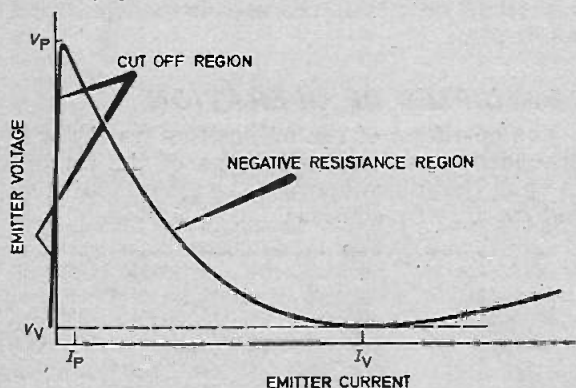

Fig. 3. The emitter characteristic of a unijunction transistor.

When the junction conducts, holes are injected from the emitter (hence its name) into the silicon bar. The electric field in the bar causes the injected positive holes to move towards the negative base 1.

In order that the silicon bar shall remain neutral as a whole, electrons are injected from the base 1 electrode into the silicon at the same rate as the holes are injected from the emitter. Thus both the electron and the hole concentration in the silicon increase in the region between the emitter and the base 1.

The increase in the charge carrier concentration in this region results in a decrease in the resistance between the emitter and base 1.

NEGATIVE RESISTANCE

The decrease in resistance results in a decrease in the voltage drop between the emitter and base 1. This results in still more holes being injected from the emitter and the resistance decreases further which, in turn, results in yet more holes being injected from the emitter and more electrons from base 1.

The process is therefore a regenerative one and once the peak voltage, V_p , in Fig. 3 has been

reached, the device current quickly increases towards the valley current, I_v .

The region in which the emitter current rises as the value of the emitter voltage falls is known as the negative resistance region. Although the resistance in this region is not actually negative (since this would imply that the device could continually produce more output power than the power fed into it), it does show a negative resistance for small increases of current or voltage. It is this negative resistance region which enables the device to be used as an oscillator, etc.

When the resistance of the silicon becomes very low, the lifetime and the mobility of the electrons and holes falls so much that the conductivity is not increased any further if more holes and electrons are injected. The resistance is then no longer negative and the curve of Fig. 3 commences to rise again.

The region to the left of the negative resistance region is known as the "cut-off" region of the emitter characteristic. The region to the right of the negative resistance region in Fig. 3 is known as the "saturation region".

THE COMPLEMENTARY UNIUNCTION

Although most types of unijunction transistor consist of a *p*-type emitter connected to an *n*-type piece of silicon, complementary types to this form of device were introduced by the General Electric Company of the U.S.A. in 1968. They are designated types D5K1 and D5K2.

In these devices an *n*-type emitter is in contact with a *p*-type piece of silicon. The applied voltages must be of the opposite polarity to those used with normal unijunction devices and the current flow in the opposite directions.

The availability of the complementary unijunction transistor permits more versatile circuit design. In addition, it can be used for stable operation at somewhat higher frequencies than is possible with some of the other types of unijunction transistors.

SYMBOLS

The symbol for the normal unijunction transistor is shown in Fig. 4(a) and that of the complementary unijunction transistor in Fig. 4(b). In each case the arrow on the emitter electrode shows the direction in which the emitter current flows.

Continued next month

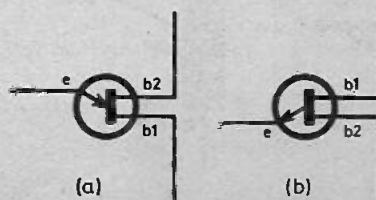

Fig. 4. The circuit symbol for (a) *n*-type (b) *p*-type base unijunction.

for your Entertainment...

By Adrian Hope

LET me tell you a few practical things about domestic video. For several years now it has been possible to buy a relatively cheap video camera and recorder (by which I mean costing under £1,000!), which can be used as a black-and-white newsreel camera to produce instant video tape movies. It is now possible to buy a colour version of the same portable system for three or four times the black-and-white price. The main firms involved are Sony, JVC and Akai. Technically, these systems all work well, but suffer from both obvious and not-so-obvious disadvantages.

Obviously it is both cheap and convenient to use a portable video tape recorder and camera to make a sound-and-vision record of an event that can be instantly played back over a TV monitor. Video tape, although more expensive than audio tape, is still relatively cheap. Also there are no processing costs, and unwanted recordings can be erased and the tape used again. But because it is so cheap and easy to make video tape films, it is equally easy to make far too many of them, and forget the crucial question—who is going to watch them?

EDITING

It is also extremely difficult and expensive to edit video tape. So many productions look very amateur. If you have ever been subjected to a seemingly endless evening of someone else's home movies, you will know what I mean. Even though editing 8mm home movie film is a simple exercise, it is surprising how few people bother to do so.

No wonder someone once said that if all the rolls of unedited video tape in the world were laid

end-to-end, a lot of innocent people would be saved some very boring experiences. I was recently invited to a 12-hour screening of amateur video tapes. I declined.

What I certainly don't decline, however, is the opportunity to free myself of broadcast TV schedules. And this is what the new breed of domestic video cassette recorders enables you to do.

There are currently three main competitive and mutually incompatible systems, the Sony U, the Philips VCR and the EIAJ Cartridge. Both the Cartridge and U systems can reproduce very fine colour pictures on a colour TV monitor. They are also very simple to use, but both systems are more likely to be found in educational or semi-professional environments than in the home. Indeed Sony, in the UK, have made no effort whatsoever to penetrate the domestic market, and although it is early days yet for the cartridge system, it too shows no signs of being marketed strongly at domestic level.

Philips, however, have not only tailor-made their VCR system to the domestic market, but have advertised it at a domestic level. Incidentally, I am not saying that the Philips system is unsuitable for educational or semi-professional use, I am simply saying that if you are interested in recording TV programmes off-air at home, the VCR system is the only one so far worth considering. There are several good reasons why one can be so positive.

PRICE

First and foremost, the Philips system is by far the cheapest. Beware here, before you write me a letter of disgusted disagreement, because direct price com-

parisons cannot be made between Sony U, EIAJ Cartridge and VCR. Whereas the basic Philips VCR has a built-in tuner and RF modulator, these are usually expensive extras for a U or Cartridge machine. What this means is that a Philips VCR can be plugged directly into the aerial socket of a domestic colour TV set for the playback of recorded tapes. But most (if not all) U or Cartridge machines can only play back through a tailor-made video monitor set (which is much more expensive than a domestic TV set) or require an external RF modulator.

Likewise, although the Philips VCR can record programmes off-air via its own, built-in tuner, most U and Cartridge machines can only record off-air via a video monitor set or a separate tuner. The fact that the Philips machine has a built-in tuner also enables it to record a programme off-air quite independently of the TV set with which it is being used.

This means that a VCR recording can be made even when your domestic TV set is switched off, faulty, disconnected or even non-existent! The presence of a built-in tuner also makes it possible for the VCR to incorporate a cooker-type time switch, which will switch it on and off while you are out, or even while you are watching another programme on a TV set to which it is connected.

SERVICE

The Philips VCR used to be available for around £450 including VAT; but cost and VAT increases have now puffed the price up by another hundred pounds or so. This is still cheap for what it is, however. But beware again. The machines are both mechanically and electronically very complex, and although in theory they can be plugged direct into the aerial socket of any domestic TV set, in practice some sets require a slight internal modification to the time base for a steady picture.

It is for these reasons that Philips try hard to ensure that VCRs are sold only by reputable dealers with competent engineers on tap. But consumer tests I have run suggest that it is easily possible to buy a VCR at cut price from an ignorant dealer, who will be forced to refer any problems to the Philips service organisation, CES.

Likewise, the tape heads on any video machine have a much shorter life than the tape heads on an ordinary audio tape recorder. They also cost far more to replace (around £50).

It is impossible to predict accurately how long Philips VCR video heads will last, because there are various governing factors like the type of tape used. But no one seems to claim a life longer than 500 working hours. This is not as ridiculously low as it sounds (because the video heads are moving across the inherently abrasive tape at around 20 miles an hour), but it does add to the cost of a video hobby. Likewise, with cassette prices running at around £20 an hour of playing time, it is quite out of the question to think in terms of building up a large personal library of tapes holding permanent recordings of your favourite programmes.

Having used various video equipment I am personally convinced that the real domestic strength of the Philips VCR lies in enabling a viewer to readjust the TV programme schedules to suit his own life-style. If the programme you want to see is on while you are out, while the British summer sun shines briefly or while you have guests (or perhaps while something else of interest is on another channel), then you simply record it and play it back hours or days later. You then re-use the same tape the next time a similar situation arises.

Whether you believe that this luxury warrants the cost of buying or hiring a VCR with a few cassettes depends entirely on

what spare money you have available and how much you watch television either for business or pleasure.

DEALERS

I have hinted above that there are already cowboys in the video business who see it as an easy way to make a fast buck. Some new video shops and offices have a decidedly unpleasant, suspicious aura about them. Plush carpeting and a surfeit of pretty girls, dealing with a technology about which they know nothing, always make me feel suspicious and uncomfortable.

Video cassettes often seem to be out of stock or "just coming in" and I have sometimes noticed a reluctance to give receipts for cassettes (costing around £20 each) purchased with cash. All this creates a very definite feeling of *déjà vu*. Anyone who remembers the attitude of some specialist dealers when hi fi stereo systems first started to appear on a limited scale will know what I mean. But those original, snooty dealers who went out of their way to put the customer ill at ease either went out of business or were forced to change their attitude. Perhaps the same will happen with video.

ELECTRONIQUES

France seems increasingly obsessed with the idea of shaking off their traditional agricultural image. Electronic gadgetry is everywhere.

On the main road outside the new, three-storey shopping complex at Pontoise, the traffic lights are equipped with photosensitive

switches which can be triggered to change the lights from red to green by a driver flashing his headlights as he approaches the crossing. To compensate for the dazzling effect which all this extra headlight flashing on the roads at night creates, French motorists are now spending money on another gadget. This is a purple light which is mounted inside the car and shines continually into the driver's eyes, supposedly to limit dazzle.

Inside the shopping complex, where everything from cars to carrots is on display under the same roof, parents can shop while their children play on a fair-ground roundabout or watch cartoon films projected on tiny screens in individual coin-in-the-slot booths.

The brand new Charles de Gaulle airport resembles a Jacques Tati film set. The complex of satellites which make up the airport are connected by sealed, transparent plastic tubes through which the passengers are conveyed like luggage on endless conveyor belts.

The duty-free liquor shop is equipped with telex-like cash registers which automatically type out a 13-line statement of account for a single sale.

Anti-terrorist security is by a metal detector gate so powerful that it is a danger to any passenger wearing a heart pacemaker, and hand-held equipment so sensitive that it is triggered by the metal cap of a bottle of perfume. The warning notices on the detector gate entrance are only in a couple of languages, so pity the poor chap with a pacemaker who can't read them.

JACK PLUG & FAMILY...



The Extraordinary Experiments of Professor Ernest Eversure

by Anthony John Bassett

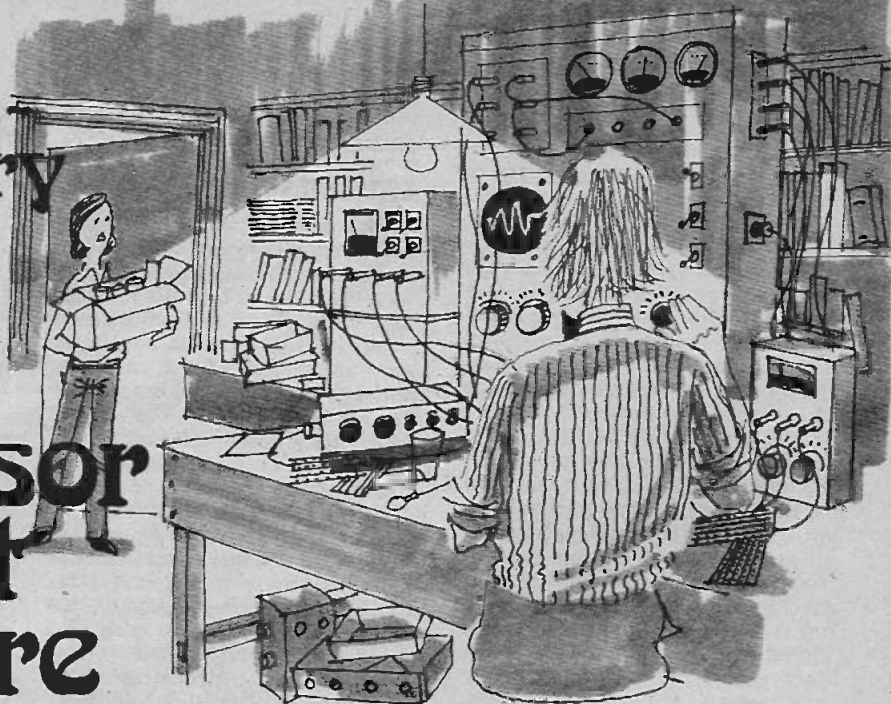

Professor Ernest Eversure, or the Prof. as his friends call him, has been experimenting in electronics for more years than anyone can remember and we thought that you might like to hear of, and perhaps repeat, some of his extraordinary experiments. Anthony J. Bassett recounts some of these experiments every month so why not follow the Prof's work and learn along with young Bob, his friend.

"I AM thinking of building some more experimental circuits using transistors d.c. coupled in the same manner as we have already tried. It would be an interesting way of using up surplus components, and maybe you could give me some tips on how to make use of some components which I bought in bargain packs."

Bob handed the Prof. a number of polythene bags of transistors and other parts which he had obtained from various "bargain" component suppliers.

"It seemed to make sense to buy these bargain packs, because in some cases each pack costs less than the price of one or two of the components they contain. Some of the packs contain circuit boards, and it is obvious that just one or two of the parts on these boards is worth far more than the price I paid for the board! But other components are either unmarked, or else their type numbers do not appear in any of the reference books I have looked in. I would like to find ways of making use of these parts in the projects I wish to build."

The Prof. examined the contents of the polythene bags with interest. He could see that they were crammed with a very wide variety of transistors, diodes, resistors, capacitors and many other components, some of whose markings were familiar, and others which did not appear to belong to the usual range of type numbers at all.

"Most of these should prove to be usable, Bob, but there are some, such as unmarked integrated circuits, which could prove very difficult to identify, and it may not be worth trying to use these. Most of the transistors appear to be junction *pnp* and *npn* types. Some are germanium, but I think most are silicon."

Bob and the Prof. surveyed the assortment of components. There seemed to be such an array of bits and pieces, that Bob hardly knew where to begin.

"Prof., I'm sure we can make something of this lot! But I'm having difficulty in relating these components with any of the projects which I would like to build."

The Prof. considered the problem.

"We could make another class A amplifier similar to the one you built a couple of months ago (June issue), as I know that Paul wants one for his car. But I know that Paul's car has a positive earth electrical system, so it would be convenient to make an amplifier using *pnp* transistors instead of the *npn* types which you used earlier. The circuit is identical except that the electrolytic capacitors are connected the "other way round", and the power-supply from the battery is connected to the negative terminal instead of the positive."

"Are those the only alterations we need to make to change this amplifier from negative earth to positive earth?" Bob queried, "Because we're using different transistors, will it not be necessary to change some of the other components also?"

TESTING AND SELECTING COMPONENTS

"The proof of the pudding is in the eating, Bob. I think that you could build up the circuit without much risk of damaging anything—then we can test it and find out whether any other alterations are necessary. Meanwhile, we can find out by experience

Fig. 1. The transistor can be regarded, for some purposes, as two diodes connected back-to-back.

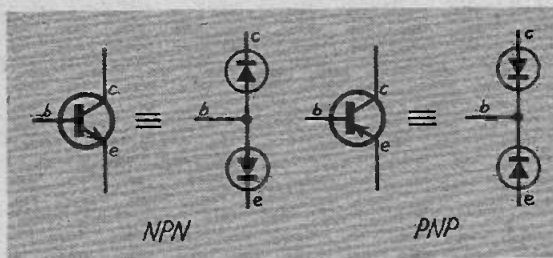

how suitable transistors may be selected and put to use.

Firstly all the transistors we will need for this amplifier are *pnp* junction transistors, so we shall use a quick method of testing to distinguish between *pnp* types and *npn* types and other components. This is simply a few checks on each transistor using a multimeter set to a resistance range.

TRANSISTOR RESISTANCE

For purposes of resistance measurement between any two terminals each transistor may be regarded as two diodes connected "back-to-back" (as shown in Fig. 1). Then the only way in which a good *pnp* transistor may indicate low resistance is with the red lead of the multimeter connected to its base, and the black lead connected to either emitter or collector (or both). A considerably higher measurement will be obtained if the leads are reversed, or if measurement is made between emitter and collector."

EXPECTED RESULTS

"What sort of resistance value should we expect, Prof.?" Bob asked.

"It is hard to give an exact figure," the Prof. informed him, "because a number of variable factors are involved. But still a large difference in resistance can be observed according to the manner in which the meter is connected. In general, the low "forward resistance" measured will be below 200 ohms, and is likely, with most meters, to be typically around 50 ohms. It may even be below 10 ohms especially with power transistors which have a large junction area."

"Are you saying," asked Bob incredulously, "that the resistance reading depends not only upon

the individual transistor which you are testing, but also upon which meter you are using to make the test?"

"Yes, Bob, this is so—but not only that, it will depend upon which range you are using on the multimeter. Here, measure the base-to-emitter resistance of this transistor, but use several different meters, and also try different ranges on each one."

Bob tried the transistor, and found that its resistance appeared to mysteriously differ from one meter to the next, and even on the same meter, different readings were obtained according to which range he was using.

METER RANGE

"Hey, Prof.," he called in astonishment, "On one of these meters the transistor measures 20 ohms on the x1 range, 150 ohms on the x10 range, 1200 ohms on the x100 range, 10 kilohms on the x1k range, and 15 kilohms on the x10k range! How can this be, since I'm measuring between the same two points with the same meter. Could it be that the meter is faulty?"

Bob watched as the Prof. shook his head, then screwed up his face, pursed his lips, and emitted a series of clicks and whistles. A few moments later the robot came to the workbench and handed the Prof. a box containing a number of precision resistors. The Prof. showed these to Bob.

These resistors have been made to a very close tolerance. Would you like to use the resistors to find out whether any of the meters is faulty?"

Bob quickly used the precision resistors to check, and soon found that the meters were reading accurately on all ranges.

"The transistor e-b junction acts as a diode," explained the Prof., "and as well as seeing a difference between resistance to

forward and reverse current flows, you are now observing the effects of something else on the resistance, and this other variable is the test current itself. Because each meter and each range uses a different test current, the apparent forward resistance of the base is different in each case. This is why it is best to use a low-resistance range for this test, as this range will show up best the difference between forward and reverse conduction.

TYPE IDENTIFICATION

Now to continue with our method of identifying *pnp* and *npn* transistors, the only way in which a good *npn* transistor may indicate low resistance is with the black lead of the multimeter connected to its base, and the red lead to either its emitter, its collector, or both, as with the *pnp* transistor but the test leads are reversed. A considerably higher measurement will be obtained if the test is made between emitter and collector."

"If you do not have a transistor tester handy, there is an easy method to determine whether a transistor is exhibiting 'transistor action' by amplifying current fed to its base. The method works well in most cases, and also helps in distinguishing between germanium and silicon transistors. Suppose that we have a *pnp* germanium transistor."

LEAKAGE

The Prof. took an AC128 transistor to illustrate this.

"Now connect the red test lead to the collector, and the black lead to the emitter. A small leakage current flows, causing a reading on the meter. This is characteristic of germanium transistors and usually does not happen with silicon types. The leakage current is most readily observed with the meter set to a high resistance range, and the transistor will then appear to show a low resistance reading. If you now connect the base and emitter leads together, the measurement will rise to show a higher resistance. The reason for this is that the transistor amplifies current which leaks from its collector to its base (Fig. 2). When we connect base and emitter together, the transistor can no longer amplify, and only a small leakage current then flows.

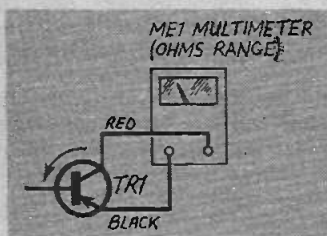

Fig. 2. Current leaks from collector to base in a germanium transistor.

With silicon transistors there is very little leakage of this kind, so that in order to apply this simple test to a silicon transistor, it is necessary to arrange an external leakage path in order that a small current may flow from collector to base. This may be done by using a high value resistor connected between collector and base (as shown in Fig. 3).

"When switch S1 is open, the meter reading should be high, maybe indicating open circuit, and when S1 is closed, the meter should indicate a resistance of apparent value less than the value of R1. If the meter shows a resistance value slightly above that of R1, the transistor is probably faulty, with either very low gain or an open circuit collector.

The other switch S2 may be used to test germanium transistors by shorting base to emitter as I have already described."

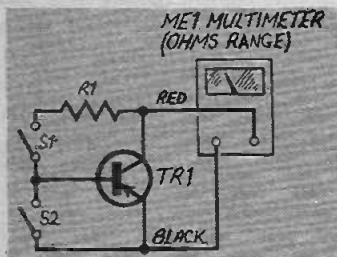

Fig. 3. Only little current leaks from collector to base in a silicon transistor.

Bob built up the circuit of Fig. 3 by mounting a transistor socket, two switches and a couple of sockets for the meter probes onto a small plastic box. He also provided three test leads with probe clips for transistors which would not fit in the socket. He wired all these together, along with R1, by means of connecting wires inside the box.

Now by placing a transistor on the test socket or by connecting the three test leads to it, he could find out whether it was *npn* or

pnp, estimate whether it was silicon or germanium, and roughly check for gain and leakage current, by manipulating S1 and S2, and by changing the meter leads around where necessary.

Bob used the transistor checker to test some of the transistors from the bargain packs and soon found two small *pnp* transistors which he decided might be usable as TR1 and TR2 in the amplifier circuit (Fig. 4).

"Although this checker does not actually measure the gain of the transistor under test, Prof., it gives a very handy quick check, and I have already managed to weed out several low-gain transistors, where the meter reading did not change much as S1 was opened and S2 was closed.

The transistors which I have sorted out for TR1 and TR2 in the amplifier seem to have good gain. With S1 closed and S2 open, the resistance reading is low. When S1 is opened, the reading rises considerably, and when S2 is closed, the reading rises a lot more."

"It sounds to me as though you have two *pnp* germanium transistors, Bob. If they were *pnp* silicon transistors such as type BC478, you would still have a low reading with S1 closed and S2 open. But as soon as S1 was opened, the reading would become so high that S2 would make no perceptible difference. However, if you close S2 first, before opening S1, the meter should read about 50 kilohms for silicon transistors, and maybe less for germanium transistors as these are more likely to leak current."

"One of the transistors I have leaks slightly more than the other, Prof.," commented Bob,

Fig. 4. A three-stage class A audio amplifier using negative feedback.

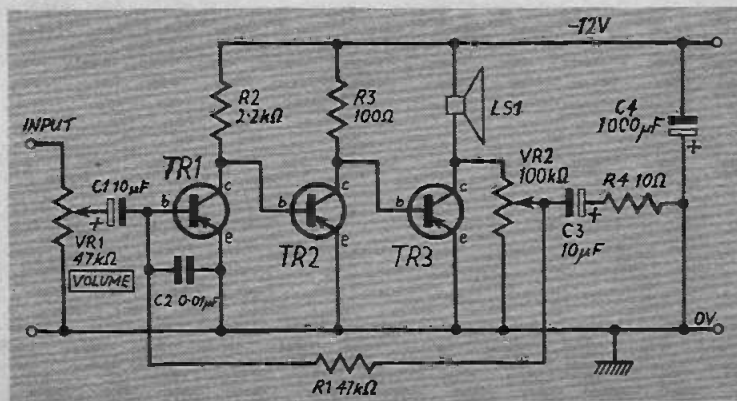

When I close S2 the resistance does not rise to as high a value. But the difference is not very great—it is nearly the same as the new AC 128 which we tested, so I think I can use this as TR2, and the less leaky one as TR1. But how do I go about finding a transistor for the TR3 position in the circuit?"

POWER TRANSISTORS

"There appear to be a lot of power transistors in the metal TO3-style case" the Prof. observed (see Fig. 5), "and almost any TO3-style *pnp* transistor should be adequate for the circuit, as most transistors of this type are constructed to pass a current of at least 1 amp, and to be capable of dissipating 10 watts or more on a suitable heatsink. You will find that the *pnp* germanium power transistors are likely to be quite leaky, though, so you need to change to a lower range on your meter in order to check them."

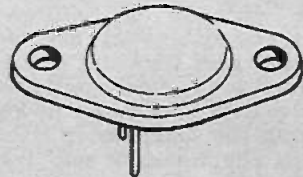

Fig. 5. The TO-3 type encapsulation.

Bob did this, and, soon he had sorted out a number of *pnp* power-transistors. He selected one of these, mounted it carefully on a heatsink using a small amount of silicone grease to assist in heat-transfer and, collecting together the remainder of the components proceeded to build up the circuit of the class A amplifier according to Fig. 4.

When he had built the circuit and checked it to make sure there were no construction errors, Bob set VR1 and VR2 to their lowest positions, connected the battery, and a source of audio signal to the input, and proceeded to adjust the controls in order to obtain a clear sound with VR2 set as low as possible. However, he found that in order to obtain an acceptable result he had to turn VR2 to its highest setting.

"Prof. there seems to be something wrong here! On this amplifier I have to adjust VR2 to its highest setting in order to get sounds through—and even then it's a bit distorted and low in volume. On the previous amplifier I made, I got a good clear result even with the control set to a much lower position. What could be the matter?"

The Prof. came over and adjusted the control. He found that as soon as it left the top portion of the track, the sound became quite badly distorted, and even more volume was lost.

"I think that the transistor which you have chosen to use for TR1 is likely to be an unsuitable type, Bob. It is a transistor which needs a greater base current in order to operate correctly, and if you lower the value of R1 to say, 5 or 10 kilohms, this would provide a base bias sufficient to enable the transistor to operate more efficiently. Unfortunately as the value of R1 also determines the amount of negative feedback in the circuit, the gain of the amplifier would decrease. So you can choose—either lower the gain of the amplifier by replacing R1, or else replace TR1 with a transistor capable of operating with a lower base current."

"Which kind of transistor could I use?" enquired Bob.

"There are very many different types of *pnp* pre-amplifier or low-level transistors which would suit, and type BC478 should be suitable."

Bob switched off the amplifier, set VR2 to its lowest position once more, and replaced TR1 with a

BC478. Soon the amplifier was in full swing with loud, clear music and VR1 set to quite a low position.

"It seems to be all right, Prof., but now I notice there is a strange thing about this amplifier. The TR1 transistor BC478 is silicon, and the other two are germanium—so that the circuit appears to work quite well with a mixture of silicon and germanium transistors! Would there be any advantage in using all silicon or all germanium?"

"Yes," replied the Prof., "in some circumstances it would be best to use germanium transistors—especially for low-voltage operation. But for Paul's car it may be best to use silicon transistors, which would mean another BC478 for TR2, and for TR3 a BD214 should be quite suitable. The reason for this is that the inside of a car can become very hot, and silicon transistors would prove to be less liable to failure due to overheating."

To be continued

Making some printed circuit boards can be a tiresome business, as there is often more copper to be covered by the etch resist than to be removed by the etchant, so it is necessary to painstakingly block in large areas of copper. This wastes time, and money too, especially if one is using one of the special pens sold for the purpose.

My method is this: take an old felt pen, remove the "sponge" from inside and wash the latter thoroughly. When it is dry, soak it for a few minutes in acetone or nail-varnish remover until it is quite full of the liquid. Then put it back in the pen.

To prepare your circuit board, first paint the copper side completely with nail-varnish—a dark colour shows up best—and allow to dry. Then remove the nail-varnish you don't need by drawing on it with the prepared felt pen. Excess acetone can be wiped off with blotting-paper.

Give the board a final rinse under the cold tap before putting into the etchant. This method gives good, professional results cheaply, quickly and easily.

T. D. Lascelles, Croydon.

PUBLISHERS ANNOUNCEMENT

The contents of EVERYDAY ELECTRONICS is fully protected by international copyright and reproduction of it in any form is prohibited without our consent.

With effect from this announcement any application for permission to reproduce, or use our material in any way or part of, must be made to the Editor. Under no circumstances will permission be given to reproduce material in a similar or competitive publication, without payment. No application need be made in the case of a private constructor, constructing one item for his/her own enjoyment and interest.



BRIGHT IDEAS

Readers' Bright Ideas; any idea that is published will be awarded payment according to its merit. The ideas have not been proved by us.

I have found that multipin sockets (with about 50 terminals) make ideal bread-boards, simply by soldering lines of terminals together.

I have mounted two sockets, wired like this, onto the lid of a Strepils tin, one centimetre apart, thus also giving a wide gap for long bodied devices, and giving twelve strips of terminals.

There is plenty of room in the base of the tin to hold as wide a selection of components as possible; thus I find this a handy experimental kit which I can carry anywhere.

M. J. Shute,
Southampton

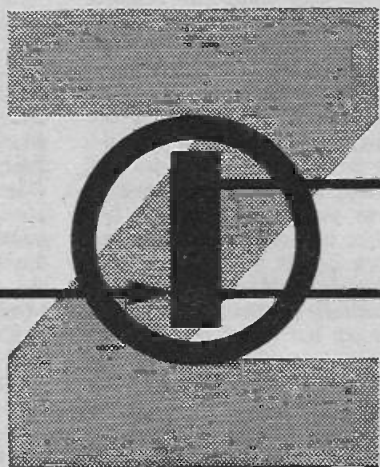
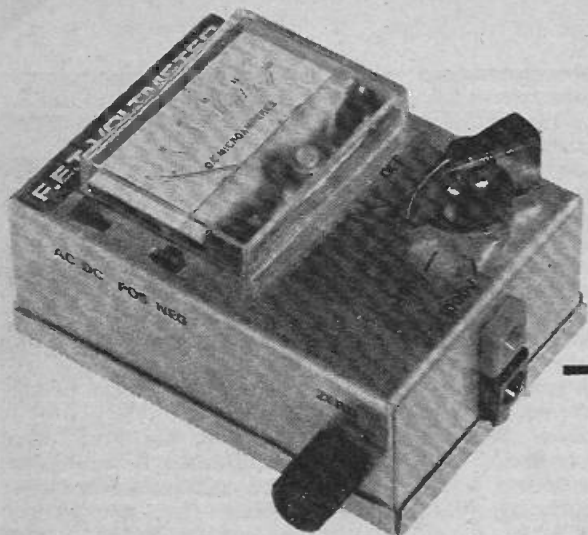

F.E.T. VOLTMETER

By **STEPHEN WEDGE**

THIS voltmeter was designed to have a high input impedance in the order of 10 megohms to enable the constructor to make accurate voltage measurements.

The voltmeter has a d.c. range of up to 1,000 volts; a.c. measurements can also be made but are only accurate for voltages above about 10 volts. On no account should the unit be used to measure a.c. voltages in excess of 300 volts.

A.C. VOLTAGES

The a.c. ranges use a single diode giving half-wave rectification, this is not conventional but simplifies construction. You should not expect absolute accuracy when measuring a.c. because the meter will be measuring an approximate root mean-square value, the precise display of which will depend to some extent on the mechanics of the movement itself, nevertheless it is sufficiently accurate for checking mains voltages and transformer output voltages.

When measuring sine wave a.c. voltages, due to the half-wave rectified signal input the indicated voltage level is only half the actual level, so the indicated level should be doubled to give correct value. Alternatively the meter face could be marked to read the correct a.c. level. The a.c. ranges are suitable for use with signals up to 1kHz.

CIRCUIT

The complete circuit diagram of the F.E.T. Voltmeter is shown in Fig. 1, and can be seen to consist of two distinct parts—an input attenuator followed by a d.c. amplifier.

With S1 in the d.c. position, the voltage at the input probe is applied to the attenuator composed of R1 to R8, the values arranged such that the voltages developed at the appropriate junctions of these resistors are in the ratio 1:10:100:1,000. The junctions of these resistors are taken to S2a allowing the required range to be switched in.

The two transistors TR1, TR2 are in circuit to protect the following circuitry in the event of the wrong range being selected when measuring. If the voltage at the wiper of S2a is greater than about plus or minus 5 volts it is limited by TR1 and TR2 thus preventing excessive voltage from reaching the d.c. amplifier.

When measuring a.c. voltages, S1 is operated and D1 is put in circuit, half-wave rectifying the input voltage.

AMPLIFIER

With no input voltage applied a reference voltage is developed at the emitter of TR4 which can be balanced out by VR2 (zero control) so that no reading is indicated on ME1.

When a voltage is applied to the gate of TR3 it will either turn TR4 harder on or off, depend-

FOR
GUIDANCE
ONLY

ESTIMATED COST*
OF COMPONENTS
excluding V.A.T.

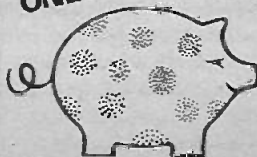

£5.80

excluding case

*Based on prices prevailing at
time of going to press

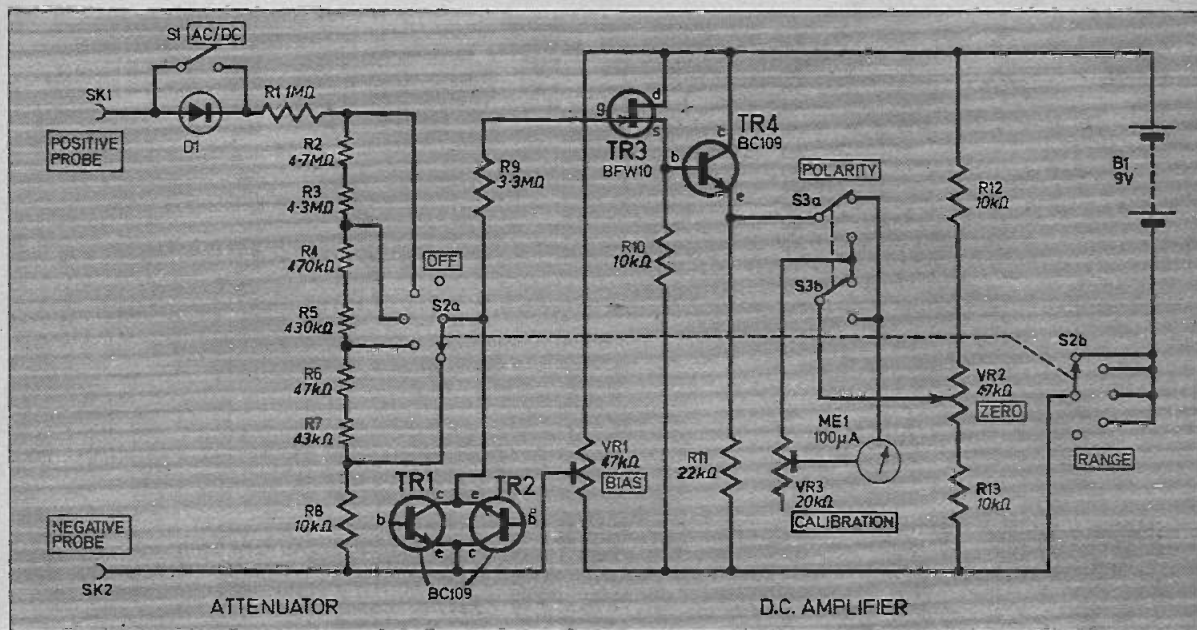

Fig. 1. The complete circuit diagram of the F.E.T. Voltmeter.

ing on whether the applied voltage is positive or negative. The result is that TR4 emitter voltage changes and causes the meter to deflect.

Bias for TR3 is obtained through VR1, R9, TR1 and TR2 and can be adjusted by means of VR1. This only requires an initial setting.

Variable resistor VR3 is in series with the meter and is included to calibrate the meter movement used, and once again only requires an initial setting.

Switch S3 is included so that the meter polarity can be changed to enable reading of negative and positive voltages without reversing the probe leads. The input voltage selector switch S2 is a ganged type, the other half being used as the on/off switch. Also, with S2 in the off position, the d.c. amplifier is disconnected from the attenuator circuit.

CONSTRUCTION

The prototype was housed in a case 100 × 70 × 40 mm and it is strongly advised that the case be a completely insulated plastic type in view of the high voltages that may be encountered.

Some of the components are mounted on a small piece of 0.1 inch matrix Veroboard size 25 holes by 6 strips, the layout of this board is shown in Fig. 2. After making the breaks along the copper strips on the underside, position and solder the components as shown. Leave the transistors until last and use a heatsink on the leads of these devices to prevent thermal damage. It is advisable to disconnect the soldering iron from the mains when soldering TR3, otherwise the device may be permanently damaged.

The remainder of the components are fitted

Components

Resistors

R1	1MΩ	R8	10kΩ
R2	4.7MΩ	R9	3.3MΩ
R3	4.3MΩ	R10	10kΩ
R4	470kΩ	R11	22kΩ
R5	430kΩ	R12	10kΩ
R6	47kΩ	R13	10kΩ
R7	43kΩ		

All ½ watt carbon ± 5% or better.

Potentiometers

VR1	47kΩ subminiature skeleton preset
VR2	4.7kΩ miniature carbon linear
VR3	20kΩ subminiature skeleton preset

Semiconductors

TR1	BC109 silicon npn
TR2	BC109 silicon npn
TR3	BFW10 n-channel f.e.t. or similar
TR4	BC109 silicon npn
D1	1N004 or similar 1000 volt (PIV) silicon diode

Miscellaneous

S1	s.p.s.t. slide or toggle (300V d.c. rating)
S2	double-pole 5-way wafer switch (300V d.c. rating)
S3	d.p.d.t. slide or toggle
SK1, 2	banana sockets (1 red, 1 black—insulated high voltage type)
ME1	100μA d.c. meter
B1	9V PP3

Veroboard: 0.1in matrix 25 holes x 6 strips; plastic case size 100 x 70 x 40mm (or larger) insulated plastic type; insulated push on or recessed screw fixing knob.

SEE
**SHOP
TALK**

F.E.T. VOLTMETER

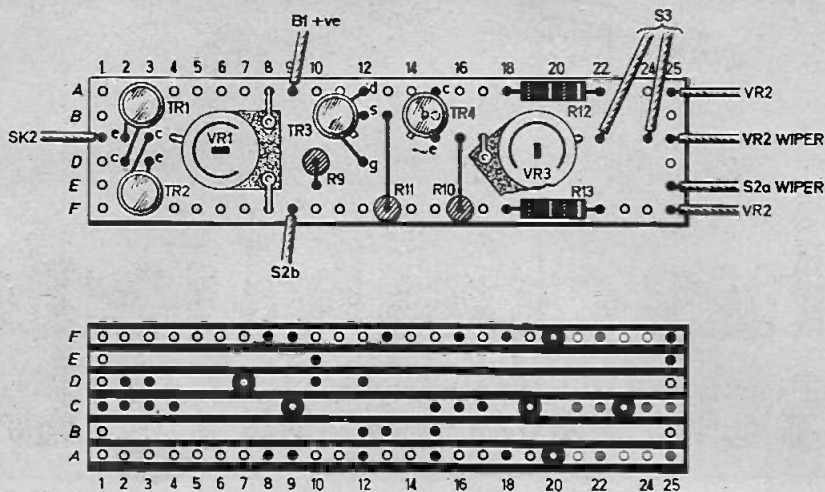

Fig. 2. The layout of the components on the Veroboard also the regions of copper to be removed from the underside.

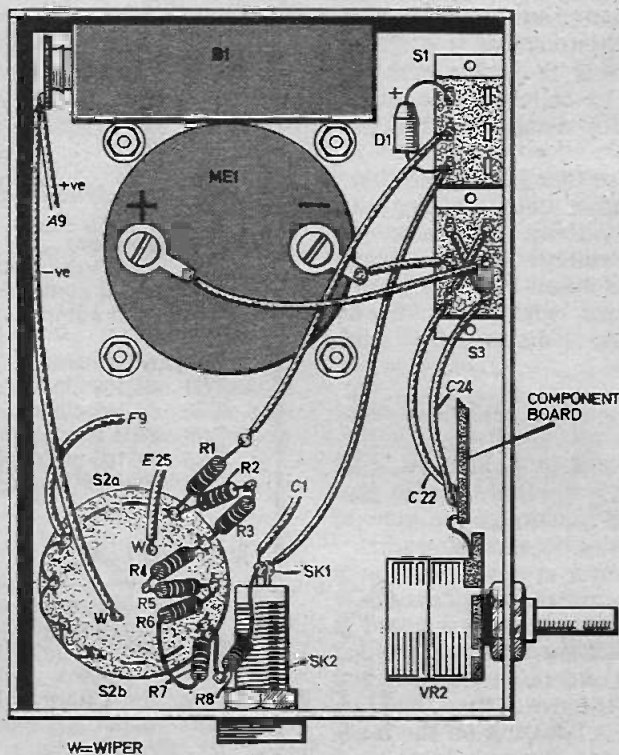
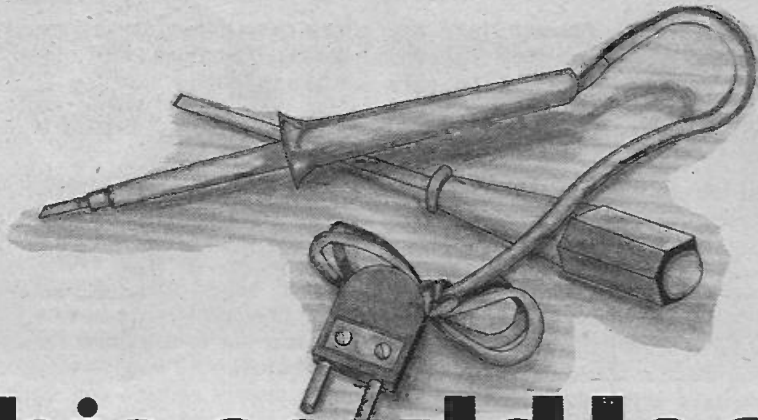

Fig. 3. Complete wiring up details of the components in the case.



This could lead to something big.

A soldering iron and a screw driver. If you know how to use them, or at least know one end from the other, you know enough to enrol in our unique home electronics course.

This new style course will enable anyone to have a real understanding of electronics by a modern, practical and visual method. No previous knowledge is required, no maths, and an absolute minimum of theory.

You build, see and learn as, step by step, we take you through all the fundamentals of electronics and show you

how easily the subject can be mastered and add a new dimension not only to your hobby but also to your earning capacity.

This course is accepted by and used in a large number of schools and colleges and forms an invaluable grounding for professional training in the subject. All the training is planned to be carried out in the comfort of your own home and work in your own time. You send them in when you are ready and not before. These culminate in a final test and a certificate of success.

1

Build an oscilloscope.

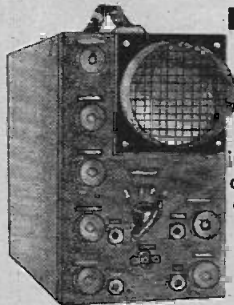

As the first stage of your training, you actually build your own Cathode ray oscilloscope! This is no toy, but a professional test instrument that you will need not only for the course's practical experiments, but also later if you decide to develop your knowledge and enter the profession. It remains your property and represents a very large saving over buying a similar piece of essential equipment.

2

Read, draw and understand circuit diagrams.

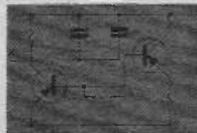

In a short time you will be able to read and draw circuit diagrams, understand the very fundamentals of television, radio, computers and countless other electronic devices and their servicing procedures.

3

Carry out over 40 experiments on basic circuits.



We show you how to conduct experiments on a wide variety of different circuits and turn the information gained into a working knowledge of testing, servicing and maintaining all types of electronic equipment, radio, t.v. etc.

PLUS



FREE GIFT!

ALL STUDENTS ENROLLING IN OUR COURSES RECEIVE A FREE CIRCUIT BOARD ORIGINATING FROM A COMPUTER AND CONTAINING MANY DIFFERENT COMPONENTS THAT CAN BE USED IN EXPERIMENTS AND PROVIDE AN EXCELLENT EXAMPLE OF CURRENT ELECTRONIC PRACTICE

To find out more about how to learn electronics in a new, exciting and absorbing way, just clip the coupon for a free colour brochure and full details of enrolment.

WAA

Brochure without obligation to:
BRITISH NATIONAL RADIO & ELECTRONICS SCHOOL, Dept EEL85
P.O. Box 156, Jersey, Channel Islands.

NAME.....

ADDRESS.....

(Block caps please)

to the case as shown in Fig. 3. Prepare the case to accept these components and then secure these in position and wire up to the component board as depicted in Fig. 3.

In the prototype no component fixing was found necessary as the zero potentiometer (VR2) tags were soldered directly to the board and were sufficiently strong to hold the board when VR2 was secured to the case. Before fixing the case backplate in position ensure that no components leads are touching.

TEST PROBES

It is essential to have well insulated probes from the point of view of safety. These can either be purchased or home built. A probe that has been found satisfactory is shown in Fig. 4, and is fabricated using the casing of an exhausted biro pen with the refill removed.

File the tip of a 6BA screw to a point and solder a length of well insulated wire to the other end. Next thread the wire through the

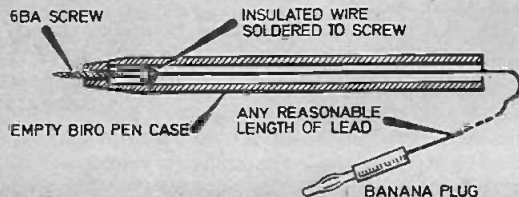

Fig. 4. Details of the probe.

biro case and glue the screw in the end of the casing. Terminate the other end of the wire in a banana plug.

SETTING UP

The setting up procedure should be followed carefully and repeated if necessary.

1. Set VR1 to midway position and S1 for d.c.
2. A series variable resistor of about 5 kilohm should be inserted in one of the battery leads and the unit switched on with the variable resistor set to maximum.
3. Adjust VR2 to give zero reading on ME1, and then slowly reduce the variable resistor at the same time adjusting VR2 to keep the meter reading zero. Continue until the variable resistor is at minimum. Remove the series resistor.
4. A 1.4 volt mercury cell or an accurate meter is now needed to calibrate the instrument. With the cell connected across the input sockets, adjust VR3 so that the meter reads 1.4 volts. If this reading cannot be realised on the 10 volt range, adjust the bias control VR1 so that the meter reads 2 volts. Disconnect the mercury cell and adjust VR2 to make ME1 read zero. Reconnect the mercury cell to obtain a reading of 1.4 volts by adjusting VR3. This procedure must be repeated until the required reading is obtained.

When condition (4) is accomplished the unit is complete and ready for use.

4-STATION INTERCOM

£16.15

Solve your communication problems with this 4-Station Transistor Intercom system (1 master and 3 Subs), in robust plastic cabinets for desk or wall mounting. Call/talk/listen from Master to Subs and Subs to Master. Ideally suitable for Business, Surgery, Schools, Hospitals and Office. Operates on one 9V battery. On/off switch. Volume control. Complete with 3 connecting wires each 6ft. and other accessories. P. & P. 66p.

MAINS INTERCOM NEW MODEL
No batteries—no wires. Just plug in the mains for instant two-way, loud and clear communication. On off switch and volume control. Price £29.99 per pair P. & P. 76p.

NEW! AMERICAN TYPE CRADLE TELEPHONE AMPLIFIER

ONLY £11.95
+ VAT 96p

Latest transistorised Telephone Amplifier with detached plug-in speaker. Placing the receiver on to the cradle activates a switch for immediate two-way conversation without holding the handset. Many people can listen at a time. Increase efficiency in office, shop, workshop. Perfect for "conference" calls: leaves the user's hands free to make notes, commit files. No long waiting, saves time with long-distance calls. On/off switch, volume. Direct tape recording model at £12.95 + VAT £1.04 P. & P. 65p, 10-day price refund guarantee.

WEST LONDON DIRECT SUPPLIES (FEB)
169 KENSINGTON HIGH STREET, LONDON, W8

ELECTRONI-KIT

"EDUCATIONAL KITS of EXCEPTIONAL QUALITY"
(AUDIO mag).

All components are beautifully encapsulated in unbreakable transparent plastic blocks. Perfect connections are made WITHOUT SOLDERING, SCREWING OR WIRING

INCREDIBLE VALUE. Build, dismantle and rebuild projects any number of times and invent your own experiments.

COMPLETELY SAFE. Instructive and FUN—all kits operate from 9v. battery.

VALUABLE MANUALS included with every kit. No previous knowledge is required, even with the largest kits.

KIT 2A—30 projects £10.45. Radios, amplifiers, alarms, microphones, Morse, etc.

KIT 3A—100 projects £20.45. As 2A plus electronic birds, cats, sirens, organs, metronome, guns, light and sound, burglar alarms, etc.

3ADX—105 projects £25.25. As 3A plus solar cell experiments and complete sophisticated control panel, etc.

4ADX—150 projects £33.95. As 3ADX plus Relay and Meter experiments; ion concentration—, volume—, out-put—, field intensity—, volt—, resistance meters, ammeter, illuminometer, etc. and many, many more.

ADD-ON parts and manuals available.

The three larger kits include Electrical experiments too.

All prices include Battery, Manual, VAT & p. & p.

Cheque/P.O. (or 11p for literature) to:

Satisfaction guaranteed
ELECTRONI-KIT LTD, 408 St. John's Street,
London, EC1. (01-278 4579)

66 PAGES
3000 ITEMS
600 PICTURES

YOUR COMPLETE ELECTRONIC STORES. MAIL ORDER AND SHOP

HAVE YOU GOT YOURS

CATALOGUE No. 4 NEW CONVENIENT SIZE AND FULLY ILLUSTRATED

CONTAINS MANY HARD TO GET ITEMS

20p

PAYS FOR ITSELF WITH DISCOUNT VOUCHERS WORTH 20p

*DISCOUNTS
*ALL NEW STOCK
*SATISFACTION GUARANTEE

*DEPENDABLE SERVICE

B. H. COMPONENT FACTORS LTD.
(E.E.), LEIGHTON ELECTRONICS CENTRE, 59 NORTH STREET, LEIGHTON BUZZARD, LU7 7EG. Tel.: Leighton Buzzard 2316 (Std. Code 05253).



In November 1965, The St. Cyres Electronic Group was started, and at their meetings they saw a series of excellent Mullard, I.B.M., C.O.I. and other technical firms. There was a great deal of enthusiasm shown, so in May 1966 it was decided to change the name to The British Amateur Electronics Club (B.A.E.C.) and a committee was elected and a Constitution adopted. The B.A.E.C. expanded considerably, and electronic enthusiasts from all over the British Isles and overseas enrolled.

Naturally, it is not possible for all members to go to meetings even though there are some affiliated groups, so they keep in touch, exchange ideas and help each other through the B.A.E.C. Newsletter, which is sent to members four times a year. Members range from beginners to experts, and the newsletter is designed to help them all. It is particularly satisfying that experts go out of their way to help beginners with articles in the newsletter and also by contacting them directly.

The B.A.E.C. Exhibition has been held every year since 1966 and has gradually grown, last year was the best exhibition so far, with many very interesting projects made by members in all parts of the country.



Some of the B.A.E.C. members getting to grips with constructional projects of their own or published designs. Expert help is always available if needed.

One of the many games exhibited that visitors can play. This one is an electronic race for two players. It incorporates an electronic dice and penalty chance lamps. The first player to get all the way up the chain and light the lamp at the top is the winner. Proceeds from this and other games go to charity.

Everyday Electronics, August 1975



A general view of last year's exhibition showing the large variety of displays together with some of the people responsible for setting up and running the exhibition.

For the first time there was a beginners section, and this was so popular that several members enrolled on the spot! This year the B.A.E.C. will be holding its 10th annual exhibition in Penarth, Glamorgan, from July 19 to 26, and they are already planning to make it special.

The B.A.E.C. welcomes new members, so if any reader would like further details please write to the Hon. Secretary, Mr. J. G. Margetts, 11 Peartree Avenue, Ditton, Maidstone, Kent. The subscription is £1 per year (50p if under 16).



The beginners section at the B.A.E.C. exhibition last year. Various circuit and layout diagrams are provided together with the necessary components and a plug-in wiring board. Visitors are then invited to build a simple project and try it out.



FOR 2 PLAYERS
10p PER GAME
WINNER GETS 5p
ALL PROCEEDS GO TO CHARITY

DOWN TO EARTH

By GEORGE HYLTON

ELECTRONIC components are only suitable for use over a limited range of frequencies. Thus ordinary iron-cored transformers are for power and audio frequencies. They do not perform well at radio frequencies.

An Edinburgh reader, P. Faccenda, asks about the frequency limitations of resistors of various kinds. In the case of high stability resistors of the carbon film or metal oxide type, he wonders whether the shape of the resistive track affects performance at v.h.f.

These resistors are made by coating a ceramic rod with a film of carbon or tin oxide and then cutting a spiral groove in the film. This leaves a spiral resistive track in the form of a solenoid coil (Fig. 1). Such a track has inductance, and the impedance of an inductance rises with a frequency. This is evidently the basis of our reader's question.



Fig. 1. Carbon film resistor with spiral track.

Is a resistor which is 100 ohms at d.c. still 100 ohms at 50 MHz? Or has the spiral inductance pushed up the impedance to some significantly higher value? If it has, then you can't use the resistor in applications where precision is important, such as the attenuators in radio frequency signal-generators (test oscillators).

CAPACITANCE

In diagrammatic form (Fig. 2) what is needed is the pure resistance (a), but what you seem to get is a resistance in series with an inductance (b).

However, the picture is still incomplete. Any two conductors placed close together make a capacitance. In a spiral resistor, there is a capacitance between

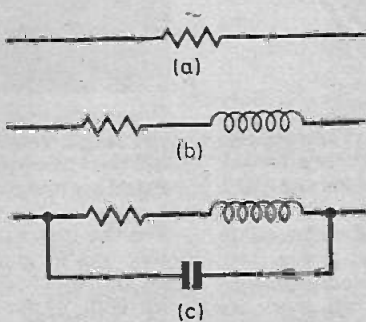

Fig. 2. What a resistor looks like at various frequencies. At v.h.f. (c) is the best model for explaining performance.

adjacent turns of the spiral. This enables high-frequency currents to leak across the space between turns, so bypassing part of the resistance. This tends to reduce the impedance as the frequency rises.

The new picture of the resistor, with capacitance, is shown at (c). So two opposing effects occur: inductance which increases impedance as the frequency goes up, and capacitance which decreases the impedance.

CANCELLATION

To some extent at least, these opposing effects must cancel one another, and help to keep the impedance constant. The extent to which this cancellation is complete depends on the shape and the resistance. For most types of

high-stability resistor, cancellation is greatest at about 80 ohms.

Below 80 ohms, inductance gets the upper hand, and the impedance rises with frequency. Above 80 ohms, capacitance effects predominate and the impedance falls as frequency rises. However, the amount of rise or fall is not great so long as the resistance is not vastly smaller or greater than 80 ohms, and in theory you could get away with values from about 10 ohms to 1000 ohms at v.h.f.

However, the actual layout of components usually adds stray capacitance so the higher end of this resistance range should be avoided. This means that, in an attenuator (Fig. 3) the amount of attenuation in any one section should not be too large, because this calls for high and low resistances. Many attenuators used for adjusting the strength of the outputs of signal generators have a few 20dB sections and use the input potentiometer for intermediate settings. This potentiometer, if wirewound, may have an appreciable inductance. This doesn't upset the frequency response too much so long as its resistance is low compared with the impedance of the attenuator.

In wire-wound resistors, the inductive effect usually predominates if a simple solenoid shape is used. For this reason high-frequency wire-wound resistors are made in shapes which reduce the inductance, such as windings on thin flat cards, or arrangements where the inductance of one part cancels that of another.

It is also possible to compensate the inductance by deliberately adding capacitance, but the price for this is a reduced upper frequency limit, because compensation is only good up to a certain frequency, after which the impedance goes down.

Fig. 3. Signal generator output attenuator: VR1 gives smooth adjustment of the oscillator output; S1 and S2 switch in "step attenuators" often of 20dB (voltage attenuation of 10).

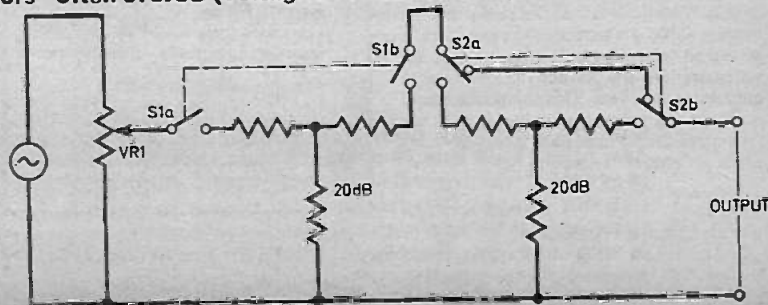

Sinclair Scientific kit

Britain's most original calculator – now in kit form

The Sinclair Scientific is an amazing calculator.

It offers logs, trig, and true scientific notation over a 200-decade range – features normally found on calculators costing around £50 or more.

Yet even ready-built, it costs a mere £21.55 (including VAT)

And as a kit it costs under £15!

Forget slide rules and four-figure tables

On the Scientific, you can handle *directly*

all three trig functions,

their inverses,

\log_{10} , antilog_{10} , giving quick access

to x^y (including square and

other roots),

plus, of course, the four arithmetic functions and any calculation based on them.

In fact, virtually all complex scientific or mathematical

calculations can be handled with

ease.



**Now only
£14.95
(inc. VAT)**

So is the Scientific difficult to assemble?

No. Powerful though it is, the Sinclair Scientific is a model of tidy engineering.

All parts are supplied – all you need provide is a soldering iron and pair of cutters. Complete step-by-step instructions are provided, and our Service Department will back you throughout if you've any queries or problems.

Of course, we'll happily supply the Scientific or the Cambridge already built, if you prefer – they're still exceptional value. Use the order form.

Features of the Scientific

- 12 functions on a simple keyboard
- Scientific notation
- 200-decade range
- Reverse Polish logic
- 25-hour battery life
- Genuinely pocketable

Sinclair Cambridge kit

At its new low price, the Sinclair Cambridge kit remains unbeatable value.

The Cambridge is now Britain's most popular pocket calculator. And it's not surprising. Check the features – then ask yourself what other calculator offers such a powerful package at such a reasonable price.

**Now only
£9.95
(inc. VAT)**



Features of the Cambridge

- Only $4\frac{3}{8}'' \times 2'' \times \frac{11}{16}''$. Weight $3\frac{1}{2}$ oz.
- Fully-floating decimal point.
- Algebraic logic.
- Constant on all four functions (+ - × ÷).
- Constant and algebraic logic combine to act as limited memory.
 - Clear, bright 8-digit display.
 - Operates for weeks on 4 AAA batteries.

Take advantage of this money-back no-risk offer today

The Sinclair Cambridge and Scientific kits are fully guaranteed. Return either kit within 10 days, and we'll refund your money without question. All parts are tested and checked before despatch – and we guarantee any correctly-assembled calculator for a year. This guarantee also applies to calculators supplied in built form.

Simply fill in the preferential order form below and post it – today!

To: Sinclair Radionics Ltd, FREEPOST, St Ives, Huntingdon, Cambs., PE17 4BR.

Please send me

- Scientific kit – £14.95 inc. VAT
- Scientific built – £21.55 inc. VAT
- Cambridge kit – £9.95 inc. VAT
- Cambridge built – £13.99 inc. VAT

*I enclose a cheque for..... made out to Sinclair Radionics Ltd, crossed.
*Please debit my *Access/Barclaycard account number:

*Delete as required

Signed _____

Name _____

Address _____

Please print. FREEPOST – no stamp required.

EE/875

Sinclair Radionics Ltd.

London Road, St Ives, Huntingdon, Cambs., PE17 4JH. Tel: St Ives (0480) 64646

Reg. no: 699483 England. VAT Reg. no: 213 8170 88

sinclair

Sinclair Project 80

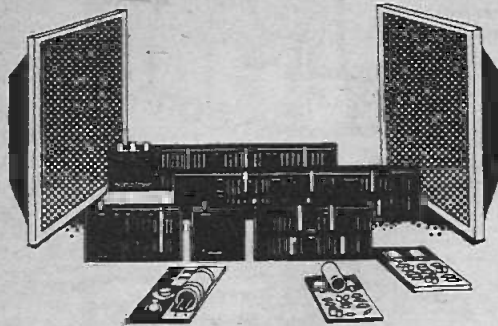

The watts...

14 different hi-fi modules. Between them they cater for every variety of hi-fi set-up, from a tuner amp to a full CBS SQ quadrophonic system. The value for money's amazing. A genuine 25 W per channel quadraphonic amplifier for under £80...

a 12 W per channel stereo amp for around £30...

And the satisfaction's even greater! If you can handle a soldering iron, you can handle Project 80. And if you can't... use Project 805 - the same modules but with solderless clip connections.

and the wherefores.

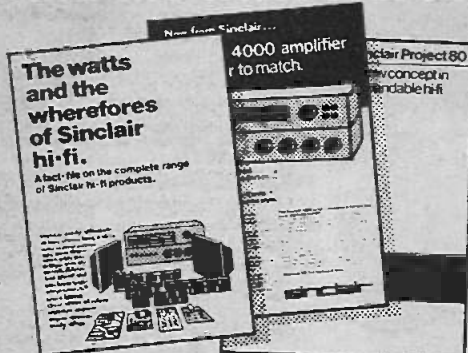

Take a look at some of the hi-fi systems you can build...

Get the full technical specifications...

See what impartial hi-fi journals thought of its performance...

And read up on the rest of the Sinclair hi-fi range...

It's all in the Sinclair hi-fi range fact-file.

Send for Sinclair's fact-file - now!

See if the answer's here - the information on the component you've been looking for.

Simply cut the coupon and send it to the no-stamp-needed FREEPOST address below.

We'll send you the Sinclair fact-file - giving you all you need to know about Project 80, and the rest of the Sinclair hi-fi range.

Plus information about a few extras you're sure to find rather interesting.

You've plenty to gain... so cut the coupon - now!

Sinclair Radionics Ltd,
London Road, St Ives,
Huntingdon, Cambs., PE17 4HU
St Ives (0480) 64646

Please send me the Sinclair range fact-file immediately

Name _____

Address _____

EE/P8/8

Please print

To: Sinclair Radionics Ltd,
FREEPOST, St Ives,
Huntingdon, Cambs., PE17 4BR

sinclair

ENGINEERS

FREE



YOURSELF FOR A BETTER JOB WITH MORE PAY!

Do you want promotion, a better job, higher pay? "New opportunities" shows you how to get them through a low-cost, Home Study Course. There are no books to buy and you can pay as you learn.

This easy to follow GUIDE TO SUCCESS should be read by every ambitious engineer. Send for this helpful 76-page free book NOW! No obligation, nobody will call on you. It could be the best thing you ever did.

CHOOSE A BRAND NEW FUTURE HERE



CUT OUT THIS COUPON
Tick or state subject of interest.
Post to address below.

- | | | |
|--|---|--|
| <input type="checkbox"/> ELECTRICAL ENGINEERING
City & Guilds Wiring and Installations
C. G. Electrical Tech-Primary
Gen. Electrical Eng. | <input type="checkbox"/> RADIO & TV
Gen. Radio and TV Eng.
Radio Servicing, Maintenance and Repairs
Practical Radio & Electronics (with self-build kit)
Radio Amateurs' Exam | <input type="checkbox"/> DRAUGHTSMAN-SHIP
Institute of Engineering Draughtsmen & Designers
General Draughtsmanship
Architectural Draughtsmanship
Technical Drawing |
| <input type="checkbox"/> AERONAUTICAL ENGINEERING
Air Registration Board Certificates
Gen. Aero Engineering | <input type="checkbox"/> ELECTRONIC ENGINEERING
Gen. Electronic Eng.
Practical Electronics (with kit) | <input type="checkbox"/> CONSTRUCTION & BUILDING
Institute of Building
Construction Surveyor's Inst.
Clerk of Works Diploma
C. & G. Building Quantities
General Building
General Civil Eng. |
| <input type="checkbox"/> AUTO ENGINEERING
City & Guilds Auto Engineering
Practice
Inst. Motor Industry
M.A.A./I.M.I. Management Diploma
Gen. Auto Engineering
Auto Diesel Maintenance
Motor Mechanics
Service Station and Garage Management | <input type="checkbox"/> AGRICULTURAL ENGINEERING | <input type="checkbox"/> HEATING, VENTILATING & AIR CONDITIONING
Carpentry & Joinery
Painting & Decorating
Plumbing
C.E.I. (Part 1)
Inst. Cost & Management
Accountants
Works Management etc. etc. |
| <input type="checkbox"/> TELECOM-MUNICATIONS
City & Guilds Telecommunications | <input type="checkbox"/> REFRIGERATOR SERVICING | <input type="checkbox"/> MECHANICAL ENGINEERING
Society of Engineers
Inst. Engineers and Technicians
General Mechanical Eng.
Welding
Maintenance Eng.
General Diesel Eng. |



G.C.E.

—58 'O' & 'A' Level Subjects
—over 10,000 Group Passes!

Aldermaston College

Dept. TEE08 Reading RG7 4PF.

also at our London Advisory Office, 4 Fore Street Avenue, Moorgate, London EC2Y 5EJ. Tel. 01-628 2721.

NAME (Block Capitals) _____

ADDRESS _____

Postcode _____

Other subjects of interest _____ Age _____

Accredited by C.A.C.C. Member of A.B.C.C.

HOME OF BRITISH INSTITUTE OF ENGINEERING TECHNOLOGY

Sinclair System 4000

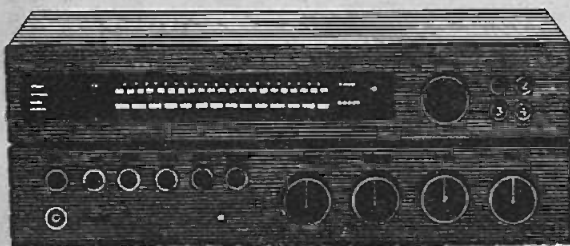

The watts...

Black, beautiful, and incredibly good value. Sinclair's two self-contained hi-fi units - in one handsome, elegant style.

A 17 watts per channel amplifier and a matching FM tuner.

The amplifier offers 17 W RMS per channel output... 0.05% total harmonic distortion... and a price tag

of around £50.

The System 4000 tuner completes a handsome, hard-working system.

Engineered and designed to accompany the System 4000 stereo amplifier, the FM tuner matches it in specification and design - and at around £40 completes a system of outstanding value.

and the wherefores.



Get the full technical specifications...

See what impartial hi-fi journals thought of its performance...

And read up on the rest of the Sinclair range...

It's all in the Sinclair hi-fi range fact-file.

Send for Sinclair's fact-file now!

See if the answer's here - the information on the component you've been looking for.

Simply cut the coupon and

send it to the no-stamp-needed FREEPOST address below.

We'll send you the Sinclair fact-file - giving you all you need to know about System 4000, and the rest of the Sinclair hi-fi range.

Plus information about a few extras you're sure to find rather interesting.

You've plenty to gain... so cut the coupon now!

Sinclair Radionics Ltd,
London Road, St Ives,
Huntingdon, Cambs., PE17 4HJ
St Ives (0480) 64646

Please send me the Sinclair range fact-file immediately

Name _____

Address _____

EE/4K/8

Please print

To: Sinclair Radionics Ltd,
FREEPOST, St Ives,
Huntingdon, Cambs., PE17 4BR

sinclair

QUALITY STEREO SOUND

ALMOST $\frac{1}{2}$ PRICE OFFER! SOLENT AUDIO SYSTEM

MADE TO SELL AT
DOUBLE THE PRICE
IN CABINET FORM
OUR
PRICE £59.95

£5.95
down

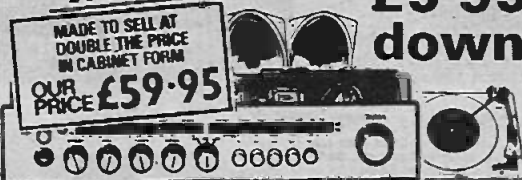

*Stereo Tuner Amplifier chassis with AM/FM radio covering long medium short and Stereo FM wavebands. Separate Base and Treble controls. 30 watts total power output (frequency response 25-20,000 Hz) Tape record and playback facilities. Dimensions 18" x 8 1/2" x 3 1/2". The very latest BSR automatic record deck with cue and pause control- Two matching elliptical speaker units.

Order early limited stocks available cash price £59.95. Credit Sale £5.95 deposit 9 monthly payments of £7.00 (Total Credit price £68.95). P. & P. £3.00. Send £8.95 today.

Chassis only available for cash at £42.00.

Full 12 months Guarantee.

CALLERS WELCOME.

Stereo headphones supplied with every complete order.

LEWIS radio EE/8/75 100 CHASE SIDE SOUTHGATE
LONDON N14 5PL Telephones: 01-882-1644

ENGINEERS

FREE

YOURSELF FOR A

BETTER JOB WITH MORE PAY!

Do you want promotion, a better job, higher pay? "New Opportunities" shows you how to get them through a low-cost home study course. There are no books to buy and you can pay-as-you-learn.

This helpful guide to success should be read by every ambitious engineer. Send for this helpful 76 page FREE book now. No obligation and nobody will call on you. It could be the best thing you ever did.



CUT OUT THIS COUPON
CHOOSE A BRAND NEW FUTURE HERE!

Tick or state subject of interest. Post to the address below.

- | | | |
|--|---|---|
| <input type="checkbox"/> Electrical Engineering | <input type="checkbox"/> General Radio and TV Engineering | <input type="checkbox"/> CITY AND GUILDS Electrical Technicians |
| <input type="checkbox"/> Electrical Installations and Wiring | <input type="checkbox"/> Radio Servicing, Maintenance and Repairs | <input type="checkbox"/> CITY AND GUILDS Telecommunications |
| <input type="checkbox"/> Electrical Draughtsmanship | <input type="checkbox"/> Transistor Technology | <input type="checkbox"/> Radio Amateurs' Exam. |
| <input type="checkbox"/> Electrical Mathematics | <input type="checkbox"/> CITY AND GUILDS Installations and Wiring | <input type="checkbox"/> etc. etc. |
| <input type="checkbox"/> Electronic Engineering | <input type="checkbox"/> Computer Prog | |

To: ALDERMASTON COLLEGE
DEPT. EEV 08, READING RG7 4PF

Also at our London Advisory Office, 4 Fore Street Avenue,
Moorgate, London EC2Y 5EJ. Tel: 01-628 2721.

NAME (Block Capital's Please) _____

ADDRESS _____

POSTCODE _____

Other subjects _____

Accredited by C.A.C.C.

Age _____

Member of A.B.C.C.

HOME OF BRITISH INSTITUTE OF ENGINEERING TECHNOLOGY

BI-PRE-PAK

Bargains in Semi-Conductors, components, modules & equipment.

Bargains from our FREE Catalogue

20 large pages, filled with real bargains in transistors, I.C.s, components, equipment, etc. Send large S.A.E. with 10p stamp for your FREE copy of 6th Edition by return. Meanwhile, for prompt delivery order from this month's ad. NOW.

TRANSISTOR PACKS ALL AT 50p EACH

TESTED & GUARANTEED

879	4	IN4007 Sil. Rec. diodes. 1,000PIV 1 amp. plastic	H39	6	Integrated circuits 4 gates BMC 962, 2 flip flops BMC943
881	10	Reed Switches, 1 long 1/2" dia. High-speed P.O. type	H41	2	BD131/BD132 Complementary Plastic Transistors 40361 Type NPN Sil. Transistors TO-5 can comp. to H66
H35	100	Mixed Diodes, Germ. Gold bonded, etc. Marked and Unmarked.	H45	4	40382, Type PNP Sil. Transistors TO-5 can comp. to H65
H38	30	Short lead, NPN Silicon Planar Ex Equipment.			

UNMARKED & UNTESTED

B1	50	Germanium Transistors PNP, AF and RF	H6	40	250mV zener diodes. At least 20 good.
886	150	Germanium Diodes Min. glass type	H15	30	Silicon rectifiers 750mA assorted. Top-hat type.
H48	10	Experimenter's pack of 1 I.C., D.T.L. and T.T.L. (some marked)	H34	15	Power Transistors, PNP, Germ. NPN Silicon TO-3 Can
888	100	Sil. Diodes sub. min. IN814 and IN918 types	H67	10	3819N Channel FET's plastic case type

PLASTIC POWER TRANSISTORS

40 WATT SILICON *				
Type	Polarity	Gain	VCE	Price
40N1	NPN	15	15	28p
40N2	NPN	40	40	39p
40P1	PNP	15	15	28p
40P2	PNP	40	40	39p
80 WATT SILICON *				
Type	Polarity	Gain	VCE	Price
80N1	NPN	15	15	25p
80N2	NPN	40	40	35p
80P1	PNP	15	15	25p
80P2	PNP	40	40	35p

NEW X-HATCH GENERATOR Mk. 2



Essential for Colour T.V. alignment of 4 patterns. Featuring plug in IC's and a more sensitive sync. pick-up circuit. The case is virtually unbreakable—ideal for the engineer's toolbox—only measures 3" x 5 1/2" x 3". Operates from 3 U2 type batteries (extra).

P/P add 30p Complete Kit **£7-93*** Ready built unit only **£9-93***

TO CLEAR

Hundreds of various portable transistor radio chassis with FM & AM tuning. Ideal for experimenters. All electronic components in good order, but no instructions or tuning drives. A cheap way to make a portable. Each £1

SUNDRY

Capacitor Discharge Ignition Kit £7-30 (8). 8 assorted relays £1-00 (8). Rev counter device (for cars) £1-00. U.H.F./TV Tuner Units £2-50. LM-399 Audio I.C. £1-00. Technical books of all kinds. (No VAT).

TERMS OF BUSINESS

V.A.T. Prices shown do not include V.A.T. This must be added to total value of your order at 25% except for prices marked * or (8%) when only 8% V.A.T. is required. No V.A.T. on overseas orders.

POSTAGE Except where stated, add 22p for postage & packing in U.K. Overseas—add £1, any difference being charged or refunded.

PAYMENT Cash with order. Cheque or money order. Minimum order value £1-25. You can also pay by ACCESS.

IMPORTANT—Every effort is made to ensure accuracy of prices and description at time of preparing this advertisement and going to press. Prices are subject to alteration without notice.

BI-PRE-PAK LTD

222 224 WEST ROAD, WESTCLIFF-ON-SEA, ESSEX SSO 9DF.

TELEPHONE: SOUTHEND (0702) 46344.

WRITE ORDER SEPARATELY AND ATTACH COUPON IF REQUIRED

challenging values!



Stirling Sound

STIRLING SOUND AUDIO MODULES come to you as basic units assembled on P.C.B.s enabling you to add required components in layouts of your own choice. Modules are tested and boxed before despatched and include well printed instructions.

PRE-AMP TONE CONTROLS

- Pre-amplifiers; tone control
- SS.100 Active tone control unit to provide bass, treble, balance and volume controls **£1-60**
 - SS.101 Pre-amp for ceramic cartridge, tape and radio **£1-60**
 - SS.102 Pre-amp for low output magnetic cartridge, tape and radio. With R.I.A.A. correction $\pm 1\text{dB}$ at 1K **£2-25**

POWER AMPLIFIERS

- SS.103 Compact I.C. amp. with 3 watts R.M.S. output. Operating voltage 10-20v. Size 3 1/2" x 2" **£1-75**
- SS.103-3 Stereo version of above using one I.C. on each channel **£3-25**
- SS.105 New improved all-purpose power amp which will run excellently on a 12V supply. With 5 watt output, two make a good stereo amp. Size 3 1/2" x 2" **£2-25**
- SS.110 Similar in size to SS.103 but with a 10 watt output. Ideal for many domestic and small-size P.A. applications. Operates from 26 to 32V **£2-75**
- SS.140 Excellently designed 40 watt R.M.S. (into 4 ohms) hi-fi amplifier. S/N ratio better than 75dB. THD better than 0.2%. Power requirements—45V. d.c. With 0.15" centre grade connections. Two can be bridged to give 80 watts R.M.S. into 8 ohms **£3-60***

BUILD A STEREO FM TUNER!

- SS.201 Ganged tuning condenser with accurately engineered slow-motion drive in rugged housing. Excellent sensitivity. Tunes 88-108MHz. With A.F.C. facility. Operates from 6-16V **£6-25**
- SS.202 I.F. stage (with I.C.) Pre-tuned. A.F.C. connection. Operates from 4.5 to 14V **£5-25**
- SS.203 Stereo Decoder. Designed essentially for use with SS.201 and 2, this module can also be used in most mono FM tuners. A LED may be attached. Operating voltage 9-16V. d.c. **£5-62**

SPECIAL £3 MONEY SAVING OFFER
Buy all three modules for building a stereo FM Tuner (Total list £17-21) and you pay only £12-12

POWER SUPPLY STABILIZER

- SS.300 Add this to an unregulated supply (say typically 45V output) to obtain a steady powerful working output adjustable from 12 to 60V. Essential on your audio and special systems as well as test bench. Money saving and very reliable **£3-25***

MAINS TRANSFORMERS FOR ABOVE

- Add 35p per transformer for P/P
- Type A 18V/1A (Suit SS.103) **£1-50**
 - Type B 25V/2A (Suit SS.110) **£2-00**
 - Type C 30V/2A (Suit SS.140) **£4-50***
 - Bridge Rectifiers—Type A 27p. Types B & C 38p

Founded 1959

To BI-PRE-PAK, 224-226 WEST RD., WESTCLIFF-ON-SEA, ESSEX

Please send

for which I enclose Inc. V.A.T.

Name

Address

E.E.8

Everyday Electronics Classified Advertisements

RATES: 11p per word (minimum 12 words). Box No. 30p. extra. Semi-display—£7.50 per single column inch. Advertisements must be prepaid and addressed to Classified Advertisement Department, "EVERYDAY ELECTRONICS," I.P.C. Magazines Ltd., Fleetway House, Farringdon Street, London EC4A 4AD. (01—634 4379)

EDUCATIONAL

CITY & GUILDS EXAMS

Study for success with ICS. An ICS home study course will ensure that you pass your C. & G. exams. Special courses for: Telecoms Technicians', Electrical Installations, Radio, TV & Electronics Technicians', Radio Amateurs'. Full details from ICS School of Electronics, Dept. 335, Intertext House, London SW8 4UJ. Tel: 01-622 9911 (all hours).

TECHNICAL TRAINING

Get the training you need to move up into a higher paid job. Take the first step now—write or phone ICS for details of ICS specialist home study courses on Radio, TV, Audio Eng. and Servicing, Electronics, Computers; also self-build radio kits. Full details from ICS School of Electronics, Dept. 336, Intertext House, London SW8 4UJ. Tel: 01-622 8911 (all hours).

COLOUR TV SERVICING

Learn the technique of servicing Colour TV sets through new home study course approved by leading manufacturer. Covers principles, practice and alignment with numerous illustrations and diagrams. Other courses for radio and audio servicing. Full details from ICS School of Electronics, Dept. 337, Intertext House, London SW8 4UJ. Tel. 01-622 9911 (all hours).

FOR SALE

MICROPHONES: AKG D202E1, £45.00; AKG D190C or 'E' £20.00; AKG D224, £60.00; Sennheiser MD211N, £45.00. All brand new and boxed. Please add 25% for VAT. All other AKG and Sennheiser mikes. SAE for quote to J. J. Francis (Wood Green), Ltd., Manwood House, Matching Green, Harlow, Essex. Tel: Matching 476.

E.E. MAY 1972—March 1974. Offers: 68 Carisbrooke Way, Cardiff. Tel: 439637.

RECEIVERS and COMPONENTS

VALVES, RADIO, TV, TRANSMITTING, INDUSTRIAL. 1930 to 1975, 2,200 types stocked, many obsolete. TH41, 2P, X101, U19, N78, EBL21, PX4, PX25, X79, 6F33, etc. List 20p. SAE for quotation. We purchase new and boxed valves. Cox Radio (Sussex) Ltd., The Parade, East Wittering, Sussex. West Wittering 2023.

COMPONENTS GALORE. Pack of 600 mixed components manufacturers surplus plus once used. Pack includes Resistors, carbon and W.W., capacitors various, transistors, diodes, trimmers, potentiometers etc. Send £1+10p p. and p. c.v.o. to CALEDONIAN COMPONENTS, Strathore Road, Thornton, Fife.

3 ASSORTED M.C. METERS £1.30 (40p). **LARGE COMPUTER PANELS 35-50** Transistors, Long Leads, 85p (50p), **COPPER CLAD PAK PANELS** 5 1/2" x 5 1/2", 6—65p, c.p. 8 1/2" x 9 1/2" 3—£1 c.p. 12" x 12" 60p c.p. **T.V. CONVERGENCE PANELS 2x AC128.** 3 Slugged Coils, 3 Slide Switches 11 w.w. Pots, 3 Carbon Presents, 2 Ferrite Chokes, etc. £1.20 c.p. **VALU-PAKS P9.** 100 S/mica Caps 73p, c.p. P24, 100 Polyester Caps. Mullard C280 series, £1.18, c.p. Send 12p for lists. Refund on purchase. **71bs ASSORTED COMPONENTS £2.20, c.p.** **J. W. B. RADIO**
2 Barnfield Crescent, Sale, Cheshire M33 1NL
Postage in Brackets Mail Order Only

MISCELLANEOUS

GADGETS GALORE!!

★ READY BUILT + TESTED ★

Signal Injector £2.25 Signal Tracer £2.25
Logic Probe £4.45 Noise Generator £4.95
Metronome £3.95 Continuity Tester £3.95

Now available from our new shop!!
Prices include U.K. Postage and Batteries
Please call or write (SAE list) to:

G.K. SERVICES. (62)
28 High St., St. Mary Cray, Orpington
BR5 3NJ

DIGITAL CLOCK CHIP, AY-5-1224, with data and circuit diagram, £3.66 plus VAT. "Jumbo" LED digits (16mm high), Economy type DL-747, only £2.04 each plus VAT, post free. Green-Bar Electronics, 94 New Chester Road, Wirral, Merseyside L62 5AG.

H.M. ELECTRONICS (E.E.)

DEC CABINETS

A beautifully designed modern cabinet to give that extra finish to your work. 5 standard sizes. Please send 15p (refundable) for folder of leaflets.



CONSTRUCTION AIDS. Screws, nuts, spacers, etc., in small quantities. Aluminium panels punched to spec. or plain sheet supplied. Fascia panels etched aluminium to individual requirements. Printed circuit board-masters, negatives and boards, one-off or small numbers. Send 6p for list. **RAMAR CONSTRUCTOR SERVICES,** 29 Shelbourne Road, Stratford-on-Avon, Warks.

LOUDSPEAKERS



Speakers, kits and cabinets for D.I.Y., HiFi, P.A., Disco, etc. by EMI, Fane, Goodmans, Baker, Kef, Elac, Richard Allan, Wharfedale, etc. Send stamp for free booklet "Choosing a speaker"

WILMSLOW AUDIO

Dept. EE, Swan Works, Bank Square,
Wilmslow, Cheshire SK9 1HF
Tel. Wilmslow 29599

THE SCIENTIFIC WIRE CO

Copper - Nickel Chrome - Eureka - Manganin Wires.
Enamelled - Silk - Cotton - Tinned Coverings.
No minimum charges or quantities.
Trade and Export enquiries welcome.
S.A.E. Brings List.
P.O. BOX 30, LONDON, E4 9BW

SUPERB instrument cases by Bazelli, manufactured from heavy duty P.V.C. faced steel. Hundreds of Radio, Electronic and Hi-Fi enthusiasts are choosing the case they require from our range. Make your VAT go further with our competitive prices which begin at a low 75p. Examples: width, depth, height: 7in x 7in x 5in, £2-65; 8in x 10in x 6in, £3-60; 12in x 8in x 7in, £4-00; 12in x 12in x 7in, £4-40. Over 200 models to choose from. Prompt despatch, free literature (stamp would be appreciated). Bazelli, Department No. 24, St. Wilfrids, Foundry Lane, Halton, Lancaster LA2 6LT.

AERIAL BOOSTERS £3.30

We make three types of aerial boosters B45-UHF-TV, B12-VHF-TV, B11-VHF-Radio.

VALVES BARGAINS

ANY 5-50p, 10-75p, 50-£3.30.
ECC82, EF80, EF183, EF184, PCC189, PCF80, PCF802, PCL82, PCL84, PCL83/805, PFL200, PL56, PL504, PY800, PY83.

COLOUR TV VALVES—PL508, PL509, PY600-25p each.

Prices exclude VAT, P&P 10p, SAE—leaflet
Electronic Mail Order Ltd, 62 Bridge Street,
Rambottom, Bury, Lancs. Tel RAMS 3936.

LOWEST COST IC SOCKETS. Use Soldercon IC socket pins for 8 to 40 pin DIL's. 50p for strip of 100 pins, £1-50 for 3 strips of 100, £4 for 1000. 10p p&p for orders under £2. Add 8% VAT. Instructions supplied—send sae for sample. SİNTEL, 55e Aston Street, Oxford. Tel: 0865 43203.

MULTIMETER

Type U4224

20,000Ω/V, Overload protected.
Ranges: 0-8, 1-2, 3, 12, 30, 60, 120, 600, 1200V DC; 3, 6, 15, 60, 180, 300, 600, 900V AC; 0-06, 0-6, 6, 60, 600mA, 3A DC; 0-3, 3, 30, 300mA, 3A AC; 6 resistance ranges to 5MΩ dBs, —10 to +12. Size 167 x 98 x 63mm. Supplied complete with test leads, clip spare diode and instructions.

ONLY £11.00

PC ETCHING KIT

Contains 1lb Ferric chloride, DALO etch-resist pen, 100 sq ins copper clad board, etching dish, abrasive cleaner and instructions. £3.30

FERRIC CHLORIDE

Anhydrous to Mill-spec in double-sealed 1lb packs. 1lb 90p; 3lb £1.80; 10lb £4.70.

VEROBOARD

100 sq ins 0-1, 0-15 & 0-2" good-size offcuts (About 8 pieces) £1.15.

TRANSFORMERS

Miniature type, mains primary, 100mA sec. 6-0-6V 95p; 0-0-0V £1.00; 12-0-12V £1.05.

71b BARGAIN PARCELS

Contain hundreds of resistors, pots, capacitors, switches & PC boards with transistors and diodes, also loads of odds and ends. £3.00.

GREENWELD ELECTRONICS [EEO]

51 SHIRLEY PARK ROAD,
SOUTHAMPTON SO1 4FX

Tel (0703) 772501. Also at 88 Lower Adiscombe Rd, Croydon & 21 Denford Bdy SE8.

ALL PRICES INCLUDE VAT AND UK POSTAGE. SAE LIST, ENQUIRIES. CALLERS WELCOME.

HOME SCIENTISTS
Get the key to a FANTASTIC WORLD of previously UNHEARD-OF-PROJECTS. The NEW Boffin catalogue lists LOTS of HIGHLY UNUSUAL, LOW-COST BARGAINS, READY-BUILT MODULES. Here are just a few examples, there are stacks more!

Dazzling MINI-STROBE (pocket size) £3-50
PEOPLE DETECTOR £4-20
Big-Ear SOUND-CATCHER £4-20
Mini DREAM LABORATORY £4-20
Don't take our word for it though! GET A COPY & SEE!
SEND ONLY 20p, and we'll RUSH YOU A COPY (YOU'LL GET THE GOODIES' JUST AS QUICKLY TOO!)

BOFFIN PROJECTS
4 Cunliffe Road, Stoneleigh,
Ewell, Surrey
(Mail Order U.K. Only)

BUILD THE TREASURE TRACER MK III Metal Locator



- Varicap tuning
- Britain's best selling metal locator kit
- Weighs only 22oz. Fitted with Faraday shield.
- Speaker and earphone operation
- Knocks down to only 17in.
- Prebuilt search coil assembly
- Thoroughly professional finish
- As seen on BBC1 and BBC2 TV
- You only need soldering iron, screwdriver, pliers and snips
- Five transistor circuit

Complete Kit £10-90 Built & tested £15-25
Post 60p 92p VAT(8%) Post 69p £1-21 VAT(8%)
MINIKITS ELECTRONICS
6b CLEVELAND ROAD,
LONDON, E18 2AN (Mail order only)

**PLEASE MENTION
Everyday
Electronics**

**WHEN
REPLYING TO
ADVERTISEMENTS**

**SPARKRITE MK2
CAPACITIVE DISCHARGE
ELECTRONIC IGNITION KIT**

Sparkrite Mk. 2 is a high performance, high quality, capacitive discharge, electronic ignition system. Because of the superior design of the Sparkrite circuit it completely eliminates problems of the contact breaker. There is no misfire because contact breaker bounce is eliminated electronically by a pulse suppression circuit which prevents the unit firing if the points bounce open at high R.P.M. Contact breaker burn is eliminated by reducing the current to about 1/50th of the norm. It will perform equally well with new, old, or even badly pitted points and is not dependent upon the dwell time of the contact breaker for recharging the system. Sparkrite incorporates a short circuit protected inverter which eliminates the problems of SCR lock on and therefore eliminates the possibility of blowing the transistors or the SCR. (Many capacitive discharge ignitions are not completely foolproof in this respect.)

Sparkrite can therefore give you:
up to 20% better fuel consumption, instant all weather starting, cleaner plugs—they last up to 5 times longer without attention, faster acceleration, higher top speeds, longer coil and battery life, efficient fuel burning and less air pollution, smoother running, continual peak performance.

NOTE—FUEL CONSUMPTION:
The fitting of a Sparkrite Mk. 2 should reduce fuel consumption although the amount of the reduction will vary. A fair estimate of the savings which could be expected, based on reports by our customers and upon our own experience, are as follows:
any 4-cylinder vehicle, 10% improvement
any 6-cylinder vehicle, 15% improvement
any 8-cylinder vehicle, 20% improvement
It is worth remembering that while fuel saving is important there are many other advantages to be gained from fitting a Sparkrite ignition system.

*Voted best of 8
ignition systems
tested by a leading
Motoring Magazine*

THE KIT COMPRISES EVERYTHING NEEDED: Ready drilled pressed steel case coated in matt black epoxy resin, ready drilled base and heatsink, top quality 5-year guaranteed transformer and components, cables, coil connectors, printed circuit board, nuts, bolts, silicon grease, full instructions to make the kit negative or positive earth, and 10 page installation instructions
WE SAY IT IS THE BEST SYSTEM AT ANY PRICE.

OPTIONAL EXTRAS
Electronic R.P.M. limiter
This can be included in the unit to prevent over-revving, an advantage to most companies, hire firms, high performance drivers, etc.

Electronic/conventional ignition switch.
Gives instant changeover from 'Sparkrite' ignition to conventional ignition for performance comparisons, static timing, etc. and will also switch the ignition off completely as a security device, includes switch, connectors, mounting bracket and instructions. Cables excluded.

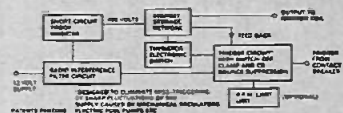

PRICES: D.I.Y. assembly kit £10-83; Ready built unit £13-86* (both to fit all vehicles with coil/distributor ignition up to 8-cylinders).
Switch for instant changeover from 'Sparkrite' ignition to conventional ignition £2-79; R.P.M. limiting control £2-42* (fitted in case of ready built unit, dashboard mounting on kit).
*including VAT, post and packing.
We can supply units for any petrol-engined vehicle (boat, motorcycle, etc.) with coil/contact breaker ignition. Details on request.
CALL IN AND SEE US FOR A DEMONSTRATION.

ELECTRONICS DESIGN ASSOCIATES of WALSALL

**ALUMINIUM
BOXES**

These project boxes are manufactured from 16-gauge aluminium and come complete with lids and screws.
The prices shown include VAT (at 8%), but 18p should be added to the total order value for postage and packing.

Order No.	Length (in)	Width (in)	Height (in)	Price (inc. VAT)
7	5 1/2	2 1/2	1 1/2	47p
8	4	4	1 1/2	48p
9	4	2 1/2	1 1/2	48p
10	5 1/2	4	1 1/2	49p
11	4	2 1/2	2	46p
12	3	2	1	35p
13	3	4	2	58p
14	7	5	2 1/2	75p
15	8	6	3	93p
16	10	7	3	£1-14

Boxes can be made to any size but the minimum order for special sizes is 500. General trade enquiries welcome.

**FLUORESCENT
LIGHT KIT**

You can build this reverse polarity protected 12 volt, 8 watt, fluorescent light. Everything needed is supplied: white enamelled drilled metalwork, ready drilled heatsink, printed circuit board, high quality components and transformer, end caps, cable, the fluorescent tube, nuts, bolts, washers, and simple assembly and operating instructions.

When complete the light has many uses: workshop and workbench illumination, garage lighting, emergency lighting, lighting for camping, caravanning, and boating, as an inspection lamp and many more.

If you can't spare 1 hour to put the light together then we will supply it ready built! (FOR A FEW EXTRA PENCE)
PRICES:
Assembly kit £3-46 inc. VAT post and packing
Ready built £4-10 inc. VAT post and packing.
Diffuser 59p inc. VAT post and packing.

ORDER NOW

To: ELECTRONICS DESIGN ASSOCIATES DEPT., 62 Bath Street, Walsall WS1 3DE. Phone 33662

From: Name _____
Address _____

Please Supply

Quantity	SPARKRITE Mk. 2 D.I.Y. assembly kit at £10-83
	SPARKRITE Mk. 2 ready built negative earth at £13-86
	SPARKRITE Mk. 2 ready built positive earth at £13-86
	Ignition changeover switches at £2-79
	R.P.M. Limit systems in the above units at £2-42
	Fluorescent light assembly kits at £3-46
	Fluorescent light built units at £4-10
	Diffusers for the above at 59p
	of number aluminium boxes at _____
	of number glass boxes at _____

I enclose cheque/P.O. for £ _____ Cheque No. _____
(Send S.A.E. if brochure only required)

New **BIGGER! BETTER!** **DORAM**

CATALOGUE 2nd Edition

SPECIFICALLY DESIGNED FOR THE AMATEUR
RADIO, ELECTRONICS AND HI-FI ENTHUSIAST.

- * MUCH, MUCH BIGGER RANGE OF QUALITY ELECTRONIC COMPONENTS AND AUDIO ACCESSORIES FROM TRUSTED BIG NAME MANUFACTURERS
- * THOUSANDS UPON THOUSANDS OF COMPONENTS - ILLUSTRATED, INDIVIDUALLY CODED AND PRICED. MANY NEW COMPONENTS ADDED FROM CUSTOMER REQUESTS
- * 16 EXTRA PAGE DATA SECTION
- * UNIQUE FREE UP-DATE PRODUCT INFORMATION SERVICE DURING LIFE SPAN OF CATALOGUE
- * ALL COMPONENT REQUIREMENTS SENT BY RETURN POST
- * POST AND PACKING FREE (only applies for Great Britain, N. Ireland plus B.F.P.O. Nos. - overseas orders F.O.B.)
- * NO-QUIBBLE REPLACEMENT PART SERVICE

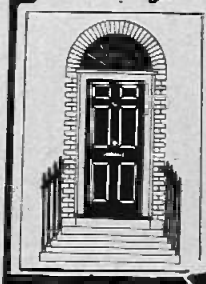

ONLY
60p
Inc. Post and Packing

All this and more - so don't delay

*send for
your new
catalogue
TODAY!*

The doorway to amateur electronics

DORAM

DORAM ELECTRONICS LIMITED
P. O. Box TR8
Leeds LS12 2UF

I enclose 60p. Please send me by return my new Doram Catalogue. (Overseas orders except for N. Ireland, please add 30p for post and packing surface only).

PLEASE PRINT BLOCK CAPITALS  EE 8

NAME _____

ADDRESS _____

Post Code _____

HENRY'S

PARFIT

LARGEST SELECTION OF ELECTRONIC COMPONENTS AND EQUIPMENT. LOW PRICES - MEAN LESS VAT.



AMPLIFIERS with Controls

EL210 12 volt 2+4, 24 watts 8 ohms	£9.34
SA C14 Mains 7+1, 7 watts 8 ohms	£14.70
SAC30 Mains 15+15 watts 8 ohms	£18.90
CAD38 9 volt 14+14 watts 8 ohms	£8.68
CA068 12 volt 3+3 watts 8 ohms	£13.12

MULLARD MODULES

LP1157 AM Type	£3.12
LP1185 10.7 I.F. Unit	£6.75
LP1186 10.7 F.M. Tuner	£7.30
Gorlier Perm. F.M. Tuner	£5.25

FM and AM TUNERS and DECODERS

FMS261 (tu 2) 6 volt fm tuner	£9.95
TU3 12 volt version (FM use with Decoder)	£9.95
SD4912 Stereo Decoder for Tu 3-12 volt	£9.95
SP26H 6 volt stereo FM tuner	£18.50
A1007 9 volt MW-AM	£6.18
A1018 9 volt FM tuner in cabinet	£17.45
A1005M (S) 8-12 volt Stereo decoder? FM for above	£9.37
5475 Stereo decoder kit	£8.73

POWER SUPPLIES MAINS INPUT

(*chassis-rest cased)	£2.43
470C 6.75/9V 300 MA with adaptors	£2.00
P500 9 volt 500 MA	£5.94
HC24AR 3.6/7.5/9V, 400 MA stabilised	£5.94
*P11 2V 1 amp 3-30	£3.55
*P15 28V 1 amp	£3.55
*P1080 12V 1A	£5.87
*P1081 45V 0.9 amp	£8.42
P12 45-12V 0.4-1 amp	£7.77
SE1015 3.6/9/12V 1 amp stabilised	£13.77
P1076 3.4/6.7/9/12V 1 amp	£4.50
SE800A 1-15 VOLT 0-1A stabilised	£18.90

SINCLAIR MODULES & KITS

Sinclair Project 80

ST80 Stereo preamplifier	£14.85
Audio Filter Unit	£8.17
Z40 15 Watt Amplifier	£6.40
Z60 25 Watt Amplifier	£8.17
P25 Power Supplies for 1 or 2 Z40	£5.72
P24 Power Supplies (S Tab) for 1 or 2 Z40	£8.18
TRANSFORMER FOR P25	£4.86
FM TUNER	£14.95
STEREO DECODER	£9.34
IC20 power amp kit	£9.34
PZ20 power supply for 1 or 2 IC20	£5.88

PACKAGE DEALS

2 x Z40 ST80 PZ5 (carr./packg. 35p)	£29.32
2 x Z60 ST80 PZ6	£32.60
2 x Z60 ST80 PZ5-trans	£40.42
805 Kit	£42.25

SINCLAIR SPECIAL PURCHASES

*Project 80 stereo preamp	£7.94 (post 20p)
*Project 805 Kit	£23.44 (post 25p)

EMI SPEAKERS SPECIAL PURCHASE

13 in. x 8 in. chassis speakers (Carr./packing 30p ea. or 50p pr.)	
*150 TC 10 watts 8 ohms twin cone	£2.53
450A built in tweeter 8 ohms	£4.42
EW 15 watt 8 ohms with tweeter	£7.18
350 20 watt 8, 15 ohm with tweeter	£10.29
*polished wood cabinet Carr. etc. 35p each or 50p pair.	£6.00

PA-DISCOTHEQUE LIGHTING EQUIPMENT



Without doubt U.K.'s best range of modular and complete equipment. Lighting, mixing, microphones, accessories, speakers, amplifiers, lenses, etc., etc. FREE stock lists (Ref. No. 18) on request CALL IN AND SEE FOR YOURSELF AT HENRY'S DISCO CENTRE, 309 EDGWARE ROAD, TEL. 01-723 8963

EP27 LOW COST SEVEN SEGMENT INDICATOR DIGIT HEIGHT 1/3 inch £1.45 each p. & p. 15p

L40 RECHARGEABLE BATTERY 2V 4000mAh 54p p. & p. 15p

PHILIPS 12V FLUORESCENT INVERTOR FOR 8W FLUORESCENT TUBE. SUPPLIED WITH INSTRUCTIONS AND TUBE £3.78 p. & p. 35p

STC & ITT MINIATURE RELAYS	
150R 8V	2pco
180R 6.75/12V	2pco
185R 12V	2pco
1250R 12/25V	2pco
1700R 18/24V	2pco
1800R 24V	4pco
2500R 18/24V	2pco
4000R 24V	2pco

BRAND NEW p.p. 15p

ALL PRICES ARE INCLUSIVE OF VAT

TAPE HEADS

Marriot XRPS/174 Track High	£3.17
Marriot XRPS/184 Track Med.	£4.60
Marriot XRPS/351 Track Med.	£5.25
Marriot XRPS/631 Track High	£2.00
Marriot Erase Heads for XRSP 17/18/36 (XES11)	88p
Marriot BX12E 343 1/2 Track erase	88p
MR/PI Rec'd/Play 1/2 Track	46p
HR Single Track Rec'd/Play	37p
Bogen Type UL200 Erase	£1.69
Miniature Stereo Cassette Rec'd/Play	£2.60

EXCLUSIVE 5 WATT IC AMPLIFIERS

Special purchase 5 watt output 8-16 ohm load. 30 volt max. D.C. operation, complete with data. Price £1.75 each or 2 for £3.30 Printed Circuit Panels 60p

8 DIGIT POCKET ELECTRONIC CALCULATORS

Sinclair Cambridge	
Built	£11.85
Cambridge Kit	£9.94
Cambridge Memory	
Built	£18.90
Scientific Built	£18.30
Scientific Kit	£14.90

SPECIAL OFFER GARRARD CT4 STEREO CASSETTE TRANSPORT MECHANISM

Features:

- Stereo Heads
- Built in Motor Stabiliser
- Auto Stop & Eject
- Pause Control
- 12V DC Operation

 Robust, precision engineered mechanism based on the "STARR" patented design, ideal for use in Car stereo cassette players, Hi-Fi stereo cassette recorders, industrial and many other applications. Suitable for the 'PW' Ascot Stereo Cassette Deck.

£13.50 inc. VAT p & p 35p

TEST EQUIPMENT MULTIMETERS

Carr./packing 35p	
U4324 20k Q/V	
with case	£10.30
U4313 20k Q/V with steel case	£14.90
U4317 20k Q/V with case	£18.36
U4317 20k Q/V plus transistor steel case	£11.88
U4323 20k Q/V plus 1kHz OSC with case	£8.64
U4311 Laboratory meter	£56.16
U4312 20k Q/V with case	£11.88
U4315 20k Q/V with case	£10.80
U4317 20k Q/V with case	£18.36
IT1-2 20k Q/V slim type	£6.42
THL33D (L33DX) 2k Q/V Robust	£8.10
TP55N 20k Q/V (case £2)	£11.61
TP10S 20k Q/V	£9.18
TV20S 20k Q/V	£14.94
TV50K 50k Q/V	£15.40
S100TR 100k Q/V plus transistor tester	£24.30

NEW REVOLUTIONARY SUPERTESTER 680R

680R Multi-tester	£19.98
TE40 AC Multivoltmeter	£21.33
TE15 Grid dip meter 440kHz-28MHz	£21.06
TE65 28 Range valve voltmeter	£24.30
TE20D RF Generator 120kHz-500MHz	£20.45
TE22D AF Generator 20Hz-200kHz	£21.54
*HM350 In circuit transistor tester	£21.06
*CC205 Deluxe meter 1-300MHz	£7.50
TT145 Compact transistor tester	£15.93
YG36 R/C osc. 20Hz-200kHz	£21.33
*SE350A De-luxe signal tracer	£13.98
*SE400 Mini-lab all in one tester	£18.74
CI-5 Scope 500,000Hz (carr. £1.00)	£50.76
Radio activity counter 0-10r (Carr. £1)	£10.76
Mains unit for above (carr. 50p)	£4.05

Don't miss your copy of HENRY'S NEW 1975 CATALOGUE

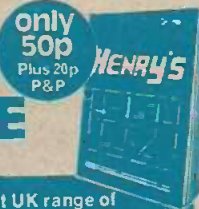

- ★ OVER 5,000 ITEMS - largest UK range of electronic components for home constructors.
- ★ 200 PAGES - every aspect of electronics and components for amateurs and hobbyists - kits, projects, test gear.
- ★ DOZENS of new lines and new ranges.
- ★ MANY price reductions throughout the new Catalogue.
- ★ A Discount Voucher with every copy, worth 50p.

ELECTRONIC FOOTBALL & TENNIS WITH THE FABULOUS VIDEO SPORT ON YOUR OWN TV

Play three exciting electronic ball games. FOOTBALL, TENNIS, HOLE IN THE WALL on your own TV. Just plug Video Sport into the aerial socket of your TV and away you go. Completely safe for you, your children and your TV. Mains operated. OUR INCREDIBLE PRICE £29.50 inc VAT DEMONSTRATIONS NOW IN ALL HI FI CENTRES!

AM/FM MODULES LP1179, LP1171 Combined AM/FM tuner modules, together with a small number of R.C.'s ferrite aerials, make up a sensitive FM/MW/LW tuner. 6 volts supply, supplied with data and circuit sheets.

LP1171 COMBINED IF STRIP £1.60 LP1179. FM FRONT END AND AM GAWG £4.60. £6.62 the pair, Suitable Ferrite serial 87p.

UHF TV TUNERS

TYPE A var. tun. slow motion drive	£3.50
TYPE C variable tuning	£2.90
TYPE B 4-button (adj.)	£4.60
TYPE D 6-button UHF/VHF tuner	£5.20

BUILD THE TEXAN+FM TUNER TEXAN 29+20W STEREO AMP

Features glass fibre PC board, Gardners low field transformers 6-IC's 10-transistors plus diodes etc. Designed by Texas instruments engineers for Henry's and P.W. 1972. Overall size 154" x 22" x 62" mains operated. Free test leads. £29.95 (also built and tested £39.95)

HENELEC STEREO FM TUNER Features capacity diode tuning, lead and tuning meter indicators, mains operated. High performance and sensitivity. Overall size in leak sleeve 8" x 22" x 62". Complete kit with leak sleeve. £26.25 (Carriage 50p). (also built and tested £31.20). Join the large band of constructors!

FREE: SEND NOW FOR OUR FREE LIST NO. 36 FOR OUR COMPLETE RANGE OF OVER 10,000 SEMI CONDUCTOR DEVICES AT NEW LOW PRICES.

EXTRA DISCOUNTS Semiconductors - Any one type or mixed SN74 Series 'IC' 12-extra 10%; 25-extra 15%; 100-extra 20%.

TRANSISTORS & INTEGRATED IC'S TTL "7400 series" IC's from 18p each Cosmos "4000 series" IC's from 28p each Linear Op-Amps from 43p each Synetics Phase Lock IC's; RCA Linear IC's; TO3 Power Devices in PNP and NPN; BC107 and "BC range" from 13p each Range of OC Types 20p Plastic Power Devices, Rectifiers, Zener Power Regulator IC's and many others. Diodes up to 10 watts.

ALL HENRY'S PRICES INCLUSIVE OF VAT

Write now for your copy, enclosing 70p remittance.

Now Open—Supermarket, Browse Round The New Supermarket at 404 Edgware Road

HENRY'S

Electronic Conveyors 404-406 Electronic Components & Equipment 01 402 8381 354 PA Disco Lighting High Power Sound 61-402 8534 303 Special offers and bargains store All mail to 303 Edgware Road London W2 1BW Prices correct at time of preparation Subject to change without notice £ 5 0 1 Hi-Fi and Electronic Centres Open 9am-6pm