

PARFITT

Inexpensive, easy to build projects

everyday electronics

JUNE 75
25p

This issue includes
INDEX
for
Vol. 3

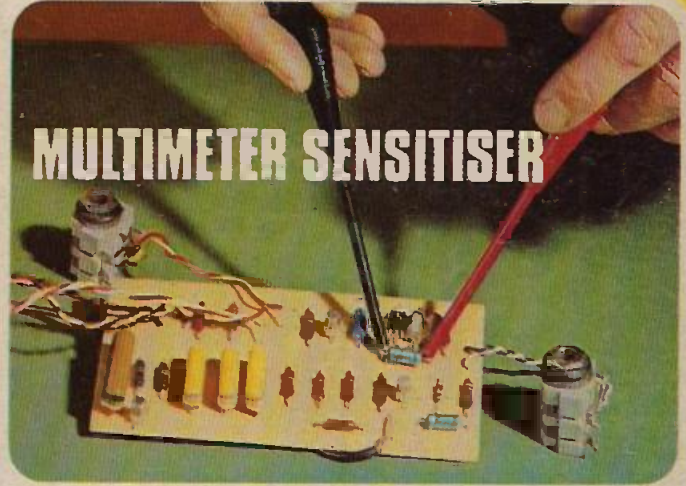

MULTIMETER SENSITISER

THE LINE FOLLOWER ...

WHITE LINE FOLLOWER...

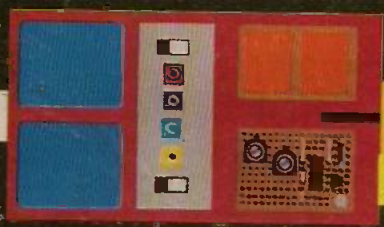

LINE FOLLOWER...



IT'S NOT MY FAULT!!

FAULT FINDING FEATURE

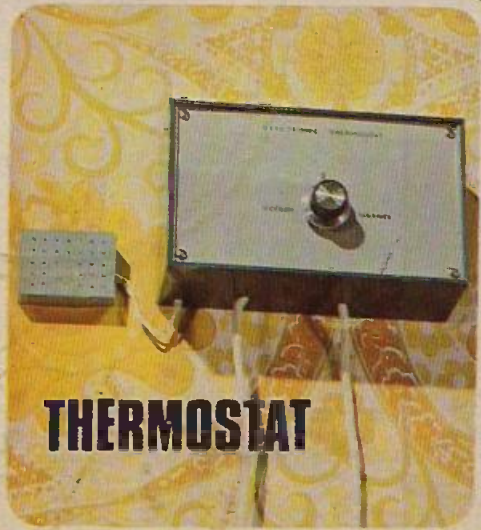

THERMOSTAT



NEW EDU-KIT MAJOR

Completely Solderless Electronic Construction Kit
Build these projects without soldering iron or solder

- ★ 4 Transistor Earpiece Radio.
- ★ 5 Transistor Push Pull Amplifier.
- ★ Batteryless Crystal Radio.
- ★ Signal Tracer.
- ★ 7 Transistor Loudspeaker Radio MW/LW.
- ★ One Transistor Radio.
- ★ Signal Injector.
- ★ 5 Transistor Short Wave Radio.
- ★ 2 Transistor Regenerative Radio.
- ★ Transistor Tester NPN-PNP.
- ★ Electronic Metronome.
- ★ 3 Transistor Regenerative Radio.
- ★ 4 Transistor Push Pull Amplifier.
- ★ Electronic Noise Generator.
- ★ Audible Continuity Tester.
- ★ Sensitive Pre-Amplifier.

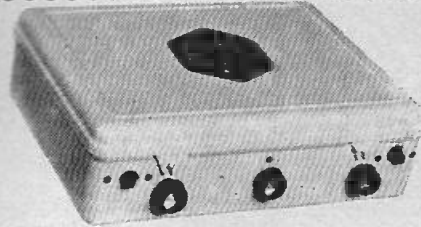

Total building costs

£7.23 P & Ins. 58p
(Overseas Seamail P & P £3.40)
(+ 25% VAT £1.80)

Components Include: 24 Resistors ● 21 Capacitors ● 10 Transistors ● 3 1/2" Loudspeaker ● Earpiece ● Mica Baseboard ● 3 12-watt connectors ● 2 Volume controls ● 2 Slider Switches ● 1 Tuning Condenser ● 3 Knobs ● Ready Wound MW/LW/SW Coils ● Ferrite Rod ● 6 1/2 yards of wire ● 1 Yard of sleeving etc. ● Parts Price List and Plans 55p free with parts.

ROAMER TEN Mk 2

WITH VHF INCLUDING AIRCRAFT

Now with free earpiece and switched socket.

10 Transistors. Latest 4" 2 watt Ferrite Magnet Loudspeaker.

9 Tunable Wavebands. MW1, MW2, LW, SW1, SW2, SW3, Trawler Band, VHF and Local Stations also Aircraft Band.

Built in Ferrite Rod Aerial for MW/LW. Chrome plated 6 section Telescopic Aerial can be angled and rotated for peak short wave and VHF listening. Push/Pull output using 600mW Transistor. Car Aerial and Tape Record Sockets. 10 Transistors plus 3 Diodes. Ganged Tuning Condenser with VHF section. Separate coil for Aircraft Band. Volume on/off. Wave Change and tone Controls. Attractive Case in black with silver blocking. Size 9" x 7" x 4". Easy to follow instructions and diagrams. Parts price list and plans 50p free with parts.

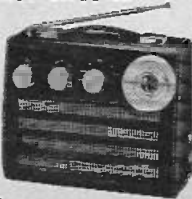

Total building costs (Overseas Seamail P & P £3.50)

£9.50 P & Ins. 60p
(+ 25% VAT £2.37)

POCKET FIVE

NOW WITH 3" LOUD-SPEAKER

3 Tunable wavebands. M.W. L.W. and Trawler Band. 7 stations, 5 transistors and 2 diodes, super-sensitive ferrite rod aerial, attractive black and gold case. Size 5 1/2" x 1 1/2" x 3 1/2" approx. Plans and Parts Price List free with parts.



Total building costs P & P & Ins. 38p
(+ 25% VAT 62p)
(Overseas Seamail P & P £2.30)

ROAMER EIGHT Mk 1

NOW WITH VARIABLE TONE CONTROL

7 Tunable Wavebands: MW1, MW2, LW, SW1, SW2, SW3 and Trawler Band. Built in Ferrite Rod Aerial for MW and LW. Chrome plated Telescopic aerial can be angled and rotated for peak short wave listening. Push/pull output using 600mW Transistor. Car aerial and Tape record sockets. Selectivity switch. 8 transistors plus 3 diodes. Latest 4" 2 watt ferrite magnet loudspeaker. Air spaced ganged tuning condenser. Volume/on/off, tuning, wave change and tone controls. Attractive case in rich chestnut shade with gold blocking. Size 9 x 7 x 4 1/2 in. approx. Easy to follow instructions and diagrams. Parts price list and plans free with parts.

Total building costs (Overseas Seamail P & P £3.50)

£6.98 P & Ins. 65p
(+ 25% VAT £1.75)



NEW JIFFY TESTER

Easy to build and operate, fits in the pocket. A quick checker for continuity of resistors, chokes, diodes, transistors, circuit wiring (not mains) and loudspeakers. Also for checking short circuits of capacitors, tuning capacitors and many other uses not listed here. See instruction sheet free with kit. Complete with earpiece, jack plug and socket, resistors, capacitors, component, etc. Parts Price List and Easy Build Plans free with Parts.

Total building costs P & Ins. 22p
(+ 25% VAT 56p)
(Overseas Seamail P & P. £1.70)

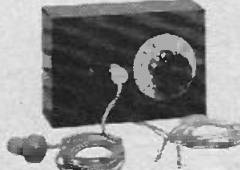

NEW Everyday Series

Build this Exciting New Series of designs

E.V.6

Attractive case in black with red grille, dial and black knobs with polished metal inserts. Size 9 x 5 1/2 x 2 1/2 in. approx. 4 Transistors and 3 diodes. Powered by 9 volt battery. Ferrite rod aerial, 3" loudspeaker, etc., MW/LW coverage. Push Pull output. Parts Price List and Plans free with parts.

Total building costs (Overseas Seamail P & P £2.80)

£3.98

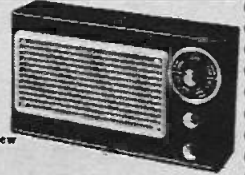

TRANS EIGHT

8 TRANSISTORS AND 3 DIODES

6 Tunable Wavebands: MW, LW, SW1, SW2, SW3 and Trawler Band. Sensitive ferrite rod aerial for M.W. and L.W. Telescopic aerial for Short Waves. 3in. Speaker. 8 improved type transistors plus 3 diodes. Attractive case in black with red grille, dial and black knobs with polished metal inserts. Size 9 x 5 1/2 x 2 1/2 in. approx. Push/pull output. Battery economiser switch for extended battery life. Ample power to drive a larger speaker. Parts price list and plans free with parts.

Total building costs (Overseas Seamail P & P £2.80)

£4.48

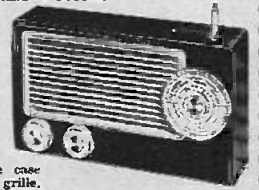

RADIO EXCHANGE CO

To RADIO EXCHANGE CO., 61a HIGH STREET, BEDFORD, MK40 1SA

Tel. : 0234 52367- Reg. No. 788372.

- I enclose £..... for
- ROAMER TEN EV6
 - ROAMER EIGHT TRANS EIGHT
 - JIFFY TESTER MAJOR EDU KIT
 - POCKET FIVE EDU-KIT

Parts

Name

Address

(Dept. EE6)

NEW! "EDU-KIT"

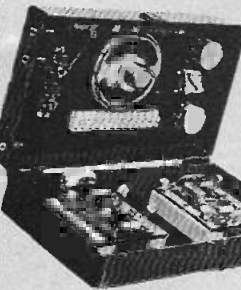

Build Radios, Amplifiers, etc., from easy stage diagrams.

Five units including master unit to construct.

Components include: Tuning Condenser; 2 Volume Controls; 2 Slider Switches; Fine Tone 3" Moving Coil Speaker; Terminal Strip; Ferrite Rod Aerial; Battery Clips; 4 Tag Boards; 10 Transistors; 4 Diodes; Resistors; Capacitors; Three 1/2" Knobs. Units once constructed are detachable from Master Unit, enabling them to be stored for future use. Ideal for Schools, Educational Authorities and all those interested in radio construction. Parts price list and plans free with parts.

Total building costs P & P Ins. 50p
(Overseas Seamail P & P £3.40)

Prices are subject to alteration without notice (+ 25% VAT £1.37)

- ★ Callers side entrance "Lavelle's" shop.
- ★ Open 10-1, 2.30-4.30, Mon.-Fri. 9-12 Sat.



Recently I've been telling you just why I've been a customer of Home Radio Components for so long. I've given special emphasis to their superb catalogue, and now its time to show you a typical page. The problem is . . . which one? There are 240 to choose from—for example, 17 pages of capacitors, 6 of resistors, 10 of switches and 8 of styli. These are run-of-the-mill things, but here's a page that's specially interesting . . . page 94, showing a Short Wave Kit and an Etching Kit. The managing director of Home Radio Components tells me there's quite a story behind these items. Briefly, Home Radio Components always listed a S.W. Kit, but eventually the firm making them ceased trading so H.R.C. decided to produce their own. When they looked around for an Etching Kit they were unable to find any at a sensible price, so again they said "Right, we'll make our own!" Sounds simple, but the managing director told me that if you produce any kit within 12 months of deciding to go ahead you're doing very well. "As for the problems of producing an Etching Kit," he said, "I could write a book about it!"

For Prices see Supplement

HOME RADIO (COMPONENTS) LTD.

CONSTRUCTIONAL KITS—Continued

KT4B. Radiokit No. 4B. A unique one valve model with world-wide range. Continuous coverage from approx. 10 metres to 47 metres, this covers the usual long-distance broadcasts. Band spread tuning. This set which was designed by us, uses only the finest components. Jackson and Wavemaster capacitors, Warrle P. Coils and Mazda valves. Great fun both to build and to use. Unfavourable atmospheric conditions you will be able to bear such far off places as Moscow, Australia and America.

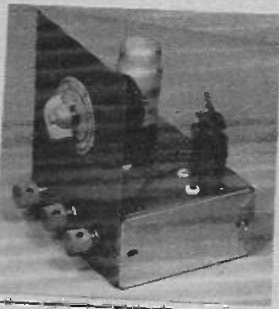

KT4B

AN ETCHING KIT

KT 253. Etching Kit. An ideal kit for the Constructor wishing to Etch his own Circuits. All essentials and detailed instructions included in every Kit.



KT253

Contents:—

- (1) Plastic Dish.
- (2) Suitable pieces of copper clad board.
- (3) Laminator.
- (4) Ferric Chloride.
- (4A) Large Plastic Spoon.
- (5) Decon Etch resist pen (An alternative may be supplied if this is not available). If at any time items are not available the kit will be supplied minus these articles and the price adjusted accordingly.
- (6) Instructions (4 Pages).

94

ETCHING MATERIALS LISTED ON PAGE 95

Incidentally, if you want to order either of these kits the prices are:

KT4B. S.W. Kit £4.75 plus VAT, plus 35p for p & p.

KT253 Etching Kit £3.75 plus VAT, plus 35p for p & p.

In any case, you'll surely want to study all the other pages in this famous catalogue. There are getting on for 2,000 illustrations by the way. Simply send the coupon below, with cheque or PO for 98p (65p plus 33p for post, packing and insurance). The catalogue contains 14 vouchers, each worth 5p when used as directed, so you can soon recover 70 pence of your investment. You just can't go wrong!



65p.
plus 33p POST AND PACKING

Send off the coupon today.

The price of 98p applies only to customers in the U.K. and to BFPO Addresses.

Please write your Name and Address in block capitals

NAME

ADDRESS



HOME RADIO (Components) LTD., Dept. EE,
234-240 London Road, Mitcham, Surrey CR4 3HD

(Regn. No
London 912966)



GIRO NO. 331 7056 ACCESS ACCEPTED
C.W.O. only. P. & P. 15p on orders below £5
Discount: £10-10%, (except net items)
Exports Order enquiries welcome (VAT free)

Official Orders accepted from
Educational & Government Departments
ALL PRICES INCLUDE VAT

SPECIAL RESISTOR KITS (Prices include post & packing)

10E12 $\frac{1}{2}$ W KIT: 10 of each E12 value, 22 ohms—1M, a total of 570 (CARBON FILM 5%), £3.85 net
10E12 $\frac{1}{4}$ W KIT: 10 of each E12 value, 22 ohms—1M, a total of 570 (CARBON FILM 5%), £3.95 net
25E12 $\frac{1}{2}$ W KIT: 25 of each E12 value, 22 ohms—1M, a total of 1425 (CARBON FILM 5%), £9.00 net
25E12 $\frac{1}{4}$ W KIT: 25 of each E12 value, 22 ohms—1M, a total of 1425 (CARBON FILM 5%), £9.00 net
5 $\frac{1}{2}$ W KIT: 5 of each E12 value, 10 ohms—1M, a total of 305 (METAL FILM 5%), £3.45 net
DUE TO CURRENT WORLD SHORTAGES, RESISTOR KITS MAY TEMPORARILY CONTAIN WATTAGE OR VALUE SUBSTITUTIONS.

MULLARD POLYESTER CAPACITORS C280 SERIES
250V P.C. Mounting: 0.01 μ F, 0.015 μ F, 0.022 μ F, 0.033 μ F, 0.047 μ F, 3 μ p, 0.068 μ F, 0.1 μ F, 4 μ p, 0.15 μ F, 5 μ p, 0.22 μ F, 6 μ p, 0.33 μ F, 8 μ p, 0.47 μ F, 10 μ p, 0.68 μ F, 13 μ F, 1 μ F, 16 μ p, 1.5 μ F, 24 μ p, 2.2 μ F, 27 μ p.

MULLARD POLYESTER CAPACITORS C294 SERIES
400V: 0.001 μ F, 0.0015 μ F, 0.0022 μ F, 0.0033 μ F, 0.0047 μ F, 3 μ p, 0.0068 μ F, 0.01 μ F, 0.015 μ F, 0.022 μ F, 0.033 μ F, 3 μ p, 0.047 μ F, 0.068 μ F, 0.1 μ F, 4 μ p, 0.15 μ F, 7 μ p, 0.22 μ F, 9 μ p, 0.33 μ F, 13 μ p, 0.47 μ F, 13 μ p.
150V: 0.01 μ F, 0.015 μ F, 0.022 μ F, 3 μ p, 0.047 μ F, 0.068 μ F, 4 μ p, 0.1 μ F, 4 μ p, 0.15 μ F, 5 μ p, 0.22 μ F, 6 μ p, 0.33 μ F, 7 μ p, 0.47 μ F, 9 μ p, 0.68 μ F, 13 μ F, 1 μ F, 15 μ p.

MINIATURE CERAMIC PLATE CAPACITORS
50V: (pF) 22, 27, 33, 39, 47, 56, 68, 82, 100, 120, 150, 180, 220, 270, 330, 390, 470, 560, 680, 820, 1K, 1K5, 2K2, 3K3, 4K7, 6K8, (nF) 0.01, 0.015, 0.022, 0.033, 0.047, 2 μ p, each: 0.1, 30V, 5p.

POLYSTYRENE CAPACITORS 160V 5%
(pF) 10, 15, 22, 33, 47, 68, 100, 150, 220, 330, 470, 680, 1000, 1500, 2200, 3300, 4700, 6800, 10,000, 4 μ p.

RESISTORS

CF—High Stab Carbon Film, 5%	MF—High Stab Metal Film, 5%	
W. Value Range	1-99	100-499 500-999 1000+
1/4 CF 22-1M	1	0.80 0.65 0.60
1/2 CF 22-2M2	1	0.80 0.65 0.60
1/4 CF 22-1M	1	0.80 0.65 0.60
1/2 MF 10-2M7	2	1.7 1.4 1.2
1/4 MF 10-2M2	2	1.6 1.3 1.1
1/2 MF 10-10M	3	1.98 1.81 1.65
2 MF 10-10M	4-5	3.52 3.08 2.75

For value mixing prices, please refer to our catalogue. (price in pence each)
VALUES AVAILABLE—E12 Series only. (Net prices above 100.)

PRESET SKELETON POTENTIOMETERS

MINIATURE 0.25W Vertical or horizontal 7p each 1K, 2K2, 4K7, 10K, etc. up to 1M Ω
SUB-MIN 0.05W Vertical, 100 Ω to 220K Ω 7p each

B. H. COMPONENT FACTORS LTD.

(E.E.) 59, NORTH STREET,
LEIGHTON BUZZARD, BEDS.
Tel. Leighton Buzzard 2316 (Std. Code 05253)
CATALOGUE No. 4-20p

Miniature Mullard Electrolytics

1.0 μ F 63V 7p	68 μ F 63V 14p
1.5 μ F 63V 7p	100 μ F 10V 7p
2.2 μ F 63V 7p	100 μ F 25V 7p
3.3 μ F 63V 7p	100 μ F 63V 17p
4.7 μ F 63V 7p	150 μ F 16V 7p
6.8 μ F 63V 7p	150 μ F 63V 17p
10 μ F 25V 7p	220 μ F 6.4V 7p
10 μ F 63V 7p	220 μ F 10V 7p
15 μ F 16V 7p	220 μ F 16V 8p
15 μ F 63V 7p	220 μ F 63V 25p
16 μ F 40V 7p	330 μ F 16V 14p
22 μ F 25V 7p	330 μ F 63V 28p
22 μ F 63V 7p	470 μ F 6.4V 8p
33 μ F 10V 7p	470 μ F 40V 25p
33 μ F 16V 7p	680 μ F 16V 17p
33 μ F 40V 7p	680 μ F 40V 28p
47 μ F 10V 7p	1000 μ F 16V 25p
47 μ F 25V 7p	1000 μ F 25V 28p
47 μ F 63V 8p	1500 μ F 6.4V 17p
68 μ F 16V 7p	1500 μ F 16V 28p
	2200 μ F 10V 28p
	3300 μ F 6.4V 28p

VEROBOARD 0.1 0.15

24 x 5"	36p 36p
24 x 3 1/2"	33p 25p
34 x 5"	42p 46p
34 x 3 1/2"	36p 36p
24 x 1 1/2" (Plain)	10p 9p
24 x 3 1/2" (Plain)	— 16p
5 x 3 1/2" (Plain)	— 29p
Insertion tool	73p 73p
Track Cutter	56p 56p
Pins, Pk, 50	22p 22p

TRANSISTORS

AC127 21p	BC212L 13p
AC128 22p	BC213L 13p
BC107 12p	BC214L 18p
BC108 12p	OC44 19p
BC109 13p	OC71 13p
BC148 13p	OC81 17p
BC149 13p	OC170 39p
BC182L 13p	T1543 34p
BC183L 13p	2N2926 13p
BC184L 14p	2N3702 14p

POTENTIOMETERS

Carbon Track 5K Ω to 2M Ω , log or lin. Single, 17 $\frac{1}{2}$ p Dual Gang 43p. Log Single with switch 28p
Slider Pots. 10K, 100K, 500K, 30mm, 34p, 45mm, 47p, 60mm, 55p.

DIODES

IN4001 6p	DIN 2 Pin 12p
IN4002 7p	3 Pin 13p
IN4003 9p	5 Pin 18 $\frac{1}{2}$ 16p
IN4004 9p	Std. Jack 20p
IN4005 13p	2.5mm Jack 13p
IN4006 14p	Phono 7p
IN914 7p	DIN 2 Pin 10p
BA100 10p	3 Pin 10p
OA5 42p	5 Pin 18 $\frac{1}{2}$ 12p
OA47 9p	Std. Jack 18p
OA81 11p	2.5mm Jack 13p
OA200 8p	Phono 7p

PLUGS

DIN 2 Pin 12p
3 Pin 13p
5 Pin 18 $\frac{1}{2}$ 16p
Std. Jack 20p
2.5mm Jack 13p
Phono 7p
DIN 2 Pin 10p
3 Pin 10p
5 Pin 18 $\frac{1}{2}$ 12p
Std. Jack 18p
2.5mm Jack 13p
Phono 7p

ELECTROLYTIC CAPACITORS, Tubular & Large Cans

(uF/V): 125, 275, 425, 4.7/10, 5/25, 8/25, 10/10, 10/50, 16/25, 22/63, 25/25, 25/50, 32/25, 50/25, 100/10, 100/25, 7p, 50/50, 8p, 100/50, 200/25, 10p, 250/50, 18p, 500/10, 8p, 500/25, 17p, 500/50, 25p, 1000/10, 17p, 1000/25, 25p, 1000/50, 40p, 2000/10, 20p, 1000/100 90p, 2000/25, 30p, 2000/100, 95p, 2500/25, 36p, 2500/50, 68p, 5000/50, 80p, 5000/25, 69p, 5000/50, 41.20.
HI-VOLT: 8/350, 23p, 16/350 35p, 32/350, 38p, 50/250, 27p, 100/100, 27p, 100/250, 40p, 32/500, 46p, 16 + 32 + 32/350, 65p.

METALLISED PAPER CAPACITORS

250V: 0.05 μ F, 0.1 μ F, 6p, 0.25, 6p, 0.5 μ F, 7 μ p, 1 μ F, 9p, 500V: 0.025, 0.05, 6p, 0.1, 6p, 0.25, 7 μ p, 0.5, 9p, 1000V: 0.01, 11p, 0.022, 13p, 0.047, 0.1, 19p, 0.22, 28p, 0.47, 36p.

STOP PRESS

Our Retail Shop
in new open
in North St.,
Leighton Buzzard

Screened Wire, Metre	7p	SE12 $\frac{1}{2}$ W METAL
Twin Screened Wire, Metre	13p	13p
Starco Screened Wire, Metre	13p	FILM. 5 each Value
Connecting Wire, All colours, Metre	21p	10 Ω -1M. Total of 305
Neon Bulb, 90V Wire, Ended	5 for 25p	£3.75. NET
Panel Neon, 240V Red, Amber, Clear	21p	



4 1/2 in x 3 1/2 in METER. 30 μ A, 50 μ A or 100 μ A, £3.85. P. & P. 11p.

TAPE RECORDER LEVEL METER
500 μ A, 70p
P. & P. 5p.

CARDIOID DYNAMIC MICROPHONE
Model UD-130. Frequency response 50-15,000c/s. Impedance Dual 50K and 600 ohms, £6.55. P. & P. 11p.

42 x 42mm METERS 100 μ A, 500 μ A, 1mA, 500mA £2.76, 11p P. & P.

60 x 45mm METERS 50 μ A, 100 μ A, 500 μ A and 1mA VU METER £2.92, 11p P. & P.

EDGEWISE METERS, 90mm x 34mm, 1mA £3.40, 11p P. & P.

MULTI-METER
Model ITI-2
20,000 ohm/volt, £6.90.
P. & P. 15p.

3WATT STEREO AMPLIFIER
1 1/2W PER CHANNEL
£4.30. P. & P. 10p.

All above prices include 8% V.A.T. LARGE S.A.E. for List No. 11. Special prices for quantity quoted on request.

M. DZIUBAS

158 Bradshawgate · Bolton · Lancs. BL2 1BA



become a RADIO-AMATEUR!

learn how to become a radio-amateur in contact with the whole world. We give skilled preparation for the G.P.O. licence

free! Brochure, without obligation to:

BRITISH NATIONAL RADIO & ELECTRONICS SCHOOL

Dept EEB 65 P.O. Box 156, JERSEY

NAME: _____
ADDRESS: _____

BLOCK CAPS please

NEW ITEMS THIS MONTH

The bargains in this column are just some of the items which appeared in the April supplement to our catalogue. You can receive this catalogue and the next 12 supplements by sending a £1.

Miniature microswitch with roller, Cherry ref. no. E62, size approx. $\frac{1}{8}$ " long x $\frac{1}{8}$ " high x $\frac{1}{8}$ " thick with steel roller on $\frac{1}{8}$ " long actuating lever. 25p each.

Triac, ex unused computer American "GE" ref. no. SC 40D, this is a 60V 12 amp triac. A amp at £1.40.

Rectifier, American "GE", 100V 10 amp. 65p each. Computer condensers, American made Bangamo, their type DCM: 21,500 mfd, 35V DC working with mounting slip and terminal sockets. Price £1 each 25p post.

Reel to reel tapes, pre-recorded with classic and light music, new in perspex type storage box, 10 different titles (our assortment). 25 the lot, which makes them worth buying even if you do not like the music recorded on them. Please add 30p post. 50 all different 25s.

Multi-voltage transformer 12 watts, an extremely versatile transformer and it is quite surprising the number of different voltages which may be obtained by using its two windings or parts of these windings in assisting or opposing modes. In addition to the three voltages mentioned above 25-0-25 or 130-0-130 may be obtained. The two secondary windings are (1) 60V tapped at 30V and (2) 280V tapped at 240, 220, 200 and 130. Special snip price, only £1 + 30p post.

Ring main cable. Springtime is the time for alterations at home and if you are contemplating any lighting or heating alterations, then note we have good quality ring main cable 13 amp twin and earth, price 15p per metre, cut to your length, or £1.75 per 100 metres + £1 post.

Ditto for lighting. 12p per metre, cut to your length, or £7.75 per 100 metres. Also for ring mains etc. we have junction boxes at 14p each, 13 amp ring main sockets, flush mounting, white at 40p each, brown at 25p each or brown switched at 30p each. 18 amp 2 gang sockets, brown, unswitched, at 60p each. 6 amp 3 pin sockets, white at 25p each, switched 30p. White spur boxes 20p each—white spur with 13 amp socket 50p. 3KW tangential heaters. We have had a further small delivery of these and can once again supply. Price, a little up unfortunately, now £4.80 + 60p post. Control switch 55p. Knob for same 25p.

Break-down unit, contains a wide range of most useful parts some of which are as follows—56 silicon diodes equivalent OA91. 68 resistors, mostly $\frac{1}{2}$ watt 5% covering a wide range of values. 4 x 1 mfd 400V condensers. 15 x .01 mfd 100V condensers. 2 RF chokes. 8 x D9 valve holders. 1 x 4E choke. 1 x 117V transformer. 1 boxed unit containing 4 delay lines. Tag panels, trimmer condensers, suppressors, all mounted up on a useful chassis sized approx. 8" x 5" x 7". Offered at only 75p—the 66 diodes would cost at least 10 times this amount, so this is obviously a snip and is to be missed. Post and packing 60p.

Waterproof 3 core leads for lawn mowers etc., new colour code, 5A rating, this is a perfectly standard PVC circular flex which will cost you 15p per metre in your local shop. Offered at the special price of £1.85 per 25 metre length + 30p post. Fits a 13 amp socket to a cable drum, wind this lead round it and terminate with a 3 amp rubber covered plug (available, price 40p) and you have a very useful extension lead.

Aquarium thermostat, in a sealed glass tube, but adjustable over the tropical fish range. Price £1 each.

Computer boards with ICs. We guarantee each board have at least 16 ICs, the boards are in tip top condition, as far as we know they were never put into service. Price 75p each.

Computer cooling fans, the famous Piannair, these are a six bladed 4" fan rotating at approx. 3000 revs per minute. In a die cast case sized approx. 8" square with 4 fixing holes and cable entry box. Now new, but any not in perfect working order would be replaced. Price £3 each + 30p post.

Double-ended mains motors, special snip this month! It has a normal speed motor, not high powered but quite suitable for operating a fan in a heater or cooker hood or similar. This has the advantage that having a spindle from each end thus any fan blade should be right. Another feature is that this has a 4 mounting feet. Special price, only 55p each.

Slot meter. Another special bargain this month because of its high and useful breakdown value is the slot meter. (a) It is in a useful box with lock, size approx. 8" x 3" x 4" (b) it has a Bangamo motor of 1 rev per hour which the makers price at £3.49 (c) it has a 3 digit counter and (d) it has a coin switch mechanism. Undoubtedly an unrepeatable bargain at £2 + 30p post.

High power battery motor, 12V operated, strong enough to power a motor mower, go-cart or similar. Speed easily variable. These motors can also be used as a brake for any rotating machine, simply by coupling the spindle to the machine and short-circuiting the windings by a variable resistance, price £2.80.

Transistor type BR3055, thoroughly checked for high gain, suitable for fluorescent lighting in verters etc. 45p each.

Relay "elasta" Swiss made with watchmaker's precision, 1600 ohm coil operates heavy duty gold or silver contacts, one set changeover and two other sets open or relay closing. A really high class relay, supplied in a transparent plastic box which can be used as a dust cover. Do not miss this bargain at 55p.

2 circuit toggle switch normal panel mounting through $\frac{1}{8}$ " hole, one circuit changeover, the other circuit simply on-off. 20p each.

MULLARD UNILEX STEREO SYSTEM

There is no doubt that it is a good system, we believe that for the money it is without comparison. We demonstrate gladly at our Tamworth Road depot. Prices of the individual items for this:

- 1 Unilex Amplifier Ref. EP.9000 £1.60
- 1 Unilex Amplifier Ref. EP.9000 £1.60
- 1 Unilex Pre-Amp Ref. EP.9001 £1.98
- 1 Unilex Power Unit Ref. EP.9002 £2.53
- 1 Control panel kit with spun aluminium faced knobs £3.80

Pair of 15 ohm speakers made by Goodmans are also available if required, price £3.30 the pair. No extra postage if ordered with the above, otherwise add 25p.

SPECIAL PRICES TO COLLEGES AND INSTITUTIONS WISHING TO INCLUDE THIS KIT IN THEIR CURRICULUM.

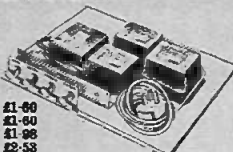

SMITHS CENTRAL HEATING CONTROLLER



Push button gives 10 variations as follows:—(1) continuous hot water and continuous central heating (2) continuous hot water but central heating off at night (3) continuous hot water but central heating only for 2 periods during the day (4) hot water and central heating both on but day time only (5) hot water all day but central heating only for 2 periods during the day (6) hot water and central heating on (7) hot water continuous (8) hot water day time only (9) hot water during daily (10) everything off. A handsome looking unit with 24 hose movement and the switches and other parts necessary to select the desired programme of heating. Supplied complete with wiring diagram. Originally sold, we believe, at over £15—we offer these, while stocks last, at £5.95 each, post 30p.

WALL THERMOSTATS

Wall mounting and in a handsome plastic case. (Cream and beige). Adjustable by slider (lockable) and may be set to control temperatures from around freezing through to 50°C. The slide panel is engraved and indicates (frost), (warm), (very warm), etc. The thermostat will control heaters, etc. up to 15 amp at normal mains voltage and is ideal for living room, bedroom and greenhouse, etc. Price £1.65. Don't miss this.

THIS MONTH'S SNIP

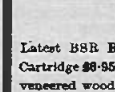

Latest BBR Record Changer with ceramic Stereo Cartridge £8.95 and if purchased at the same time teak veneered wooden plinth and Perspex cover for only £4.00 instead of £4.95 P.&P. £1 on one or both items.



TRANSISTOR ASSISTED CAR IGNITION

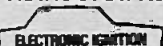

This system which has proved to be efficient and reliable, was described in the April *Wireless World*. We can supply kit of parts. Price £5.85 plus 30p post. When ordering please state whether for positive or negative systems.

RADIO STETHOSCOPE

Easiest way to fault find, traces signal from aerial to speaker when signal stops you've found the fault. Use it on Radio, TV, amplifier, anything. Complete kit comprises two special transistors and all parts including probe tube and crystal earpiece. £2.20 twin stereo set instead of earpiece 85p extra post and ins. 20p.

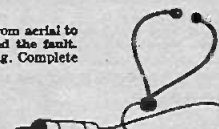

DISTRIBUTION PANELS

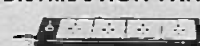

Just what you need for work bench or lab. 4 x 13 amp sockets in metal box to take standard 13 amp fused plugs and on/off switch with neon warning light. Supplied complete with 6 feet of flex cable. Wired up ready to work. £2.75 plus 40p P. & P.

WHITE LINE FOLLOWER MULTIMETER SENSITIZER

I.C. THERMOSTAT

To quickly receive parts to construct these projects simply send the estimated cost as shown—any price adjustments can be made later.

SHORTWAVE CRYSTAL SET

Although this uses no battery it gives really amazing results. You will receive an amazing assortment of stations over the 19, 25, 31, 39 metre bands—Kit contains chassis front panel and all the parts. £1.25—crystal earphone 50p.



INSTANT START FLUORESCENT LIGHTING BARGAINS

Startersless control gear, complete with tube ends and tube clips for window lighting, signs, fascias, etc. 4 ft. 40 w. £1.50; 5 ft. 65w. £1.60; 5 ft. 80w. £1.75; 6 ft. 80w. £1.95; and for pairs as follows:—twin 2 ft. 20w. £2.55; twin 3 ft. 30w. £2.75; twin 4 ft. 40w. £2.95; twin 5 ft. 65w. £3.25; twin 5 ft. 80w. £3.95; twin 8 ft. 125w. £4.50. These are about one half of maker's current prices and can't be repeated once stocks are cleared. Please add 30p per piece to cover postage or carriage.

TERMS—

ADD V.A.T.
Send postage where quoted—other items, post free if order for these items is £6.00, otherwise add 45p.

MAINS TRANSFORMERS

All standard 230-250 volt primaries.

		2 p
1v	1 amp (special)	1.75
2.4v	5 amp	.85
6.2v	2 amp	1.00
6.3v	3 amp	1.50
9v	1 amp	.95
12v	3.5 amp	1.95
15v	1 amp	1.50
15v	1 amp	1.00
6.5-0-6.5v	1 amp	1.35
20v	1 amp	1.25
20v	1 amp	1.00
24v	1 amp	1.30
24v	3 amp	3.80
24-0-24v	50mA	1.50
18-0-18v	50mA	1.20
8-0-8v	1 amp	1.25
18-0-18v	2 amp	3.50
25v	1 amp	1.95
80v 2 amp & 6.3v	1 amp	4.50
60v 5 amp & 0v	1 amp	7.50
27v	8 amp	4.50
30v	37 amp	22.00
60v tapped 75v & 70v	4 amp	5.50
230v-60mA & 6.3v	1.5 amp	1.75
275-0-275v at 90mA & 6.4v	3 amps	2.25
EHT Transformer 6000V 23mA	(intermittent)	5.50

Ubrager Transformers

6v and 12v	2 amp	1.25
6v and 12v	3 amp	2.25
6v and 12v	5 amp	3.50

DEDUCT 10% IF YOU ORDER 10 OR MORE OF ONE TYPE, ADD 36p PER TRANSFORMER IF NOT COLLECTING.

RELAY BARGAIN

Type 600 relay, 2 changeover one open and one closed contact. Twin 500 ohm coils make this suitable for driving an DC DC 12v, DC 24v or AC mains using reactor and rectifier. 35p each. Resistor and rectifier 20p extra.

BLACK LIGHT

As used in discotheques and for stage effects, etc. Virtually no white light appears until the rays impinge on luminous paint or white shirts, etc. We offer 12" SW tubes complete with starter, choke, lamp-holders and starter-holder. Price £2.75 + 30p post. Tubes only £2 + 30p post.

TAPE DECK

In metal case with carrying handle, heavy fly wheel and capstan drive. Tape speed 32. Mains operated on metal platform with tape head and guide. Not new but guaranteed good working order. Price £1.95 plus £1 post and insurance.



LIGHT SWITCH

Automatically switches on lights at dusk and off at dawn. Can also be used where light and dark is a convenient way to stop and start an operation. Requires only a pair of wires to the normal switch. In bakelite base, normal switch-plate size. 1 amp model £2.95.

MAINS TRANSISTOR POWER PACK

Designed to operate transistor sets and amplifiers. Adjustable output 6V, 9V, 12 volts for up to 80mA (class B working). Takes the place of any of the following batteries: FF1, FF2, FF4, PP6, PP7, PP9 and others. Kit comprises: main transformer rectifier, smoothing and load resistor, condensers and instructions. Real snip at only £1.20.

SOUND TO LIGHT UNIT

Add colour or white light to your amplifier. Will operate 1, 2 or 3 lamps (maximum 40W). Unit in Box all ready to work. £7.95 plus 96p VAT and postage.



MAINS MOTOR

Precision made—as used in record decks and tape recorders—ideal also for extractor fans, blower, heaters, etc. New and perfect. Snip at 75p. Postage 20p for first one the 10p for each one ordered. 1" stackmotor £1.04. 1 1/2" stackmotor £1.20.

AUTO-ELECTRICAL CAR AERIAL with dashboard control switch—fully extendable to 40in or fully retractable. Suitable for 12V positive or negative earth. Supplied complete with fitting instructions and ready wired dashboard switch. £5.95 plus 45p post and insurance.



J. BULL (ELECTRICAL) LTD.
(Dept. E.E.), 103 TAMWORTH ROAD,
CROYDON CRO IXX

-the lowest prices!

BI-PAK QUALITY COMES TO AUDIO!

AL10/AL20/AL30 AUDIO AMPLIFIER MODULES



The AL10, AL20 and AL30 units are similar in their appearance and in their general specification. However, careful selection of the plastic power devices has resulted in a range of output powers from 3 to 10 watts R.M.S. The versatility of their design makes them ideal for use in record players, tape recorders, stereo amplifiers and cassette and cartridge tape players in the car and at home.

Parameter	Conditions	Performance
HARMONIC DISTORTION	Po = 3 WATTS f=1KHz	0.25%
LOAD IMPEDANCE	—	8-16 Ω
INPUT IMPEDANCE	f=1KHz	100 k Ω
FREQUENCY RESPONSE ± 3dB	Po=2 WATTS	50 Hz-25KHz
SENSITIVITY for RATED O/P	Vs=25V, Ri=8 Ω f=1KHz	75mV. RMS
DIMENSIONS	—	3" x 2 1/2" x 1"

The above table relates to the AL10, AL20 and AL30 modules. The following table outlines the differences in their working conditions.

Parameter	AL10	AL20	AL30
Maximum Supply Voltage	25	30	30
Power output for 2% T.H.D. (RL = 8 Ω f = 1 KHz)	3 watts RMS Min.	5 watts RMS Min.	10 watts RMS Min.

AUDIO AMPLIFIER MODULES

AL 10. 3 watts RMS	£2.50
AL 20. 5 watts RMS	£2.85
AL 30. 10 watts RMS	£3.20

POWER SUPPLIES

PS 12. (Use with AL10, AL20, AL30) 95p
SPM 80. (Use with AL60) 43.25
FRONT PANELS F.P. 12 with Knobs 11.10

PRE-AMPLIFIERS

PA 12. (Use with AL10, AL20 & AL30)	£4.35
PA 100. (Use with AL60)	£13.15

TRANSFORMERS

T481 (Use with AL10)	£1.60 P & P 22p
T538 (Use with AL20, AL30)	£2.30 P & P 22p
BMT80 (Use with AL60)	£2.75 P & P 37p

PA 12. PRE-AMPLIFIER SPECIFICATION

The PA 12 pre-amplifier has been designed to match into most budget stereo systems. It is compatible with the AL 10, AL 20 and AL 30 audio power amplifiers and it can be supplied from their associated power supplies. There are two stereo inputs, one has been designed for use with ceramic cartridges while the auxiliary input will suit most magnetic cartridges. Full details are given in the specification table. The four controls are, from left to right: Volume and on/off switch, balance, bass and treble. Size 152mm x 84mm x 35mm.

Frequency response—
20Hz-20KHz (±3dB)
Bass control—
± 12dB at 60Hz
Treble control—
± 14dB at 14KHz
*Input 1 Impedance
1 Meg. ohm
Sensitivity 300mV
†Input 2 Impedance
30 K ohms
Sensitivity 4mV

Look for our

SEMICONDUCTOR ADVERTISEMENTS in

Practical Wireless Wireless World Radio Constructor

ALL PRICES INCLUDE V.A.T.

The STEREO 20

The 'Stereo 20' amplifier is mounted, ready wired and tested on a one-piece chassis measuring 20 cm x 14 cm x 5.5 cm. This compact unit comes complete with on/off switch volume control, balance, bass and treble controls, Transformer, Power supply and Power amps. Attractively printed front panel and matching control knobs. The 'Stereo 20' has been designed to fit into most turntable plinths without interfering with the mechanism or alternatively, into a separate cabinet. Output power 20w peak. Input 1 (Cer.) 300mV into 1M. Freq. res. 20Hz-20KHz. Input 2 (Aux.) 4mV into 30K. Harmonic distortion. Bass control ±12dB at 60Hz typically 0.25% at 1 watt. Treble con. ±14dB at 14kHz.

TC20 TEAK VENEERED CABINET

For Stereo 20 (front board undrilled) size 10 1/2" x 8 1/2" x 2", £3.95, plus 45p postage

SHP80 STEREO HEADPHONES

4-16 ohms impedance. Frequency response 20 to 20,000Hz Stereo/mono switch and vol. u.m. controls £4.95

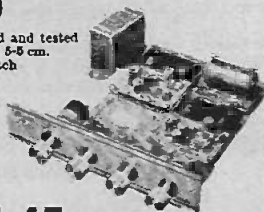

£14.45 p. & p. 45p.

NOW WE GIVE YOU
50w PEAK (25w R.M.S.)
PLUS THERMAL PROTECTION!
The NEW AL60 Hi-Fi
Audio Amplifier FOR ONLY
£4.25

- Max Heat Sink temp. 90°C.
- Frequency Response 20Hz to 100KHz
- Distortion better than 0.1% at 0.1KHz
- Supply voltage 15-50 volts
- Thermal Feedback
- Latest Design Improvements
- Load—3, 4, 8 or 16 ohms
- Signal to noise ratio 80dB
- Overall size 63mm x 105mm x 13mm

Especially designed to a strict specification. Only the finest components have been used and the latest solid state circuitry incorporated in this powerful little amplifier which should satisfy the most critical A.F. enthusiast.



STABILISED POWER MODULE SPM80

SPM80 is especially designed to power 2 of the AL60 Amplifiers, up to 15 watt (r.m.s.) per channel simultaneously. This module embodies the latest components and circuit techniques incorporating complete short circuit protection. With the addition of the Mains Transformer BMT80, the unit will provide outputs of up to 1.5 amps at 35 volts. Size: 63mm x 105mm x 30mm. These units enable you to build Audio Systems of the highest quality at a hitherto unobtainable price. Also ideal for many other applications including:—Disc Systems, Public Address Intercom Units, etc. Handbook available 10p

PRICE £3.25

TRANSFORMER BMT80 £2.75 p. & p. 40p

STEREO PRE-AMPLIFIER TYPE PA100

Built to a specification and NOT a price, and yet still the greatest value on the market, the PA100 stereo pre-amplifier has been conceived from the latest circuit techniques. Designed for use with the AL30 power amplifier system, this quality made unit incorporates no less than eight silicon planar transistors, two of these are specially selected low noise NPN devices for use in the input stages. Three switched stereo inputs, and rumble and scratch filters are features of the PA100 which also has a STEREO/MONO switch, volume, balance and continuously-variable bass and treble controls.

SPECIFICATION

Frequency Response
Harmonic Distortion
Inputs: 1. Tape Head
2. Radio, Tuner
3. Magnetic P.U.
All input voltages are for an output of 250mV. Tape and P.U. inputs equalized to RLA curve within ± 1dB from 20Hz to 20KHz.
Bass Control
Treble Control
Filters: Rumble (High Pass)
Scratch (Low Pass)
Signal/Noise Ratio
Input overload
Supply
Dimensions

20Hz - 20KHz ± 1dB
better than 0.1%
3-25 mV into 50K Ω
75 mV into 50K Ω
3 mV into 50K Ω
± 15dB at 20Hz
± 15dB at 20 KHz
100Hz
8KHz
better than -65dB
- 26dB
+ 35 volts at 20mA
292mm x 82mm x 35mm

ONLY £14.25

MK 60 AUDIO KIT

Comprising: 2 x AL60, 1 x SPM80, 1 x BMT80, 1 x PA 100, 1 front panel, 1 kit of parts to include on-off switch, neon indicator, stereo headphone sockets plus instruction booklets. Complete Price: £29.75 plus 45p postage

TEAK 60 AUDIO KIT

Comprising: Teak veneered cabinet size 16 1/2" x 11 1/2" x 3 1/2", other parts include aluminium chassis, heat sink and front panel bracket, plus back panel and appropriate sockets etc. Kit price: £9.95 plus 45p postage

Giro No. 388-7006

Please send all orders direct to warehouse and despatch department.

BI-PAK

P.O. BOX 6, WARE · HERTS

Postage and packing add 20p. Overseas add extra for airmail.

Minimum order 55p. Cash with order please.

Guaranteed Satisfaction or Money Back



"I MADE IT MYSELF"

Imagine the thrill you'll feel! Imagine how impressed people will be when they're hearing a programme on a modern radio you made yourself.

Now! Learn the secrets of radio and electronics by building your own modern transistor radio!

Practical lessons teach you sooner than you would dream possible.

What a wonderful way to learn—and pave the way to a new, better-paid career! No dreary ploughing through page after page of dull facts and figures. With this fascinating Technatron Course, you learn by building!

You build a modern Transistor Radio . . . a Burglar Alarm. You learn Radio and Electronics by doing actual projects you enjoy—making things with your own hands that you'll be proud to own! No wonder it's so fast and easy to learn this way. Because learning becomes a hobby! And what a profitable hobby. Because opportunities in the field of Radio and Electronics are growing faster than they can find people to fill the jobs!

No soldering – yet you learn faster than you ever dreamed possible.

Yes! Faster than you can imagine, you pick up the technical know how you need. Specially prepared step-by-step lessons show you how to read circuits—assemble components — build things — experiment. You enjoy every minute of it! You get everything you need. Tools. Components. Even a versatile Multimeter that we teach you how to use. All included in the course. **AT NO EXTRA CHARGE!** And this is a course anyone can afford. (You can even pay for it by easy instalments).

So fast, so easy, this personalised course will teach you even if you don't know a thing today!

No matter how little you know now, no matter what your background or education, we'll teach you. Step by step, in simple easy-to-understand language, you pick up the secrets of radio and electronics.

You become a man who makes things, not just another of the millions, who don't understand. And you could pave the way to a great new career, to add to the thrill and pride you receive when you look at what you have achieved. Within weeks you could hold in your hand your own transistor radio. And after the course you can go on to acquire high-powered technical qualifications, because our famous courses go right up to City & Guilds levels.

Send now for FREE 76 page book – see how easy it is – read what others say!

Find out more now! This is the gateway to a thrilling new career, or a wonderful hobby you'll enjoy for years. Send the coupon now. There's no obligation.

ELECTROVALUE

The best of all!

CATALOGUE 7 ISSUE 3

with 25p refund voucher

Up-dated Price & Product Information

112 pages plus cover As comprehensive and up-to-the-minute as possible. Thousands of items from vast ranges of semi-conductors including I.C.s to components, tools, accessories, technical information and diagrams are included as well as a refund voucher worth 25p for spending on orders list value £5 or more **SEND NOW FOR YOUR COPY BY RETURN 30p** post it's an investment in practical money-saving and reliability!

PRICES as shown in our latest catalogue (No. 7, issue 3) were due for review by April 1st. In fact these have remained unchanged since January, reviewed only at 3-monthly intervals as from July 1st next. This is instead of making day-to-day price changes.

DISCOUNTS apply on all items except the few where prices are shown **NETT. 5%** on orders from £5 to £14.99; 10% on orders list value £15 or more.

FREE POST AND PACKING in U.K. for pre-paid mail orders over £2 (except Baxandall cabinets). If under there is an additional handling charge of 10p.

QUALITY GUARANTEE. All goods are sold on the understanding that they conform to maker's specification. No rejects, seconds or sub-standard merchandise.

ELECTROVALUE LTD

All communications to Section 2/5, 28, ST. JUDES RD, ENGLEFIELD GREEN, EGHAM, SURREY TW20 0HB. Telephone Egham 3603, Telex 284475. Shop hours: 9-5.30 daily, 9-1 pm Sats.

NORTHERN BRANCH: 690, Burnage Lane, Burnage, Manchester M19 1NA. Telephone (061) 432 4945. Shop hours: Daily 9-5.30 pm; 9-1 pm Sats.

QUALITY STEREO SOUND

SOLENT AUDIO SYSTEM

ALMOST **1/2 PRICE OFFER!**

MADE TO SELL AT DOUBLE THE PRICE IN CABINET FORM

OUR PRICE **£49.95**

£5 down

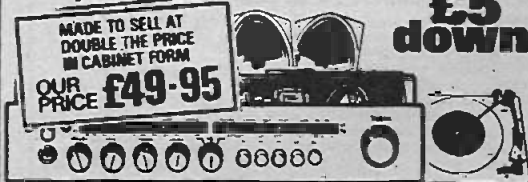

*Stereo Tuner Amplifier chassis with AM, FM radio covering long medium short and Stereo FM wavebands. Separate Base and Treble controls. 30 watts total power output (frequency response 25-20,000 Hz) Tape record and playback facilities. Dimensions 18" x 8 1/2" x 3 1/4". The very latest BSR automatic record deck with cue and pause control. Two matching elliptical speaker units.

Order early limited stocks available cash price £59.95. Credit Sale £5.95 deposit 9 monthly payments of £7 (Total Credit price £68.95). P. & P. £2.50. Send £8.95 today.

Chassis only available for cash at £42.00.

Full 12 months Guarantee.

CALLERS WELCOME.

Stereo headphones supplied with every complete order.

LEWIS radio

EE/6/75

100 CHASE SIDE SOUTHGATE LONDON N14 5PL Telephones: 01-882-1644

POST TODAY FOR FREE BOOK

TO: ALDERMASTON COLLEGE DEPT. CEE 06 READING RG7 4PF CEE 06

Yes, I'd like to know more about your course. Please send me free details—plus your big, 76-page book that tells about all your courses.

NAME

ADDRESS

POSTCODE



HOME OF BRITISH INSTITUTE OF ENGINEERING TECHNOLOGY

Marshall's

Everything you need is in our
New 1975 Catalogue
available now price 25p
(100 pages of prices and data)

A. Marshall (London) Ltd. Dept. EE
42 Cricklewood Broadway London NW2 3HD Telephone 01-452 0161/2 Telex 21492
& 65 West Regent Street Glasgow G2 2OD Telephone 041-332 4133

Call in and see us 9-5.30 Mon-Fri
9-5.00 Sat

Trade and export enquiries welcome

Top 500 Semiconductors from the largest range in the UK

2N456	0-80	2N2924	0-20	2N5195	1-46	AF117	0-35	BC2144L	0-18	BF178	0-35	BD1L	0-38	OC72	0-23
2N456A	0-85	2N2926	0-20	2N5294	0-48	AF118	0-35	BC237	0-16	BF179	0-43	14DL1L	0-40	OC81	0-25
2N457A	1-28	2N3053	0-25	2N5294A	0-48	AF124	0-30	BC238	0-15	BF180	0-35	LM710	0-47	OC83	0-24
2N490	3-16	2N3054	0-60	2N5295	0-48	AF125	0-30	BC239	0-15	BF181	0-36	LM3900	0-70	ORP12	0-53
2N491	4-38	2N3055	0-75	2N5296	0-48	AF126	0-28	BC251	0-25	BF182	0-35	LM723C	0-90	R53	1-80
2N492	5-00	2N3059	0-45	2N5298	0-80	AF127	0-28	BC253	0-25	BF183	0-53	LM741T099		SL1414A	1-80
2N493	5-20	2N3391	0-28	2N5457	0-49	AF139	0-65	BC257	0-16	BF184	0-30	8D1L	0-40	SL610C	1-70
2N696	0-22	2N3391A		2N5458	0-46	AF186	0-46	BC258	0-16	BF185	0-30	14DL1L	0-38	SL612C	1-70
2N697	0-16		0-29	2N5459	0-49	AF200	0-65	BC259	0-17	BF194	0-12	LM747	1-00	SL620C	2-60
2N698	0-82	2N3392	0-15	2N5492	0-58	AF239	0-65	BC261	0-25	BF195	0-12	LM7488DDIL		SL621C	2-60
2N699	0-59	2N3393	0-15	2N5494	0-58	AF240	0-90	BC262	0-25	BF196	0-13	LM7805	2-50	SL623	4-59
2N706	0-14	2N3394	0-15	2N5496	0-61	AF279	0-70	BC263	0-25	BF197	0-15	14DL1L	0-73	SL640C	3-10
2N706A	0-16	2N3402	0-18	2N6027	0-45	AF280	0-79	BC300	0-38	BF198	0-18	14DL1L	0-73	SL641C	3-10
2N708	0-17	2N3403	0-19	2N5777	0-45	AF139	0-65	BC327	0-27	BF254	0-19	LM7812	2-50	SN76003N	
2N709	0-43	2N3403	0-59	3N128	0-73	AL103	0-00	BC302	0-29	BF255	0-19	MC1303	1-50	SN76013N	1-95
2N711	0-50	2N3441	0-97	3N139	1-42	BC107	0-14	BC303	0-54	BF244	0-21	MC1310	1-50	SN76023N	1-60
2N718	0-23	2N3442	1-40	3N140	1-00	BC108	0-14	BC307	0-17	BF245	0-45	MC1330CP		SN76033N	2-92
2N718A	0-28	2N3414	0-10	3N141	0-81	BC109	0-14	BC308A	0-15	BF246	0-58	MC1351P		ST2	0-20
2N720	0-57	2N3415	0-10	3N200	2-49	BC113	0-15	BC309C	0-20	BE247	0-65	MC1352P		STZ	0-20
2N914	0-39	2N3416	0-15	40361	0-40	BC115	0-17	BC327	0-27	BF254	0-19	MC1466	3-50	TAA263	1-10
2N916	0-28	2N3417	0-21	40362	0-45	BC116	0-17	BC328	0-28	BF255	0-19	MC1469	2-75	TAA350	2-10
2N918	0-32	2N3638	0-15	40363	0-88	BC116A	0-18	BC337	0-20	BF257	0-47	MC1469	2-75	TAA611C	1-60
2N929	0-37	2N3638A		40389	0-46	BC117	0-21	BC338	0-20	BF258	0-53	ME4002	0-20	TAA621	2-03
2N930	0-22		0-15	40394	0-56	BC118	0-14	BCY30	0-80	BF259	0-55	ME4004	0-13	TAA661	1-32
2N1302	0-19	2N3639	0-27	40395	0-65	BC119	0-29	BCY31	0-85	BF259	0-55	ME4012	0-18	TBA641B	1-32
2N1303	0-19	2N3641	0-17	40406	0-44	BC127	0-35	BCY32	1-13	BF271	0-30	ME4104	0-11	TBA651	1-69
2N1304	0-26	2N3702	0-14	40407	0-35	BC125	0-16	BCY33	0-79	BF282	0-92	ME4104	0-11	TBA810	1-50
2N1305	0-24	2N3703	0-12	40408	0-50	BC126	0-23	BCY34	0-79	BF282	0-92	ME4104	0-11	TBA820	1-15
2N1306	0-31	2N3704	0-15	40409	0-52	BC132	0-30	BCY38	1-00	BF561	0-27	ME4104	0-11	TBA920	4-00
2N1307	0-30	2N3705	0-15	40410	0-52	BC134	0-13	BCY39	1-50	BF598	0-25	ME4104	0-11	TBA920	4-00
2N1308	0-47	2N3706	0-15	40411	0-75	BC135	0-13	BCY40	0-97	BFX29	0-30	ME4104	0-11	TBA920	4-00
2N1309	0-47	2N3707	0-18	40594	0-24	BC136	0-17	BCY42	0-98	BFX30	0-27	ME4104	0-11	TBA920	4-00
2N1671	1-34	2N3709	0-15	40595	0-14	BC137	0-17	BCY5	0-33	BFX84	2-30	ME4104	0-11	TBA920	4-00
2N1671A	1-67	2N3709	0-15	40601	0-67	BC138	0-24	BCY59	0-33	BFX85	0-30	ME4104	0-11	TBA920	4-00
2N1671B	1-85	2N3710	0-15	40602	0-61	BC140	0-68	BCY70	0-17	BFX87	0-28	ME4104	0-11	TBA920	4-00
2N1711	0-45	2N3712	1-20	40604	0-58	BC141	0-68	BCY71	0-22	BFX88	0-25	ME4104	0-11	TBA920	4-00
2N1907	5-50	2N3713	1-20	40636	1-10	BC143	0-25	BD115	0-75	BFY50	0-23	ME4104	0-11	TBA920	4-00
2N2102	0-60	2N3714	1-20	40637	1-10	BC145	0-21	BD116	0-75	BFY51	0-23	ME4104	0-11	TBA920	4-00
2N2148	0-94	2N3715	1-50	40673	0-73	BC147	0-14	BD121	1-00	BFY52	0-21	ME4104	0-11	TBA920	4-00
2N2160	0-50	2N3716	1-80	AC126	0-20	BC148	0-14	BD123	0-82	BFY53	0-18	ME4104	0-11	TBA920	4-00
2N2218A	0-22	2N3722	1-80	AC127	0-20	BC149	0-15	BD124	0-67	BFY90	0-75	ME4104	0-11	TBA920	4-00
2N2219	0-24	2N3773	2-65	AC151V	0-37	BC153	0-18	BD131	0-40	BRY39	0-48	ME4104	0-11	TBA920	4-00
2N2219A	0-26	2N3774	3-42	AC152A	0-38	BC154	0-18	BD132	0-50	BSX20	0-21	ME4104	0-11	TBA920	4-00
2N2220	0-15	2N3791	2-35	AC153K	0-35	BC157	0-16	BD135	0-43	BSX21	0-29	ME4104	0-11	TBA920	4-00
2N2221	0-28	2N3792	2-60	AC154	0-25	BC158	0-16	BD136	0-49	BU104	2-90	ME4104	0-11	TBA920	4-00
2N2221A	0-21	2N3794	0-10	AC176	0-30	BC167B	0-15	BD138	0-35	BU105	2-25	ME4104	0-11	TBA920	4-00
2N2222	0-20	2N3819	0-37	AC176K	0-40	BC168B	0-15	BD139	0-31	CA180A	0-85	ME4104	0-11	TBA920	4-00
2N2222A	0-25	2N3823	0-42	AC187K	0-35	BC168C	0-15	BD140	0-87	CA3020A	1-80	ME4104	0-11	TBA920	4-00
2N2368	0-25	2N3904	0-27	AC188K	0-35	BC169B	0-15	BD140	0-87	CA3020A	1-80	ME4104	0-11	TBA920	4-00
2N2369	0-20	2N4036	0-67	AC191	0-27	BC169C	0-15	BD150	0-80	CA3028A	1-80	ME4104	0-11	TBA920	4-00
2N2369	0-22	2N4037	0-42	AC192	0-26	BC170	0-15	BD159	0-24	CA3035	1-37	ME4104	0-11	TBA920	4-00
2N2369	0-22	2N4038	0-18	AC193	0-20	BC171	0-16	BD179	0-16	CA3052	1-62	ME4104	0-11	TBA920	4-00
2N2445	0-55	2N4059	0-15	ACY30	0-58	BC172	0-17	BDY20	1-05	CA3046	0-70	ME4104	0-11	TBA920	4-00
2N2647	0-98	2N4060	0-15	AD142	0-57	BC177	0-28	BF115	0-36	CA3052	1-62	ME4104	0-11	TBA920	4-00
2N2904	0-22	2N4061	0-15	AD143	0-68	BC178	0-27	BF117	0-55	CA3046	0-70	ME4104	0-11	TBA920	4-00
2N2904A	0-24	2N4062	0-15	AD149	1-10	BC179	0-30	BF121	0-35	CA3048	2-11	ME4104	0-11	TBA920	4-00
2N2905	0-25	2N4126	0-21	AD150	1-15	BC182L	0-12	BF123	0-35	CA3089E	1-61	ME4104	0-11	TBA920	4-00
2N2905A	0-26	2N4219	0-95	AD161	1-15	BC183	0-12	BF125	0-35	CA3090Q	1-61	ME4104	0-11	TBA920	4-00
2N2906	0-19	2N4220	0-80	AD162	1-05	BC184	0-12	BF153	0-25	NE555U	1-30	ME4104	0-11	TBA920	4-00
2N2906A	0-21	2N4221	1-00	AD161	1-05	BC184L	0-13	BF159	0-27	NE560	4-48	ME4104	0-11	TBA920	4-00
2N2907	0-22	2N4222	0-29	AD162	1-05	BC186	0-25	BF160	0-23	NE561	4-48	ME4104	0-11	TBA920	4-00
2N2908	0-19	2N4223	0-29	AD163	1-05	BC187	0-27	BF163	0-32	NE565A	4-48	ME4104	0-11	TBA920	4-00
2N2909	0-22	2N4224	0-29	AD164	1-05	BC207	0-12	BF166	0-40	OC23	1-35	ME4104	0-11	TBA920	4-00
2N2909A	0-24	2N4225	0-29	AD165	1-15	BC208	0-11	BF167	0-25	OC28	0-76	ME4104	0-11	TBA920	4-00
		2N4226	0-29	AD166	1-15	BC212K	0-16	BF173	0-27	OC35	0-60	ME4104	0-11	TBA920	4-00
		2N4227	0-29	AD167	1-15	BC212L	0-16	BF177	0-29	OC42	0-50	ME4104	0-11	TBA920	4-00
		2N4228	0-29	AD168	1-15					OC45	0-32	ME4104	0-11	TBA920	4-00
		2N4229	0-29	AD169	1-15					OC71	0-17	ME4104	0-11	TBA920	4-00

PW TELENNIS KIT
As featured in BBC Nationwide and in the Daily Mail 2 Oct '74. Ideal game for whole family. No need to modify your TV set, just plugs in to aerial socket.
Parts list as follows: A Resistor Pack £1-00 p & 20p; B Potentiometer Pack £1-25 p & 20p; C Capacitor Pack £3-10 p & 20p; D Semiconductor Pack £14-50 p & 20p; E IC Sockets £4-00 p & 20p; F Transformer £1-15 p & 20p; G PCB's £7-50 p & 20p; H Switches £4-50 p & 20p; I UHF Modular Kit £7-50 p & 20p.

Special Prices—complete kit excluding case £42-00 p & 50p. Sections A-F incl. £23-50 p & 30p. Complete instructions with component kit or 75p on request.

P.C. Marker Pen Dalo 33PC 0-87p
Zenker 400MW-11p; 1W-17p
IC Sockets 8D1L 16p; 14DL1 17p; 16DL1 20p.
Resistors 1w-2p; 1w-3p; 2w-9p; 5w-10p; 10w-12p.
Scorpio Car Ignition Kit-£11-50 + VAT
1 IMF440V-£1-10. Transformer-BSTB0246-£1-20; £3-00.
OPTO & LED'S
Red, green and yellow
0-16 diameter, 31p
0-20 diameter, 33p
DL707 £2-35 or 4 for £8-00
Mintron £1-55

Cmos Circuits—CD Range

4001	0-36	4016	0-66	4030	0-87
4001	0-36	4017	1-72	4031	5-19
4002	0-36	4018	2-55	4037	1-93
4006	1-58	4019	0-86	4041	1-86
4007	0-36	4020	1-91	4042	1-38
4008	1-63	4021	0-72	4043	1-80
4009	1-18	4022	1-66	4044	1-80
4010	1-18	4023	0-36	4045	2-65
4011	0-36	4024	1-24	4046	2-84
4012	0-36	4025	0-32	4047	1-65
4013	0-66	402			

Go quad for around £50

(including the speakers!)

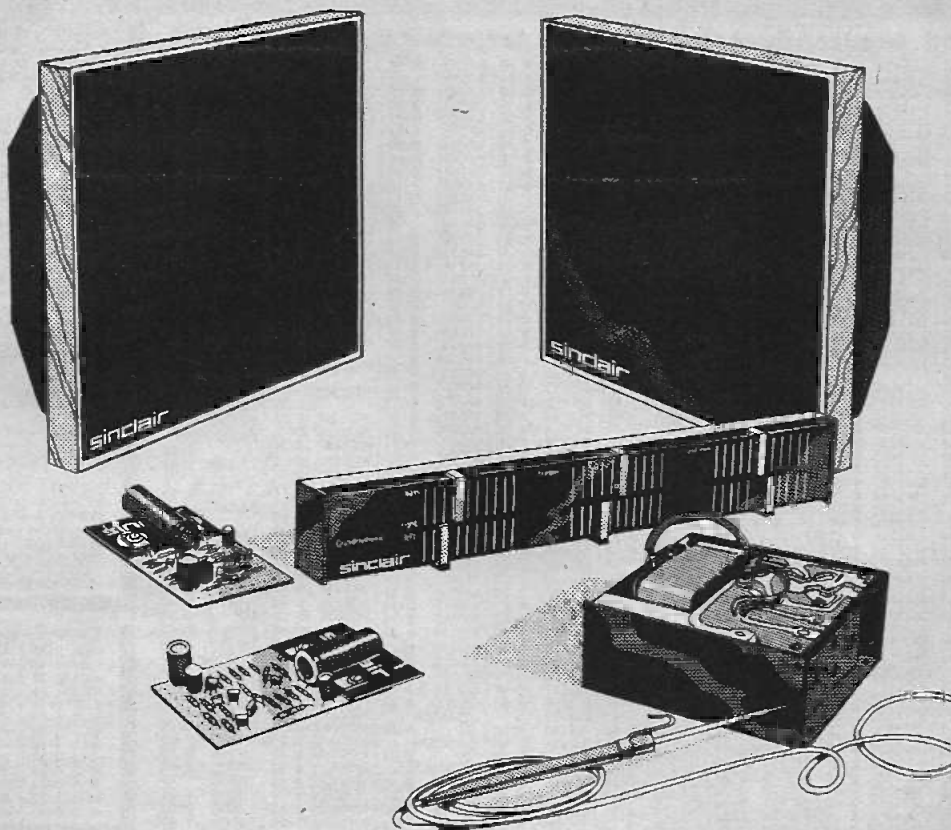

Sinclair Project 80 hi-fi modules

If you've thought of switching to quad, you've probably found it an expensive process. Do you part with your existing stereo amp – which probably cost you a lot in the first place – and replace it with an even more costly quad amp? Or do you buy an expensive add-on kit – often costing as much as £90 even *without* the extra speakers?

With Sinclair Project 80 hi-fi modules, you can keep your existing amplifier... add a quad decoder, two power amps and a power supply unit... a couple of Sinclair Q16 speakers and you've got a high-quality, true quad system which will have cost you only £50 or so to convert!

How does Sinclair Project 80 work?

Project 80 is a comprehensive set of hi-fi modules or sub-assemblies. Amps... pre-amps... FM tuner... quad decoder... control units... everything you need to assemble hi-fi units. They're all designed to look alike and are all completely compatible with each other. Simply decide on the specification of the unit (stereo or quad) you want to build... buy the necessary modules... connect them up and house them.

You can even build a quad amp entirely from Project 80 modules. Two power amplifiers, a control unit and a power

supply give you a stereo amp for as little as £31.80 plus VAT. The necessary add-on quad modules cost only £36.80 + VAT. Together, they make up a true hi-fi quad amp for only £68.60 + VAT!

And whenever you choose, you can add extra Project 80 refinements. An FM tuner... a scratch/rumble filter... higher-output power amps – Project 80 is an enjoyable way to develop your own hi-fi system!

Is it difficult to build?

Not at all. All Project 80 module circuitry is complete in itself – all you have to do is connect the external wiring to numbered solder points.

And if you're not so hot with a soldering iron? Use Project 805 Kits. Project 805 uses Project 80 modules, but provides special clip-on tagged-wire connections – positively no soldering! There are two Project 805 kits – the basic 805 stereo amplifier kit, and the 805Q quad conversion kit.

805Q can be used to convert a Project 80 or 805 stereo system, or your existing stereo system.

You'll find more details and some system suggestions opposite.

Project 80 hi-fi modules – the easy way to true quadrasonics.



Project 80 SQ quadrasonic decoder

Combines with and exactly matches Project 80 control unit for true quadrasonics. This unit is based on the CBS SQ system and is a complete quadrasonic decoder, rear channel pre-amp and control unit.

Specification
(9½ in x 2 in x ¾ in.) Connects with tape socket on Project 80

Project 80 power amplifiers

Two different amplifiers, designed to be used separately or combined, with Project 80 modules or as add-ons to existing equipment. Protected against short circuits and damage from mis-use.

Z40 Specification
(2¼ in x 3 in x ¾ in.) 8 transistors. Input sensitivity: 100 mV. Output: 12 W RMS continuous into 8 Ω (35 V). Frequency response: 30 Hz – 100 kHz ± 3 dB. S/N ratio: 64 dB. Distortion: 0.1% at 10 W into 8 Ω at 1 kHz. Voltage requirements: 12 V – 35 V. Load Imp: 4 Ω – 15 Ω; safe on open circuit. Protected against short circuit.

Price: £5.95 + VAT

Project 80 power supply units

Range of power supply units to match desired specification of final system.

PZ5 Specification
Unstabilised. 30 V output. Including mains transformer.

Price: £5.95 + VAT

PZ6 Specification
Stabilised. 35 V output. Including mains transformer.

Price: £8.95 + VAT

Project 80 SQ quadrasonic add-on kit

Converts your existing stereo hi-fi system to quad using solderless connections

Contains following Project 80 units:

Project 80 SQ quad decoder/rear channel pre-amp and controls unit

Sinclair Q16 speaker

Original and uniquely designed speaker of outstanding quality.

Specification
(10½ in square x 4¼ in deep.) Pedestal base. All-over black front. Teak surround. Balanced

control unit or similar facility on any stereo amplifier. Separate slider controls on each channel for treble, bass and volume. Frequency response: 15 Hz to 25 kHz ± 3 dB. Distortion: 0.1%. S/N ratio: 58 dB. Rated output: 100 mV. Phase shift network: 90 ± 10, 100 Hz to 10 kHz. Operating voltage: 22 V – 35 V.

Price: £18.95 + VAT

Z60 Specification

(2¼ in x 3¼ in x ¾ in.) 12 transistors. Input sensitivity: 100 mV – 250 mV. Output: 25 W RMS continuous into 8 Ω (50 V). Frequency response: 10 Hz to more than 200 kHz + 3 dB. S/N ratio: better than 70 dB. Distortion: less than 0.1% at 12 W into 4 Ω at 1 kHz. Voltage requirements: 12 V – 50 V. Load Imp: 4 Ω min; max safe on open circuit. Protected against short circuit.

Price: £7.45 + VAT

PZ8 Specification
Stabilised. Output adjustable from 20 V to 60 V approx. Re-entrant current limiting makes damage from overload or even shorting virtually impossible. Without mains transformer.

Price: £8.45 + VAT

2 x Z40 power amps
PZ5 power supply unit
Masterlink unit
On/off switch
plus pre-cut wiring loom with clip-on tagged wire connections, nuts and bolts, instruction manual.

Price: £44.95 + VAT

sealed sound chamber. Special driver assembly. Frequency response: 60 Hz to 16 kHz. Power handling: up to 14 W RMS. Impedance: 8 Ω.

Price: £8.95 + VAT

Quad system suggestions from Sinclair

1. Add-on quad to existing system:

12 W per rear channel RMS
Quadrasonic decoder + 2 x Z40 amps + 1 x PZ6 power supply + (existing stereo amplifier) + 2 x Q16 speakers + (2 existing speakers) + (turntable). Total Project 80 cost: £57.70 + VAT.

2. Add-on quad to existing system:

25 W per rear channel RMS
Quadrasonic decoder + 2 x Z60 amps + 1 x PZ8 power supply + (mains transformer) + (existing stereo amplifier) + (2 x equivalent speakers) + (2 x existing speakers) + (turntable). Total Project 80 cost: £42.30 + VAT.

3. Quadrasonic system built from scratch:

12 W per channel RMS
Pre-amp/control unit + quadrasonic decoder + 4 x Z40 amps + 2 x PZ6 power supply + 4 x Q16 speakers + (turntable). Total Project 80 cost: £110.40 + VAT.

What more can we tell you?

All Project 80 modules are backed by the remarkable no-quibble Sinclair guarantee. Should any defect arise from normal use within a year, we'll service the modules free of charge. And our Consumer Advisory Service is always available if you run into any problems. You'll find Project 80 at stores like Laskys and Henry's – but before you look, why not get really detailed information? Clip the FREEPOST coupon for the fully-illustrated Project 80 folder – today!

Sinclair Radionics Ltd,
London Road, St Ives, Huntingdon, Cambs., PE17 4HJ.
Telephone: St Ives (0480) 64646.

sinclair

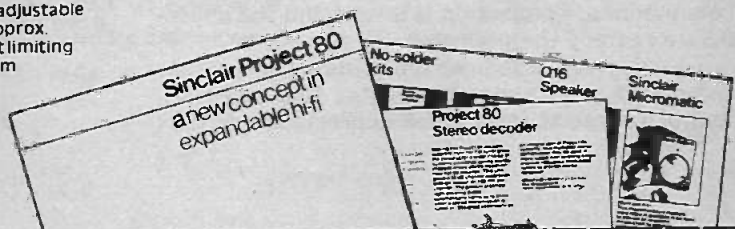

To: Sinclair Radionics Ltd, FREEPOST, St Ives, Huntingdon, Cambs., PE17 4BR.

Please send me, by return post, a copy of the fully-illustrated Project 80 folder.

Name _____

Address _____

Please print FREEPOST – no stamp needed

EE/6/75

everyday electronics

PROJECTS
THEORY...

FAULT FINDING

For the electronics constructor, one of life's little thrills comes with every initial switching on of a completed project. Will it, or won't it—a moment of anxiety before reassuring evidence is forthcoming, denoting that all is well.

But what if silence, or complete inactivity, is all one is rewarded with after power has been applied? A state of affairs that is not at all uncommon—and not the experience of novices alone, let it be made clear! Impatient fiddling with connections, a rapid visual examination of the whole assembly with the desperate hope that by luck or chance the defective part or connection will reveal itself or, if one is extra lucky, the fault will miraculously become cured.

Every seasoned constructor must have performed this ritual more times than he cares to remember.

But what if this initial check fails to bring life to the assembled circuit? This in fact becomes the moment when the men are sorted from the boys, as the saying goes. Logic now takes over and a careful and reasoned approach is made to the matter. The circuit is tested systematically stage by stage until the offending component or connection is traced and the appropriate remedy then effected.

To carry out a logical fault-finding procedure requires a good understanding of fundamentals, and of course at least some appreciation of how

the particular circuit operates. Admittedly electronic green fingers do exist, and some folk who have but little formal knowledge of theoretical matters often are able to track down the source of trouble in a most uncanny way. This knack or intuition is a valuable asset, but obviously it is better to have a sounder base from which to operate.

Also, by contrast, there are those who are well conversant with circuit theory yet have quite a bother when it comes to dealing with real-life problems in a practical electronic assembly.

The title of one of this month's features, *It's Not My Fault!* may cause a wry smile or two. But it's an expression that is all too painfully familiar. With the aid of this article and others to follow, we hope it will become less commonplace in future.

MAIDEN VOYAGE

We have always maintained that sex discrimination has no place in our hobby. Nor has it in professional electronics. Nice to see a young lady featured in the careers article this month. Good luck Radio Officer Meryl. Guess you will have set many other gals athinking!

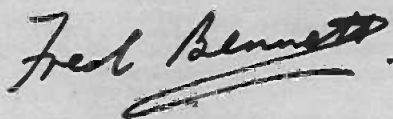

Our July issue will be published on Friday, June 20

EDITOR F. E. Bennett • ASSISTANT EDITOR M. Kenward • TECHNICAL EDITOR B. W. Terrell B.Sc.
ART EDITOR J. D. Pountney • P. A. Loates • K. A. Woodruff
ADVERTISEMENT MANAGER D. W. B. Tilleard

© IPC Magazines Limited 1975. Copyright in all drawings, photographs, and articles published in EVERYDAY ELECTRONICS is fully protected, and reproduction or imitations in whole or part are expressly forbidden.

All reasonable precautions are taken by EVERYDAY ELECTRONICS to ensure that the advice and data given to readers are reliable. We cannot, however, guarantee it, and we cannot accept legal responsibility for it. Prices quoted are those current as we go to press. Everyday Electronics Fleetway House, Farringdon Street, London, E.C.4. Phone: Editorial 01-634-4452; Advertisements 01-634-4202.

EASY TO CONSTRUCT SIMPLY EXPLAINED

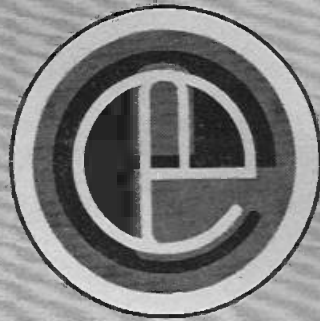

VOL. 4 NO. 6

JUNE 1975

CONSTRUCTIONAL PROJECTS

WHITE LINE FOLLOWER <i>A novel motorised vehicle</i> by Malcolm Plant	300
MULTIMETER SENSITISER <i>For use with most test meters</i> by R. A. Penfold	314
ELECTRONIC THERMOSTAT <i>Provides accurate temperature control</i> by Michael J. Holt	317

GENERAL FEATURES

EDITORIAL	298
FOR YOUR ENTERTAINMENT <i>Cars and calculators</i> by Adrian Hope	305
ITS NOT MY FAULT! <i>Basic fault finding techniques</i> by Phil Allcock	306
COUNTER INTELLIGENCE by Paul Young	309
YOUR CAREER IN ELECTRONICS <i>The Professional Institutions</i> by Peter Verwijg	310
READERS' LETTERS <i>From you to us</i>	312
BRIGHT IDEAS <i>Readers' constructional hints</i>	312
PHYSICS IS FUN <i>Static electricity</i> by Derrick Daines	313
PLEASE TAKE NOTE	316
SHOP TALK <i>Component buying for the constructional projects</i> by Mike Kenward	322
WORKSHOP PRACTICE <i>Part 3 Professional Finish</i> by Mike Hughes	323
PROFESSOR ERNEST EVERSURE <i>The Extraordinary Experiments of.</i> by Anthony J. Bossett	326
DOWN TO EARTH <i>Multimeter sensitivity</i> by George Hylton	332

PULL-OUT SUPPLEMENT

INDEX FOR VOL. 3, January to December 1974	between pages	314/315
---	---------------	---------

Publisher's Annual Subscription Rate, including postage Inland £4.00, Overseas £3.90, USA/Canada \$11. International Giro facilities Account No. 5122007. State reason for payment "message to payee". Address to Everyday Electronics, Subscription Department, Carlton House, Great Queen Street, London, WC2E 9PR. Binders for volumes 1 to 4 (state which) and indexes for volume 1 and 2 available for £1.85 and 30p respectively, including postage, from Binding Department, at the above address.

We are unable to supply back copies of Everyday Electronics or reprints of articles and cannot undertake to answer readers' letters requesting designs, modifications or information on commercial equipment or subjects not published by us. An s.a.e. should be enclosed for a personal reply. Letters concerning published articles should be addressed to: The Editor, those concerning advertisements to: The Advertisement Manager, both at the address shown opposite.

Next Month

AUTOMATIC GARAGE DOORS

See PAGE 325

A novel electronic motorised vehicle that will follow a white line.

ELECTRONIC control systems are incorporated in a greater part of the technology which influences most of us every day of our lives; for instance, control systems using electronics are vital to the safety of air, sea and rail transportation systems. And the efforts of the home constructor are, in no small way, bringing the benefits of electronic control circuitry into the car and home.

For example, the electronics hobbyist is making use of readily obtainable semiconductor devices to build circuits providing improved control of the functions of his car; and in the home he is using electronics for humidity and temperature control, the automatic opening of doors, for the control of gain and noise in hi fi systems, etc.

The White Line Follower described in this article illustrates admirably the function of a control system known as a "servomechanism" incorporating the elements of command, amplification, work and feedback. Two photocells mounted side-by-side "look at" the white line and provide the command signal when they "see" a difference of illumination.

Fig. 2. The complete circuit diagram of the White Line Follower.

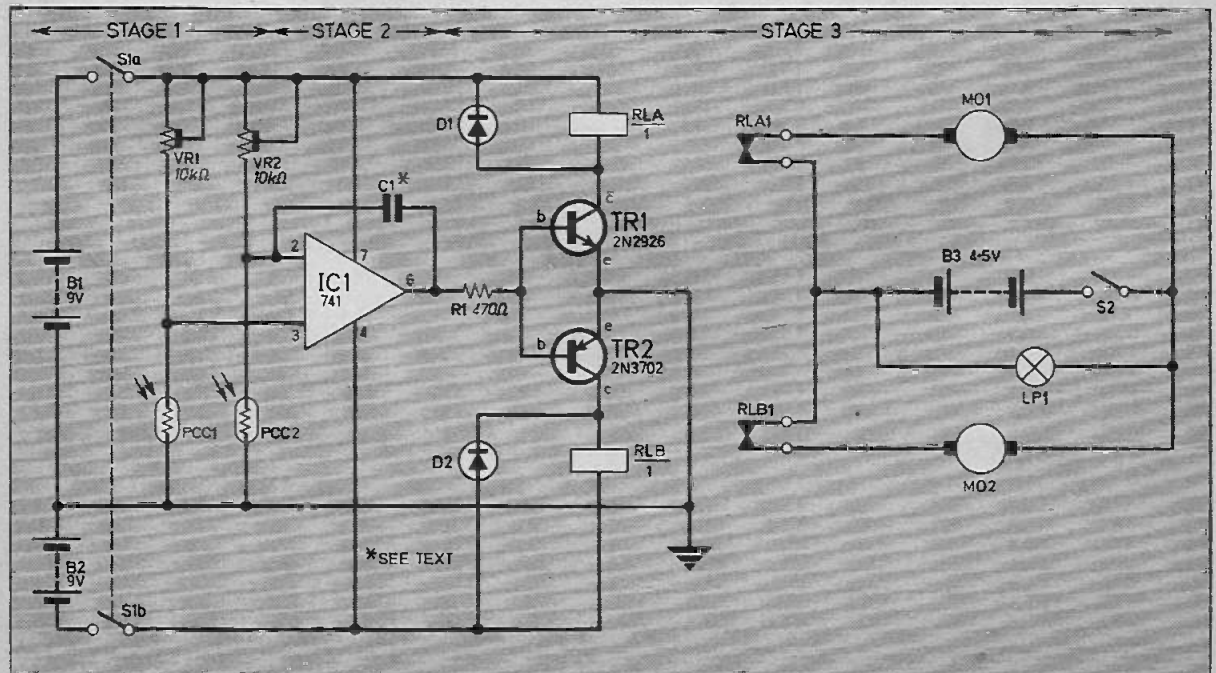

An operational amplifier (op. amp.) detects this differential command signal and via current buffer transistors and relays amplifies this signal to operate two electric motors connected to drive wheels. These motors provide the feedback essential for the vehicle to take corrective action in order to maintain equal illumination of the photocells. Thus the vehicle is compelled to follow the white line.

THE CIRCUIT

The general-purpose integrated circuit operational amplifier—the “741” type—is well suited to this application. Those of you who have used this i.c. will know that it has two input terminals, an inverting input and a non-inverting input. As shown in Fig 1, these terminals are,

If V_1 is greater (more positive) than V_2 , the output voltage is positive with respect to earth, and if V_2 is greater than V_1 , the output voltage is negative with respect to earth. This is the secret of operation of the White Line Follower: the output voltage swings from almost $+V$ to almost $-V$ as $(V_1 - V_2)$ changes from a positive difference to a negative difference.

Due to the very high gain (at least 10,000) of the op. amp., the output voltage saturates at the negative and positive supply voltages for very small differences in voltage across the input terminals.

Now take a look at the complete control circuit shown in Fig 2. This circuit is divided into three stages in order to understand its operation better. We have already seen the operation of

FOLLOWER

By MALCOLM PLANT

respectively, pins 2 and 3 for the 8-pin d.i.l. version.

The 741 is operated with a dual, or double-ended, power supply, which means that pin 7 is connected to the positive terminal and pin 4 to the negative terminal of two series-connected batteries, the common terminal being connected to ground or “earth” in the circuit. The input voltages V_1 and V_2 and the output voltage V_{out} are measured relative to this connection.

The arrangement shown in Fig. 1 acts as a difference amplifier since it is the difference ($V_1 - V_2$) of voltage which is amplified by the op. amp. and appears at the output terminal.

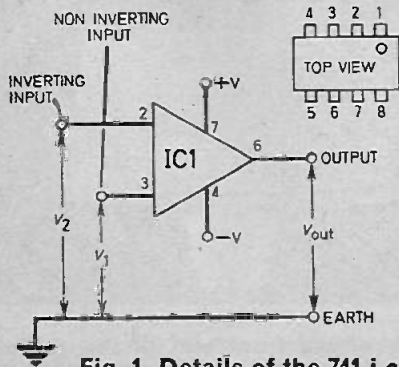

Fig. 1. Details of the 741 i.c.

stage 2, the op. amp.'s part in amplifying the voltage difference between pins 2 and 3.

In stage 1 of the circuit, two light-sensitive voltage dividers $VR1/PCC1$ and $VR2/PCC2$, provide the changing voltages at the input terminals. Assuming that $VR1$ and $VR2$ have equal resistances, and photocells $PCC1$ and $PCC2$ have identical electrical characteristics, equal illumination of the photocells will make V_1 equal to V_2 so that there is no voltage difference to be amplified and, consequently, the output voltage is zero.

Now if $PCC1$ is illuminated less strongly than $PCC2$, its resistance is higher than that of $PCC2$, V_1 is greater than V_2 giving a positive voltage at the output. And if $PCC1$ is illuminated more strongly than $PCC2$, V_2 becomes greater than V_1 , and the output voltage is negative. The

FOR
GUIDANCE
ONLY

ESTIMATED COST*
OF COMPONENTS
including V.A.T.



£7.00

*Based on prices prevailing at time of going to press

changing illumination of the photocells is brought about by the vehicle attempting to follow the white line marked out on the floor.

FINAL STAGE

Stage 3 consists of a *npn/pnp* pair of transistors, TR1 and TR2, which act as solid-state switches, sensing the polarity of the output voltage from the op. amp. and controlling the action of the relays in their collector circuits. Notice that a normally-closed contact on each relay is connected to the motor circuits so that if the output voltage is zero, both transistors are off and the vehicle moves on a straight course.

If PCC1 is less strongly illuminated than PCC2, the output voltage goes positive, TR1 switches on, the normally-closed contact of RLA opens and motor 1 switches off while motor 2 stays on. If we now have the situation where PCC1 is less strongly illuminated than PCC2 the vehicle will be caused to veer to the left of the line. To bring the vehicle back on course, with both motors driving and both photocells equally illuminated, requires the circuit to behave in the way just explained.

You will be able to work out that if the vehicle swings to the right, PCC2 picks up less light than PCC1, and motor 2 switches off to bring the vehicle back on course.

Thus the control circuit incorporates an optoelectronic element (stages 1 and 2) and an electromechanical element (stage 3). These stages make up what is known as a "servo-system" having the elements of "command", "amplification", "work" and "feedback" previously mentioned.

For the White Line Follower, the "command" is originated by the photocells "picking up" light from the white line, the "amplification" is produced by the op. amp. and transistors acting as current buffers, the "work" is done by the motors which drive the vehicle back on course when required, and the "feedback" is accomplished by the motors effectively adjusting the illumination of the photocells until the light levels are equal.

FEEDBACK CONTROL

There is one modification to the circuit of the control system which is well advised: the op. amp. is operated "open loop" that is, with no signal being fed back from the output to the input terminals. Consequently, the op. amp. provides a very high gain causing the motors to switch on and off very rapidly for very small changes in the relative illumination of the photocells.

A resistor could be connected between the output and inverting input terminal of the op. amp. in order to reduce the gain by providing negative feedback. However, an effective solu-

tion to the problem of eliminating spurious switching of the relays for small changes of illumination, as well as switching caused by the voltage spikes generated by the operation of the relays and motors, is to connect a small-value capacitor (C1) between pins 2 and 6. This capacitor has the following effect.

A sharply rising positive voltage at pin 6 (caused by the voltage at pin 3 rising just above that at pin 2) is transmitted by (C1) to the inverting input and tends to lower the difference of voltage between pins 2 and 3. Similarly, a sharply rising negative output voltage (caused by the voltage at pin 2 rising just above that at pin 3) is transmitted by (C1) to have the same effect on the input voltage difference. A value for C1 of about 0.01 μ F was found suitable but its optimum value can be chosen by experiment.

CIRCUIT ASSEMBLY

The chassis for the prototype vehicle was a piece of 15 x 20 mm 5-ply under which was mounted the independently-controlled driving motors and wheels. Also mounted underneath the chassis were the two photocells and the lamp to illuminate the white line. On top of the chassis were mounted the relays, batteries and switches as well as the circuit mounted on Veroboard (Fig. 3).

The components to be mounted on Veroboard are shown in Fig. 4. Note that the transistors may be any general-purpose medium current *npn/pnp* pair, not necessarily a matched pair. Suitable pairs are ZTX330/ZTX500, 2N2926/2N3702, BC182L/BC212L. The protective diodes D1 and D2 may be general-purpose germanium or silicon types.

The battery voltage is determined by the motors used but should be able to drive the motors and the lamp with ease. It is necessary to gear down the motor so that the vehicle does not "lose" the line by moving too fast. Although rather costly and large, 6V Meccano motors

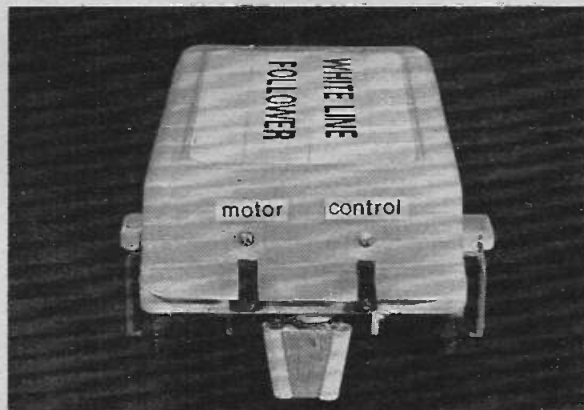

Photograph of the front end of the prototype showing photocell and lamp arrangement.

WHITE LINE FOLLOWER

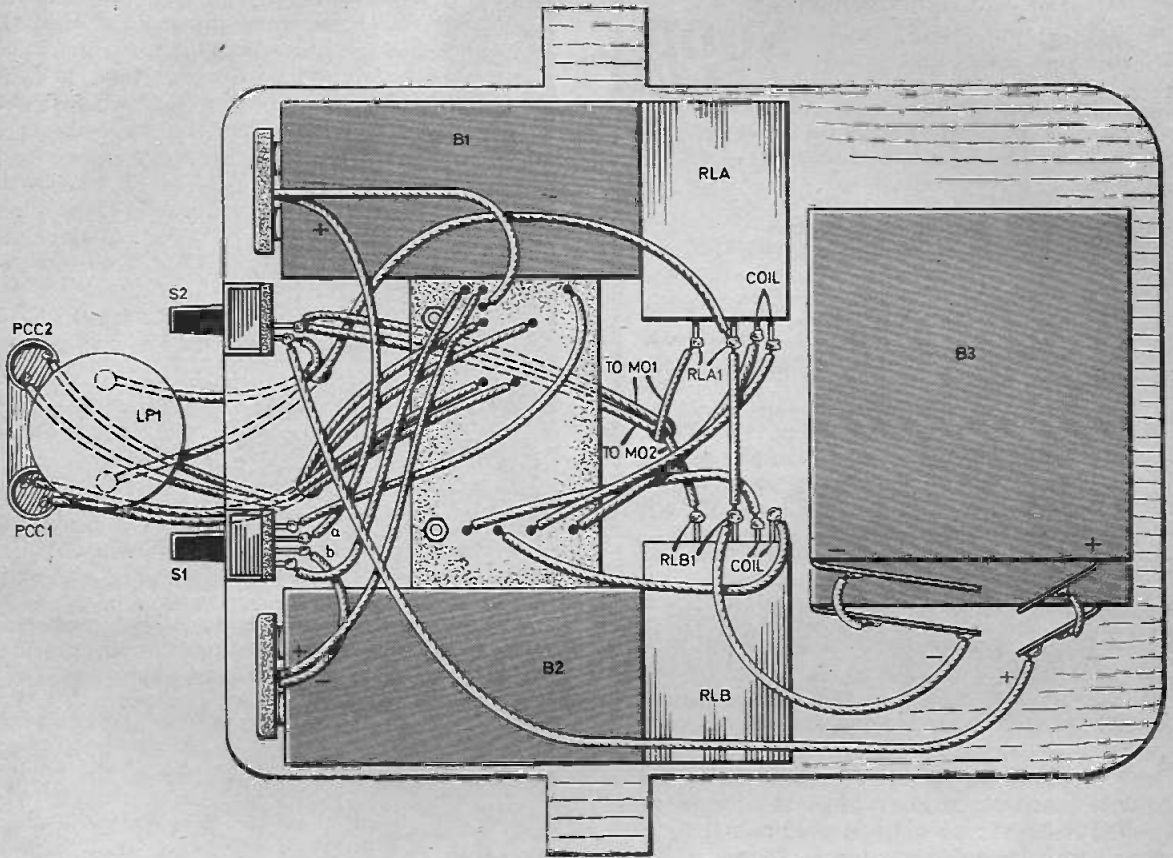

Fig. 3. The positioning and wiring up of the components mounted on the top side of the chassis.

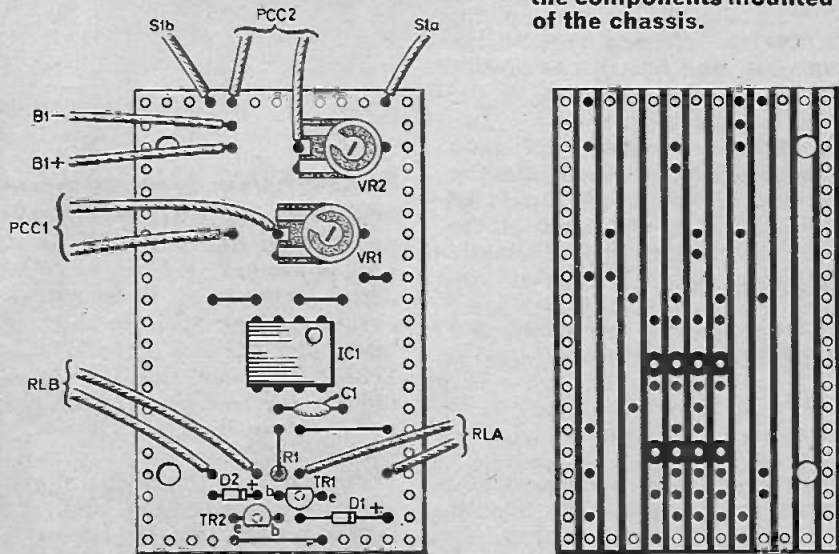

Fig. 4. The layout of the components on the Veroboard, wiring details and breaks to be made along the copper strips on the underside of the board.

Components....

Resistor

R1 470 Ω $\frac{1}{4}$ W $\pm 10\%$ carbon SEE

Capacitor

C1 0.01 μ F—see text

Semiconductors

PCC1, 2 miniature photoconductive cell
(light dependent resistor)—2 off

TR1 2N2926 silicon *npn*

TR2 2N3702 silicon *pn*p

IC1 741 8-pin d.i.l. op. amp.

D1, 2 OA91 or similar diode (2 off)

Miscellaneous

VR1, 2 10k Ω miniature skeleton presets (2 off)

RLA, RLB 6 to 12V 180 Ω or greater relay
with one set of normally closed contacts
(2 off)

LP1. 3.5V 100mA lamp and batten mounting
holder

S1 d.p.s.t. toggle or slider switch

S2 s.p.s.t. toggle or slider switch

MO1, MO2 Orbit 605 d.c. motor with 40 to 1
worm gears to fit spindle and axles (2 sets)

B1, B2 9V PP6 battery and clips (2 off)

B3 4.5V (two 1289 types in parallel)

Veroboard 22 holes x 10 strips; 0.1 inch
matrix. Materials for chassis and gear
mounting, two rubber tyred wheels approx
40mm diameter, castor wheel, tubes to hold
PCC1 and PCC2 approx 25mm long, plastic
food box for "case", wood and 4BA fixings
etc.

**SHOP
TALK**

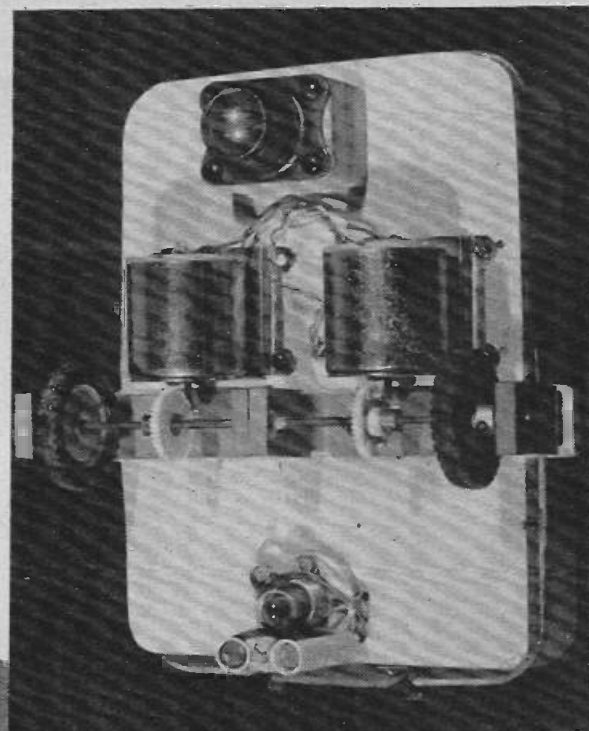

Photograph of the underside of the prototype showing motors and gearing fixings, photcell and lamp set up, and ball type castor.

The prototype unit used a ball-type castor as the third wheel but any small castor will suit and this can be mounted directly on the chassis or on a block to achieve the correct height. The lamp holder and a balsa block to secure the photocells are mounted at the other end of the vehicle by two wood screws. The photocells in their protective tubes may be fixed to the block with glue or insulation tape.

Finally, a plastic food box can be cut to a size and inverted over the chassis to finish the unit.

PREPARING THE VEHICLE

Set VR1 and VR2 towards the high resistance end of their tracks. With S1 on and S2 off, shield the photocells individually and observe the action of the relay. Refer to Figs 2, 3 and 4 and ensure that as PCC1 is shielded, RLA is energised, and as PCC2 is shielded RLB is energised. Switch on S2 and the lamp should light and the motors move. Make sure they are both driving in the same direction. If not, interchange the connections to the offending motor.

Mark out on the floor a narrow white line of strips of paper or chalk and set the vehicle over it. Make sure that the ambient lighting is not too strong and the contrast between the floor and line not too low. Make slight adjustments to VR1 and VR2 until the vehicle moves along the line without tending to veer off it. □

could be used since they have selectable gear ratios. The prototype vehicle used two Orbit 605 motors and nylon wormgears. Using a 4.5V battery the vehicle moves forward at a suitable speed.

As the motors provide a varying load on B3, the lamp brightens and dims but this behaviour does not adversely affect the operation of the vehicle.

The photocells and the lamp need positioning carefully. The lamp should not illuminate the photocells directly and the photocells should be housed in short lengths of tubing, open at the "viewing" end and preferably angled slightly towards each other so as to be "looking at" the same part of the white line. Ideally, some adjustment should be allowed for positioning the lamp and photocells after the vehicle is assembled.

MECHANICS

Mechanical construction of the vehicle should be kept as simple as possible; "U" Shaped brackets made from strips of aluminium can be used to mount the axles and wheels, with p.v.c. sleeving pushed over the ends of the axles to keep them in position. The height of the axles must be correct so that the gears mesh properly.

For your Entertainment...

By Adrian Hope

THE British Car industry is in a pretty poor financial state. Apart from strikes and price increases, it suffers because some foreign cars have a far better reputation for reliability. A friend recently drew my attention to something that sums up why some people just do not want to buy British. He owns an expensive, large British car which uses an electrical relay system to control functions such as ignition, horn, windscreen wiper and so on. The idea is to let heavy duty relays control these functions, the relays being operated by light duty switches on the dashboard. This would be all very well if the relays were really heavy duty. But when the ignition relay burnt out we took it apart and found it to be virtually nothing more than a coil of wire and a few pieces of bent tin.

A replacement was listed at £3, for which money any reader of the adverts in this or related magazines could buy himself two or three precision made relays of equivalent electrical rating. But of course the chances of finding an electrical equivalent of the right size and matching connections are virtually nil.

BURNT OUT

In the event, the local auto spares depot was out of stock of the relays. They had what appeared to be an exact equivalent, but it was actually intended for use in the horn rather than the ignition circuit. In desperation this was bought and fitted, but within a few minutes of use it burnt out.

We striped it down and found it was of the same, tinny construction as the original. What's

more, even though it cost as much as the ignition relay, the coil was wound with only half the turns that would be necessary to carry a constant current. This is why it had burnt out when used in the ignition rather than the horn circuit.

So here we have a car manufacturer who is so desperate to cut corners that he will actually wind a relay coil short, on the assumption that no one will blow their horn long enough to burn it out. And the manufacturer doesn't even pass on the cash saving to the customer.

Remember that this is not a cheap car, it's a prestige export. And if it is used in a country where horn blowing is a national hobby or if it is fitted with a burglar alarm that leaves the horn blasting to signal an attempt at theft, a relay will burn out.

I'll bet this isn't the only example of its kind, and it makes me fear for our future. If that instance typifies widespread industrial attitudes, we haven't a hope in Europe.

CALCULATION

On a lighter note here's a lovely way to amaze your friends with a calculator—or if you're a gambling man, win a few bets (provided of course that the people you are gambling with don't also read this magazine).

On most, if not all calculators the numbers on the keyboard are arranged in a 3 x 3 square as follows:

7	8	9
4	5	6
1	2	3

Punch out the three numbers of the top line in any order (say, 7,8,9). Then punch out the three numbers of the middle line, also

in any order (say 6,5,4). Now press the minus sign on a chain flow machine or the plus sign on a reverse logic machine. Next, punch out the numbers of the middle and bottom rows in the same order as you punched out the numbers of the top and middle rows (in our example, you must punch out 4,5,6 and 3,2,1).

Finally on a chain flow logic machine press the equals key and, on a reverse logic machine, press the minus equals key. The answer will always be 333333, whatever order you originally chose to punch the numbers, and thus whatever numbers you punched in.

Now mystify your freinds even further. Clear the calculator and do the same things using vertical columns. Take the left hand column and punch out the three numbers in any order (say 1,4,7). Now punch out the numbers of the centre column in any order (say 2,5,8). Now, as before, enter minus (if you have a chain flow calculator) or plus (if you are using a reverse flow machine). Next punch out the numbers of the centre and right columns in the same order as the left and centre columns (in this example, 2,5,8 and 3,6,9).

Now read out the answer by pressing the equals key on a chain flow machine or the minus equals key on a reverse logic machine. Whatever order you choose to press the numbers in, and thus whatever numbers you put in, the answer will always be 111111.

Now try the same tricks, but moving right to left and bottom to top instead of left to right and top to bottom. Of course it's not magic, the layout of the keys always pnts a difference of 1 or 3 between adjacent keys, depending on which direction you are moving in. But it certainly seems like magic to all but the most dedicated calculator buff.

FINAL WORD!

But the final word on calculators must come from a fourteen-year-old reader from Luton. He points out that if you alter the decimal places in my little sum for getting a calculator to talk ($1.1601 \times 4 \div 6$ and invert the display) you get a very different answer. Shift the decimal places so that the sum becomes $11601 \times 40 \div 6$ and read out the answer upside down!

IT'S NOT MY FAULT!

By P. ALLCOCK

An introduction to basic fault finding techniques.

FROM time to time we receive letters from readers who have built up a circuit . . . "exactly as described in the article" . . . only to find that nothing happens when the darned thing is turned on. Often in desperation these projects will be put (or thrown!) on one side, simply because the fault cannot be found.

It is not that the original design is faulty or suspect, or that insufficient constructional details have been given in the article—it is simply a case of not being able to anticipate or allow for all the possible errors and faults that might occur without using up an excessive amount of magazine space for each project.

The guide lines in this article will help to illustrate typical faults and show how to locate and identify them. In this way, we can help readers interested in the project used for illustrating the points and also show some of the fault-finding techniques that might be applied to other circuits.

For this exercise we have selected the *Egg Timer* project which was described in E.E. May 1974. Obviously it helps if the constructor understands how the circuit is supposed to work but with practice it is often possible to diagnose faulty circuit operation without understanding all the finer circuit details.

The *Egg Timer* breaks down into three units or parts, the unijunction timing circuit, the bi-stable and the tone oscillator (Fig. 1), each of these individual parts are often found in other circuits and so the fault finding information is not just applicable to one circuit.

If necessary, each of these parts can be tested as a separate entity to see if they operate correctly "on their own", but for the moment let



us assume we have built the complete circuit and have just found that "nothing" happens. What do we do first.

CONSTRUCTION CHECK

With all home constructed equipment it usually pays to check the circuit wiring and soldering, leads and connections of transistors, diodes and polarised capacitors very carefully. "But I have checked it" you might say. Well, check it again, section by section and pay particular attention to the following (all too common) pitfalls:

1. Leads reversed for "outermost" connections of transistors—especially those with all leads in one line (see later comments re. TR1).

2. Reversed polarity of diode connections. Positive (cathode) end usually has a line or band marking. It is good practice to check diodes with a meter for correct polarity before use—sometimes the marking can be incorrect.

Checking, also locates faulty items before they cause damage to other components. This is especially important when re-using components from other projects or using components salvaged from scrap circuit boards.

Note that the voltage polarity of most test meters is opposite to that indicated (by terminal colour or marking) when used on resistance or ohms ranges. If in doubt check by testing a good diode.

3. Check all polarised capacitors—the positive side must be joined to that part of the circuit which is the most positive. In your own designs, if in doubt, check the voltage polarity with a voltmeter (with the capacitor disconnected).

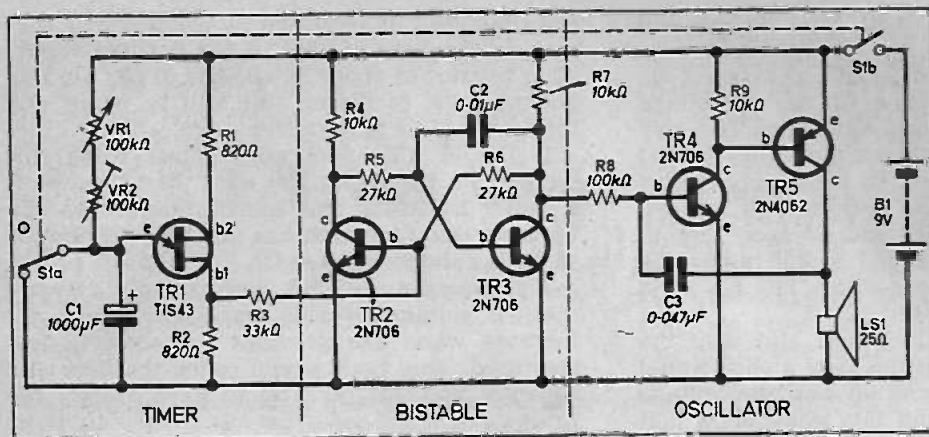

Fig. 1. The circuit diagram of the *Egg Timer*, which is used to illustrate typical faults and methods of fault finding.

4. Check the connections, especially soldered and screw terminal joints and watch out for small "slivers" of solder between copper tracks on Veroboard and printed circuit boards.

5. If the circuit operates from batteries check their condition on load. A temporary load can be provided by connecting a resistor across the battery whilst observing the voltmeter reading.

The resistor value should be chosen to draw a current of about 20 to 50mA. Thus a resistance of say 20 to 50 ohms for every "battery volt" is about right. Low capacity "pen cells" can be tested at the lower current whilst "radio type" batteries should be tested at the higher current level. Excessive voltage reduction on load indicates an exhausted unit.

6. Check that metal cases on panels do not contact parts of the circuit other than those intended. Watch out for metal cased transistors which often have the case joined to the collector lead internally.

When you are quite satisfied with the visual and physical checks, if the circuit still fails to operate when switched on, it is necessary to try some electrical tests. The nature of these tests will depend on the circuit details, so let us return to our *Egg Timer* and consider what can be done in this case.

INITIAL CHECKS

From the description given in the article it is obvious that the end of the timed interval is indicated by the tone from the oscillator. If no tone appears after a reasonable time it might be that the oscillator unit is not responding to the changeover of the bistable (which causes a positive voltage at TR3 collector). Alternatively, perhaps the bistable is not changing over when the timer tells it to! Or perhaps the timer itself is not working. How can we tell?

One way is to start at some convenient mid-point in the system and see if the circuit operation is correct "up to that point." This assumes that there is a logical sequence or "flow" to the circuit operation and this is indeed the case with

the *Egg Timer*. We can check the voltage at TR3 collector to see if this transistor is turned "on" or "off".

If the transistor is on the voltage between c and e will be very small, perhaps 200mV. By shorting the base to the emitter we can test TR3 to see if it will turn off. The transistor should remain off when the short circuit is removed and the oscillator should operate. If this occurs the fault most likely lies earlier in the operating sequence although it is quite possible to have more than one fault at a time!

Notice that the short circuit applied between b and e of TR3 cannot cause any harm in this circuit, due to the presence of R5 and R4, which limit the current flow via the short circuit. Before using this "dodge" always examine the circuit carefully and avoid joining the base to the collector or transistor case by mistake as this may cause damage to the transistor.

OSCILLATOR

Our next move obviously depends on the outcome of this test. If the oscillator fails to give any sound there is most likely a fault in the oscillator section if the test shows that TR3 does turn off. Under these conditions (and assuming only one fault) it is quite likely that the bistable does in fact operate at the end of the timing period and this can easily be checked by watching the voltmeter, connected across c and e of TR3. A sudden increase in voltage should occur when the bistable changes state.

Lets assume that we suspect our oscillator and the rest of the circuit appears to function correctly—what is our next step to be. Can we check the transistors in the oscillator section. Certainly we can take voltage measurements across the collector-emitter connections of TR4 and TR5. With TR3 on, both TR4 and TR5 should be off. The voltage across c-e for each transistor should therefore be about 9 volts (see Table 1).

It is assumed here that a reasonable testmeter of 20 kilohms/volt sensitivity is available—with-

out this, serious attempts at fault finding will be difficult in most cases.

By allowing (or forcing) TR3 to turn off we should be able to detect a change in voltage across TR4. If this does not occur then TR4 may be faulty, R8 may be open circuit (dry joint!) or C3 may be short circuit. By measuring the b-e voltage of TR4 when TR3 is turned off, we can check for R8 open circuit and C3 short circuit. If C3 is suspect its removal should allow the normal 0.6 volts to appear across TR4 b-e when TR3 is off.

An open circuit in C3 would also stop the oscillator working but in this case a click would be heard when TR3 turns off and the voltage measurements on TR4 and TR5 would show that these transistors were conducting current. In fact with this fault the current in TR5 could rise to a "steady" value of some 300mA (limited by the speaker resistance of 25 ohms if TR5 turns fully on). A faulty R8 (or C3) could be checked by component substitution.

One other possibility in the oscillator is that the loudspeaker or its wiring might be open circuit. This could be checked by the testmeter on "ohms" and would also show up due to the absence of voltage across TR5 (c-e) when TR3 was on and TR4 was off.

In some cases the oscillator may work without R9 connected since TR4 can still receive collector current via the base-emitter junction of TR5. From a design point of view it might have been better to have limited the current flow in this part of the circuit by a resistor between the collector of TR4 and the base of TR5.

Well that just about covers the possibilities for oscillator faults, lets go back to the TR3 test and assume that the oscillator did operate when TR3 was forced to turn off.

BISTABLE

Obviously we must go back one step in the operating sequence and check that the bistable section is operating correctly. Since the change-over of the bistable is initiated by a positive-going pulse from base 1 of the unijunction we

Two illustrations of the type of meter required for fault finding. Below, the Chinaglia Minor and on the right a Russian instrument.

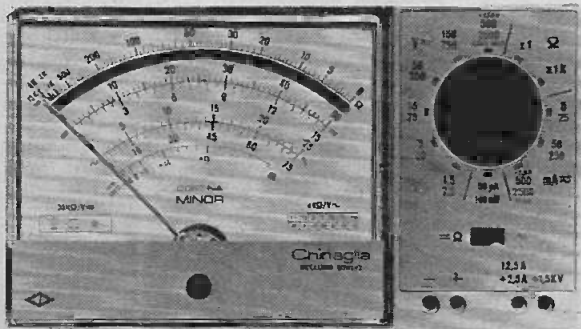

can simulate this condition by momentarily connecting the base of TR2 to the positive supply via a resistor of about 33 kilohms. If the bistable operates, the oscillator note will be heard and the fault will lie in the timer stage.

If the bistable does not operate using this method of triggering the most likely cause is a faulty transistor and substitution checks can be used. One fault that has not been mentioned so far is a short circuit in C2.

This would make TR3 "permanently on" and the c-e voltage of this transistor would not increase when the previous b-e shorting test was used. This fault would cause the base and collector voltages for TR3 to have exactly the same value if the capacitor was completely short circuit (some capacitors, usually of the electrolytic variety, can develop excess leakage without becoming fully short-circuit).

TIMER

If the bistable section operates correctly the fault must be in the timer stage and here the two most likely sources of trouble are the 1,000 μ F capacitor and the transistor. Re-check the transistor connections first, since this device has different lead markings to the more usual npn/pnp bipolar transistors. The lead arrangement used in the layout of the board may not be the same as the transistor lead-out arrangement and the leads may "change-over" positions. Make sure the leads do not short together.

If the wiring is correct the quickest way to check the transistor is to disconnect C1. When the unit is switched on the oscillator should sound immediately since the time-delay is missing. If this test works replace capacitor C1 with a new component which must have low leakage (correct polarity is also important).

If no sound is obtained with C1 removed check the preset VR2 for an open circuit at the wiper contact. If this is in order a replacement TR1 should be tried.

An alternative method of checking the timer stage transistor TR1 is to replace C1 with a

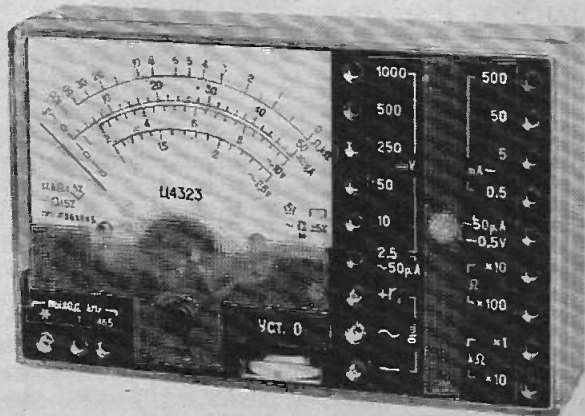

capacitor of about $0.047\mu\text{F}$. If the loudspeaker is temporarily connected across R2 a tone should be heard if the transistor is working, and variation of the time control VR1 should alter the frequency of this tone. Note that only one lead of the loudspeaker need be removed for this test since the other lead is already common to R2.

VOLTAGES

The voltage readings obtained from the prototype *Egg Timer* circuit are given in Table 1 below:

Table 1

All readings in volts (20 k Ω /V meter on 5V or 15V range)

TR1		TR2			TR3			TR4			TR5			
b1	e	b2	e	b	c	e	b	c	e	b	c	e	b	c
1.4	—	7.5	0	0.6	6.3	0	0.7	0.1	0	0	8.8	0	8.8	9.0
(0.8)				(0.4)(5.6)										

From these readings it can be seen that TR2 is on the verge of conduction due to the rather high voltage present across R2. This voltage, attenuated by the potential divider action of R3 and R6, gives a V_{BE} of 0.6 volts for TR2 and if a transistor with a high current gain is used this could cause TR2 to conduct to such an extent that the bistable operation would be affected.

If trouble is experienced from this aspect, resistor R2 can be reduced to 470Ω which will give the voltage readings shown in brackets. Do not forget to recalibrate the unit after this circuit change as R2 affects the switching voltage level for the unijunction circuit. (It should perhaps be mentioned at this point that the voltage across R2 depends on the interbase resistance R_{BB} , of the unijunction and this can vary between samples over a range of about 2:1. The voltage of 1.4V is about the maximum that can occur when R_{BB} is at its lower limit. The slight rise in the collector voltage of TR2 when R2 is reduced to 470Ω is evidence of the slight conduction that occurred with the prototype unit.)

These notes should help to point out some of the tests and methods that can be applied. It is usually helpful to measure and record the voltages on each transistor, since these can often throw light on possible wiring or component faults and it is hoped to cover this topic more fully in a future article.

If one of your projects fails to work correctly why not have a go at fault finding—the effort will invariably be rewarded and the challenge can be very stimulating. The best way to learn fault finding is to experience it first hand. \square



...Counter Intelligence

BY PAUL YOUNG

A retailer discusses component supply matters.

THE other morning as I took my usual constitutional stroll down the half mile street where my premises are situated, what a lamentable sight met my eyes. At least ten shops were closed or in the process of closing down. In the evening having taken enough money to buy myself an orange, I went across the road to my favourite fruiterers and asked Doreen for one of her best Jaffas. Doreen has been selling me oranges for nearly thirty years so when she said, "I am closing down," I looked at my watch and said, "Its a bit early for you, isn't it?" She said, "I mean for good."

I was so surprised, I questioned her further and she summed it up in a few words, "I am fed up with working for the landlord and the Government. What with rent, rates and V.A.T. the whole thing has become a nightmare."

Before you say "What's all this to do with electronic components?", let me hasten to enlighten you. The majority of your component

suppliers, are the equivalent of the little man with the corner shop. Now, I am not saying you will not get good service from the big suppliers, because this would not be true, but when establishments get too large the man at the top is too far removed from you, the customer, and those at the bottom probably do not care anyway. This soon becomes apparent if you have a complaint.

With the large firm, you may well suffer the frustration of interminable delay, while your complaint is passed to different departments. With the small man, he knows he must deal with it personally and as speedily as possible. The small man has to give good service, because so often, it is all he has to offer.

This brings me to the main point. It became apparent to me many years ago that what the small man lacks, is buying power. In many cases, when you can talk of buying in thousands, prices shrink dramatically. This enables

the supplier to offer substantial reductions in prices and still make a reasonable margin of profit.

I then started to reason, that if several of us got together, with each of us buying one or two items in large quantities, and all sharing in the purchases, we could in time cover the whole field of components and start to contain prices, even perhaps to bring prices down! Thus, was born the idea of a consortium of retailers forming a buying group for the purchases of electronic components, the first of its kind and therefore called Group One.

The group has been active for about four years now, and has had many successes. We have about twenty-five members but if we had more, we could cover a wider field which would be to your advantage and ours. In the past I have tried to assist you, with suggestions on the purchase of your components, now is your chance to return the compliment. Next time you buy a few parts from your local man, ask him if he is a member of Group One. If he is not, explain the advantages to him and to you. If he is interested in joining ask him to drop a line to Paul Young, care of EVERYDAY ELECTRONICS.

Your Career in **ELECTRONICS**

By Peter Verwig

A career in electronics is an exciting prospect! Month by month our contributor Peter Verwig will explain what working in electronics is all about, how to prepare yourself for a rewarding career, and the job opportunities available in the world's fastest growing industry.

THE PROFESSIONAL INSTITUTIONS

LAST month we discussed qualifications and advised our readers to aim high. This month we take a closer look at the professional institutions and, again, you are urged to aim high.

Do not confuse a professional institution with a trade union. The latter is an organisation largely concerned with pay and working conditions. The professional institution is a learned society with quite different aims. And whereas entry to a trade union is comparatively easy (indeed, in some firms where the "closed shop" is in operation membership is compulsory), you will have to demonstrate to the council of a professional institution that you are worthy of election.

I.E.E.

By far the oldest of the institutions serving the professional electrical and electronics engineer is the Institution of Electrical Engineers (I.E.E.) which came into being long before the word electronics was coined. In the early days the I.E.E. membership was composed almost entirely of power engineers. Men who were fascinated by the theory and practice of generation of electric power, of its distribution by cable and its conversion to other forms of energy.

This was essentially heavy current engineering and many years were to elapse before electronics was considered to be a subject worthy of consideration. But such has been the impact of electronics in recent years that the I.E.E. is now recognised as

being one of the world's premier institutions for the electronics engineer.

OTHER INSTITUTIONS

As mentioned in the first article, it was the rapid spread of radio broadcasting in the 1920's and 1930's that saw the birth of the electronics industry. This new-fangled science appealed very little to the power men in the I.E.E. and so radio engineering pioneers pooled together their common interests and formed the Institution of Radio Engineers, not at that time in 1925 as a rival body to the I.E.E., but because there was no appropriate home for them anywhere else.

The I.R.E. prospered and was incorporated by Royal Charter in 1961 and has also changed its name to the Institution of Electronic and Radio Engineers (I.E.R.E.), thus broadening its scope of activities.

Today both institutions operate in friendly rivalry and frequently co-operate in joint meetings. From time to time there have been rumours of a merger being discussed, or even about to happen, but today they still retain their separate identities.

In 1965 two new institutions were formed especially to cater for technician engineers. The entry qualifications for these are less exacting than those for the senior institutions where university degree standard is required for corporate membership. The equivalent technician institution of the I.E.E. is the Institution of Electrical and Electronic Technician Engineers (I.E.E.T.E.) and that of the I.E.R.E. is the Society

of Electronic and Radio Technicians (S.E.R.T.). In both cases they operate quite separately and autonomously.

Which to join? There are clearly some advantages in size of membership. Big institutions are generally richer and more powerful and this certainly applies to the I.E.E. and the I.E.E.T.E. But of course a substantial part of their total membership consists of electrical engineers.

If you happen to be professionally engaged in electronic control of electrical power systems it could well be that you might welcome rubbing shoulders with and talking to electrical engineers and then the I.E.E. or I.E.E.T.E. would be the better choice. But if your interests lie in, say, radio communications then the I.E.R.E. or S.E.R.T. may be more suitable.

ENTRY QUALIFICATIONS

The best course of action is to write to the secretaries for details of entry qualifications, grading structures, and facilities offered. The addresses are given in the panel.

As mentioned last month, your goal should be to reach professional status and get your name on the composite register of the Engineers Registration Board (E.R.B.) set up under the Royal Charter of the Council of Engineering Institutions. You can only get your name on the Register through membership of a professional institution.

To get the top rating of Chartered Engineer you will need to work towards corporate membership of the I.E.E. or I.E.R.E. The Technician Engineer and Technician designation can be obtained through the I.E.E.T.E. or S.E.R.T. once you have reached the appropriate grade of membership.

STUDENT MEMBERSHIP

You don't need to have a whole dossier of qualifications to join a professional institution. Study the membership regulations and see where you can fit in. For those just starting on their training there are student grades of membership with appropriately reduced fees.

The only qualifications needed for the student member of S.E.R.T. are that the applicant must be over 16 years of age and that he or she must be pursuing a regular course of further education approved by the council and which will satisfy the requirements for eventual admission to a higher grade. In S.E.R.T. you can remain a student member for five years while carrying on with your studies.

Naturally, the qualifications for student membership of the I.E.E. and I.E.R.E. are more stringent, the latter for example calling for a G.C.E. in five subjects (one

being English) with two at "A" level and these preferably in mathematics and physics. But not having these does not necessarily debar you from entry because there are other qualifications which you may have which may be considered by the council as suitable.

If you have already been working as a technician but haven't yet bothered to advance yourself academically you can still join a professional institution in a non-corporate grade. For example you can become an associate in S.E.R.T. if you are over 21 and have a minimum of three years experience at work.

BENEFITS

What are the benefits of membership? Institutional journals and news letters let you know what is going on through technical articles and professional news. There are conferences and meetings you can attend and, of course, the opportunity of meeting like-minded people, your fellow professionals either in London or at the many events held in the regions.

As your career advances you climb the ladder of membership up to fellow although this may yet be a long way ahead. The S.E.R.T. regulations lay down that to be elected a fellow you must be 30 years of age, have qualifications acceptable for registration as a technician engineer, have ten years experience in the profession (which can include time spent training) and have served five of these years in a position of superior responsibility.

The main thing to remember is that there is a world of difference between just having a job in electronics and having a well-defined set of goals in a professional career structure. Membership of one of the institutions helps self-development and opens up new opportunities.

Next month we shall examine what is involved in an apprenticeship and what life as an apprentice is really like.

Addresses: In all cases apply to the secretary:

The Institution of Electrical Engineers,
Savoy Place,
London, WC2R 0BL.

Institution of Electronic and Radio Engineers,
8-9 Bedford Square,
London, WC1B 3RG.

The Institution of Electrical and Electronics Technician Engineers,
2 Savoy Hill,
London, WC2R 0BS.

The Society of Radio and Electronic Engineers,
8-10 Charing Cross Road,
London, WC2H 0HP.

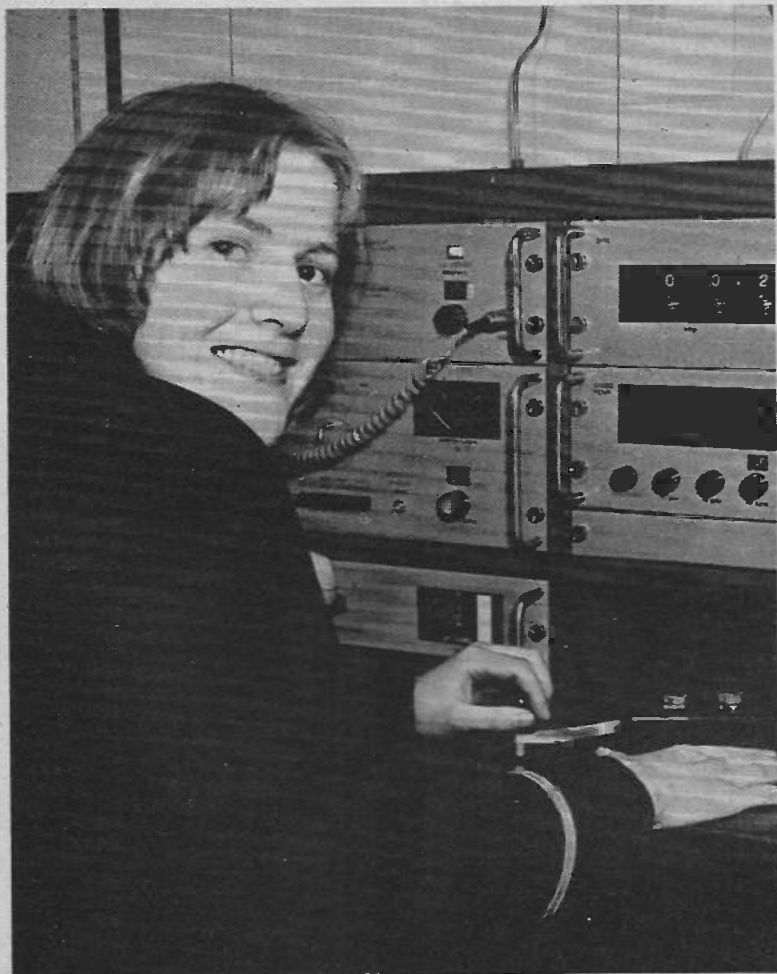

It's her world, too. Eighteen year old Meryl Swannack puts to sea as a radio officer having obtained the Ministry of Posts and Telegraphs certificate and taken the Department of Trade radar course. She is the first lady in the seagoing staff of Kelvin Hughes. After experience at sea she can study further to become an electronics officer capable of maintaining all the electronic navigation equipment on a ship as well as radio equipment.

READERS' LETTERS

Bored

We have been following your magazine since it started and have had generally no complaints. But we couldn't help noticing lately the repetition of some of your projects. For instance, after browsing through the magazines we have collected, we came up with this; so far you have published projects of three rain alarms, three security systems, two ice warning alarms, three reaction testers and four wind-screen wiper controls. We think it is about time you pulled your socks up and got some more varied projects.

Bored Kiwis,
Malcolm Landett,
New Zealand.

Yes in the 3½ years E.E. has been published we have provided details for three rain alarms—all different, one with an oscillator output, one with an automatic cut out at night and one very simple design with electromechanical output device.

The three security systems have again all been different, one was simply a light controlled switch, one was an infra-red beam

and one a wired system, in fact all three could be put to good use in one house. Two ice warning alarms have been published one using transistors the other with an i.c. The three reaction testers were again all different—a very simple design, a design with timed start lamp and a reaction timer.

As far as the wiper controls go we have only published three designs, all different and one was for a wash/wipe and could be used with either of the other two.

We are pleased that you have taken E.E. since it was first published (two of the projects you mention were in the first issue), but you must realise that we do cater for beginners in electronics and we are continually getting new readers who are interested in these useful and simple designs; we have also published about 125 other designs. If you have some suggestions for projects we have not yet covered, and they are not too complex in nature, we would be pleased to hear of them.

Transmitters

As your magazines are for beginners, and I am one, I wondered if you could help me out of a serious quandary, whether or not to buy a kit for a "walkie talkie". My problem is that I have often seen these advertised and underneath it says "not licencable in U.K.", so would you please tell me how I stand in regard to the law on "walkie talkies", and would I

have to take the transmitter exam to use one?

R. J. Scholefield,
Halifax.

We must advise you that the use of transmitting apparatus (other than for radio control on special bands) is prohibited in this country, except by those persons who have passed the appropriate examination and have obtained an amateur transmitting licence from the Home Office.

It is true that certain "walkie talkies" are advertised, but this in no way permits an individual to use these without the necessary licence.

If you are interested in becoming a radio amateur, we suggest you get in touch with the following: Radio Regulation Dept., Waterloo Bridge House, Waterloo Road, London, SE8UA. We suggest also that you contact the Radio Society of Great Britain, 35 Doughty Street, London WC1N 2AE.

Modules, I.C.'S and Discrete

I am 12 and I buy EVERYDAY ELECTRONICS monthly. I agree with Paul Young (Counter Intelligence) on modules and i.c.'s in the April 1975 issue.

The more I can construct myself the better, the i.c.'s are best employed in miniature instruments such as pocket calculators where it is more important to get it as small as possible.

Richard Ferries,
Bromsgrove,
Worcestershire.

Whilst planning a logic patch-board, I realized that the cost of plugs and sockets would be approximately four times the price of components to go into the device.

By drilling a hole in suitably thick plastic or other material and bending a piece of springy brass as shown, an acceptable socket is formed. Note the glue should be well away from the hole.

A matching plug is made by removing the head from a nail and filing a groove in it to solder the wire to. A piece of sleeving over the joint serves to hide the joint and to form a "stop" to avoid the plug sinking too far into the socket.

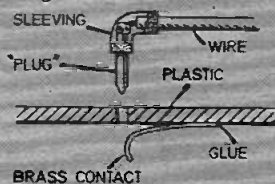

P. Gooderham,
Middlesbrough



Physics is FUN!

By Derrick DAINES



LIGHTING A NEON LAMP WITH STATIC

Previously we have said that a static charge is usually of very high voltage. Now a neon lamp, of the small encapsulated type (see Fig. 1), frequently has a striking voltage—that is, the voltage at which it comes on—of 60 to 90 volts, depending upon the type.

The lamp has two small wires called electrodes connected to a metal cap at each end. These electrodes are enclosed in a glass tube, but do not touch each other so that when a voltage is applied the current does not flow through a continuous wire as in a tungsten lamp, but leaps across a gap, through a rarified gas. The action of the electrons passing through the gas makes it glow. If the reader does not already have a miniature neon lamp in his possession, the type used in neon screwdrivers, it is strongly recommended that he buy one. They are very cheap and incidentally is the first item we have recommended buying for this series.

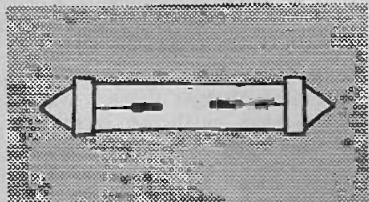

Fig. 1. Shows the type of neon lamp used in the experiment.

Rub a plastic film vigorously with a woollen cloth and then holding it by one hand, hold the neon lamp by *one cap* in the other hand and slowly bring it up to the film. It will be found that at certain points the lamp will glow for a brief instant before going out again. The points will increase in

number as the lamp is brought towards the film, as in Figure 2, where the glow-points are numbered 1 to 4.

What happens is that the contact held in the hand is effectively earthed, so the free-cap passes through zones of electricity planes parallel to the film. As the cap reaches each of these in turn, the striking voltage of 90 volts is reached or exceeded and the lamp lights. However, the free electrons around the points numbered flow through the lamp so quickly that the voltage quickly drops and the lamp goes out.

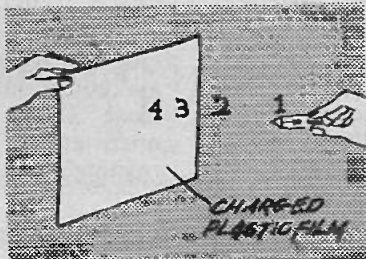

Fig. 2. Bringing up the neon lamp to a charged plastic film will cause the neon to flash as it passes through "zones" marked 1 to 4.

Repeat the experiment and notice carefully that only one of the two electrodes inside the capsule actually glows. Experiment will show that this is caused by a negative electric field, and it seems that we must think about electric fields sweeping out into space in just the same way that we think about magnetic fields.

The reader might have wondered, whilst vigorously rubbing his plastic film, if there is not an easier method, whether it can be mechanised. The answer is yes, it can be.

A chap called van de Graaff invented just such a machine in 1931 and there have been various

models made based upon the same principle of rubbing two substances together, usually at high speed.

At a later date, I will describe how the reader may make one for himself, but if he is particularly interested there are one or two distributors who advertise in *Everyday Electronics* and *Practical Electronics*, (Boffin Projects, for example), who offer various devices for high-voltage experiments.

The reader may rest assured on two points—if it is a van de Graaff generator that is advertised, it is simply a motor-driven armature rubbing two materials together, and although some thousands of volts are available, these of themselves are not lethal or even dangerous if used with care, as this month's experiments have shown.

A typical van de Graaff generator is shown in Figure 3.

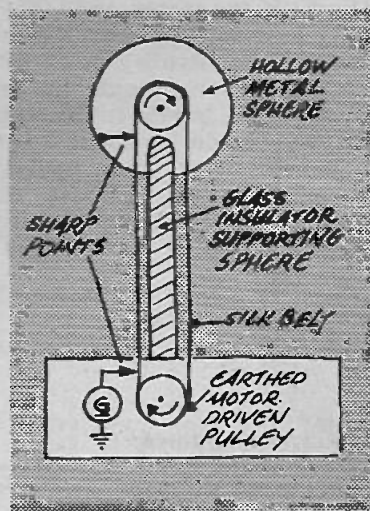

Fig. 3. The basic details of a van de Graaff machine for producing very high voltages.

MULTIMETER SENSITISER

By R.A. PENFOLD

A simple unit to increase the input impedance of a multimeter.

Now that modern silicon transistors have largely superseded the earlier germanium types, there is a tendency to use ever smaller operating currents in contemporary circuit design. Many of the transistors in general use today operate quite satisfactorily at collector currents as low as 10 microamps, and in low noise circuits often are used at such low currents. The input current to the base of the transistor is of course only a fraction of the collector current, and is often less than 1 microamp.

An ordinary multimeter with a sensitivity of 20 kilohms/volt requires an input current of 50 microamps to give full scale deflection (f.s.d.) of the meter, and is therefore unsuitable for taking voltage measurements in "low operating current" circuitry.

Consider for example, the fairly typical audio stage shown in Fig. 1. The base potential of the BC169C should be about 0.6 to 0.7 volts, and if a multimeter set to read 1V f.s.d. was connected between its base terminal and the negative supply, it might reasonably be expected to give a reading of about this figure. Assuming

that the meter has a sensitivity of about 20kΩ/V, it will in fact give a reading of virtually zero.

This is because the meter needs 50 microamps to produce f.s.d., and therefore on the 1 volt range will require 30 to 35 microamps to give a reading of 0.6 to 0.7V. Since the meter is connected to the positive supply via the 2.7 megohm base bias resistor, this will limit the maximum current flow to the meter to little more than 2 microamps ($6V/2.7M\Omega = 2.22$ microamps), and obviously a totally inaccurate reading is obtained.

ELECTRONIC VOLTMETER

For this kind of voltage measurement where only a very limited drive current is available, an electronic voltmeter of some kind is required. This type of device has an amplifier added ahead of the meter to boost the input impedance, so that a far smaller input current is required to produce f.s.d. on the meter.

The circuit diagram of a simple device which can be used in conjunction with an ordinary 20kΩ/V multimeter, or one of the popular dual range instruments, when switched to their 50 microamp range is shown in Fig. 2.

Fig. 1. An ordinary 20kΩ/V meter is unsuitable for voltage measurements where only a few microamps flow in the measured circuit.

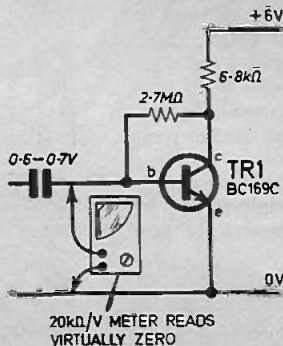

FOR GUIDANCE ONLY

ESTIMATED COST* OF COMPONENTS including V.A.T.

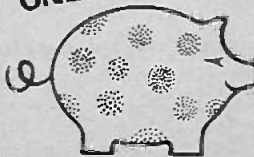

£2.50 excluding case

*Based on prices prevailing at time of going to press

everyday electronics

VOLUME 3 INDEX

JANUARY 1974 TO DECEMBER 1974

<i>Pages</i>	<i>Issue</i>	<i>Pages</i>	<i>Issue</i>
1-64	January	353-416	July
65-128	February	417-472	August
129-184	March	473-528	September
185-240	April	529-592	October
241-296	May	593-656	November
297-352	June	657-712	December

We are unable to provide back numbers, or copies of articles.

CONSTRUCTIONAL PROJECTS

ACROSS THE RIVER by F. G. Rayer	684	METAL LOCATOR by R. A. Penfold	484, 578
ALARM, FREEZER TEMPERATURE	308	MONITOR RADIATION	454
ALERT, LIGHTS ON	430	MONITOR, TELEPHONE REMOTE	620
AMATEUR BANDS RECEIVER by R. A. Penfold	322		
AMPLIFIER FOR 4 BAND T.R.F. RECEIVER by F. G. Rayer	42	NOISE LIMITER, TAPE	606
AMPLIFIER, GENERAL PURPOSE 5W	390		
AUDIO FREQUENCY OSCILLATOR (E.E. Test Gear Five)	142	OSCILLATOR, AUDIO FREQUENCY	142
AUTOMATIC LIGHT LEVEL CONTROLLER by M. Dvorak	384, 502	PLANT PROPAGATOR by D. T. Goodwin	160
		POWER SUPPLY UNIT (E.E. Test Gear Five)	99, 146
		PROJECTOR TIMER, SLIDE	90
BAGPIPES, ELECTRONIC	542		
BATTERY ELIMINATOR by R. A. Penfold	630	R.F. SIGNAL GENERATOR (E.E. Test Gear Five)	329
BUZZER, SIMPLE	258	RADIATION MONITOR by M. H. George	454
		REACTION TIMER by Phil Allcock	564
CHARGE CALCULATOR, TELEPHONE CALL COMMUNICATOR, 2 WAY IN-HOUSE	366, 502	RECEIVER, AMATEUR BANDS	322
CONTROL, SEWING MACHINE SPEED	34	RECEIVER, AMPLIFIER FOR 4 BAND T.R.F.	42
CONTROL, ULTRASONIC REMOTE	670	RECEIVER, FETSET M.W.	38
CONTROLLER, AUTOMATIC LIGHT LEVEL	384, 502	RECEIVER, LIGHT POWERED	208
CONTROLLER, WINDSCREEN WIPER	624	RECEIVER, M.W. REFLEX	694
CRYSTAL SET, SIMPLE	500	REMOTE CONTROL, ULTRASONIC	670
		REMOTE MONITOR, TELEPHONE	620
E.E. DELTA GUITAR by Brian W. Terrell	558	SECURITY SYSTEM, HOME	542
EFFECTS UNIT, V.C.O.	16	SEWING MACHINE SPEED CONTROL by J. A. Brett	34
EGG TIMER by R. A. Penfold	276	SIGNAL GENERATOR, R.F.	329
ELECTRONIC BAGPIPES by T. Richardson	254	SIMPLE BUZZER by A. Russell	258
ELECTRONIC VOLTMETER (E.E. Test Gear Five)	216, 275	SIMPLE CRYSTAL SET by F. G. Rayer	500
ELIMINATOR, BATTERY	630	SLIDE PROJECTOR TIMER by C. G. Gammons	90
EMERGENCY LIGHTING UNIT by Mike Hughes	82	SPEED GUARD by Mike Hughes	155
EXPERIMENT IN HEADPHONE STEREO by W. T. Kitchen	449	STEREO, EXPERIMENT IN HEADPHONE SUPPLY UNIT, POWER	449 99, 146
		SWITCH, GENERAL PURPOSE	329
FETSET M.W. RECEIVER by R. A. Penfold	38		
FREEZER TEMPERATURE ALARM by T. P. Manning and R. D. Wilder	308	T.R.F. RECEIVER, AMPLIFIER FOR 4 BAND	42
		TAPE NOISE LIMITER by R. A. Penfold	606
GENERAL PURPOSE SWITCH by J. Lewis	554	TELEPHONE CALL CHARGE CALCULATOR B. W. Terrell	366, 502
GENERAL PURPOSE 5W AMPLIFIER by Tom Mason	390	TELEPHONE REMOTE MONITOR by Alistair Morgan	620
GENERATOR, R.F. SIGNAL	329	TEMPERATURE ALARM, FREEZER	308
GUARD, SPEED	155	TEST GEAR FIVE, E.E.	
GUITAR, E.E. DELTA	558	AUDIO FREQUENCY OSCILLATOR	142
		ELECTRONIC VOLTMETER	216, 275
HEADPHONE STEREO, EXPERIMENT IN HEADS OR TAILS by M. G. Argent	449 435	POWER SUPPLY UNIT	99, 146
HOME SECURITY SYSTEM by P. H. Alley	542	R.F. SIGNAL GENERATOR	329
		TRANSISTOR TESTER	266
IGNITION, TRANSISTOR ASSISTED (6V Version)	690	TIMER, EGG	276
(12V Version)	198	TIMER, REACTION	564
IN-HOUSE COMMUNICATOR, 2 WAY	508	TIMER, SLIDE PROJECTOR	90
		TRANSISTOR ASSISTED IGNITION (6V Version)	690
LIGHT LEVEL CONTROLLER, AUTOMATIC	384, 502	(12V Version)	198
LIGHT POWERED RECEIVER by F. G. Rayer	208	TRANSISTOR TESTER (E.E. Test Gear Five)	266
LIGHTING UNIT, EMERGENCY	82		
LIGHTS ON ALERT by E. J. Byatt	430	ULTRASONIC REMOTE CONTROL Part 1 by J. B. Dance	670
LIMITER, TAPE NOISE	606		
LOCATOR, METAL	484, 578	V.C.O. EFFECTS UNIT by C. C. Evans	16
		VOLTMETER, ELECTRONIC	216, 275
M.W. RECEIVER, FETSET	38		
M.W. REFLEX RECEIVER by R. A. Penfold	694	WINDSCREEN WIPER CONTROLLER by Eric Moore	624
		2 WAY IN-HOUSE COMMUNICATOR by C. F. Terrell	508

GENERAL FEATURES

BRIGHT IDEAS	98, 146, 212, 396, 453, 568	READERS LETTERS	21, 114, 174, 229, 289, 313, 402, 465, 520, 582, 619
COMPETITION	338, 398	RUMINATIONS <i>by Sensor</i>	20, 106, 280, 321, 557, 627, 674
COMPETITION RESULTS	693	<i>by Mrs Sensor</i>	153
COUNTER INTELLIGENCE <i>by Paul Young</i>	104, 225, 270, 433, 498, 553, 623, 687	SHOP TALK <i>by Mike Kenward</i>	37, 98, 154, 212, 275, 328, 401, 434, 493, 570, 637, 698
EDITORIAL	14, 80, 140, 196, 252, 306, 364, 428, 482, 540, 604, 668	WHAT DO YOU KNOW?	
HELP!	106, 282, 382, 452, 582, 633	Electronic Terms	85
JACK PLUG AND FAMILY	154, 211, 285, 328, 402, 434, 493, 570, 698	Ohm's Law	174
PLEASE TAKE NOTE		Loudspeakers	215
Power Supply Unit	146	Capacitors	289
Integrated Circuit Data Chart	206	Diodes	465
Electronic Voltmeter, Demo Circuits 13, Teach-In '74 No. 6.	275	Current	563
Telephone Call Charge Calculator, Automatic			
Light Level Controller	502		
Semiconductor Primer 20. Metal Locator	578		

SPECIAL FEATURES

CENTENARY OF AN AMATEUR <i>by Bill Maconachie</i>	442	RADIO ASTRONOMY AT JODRELL BANK	
		<i>by S. McClelland</i>	379
ELECTRONICS AND THE MOTOR CAR		SATELLITE POWER STATIONS <i>by D. V. Eddolls</i>	213
<i>by C. S. Pointer</i>	271, 319	SOLDERING FOR BEGINNERS <i>by Phil Allcock</i>	616
ELECTRONICS AT SCHOOL <i>by T. R. de Vaux-Balbirnie</i>	573	THE WORLD OF THE I.C. <i>by S. McClelland</i>	675
INTRODUCTION TO INTEGRATED CIRCUITS		ULTRASONICS <i>by J. B. Dance</i>	610
<i>by J. B. Dance</i>	94, 164	WRISTWATCHES GO ELECTRONIC <i>by J. B. Dance</i>	494, 548
PICKUPS AND TURNTABLES 2 <i>by Gordon J. King</i>	28		

SPECIAL SERIES

<p>BEGIN HERE by <i>Donald Maynard</i> 1 Passive Components 680</p> <p>DEMO CIRCUITS by <i>Mike Hughes</i> 12 The AND Gate 109 13 The Series Resonant Filter 221, 275 14 The Parallel Resonant Filter 505</p> <p>DOWN TO EARTH by <i>George Hylton</i> Decibels 46 Mains Voltage 113 Transistor Gain 173 Zener Diodes 226 Impedance 286 The Amplified Diode 342 Unwanted Radio Reception 406 Current Flow 462 Virtual Earth 516 Copper Loss 581 Transformer Identification 642 Induced Hum 705</p> <p>FOR YOUR ENTERTAINMENT by <i>Adrian Hope</i> Going Abroad 378 Calculators 519 Cassette Production 634</p> <p>KNOW YOUR COMPONENTS by <i>Ron Adams</i> The Resistor 405 Capacitors 448 Diodes and Transistors 515</p> <p>PHYSICS IS FUN by <i>Derrick Davies</i> Magnetism 389 The Magnetic Field 458 Magnetic Induction 504 Static Electricity 577 Home Made Electroscope 628 Opposite Charges 688</p>	<p>PROFESSOR ERNEST EVERSURE by <i>Anthony J. Bassett</i> Musical Note Generator 551 Making Resistors 638 Making Resistors 701</p> <p>SEMICONDUCTOR PRIMER by <i>A. P. Stephenson</i> 1 Development of the Transistor 33 2 The Semiconductor Barrier Potential 33 3 PN Junction Action 93 4 Construction of a Transistor 93 5 The "Two Diodes" Concept 93 6 Correct Transistor Supply Polarities 163 7 How a Transistor Amplifies 163 8 The Three Currents In a Transistor 163 9 Manufacturers' Data Symbols 220 10 The Four "h Parameters" 220 11 Important Transistor Curves 281 12 BC107, BC108, BC109 Transistors 281 13 The Transition Frequency 341 14 Choice of Collector Current 341 15 Production Spreads 341 16 Testing Transistors 383 17 Various Biasing Methods 383 18 Experimental Transistor Circuit 461 19 Signal Ground 461 20 Simple Designing 512, 578 21 D.C. Component at the Output 512</p> <p>TEACH-IN '74 by <i>Phil Allcock</i> Lesson 4: The Transistor 22 Lesson 5: Transistor Characteristics 86 Lesson 6: Basic Circuits 148, 275 Lesson 7: Basic Circuits 202 Lesson 8: The Astable and Alternating Current 260 Lesson 9: Inductance and the Transformer 314 Lesson 10: Transformer, Reed Relay, Loudspeaker and Unijunction 372 Lesson 11: The Field Effect Transistor 438 Lesson 12: The Thyristor 490 TEACH-IN '74 QUESTION TIME ANSWERS 32 TEACH-IN '74 END OF TERM TEST 492 Answers 578</p>
--	---

SPECIAL INSERTS

INTEGRATED CIRCUIT DATA CHART	March 1974, 206
SPECIAL SUPPLEMENT—TEST GEAR	April 1974
DICTIONARY OF ELECTRONIC TERMS	May 1974
E.E. DELTA GUITAR BLUEPRINT	October 1974
DATA CHECK CARD	December 1974

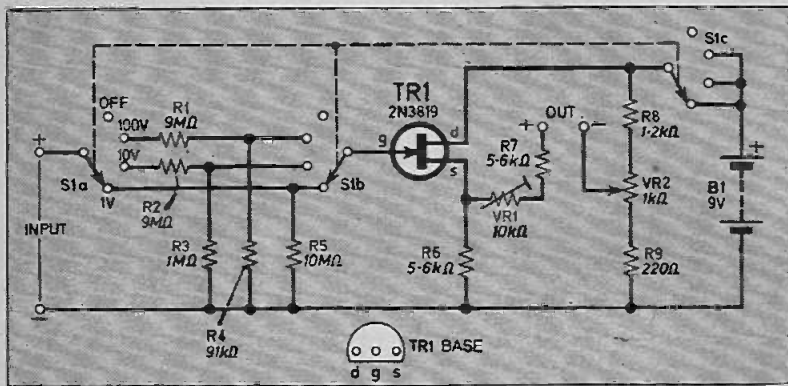

Fig. 2. Circuit diagram of the complete Multimeter Sensitiser.

It provides three voltage ranges, these being 0 to 1, 10, and 100 volts, and the input impedance is approximately 10 megohms on all ranges. This corresponds to a sensitivity of 10MΩ/V on the 1V range, 1MΩ/V on the 10V range, and 100kΩ/V on the 100V range.

HOW IT WORKS

The unit is based on a simple bridge circuit, one side of the bridge being formed by TR1 and R6, and the other side by R8 plus the upper part of VR2, and R9 plus the lower part of VR2. With no input voltage present, VR2 is adjusted so that there is the same voltage at its slider as appears at the source of TR1. The multimeter is connected between these two points via VR1 and R7, and will therefore indicate any unbalance in the bridge circuit, which with no input is zero.

Transistor TR1 has either R3, R4, or R5 as its gate bias resistor, depending on which range S1 is switched to. When an input voltage is con-

nected TR1 turns harder on, and the voltage at its source increases. This unbalances the bridge, and the degree of unbalance, which is proportional to the input voltage, is indicated by the meter.

Preset VR1 is adjusted to give the unit a basic sensitivity of 1V f.s.d. On the 10V range the potential divider action of R2 and R3 reduces the sensitivity to the required level, and R1 and R4 perform a similar function on the 100V range.

Transistor TR1 is used in the grounded source mode, and therefore has 100 per cent negative feedback, resulting in it having a voltage gain of slightly less than unity. This gives the circuit excellent linearity, and means that as the gain of the unit is virtually unaffected by changes in supply potential, an unstabilised supply can be used.

Apart from being the range switch, S1 also functions as the on/off switch, position 1 being the off position.

WIRING

Most of the components are mounted on a small 0.1 inch matrix Veroboard having 14 holes by 15 copper strips. This is shown in Fig. 3, where all other wiring of the unit is also shown.

Start by mounting and connecting the components which are fitted to the Veroboard panel, leaving TR1 until last. Then wire R1 and R2 to the range switch; 9 megohm resistors are not available, and so these are made by connecting any combination of resistors in series which totals 9 megohms. For instance, on the prototype R1 consists of a 3 megohm, a 2.7 megohm and a 3.3 megohm in series, and R2 consists of two 1.5 megohm, a 2.7 megohm, and a 3.3 megohm in series. These resistors should have tolerances of ± 5 per cent or better.

Now using five short lengths of heavy gauge insulated wire, connect up the leads between the component panel and S1. As the component panel is quite small this will provide it with a quite rigid mounting, and no further mounting should be required. Finally, connect up the remaining wiring using insulated leads.

Components....

Resistors

R1	9MΩ (see text)	R6	5.6kΩ
R2	9MΩ (see text)	R7	5.6kΩ
R3	1MΩ $\pm 2\%$	R8	1.2kΩ
R4	91kΩ $\pm 2\%$	R9	220Ω
R5	10MΩ		

All $\pm 5\%$ $\frac{1}{4}$ W except where stated

Potentiometers

VR1	10kΩ miniature skeleton preset
VR2	1kΩ lin. carbon

Transistor

TR1 2N3819 n channel f.e.t.

SEE

**SHOP
TALK**

Miscellaneous

S1 3 pole 4 way rotary switch
 B1 9V PP3 battery and clips
 Veroboard 14 holes by 15 strips, crocodile clips (insulated type 1 red and 1 black), test prods and leads, small case—see text, connecting wire, knobs for VR2 and S1.

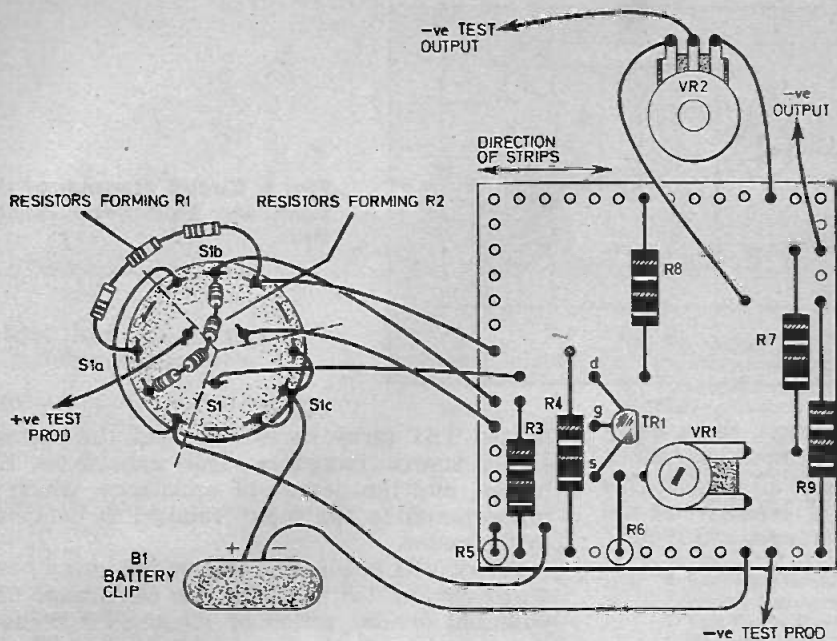

Fig. 3. Layout and wiring of the Vero-board and associated components for the sensitiser. There are no breaks in the copper strips.

CASE

The prototype is housed in a home made plywood box with inside dimensions of approximately 90 x 50 x 50mm. Any box of a similar size, provided it is not significantly smaller, can be used. Several suitable commercially made cases are available.

The general layout used on the prototype is with VR2 mounted on the left-hand side of the front panel, with S1 towards the centre, and the battery on the extreme right-hand side of the case. The component panel is positioned behind VR2.

A hole is drilled at a convenient point on the front panel, and is fitted with a grommet. This is used as an exit for the test leads. The plugs at the ends of the test leads are removed to enable direct soldered connection to the rest of the circuit. A second hole is drilled and fitted with a grommet, and is used as an exit for the two output leads. These are terminated in small coloured crocodile clips which connect to the test prods of the multimeter.

ADJUSTMENT

Before turning the unit on, adjust both VR1 and VR2 almost fully anticlockwise. Before connecting the multimeter to the output of the unit, use it to measure the battery voltage of the PP3 used to power the sensitiser, and make a note of the exact reading obtained. The sensitiser should be turned on while this reading is taken.

Now switch the meter to the 50 microamp range, connect it to the unit being careful to observe the correct polarity, and immediately

zero the meter using VR2. With the unit switched to the 10 volt range connect the positive test prod to the battery positive terminal, and adjust VR1 to give a reading which is identical to that obtained when the multimeter alone was used to measure the battery voltage.

The unit is then ready for use. Before making a measurement with the unit always ensure that the meter is properly zeroed, by adjusting VR2 if necessary. □

PLEASE TAKE NOTE

In the *Modula 3 Stereo Amplifier* (March 1975) Fig. 11 page 131 the junctions between the wipers of VR4/104 and VR3/103 must be changed around at the VR3/103 end.

In *Shop Talk* (May 1975) under the *Warning Winker* paragraph, when referring to the "arrow head" of the diode sign we mean the bar end of the symbol.

In the *MW/LW Tuner* (May 1975) two C7's are shown in both Fig. 2 and Fig. 5. These can both be 0.01µF disc ceramic types.



ELECTRONIC THERMOSTAT

By MICHAEL J. HOLT

THE circuit to be described is a sensitive integrated circuit thermostat able to control wall heaters, electric bar fires and the like, retaining the ambient temperature stable within a very narrow temperature range about a set value. It utilises an operational amplifier to achieve high sensitivity while retaining low cost.

CIRCUIT DESCRIPTION

The circuit diagram of the electronic thermostat is shown in Fig. 1 and uses a very common operational amplifier type 741C.

Resistor R1 together with Zener diode D1 produces a stable reference voltage of 5.6 volts which is tapped to produce a potential for inputting to the inverting input of IC1. A 5.6 volt Zener is important since this is the voltage value that changes least with temperature. This is necessary because the circuit has to detect a temperature change of a fraction of a degree using a thermal sensitive resistor RTH1, and the reference voltage must not interfere with the detection circuitry otherwise the thermostat will not switch reliably.

Presel. potentiometers VR1 and VR2 and variable potentiometer VR1 set the potential at the inverting input (pin 4) to IC1 while R2 together with thermistor RTH1 set the potential at the non-inverting input (pin 5). As RTH1 resistance varies with temperature, so the potential at the non-inverting input changes.

The 741C has a very high gain, around 200,000, so that a difference in potential between the inputs of more than a fraction of a millivolt results in the output being close to the potential of one or other of the supply rails. Hence when the voltage at one input crosses that at the other, the output of the 741 effectively switches from one supply rail to the other. In this sense the 741 is working as a comparator.

Thus when VR1 and VR2 have been set so that the inputs are at the same potential at the required temperature, any change from this temperature causes the 741 output to switch. The circuit is so designed that the output rises in potential when the temperature falls. This causes transistor TR1 to conduct, energising the relay which in turn energises the heater being used.

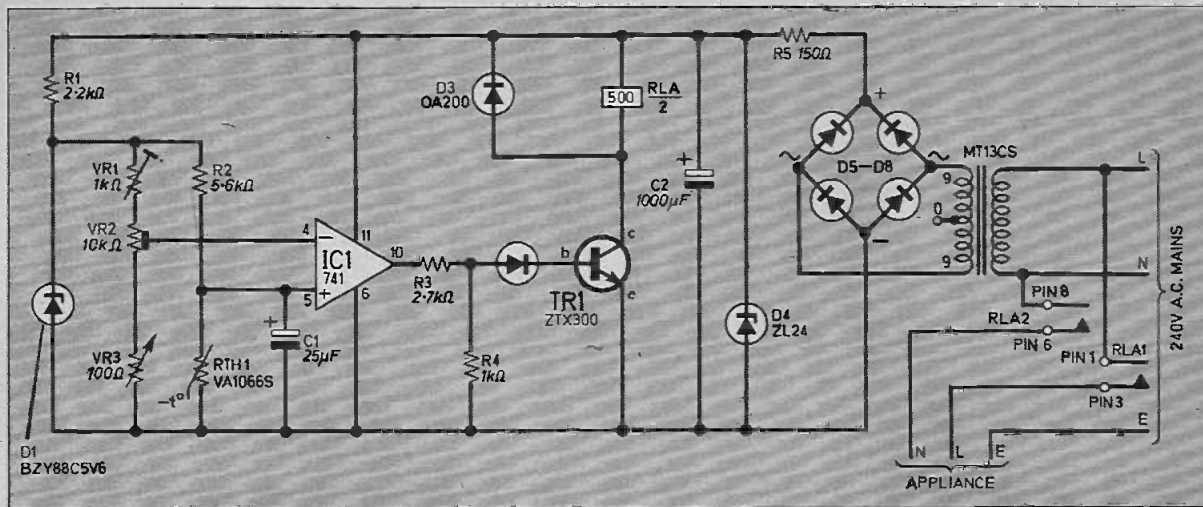

Fig.1. The circuit diagram of the Electronic Thermostat.

When the temperature has risen slightly above the chosen temperature the 741 output falls, TR1 turns off, the relay drops out, switching off the heater.

The circuit sensitivity is such that the 741 will switch with a temperature change of less than 0.1 degree Fahrenheit, but thermal lag effects reduce the performance slightly so that the room temperature fluctuates by approximately 0.3 degrees Fahrenheit. This is considerably more sensitive than bi-metal thermostats.

Preset VR1 is actually used as a fine control while VR2 is a coarse adjustment; VR3 is a control brought out to the front panel for slight alteration in temperature to suit personal choice and provides a degree variation of about 2 to 3 Fahrenheit degrees.

Capacitor C1 is an anti-hum component which shorts away any a.c. picked up by the thermistor and its leads. This is necessary since the thermistor will more than likely be mounted close to the case.

The power supply section is a conventional bridge rectifier type giving full-wave rectification. Resistor R5 and Zener diode D4 holds the supply voltage to the rest of the circuitry steady at 24 volts.

CONSTRUCTION

The circuit is built on 0.1in matrix Veroboard, two panels size 19 strips by 35 holes; one holds

Components....

SEE
**SHOP
TALK**

Resistors

R1	2.2kΩ
R2	5.6kΩ
R3	2.7kΩ
R4	1kΩ
R5	150Ω
All ¼W carbon ± 10%	

Potentiometers

VR1	1kΩ subminiature skeleton preset
VR2	10kΩ subminiature skeleton preset
VR3	100kΩ carbon linear

Capacitors

C1	25μF 25V elect.
C2	1000μF 50V elect.

Semiconductors

TR1	ZTX300 silicon npn
IC1	operational amplifier type 741C 14-pin d.i.l.
D1	BZY88C5V6 Zener diode 5.6V 400mW
D2	OA200
D3	OA200
D4	ZL24 Zener diode 24V 1.5W
D5-D8	B1/05 ½A 50V bridge rectifier
RTH1	VA1066S thermistor

Miscellaneous

T1 MT13CS (Douglas) mains/9-0-9 volt 100mA secondary
 RLA 8-pin plug-in relay 24V d.c. coil resistance 475 ohms with two sets of changeover contacts rated at 10A each (Doram type 348-784)
 Veroboard: 0.1in. matrix 19 strips by 35 holes (2 off); Paxolin sheet 90 x 50mm; octal base for RLA; 10 amp 5-way terminal block; 14-pin d.i.l. socket for IC1; case—Zippy type P3 (Henry's Radio); knob; connecting wire; mains 3-core cable to suit appliance used.

FOR
GUIDANCE
ONLY

ESTIMATED COST*
OF COMPONENTS
including V.A.T.

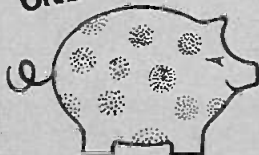

£7.25
excluding case

*Based on prices prevailing at time of going to press

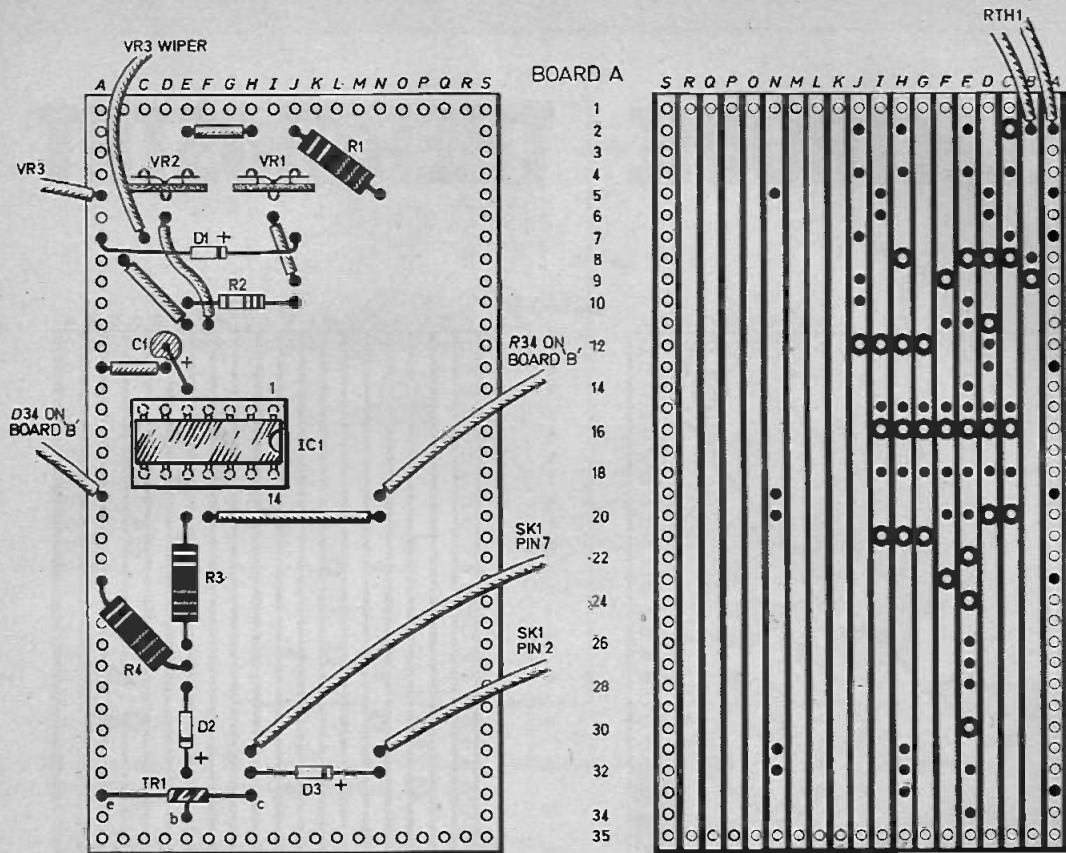

Fig. 2. Layout of the components and wiring-up details of board A.

the main thermostat circuitry, board A, and the other holds the power supply, board B. The relay is mounted on a separate piece of Paxolin sheet, board C, the same size as the Veroboard panels. The three boards were all mounted in a Zippy case type P3 which is slotted to take the panels used and provides an attractive compact case. This case is not critical and may be changed to suit individual requirements.

Begin construction by cutting the two Veroboard panels to size and making the breaks along the copper strips on the underside. The layout of the components on board A is shown in Fig. 2. Note that a 14-pin d.i.l. socket is used to mount IC1. Position and solder the i.c. socket followed by the capacitor, resistors, potentiometers and link wires. Solder the semiconductors in place last of all and use a heatshunt when soldering to avoid damage to these devices from the hot soldering iron. Pay special attention to the diode polarities.

The layout of the components for board B is shown in Fig. 3. The transformer used in the prototype had short stub lead-out wires protruding from the underside. These are to be soldered to the board through the holes specified in Fig. 3. Ensure that the bridge rectifier (D5 to D8) is connected in the right way round.

With reference to Fig. 4, prepare the piece of Paxolin (board C) to accept the relay socket SK1

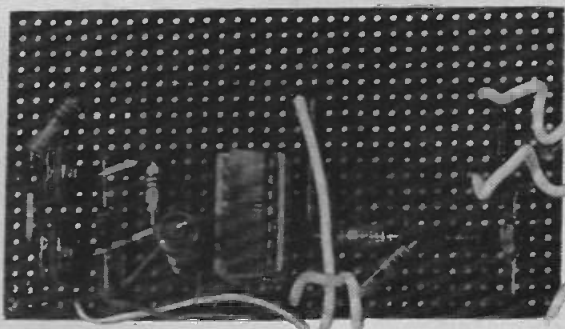

Photograph of the prototype board A.

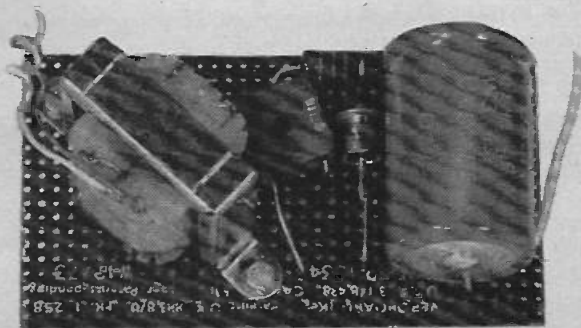

Board B of the prototype thermostat.

ELECTRONIC THERMOSTAT

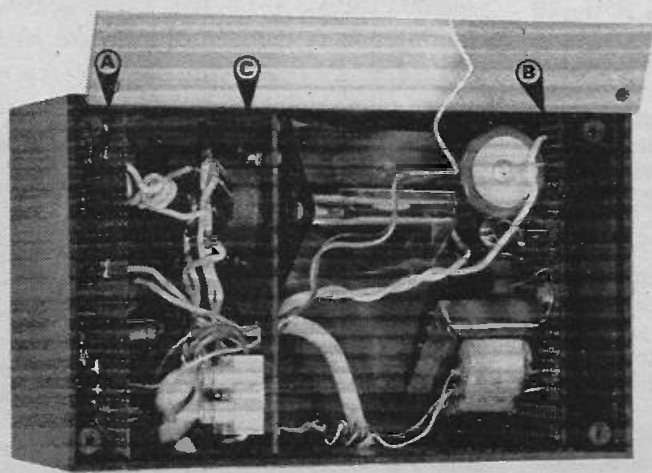
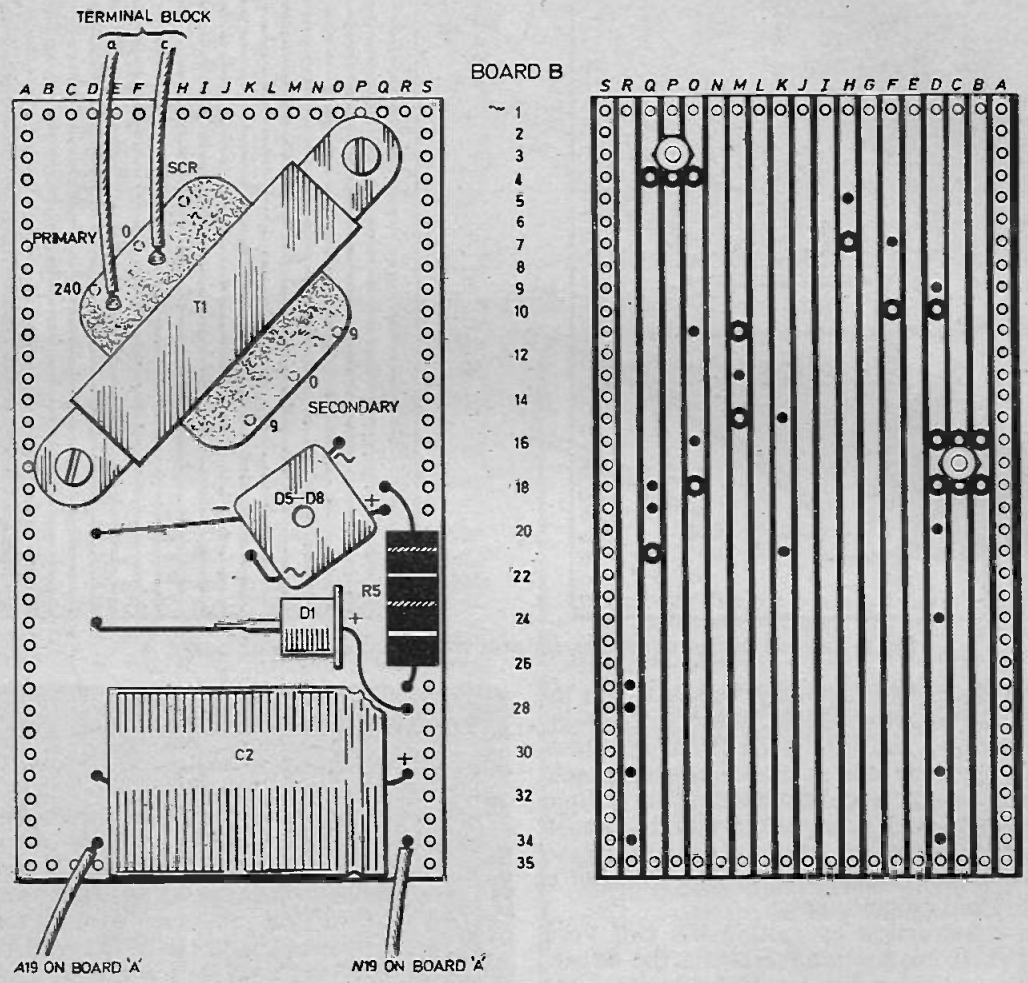

Fig.3. (above). The layout of the components on board B and details of wiring to the other boards.

Photograph (left) of the prototype showing positions of the three boards within the case.

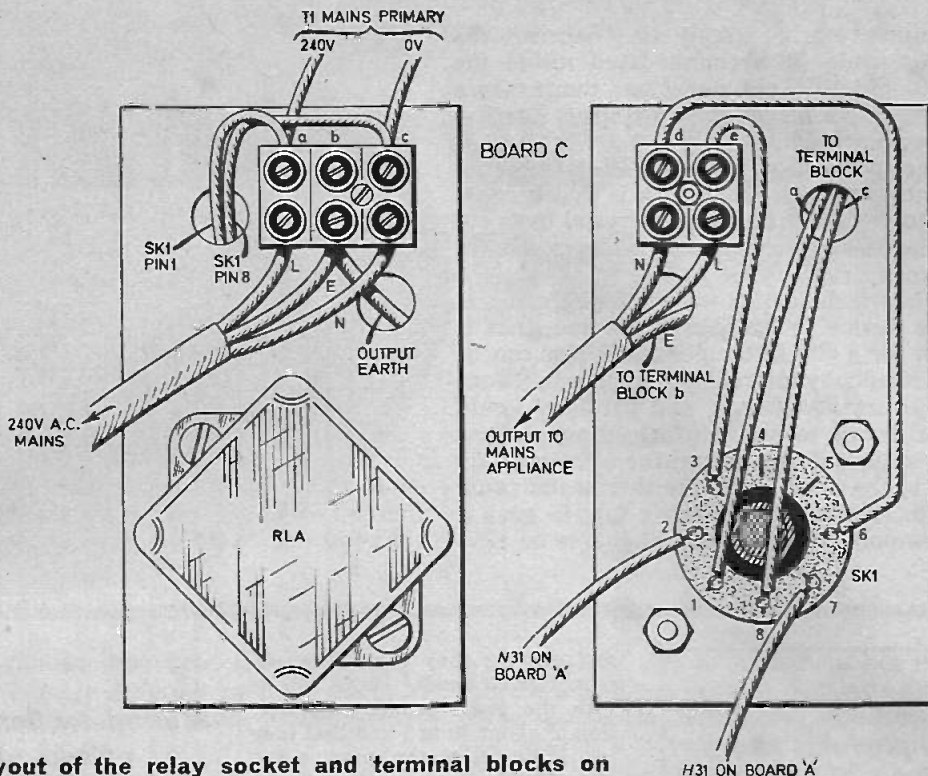

Fig.4. The layout of the relay socket and terminal blocks on board C and wiring details to other boards.

and the terminal blocks, and drill the two holes for feeding through the flying leads. Secure SK1 and the terminal blocks and wire up the three boards as indicated, keeping in mind their relative positions within the case. Next secure the control potentiometer VR3 to the front panel and connect up as shown.

The thermistor is connected to the main board by a pair of wires fed through the side of the case; solder the wires to the board before soldering the thermistor to the wires. Place the boards in the slots in the case as shown in photograph and then feed the external wires through holes drilled in the side of the case. The thermistor can be mounted on a small piece of Veroboard, and for the sake of neatness and protection, housed in a small aerated box.

All mains leads should be of adequate gauge for the heater being used, and should, for safety, be connected using screw connector blocks as shown.

SENSOR POSITION

The thermistor being the temperature sensitive element must be positioned carefully. It should ideally be fixed at 1 metre from the floor, and at least 1 metre away from any doors and windows. It also must not be too close to the heater, preferably some 2 to 3 metres away. It is because of the importance of positioning that the thermistor is mounted outside the case on wire leads, so that it can be correctly located

while placing the thermostat case in the most convenient position. The leads to the sensor could be any length up to about 3 metres.

SETTING UP

The thermostat is easily set up once the thermistor has been correctly positioned. If the ambient temperature is below the required temperature, adjust VR2 until the device just switches on, leaving VR1 at the centre of its travel. When the required temperature is reached, trim VR2 and then VR1 until the circuit is just on its switching threshold with the front control VR3 at the centre of its travel. The thermostat is now set up.

OTHER APPLICATIONS

Although originally designed to control a 500 watt wall heater the thermostat is able to serve in a wide variety of other applications. It could in fact operate without alteration over a temperature range of about -50 to $+120$ degrees Fahrenheit simply by adjusting VR2, so that it could handle a number of special purpose applications.

It could be utilised in a heated greenhouse, perhaps retaining the temperature considerably above that outside as may be required for tropical plants. It may interest amateur photographers who use the standard do-it-yourself photographer's dishwarmer—a 40 watt light

bulb mounted in a biscuit tin—because the thermistor could be accommodated inside the tin and would hold the developer temperature accurately stable, as is often required, particularly for colour work.

Another possibility perhaps of interest to those concerned with radio work is that it could be used to control a home-built crystal oven for a frequency standard, probably using a smaller relay in such a case.

There is a modification which can be made to allow the device to operate in reverse, that is switch on for a rise in temperature. This can be achieved simply by interchanging all connections to the 741 inputs (pins 4 and 5). This would allow the device to detect overheating perhaps in a car engine; if the thermistor were suitably attached to the head block, the thermostat could be used to switch on an electric fan. In such a case the supply voltage would of course be 12V,

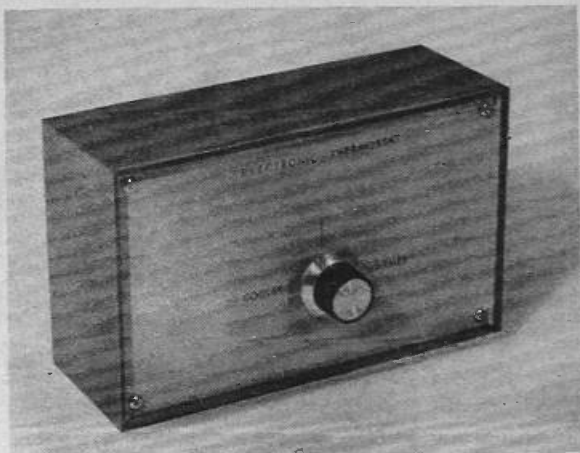

but this will not affect the operation of the circuit except that the relay should be a 6 to 12V type of coil resistance greater than 150 ohms. □

**New products and
component buying
for constructional
projects**

SHOP TALK

By Mike Kenward

WHAT next? The Mickey Math is now with us and the makers claim it is being distributed as an educational aid and also as an executive gift (one wonders just what these executives do with all their gifts). The Mickey Math is simply a normal calculator fitted in an enlarged case with a large picture of Mickey Mouse on the case.

The Mickey Math is distributed by Decimo, already well known for calculators and costs £17.50 plus V.A.T.

White Line Follower

Some unusual parts are needed for the *White Line Follower*, in particular the gears, motors, axles

and wheels; they can all be obtained from model shops. Make sure the gears provide a reduction of about 40 to 1 and that they will fit on the motor spindles and axles. Battery mounting on the prototype unit was achieved using double sided Sellotape.

As far as the "electronic components" go the relays and photocells are the only parts that need some explanation. The relays can be any small type that will work from 9V, have a coil resistance of at least that specified—greater is in order—and have one set of normally closed contacts. The photocells can be any of the cadmium sulphide photo conductive type—the smaller the better. We suggest you go for some fairly small ones that are relatively cheap.

Electronic Thermostat

One or two parts for the *Electronic Thermostat* may be hard to find. They are not unusual but if the wiring of the prototype is to be followed particular types must be obtained. The relay is a Doram type with plug in base; if other types are used the wiring and pin connections may need altering. The transformer is a Douglas type with printed circuit pin connections—others of the correct specification could be used but the wiring of the mounting board will need alteration.

The transformer (type MT 13CS) is available from Barrie Electronics, 3 The Minorities, London EC3N 1BJ. Price, includ-

ing post, packing and V.A.T. is £1.74.

Multimeter Sensitiser

No problems when buying for the multimeter sensitiser, all the parts should be readily available. Test probes and leads can be purchased from most shops and a variety are usually available. The case for the project can be home made from wood or any suitably sized plastic box could be used—we suggest you go for a fairly strong one as it may get a great deal of use.

Catalogues

We have recently received some new catalogues; Home Radio have once again produced their high quality comprehensive catalogue containing 244 pages size 290×200mm approx. and listing over 6,000 items. Cost 65p plus 33p post and packing. Each catalogue contains 70p worth of vouchers when used as directed.

Doram have produced a catalogue amendment leaflet (No. 2) dated March 24, 1975, and a new price list, dated April 1, 1975, to complement their catalogue—price 25p including post and packing. The cost of this catalogue is refunded when an order for £5 or more (plus V.A.T.) is placed.

Prices

Will readers please note that prices quoted in this issue may be subject to alteration arising from the new Budget proposals.

Everyday Electronics, June 1975

Workshop Practice

By MIKE HUGHES M.I.E.R.E.
PART THREE
A Professional Finish

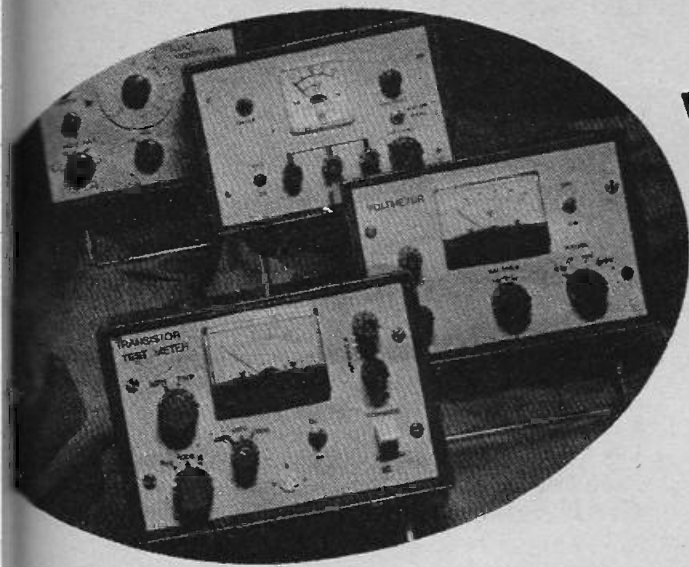

WE CONTINUE on the same theme as last month, namely covering cabinets and in particular wooden cabinets and loudspeaker coverings.

WOODEN CABINETS

You can use paint or plastic film on wooden cases but you have to be a little bit more careful. First, ensure that the wood is thoroughly sanded and then dusted off. When painting, go through all the steps we recommend for metal cases except that you can usually forget about the first coat of primer. Two coats of undercoat should be applied instead but you must rub down the surface between these coats as the first will raise the grain. Provided you do this rubbing down carefully you can get a surface that looks no different from that obtained on metal. An advantage with wood is that you can easily fill any nasty chips or cracks with one of the proprietary filling compounds before the undercoat operation.

Remember that when you have bolts going through a piece of plywood there is a tendency for the heads to sink into the wood if you are going to tighten the nuts hard. To avoid this happening use ample sized washers under the screw heads.

Whether working on wood or metal always try to use chromium plated screws for outside surfaces, they cost a little more and are a bit more difficult to obtain but they make all the difference to the appearance of the finished job.

COVERING WOOD

Applying self adhesive plastic film to wood is a little more difficult because it will not stick (for long periods) to the rough surface of normally sanded wood. The only exception to this

is the finished side of hardboard but even then there is a problem because nothing on earth will make it stick to the reverse side when you do any returns. The only satisfactory solution is to paint the wood first, just as we have described, and then apply the film.

Of course you do not have to be quite so fussy about the painted finish but it must be glossy to get the best adhesion. You must not expect the film to hide any cracks or lumps and bumps in your woodwork, if anything their presence will be emphasised through the film so make sure you do any filling that is necessary before painting.

VENEER

When dealing with wooden cabinets one of the best looking finishes is a real wood veneer. This has the advantage of not only looking good but it can hide a multitude of sins. It is a little more tricky to do properly than the forgoing methods but all in all it is a somewhat quicker operation with the do-it-yourself aids that are now available. There are numerous types of veneer available and they come in all sorts of finish from Birds Eye Maple to Teak and, probably the cheapest, Sapele Mahogany.

You can buy veneer with an already plastic treated finished surface with a strengthening backing—one such brand is called "Rollwood". This is particularly easy to use because it will not chip or splinter, can be bent round corners and needs no polishing operation to finish it off.

Alternatively you can get a straightforward veneer which has an iron-on glue deposited on the back surface. This, again is easy to apply but you have to be careful at edges to prevent the veneer splitting down the grain when you do the trimming. Cheapest of all is raw veneer.

If you choose Rollwood or ordinary veneer you must supply your own adhesive for bonding it to your cabinet. Without doubt the best adhesive to use is one of the impact varieties like Evo-stick.

When using this make sure that you have a very even layer on both the reverse surface of the veneer and the surface of the cabinet. There should be no areas left uncoated as these will give rise to airblisters in the finished job. At the same time do not apply too much adhesive as you will not get a strong bond. Provided you follow the manufacturers recommendations correctly you should have no trouble getting a good bond but make sure that you burnish down the edges well to prevent any tendency to lift off.

With iron-on veneers make sure you have the iron set at the right temperature by testing it on a few scraps first before starting on the main job. Ideally the glue should flow and stay soft for about 5 or 10 seconds before it cools down sufficiently to set. During the setting period you must remember to apply pressure to the veneer to prevent air bubbles forming. This can be a bit of a problem when using large areas, therefore it is best to start the ironing operation at the centre of the job and work out towards the edges in a methodical manner. Again pay special attention to the edges!

TRIMMING AND SANDING VENEER

You can obtain some extremely professional looking finishes with veneer including inlay effects at edges, but this technique ought to be left until you gain a bit of experience in handling the material.

When trimming the edges make sure that you use a sharp knife and trim in the direction of the grain of the veneer to avoid digging the knife into the edge of your cabinet. Finish off the edges with fine sandpaper held on a wooden block. Finally stick edging strip on any exposed edges and trim these down in like manner.

Unless you have used a ready finished veneer you must now use the finest sandpaper you can get and gently rub down each surface *along the grain* to get a silk-like finish. Be careful at corners that you do not sand through the veneer to the underlying wood.

WAXING AND VARNISHING

There are various methods of finishing off a wood veneer surface. The author prefers a dull gloss finish, as obtained by waxing. Before applying the wax it is a good idea to feed the grain with an oil such as teak oil (it does no harm applying this to mahogany or other dark woods). This should be rubbed in liberally and allowed to dry. If you run your fingers over the surface you will find that the grain has lifted

slightly so it is then a good idea to give the surfaces another very gentle sanding and then follow this with a liberal polishing with any household wax. The more you polish the better the colour of the wood and the more attractive the finish.

Perhaps one of the reasons why the author prefers this method is that once the first few operations have been carried out the rest can be left to the wife to be incorporated into the normal round of domestic chores!

A higher gloss finish can be obtained by using polyurethane varnish but this should *not* be applied to teak veneer as the natural oils in the teak prevent the varnish setting properly. To get the best gloss finish you should apply one layer of ordinary varnish, let it dry thoroughly and then rub it down with fine sandpaper and then apply a further coat. Three or four coats applied in this way will produce a mirror-like finish.

LOUDSPEAKER COVERING

It is worth mentioning how to handle loudspeaker grill material. This could be of the expanded metal variety, Tygan or cloth. Each has its own problems in fixing. Probably the easiest to handle is the expanded metal as it is usually fixed by glueing with epoxy resin to the inside surface of the final box or can be held in place over the same screws which fix the loudspeaker (being sandwiched between the loudspeaker and the inside of the case).

Tygan is the proprietary name for plastic loudspeaker material—woven out of plastic threads. It is extremely attractive and enhances the outside appearance of an enclosure tremendously. It is usually applied over the whole front surface of a loudspeaker obscuring the aperture. This makes it easy to apply because you simply stick it over the whole of the front panel *before* the panel is inserted into the enclosure.

Before sticking it you should paint the front of the panel black so that there is no chance of seeing the loudspeaker aperture through the materials. Evo-stick is probably the best adhesive to hold Tygan into place but you must return the material round the edges of the panel to hold it securely. Once the Tygan is stuck there is a very nice little trick which helps get rid of the wrinkles over the aperture. By warming it up in front of an electric fire the material has the property of shrinking slightly and it will pull itself taught—another reason for returning it round the edges of the panel.

Finally you can use loudspeaker fabric in exactly the same way as Tygan (don't forget to paint the surface of the panel black) but you should use Copydex or a similar non-staining adhesive and you have to do the best you can about getting rid of creases, but be careful not to overstretch the material.

To be continued

Next Month!



AUTOMATIC GARAGE DOORS...

Just flash your headlamps a couple of times and up they go! We will show you how to build the complete system so that you can have the luxury of your own automatic doors.

Also

ADD-ON AMPLIFIER

A simple and inexpensive amplifier that can be used with tuners, oscillators, record decks etc.

SELF POWERED RECEIVER

An unusual design that uses the power of the received signal to drive the single transistor receiver.

DEAC CHARGER

Constant current charger for Deac cells and batteries, provides three charging rates with l.e.d. indication.

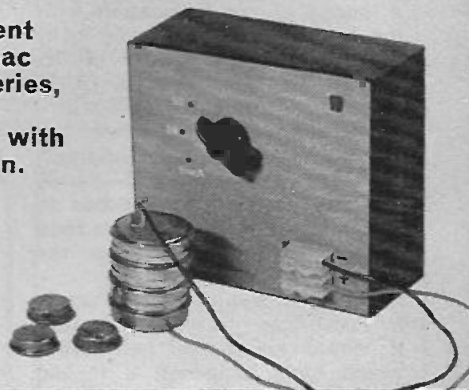

everyday electronics

JULY ISSUE
ON SALE
FRIDAY JUNE 20

The Extraordinary Experiments of Professor Ernest Eversure

by Anthony John Bassett

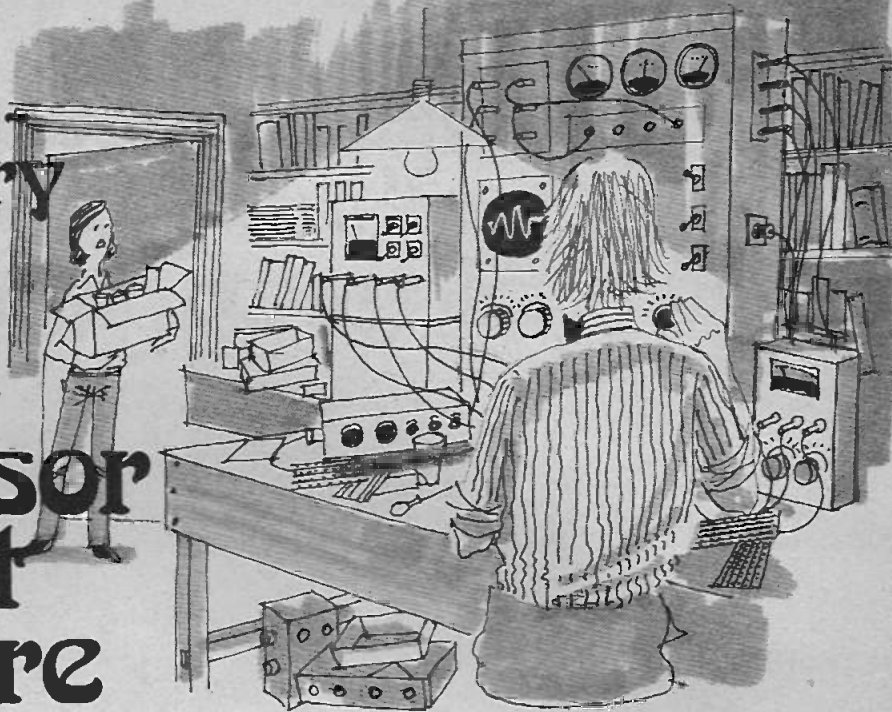

Professor Ernest Eversure, or the Prof. as his friends call him, has been experimenting in electronics for more years than anyone can remember and we thought that you might like to hear of, and perhaps repeat, some of his extraordinary experiments. Anthony J. Bassett recounts some of these experiments every month so why not follow the Prof's work and learn along with young Bob, his friend.

As the "foaming robot" approached the Prof., Bob could hear the sounds of the clicking and whistling noises it made, as a means of communication with the Prof. Bob warily moved away as the foaming mass slowly approached, but the Prof. called out and told him to stand still.

"It will not quite reach the point where you are standing", he reassured Bob, and surely enough, the mass approached to within a few inches of Bob's feet, then slowly drew back in the direction whence it came.

Bob was astounded. "What is it, Prof? How did you know that it would not reach me? What would have happened if it had reached me?"

"My experimental liquid-state amplifier must have bubbled over" remarked the Prof. "But in accordance with the law of conservation of energy, I knew that there was insufficient available energy to expand the foaming mass to reach the point where you stood."

With a few more clicks and

whistles, the Prof. gave further instructions to the robot, which made its way to one of the workbenches and returned with a strange device of metal tubing and flexible plastic hosepipe. It connected one of the tubes to a water tap and turned on.

The device sprayed the mass of bubbles with fine jets of water, and simultaneously sucked it up by means of a venturi activated by a stream of cold water, then dumped the mess down the drain! The Prof. could see that the lab. would soon be clean and in good order once again.

Meanwhile Bob had been deep in thought.

"Prof.," he said, "Because you know about the law of conservation of energy, and so many other scientific things, you were able to predict that the foam would not reach me. I wish I knew a lot more about all these things—transistors, electronics, energy. It would be possible for me to build all sorts of helpful devices—and even to invent a few, maybe, like you do!"

"I am sure that the time and effort involved in such studies is not wasted," agreed the Prof. "The results can be of enormous benefit even where there is no immediately obvious practical application."

ENERGY RELATIONSHIPS

"If we consider once more the energy relationships in a simple amplifier stage, it can be seen that in a transistor (Fig. 1) a small electrical energy change which forms an input signal-current results in a larger energy change as an output current. For the carbon granule microphone (which can be used as the active element of the audio amplifier described last month) the output energy is

Fig. 1. Energy change in a transistor circuit.

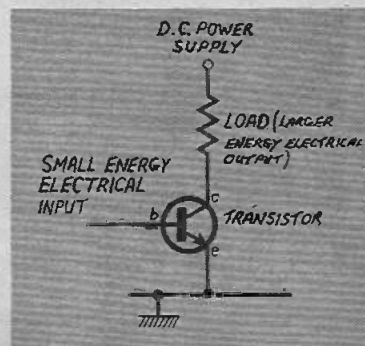

Everyday Electronics, June 1975

Complete the coupon and we'll send you our new catalogue, Completely free.



The new Heathkit catalogue is now out. Full as ever with exciting, new models. To make building a Heathkit even more interesting and satisfying.

And, naturally, being Heathkit, every kit is absolutely complete. Right down to the last nut and bolt. So you won't find yourself embarrassingly short of a vital component on a Saturday evening—when the shops are shut.

You'll also get a very easy to understand instruction manual that takes you step by step through the assembly.

Clip the coupon now and we'll send you your free copy to browse through.

With the world's largest range of electronic kits to choose from, there really is something for everyone.

Including our full range of test equipment, amateur radio gear, hi-fi equipment and many general interest kits.

So, when you receive your catalogue you should have hours of pleasant reading.

And, if you happen to be in London or Gloucester, call in and see us. The London Heathkit Centre is at 233 Tottenham Court Road. The Gloucester showroom is next to our factory in Bristol Road.

At either one you'll be able to see for yourself the one thing the catalogue can't show you.

Namely, how well a completed Heathkit performs. Heath (Gloucester) Limited, Dept. EE-65 Bristol Road, Gloucester, GL2 6EE. Tel: Gloucester (0452) 29451.

A new oscilloscope from the Heathkit range.



Marine direction finder with digital read-out.



Stereo cassette deck with built-in Dolby.

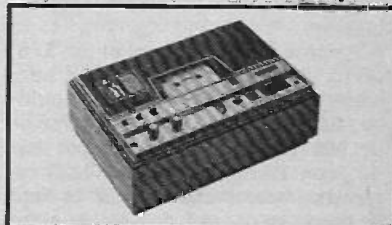

The new Heathkit catalogue. Out now. FREE.

To: Heath (Gloucester) Limited, Dept. EE-65 Gloucester, GL2 6EE. Please send me my free Heathkit catalogue.

Name _____

Address _____

Postcode _____

Remember easy terms are available with the Heathkit Monthly Budget Plan.



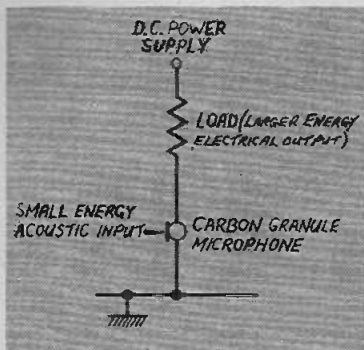

Fig. 2. Energy change in a circuit powered by a carbon microphone.

provided in similar form, but the input energy required by this device is in the form of mechanical or acoustic vibrations." (Fig. 2).

"I see" said Bob, "Amplifiers in effect convert a small energy input signal into a large energy output signal which is a replica or a reflection of the input."

"Yes" replied the Prof., "and the power rating of the amplifier is a guide to the rate at which the output energy can be delivered to the load."

The Prof. drew another circuit diagram (Fig. 3).

"I know that you are wanting to experiment with amplifiers, and I think that this should interest you, Bob. It is a three-transistor class A amplifier with the transistors directly coupled to each other like those which you drew earlier (Fig. 3 last month). The loudspeaker is directly connected to the collector of TR3 so that when the resistance of TR3 varies, it allows varying amounts of current to pass through the loudspeaker and sounds are produced accordingly.

Almost any loudspeaker of 3, 8 or 15 ohms can be used, and one from an old T.V. or radio should be suitable. The speaker is connected so that the red spot or + sign connects to the battery positive when the switch is on. If there is no red dot or + sign on the loudspeaker, connect it so that when the switch is turned on the speaker cone moves slightly outwards."

"When a signal reaches the input transistor TR1 through VR1 and C1, the resistance of TR1 varies slightly. This causes a bigger variation in the resistance of TR2, followed in turn by an

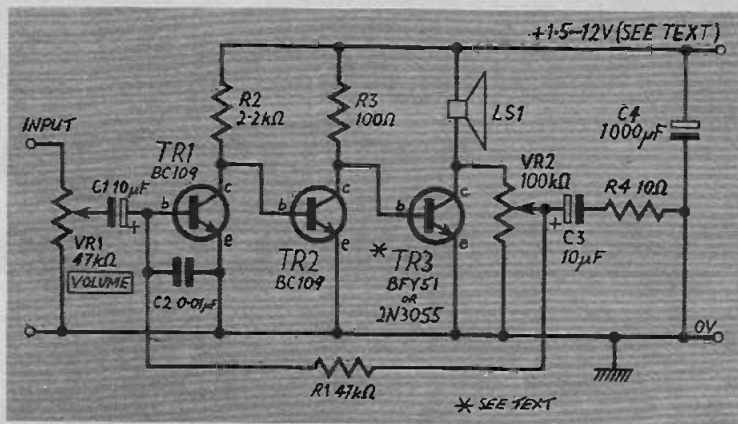

Fig. 3. An experimental class A amplifier.

even greater variation in the resistance of TR3, which will produce an audible output from the loudspeaker. By adjustment of VR2 the operating current of TR3 is varied, and VR2 should be adjusted to a point as near to the negative line as possible, consistent with clear sound output from the speaker. If only very low volume is wanted, a very low setting can be used, which gives a lower operating current. This helps to conserve the battery."

Bob collected together the necessary components. He smeared the case of TR3 with silicone grease and fitted a push-on heat-sink. He then mounted the transistors, resistors and capacitors on a piece of perforated board, and connected the battery, on/off switch, loudspeaker, volume control VR1, and an input-socket by means of flexible wires to give the circuit of Fig. 3. He used screened wires to the volume control in order to avoid interference.

After adjusting VR1 to give minimum volume, and VR2 to give minimum bias, it only remained to connect a source of audio signal to the input to test the amplifier, and to adjust the bias control VR2 for correct operation.

"The amplifier may be used to amplify a microphone, record-player deck, tape recorder or cassette deck, or with your musical note-generator or electric kazoo. It may be used to amplify almost any audio signal of sufficient amplitude." remarked the Prof.

Bob connected the musical note-selector which he had made earlier, to the input of the amplifier, and soon the sounds of melodies and glissando sound-

effects could be heard in the laboratory. Next he connected an electric guitar, then a series of other sources of sound-signal to the input as Prof. had suggested.

POWER

"Before I install this amplifier into a cabinet", Bob asked, "I wonder whether there is anything I can do to improve its performance? It is quite suitable as a small amplifier, and for most purposes it is reasonably loud and clear. But I wonder whether there are some simple modifications which I could do at low cost?"

"What do you have in mind?" asked the Prof.

"I wondered whether it would be possible to use two speakers instead of one," remarked Bob, "and connect the extra speaker whenever I need more volume. Also, could I get more volume by using a bigger battery? Can we do a few experiments with this amplifier to find the answers to these questions?"

"Yes", replied the Prof. "I think a few experiments with this circuit would be well worthwhile, as I am sure that we can increase the output from the amplifier and learn a few things at the same time."

"Firstly, if you increase the power output of this class A design in any way, it will become more expensive to use because of battery costs. So although running costs are not high, they could become quite a lot higher unless you changed the circuit slightly to enable a rechargeable battery to be used. We can try using a 6 volt lantern battery or a 6 volt motorcycle battery; and we might even try a 12 volt car

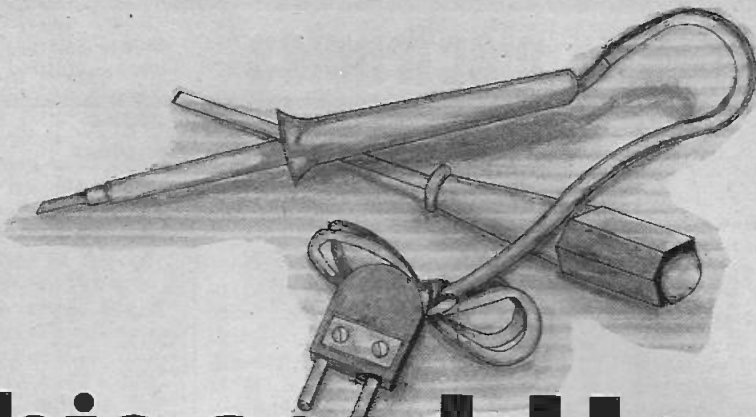

This could lead to something big.

A soldering iron and a screw driver. If you know how to use them, or at least know one end from the other, you know enough to enrol in our unique home electronics course.

This new style course will enable anyone to have a real understanding of electronics by a modern, practical and visual method. No previous knowledge is required, no maths, and an absolute minimum of theory.

You build, see and learn as, step by step, we take you through all the fundamentals of electronics and show you

how easily the subject can be mastered and add a new dimension not only to your hobby but also to your earning capacity.

This course is accepted by and used in a large number of schools and colleges and forms an invaluable grounding for professional training in the subject. All the training is planned to be carried out in the comfort of your own home and work in your own time. You send them in when you are ready and not before. These culminate in a final test and a certificate of success.

1

Build an oscilloscope.

As the first stage of your training, you actually build your own Cathode ray oscilloscope! This is no toy, but a professional test instrument that you will need not only for the course's practical experiments, but also later if you decide to develop your knowledge and enter the profession. It remains your property and represents a very large saving over buying a similar piece of essential equipment.

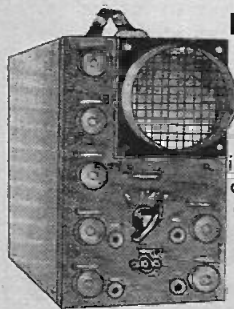

2

Read, draw and understand circuit diagrams.

In a short time you will be able to read and draw circuit diagrams, understand the very fundamentals of television, radio, computers and countless other electronic devices and their servicing procedures.



3

Carry out over 40 experiments on basic circuits.

We show you how to conduct experiments on a wide variety of different circuits and turn the information gained into a working knowledge of testing, servicing and maintaining all types of electronic equipment, radio, t.v. etc.



PLUS



FREE GIFT!

ALL STUDENTS ENROLLING IN OUR COURSES RECEIVE A FREE CIRCUIT BOARD ORIGINATING FROM A COMPUTER AND CONTAINING MANY DIFFERENT COMPONENTS THAT CAN BE USED IN EXPERIMENTS AND PROVIDE AN EXCELLENT EXAMPLE OF CURRENT ELECTRONIC PRACTICE

To find out more about how to learn electronics in a new, exciting and absorbing way, just clip the coupon for a free colour brochure and full details of enrolment.

WAA

Brochure without obligation to:
BRITISH NATIONAL RADIO & ELECTRONICS SCHOOL, Dept EEL/65
P.O. Box 156, Jersey, Channel Islands.

NAME.....

ADDRESS.....

(Block caps please)

CHROMASONIC electronics

Dept. 1
56, Fortis Green Road, London, N10 3HN.
telephone: 01-883 3705

RESISTORS

The standard ranges of Resistor stocked are either E12 or E24 and the values are all in multiples of ten times the decade shown below. The E12 items are only those in bold type. The E24 items are both those in bold and light type.

10	18	33	56
11	20	36	62
12	22	39	68
13	24	43	75
15	27	47	82
16	30	51	91

CARBON FILM $\frac{1}{4}$ watt $\pm 5\%$ tol. 2p ea.
E12 Series 10 Ω to 330K Ω

CARBON FILM $\frac{1}{2}$ watt $\pm 5\%$ tol. 1p ea.
E24 Series 10 Ω to 10M Ω

CERMET THICK FILM $\frac{1}{4}$ watt $\pm 2\%$ tol. 8p ea.
E12 series 56 Ω to 150K Ω

METAL OXIDE FILM $\frac{1}{4}$ watt $\pm 2\%$ tol. 4p ea.
E12 series 10 Ω to 1M Ω

CARBON COMPOSITION $\frac{1}{2}$ watt 4p ea.
2.2 ; 2.7 ; 3.3 ; 3.9 ; 4.7 ; ± 0.5 tol.
5.6 ; 6.8 ; 8.2 $\pm 10\%$ tol.

CARBON COMPOSITION 1 watt 5p ea.
2.2 ; 2.7 ; 3.3 ; 3.9 ; 4.7 ; ± 0.5 tol.
5.6 ; 6.8 ; 8.2 $\pm 10\%$ tol.

CARBON FILM 1 watt $\pm 5\%$ tol. 3p ea.
E12 series 10 Ω to 10M Ω

CARBON FILM 2 watt $\pm 5\%$ tol. 6p ea.
E12 series 10 Ω to 10M Ω

WIREWOUND 2 $\frac{1}{2}$ watt $\pm 5\%$ tol 0.22 to 0.45V15p
E12 series $\pm 10\%$ 1 to 270 Ω 13p

WIRE WOUND 5 WATT 13p ea.

1	25	250	1.5K
1	30	270	1.8K
1.8	39	390	2K
2.2	50	330	2.2K
2.7	60	350	2.5K
3.3	68	400	2.7K
3.9	75	470	3K
4.7	82	500	3.3K
5	100	560	3.5K
5.6	120	600	3.9K
6.8	150	680	4.7K
8.2	180	750	5K
10	200	820	5.6K
15	250	1K	6.8K
21	220	1.2K	8.2K

WIRE WOUND 10 watt 14p ea.
All the values shown in bold in the 5 watt range

WIRE WOUND 10 watt $\pm 5\%$ tol. 20p ea.
10K ; 15K ; 20K ; 25K

WIRE WOUND 15 watt 13p ea.
All the values from 10 Ω upward shown in bold in the 5 watt range.

POTENTIOMETERS



5K 250K Log or Lin Less Switch (and 1K Lin) 14p
10K 500K Log or Lin with Switch 26p
25K 1 Meg Dual Less Switch 46p
50K 2 Meg 1 Meg Log only 57p
100K 10K Log + 10K A or 10K Log Less Switch

Sliders

10K Single 33p
25K DUAL 55p
50K
100K

Presets

Vertical or Horizontal
.1 Watt 5p .25 Watt 7p
100 1K 10K 100K 1Meg
250 2.5 25K 250K 2.5 Meg
500 5K 50K 500K 5Meg

Cermets

100 2.5K 25K 250K
500 5K 50K 500K
1K 10K 100K 1Meg

CAPACITORS

Ceramic Plate
Mullard C333 Series 63 Volts Wtg.
all at 5p each
 $\pm 0.25\mu\text{f}$ 1.8p $\pm 2\%$ 12p $\pm 2\%$ 68p
2.2p 15p 82p
3.3p 18p 100p
3.9p 22p 120p
4.7p 27p 150p
5.6p 33p 180p
6.8p 39p 220p
8.2p 47p 270p
10p 56p 330p

Mullard 630 series 40 volts $\pm 10\%$ tol.
629 series 100 volts
all at 5p each
390p 1000p 3300p
470p 1200p 3900p
560p 1500p 4700p
680p 1800p * 10nf
820p 2200p * 22nf
2700p

Erie Monolithic Ceramic 30 Volts Wtg.
27nf 11p; 47nf 13p; 100nf 17p

Low Voltage Disc Ceramics
all at 5p each
0.01uF 18v ; 0.1uF 30v
0.022uF 18v ; 0.22uF 50v
0.047uF 18v ; 0.47uF 50v

Mylar Film 100 Volts Wtg.
1000pF 2p ; 0.05uF 3p
200pF 2p ; 0.0068uF 5p
5000pF 2p ; 0.1uF 5p
0.01uF 3p ; 0.2uF 6p
0.02uF 3p ; 0.47uF 7p
0.04uF 3p

MULLARD C295 Series 63 Volts
Tolerance $\pm 1\%$
6,800pF (6.8nf) C295 AH/D4K8 11p
8,200pF (8.2nf) C295 AH/D8K2 11p
13,000pF (13nf) C295 AH/D13K 15p
18,000pF (18nf) C295 AH/D18K 15p
20nF (.02uF) C295 AH/D20K 15p
30nF (.03uF) C295 AH/D30K 18p
39nF (.039uF) C295 AH/D39K 18p
51nF (.051uF) C295 AH/D51K 25p

Polystyrene 160 Volts Wtg.
Tolerance $\pm 5\%$ up to 33p ; $\pm 5\%$ 47p up.
10pF to 10,000pF (0.01uF) in multiples of:
10 ; 15 ; 22 ; 33 ; 47 ; 68

Mullard C280 Series. 250 Volts Wtg.
Metallized Polyester Film
0.01uF 3p ; 0.22uF 5p
0.015uF 3p ; 0.33uF 7p
0.022uF 3p ; 0.47uF 9p
0.033uF 3p ; 0.68uF 12p
0.047uF 3p ; 1.0uF 14p
0.068uF 4p ; 1.5uF 22p
0.1uF 4p ; 2.2uF 26p
0.15uF 4p

Mullard C281 series 400 Volts Wtg.
Metallized Polycarbonate Film $\pm 10\%$
0.01uF 5p ; 0.1uF 8p
0.015uF 5p ; 0.15uF 9p
0.022uF 5p ; 0.22uF 11p
0.033uF 6p ; 0.33uF 15p
0.047uF 6p ; 0.47uF 16p
0.068uF 6p

VDR's & Thermistors



CZ1 17p
CZ4 18p
CZ13A 18p
CZ19 18p
E298CDA258 13p
E298DA258 13p
E298EDA260 13p
E298EDA262 13p
E298EDA265 13p
E298ED268 13p
E298ED265 13p
E298Z206 13p
E299DDP336 14p
E299DDP338 14p
E299DDP342 14p
E299DDP348 14p
GL16 E1.21
GL23 E1.21
RS3 E1.49
RS4 E1.41
VA1005 10p
VA1026 10p
VA1033 10p
VA1034 10p
VA1039 10p
VA1040 10p
VA1053 10p
VA1055S 10p
VA1056S 10p
VA1066S 17p
VA1067S 17p
VA1077 19p
VA1098 21p
VA1104 31p
VA1107 27p

CAPACITORS



Silvered Mica 350V.
Tol. $\pm 0.5\mu\text{f}$ 11p each
2.2p 18p 30p
3.3p 20p 33p
5p 22p 39p
10p 25p 47p
Tol. $\pm 1\%$ 11p each
50p 150p
50p 82p 180p
68p 100p 200p
75p 120p 220p
12p each
250p 330p 560p
270p 390p 680p
300p 470p 820p
17p each
1000p 1500p 220p
1800p
26p each
2700p 3600p 5000p
4700p
6800p 8200p 10000p
33p each

Mixed Dielectric 600 Volts Wtg.
0.01uF 8p ; 0.1uF 9p
0.022uF 8p ; 0.22uF 17p
0.033uF 8p ; 0.47uF 26p
0.047uF 8p ; 1uF 36p
0.068uF 7p

Mixed Dielectric 1000 Volts Wtg.
1000pF 6p ; 0.022uF 11p
2200pF 6p ; 0.047uF 13p
3300pF 7p ; 0.1uF 13p
4700pF 7p ; 0.22uF 24p
0.01uF 10p ; 0.47uF 33p

Solid Tantalum Beads
all at 16p
0.1uF 35v ; 10uF 6.3v
0.22uF 35v ; 10uF 16v
0.47uF 35v ; 10uF 25v
1.0uF 35v ; 22uF 16v
2.2uF 35v ; 47uF 6.3v
4.7uF 35v ; 100uF 3v

Feed-through Ceramics
1000pF 350v 6p

Disc Ceramics 750 Volts Wtg.
all at 5p each
470pF ; 1000pF ; 5000pF ; 0.01uF

Tubular HI-K Ceramics 750 Volts Wtg.
1000pF 5p ; 3000pF 5p
1500pF 5p ; 5000pF 5p
2000pF 5p ; 0.01uF 5p

Pulse Ceramics all at 10p each
12kv D.C. Wtg 8kv D.C.
10pF 120pF 200pF
22pF 140pF 220pF
68pF 150pF 250pF
82pF 180pF 270pF
100pF 200pF 300pF

VAT INCLUSIVE PRICES AT 8% OVERSEAS CUSTOMERS DEDUCT ^{2/21}
VAT INVOICES ON REQUEST
P&P On U.K. Orders 15p Overseas Orders at Cost

battery. That could make it quite a lot louder! But I think that modifications will become necessary if we wish to operate at over 6 volts, or to use several loudspeakers."

Bob decided to start with a low voltage and work up. He found that with a 1.5 volt dry-cell he could connect 2 or 3 three ohm loudspeakers together to the terminals of the amplifier, but after a few minutes the sound faded and became distorted. The battery he was using was not a fresh one, however, and when he tried a new battery the sound was a lot better.

"If you continue to use a large number of speakers of only 3 ohms," observed the Prof., "The battery will not last for very long. However, an equal number of 8 ohm speakers will enable the battery to last approximately twice as long, and 15-ohm speakers would enable the battery to last even longer."

Still using the 1.5-volt dry-cell, Bob connected a pair of low-impedance headphones in place of the speakers, and found that the unit made a fine headphone amplifier. Then he changed back to the loudspeakers and replaced the single dry cell with a 3 volt cycle front-lamp battery.

Before switching on again, he was careful to turn VR2 to lowest bias, so that the bias could be reset to suit the new voltage. He noticed that the sound output could be made considerably louder with the 3 volt supply than when he had been using only 1.5 volts.

"Will it be all right to use a 4.5 volt or a 6-volt battery now, Prof.?" he asked.

MODIFICATIONS

"If you use either a smaller number of loudspeakers, or speakers of higher impedance in ohms, so that TR3 does not overheat, then you will only need to adjust the bias control again to operate the amplifier successfully.

If you go above 6 volts, it will be necessary to alter R3, and I would suggest using a 220 ohm wirewound 2.5 watt resistor. Also, it may be necessary to replace TR3 with a transistor capable of handling higher current and power dissipation. This would depend upon the speakers you use, and the bias setting."

Bob drilled some holes in a

piece of 16 s.w.g. aluminium about 50 sq. cm. in area and bolted a 2N3055 transistor into place on it, using a small quantity of silicone grease for good heat transfer. He replaced R3 with a 220 ohm 2.5 watt w.w. resistor as the Prof. had suggested. Now he readjusted the bias control VR2 to zero, connected a 6 volt battery and switched on. He found that two or three 3 ohm speakers could be used, and the volume from each speaker was now considerably greater than before.

"It is loud enough now" remarked Bob, "to use for a small party, or to have a few friends around to listen!"

The Prof. agreed. "The output from the amplifier is quite powerful now—and I would not advise the use of headphones without a series resistor to cut down the power. Also, if you touch the heat sink, you will notice that TR3 is now quite warm. This is all right as it will operate at quite a high temperature. But it is a sign that a larger heat sink would be beneficial if we boost the output power of the amplifier much more!"

"I would like to try using a 12 volt car battery" remarked Bob. While he fitted a larger heat sink, the Prof. pursed his lips and emitted a series of clicks and whistles. A series of answering signals came from another part of the laboratory, and a few minutes later, the Prof's experimental robot came into view, carefully clutching a 12-volt car battery. Being very careful not to short-circuit the battery with his metal arms or body, he set it down on the bench near to where Bob was working. Next to the battery he deposited a set of red and black connecting leads with crocodile clips attached.

Turning the bias control to zero setting, Bob connected a single 15 ohm speaker to the amplifier, then connected the 12 volt battery. He adjusted the bias control once more until the music signal which he was feeding to the input came through loud and clear.

Now the music was so much louder that Bob found that it had attracted a small audience. From different parts of the laboratory the Prof. and his experimental robot came and stood beside Bob as he made adjustments to the controls.

"I see that you have used a larger speaker now that the amplifier is being operated from

12 volts," remarked the Prof. "That is a very wise precaution, as the speaker coil may be required to dissipate several watts under normal working conditions, and if VR2 were incorrectly adjusted the dissipation could exceed 10 watts, which would be enough to damage some speakers.

If you decide to try the amplifier with an 8 ohm speaker at this voltage, it would be necessary to either use an even more powerful speaker, or to exercise care when adjusting VR2, so that excess current does not flow in the speaker coil."

The Prof. listened carefully to the amplifier.

"It is Paul's birthday soon," he remarked, "And I think I heard him mention that he would like a 12 volt amplifier for use in his car!"

The Prof's experimental robot had also been listening carefully to the amplifier. Soon the Prof. and the robot were engaged in what appeared to Bob to be a lively conversation in a special code of clicks and whistles.

"What was all that about, Prof.?" he asked when they had finished.

"The robot was giving me a list of the distortion figures at various frequencies and degrees of intermodulation which he has deduced by listening to the equipment just now. It may sound just fine to us humans—but apparently it's not quite up to the robot's high standard."

"The robot is sensitive to the technical quality of the sound reproduction, but we are sensitive to the qualities of the music which is being reproduced."



"Talk about ironic! He was going to buy the components for his Lighting-up Warning and got pinched for having no lights on."

DOWN TO EARTH

By GEORGE HYLTON

METER SENSITIVITY AGAIN

MR. EBRAHIM ALI writes from Bahrein with a question which often puzzles newcomers to electronics. (To be fair, it must be said that it would puzzle a lot of old hands as well, if they stopped to think about it.) It's just this: "What do makers of multi-meters mean when they quote the sensitivity in 'ohms per volt'?"

This question was dealt with in an earlier *Down to Earth* (November, 1973, page 615) but I welcome the opportunity to have another go at it, both for the benefit of new readers and for the chance of exploring it from a rather different angle. In the earlier article I made the point that ohms per volt is really not much more than a roundabout way of stating the amount of current which has to flow through a voltmeter to move the pointer from zero to maximum on the scale; e.g., if the meter has a sensitivity of 1000 ohms per volt the current for full-scale deflection is 1mA. (To find the current, divide the full-scale volts by the ohms: $1V/1000 \text{ ohms} = 1mA$.)

The only reason for quoting ohms per volt is that it gives a quick way of working out the resistance of a voltmeter when set to a particular voltage range. Thus a meter of 20 kilohms/volt has a resistance of 20 kilohms on its 1V range, 200 kilohms on its 10V range, and so on. This resistance has an effect on the circuit being measured, and knowing it helps you to see whether the effect is serious and if necessary to allow for it.

VERY SIMPLE CASE

To take a very simple case, suppose you want to use your voltmeter to test a dry battery. If your meter is 20 kilohms/volt and you set it to a 10V range to check a 9V battery, the meter

resistance is 200 kilohms. To read 9V, the meter will draw only 45 microamps. But the battery, in actual service, will usually have to deliver a lot more than this, and the voltage will then fall.

A more realistic test will be to put the battery in its equipment, switch on, and check the voltage on load.

This is one of the few cases where the meter is too sensitive for the job. Usually it isn't sensitive enough. The reason is easily seen from a practical measurement (Fig. 1). Here the flow of collector current I_c sets up a volts drop across R_c ($V = I_c R_c$ by Ohm's law). When the meter is connected, the meter resistance R_m is in parallel with R_c and part of I_c is now diverted through R_m . The result is to reduce V . So the meter indicates something less than the "true" voltage.

LOADING ERROR

To take a simple case, if $R_m = R_c$, then half the current is diverted through the meter and the voltage reading is 50 per cent low. Clearly, if the error is to be small, R_m should be much greater than R_c so that only a small portion of I_c is diverted. Ideally, R_m should be infinite, then there would be no such "meter loading error", but this ideal is approached only by electronic voltmeters. With ordinary multi-

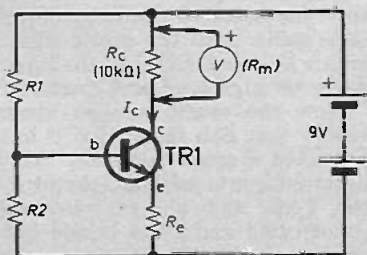

Fig. 1. Measuring the voltage across the collector load of a simple amplifier.

meters there is always some error. The question is, is it serious?

SIMPLE RULE

Well, to take another case, if R_m is 100 times R_c common sense tells you that only about one-hundredth of the current is diverted through the meter. The error can't be more than one-hundredth, i.e. 1 per cent, which is usually quite negligible.

The trouble is that, even with a sensitive meter of 20 kilohms/volt or more there are still plenty of cases where the meter resistance is a good deal less than 100 times the circuit resistance. Can you allow for this? That is, can you estimate the error? Yes, and the rule is quite simple. If the meter resistance is ten times the circuit resistance then the meter reads low by one eleventh, and so on.

Thus if R_c were 10 kilohms and R_m 200 kilohms, which makes $R_c/R_m = 1/20$, the error would be $1/21$ of the reading. The error fraction has a number at the bottom which is always one more than the resistance fraction. In symbols, if the "true" voltage is called V_o and the meter reading V_m , then:

$$V_o = V_m (1 + R_c/R_m)$$

This says that to find the true voltage you add to the indicated voltage the resistance fraction times the indicated voltage.

In Fig. 1, suppose R_c is 10 kilohms, and the meter is 20 kilohms/volt, set to its 10V range, and the meter reads 5V. What's the true voltage?

First, work out R_m . At 20 kilohms/volt and 10V, $R_m = 10 \times 20 = 200$ kilohms. So $V_o = 5 (1 + 10/200) = 5.25$ V. Not a very serious error. But if the meter sensitivity had been only 2 kilohms/volt the true voltage would have been 7.5V for a 5V indicated voltage, quite a serious error in this particular case.

REDUCING ERROR

To reduce the loading error you can switch to a higher voltage range. Changing from a 10V range to a 100V range multiplies the meter resistance by 10. The price you have to pay is a much smaller pointer deflection, making it hard to read the voltage accurately, but sometimes the price is worth paying.

SINCLAIR OM2 DIGITAL MULTIMETER

Will measure AC and DC volts, AC and DC current, and resistance in a total of 20 ranges. The large light emitting diode display will read up to 999 and automatically indicate polarity. Indication of over-range and negative overload is also provided. The instrument is fitted with a combined carrying handle and bench stand and sockets are provided for the connection of an external power supply.

RANGES:
DC VOLTS: 1v, 10, 100v, 1000v.
AC VOLTS: 1v, 10v, 100v, 1000v.
DC CURRENT: 1mA, 10mA, 100mA, 1000mA.
AC CURRENT: 1mA, 10mA, 100mA, 1000mA.
RESISTANCE: 1k, 10k, 100k, 1000k.

OUR PRICE £59.95 Ins. P & P 50p

RUSSIAN C16 Double Beam OSCILLOSCOPE
5 MHz pass band. Separate Y1 and Y2 amplifiers. Rectangular 5" x 4" CRT. Calibrated triggered sweep from 0.2sec. to 200µs. Multi-scale. Free running time base, 50kHz-1MHz. Built-in time base. Calibrator and amplitude Calibrator. Supplied complete with all accessories and instruction manual.

OUR PRICE £87.00 Carr. paid

MODEL TE15 GRID DIP METER
Transistorised. Operates as Grid Dip, Oscillator, Absorber, Wave Meter and Oscillating Detector. Frequency range 40kHz-200kHz. In size coils, 500µA meter. 9V battery operation. Size: 180 x 80 x 48mm.

OUR PRICE £17.50 Ins. P & P 30p

TRANSISTORISED L.C.R. A.C. BR/8 MEASURING BRIDGE
A new portable bridge offering excellent range and accuracy at low cost. Resistance: 5 ranges; 0.1 ohm-11.3 megohm ± 1% indication; 6 ranges: 1 microhenry-111 henries ± 2% Capacity. 6 ranges: 10pf-1110 mfd ± 2% Turns Ratio. 6 ranges: 1:1, 1000:1, 1:100, ± 1%. Bridge Voltage at 1,000cps. Operated from 9-volt battery. 100 microamp meter indication. Size 78" x 6" x 2"

OUR PRICE £27.50 Ins. P & P 30p

TE16A TRANSISTORISED SIGNAL GENERATOR
6 ranges, 400kHz to 30 MHz. An innovative instrument for the handy-man. Operates on 9V battery. Wide easy to read scale. 800kHz modulation. Size: 149 x 149 x 92mm. Complete with instructions and leads.

OUR PRICE £8.97 Ins. P & P 30p

TE-20D RF SIGNAL GENERATOR
Adjustable wide range signal generator covering 120 kHz 500 MHz on 6 bands. Directly calibrated. Variable R.F. attenuator audio output. Xial socket for calibration. 220/240V a.c. Brand new with instructions. Size 140mm x 216mm x 170mm.

OUR PRICE £22.50 Ins. P & P 50p

ARF 300 AF/RF SIGNAL GENERATOR
All transistorised compact fully portable. AF sine wave 15Hz to 220 kHz. AF square wave 15Hz to 100k Hz. Output Square/Sine wave 10V. P.F. 100kHz to 200MHz. Output 1V maximum. 220/240V A.C. operation. Complete with instructions and leads.

OUR PRICE £37.50 Ins. P & P 50p

MODEL TE20 RF SIGNAL GENERATOR
Six bands, 120kHz-260MHz. Dual output R.F. terminals. Separate variable audio output. Accuracy ± 2%. Audio output to 8V. Power requirements: 105-125V, 220-240V A.C. Size 183 x 265 x 150mm. Complete with test leads etc.

OUR PRICE £18.95 Ins. P & P 30p

TE22 SINE SQUARE WAVE AUDIO GENERATOR
Sine 20cps to 200kHz on 4 bands. Square 20 cps to 30 kHz. Output impedance 500 Ohms. 200/250V A.C. operation. Supplied brand new guaranteed, with instruction manual and leads.

OUR PRICE £24.95 Ins. P & P 50p

STOP PRESS!!

TODAYS BEST VALUE

WHARFEDALE SPEAKERS at Special LASKYS PRICES

DENTON 2 In Walnut of Rosewood £28.00 per pair plus VAT

LINTON 2 In Walnut £36.98 per pair plus VAT

GLENDALE 3 In Teak £57.50 per pair plus VAT

UNREPEATABLE OFFER - BUY NOW LIMITED STOCKS

NEARLY 25% OFF GARRARD 865B MODULE
This complete unit comes fitted in white plinth with hinged cover. shura M7658M magnetic cartridge. This 2-speed belt drive deck comes with many features. Bias control, low-resonance arm. Today's value £50.00.

OUR PRICE £35.95 Ins. P & P £1

BATTERY/LEVEL PANEL INDICATOR
18mm 18mm Panel mounting. **OUR PRICE** 75p P&P Ins. 15p Discounts for quantity.

NEW GOLDING G102 KIT

Belt-drive 2-speed turntable in kit form complete with pick up arm and head shell.

OUR PRICE £16.95 Ins. P & P 75p

VU METER TYPE 3
250µA Size: 33mm 20mm. **£1.25** P & P Ins. 16p

T.T.C. SPRITE STEREO HEADPHONES
Feather weight (1oz) Dynamic stereo headphones providing high quality reproduction at a budget price. Soft removable ear pads and adjustable headband. Speaker size: 28mm. Impedance: 8 ohms. Frequency response: 30-13000 Hz.

OUR PRICE £1.95 Ins. P & P 30p

SDH8V MONO/STEREO HEADPHONES
Volume control for each channel. 4/16 ohms impedance. Frequency response 20Hz-18kHz. Complete with 10ft. coiled lead and jack plug.

OUR PRICE £4.97 Ins. P & P 30p

AUDIOTRONIC HEADPHONES LSH20 Individual volume controls Mono/stereo switch. 40-1000 Hz. **OUR PRICE £4.50** Ins. P & P 50p

LSH30 Individual tone and volume controls. Mono/stereo switch. 30-20,000 Hz. 8 ohms. **OUR PRICE £7.00** Ins. P & P 30p

LSH40 Two-way speaker system. Individual volume controls. 20-20,000 Hz. **OUR PRICE £8.50** Ins. P & P 30p

RANK AUDIO RA 210T STEREO AMPLIFIER
73 7j wetts rms. Inputs for magnetic phono, tuner, tape and tone. Separate bass, treble, balance and volume controls. Headphone socket. Teak case. Unrepeatable offer.

OUR PRICE £17.50 Ins. P & P 50p

SUPERB QUALITY LOW PRICES AUDIOTRONIC DIGITAL CLOCK RADIOS

ADC22 24-hour clock radio covering MW/FM wavebands. 180-minute sleep timer. Choice of Grey or White cabinet. **NOW ONLY £13.95** Ins. P & P £1

ADC33 24-hour clock radio covering MW/FM wavebands. 180-minute sleep timer. Buzzer alarm. Tone control. **NOW ONLY £15.95** Ins. P & P £1

SPECIAL OFFER! CONVERT YOUR STEREO SYSTEM TO 4D SOUND

This clever unit enables you to add 4D sound to your existing system. Complete with simple connection details. Use this converter (together with 2 extra speakers) to achieve the fantastic 4D quadrophonic sound! The effect of being immersed within the music becomes a thrilling new experience (2 year guarantee).

OUR PRICE £3.95 Ins. P & P 50p

FM TUNER CHASSIS
6 transistor high quality tuner. Size only 153 x 101 x 83mm 3 IF stages. Double tuned discriminator. Ample output to feed most amplifiers. Operates on 9V battery. 89-106MHz. Ready built, ready for use. Fantastic value for money.

OUR PRICE £8.95 Ins. P & P 20p

WALKIE TALKIES SKYFON NV7
Super low cost transmitter/receivers. 100MW with call buzzer and on/off volume control. 7 transistors. Telescopic rod antenna. **OUR PRICE £31.50** per PAIR Ins. P & P 50p. NOT LICENSABLE IN THE U.K.

POCKET CALCULATOR 'TECO TE8053'
8 digit, 4 function. **List Price £10.50** **OUR PRICE £8.95** P&P Ins. 25p

SINCLAIR CALCULATORS LOWEST PRICES EVER!

SINCLAIR CAMBRIDGE 8 digit, Constant, DC only. List Price £12.95 **OUR PRICE £11.00** P & P Ins. 25p

SINCLAIR CAMBRIDGE MEMORY 8 digit, Automatic Constant, Memory, DC only. List Price £17.95 **OUR PRICE £15.25** P & P Ins. 25p

SINCLAIR SCIENTIFIC Logs Trig, Arithmetic, Scientific notation, DC only. List Price £19.95 **OUR PRICE £16.95** P & P Ins. 25p

SINCLAIR EXECUTIVE MEMORY 8 digit, Constant, Memory, DC only. List Price £24.95 **OUR PRICE £21.25** P & P Ins. 25p

SINCLAIR NEW OXFORD RANGE
OXFORD 100 4 function. (DC). Mains adaptor optional extra. List Price £12.95 **OUR PRICE £11.00** P & P Ins. 25p

OXFORD 200 4 function plus Memory and Percentage (DC). Mains adaptor optional extra. List Price £19.95 **OUR PRICE £16.95** P & P Ins. 25p

OXFORD 300 Scientific (Available late March) (DC). Mains adaptor optional extra. List Price £29.95 **OUR PRICE £25.50** P & P Ins. 25p

OXFORD MAINS ADAPTOR **OUR PRICE £2.95** optional extra

ELECTRONIC CALCULATORS

We carry a tremendous range of both pocket and desk calculators from as little as £8.45. Owing to the demand it is not possible to include them in this advertisement, so send for our latest price list or call into any branch.

MINIATURE ORGAN MUSIC MASTER AM100

Spanning nearly two octaves. Including semi-tones. This instrument will give hours of enjoyment to all the family. Beautifully finished. The Keyboard range can be adjusted to be in tune with any instrument. Operates from internal 9V battery. Fitted with on/off switch, vibrato switch, earphone socket and external 9V D.C. socket. Size 229mm x 127mm x 64mm. **OUR PRICE £7.95** Ins. P & P 50p.

HANIMEX HDC 1900 DIGITAL ALARM CLOCK

240V operation with large clear numbers, night light and 'snooze' switch. Attractively finished in white and silver. **OUR PRICE £7.50** Ins. P & P £1.00

SINCLAIR Project 80 Modules
240 Power Amp. £4.50 Ins. P & P 15p
280 Power Amp. £5.80 Ins. P & P 15p
Stereo 80 Pre-Amp. £7.45 Ins. P & P 15p
Active Filter Unit £7.45 Ins. P & P 15p
FM Tuner £10.50 Ins. P & P 15p
Stereo Decoder £5.75 Ins. P & P 15p
P25 Power Supply £3.75 Ins. P & P 30p
P26 Power Supply £6.75 Ins. P & P 30p
P26 Power Supply £6.35 Ins. P & P 30p
Transformer for P24 £4.05 Ins. P & P 30p

AUDIOTRONIC LOW NOISE CASSETTES

TYPE	5	10	25
C60	£1.57	£3.00	£7.08
C90	£2.24	£4.26	£10.00
C120	£2.73	£5.17	£12.24

Ins. P & P 3p each. 10 and over Post Free

AUDIOTRONIC ANA101 Stereo Headphone Amplifier

All silicon. All transistor amplifier operates from magnetic, ceramic or tuner inputs with twin stereo headphone outputs and separate volume controls for each channel. Operates from 9V battery. INPUTS: 5mV and 100mV. OUTPUT: 500mV per channel. **OUR PRICE £8.50** Ins. P & P 30p

HIGH QUALITY CONSTRUCTION KITS

WE ARE STOCKISTS AT Oxford Street, 42 & 257 Tottenham Court Road, 34 Lisle Street, 152, Fleet Street, 311 Edgware Road, CROYDON BIRMINGHAM KINGSTON LEICESTER LEICESTER SOUTHEND TUNBRIDGE WELLS WOLVERHAMPTON branches or by Mail Order.

All kits are complete with comprehensive easy to follow instructions and covered by full guarantees. Post and Packing Ins. 15p per kit.

AF20 Mono amplifier	£5.61
AF25 Mixer	£3.29
AF25 Mono pre-amplifier	£3.20
AF35 Smitter amplifier	£4.82
AF80 0.5W stereo amplifier	£4.86
AF305 Intercom	£7.63
AF310 2 Mono Amplifier	£7.55
M160 Multi-vibrator	£8.10
M1302 Transistor tester	£8.13
M191 VU Meter	£5.37
M192 Stereo balance meter	£5.93
L330 Quadraphonic device	£ 8.42
AT5 Automatic light control	£3.75
AT30 Photo cell switch unit	£5.68
AT50 400W triac light dimmer/speed control	£5.18
AT56 2.200V triac light dimmer/speed control	£6.75
AT60 1 channel light control	£10.82
AT65 3 channel light control	£14.52
GU330 Triac unit	£8.10
HF61 Diode detector	£3.87
HF65 FM transmitter	£3.21
HF75 FM receiver	£2.88
HF310 FM tuner	£18.32
HF325 Delux FM tuner	£24.33
HF330 Decoder (HF310/325)	£10.55
GP310 Stereo pre-amp	£22.98
GP32 Circuit board	£10.02
GP304 Circuit board	£5.33
HF380 w/h/h aerial amplifier	£6.02
HF395 broadband aerial amp	£2.10
NT10 Stabilised power supply	
100mA V	£6.27
NT300 Stabilised p. supply	£13.16
NT310 Power Supply 240V AC or 2 x 18V D.C. at 2amps	£5.84
NT305 Voltage converter	£5.64
NT315 Power supply 240V AC to 4 x 15V DC, 500mA	£12.06

Amateur Electronics by Josy Kit, the professional book for the amateur - covers the subject from basic principals to advanced electronic techniques. Complete with circuit board for AE1 to AE10 listed below. **OUR PRICE £3.30** (No VAT) Ins. P & P 25p plus VAT.

AE1 100mW output stage	£1.55
AE2 Pre-amplifier	£1.32
AE3 Diode receiver	£2.05
AE4 Flasher	£1.26
AE5 Astable multi-vibrator	£1.14
AE6 Monostable multi-vibrator	£1.11
AE7 RC generator	£1.08
AE8 Bass filter	£1.05
AE9 Tickle filter	£1.05
AE10 PCB filter	£1.05

Also see previous page

ALL PRICES EXCLUDE VAT

ENGINEERS

FREE

YOURSELF FOR A BETTER JOB WITH MORE PAY!

Do you want promotion, a better job, higher pay? "New Opportunities" shows you how to get them through a low-cost home study course. There are no books to buy and you can pay-as-you-learn.

This helpful guide to success should be read by every ambitious engineer. Send for this helpful 75 page FREE book now. No obligation and nobody will call on you. It could be the best thing you ever did!



CUT OUT THIS COUPON
CHOOSE A BRAND NEW FUTURE HERE!

Tick or state subject of interest. Post to the address below.

- | | | |
|--|---|---|
| <input type="checkbox"/> Electrical Engineering | <input type="checkbox"/> General Radio and TV Engineering | <input type="checkbox"/> CITY AND GUILDS Electrical Technicians |
| <input type="checkbox"/> Electrical Installations and Wiring | <input type="checkbox"/> Radio Servicing, Maintenance and Repairs | <input type="checkbox"/> CITY AND GUILDS Telecommunications |
| <input type="checkbox"/> Electrical Draughtsmanship | <input type="checkbox"/> Transistor Technology | <input type="checkbox"/> Radio Amateurs' Exam. etc. etc. |
| <input type="checkbox"/> Electrical Mathematics | <input type="checkbox"/> CITY AND GUILDS Installations and Wiring | |
| <input type="checkbox"/> Electronic Engineering | | |
| <input type="checkbox"/> Computer Programming | | |

ALDERMASTON COLLEGE

Dept EEV 06 Reading RG7 4PF

NAME (Stock Capitals Please)

ADDRESS

POSTCODE

Other subjects

Age

Accredited by C.A.C.C.

Member of A.B.O.C.

EEV 06

HOME OF BRITISH INSTITUTE OF ENGINEERING TECHNOLOGY

CJL PRICES INCLUDE P&P AND V.A.T.

- AERIAL, telescopic, 15-120cm. £1.20
- AERIAL, telescopic, h and v swivel, 15-80cm. £1.78
- BIB HI-FI ACCESSORIES**
- CASSETTE TAPE RECORDER CARE KIT £1.95
- CASSETTE SPLICING AND EDITING KIT £1.50
- HI-FI STEREO TEST CASSETTE £2.10
- 1" TAPE EDITING KIT £1.35
- GROOV-KLEEN RECORD CLEANER £1.85
- EARPHONE, stethoscope style, 8 ohm dynamic. £1.00
- HAND DRILL (Leytool), compact precision drill, 5/16" chuck. Gears totally enclosed. S/L bearings. £2.99
- INTEGRATED CIRCUITS**
- AUDIO POWER AMPLIFIER (National) LM380 £1.00
- A.M. RADIO RECEIVER (RCA) CA3123E £1.40
- F.M. STEREO DECODER (Motorola) MC1310P £2.80
- TIMER (Signetics) NE555V £0.78
- VOLTAGE REGULATOR (Fairchild) uA7805 £1.70
- VOLTAGE REGULATOR (Signetics) NE550A £0.80
- D.I.L. SOCKETS (Pk of 3) 8 or 14 pin £0.50
- KEYNECTOR, rapid connect to mains-single/multiple leads. Built-in piano switches neon & 13A fuse £3.20
- LOCKFLEX RULE (Rabone Chesterman), 3m/10ft precision pocket rule. Easy to read, 13mm/1/2" wide steel tape. Blade length lockable-power return. A superb rule £0.93
- MICROPHONE, lightweight dynamic, remote start stop, 200 ohms, 100-10kHz, 6mV average output £1.80
- MULTIMETER, attractive design, Vdc-10, 50, 250, 1,000. Vac-10, 50, 250, 1,000. Idc-100mA. R-150k £4.95
- SIGNAL INJECTOR, audio through video signals, excellent for servicing amplifiers, radio & tv £3.92
- SOLDERING IRON, 25 WATT (Antex), X25, 240V. Very low leakage, 1/8" long life bit (interchangeable) £2.05
- 3/32" bit £0.47 3/16" bit £0.47 Element £1.10
- STAND, ST3, High grade base, chrome plated spring, sponges and accommodation for spare bits £1.00
- SPEAKER, miniature, 75mm dia, 8 ohms. £0.80



CJL LTD. P.O. BOX 34, CANTERBURY, CT1 1YT

VEROSTRIP

LENGTH 8.5"

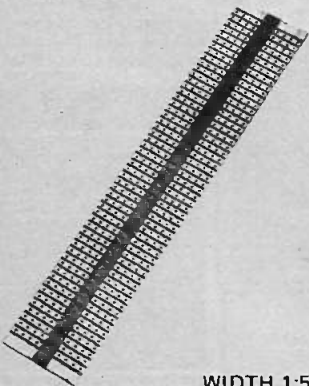

WIDTH 1.5"

Available from your Local Retailer

0.1 and 0.15 pitch Vero Strip is suitable for all applications where Tag Boards can be used.



VERO ELECTRONICS LTD.
INDUSTRIAL ESTATE
CHANDLERS FORD HANTS.

4-STATION INTERCOM



£16.15

Solve your communication problems with this

4-Station Transistor Intercom system (1 master and 3 Subs), in robust plastic cabinets for desk or wall mounting. Call/talk/listen from Master to Subs and Subs to Master. Ideally suitable for Business, Surgery, Schools, Hospitals and Office. Operates on one 9V battery. On/off switch. Volume control. Complete with 3 connecting wires each 66ft. and other accessories. P. & P. 65p.

MAINS INTERCOM NEW MODEL

No batteries—no wires. Just plug in the mains for instant two-way, loud and clear communication. On off switch and volume control. Price £28.74 per pair P. & P. 70p.

NEW! AMERICAN TYPE CRADLE TELEPHONE AMPLIFIER



ONLY

£11.95

VAT 96p

Latest transistorised Telephone Amplifier with detached plug-in speaker. Placing the receiver on to the cradle activates a switch for immediate two-way conversation without holding the handset. Many people can listen at a time. Increase efficiency in office, shop, workshop. Perfect for "conference" calls: leaves the user's hands free to make notes, consult files. No long waiting, saves time with long-distance calls. On/Off switch, volume. Direct tape recording model at £12.95 + VAT £1.04 P. & P. 65p. 10-day price refund guarantee.

WEST LONDON DIRECT SUPPLIES (E8)
169 KENSINGTON HIGH STREET, LONDON, W8

ELECTRON-KIT

Electronic fun for all ages

The most versatile electronics kits. All components are beautifully encapsulated in unbreakable transparent plastic blocks. Perfect connections are made WITHOUT SOLDERING, SCREWING OR WIRING. INCREDIBLE VALUE. Build, dismantle and rebuild projects any number of times and invent your own experiments too.

COMPLETELY SAFE. Instructive and FUN—all kits operate from 9v. battery only.

VALUABLE MANUALS included with every kit. No previous knowledge is required, even with the largest kits.

KIT 2A—30 projects £10.45. Radios, amplifiers, alarms, microphones, Morse, etc.
KIT 3A—100 projects £20.45. As 2A plus electronic birds, cats, sirens, organs, metronome, guns, light and sound, burglar alarms, etc.

3ADX—105 projects £25.25. As 3A plus solar cell experiments and complete sophisticated control panel, etc.

4ADX—150 projects £33.95. As 3ADX plus Relay and Meter experiments; ion concentration—, volume—, out-put—, field intensity—, volt—, resistance meters, ammeter, illuminometer, etc. and many, many more.

ADD-ON parts and manuals available as required.

The three larger kits include Electrical experiments too.

All prices include Battery, Manual, VAT & p. p.

Cheque/P.O. (or 6p for literature) to:

Satisfaction guaranteed

ELECTRON-KIT LTD, 408 St. John's Street, London, EC1. [01-278 4579]

BI-PRE-PAK

Bargains in Semi-Conductors, components, modules & equipment.

Bargains from our FREE Catalogue

20 large pages, filled with real bargains in transistors, I.C.s, components, equipment, etc. Send large S.A.E. with 6p stamp for your FREE copy of 6th Edition by return. Meanwhile, for prompt delivery order from this month's ad. NOW.

TRANSISTOR PACKS ALL AT 50p EACH TESTED & GUARANTEED

B79	4	1N4007 Sil. Rec. diodes. 1,000PIV 1 amp. plastic	H39	6	Integrated circuits 4 gates BMC 962, 2 flip flops BMC945 BD131/BD132
B81	10	Reed Switches. 1 long 1/2" dia. High-speed P.O. type	H41	2	Complementary Plastic Transistors 40361 Type NPN Sil. Transistors TO-5 can comp. to H68
H35	100	Mixed Diodes, Germ. Gold bonded, etc. Marked and Unmarked.	H65	4	40382. Type PNP Sil. Transistors TO-5 can comp. to H65
H38	30	Short lead, NPN Silicon Planar Ex Equipment.			

UNMARKED & UNTESTED

B1	50	Germanium Transistors PNP, AF and RF	H6	40	250mV zener diodes, At least 20 good.
B66	150	Germanium Diodes Min. glass type	H15	30	Silicon rectifiers 750mA assorted. Top-hat type.
H68	10	Experimenter's pack of I.C.s, D.T.L. and T.T.L. (some marked)	H34	15	Power Transistors, PNP. Germ. NPN Silicon TO-3 Can
B86	100	Sil. Diodes sub. min. 1N914 and 1N916 types	H67	10	3819N Channel FET's plastic case type

PLASTIC POWER TRANSISTORS

40 WATT SILICON				
Type	Polarity	Gain	VCE	Price
40N1	NPN	15	15	20p
40N2	NPN	40	40	30p
40P1	PNP	15	15	20p
40P2	PNP	40	40	30p
30 WATT SILICON				
Type	Polarity	Gain	VCE	Price
30N1	NPN	15	15	25p
30N2	NPN	40	40	35p
30P1	PNP	15	15	25p
30P2	PNP	40	40	35p

NEW X-HATCH GENERATOR Mk. 2



Essential for Colour T.V. alignment of 4 patterns. Featuring plug in IC's and a more sensitive sync. pick-up circuit. The case is virtually unbreakable—ideal for the engineer's toolbox—only measures 3" x 5 1/2" x 3". Operates from 3 U2 type batteries (extra).

P/P add Complete kit- **£7.93** Ready built unit only **£9.93**

TO CLEAR

Hundreds of various portable transistor radio chassis with FM & AM tuning. Ideal for experimenters. Components in going order, but no instructions or tuning drives. A cheap way to make a portable. Each £1

SUNDRY

Capacitor Discharge Ignition Kit £7.50. 8 assorted relays £1.00. Rev counter device (for cars) £1.00. U.H.F./TV Tuner Units £2.50. Technical books including Newnes & Butterworth, of all kinds.

TERMS OF BUSINESS

V.A.T. Prices shown do not include V.A.T. This must be added to total value of your order including postage at current rate.

No V.A.T. on overseas orders. POSTAGE Except where stated, add 20p for postage & packing in U.K. Overseas—add £1, any difference being charged or refunded.

PAYMENT Cash with order, Cheque or money order. Minimum order value £1. You can also pay by ACCESS.

IMPORTANT—Every effort is made to ensure accuracy of prices and description at time of preparing this advertisement and going to press. Prices are subject to alteration without notice.

BI-PRE-PAK LTD

Co. Reg. No. 212170

222 224 WEST ROAD, WESTCLIFF-ON-SEA, ESSEX SSO 9DF.

TELEPHONE: SOUTHEND (0702) 46344.

WRITE ORDER SEPARATELY AND ATTACH COUPON IF REQUIRED



challenging values!

Stirling Sound

STIRLING SOUND AUDIO MODULES come to you as basic units assembled on P.C.B.s enabling you to add required components in layouts of your own choice. Modules are tested and boxed before despatched and include well printed instructions.

PRE-AMP TONE CONTROLS

Pre-amplifiers; tone control		
SS.100	Active tone control unit to provide bass, treble, balance and volume controls	£1.60
SS.101	Pre-amp for ceramic cartridge, tape and radio	£1.60
SS.102	Pre-amp for low output magnetic cartridge, tape and radio. With R.I.A.A. correction ±1dB at 1K	£2.25

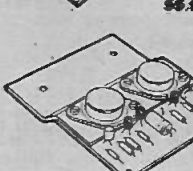
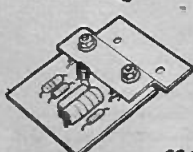
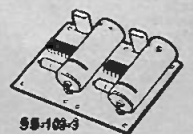

POWER AMPLIFIERS

SS.103	Compact I.C. amp. with 3 watts R.M.S. output. Operating voltage 6 to 22. Size 3" x 2"	£1.75
SS.103-3	Stereo version of above using one I.C. on each channel	£3.25
SS.105	A compact and useful all-purpose amplifier which will run excellently on a 12V supply. With 5 watt output, two make a good stereo amp. Size 2 1/2" x 1 1/2"	£1.95
SS.110	Similar in size to SS.103 but with a 10 watt output. Ideal for many domestic and small-size P.A. applications. Operates from 26 to 32V.	£2.40
SS.140	Excellent designed 40 watt R.M.S. (into 4 ohms) hi-fi amplifier. S/N ratio better than 75dB. THD better than 0.2%. Power requirements—45V, d.c. With 0-15" centre edge connections. Two can be bridged to give 80 watts R.M.S. into 4 ohms	£3.60

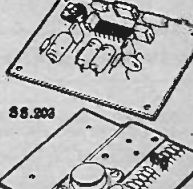
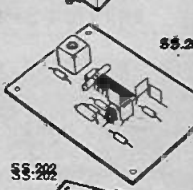
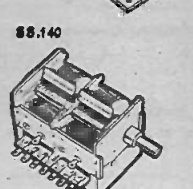
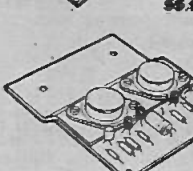

BUILD A STEREO FM TUNER!

SS.201	Ganged tuning condenser with accurately engineered slow-motion drive in rugged housing. Excellent sensitivity. Tunes 88-108MHz. With A.F.C. facility. Operates from 6-16V	£6.25
SS.202	I.F. stage (with I.C.) Pre-tuned. A.F.C. connection. Operates from 4.5 to 14V	£5.25
SS.203	Stereo Decoder. Designed essentially for use with SS.201 and 2. This module can also be used in most mono FM tuners. A LED may be attached. Operating voltage 9-16V. d.c.	£5.62

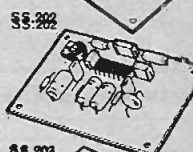
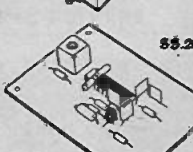
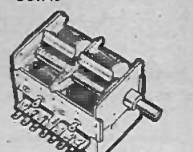

SPECIAL £5 MONEY SAVING OFFER
Buy all three modules for building a stereo FM Tuner (Total list £17.12) and you pay only **£12.12**

POWER SUPPLY STABILIZER

SS.300	Add this to an unregulated supply (say typically 45V output) to obtain a steady powerful working output adjustable from 12 to 60V. Essential on your audio and special systems. Money saving and very reliable	£3.25
--------	--	--------------

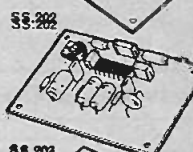

MAINS TRANSFORMERS FOR ABOVE

Add 35p per transformer for PIP	
Type A 18V/1A (Suit SS.103)	£1.50
Type B 25V/2A (Suit SS.110)	£2.00
Type C 30V/2A (Suit SS.140)	£4.50
Bridge Rectifiers—Type A 27p. Types B & C 38p	

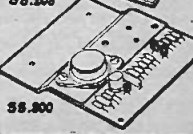

To BI-PRE-PAK, 224-226 WEST RD., WESTCLIFF-ON-SEA, ESSEX

Please send

for which I enclose

Name

Address

EE6

Everyday Electronics Classified Advertisements

RATES: 11p per word (minimum 12 words). Box No. 30p. extra. Semi-display—£7.50 per single column inch. Advertisements must be prepaid and, addressed to Classified Advertisement Department, "EVERYDAY ELECTRONICS," I.P.C. Magazines Ltd., Fleetway House, Farringdon Street, London EC4A 4AD.

EDUCATIONAL

C AND G EXAMS

Make sure you succeed with an ICS home study course for C and G Electrical Installation Work & Technicians Radio/TV/Electronics Technicians. Telecomms Technicians and Radio Amateurs.

COLOUR TV SERVICING

Make the most of the current boom! Learn the techniques of servicing Colour and Mono TV sets through new home study courses, approved by leading manufacturers.

TECHNICAL TRAINING

Home study courses in Electronics and Electrical Engineering, Maintenance, Radio, TV, Audio, Computer Engineering and Programming. Also self-build radio kits. Get the qualifications you need to succeed.

Free details from:

INTERNATIONAL CORRESPONDENCE SCHOOLS.

Dept 751, Interlex House, London SW8 4UJ. Or Phone 01-822 9911 (all hours)

FOR SALE

MICROPHONES: AKG D109, £12.65; AKG D202E1, £43.45; AKG D190C, £18.70; AKG D190E, £20; AKG D224, £55; Sennheiser MD211N, £49.50; Sennheiser MD413N, £29.70. All brand new and boxed. Send CWO to J. J. Francis (Wood Green) Ltd., Manwood House, Matching Green, Harlow, Essex. Tel: Matching 476.

WANTED

TELEPHONES WANTED, candlestick type or older (foreign and English). 01-722 4151.

SERVICE SHEETS

BELL'S TELEVISION SERVICES for Service Sheets, Manuals, Books on Radio's TVs etc. Service Sheets 40p plus SAE. Free book lists on request. Back issues of PW, PE, EE, TV available, cover price plus 9p post. SAE with enquiries. B.T.S. (Mail Order Dept.), 190 Kings Road, Harrogate, Yorks. Telephone (0423) 55885.

RECEIVERS and COMPONENTS

3 ASSORTED M.C. METERS £1.30 (40p). LARGE COMPUTER PANELS 35-50 Transistors, Long Leads, 85p (50p). COPPER CLAD PAX PANELS 51" x 51", 6-65p, c.p. 81" x 91" 3-£1 c.p. 12" x 12" 60p c.p. T.V. CONVERGENCE PANELS 2x AC128, 3 Slugged Coils, 3 Slide Switches 11 w.w. Pots, 3 Carbon Presents, 2 Ferrite Chokes, etc. £1.20 c.p. VALU-PAKS P9, 100 S/mica Caps 73p, c.p. P24, 100 Polyester Caps, Mullard C280 series, £1.18, c.p. Send 12p for lists. Refund on purchase. 71b ASSORTED COMPONENTS £2.20, c.p.

J. W. B. RADIO

2 Barnfield Crescent, Sale, Cheshire M33 1NL Postage in Brackets Mail Order Only

VALVES. Radio, TV, Transmitting, Industrial. 1930 to 1975. 2,000 types stocked, many obsolete: X78-TH4-2P-N78 EBL1 EBL21-TH41-PX4, etc. List 20p. We wish to purchase new and boxed valves. Cox Radio (Sussex) Ltd., The Parade, East Wittering, Sussex. West Wittering 2023.

COMPONENTS GALORE. Pack of 600 mixed components manufacturers surplus plus once used. Pack includes Resistors, carbon and W.W., capacitors various, transistors, diodes, trimmers, potentiometers etc. Send £1+10p p. and p. c.w.o. to CALEDONIAN COMPONENTS, Strathore Road, Thornton, Fife.

MISCELLANEOUS

DIGITAL CLOCK CHIP, AY-5-1224, with data and circuit diagram, £3.66 plus VAT. "Jumbo" LED digits (16mm high), type DL-747, only £2.04 each plus VAT, post free. Greenbank Electronics, 94 New Chester Road, Wirral, Merseyside L62 5AG.

BUDGET MINI AUDIO MIXERS

With Professional Facilities. Slider Faders * Tone Controls * Monitoring * V.U. Meter. Mono or Stereo * Ready to use or Kits. Details Ref. EE

PARTRIDGE ELECTRONICS 21-25 Hart Road, Benfleet, Essex

LOWEST COST IC SOCKETS. Use Soldercon IC socket pins for 8 to 40 pin DIL's. 50p for strip of 100 pins, £1.50 for 3 strips of 100, £4 for 1000. 10p p&p for orders under £2. Add 8% VAT. Instructions supplied—send sae for sample. SINTEL, 53e Aston Street, Oxford. Tel: 0865 43203.

PRINTED CIRCUIT COPPER CLAD

Single Sided. Quality material. Flame retardant to N.E.M.A. Spec. Paper Base (FR2) 1/16 x 7 x 5, 3 for £1. Epoxy Glass (FR4) 1/16 x 7 x 5, 2 for £1. Also panels cut to your requirements, quotation by return. Prices include P. & P. Cash with order.

P. G. Oliver & Co.
4 Hearsall Lane,
COVENTRY CV5 6HH

LOUD 6V SIRENS for burglar alarms, etc. £1.20p, add 15p P&P. Micro switches for door/window contacts, 10p. List 8p. Grimsby Electronics, 64 Tennyson Road, Cleethorpes, South Humberside.

LOUDSPEAKERS

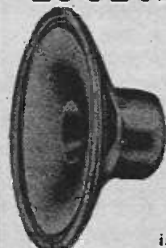

Speakers, kits and cabinets for D.I.Y., Hi Fi, P.A., Disco, etc. by EMI, Fane, Goodmans, Baker, Kef, Elac, Richard Allan, Wharfedale, etc. Send stamp for freebooklet "Choosing a speaker"

WILMSLOW AUDIO

Dept. EE, Swan Works, Bank Square, Wilmslow, Cheshire SK9 1NF Tel. Wilmslow 29599

GADGETS GALORE!!

★ READY BUILT + TESTED ★

Signal Injector £1.95 Signal Tracer £2.95
Logic Probe £4.45 Noise Generator £6.95
Metronome £3.50 Continuity Tester £3.95
Automatic Transistor Checker £19.25

Prices include U.K. Postage and Batteries
—Mail Order Only— S.A.E. list to.

G.K. SERVICES. (G2)
43 Westdale Road, London SE18 3BQ

SUPERB instrument cases by Bazelli, manufactured from heavy duty P.V.C. faced steel. Hundreds of Radio, Electronic and Hi-Fi enthusiasts are choosing the case they require from our range of over 200 models. Largest choice at highly competitive prices, why pay more, prompt dispatch. Free literature (stamp would be appreciated). Bazelli, Department No. 24, St. Wilfrids, Foundry Lane, Halton, Lancaster, LA2 6LT.

AERIAL BOOSTERS £3.30

We make three types of aerial boosters B45-UHF-TV, B12-VHF-TV, B11-VHF-Radio.

VALVES BARGAINS

ANY 5-50p, 10-75p, 50-£3.30.
EC82, EF80, EF183, EF184, PCC189, PCF80, PCF82, PCL82, PCL84, PCL85/805, PFL200, PL36, PL504, PY800, PY88.

COLOUR TV VALVES—PL508, PL509, PY500—25p each.

Prices exclude VAT, P&P 10p, SAE—leaflet
Electronic Mail Order Ltd, 62 Bridge Street,
Ramsbottom, Bury, Lancs. Tel. RAMS 3036

CONSTRUCTION AIDS. Screws, nuts, spacers, etc., in small quantities. Aluminium panels punched to spec. or plain sheet supplied. Fascia panels etched aluminium to individual requirements. Printed circuit boardmasters, negatives and boards, one-off or small numbers. Send 6p for list. **RAMAR CONSTRUCTOR SERVICES,** 29 Shelbourne Road, Stratford-on-Avon, Warks.

MULTIMETER

Type U4324

20,000 Ω/V, Overload protected. Ranges: 0.6, 1.2, 3, 12, 30, 60, 120, 600, 1200V DC; 8, 6, 15, 60, 150, 300, 600, 900V AC; 0.06, 0.6, 6, 60, 600mA, 3A DC; 0.3, 3, 30, 300mA, 3A AC; 5 resistance ranges to 5M Ω, dBa, —10 to +12. Size 187 x 98 x 83mm. Supplied complete with test leads, clips spare diode and instructions.

ONLY £11.00.

PC ETCHING KIT

Contains 1lb Ferric chloride, DALO etch-resist pen, 100 sq ins copper clad board, etching dish, abrasive cleaner and instructions. £3.30

FERRIC CHLORIDE

Anhydrous to Mill-spec in double-sealed 1lb packs. 1lb 90p; 3lb £1.80; 10lb £4.70.

VEROBOARD

100 sq ins 0.1, 0.15 & 0.2" good-size offcuts (About 8 pieces) £1.15.

TRANSFORMERS

Miniature type, mains primary, 100mA sec. 6.0-6V 85p; 9.0-9V 90p; 12.0-12V 95p.

71b BARGAIN PARCELS

Contain hundreds of resistors, pots, capacitors, switches + PC boards with transistors and diodes, also loads of odds and ends.

GREENWELD ELECTRONICS [EE6]

51 SHIRLEY PARK ROAD,
SOUTHAMPTON SO1 4FX
Tel (0703) 772501. Also at 38 Lower Adalcombe Rd, Croydon & 21 Deptford 8th SE8.
ALL PRICES INCLUDE 8% VAT AND UK POSTAGE. SAE LIST, ENQUIRIES. CALLERS WELCOME.

HOME SCIENTISTS
Get the key to a FANTASTIC WORLD of previously UNHEARD-OF-PROJECTS. The NEW Boffin catalogue lists LOTS of HIGHLY UNUSUAL, LOW-COST BARGAINS, READY-BUILT MODULES. Here are just a few examples, there are stacks more!

Dazzling MINI-STROBE (packet size) £2.90
PEOPLE DETECTOR £3.20
Big-Ear SOUND-CATCHER £3.20
Mini DREAM LABORATORY £3.20
Don't take our word for it though! GET A COPY & SEE!
SEND ONLY 20p, and we'll RUSH YOU A COPY (YOU'LL GET THE GOODIES' JUST AS QUICKLY TOO!)

BOFFIN PROJECTS
4 Cunliffe Road, Stoneleigh,
Ewell, Surrey
(Mail Order U.K. Only)

TREASURE TRACER



- MK III Metal Locator**
- Varicap tuning
 - Britain's best selling metal locator kit
 - Weighs only 22oz. Fitted with Faraday shield.
 - Speaker and earphone operation
 - Knocks down to only 17in.
 - Prebuilt search coil assembly
 - Thoroughly professional finish
 - As seen on BBC1 and BBC2 TV
 - You only need soldering iron, screwdriver, pliers and snips
 - Five transistor circuit
 - Send stamped, addressed envelope for leaflet

Complete Kit £10.90 Built & tested £15.25
Post 60p : 82p VAT(8%) Post 60p : £1.27 VAT(8%)

MINIKITS ELECTRONICS
65 CLEVELAND ROAD,
LONDON, E18 2AN (Mail order only)

PLEASE MENTION

Everyday Electronics

WHEN REPLYING TO ADVERTISEMENTS

SPARKRITE MK2
CAPACITIVE DISCHARGE ELECTRONIC IGNITION KIT

Sparkrite Mk 2 is a high performance, high quality, capacitive discharge, electronic ignition system. Because of the superb design of the Sparkrite circuit it completely eliminates problems of the contact breaker. There is no misfire because contact bounce is eliminated electronically by a pulse suppression circuit which prevents the anti firing if the points bounce open at high R.P.M. Contact breaker burn is eliminated by reducing the current to about 1/50th of the norm. It will perform equally well with new, old, or even badly pitted points and is not dependent upon the dwell time of the contact breaker for recharging the system. Sparkrite incorporates a short circuit protected inverter which eliminates the problems of SCR lock on and therefore eliminates the possibility of blowing the transistors or the SCR. (Many capacitive discharge ignitions are not completely foolproof in this respect.)

Sparkrite can therefore give you: up to 20% better fuel consumption, instant all weather starting, cleaner plugs—they last up to 5 times longer without attention, faster acceleration, higher top speeds, longer coil and battery life, efficient fuel burning and less air pollution, smoother running, continual peak performance.

NOTE—FUEL CONSUMPTION:
The fitting of a Sparkrite Mk 2 should reduce fuel consumption although the amount of the reduction will vary. A fair estimate of the savings which could be expected, based on reports by our customers and upon our own experience, are as follows:
any 4-cylinder vehicle, 10% improvement
any 6-cylinder vehicle, 15% improvement
any 8-cylinder vehicle, 20% improvement
It is worth remembering that while fuel saving is important there are many other advantages to be gained from fitting a Sparkrite ignition system.

Voted best of 8 ignition systems tested by a leading Motoring Magazine

THE KIT COMPRISES EVERYTHING NEEDED: Ready drilled pressed steel case coated in matt black epoxy resin, ready drilled base and heatsink, top quality 5-year guaranteed transformer and components, cables, coil connectors, printed circuit board, nuts, bolts, silicon grease, full instructions to make the kit negative or positive earth, and 10 page installation instructions.

WE SAY IT IS THE BEST SYSTEM AT ANY PRICE.

OPTIONAL EXTRAS

Electronic R.P.M. limitation
This can be included in the unit to prevent over revving. An advantage to most companies, hire firms, high performance drivers, etc.

Electronic/conventional Ignition switch.
Gives instant changeover from "Sparkrite" ignition to conventional ignition for performance comparisons, static timing, etc., and will also switch the ignition off completely as a security device. Includes: switch, connectors, mounting bracket and instructions. Cables excluded.

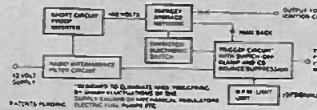

PRICES: D.I.Y. assembly kit £10.93. Ready built unit £13.86* (both to fit all vehicles with coil/distributor ignition up to 6-cylinders)
Switch for instant changeover from "Sparkrite" ignition to conventional ignition £2.79; R.P.M. limiting control £2.42* (fitted in case on ready built unit, dashboard mounting on kit)
* including VAT, post and packing.
We can supply units for any petrol-engined vehicle (boat, motorcycle, etc.) with coil/contact breaker ignition. Details on request.
CALL IN AND SEE US FOR A DEMONSTRATION.

ELECTRONICS DESIGN ASSOCIATES of WALSALL

ALUMINIUM BOXES **FLUORESCENT LIGHT KIT**

These project boxes are manufactured from 16-gauge aluminium and come complete with lids and screws. The prices shown include VAT (at 8%) but 18p should be added to the total order value for postage and packing.

Order No.	Length (in)	Width (in)	Height (in)	Price (inc. VAT)
7	5 1/2	4	1 1/2	47p
8	4	4	1 1/2	48p
9	4	2 1/2	1 1/2	46p
10	5 1/2	4	1 1/2	48p
11	4	2 1/2	2	46p
12	3	2	1	38p
13	6	5	2	58p
14	7	5	2 1/2	75p
15	8	6	3	83p
16	10	7	3	£1.14

Boxes can be made to any size but the minimum order for special sizes is 500. General trade enquiries welcome.

You can build this reverse polarity protected 12V, 8W, fluorescent light. You will receive all of the necessary parts: white enamelled ready drilled metalwork, ready drilled heatsink, printed circuit board, high quality components and transformer, end caps and cable, the fluorescent tube, nuts, bolts and washers, etc. and simple assembly instructions and operating instructions.

When complete the light has a wide variety of uses such as workshop and workbench illumination, garage lighting, emergency lighting, lighting for camping, caravanning or boating, as an inspection lamp and many more. If you can't spare the time to put the light together then we will supply it ready built (for a few extra pence).

PRICES
Assembly kit £3.19 (inc. VAT, post and packing).
Ready built £3.78 (inc. VAT, post and packing).
Diffuser 59p extra (inc. VAT, post and packing).

ORDER NOW

To: ELECTRONICS DESIGN ASSOCIATES DEPT. E.E. 6
82 Bath Street, Walsall WS1 2DE Phone 30552

From: Name _____
Address _____

Please Supply

Quantity	Description
	SPARKRITE MK2 D.I.Y. assembly kit at £10.93
	SPARKRITE MK2 ready built positive earth at £13.86
	SPARKRITE MK2 ready built negative earth at £13.86
	Ignition changeover switches at £2.79
	R.P.M. Limit systems in the above units at £2.42
	Fluorescent light assembly kits at £3.19
	Fluorescent light bulb units at £3.76
	Diffusers for the above at 59p
	of number alum. boxes at
	of number alum. boxes at
	of number alum. boxes at

I enclose cheque/P.O. for £ _____ Cheque top
(Send S.A.E. if brochure only required)

CRESCENT RADIO LTD.

11-15 & 17 MAYES ROAD, LONDON N22 6TL
(also) 13 SOUTH MALL, EDMONTON, N.9

MAIL ORDER DEPT.
11 MAYES ROAD, LONDON N22 6TL
Phone 888 3206 & (EDM). 803 1685

ABS PLASTIC BOXES

Handy boxes for construction projects. Moulded extrusion rails for P.C. or chassis panels. Fitted with 1mm front panels.
1005-106mm x 73mm x 45mm-51p.
2006-150mm x 74mm x 47mm-66p.
1007-185mm x 124mm x 60mm-96p.
1021-106mm x 74mm x 45mm-60p.
(slipping front) Plus 8% VAT

CLEAR PLASTIC PANEL METERS

Size 59mm x 46mm x 35mm these meters require a 38mm hole for mounting.
ME6 - 0 to 50 micro amp Full Scale
ME7 - 0 to 100 micro amp " " "
ME8 - 0 to 500 micro amp " " "
ME9 - 0 to 1mA " " "
ME10 - 0 to 5mA " " "
ME11 - 0 to 10mA " " "
ME12 - 0 to 50mA " " "
ME13 - 0 to 100mA " " "
ME14 - 0 to 500mA " " "
ME16 - 0 to 1 amp " " "
ME18 - 0 to 50 volts " " "
ME17 - 0 to 300 volts A.C. Full Scale
ME19 - "5" Meter



"VU" Meter
OUR PRICE
£3.00
Plus 8% VAT

LOW VOLTAGE AMPLIFIER

5 transistor amplifier complete with volume control. Is suitable for 9V d.c. and s.o. supplies. Will give about 1W at 8 ohm output. With high IMP input this amplifier will work as a record player, baby alarm, etc., amplifier. £2.00
Plus 25% VAT



LIGHT EMITTING DIODES

TL 209 (Red) with Clip 22p each
TL 209 (Green) with Clip 89p each
TL 209 (Yellow) with Clip 90p each
Mixed 500 T092 Type 16p each
Plus 8% VAT

CLOCK CHIP

CT7001 MOS/LSI Digital Clock/Calendar Chip plus full Circuits and Information Leaflet. £4.95
Circuits and Information Sheet 16p
Lit704 Led Display for above £1.90
Or 4 for £4.20
Plus 8% VAT

3 KILOWATTS PSYCHEDELIC LIGHT CONTROL UNIT

Three Channel: Bass—Middle—Treble. Each channel has its own sensitivity control. Just connect the input of this unit to the loudspeaker terminals of an amplifier, and connect three 250V up to 1000W lamps to the output terminals of the unit, and you produce a fascinating sound-light display. (All guaranteed.)
£18.50 plus 38p P. & P.
Plus 8% VAT

POWER PACKS

PP1 Switched 3, 4, 6, 7, 9 and 12 volt @ 500 mA, with on/off switch and pilot light.
Size=180mm x 55mm x 75mm
ONLY=£4.00
PP2 Switched 6-7-9 volt Battery Eliminator. Approx size 2 1/2" x 2 1/2" x 3 1/2". Ideal for cassette recorders. £3.25 each.
PP3 Car converter. From 12v Pos. or Neg to = 6-7-9 volt. Easy to fit and transistor regulated. £3.90 each.
Plus 8% VAT

U.K. CARR.
20p unless otherwise stated

Send 30p for a CRESCENT CATALOGUE

VEROBOARD

	-1	-15	Plain-15
2 1/2 x 3 1/2	33p	24p	15p
2 1/2 x 5	34p	24p	18p
3 1/2 x 3 1/2	34p	24p	...
3 1/2 x 5	39p	25p	...
17 x 2 1/2	1.06p	77p	60p
17 x 3 1/2	1.45p	1.18p	75p
17 x 5	1.85p	...	1.10p

Pin insertion tool 63p, Spot face Cutter 45p, Pkt. 36 pins (state 1 or 15) 25p
Plus 8% VAT

10 INCH DUAL CONE L/S

Manufactured by "ELAC" to a very high standard these loudspeakers are a real bargain.
Spec: Size—10" Dual Cone
Power—10" Watts
Frequency=40-12000Hz
Our Prices £2.75 Plus 25% VAT

WIRE WOUND VARIABLE CONTROL

2500hm approx diameter—1 inch long
Standard spindle only 25p each.
Plus 25% VAT

ALUMINIUM BOXES

Metal Project Boxes give your work a professional finish.

	L	W	H	Price
AB7	2 1/2	5 1/2	1 1/2	54p
AB8	4	4	1 1/2	63p
AB9	4	2 1/2	1 1/2	54p
AB10	4	5 1/2	1 1/2	63p
AB11	4	2 1/2	1	54p
AB12	3	2	1	45p
AB13	6	4	2	69p
AB14	7	5	2 1/2	84p
AB15	8	6	3	99p
AB16	10	7	3	£1.25
AB17	10	4 1/2	3	£1.02
AB18	12	8	3	£1.20
AB19	12	8	3	£1.50

All size are approx and in inches.
Plus 8% VAT

BARGAIN PROJECT BOX

A plastic box with moulded extrusion rails for PC or Chassis panels with metal front plate fitted with four screws (all supplied).

An ideal box to give a small project a professional finish.
SIZE (internal) 81mm x 51mm x 28mm.
OUR PRICE 40p Plus 8% VAT

BARGAIN TRANSFORMERS

18 volt 500mA
240 volt primary
approx size = 60mm x 40mm x 50mm
fixing centres = 75mm
Our Price £1.00 Plus 8% VAT

CABLELESS SOLDERING IRON WAHL "ISO-TIP"

★ Completely Portable
★ Solders up to 150 joints per charge
★ Re-charges in its own stand
★ Fine tip for all types of soldering
★ Only 8" long and weighs just 6 ozs.
Our Price £9.75. Plus 8% VAT
(Spare bits are available)

12-0-12 VOLT 500mA/240 VOLT PRIMARY TRANSFORMER

approx. size = 60mm x 40mm x 60mm. Fixing centres—75mm.
A REAL BARGAIN AT £1.20 each.
Plus 8% VAT

LOW NOISE LOW PRICE CASSETTES

Good quality tape in well made screw type cassettes.
Presented in single plastic cases.
C60 = 31p
C90 = 42p
C120 = 53p
10% discount on ten or more cassettes of one type Plus 8% VAT

All prices are excluding VAT. Please add to each item the VAT rate indicated to all orders

IMPROVE PETROL CONSUMPTION



Fit the brilliant New Scorpio Mk II "Dual Polarity" Capacitive Discharge Electronic Ignition System. Suitable for all cars with coil/distributor ignition up to eight cylinders.

- Genuine improvement in overall petrol consumption (Independent report claims at least 8 — 10%).
- Much easier cold weather starting, less strain on your battery.
- Less use of choke — increase engine life.
- Smoother running at lower revs. — makes your four cylinder car feel like a six cylinder.

TOGETHER WITH THE FOLLOWING "SCORPIO" MK II PLUS FEATURES NOT PREVIOUSLY AVAILABLE WITH OTHER MAKES:

- Only one model used for both positive (+) and negative (-) earth vehicles — if you change your car, you can certainly transfer your "Scorpio". No need to specify vehicle polarity when ordering.
- There is a 6 volt model available.
- Specially suppressed against radio interference (can be troublesome with electronic ignition systems).
- Retains your original contact-breaker points, which last their mechanical life — no points burn.
- Will drive electronic tachometers.

PRICE for complete "Scorpio" Mk II unit, fully tested and ready for immediate installation, with easy to follow instructions — £13.65 (includes V.A.T., post and packing free — UK only) PLEASE STATE WHETHER 12 VOLT OR 6 VOLT REQUIRED.

For the D.I.Y. Man, there is a complete kit of parts available with easy to follow, comprehensive instructions, PRICE only £10.85 (includes V.A.T., post and packing free — UK only). THOUSANDS ALREADY IN USE, FULLY GUARANTEED.

Please forward stamped addressed envelope for our FREE interesting brochure — "Electronic Ignition — How it Works," containing circuit and itemised price list.

ELECTRO SPARES, Dept. E.E., 228 Ecclesall Road, Sheffield S11 8PE.
Telephone:—Sheffield (0742) 683333.

BINDERS FOR E.E.

Why not keep your copies of Everyday Electronics neatly on the bookshelf?

You can with an E.E. Binder. Finished in orange with title and volume on the spine these hardback binders protect your issues and, with a yearly index, provide a means of quick easy reference.

BINDERS FOR VOLUMES 1 to 4
(state which), £1.85 each.
INDEXES FOR VOLUMES 1 and 2
(state which) 30p each.

Both prices include postage.

Send cheque or P.O. to Binding Department, Everyday Electronics, Carlton House, Great Queen Street, London, WC2E 9PR

everyday electronics

FREE!

Over 150 ways to engineer a better future

HIGHER PAY **A BETTER JOB**

SECURITY

find out how in just 2 minutes

That's how long it will take you to fill in the coupon. Mail it today and we'll send you full details and a free book. We have successfully trained thousands of men at home—equipped them for higher pay and better, more interesting jobs. We can do as much for YOU. A low-cost home study course gets results fast—makes learning easier and something to look forward to. There are no books to buy and you can pay-as-you-learn.

Why not do the thing that really interests you? Without losing a day's pay, you could quietly turn yourself into something of an expert. Complete the coupon (or write if you prefer not to cut the page). No obligation and nobody will call in on you . . . but it could be the best thing you ever did.

Others have done it, so can you

"Yesterday I received a letter from the Institution informing that my application for Associate Membership had been approved. I can honestly say that this has been the best value for money I have ever obtained, a view echoed by two colleagues who recently commenced the course".
Student D.I.B., Yorks.

"Completing your course, meant going from a job I detested to a job that I love, with unlimited prospects"—Student J.A.O. Dublin.
"My training quickly changed my earning capacity and, in the next few years, my earnings increased fourfold". Student C.C.P., Bucks.

FIND OUT FOR YOURSELF

These letters and there are many more on file at Aldermaston College, speak of the rewards that come to the man who has given himself the specialised know-how employers seek. There's no surer way of getting ahead or of opening up new opportunities for yourself. It will cost you a stamp to find out how we can help you. Write to

ALDERMASTON COLLEGE

Dept. TEE 06 Reading RG7 4PF.

HOME OF BRITISH INSTITUTE OF ENGINEERING TECHNOLOGY

Practical Radio & Electronics Certificate course includes a learn while you build **3 transistor radio kit.** Everything you need to know

about **Radio & Electronics** maintenance and repairs for a **spare time income** and a **career** for a better future.

This FREE 76 page book can put you on the road to success through a B.I.E.T Home Study Course. Choose your subject now!

CUT OUT THIS COUPON

Tick or state subject of interest. Post to address below.

<input type="checkbox"/> ELECTRICAL ENGINEERING City & Guilds Writing and Installations C. G. Electrical Tech-Primary Gen. Electrical Eng.	<input type="checkbox"/> Practical Radio & Electronics (with self-build kit) Radio Amateurs' Exam	<input type="checkbox"/> ELECTRONIC ENGINEERING Gen. Electronic Eng. Practical Electronics (with kit)	<input type="checkbox"/> Construction Surveyor's Inst. Clerk of Works Diploma C. & G. Building Quantities General Building General Civil Eng. Heating, Ventilating & Air Conditioning Carpentry & Joinery Painting & Decorating Plumbing
<input type="checkbox"/> AERONAUTICAL ENGINEERING Air Registration Board Certificates Gen. Aero Engineering	<input type="checkbox"/> AGRICULTURAL ENGINEERING	<input type="checkbox"/> REFRIGERATOR SERVICING	<input type="checkbox"/> C.E.I. (Part 1) Inst. Cost & Management Accountants Works Management etc. etc.
<input type="checkbox"/> AUTO ENGINEERING City & Guilds Auto Engineering Practice Inst. Motor Industry M.A.A./I.M.L. Management Diploma Gen. Auto Engineering Auto Diesel Maintenance Motor Mechanics Service Station and Garage Management	<input type="checkbox"/> MECHANICAL ENGINEERING Society of Engineers Inst. Engineers and Technicians General Mechanical Eng. Welding Maintenance Eng. General Diesel Eng.	<input type="checkbox"/> DRAUGHTSMAN-SHIP Institute of Engineering Draughtsmen & Designers General Draughtsmanship Architectural Draughtsmanship Technical Drawing	<input type="checkbox"/> CONSTRUCTION & BUILDING Institute of Building
<input type="checkbox"/> TELECOMMUNICATIONS City & Guilds Telecommunications	<input type="checkbox"/> RADIO & TV Gen. Radio and TV Eng. Radio Servicing, Maintenance and Repairs		

G.C.E.
—58 'O' & 'A'
Level Subjects
—over 10,000
Group Passes!

POST TODAY FOR A BETTER TOMORROW

To Aldermaston College,
Dept. TEE 06, Reading RG7 4PF.

NAME.....
Block capitals please
ADDRESS.....
POSTCODE.....
OTHER SUBJECTS.....
AGE.....

Accredited by C.A.C.C. Member of A.B.C.C.

Published approximately the third Friday of each month by IPC Magazines Ltd., Fleetway House, Farringdon Street, London E.C.4 3AD. Printed in England by Index Printers Ltd., Dunstable, Beds. Sole Agents for Australia and New Zealand—Gordon and Gotch (A/S) Ltd. South Africa—Central News Agency Ltd. Publisher's Subscription Rate including postage for one year, Inland £4.00. Overseas £3.90. USA/Canada \$11.00. International Giro facilities Account No. 6122007. Please state reason for payment, message to payee. Everyday Electronics is sold subject to the following conditions, namely that it shall not, without the written consent of the Publishers first given, be lent, resold, hired out or otherwise disposed of by way of Trade at more than the recommended selling price shown on cover, excluding Euro where the selling price is subject to V.A.T., and that it shall not be lent, resold, or hired out or otherwise disposed of in a mutilated condition or in any unauthorised cover by way of Trade, or affixed to or as part of any publication or advertising, literary or pictorial matter whatsoever.

Henry's Radio

LARGEST SELECTION OF ELECTRONIC COMPONENTS AND EQUIPMENT. LOW PRICES - MEAN LESS VAT.



You can build the Texan and Stereo FM Tuner

TEXAN 20 + 20 WATT IC STEREO AMPLIFIER

Features glass fibre PC board, Gardners low field transformer 6-IC's, 10-transistors plus diodes, etc. Designed by Texas Instruments engineers for Henry's and, P.W. 1972. Supplied with full chassis work, detailed construction handbook and all necessary parts. Full input and control facilities. Stabilised supply. Overall size 152" x 22" x 61" mains operated. Free teak sleeve with every kit. **£31.00 (Carriage 50p).** (also built and tested **£37.50**)

HENELEC STEREO FM TUNER

Features capacitor diode tuning, lead and tuning meter indicators, stabilised power supply—mains operated. High performance and sensitivity with unique station indication IC stereo decoder. Overall size in teak sleeve 8" x 21" x 61". Complete kit with teak sleeve **£21.00 (Carriage 50p).** (also built and tested **£24.95**)

JOIN THE LARGE BAND OF HAPPY CONSTRUCTORS!

NEW SPECIAL PURCHASE MULLARD TYPE LP1179 AND LP1171 AM/FM TUNER MODULES

These two modules covering the long a high quality AM/FM tuner together form a high medium and VHF broadcast bands. Requires only 16 resistors and capacitors and a switch to complete. Supplied with circuits and spec. data

LP1179 FM Coverage 87-108 MHz Bandwidth 300 KHz Selectivity 36 dB Signal to noise at limiting threshold 40 dB Audio output 75 mV with built in tuning gang



LP1171 AM Bandwidth 6-5 KHz Sensitivity 1 DV Built-in AGC LP1171 Supply 6V negative earth LP1179 and LP1171 £4 each or £7.50 pr. Suitable Ferrite aerial £0.75 £4.00 each or £7.50 pair



Mullard Modules
LP1157 AM Type 2-50
LP1185 10-7 I.F. Unit 5-50
LP1186 10-7 F/M Tuner 5-85
Goiler Perm. F/M Tuner 4-20

Amplifiers with controls
E1210 12 volt 24 + 24 watts 8 ohms 8-25
SAC14 Mains 7 + 7 watts 8 ohms 11-75
SAC30 Mains 15 + 15 watts 8 ohms 14-85
CAO38 9 volt 14 + 14 watts 8 ohms 8-95
CAO68 12 volt 8 + 3 watts 8 ohms 10-50

FM and AM Tuners and Decoders
FM5231 (2) 6 volt fm tuner 7-95
TU13 12 volt version (FM use with Decoder) 7-95
SD4912 Stereo Decoder for Tu 3-12 volt SPB2H 6 volt stereo FM tuner 14-80
A1007 9 volt MW-AM 4-95
A1018 9 volt FM tuner in cabinet 13-95
A1005M (S) 9-12 volt Stereo decoder FM for above 7-50
S475 12 volt Stereo decoder general purpose kit 6-99

Power Supplies Mains Input (*chassis-rest cased)
470C 6.75/9V 300 MA with adaptors 2-25
P500 9 volt 500 MA 3-20
HC244R 3.6/7.5/9/400 MA stabilised 5-50
*P11 2v, 3 amp 3-30
*P15 28V, 1 amp 3-30
*P1080 12V 1A 4-70
*P1081 45V 0-9A 7-80
P12 4-12V, 0-4-1 amp 7-45
SE105 3.6/9/12V, 1 amp stabilised 12-75
P1076 3.6/6/7.5/9/12V, 1 amp 12-75
SE800A 1-15 VOLT 0-1A stabilised 17-50

SINCLAIR MODULES & KITS

SINCLAIR PROJECT 80
ST80 Stereo preamplifier 11-95
Audio Filter Unit 8-95
Z40 15 Watt Amplifier 5-45
Z60 25 Watt Amplifier 6-95
PZ3 Power Supplies for 1 or 2 Z40 4-98
PZ6 Power Supplies (S Tab) for 1 or 2 Z40 7-98
TRANSFORMER FOR PZ3 4-00
FM TUNER 11-95
STEREO DECODER 7-95
IC20 power amp kit 7-95
PZ20 power supply for 1 or 2 IC20 5-45

EMI SPEAKERS SPECIAL PURCHASE

13 in. x 8 in. chassisspeakers (Carr./packing 30p ea. or 50p pr.) *150 TC 10 watts 8 ohms twin cone **£2-20**
450A Built in tweeter 8 ohms **£3-85**
EW 15 watt 8 ohms with tweeter **£6-25**
350 20 watt 8, 15 ohm with tweeter **£8-95** each
*Polished wood cabinet £4-80 carr. etc. 35p each or 50p pair.



UHF TV TUNERS

625 line receiver UHF transistorised tuners UK operation. Brand new. (Post packing 25p. each).
TYPE A variable tuning slow motion drive **£3-00**
TYPE B 4-button push-button (adjustable) **£3-50**
TYPE C variable tuning **£2-50**
TYPE D 6 Button UHF/VHF **£4-50**

PA-DISCOTHEQUE LIGHTING EQUIPMENT



Without doubt U.K.'s best range of modular and complete equipment. Lighting, mixing, microphones, accessories, speakers, amplifiers, lenses, etc., etc.
FREE stock lists (Ref. No. 18) on request CALL IN AND SEE FOR YOURSELF at **HENRY'S DISCO CENTRE, 309 EDGWARE ROAD, TEL. 01-723 6963**

PACKAGE DEALS (carr./packg 35p)

2 x Z40 ST80 PZ5 25-00
2 x Z60 ST80 PZ6 27-75
2 x Z60 ST80 PZ8-trans 34-40
805 Kit 35-95

Sinclair Special Purchases

*Project 80 stereo preamp **£6-75** (post 20p)
*Project 605 Kit **£19-95** (post 25p)

TEST EQUIPMENT MULTIMETERS

Carr./packing 35p) £ p
U4324 20kΩ/V with case **9-85**
U4313 20kΩ/V with steel case **13-80**
U4317 20kΩ/V with case **17-00**
U4341 33kΩ/V plus transistor steel case **11-00**
U4323 20kΩ/V plus 1kHz OSC with case **8-00**
U4311 Laboratory meter **£52-00**
U4312 20KΩ/V with case **£10-75**
U4315 20KΩ/V with case **£10-00**
U4317 20KΩ/V with case **£17-00**
IT1-2 20kΩ/V slim type **5-95**
THL33D (L33D/X) 2kΩ/V Robust **7-50**
TP5SN 20kΩ/V (Case £2) **10-75**
TP10S 20kΩ/V **8-50**
TW20S 20kΩ/V **13-00**
TW50K 50kΩ/V **14-50**
S100TR 100kΩ/V plus transistor tester **22-50**



NEW REVOLUTIONARY SUPERTESTER 680R

£ p
880R Multi-tester **18-50**
†TE40 AC Multivoltmeter **19-75**
†TE15 Grid dip meter 400KHz-28MHz **19-50**
†TE65 28 Range valve voltmeter **22-50**
†TE20D RF Generator 120KHz-500MHz **18-95**
†TE22D AF Generator 20Hz-200KHz **19-95**
*HM350 In circuit transistor tester **19-50**
*C3025 Deluxe meter 1-300MHz **6-95**
*T1145 Compact transistor tester **14-75**
†G3-36 R/C osc. 20Hz-200KHz **19-75**
*SE350A De-luxe signal tracer **12-95**
*SE400 Mini-lab all in one tester **15-50**
CI-5 Scope 500,000KHz (carr. £1-00) **43-00**
Radio activity counter 0-10r (carr. £1) **9-75**
Mains unit for above (carr. 50p) **3-75**

TAPE HEADS

Marrlot XRPS1/17 Track High **2-50**
Marrlot XRPS1/18 1/2 Track Med. **3-50**
Marrlot XRPS3/8 1/2 Track Med. **5-00**
Marrlot XRPS/63 1/2 Track High **1-75**
Marrlot Erase Heads for XRSP 17/18/36 (XES11) Marrlot BX1ZE343 1/2 Track **75p**
R/RP1 Rec'd/Play 1/2 Track HRP S'igle Trk Rec/Play 35p
Bogen Type UL290 Erase Miniature Stereo Cassette Rec/Play **2-25**

EXCLUSIVE 5 WATT IC AMPLIFIERS

Special purchase 5 watt output 8-15 ohm load. 30 volt max. DC operation. complete with drive. Price **£1-50** each or 2 for **£2-85**.

Printed Circuit Panels **50p.**

8 DIGIT POCKET ELECTRONIC CALCULATORS

Sinclair Cambridge Built £11-00
Cambridge Kit £9-00
Cambridge Memory Built £17-50
Scientific Built £16-00
Scientific Kit £13-50

ALL PRICES SUBJECT TO VAT

FREE:— SEND NOW FOR OUR FREE LIST NO. 36 FOR OUR COMPLETE RANGE OF OVER 10,000 SEMICONDUCTOR DEVICES AT NEW LOW PRICES.

EXTRA DISCOUNTS

Semiconductors—Any one type or mixed SN74 Series 'IC' 12—extra 10%; 25—extra 15%; 100—extra 20%.

TRANSISTORS & INTEGRATED IC's

TTL "7400 series" IC's from **16p** each
Cosmos "4000 series" IC's from **25p** each
Linear Op-Amps from **40p** each
Signetics Phase Lock IC's; RCA Linear IC's; TO3 Power Devices in PNP and NPN;
BC107 and "BC range" from **12p**
Range of OC Types **18p**
Plastic Power Devices, Rectifiers, Zener, Power Regulator IC's and many others.
Diodes up to 10 watts

DIL SOCKETS

8 PIN **14p**
14 PIN **15p**
16 PIN **19p**
24 PIN **£1-15**
28 PIN **£1-25**



NOMBREX TEST EQUIPMENT

Model 35 Stabilised Power Supply
A short circuit proof power supply delivery up to 30 volts at 1 Amp. Built-in Volts and ammeters **£34-00**

Model 40 Wide Range Audio Signal Generator
A high stability signal generator using the low distortion Wien bridge principle. **£34-00**

Model 41 RF Signal Generator
Covering 150 KHz to 220 MHz in 8 ranges. Built in AF mod. Output up to 50mV. **£38-00**

Model 42 Wide Range RF Signal Generator
Covering 150 KHz to 300 MHz in 8 ranges. Highest range on harmonic. **£24-50**

Model 43 RC Bridge
Null indicating bridge for resistors and capacitors. Resistance range 10R to 10M ±2% at Centre Scale. **£23-50**

Model 44 Inductance Bridge
Measures 1μH to 100H in 4 ranges ±5% accuracy. Q measurement from 0-1-1,000 ±10%. **£34-00**

Model 45 Direct Reading Frequency Meter
40Hz to 100 KHz in 4 ranges. Input from 10MV to 5V **£36-00**

All models except Model 35 are internally powered from 9V battery (extra). Carriage and packing all models 37p.

ELECTRONIC FOOTBALL & TENNIS WITH THE VIDEO SPORT ON YOUR OWN TV

Play three exciting electronic ball games ● FOOTBALL ● TENNIS ● HOLE IN THE WALL on your own TV! Just plug Video Sport into the aerial socket of your TV and away you go. Completely safe for you, your children and your TV. Mains operated.

OUR INCREDIBLE PRICE £34-72 + VAT
DEMONSTRATIONS NOW IN ALL HI-FI CENTRES

NOW OPEN—SUPERMARKET
Come and browse round the new components supermarket at 404 Edgware Road. Bargains galore. Goodie Bags. Components, etc. **WATCH FOR FURTHER DEVELOPMENTS!**

Henry's Radio

Electronic Centres
404-406 Electronic Components & Equipment 01 402 8381
309 PA-Disco-Lighting High Power Sound 01-723 6963
303 Special offers and bargains store
All mail to 303 Edgware Road London W2 1BW
Prices correct at time of preparation Subject to change without notice. £ 60 P

Hi-Fi and Electronics Centres Open 9 am - 6 pm